



საქართველოს ინტელექტუალური საკუთრების ეროვნული ცენტრი  
NATIONAL INTELLECTUAL PROPERTY CENTER OF GEORGIA

საქპატენტი  
SAKPATENTI

**OFFICIAL BULLETIN  
OF THE INDUSTRIAL PROPERTY**

**22(530)**

2019  
TBILISI

# INID CODES FOR IDENTIFICATION OF BIBLIOGRAPHIC DATA

## INVENTIONS, UTILITY MODELS

- (10) Number of publication for application, which has been examined
- (11) Number of patent and kind of document
- (21) Serial number of application
- (22) Date of filing of the application
- (23) Date of exhibition or the date of the earlier filing and the number of application, if any
- (24) Date from which patent may have effect
- (31) Number of priority application
- (32) Date of filing of priority application
- (33) Code of the country or regional organization allotting priority application number
- (44) Date of publication of application not granted, but examined and number of bulletin
- (45) Date of publication of registered document
- (51) International Patent Classification Index

- (54) Title of the invention
- (57) Abstract
- (60) Number of examined patent document granted by foreign patent office, date from which patent has effect and country code
- (62) Number of the earlier application and in case of divided application, date of filing an application
- (71) Name, surname and address of applicant (country code)
- (72) Name, surname of inventor (country code)
- (73) Name, surname and address of patent owner (country code)
- (74) Name, surname of representative or patent attorney
- (85) Date of commencement of the national phase of International Application
- (86) Number and date of filing of international application
- (87) Number and date of publication of international application
- (94) Calculated date of expiry of the SPC or the duration of the SPC

## DESIGNS

- (10) Number of publication for application
- (11) Number of patent and kind of document or number of registration
- (15) Date of registration/Date of patent renewal
- (18) Expected expiration date of patent or registration
- (21) Serial number of application
- (22) Date of filing of the application
- (23) Date of exhibition or the date of the earlier filing and the number of application, if any
- (24) Date from which patent may have effect
- (28) Number of designs included in the application
- (30) Data relating to priority (number of application, date of filing of application, two-letter code identifying the authority with whom the priority application was made)
- (31) Number of priority application
- (32) Date of filing of priority application
- (33) Code of the country or regional organization allotting priority application number
- (34) Two-letter code according to WIPO St.3 identifying the authority with which the priority application was made
- (44) Date of publication of design and number of bulletin (the first publication)
- (45) Date of publication of design registered by WIPO and number of bulletin

- (51) International Classification for designs (class and subclass of the Locarno Classification)
- (54) Title of the invention
- (55) Reproduction of the design
- (57) Description of characteristic features of the design including indication of colors
- (58) Date of recording of any kind of amendment in the Register
- (62) Number of the earlier application, registration and document number and if available the date of filing an application in case of divided application
- (71) Name, surname and address of applicant (country code)
- (72) Name, surname of creator (country code)
- (73) Name, surname and address of patent owner (country code)
- (74) Name, surname of representative or patent attorney
- (81) Contracting states concerned
  - II designated contracting states according to the 1960 Act
  - III designated contracting states according to the 1999 Act
- (85) Owner's permanent address
- (86) Owner's nationality
- (87) Owner's residence
- (88) State in which the owner has a real and effective industrial or commercial establishment

## TRADEMARKS

- (111) - Number of registration
- (151) - Date of registration
- (156) - Date of the renewal
- (181) - Expected expiration date of registration
- (186) - Renewal expiration date of registration
- (141) - Date of cancel of duration of the mark
- (210) - Serial number of application
- (220) - Date of filing of the application
- (230) - Data concerning exhibition
- (260) - Number of application, for which favorable decision of examination about registration has been taken (publication number)
- (310) - Number of the first application
- (320) - Date of filing of the first application
- (330) - Code, identifying national or regional Office where the first application was made
- (511) - International Classification of Goods and Services for the purposes of registration of trade marks and/or list of goods and/or services classified according thereto
- (526) - Disclaimer
- (531) - Description of figurative elements of Trade Marks according to the International Classification of the Figurative Elements of Marks

- (540) - Reproduction of Trade Mark
- (550) - Nature and kind of Trade Mark
- (551) - Indication to the effect that the mark is a collective mark, a certification mark or a guarantee mark
- (554) - Three-dimensional mark
- (580) - Date of recording of any kind changes in respect of applications or registrations
- (591) - Information concerning colors claimed
- (731) - Name and address of the applicant
- (732) - Name and address of the holder of the registration
- (740) - Name and address of the representative
- (750) - Addreses for correspondence
- (770) - Name and address of the previous applicant or holder in case of change in ownership
- (771) - Previous name and address of the applicant or holder in case of change in ownership
- (791) - Name and address of the licensee
- (793) - Indication of conditions and/or restrictions under the license (Type of license, number of license agreement, data of license, data of validity of license)
- (800) - Certain data relating to the international registration of Trade Marks under the Protocol Relating to Madrid Agreement (International registration number
- (852) - Partial cancellation of the list of goods and services
- (891) - Date of subsequent designation

## CODES FOR PUBLICATION IN BULLETIN

- (21) AP 0000 000000 - serial number of application for invention
- (10) AP 0000 0000 A - number of published application for invention (first publication)
- (11) P 0000 0000 B - number of patent for invention (second publication)
- (21) API 0000 000000 - number of application for imported patent
- (11) PI 0000 0000 A - number of imported patent (first publication)
- (21) AU 0000 000000 - serial number of application for utility model
- (10) AU 0000 000 U - number of published application for utility model (first publication)
- (11) U 0000 000 Y - number of patent for utility model (second publication)
- (21) AD 0000 000000 - serial number of application for design
- (10) AD 0000 000 S - number of published application for design (first publication)
- (11) D 0000 000 S - registered design

## INTERNATIONAL PATENT CLASSIFICATION FOR INVENTIONS AND UTILITY MODELS

- SECTION A - HUMAN NECESSITIES
- SECTION B - PERFORMING OPERATIONS; TRANSPORTING
- SECTION C - CHEMISTRY; METALLURGY
- SECTION D - TEXTILES; PAPER
- SECTION E - FIXED CONSTRUCTIONS
- SECTION F - MECHANICAL ENGINEERING; LIGHTING; HEATING; WEAPONS; BLASTING
- SECTION G - PHYSICS
- SECTION H - ELECTRICITY

- 
- M - Trade Mark
  - (210) AM 0000 000000 - Serial number of application;
  - (260) AAM 0000 00000 A - Publication number of application;
  - (111) M 0000 00000 R - Number of registration;
  - (111) MMM0000 00000 Rn - Number of renewals, in which n=1,2,3;
  - (111) M 0000 00000 R(P) - Number of registration under partial assignment of rights
-

**LIST OF CODES, IN ALPHABETIC SEQUENCE, AND THE CORRESPONDING (SHORT) NAMES OF STATES, OTHER ENTITIES AND INTERGOVERNMENTAL ORGANIZATIONS  
(WIPO STANDARD ST.3)**

|    |  |    |   |    |  |
|----|--|----|---|----|--|
| AD | Andorra  |    |   |    |  |
| AE | United Arab Emirates   | GD | Grenada   | NE | Niger  |
| AF | Afghanistan  | GG | Guernsey  | NG | Nigeria  |
| AG | Antigua and Barbuda  | GH | Ghana   | NI | Nicaragua  |
| AI | Anguilla   | GI | Gibraltar   | NL | Netherlands  |
| AL | Albania  | GT | Guatemala   | NO | Norway   |
| AM | Armenia  | GW | Guinea- Bissau  | NP | Nepal  |
| AN | Netherlands Antilles   | GY | Guyana  | NR | Nauru  |
| AO | Angola   | HK | The Hong Kong Special Administrative Region of the People's Republic of China | NZ | New Zealand  |
| AP | African Regional Intellectual Property Organization (ARIPO)                    | HN | Honduras  | OA | African Intellectual Property Organization (OAPI)          |
| AR | Argentina  | HR | Croatia   | OM | Oman   |
| AT | Austria  | HT | Haiti   | PA | Panama   |
| AU | Australia  | HU | Hungary   | PE | Peru   |
| AW | Aruba  | IB | International Bureau of the World Intellectual Property Organization (WIPO)   | PG | Papua New Guinea   |
| AZ | Azerbaijan   | ID | Indonesia   | PH | Philippines  |
| BA | Bosnia and Herzegovina   | IE | Ireland   | PK | Pakistan   |
| BB | Barbados   | IL | Israel  | PL | Poland   |
| BD | Bangladesh   | IM | Isle of Man   | PT | Portugal   |
| BE | Belgium  | IN | India   | PW | Palau  |
| BF | Burkina Faso   | IQ | Iraq  | PY | Paraguay   |
| BG | Bulgaria   | ID | Indonesia   | QA | Qatar  |
| BH | Bahrain  | IE | Ireland   | QZ | Community Plant Variety Office (European Community) (CPVO) |
| BI | Burundi  | IL | Israel  | RO | Romania  |
| BJ | Benin  | IM | Isle of Man   | RS | Serbia   |
| BM | Bermuda  | IN | India   | RU | Russian Federation   |
| BN | Brunei Darussalam  | IQ | Iraq  | RW | Rwanda   |
| BO | Bolivia  | IR | Iran (Islamic Republic of)  | SA | Saudi Arabia   |
| BR | Brazil   | IS | Iceland   | SB | Solomon Islands  |
| BS | Bahamas  | IT | Italy   | SC | Seychelles   |
| BT | Bhutan   | JE | Jersey  | SD | Sudan  |
| BV | Bouvet Island  | JM | Jamaica   | SG | Singapore  |
| BW | Botswana   | JO | Jordan  | SH | Saint Helena   |
| BX | Benelux Office for Intellectual Property (BOIP)                                | JP | Japan   | SI | Slovenia   |
| BY | Belarus  | KE | Kenya   | SK | Slovakia   |
| BZ | Belize   | KG | Kyrgyzstan  | SL | Sierra Leone   |
| CA | Canada   | KH | Cambodia  | SM | San Marino   |
| CD | Democratic Republic of the Congo   | KI | Kiribati  | SN | Senegal  |
| CF | Central African Republic   | KM | Saint Kitts and Nevis   | SO | Somalia  |
| CG | Congo  | KP | Democratic People's Republic of Korea   | SR | Suriname   |
| CH | Switzerland  | KR | Republic of Korea   | ST | Sao Tome and Principe                                      |
| CI | Cote d'Ivoire  | KW | Kuwait  | SV | El Salvador  |
| CK | Cook Islands   | KY | Cayman Islands  | SY | Syrian Arab Republic                                       |
| CL | Chile  | KZ | Kazakhstan  | SZ | Swaziland  |
| CM | Cameroon   | LA | Lao People's Democratic Republic  | TC | Turks and Caicos Islands                                   |
| CN | China  | LB | Lebanon   | TD | Chad   |
| CO | Colombia   | LC | Saint Lucia   | TG | Togo   |
| CR | Costa Rica   | LI | Liechtenstein   | TH | Thailand   |
| CU | Cuba   | LK | Sri Lanka   | TJ | Tajikistan   |
| CV | Cape Verde   | LR | Liberia   | TL | Timor-Leste  |
| CY | Cyprus   | LS | Lesotho   | TM | Turkmenistan   |
| CZ | Czech Republic   | LT | Lithuania   | TN | Tunisia  |
| DE | Germany  | LU | Luxembourg  | TO | Tonga  |
| DJ | Djibouti   | LV | Latvia  | TR | Turkey   |
| DM | Dominica   | LY | Libyan Arab Jamahiriya  | SE | Sweden   |
| DO | Dominican Republic   | MA | Morocco   | TT | Trinidad and Tobago  |
| DZ | Algeria  | MC | Monaco  | TV | Tuvalu   |
| EA | Eurasian Patent Organization (EAPO)  | MD | Republic of Moldova   | TW | Taiwan, Province of China                                  |
| EC | Ecuador  | ME | Montenegro  | TZ | United Republic of Tanzania                                |
| EE | Estonia  | MG | Madagascar  | UA | Ukraine  |
| EG | Egypt  | MK | The former Yugoslav Republic of Macedonia                                     | UG | Uganda   |
| EH | Western Sahara   | ML | Mali  | US | United States of America                                   |
| EM | Office for Harmonization in the Internal Market (Trademarks and Designs)(OHIM) | MM | Myanmar   | UY | Uruguay  |
| EP | European Patent Office (EPO)   | MN | Mongolia  | UZ | Uzbekistan   |
| ER | Eritrea  | MO | Macao   | VA | Holy See   |
| ES | Spain  | MP | Northern Mariana Islands  | VC | Saint Vincent and the Grenadines                           |
| ET | Ethiopia   | MR | Mauritania  | VE | Venezuela  |
| FI | Finland  | MS | Montserrat  | VG | Virgin Islands (British)                                   |
| FJ | Fiji   | MT | Malta   | VN | Viet Nam   |
| FK | Falkland Islands (Malvinas)  | MU | Mauritius   | VU | Vanuatu  |
| FO | Faroe Islands  | MV | Maldives  | WO | World Intellectual Property Organization (WIPO)            |
| FR | France   | MW | Malawi  | WS | Samoa  |
| GA | Gabon  | MX | Mexico  | XN | Nordic Patent Institute (NPI)                              |
| GB | United Kingdom   | MY | Malaysia  | YE | Yemen  |
| GC | Patent Office of the Cooperation Council for the Arab States of the Gulf (GCC) | MZ | Mozambique  | ZA | South Africa   |
|    |  | NA | Namibia   | ZM | Zambia   |
|    |  |    |   | ZW | Zimbabwe   |

**OFFICIAL BULLETIN  
OF THE INDUSTRIAL PROPERTY**

**22(530)**

**INVENTIONS  
UTILITY MODELS  
DESIGNS  
TRADEMARKS**

DATE OF PUBLICATION  
2019 11 25

# CONTENTS

|   |     |
|---|-----|
| <b>PUBLISHED TITLES OF PROTECTION</b> .....   | 3   |
| <b>INVENTIONS</b>   |     |
| ▪ APPLICATIONS APPROVED FOR GRANTING PATENTS .....                                      | 4   |
| ▪ PATENTED INVENTIONS .....   | 7   |
| <b>UTILITY MODELS</b>   |     |
| ▪ APPLICATION APPROVED FOR GRANTING PATENT .....  | 9   |
| ▪ PATENTED UTILITY MODEL .....  | 10  |
| <b>DESIGNS</b>  |     |
| ▪ REGISTERED DESIGNS .....  | 11  |
| <b>TRADEMARKS</b>   |     |
| ▪ APPLICATIONS FILED UNDER THE NATIONAL PROCEDURE APPROVED FOR<br>REGISTRATION .....    | 12  |
| ▪ REGISTERED TRADEMARKS .....   | 20  |
| ▪ TRADEMARKS REGISTERED ACCORDING TO THE ACCELERATED PROCEDURE .....                    | 23  |
| ▪ INTERNATIONAL TRADEMARKS FOR WHICH A DECISION ON GANTING PROTECTION IS<br>TAKEN ..... | 25  |
| ▪ INTERNATIONAL TRADEMARKS PROTECTED IN GEORGIA .....                                   | 174 |
| <b>OFFICIAL NOTIFICATIONS</b>   |     |
| <b>INVENTIONS</b>   |     |
| ▪ EXPIRATION OF PATENTS RESTORATION .....   | 183 |
| ▪ ABOLITION OF PATENTS WITH THE RIGHT TO RESTORE .....                                  | 183 |
| ▪ EXPIRATION OF TERM OF RESTORATION OF PATENTS .....                                    | 185 |
| <b>UTILITY MODELS</b>   |     |
| ▪ ABOLITION OF PATENTS WITH THE RIGHT TO RESTORE .....                                  | 186 |
| <b>DESIGNS</b>  |     |
| ▪ TRANSFER OF RIGHT .....   | 187 |
| ▪ EXTENSION OF REGISTRATION OF INTERNATIONAL DESIGNS .....                              | 187 |
| <b>TRADEMARKS</b>   |     |
| ▪ RENEWAL OF REGISTRATIONS .....  | 199 |
| ▪ COMPLET TRANSFER OF RIGHTS .....  | 202 |
| ▪ CHANGES OF NAMES AND/OR ADDRESSES OF OWNERS .....                                     | 203 |
| ▪ TERMINATION OF TRADEMARKS REGISTRATIONS .....   | 204 |
| ▪ LICENSE AGREEMENTS .....  | 208 |
| <b>CLASSIFICATION INDEXES</b>   |     |
| INVENTIONS .....  | 209 |
| UTILITY MODELS .....  | 210 |
| DESIGNS .....   | 211 |
| TRADEMARKS .....  | 213 |

# PUBLISHED TITLES OF PROTECTION

## INVENTIONS

- **APPLICATIONS APPROVED FOR GRANTING PATENT:**  
14878; 14732; 14688; 14320; 14203; 14636
- **PATENTED INVENTIONS:**  
7042-7045

## UTILITY MODELS

- **APPLICATION APPROVED FOR GRANTING PATENT:**  
14993
- **PATENTED UTILITY MODEL:**  
2023

## DESIGNS

- **REGISTERED DESIGNS:**  
826-828

## TRADEMARKS

- **APPLICATIONS FILED UNDER THE NATIONAL PROCEDURE APPROVED FOR REGISTRATION:**  
99069; 99884-99886; 99959; 100065; 102360, 102361; 102371; 102383; 102403; 102516; 102523, 102524; 102535; 102545; 102547; 102561; 102697; 102701; 102706; 102710; 102712; 102716, 102717; 102723; 102729; 102731; 102735, 102736; 102812; 102815; 102826; 102833; 102835-102841; 102916, 102917; 102920; 103093
- **REGISTERED TRADEMARKS:**  
31971-32005
- **TRADEMARKS REGISTERED ACCORDING TO THE ACCELERATED PROCEDURE:**  
31970; 32006-32012
- **INTERNATIONAL TRADEMARKS FOR WHICH A DECISION ON GRANTING PROTECTIONS IS TAKEN:**  
99117; 99606; 101071; 101121; 101147; 101166; 101173, 101174; 101362-101368; 101429; 101431; 101440; 101446; 101448; 101472; 101482; 101530-101532; 101534; 101536; 101539-101556; 101563, 101564; 101566-101571; 101573; 101577-101579; 101581-101585; 101596; 101696-101703; 101705-101707; 101709; 101711-101714; 101717-101724; 101726-101728; 101737-101739; 101741-101745; 101750, 101751; 101753; 101755, 101756; 101759-101761; 101764-101772; 101798; 101800, 101801; 101803; 101830; 101832; 101836-101845; 101847-101859; 101868-101871; 101875-101879; 101892; 101944; 101947; 101949; 101965-101977; 101979; 101981-101985; 101997, 101998; 102016-102020; 102084-102088; 102099-102107; 102120; 102123; 102186; 102196; 102206; 102208; 102210; 102219; 102275-102280; 102293; 102302, 102303; 102305; 102307-102310; 102337; 102339, 102340; 102414- 102420; 102441; 102445; 102467; 102480, 102481; 102483; 102582; 102584-102592; 102671-102675; 102679-102681; 102773-102779; 102794; 102797; 102800; 102885, 102886; 102888-102892; 102947-102951; 103054; 103631
- **INTERNATIONAL TRADEMARKS PROTECTED IN GEORGIA:**  
97055; 98087; 99208; 99721; 99728; 99742; 99809-99811, 99814; 99816-99819; 99825; 99833, 99834; 99840, 99841; 100104-100106; 100108, 100109; 100111; 100130; 100135-100137; 100139, 100140; 100142; 100144, 100145; 100147-100151; 100175-100177; 100182; 100185, 100186; 100190; 100192-100201; 100218-100220; 100223, 100224; 100227; 100231; 100254-100256; 100273-100276; 100278-100280; 100332, 100333; 100335-100337; 100339, 100340; 100469; 100478, 100479; 100494-100503; 100555-100559; 100565-100568; 100619, 100620; 100626-100630; 100749; 100857; 100940-100944; 100952-100955; 101030; 101032, 101033; 101044; 101047; 101051; 101054-101057; 101059; 101061-101063

# INVENTIONS

## APPLICATIONS APPROVED FOR GRANTING PATENTS

The decision can be appealed at the Chamber of Appeal of Sakpatenti within 3 months from the publication or at the Mtskheta District Court Administrative Cases Board (Address: №17, Samkhedro str., Mtskheta), within 1 month following the publication.

### PART A

#### A 47

(10) AP 2019 14878 A (51) Int. Cl. (2006)

A 47 L 1/00

(21) AP 2018 14878 (22) 2018 09 18

(71) LTD "IRNERO" (GE)

Sanapiro St. 2a, 0105, Tbilisi (GE)

(72) Luka Patchkoria (GE)

(74) Shalva Gvaramadze

(54) **EQUIPMENT FOR WINDOW**

**AUTOMATIC CLEANING**

(57) An equipment includes a case for fastening onto window frame as a frame, executed so that frame upper part consists of two sections 23, 24 separated with partition and disposed above window surface, horizontally, wherein washing solution tank 1 is placed in first section and a pump 2 is connected thereto with a hose 3, a hose 5 for solution inlet into the tank and electronic control unit 6; perforated alumenic pipe 7 is disposed in another section on whole length thereof, and connected to a hose 4 for liquid outlet from the pump, reverse motor 9 fastened onto a fastener 10 is placed on section one side; furthermore, the equipment includes cleaning component 18 with connecting componentry 17a and 17b engaged with ends thereof, disposed horizontally relative to the window, and fastened onto moving means thereof executed as toothed belts 16a and 16b engaged with the pulleys 15 fastened onto the axes 11 rotating in the bearings 13; at that, first and second changeover mechanisms 8a and 8b moving cleaning component up-down are fastened onto the belts. Furthermore, ventilation propeller 20 is placed in first section, and air inlet component – in another, a component for air passing from second section to first is formed in the partition 25 and executed as perforation; ventilation propeller, in its turn, is connected to ventilation cut 22 equipped with a lid 21 and executed on first section outer faset.

Claims: 1 independent

5 dependent

Fig.: 3

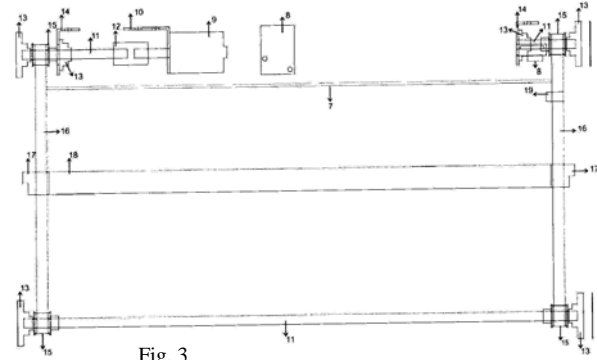

Fig. 3

### PART B

#### B 22

(10) AP 2019 14732 A (51) Int. Cl. (2006)

B 22 F 3/11

B 22 F 3/23

C 22 C 1/08

(21) AP 2018 14732 (22) 2018 03 20

(71) Nona Tevdoradze (GE)

Melikishvili St. 11/12, 4600, Kutaisi (GE);

Mirian Bezhitadze (GE)

Tarkhnishvili St. 26, 0179, Tbilisi (GE);

Amiran Khvadagiani (GE)

Khakhanashvili St. 4, 4600, Kutaisi (GE);

Badri Zivzivadze (GE)

Tabukashvili St. 92/39, 4600, Kutaisi (GE);

Merab Iremadze (GE)

Otskheli St. 4/23, 4600, Kutaisi (GE)

(72) Nona Tevdoradze (GE);

Mirian Bezhitadze (GE);

Amiran Khvadagiani (GE);

Badri Zivzivadze (GE);

Merab Iremadze (GE)

(74) Archil Geguchadze

(54) **METHOD FOR RECEIVING WASTE AIR CATALYZE NEUTRALIZER WITH SELF-PROPAGATED HIGH TEMPERATURE SYNTHESYS**

(57) Method for receiving waste air catalyze neutralizer with self-propagated high temperature synthesys provides powder mixture preparation

with mixing of following componentry: titanium, copper, chrome, nickel, cobalt, and boron and/or gold and/or platinum and/or palladium and/or radium, in the certain ratio, compaction thereof and initiation of syntheses.

Claims: 1 independent

## PART C

### C 07

(10) AP 2019 14688 A (51) Int. Cl. (2006)

C 07 D 405/14

C 07 D 413/14

C 07 D 401/04

C 07 D 401/12

C 07 D 405/12

C 07 D 471/10

C 07 D 493/10

C 07 D 498/10

C 07 D 515/10

C 07 D 401/14

(21) AP 2016 14688 (22) 2016 07 18

(31) 62/335,290; 62/199,330

(32) 2016 05 12; 2015 07 31

(33) US; US

(71) PFIZER INC. (US)

35 East 42nd Street New York, NY (US)

(72) ROGERS, Bruce Nelsen (US);

BECK, Elizabeth Mary (GB);

BRODNEY, Michael Aaron (US);

VERHOEST, Patrick Robert (US);

JOHNSON, Douglas Scott (US);

HELAL, Christopher John (US);

O'NEIL, Steven Victor (US);

MCALLISTER, Laura Ann (US);

MONTGOMERY, Justin Ian (US);

WEBB, Damien (US);

BUTLER, Christopher Ryan (US);

GILBERT, Adam Matthew (US)

(74) Tamar Kochlamazashvili

(85) 2018 01 30

(86) PCT/IB2016/054266, 2016 07 18

(54) **1,1,1-TRIFLUORO-3-HYDROXY-PROPAN-2-YL CARBAMATE DERIVATIVES AND 1,1,1-TRIFLUORO-4-HYDROXYBUTAN-2-YL CARBAMATE DERIVATIVES AS MAGL INHIBITORS**

(57) Present invention relates to compound of formula I:

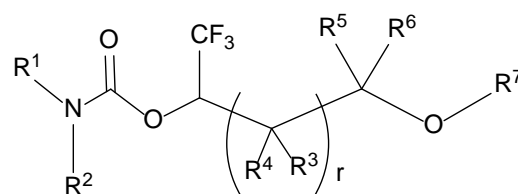

I

and pharmaceutically acceptable salts; preparation methods thereof, and compositions containing said compounds and salts; usage therefor the treatment of diseases or disorders caused with MAGL, as well.

Claims: 7 independent

18 dependent

(10) AP 2019 14320 A (51) Int. Cl. (2006)

C 07 D 413/14

C 07 D 213/82

C 07 D 231/14

C 07 D 333/38

C 07 D 333/40

C 07 D 407/12

C 07 D 409/12

C 07 D 417/12

C 07 D 417/14

C 07 D 285/08

C 07 D 285/135

A 61 K 31/421

A 61 K 31/166

(21) AP 2015 14320

(22) 2015 04 09

(31) 2014-082057

(32) 2014 04 11

(33) JP

(71) TAKEDA PHARMACEUTICAL

COMPANY LIMITED (JP)

1-1, Doshomachi 4-chome, Chuo-ku,

Osaka-shi, Osaka 5410045 (JP)

(72) MATSUMOTO, Shigemitsu (JP);

HATTORI, Yasushi (JP);

TOYOFUKU, Masashi (JP);

MORIMOTO, Shinji (JP);

DAINI, Masaki (JP);

KOJIMA, Takuto (JP);

KAKU, Tomohiro (JP);

ITO, Mitsuhiro (JP)

(74) Shalva Gvaramazde

(85) 2016 11 08

(86) PCT/JP2015/061651, 2015 04 09

(54) **CYCLOPROPANAMINE COMPOUND AND USE THEREOF**

(57) The present invention relates to cyclopropyl carboxamide compounds, the medicines containing them and their usage for the treatment of disorders caused with schizophrenia development, and neurodegenerative diseases, epilepsy and other similar diseases.

Claims: 14 independent

2 dependent



(10) AP 2019 14203 A (51) Int. Cl. (2006)  
C 07 F 9/576  
A 61 P 19/02  
A 61 K 31/675

(21) AP 2014 14203 (22) 2014 12 12

(31) 61/915,937

(32) 2013 12 13

(33) US

(71) VERTEX PHARMACEUTICALS  
INCORPORATED (US)

50 Northern Avenue, Boston,  
MA 0221050 (US)

(72) ANDERSON, Corey (US);

HADIDA-RUAH, Sara, Sabina (US);

GOLEC, Julian Marian, Charles (GB);

ZHANG, Beili (US);

LITTLER, Benjamin, Joseph (US);

KESHAVARZ-SHOKRI, Ali (US);

ALCACIO, Tim, Edward (US);

BELMONT, Daniel, T. (US)

(74) Shalva Gvaramazde

(85) 2016 07 08

(86) PCT/US2014/069916, 2014 12 12

(54) **PRODRUGS OF PYRIDONE**

**AMIDES USEFUL AS MODULATORS  
OF SODIUM CHANNELS**

(57) Compound of formula (I),

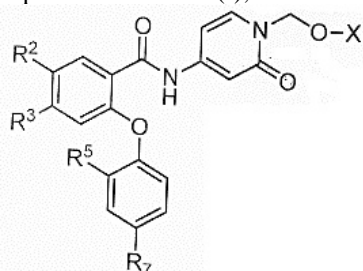

(I)

pharmaceutical compositions on the basis thereof,  
and their usage for various disorders treatment  
including pain.

Claims: 21 independent

52 dependent

Table: 9

Fig.: 6

## PART F

### F 42

(10) AP 2019 14636 A (51) Int. Cl. (2006)  
F 42 B 7/06  
F 42 B 77/08

(21) AP 2015 14636 (22) 2015 04 30

(71) LÓPEZ-POZAS LANUZA, Enrique (ES)

Nuestra Señora de Gracia 3-5A, Marbella,  
Malaga, 29602 (ES)

(72) LÓPEZ-POZAS LANUZA, Enrique (ES)

(74) Larisa Amirkhanyan

(85) 2017 11 30

(86) PCT/ES2015/070356, 2015 04 30

(54) **BIODEGRADABLE CARTRIDGE  
FOR SHOTGUNS**

(57) A cartridge consists of base, cartridge case,  
and at least one base wad, and at least one container  
wad, wherein said cartridge case, at least one base  
wad and at least one container wad is made with  
material consisting of plant or fermentative origin,  
at least one biodegradable bioplastic, inert and non-  
toxic mineral charge, wherein said mineral charge  
contains no more than 70 mass% of total weight of  
said material.

Claims: 1 independent

13 dependent

# PATENTED INVENTIONS

## PART A

### A 61

- (11) **P 2019 7043 B** (51) **Int. Cl. (2006)**  
**A 61 K 31/496**  
**A 61 P 19/04**  
**A 61 P 19/02**  
**C 07 D 403/06**
- (10) AP 2019 14546 A (44) 14(522)/2019  
(21) AP 2015 14546  
(22) 2015 12 18  
(24) 2015 12 18  
(31) EP14307129.8  
(32) 2014 12 22  
(33) EP  
(86) PCT/EP2015/080430, 2015 12 18  
(73) LES LABORATOIRES SERVIER (FR);  
35 rue de Verdun 92284 Suresnes (FR);  
GALAPAGOS NV (BE)  
Generaal De Wittelaan L11/A3 2800  
Mechelen (BE)  
(72) POP-BOTEZ, Iuliana, Ecaterina (FR);  
JARY, Helène, Marie (FR);  
CEUNINCK, Frédéric, André (FR);  
AMANTINI, David (FR);  
GOSMINI, Romain, Luc, Marie (FR);  
PEIXOTO, Christophe (FR);  
VARIN, Marie, Laurence, Claire (FR);  
ALVEY, Luke, Jonathan (FR);  
BREBION, Franck, Laurent (FR);  
DEPREZ, Pierre, Marc, Marie, Joseph (FR)  
(74) Tamaz Shilakadze  
(85) 2017 07 17  
(86) PCT/EP2015/080430, 2015 12 18  
(54) **5-[(PIPERAZIN-1-YL)-3-OXO-PROPYL]-  
IMIDAZOLIDINE-2,4-DIONE DERIVA-  
TIVES AS ADAMTS INHIBITORS FOR  
THE TREATMENT OF  
OSTEOARTHRITIS**

## PART C

### C 03

- (11) **P 2019 7042 B** (51) **Int. Cl. (2006)**  
**C 03 B 5/235**  
**C 03 B 5/237**  
**F 27 D 17/00**
- (10) AP 2019 14660 A (44) 14(522)/2019  
(21) AP 2016 14660  
(22) 2016 05 30  
(24) 2016 05 30  
(31) 1555009  
(32) 2015 06 02  
(33) FR  
(86) PCT/FR2016/051289, 2016 05 30  
(73) SAINT-GOBAIN GLASS FRANCE (FR)  
18 Avenue d'Alsace 92400 Courbevoie (FR);  
VERALLIA FRANCE (FR)  
Tour CARPE DIEM Place des Corolles-  
Esplanade Nord 92400 Courbevoie (FR)  
(72) HAYAU, Frédéric (FR);  
GARNIER, Laurent (FR)  
(74) Tamaz Shilakadze  
(85) 2017 12 27  
(86) PCT/FR2016/051289, 2016 05 30  
(54) **SONIC INJECTION FURNACE**

## PART E

### E 01

- (11) **P 2019 7045 B** (51) **Int. Cl. (2006)**  
**E 01 B 11/54**
- (10) AP 2019 14537 A (44) 10(518)/2019  
(21) AP 2017 14537  
(22) 2017 06 30  
(24) 2017 06 30  
(73) Nino Mukhigulashvili (GE)  
Tsitsamuris q. 16, 0180, Tbilisi (GE);  
Vakhtang Kupradze (GE)  
Dighmis mas., III kv., korp. 5, b. 83,  
0159, Tbilisi (GE);  
Giorgi Keshelava (GE)  
Chubinashvilis q. 75, 0112, Tbilisi (GE);  
Merab Chaladze (GE)  
Javakhetis q., II shes., korp. 10, b. 30,  
0182, Tbilisi (GE)  
(72) Nino Mukhigulashvili (GE);  
Vakhtang Kupradze (GE);

Giorgi Keshelava (GE);

Merab Chaladze (GE)

- (54) **METHOD FOR INSULATING JOINT  
PRELIMINARY CONDITION OF  
DAMAGE MONITORING**
- 

## **PART H**

### **H 05**

- (11) **P 2019 7044 B**      (51) **Int. Cl. (2006)**

**H 05 B 7/08**

**C 22 B 9/187**

- (10) AP 2019 14147 A      (44) 10(518)/2019

(21) AP 2016 14147

(22) 2016 05 18

(24) 2016 05 18

- (73) Marlen Shalamberidze (GE)

Sop. Godogani, 2400, Terjolis r/ni

Kutaisi (GE);

Akaki Kakauridze (GE)

Moze Khonelis shes. 9, 5900, Khoni (GE);

Tamar Tskipurishvili (GE)

Nikeas q. 1, b. 8/8, 4600, Kutaisi (GE);

Tedore Pkhakadze (GE)

Tabukashvilis q. 92, 4600, Kutaisi (GE)

- (72) Marlen Shalamberidze (GE);

Akaki Kakauridze (GE);

Tamar Tskipurishvili (GE);

Tedore Pkhakadze (GE)

- (54) **CRYSTALLIZER WITH NON-FITTED  
ELECTRODES FOR ELECTROSLAG  
REMELTING OF METALS**
-

---

# UTILITY MODEL

## APPLICATION APPROVED FOR GRANTING PATENT

The decision can be appealed at the Chamber of Appeal of Sakpatenti within 3 months from the publication or at the Mtskheta District Court Administrative Cases Board (Address: №17, Samkhedro str., Mtskheta), within 1 month following the publication.

### PART E

#### E 04

(10) AU 2019 14993 U (51) Int. Cl. (2006)  
E 04 B 1/01

(21) AU 2019 14993 (22) 2019 02 06

(71) Revaz Sikharulidze (GE)

Tkibuli St. 16, 0178, Tbilisi (GE)

(72) Revaz Sikharulidze (GE)

(54) SIKHARULIDZE'S WALL

(57) A wall includes double-layered blocks 2 disposed on a fundament 1 in vertical rows. Reinforcing flat frame 5 consisting of two vertical reinforcing stems 6 and 7 and wavy or zigzag rolled wire 8 connected thereto and welded to said stem with curved places is located between adjoining blocks vertical rows. Flat frame is located between blocks along block foam layers 4 opposite of side walls. Each block concrete layer 3 is equipped with reinforcing stem 16, which edges 9 and 10 are passing along said block opposite side walls and are bent towards inner foam layer, edge ends are curved and engaged with one adjoining reinforcement flat frame vertical stem, said curved ends are connected to reinforcing flat frame second vertical stem with a wire. Space between vertical rows is filled with the concrete 12, foam layer is covered with metallic grid 14 and coated.

Claims: 1 independent

Fig.: 4

#### NODE 1

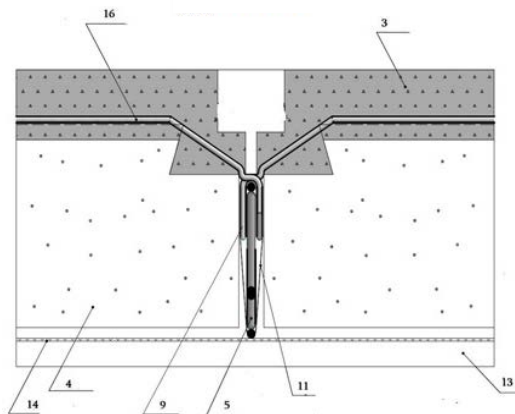

Fig. 4

## PATENTED UTILITY MODEL

### PART B

#### B 21

(11) U 2019 2023 Y (51) Int. Cl. (2006)

**B 21 F 1/04**

(10) AU 2019 14944 U (44) 14(522)/2019

(21) AU 2018 14944

(22) 2018 11 30

(24) 2018 11 30

(73) Revaz Sikharulidze (GE)

Tkibulis q. 16, 0178, Tbilisi (GE)

(72) Revaz Sikharulidze (GE)

(54) **DEVICE FOR FLEXIBLE ROD**

---

---

# DESIGNS

## REGISTERED DESIGNS

**(11) D 2019 827 S**      **(51) 07-06**  
(10) AD 2019 1083 S      (44) 2019 08 12 №15  
(21) AD 2019 1083  
(22) 2019 04 08  
(24) 2019 04 08  
(28) 4  
(18) 2024 04 08  
(73) Maizer Zakarashvili (GE)  
K. Kutateladze St. 6, 0179, Tbilisi,  
Georgia (GE)  
(72) Maizer Zakarashvili (GE)  
(54) **2. HALF KHINKALI-SHAPED CERAMIC  
SALTCELLAR  
3. HALF KHINKALI-SHAPED CERAMIC  
PEPPER POT  
4.-5. CERAMIC SET**

---

**(11) D 2019 826 S**      **(51) 09-01**  
(10) AD 2019 1079 S      (44) 2019 08 12 №15  
(21) AD 2019 1079  
(22) 2019 03 20  
(24) 2019 03 20  
(28) 1  
(18) 2024 03 20  
(73) Tinatin Bregadze (GE)  
Vill. Rokhi, 1006, Baghdati, Georgia (GE)  
(72) Tinatin Bregadze (GE)  
(54) **BOTTLE**

---

**(11) D 2019 828 S**      **(51) 19-08**  
(10) AD 2019 1085 S      (44) 2019 08 12 №15  
(21) AD 2019 1085  
(22) 2019 04 10  
(24) 2019 04 10  
(28) 6  
(18) 2024 04 10  
(73) Evgenia Karacheva (RU)  
Ul. Gorbunova, Dom 19, korp. 1, kvartira 20,  
Moscow, Russian Federation (RU)  
(72) Eugenia Karacheva (RU)  
(74) Mzia Nadaraia (GE)  
(54) **1.-6. LABELS**

---

---

# TRADEMARKS

## APPLICATIONS FILED UNDER THE NATIONAL PROCEDURE APPROVED FOR REGISTRATION

The decision can be appealed at the Chamber of Appeal of Sakpatenti within 3 months from the publication or at the Mtskheta District Court Administrative Cases Board (Address: №17, Samkhedro St., Mtskheta), within 1 month following the publication.

(260) AM 2019 99069 A

(210) AM 99069

(220) 2019 05 03

(731) LTD "Georgian Post"

Station Square 2, 0100, Tbilisi,  
Georgia

(540)



Woodoo Post

(591) Blue

(531) 27.05.01; 29.01.04

(511) 9

(540)



(591) Dark green, white

(531) 01.03.01; 01.03.15; 05.01.02; 05.01.03;  
12.01.10; 12.01.16; 28.19; 29.01.12

(526) ბორჯომი

(511) 5, 32, 35

---

(260) AM 2019 99884 A

(210) AM 99884

(220) 2019 03 29

(731) LTD "IDS BORJOMI BEVERAGE  
COMPANY"

Tori St. 39, 1200, Borjomi, Georgia

(540)



(591) Dark green, white

(531) 11.01.01; 11.01.02; 11.01.03; 11.01.04;  
11.01.22; 11.01.25; 11.03.02; 11.03.13;  
19.07.01; 28.19; 29.01.12

(526) ბორჯომი

(511) 5, 32, 35

---

(260) AM 2019 99886 A

(210) AM 99886

(220) 2019 03 29

(731) LTD "IDS BORJOMI BEVERAGE  
COMPANY"

Tori St. 39, 1200, Borjomi, Georgia

(540)

ბორჯომი-იცხოვრე  
ვულკანის ძალით

(591) Black, white

(526) ბორჯომი

(511) 5, 32, 35

---

(260) AM 2019 99885 A

(210) AM 99885

(220) 2019 03 29

(731) LTD "IDS BORJOMI BEVERAGE  
COMPANY"

Tori St. 39, 1200, Borjomi, Georgia

(540)



(591) Grey, orange, yellow, light grey, white  
 (531) 02.09.10; 27.05.01; 27.05.11; 29.01.13  
 (511) 44

(260) AM 2019 100065 A  
 (210) AM 100065  
 (220) 2019 04 23  
 (731) LTD "TALISMAN"  
 N. Tskhvedadze St. 28, 0162, Tbilisi, Georgia  
 (540)

**ВАЙ МЕ**  
**ვანო ვან**

(591) Black, white  
 (511) 33

(260) AM 2019 102360 A  
 (210) AM 102360  
 (220) 2019 03 24  
 (731) OBA RETAIL CHAIN MMC  
 AZ5001, Sumqayit seheri, 9 mkr, ev 25C,  
 Baku, Azerbaijan  
 (740) Giorgi Kartvelishvili  
 (540)

**OBA**

(591) Black, white  
 (511) 35, 39

(260) AM 2019 102361 A  
 (210) AM 102361  
 (220) 2019 03 24  
 (731) OBA RETAIL CHAIN MMC  
 AZ5001, Sumqayit seheri, 9 mkr, ev 25C,  
 Baku, Azerbaijan  
 (740) Giorgi Kartvelishvili  
 (540)



(591) White, sky-blue, blue, red, orange, yellow  
 (531) 07.01.13; 26.01.05; 26.01.16; 26.01.24;  
 27.05.01; 27.05.23; 27.05.24; 29.01.15  
 (511) 35, 39

(260) AM 2019 102371 A  
 (210) AM 102371  
 (220) 2019 03 25  
 (731) BOTTEGA VENETA S.R.L.  
 Località Conti Maltraverso 1, 36054  
 Montebello Vicentino (VI), Italy  
 (740) Shalva Gvaramadze  
 (540)

**BOTTEGA VENETA**

(591) Black, white  
 (511) 9, 14, 18, 25, 35

(260) AM 2019 102383 A  
 (210) AM 102383  
 (220) 2019 03 26  
 (731) LTD "AISI"  
 Varketili III, mkr. I, bl. 28, ap. 26, 0163,  
 Tbilisi Georgia  
 (540)

**UNIX**  
**იუნისიქსი**  
**ЮНИКС**

(591) Black, white  
 (511) 2, 4

(260) AM 2019 102403 A  
 (210) AM 102403  
 (220) 2019 03 28  
 (731) LTD "Royal Racha"  
 Shartava St. 40, Fl. 7, 0160, Tbilisi,  
 Georgia  
 (540)





(591) Black, golden  
 (531) 05.01.19; 06.19.07; 06.19.16; 07.01.03;  
 24.01.03; 24.01.10; 24.01.11; 24.01.17;  
 24.01.18; 24.09.01; 25.01.05; 25.01.19;  
 29.01.12

(526) racha  
 (511) 33

(260) AM 2019 102516 A  
 (210) AM 102516  
 (220) 2019 04 03  
 (731) KRAFT FOODS SCHWEIZ HOLDING  
 GMBH  
 Chollerstrasse 4, Zug 6301, Switzerland  
 (740) Giorgi Taktakishvili  
 (540)



(591) White, light lilac, lilac, dark lilac,  
 yellow, brown  
 (531) 01.03.01; 01.03.06; 03.04.02; 03.13.01;  
 08.01.16; 27.05.01; 27.05.24; 29.01.15  
 (511) 30

(260) AM 2019 102523 A  
 (210) AM 102523  
 (220) 2019 04 03  
 (731) LTD "GMP"  
 Village Ponitchala 65, 0165, Tbilisi, Georgia  
 (740) Nugzar Ksovreli  
 (540)

**გასტრომაგნილი**  
**Гастромагнил**  
**Gastromagnyl**

(591) Black, white  
 (511) 5

(260) AM 2019 102524 A  
 (210) AM 102524  
 (220) 2019 04 03  
 (731) LTD "GMP"  
 Village Ponitchala 65, 0165, Tbilisi, Georgia  
 (740) Nugzar Ksovreli

(540)

**გასტრომაგნოლი**  
**Гастромагнोल**  
**Gastromagnol**

(591) Black, white  
 (511) 5

(260) AM 2019 102535 A  
 (210) AM 102535  
 (220) 2019 04 05  
 (731) LTD "Studio Bicycle"  
 Gldani VI mkr., bl. 20, ap. 81, 0107,  
 Tbilisi Georgia  
 (540)



ჟირაფი ჟოზე

(591) Yellow, white, black, brown  
 (531) 03.02.09; 03.02.26; 29.01.14  
 (511) 5, 9, 16, 21, 24, 25, 27, 28, 29, 30, 32, 35, 41

(260) AM 2019 102545 A  
 (210) AM 102545  
 (220) 2019 04 08  
 (731) ANNA GODABRELIDZE  
 Politkovskaya St. 37, 0186, Tbilisi, Georgia

(540)



(591) White, red  
 (531) 26.01.01; 26.01.03; 26.01.19; 26.01.22;  
 26.01.24; 27.05.01; 27.05.08; 27.05.09;  
 27.05.10; 27.05.24; 29.01.12  
 (511) 41

(260) AM 2019 102547 A  
 (210) AM 102547  
 (220) 2019 04 10  
 (310) 2019710393  
 (320) 11 03 2019  
 (330) RU  
 (731) Intercontinental Great Brands LLC  
 100 Deforest Avenue, East Hanover,  
 New Jersey 07936, USA  
 (740) Giorgi Taktakishvili  
 (540)



(591) White, sky-blue, brown  
 (531) 08.01.10; 26.04.22; 26.04.24; 28.05; 29.01.13  
 (511) 30

(260) AM 2019 102561 A  
 (210) AM 102561  
 (220) 2019 04 11  
 (731) Ramaz Samkharadze  
 Mukhiani IV mkr., bl. 40, ap. 7, 0172,  
 Tbilisi, Georgia  
 (540)



(591) Red, yellow, green, orange, black, white  
 (531) 05.07.11; 05.07.12; 05.07.22; 26.04.22;  
 26.04.24; 27.05.09; 27.05.10; 27.05.24;  
 27.07.11; 27.07.17; 29.01.15  
 (511) 38

(260) AM 2019 102697 A  
 (210) AM 102697  
 (220) 2019 04 12  
 (731) JSC "GEORGIAN BEER COMPANY"  
 Vil. Saguramo, 3311, Mtskheta, Georgia

(540)

ამირანი  
**Amirani**

(591) Black, white  
 (511) 32

(260) AM 2019 102701 A  
 (210) AM 102701  
 (220) 2019 04 12  
 (731) JSC "GEORGIAN BEER COMPANY"  
 Vil. Saguramo, 3311, Mtskheta, Georgia  
 (540)

ოდისეა  
**Odyssey**

(591) Black, white  
 (511) 32

(260) AM 2019 102706 A  
 (210) AM 102706  
 (220) 2019 04 12  
 (731) JSC "GEORGIAN BEER COMPANY"  
 Vil. Saguramo, 3311, Mtskheta, Georgia  
 (540)

პონტო  
**Ponto**

(591) Black, white  
 (511) 32

(260) AM 2019 102710 A  
 (210) AM 102710  
 (220) 2019 04 12  
 (731) N(N)LE Rugby Union of Georgia  
 Chabua Amirejibi Road. 6, benchmark  
 6.00, Office Space 3, Tbilisi, Georgia  
 (540)

**THE LELOS**

(591) Black, white  
 (511) 25, 28, 36, 41

(260) AM 2019 102712 A  
 (210) AM 102712  
 (220) 2019 04 12  
 (731) Changhong Meiling Company Limited  
 2163 Hao, Lianhualu Economic-Techno-  
 logical Development Area, Hefeishi Anhui  
 230000, China  
 (740) Giorgi Kartvelishvili

(540)

**MELING**(591) Black, white  
(511) 7, 11(260) AM 2019 102716 A  
(210) AM 102716  
(220) 2019 04 15  
(731) LTD "G COMMERCY"  
P. Kavtaradze St. 4, Blok B, Commercial  
Place 8, Vake district, 0186, Tbilisi, Georgia  
(740) Mariam Mikeltadze  
(540)**სურვილის სისწრაფით**(591) Black, white  
(511) 35, 36, 39(260) AM 2019 102717 A  
(210) AM 102717  
(220) 2019 04 15  
(731) LTD "Tural Group"  
Guramishvili St. Ozurgeti, Georgia  
(540)**RAINFORD**(591) Black, white  
(531) 27.05.01  
(511) 7, 9, 11(260) AM 2019 102723 A  
(210) AM 102723  
(220) 2019 04 16  
(731) LTD "G COMMERCY"  
P. Kavtaradze St. 4, Blok B, Commercial  
Place 8, Vake district, 0186, Tbilisi, Georgia  
(740) Mariam Mikeltadze  
(540)**VENDOO.GE**(591) Crimson, lilac, sky-blue, blue, green, orange  
(531) 27.05.01; 27.05.17; 29.01.14  
(511) 35, 36, 39(260) AM 2019 102729 A  
(210) AM 102729  
(220) 2019 04 17  
(731) LTD "BEDEGI"  
Brothers Slovinskiy St. 6, Tbilisi,  
Georgia

(540)

(591) White, orange  
(531) 26.04.01; 26.04.03; 26.04.04; 26.04.06;  
26.04.07; 29.01.12  
(511) 19, 35, 37(260) AM 2019 102731 A  
(210) AM 102731  
(220) 2019 04 18  
(731) GIORGI DALAKISHVILI  
Vil. Mukhrani, 3309, Mtskheta, Georgia  
(540)(591) Blue, white  
(531) 03.09.01; 26.01.04; 26.01.06; 26.02.07;  
27.05.01; 28.05; 28.19; 29.01.12  
(511) 5, 10, 31(260) AM 2019 102735 A  
(210) AM 102735  
(220) 2019 04 18  
(731) JSC "GEPHA"  
Akaki Belashvili St. 142, 0159, Tbilisi,  
Georgia  
(740) Salome Jeladze  
(540)**PRIO**

(511) 35, 44

(260) AM 2019 102736 A  
(210) AM 102736  
(220) 2019 04 18  
(731) NSAR GENERAL TRADING LLC  
1502 Green Tower, Baniyas Street, P.O. Box  
171611, Dubai, United Arab Emirates  
(740) Pavle Meipariani

(540)

**CEDRUS**(591) Black, white  
(511) 3, 29, 30, 32

(260) AM 2019 102812 A

(210) AM 102812

(220) 2019 04 19

(731) LTD "MARKET GROUP"

Gonio, Batumi, Georgia

(540)

**REA INVESTMENT**

(591) Black, white

(511) 35, 36, 37

(260) AM 2019 102815 A

(210) AM 102815

(220) 2019 04 22

(731) LTD "Wine Gards"

D. Aghmashenebeli II Lane 5, Vil. Dighomi,  
Tbilisi, Georgia

(540)

**არქიპელაგო - Archipelago**

(591) Black, white

(511) 33

(260) AM 2019 102826 A

(210) AM 102826

(220) 2019 04 24

(731) LTD "ALFA"

Tevdore Mghvdeli St. 53, 0154, Tbilisi,  
Georgia

(740) Nugzar Ksovreli

(540)

**ЖАРКОФФ**

(591) Black, white

(511) 29

(260) AM 2019 102833 A

(210) AM 102833

(220) 2019 04 25

(731) ALEKSANDR SUPRUNOV

Viktor Jorbenadze St. 15, 0103, Tbilisi,  
Georgia

(540)

**ლიმონუნა****LIMONUNA**

(591) Black, white

(511) 33

(260) AM 2019 102835 A

(210) AM 102835

(220) 2019 04 25

(731) BOSNALIJEK D.D.

Jukiceva 53, Sarajevo, 71000, Bosnia and  
Herzegovina

(740) Giorgi Kankava

(540)

**BOSTROMBIN**

(591) Black, white

(511) 5

(260) AM 2019 102836 A

(210) AM 102836

(220) 2019 04 25

(731) BOSNALIJEK, D.D.

Jukiceva 53, Sarajevo, 71000, Bosnia and  
Herzegovina

(740) Giorgi Kankava

(540)



(591) White, blue

(531) 26.02.01; 26.02.03; 26.02.07; 27.05.01;  
29.01.12

(511) 5, 35

(260) AM 2019 102837 A

(210) AM 102837

(220) 2019 04 25

(731) BOSNALIJEK, D.D.

Jukiceva 53, Sarajevo, 71000, Bosnia and  
Herzegovina

(740) Giorgi Kankava

(540)

**LYSODERM**

(591) Black-white

(511) 5

(260) AM 2019 102838 A

(210) AM 102838

(220) 2019 04 25

(731) BOSNALIJEK, D.D.

Jukiceva 53, Sarajevo, 71000, Bosnia and  
Herzegovina

(740) Giorgi Kankava

(540)

**RINOBACT**(591) Black, white  
(511) 5

(260) AM 2019 102839 A

(210) AM 102839

(220) 2019 04 25

(731) BOSNALIJEK, D.D.

Jukiceva 53, Sarajevo, 71000, Bosnia and  
Herzegovina

(740) Giorgi Kankava

(540)

**RINOBACT P**(591) Black, white  
(511) 5

(260) AM 2019 102840 A

(210) AM 102840

(220) 2019 04 25

(731) Majid Al Futtaim Hypermarkets LLC

5th Floor, MAF Tower 1, Port Saeed,  
Deira, United Arab Emirates

(740) Merab Kvimsadze

(540)



(591) Black, white

(531) 26.01.19; 26.04.02; 26.04.10; 26.04.24; 28.01

(511) 3, 16, 29, 30, 31, 32

(260) AM 2019 102841 A

(210) AM 102841

(220) 2019 04 25

(731) LTD "NAVNE"

Didube St. 21, 0154, Tbilisi, Georgia

(540)

**ნავნე  
Navne**

(591) Black, white

(511) 3, 20, 21, 25, 35

(260) AM 2019 102916 A

(210) AM 102916

(220) 2019 04 30

(310) 018052259

(320) 16 04 2019

(330) EUIPO

(731) Reign Beverage Company LLC

1547 N. Knowles Ave., Los Angeles,  
California 90063, USA

(740) Natela Otardidze

(540)

**REIGN**

(591) Black, white

(511) 32

(260) AM 2019 102917 A

(210) AM 102917

(220) 2019 04 30

(731) INPHA LLP Representative office in Georgia

Besiki St. 4 (plot 46/10), 0108, Tbilisi,  
Georgia

(540)

**ESTEGRAN  
ԵՏԵՐՄԱԿ  
სტეგრან**

(591) Black, white

(511) 5

(260) AM 2019 102920 A

(210) AM 102920

(220) 2019 04 30

(731) ANKER INNOVATIONS TECHNOLOGY  
CO., LTD.Room 701, 7F building 7, 1st phase of  
Headquarters Building of Changsha  
Zhongdian Software Park Co., Ltd, No.39  
Jianshan Road, Changsha National High-  
tech Industrial Development Zone, Changsha,  
China

(740) Liliana Darakhvelidze

(540)

**soundcore**

(591) Black, white

(531) 27.05.01

(511) 9

(260) AM 2019 103093 A

(210) AM 103093

(220) 2019 05 10

(731) LTD "BUFALO"

Khizabavra St. 5, entrance 1, flat 4, 0167,  
Tbilisi, Georgia

(740) Nino Gazdeliani  
(540)



(591) White, dark grey  
(531) 27.05.10; 27.05.22  
(526) COFFEE  
(511) 43

---

## REGISTERED TRADEMARKS

(111) M 2019 31971 R  
 (151) 2019 11 12  
 (181) 2029 11 12  
 (260) AM 2017 95355 A  
 (220) 2017 12 05

(732) N(N)LE "Georgian Glass and Mineral Water"  
 Sop. Kvibisi, №2 Taping factory, Borjomi,  
 Georgia  
 (551) Collective

(111) M 2019 31972 R  
 (151) 2019 11 12  
 (181) 2029 11 12  
 (260) AM 2018 100048 A  
 (220) 2018 10 29

(732) AGIO PHARMACEUTICALS LTD  
 38 Nandjiot, Ind. Esteit, Kurla-Andkheri  
 Roaud, Seifdpul, Mumbai 400 072, India

(111) M 2019 31973 R  
 (151) 2019 11 12  
 (181) 2029 11 12  
 (260) AM 2018 100380 A  
 (220) 2018 11 12

(732) LTD "Bolero & Company"  
 Marshal Gelovani Av. 13, floor 9, 0159, Tbilisi,  
 Georgia

(111) M 2019 31974 R  
 (151) 2019 11 12  
 (181) 2029 11 12  
 (260) AM 2018 100586 A  
 (220) 2018 11 26

(732) Vakhtang Yurievich Kasradze  
 Ul. Mayakovskogo Bl. 49, Ap. 19, Omsk,  
 644010, Russian Federation

(111) M 2019 31975 R  
 (151) 2019 11 12  
 (181) 2029 11 12  
 (260) AM 2018 100587 A  
 (220) 2018 11 26

(732) LTD "DAISI+"  
 Saknavti Settlement, plot 07/006, 0198, Tbilisi,  
 Georgia

(111) M 2019 31976 R  
 (151) 2019 11 12  
 (181) 2029 11 12  
 (260) AM 2018 100701 A  
 (220) 2018 12 06

(732) NISSAN CHEMICAL CORPORATION  
 5-1 Nihonbashi 2-chome, Chuo-ku, Tokyo,  
 Japan

(111) M 2019 31977 R  
 (151) 2019 11 12  
 (181) 2029 11 12  
 (260) AM 2018 100702 A  
 (220) 2018 12 06

(732) LTD "BUTTERFLY"  
 Bakhtrioni St. 28, b. 66, Vake-Saburtalo  
 district, 0194, Tbilisi, Georgia

(111) M 2019 31978 R  
 (151) 2019 11 12  
 (181) 2029 11 12  
 (260) AM 2018 100818 A  
 (220) 2018 12 20

(732) LLC "Shalvino"  
 G. Panaskerteli-Tsitsishvili St., Bl. 1, Ap. 10,  
 Saburtalo district, Tbilisi, Georgia;  
 Aleksandr Levakov  
 N. Kipshidze St. 3b, Ap. 82, 0162, Tbilisi,  
 Georgia

(111) M 2019 31979 R  
 (151) 2019 11 12  
 (181) 2029 11 12  
 (260) AM 2018 100908 A  
 (220) 2018 12 28

(732) Lijian Yuan  
 No.1612, Shandong Road No. 18A, Shinan  
 District, Qingdao Sity, Shandong Province, China

(111) M 2019 31980 R  
 (151) 2019 11 12  
 (181) 2029 11 12  
 (260) AM 2019 100914 A  
 (220) 2019 01 03

(732) Exxon Mobil Corporation  
 5959 Colinas Boulevard, Irving, Texas,  
 75039-2298, USA

(111) M 2019 31981 R  
 (151) 2019 11 12  
 (181) 2029 11 12  
 (260) AM 2019 100929 A  
 (220) 2019 01 09

(732) PHILIP MORRIS BRANDS SÀRL  
 Quai Jeanrenaud 3, 2000 Neuchâtel, Switzerland

(111) M 2019 31982 R  
(151) 2019 11 12  
(181) 2029 11 12  
(260) AM 2019 100932 A  
(220) 2019 01 09  
(732) PHILIP MORRIS BRANDS SÀRL  
Quai Jeanrenaud 3, 2000 Neuchâtel, Switzerland

(111) M 2019 31988 R  
(151) 2019 11 12  
(181) 2029 11 12  
(260) AM 2015 80925 A  
(220) 2015 02 20  
(732) LTD "G-M-P"  
Vil. Ponitchala 65, 0165, Tbilisi, Georgia

(111) M 2019 31983 R  
(151) 2019 11 12  
(181) 2029 11 12  
(260) AM 2019 101231 A  
(220) 2019 01 15  
(732) LTD "MY HOUSE"  
Digomi Training Trial Farming Area, Fl. 2,  
0131, Saburtalo District, Tbilisi, Georgia

(111) M 2019 31989 R  
(151) 2019 11 12  
(181) 2029 11 12  
(260) AM 2018 98672 A  
(220) 2018 07 24  
(732) LTD "Digital Development of Product"  
III Massiv, z/p 5, ap. 43, 0182, Tbilisi, Georgia

(111) M 2019 31984 R  
(151) 2019 11 12  
(181) 2029 11 12  
(260) AM 2019 101232 A  
(220) 2019 01 15  
(732) LTD "MY HOUSE"  
Digomi Training Trial Farming Area, Fl. 2,  
0131, Saburtalo District, Tbilisi, Georgia

(111) M 2019 31990 R  
(151) 2019 11 12  
(181) 2029 11 12  
(260) AM 2018 99173 A  
(220) 2018 08 30  
(732) LTD "YELM"  
Angisa Str. 2, ap. 181, 6004, Batumi, Georgia

(111) M 2019 31985 R  
(151) 2019 11 12  
(181) 2029 11 12  
(260) AM 2019 101370 A  
(220) 2019 01 25  
(732) LTD "FREE UNIVERSITY OF TBILISI"  
David Aghmashenebeli Alley 240, 0131,  
Tbilisi, Georgia

(111) M 2019 31991 R  
(151) 2019 11 12  
(181) 2029 11 12  
(260) AM 2018 99482 A  
(220) 2018 09 24  
(732) Kentuki Fraid Chiken Interneshenel  
Holdings LLC  
7100 Corporate Drive, TX, Plano, 75024, USA

(111) M 2019 31986 R  
(151) 2019 11 12  
(181) 2029 11 12  
(260) AM 2019 101407 A  
(220) 2019 01 30  
(732) LTD "UNIVERSAL CARD CORPORATION"  
Vazha-Pshavela Av. 71, Fl. 3, Tbilisi, Georgia

(111) M 2019 31992 R  
(151) 2019 11 12  
(181) 2029 11 12  
(260) AM 2018 99501 A  
(220) 2018 09 24  
(732) Al Saily Commerce & Industry Tobacco  
A Shoha bemelk Sobh Abu Alenien  
Abu Alenien Alfar, Mansoura Center,  
Al Dakahleya, Egypt

(111) M 2019 31987 R  
(151) 2019 11 12  
(181) 2029 11 12  
(260) AM 2019 101408 A  
(220) 2019 01 30  
(732) LTD "UNIVERSAL CARD CORPORATION"  
Vazha-Pshavela Av. 71, Fl. 3, Tbilisi, Georgia

(111) M 2019 31993 R  
(151) 2019 11 12  
(181) 2029 11 12  
(260) AM 2018 99792 A  
(220) 2018 10 11  
(732) Amaresh Kumar Mattoo  
P.O. Box 4936, Fujairah, United Arab Emirates



(111) M 2019 31994 R  
(151) 2019 11 12  
(181) 2029 11 12  
(260) AM 2018 99895 A  
(220) 2018 10 18  
(732) ADAMA MAKHTESHIM LTD  
P.O. Box 60, Beer Sheva 8410001, Israel

---

(111) M 2019 31995 R  
(151) 2019 11 12  
(181) 2029 11 12  
(260) AM 2018 99896 A  
(220) 2018 10 18  
(732) ADAMA MAKHTESHIM LTD  
P.O. Box 60, Beer Sheva 8410001, Israel

---

(111) M 2019 31996 R  
(151) 2019 11 12  
(181) 2029 11 12  
(260) AM 2018 99897 A  
(220) 2018 10 18  
(732) ADAMA MAKHTESHIM LTD  
P.O. Box 60, Beer Sheva 8410001, Israel

---

(111) M 2019 31997 R  
(151) 2019 11 12  
(181) 2029 11 12  
(260) AM 2018 99898 A  
(220) 2018 10 18  
(732) ADAMA MAKHTESHIM LTD  
P.O. Box 60, Beer Sheva 8410001, Israel

---

(111) M 2019 31998 R  
(151) 2019 11 12  
(181) 2029 11 12  
(260) AM 2018 99899 A  
(220) 2018 10 18  
(732) ADAMA MAKHTESHIM LTD  
P.O. Box 60, Beer Sheva 8410001, Israel

---

(111) M 2019 31999 R  
(151) 2019 11 12  
(181) 2029 11 12  
(260) AM 2018 99900 A  
(220) 2018 10 18  
(732) ADAMA MAKHTESHIM LTD  
P.O. Box 60, Beer Sheva 8410001, Israel

---

(111) M 2019 32000 R  
(151) 2019 11 12  
(181) 2029 11 12  
(260) AM 2018 99901 A  
(220) 2018 10 18

(732) ADAMA MAKHTESHIM LTD  
P.O. Box 60, Beer Sheva 8410001, Israel

---

(111) M 2019 32001 R  
(151) 2019 11 12  
(181) 2029 11 12  
(260) AM 2018 99902 A  
(220) 2018 10 18  
(732) ADAMA MAKHTESHIM LTD  
P.O. Box 60, Beer Sheva 8410001, Israel

---

(111) M 2019 32002 R  
(151) 2019 11 12  
(181) 2029 11 12  
(260) AM 2018 99903 A  
(220) 2018 10 18  
(732) ADAMA MAKHTESHIM LTD  
P.O. Box 60, Beer Sheva 8410001, Israel

---

(111) M 2019 32003 R  
(151) 2019 11 12  
(181) 2029 11 12  
(260) AM 2018 99904 A  
(220) 2018 10 18  
(732) ADAMA MAKHTESHIM LTD  
P.O. Box 60, Beer Sheva 8410001, Israel

---

(111) M 2019 32004 R  
(151) 2019 11 12  
(181) 2029 11 12  
(260) AM 2018 99905 A  
(220) 2018 10 18  
(732) ADAMA MAKHTESHIM LTD  
P.O. Box 60, Beer Sheva 8410001, Israel

---

(111) M 2019 32005 R  
(151) 2019 11 12  
(181) 2029 11 12  
(260) AM 2018 99906 A  
(220) 2018 10 18  
(732) ADAMA MAKHTESHIM LTD  
P.O. Box 60, Beer Sheva 8410001, Israel

---

## TRADEMARKS REGISTERED ACCORDING TO THE ACCELERATED PROCEDURE

The decision can be appealed at the Chamber of Appeal of Sakpatenti within 3 months from the publication.

(111) M 2019 31970 R

(151) 2019 11 12

(181) 2029 11 12

(210) AM 105555

(220) 2019 10 29

(732) LTD "ONLINE MALL"

V. Barnovi/Tarkhnishvili St. 49/29, ap. 6,  
Tbilisi, Georgia

(540)

**ბავშვთა სამყარო -  
Baby Universe**

(591) Black, white

(511) 35

(111) M 2019 32006 R

(151) 2019 11 13

(181) 2029 11 13

(210) AM 105540

(220) 2019 10 25

(732) LTD "MIEN"

Trialeti St. 18, 0182, Tbilisi, Georgia

(540)

  
**mi en**  
HOTEL TEXTILE

(591) Black, golden, white

(531) 26.04.09; 26.04.18; 26.04.24; 27.05.01;  
27.05.09; 27.05.10; 27.05.24; 29.01.13

(511) 24

(111) M 2019 32007 R

(151) 2019 11 13

(181) 2029 11 13

(210) AM 105638

(220) 2019 11 04

(732) NATIA GVENETADZE

Sholokhov St. 2, Flat 150, Moscow,  
Russian Federation

(540)

  
**ASOMATAV**

(591) Black, white

(531) 27.05.01; 27.05.22

(511) 14, 18, 25, 35

(111) M 2019 32008 R

(151) 2019 11 13

(181) 2029 11 13

(210) AM 105560

(220) 2019 10 31

(732) LTD "MTEVINO"

S. Janashia St. 8, Tbilisi, Georgia

(540)



(591) Golden, black

(531) 05.07.10; 26.04.02; 26.04.05; 26.04.15;  
26.04.22; 26.04.24; 27.05.24; 29.01.12

(511) 33, 35

(111) M 2019 32009 R

(151) 2019 11 13

(181) 2029 11 13

(210) AM 105657

(220) 2019 11 05

(732) LTD "Nextra Group"

Ir. Evdoshvili St. 18, Fl. 2, Office Space 3,  
0154, Tbilisi, Georgia

(540)

**პროტაზონი  
Protazon  
Протазон**

(591) Black, white

(511) 5

(111) M 2019 32010 R

(151) 2019 11 13

(181) 2029 11 13

(210) AM 105658

(220) 2019 11 05

(732) LTD "Nextra Group"

Ir. Evdoshvili St. 18, Fl. 2, Office Space 3,  
0154, Tbilisi, Georgia

(540)

**Treviton B**  
**ტრევიტონი ბ**  
**ТРЕВИТОН Б**

(591) Black, white

(511) 5

---

(111) M 2019 32011 R

(151) 2019 11 14

(181) 2029 11 14

(210) AM 105645

(220) 2019 11 05

(732) Giuli Jananashvili

Gldani I mkr. 17/48, Tbilisi, Georgia

(540)



(591) Black, white, golden

(531) 02.03.01; 02.03.16; 26.01.14; 27.05.01;  
27.05.09; 27.05.10; 28.19; 29.01.13

(511) 44

---

(111) M 2019 32012 R

(151) 2019 11 14

(181) 2029 11 14

(210) AM 105738

(220) 2019 11 08

(732) JSC "ALEF-VINAL"

1 Sobinova St. Dnipro, Ukraine

(740) Irakli Gvilia

(540)

**ADJARI**

(591) Black, white

(511) 33

---

## INTERNATIONAL TRADEMARKS FOR WHICH A DECISION ON GRANTING PROTECTIONS IS TAKEN

The decision can be appealed at the Chamber of Appeal of Sakpatenti within 3 months from the publication or at the Mtskheta District Court Administrative Cases Board (Address: №17, Samkhedro str., Mtskheta), within 1 month following the publication.

(260) AM 2019 99117 A

(800) 1419622

(151) 2017 09 20

(891) 2017 09 20

(731) PROFIOFFICE GMBH

Beyerbach Str. 9, 65830 Kriftel, Germany

(540)



(540)

(591) Black, white

(531) 27.05.19; 27.05.22

(511)

9 – Compact discs [ROM, memory]; compact discs [sound, image]; computer keyboards; magnets; mice [data processing equipment]; mouse pads [mouse mats]; microphones.

(260) AM 2019 99606 A

(800) 1425244

(151) 2018 07 11

(891) 2018 07 11

(731) "UNIPHARM-UKRAINE", LLC

Moskovskiy prospect 9-V, Kyiv 04073, Ukraine

(540)

### NIGHTWELL

(591) Black, white

(511)

3 – Bleaching preparations and other substances for laundry use; cleaning, polishing, scouring and abrasive preparations; non-medicated soaps; perfumery, essential oils, non-medicated cosmetics, non-medicated hair lotions; non-medicated dentifrices.

5 – Pharmaceuticals, medical and veterinary preparations; sanitary preparations for medical purposes; dietetic food and substances adapted for medical or veterinary use, food for babies; dietary supplements for humans and animals; plasters, materials for dressings; material for stopping teeth, dental wax; disinfectants; preparations for destroying vermin; fungicides, herbicides.

32 – Beers; mineral and aerated waters and other non-alcoholic beverages; fruit beverages and fruit ju-

ices; syrups and other preparations for making beverages.

(260) AM 2019 101071 A

(800) 1442067

(151) 2017 10 12

(891) 2017 10 12

(731) JM HOLDING GMBH & CO. KGAA

Horchheimer Straße 50, 67547 Worms, Germany

(540)

### Renolit

(591) Black, white

(511)

1 – Adhesives used in industry; mineral suspensions for water treatment, especially for binding metal ions; unprocessed plastics; plastic granulate for manufacturing medical articles; unprocessed artificial resins; chemical preparations in the form of pastes and coatings for waterproofing and for protecting tiles and shingles (except paints); chemical products based on polymers and synthetic resins used for making waterproofing coating materials; solvents for industrial use; solvent welding compound.

2 – Paints, pastes, coatings and varnishes used for waterproofing and for protecting tiles, shingles, roofs, terraces and balconies from deterioration due to environmental effects; varnishes, lacquer pens for repairing plastic surfaces and for colouring joints and butt joints of plastic parts; anti-corrosion goods; antifouling self-adhesive tapes [anti-corrosion goods]; self-adhesive antifouling films and sheets [anti-corrosion goods]; corrosion prevention self-adhesive tapes; self-adhesive corrosion prevention films and sheets.

6 – Metal building materials, building materials of metal; laminated metal sheets, laminated metal plates; composite metal sheets and profiles; metal screws, profiles of metal, metal bars, metal plates; rivets, especially expanding rivets, from metal; roofing elements of metal; plastic coated metal cladding panels.

10 – Medical apparatus and instruments; bags, containers, and tubes for surgical, medical, dental and veterinary purposes; drainage tubes for medical purposes; adapted caps, closures, ports, and connectors for bags, containers, and tubes for surgical, medical,

dental and veterinary purposes; continuous ambulatory peritoneal dialysis system comprising bags, connecting tubes and valves; plastic films and sheets (medical grade materials) for surgical, medical, pharmaceutical, biopharmaceutical, dental and veterinary use.

16 – Self-adhesive sheets of plastics as stationary; adhesive tape for decoration purposes with or without a protective layer as stationary; films designed for overwrapping and the outer packaging of medical devices in particular sterile solution bags and blood bag systems; printed matter; magazines and periodicals; advertising pamphlets, advertising posters; films for packaging of food, especially fresh meat and fish; films for packaging cosmetics; protection film for food; protection films and sheets for packaging; protection film from laminated plastic for use in packaging; sterilizable packaging and packaging materials of plastic for foods for surgical, medical, dental and veterinary use.

17 – Semi-finished products from plastic materials (for further manufacturing) in the form of films, sheets, bars, pipes, blocks, pellets, plates; plastic substances partly processed; synthetic resins [semi-finished products]; artificial resins [semi-finished products]; plastics films and sheets for industrial use; films and sheets of plastic material except for packaging; films and sheets from plastic for use in manufacturing; calendared films and sheets for further manufacturing; films and sheets from plastic for thermoforming; plastic films and sheets with antimicrobial surface; films, sheets, and panels of plastic not for packaging, all aforementioned goods also of plastic including fillers like wood fibers, glass fibers or particles, and mineral fibers or particles as well as in the form of multilayer laminates incorporating other films and sheets of plastics, paper, rubber, leather, wood, metal, woven fabrics, knit fabrics, non-wovens of paper, textile material or plastic; thermoformable films, sheets, panels of plastic or of plastic including fillers like wood fibers, glass fibers or particles, and mineral fibers or particles, as far as included in this class; plastic films, sheets and panels for the manufacture of furniture, furniture parts, and furnishings; films and sheets of plastic for the surface of furniture, including furniture fronts, furniture doors, shelves, edges for furniture, carcasses, sides, or rear panels; films and sheets of plastic for coating or covering of furniture, furniture parts, and furnishings for use in manufacture; films and sheets of plastic for the coating of profiles for furniture, including light rails and mouldings for use in manufacture; films and sheets from plastic for covering drawer frames and for coating shelves for use in manufacture; films and sheets of plastics for coating or covering of building materials or of building components, including doors, door frames, windows, window frames, fences, facades, profiles, mouldings,

plates, beams, boards, paneling, ceiling liners, pipes, piles, window panes, gates, steps, partitions, of wood, metal, plastic and other materials; plastic films and sheets for manufacturing cladding of doors, walls and ceilings; plastic films and sheets for manufacturing housings of electrical equipment; plastic films and sheets for manufacturing interior decoration parts of automobiles, caravans, ships, boats, elevators, offices, hotels, shops, and rooms in private and public buildings; films, sheets and plates made of plastic material, extruded thermoformable, sheets and plates made of plastic material, extruded grained and/or printed films, sheet and plates, extruded thermoformable films, sheets and plates made of composite materials, extruded thermoformable films, sheets and plates made of plastic material and natural fibres and/or mineral fillers, plates including honeycomb structure and films and/or sheets, all for manufacturing vehicle parts; films and sheets from plastic for the manufacturing of windows, windows for soft tops of cars, and windows for sprayhoods and enclosures of boats; films, cloth and sheets from plastic for the manufacturing of sails, tarpaulins and casings for the shipping industry; films and sheets from plastic for the manufacturing of office supplies, organizational aids for offices, book covers and stationery; films and sheets from plastic for the manufacturing of promotional items; films and sheets from plastic for the manufacturing of items of camping equipment, recreation-oriented products and household goods; films and sheets from plastic for use in manufacturing solar modules; films [semi-finished goods] for building stretch ceilings; transparent films, sheets and plates from plastic for commercial use and further manufacturing; films and sheets and self adhesive films and sheets from plastic for manufacturing facade elements and for coating and renovating facade elements; flexible pipes (not of metal); flexible tubes made of plastic materials; plastic films for manufacturing medical containers and bags also sealable and sterilizable, especially blood bags, bags for infusion solution, containers for medicaments, multi chamber containers and bags with frangible partition; plastic films for manufacturing medical coverings; plastic films for manufacturing body bags; plastic films for manufacturing protective clothing; sealants; sealants in the form of waterproofing products for roofs, floors and walls; pastes and coating for sealing tiles, shingles, roofs, terraces and balconies against water and environmental effects; sealing strip; face to face welding tape of plastic; seam welding agents [sealant]; films for protecting surfaces (films for protecting against soiling); protective films and sheets of plastic, in particular antifouling films and sheets and corrosion prevention films and sheets; films and sheets of plastic coated with silicone or containing a layer from silicone for applying to surfaces; self-adhesive sheets of plastics for industrial use; adhesive tape for decoration purposes with

or without a protective layer for industrial use; self-adhesive film strips for repairing or mending surfaces laminated with film; self-adhesive protection film; protective film coated with antifouling substances or containing antifouling substances; protective film coated with non-corrosive substances or containing non-corrosive substances, self-adhesive, flocked protective films; adhesive tape for antifouling purposes with or without a protective layer; flocked films and sheets of plastic for use in covering floors, walls, stairways and other surfaces of buildings and vehicles for locomotion by land, air, water or rail; films and sheets with anti-slipping surface of plastic or of plastic with fillers for use in covering floors, walls, stairways and other surfaces of buildings and vehicles for locomotion by land, air, water or rail; films, sheets, membranes, and plates of plastic as waterproofing materials, for the waterproofing of terraces, tunnels, foundations, and buildings, as membrane sheets for sealing of roofs; films of plastic for swimming pools and garden ponds, for structural and civil engineering, for the building of roads, canals, dykes and river beds, for construction for environmental protection purposes, in particular storage pools and reservoirs for storing solid and liquid waste, retaining lakes, dams, tunnels, drainages, ducts, floating covers (for example on water basins), large area coverings (for example at salines), for protecting the ground including at filling stations, landfills, highways, waste deposits; plastic films for roofing; sheets and membranes (not of metal) for waterproofing roofing; antifouling films and tapes from plastic for construction; corrosion prevention films from plastic for construction; flocked films from plastic for use in construction; films with anti-slipping surface from plastic or from plastic with fillers for use in construction; films with anti-abrasion surface from plastic or from plastic with fillers for use in constructions; films of plastic for use in construction.

19 – Building materials made of plastic; processed plastic materials for use In construction; sheets and panels of plastic for use in construction but not as sealant or for insulation; lightweight panels; lightweight panels of plastic or of composite materials based on plastic; plastic films and sheets for use as geomembranes; geomembranes; sheets, membranes, and plates of plastic for swimming pools and garden ponds, as construction materials, for structural and civil engineering, for the building of roads, canals, dykes and river beds, for construction for environmental protection purposes, in particular storage pools arid reservoirs for storing solid and liquid waste, retaining lakes, dams, tunnels, drainages, ducts, floating covers, large area coverings, for protecting the ground including at filling stations, landfills, highways, waste deposits, skylight domes and lighting ridges for buildings, also ventilated; molded parts for ridges, eaves and wall connection; thermoformable

sheets and panels for construction purposes; honeycomb panels from plastic for use in construction; textile and fibre reinforced films and sheets of plastic for use in construction; roof covering, not of metal; plastic sheets for roofing; plastic profiles for roofing; sheets and transparent sheets of plastic for building, in particular for roofs, walls, coverings, facade claddings and for exhibition stand construction; cladding parts for buildings, not of metal; transparent plates from plastic with perforations and/or stiffening ribs as wall panels; plastic window screens; flexible plastic window screens; building material (not of metal), in the nature of facade elements; coatings for use in construction except paint; non-wovens made of synthetic fibres for use in the building Industry; stretch ceiling film and stretch ceilings; plastic coated cladding panel not of metal; protective plate, sheet from plastic for construction; antifouling sheets from plastic for construction; corrosion prevention sheets from plastic for construction; flocked sheets from plastic for use in construction; sheets with anti-slipping surface from plastic or from plastic with fillers for use in construction; sheets with anti-abrasion surface from plastic or from plastic with fillers for use in construction; covers not from metal in the form of thermoformed protective covers for covering conveyors; transparent plates from plastic.

27 – Floor coverings; wall coverings; wall hangings (non-textile); wall paper (not of textile material).

35 – Market research and trend analysis in the field of colour trends of plastic films for others.

41 – Training, organizing workshops and seminars in the field of cleaning and repairing film surfaces, especially of film coatings on building elements such as windows, doors, facade elements; training, organizing workshops and seminars in the field of roofing and waterproofing roofs, and waterproofing especially with respect to decorating with profiles and fixing of solar modules; training, organizing workshops and seminars in the field of pasting faces of buildings with plastic film; training, organizing workshops and seminars in the field of swimming pool construction (relating to the installation of swimming pool membrane); Training, organizing workshops and seminars in the field of handling, manipulation, installation and maintenance of plastic films, plastic sheets and plastic plates.

42 – Development of colours and colour palettes, for others; styling services (industrial design); conception (services of an engineer) of production lines and machines for laminating plastic films.

---

(260) AM 2019 101121 A  
 (800) 1443188  
 (151) 2018 11 10  
 (891) 2018 11 10

(731) APPLE INC.  
One Apple Park Way, Cupertino CA 95014,  
USA

(540)

## EVERYONE CAN CODE

(591) Black, white

(511)

9 – Educational computer software in the field of computers and software coding; downloadable electronic books, coursebooks, teacher guides, and tutorials in the field of computers and software coding.

41 – Instructional non-downloadable videos in the field of computers and software coding.

42 – Providing computer software information online; support and consultation services for developing computer applications.

(260) AM 2019 101147 A

(800) 1443496

(151) 2018 10 18

(891) 2018 10 18

(731) ITR Industry to Retail GmbH  
Frielingsdorfweg 12, 45239 Essen,  
Germany

(540)

## LUKA

(591) Black, white

(511)

9 – E-readers, included in this class, electronic writing implements, included in this class, teaching apparatus and instruments; apparatus for recording, transmission or reproduction of sound or images, electronic monitoring apparatus, electronic apparatus for transmission of audio signals, apparatus for electronic games for use with transmitters and receivers (included in this class), radio transmitters, media players for sound recording and image carriers, interactive games consisting of computer hardware and parts therefor, and software; magnetic recording apparatus, data processing apparatus and computers, peripherals adapted for use with computers, interfaces for computers; programs for computers, games software, games software, games software, computer game software downloaded from the Internet, video games [computer games] in the form of computer programs recorded on data carriers, interactive multimedia computer game programs.

41 – Education, providing of training, and entertainment; electronic games services, including provision of computer games on-line or by means of a global computer network; electronic games services provided from a computer database or by means of the Internet; services relating to electronic games and competitions provided via the Internet or global computer networks, Internet games (non-downloadable); providing information on-line relating to computer

games and computer enhancements for games, gaming services for entertainment purposes.

(260) AM 2019 101166 A

(800) 1443883

(151) 2018 11 07

(891) 2018 11 07

(731) Joint-Stock Company "VORONEZHSKAYA  
CONDITERSKAYA FABRIKA"  
ul. Koltsovskaya, d. 40, RU-394030  
Voronezh, Russian Federation

(540)



(591) White, dark red, dark pink, pink, light pink, dark brown, red-brown and yellow

(531) 26.04.02; 26.04.05; 26.04.12; 26.04.18;  
26.11.03; 26.11.12; 26.11.13; 26.11.25;  
27.05.03; 27.05.09; 28.05

(526) The latin words "Toffee", "original", and the Cyrillic characters transliterated as "s nachinkoj".

(511)

30 – Sweetmeats [candy], namely sweetmeats with a soft caramel body and with filling.

(260) AM 2019 101173 A

(800) 1443987

(151) 2018 08 15

(891) 2018 08 15

(731) Telefonaktiebolaget LM Ericsson  
SE-164 83 STOCKHOLM, Sweden

(540)

## MEDIAKIND

(591) Black, white

(511)

9 – Computer hardware; computer software; computer networks; application software for cloud computing services.

38 – Telecommunications services; computer network communication services; providing access to global computer networks; providing access to platforms on the Internet; broadcasting programs via a global computer network; transmission of audio and video content via computer networks; provision of

telecommunication access to video content provided via the Internet.

(260) AM 2019 101174 A  
 (800) 1444013  
 (151) 2018 08 15  
 (891) 2018 08 15  
 (731) Telefonaktiebolaget LM Ericsson  
 SE-164 83 STOCKHOLM, Sweden  
 (540)

**MediaKind**

(591) Blue, red and turquoise  
 (531) 26.01.03; 26.03.01; 27.01.25; 27.05.01;  
 29.01.13

(511)  
 9 – Computer hardware; computer software; computer networks; application software for cloud computing services.

38 – Telecommunications services; computer network communication services; providing access to global computer networks; providing access to platforms on the Internet; broadcasting programs via a global computer network; transmission of audio and video content via computer networks; provision of telecommunication access to video content provided via the Internet.

(260) AM 2019 101362 A  
 (800) 684419  
 (151) 1997 12 12  
 (891) 2018 12 11  
 (731) ACM  
 17 rue de Neuilly, Impasse Passoir,  
 F-92110 CLICHY, France  
 (540)

**BOREADE**

(591) Black, white  
 (511)  
 3 – Cosmetic products for skin care, cosmetic creams, cosmetic kits, lotions for cosmetic purposes, tissues impregnated with cosmetic lotions, beauty masks, make-up removing products, soaps, medicated soap, cleansing milk, almond oil for cosmetic purposes, oils for cosmetic purposes, almond oil, cosmetic preparations for slimming purposes, sunscreen products, astringents for cosmetic purposes, cosmetic preparations for baths, cotton sticks for cosmetic purposes, creams for whitening the skin, perfumery goods, essential oils, cosmetics, hair lotions, dentifrices, cosmetic products.

(260) AM 2019 101363 A  
 (800) 822485  
 (151) 2004 02 11

(891) 2018 12 11  
 (731) ACM  
 17, rue de Neuilly, Impasse Passoir,  
 F-92100 CLICHY, France  
 (540)

**ROSAKALM**

(591) Black, white  
 (511)  
 3 – Soaps, perfumery goods, essential oils, cosmetics, hair lotions, dentifrices.

(260) AM 2019 101364 A  
 (800) 1141434  
 (151) 2012 09 07  
 (891) 2019 01 10  
 (731) DEERE & COMPANY  
 One John Deere Place, Moline, Illinois  
 61265-8098, USA  
 (540)

**HY-GARD**

(591) Black, white  
 (511)  
 1 – Hydraulic oils.  
 4 – Industrial oils and greases, for example lubricants, spray oils, engine oils, gear lubricants, gear, servo, hydrostatic powdered graphite, bearing lubricants, lubricants for mechanical cotton picker spindles, chain lubricants, general purposes lubricants, lubricating grease.

(260) AM 2019 101365 A  
 (800) 1162778  
 (151) 2013 05 22  
 (891) 2018 12 17  
 (731) CITIZEN WATCH COMPANY OF  
 AMERICA, INC., d/b/a Bulova  
 Empire State Building, 350 Fifth Avenue,  
 29th Floor, New York NY 10118, USA  
 (540)

**CARAVELLE**

(591) Black, white  
 (511)  
 14 – Watches.

(260) AM 2019 101366 A  
 (800) 1174570  
 (151) 2013 07 23  
 (891) 2019 01 08  
 (731) ALBIONE POLAND KATARZYNA  
 JANOWSKA PUDLO  
 ul. Rolna 311, PL-05-830 Nadarzyn, Poland  
 (540)

**ALBIONE**



(591) Black, white  
 (531) 26.11.02; 26.11.07; 26.11.11; 27.05.10;  
 27.05.11  
 (511)  
 3 – Cosmetics.  
 25 – Clothing.

(260) AM 2019 101367 A  
 (800) 1199468  
 (151) 2014 02 13  
 (891) 2019 01 08  
 (731) MONTEROSSO SP. Z O.O.  
 ul. Trakt Lubelski 84, PL-04-790 Warszawa,  
 Poland  
 (540)

## Mezzatorre

(591) Black, white  
 (511)  
 3 – Cosmetics.  
 18 – Bags.  
 25 – Suits; shirts; trousers; shoes; neckties; pocket squares; waistcoats; vests; jackets; overcoats, topcoats; belts; skirts; scarves, scarfs; sweaters; shawls; clothing; pelerines; stuff jackets.

(260) AM 2019 101368 A  
 (800) 1354891  
 (151) 2017 04 11  
 (891) 2018 12 03  
 (731) SAMSUNG ELECTRONICS CO., LTD.  
 129, Samsung-ro, Yeongtong-gu, Suwon-si,  
 Gyeonggi-do, Republic of Korea  
 (540)

## Bixby

(591) Black, white  
 (511)  
 9 – Computer software for personal information management; smartphones; computer application software for smart phones, mobile telephones, portable computers and tablet computers, namely, software used to operate voice recognition system; computer software for use by software professionals to implement an interactive, personalized and intelligent interface for application software and computer hardware devices; computer software for dictation; computer software used to process voice commands; speech to text conversion software; voice recognition software; computer software for enabling hands-free use of a mobile phone through voice recognition; computer hardware used for the control of voice controlled information and communication devices; computer software used for the control of voice controlled information and communication devices; mobile telephones; computer software for users to

share information to provide interactive and personalized intelligence for use by their computer hard devices and software for interfacing with the internet; electronic voice recognition apparatus; computer software for scheduling appointments, reminders, and events on an electronic calendar; telephone-based information retrieval software; computer software for storing, organizing, and accessing phone numbers, addresses, and other personal contact information; computers; tablet computers; portable computers; operating software for portable telecommunications apparatus and digital electronic products.

42 – Software as a service (SAAS) services featuring computer software for creating, authoring, distributing, downloading, transmitting, receiving, playing, editing, extracting, encoding, decoding, displaying, storing and organizing text, graphics, images, audio, video, and multimedia content, computer software for personal information management, database management software, database synchronization software, voice recognition software, speech to text conversion software, voice-enabled software applications, computer software for accessing, browsing and searching online databases, computer software used to process voice commands and create audio responses to voice commands, computer software for dictation, computer software for scheduling appointments, reminders, and events on an electronic calendar, computer software for organizing and accessing phone numbers, addresses, and other personal contact information, computer software for providing travel directions, computer software for enabling hands-free use of a mobile phone through voice recognition, and computer software for making reservations at hotels and restaurants; application service provider (ASP) services featuring computer software and providing online non-downloadable software, namely, computer software for creating, authoring, distributing, downloading, transmitting, receiving, playing, editing, extracting, encoding, decoding, displaying, storing and organizing text, graphics, images, audio, video, and multimedia content, computer software for personal information management, database management software, database synchronization software, voice recognition software, speech to text conversion software, voice-enabled software applications, computer software for accessing, browsing and searching online databases, computer software used to process voice commands and create audio responses to voice commands, computer software for dictation, computer software for scheduling appointments, reminders, and events on an electronic calendar, computer software for organizing and accessing phone numbers, addresses, and other personal contact information, computer software for providing travel directions, computer software for enabling hands-free use of a mobile phone through voice recognition, and computer software for making reservations at hotels and restaurants; providing tem-

porary use of on-line non-downloadable software and applications for users to share information to provide interactive and personalized intelligence for use in interfacing with computer devices and the internet.

(260) AM 2019 101429 A

(800) 1446484

(151) 2018 12 13

(891) 2018 12 13

(731) LTD "VALENTA-INTELLEKT"

ul. Generala Dorokhova, d.18, str.2Б  
RU-119530 Moscow, Russian Federation;  
E. Schelkunova, Patent & Law Firm "YUS"  
Patent & Law Firm "YUS", LLC, d.6,  
Prospekt Mira, RU-129090 Moscow,  
Russian Federation

(540)

## НАНОТРОПИЛ

(591) Black, white

(531) 28.05

(511)

5 – Pharmaceutical preparations; sanitary preparations for medical purposes; dietetic substances adapted for medical use; food for babies; medical plasters; materials for dressings.

(260) AM 2019 101431 A

(800) 1446554

(151) 2018 10 31

(891) 2018 10 31

(731) ADALYA TOBACCO INTERNATIONAL  
GMBH

Vogelsanger Weg 80 40470 Düsseldorf,  
Germany

(540)



(591) Blue and mint

(531) 01.15.24; 26.11.01; 26.11.12; 29.01.12

(511)

34 – Articles for use with tobacco; matches; personal vaporisers for smoking purposes and electronic cigarettes, and flavourings and solutions therefor; tobacco and tobacco products (including substitutes).

(260) AM 2019 101440 A

(800) 1446848

(151) 2018 10 18

(891) 2018 10 18

(731) ABSTRAGAN HOLDING LIMITED

Astra House Arklow Road, London  
SE14 6EB, United Kingdom

(540)

## Lady Healthcare

(591) Black, white

(511)

5 – Food for babies, material for stopping teeth, dental wax; disinfectants; preparations for destroying vermin; fungicides, herbicides.

(260) AM 2019 101446 A

(800) 1446919

(151) 2018 10 24

(891) 2018 10 24

(731) "ADRIATIC MARINAS" d.o.o.

Obala bb, Tivat, 85320 Crna Gora,  
Montenegro

(540)

## M Residences

(591) Black, white

(531) 27.05.17

(511)

36 – Insurance; financial affairs; monetary affairs; real estate affairs.

39 – Transport; packaging and storage of goods; travel arrangement.

41 – Education; providing of training; entertainment; sporting and cultural activities.

43 – Services for providing food and drink; temporary accommodation.

44 – Medical services; veterinary services; hygienic and beauty care for human beings or animals; agriculture, horticulture and forestry services.

(260) AM 2019 101448 A

(800) 1446968

(151) 2018 10 23

(891) 2018 10 23

(731) "UNIPHARM-UKRAINE", LLC

Moskovskiyi prospect 9-V, Kyiv 04073,  
Ukraine

(540)

## НАЙТВЕЛЛ

(591) Black, white

(531) 28.05

(511)

3 – Bleaching preparations and other substances for laundry use; cleaning, polishing, scouring and abrasive preparations; non-medicated soaps; perfumery, essential oils, non-medicated cosmetics, non-medicated hair lotions; non-medicated dentifrices.

5 – Pharmaceuticals, medical and veterinary preparations; sanitary preparations for medical purposes;

dietetic food and substances adapted for medical or veterinary use, food for babies; dietary supplements for humans and animals; plasters, materials for dressings; material for stopping teeth, dental wax; disinfectants; preparations for destroying vermin; fungicides, herbicides.

32 – Beers; mineral and aerated waters and other non-alcoholic beverages; fruit beverages and fruit juices; syrups and other preparations for making beverages.

(260) AM 2019 101472 A

(800) 1447668

(151) 2018 11 08

(891) 2018 11 08

(731) ITALPIZZA S.p.A.

Via Gherbella, 454/A, I-41126 Modena, Italy

(540)



(591) Red and white

(531) 01.15.05; 02.01.01; 02.01.11; 02.01.23;  
11.01.09; 29.01.12

(511)

30 – Flour and preparations made from cereals; frozen, fresh and pre-baked pizzas; pizza crust; calzones; flat bread; pies; typical Italian oval focaccia and/or pizza made from mixed flours and other toppings [pinsa]; bread; breadsticks; pasta; salted biscuits made from cereals; pastry; biscuits; baking-powder; yeast for pizzas; sauces and condiments; sauces and condiments for pizzas; spices.

35 – Advertising; retail and wholesale services, including online retail and wholesale services, in relation to flour and preparations made from cereals, pizzas, pizza crust, calzones, flat bread, pies, typical Italian oval focaccia and/or pizza made from mixed flours and other toppings [pinsa], bread, breadsticks, pasta, salted biscuits made from cereals, pastry, biscuits, baking-powder, yeast for pizzas, sauces and condiments, spices.

43 – Restaurant services; pizzerias; contract food services.

(260) AM 2019 101482 A

(800) 866366

(151) 2005 04 25

(891) 2019 01 14

(731) KERMI GMBH

Pankofen-Bahnhof 1, 94447 Plattling,  
Germany

(540)

## Therm x2

(591) Black, white

(511)

11 – Bath and shower tubs; shower cubicles, partitions of light metal, plastic or glass for showers and bath tubs (enclosures); air filtering installations, air filters; sanitary apparatus and installations, toilets, bidets, urinals, toilet seats, water flushing installations, flushing tanks, wash-hand basins, water taps, water conduits installations, mixer taps for water pipes, water supply installations, water distribution installations, water purification installations, water intake apparatus; whirlpool tubs, spa baths (vessels), whirlpool-jet apparatus.

(260) AM 2019 101530 A

(800) 1447731

(151) 2018 11 17

(891) 2018 11 17

(731) PACIFIC PHARMACEUTICALS PTE LTD

101 Cecil Street, #17-07 Tong Eng Building,  
Singapore 069533, Singapore

(540)

## Pacmol

(591) Black, white

(511)

5 – Mineral dietary supplements for humans; pharmaceutical drugs.

(260) AM 2019 101531 A

(800) 1447732

(151) 2018 11 17

(891) 2018 11 17

(731) PACIFIC PHARMACEUTICALS PTE LTD

101 Cecil Street, #17-07 Tong Eng Building,  
Singapore 069533, Singapore

(540)

## Medigesic

(591) Black, white

(511)

5 – Pharmaceutical drugs; mineral dietary supplements for humans.

(260) AM 2019 101532 A

(800) 1447757

(151) 2018 10 18

(891) 2018 10 18

(731) İSTANBUL SİLAH VE SAVUNMA

SANAYİ TİCARET ANONİM ŞİRKETİ

Dudullu OSB 1.Cadde No.7, ÜMRANİYE –  
İSTANBUL, Turkey

(540)



(591) Black, white, red

(531) 26.03.06; 26.11.03; 26.11.12; 27.05.01;  
29.01.12

(511)

13 – Firearms, air pistols (weapons), weapon cases for firearms, belts adapted for ammunition and shoulder straps for weapons.

(260) AM 2019 101534 A

(800) 1447785

(151) 2018 03 09

(891) 2018 03 09

(731) SUPERIOR 14 INDUSTRIAL  
KERESKEDELMI KORLÁTOLT  
FELELŐSSÉGŰ TÁRSASÁG  
ECSERI ÚT 14-16, H-1097 BUDAPEST,  
Hungary

(540)



(591) Black, white

(531) 27.05.10

(511)

5 – Pharmaceuticals, medical and veterinary preparations; sanitary preparations for medical purposes; dietetic food and substances adapted for medical or veterinary use, food for babies; dietary supplements for humans and animals; plasters, materials for dressings; material for stopping teeth, dental wax; disinfectants; preparations for destroying vermin; fungicides, herbicides.

28 – Games, toys and playthings; video game apparatus; gymnastic and sporting articles; decorations for Christmas trees.

32 – Beers; mineral and aerated waters and other non-alcoholic beverages; fruit beverages and fruit juices; syrups and other preparations for making beverages.

(260) AM 2019 101536 A

(800) 1447817

(151) 2018 11 17

(891) 2018 11 17

(731) PACIFIC PHARMACEUTICALS PTE LTD  
101 Cecil Street, #17-07 Tong Eng Building,  
Singapore 069533, Singapore

(540)

**Energen**

(591) Black, white

(511)

5 – Mineral dietary supplements for humans; pharmaceutical drugs.

(260) AM 2019 101539 A

(800) 1447964

(151) 2018 12 18

(891) 2018 12 18

(731) DAVINES S.p.A.

Via Ravasini, 9/A, I-43100 PARMA (PR),  
Italy

(540)

**THE CIRCLE CHRONICLES**

(591) Black, white

(511)

3 – Cosmetics; hair masks; hair care masks; hair care lotions; hair preparations and treatments; hair spray; hair creams; cosmetic preparations for hair care; hair texturizers; conditioning preparations for the hair; shampoo; hair balm; hair dye; hair bleaching preparations; soaps; perfumery; essential oils.

(260) AM 2019 101540 A

(800) 1447974

(151) 2018 12 18

(891) 2018 12 18

(731) DAVINES S.p.A.

Via Ravasini, 9/A, I-43100 PARMA, Italy

(540)

**THE CENTURY OF  
LIGHT**

(591) Black, white

(511)

3 – Cosmetics; hair bleaching preparations; brightening agents for hair; hair lighteners; hair powder; hair colour removal powders; oils for hair conditioning; hair lightening oils; hair dye; hair masks; hair care lotions; hair preparations and treatments; hair spray; hair creams; cosmetic preparations for hair care; hair texturizers; conditioning preparations for the hair; shampoo; hair balm; soaps; perfumery; essential oils.

(260) AM 2019 101541 A

(800) 1447992

(151) 2018 11 23

(891) 2018 11 23

(731) BELYAEVA YULIA ALEXANDROVNA  
Akademika Anokhina Street, d. 56, kv. 36,  
RU-119571 Moscow, Russian Federation

(540)

**THERR MAITZ**

(591) Black, white

(511)

3 – Amber [perfume]; aromatics [essential oils]; air fragrancing preparations; cake flavorings [essential oils]; flavorings for beverages [essential oils]; breath freshening sprays; balms, other than for medical purposes; lip glosses; petroleum jelly for cosmetic purposes; cotton wool for cosmetic purposes; sachets for perfuming linen; drying agents for dishwashing machines; adhesives for cosmetic purposes; scented water; Javelle water; lavender water; toilet water; floor wax; non-slipping wax for floors; depilatory wax; mustache wax; tailors' wax; polish for furniture and flooring; shoemakers' wax; polishing wax; massage gels, other than for medical purposes; heliotropine; dental bleaching gels; geraniol; make-up; deodorants for pets; scented wood; perfumes; non-slipping liquids for floors; windshield cleaning liquids; greases for cosmetic purposes; volcanic ash for cleaning; perfumery; decorative transfers for cosmetic purposes; ionone [perfumery]; shaving stones [astringents]; smoothing stones; eyebrow pencils; cosmetic pencils; silicon carbide [abrasive]; carbides of metal [abrasives]; alum stones [astringents]; tripoli stone for polishing; adhesives for affixing false eyelashes; adhesives for affixing false hair; quillaia bark for washing; corundum [abrasive]; beard dyes; colorants for toilet purposes; cosmetic dyes; laundry starch; laundry glaze; creams for leather; polishing creams; shoe polish; cosmetic creams; skin whitening creams; polishing rouge; incense; hair spray; nail polish; hair lotions; lotions for cosmetic purposes; after-shave lotions; beauty masks; oils for perfumes and scents; oils for cosmetic purposes; oils for toilet purposes; essential oils; essential oils of cedarwood; essential oils of lemon; essential oils of citron; oils for cleaning purposes; bergamot oil; gaultheria oil; jasmine oil; lavender oil; almond oil; rose oil; oil of turpentine for degreasing; whiting; cleaning chalk; almond milk for cosmetic purposes; cleansing milk for toilet purposes; musk [perfumery]; soap; deodorant soap; shaving soap; soap for brightening textile; cakes of toilet soap; antiperspirant soap; soap for foot perspiration; almond soap; mint for perfumery; cosmetic kits; emery; nail art stickers; false nails; eau de Cologne; bases for flower perfumes; cotton sticks for cosmetic purposes; joss sticks; pastes for razor strops; dentifrices; pumice stone; hydrogen peroxide for cosmetic purposes; breath freshening strips; abrasive cloth; glass cloth [abrasive cloth]; lipsticks; pomades for cosmetic purposes; shaving preparations; cosmetic preparations for baths; toiletry preparations; hair waving preparations; laundry soaking preparations; grinding preparations; douching preparations for personal sanitary or deodorant purposes [toilettries]; smoothing preparations [starching]; color-removing preparations; leather bleaching preparations; polishing preparations; denture polishes; mouthwashes, not for medical purpo-

ses; cosmetic preparations for slimming purposes; starch glaze for laundry purposes; refurbishing preparations; fabric softeners for laundry use; laundry bleach; dry-cleaning preparations; paint stripping preparations; lacquer-removing preparations; make-up removing preparations; floor wax removers [scouring preparations]; varnish-removing preparations; nail care preparations; cleaning preparations; preparations for cleaning dentures; wallpaper cleaning preparations; preparations for unblocking drain pipes; laundry preparations; aloe vera preparations for cosmetic purposes; sunscreen preparations; color-brightening chemicals for household purposes [laundry]; shining preparations [polish]; make-up powder; diamantine [abrasive]; stain removers; scouring solutions; false eyelashes; tissues impregnated with cosmetic lotions; safrol; laundry blueing; turpentine for degreasing; potpourris [fragrances]; bleaching soda; washing soda, for cleaning; bath salts, not for medical purposes; bleaching salts; fumigation preparations [perfumes]; preservatives for leather [polishes]; ammonia [volatile alkali] [detergent]; astringents for cosmetic purposes; eyebrow cosmetics; make-up preparations; sun-tanning preparations [cosmetics]; hair dyes; neutralizers for permanent waving; preparations to make the leaves of plants shiny; cosmetic preparations for eyelashes; hair removal products, depilatory preparations; depilatory preparations; cosmetic preparations for skin care; shoe cream; cosmetics; cosmetics for animals; mascara; detergents, other than for use in manufacturing operations and for medical purposes; degreasers, other than for use in manufacturing processes; bleaching preparations [decolorants] for cosmetic purposes; antiperspirants [toilettries]; talcum powder, for toilet use; terpenes [essential oils]; emery cloth; cloths impregnated with a detergent for cleaning; henna [cosmetic dye]; shampoos; shampoos for animals [non-medicated grooming preparations]; dry shampoos; sandpaper; soda lye; extracts of flowers [perfumes]; ethereal essences; badian essence; mint essence [essential oil].

25 – Wimples; bandanas [neckerchiefs]; underwear; sweat-absorbent underwear; berets; overalls; boas [necklets]; teddies [underclothing]; ankle boots; ski boots; boots for sports; breeches for wear; trousers; football boots; brassieres; detachable collars; collars [clothing]; shirt yokes; veils [clothing]; gabardines [clothing]; galoshes; neckties; ascots; leggings [leg warmers]; gaiters; boot uppers; corselets; jerseys [clothing]; vests; sports jerseys; hosiery; heels; long underwear; hoods [clothing]; hat frames [skeletons]; pockets for clothing; neck scarfs [mufflers]; cap peaks; tights; slips [underclothing]; combinations [clothing]; wet suits for water-skiing; bodices [lingerie]; corsets [underclothing]; suits; bathing suits; masquerade costumes; beach clothes; jackets [clothing]; stuff jackets [clothing]; fishing vests; leggings [trousers]; liveries; camisoles; cuffs; short-sleeve

shirts; mantillas; coats; sleep masks; furs [clothing]; mittens; miters [hats]; muffs [clothing]; footmuffs, not electrically heated; heelpieces for footwear; bibs, not of paper; fur stoles; ear muffs [clothing]; socks; beach shoes; sports shoes; footwear; paper clothing; outerclothing; ready-made clothing; motorists' clothing; cyclists' clothing; clothing for gymnastics; clothing of imitations of leather; clothing of leather; uniforms; clothing; fittings of metal for footwear; maniples; overcoats; parkas; pelerines; gloves [clothing]; ski gloves; pajamas; bathing trunks; shirt fronts; scarfs; pocket squares; dresses; raincoats; headbands [clothing]; garters; sock suspenders; stocking suspenders; ready-made linings [parts of clothing]; dress shields; soles for footwear; braces for clothing [suspenders]; lace boots; ponchos; girdles; belts [clothing]; money belts [clothing]; layettes [clothing]; non-slipping devices for footwear; sweaters; heelpieces for stockings; welts for footwear; chasubles; shirts; wooden shoes; sandals; bath sandals; boots; sarongs; jumper dresses; saris; footwear uppers; inner soles; bath slippers; togas; knitwear [clothing]; underpants; gymnastic shoes; slippers; shoes; skull caps; turbans; headgear for wear; aprons [clothing]; tee-shirts; dressing gowns; bath robes; top hats; tips for footwear; stockings; sweat-absorbent stockings; shawls; caps [headwear]; paper hats [clothing]; shower caps; bathing caps; sashes for wear; studs for football boots; hats; babies' pants [clothing]; trouser straps; pelisses; esparto shoes or sandals; skirts; petticoats; skorts.

41 – Dubbing; publication of books; entertainment information; movie studio services; microfilming; videotape editing; production of radio and television programmes; presentation of variety shows; music composition services; organization of balls; providing recreation facilities; arranging and conducting of concerts; organization of lotteries; theatre productions; educational examination; videotape film production, other than advertising films; film production, other than advertising films; rental of sound recordings; rental of audio equipment; rental of video cameras; rental of video cassette recorders; rental of videotapes; rental of show scenery; rental of films; rental of cinematographic apparatus; rental of motion pictures; scriptwriting, other than for advertising purposes; recording studio services.

(260) AM 2019 101542 A  
(800) 1447999  
(151) 2018 12 12  
(891) 2018 12 12  
(731) APPLE INC.

One Apple Park Way, Cupertino CA 95014,  
USA

(540)

**SILVERVERB**

(591) Black, white

(511)

9 – Computer software for creating and recording music; computer software for sound mixing and synthesizing; computer software for digital audio production, processing, and editing; computer software for control and customization of audio effects.

(260) AM 2019 101543 A

(800) 1448012

(151) 2018 11 27

(891) 2018 11 27

(731) IRISH DISTILLERS LIMITED

Simmons Court House, Simmons Court Road,  
Ballsbridge, 4 Dublin, Ireland

(540)



(591) Black, white, green, brown

(531) 19.07.01; 27.01.12; 29.01.13

(554) Three-dimensional

(511)

33 – Alcoholic beverages [except beers].

(260) AM 2019 101544 A

(800) 1448015

(151) 2018 10 17

(891) 2018 10 17

(731) DELI GROUP CO., LTD.

DELI INDUSTRIAL PARK, NINGHAI  
COUNTY, NINGBO, 310008 ZHEJIANG,  
China

(540)

**deli**

(591) Black, white

(531) 27.05.17

(511)

8 – Pickhammers; bits [parts of hand tools]; dies [hand tools]; cutting tools [hand tools]; saws [hand tools]; planes; plane irons; punches [hand tools]; crow bars; tube cutters [hand tools]; irons [non-electric hand tools]; guns, hand-operated, for the extrusion of mastics; tweezers; graving tools [hand tools]; penknives; reamers; wire strippers [hand tools]; scraping tools [hand tools]; expanders [hand tools]; hobby knives [scalpels]; blades [hand tools]; ceramic knives; handles for hand-operated hand tools; side arms, other than firearms; garden tools,

hand-operated; spanners [hand tools]; screwdrivers, non-electric; axes; hammers [hand tools]; augers [hand tools]; pincers; vices; perforating tools [hand tools]; ratchets [hand tools]; spatulas [hand tools]; trowels; emery files; glaziers' diamonds [parts of hand tools]; pruning scissors; milling cutters [hand tools]; table cutlery [knives, forks and spoons]; gouges [hand tools]; centre punches [hand tools]; files [tools]; nail punches; riveters [hand tools]; non-electric caulking guns; metal wire stretchers [hand tools]; scissors; knives.

(260) AM 2019 101545 A

(800) 1448044

(151) 2018 12 13

(891) 2018 12 13

(731) LI JIANHAI

ROOM 1701, No. 4, TIANLEJING, TIANHE DISTRICT, GUANGZHOU, GUANGDONG, China

(540)



(591) Black, white

(531) 24.01.05

(511)

11 – Air conditioning apparatus; extractor hoods for kitchens; heating apparatus; taps [faucets]; heating installations [water]; pipes [parts of sanitary installations]; bath tubs; bath installations; bath fittings; toilet bowls; sauna bath installations; shower enclosures; sinks; solar water heaters; water purification installations; purification installations for sewage.

(260) AM 2019 101546 A

(800) 1448067

(151) 2018 07 17

(891) 2018 07 17

(731) LOUIS VUITTON MALLETIER

2 rue du Pont-Neuf, F-75001 Paris, France

(540)



(591) Black, white

(511)

3 – Bleaching preparations and other substances for laundry use, cleaning, polishing and degreasing preparations, cleaning products, oils for cleaning, preservatives for leather (waxes), leather bleaching products, polishing creams, creams for leather, shoe creams, shoe polishes, waxes, wax for cobblers; perfumery products; perfumes; eaux de toilette; eaux de parfum; eaux de cologne; perfume bases; extracts of flowers; essential oils; air freshening products; pot-pourris [fragrances]; incense; cosmetic skin and lip care products; cosmetic preparations for slimming; lotions for cosmetic use; beauty masks; cosmetic hand, face and body care products; hair care products; conditioners; hair lotions; hair bleaches; hair dyes; hair styling creams or gels; hair sprays; depilatory creams, hair-removing waxes; shaving products; shaving soap; shaving foam; after shave products; sunscreen products for cosmetic use; suntan enhancing preparations for cosmetic use; self-tanning preparations for cosmetic use; toiletries; dentifrice; soaps; shampoos; shower gels; bath gels; bath oils; bath salts; foaming bath products; bath beads; talcum powder for toilet use, cleansing milk for toilet use; deodorants; make-up products; lipstick; mascaras for eyelashes; blushers; make-up powder; eye shadows; make-up pencils; make-up removing products; decorative transfers for cosmetic use, temporary tattoos for the body and nails; make-up sets; nail care and nail appearance improvement products; nail polish, nail protectors, nail lacquers, nail product removers; false nails for the hands and feet, false nail kits, false nail adhesives.

9 – Scientific, nautical, surveying, photographic, cinematographic, optical, weighing, measuring, signaling, checking (supervision), life-saving and teaching apparatus and instruments, apparatus for recording, transmission, reproduction of sound or images, magnetic recording media, sound recording disks; bags and cases for video cameras or photographic apparatus; compact disks, DVDs and other digital recording media; calculating machines, data processing equipment, computers and computer equipment; mouse pads; software; USB stick, electronic diaries, game software, recorded computer programs, computer and mobile phone programs (downloadable software) and electronic publications downloadable online or from the Internet; optical goods, spectacles, sunglasses, goggles for sports; spectacle frames; spectacle lenses, contact lenses; cases for spectacles or for contact lenses; binoculars; sleeves for laptops; bags designed for laptop computers; photographic apparatus; signaling buoys, positioning buoys; telephones, mobile telephones, smartphones, tablets, personal electronic assistants and MP3 players; accessories for telephones, mobile telephones, smartphones, tablets, PDAs and MP3 players, namely: hands-free kits for telephones, batteries, covers, casings, facings, chargers, straps or lanyards, earp-

hones; bags and cases for mobile telephones and telephone equipment.

14—Jewelry and jewelry products (including fashion jewelry); precious or semi-precious stones; pearls; jewelry cases [caskets]; finger rings, earrings, cuff links, bracelets, charms, brooches, chains, necklaces, pendants, key rings (trinkets or fobs), tie pins, medallions, medals, jewelry for bags; jewelry boxes; trophies of precious metal; timepiece products and chronometric instruments, watches, wristwatches, watch bands, alarm clocks, chronometers, wall clocks, cases or presentation cases for timepieces; clocks (timepieces).

16 – Paper or cardboard products, namely, bags and wrapping paper, paper or cardboard bags and boxes, hat boxes, watercolors, drawings, stage sets, architectural models; printed products in particular posters, albums, atlases, brochures, maps, postcards, catalogs, non-fabric labels, printed matter, books, newspapers, periodicals, publications, journals, diaries, ribbons; bookbinding material; photographs; stationery in particular, blocks, drawing pads, blotters, notebooks, calendars, notebooks, envelopes, writing paper, directories; adhesives for stationery or household purposes; artists' materials; paintbrushes; typewriters and office requisites (except for furniture), in particular writing slates, seal boxes and stamp pads, letter trays, letter openers, pencils, writing boards, inkwells, paperweights, pencil holders, pen holder, desk pad, pens, balls and nibs for pens; instructional or teaching material (except apparatus); plastic materials for packaging (not included in other classes); printing type; printing blocks.

18 – Leather and imitations of leather; trunks and suitcases; traveling bags, sports bags; handbags, backpacks; beach bags, school bags, satchels, shopping bags; traveling trunks; travel bags for clothing and shoes; attaché cases and document cases, attaché cases for documents, briefcases (leather goods); purses, wallets, card holders (wallets), coin purses not of precious metal, key cases (leather goods); boxes of leather or imitation leather; traveling sets (leatherware); vanity cases; pouches of leather, clutch bags (evening handbags); parasols; umbrellas; clothing for animals, bags for carrying animals.

24 – Textiles and textile goods not included in other classes, bed and table covers, plaids, duvets, travel blankets; household linen, covers for cushions, bed linen, bedspreads, sheets, pillow covers, duvet covers; bath linen [except for clothing], bath sheets, towels, washcloths, table linen not of paper, tablecloths not of paper, napkins of textiles, place-mats not of paper, textile handkerchiefs, textile labels, sleeping bags, textiles wall hangings.

25 – Clothing, pullovers, vests, shirts, tee-shirts, trousers, jackets, suits, coats, raincoats, overcoats, parkas, skirts, dresses, shorts; pajamas, house coats, nightgowns and nightshirts, dressing gowns; hats,

caps of all kinds, gloves (clothing), neckties, belts (clothing), leather belts, scarves, pocket squares (clothing), sashes for wear, shawls, stockings, socks, tights, suspenders, stoles; underwear, lingerie; bathing suits; footwear, slippers, boots and half-boots.

35 – Advertising; rental of advertising space; dissemination of advertisements; dissemination of advertisements by mail; dissemination of advertising material (leaflets, prospectuses, printed matter, samples); arranging newspaper subscriptions for others; publication of advertising texts; commercial business management; commercial administration; distribution of prospectuses, of samples; business advice, business information or inquiries; business research; commercial or industrial company management assistance; appraisals for business or industry; accounting; document reproduction; employment agencies; computer file management; data entry and processing services, rental of commercial computer files; organization of exhibitions for commercial or advertising purposes; online advertising on a computer network; rental of advertising time on all communication media; public relations; modeling services for advertising or sales promotion; bill-posting, shop window dressing; sales promotion for others; promotion of products by televisions, the Internet and catalogs with sales offers; organization of events for commercial purposes; administration of exhibition sites; presentation of products on any means of communication for retail sale; commercial information and advice for consumers; business administration of the licensing of goods and services; arranging of telecommunication service subscriptions for others; bringing together for the benefit of others of various leather goods, jewelry, watchmaking, eye-wear, stationery, pens, umbrellas, sporting articles, articles for smokers, clothing and footwear articles and telecommunication apparatus (except for their transport), enabling consumers to see and purchase them conveniently in-store; wholesale and retail sale of stationery, leather products, jewelry, watchmaking, eye-wear, pens, umbrellas, sporting goods, smokers' articles, clothing and footwear articles and telecommunication apparatus, books.

38 – Communication and telecommunication services, particularly on terminals, computer peripheral devices or electronic and/or digital equipment; transmission and dissemination of images, sounds, data, information via computer terminals or via any other telecommunication means, and in particular via the Internet; interactive communication services, broadcasting of multimedia programs (editing of texts and/or images, still or animated, and/or musical sounds); provision of discussion forums on the Internet; connection services to the Internet or to databases by telecommunication means; providing access to a site on a global computer network for the distribution of information and documents of all kinds.



41 – Sporting activities, namely, arranging and organization of sports events, races, competitions and demonstrations; radio, television and film production; entertainment services and information concerning sailing, sailing competitions and water vehicles; publication of books; publication of texts other than advertising texts; electronic publishing of books online; timing of sporting events; publication of information concerning sailing; provision of venues, circuits and other installations for sports events, races, competitions and demonstrations; organization of exhibitions for cultural or educational purposes; photographic reporting; organization of fashion shows for entertainment purposes.

(260) AM 2019 101547 A

(800) 1448073

(151) 2018 12 13

(891) 2018 12 13

(731) LI JIANHAI

Room 1701, No.4, Tianlejing, Tianhe  
District, Guangzhou, Guangdong, China

(540)

**HIMARK**

(591) Black, white

(531) 27.05.01

(511)

11 – Air conditioning apparatus; extractor hoods for kitchens; heating apparatus; taps [faucets]; heating installations [water]; pipes [parts of sanitary installations]; bath tubs; bath installations; bath fittings; toilet bowls; sauna bath installations; shower enclosures; sinks; solar water heaters; water purification installations; purification installations for sewage.

(260) AM 2019 101548 A

(800) 1448132

(151) 2018 10 20

(891) 2018 10 20

(731) WEIFANG HUADONG RUBBER CO., LTD.

LIUJIAHETOU VILLAGE, TAITOU TOWN,  
SHOUGUANG CITY, WEIFANG CITY,  
262700 SHANDONG PROVINCE, China

(540)

**ROCKBLADE**

(591) Black, white

(531) 27.05.01

(511)

12 – Tires for vehicle wheels; solid tires for vehicle wheels; automobile tires; inner tubes for pneumatic tires; repair outfits for inner tubes; spikes for tires; pneumatic tires; casings for pneumatic tires [tyres]; adhesive rubber patches for repairing inner tubes; inner tubes for bicycle tires.

(260) AM 2019 101549 A

(800) 1448178

(151) 2018 02 27

(891) 2018 02 27

(731) ZF FRIEDRICHSHAFEN AG

Löwentaler Str. 20, 88046 Friedrichshafen,  
Germany

(540)



(591) Black, white

(531) 26.01.03; 26.01.18; 27.05.01

(511)

7 – Machines for processing metal, wood and plastics, and agricultural machines; construction machines; machine tools; driving devices for machines; power transmission couplings for machines; agricultural implements other than hand-operated; transmissions, drives and couplings for machines, in particular machine tools and industrial robots; control and regulating systems for transmissions for machines for processing metal, wood and plastics, for agricultural machines, and for construction equipment, machine tools and motors and engines; planetary gears for hydrostatic and electric machine drives; elevator gears; gear systems and drives for hoists; hydraulic pumps, wheels, valves and brakes being parts for machines; steering pump; electric generators for motor vehicles; automatic vending machines; electrically operated welding apparatus and instruments; arc welding and stud welding apparatus; welding electrodes; valves for engines; fuel pumps for vehicles; remote electric door openers; housings as parts of machines; mechanical measuring, controlling, regulating and information devices for drivers and passengers, and for drive, chassis, steering and security systems for motor vehicles; synchronizing rings and synchronizing devices for gear boxes; hydrostatic and hydrodynamic power shift transmissions for construction machines; hydrodynamic torque converters for machines; synchromesh and power shift transmissions for agricultural tractors; gear systems and infinitely variable change-speed split-torque gears for self-propelled agricultural machines, work machines and construction machines; travelling gear for work machines; transmissions for floor conveyors and hoists; mechanical, hydraulic, electrohydraulic and electric steering systems for agricultural and construction machines and self-propelled operating machines; auxiliary drives for machines for propelling auxiliary units; self-locking and limited slip differentials for self-propelled operating

machines; axles, axle systems and axle drives for agricultural, forestry and construction machines, and floor conveyors; brakes, magnetically and electromagnetically actuated brakes for machines; printing cylinders; valves as parts of machines; spur gear wheels; worm wheels and worm gears; bevel wheels; racks and pinions being parts for machines; sprockets being parts for machines; internal gears; rolling machines for beveled rolling or cylindrical back rolling; machine tools for manufacturing and processing gears, namely gear cutting machines, gear paring machines, gear milling machines and gear grinding machines; mechanical tools for manufacturing and processing toothed wheels; machine components for manufacturing and processing toothed wheels; machines for running-in gears; engine and gear bearing arrangements; components and parts for the aforesaid goods; rocker arms for vehicles; cylinder covers; hoses not of metal for use in vehicles; printing cylinders; starters, generators and integrated starter generators; oil tanks.

9 – Scientific, nautical, surveying, photographic, cinematographic, optical, weighing, measuring, signaling, checking, life-saving and teaching apparatus and instruments; apparatus and instruments for conducting, switching, transforming, accumulating, regulating or controlling electricity; apparatus and instruments for recording, transmission, reproduction, storage, decryption, conversion, processing of data, sound and images; audiovisual telecommunications and telematics apparatus; remote control mechanisms; video monitors; modems; access and access monitoring apparatus for data processing equipment; authentication apparatus for telecommunications networks; apparatus for scrambling and descrambling signals; digital terminals; electronic apparatus, namely data processing equipment, computers and apparatus for telematics; computer components, namely memories, processors, microprocessors; peripherals adapted for use with computers; devices for simultaneous programming; programs for data processing; magnetic data media; flight simulators and flight controls for helicopters, rotorcraft and fixed-wing aircraft; electric, electronic, acoustic, optical, haptic and cognitive measuring, controlling, regulating and information apparatus for drivers and passengers regarding drive, chassis, steering and security systems in motor vehicles; electrical and electronic controllers for gears and gear programs for gear boxes to control gear, automatic transmissions, continuously variable automatic transmissions, hydrodynamic and hydrostatic transmissions, transfer cases, axles, differentials, chassis parts, torque transducers, couplings and retarders; diagnostic and testing apparatus for motor vehicle electronic control systems; electronic control and regulating systems for drive components for ships and boats; electric and electronic material testing instruments and machines; computer hardware; computer software; el-

ectric and electronic control and regulation apparatus for the partly automated, highly automated and fully automated operation of motor vehicles; computer hardware and software relating to global communications networks; telecommunications microelectronics and microchips; antennas; dish aerials; high frequency transceivers; communications, positioning and data transmission and processing equipment; electronic apparatus and instruments for detecting and processing impact accidents; steering electronics; sensors and electronics for smart restraint systems; vehicle communication and integration electronics; electronic cruise control apparatus; impact sensors; airbag impact sensors; forward collision warning systems; lane change warning systems; lane change guidance systems; electronic vehicle stability control systems; following distance indication systems; inertial sensors; radar, lidar and camera systems for motor vehicles; fire-extinguishing apparatus; electric and electronic apparatus and instruments being parts of electric and electronic systems for land vehicles, aircraft and watercraft, brake systems, control systems and safety belt systems for vehicle occupants; electronic controls for heating, ventilating and air conditioning apparatus in motor vehicles; instrument panel controls; braking and wheel suspension controls; steering column controls; laser apparatus; space communications systems; solar panels; airborne and ground based technical reconnaissance systems; avionics systems; fingerprint identification apparatus; electrical plugs; electric switches; software downloaded from the internet; electronic publications downloadable from the internet; telecommunication apparatus; apparatus for navigation purposes; apparatus for driving vehicles automatically; calipers; mass flow meters; wheel speed sensor; tire monitoring systems; remote keyless entry systems for motor vehicles; infrared sensors; electric valve timing controls for motors and engines; man and machine interface controls and switches; rollover prevention and mitigation systems; electronic grade control systems; speed limit sign recognition systems; remote-controlled acceleration sensors for collisions; occupant sensing systems; seatbelt buckle sensors; seatbelt reminder systems; parking assistance systems; test benches and apparatus for the aforesaid goods; electric and electronic material testing apparatus; steer-by-wire systems; steering torque, steering angle of rotation, steering speed and steering acceleration sensors; parts and fittings for all the aforesaid goods; machines and mechanical apparatus for testing of gearings for manufacturing precision and in relation to operating noise; material test machine; cable harnesses for interior fitting of motor vehicles; cable housings, protective sheaths for cables, cable sheaths and cable rings; cable guide conduits, cable housings and cables for motor vehicles.

12 – Apparatus for locomotion by land, air, on water or in water; vehicles and parts therefor; gears for

land vehicles; gear boxes for land vehicles; synchromesh and power shift transmissions; automatic transmissions; continuously variable automatic transmissions; dual clutch transmissions; hydrodynamic and hydrostatic transmissions; gear boxes; manual gearboxes for passenger vehicles, lorries, buses and special purpose vehicles; automatic, mechanical gears for passenger vehicles, lorries, buses, special purpose vehicles and rail vehicles; automatic gears and automatic infinitely variable change-speed gears for passenger vehicles, lorries, buses and special purpose vehicles; transfer cases integrated into automatic gears; mechanical and hydrostatic variators for adjusting the speed increasing ratio in automatic infinitely variable change-speed gears; power shift transmissions for lorries, buses, special purpose vehicles and rail vehicles; hydrostatic and hydrodynamic power shift transmissions for special-purpose vehicles and rail vehicles; transfer cases for passenger vehicles and special purpose vehicles with and without all-wheel drives; self-locking and limited slip differentials for passenger vehicles, lorries and special purpose vehicles; gear systems, gear preselectors, automatic switching apparatus, in particular for automatic gear shifting; synchronizing rings and synchronizing devices for gear boxes; transmission for tracked vehicles; electric, electromechanical and electrohydraulic drives and drive systems and hybrid drives for passenger vehicles, lorries, buses and special purpose vehicles; wheel hub drive systems and wheel hub gears; drives for rail vehicles; planetary gears for hydrostatic and electric drives; helicopter rotor blade adjustment devices; mechanical, hydraulic, electrohydraulic and electrically-assisted steering mechanisms and steering systems for passenger vehicles, lorries, buses, special purpose vehicles and track vehicles; axles; axles, axle systems and axle drives for passenger vehicles, lorries, buses, special purpose vehicles and rail vehicles; apparatus for roll stabilization and for level regulation of land vehicles; differentials; chassis components; torque converters; couplings; retarders; brakes; clutches; auxiliary drives; axle drives; suspension shock absorbers; shock absorbing springs; tie rods; stabilizers; panhard rods and track rod ends; handle bars; wheel joints; four-point links; triangular links; axle struts; electric, electrohydraulic, hydraulic and mechanical steering; steering columns; wheel drives; electric motors for motor vehicles; internal combustion engines for motor vehicles; electric motors for motor cars; hybrid drives for motor vehicles; wheelchairs for transporting invalids; motors for land vehicles; bodywork parts for vehicles; parts and fittings for interior fitting of motor vehicles in the form of precision plastic molds and assemblies, pipes and fastenings; brakes and brake systems for vehicles, namely anti-lock braking systems, traction controls and vehicle stability control braking systems; base brakes; disc brakes; drum brakes; rotors; brake sho-

es; actuators for brake systems, in particular master cylinders; seat belts and seat belt pretensioners; child restraints; airbag coverings; air bags; integrated vehicle safety systems; anti-theft protection systems for vehicles; wheel suspensions; steering racks; steering gears; wheel suspension ball joints; steering linkages; hydraulic steering systems; power steering systems; electrically powered steering; electrically powered hydraulic steering; integrated steering and wheel suspension modules; steering wheels; intermediate columns; metal guides and seat inserts of metal for vehicles; valve lifters; valve train rotators, retainer caps and retainer locks; wheel cylinders for vehicles; parking brakes; hydraulic boosters; mechanical brake assistance systems; vacuum boosters; slip control boost actuation; electric hydraulic braking systems; electric mechanical brakes; electric parking brakes; electro-hydraulic brakes; belt and rack drive electronic power steering; column drive electronic power steering; rear wheel steering systems for motor vehicles; steer-by-wire systems; manual mechanical steering systems; active dynamic wheel suspensions; semi-active roll control; active roll control; axle boots for vehicles; vehicle parts, namely, sunspension linkages and sunspension struts; advanced steering systems; steering fluid supply; integral steering gear; active and adaptive restraint systems; active control retractor systems for safety belts; retractor and buckle assemblies for safety belts; vehicle seat height adjustment devices; single stage airbag inflators; dual stage airbag inflators; assistance systems for bypassing the blind spot for automobiles; disk brake pads; drum brake pads; cantilever brakes; distribution cable yokes for cantilever brakes; brake kits; clutch slave cylinders; brake boosters; racks and pinions for steering of vehicles; bellows for cardan joints of motor vehicles; drag links; radius rods; automatic emergency braking systems for vehicles; active front axle steering systems; collision mitigation braking systems; front impact multi-stage airbag inflators; side impact multi-stage airbag inflators; steering accessories, namely cardan joints, angular gears, steering columns, valves valves for vehicle tyres and work cylinders for steering systems; worm gears for steering mechanisms; fixed and adjustable steering columns, steering axles, steering brakes, steering valves, intermediate steering gear; torsional vibration dampers; valves; separate and integrated primary and secondary retarder brake systems for lorries, buses, special purpose vehicles and rail vehicles; parts and components for the aforesaid goods for motor vehicles; transmissions for helicopters, aircraft and airships; engine transmissions for helicopters; actuators for aircraft; transmissions and transmission parts for ships; parts for drive trains of ships between gears and propellers, namely couplings, propeller shafts and flanges; marine propulsion units; surface drives for ships; rever-

sing gears and step-up gears for water vehicles; gear shift knobs for vehicles.

37 – Building construction; conducting of maintenance and repair work on apparatus for locomotion by land, air, on water or in water, and parts thereof; conducting of maintenance and repair work on vehicles and parts thereof; conducting of maintenance and repair work on computer hardware.

(260) AM 2019 101550 A

(800) 1448180

(151) 2018 08 10

(891) 2018 08 10

(731) "HELLENIC FUELS AND LUBRICANTS INDUSTRIAL AND COMMERCIAL S.A." also trading as "EKO ABEE"  
8A Cheimarras street, GR-151 25 Marousi, Greece

(540)



(591) Red (Pantone 186C), blue (Pantone 294C) and white

(531) 26.01.12; 26.04.05; 26.04.16; 26.04.24; 26.11.01; 26.11.13; 27.05.01; 29.01.13

(511)

1 – Chemicals used in industry, science and photography, as well as in agriculture, horticulture and forestry; unprocessed artificial resins, unprocessed plastics; manures; fire extinguishing compositions; tempering and soldering preparations; chemical substances for preserving foodstuffs; tanning substances; adhesives used in industry; chemical additives for use in the production of lubricants; chemical additives; chemical additives for lubricants; detergent additives for lubricants; petroleum derivatives; petroleum dispersants; petroleum cracking catalysts; chemical petrol additives; detergent additives to gasoline [petrol]; chemical additives for heating oils; chemical products derived from petroleum; water flooding additives; chemical preparations for the dispersal of petroleum; additives (chemical-) for petroleum products; chemical products of use in the oil industry; chemical additives for oil well drilling fluid; chemical additives for diesel fuels; catalysts for use in the oil processing industry; chemicals for use in the oil refining industry; chemicals for use in the formation of oil wells; additives for raising the octane number in petrol; polymers for use in the drilling

and oil industries; fluids for use in the transport of particulate materials in oil wells; chemical additives for oil well cements; sealing compounds for stopping leakage from oil tanks [chemicals]; chemical additives for petrol; hydraulic oils.

2 – Paints, varnishes, lacquers; preservatives against rust and against deterioration of wood; colorants; mordants; raw natural resins; metals in foil and powder form for use in painting, decorating, printing and art.

4 – Industrial oils and greases; lubricants; dust absorbing, wetting and binding compositions; fuels (including motor spirit) and illuminants; candles and wicks for lighting; lubricating oil; oils for turbines; synthetic oils; mineral oils; lubricating greases; automobile lubricants; automotive lubricants for car engines; lubricating oil for motor vehicle engines; motor vehicle lubricants; all purpose lubricants; oil well drilling lubricants; marine oils; lubricants for use in industrial processes; synthetic lubricants; greases; automotive greases; lubrication grease for vehicles; grease for brake pads; petroleum; raw oil; illuminating oil; artificial petroleum; liquefied petroleum gas; petroleum by-products; petroleum coke; petroleum ether; industrial fuel oil; oil-gas; ligroin; fuels derived from oil; fuels derived from crude oil; liquefied petroleum gases to be used in motor vehicles; gas oil for domestic heating; liquefied petroleum gases to be used for domestic purposes; liquefied petroleum gases to be used for industrial purposes; combustion enhancers [petroleum products]; additives (non-chemical) for petroleum products; petroleum coke for use as fuels; gas oil for industrial heating; petroleum-based dust absorbing compositions; additives (non-chemical) for fuels; diesel oil; mazut; crude oil; motor oil; industrial oils; soluble cutting oils; cutting fluids; penetrating oils; fine oils for motors; automotive engine oils; chain oil; demoulding oil; oils for automobiles; oils for tempering metals; oils for thermic treatment of metals; heat treatment oils for use in metal working; cutting oil for industrial metal working; oils for surface treatment; automotive final drive oils; oils for turbo units; oil for the preservation of masonry; oils for the hydrodynamic drive for vehicles; oils for use with machine tools; oils for use as additives to heating oils; oils containing rust preventing additives; oils containing water dispersant additives; moistening oil; froth flotation oils; leather preserving oil; process oil for use in bitumen extenders; extreme pressure oils; textile oils; white oils; isolating oils; oils for releasing form work [building]; synthetic compressor oils; metalworking [cutting] fluids; metalworking products having lubricating properties; mineral oils for use in the manufacture of paints; mineral oil for use in the manufacture of metal cutting fluids; mineral oils and greases for industrial purposes [not for fuels]; mineral oil for use in the manufacture of cosmetics and

skin care products; industrial oil; leather preserving grease; duct lubricants; lubricating oils for automotive apparatus; lubricants for machines; lubricating oils for petrol engines; gear oils; mould releasing oils; deep drawing lubricants; lubricants of agricultural origin; drilling lubricants; lubricants for conveyor chains containing a disinfecting agent; lubricants having cleaning properties; lubricants for conveyor chains containing a corrosion inhibitor; lubricants for demounting pneumatic tyres; lubricants for industrial apparatus; lubrication oils for industrial refrigeration apparatus; lubricants for agricultural implements; belt dressings; lubricants for cables; greases for the lubrication of cables; lubricants for metallic surfaces; lubricants for metal working; lubricant oils for the cutting of metal pieces; casting oils; lubricants for plastic materials; lubricants for polymeric surfaces; lubricants for the protection of the chains of chainsaws; lubricants for use on conveyors; lubricants for use on wire ropes; lubricants for use in machine cutting; lubricating oils for cooling metal during cutting; lubricants being gear oils; lubricating oils for wheels; lubricating oils for use as cutting fluid; thread cutting and tapping lubricant; lubricants containing low friction additives; non-mineral oils for industrial purposes [not for fuel]; grease; chassis grease; greases for the lubrication of exposed gears; grease for machines; grease for arms [weapons]; grease for brake shoes; greases for technical purposes; grease for belts; electrical energy; fuel gas; vaporized fuel mixtures; butane gas for use as a fuel; solidified gas [fuel].

7 – Handling machines, automatic (manipulators); fuel dispensing pumps for service stations; self-regulating fuel pumps; elevating apparatus; lifting mechanisms for vehicles; lifting mechanisms for trailers; dust exhausting installations for cleaning purposes; vacuum cleaner attachments for disseminating perfumes and disinfectants; suction machines for industrial purposes; automatic vending machines; dust removing installations for cleaning purposes; jacks (machines); electromechanical machines for the chemical industry; cranes (lifting apparatus); roller bridges; handling apparatus for loading and unloading; sorting machines for industry; oil refining machines; vehicle washing installations; hand-held tools, other than hand-operated; cleaning machines and cleaning apparatus, electric; cleaning appliances utilizing steam; high-pressure cleaning apparatus; fuel conversion apparatus for internal combustion engines; fuel economizers for motors and engines; coin-operated washing machines; lubricating pumps; catalytic converters; fuel conversion apparatus for internal combustion engines; transporting machines; machines and apparatus for cleaning, electric; pneumatic transporters; washing installations for vehicles; air cushion devices for moving vehicles; pneumatic tube conveyors; tarring machines; rinsing machines; compacting machines; compressors (machines); electric we-

lding apparatus; welding apparatus, electric; sealing machines for industrial purposes; belts for conveyors; loading platforms; blowing machines for the compression, exhaustion and transport of gases; diesel electric generators; oil-well pumping machines; oil drilling rigs; oil drilling tools; oil pumps for land vehicle engines; agricultural, earthmoving, construction, oil and gas extraction and mining equipment.

12 – Vehicles; apparatus for locomotion by land, air or water; engines for land vehicles; diesel engines for land vehicles; gasoline engines for land vehicles; electric engines for land vehicles; jet engines for land vehicles; gas engines for land vehicles; turbojet engines for land vehicles; combustion engines for land vehicles; motors for land vehicles; electric cars.

16 – Paper and cardboard; printed matter; bookbinding material; photographs; stationery and office requisites, except furniture; adhesives for stationery or household purposes; artists' and drawing materials; paintbrushes; instructional and teaching materials; plastic sheets, films and bags for wrapping and packaging; printers' type, printing blocks; magazines.

19 – Building materials (non-metallic); non-metallic rigid pipes for building; asphalt, pitch and bitumen; non-metallic transportable buildings; monuments, not of metal.

35 – Advertising; business management; business administration; office functions; retail services in relation to: chemicals used in industry, science and photography, as well as in agriculture, horticulture and forestry, unprocessed artificial resins, unprocessed plastics, manures, fire extinguishing compositions, tempering and soldering preparations, chemical substances for preserving foodstuffs, tanning substances, adhesives used in industry, chemical additives for use in the production of lubricants, chemical additives, chemical additives for lubricants, detergent additives for lubricants, petroleum derivatives, petroleum dispersants, petroleum cracking catalysts, chemical petrol additives, detergent additives to gasoline [petrol], chemical additives for heating oils, chemical products derived from petroleum, water flooding additives, chemical preparations for the dispersal of petroleum, additives (chemical-) for petroleum products, chemical products of use in the oil industry, chemical additives for oil well drilling fluid, chemical additives for diesel fuels, catalysts for use in the oil processing industry, chemicals for use in the oil refining industry, chemicals for use in the formation of oil wells, additives for raising the octane number in petrol, polymers for use in the drilling and oil industries, fluids for use in the transport of particulate materials in oil wells, chemical additives for oil well cements, sealing compounds for stopping leakage from oil tanks [chemicals], paints, varnishes, lacquers, preservatives against rust and against dete-

rioration of wood, colorants, mordants, raw natural resins, metals in foil and powder form for use in painting, decorating, printing and art, industrial oils and greases, lubricants, dust absorbing, wetting and binding compositions, fuels (including motor spirit) and illuminants, candles and wicks for lighting, lubricating oil, oils for turbines, synthetic oils, mineral oils, lubricating greases, automobile lubricants, automotive lubricants for car engines, lubricating oil for motor vehicle engines, motor vehicle lubricants, all purpose lubricants, oil well drilling lubricants, marine oils, lubricants for use in industrial processes, synthetic lubricants, greases, automotive greases, lubrication grease for vehicles, grease for brake pads, petroleum, raw oil, illuminating oil, artificial petroleum, liquefied petroleum gas, petroleum by-products, petroleum coke, petroleum ether, industrial fuel oil, oil-gas, ligroin, chemical additives for petrol, fuels derived from oil, fuels derived from crude oil, liquefied petroleum gases to be used in motor vehicles, gas oil for domestic heating, liquefied petroleum gases to be used for domestic purposes, liquefied petroleum gases to be used for industrial purposes, combustion enhancers [petroleum products], additives (non-chemical) for petroleum products, petroleum coke for use as fuels, gas oil for industrial heating, petroleum-based dust absorbing compositions, additives (non-chemical) for fuels, diesel oil, mazut, crude oil, motor oil, industrial oils, soluble cutting oils, cutting fluids, penetrating oils, fine oils for motors, automotive engine oils, chain oil, demoulding oil, oils for automobiles, oils for tempering metals, oils for thermic treatment of metals, heat treatment oils for use in metal working, cutting oil for industrial metal working, oils for surface treatment, automotive final drive oils, oils for turbo units, oil for the preservation of masonry, oils for the hydrodynamic drive for vehicles, oils for use with machine tools, oils for use as additives to heating oils, oils containing rust preventing additives, oils containing water dispersant additives, moistening oil, froth flotation oils, leather preserving oil, process oil for use in bitumen extenders, extreme pressure oils, textile oils, white oils, isolating oils, oils for releasing form work [building], synthetic compressor oils, metalworking [cutting] fluids, metalworking products having lubricating properties, mineral oils for use in the manufacture of paints, mineral oil for use in the manufacture of metal cutting fluids, mineral oils and greases for industrial purposes [not for fuels], mineral oil for use in the manufacture of cosmetics and skin care products, industrial oil, leather preserving grease, duct lubricants, lubricating oils for automotive apparatus, lubricants for machines, lubricating oils for petrol engines, gear oils, mould releasing oils, deep drawing lubricants, lubricants of agricultural origin, drilling lubricants, lubricants for conveyor chains containing a disinfecting agent, lubricants having cleaning properties, lubricants for conveyor

chains containing a corrosion inhibitor, lubricants for demounting pneumatic tyres, lubricants for industrial apparatus, lubrication oils for industrial refrigeration apparatus, lubricants for agricultural implements, belt dressings, lubricants for cables, greases for the lubrication of cables, lubricants for metallic surfaces, lubricants for metal working, lubricant oils for the cutting of metal pieces, casting oils, lubricants for plastic materials, lubricants for polymeric surfaces, lubricants for the protection of the chains of chainsaws, lubricants for use on conveyors, lubricants for use on wire ropes, lubricants for use in machine cutting, lubricating oils for cooling metal during cutting, lubricants being gear oils, lubricating oils for wheels, lubricating oils for use as cutting fluid, thread cutting and tapping lubricant, lubricants containing low friction additives, non-mineral oils for industrial purposes [not for fuel], hydraulic oils, grease, chassis grease, greases for the lubrication of exposed gears, grease for machines, grease for arms [weapons], grease for brake shoes, greases for technical purposes, grease for belts, electrical energy, fuel gas, vaporized fuel mixtures, butane gas for use as a fuel, solidified gas [fuel], handling machines, automatic (manipulators), fuel dispensing pumps for service stations, self-regulating fuel pumps, elevating apparatus, lifting mechanisms for vehicles, lifting mechanisms for trailers, dust exhausting installations for cleaning purposes, vacuum cleaner attachments for disseminating perfumes and disinfectants, suction machines for industrial purposes, automatic vending machines, dust removing installations for cleaning purposes, jacks (machines), electromechanical machines for the chemical industry, cranes (lifting apparatus), roller bridges, handling apparatus for loading and unloading, sorting machines for industry, oil refining machines, vehicle washing installations, hand-held tools, other than hand-operated, cleaning machines and cleaning apparatus, electric, cleaning appliances utilizing steam, high-pressure cleaning apparatus, fuel conversion apparatus for internal combustion engines, fuel economizers for motors and engines, coin-operated washing machines, lubricating pumps, catalytic converters, fuel-conversion apparatus for internal combustion engines, transporting machines, machines and apparatus for cleaning, electric, pneumatic transporters, washing installations for vehicles, air cushion devices for moving vehicles, pneumatic tube conveyors, tarring machines, rinsing machines, compacting machines, compressors (machines), electric welding apparatus, welding apparatus, electric, sealing machines for industrial purposes, belts for conveyors, loading platforms, blowing machines for the compression, exhaustion and transport of gases, diesel electric generators, oil-well pumping machines, oil drilling rigs, oil drilling tools, oil pumps for land vehicle engines, agricultural, earthmoving, construction, oil and gas extraction and mining equipment, vehicles,

apparatus for locomotion by land, air or water, engines for land vehicles, diesel engines for land vehicles, gasoline engines for land vehicles, electric engines for land vehicles, jet engines for land vehicles, gas engines for land vehicles, turbojet engines for land vehicles, combustion engines for land vehicles, motors for land vehicles, electric cars, paper and cardboard, printed matter, bookbinding material, photographs, stationery and office requisites, except furniture, adhesives for stationery or household purposes, artists' and drawing materials, paintbrushes, instructional and teaching materials, plastic sheets, films and bags for wrapping and packaging, printers' type, printing blocks, magazines, building materials (non-metallic), non-metallic rigid pipes for building, asphalt, pitch and bitumen, non-metallic transportable buildings, monuments, not of metal.

37 – Retreading of tires; pump repair; car wash; varnishing; vulcanization of tires (repair); drilling of deep oil or gas-wells; installation, maintenance and repair of machines; factory construction; installation and repair of electric appliances; installation and repair of heating equipment; vehicle cleaning; "building construction supervision; repair and maintenance of burners; boiler cleaning and repair; vehicle lubrication; mining extraction; installation, repair and maintenance of machinery; rental of construction equipment; rental of laundry washing machines; motor vehicle wash; vehicle wash; vehicle polishing; vehicle maintenance; vehicle maintenance and repair; pipeline construction and maintenance; vehicle service stations (refueling and maintenance); recharging services for electric vehicles; maintenance and repair of electric vehicles; services of service stations (petrol stations), repair or maintenance of gasoline station equipment, providing information relating to the repair or maintenance of gasoline station equipment; oil pumping; regulation of oil burners; oil pipeline construction; oil pipeline laying; pumping crude oil; extraction of oil; oil-field exploitation for the extraction of oil; drilling for crude oil; grout reinforcement for oil platforms; oil and gas drilling; construction of structures for the production of crude oil; construction of structures for the storage of crude oil; construction of structures for the transportation of crude oil; oil well casing, tubing, and drill pipe installation; oil well fracturing.

38 – Telecommunications; transmission and sending of information electronically through web sites or based on internet web sites.

39 – Transport; packaging and storage of goods; travel arrangement; transport of oil; storage of oil; storage of fuel oil; transportation of crude oil; oil distribution services; transport by pipeline; information services relating to the transportation of petroleum.

40 – Recycling of trash and waste; waste treatment (transformation); incineration of waste and trash;

destruction of waste and trash; decontamination of hazardous materials; abrasion; oil refinery services; rental of boilers; processing of oil; material treatment information; boiler-making; refining of gas; gas processing services; purification of gases; filtration of gases; generation of gas and electricity; processing of gas; gas production services; gas compression services; petroleum gas liquefaction; incineration of gases; processing of dry gas; processing of natural gas; treatment of natural gas; natural gas liquefaction services; treatment of hazardous gases; recovery of hydrocarbons from gas; chemical treatment of exhaust gases from fossil fuel combustion; fuel processing; fuel refining; fuel treatment services; processing of fuel materials; refinement of fuel materials; oil-spill treatment; refining of petroleum products; refining of crude oil; oil refining services; processing of waste oil; processing of gas and oil; consultancy related to the treatment of oil pollution.

42 – Scientific and technological services and research and design relating thereto; industrial analysis and research services; design and development of computer hardware and software; oil prospecting; oil-well testing; oil-field surveys; analysis of oil soaking; surveying of oil-bearing seams; analysis for oil field exploitation; oil-beds (preparing surveys of-); oil-bearing seams (preparing surveys of-); design of oil-field surveys; exploration services to locate oil; exploration and searching of oil and gas; geophysical exploration for the oil industry; analytical services relating to the exploration of oil fields; analytical and testing services relating to the oil industry; analytical and testing services in the field of oil exploitation; analytical and testing services relating to oil exploration; conducting feasibility studies relative to oil field exploration; conducting feasibility studies relative to oil field exploitation; geophysical exploration for the oil, gas and mining industries; conducting magnetic resonance imaging interpretation and analysis for the petroleum industry; exploration and searching of gas and oil.

(260) AM 2019 101551 A

(800) 1448198

(151) 2018 05 04

(891) 2018 05 04

(731) TECTONE TEKNOLOJİ SANAYİ VE

TİCARET ANONİM ŞİRKETİ

Organize Sanayi Bölgesi, Atatürk Caddesi 8.

Sokak No:8, Karaağaç Köyü, TR-59510

Kapaklı Çerkezköy-Tekirdağ, Turkey

(540)



(591) Black, white  
 (531) 26.04.24; 27.05.24  
 (511)

7 – Machines, machine tools and industrial robots for processing and shaping wood, metals, glass, plastics and minerals, 3D printers; construction machines and robotic mechanisms (machines) for use in construction: bulldozers, diggers (machines), excavators, road construction and road paving machines, drilling machines, rock drilling machines, road sweeping machines; lifting, loading and transmission machines and robotic mechanisms (machines) for lifting, loading and transmission purposes: elevators, escalators and cranes; machines and robotic mechanisms (machines) for use in agriculture and animal breeding, machines and robotic mechanisms (machines) for processing cereals, fruits, vegetables and food; machines for preparing and processing beverages; engines and motors, other than for land vehicles, parts and fittings therefor: hydraulic and pneumatic controls for engines and motors, brakes other than for vehicles, brake linings for engines, crankshafts, gearboxes, other than for land vehicles, gearboxes, cylinders for engines, pistons for engines, turbines, not for land vehicles, filters for engines and motors, oil, air and fuel filters for land vehicle engines, exhausts for land vehicle engines, exhaust manifolds for land vehicle engines, engine cylinders for land vehicles, engine cylinder heads for land vehicles, pistons for land vehicle engines, carburetors for land vehicles, fuel conversion apparatus for land vehicle engines, injectors for land vehicle engines, fuel economisers for land vehicle engines, pumps for land vehicle engines, valves for land vehicle engines, starter motors for land vehicles, dynamos for land vehicle engines, sparking plugs for land vehicle engines; bearings (parts of machines), roller or ball bearings; machines for mounting and detaching tires; alternators, current generators, electric generators, current generators operated with solar energy; painting machines, automatic spray guns for paint, electric, hydraulic and pneumatic punching machines and guns, electric adhesive tape dispensers (machines), electric guns for compressed gas or liquid spraying machines, electric hand drills, electric hand saws, electric jigsaw machines, spiral machines, compressed air machines, compressors (machines), vehicle washing installations, robotic mechanisms (machines) with the abovementioned functions; electric and gas-operated welding apparatus, electric arc welding apparatus, electric soldering apparatus, electric arc cutting apparatus, electrodes for welding machines, industrial robots (machines) with the abovementioned functions; printing machines; packaging machines, filling, plugging and scaling machines, labellers (machines), sorting machines, industrial robots (machines) with the abovementioned functions, electric packing machines for plugging and sealing of plastics; machines for textile processing, sewing

machines, industrial robots (machines) with the abovementioned functions; centrifugal pumps, axial flow pumps, compressed air pumps, electric pumps, fuel dispensing pumps for service stations, self-regulating fuel pumps; electric kitchen machines for chopping, grinding, crushing, mixing and mincing foodstuff, washing machines, laundry washing machines, dishwashers, spin driers (not heated), electric cleaning machines for cleaning floors, carpets or floorings, vacuum cleaners and parts thereof; automatic vending machines; galvanizing and electroplating machines; electric door openers and closers; gaskets for engines and motors.

8 – Forks, spoons, knives and non-electric cutters, slicers, peelers for kitchen use, including those made of precious metals; side arms and blades (weapons); tools and apparatus for personal beauty care use, namely tools and apparatus for shaving, epilation, manicure and pedicure, electric hand implements for straightening and curling hair, scissors; hand-operated [non-electric] hand tools for the repair of machines, apparatus and vehicles and for use in construction, agriculture, horticulture and forestry, none of them being power tools; electric or non-electric irons; steam irons; handles for hand-operated hand tools.

9 – Measurement apparatus and equipment including those for scientific, nautical, topographic, meteorologic, industrial and laboratory purposes, thermometers, not for medical purposes, barometers, ammeters, voltmeters, hygrometers, testing apparatus not for medical purposes, telescopes, periscopes, directional compasses, speed indicators, laboratory apparatus, microscopes, magnifying glasses, stills, binoculars, ovens and furnaces for laboratory experiments; apparatus for recording, transmission or reproduction of sound or images, cameras, photographic cameras, television apparatus, video recorders, CD and DVD players and recorders, MP3 players, computers, desktop computers, tablet computers, wearable technological devices, namely, smartwatches, smart wristbands and head-mounted cameras, microphones, loudspeakers, earphones, telecommunications apparatus, apparatus for the reproduction of sound or images, computer peripheral devices, cell phones, covers for cell phones, telephone apparatus, computer printers, scanners [data processing equipment], magnetic and optic data carriers and computer software and programmes recorded thereto, downloadable and recordable electronic publications, encoded magnetic and optic cards, movies, tv series and video music clips recorded on magnetic, optical and electronic media; antennas, satellite antennas, amplifiers for antennas, parts of the aforementioned goods; ticket dispensers, automatic teller machines (ATM); electronic components used in the electronic parts of machines and apparatus, semi-conductors, electronic circuits, integrated circuits,



chips [integrated circuits], diodes, transistors [electronic], magnetic heads for electronic apparatus, electronic locks, photocells, remote control apparatus for opening and closing doors, optical sensors; counters and quantity indicators for measuring the quantity of consumption, automatic time switches; clothing for protection against accidents, irradiation and fire, safety vests and life-saving apparatus and equipment; eyeglasses, sunglasses, optical lenses and cases, containers, parts and components thereof; apparatus and instruments for conducting, transforming, accumulating or controlling electricity, electric plugs, junction boxes [electricity], electric switches, circuit breakers, fuses, lighting ballasts, battery starter cables, electrical circuit boards, electric resistances, electric sockets, transformers [electricity], electrical adapters, battery chargers, electric door bells, electric and electronic cables, batteries, electric accumulators, solar panels for production of electricity; alarms and anti-theft alarms, other than for vehicles, electric bells; signalling apparatus and instruments, luminous or mechanical signs for traffic use; fire extinguishing apparatus, fire engines, fire hose and fire hose nozzles; radar apparatus, sonars, night vision apparatus and instruments; decorative magnets; metronomes.

11 – Lighting installations; lights for vehicles and interior-exterior spaces; heating installations using solid, liquid or gas fuels or electricity, central heating boilers, boilers for heating installations, radiators [heating], heat exchangers, not parts of machines, stoves, kitchen stoves, solar thermal collectors [heating]; steam, gas and fog generators, steam boilers, other than parts of machines, acetylene generators, oxygen generators, nitrogen generators; installations for air-conditioning and ventilating; cooling installations and freezers; electric and gas-powered devices, installations and apparatus for cooking, drying and boiling: cookers, electric cooking pots, electric water heaters, barbecues, electric laundry driers; hair driers; hand drying apparatus; sanitary installations, taps [faucets], shower installations, toilets [water-closets], shower and bathing cubicles, bath tubs, toilet seats, sinks, wash-hand basins [parts of sanitary installations], washers for water taps, valves [taps] being parts for sanitary installations; water softening apparatus; water purification apparatus; water purification installations; waste water purification installations; electric bed warmers and electric blankets, not for medical use; electric pillow warmers; electric or non-electric footwarmers; hot water bottles, electrically heated socks; filters for aquariums and aquarium filtration apparatus; industrial type installations for cooking, drying and cooling purposes; pasteurizers and sterilizers.

21 – Hand-operated non-electric cleaning instruments and appliances, brushes, other than paintbrushes, steel chips for cleaning, sponges for cleaning,

steel wool for cleaning, cloths of textile for cleaning, gloves for dishwashing, non-electric polishing machines for household purposes, brooms for carpets, mops; toothbrushes, electric toothbrushes, dental floss, shaving brushes, hairbrushes, combs; non-electric household or kitchen utensils, [other than forks, knives, spoons], services [dishes], pots and pans, bottle openers, flower pots, drinking straws, non-electric cooking utensils; ironing boards and shaped covers therefor, drying racks for washing, clothes drying hangers; cages for household pets, indoor aquariums, vivariums and indoor terrariums for animals and plant cultivation; ornaments and decorative goods of glass, porcelain, earthenware or clay namely statues, figurines, vases and trophies; mouse traps, insect traps, electric devices for attracting and killing flies and insects, fly catchers, fly swatters; perfume burners, perfume sprayers, perfume vaporizers, electric or non-electric make-up removing appliances, powder puffs, toilet cases; nozzles for sprinkler hose, nozzles for watering cans, watering devices, garden watering cans; unworked or semi-worked glass, except building glass, mosaics of glass and powdered glass for decoration, except for building, glass wool other than for insulation or textile use.

35 – Advertising, marketing and public relations; organization of exhibitions and trade fairs for commercial or advertising purposes; design for advertising, provision of an online marketplace for buyers and sellers of goods and services; office functions; secretarial services; arranging newspaper subscriptions for others; compilation of statistics; rental of office machines; systemization of information into computer databases; telephone answering for unavailable subscribers; business management, business administration and business consultancy; accounting; commercial consultancy services; personnel recruitment, personnel placement, employment agencies, import-export agencies; temporary personnel placement services; auctioneering; the bringing together, for the benefit of others, of a variety of goods, namely, machines, machine tools and industrial robots for processing and shaping wood, metals, glass, plastics and minerals, 3D printers, construction machines and robotic mechanisms (machines) for use in construction, bulldozers, diggers (machines), excavators, road construction and road paving machines, drilling machines, rock drilling machines, road sweeping machines, lifting, loading and transmission machines and robotic mechanisms (machines) for lifting, loading and transmission purposes: elevators, escalators and cranes, machines and robotic mechanisms (machines) for use in agriculture and animal breeding, machines and robotic mechanisms (machines) for processing cereals, fruits, vegetables and food, machines for preparing and processing beverages, engines and motors, other than for land vehicles, parts and fittings therefor: hydraulic and pne-

umatic controls for engines and motors, brakes other than for vehicles, brake linings for engines, crankshafts, gearboxes, other than for land vehicles, gearboxes, cylinders for engines, pistons for engines, turbines, not for land vehicles, filters for engines and motors, oil, air and fuel filters for land vehicle engines, exhausts for land vehicle engines, exhaust manifolds for land vehicle engines, engine cylinders for land vehicles, engine cylinder heads for land vehicles, pistons for land vehicle engines, carburetors for land vehicles, fuel conversion apparatus for land vehicle engines, injectors for land vehicle engines, fuel economisers for land vehicle engines, pumps for land vehicle engines, valves for land vehicle engines, starter motors for land vehicles, dynamos for land vehicle engines, sparking plugs for land vehicle engines, bearings (parts of machines), roller or ball bearings, machines for mounting and detaching tires, alternators, current generators, electric generators, current generators operated with solar energy, painting machines, automatic spray guns for paint, electric, hydraulic and pneumatic punching machines and guns, electric adhesive tape dispensers (machines), electric guns for compressed gas or liquid spraying machines, electric hand drills, electric hand saws, electric jigsaw machines, spiral machines, compressed air machines, compressors (machines), vehicle washing installations, robotic mechanisms (machines) with the abovementioned functions, electric and gas-operated welding apparatus, electric arc welding apparatus, electric soldering apparatus, electric arc cutting apparatus, electrodes for welding machines, industrial robots (machines) with the abovementioned functions, printing machines, packaging machines, filling, plugging and sealing machines, labellers (machines), sorting machines, industrial robots (machines) with the abovementioned functions, electric packing machines for plugging and sealing of plastics, machines for textile processing, sewing machines, industrial robots (machines) with the abovementioned functions, pumps other than parts of machines or engines, fuel dispensing pumps for service stations, self-regulating fuel pumps, electric kitchen machines for chopping, grinding, crushing, mixing and mincing foodstuff, washing machines, laundry washing machines, dishwashers, spin driers (not heated), electric cleaning machines for cleaning floors, carpets or floorings, vacuum cleaners and parts thereof, automatic vending machines, galvanizing and electroplating machines, electric door openers and closers, gaskets for engines and motors, forks, spoons, knives and non-electric cutters, slicers, peelers for kitchen use, including those made of precious metals, side arms and blades (weapons), tools and apparatus, for personal beauty care use, tools and apparatus for shaving, epilation, manicure and pedicure, electric hand implements for straightening and curling hair, scissors, hand-operated [non-electric] hand tools for the

repair of machines, apparatus and vehicles and for use in construction, agriculture, horticulture and forestry, none of them being power tools, electric or non-electric irons, steam irons, handles for hand-operated hand tools, measurement apparatus and equipment including those for scientific, nautical, topographic, meteorologic, industrial and laboratory purposes, thermometers, not for medical purposes, barometers, ammeters, voltmeters, hygrometers, testing apparatus not for medical purposes, telescopes, periscopes, directional compasses, speed indicators, laboratory apparatus, microscopes, magnifying glasses, stills, binoculars, ovens and furnaces for laboratory experiments, apparatus for recording, transmission or reproduction of sound or images, cameras, photographic cameras, television apparatus, video recorders, CD and DVD players and recorders, MP3 players, computers, desktop computers, tablet computers, wearable technological devices (smart watches, wristbands, head-mounted devices) microphones, loudspeakers, earphones, telecommunications apparatus, apparatus for the reproduction of sound or images, computer peripheral devices, cell phones, covers for cell phones, telephone apparatus, computer printers, scanners [data processing equipment], magnetic and optic data carriers and computer software and programmes recorded thereto, downloadable and recordable electronic publications, encoded magnetic and optic cards, movies, tv series and video music clips recorded on magnetic, optical and electronic media, antennas, satellite antennas, amplifiers for antennas, parts of the aforementioned goods, ticket dispensers, automatic teller machines (ATM), electronic components used in the electronic parts of machines and apparatus, semi-conductors, electronic circuits, integrated circuits, chips [integrated circuits], diodes, transistors [electronic], magnetic heads for electronic apparatus, electronic locks, photocells, remote control apparatus for opening and closing doors, optical sensors, counters and quantity indicators for measuring the quantity of consumption, automatic time switches, clothing for protection against accidents, irradiation and fire, safety vests and life-saving apparatus and equipment, eyeglasses, sunglasses, optical lenses and cases, containers, parts and components thereof, apparatus and instruments for conducting, transforming, accumulating or controlling electricity, electric plugs, junction boxes [electricity], electric switches, circuit breakers, fuses, lighting ballasts, battery starter cables, electrical circuit boards, electric resistances, electric sockets, transformers [electricity], electrical adapters, battery chargers, electric door bells, electric and electronic cables, batteries, electric accumulators, solar panels for production of electricity, alarms and anti-theft alarms, other than for vehicles, electric bells, signalling apparatus and instruments, luminous or mechanical signs for traffic use, fire extinguishing apparatus, fire engines, fire hose and fire hose nozzles,

radar apparatus, sonars, night vision apparatus and instruments, decorative magnets, metronomes, lighting installations, lights for vehicles and interior-exterior spaces, heating installations using solid, liquid or gas fuels or electricity, central heating boilers, boilers for heating installations, radiators [heating], heat exchangers, not parts of machines, stoves, kitchen stoves, solar thermal collectors [heating], steam, gas and fog generators, steam boilers, other than parts of machines, acetylene generators, oxygen generators, nitrogen generators installations for air-conditioning and ventilating, cooling installations and freezers, electric and gas-powered devices, installations and apparatus for cooking, drying and boiling, cookers, electric cooking pots, electric water heaters, barbecues, electric laundry driers, hair driers, hand drying apparatus, sanitary installations, taps [faucets], shower installations, toilets [water-closets], shower and bathing cubicles, bath tubs, toilet seats, sinks, wash-hand basins [parts of sanitary installations], washers for water taps, stuffings (tap valves), water softening apparatus, water purification apparatus, water purification installations, waste water purification installations, electric bed warmers and electric blankets, not for medical use, electric pillow warmers, electric or non-electric foot-warmers, hot water bottles, electrically heated socks, filters for aquariums and aquarium filtration apparatus, industrial type installations for cooking, drying and cooling purposes, pasteurizers and sterilizers, hand-operated non-electric cleaning instruments and appliances, brushes, other than paintbrushes, steel chips for cleaning, sponges for cleaning, steel wool for cleaning, cloths of textile for cleaning, gloves for dishwashing, non-electric polishing machines for household purposes, brooms for carpets, mops, toothbrushes, electric toothbrushes, dental floss, shaving brushes, hairbrushes, combs, non-electric household or kitchen utensils, [other than forks, knives, spoons], services [dishes], pots and pans, bottle openers, flower pots, drinking straws, non-electric cooking utensils, ironing boards and shaped covers therefor, drying racks for washing, clothes drying hangers, cages for household pets, indoor aquariums, vivariums and indoor terrariums for animals and plant cultivation, ornaments and decorative goods of glass, porcelain, earthenware or clay namely statues, figurines, vases and trophies, mouse traps, insect traps, electric devices for attracting and killing flies and insects, fly catchers, fly swatters, perfume burners, perfume sprayers, perfume vaporizers, electric or non-electric make-up removing appliances, powder puffs, toilet cases, nozzles for sprinkler hose, nozzles for watering cans, watering devices, garden watering cans, unworked or semi-worked glass, except building glass, mosaics of glass and powdered glass for decoration, except for building, glass wool other than for insulation or textile use enabling customers to conveniently view and

purchase those goods, such services may be provided by retail stores, wholesale outlets, by means of electronic media or through mail order catalogues.

(260) AM 2019 101552 A

(800) 1448200

(151) 2018 11 28

(891) 2018 11 28

(731) Obshchestvo s ogranichennoy  
otvetstvennostyu "LABORATORIYA  
SOVREMENNOGO ZDOROVYA"  
ul. Khimzavodskaya, 11/20, Berdsk,  
RU-633004 Novosibirskaya oblast,  
Russian Federation

(540)

## ENDEMIX

(591) Black, white

(511)

3 – Adhesives for cosmetic purposes; after-shave lotions; almond milk for cosmetic purposes; aloe vera preparations for cosmetic purposes; antiperspirants [toilettries]; antistatic preparations for household purposes; aromatics [essential oils]; balms, other than for medical purposes; bath salts, not for medical purposes; beauty masks; bleaching preparations [decolorants] for cosmetic purposes; breath freshening sprays; breath freshening strips; cakes of toilet soap; canned pressurized air for cleaning and dusting purposes; cleaning preparations; cleansing milk for toilet purposes; cloths impregnated with a detergent for cleaning; collagen preparations for cosmetic purposes; color-brightening chemicals for household purposes [laundry]; color-removing preparations; cosmetics; cosmetic creams; cosmetic dyes; cosmetic kits; cosmetic pencils; cosmetic preparations for baths; cosmetic preparations for eyelashes; cosmetic preparations for slimming purposes; cosmetic preparations for skin care; cotton sticks for cosmetic purposes; cotton wool for cosmetic purposes; decorative transfers for cosmetic purposes; degreasers, other than for use in manufacturing processes; dental bleaching gels; dentifrices; deodorant soap; deodorants for human beings or for animals; depilatories; descaling preparations for household purposes; detergents, other than for use in manufacturing operations and for medical purposes; dry-cleaning preparations; dry shampoos; eau de Cologne; essential oils; eyebrow cosmetics; fabric softeners for laundry use; false eyelashes; false nails; floor wax; fumigation preparations [perfumes]; refurbishing preparations; greases for cosmetic purposes; hair colorants; hair conditioners; hair lotions; hair spray; hair straightening preparations; hair waving preparations; joss sticks; lacquer-removing preparations; laundry preparations; laundry soaking preparations; leather bleaching preparations; lip glosses; lipsticks; lotions for cosmetic purposes; make-up; make-up powder; make-up preparations; make-up removing preparations; mascara;

massage gels, other than for medical purposes; mouthwashes, not for medical purposes; mustache wax; nail art stickers; nail care preparations; nail varnish; neutralizers for permanent waving; non-slipping liquids for floors; oils for cosmetic purposes; oils for perfumes and scents; oils for toilet purposes; paint stripping preparations; perfumery; perfumes; petroleum jelly for cosmetic purposes; polish for furniture and flooring; polishing creams; polishing preparations; polishing wax; pomades for cosmetic purposes; potpourris [fragrances]; preparations to make the leaves of plants shiny; sachets for perfuming linen; scented water; scouring solutions; shampoos; shaving preparations; shining preparations [polish]; shoe cream; shoe wax; smoothing preparations [starching]; stain removers; starch glaze for laundry purposes; sunscreen preparations; sun-tanning preparations [cosmetics]; teeth whitening strips; tissues impregnated with cosmetic lotions; tissues impregnated with make-up removing preparations; toilet water; vaginal washes for personal sanitary or deodorant purposes; waxes for leather; windshield cleaning liquids.

5 – Absorbent cotton; acne treatment preparations; adhesive plasters; adhesive tapes for medical purposes; air deodorising preparations; air purifying preparations; albuminous foodstuffs for medical purposes; albumin dietary supplements; alginate dietary supplements; aloe vera preparations for pharmaceutical purposes; amino acids for medical purposes; anaesthetics; analgesics; antibiotics; antioxidant pills; antiparasitic preparations; antiseptic cotton; antiseptics; appetite suppressant pills; appetite suppressants for medical purposes; aseptic cotton; asthmatic tea; astringents for medical purposes; babies' diapers; balms for medical purposes; barks for pharmaceutical purposes; candy for medical purposes; candy, medicated; casein dietary supplements; chemico-pharmaceutical preparations; chemical preparations for medical purposes; chemical preparations for pharmaceutical purposes; chilblain preparations; cod liver oil; collagen for medical purposes; compresses; contact lens cleaning preparations; cotton sticks for medical purposes; collyrium; decoctions for pharmaceutical purposes; deodorants for clothing and textiles; depuratives; dietary fiber; dietetic beverages adapted for medical purposes; dietetic foods adapted for medical purposes; dietetic substances adapted for medical use; digestives for pharmaceutical purposes; drugs for medical purposes; elixirs [pharmaceutical preparations]; enzyme dietary supplements; first-aid boxes, filled; flour for pharmaceutical purposes; food for babies; frostbite salve for pharmaceutical purposes; fumigating sticks; gelatine for medical purposes; glucose dietary supplements; hematogen; herbal teas for medicinal purposes; infant formula; lacteal flour for babies; laxatives; lecithin dietary supplements; liniments; linseed dietary supplements; linseed oil dietary supplements; lotions for pharmaceuti-

cal purposes; medicinal drinks; medicinal hair growth preparations; medicinal herbs; medicinal infusions; medicinal mud; medicinal oils; medical preparations for slimming purposes; medicinal roots; medicinal tea; medicine cases, portable, filled; milk ferments for pharmaceutical purposes; mineral food supplements; mineral waters for medical purposes; mint for pharmaceutical purposes; mouthwashes for medical purposes; mud for baths; nervines; nutritional supplements; ootherapy preparations; pearl powder for medical purposes; pharmaceutical preparations; pharmaceutical preparations for skin care; pharmaceutical preparations for treating dandruff; pharmaceutical preparations for treating sunburn; pharmaceuticals; plant extracts for pharmaceutical purposes; preparations of trace elements for human and animal use; pollen dietary supplements; powdered milk for babies; propolis dietary supplements; protein dietary supplements; protein supplements for animals; purgatives; remedies for foot perspiration; royal jelly dietary supplements; royal jelly for pharmaceutical purposes; salts for mineral water baths; sanitary napkins; sedatives; serums; slimming pills; solutions for contact lenses; sunburn ointments; suppositories; syrups for pharmaceutical purposes; tanning pills; therapeutic preparations for the bath; tissues impregnated with pharmaceutical lotions; tonics [medicines]; turpentine for pharmaceutical purposes; vermifuges; vitamin preparations; wadding for medical purposes; wheat germ dietary supplements; yeast dietary supplements; yeast for pharmaceutical purposes.

(260) AM 2019 101553 A

(800) 1448222

(151) 2018 12 24

(891) 2018 12 24

(731) JOINT-STOCK COMPANY

"BRYANKONFI"

Vokzalnaya Street, 116, RU-241014

Bryansk, Russian Federation

(540)

# Брянка

(591) Black, white

(531) 28.05

(511)

30 – Aromatic preparations for food; flavorings, other than essential oils, for cakes; star aniseed; pancakes; buns; bread rolls; vanillin [vanilla substitute]; waffles; vermicelli [noodles]; natural sweeteners; sausage binding materials; sea water for cooking; glucose for culinary purposes; mustard; thickening agents for cooking foodstuffs; artificial coffee; vegetal preparations for use as coffee substitutes; confectionery for decorating Christmas trees; cakes; pastries; peanut confectionery; almond confectionery; pas-

ta; frozen yogurt [confectionery ices]; cocoa; capers; caramels [candy]; quiches; gluten prepared as foodstuff; sweetmeats [candy]; liquorice [confectionery]; peppermint sweets; coffee; unroasted coffee; starch for food; crackers; custard; groats for human food; corn, milled; corn, roasted; meat pies; turmeric; couscous [semolina]; noodles; ice for refreshment; ice, natural or artificial; edible ices; candy; rice cakes; maltose; marzipan; honey; royal jelly; ice cream; muesli; mint for confectionery; cocoa beverages with milk; coffee beverages with milk; coffee-based beverages; tea-based beverages; chocolate beverages with milk; chocolate-based beverages; cocoa-based beverages; infusions, not medicinal; crushed oats; husked oats; nutmegs; lozenges [confectionery]; molasses for food; pepper; biscuits; pies; pizzas; fondants [confectionery]; popcorn; powders for making ice cream; pralines; condiments; meat tenderizers for household purposes; cereal preparations; oat-based food; bee glue; propolis; gingerbread; spices; petits fours [cakes]; puddings; cake powder; ravioli; chewing gum; rice; spring rolls; sugar; aniseed; sugar confectionery; malt for human consumption; salt for preserving foodstuffs; cooking salt; celery salt; sorbets [ices]; spaghetti; preparations for stiffening whipped cream; rusks; breadcrumbs; sushi; sandwiches; tabbouleh; tacos; cake batter; almond paste; tapioca; tortillas; vinegar; halvah; bread; unleavened bread; chips [cereal products]; chicory [coffee substitute]; tea; iced tea; chocolate; malt extract for food; essences for foodstuffs, except etheric essences and essential oils.

(260) AM 2019 101554 A

(800) 1448232

(151) 2018 09 14

(891) 2018 09 14

(731) Open-Type Joint Stock Company

"Confectionery Concern Babayevsky"

ul. Malaya Krasnoselskaya, d. 7, RU-107140

Moscow, Russian Federation

(540)

**СОРВАНЕЦ**

(591) Black, white

(531) 28.05

(511)

30 – Aromatic preparations for food; star aniseed; noodle-based prepared meals; vermicelli [noodles]; sausage binding materials; sea water for cooking; seaweed [condiment]; cloves [spice]; mustard; gluten additives for culinary purposes; yeast; thickening agents for cooking foodstuffs; dressings for salad; pasta; ginger [spice]; capers; curry [spice]; ketchup [sauce]; starch for food; cinnamon [spice]; crushed barley; corn, milled; corn, roasted; noodles; turmeric; mayonnaise; macaroni; maltose; hominy; marinades; flour; bean meal; tapioca flour; potato flour;

corn flour; wheat flour; soya flour; barley meal; crushed oats; husked oats; soya bean paste [condiment]; molasses for food; pepper; allspice; peppers [seasonings]; pesto [sauce]; pizzas; meat gravies; mustard meal; condiments; meat tenderizers for household purposes; cereal preparations; oat-based food; propolis; spices; ravioli; relish (condiment); wheat germ for human consumption; spring rolls; sago; aniseed; baking soda [bicarbonate of soda for cooking purposes]; malt for human consumption; salt for preserving foodstuffs; cooking salt; celery salt; soya sauce; tomato sauce; sauces [condiments]; spaghetti; seasonings; breadcrumbs; sushi; sandwiches; tabbouleh; tacos; tapioca; tortillas; garden herbs, preserved [seasonings]; beer vinegar; vinegar; ferments for pastes; chutneys [condiments]; cheeseburgers [sandwiches]; chow-chow [condiment]; saffron [seasoning]; malt extract for food; essences for foodstuffs, except etheric essences and essential oils; husked barley.

(260) AM 2019 101555 A

(800) 1448252

(151) 2018 12 19

(891) 2018 12 19

(731) ACINO PHARMA AG

Birsweg 2, CH-4253 Liesberg,

Switzerland

(540)

**Velogir**

(591) Black, white

(511)

5 – Pharmaceutical products.

(260) AM 2019 101556 A

(800) 1448254

(151) 2018 12 19

(891) 2018 12 19

(731) ACINO PHARMA AG

Birsweg 2, CH-4253 Liesberg,

Switzerland

(540)

**Hypretive**

(591) Black, white

(511)

5 – Pharmaceutical products.

(260) AM 2019 101563 A

(800) 1448305

(151) 2017 10 18

(891) 2017 10 18

(731) MONCLER S.P.A.

Via Stendhal, 47, I-20144 MILANO,

Italy

(540)



(591) Black, white

(531) 26.04.08; 26.04.18; 27.05.01

(511)

3 – Perfumes; toilet water; deodorants for personal use [perfumery]; incense; joss sticks; air fragrancing preparations; sachets for perfuming linen; essential oils for personal use; henna [cosmetic dye]; eye shadow; cosmetic pencils; foundation; make-up powder; face powder [for cosmetic use]; talcum powder [for cosmetic use]; blusher; lipsticks; lipstick cases; lip glosses; mascara; sunscreen preparations; sun-tanning preparations [cosmetics]; nail polish; beauty masks; facial scrubs [cosmetic]; face creams for cosmetic purposes; cosmetic body creams; cosmetic creams; cosmetic preparations for slimming purposes; creams for cellulite reduction for cosmetic use; hair spray; cosmetic hair lotions; hair bleaching preparations; hair dyes; hair coloring preparations; hair rinses [shampoo-conditioners]; hair lighteners; hair conditioners; hair moisturizers; preparations for the permanent waving of hair; gels, sprays, mousses and balms for hair styling and hair care; depilatory preparations; hair straightening preparations; tissues impregnated with make-up removing preparations; phytocosmetic preparations; hand soap; cosmetic soap; facial soaps; skin cleansing creams; skin cleansing lotions; shower gel; bubble bath preparations [for cosmetic use]; non-medicated bath oils; non-medicated bath pearls; non-medicated bath salts; cosmetic creams and lotions for face and body care; shaving balms; shaving creams; shaving soap; after-shave lotions; hair shampoos; bath preparations, not for medical purposes; mouthwashes, not for medical purposes; non-medicated dentifrices; cosmetic preparations for the care of mouth and teeth; laundry starch; laundry soap; stain removers; cleaning preparations; rust removing preparations; carpet shampoos; cloths impregnated with a detergent for cleaning; emery; pumice stone; polishing powder; shoe polish; shoe wax; shoe cream; creams for leather; leather bleaching preparations; baby lotions [toilettries]; baby oils [toilettries]; baby powder [toilettries]; shampoos for babies; hair conditioners for babies; children's play cosmetics; cosmetics for animals; preparations for cleaning, protecting and preserving

vehicle surfaces; bleaching preparations and other substances for laundry use; cleaning, polishing, scouring and abrasive preparations; non-medicated soaps; perfumery, essential oils, non-medicated cosmetics, non-medicated hair lotions; non-medicated dentifrices.

9 – Eyeglasses; sunglasses; anti-glare glasses; goggles for sports; swimming goggles; eyeglass and sunglass cases; eyeglass and sunglass lenses; eyeglass and sunglass frames; eyeglass and sunglass chains; eyeglass and sunglass cords; pince-nez; pince-nez cases; pince-nez chains; pince-nez cords; pince-nez mountings; correcting lenses [optics]; contact lenses; containers for contact lenses; ski goggles; spectacle cases; optical lenses; binoculars; binocular cases; monocles; opera glasses; telescopes; optical discs; prisms [optics]; magnifying glasses; magnifying glass cases; objectives [lenses] [optics]; smartglasses; 3D spectacles; electronic game software for cellular phones; electronic game software for handheld electronic devices; computer game software; computer game programs; computer software, recorded; downloadable computer programs; floppy disks; personal computers; cases adapted for personal computers; notebook computers; hand-held computers; cases adapted for hand-held computers; carrying cases adapted for computers; tablet computers; protective cases for tablet computers; covers for tablet computers; laptop computers; cases for laptops; bags adapted for laptops; sleeves for laptops; docking stations for laptops; wrist rests for use with computers; computer mice; mouse pads; computer keyboards; printers for use with computers; computer peripheral devices; monitors [computer hardware]; carrying cases for radio pagers; radio cases; radios; mobile phones; lanyards [straps] for cellular phones; covers adapted for cellular phones; cases adapted for cellular phones; antennas for cellular phones; cellular phones; smartphones; protective covers for smartphones; protective cases for smartphones; electronic pagers; electronic book readers; protective cases for electronic book readers; cordless telephones; cordless telephone holders; telephone receivers; telephone apparatus; video telephones; cell phone straps; batteries for cellular phones; microphones for cellular phones; loudspeakers for cellular phones; earphones for cellular phones; battery chargers for cellular phones; battery charger cases for cellular phones; in-ear headphones; headphones; headphone cases; hands free kits for telephones; hands free kits for cellular phones; smartwatches; protective films adapted for smartphones; selfie sticks [hand-held monopods]; selfie sticks for use with smartphones; virtual reality headsets; multi-purpose cameras; disposable cameras; cases adapted for cameras; cameras [photography]; digital cameras; television cameras; camcorders; cases especially made for photographic apparatus and instruments; lanyards [straps] for cameras; digital photo frames;

exposed slide film cases; slides [photography]; video screens; home theater projectors; protective helmets for sports; clothing and footwear for protection against accidents, irradiation and fire; compact discs [audio-video]; DVDs; holders and cases for compact discs and DVDs; protective carrying cases for portable music players; music and video player cases; digital audio players; loudspeakers; compact disc players; cases adapted for CD players; DVD recorders; DVD players; cases adapted for DVD players; portable MP3 players; cases for portable MP3 players; covers for portable MP3 players; portable compact disc music players; prerecorded magnetic tapes, cartridges and disks; walkie-talkies; antennas; audio-visual teaching apparatus; films, exposed; transmitters of electronic signals; television apparatus; electronic publications, downloadable; magnetic data carriers; sound recording discs; prerecorded audio discs; prerecorded DVDs; audio and video tapes; sound recording carriers; video recorders; video cassettes; USB flash drives; electronic key fobs being remote control apparatus; time clocks [time recording devices]; counters; rulers [measuring instruments]; teaching apparatus; measuring devices, electric; barometers; thermometers, not for medical purposes; calculating machines; pocket calculators; chronographs [time recording apparatus]; scales; pedometers; navigation apparatus for vehicles [on-board computers]; credit card cases [fitted holders]; magnetically encoded key cards; electronic agendas; cases for electronic agenda; covers for electronic agendas; coin-operated musical automata [juke boxes]; magic lanterns; holograms; electronic interactive whiteboards; interactive touch screen terminals; decorative magnets; electronic pens [visual display units]; lanyards [straps] especially adapted for holding cellular phones, MP3 players, cameras, video cameras, eyeglasses, sunglasses, magnetic encoded cards; nose clips for divers and swimmers; baby monitors; audio baby monitors; video baby monitors; baby scales; protective helmets for children; educational software for children; scientific, nautical, surveying, photographic, cinematographic, optical, weighing, measuring, signalling, checking [supervision], life-saving and teaching apparatus and instruments; apparatus and instruments for conducting, switching, transforming, accumulating, regulating or controlling electricity; apparatus for recording, transmission or reproduction of sound or images; magnetic data carriers, recording discs; compact discs, DVDs and other digital recording media; mechanisms for coin-operated apparatus; cash registers, calculating machines, data processing equipment, computers; computer software; fire-extinguishing apparatus.

14 – Precious metals; gold; palladium; precious stones; jade; imitation jewellery; costume jewellery; trinkets [jewellery and imitation jewellery]; charms [jewellery and imitation jewellery]; silver thread [jewellery]; threads of precious metal [jewellery]; three-

ads of precious metal [jewellery and imitation jewellery]; gold thread [jewellery]; bracelets [jewellery and imitation jewellery]; bracelets made of embroidered textile [jewellery]; cloisonné jewellery; pearls [jewellery]; necklaces [jewellery and imitation jewellery]; lockets [jewellery and imitation jewellery]; chains [jewellery and imitation jewellery]; rings [jewellery and imitation jewellery]; brooches [jewellery and imitation jewellery]; earrings; diadems; medallions [jewellery and imitation jewellery]; medals; pins [jewellery and imitation jewellery]; ornamental pins; tie pins; pendants [jewellery]; cuff links; lanyards [keycords]; key chains [key chains with trinket or decorative fob]; key rings [split rings with trinket or decorative fob]; charms for key rings; key fobs of metal; key rings of leather; key rings, not of metal; split rings of precious metal for keys; key fobs of leather; key fobs of imitation leather; charms for key rings; key fobs of common metal; key fobs, not of metal; fancy key holders of precious metal; key holders of precious metal; key holders of metal; key tags of plastic; badges of precious metal; amulets [jewellery and imitation jewellery]; rosaries; paste jewellery [costume jewellery]; hat jewellery; shoe jewellery; shoe ornaments of precious metal; hat ornaments of precious metal; jewellery cases [caskets], not of precious metal; jewellery cases [caskets]; decorative boxes of precious metal; trophies of precious metal; statues of precious metal; figurines [statuettes] of precious metal; statuettes of precious metal; works of art of precious metal; clocks; wall clocks; watches; alarm clocks; chronometers; chronographs [watches]; wristwatches; stopwatches; pocket watches; cases for clocks and watches; watch bands; watch straps; watch chains; watch bracelets; precious metals and their alloys; jewellery, precious and semi-precious stones; horological and chronometric instruments.

16 – Magazines [periodicals]; magazines featuring stories, games and learning activities; newspapers; newspaper comic strips [printed matter]; pamphlets; pamphlets featuring stories, game and learning activities; booklets; periodicals; newsletters; printed publications; posters; handbooks [manuals]; calendars; catalogues; brochures; flyers; books; books featuring stories, games and learning activities; children's books; children's activity books; children's books incorporating audio contents; coloring books; school writing books; yearbooks; manuals [handbooks]; wrapping paper; gift wrapping paper; banners of paper; bunting of paper; writing paper; handkerchiefs of paper; bibs of paper; towels of paper; face towels of paper; table linen of paper; place mats of paper; table runners of paper; table napkins of paper; boxes of paper or cardboard; hat boxes of cardboard; containers made of cardboard; patterns for making clothes; sewing patterns; embroidery designs [patterns]; printed patterns; knitting patterns; decorative stickers for helmets; bumper stickers; transfers [decalco-

manias]; event albums; sketch books; scratch pads; sketches; architects' models; blueprints; prospectuses; photographs [printed]; graphic reproductions; graphic art reproductions; printed art reproductions; works of art of paper; figurines [statuettes] of papier mâché; engravings; lithographs; lithographic works of art; oleographs; occasion cards; cards bearing universal greetings; gift tags of paper; announcement cards [stationery]; invitation cards; postcards; cards; albums; photograph stands; photographs [printed]; photograph albums; stickers [stationery]; sticker albums; photo holders made of paper; bookmarkers; pens [office requisites]; fountain pens; ball-point pens; roller-tip pens; writing pens; felt-tip markers; pencils; pastels; crayons; chalks; painting sets for children; drawing brushes; stationery cases; cases of leather for agendas and weekly planners; drawing sets; pen boxes; pencil boxes; pen toppers; pencil toppers; pen cases; pencil cases; penholders; pencil holders; stands for pens and pencils; modelling clay for children; modelling materials and compounds for use by children; covers [stationery]; document files [stationery]; document holders [stationery]; desk mats; desk top organizers; personal organizers; exercise books [blank]; note books; cube-shaped notebooks; scratch pads; notepads; diaries; agendas; weekly planners [stationery]; agenda covers; weekly planner covers; address booklet covers; album covers; book covers; folders [stationery]; labels of paper or cardboard; labels, not of textile; adhesive labels, not of textile; paperweights; page holders; pencil sharpeners, electric or non-electric; drawing pads; adhesive bands for stationery or household purposes; adhesive tape dispensers [office requisites]; adhesive tapes for stationery or household purposes; paper knives [cutters] [office requisites]; rubber erasers; erasers; erasing products; correspondence holders; passport holders; stationery-type portfolios; illustration boards; paper ribbons; stationery; inkstands; clipboards; presentation folders; document portfolios [stationery]; trading cards, other than for games; paper bags; shopping bags of plastic; shopping bags of paper; bags [envelopes, pouches] of paper or plastics for packaging; placards of paper or cardboard; printed advertising boards of paper or cardboard; money clips; typewriters, electric or non-electric; paper and cardboard; printed matter; book-binding material; photographs; stationery and office requisites, except furniture; adhesives for stationery or household purposes; artists' and drawing materials; paintbrushes; instructional and teaching materials; plastic sheets, films and bags for wrapping and packaging; printers' type, printing blocks.

18 – Boxes of leather or leatherboard; cases of leather or leatherboard; leather straps; card cases [note-cases]; credit card cases [wallets]; calling card cases; furniture coverings of leather; business card cases; document cases; bags [envelopes, pouches] of leather, for packaging; labels of leather; clothing for

pets; collars for pets; bags for carrying animals; nose bags [feed bags]; bridles [harness]; leather, unworked or semi-worked; moleskin [imitation of leather]; fur; raw skins; bags; handbags; evening purses [handbags]; shopping bags; leather shopping bags; wheeled shopping bags; duffle bags; waist bags; Boston bags; shoulder bags; travelling trunks; beach bags; clutch bags; attaché cases; school bags; school satchels; schoolchildren's backpacks; randsels [Japanese school satchels]; bags for sports; garment bags for travel; purses; wallets; pocket wallets; carrying cases for documents; key cases; key bags; key wallets; briefcases; pouches, of leather, for packaging; luggage; pouches for holding make-up, keys and other personal items; shoe bags for travel; all-purpose sports bags; saddle bags; knapsacks; backpacks; rucksacks; haversacks; overnight suitcases; trunks [luggage]; vanity cases, not fitted; hat boxes for travel; hat boxes of leather; handbag frames; key cases of leather; shoulder belts [straps] of leather; leather straps; pouches of leather; suitcases; suitcases with wheels; travelling sets [leatherware]; travelling bags of leather; bags for campers; bags for climbers; sling bags for carrying infants; slings for carrying infants; pouch baby carriers; backpacks for carrying babies; infant carriers worn on the body; umbrellas for children; reins for guiding children; umbrellas; parasols; walking sticks; mountaineering sticks; harness fittings; golf umbrellas; umbrella covers; leather and imitations of leather; animal skins and hides; luggage and carrying bags; umbrellas and parasols; walking sticks; whips, harness and saddlery; collars, leashes and clothing for animals.

25 – Jackets [clothing]; sleeved or sleeveless jackets; heavy jackets; lightweight jackets [clothing]; bomber jackets; reversible jackets; rain jackets; leather jackets; padded jackets; wind-resistant jackets; waterproof jackets; stuff jackets [clothing]; down jackets; sleeveless down jackets; sports jackets; ski jackets; snowboard jackets; long jackets; windcheaters; ski windcheaters; snowboard windcheaters; anoraks [parkas]; down anoraks; parkas; down parkas; fur jackets; waistcoats; waistcoats with removable lining; overcoats; coats; fur coats; raincoats; cardigans; pullovers; shirts; T-shirts; polo shirts; sport shirts; undershirts; shirts for wear with suits; chemises; camisoles; blouses; blousons; sweatshirts; sweaters; jumpers [pullovers]; jerseys [clothing]; sports jerseys; trousers; ski pants; snowboard pants; ski trousers; shorts; Bermuda shorts; jeans; skirts; skorts; work overalls; clothing for gymnastics; jogging suits; jogging suit trousers; training suits; track suits; ski suits; snowboard suits; suits; dresses for women; evening dresses; gowns; blazers; formal wear; petticoats; corselets; wristbands [clothing]; headbands [clothing]; twin sets; leggings [trousers]; leggings [leg warmers]; leg warmers; dungarees; ponchos; veils [clothing]; wedding dresses; ready-made clothing; outer clothing; masquerade costumes; tops



[clothing]; tank-tops; knitwear [clothing]; hosiery; clothing of leather or imitations of leather; furs [clothing]; waterproof clothing; pants; sweat pants; pelearines; pinafore dresses; tuxedos; romper suits; leotards; gabardines [clothing]; slacks; tunics; school uniforms; athletic uniforms; breeches for wear; golf clothing, other than gloves; cuffs; dance clothing; aprons [clothing]; smocks; ski masks [clothing]; kimonos; judo uniforms; karate uniforms; bathing suits; bathing caps; swimming caps; shower caps; beach cover-ups; beach clothes; swimming costumes; swimsuits; bathing drawers; bathing trunks; bikinis; bath robes; pareus; clothing for children; footwear for children; headgear for children; articles of clothing, footwear and headgear for babies and toddlers; babies' pants [clothing]; bibs, not of paper; layettes [clothing]; babies' sleepwear; costumes for use in the children's dress up play; socks; stockings; tights; sports socks; panty hose; unitards; garters; sock suspenders; stocking suspenders; shoes; leather shoes; sports shoes; gymnastic shoes; beach shoes; mountaineering shoes; running shoes; ski footwear; after ski footwear; footwear for snowboarding; rain footwear; sneakers; slippers; bath slippers; sandals; bath sandals; flip-flops [footwear]; heels; heelpieces for boots and shoes; inner soles; tips for footwear; soles for footwear; footwear uppers; boots; half-boots; lace boots; rain boots; ski boots; after ski boots; snowboard boots; boots for sports; horse-riding boots; clogs; overshoes; galoshes; gaiters; valenki [felted boots]; scarves; cloaks; shawls; stoles; fur stoles; bandanas [neckerchiefs]; foulards [clothing articles]; neckties; bow-ties; ascots; neckerchiefs; pocket squares; neck warmers; gloves [clothing]; muffs [clothing]; mittens; ski gloves; snowboard gloves; belts [clothing]; braces for clothing [suspenders]; suspenders; waistbands [parts of clothing]; money belts [clothing]; sashes for wear; boas [necklets]; collars [clothing]; mufflers [neck scarves]; underwear; singlets; sport singlets; slips [undergarments]; panties; underpants; drawers [clothing]; briefs; boxer briefs; pyjamas; dressing gowns; nightgowns; vests; brassieres; corsets [underclothing]; bodices [lingerie]; girdles; teddies [underclothing]; sleep masks; caps [headwear]; hats; cap peaks; caps with visors; berets; hoods [clothing]; ear muffs [clothing]; visors [headwear]; clothing, footwear, headgear.

28 – Apparatus for games other than those adapted for use with an external display screen or monitor; video game machines; apparatus for games; pocket-sized apparatus for playing video games; pocket-sized video game machines; pocket-sized electronic game machines; hand-held games with liquid crystal displays; portable games with liquid crystal displays; stand-alone video game machines; arcade video game machines; controllers for game consoles; balls for games; counters [discs] for games; bladders of balls for games; ring games; conjuring apparatus;

roulette wheels; skittles [games]; shuttlecocks; marionettes; kites; kite reels; quoits; toy vehicles; radio-controlled toy vehicles; remote-controlled toy vehicles; toy cars; kaleidoscopes; masks [playthings]; theatrical masks; play balloons; toy pistols; dolls; dolls' beds; dolls' feeding bottles; dolls' clothes; dolls' houses; dolls' rooms; teddy bears; spinning tops [toys]; puzzles; jigsaw puzzles; parlor games; mobiles [toys]; building blocks [toys]; flying discs [toys]; scooters [toys]; rocking horses; dominoes; building games; toy construction kits; soap bubbles [toys]; slides [playthings]; practical jokes [novelties]; butterfly nets; scale model vehicles; playing cards; cases for playing cards; dice; draughts [games]; draughtboards; backgammon games; checkers [games]; board games; chess games; chess sets; chess pieces; checkerboards; chessboards; mah-jong; bingo cards; rackets; playing balls; nets for sports; race tracks [toys]; darts; swimming pools [play articles]; novelties for parties, dances [party favors, favours]; cases for play accessories; Christmas trees of synthetic material; bells for Christmas trees; snow globes; paper party hats; scratch cards for playing lottery games; toys for pets; plush characters and animals; rubber character toys; animated and non-animated toy figures; stuffed toys and unstuffed toys in the form of plastic character toys; puppets; stuffed puppets; plush toys; stuffed toys; rattles [playthings]; rattles for babies; baby rattles incorporating teething rings; cot musical toys for babies; baby gyms; plush toys with attached comfort blanket; tricycles for infants [toys]; tables for indoor football; tables for table tennis; golf bags, with or without wheels; golf gloves; golf clubs; divot repair tools [golf accessories]; billiard cues; pool cue tips; billiard markers; billiard tables; billiard balls; tennis nets; tennis ball throwing apparatus; tennis rackets; rackets; battledores; table tennis rackets; strings for rackets; bowling apparatus and machinery; cricket bags; hockey sticks; coin-operated billiard tables; grip tapes for rackets; skis; snow skis; edges of skis; ski brakes; ski poles; ski sticks; ski bindings; shaped covers for ski bindings; shaped covers for skis; bags adapted for skis; sole coverings for skis; seal skins [coverings for skis]; bindings for alpine skis; surf skis; bob-sleighs; discuses for sports; surfboards; sleds [sports articles]; snow sleds for recreational use; sailboards; snowboards; stationary exercise bicycles; machines for physical exercises; foils for fencing; harpoon guns [sports articles]; bar-bells; appliances for gymnastics; fencing weapons; climbers' harness; mountaineering equipment, namely, ascenders, binding straps, hooks, hook and ring combinations; paragliders; hang gliders; skateboards; spring boards [sports articles]; twirling batons; bags especially designed for surfboards; harness for sailboards; masts for sailboards; paintball guns [sports apparatus]; surfboard leashes; starting blocks for sports; sling shots [sports articles]; horizontal bars

for gymnastics; weight lifting belts [sports articles]; parallel bars for gymnastics; exercise platforms; poles for pole vaulting; skipping ropes; batting gloves [accessories for games]; fencing gauntlets; exercise pulleys; exercise benches; jumping ropes; body-building apparatus; body-training apparatus; archery implements; punching bags; roller skates; in-line roller skates; ice skates; skating boots with skates attached; boxing gloves; baseball gloves; gloves for games; snowshoes; swimming belts; swimming life rings; swimming kick boards; flippers for swimming; water wings; arm floats for swimming; swimming jackets; hunting game calls; fishing tackle; rods for fishing; fishing lines; bows for archery; camouflage screens [sports articles]; hunting and fishing equipment; floats for swimming; swimming gloves; inflatable armbands for swimming; swimming floats for recreational use; party poppers; streamers [party novelties]; balloons [party novelties]; decorations for artificial Christmas trees; games, toys and playthings; video game apparatus; gymnastic and sporting articles; decorations for Christmas trees.

35 – Retail and wholesale services on behalf of third parties, also on-line, of bleaching preparations and other substances for laundry use, detergents, cleaning, polishing, scouring and abrasive preparations, non-medicated soaps, perfumery, essential oils, non-medicated cosmetics, non-medicated hair lotions, non-medicated dentifrices; retail and wholesale services on behalf of third parties, also on-line, of candles, eyeglasses, sunglasses, anti-glare glasses, ski goggles, goggles for use in sport, swimming goggles, eyeglass and sunglass cases, eyeglass and sunglass lenses, eyeglass and sunglass frames; retail and wholesale services on behalf of third parties, also on-line, of eyeglass and sunglass chains, eyeglass and sunglass cords, pince-nez, pince-nez cases, pince-nez chains, pince-nez cords, pince-nez mountings, correcting lenses [optics]; retail and wholesale services on behalf of third parties, also on-line, of holders, cases, covers, electronic apparatus holders, electronic apparatus cases, electronic apparatus covers; retail and wholesale services on behalf of third parties, also on-line, of scientific, nautical, surveying, photographic, cinematographic, optical, weighing, measuring, signalling, checking [supervision], life-saving and teaching apparatus and instruments, apparatus and instruments for conducting, switching, transforming, accumulating, regulating or controlling electricity; retail and wholesale services on behalf of third parties, also on-line, of apparatus for recording, transmission or reproduction of sound or images, magnetic data carriers, recording discs, compact discs, DVDs and other digital recording media, mechanisms for coin-operated apparatus, cash registers, calculating machines, data processing equipment, computers, computer software, fire-extinguishing apparatus; retail and wholesale services on

behalf of third parties, also on-line, of apparatus for lighting, lamps, precious metals and their alloys, jewellery, precious and semi-precious stones, horological and chronometric instruments, key rings, key fobs, key cases, key holders, key bags; retail and wholesale services on behalf of third parties, also on-line, of paper and cardboard, printed matter, bookbinding material, photographs, stationery and office requisites, adhesives for stationery or household purposes, artists' and drawing materials, paintbrushes, instructional and teaching materials, plastic sheets, films and bags for wrapping and packaging, printers' type, printing blocks; retail and wholesale services on behalf of third parties, also on-line, of bags, cases and holders [leatherware], leatherware, leather and imitations of leather, animal skins, hides, trunks, travelling bags, umbrellas and parasols, walking sticks, whips, harness, saddlery, collars, leashes and clothing for animals; retail and wholesale services on behalf of third parties, also on-line, of furniture, mirrors, picture frames, ropes and string, nets, tents and tarpaulins, awnings of textile or synthetic materials, sails, sacks for the transport and storage of materials in bulk, padding, cushioning and stuffing materials, raw fibrous textile materials and substitutes therefor; retail and wholesale services on behalf of third parties, also on-line, of textiles and substitutes for textiles, household linen, curtains of textile or plastic, bed covers, table covers, clothing, footwear, headgear; retail and wholesale services on behalf of third parties, also on-line, of lace and embroidery, ribbons and braid, buttons, hooks and eyes, pins and needles, artificial flowers, hair decorations, false hair, carpets, rugs, mats and matting; retail and wholesale services on behalf of third parties, also on-line, of games, toys and playthings, video game apparatus, gymnastic and sporting articles, decorations for Christmas trees, smokers' articles; presentation of goods on communication media, for retail purposes; commercial information and advice for consumers [consumer advice shop]; sales promotion for others; outsourcing services [business assistance]; procurement services for others [purchasing goods and services for other businesses]; demonstration of goods; shop window dressing; sponsorship search; business inquiries; business information; administrative processing of purchase orders; organization and management of customer loyalty programs; administration of consumer loyalty programs; auctioneering; auctioneering services provided on the Internet; commercial administration of the licensing of the goods and services of others; organization of fashion shows for promotional purposes; organization of events, exhibitions, trade fairs and fashion shows for commercial, promotional and advertising purposes; organization of trade fairs for commercial or advertising purposes; organization of advertising events; arranging and conducting of promotional and marketing events; event marketing; news clipping servi-

ces; public relations; on-line advertising on a computer network; advertising of goods and services on the Internet and by means of mobile telephony services and by electronic mail; bill-posting; rental of advertising space; publicity material rental; dissemination of advertising matter; advertising agency services; modelling for advertising or sales promotion; writing of publicity texts; publication of publicity texts; promoting the sale of fashion goods through promotional articles in magazines; distribution of samples; distribution and dissemination of advertising materials [leaflets, prospectuses, printed material, samples]; advertising planning services; promotional services; merchandising services; search engine optimization for sales promotion; web site traffic optimization; consultancy regarding advertising communications strategy; consultancy regarding public relations communications strategy; social media strategy and marketing consultancy; business management and organization consultancy; consultancy and advisory services in the field of business strategy; business management consultancy relating to strategy, marketing, production, personnel and retail sale matters; business research; business management assistance; marketing strategy planning; advice in the field of business management and marketing; business information and accounting advisory services; import-export agency services; economic forecasting; marketing research; market studies; business investigations; opinion polling; franchising, namely services rendered by a franchisor, that is transfer of business and organisational know-how; assistance in the development and management of a commercial enterprise; providing an on-line commercial information directory on the Internet; compiling indexes of information for commercial or advertising purposes; compilation of information into computer databases; relocation services for businesses; business auditing; book-keeping; accounting; personnel placement and recruitment; personnel management consultancy; secretarial services; rental of vending machines; business management of hotels; photocopying services; business management of performing artists; computerized business record keeping services; advertising; business management; business administration; office functions.

41 – Conducting entertainment events, cultural events, live sports events, educational events, and entertainment and cultural activities; entertainment services; organization, production, presentation and conducting of music concerts, festivals, tours and other musical and cultural performances, events and activities; arranging of film events, musical events, cultural and sporting events and live entertainment events; organization of fashion shows for entertainment purposes; entertainment in the nature of fashion shows; arranging award ceremonies and gala evenings for entertainment purposes; party planning [entertainment]; organization and presentation of

shows, competitions, games, concerts and entertainment events; organization of balls; organization of exhibitions for cultural purposes; organization of exhibitions for cultural or educational purposes; providing recreation facilities; providing recreation facilities and services; providing information about education, training, entertainment, sporting and cultural activities; providing information about entertainment and entertainment events via on-line networks and the Internet; production and presentation of audio and video recordings, and still and moving images; electronic publishing services; on-line digital publishing services; on-line publication of electronic books and journals; digital video, audio and multimedia entertainment publishing services; publication of fashion magazines for entertainment purposes; news reporting services in the field of fashion; publication of multimedia material on-line; electronic desktop publishing; publication of yearbooks; publication of calendars; publication of brochures; publication of newsletters; publication of catalogs; publication of books, magazines and other texts, other than publicity texts; publication of printed matter, also in electronic form, other than for advertising purposes; publication of texts, other than publicity texts; electronic publication of information on a wide range of topics on-line; publishing services; providing on-line electronic publications, not downloadable; writing of texts; layout services, other than for advertising purposes; arranging of symposiums and training workshops; arranging and conducting of conferences, conventions, educational exhibitions, classes, lectures, seminars and training workshops; provision of training courses; providing of training via a global computer network; conducting of instructional, educational and training courses for young people and adults; conducting of training workshops; conducting of educational courses; training in the field of design; training to recognize fake products for the prevention of counterfeiting; conducting of training courses in the field of technology and innovation; education and training in the field of electronic data processing; education and training relating to nature conservation and the environment; business training; vocational skills training; vocational guidance [education or training advice]; higher education, academic, linguistic and vocational education and training services; photography; photographic reporting; health club services [health and fitness training]; club services [entertainment or education]; club services in the nature of entertainment; organization of sports events and competitions; providing golf facilities; providing physical education, games and sporting facilities; rental of sports equipment, except vehicles; rental of sports grounds; providing facilities for winter sports; providing sports facilities; games equipment rental; arranging of games and competitions via the Internet; organization of games and competitions; organization of educational, entertain-

ment, cultural and sporting competitions; arranging of beauty contests; organization of lotteries; providing on-line entertainment in the nature of game shows; electronic games services provided by means of the Internet or other communication network; game services provided on-line from a computer network; providing recreational areas in the nature of play areas for children; providing educational entertainment services for children in after-school centers; franchising, namely services rendered by a franchisor, that is basic training of personnel; modelling for artists; museum services; providing museum facilities [presentation, exhibitions]; rental of artwork; interpretation and translation services; amusement park services; holiday camp services [entertainment]; discotheque services; ticket reservation and booking services for entertainment, sporting and cultural events; ticket agency services [entertainment]; providing non-downloadable digital music from the Internet; providing on-line videos, not downloadable; education; providing of training; entertainment; sporting and cultural activities.

42 – Dress designing; design of fashion accessories; fashion design; footwear design; clothing design; design of headgear; jewellery and imitation jewellery design; providing information about fashion design services; styling [industrial design]; industrial and graphic art design; illustrators' services; architectural consultancy; interior decoration consultancy; interior design; design of interior decor; commercial art design; packaging design; development, design and updating of homepages; providing temporary use of non-downloadable software to enable sharing of multimedia content and comments among users; creation, design, development, and maintenance of web sites; electronic site authoring; creating and maintaining web pages; administration of user rights in computer networks; creating and designing web-site-based indexes of information for others [information technology services]; providing search engines for obtaining data via communications networks; providing Internet search engines with specific search options; providing temporary use of on-line applications and software tools; providing temporary use of non-downloadable software applications accessible via a web site; providing temporary use of non-downloadable business software; providing temporary use of on-line non-downloadable software for importing and managing data; hosting multimedia and interactive applications; hosting computerized data, files, applications and information; web site design consultancy; consultancy relating to the creation of homepages and Internet pages; consultancy in the field of computer system integration; computer system design; design and development of electronic databases; design and development of systems for data input, output, processing, display and storage; data encryption and decoding services; design, maintenance, rental and updating of computer software;

design, updating and rental of computer software; configuration, installation, fault diagnosis, repair, upgrading and maintenance of computer software; design and development of computer software for reading, transmitting and organizing data; design, development, maintenance and updating of computer software for word processing, data processing and process control; rental of computer software; data security consultancy; internet security consultancy; consultancy in the design and development of computer hardware; outsource service providers in the field of information technology; quality control; quality control of goods and services; quality control of partly manufactured goods; quality control testing; inspection of goods for quality control; conducting of quality control tests; quality testing; testing, analysis and evaluation of the goods and services of others for the purpose of certification; quality control services for certification purposes; testing services for the certification of quality or standards; technical testing and quality control services; quality control testing and consultancy relating thereto; quality assurance consultancy; process monitoring for quality assurance; consumer product safety testing; testing of raw materials; textile testing; testing, authentication and quality control; technical research projects and studies; development of measuring and testing methods; surveying; analytical laboratory services; laboratory research and analysis; providing technical advice in the field of scientific and industrial research; analysis and evaluation of product development; research services for the development of new products; development of new technology for others; franchising, namely services rendered by a franchisor, that is transfer of technical know-how; consultancy relating to the planning and layout design of shops, the interior decor of shops and related signs; scientific and technological services and research and design relating thereto; industrial analysis and research services; design and development of computer hardware and software.

(260) AM 2019 101564 A

(800) 1448366

(151) 2018 07 19

(891) 2018 07 19

(731) BOYNER HOLDING ANONIM SİRKETİ  
Eski Büyükdere cad. No.14, Park Plaza K.  
15-16 Maslak, Sarıyer, İstanbul, Turkey

(540)

# MORHIPO

(591) Black, white

(511)

35 – Advertising, marketing and public relations, organization of exhibitions and trade fairs for commercial or advertising purposes, office functions,

secretarial services, compilation of statistics, systemization of information into computer databases, business management, business administration and business consultancy, accounting, commercial consultancy services, import-export agencies, arranging commercial transactions for others via online shops, advertising services to promote public awareness of the benefits of shopping, retail department stores featuring a bonus incentive program for customers, business management and consultation in the field of fee refund to customers, business consulting related to commerce and e-commerce, business management consultancy services, commercial intermediation services, commercial information agency services, commercial or industrial management assistance, provision of commercial and business contact information, web indexing for commercial or advertising purposes, commercial information and advice for consumers, administration of consumer loyalty programs, administrative processing of purchase orders, business management of reimbursement programmes for others, compilation of information into computer databases, computerized file management, cost price analysis, market studies, marketing research, provision of on-line marketplace for buyers and sellers of goods and services, price comparison services, sales promotion for others, search engine optimization for sales promotion, telemarketing services, provision of online marketplace for buyers and sellers of goods and services, bringing together, for the benefit of others, of a variety of goods namely adhesives, paints, dyes, cosmetics, perfumery, toiletries, dentifrices, soaps, detergents, deodorants for personal use and household use, bleaching and cleaning preparations, dental care preparations, dentifrices, mouth washes, polishing preparations, candles, wax, liquid and gas fuel, pharmaceuticals, veterinary and medical preparations, disinfectants, dietary supplements, baby food, herbs and herbal beverages, sanitary preparations, sanitary diapers, sanitary pads, preparations for destroying vermin, fungicides, herbicides, goods and materials of common metal used for storage, wrapping, packaging and sheltering purposes, containers of metal (storage, transport), buildings, poles, frames of metal, metal boxes, packaging containers of metal, aluminium foil, fences made of metal, storage containers of metal, metal containers for the transportation of goods, ladders of metal, ironmongery, small hardware of metal, safes of metal, metal pallets and metal ropes for lifting, loading and transportation purposes, metal hangers, ties, straps, tapes and bands used for load-lifting and load-carrying, machines, machine tools and industrial robots for processing and shaping wood, metals, glass, plastics and minerals, 3D printers, machines and robotic mechanisms (machines) for use in agriculture and animal breeding, machines and robotic mechanisms (machines) for processing cereals, fruits, vegetables and food, electric

kitchen machines for chopping, grinding, crushing, mixing and mincing foodstuff, washing machines, laundry washing machines, dishwashers, spin driers (not heated), electric cleaning machines for cleaning floors, carpets or floorings, vacuum cleaners and parts thereof, forks, spoons, knives and non-electric cutters, sheers, peelers for kitchen use, including those made of precious metals, tools and apparatus for personal beauty care use, tools and apparatus for shaving, epilation, manicure and pedicure, electric hand implements for straightening and curling hair, scissors, hand-operated hand tools for the repair of machines, apparatus and vehicles and for use in construction, agriculture, horticulture and forestry, electric or non-electric irons, steam irons, measurement apparatus and equipment including those for scientific, nautical, topographic, meteorological, industrial and laboratory purposes, thermometers, barometers, ammeters, voltmeters, hygrometers, testing apparatus, telescopes, periscopes, directional compasses, speed indicators, laboratory apparatus, microscopes, magnifying glasses, stills, ovens and furnaces for laboratory experiments, apparatus for recording, transmission or reproduction of sound or images, cameras, photographic cameras, television apparatus, video recorders, CD and DVD players and recorders, MP3 players, computers, desktop computers, tablet computers, microphones, loudspeakers, earphones, telecommunications apparatus, apparatus for the reproduction of sound or images, computer peripheral devices, cell phones, covers for cell phones, telephone apparatus, computer printers, scanners as data processing equipment, photocopiers, magnetic and optic data carriers and computer software and programmes recorded thereto, downloadable and recordable electronic publications, encoded magnetic and optic cards, antennas, electronic components used in the electronic parts of machines and apparatus, semi-conductors, electronic circuits, integrated circuits, chips as integrated circuits, diodes, electronic transistors, magnetic heads for electronic apparatus, electronic locks, photocells, remote control apparatus for opening and closing doors, optical sensors, counters, clothing for protection against accidents, irradiation and fire, safety vests and life-saving apparatus and equipment, eyeglasses, sunglasses, optical lenses and cases, containers, parts and components thereof, apparatus and instruments for conducting, transforming, accumulating or controlling electricity, electric plugs, electricity junction boxes, electric switches, circuit breakers, fuses, lighting ballasts, battery starter cables, electrical circuit boards, electric resistances, electric sockets, electricity transformers, electrical adapters, battery chargers, electric door bells, electric and electronic cables, batteries, electric accumulators, alarms and anti-theft alarms, electric bells, fire extinguishing apparatus, fire engines, fire hose and fire hose nozzles, radar apparatus, sonars, night vision apparatus and

instruments, decorative magnets, metronomes, medical orthopaedic articles, corsets for medical purposes, orthopaedic shoes, elastic bandages and supportive bandages, condoms, babies' bottles, babies' pacifiers, teats, teethingers for babies, lighting installations, lights for vehicles and interior-exterior spaces, heating installations using solid, liquid or gas fuels or electricity, central heating boilers, boilers for heating installations, radiators, heat exchangers, stoves, kitchen stoves, solar thermal collectors, steam, gas and fog generators, steam boilers, acetylene generators, oxygen generators, nitrogen generators, installations for air-conditioning and ventilating, cooling installations and freezers, electric and gas-powered devices, installations and apparatus for cooking, drying and boiling, cookers, electric cooking pots, electric water heaters, barbecues, electric laundry driers, hair driers, hand drying apparatus, sanitary installations, taps [faucets], shower installations, toilets, shower and bathing cubicles, bath tubs, toilet seats, sinks, wash-hand basins, water softening apparatus, water purification apparatus, water purification installations, waste water purification installations, electric bed warmers and electric blankets, not for medical use, electric pillow warmers, electric or non-electric foot warmers, hot water bottles, pasteurizers and sterilizers, motor land vehicles, motorcycles, mopeds, engines and motors for land vehicles, parts thereof, bicycles, vehicle seats, head-rests for vehicle seats, safety seats for children, for vehicles, seat covers for vehicles, vehicle covers, sun-blinds adapted for vehicles, wipers for vehicles, tires for vehicles, mirrors for vehicles, anti-skid chains for vehicles, air pumps for inflating tires, anti-theft alarms for vehicles, horns for vehicles, baby carriages, wheelchairs, pushchairs, shopping carts, shopping trolleys, vehicles for locomotion by water, vehicles for locomotion by air, fireworks, sprays for personal defence, jewellery, watches, statuettes and figurines of precious metal, clocks, watches, parts thereof, chronometers, music instruments, their cases, paper and cardboard, paper and cardboard for packaging and wrapping purposes, cardboard boxes, paper towels, toilet paper, paper napkins, plastic materials for packaging and wrapping purposes, printed publications, printed matter, books, magazines, newspapers, bill books, printed dispatch notes, printed vouchers, calendars, posters, photographs [printed], paintings, stickers [stationery], postage stamps, stationery, office stationery, instructional and teaching material [except furniture and apparatus], writing and drawing implements, artists' materials, paper products for stationery purposes, adhesives for stationery purposes, pens, pencils, erasers, adhesive tapes for stationery purposes, cardboard cartons [artists' materials], writing paper, copying paper, paper rolls for cash registers, drawing materials, chalkboards, painting pencils, watercolours [paintings], stationery, instructional and teaching material, writing and drawing imple-

ments, artists' materials, paper products for stationery purposes, adhesives for stationery purposes, pens, pencils, erasers, adhesive tapes for stationery purposes, cardboard cartons [artists' materials], writing paper, copying paper, paper rolls for cash registers, drawing materials, chalkboards, painting pencils, watercolours [paintings], pint roller, paint brushes, rosaries, goods made of leather, imitations of leather or other materials, designed for carrying items, bags, wallets, straps, boxes and trunks made of leather or stout leather, key cases, trunks [luggage], suitcases, umbrellas, parasols, walking sticks, monuments and statuettes of stone, concrete and marble, furniture, mattresses, pillows, air mattresses and cushions, sleeping bags for camping, water beds, mirrors, bouncing chairs for babies, playpens for babies, cradles, infant walkers, display boards, frames for pictures and paintings, identification plates, identification tags, nameplates, identification labels made of wood or synthetic materials, packaging containers of wood or plastics, casks for use in transportation or storage, barrels, storage drums, tanks, boxes, storage containers, transportation containers, chests, loading pallets and closures for the aforementioned goods, of wood or plastics, small hardware goods of wood or synthetic materials, furniture fittings, of wood or synthetic materials, opening and closing mechanisms of wood or synthetic materials, ornaments and decorative goods of wood, cork, reed, cane, wicker, horn, bone, ivory, whalebone, shell, amber, mother-of-pearl, meerschaum, beeswax, plastic or plaster, figurines, holiday ornaments for walls and sculptures, baskets, kennels, nesting boxes and beds for household pets, cages for household pets, indoor aquariums, vivarium and indoor terrariums for animals and plant cultivation, portable ladders, bamboo curtains, roller indoor blinds [for interiors], slatted indoor blinds, strip curtains, bead curtains for decoration, curtain hooks, curtain rings, curtain tie-backs, curtain rods, hand-operated non-electric cleaning instruments and appliances, brushes, other than paintbrushes, steel chips for cleaning, sponges for cleaning, steel wool for cleaning, cloths of textile for cleaning, gloves for dishwashing, non-electric polishing machines for household purposes, brooms for carpets, mops, tooth brushes, shaving brushes, hair brushes, non-electric household or kitchen utensils, services [dishes], pots and pans, bottle openers, flower pots, drinking straws, non-electric cooking utensils, ironing boards and shaped covers therefor, drying racks for washing, clothes drying hangers, ornaments and decorative goods of glass, porcelain, earthenware or clay, statues, figurines and vases, perfume burners, perfume sprayers, perfume vaporizers, electric or non-electric make-up removing appliances, powder puffs, toilet cases, plant watering devices and containers, ropes, strings, hammocks, tents, bags of textile, yarns, threads, textile goods for household use, curtains, bed covers, sheets (textile), pil-

lowcases, blankets, quills, towels, flags, labels, blankets, clothing, headgear, footwear, swimwear, scarves, hats, caps, laces and embroidery, guipures, festoons, ribbons (haberdashery), ribbons and braid, fastening tapes for clothing, cords for clothing, letters and numerals for marking linen, embroidered emblems, badges for wear, not of precious metal, shoulder pads for clothing, buttons for clothing, fasteners for clothing, eyelets for clothing, zippers, buckles for shoes and belts, fasteners, shoe and belt buckles, pins, other than jewellery, adhesive patches for decoration of textile articles, laces, needles, sewing needles, needles for sewing machines, needles for knitting and embroidery, boxes for needles, needle cushions, artificial flowers, artificial fruits, hair pins, hair buckles, hair bands, decorative articles for the hair, wigs, hair extensions, electric or non-electric hair curlers, carpets, rugs, mats, wallpaper, wall hangings, games, toys, gymnastic and sporting articles, fishing tackle, artificial fishing bait, decoys for hunting and fishing, Christmas trees of artificial material, ornaments for Christmas trees, artificial snow, rattles (playthings), novelties for parties, paper party hats, foodstuff, beverages, matches, tobacco and tobacco products enabling customers to conveniently view and purchase those goods, such services may be provided by retail stores, wholesale outlets, through vending machines, mail order catalogues or by means of electronic media, for example, through web sites or television shopping programmes.

(260) AM 2019 101566 A  
 (800) 1448423  
 (151) 2018 12 07  
 (891) 2018 12 07  
 (731) BRITISH AMERICAN TOBACCO  
 (BRANDS) LIMITED  
 Globe House, 4 Temple Place, London  
 WC2R 2PG, United Kingdom  
 (540)



(591) Black, white  
 (531) 05.03.11; 05.03.13; 05.03.15  
 (511)  
 34 – Cigarettes; tobacco, raw or manufactured; tobacco products; tobacco substitutes (not for medical purposes); cigars, cigarillos; cigarette lighters; matches; smokers' articles; cigarette paper, cigarette tubes, cigarette filters; pocket apparatus for rolling cigarettes; hand held machines for injecting tobacco into paper tubes; electronic cigarettes; liquids for electronic cigarettes; tobacco products for the purpose

of being heated; electronic devices and their parts for the purpose of heating cigarettes or tobacco.

(260) AM 2019 101567 A  
 (800) 1448461  
 (151) 2018 11 21  
 (891) 2018 11 21  
 (731) SHENZHEN AIFENGCHENGPIN  
 TRADING CO., LTD  
 1006, Block A Qunxing Square, Huaqiang  
 North Road, Huaqiang North Street, Futian,  
 Shenzhen, China  
 (540)

# VIDVIE

(591) Black, white  
 (531) 27.05.01  
 (511)  
 9 – Computers; time recording apparatus; weighing machines; telephone apparatus; telephone covers; loudspeakers; photographic cameras; electric accumulators; cables, electric; integrated circuits; electric switches; fire extinguishers; protection devices for personal use against accidents; annunciators; spectacles; intercoms; covers for smartphones; wireless headsets for smartphones; cabinets for loudspeakers; battery chargers; batteries, electric; solar cells; earphones; electrical power supplies; cases for smartphones; cell phone straps; electric connectors; electronic pens [visual display units]; blank USB flash drives; memory cards for video game machines; encoded identification bracelets, magnetic; chargers for electronic cigarettes.

(260) AM 2019 101568 A  
 (800) 1448500  
 (151) 2018 10 11  
 (891) 2018 10 11  
 (731) EAE ELEKTRİK ASANSÖR ENDÜSTRİSİ  
 İNŞAAT SANAYİ VE TİCARET ANONİM  
 ŞİRKETİ  
 Akçaburgaz Mah. 3114, Sok. No:10/1,  
 Esenyurt, İstanbul, Turkey  
 (540)



(591) Red and white  
 (531) 26.04.05; 26.04.18; 27.05.17; 27.05.24;  
 29.01.12

(511)

11 – Lighting installations; lights for vehicles and interior-exterior spaces; heating installations using solid, liquid or gas fuels or electricity, central heating boilers, boilers for heating installations, radiators [heating], heat exchangers, not parts of machines, stoves, kitchen stoves, solar thermal collectors [heating]; steam, gas and fog generators, steam boilers, other than parts of machines, acetylene generators, oxygen generators, nitrogen generators; installations for air-conditioning and ventilating; cooling installations and freezers; electric and gas-powered devices, installations and apparatus for cooking, drying and boiling: cookers, electric cooking pots, electric water heaters, barbecues, electric laundry driers; hair driers; hand drying apparatus; sanitary installations, taps [faucets], shower installations, toilets [water-closets], shower and bathing cubicles, bath tubs, toilet seats, sinks, wash-hand basins [parts of sanitary installations], washers for water taps, valves [taps] being parts for sanitary installations; water softening apparatus; water purification apparatus; water purification installations; waste water purification installations; electric bed warmers and electric blankets, not for medical use; electric pillow warmers; electric or non-electric footwarmers; hot water bottles, electrically heated socks; filters for aquariums and aquarium filtration apparatus; industrial type installations for cooking, drying and cooling purposes; pasteurizers and sterilizers.

(260) AM 2019 101569 A

(800) 1448541

(151) 2018 11 30

(891) 2018 11 30

(731) PAYPAL, INC.

2211 North First Street, San Jose CA 95131,  
USA

(540)

**XOOM**

(591) Black, white

(511)

36 – Financial transaction and payment processing services provided by an internet website portal; money transfer services; electronic funds transfer services; bill payment remittance services; electronic processing and transmission of payment and payment data services; payment processing services relating to mobile device reloading.

(260) AM 2019 101570 A

(800) 1448543

(151) 2018 12 07

(891) 2018 12 07

(731) NATURE REPUBLIC CO., LTD.

534, Teheran-ro, Gangnam-gu, Seoul,  
Republic of Korea

(540)

**NATURE REPUBLIC**

(591) Black, white

(511)

3 – Cosmetics; eyebrow cosmetics; liquid rouge; lipsticks; mascara; nail polish; nail varnish removers; make-up; hair colorants; baby oil; blush; mouthwashes, not for medical purpose; shampoos; sunblock lotions; sunscreen lotion; sunscreen cream; toiletry preparations; liquid detergents; oils for cleaning purposes; shaving cream; cosmetic preparations for eyelashes; skin lotions; cosmetic preparations for skin care; eye liner; eye make-up removers; eye shadow; after-shave lotions; essential oils; false eyelashes; deodorant for personal use; soaps for personal use; common toilet water; lip skin protecting materials; dentifrices; permanent wave preparations; foundation; cosmetics for the face and body; hand lotions; perfume; hair lotions; hair rinses; hair spray; hair conditioners; make-up removing preparations.

(260) AM 2019 101571 A

(800) 1448583

(151) 2018 11 29

(891) 2018 11 29

(731) SAKURA BLOSSOM LIMITED

First FLOOR, BLOCK ONE, QUAYSIDE  
BUSINESS PARK, DUNDALK, CO LOUTH  
A91 DP8R, Ireland

(540)

**WELLBET**

(591) Black, white

(511)

9 – Computer software; game software; gaming software; betting software; gambling software; computer games; computer games programmes.

41 – Provision of internet games; gaming services; gambling services; betting services; online gaming services; online gambling services; online betting services; online slot machine games; slot machine games provided through mobile software.

(260) AM 2019 101573 A

(800) 1448683

(151) 2019 01 04

(891) 2019 01 04

(731) CITIZEN WATCH COMPANY OF AMERICA, INC.

350 Fifth Avenue, 29th Floor, Empire  
State Building, New York NY 10118,  
USA

(540)

**BULOVA**

(591) Black, white



(511)  
9 – Sunglasses and eyeglasses.

(260) AM 2019 101577 A  
(800) 1448836  
(151) 2018 10 01  
(891) 2018 10 01  
(731) PIASTEN GMBH  
Piastenstraße 1, 91301 Forchheim, Germany  
(540)

## TREETS

(591) Black, white  
(511)  
29 – Fat-containing mixtures for bread slices, peanut butter, peanuts (processed), almonds (processed), nuts (processed).

30 – Sweet spreads so far as included in this class, in particular chocolate spreads containing nuts; chocolate-based spreads and chocolate creams.

(260) AM 2019 101578 A  
(800) 1448862  
(151) 2018 12 12  
(891) 2018 12 12  
(731) APPLE INC.  
One Apple Park Way, Cupertino CA 95014, USA  
(540)



(591) Gray, black, and orange  
(531) 24.15.03; 26.04.03; 26.04.04; 26.15.09;  
29.01.13  
(511)  
9 – Computer software used in developing other software applications; application development software.

(260) AM 2019 101579 A  
(800) 1448877  
(151) 2018 07 23  
(891) 2018 07 23  
(731) ASRY TEKSTİL SANAYİ VE TİCARET LİMİTED ŞİRKETİ  
Firuzköy Mahallesi, Aziz Caddesi, No:24,  
B Blok, Avcılar – İstanbul, Turkey

(540)



(591) Yellow, white, black  
(531) 26.11.01; 26.11.12; 27.05.10; 27.05.11;  
29.01.12

(526) UNDERWEAR

(511)  
18 – Leather and imitation leather, animal skins; animal hides, artificial leathers, stout leathers; goods made of leather, imitation leather or synthetic leather, namely, travel bags, valises, wallets, handbags, backpacks for carrying babies, leather and stout leather boxes for storing greeting cards, leather hat boxes for travel; make-up cases sold empty, toiletry bags sold empty, vanity cases sold empty, tool bags sold empty; book bags; carrying cases for documents, briefcases, backpacks, school bags, leather shopping bags, leather cases for banknotes in the nature of wallets; umbrellas, sun umbrellas, namely, parasols and canes; whips, harnesses and saddlery, stirrups, horse bridles.

25 – Clothing, namely, trousers, jackets, overcoats, coats, skirts, suits, jerseys, waistcoats, shirts, ready-made leather linings (parts of clothing), T-shirts, sweatshirts, dresses, pullovers, jeans, tracksuits, rainwear, bathing suits; clothing for sports (for exclusive use for sports), clothing for babies, namely, shirts, pants, coats, dresses; socks; footwear, namely shoes excluding orthopedic shoes, sandals, waterproof boots, walking boots, booties, sporting shoes, slippers; shoe parts namely heelpieces, insoles for footwear, footwear uppers; headgear, namely caps, skull caps, sports caps, hats, berets; gloves (clothing), stockings, belts (clothing), camisoles, sarongs, scarves, neck scarves, shawls, collars, neckties, ties; shorts, Bermuda shorts; sleepwear; pajamas; baby doll pajamas; beachwear; swimming suits; undershirts; singlets; underwear, namely, boxer shorts, briefs, boxer briefs, brassieres, panties, pants, thermal underwear, ladies' underwear, children's underwear, women's underwear, men's underwear, knitted underwear, G-strings; camisoles; body shirts; body shapers; bodies being underclothing; body suits for adults, children, women, men; undergarments; suspender belts.

(260) AM 2019 101581 A  
(800) 1448923  
(151) 2018 12 20  
(891) 2018 12 20  
(731) Joint-stock company "OBNINSKORGSINTEZ"  
Kievskoe highway, 57, Obninsk, RU-249032  
Kaluga region, Russian Federation

(540)

**MULTIFREEZE**

(591) Black, white

(511)

1 – Combusting preparations [chemical additives to motor fuel]; corrosive preparations; alginates for industrial purposes; anti-knock substances for internal combustion engines; antioxidants for use in manufacture; antifreeze; water-softening preparations; oil dispersants; petroleum dispersants; brake fluid; transmission fluid; transmission oil; synthetic materials for absorbing oil; filtering materials [unprocessed plastics]; filtering materials [chemical substances]; filtering materials [mineral substances]; filtering materials [vegetable substances].

(260) AM 2019 101582 A

(800) 1448940

(151) 2018 09 24

(891) 2018 09 24

(731) Limited Liability Company "ORIMI"

1-st Microrayon Street, 15/4 plot, Sverdlov factory settlement, Vsevolozhsk district, RU-188682 Leningrad oblast, Russian Federation

(540)

**ГИТА**

(591) Black, white

(531) 28.05

(511)

30 – Tea; iced tea; tea-based beverages.

(260) AM 2019 101583 A

(800) 1448950

(151) 2018 11 16

(891) 2018 11 16

(731) SAVE THE DUCK S.R.L.

Via Arcivescovo Calabiana 6, I-20139 Milano (MI), Italy

(540)



(591) Black, white

(531) 01.15.15; 03.07.06; 03.07.24; 26.01.04; 26.01.15; 26.01.16; 26.01.21

(511)

3 – Perfumery, essential oils; cosmetics; toiletries; non-medicated cosmetics and toiletry preparations.

18 – Umbrellas; umbrellas for children; luggage, bags, wallets and other carriers; toiletry bags; cases of imitation leather; key cases made of leather; cosmetic cases sold empty; key cases; luggage; travel luggage; vanity cases, not fitted; trunks and travelling bags; casual bags; shoulder bags; cross-body bags; wheeled bags; travel baggage; small bags for men; pouches; handbags; duffel bags; holdalls for sports clothing; pouches for holding make-up, keys and other personal items; bumbags; credit card cases [wallets]; briefcases and attache cases; wallets; leather coin purses; haversacks; travelling bags; travelling sets; suitcases; wheeled suitcases; daypacks; backpacks.

25 – Clothing; casualwear; thermally insulated clothing; weather resistant outer clothing; girls' clothing; menswear; children's outer clothing; outer clothing for boys; ladies' clothing; boys' clothing; windproof clothing; sweat shirts; rainproof jackets; long jackets; reversible jackets; jackets being sports clothing; sleeveless jackets; warm-up jackets; quilted jackets [clothing]; heavy jackets; blousons; sweaters; polo sweaters; polo shirts; tee-shirts; short-sleeved t-shirts; long-sleeved shirts; underwear; waist belts; neckties; gloves [clothing]; footwear; headgear.

28 – Games; toys; video output game machines for use with televisions; video game apparatus; gymnastic and sporting articles.

(260) AM 2019 101584 A

(800) 1448951

(151) 2018 10 15

(891) 2018 10 15

(731) GRANITIFIANDRE SOCIETA' PER AZIONI

Via Radici Nord, 112, I-42014 CASTELLARANO (Reggio Emilia), Italy

(540)

**EIFFELGRES**

(591) Black, white

(511)

19 – Non-metallic building tiles; non-metallic building materials, namely, tiles, panels and slabs made of ceramic or stoneware for covering walls, floors and ceiling, for outdoors and indoors.

(260) AM 2019 101585 A

(800) 1448964

(151) 2018 11 26

(891) 2018 11 26

(731) AKTSIONERNOYE OBSHESTVO "YUZHMOREYBFLLOT"

ul. Zavodskaya, 16, p. Yuzhno-Morskoy, g. Nakhodka, RU-692954 Primorsky kray, Russian Federation

(540)



(591) Black, white, yellow, grey, golden  
 (531) 02.01.12; 06.03.04; 18.03.23; 21.03.16;  
 26.05.01; 28.05; 29.01.14  
 (526) SAIRA, TIKHOOKEANSKAYA, NATURALNAYA, S DOBAVLENIEM MASLA, 245G  
 (511)  
 29 – Fish, preserved.

(260) AM 2019 101596 A  
 (800) 1421820  
 (151) 2018 05 24  
 (891) 2018 09 20  
 (731) Limited Liability Company "SURFACE LAB"  
 ul. Butlerova, 17B, floor 7, room 37,  
 RU-117342 Moscow, Russian Federation

(540)



(591) Black, white  
 (531) 26.04.02; 26.04.09; 26.04.24; 27.01.05;  
 27.05.10

(511)

19 – Building materials, not of metal, including ceramic tiles, artificial stone, wall claddings, not of metal; building materials, not of metal; non-metallic building materials; ceramic tiles; glazed ceramic tiles; ceramic floor tiles; ceramic tiles for tile floors and coverings; ceramic wall tiles; ceramic tiles for walls, floors and ceilings; ceramic tiles for flooring and lining; artificial stone; wall claddings, not of metal, for building; wall tiles, not of metal; rock materials used in building flooring, roofing, countertops, walls, cladding and fireplaces.

35 – Demonstration of goods; demonstration of goods for advertising purposes; arranging and conducting of commercial exhibitions and shows; arranging and conducting of commercial exhibitions; arranging and conducting of trade shows; organization of exhibitions for commercial or advertising purposes; commercial or industrial management assistance; business management of wholesale outlets; business management of retail outlets.

(260) AM 2019 101696 A  
 (800) 1449178  
 (151) 2018 11 19  
 (891) 2018 11 19  
 (731) RICHTER GEDEON NYRT.  
 Gyömrői út 19-21, H-1103 Budapest, Hungary

(540)

## DROSDION

(591) Black, white  
 (511)  
 5 – Pharmaceutical preparations.

(260) AM 2019 101697 A  
 (800) 1449181  
 (151) 2018 11 19  
 (891) 2018 11 19  
 (731) RICHTER GEDEON NYRT.  
 Gyömrői út 19-21, H-1103 Budapest, Hungary  
 (540)

## FANOVERYN

(591) Black, white  
 (511)  
 5 – Pharmaceutical preparations.

(260) AM 2019 101698 A  
 (800) 1449189  
 (151) 2018 11 19  
 (891) 2018 11 19  
 (731) RICHTER GEDEON NYRT.  
 Gyömrői út 19-21, H-1103 Budapest,  
 Hungary  
 (540)

## FEMFETYN

(591) Black, white  
 (511)  
 5 – Pharmaceutical preparations.

(260) AM 2019 101699 A  
 (800) 1449196  
 (151) 2018 11 19  
 (891) 2018 11 19  
 (731) RICHTER GEDEON NYRT.  
 Gyömrői út 19-21, H-1103 Budapest,  
 Hungary  
 (540)

## KLIMDA

(591) Black, white  
 (511)  
 5 – Pharmaceutical preparations.

(260) AM 2019 101700 A  
 (800) 1449197  
 (151) 2018 11 15  
 (891) 2018 11 15  
 (731) LIKINO BUS PLANT – LTD  
 Kalinina Street, 1, Likino-Dulevo,  
 Orekhovo-Zuevo district, RU-142671  
 Moscow region, Russian Federation

(540)

**CRUISE**

(591) Black, white

(531) 27.05.01; 27.05.17

(511)

12 – Motor buses; motor coaches; automobile bodies; tipping bodies for trucks; bodies for vehicles.

(260) AM 2019 101701 A

(800) 1449198

(151) 2018 12 13

(891) 2018 12 13

(731) LTD "VALENTA-INTELLEKT"

ul. Generala Dorokhova, d.18, str.2,

RU-119530 Moscow, Russian Federation

(540)



(591) Black, white

(531) 26.13.25; 27.05.22

(511)

5 – Balms for medical purposes; bandages for dressings; dietetic substances adapted for medical use; mineral waters for medical purposes; mineral food supplements; cod liver oil; insecticides; capsules for medicines; cachets for pharmaceutical purposes; wart pencils; adhesive plasters; lotions for pharmaceutical purposes; liniments; gauze for dressings; medicinal oils; dental abrasives; dental impression materials; teeth filling material; dressings, medical; drugs for medical purposes; medicines for veterinary purposes; medicines for human purposes; medicines for dental purposes; medicinal drinks; dietetic beverages adapted for medical purposes; medicinal infusions; tinctures for medical purposes; decoctions for pharmaceutical purposes; medical plasters; pomades for medical purposes; bacterial preparations for medical and veterinary use; bacteriological preparations for medical and veterinary use; biological preparations for medical or veterinary purposes; veterinary preparations; air purifying preparations; sterilising preparations; preparations for destroying noxious animals; herbicides; larvae exterminating preparations; pharmaceutical preparations for skin care; contact lens cleaning preparations; pharmaceutical preparations; chemico-pharmaceutical preparations; chemical preparations for veterinary purposes; chemical preparations for medical purposes; chemical preparations for pharmaceutical purposes; dietetic foods adapted for medical purposes; sanitary to-

wels; vaginal washes for medical purposes; disinfectants for contact lenses; solutions for contact lenses; insect repellents; tobacco-free cigarettes for medical purposes; syrups for pharmaceutical purposes; greases for veterinary purposes; greases for medical purposes; semen for artificial insemination; adjuvants for medical purposes; parasiticides; mouthwashes for medical purposes; detergents for medical purposes; steroids; serums; tampons for medical purposes; medicinal herbs; sanitary panties; fungicides; elixirs [pharmaceutical preparations]; poisons; sanitary tampons; wadding for medical purposes; mustard plasters; nutritional supplements; candy, medicated; first-aid boxes, filled; medicine cases, portable, filled; compresses; chemical conductors for electrocardiograph electrodes; albuminous foodstuffs for medical purposes; food for babies; chewing gum for medical purposes.

36 – Credit bureau services; debt collection agency services; real estate agency services; financial analysis; lease-purchase financing; savings bank services; accommodation bureau services [apartments]; rent collection; issuance of travelers' checks; issuance of credit cards; issuance of tokens of value; capital investment; insurance information; financial information; clearing, financial; insurance consultancy; financial consultancy; stock exchange quotations; business liquidation services, financial; brokerage; financial management; exchanging money; factoring; antique appraisal; jewelry appraisal; stamp appraisal; real estate appraisal; financial evaluation [insurance, banking, real estate]; surety services; charitable fund raising; financial sponsorship; insurance underwriting; real estate management; banking; financing services; fiscal valuation; safe deposit services; duty drawback services; financial customs brokerage services; rental of farms; processing of debit card payments; processing of credit card payments; numismatic appraisal; art appraisal; electronic funds transfer; real estate brokerage; insurance brokerage; loans [financing]; pawnbrokerage; check verification; real estate lease surrender services; mortgage lending; instalment loans; apartment house management; actuarial services; retirement payment services; trusteeship; mutual funds; deposits of valuables.

(260) AM 2019 101702 A

(800) 1449200

(151) 2018 11 19

(891) 2018 11 19

(731) RICHTER GEDEON NYRT.

Gyömrői út 19-21, H-1103 Budapest, Hungary

(540)

**GENERATRIX**

(591) Black, white

(511)

5 – Pharmaceutical preparations.

(260) AM 2019 101703 A  
 (800) 1449207  
 (151) 2018 11 19  
 (891) 2018 11 19  
 (731) RICHTER GEDEON NYRT.  
 Gyömrői út 19-21, H-1103 Budapest, Hungary  
 (540)

## BORINTON

(591) Black, white  
 (511)  
 5 – Pharmaceutical preparations.

(260) AM 2019 101705 A  
 (800) 1449234  
 (151) 2018 07 23  
 (891) 2018 07 23  
 (731) VF INTERNATIONAL SAGL  
 Via Laveggio 5, CH-6855 Stabio,  
 Switzerland  
 (540)



(591) Black, white  
 (531) 27.05.01  
 (511)  
 18 – Leather, unworked or semi-worked; imitation leather; animal skins; traveling bags, trunks; traveling trunks, traveling bags; bags; handbags; school satchels; sports bags; suitcases; backpacks; wallets; belt bags and waist bags; address tags for luggage; umbrellas; key case pouches, key cases; make-up bags (sold empty); toiletry cases (sold empty).

28 – Sports equipment and articles (except clothing); costume masks; toys; plush toys, stuffed toy animals; bath toys; figurines [toys]; games.

(260) AM 2019 101706 A  
 (800) 1449235  
 (151) 2018 11 16  
 (891) 2018 11 27  
 (731) TIS SMARTHOMES MAROC  
 56 Rue Al Fourat, Residence Sanaa, 2ème  
 étage, Appt 21, Casablanca, Morocco  
 (540)



(591) White and red  
 (531) 26.04.05; 26.04.18; 26.04.24; 26.11.03;  
 26.11.05; 26.11.07; 26.11.08; 27.05.11;  
 27.05.24; 29.01.12  
 (511)  
 9 – Scientific, nautical, surveying, photographic, cinematographic, optical, weighing, measuring, signaling, checking, life-saving and teaching apparatus and instruments; apparatus and instruments for conducting, switching, transforming, accumulating, regulating or controlling electricity; apparatus for recording, transmission or reproduction of sound or images; magnetic recording media; sound recording disks; compact disks; CDs, DVDs and other digital recording media.

(260) AM 2019 101707 A  
 (800) 1449244  
 (151) 2018 11 19  
 (891) 2018 11 19  
 (731) RICHTER GEDEON NYRT.  
 Gyömrői út 19-21, H-1103 Budapest, Hungary  
 (540)

## CORDOLLA

(591) Black, white  
 (511)  
 5 – Pharmaceutical preparations.

(260) AM 2019 101709 A  
 (800) 1449251  
 (151) 2018 11 19  
 (891) 2018 11 19  
 (731) RICHTER GEDEON NYRT.  
 Gyömrői út 19-21, H-1103 Budapest, Hungary  
 (540)

## AMVENON

(591) Black, white  
 (511)  
 5 – Pharmaceutical preparations.

(260) AM 2019 101711 A  
 (800) 1449258  
 (151) 2018 11 19  
 (891) 2018 11 19  
 (731) RICHTER GEDEON NYRT.  
 Gyömrői út 19-21, H-1103 Budapest, Hungary  
 (540)

## COLINDA

(591) Black, white  
 (511)  
 5 – Pharmaceutical preparations.

(260) AM 2019 101712 A  
 (800) 1449272  
 (151) 2018 11 19  
 (891) 2018 11 19  
 (731) RICHTER GEDEON NYRT.  
 Gyömrői út 19-21, H-1103 Budapest, Hungary  
 (540)

**AMTENSON**

(591) Black, white  
 (511)  
 5 – Pharmaceutical preparations.

(260) AM 2019 101713 A  
 (800) 1449277  
 (151) 2018 11 19  
 (891) 2018 11 19  
 (731) RICHTER GEDEON NYRT.  
 Gyömrői út 19-21, H-1103 Budapest, Hungary  
 (540)

**DARDANELL**

(591) Black, white  
 (511)  
 5 – Pharmaceutical preparations.

(260) AM 2019 101714 A  
 (800) 1449287  
 (151) 2016 08 19  
 (891) 2016 08 19  
 (731) ASELSAN ELEKTRONİK SANAYİ VE  
 TİCARET ANONİM ŞİRKETİ  
 Mehmet Akif Ersoy Mah., 296.Cadde  
 No:16, Yenimahalle, ANKARA, Turkey  
 (540)

**aselsan**

(591) Black, white  
 (531) 27.05.17  
 (511)  
 9 – AC driver system (consisting of alternator, which converts DC motors to AC motor driver system, AC driver unit, protection & control unit and AC motor), angular position sensors, current rectifiers, acoustic sensors and transducers, acoustic jammers, acoustic signal processing software, acoustic test & analysis devices, alarms, transceivers, receivers, transmitters, Radio Frequency power amplifiers, altimeters, ammeters, amplifiers (audio amplifiers), anemometers, speakers, anode batteries, antennas, steering apparatus for vehicles, fixed type sirens to be used in mobile built-in units for vehicles, simulators for the steering and control of vehicles, search and rescue systems, sub-systems, devices and units, namely search and rescue radios, military guidance and switching computer systems, inertial navigation system control and monitoring units, inertial

navigation devices and computer programs to control fire, fire control software, electronic units for fire control system, ignition regulators, avionic communication systems, sub-systems, devices and units, avionic central control computer, bar code readers, printed circuits, printed circuit boards, batteries, battery boxes, battery chargers, ticket dispensers, data processing apparatus, computer interfaces, computer peripheral hardware, computer memories, computer and system software, printers for use with computers, radio repeaters and control unit devices which control and establish audio & data communication with those radios, couplers (data processing devices), converters (analog to digital/digital to analog, synchronous to computational, computational to synchronous), chips, multifunctional indicator devices, narrow band video codec devices, software drivers for DC motors, detectors, inclinometers, gradient indicators, variable message pointers, sea and underwater/surface platform communication computer systems, sub systems, devices and units, sonars, maritime inertial navigation devices, depth measuring devices (depth finder), circuit switches and breakers, whistle alarms, communication devices acquiring coordinates according to signals received from orbiting satellites, electric monitoring devices, educational devices, electric power units, electric power supply units, electric batteries, electromagnetic coils, computer systems for acquiring position and direction of electromagnetic signals, electronic warfare command control systems, electronic warfare and signal intelligence systems, transmitters of electronic signals, electronic transistors, electronic devices (GPS) and geolocation equipment for air and sea vehicles, electro-optic devices and multi-functional tactical control monitors, secure IP telephone systems, integrated circuit boards, integrated circuits, actuators, inertial navigation devices with fiber optic gyroscope, radio systems aiming efficient use of frequency spectrum, frequency meters, missile receiver warheads and missile hunter warheads, missile warning receivers and missile guidance electronics, electro-optic night/day thermal vision devices, night vision binoculars, night vision goggles, night vision sight, image processing and follow-up software and hardware, image based traffic (speed, volume, intensity) measurement and incident detection devices, image intensifier tubes, visual speeding detection devices, visual red light violation detection devices, audio-visual educational devices, display unit, mobile or stationary radar devices for surveillance, gunner regulation and air defence, inertial positioning devices with GPS integrated ring laser gyroscope, navigational devices showing vehicle speed, coordinates, altitude and target azimuth angle used in any land vehicle requiring positioning and preference information, navigation devices with GPS integrated ring laser gyroscope, inertial navigation devices with embedded GPS, GSM cell phones, missile guidance

electronics, guidance and control systems, solar batteries for TV and cameras, cryptographic devices for security audio and data communication of security forces, communication networks enabling connection of communication base stations with switching units, communication devices, software for motion analysis (analysis of a characteristic features of an object by analyzing data received from TV, thermal sensors, radars or acoustic sensors), animated digital maps, computer input devices controlled by datalinks from a mobile or stationary control center for executing intelligence missions and for communication for use with electro-optical, electronic warfare communication devices and devices enabling navigation of air vehicles under any weather conditions, devices reporting speed, coordinate, altitude, situational and inclination angle of vehicle, control monitors, devices used for determination of target coordinate by means of integration into any kind of vision systems, electronic equipment for air vehicles and vessels, devices reporting speed, coordinate, altitude, situational and inclination angle of air vehicles, air/ground communication devices, thermal vision devices air and sea vehicles, speed measuring devices (odometers and speed measuring device), devices designed for fast transmission, fast and accurate calculation, digital communication, anti-theft warning apparatus, hybrid circuits, speaker cabinets, speakers, solar batteries, signature detection devices, intercommunication apparatus, transmitters (telecommunication), telecommunication transmitting sets, wired & wireless audio broadcast devices, navigation systems for land and countermeasure launching system and helmet integrated controller, recorded computer programs, personal communication devices, infrared electro-optical detector arrays, electric apparatus for commutation, commutators, connectors (electric connection parts), control panels (electricity), communication devices for command and control, workstation in the nature of a command and control console (computer hardware), command and control software for water surface and under water use, capacitors/condensers, control and display units, conventional radios, cryptographic devices for conventional radios (civil communication), joysticks/control stick, laser guidance equipment, laser target pointers, laser target acquisition and designation devices, laser warning receivers, laser range finders, material test equipment and devices, soldier radios, magnetic recording carriers, magnetic encoders, magnetic coded cards, magnetic encryption devices, magnetic wires, magnetic data media, magnetic data carriers, central processing units, messaging and display units, meteorological balloons, meteorological sensors (in radio), radio direction finders, devices incorporating meteorological data processing units, devices capable of meteorological data measurement, processing and transmission, microprocessors, microphones, micro-electronic circuits, mo-

dem, components for any vision system to be mounted to any weapon namely optical sights, binoculars, moving lenses, night vision goggles, odometer interface units, readers (data processing hardware), optical apparatus and instruments, optical lanterns, optical fibers (light conducting filaments), optical glasses, optical condensers, optical lamps, optical lenses, optical data media, coin-operated device mechanisms, automatic test equipment, electronic apparatus for controlling toll points, computer controlled electronic apparatus for controlling toll points, packet radio, night vision glasses for pilots, batteries, radar warning receiver, radars, radios, radio transmitters/relays, radiolink devices, Radio Frequency jammers, radar absorbing paints, elastomeric radar absorbing materials, composite radar absorbing structures, honeycomb radar absorbing structures, circuit analog radar absorbing structures, ceramic radar absorbing material mainly used to reduce radar cross section RCS levels of land, air, naval and submarine platforms, these products are also used to mitigate antenna-platform interactions for improving the installed system performance of the radar and electronic warfare systems, computer input devices collecting data received from main sensors in particular direction finding land surveillance radars constructed on stationary or mobile platforms as well as from the sensors operating with acoustical, magnetic, infrared, micro-wave techniques embedded into soil or camouflages, field telephones, counters, mechanisms for devices with counters, servo control and stabilization algorithms and software, audio alarms, audio-video receivers, audio-video recorders, power amplifiers, transmitter devices, audio visual playback and computer memory devices, audio-data cryptographic devices, metal detectors for industrial and military purposes, fuses, sighting telescopes for firearms, signal recording, analysis and recognition devices, sirens, system communication units, sonars (submarine radars), stabilized periscopes, driver vision camera systems, prediction softwares (prediction of behaviour of an object based on data obtained from various sources), tactical secure wireless local area network system, tactical field warfare computer systems, tactical surveying systems, tactical field radios (for military communication), tactical radios, systems subsystems, device and units used in identification of targets that are cooperative or non cooperative in nature, tank fire control systems, tanks electronic artillery range navigational systems, scanners (data processing equipment), an old version of software based radio family, named as software defined radio (SDR), wire connectors (electricity), telephone receivers and transmitters, switchboards, telephones, radio masts, radio accessories and auxiliary units, namely microphone, speaker, charger, battery, power supplies, communication devices for radio systems, receiver, transmitter, driver, Radio Frequency power amplifier, power supplies, radio relays,

mobile radio relays, Radio Frequency links, wireless phone sets, thermal vision systems, thermal cameras, thermal weapon sights, test program sets, test systems, lasers, not for medical purposes, navigational devices directing all other artilleries in the battery to the same direction using laser range finders and optical binoculars in order to position the main artillery, traffic measuring (speed, volume, density, segment) devices, devices for measuring travel time in traffic, integrated electro-optical systems, TV relay transmitters, TV receivers, airplane radios, apparatus for checking flight parameters, satellite communication systems, sub-systems, devices and units, satellite systems, sub-systems, devices and units, distance recording devices, distance measuring devices, remote control apparatus, electrical ignition devices for remote ignition (allowing electrical passenger carriers to be heated before travel under winter conditions), heating-automatic temperature control units for passenger carriers (regulates internal temperature of electrical passenger carriers and maintains it at a fixed temperature), small terminal units for data processing, data processing hardware and computer data link systems, sub-systems, devices and units, data terminals, video cameras, video cassette recorder, wired wireless communication system consisting of central unit for sending call to aid station, relaying unit and telephone, cash registers, software based tactical radios, direction finding devices, management computer software, high frequency radio devices, high frequency memory and signal generating computer hardware, high voltage batteries, navigational devices capable of finding location with a intelligence operation and providing direction information with high speed, high precision, high accuracy and high stability, time recording devices.

(260) AM 2019 101717 A  
 (800) 1449340  
 (151) 2018 07 18  
 (891) 2018 07 18  
 (731) NORDEPLAST, Liepājas speciālās ekonomiskās zonas SIA  
 Ziemeļu iela 19, LV-3405 Liepāja, Latvia  
 (540)

 **Nordeplast**<sup>®</sup>

(591) Blue, red and white  
 (531) 26.11; 26.11.12; 26.11.13; 27.05; 27.05.09;  
 27.05.10; 29.01; 29.01.13  
 (511)  
 5 – Adhesive plasters and bandages.

(260) AM 2019 101718 A  
 (800) 1449347  
 (151) 2018 11 19  
 (891) 2018 11 19  
 (731) Closed Joint Stock Company  
 "STARODVORSKIE KOLBASY"  
 ul. Poliny Osipenko, d. 41, of. 210,  
 RU-600009 g. Vladimir, Russian Federation  
 (540)



(591) Red, white, light yellow, brown and dark yellow  
 (531) 06.19.01; 07.01.08; 07.01.09; 25.01.19; 28.05; 29.01.14  
 (511)  
 29 – Albumen for culinary purposes; seaweed extracts for food; gelatine; edible fats; anchovy, not live; peanut butter; butter; cocoa butter for food; coconut butter; buttercream; white of eggs; black pudding; bouillon; preparations for making bouillon; caviar; fruit, preserved; charcuterie; potato chips; sauerkraut; coconut, desiccated; colza oil for food; bouillon concentrates; jams; frozen fruits; soups; raisins; gherkins; vegetables, preserved; vegetables, cooked; vegetables, dried; oils for food; cream [dairy products]; cheese; crystallized fruits; croquettes; crustaceans, not live; dates; milk; crayfish, not live; rennet; fruit, stewed; fruit jellies; fruit pulp; meat; fish, not live; jellies for food; meat jellies; game, not live; ginger jam; soya beans, preserved, for food; fatty substances for the manufacture of edible fats; fat-containing mixtures for bread slices; herrings, not live; lobsters, not live; corn oil for food; palm kernel oil for food; sesame oil for food; oysters, not live; isinglass for food; ham; yolk of eggs; yogurt; vegetable soup preparations; vegetable juices for cooking; meat extracts; kephir [milk beverage]; kumys [milk beverage]; milk beverages, milk predominating; whey; milk products; spiny lobsters, not live; bacon; lentils, preserved; margarine; marmalade; animal marrow for food; shellfish, not live; mussels, not live; palm oil for food; nuts, prepared; eggs; powdered eggs; liver pâté; onions, preserved; olives, preserved; olive oil for food; bone oil for food; pectin for culinary purposes; pickles; peas, preserved; sausages; salted meats; preparations for making soup; vegetable salads; lard; fruit salads; sardines, not live; salmon, not live; suet for food; tuna, not live; tomato juice for cooking; sunflower oil for food; tripe; truffles, preserved; poultry, not live; fruit peel; alginates for culinary purposes; almonds, ground; peanuts, prepared; mushrooms, preserved; coconut fat; coconut oil for food; beans, preserved; liver;



fish-based foodstuffs; fruit chips; clams, not live; fruit preserved in alcohol; pollen prepared as foodstuff; prawns, not live; fish, preserved; meat, preserved; shrimps, not live; snail eggs for consumption; tofu; whipped cream; pork; edible birds' nests; fish, tinned; fish meal for human consumption; fruits, tinned; meat, tinned; potato fritters; salted fish; silk-worm chrysalis for human consumption; vegetables, tinned; sausages in batter; potato flakes; apple purée; cranberry compote; tahini [sesame seed paste]; hummus [chickpea paste]; fruit-based snack food; kimchi [fermented vegetable dish]; soya milk; milk shakes; ajvar [preserved peppers]; sunflower seeds, prepared; fish mousses; non-alcoholic eggnog; vegetable mousses; fish roe, processed; seeds, prepared; aloe vera prepared for human consumption; preserved garlic; albumin milk; low-fat potato chips; lecithin for culinary purposes; milk ferments for culinary purposes; compotes; condensed milk; smetana [sour cream]; prostokvasha [soured milk]; tomato purée; vegetable marrow paste; eggplant paste; peanut milk for culinary purposes; almond milk for culinary purposes; rice milk; artichokes, preserved; arrangements of processed fruit; powdered milk; yakitori; bulgogi [Korean beef dish]; candied nuts; flavored nuts; hazelnuts, prepared; berries, preserved; guacamole [mashed avocado]; onion rings; falafel; lemon juice for culinary purposes; freeze-dried meat; oat milk; vegetable-based cream; freeze-dried vegetables; galbi [grilled meat dish]; edible insects, not live; sweet corn, processed; nut-based spreads; potato-based dumplings; hot dog sausages; soya bean oil for food; milk substitutes; almond milk; peanut milk; coconut milk; coconut milk for culinary purposes; coconut milk-based beverages; rice milk for culinary purposes; almond milk-based beverages; peanut milk-based beverages; sausage casings, natural or artificial; klipfish [salted and dried cod]; cottage cheese fritters; pressed fruit paste; yuba [tofu skin]; soya patties; tofu patties; fish fillets; corn dogs; escamoles [edible ant larvae, prepared]; extra virgin olive oil for food; ryazhenka [fermented baked milk]; linseed oil for food.

30 – Seaweed [condiment]; pasta; almond paste; aniseed; star aniseed; confectionery for decorating Christmas trees; infusions, not medicinal; coffee flavorings; seasonings; unleavened bread; salt for preserving foodstuffs; rusks; cookies; malt biscuits; peppermint sweets; sweetmeats [candy]; waffles; buns; cocoa; coffee; unroasted coffee; vegetal preparations for use as coffee substitutes; cakes; cinnamon [spice]; capers; caramels [candy]; curry [spice]; cereal preparations; chewing gum; chicory [coffee substitute]; tea; chocolate; marzipan; cloves [spice]; condiments; confectionery; corn flakes; popcorn; preparations for stiffening whipped cream; ice cream; pancakes; essences for foodstuffs, except etheric essences and essential oils; cooking salt; thickening agents for cooking foodstuffs; turmeric; natural swe-

eteners; spices; gingerbread; allspice; flour; bean meal; corn flour; mustard meal; barley meal; soya flour; wheat flour; starch for food; ferments for pastes; fondants [confectionery]; petits fours [cakes]; sugar; flavorings, other than essential oils, for cakes; cake powder; cake dough; ginger [spice]; binding agents for ice cream; ice, natural or artificial; ice for refreshment; glucose for culinary purposes; gluten prepared as foodstuff; groats for human food; vinegar; ketchup [sauce]; cocoa beverages with milk; coffee beverages with milk; chocolate beverages with milk; leaven; yeast; sausage binding materials; macaroons [pastry]; macaroni; corn, milled; corn, roasted; bread; maltose; molasses for food; mint for confectionery; honey; husked barley; mustard; nutmegs; noodles; pies; crushed barley; sandwiches; pastilles [confectionery]; pastries; petit-beurre biscuits; bread rolls; peppers [seasonings]; pizzas; pepper; potato flour; puddings; pralines; ravioli; liquorice [confectionery]; rice; saffron [seasoning]; sago; sauces [condiments]; celery salt; semolina; sherbets [ices]; spaghetti; tapioca; tapioca flour; tarts; vanilla flavorings for culinary purposes; vanillin [vanilla substitute]; vermicelli [noodles]; meat pies; pâtés en croûte; meat tenderizers for household purposes; edible ices; powders for making ice cream; almond confectionery; peanut confectionery; food flavorings, other than essential oils; flavorings, other than essential oils, for beverages; crushed oats; husked oats; oat-based food; oat flakes; oatmeal; stick liquorice [confectionery]; beer vinegar; coffee-based beverages; artificial coffee; candy; chips [cereal products]; chow-chow [condiment]; couscous [semolina]; malt extract for food; malt for human consumption; propolis; relish [condiment]; royal jelly; sea water for cooking; sushi; tomato sauce; mayonnaise; crackers; custard; fruit jellies [confectionery]; muesli; rice cakes; soya sauce; frozen yogurt [confectionery ices]; chutneys [condiments]; spring rolls; tacos; tortillas; iced tea; tea-based beverages; dressings for salad; breadcrumbs; tabbouleh; halvah; quiches; meat gravies; cereal-based snack food; rice-based snack food; hominy; hominy grits; baking powder; baking soda [bicarbonate of soda for cooking purposes]; garden herbs, preserved [seasonings]; noodle-based prepared meals; cake frosting [icing]; chocolate mousses; dessert mousses [confectionery]; fruit coulis [sauces]; marinades; cheeseburgers [sandwiches]; pesto [sauce]; ham glaze; linseed for culinary purposes [seasoning]; wheat germ for human consumption; high-protein cereal bars; gluten additives for culinary purposes; pasta sauce; cereal bars; palm sugar; dough; flowers or leaves for use as tea substitutes; pastry dough; vareniki [stuffed dumplings]; chocolate decorations for cakes; candy decorations for cakes; chocolate-coated nuts; nut flours; minced garlic [condiment]; baozi [stuffed buns]; rice pulp for culinary purposes; jiaozi [stuffed dumplings]; ramen

[Japanese noodle-based dish]; okonomiyaki [Japanese savory pancakes]; batter mixes for okonomiyaki [Japanese savory pancakes]; gimbap [Korean rice dish]; edible paper; edible rice paper; chocolate-based spreads; chocolate spreads containing nuts; flour-based dumplings; agave syrup [natural sweetener]; mirror icing [mirror glaze]; freeze-dried dishes with the main ingredient being rice; freeze-dried dishes with the main ingredient being pasta; chamomile-based beverages; dulce de leche; bibimbap [rice mixed with vegetables and beef]; onigiri [rice balls]; instant rice; hot dog sandwiches; ice cubes; processed seeds for use as a seasoning; sesame seeds [seasonings]; piccalilli; quinoa, processed; bulgur; buckwheat, processed; buckwheat flour; cranberry sauce [condiment]; apple sauce [condiment]; croûtons; lomper [potato-based flatbread]; zephyr [confectionery]; pastila [confectionery]; senbei [rice crackers]; kimchijeon [fermented vegetable pancakes]; shaved ice with sweetened red beans; mints for breath freshening; chewing gum for breath freshening; udon noodles; soba noodles; pelmeni [dumplings stuffed with meat]; soya bean paste [condiment].

35 – Business management assistance; business inquiries; bill-posting; import-export agency services; commercial information agency services; cost price analysis; dissemination of advertising matter; photocopying services; employment agency services; office machines and equipment rental; book-keeping; drawing up of statements of accounts; business auditing; business management and organization consultancy; personnel management consultancy; business management consultancy; typing; demonstration of goods; direct mail advertising; commercial or industrial management assistance; document reproduction; updating of advertising material; distribution of samples; business efficiency expert services; auctioneering; market studies; business appraisals; business investigations; publicity material rental; business organization consultancy; publication of publicity texts; radio advertising; business research; public relations; shorthand; television advertising; transcription of communications [office functions]; shop window dressing; advertising agency services; advisory services for business management; modelling for advertising or sales promotion; marketing research; computerized file management; professional business consultancy; economic forecasting; organization of exhibitions for commercial or advertising purposes; business information; opinion polling; payroll preparation; personnel recruitment; relocation services for businesses; rental of advertising space; tax preparation; telephone answering for unavailable subscribers; word processing; business management of hotels; systemization of information into computer databases; organization of trade fairs for commercial or advertising purposes; rental of photocopying machines; on-line advertising on a computer network; procurement services for others

[purchasing goods and services for other businesses]; data search in computer files for others; rental of advertising time on communication media; news clipping services; rental of vending machines; psychological testing for the selection of personnel; price comparison services; commercial information and advice for consumers in the choice of products and services; arranging subscriptions to telecommunication services for others; administrative processing of purchase orders; commercial administration of the licensing of the goods and services of others; outsourcing services [business assistance]; invoicing; writing of publicity texts; compilation of statistics; layout services for advertising purposes; sponsorship search; organization of fashion shows for promotional purposes; production of advertising films; business management of sports people; marketing; telemarketing services; retail services for pharmaceutical, veterinary and sanitary preparations and medical supplies; provision of commercial and business contact information; search engine optimization for sales promotion; commercial intermediation services; business management for freelance service providers; negotiation and conclusion of commercial transactions for third parties; updating and maintenance of data in computer databases; business project management services for construction projects; providing business information via a web site; provision of an on-line marketplace for buyers and sellers of goods and services; design of advertising materials; tax filing services; business management of reimbursement programs for others; writing of résumés for others; web indexing for commercial or advertising purposes; administration of frequent flyer programs; appointment scheduling services [office functions]; appointment reminder services [office functions]; administration of consumer loyalty programs; scriptwriting for advertising purposes; registration of written communications and data; updating and maintenance of information in registries; compiling indexes of information for commercial or advertising purposes; business intermediary services relating to the matching of potential private investors with entrepreneurs needing funding; production of teleshopping programmes; consultancy regarding advertising communication strategies; negotiation of business contracts for others; promotion of goods and services through sponsorship of sports events; competitive intelligence services; market intelligence services; online retail services for downloadable ring tones; online retail services for downloadable and pre-recorded music and movies; wholesale services for pharmaceutical, veterinary and sanitary preparations and medical supplies; gift registry services; targeted marketing; interim business management; retail services for works of art provided by art galleries; administrative assistance in responding to calls for tenders; sales promotion for others; secretarial services; marketing in the framework of softwa-

re publishing; financial auditing; online retail services for downloadable digital music; consultancy regarding public relations communication strategies; rental of signs for advertising purposes; outsourced administrative management for companies; web site traffic optimization; rental of sales stands; presentation of goods on communication media, for retail purposes; business management of performing artists; compilation of information into computer databases; arranging newspaper subscriptions for others; advertising by mail order.

43 – Accommodation bureau services [hotels, boarding houses]; food and drink catering; retirement home services; café services; cafeteria services; providing campground facilities; canteen services; rental of temporary accommodation; boarding house services; tourist home services; hotel services; day-nursery [crèche] services; restaurant services; boarding house bookings; hotel reservations; self-service restaurant services; snack-bar services; boarding for animals; bar services; holiday camp services [lodging]; rental of transportable buildings; temporary accommodation reservations; motel services; rental of chairs, tables, table linen, glassware; rental of meeting rooms; rental of tents; rental of cooking apparatus; rental of drinking water dispensers; rental of lighting apparatus; food sculpting; reception services for temporary accommodation [management of arrivals and departures]; washoku restaurant services; udon and soba restaurant services.

(260) AM 2019 101719 A

(800) 1449370

(151) 2018 11 07

(891) 2018 11 07

(731) AKSAN KOZMETİK SANAYİ VE  
TİCARET ANONİM ŞİRKETİ  
Hadımköy Mah. Şahmaran Sok. No:1/A,  
Arnavutköy, İstanbul, Turkey

(540)

**SAVON  
DE  
ROYAL**

(591) Black, white

(531) 27.05.01; 27.05.15

(511)

3 – Bleaching and cleaning preparations, detergents other than for use in manufacturing operations and for medical purposes, laundry bleach, fabric softeners for laundry use, stain removers, dishwasher detergents; perfumery, non-medicated cosmetics, fragrances, deodorants for personal use and animals; so-

aps; dental care preparations; dentifrices, denture polishes, tooth whitening preparations, mouth washes, not for medical purposes; abrasive preparations, emery cloth, sandpaper, pumice stone, abrasive pastes; polishing preparations for leather, vinyl, metal and wood, polishes and creams for leather, vinyl, metal and wood, wax for polishing.

(260) AM 2019 101720 A

(800) 1449376

(151) 2018 09 14

(891) 2018 09 14

(731) YILDIZ HOLDİNG ANONİM ŞİRKETİ  
Kısıklı Mahallesi, Çeşme Çıkmazı Sokak  
No:6/1, Üsküdar, İstanbul, Turkey

(540)



(591) Orange, red, black and white

(531) 19.03.03; 19.03.25; 25.05.02; 27.05.02;  
27.05.03; 27.05.10; 29.01.15

(511)

30 – Confectionery, chocolate, biscuits, crackers, wafers; cakes, chewing gums, ice-cream, edible ices.

(260) AM 2019 101721 A

(800) 1449388

(151) 2018 11 19

(891) 2018 11 19

(731) RICHTER GEDEON NYRT.  
Gyömrői út 19-21, H-1103 Budapest, Hungary

(540)

**DANDALO**

(591) Black, white

(511)

5 – Pharmaceutical preparations.

(260) AM 2019 101722 A

(800) 1449389

(151) 2019 01 15

(891) 2019 01 15

(731) BEIERSDORF AG  
Unnastr. 48, 20253 Hamburg, Germany

(540)

**BLACK & WHITE**

(591) Black, white

(511)

3 – Non-medicated cosmetics; deodorants and anti-perspirants for personal use.

(260) AM 2019 101723 A  
 (800) 1449394  
 (151) 2018 11 19  
 (891) 2018 11 19  
 (731) RICHTER GEDEON NYRT.  
 Gyömrői út 19-21, H-1103 Budapest, Hungary  
 (540)

## ERANTUM

(591) Black, white  
 (511)  
 5 – Pharmaceutical preparations.

(260) AM 2019 101724 A  
 (800) 1449399  
 (151) 2018 11 19  
 (891) 2018 11 19  
 (731) RICHTER GEDEON NYRT.  
 Gyömrői út 19-21, H-1103 Budapest, Hungary  
 (540)

## KLIMELLA

(591) Black, white  
 (511)  
 5 – Pharmaceutical preparations.

(260) AM 2019 101726 A  
 (800) 1449428  
 (151) 2018 07 19  
 (891) 2018 07 19  
 (731) Charitable endowment "FUTURE  
 CHAMPIONS LEAGUE"  
 Pobedy St., 11, Khimki, RU-141401 Moscow  
 region, Russian Federation  
 (540)



(591) Black, white  
 (531) 27.05.02; 27.05.04; 27.05.17  
 (511)  
 30 – Cereal bars; high-protein cereal bars; high-protein chocolate bars; fruit jellies [confectionery]; peanut confectionery; almond confectionery; refreshing candy; rice-based snack food; cereal-based snack food; rice cakes; oat cakes; muesli; cocoa beverages with milk; coffee beverages with milk; coffee-based beverages; cocoa-based beverages; chamomile-based beverages; tea-based beverages; chocolate beverages with milk; chocolate-based beverages; pastilles [confectionery]; bars [confectionery]; cookies; petit-

beurre biscuits; cereal preparations; oat-based food, in particular oat protein biscuits; chocolate.

(260) AM 2019 101727 A  
 (800) 1449469  
 (151) 2019 01 11  
 (891) 2019 01 11  
 (731) NOVARTIS AG  
 CH-4002 Basel, Switzerland  
 (540)

## EASYPACK

(591) Black, white  
 (511)  
 10 – Surgical and medical apparatus and instruments for ophthalmic surgery.

(260) AM 2019 101728 A  
 (800) 1449495  
 (151) 2018 11 23  
 (891) 2018 11 23  
 (731) BELYAEVA YULIA ALEXANDROVNA  
 Akademika Anokhina Street, d. 56, kv. 36,  
 RU-119571 Moscow, Russian Federation  
 (540)

## THERR MAITZ

(591) Black, white  
 (511)  
 18 – Mountaineering sticks; slings for carrying infants; luggage tags; pocket wallets; credit card cases [wallets]; saddlecloths for horses; business card cases; reins; harness fittings; parts of rubber for stirrups; chamois leather, other than for cleaning purposes; umbrellas; parasols; saddlery; frames for umbrellas or parasols; handbag frames; card cases [note-cases]; cases of leather or leatherboard; valves of leather; whips; imitation leather; leather, unworked or semi-worked; leatherboard; casings, of leather, for springs; umbrella rings; hat boxes of leather; boxes of leather or leatherboard; boxes of vulcanized fibre; boxes of vulcanized fiber; purses; chain mesh purses; fastenings for saddles; butts [parts of hides]; saddle trees; bags [envelopes, pouches] of leather, for packaging; moleskin [imitation of leather]; travelling sets [leatherware]; knee-pads for horses; muzzles; halters; vanity cases, not fitted; leather thread; furniture coverings of leather; clothing for pets; trimmings of leather for furniture; collars for animals; music cases; goldbeaters' skin; cat o' nine tails; leather leashes; pads for horse saddles; horseshoes; girths of leather; horse blankets; garment bags for travel; shoulder belts [straps] of leather; briefcases; traces [harness]; fur; randsels [Japanese school satchels]; haversacks; leather straps; straps for soldiers' equipment; harness straps; straps for skates; straps of leather [saddlery]; chin straps, of leather; stirrup leathers; umbrella handles; walking stick handles; suit-

case handles; rucksacks; travelling bags; riding saddles; net bags for shopping; umbrella or parasol ribs; stirrups; bags; bags for climbers; tool bags, empty; portmanteaux; handbags; pouch baby carriers; beach bags; bags for sports; bags for campers; shopping bags; wheeled shopping bags; school satchels; travelling trunks; nose bags [feed bags]; bridoons; walking canes; umbrella sticks; walking stick seats; bits for animals [harness]; bridles [harness]; harness for animals; key cases; horse collars; trunks [luggage]; valises; attaché cases; covers for horse saddles; umbrella covers; kid; curried skins; animal skins; cattle skins; leather laces; blinkers [harness]; game bags [hunting accessories].

---

(260) AM 2019 101737 A

(800) 1449613

(151) 2018 12 20

(891) 2018 12 20

(731) FERRERO INTERNATIONAL S.A.

Findel Business Center, Complexe B,

Rue de Trèves, L-2632 Findel, Luxembourg

(540)

## BUTTERFINGER

(591) Black, white

(511)

30 – Pastry and confectionery; biscuits; cakes; chocolate and chocolate-based products; cereal-based snacks; edible ices; all the aforementioned goods containing peanut butter.

---

(260) AM 2019 101738 A

(800) 1449632

(151) 2018 08 20

(891) 2018 08 20

(731) HASHGRAPH CONSORTIUM, LLC

800 Southern Hills Court, College

Station TX 77845, USA

(540)

## HEDERA

(591) Black, white

(511)

9 – Computer software platforms for distributed consensus computing; computer application software for distributed ledger based platforms, namely, software for using a consensus engine incorporating distributed ledger technology for cryptographically securing data.

35 – Online retail store services featuring computer software provided via the internet and other computer and electronic communication networks; managing computer networks, namely, computer networks with distributed ledger based platforms; promoting public awareness of distributed ledger technology.

41 – Educational services, namely, providing training in the fields of computer software and distributed ledger technology.

42 – Design, development, and implementation of software for distributed computing platforms; design, development, and implementation of software for distributed ledger technology; research and development of computer software; software development and product development consulting in the field of distributed computing platforms; providing a website featuring information about distributed ledger computing (terms considered too vague by the International Bureau – (rule 13.2.b) of the Common Regulations); software as a service (SAAS) services featuring software for distributed ledger technology, cryptocurrency, virtual currency, and digital tokens; platform as a service featuring computer software platforms for distributed ledger technology and authenticating, facilitating and processing data in the fields of cryptocurrency, virtual currency, and digital tokens; providing information in the fields of computer software and distributed ledger technology.

---

(260) AM 2019 101739 A

(800) 1449738

(151) 2018 12 14

(891) 2018 12 14

(731) DAW SE

Roßdörfer Str. 50, 64372 Ober-Ramstadt,  
Germany

(540)

## Artefloor

(591) Black, white

(511)

2 – Paints; varnishes; lacquers; glazes; coatings; preservatives against rust; primers; colorants; dyestuffs; dye pastes; mordants; paint thickeners; fixatives; siccatives for paints; raw natural resins; thinning and binding preparations for paints and lacquers; solvents for thinning paints; preparations for preserving wood; wood mordants; wood preserving oils; paints, including structuring paints; bactericidal and/or fungicidal paints; anti-corrosion preparations; protective preparations for metals; metals in foil and powder form for painters, decorators, printers and artists.

---

(260) AM 2019 101741 A

(800) 1449767

(151) 2018 12 20

(891) 2018 12 20

(731) FERRERO INTERNATIONAL S.A.

Findel Business Center, Complexe B,

Rue de Trèves, L-2632 Findel, Luxembourg

(540)

## BABY RUTH

(591) Black, white  
(511)  
30 – Pastry and confectionery; biscuits; cakes; chocolate and chocolate-based products; cereal-based snacks; edible ices.

(260) AM 2019 101742 A  
(800) 1449772  
(151) 2019 01 10  
(891) 2019 01 10  
(731) ABAKUMOV ANDREY MIKHAILOVICH  
Novorossiyskaya Str., 180, apt. 26,  
RU-350059 Krasnodar, Russian Federation  
(540)

## JAX

(591) Black, white  
(511)  
7 – Ironing machines; knitting machines; sewing machines; hemming machines; lawnmowers [machines]; coffee grinders, other than hand-operated; vacuum cleaners; dishwashers; meat choppers [machines]; blenders, electric, for household purposes; crushers, electric, for household purposes; fruit presses, electric, for household purposes; parquet wax-polishers, electric; washing machines [laundry]; food processors, electric; mills for household purposes, other than hand-operated; mixers, electric, for household purposes; food preparation machines, electromechanical; beverage preparation machines, electromechanical; laundry washing machines for household purposes.

11 – Microwave ovens [cooking apparatus]; sanitary apparatus and installations; bath fittings; hair dryers; refrigerators; freezers; coffee roasters; deep fryers, electric; heaters for heating irons; immersion heaters; heating apparatus, electric; heating plates; kettles, electric; coffee machines, electric; heating boilers; gas boilers; boilers, other than parts of machines; air-conditioning apparatus; cooking rings; heating apparatus for solid, liquid or gaseous fuels; cooking utensils, electric; cooker hoods; heaters for baths; lighting apparatus and installations; chandeliers; lamps; extractor hoods for kitchens; drying apparatus; laundry dryers, electric; water purification installations; air filtering installations; filters for air conditioning; filters for drinking water; electric cookers; gas stoves for household purposes; bread toasters; bread baking machines; bakers' ovens; heating installations; radiators [heating]; electric fans for personal use.

35 – Market studies; business investigations; business efficiency expert services; business appraisals; professional business consultancy; import-export agency services; commercial information agency services; business information; sales promotion for others; commercial or industrial management assis-

tance; procurement services for others [purchasing goods and services for other businesses].

42 – Research and development of new products for others.

(260) AM 2019 101743 A  
(800) 1449781  
(151) 2018 11 12  
(891) 2018 11 12  
(731) Public Joint-stock Company "ARNEST COMPANY"  
ul. Kombinatskaya, 6, Stavropolsky krai,  
RU-357111 g. Nevinnomyssk, Russian Federation  
(540)



(591) Black, white, grey  
(531) 26.13.01  
(511)  
3 – Deodorants for human beings or for animals; antiperspirants for personal use; perfumery; adhesives for affixing false hair; hair conditioners; hair spray; hair mousse; hair gel; preparations for styling the hair; cosmetic hair dressing preparations; hair lotions; after-shave lotions; deodorant soap; cosmetic kits; shaving preparations; after-shave preparations; hair straightening preparations; hair waving preparations; hair dyes; neutralizers for permanent waving; cosmetics; cosmetic preparations; cosmetics for children; cosmetics for animals; douching preparations for personal sanitary or deodorant purposes [toiletries]; antiperspirants [toiletries]; henna [cosmetic dye]; shampoos for animals [non-medicated grooming preparations]; shampoos for pets [non-medicated grooming preparations]; shampoos; dry shampoos.

(260) AM 2019 101744 A  
(800) 1449793  
(151) 2018 10 26  
(891) 2018 10 26

(731) ROCHE DIABETES CARE GMBH  
Sandhofer Strasse 116, 68305 Mannheim,  
Germany

(540)

## ACCU-CHEK GUIDE ME

(591) Black, white

(511)

10 – Medical instruments and apparatus, including accessories thereof; blood glucose monitors, including accessories thereof.

(260) AM 2019 101745 A

(800) 1449799

(151) 2018 12 21

(891) 2018 12 21

(731) APPLE INC.

One Apple Park Way, Cupertino CA 95014,  
USA

(540)

## MAC

(591) Black, white

(511)

9 – Telecommunications apparatus and instruments; apparatus for the transmission of voice, data, images, audio, video, and multimedia content; network communication apparatus; electronic book readers; computer software for setting up, configuring, operating and controlling computers, computer peripherals, mobile devices, mobile telephones, smartwatches, wearable devices, earphones, headphones, set top boxes, audio and video players and recorders, home theatre systems, and entertainment systems; biometric identification and authentication apparatus; monitors, display screens, virtual and augmented reality displays; cameras sold as a component feature of computers; flashes for cameras sold as a component feature of computers; keyboards, mice, mouse pads, track pads and touch bars; sound recording and reproducing apparatus; digital audio and video players and recorders; audio speakers; audio amplifiers and receivers; voice recording and voice recognition apparatus; microphones sold as a component feature of computers; radios; radio transmitters and receivers; data storage apparatus; electrical connectors, wires, and cables; electronic agendas.

(260) AM 2019 101750 A

(800) 1449915

(151) 2018 11 15

(891) 2018 11 15

(731) Joint Venture Joint-Stock Company

"KOMMUNARKA"

ul. Aranskaya 18, 220033 Minsk,  
Belarus

(540)

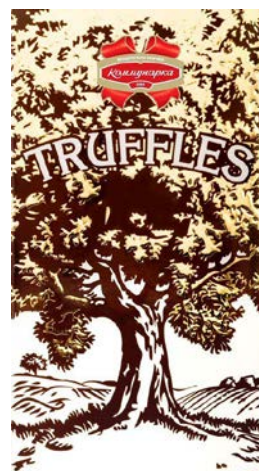

(591) Red, shades of brown and white

(531) 05.01.05; 05.01.16; 09.01.10; 27.05.02; 28.05;  
29.01.13

(511)

30 – Cocoa; confectionery; waffles; confectionery for decorating Christmas trees; pastries; peanut confectionery; almond confectionery; caramels; sweetmeats; liquorice [confectionery]; peppermint sweets; crackers; candy; cocoa beverages with milk; chocolate beverages with milk; chocolate-based beverages; cocoa-based beverages; pastilles [confectionery]; cookies; fondants [confectionery]; pralines; gingerbread; cake powder; sugar confectionery; cakes; tarts; halvah; chocolate.

(260) AM 2019 101751 A

(800) 1449924

(151) 2018 10 18

(891) 2018 10 18

(731) Joint Venture Joint-Stock Company

"KOMMUNARKA"

ul. Aranskaya 18, 220033 Minsk, Belarus

(540)



(591) White, gray, brown, red and green

(531) 24.17.25; 26.04.08; 26.04.17; 26.04.22;  
26.04.24; 27.07.01; 28.05; 29.01.15

(511)

30 – Cocoa powder.

(260) AM 2019 101753 A  
 (800) 1449975  
 (151) 2019 01 10  
 (891) 2019 01 10  
 (731) LONDON DOLLAR LTD  
 Kemp House, 160 City Road, London  
 EC1V 2NX, United Kingdom

(540)

## DUNSTON

(591) Black, white  
 (511)  
 34 – Cigarettes; cigarettes containing tobacco substitutes, not for medical purposes; cigarillos; cigars; herbs for smoking; snuff; snuff boxes, tobacco, smokers' articles; matches.

(260) AM 2019 101755 A  
 (800) 1450014  
 (151) 2018 11 15  
 (891) 2018 11 15  
 (731) Likino bus plant – LTD  
 Kalinina Street, 1, Likino-Dulevo, Orekhovo-Zuevo district, RU-142671 Moscow region, Russian Federation

(540)

## VOYAGE

(591) Black, white  
 (531) 27.05.01; 27.05.17  
 (511)  
 12 – Motor buses; motor coaches; automobile bodies; tipping bodies for trucks; bodies for vehicles.

(260) AM 2019 101756 A  
 (800) 1450061  
 (151) 2018 10 30  
 (891) 2018 10 30  
 (731) LEVENT KİMYA SANAYİ VE TİCARET ANONİM ŞİRKETİ  
 Antalya Organize Sanayi Bölgesi, 1. Kısım,  
 1. Cadde, No:12, Döşemealtı, Antalya, Turkey

(540)



(591) Blue, red and white  
 (531) 26.01.02; 26.01.05; 26.01.19; 27.01.12;  
 27.05.02; 27.05.17; 29.01.13

(511)  
 3 – Bleaching and cleaning preparations, detergents other than for use in manufacturing operations and for medical purposes, laundry bleach, fabric softeners for laundry use, stain removers, dishwasher detergents; soaps (except medicated soap).

(260) AM 2019 101759 A  
 (800) 1450096  
 (151) 2018 08 20  
 (891) 2018 08 20  
 (731) Limited liability company "Automobile plant "GAZ"  
 prospekt Ilycha, 5, RU-603004 Nizhny Novgorod, Russian Federation

(540)



(591) Yellow, black, grey and white  
 (531) 14.07.09; 26.04.05; 26.04.18; 27.05.02;  
 27.05.09; 27.05.10; 28.05; 29.01.14  
 (526) The Cyrillic characters indicated in the mark which transliterated into "tekhnicheskij standart".  
 (511)  
 1 – Antifreeze; brake fluid.  
 7 – Filters for cleaning cooling air, for engines; pumps [parts of machines, engines or motors]; filters [parts of machines or engines].  
 9 – Thermostats for vehicles.  
 16 – Boxes of paper or cardboard.  
 39 – Delivery of goods.

(260) AM 2019 101760 A  
 (800) 1450106  
 (151) 2018 08 31  
 (891) 2018 08 31  
 (731) NOKEN DESIGN S.A  
 Ctra. Villarreal-Pueba de Arenoso (CV 20),  
 km. 2, E-12540 VILLARREAL,  
 CASTELLÓN, Spain

(540)

## LIGNAGE

(591) Black, white  
 (531) 27.05.01  
 (511)  
 11 – Apparatus for lighting, heating, steam generating, cooking, refrigerating, drying, ventilating, wa-



ter supply and sanitary purposes; bathroom sinks and fittings for bathroom sinks; sitz baths; bath apparatus; toilet bowls; portable commodes, bidets; showers and shower fittings; sanitary apparatus and installations for bathrooms and plumbing fixtures; faucets; faucets (taps) [plumbing fittings]; fittings for domestic water installations; baths and bath cladding; screens for baths and bathrooms; shower screens (metal); screens not of metal for shower trays; toilet furniture namely washbasins; shower trays; cladding adjusted for shower trays; lighting fittings; water pipe regulation accessories; bidet fittings; fittings (lighting accessories).

20 – Furniture, mirrors, picture frames; containers not of metal for storage or transport; bone, horn, whalebone or mother-of-pearl, unwrought or semi-wrought; shells; meerschaum; yellow amber; bathroom vanities; bath seats; bathroom furniture; bathroom units (furniture); bathroom stools; dressers for bathrooms.

(260) AM 2019 101761 A  
(800) 1450123  
(151) 2018 12 18  
(891) 2018 12 18  
(731) YANTAI SHUCHI VEHICLE CO., LTD.  
NO.259, LONGMEN WEST ROAD,  
LAIYANG CITY, SHANDONG PROVINCE,  
China

(540)



(591) Black, white  
(531) 14.01.13; 26.01.06; 26.13.25  
(511)

12 – Motor coaches; electric vehicles; cars; motor homes; tipping bodies for lorries [trucks]; automobile bodies; seat covers for vehicles; seats (vehicle-); upholstery for vehicles.

(260) AM 2019 101764 A  
(800) 1450177  
(151) 2019 01 18  
(891) 2019 01 18  
(731) Menarini International Operations  
Luxembourg S.A.  
1, avenue de la Gare, L-1611 Luxembourg,  
Luxembourg

(540)

**TENKASI**

(591) Black, white  
(511)  
5 – Antibiotics.

(260) AM 2019 101765 A  
(800) 1450179  
(151) 2019 01 18  
(891) 2019 01 18  
(731) Menarini International Operations  
Luxembourg S.A.  
1, avenue de la Gare, L-1611 Luxembourg,  
Luxembourg

(540)

**VABOREM**

(591) Black, white  
(511)  
5 – Antibiotics.

(260) AM 2019 101766 A  
(800) 1450180  
(151) 2019 01 18  
(891) 2019 01 18  
(731) VALIO LTD  
Meijeritie 6, FI-00370 Helsinki, Finland

(540)

**CARBO**

(591) Black, white  
(511)  
31 – Raw and unprocessed agricultural, aquacultural, horticultural and forestry products; raw and unprocessed grains and seeds; fresh fruits and vegetables, fresh herbs; natural plants and flowers; bulbs, seedlings and seeds for planting; live animals; foodstuffs and beverages for animals; malt; agricultural and aquacultural crops, horticulture and forestry products; agricultural seeds; seeds for horticultural purposes; grass seeds; seeds for planting; bulbs (plant-); seedlings.

(260) AM 2019 101767 A  
(800) 1450192  
(151) 2018 12 11  
(891) 2018 12 11  
(731) KRKA, tovarna zdravil, d.d., Novo mesto  
Šmarješka cesta 6, SI-8000 Novo mesto,  
Slovenia

(540)

**VETBENDAN**

(591) Black, white  
(511)  
5 – Veterinary preparations.

(260) AM 2019 101768 A  
 (800) 1450195  
 (151) 2018 12 07  
 (891) 2018 12 07  
 (731) RICHTER GEDEON NYRT.  
 Gyömrői út 19-21, H-1103 Budapest, Hungary

(540)  
**ТАГЛИЗОН**

(591) Black, white  
 (531) 28.05  
 (511)  
 5 – Pharmaceutical preparations.

(260) AM 2019 101769 A  
 (800) 1450196  
 (151) 2018 11 19  
 (891) 2018 11 19  
 (731) RICHTER GEDEON NYRT.  
 Gyömrői út 19-21, H-1103 Budapest, Hungary

(540)  
**TUXEVID**

(591) Black, white  
 (511)  
 5 – Pharmaceutical preparations.

(260) AM 2019 101770 A  
 (800) 1450197  
 (151) 2018 12 03  
 (891) 2018 12 03  
 (731) RICHTER GEDEON NYRT.  
 Gyömrői út 19-21, H-1103 Budapest, Hungary

(540)  
**Профанекс**

(591) Black, white  
 (531) 28.05  
 (511)  
 5 – Pharmaceutical preparations.

(260) AM 2019 101771 A  
 (800) 1450198  
 (151) 2018 12 03  
 (891) 2018 12 03  
 (731) RICHTER GEDEON NYRT.  
 Gyömrői út 19-21, H-1103 Budapest, Hungary

(540)  
**Фановерин**

(591) Black, white  
 (531) 28.05  
 (511)  
 5 – Pharmaceutical preparations.

(260) AM 2019 101772 A  
 (800) 1450254  
 (151) 2018 12 17  
 (891) 2018 12 17  
 (731) APPLE INC.  
 One Apple Park Way, Cupertino CA 95014,  
 USA

(540)



(591) Turquoise, green, blue, and white  
 (531) 15.09.18; 26.04.03; 26.15.09; 29.01.13  
 (511)  
 9 – Computer software used in developing other software applications; application development software.

(260) AM 2019 101798 A  
 (800) 1450507  
 (151) 2018 10 08  
 (891) 2018 10 08  
 (731) KAAMOS GROUP OÜ  
 Pärnu mnt 153, EE-11624 Tallinn, Estonia

(540)



(591) Dark red and gray  
 (531) 26.01.18; 27.05.01; 29.01.12  
 (511)  
 19 – Non-metallic building materials; plywood, veneer; building timber, wood veneers, manufactured timber, semi-finished products of timber; non-metallic rigid pipes for building; asphalt, pitch and bitumen; non-metallic transportable buildings; monuments, not of metal.

35 – Advertising; business management; office functions; retail and wholesale services (for others), in particular sale of timber and products of timber, including via the Internet; procurement services for others (purchasing goods and services for other businesses); organization of exhibitions for commercial or advertising purposes; demonstration of goods; sales promotion; rental of advertising space; commercial or industrial management assistance.

36 – Insurance; monetary affairs, financial affairs and real estate affairs; investments, investment activities, investment funds; rental and leasing of real

estate for commercial and office purposes; financing of real estate development projects; real estate management, administration; real estate consultancy.

37 – Building construction; repair; installation services; building construction supervision.

40 – Treatment of materials, including forest felling, woodworking, treatment of timber, sawing of materials.

44 – Medical services; veterinary services; hygienic and beauty care for human beings and animals; agriculture, horticulture and forestry services.

(260) AM 2019 101800 A

(800) 1450516

(151) 2018 10 16

(891) 2018 10 16

(731) Limited Liability Company "ORIMI"  
1-st Microrayon Street, 15/4 plot, Sverdlov  
factory settlement, Vsevolozhsk district,  
RU-188682 Leningrad oblast, Russian  
Federation

(540)

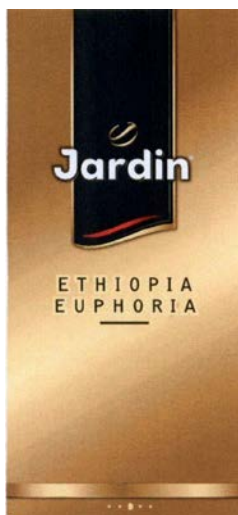

(591) White, black, red, beige and golden  
(531) 05.07.27; 26.04.18; 26.11.02; 27.05.10;  
29.01.14

(526) ETHIOPIA

(511)

30 – Coffee; unroasted coffee; artificial coffee; coffee-based beverages; coffee beverages with milk.

(260) AM 2019 101801 A

(800) 1450542

(151) 2018 08 30

(891) 2018 08 30

(731) SHAANXI HEAVY-DUTY AUTOMOBILE  
CO., LTD.

Jingwei Industrial Park, Xi'An Economic and  
Technological, Development Zone, 710200  
Xi'An, Shaanxi, China

(540)



(591) Black, white

(531) 26.01.18; 27.05.17; 27.05.21

(511)

4 – Dust removing preparations; illuminating wax.

7 – Washing installation for vehicle; vehicle bearing; dynamotor; motors, electric, other than for land vehicles; pistons [parts of machines or engines]; automobile motor piston; automobile motor spark plug; automobile motor camshaft; maintenance machines for vehicle; automobile oil pump; hydroelectric generator and motor; belts for conveyors.

9 – Vehicle breakdown warning triangles; vehicle navigation instrument [with car computer]; vehicle radio; vehicle battery; wires, electric; anti-theft warning apparatus; computers; fire engines.

42 – Conversion of data and documents from physical to electronic media; vehicle roadworthiness testing; geological surveys; industrial design; chemical analysis; technical project studies; computer software design; construction engineering services [technical project studies in the field of construction]; hosting computer sites [web sites]; quality testing.

(260) AM 2019 101803 A

(800) 1450667

(151) 2018 07 17

(891) 2018 07 17

(731) Euro Games Technology Ltd.  
"Maritsa" Str. 4, "Vranya-Lozen-Triugulnika",  
BG-1151 Sofia, Bulgaria

(540)



(591) Brown, black and yellow

(531) 27.05.03; 29.01.13

(511)

9 – Apparatus for recording, transmission or reproduction of sound or image; computer software, recorded; monitors, computer hardware.

28 – Games, that are not included in other classes; gaming machines operating with coins, banknotes and cards; gaming machines for gambling, adapted for use with an external screen or monitor.

(260) AM 2019 101830 A  
 (800) 1451052  
 (151) 2018 11 19  
 (891) 2018 11 19  
 (731) RICHTER GEDEON NYRT.  
 Gyömrői út 19-21, H-1103 Budapest, Hungary  
 (540)

## PROFANEX

(591) Black, white  
 (511)  
 5 – Pharmaceutical preparations.

---

(260) AM 2019 101832 A  
 (800) 1451071  
 (151) 2018 12 03  
 (891) 2018 12 03  
 (731) RICHTER GEDEON NYRT.  
 Gyömrői út 19-21, H-1103 Budapest, Hungary  
 (540)

## Визапол

(591) Black, white  
 (531) 28.05  
 (511)  
 5 – Pharmaceutical preparations.

---

(260) AM 2019 101836 A  
 (800) 1451086  
 (151) 2018 11 19  
 (891) 2018 11 19  
 (731) RICHTER GEDEON NYRT.  
 Gyömrői út 19-21, H-1103 Budapest, Hungary  
 (540)

## PORTAZIN

(591) Black, white  
 (511)  
 5 – Pharmaceutical preparations.

---

(260) AM 2019 101837 A  
 (800) 1451087  
 (151) 2018 12 03  
 (891) 2018 12 03  
 (731) RICHTER GEDEON NYRT.  
 Gyömrői út 19-21, H-1103 Budapest, Hungary  
 (540)

## Дарданелл

(591) Black, white  
 (531) 28.05  
 (511)  
 5 – Pharmaceutical preparations.

---

(260) AM 2019 101838 A  
 (800) 1451088  
 (151) 2018 12 03  
 (891) 2018 12 03  
 (731) RICHTER GEDEON NYRT.  
 Gyömrői út 19-21, H-1103 Budapest, Hungary  
 (540)

## Дросдион

(591) Black, white  
 (531) 28.05  
 (511)  
 5 – Pharmaceutical preparations.

---

(260) AM 2019 101839 A  
 (800) 1451093  
 (151) 2018 12 03  
 (891) 2018 12 03  
 (731) RICHTER GEDEON NYRT.  
 Gyömrői út 19-21, H-1103 Budapest, Hungary  
 (540)

## Кордолла

(591) Black, white  
 (531) 28.05  
 (511)  
 5 – Pharmaceutical preparations.

---

(260) AM 2019 101840 A  
 (800) 1451098  
 (151) 2018 12 03  
 (891) 2018 12 03  
 (731) RICHTER GEDEON NYRT.  
 Gyömrői út 19-21, H-1103 Budapest, Hungary  
 (540)

## Дандало

(591) Black, white  
 (531) 28.05  
 (511)  
 5 – Pharmaceutical preparations.

---

(260) AM 2019 101841 A  
 (800) 1451104  
 (151) 2018 12 03  
 (891) 2018 12 03  
 (731) RICHTER GEDEON NYRT.  
 Gyömrői út 19-21, H-1103 Budapest, Hungary  
 (540)

## Рениксола

(591) Black, white  
 (531) 28.05

(511)  
5 – Pharmaceutical preparations.

(260) AM 2019 101842 A

(800) 1451106

(151) 2018 12 03

(891) 2018 12 03

(731) RICHTER GEDEON NYRT.

Gyömrői út 19-21, H-1103 Budapest, Hungary

(540)

# Портазин

(591) Black, white

(531) 28.05

(511)

5 – Pharmaceutical preparations.

(260) AM 2019 101843 A

(800) 1451108

(151) 2018 12 03

(891) 2018 12 03

(731) RICHTER GEDEON NYRT.

Gyömrői út 19-21, H-1103 Budapest, Hungary

(540)

# Вуллина

(591) Black, white

(531) 28.05

(511)

5 – Pharmaceutical preparations.

(260) AM 2019 101844 A

(800) 1451139

(151) 2018 09 10

(891) 2018 09 10

(731) Andriy KALMYKOV

14, Pidvysotskogo Street, Apt. 7, Kyiv 01014,  
Ukraine

(540)

# Trade Help

(591) Black, white

(531) 27.05.01

(511)

35 – Advertising; business management; business administration; office functions; commercial information agency services; cost price analysis; auctioneering; foreign trade consultancy services; arranging and conducting of exhibitions or trade fairs for commercial or advertising purposes, including via the Internet; arranging and conducting of advertising actions and campaigns for commercial or advertising purposes; market studies; opinion polling; demonstration of goods; business appraisals; professional business consultancy, including consultancy in choo-

sing shop equipment; tender evaluation; business investigations; marketing research; business information; business inquiries; business management assistance; commercial or industrial management assistance; advisory services for business management; customer assistance in selection and purchase of various food and nonfood items; economic forecasting; business efficiency expert services; compilation of information into computer databases; business management assistance in realizing hi-tech and resource-intensive projects; business consulting services; consulting services relating to arranging, conducting and analyzing trade results; business consulting services in the field of construction and development of retail complexes; personnel recruitment; personnel management consultancy; consultancy relating to general manager recruitment; marketing services; business management services; business project management; assistance for commercial enterprises in business management; preparation of management reports, namely for commercial enterprises and retail stores; compilation of statistics; business project management assistance; shop window dressing; business auditing; public relations; outsourcing services in the field of business analytics; employment agency services; commercial management assistance; dissemination of advertising matter; distribution of samples; the bringing together, for the benefit of others, of a variety of food and nonfood items (excluding the transport thereof) enabling customers to conveniently view, order and purchase those goods at wholesale and retail outlets or supermarkets; online advertising on computer networks in relation to range of food and nonfood items and the list of provided services which allow all concerned parties to view, order and purchase those goods and to order services conveniently from web pages and web sites on the Internet, as well as to receive necessary information about those goods or provided services; sales promotion for others; provision of business statistical information; data search in computer files for others; arranging and conducting of presentations for commercial or advertising purposes.

41 – Education; providing of training; entertainment services; sporting and cultural activities; arranging and conducting of exhibitions and photo exhibitions for cultural or educational purposes, including via the Internet; organization of lotteries; arranging and conducting of seminars, symposiums, conferences, colloquiums, congresses, disputes, forums, lectures; arranging and conducting of workshops, including seminars on retail complexes and operating control; arranging and conducting of amusements, shows; production of shows; production of radio and television programmes; providing recreation facilities; production of films; education, recreation, and entertainment information; rental of videotapes; rental of audiotapes, sound recordings; rental of show scenery; providing on-line electronic publications, not

downloadable; vocational guidance (education or training advice); personnel training; training, retraining, and professional development of personnel; party planning (entertainment); translation; online digital publishing services; recording studio services; booking of seats for shows; conducting workshops; publication of texts, other than publicity texts; on-line publication of electronic books and journals; television and radio entertainment; photography; photographic reporting.

42 – Scientific and technological services and research and design relating thereto; industrial analysis and research services; design and development of computer hardware and software; architectural consultancy; conducting technical project studies; installation and technical support of computer software; video game software design; graphic design; design services; design of interior decor; design of printing products; design of corporate identity products; consultancy in the design and development of computer hardware; surveying; research and development of new products for others; information technology consultancy; creating and maintaining web pages; industrial design; creating and designing brands; creating and designing logos and slogans and creating of corporate identity; layout design for retail complexes; technical project planning.

(260) AM 2019 101845 A

(800) 1451181

(151) 2018 10 18

(891) 2018 10 18

(731) CHAPLIN MARIIA

Vul. Kubiivycha 15, kv. 7, Lviv 79011,  
Ukraine

(540)



(591) Black, white

(531) 24.17.20; 24.17.25; 27.05.10; 27.05.15

(511)

41 – Academies [education]; teaching; videotaping; arranging and conducting of congresses; arranging and conducting of colloquiums; arranging and conducting of conferences; arranging and conducting of concerts; arranging and conducting of in-person educational forums; arranging and conducting of workshops [training]; arranging and conducting of semi-

nars; arranging and conducting of symposiums; arranging of beauty contests; gymnastic instruction; electronic desktop publishing; nursery schools; dubbing; educational examination; providing on-line videos, not downloadable; providing on-line electronic publications, not downloadable; providing on-line music, not downloadable; providing television programs, not downloadable, via video-on-demand services; providing films, not downloadable, via video-on-demand services; providing sports facilities; providing recreation facilities; providing golf facilities; providing casino facilities [gambling]; booking of seats for shows; correspondence courses; game services provided on-line from a computer network; recreation information; education information; entertainment information; cinema presentations; cultural, educational or entertainment services provided by art galleries; microfilming; videotape editing; training services provided via simulators; aikido instruction; sado instruction [tea ceremony instruction]; tutoring; boarding school education; providing museum facilities [presentation, exhibitions]; screenplay writing; songwriting; scriptwriting, other than for advertising purposes; writing of texts; organization of balls; organization of shows [impresario services]; organization of exhibitions for cultural or educational purposes; organization of competitions [education or entertainment]; organization of lotteries; organization of fashion shows for entertainment purposes; organization of cosplay entertainment events; organization of sports competitions; educational services provided by schools; sign language interpretation; party planning [entertainment]; entertainer services; lending library services; disc jockey services; discotheque services; calligraphy services; layout services, other than for advertising purposes; language interpreter services; providing amusement arcade services; zoological garden services; coaching [training]; karaoke services; movie studio services; club services [entertainment or education]; health club services [health and fitness training]; modelling for artists; nightclub services [entertainment]; orchestra services; amusement park services; translation; mobile library services; personal trainer services [fitness training]; news reporters services; sport camp services; recording studio services; holiday camp services [entertainment]; ticket agency services [entertainment]; photographic reporting; gambling services; music composition services; practical training [demonstration]; presentation of live performances; presentation of variety shows; presentation of circus performances; conducting guided climbing tours; conducting guided tours; conducting fitness classes; rental of indoor aquaria; rental of audio equipment; rental of show scenery; rental of video cameras; rental of video cassette recorders; rental of videotapes; rental of sound recordings; toy rental; games equipment rental; rental of cinematographic apparatus; rental of motion pictures; rental of skin diving equi-

ipment; rental of lighting apparatus for theatrical sets or television studios; rental of radio and television sets; rental of sports grounds; rental of sports equipment, except vehicles; rental of artwork; rental of stage scenery; rental of tennis courts; rental of stadium facilities; vocational retraining; vocational guidance [education or training advice]; on-line publication of electronic books and journals; publication of books; publication of texts, other than publicity texts; radio entertainment; religious education; entertainment services; production of shows; production of music; production of radio and television programmes; film production, other than advertising films; subtitling; theatre productions; television entertainment; physical education; photography; timing of sports events.

(260) AM 2019 101847 A

(800) 1451201

(151) 2018 11 06

(891) 2018 11 06

(731) HOTREC Hotels, Restaurants and Cafés in Europe Aisbl In short HOTREC Association Internationale  
Rue Dautzenberg 36-38, B-1050 Bruxelles, Belgium

(540)



(591) Orange, blue and white

(531) 02.07.23; 16.01.11; 16.01.25; 24.17.17; 24.17.25; 26.01.12; 26.01.16; 26.11.02; 26.11.13; 26.11.21; 26.15.01; 27.05.01; 27.05.24; 29.01.14

(511)

35 – Advertising and advertising promotion services; business management assistance in connection with hotels, restaurants and cafés and other similar establishments; business management assistance and consultancy in connection with hotels, restaurants and cafés and other similar establishments; business advertising, promotional, marketing and communications assistance and consultancy; organization of events, exhibitions, trade fairs and trade shows for business, promotional and advertising purposes in connection with hotels, restaurants and cafés and other similar establishments; dissemination of advertisements and promotional material (prospectuses, catalogs, printed matter, samples); public relations; commercial lobbying services; market studies in connection with hotels, restaurants and cafés and ot-

her similar establishments; compilation of data into a computer database in connection with hotels, restaurants and cafés and other similar establishments.

41 – Advice in connection with education, training and vocational guidance in connection with the tourism and hotel industries, restaurants and cafés and other similar establishments; organization and conducting of colloquiums, conferences, congresses, seminars and symposiums in connection with the tourism and hotel industries, restaurants and cafés and other similar establishments; publishing services for, inter alia, electronic newspapers, pamphlets, periodicals and other printed matter in connection with the tourism and hotel industries, restaurants and cafés and other similar establishments; drafting and publication of texts other than advertising texts in connection with the tourism and hotel industries, restaurants and cafés and other similar establishments.

43 – Services for providing food and drink for hotels, bars, restaurants and cafés and other similar establishments; accommodation services such as board and lodging provided by hotels, boarding houses and other temporary accommodation establishments; information and advice in connection with booking accommodation for travelers, provided, in particular, by travel agencies or by brokers; booking services for hotels accommodation; reservation services for booking hotels and restaurants.

45 – Legal services and advice in connection with the tourism and hospitality industries, hotels, restaurants, cafés and other similar establishments in connection with tax law, social law, employment law, rules governing food hygiene and health in the workplace, environmental law, competition law and personnel security; lobbying services for defending occupational interests in connection with the tourism and hotel industries, restaurants, cafés and other similar establishments with respect to the European institutions.

(260) AM 2019 101848 A

(800) 1451205

(151) 2018 08 13

(891) 2018 08 13

(731) ALDAĞ ISITMA SOĞUTMA KLİMA SANAYİ VE TİCARET ANONİM ŞİRKETİ

Cumhuriyet Mahallesi, Abdi İpekçi Caddesi, No:1, Kartal, İstanbul, Turkey

(540)



(591) Dark blue, red and black

(531) 26.01.03; 26.04.05; 26.04.10; 26.04.12; 26.04.24; 26.11.01; 26.11.12; 27.05.01; 27.05.17; 29.01.13

(511)

11 – Lighting installations; lights for vehicles and interior-exterior spaces; lamps, light bulbs, lanterns, lanterns, electric lanterns, lampposts, lamps for vehicles, lighting and signal lamps (bulbs), headlamps, stop lamps, signal and parking lamp glasses, vehicle reflectors, reflector lamps; devices for heating and steam generating installations; boilers for heating and natural gas installations which are parts of heating systems, steam boilers, heat exchangers, burners, floor heating devices, air conditioners, water heaters, electric water boilers; solar thermal collectors [heating]; air conditioners, ventilators, ventilators, air conditioners, including those for vehicles; refrigerators, deep freezers, ice boxes, ice machines and appliances; electric and gas powered appliances, machines and appliances used in cooking and boiling; refrigerators, deep freezers, ice boxes, ice machines and appliances; toast machines, toaster machines, fryers, grills, ovens, cookers, autoclaves, coffee and tea cookers, water boilers and their parts; bathtubs for shower, bathtubs, shower cubicles cabinets, urinals, toilet bowls, wash basins, sinks, housings, parts and components for them; taps for water and gas installations, thermostatic valves for heating installations, level control valves for tanks, water level and gas regulators; fountains for automatic irrigation equipment, handles and spirals for showers, pipes with sanitary fittings; agricultural watering machines; water softening devices, water treatment devices, water treatment plants, waste treatment plants; electric hair dryers, hand dryers, tanning apparatus [sun beds]; ventilating louvers and electric blankets for household use, heating pads, electric or non-electric foot warmers, hot water bags (thermoformers); kitchen lighters; heating and cooking utensils, electric; filters for aquariums and aquarium filtration apparatus; industrial ovens; nuclear reactors, acrylic burners, acetylene burners and generators; pasteurizers and sterilizers; industrial drying systems, industrial cooling systems, cooling towers, iron melting furnaces; filters for household appliances, including those of this class, that are parts of industrial equipment; de-icer heating devices for vehicle windows.

(260) AM 2019 101849 A

(800) 1451206

(151) 2018 12 03

(891) 2018 12 03

(731) Croma-Pharma Gesellschaft m.b.H

Industriezeile 6, A-2100 Leobendorf, Austria

(540)

**croma**

For creators of beauty.

(591) Black, white

(531) 27.05.10

(526) No claim is made to the exclusive right to use "For creators of beauty", apart from the mark as shown.

(511)

3 – Cosmetics.

5 – Veterinary preparations; pharmaceutical preparations; dietetic foods for medicinal purposes; nutritional additives to foodstuffs for animals, for medical purposes.

10 – Surgical apparatus and instruments.

(260) AM 2019 101850 A

(800) 1451214

(151) 2018 09 28

(891) 2018 09 28

(731) WMF Group GmbH

Eberhardstraße 35, 73312 Geislingen/Steige, Germany

(540)



(591) Black, white

(531) 27.05.01; 27.05.22

(511)

8 – Hand-operated implements with knives or blades for cutting and chopping purposes for household and kitchen as well as for catering facilities, as far as included in this class; cutlery; knives, forks and spoons; cutlery, knives, forks, spoons made of precious metal.

(260) AM 2019 101851 A

(800) 1451263

(151) 2018 06 21

(891) 2018 06 21

(731) HELIOS Tovarna barv, lakov in umetnih smol

Količevo, d.o.o.

Količevo 65, SI-1230 Domžale, Slovenia

(540)





(591) Gold, black, blue and silver  
 (531) 19.01.01; 19.01.04; 26.11.03; 26.11.10;  
 27.05.09; 27.05.10; 27.05.24; 29.01.14

(554) Three-dimensional

(511)

1 – Chemical products used in industry, especially chemicals used in manufacturing of paints, industrial chemicals, aldehydes, anti-static preparations (except for household purposes), bacteriologic preparations (except for medical and veterinary purposes); chemical reactant (except for medical and veterinary purposes); concrete preservatives, except paints and oils; condensation-preventing chemicals; degreasing preparations for use in manufacturing processes; decolorants for industrial processes; emulsifiers; fireproofing preparations; preservatives used in masonry, except paints and oils; enamel staining chemicals; salts for coloring metal; artificial resins, unprocessed; plastics, unprocessed; tanning substances; adhesives for industrial purposes, solvents for varnishes.

2 – Paints, including wood colorings, bactericidal paints, fireproof paints, paints for ceramics; aluminum paints, printing ink and printing paints; painting coatings i.e. coatings, whitening substances, dyes, and binding substances for paints; varnishes for painting; lacquers, including lacquers on the basis of varnish and painting lacquers; anti-rust preparations, especially preservatives against rust; preservatives for metal, minium, red lead, white lead, undercoatings and coatings for chassis of vehicles; mastic, primers; thinners for paints and lacquers; thickeners for paints and lacquers; agglutinants for paints; mordants; enamels; fixatives for watercolors; mordants for leather; wood preservatives, including wood coatings and wood mordants; metals in foil and powder form for painters, decorators, printers and artists, colorants.

17 – Artificial resins (semi-processed), acrylic resins (semi-processed); rubber (raw or semi-processed); seals and rings of rubber; semi-processed plastics; plastic fibres, not for use in textile; adhesive bands and tapes (other than stationery and not for medical purposes); insulating fabrics, insulating oil, insulating paints, insulating varnish, insulating tape and band, substances for insulating buildings against moisture; filtering materials (semi-processed foams or films of plastics); flexible tubes, not of metal.

(260) AM 2019 101852 A  
 (800) 1451343  
 (151) 2018 11 27  
 (891) 2018 11 27  
 (731) ALPEN PHARMA AG  
 Casinoplatz 2, CH-3011 Bern,  
 Switzerland

(540)



(591) Black, white, grey  
 (531) 01.03.02; 26.11.02; 26.11.08; 27.05.01;  
 27.05.11

(511)

5 – Pharmaceutical products, medical and veterinary preparations; sanitary products for medical purposes; dietetic substances and foodstuffs for medical or veterinary use, food for babies; food supplements for humans and animals; plasters, materials for dressings; material for dental fillings and dental impressions; disinfectants; products for destroying vermin; fungicides, herbicides.

10 – Surgical, medical, dental and veterinary apparatus and instruments; artificial limbs, eyes and teeth; orthopedic articles; suture material; therapeutic and assistance devices designed for people with disabilities; massage apparatus; apparatus, devices and articles for child care; apparatus, devices and articles for sexual activities.

(260) AM 2019 101853 A  
 (800) 1451353  
 (151) 2019 01 25  
 (891) 2019 01 25  
 (731) FARCO-PHARMA GmbH  
 Gereonsmühlengasse 1-11, 50670 Köln,  
 Germany  
 (540)

## Instilla

(591) Black, white  
 (511)

5 – Pharmaceuticals, medical and veterinary preparations; sanitary preparations for medical purposes; foodstuffs and dietetic substances for medical or veterinary purposes; dietary supplements for humans and animals; disinfectants.

10 – Surgical, medical, dental and veterinary instruments and apparatus; orthopedic articles; suture materials; therapeutic and assistive devices adapted for the disabled; apparatus, devices and articles for nursing infants.

(260) AM 2019 101854 A  
 (800) 1451389  
 (151) 2019 01 25  
 (891) 2019 01 25

(731) FARCO-PHARMA GmbH  
Gereonsmühlengasse 1-11, 50670 Köln,  
Germany

(540)

## InstillaGel

(591) Black, white

(511)

5 – Pharmaceuticals, medical and veterinary preparations; sanitary preparations for medical purposes; foodstuffs and dietetic substances for medical or veterinary purposes; dietary supplements for humans and animals; disinfectants.

(260) AM 2019 101855 A

(800) 1451449

(151) 2018 10 20

(891) 2018 10 20

(731) ANDRÉ GESKE

Mühlenkamp 11, 32312 Lübbecke, Germany

(540)



(591) Black, white

(531) 03.07.11; 03.07.16; 03.07.24; 27.05.09;  
27.05.10

(511)

10 – Vibrators, being adult sexual aids; adult sexual stimulation aids; electronic massaging devices; massaging apparatus for personal use.

35 – Online marketing; newsletter marketing; direct marketing; marketing via newsletters; marketing studies; presentation of businesses and goods on the internet; computerized file management; wholesaling of goods in the erotic sector; retailing for goods in the erotic sector; mail order retail services for goods in the erotic sector; online retail services for goods in the erotic sector; retailing, wholesaling, including by means of mail order and online trading, of vibrators in the form of sexual aids for adults, stimulators in the form of sexual aids for adults, electric massage apparatus, massage apparatus for personal use; marketing services; market research and market analysis; mediation of trade business for third parties; sales demonstration [for others]; advertising in periodicals, brochures and newspapers; exhibition and presentation of goods for advertising purposes; sales promotion (for others); planning, arranging and conducting of measures for attracting customers and customer loyalty initiatives, in particular mailing, discount, voucher and/or reward schemes; commercial administration of the licensing of the goods and services of others; attracting customers and customer

care through mail order advertising (mail shots); arranging and conducting of advertising events; organization of exhibitions for commercial or advertising purposes; bill-posting; marketing planning and organizational services; presentation of companies on the internet and other media; shop window dressing; sponsorship in the form of advertising; dissemination of advertising matter; writing of publicity texts; sales promotion for others; direct mail advertising; arranging of displays for advertising purposes; arranging of demonstrations for advertising purposes; demonstration of goods for promotional purposes; preparation and presentation of audio visual displays for advertising purposes; arranging of exhibitions for advertising purposes; arranging of exhibitions for advertising purposes; organisation of trade fairs for commercial or advertising purposes; organisation of exhibitions and trade fairs for business and promotional purposes; planning and conducting of trade fairs, exhibitions and presentations for economic or advertising purposes; arranging the distribution of advertising samples; distribution of advertising material; dissemination of advertising matter online; dissemination of advertising matter by mail; market research for advertising; advertising analysis; arranging of demonstrations for advertising purposes; arranging of displays for commercial purposes; advisory services relating to sales promotion.

(260) AM 2019 101856 A

(800) 1451453

(151) 2019 01 09

(891) 2019 01 09

(731) ZHEJIANG SHUAIKANG ELECTRIC  
STOCK CO., LTD.

NO. 888, CHENGDONGNORTH ROAD,  
DITANG STREET, YUYAO CITY,  
NINGBO CITY, ZHEJIANG PROVINCE,  
China

(540)

## sacon

(591) Black, white

(511)

11 – Extraction fan; regulating and safety accessories for gas apparatus; friction lighters for igniting gas; boilers, other than parts of machines; gas boilers; heating boilers; extractor hoods for kitchens; air purifying apparatus and machines; thermostatic valve (parts of heating installations); water filtering apparatus; drinking water dispensers; cooking utensils, electric; oven for household purposes; electric appliances for making yogurt; disinfectant cupboards; processing apparatus for sewage; bread-making machines; cooking apparatus and installations; disinfectant apparatus; water sterilizers; water intake apparatus; air sterilizers; electric hot water bottle; hot air bath fittings; microwave ovens [cooking apparatus]; kitchen ranges [ovens]; floor drain; lighting

apparatus for vehicles; hearths; bath installations; gas lamps; heaters for washing (gas or electric for heating); lighting apparatus and installations; brackets for gas burners; sinks; refrigerators; gas burners; coffee machines, electric; heaters for baths; ventilation [air-conditioning] installations and apparatus; solar water heater; cooling appliances and installations; bathroom heat lamp fixture; taps / faucets; bath fittings; germicidal lamps for purifying air; hot plates; water distribution installations; multicookers; air-conditioning installations; refrigerating apparatus and machines; heating installations [water]; electric hair drier; sanitary apparatus and installations; water softening apparatus and installations; water purifying apparatus and machines; kettles, electric; radiators, electric; gas-scrubbing apparatus; drying apparatus and installations; water magnetizer.

(260) AM 2019 101857 A  
 (800) 1451569  
 (151) 2018 10 30  
 (891) 2018 10 30  
 (731) SOPRO BAUCHEMIE GMBH  
 Biebricher Straße 74, 65203 Wiesbaden,  
 Germany  
 (540)

## F20

(591) Black, white  
 (511)

1 – Chemicals used in industry; impregnating chemical preparations; adhesives used in industry, in particular made of synthetic resins; chemicals used in industry, being additives for building materials; chemicals used in industry, being additives for screed, concrete and mortar; liquid plastics, unprocessed, included in this class; preservatives for building materials (except for organic substances); refining agents for concrete, mortar and screed, included in this class, in particular for preventing the drying out of concrete and mortar, for screeds and finished concrete parts, for enhancing the resistance of cement screeds to impact, wear, frost and chemical stress, for increasing imperviousness against liquids and gases as well as for controlling the working consistency; unprocessed artificial resins; surface-active agents (tensides); damp proofing preparations for brickwork, except paints; horticulture chemicals; antifreeze; chemical additives for use in industrial cleaning processes for removing and cleaning joint compounds; solvents for paints, varnishes and lacquers; silicones.

17 – Rubber, gutta-percha, gum, asbestos, mica; goods made of plastics as semi-finished products; artificial and synthetic resins (semi-finished products); resins (semi-finished products) for fabricating adhesives; cast resins (semi-finished products) including silica sand; sealing materials; packing ma-

terials; insulating materials; sealing tapes (terms considered too vague by the International Bureau – rule 13 (2) (b) of the Common Regulations); sealing collars; rubber gloves for insulating purposes, not for household purposes; joint fillers (sealant compounds for joints); insulating coatings (paints) and insulating lacquers; insulating paints; self-adhesive tapes, other than stationery and not for medical or household purposes; insulating coatings; soundproofing materials; filling material as insulating, damping and sealing materials; fibreglass insulation materials for building purposes; fibreglass fabrics for building insulation.

19 – Building materials (non-metallic), in particular with damping and insulating properties; building materials (non-metallic), namely hydraulic binding agents in particular cement, lime, gypsum and as additives for binding and hardening concrete, mortar and stony-type building materials; building materials (non-metallic), namely hydraulic binding agents and mixtures composed thereof containing aggregates, pozzolanic materials (concrete admixtures) and/or chemical substances (concrete admixtures); mortar (building material); plaster (building material); screeds (building material); reinforcing fabrics (non-metallic) for building purposes; contact sludges (non-metallic) for building purposes; building materials, non-metallic, in the form of filling materials for building purposes for preparing surfaces made of concrete, mortar and other stony-type building materials; silica sand for building purposes; bitumen; bituminous products for building; pipes, not of metal, for building purposes; concrete; concrete building elements; roof coverings, not of metal; bituminous coatings for roofing (except for sealing and insulating purposes); windows, not of metal; felts for building; gravel; sand for building purposes; prefabricated swimming pools (not of metal); prefabricated chimneys, not of metal; floor tiles, not of metal; tile floorings, not of metal; binding material for road repair; road coating materials; bituminous coatings for roofing, for sealing and insulating purposes.

(260) AM 2019 101858 A  
 (800) 1451589  
 (151) 2018 12 25  
 (891) 2018 12 25  
 (731) SHANDONG HONGSHENG RUBBER  
 TECHNOLOGY CO., LTD.  
 EAST OF SHENGLI ROAD, WEST OF  
 XINGGONG ROAD, DAWANG TOWN,  
 GUANGRAO COUNTY, DONGYING CITY  
 257335, 250014 SHANDONG PROVINCE,  
 China  
 (540)

# IceMax

(591) Black, white  
 (531) 27.05.01; 27.05.10  
 (511)

12 – Non-skid devices for vehicle tires; casings for pneumatic tires [tyres]; pneumatic tires; automobile tires; safety seats for children, for vehicles; treads for retreading tires; tubeless tires for bicycles; tires for vehicle wheels; aircraft tires; solid tires for vehicle wheels.

(260) AM 2019 101859 A  
 (800) 1451592

(151) 2018 11 19  
 (891) 2018 11 19

(731) M.NURİ ZÜLFÜKAR  
 Dünya Ticaret Merkezi, EGS Business Park,  
 Blokları B1 Blok K:16 D:465, Yeşilköy,  
 İstanbul, Turkey

(540)



(591) Gold, white, red  
 (531) 05.03.11; 05.03.15; 26.02.07; 27.07.01;  
 29.01.13

(511)

34 – Tobacco; smokers' articles: tobacco pipes, cigars, mouthpieces for cigarette holders, ashtrays for smokers, humidors, pocket machines for rolling cigarettes, books of cigarette papers, firestones; matches.

(260) AM 2019 101868 A  
 (800) 1451636

(151) 2018 12 13  
 (891) 2018 12 13

(731) Joint Stock Company "MELON FASHION GROUP"  
 10-aya Krasnoarmeyskaya, 22, Letter A,  
 premises 1-H, 6 floor, RU-190103 Saint  
 Petersburg, Russian Federation

(540)

*Larina*

(591) Black, white  
 (531) 05.05.20; 27.03.01; 27.03.11; 27.05.01

(511)

3 – Abrasives; amber [perfume]; descaling preparations for household purposes; antistatic preparations for household purposes; aromatics [essential oils]; air fragrancing preparations; cake flavorings [essential oils]; flavorings for beverages [essential oils]; food flavorings [essential oils]; breath freshening sprays; canned pressurized air for cleaning and dusting purposes; balms, other than for medical purposes; lip glosses; polishing stones; abrasive paper; emery paper; polishing paper; petroleum jelly for cosmetic purposes; shoe polish; cobblers' wax; cotton wool for cosmetic purposes; sachets for perfuming linen; drying agents for dishwashing machines; adhesives for cosmetic purposes; scented water; Javelle water; lavender water; toilet water; wax for parquet floors; floor wax; non-slipping wax for floors; depilatory wax; mustache wax; tailors' wax; creams for leather; polish for furniture and flooring; shoemakers' wax; polishing wax; massage gels, other than for medical purposes; heliotropine; dental bleaching gels; geraniol; make-up; deodorants for pets; deodorants for human beings or for animals; depilatory preparations; air fragrance reed diffusers; scented wood; perfumes; non-slipping liquids for floors; windshield cleaning liquids; greases for cosmetic purposes; volcanic ash for cleaning; perfumery; decorative transfers for cosmetic purposes; ionone [perfumery]; shaving stones [astringents]; smoothing stones; eyebrow pencils; cosmetic pencils; silicon carbide [abrasive]; carbides of metal [abrasives]; alum stones [astringents]; tripoli stone for polishing; adhesives for affixing false eyelashes; adhesives for affixing false hair; hair conditioners; quillaia bark for washing; corundum [abrasive]; beard dyes; colorants for toilet purposes; cosmetic dyes; laundry starch; laundry glaze; shoe cream; polishing creams; cosmetic creams; skin whitening creams; polishing rouge; incense; hair spray; nail polish; hair lotions; lotions for cosmetic purposes; after-shave lotions; beauty masks; oils for perfumes and scents; oils for cosmetic purposes; oils for toilet purposes; essential oils; essential oils of cedarwood; essential oils of lemon; essential oils of citron; oils for cleaning purposes; bergamot oil; gaultheria oil; jasmine oil; lavender oil; almond oil; rose oil; oil of turpentine for degreasing; whitening; cleaning chalk; almond milk for cosmetic purposes; cleansing milk for toilet purposes; musk [perfumery]; soap; deodorant soap; shaving soap; soap for brightening textile; cakes of toilet soap; antiperspirant soap; soap for foot perspiration; almond soap; mint for perfumery; cosmetic kits; emery; nail art stickers; false nails; eau de Cologne; bases for flower perfumes; joss sticks; pastes for razor strops; dentifrices; pumice stone; lipstick cases; hydrogen peroxide for cosmetic purposes; breath freshening strips; teeth whitening strips; abrasive cloth; glass cloth [abrasive cloth]; lipsticks; pomades for cosmetic purposes; shaving preparations;

cosmetic preparations for baths; bath preparations, not for medical purposes; hair straightening preparations; hair waving preparations; laundry soaking preparations; grinding preparations; smoothing preparations [starching]; color-removing preparations; leather bleaching preparations; polishing preparations; denture polishes; mouthwashes, not for medical purposes; cosmetic preparations for slimming purposes; starch glaze for laundry purposes; refurbishing preparations; eye-washes, not for medical purposes; fabric softeners for laundry use; laundry bleach; dry-cleaning preparations; paint stripping preparations; lacquer-removing preparations; make-up removing preparations; floor wax removers [scouring preparations]; varnish-removing preparations; rust removing preparations; nail care preparations; cleaning preparations; preparations for cleaning dentures; wallpaper cleaning preparations; preparations for unblocking drain pipes; chemical cleaning preparations for household purposes; collagen preparations for cosmetic purposes; bleaching preparations [decolorants] for household purposes; laundry preparations; aloe vera preparations for cosmetic purposes; sunscreen preparations; color-brightening chemicals for household purposes [laundry]; breath freshening preparations for personal hygiene; shining preparations [polish]; make-up powder; diamantine [abrasive]; stain removers; nail varnish removers; vaginal washes for personal sanitary or deodorant purposes; scouring solutions; false eyelashes; tissues impregnated with cosmetic lotions; tissues impregnated with make-up removing preparations; saffrol; massage candles for cosmetic purposes; laundry blueing; turpentine for degreasing; potpourris [fragrances]; bleaching soda; washing soda, for cleaning; bath salts, not for medical purposes; bleaching salts; fumigation preparations [perfumes]; preservatives for leather [polishes]; ammonia [volatile alkali] [detergent]; astringents for cosmetic purposes; eyebrow cosmetics; make-up preparations; sun-tanning preparations [cosmetics]; hair dyes; neutralizers for permanent waving; preparations to make the leaves of plants shiny; cosmetic preparations for eyelashes; cosmetic preparations for skin care; shoe wax; cosmetics; cosmetics for children; cosmetics for animals; mascara; cleansers for intimate personal hygiene purposes, non medicated; douching preparations for personal sanitary or deodorant purposes [toiletries]; detergents, other than for use in manufacturing operations and for medical purposes; degreasers, other than for use in manufacturing processes; bleaching preparations [decolorants] for cosmetic purposes; toiletry preparations; antiperspirants [toiletries]; phytocosmetic preparations; talcum powder, for toilet use; cotton sticks for cosmetic purposes; terpenes [essential oils]; emery cloth; cloths impregnated with a detergent for cleaning; henna [cosmetic dye]; shampoos; shampoos for animals [non-medicated grooming preparations]; shampoos for

pets [non-medicated grooming preparations]; dry shampoos; sandpaper; soda lye; herbal extracts for cosmetic purposes; extracts of flowers [perfumes]; ethereal essences; badian essence; mint essence [essential oil].

9 – 3D spectacles; DVD players; ticket dispensers; coin-operated musical automata [juke boxes]; fire engines; answering machines; electrical adapters; batteries for electronic cigarettes; accumulators, electric; accumulators, electric, for vehicles; accelerometers; actinometers; alidades; altimeters; ammeters; anemometers; anodes; antennas; anticathodes; apertometers [optics]; high-frequency apparatus; testing apparatus not for medical purposes; remote control apparatus; electro-dynamic apparatus for the remote control of railway points; electro-dynamic apparatus for the remote control of signals; monitoring apparatus, other than for medical purposes; sound recording apparatus; Global Positioning System [GPS] apparatus; distillation apparatus for scientific purposes; diffraction apparatus [microscopy]; air analysis apparatus; apparatus to check franking; sound transmitting apparatus; apparatus for fermentation [laboratory apparatus]; breathing apparatus for underwater swimming; breathing apparatus, except for artificial respiration; apparatus and installations for the production of X-rays, not for medical purposes; cash registers; electric apparatus for commutation; magnetic resonance imaging [MRI] apparatus, not for medical purposes; intercommunication apparatus; stills for laboratory experiments; projection apparatus; fire extinguishing apparatus; radiological apparatus for industrial purposes; X-ray apparatus not for medical purposes; blueprint apparatus; flashing lights [luminous signals]; stereoscopic apparatus; telephone apparatus; facsimile machines; phototelegraphy apparatus; igniting apparatus, electric, for igniting at a distance; acid hydrometers; salinometers; acidimeters for batteries; aerometers; beacons, luminous; battery jars; barometers; anode batteries; galvanic batteries; batteries for lighting; solar batteries; solar panels for the production of electricity; batteries, electric; balances [steelyards]; betatrons; binoculars; biochips; electronic tags for goods; lens hoods; magnetic tape units for computers; computer memory devices; fire hose nozzles; encoded identification bracelets, magnetic; connected bracelets [measuring instruments]; safety tarpaulins; electronic key fobs being remote control apparatus; bullet-proof clothing; signalling buoys; life buoys; marking buoys; directional compasses; vacuum gauges; electrolyzers; variometers; verniers; scales; baby scales; bathroom scales; letter scales; weighbridges; precision balances; scales with body mass analysers; levelling staffs [surveying instruments]; camcorders; video baby monitors; video cassettes; video telephones; video screens; viewfinders, photographic; plugs, sockets and other contacts [electric connections]; micrometer screws for optical instruments; viscosi-

meters; circuit closers; wavemeters; voltmeters; mechanical signs; signs, luminous; switchboxes [electricity]; current rectifiers; gas testing instruments; gasometers [measuring instruments]; galvanometers; hands-free kits for telephones; heliographic apparatus; hygrometers; hydrometers; weights; peepholes [magnifying lenses] for doors; holograms; plotters; sounding leads; plumb bobs; range finders; densimeters; densitometers; detectors; smoke detectors; infrared detectors; counterfeit coin detectors; joysticks for use with computers, other than for video games; transparencies [photography]; slide projectors; diaphragms [photography]; dictating machines; dynamometers; light-emitting diodes [LED]; floppy disks; sound recording discs; disks, magnetic; optical discs; circular slide rules; disk drives for computers; juke boxes for computers; wearable video display monitors; electronic numeric displays; DNA chips; electronic interactive whiteboards; electronic notice boards; electric wire harnesses for automobiles; bullet-proof waistcoats; life jackets; reflective safety vests; identification threads for electric wires; nose clips for divers and swimmers; locks, electric; bells [warning devices]; alarm bells, electric; electric door bells; signal bells; audio interfaces; acoustic conduits; mirrors for inspecting work; road signs, luminous or mechanical; marine depth finders; probes for scientific purposes; buzzers; needles for surveying compasses; needles for record players; eyewear; reflective articles for wear, for the prevention of accidents; measures; pressure measuring apparatus; simulators for the steering and control of vehicles; inverters [electricity]; pressure indicators; temperature indicators; incubators for bacteria culture; measuring instruments; cosmographic instruments; mathematical instruments; levelling instruments; instruments containing eyepieces; surveying instruments; azimuth instruments; interfaces for computers; ionization apparatus not for the treatment of air or water; satellite finder meters; spark-guards; coaxial cables; fiber optic cables; cables, electric; calipers; slide calipers; screw-tapping gauges; calorimeters; calculating machines; pocket calculators; decompression chambers; rearview cameras for vehicles; cinematographic cameras; thermal imaging cameras; mouth guards for sports; life-saving capsules for natural disasters; electronic pens [visual display units]; holders for electric coils; identity cards, magnetic; video game cartridges; toner cartridges, unfilled, for printers and photocopiers; memory cards for video game machines; encoded magnetic cards; riding helmets; protective helmets; carriers for dark plates [photography]; automated teller machines [ATM]; cathodes; spools [photography]; choking coils [impedance]; coils, electric; electromagnetic coils; cinematographic film, exposed; computer keyboards; solenoid valves [electromagnetic switches]; wire connectors [electricity]; thin client computers; encoded key cards; electronic book readers; electronic agendas;

push buttons for bells; mouse pads; magnetic encoders; visors for helmets; collectors, electric; calibrating rings; smart rings; ring sizers; protective suits for aviators; commutators; compact discs [audio-video]; compact discs [read-only memory]; comparators; marine compasses; computers; laptop computers; tablet computers; notebook computers; wearable computers; condensers [capacitors]; contacts, electric; wind socks for indicating wind direction; traffic cones; branch boxes [electricity]; distribution boxes [electricity]; junction boxes [electricity]; connectors [electricity]; battery boxes; cabinets for loudspeakers; diving suits; galena crystals [detectors]; covers for electric outlets; logs [measuring instruments]; lasers, not for medical purposes; lactodensimeters; lactometers; vacuum tubes [radio]; darkroom lamps [photography]; thermionic tubes; amplifying tubes; flashlights [photography]; head cleaning tapes [recording]; magnetic tapes; videotapes; surveying chains; fire escapes; rulers [measuring instruments]; square rulers for measuring; slide-rules; contact lenses; correcting lenses [optics]; optical lenses; optical condensers; sounding lines; electricity conduits; measuring spoons; magnifying glasses [optics]; thread counters; magnets; decorative magnets; close-up lenses; crash test dummies; resuscitation mannequins [teaching apparatus]; mouse [computer peripheral]; pressure gauges; security tokens [encryption devices]; divers' masks; solderers' helmets; protective masks; respiratory masks, other than for artificial respiration; materials for electricity mains [wires, cables]; voting machines; money counting and sorting machines; material testing instruments and machines; furniture especially made for laboratories; megaphones; portable media players; diaphragms [acoustics]; diaphragms for scientific apparatus; metal detectors for industrial or military purposes; digital weather stations; metronomes; rules [measuring instruments]; carpenters' rules; dressmakers' measures; mechanisms for coin-operated apparatus; mechanisms for counter-operated apparatus; coin-operated mechanisms for television sets; shutter releases [photography]; micrometers; microprocessors; microscopes; microtomes; microphones; audio mixers; modems; lightning rods; monitors [computer hardware]; monitors [computer programs]; selfie sticks [hand-held monopods]; terminals [electricity]; junction sleeves for electric cables; teeth protectors; temperature indicator labels, not for medical purposes; knee-pads for workers; headphones; surveyors' levels; sound recording carriers; magnetic data media; optical data media; electronic sheet music, downloadable; computer software, recorded; sheaths for electric cables; identification sheaths for electric wires; weighing machines; computer hardware; punched card machines for offices; life saving apparatus and equipment; shoes for protection against accidents, irradiation and fire; objectives [lenses] [optics]; lenses for astrophotography; selfie lenses; egg-candlers;

fire extinguishers; rescue laser signalling flares; electrified fences; limiters [electricity]; clothing for protection against accidents, irradiation and fire; clothing for protection against fire; asbestos clothing for protection against fire; clothing especially made for laboratories; ozonisers [ozonators]; octants; eyepieces; ohmmeters; wrist rests for use with computers; eyeglass frames; oscillographs; plumb lines; mirrors [optics]; eyeglasses; sunglasses; goggles for sports; electronic collars to train animals; finger sizers; signalling panels, luminous or mechanical; radio pagers; pince-nez; electronic pocket translators; transmitters [telecommunication]; telephone transmitters; transmitters of electronic signals; switches, electric; periscopes; gloves for divers; gloves for protection against accidents; gloves for protection against X-rays for industrial purposes; asbestos gloves for protection against accidents; furnaces for laboratory use; pipettes; pyrometers; planimeters; plane tables [surveying instruments]; plates for batteries; computer software platforms, recorded or downloadable; wafers for integrated circuits; printed circuit boards; compact disc players; cassette players; protective films adapted for computer screens; protective films adapted for smartphones; sound recording strips; X-ray films, exposed; films, exposed; life-saving rafts; laboratory trays; digital signs; semi-conductors; polarimeters; personal digital assistants [PDAs]; fire pumps; measuring glassware; life belts; fuses; circuit breakers; converters, electric; telerupters; food analysis apparatus; diagnostic apparatus, not for medical purposes; distance recording apparatus; distance measuring apparatus; speed measuring apparatus [photography]; appliances for measuring the thickness of leather; apparatus for measuring the thickness of skins; speed checking apparatus for vehicles; teaching apparatus; time recording apparatus; apparatus and instruments for astronomy; surveying apparatus and instruments; weighing apparatus and instruments; nautical apparatus and instruments; navigational instruments; optical apparatus and instruments; apparatus and instruments for physics; chemistry apparatus and instruments; measuring apparatus; measuring devices, electric; boiler control instruments; meteorological instruments; naval signalling apparatus; observation instruments; navigation apparatus for vehicles [on-board computers]; satellite navigational apparatus; regulating apparatus, electric; telecommunication apparatus in the form of jewellery; precision measuring apparatus; audio- and video-receivers; prisms [optics]; computer software applications, downloadable; printers for use with computers; hemline markers; retorts' stands; apparatus for changing record player needles; drainers for use in photography; cleaning apparatus for sound recording discs; fire beaters; telescopic sights for firearms; telescopic sights for artillery; test tubes; pressure indicator plugs for valves; magnetic wires; telegraph wires; telephone wires; wires, elec-

tric; conductors, electric; copper wire, insulated; fuse wire; computer programs, recorded; computer game software; computer programs [downloadable software]; computer operating programs, recorded; computer screen saver software, recorded or downloadable; record players; processors [central processing units]; rods for water diviners; electronic publications, downloadable; distribution consoles [electricity]; control panels [electricity]; radar apparatus; masts for wireless aerials; transmitting sets [telecommunication]; radios; vehicle radios; sprinkler systems for fire protection; frames for photographic transparencies; screens for photoengraving; flowmeters; walkie-talkies; voltage surge protectors; voltage regulators for vehicles; stage lighting regulators; light dimmers [regulators], electric; speed regulators for record players; cell switches [electricity]; washing trays [photography]; marking gauges [joinery]; T-squares for measuring; time switches, automatic; relays, electric; safety restraints, other than for vehicle seats and sports equipment; X-ray photographs, other than for medical purposes; rheostats; respirators for filtering air; retorts; refractometers; refractors; grids for batteries; security surveillance robots; laboratory robots; teaching robots; humanoid robots with artificial intelligence; speaking tubes; horns for loudspeakers; subwoofers; saccharometers; optical fibers [light conducting filaments]; traffic-light apparatus [signalling devices]; dog whistles; signalling whistles; sports whistles; sextants; inductors [electricity]; safety nets; nets for protection against accidents; fire alarms; signals, luminous or mechanical; sirens; electronic access control systems for interlocking doors; scanners [data processing equipment]; hand-held electronic dictionaries; integrated circuit cards [smart cards]; smartglasses; smartphones; smartwatches; connections for electric lines; couplings, electric; sonars; sound locating instruments; lighting ballasts; resistances, electric; spectrograph apparatus; spectroscopes; speed indicators; alcoholmeters; satellites for scientific purposes; protection devices for personal use against accidents; audiovisual teaching apparatus; charging stations for electric vehicles; radiotelegraphy sets; radiotelephony sets; spectacle lenses; anti-glare glasses; optical glass; personal stereos; stereoscopes; stands for photographic apparatus; stroboscopes; fire boats; sulfimeters; bags adapted for laptops; drying racks [photography]; spherometers; integrated circuits; printed circuits; counters; parking meters; kilometer recorders for vehicles; revolution counters; abacuses; egg timers [sandglasses]; taximeters; ear plugs for divers; tachometers; television apparatus; telegraphs [apparatus]; telescopes; teleprompters; teleprinters; cordless telephones; cellular phones; theodolites; interactive touch screen terminals; thermo-hygrometers; thermometers, not for medical purposes; thermostats; thermostats for vehicles; crucibles [laboratory]; tone arms for record players; totalizers; tran-

sistors [electronic]; transponders; protractors [measuring instruments]; transformers [electricity]; step-up transformers; resuscitation training simulators; vehicle breakdown warning triangles; triodes; starter cables for motors; discharge tubes, electric, other than for lighting; capillary tubes; neon signs; Pitot tubes; X-ray tubes not for medical purposes; telephone receivers; squares for measuring; gauges; quantity indicators; automatic indicators of low pressure in vehicle tires; gasoline gauges; water level indicators; electric loss indicators; light-emitting electronic pointers; slope indicators; levels [instruments for determining the horizontal]; mercury levels; spirit levels; urinometers; amplifiers; particle accelerators; electric installations for the remote control of industrial operations; baby monitors; steering apparatus, automatic, for vehicles; balancing apparatus; video recorders; sound reproduction apparatus; invoicing machines; tape recorders; protection devices against X-rays, not for medical purposes; railway traffic safety appliances; data processing apparatus; oxygen transvasing apparatus; theft prevention installations, electric; film cutting apparatus; drying apparatus for photographic prints; optical character readers; centering apparatus for photographic transparencies; dosage dispensers; battery chargers; chargers for electric batteries; chargers for electronic cigarettes; acoustic alarms; sounding apparatus and machines; apparatus for editing cinematographic film; cathodic anti-corrosion apparatus; couplers [data processing equipment]; wearable activity trackers; anti-theft warning apparatus; computer peripheral devices; anti-interference devices [electricity]; demagnetizing apparatus for magnetic tapes; acoustic couplers; alarms; fog signals, non-explosive; whistle alarms; adding machines; readers [data processing equipment]; heat regulating apparatus; photocopiers [photographic, electrostatic, thermic]; electric and electronic effects units for musical instruments; bar code readers; downloadable ring tones for mobile phones; downloadable image files; downloadable music files; animated cartoons; filters [photography]; filters for respiratory masks; filters for ultraviolet rays, for photography; USB flash drives; magic lanterns; optical lamps; signal lanterns; cameras [photography]; glazing apparatus for photographic prints; shutters [photography]; darkrooms [photography]; photometers; flash-bulbs [photography]; digital photo frames; enlarging apparatus [photography]; photovoltaic cells; containers for contact lenses; eyeglass cases; containers for microscope slides; cases for smartphones; cases especially made for photographic apparatus and instruments; chromatography apparatus for laboratory use; chronographs [time recording apparatus]; laboratory centrifuges; eyeglass chains; cyclotrons; compasses for measuring; frequency meters; time clocks [time recording devices]; Petri dishes; sleeves for laptops; covers for personal digital assistants [PDAs]; covers for tablet computers; covers for

smartphones; fire blankets; chips [integrated circuits]; jigs [measuring instruments]; pedometers; meteorological balloons; electrified rails for mounting spot lights; asbestos screens for firemen; fire hose; virtual reality headsets; protective helmets for sports; head guards for sports; snorkels; cell phone straps; eyeglass cords; tripods for cameras; switchboards; distribution boards [electricity]; equalizers [audio apparatus]; screens [photography]; workmen's protective face-shields; projection screens; radiology screens for industrial purposes; fluorescent screens; exposure meters [light meters]; ducts [electricity]; galvanic cells; downloadable graphics for mobile phones; epidiascopes; ergometers; armatures [electricity]; black boxes [data recorders].

14 – Agates; diamonds; amulets [jewelry]; anchors [clock- and watchmaking]; barrels [clock- and watchmaking]; bracelets [jewelry]; bracelets made of embroidered textile [jewellery]; watch bands; charms for key rings; jewellery charms; brooches [jewelry]; alarm clocks; pins [jewelry]; ornamental pins; tie pins; beads for making jewelry; pearls made of ambroid [pressed amber]; busts of precious metal; jewelry rolls; jet, unwrought or semi-wrought; jewelry findings; key rings [split rings with trinket or decorative fob]; pearls [jewelry]; copper tokens; tie clips; cufflinks; clasps for jewelry; badges of precious metal; gold, unwrought or beaten; cloisonné jewelry; works of art of precious metal; jewelry; ivory jewelry; jewelry of yellow amber; iridium; cabochons; precious stones; semi-precious stones; spun silver [silver wire]; necklaces [jewelry]; split rings of precious metal for keys; rings [jewelry]; boxes of precious metal; presentation boxes for jewelry; watch cases [parts of watches]; clock cases; pendulums [clock- and watchmaking]; medals; locket [jewelry]; precious metals, unwrought or semi-wrought; movements for clocks and watches; clockworks; misbaha [prayer beads]; coins; gold thread [jewelry]; threads of precious metal [jewelry]; silver thread [jewelry]; olivine [gems]; osmium; palladium; platinum [metal]; chronometric instruments; watch springs; crucifixes of precious metal, other than jewelry; crucifixes as jewelry; rhodium; ruthenium; stopwatches; silver, unwrought or beaten; earrings; ingots of precious metals; alloys of precious metal; statues of precious metal; figurines [statuettes] of precious metal; watch glasses; paste jewelry [costume jewelry]; watch hands; clock hands; ornaments of jet; shoe jewelry; hat jewelry; presentation boxes for watches; chronographs [watches]; chronometers; chronoscopes; chains [jewelry]; watch chains; dials [clock- and watchmaking]; atomic clocks; watches; sundials; clocks and watches, electric; control clocks [master clocks]; clocks; wristwatches; jewelry boxes; spinel [precious stones].

16 – Fountain pens; aquarelles; albums; almanacs; document laminators for office use; mimeograph



apparatus and machines; atlases; posters; banknotes; banners of paper; paper bows, other than haberdashery or hair decorations; table linen of paper; tickets; forms, printed; announcement cards [stationery]; note books; pads [stationery]; drawing pads; loose-leaf binders; wristbands for the retention of writing instruments; pamphlets; booklets; paper; paper sheets [stationery]; waxed paper; paper for medical examination tables; paper for recording machines; paper for radiograms; papers for painting and calligraphy; electrocardiograph paper; drawer liners of paper, perfumed or not; wood pulp paper; carbon paper; copying paper [stationery]; parchment paper; writing paper; rice paper; luminous paper; toilet paper; wrapping paper; filter paper; blotters; newsletters; rollers for typewriters; house painters' rollers; composing sticks; modelling wax, not for dental purposes; signboards of paper or cardboard; sewing patterns; bunting of paper; newspapers; electrotypes; hectographs; modelling clay; polymer modelling clay; terrestrial globes; drawing sets; engravings; slate pencils; pencil leads; document holders [stationery]; pencil holders; chalk holders; holders for cheque books; holders for stamps [seals]; page holders; name badge holders [office requisites]; diagrams; table runners of paper; engraving plates; writing slates; blackboards; galley racks [printing]; drawing boards; advertisement boards of paper or cardboard; duplicators; punches [office requisites]; cream containers of paper; magazines [periodicals]; money clips; clips for name badge holders [office requisites]; tags for index cards; pen clips; bookmarkers; etching needles; tracing needles for drawing purposes; periodicals; printed publications; paper shredders for office use; graphic representations; credit card imprinters, non-electric; graining combs; drawing instruments; calendars; tracing paper; tracing cloth; tracing patterns; gums [adhesives] for stationery or household purposes; lithographic stones; ink stones [ink reservoirs]; pencils; pencil lead holders; charcoal pencils; pictures; paintings [pictures], framed or unframed; cardboard; wood pulp board [stationery]; hat boxes of cardboard; cards; index cards [stationery]; geographical maps; paper tapes and cards for the recordal of computer programmes; trading cards, other than for games; perforated cards for Jacquard looms; catalogues; spools for inking ribbons; covers of paper for flower pots; paintbrushes; painters' brushes; writing brushes; typewriter keys; glue for stationery or household purposes; isinglass for stationery or household purposes; gluten [glue] for stationery or household purposes; starch paste [adhesive] for stationery or household purposes; printing blocks; books; manifolds [stationery]; comic books; drawing pins; cigar bands; envelopes [stationery]; boxes of paper or cardboard; cases for stamps [seals]; paint boxes [articles for use in school]; correcting fluids [office requisites]; printed coupons; stencils [stationery]; french curves; paper rib

bons, other than haberdashery or hair decorations; typewriter ribbons; adhesive bands for stationery or household purposes; gummed tape [stationery]; correcting tapes [office requisites]; inking ribbons; inking ribbons for computer printers; adhesive tapes for stationery or household purposes; self-adhesive tapes for stationery or household purposes; square rulers for drawing; drawing rulers; flyers; absorbent sheets of paper or plastic for foodstuff packaging; humidity control sheets of paper or plastic for foodstuff packaging; viscose sheets for wrapping; sheets of reclaimed cellulose for wrapping; plastic bubble packs for wrapping or packaging; steel letters; type [numerals and letters]; lithographs; paint trays; architects' models; postage stamps; plastics for modelling; graphic prints; modelling materials; teaching materials [except apparatus]; sealing compounds for stationery purposes; adhesives [glues] for stationery or household purposes; stuffing of paper or cardboard; bookbinding material; packaging material made of starches; packing [cushioning, stuffing] materials of paper or cardboard; filtering materials [paper]; tablemats of paper; addressing machines; pencil sharpening machines, electric or non-electric; bookbinding apparatus and machines [office equipment]; typewriters, electric or non-electric; paper creasers [office requisites]; franking machines for office use; chalk for lithography; writing chalk; tailors' chalk; marking chalk; spray chalk; bags [envelopes, pouches] of paper or plastics, for packaging; garbage bags of paper or of plastics; plastic bags for pet waste disposal; painters' easels; hand-rests for painters; printing sets, portable [office requisites]; bibs of paper; bibs, sleeved, of paper; stickers [stationery]; finger-stalls [office requisites]; writing cases [stationery]; cords for bookbinding; paper knives [letter openers]; printed sheet music; numbering apparatus; bottle envelopes of paper or cardboard; sealing wafers; covers [stationery]; passport holders; plastic cling film, extensible, for palletization; embroidery designs [patterns]; handwriting specimens for copying; oleographs; musical greeting cards; greeting cards; postcards; etchings; conical paper bags; paper bags for use in the sterilization of medical instruments; bags for microwave cooking; palettes for painters; ink sticks; pantographs [drawing instruments]; files [office requisites]; folders for papers; papier mâché; pastels [crayons]; modelling paste; pen cases; pen wipers; office perforators; pens [office requisites]; nibs of gold; nibs; steel pens; drawing pens; song books; seals [stamps]; sealing stamps; clipboards; address plates for addressing machines; handkerchiefs of paper; plastic film for wrapping; desk mats; letter trays; trays for sorting and counting money; coasters of paper; bookends; stamp stands; mats for beer glasses; stands for pens and pencils; photograph stands; obliterating stamps; inking pads; stamp pads; binding strips [bookbinding]; towels of paper; inking sheets for document

reproducing machines; inking sheets for duplicators; bookbinding cloth; gummed cloth for stationery purposes; printers' blankets, not of textile; portraits; paperweights; writing cases [sets]; inkstands; office requisites, except furniture; writing materials; writing instruments; drawing materials; school supplies [stationery]; adhesive tape dispensers [office requisites]; hand labelling appliances; printed matter; lithographic works of art; prospectuses; printed timetables; ledgers [books]; printers' galleys; indexes; paper cutters [office requisites]; rubber erasers; elastic bands for offices; T-squares for drawing; graphic reproductions; retractable reels for name badge holders [office requisites]; marking pens [stationery]; penholders; tissues of paper for removing make-up; dental tray covers of paper; face towels of paper; place mats of paper; table napkins of paper; tablecloths of paper; paper clasps; document files [stationery]; scrapers [erasers] for offices; paper-clips; staples for offices; erasing products; biological samples for use in microscopy [teaching materials]; histological sections for teaching purposes; steatite [tailor's chalk]; writing board erasers; composing frames [printing]; sealing wax; arithmetical tables; placards of paper or cardboard; writing or drawing books; fabrics for bookbinding; stationery; pencil sharpeners, electric or non-electric; transparencies [stationery]; stencil plates; cardboard tubes; Indian inks; moisteners for gummed surfaces [office requisites]; moisteners [office requisites]; squares for drawing; chart pointers, non-electronic; bottle wrappers of paper or cardboard; envelope sealing machines for offices; sealing machines for offices; vignetting apparatus; apparatus for mounting photographs; stapling presses [office requisites]; manuals [handbooks]; figurines [statuettes] of papier mâché; paper coffee filters; flags of paper; silver paper; molds for modelling clays [artists' materials]; photo-engravings; photographs [printed]; stencil cases; canvas for painting; chromolithographs [chromos]; animation cels; compasses for drawing; numbers [type]; artists' watercolor saucers; ink; correcting ink [helio-graphy]; inkwells; blueprints; stencils; erasing shields; balls for ball-point pens; cabinets for stationery [office requisites]; printing type; address stamps; stamps [seals]; shields [paper seals]; prints [engravings]; labels of paper or cardboard.

18 – Mountaineering sticks; slings for carrying infants; luggage tags; pocket wallets; saddlecloths for horses; business card cases; reins; reins for guiding children; sling bags for carrying infants; harness fittings; credit card cases [wallets]; parts of rubber for stirrups; chamois leather, other than for cleaning purposes; umbrellas; parasols; saddlery; frames for umbrellas or parasols; handbag frames; card cases [notecases]; cases of leather or leatherboard; valves of leather; whips; imitation leather; leather, unworked or semi-worked; leatherboard; casings, of leather, for springs; umbrella rings; hat boxes of leather;

Boxes of leather or leatherboard; boxes of vulcanized fiber; purses; chain mesh purses; fastenings for saddles; butts [parts of hides]; saddle trees; bags [envelopes, pouches] of leather, for packaging; moleskin [imitation of leather]; travelling sets [leatherware]; knee-pads for horses; muzzles; halters; vanity cases, not fitted; leather thread; furniture coverings of leather; clothing for pets; covers for animals; trimmings of leather for furniture; collars for animals; hiking sticks; conference folders; music cases; goldbeaters' skin; cat o' nine tails; leather leashes; pads for horse saddles; horseshoes; girths of leather; horse blankets; garment bags for travel; shoulder belts [straps] of leather; briefcases; traces [harness]; fur; randsels [Japanese school satchels]; haversacks; leather straps; straps for soldiers' equipment; harness straps; straps for skates; straps of leather [saddlery]; chin straps, of leather; stirrup leathers; umbrella handles; walking stick handles; suitcase handles; grips for holding shopping bags; rucksacks; travelling bags; riding saddles; net bags for shopping; umbrella or parasol ribs; stirrups; bags; bags for climbers; tool bags, empty; handbags; beach bags; saddlebags; compression cubes adapted for luggage; bags for sports; bags for campers; shopping bags; wheeled shopping bags; school satchels; pouch baby carriers; travelling trunks; nose bags [feed bags]; bridoons; walking sticks; umbrella sticks; walking stick seats; tefillin [phylacteries]; bits for animals [harness]; bridles [harness]; harness for animals; key cases; horse collars; suitcases; trunks [luggage]; motorized suitcases; suitcases with wheels; valises; attaché cases; covers for horse saddles; umbrella covers; kid; curried skins; animal skins; cattle skins; leather laces; blinkers [harness]; labels of leather; game bags [hunting accessories].

25 – Wimples; bandanas [neckerchiefs]; underwear; sweat-absorbent underwear; berets; overalls; boas [necklets]; teddies [underclothing]; boxer shorts; ankle boots; ski boots; boots for sports; breeches for wear; trousers; football boots; brassieres; valenki [felted boots]; collars [clothing]; detachable collars; shirt yokes; veils [clothing]; gabardines [clothing]; galoshes; neckties; ascots; leggings [leg warmers]; gaiters; boot uppers; corselets; jerseys [clothing]; vests; sports jerseys; hosiery; heels; hoods [clothing]; hat frames [skeletons]; pockets for clothing; neck scarfs [mufflers]; kimonos; visors [headwear]; cap peaks; tights; slips [underclothing]; wet suits for water-skiing; combinations [clothing]; bodices [lingerie]; corsets [underclothing]; suits; bathing suits; masquerade costumes; beach clothes; leotards; jackets [clothing]; stuff jackets [clothing]; fishing vests; leggings [trousers]; liveries; camisoles; sports singlets; cuffs; short-sleeve shirts; mantillas; coats; sleep masks; furs [clothing]; mittens; miters [hats]; muffs [clothing]; footmuffs, not electrically heated; heel-pieces for footwear; bibs, not of paper; bibs, sleeved, not of paper; fur stoles; hairdressing capes; ear muffs

[clothing]; socks; sweat-absorbent socks; footwear; beach shoes; sports shoes; clothing; paper clothing; outerclothing; ready-made clothing; motorists' clothing; cyclists' clothing; clothing for gymnastics; clothing of imitations of leather; clothing of leather; waterproof clothing; uniforms; fittings of metal for footwear; maniples; overcoats; panties; parkas; pel-rines; gloves [clothing]; ski gloves; pajamas; bathing trunks; shirt fronts; scarfs; pocket squares; dresses; headbands [clothing]; garters; sock suspenders; stocking suspenders; ready-made linings [parts of clothing]; dress shields; soles for footwear; braces for clothing [suspenders]; half-boots; lace boots; ponchos; girdles; belts [clothing]; money belts [clothing]; layettes [clothing]; non-slipping devices for footwear; heelpieces for stockings; welts for footwear; chasubles; shirts; wooden shoes; sandals; bath sandals; boots; jumper dresses; saris; sarongs; sweaters; footwear uppers; inner soles; albs; bath slippers; togas; knitwear [clothing]; underpants; shoes; gymnastic shoes; slippers; skull caps; turbans; headgear for wear; aprons [clothing]; judo uniforms; karate uniforms; tee-shirts; dressing gowns; bath robes; top hats; tips for footwear; stockings; sweat-absorbent stockings; shawls; caps [headwear]; paper hats [clothing]; shower caps; bathing caps; sashes for wear; studs for football boots; hats; babies' pants [underwear]; trouser straps; pelisses; esparto shoes or sandals; skirts; petticoats; skorts.

35 – Arranging subscriptions to telecommunication services for others; import-export agency services; commercial information agency services; advertising agency services; cost price analysis; rental of advertising space; business auditing; financial auditing; business intermediary services relating to the matching of potential private investors with entrepreneurs needing funding; employment agency services; computerized file management; book-keeping; invoicing; demonstration of goods; transcription of communications [office functions]; opinion polling; market studies; business information; commercial information and advice for consumers in the choice of products and services; business investigations; business research; marketing research; personnel recruitment; business management and organization consultancy; business organization consultancy; business management consultancy; personnel management consultancy; professional business consultancy; consultancy regarding advertising communication strategies; consultancy regarding public relations communication strategies; layout services for advertising purposes; marketing; marketing in the framework of software publishing; targeted marketing; business management of performing artists; business management of sports people; writing of résumés for others; scriptwriting for advertising purposes; news clipping services; updating and maintenance of information in registries; updating and maintenance of data in computer databases; updating of advertising materi-

al; word processing; online retail services for downloadable and pre-recorded music and movies; online retail services for downloadable ring tones; online retail services for downloadable digital music; organization of exhibitions for commercial or advertising purposes; arranging newspaper subscriptions for others; organization of fashion shows for promotional purposes; organization of trade fairs for commercial or advertising purposes; shop window dressing; design of advertising materials; business appraisals; payroll preparation; data search in computer files for others; sponsorship search; administrative assistance in responding to calls for tenders; business management assistance; commercial or industrial management assistance; commercial intermediation services; providing business information via a web site; provision of commercial and business contact information; provision of an on-line marketplace for buyers and sellers of goods and services; web indexing for commercial or advertising purposes; presentation of goods on communication media, for retail purposes; economic forecasting; auctioneering; retail services for works of art provided by art galleries; sales promotion for others; promotion of goods and services through sponsorship of sports events; production of teleshopping programmes; production of advertising films; office machines and equipment rental; rental of advertising time on communication media; publicity material rental; rental of signs for advertising purposes; rental of vending machines; rental of sales stands; rental of photocopying machines; publication of publicity texts; radio advertising; bill-posting; distribution of samples; dissemination of advertising matter; direct mail advertising; registration of written communications and data; writing of publicity texts; advertising; on-line advertising on a computer network; advertising by mail order; television advertising; document reproduction; compilation of statistics; compilation of information into computer databases; business inquiries; systemization of information into computer databases; advisory services for business management; negotiation of business contracts for others; negotiation and conclusion of commercial transactions for third parties; compiling indexes of information for commercial or advertising purposes; tax preparation; drawing up of statements of accounts; telemarketing services; psychological testing for the selection of personnel; wholesale services for pharmaceutical, veterinary and sanitary preparations and medical supplies; retail services for pharmaceutical, veterinary and sanitary preparations and medical supplies; interim business management; outsourced administrative management for companies; business management of hotels; business management for freelance service providers; business project management services for construction projects; commercial administration of the licensing of the goods and services of others; business management of reimbursement pro-

grams for others; administration of consumer loyalty programs; administration of frequent flyer programs; administrative processing of purchase orders; public relations; competitive intelligence services; modeling for advertising or sales promotion; typing; market intelligence services; appointment reminder services [office functions]; web site traffic optimization; relocation services for businesses; tax filing services; search engine optimization for sales promotion; appointment scheduling services [office functions]; gift registry services; price comparison services; pay per click advertising; secretarial services; procurement services for others [purchasing goods and services for other businesses]; shorthand; outsourcing services [business assistance]; telephone answering for unavailable subscribers; photocopying services; business efficiency expert services.

(260) AM 2019 101869 A

(800) 1451645

(151) 2018 12 14

(891) 2018 12 14

(731) Obshchestvo s ogranichennoi otvetstvennostyu "VSK"

ul. 50-let Oktyabrya, 113, g. Dimitrovgrad,  
RU-433502 Ul'yanovskaya oblast, Russian  
Federation

(540)



(591) Yellow, brown, red

(531) 18.01.01; 19.01.01; 28.05; 29.01.13

(511)

32 – Aperitifs, non-alcoholic; waters [beverages]; beer; kvass [non-alcoholic beverage]; cocktails, non-alcoholic; beer-based cocktails; lemonades; non-alcoholic beverages; isotonic beverages; non-alcoholic honey-based beverages; whey beverages; non-alcoholic fruit juice beverages; fruit nectars, non-alcoholic; orgeat; syrups for lemonade; powders for effervescing beverages; sarsaparilla [non-alcoholic beverage]; syrups for beverages; tomato juice [beverage]; cider, non-alcoholic; vegetable juices [beverages]; fruit juices; preparations for making aerated water; preparations for making liqueurs; preparations for making beverages; must; grape must, unfermented; beer wort; malt wort; pastilles for effervescing beverages; sherbets [beverages]; non-alcoholic fruit extracts; extracts of hops for making beer; essences for making beverages.

(260) AM 2019 101870 A

(800) 1451652

(151) 2018 08 24

(891) 2018 08 24

(731) SCHMIDT ANDREY PETROVICH

ul. Sennitskaya, d. 51, k. 13, 220007 Minsk,  
Belarus

(540)



**SCHMIDT**

(591) Gold

(531) 01.15.09; 14.07.01; 14.07.04; 27.05.10;

29.01.11

(526) Soft taste

(511)

33 – Aperitifs; brandy; wine; piquette; whisky; vodka; anisette [liqueur]; kirsch; gin; digesters [liqueurs and spirits]; cocktails [alcoholic beverages]; curacao; anise [liqueur]; liqueurs; alcoholic beverages, except beer; pre-mixed alcoholic beverages, other than beer-based; alcoholic beverages containing fruit; distilled beverages; spirits [beverages]; mead [hydromel]; peppermint liqueurs; bitters; nira [sugarcane-based alcoholic beverage]; rum; sake; cider; perry; rice alcohol; alcoholic extracts; fruit extracts, alcoholic; alcoholic essences.

(260) AM 2019 101871 A

(800) 1451664

(151) 2019 01 11

(891) 2019 01 11

(731) SHANDONG HUASHENG RUBBER CO.,  
LTD.

DAOZHUANG TOWN GOVERNMENT  
STATION, GUANGRAO COUNTY,  
DONGYING CITY, 257336 SHANDONG  
PROVINCE, China

(540)

**ROADBOSS**

(591) Black, white

(531) 27.05.01

(511)

12 – Tires for vehicle wheels; automobile tires; casings for pneumatic tires [tyres]; spikes for tires; repair outfits for inner tubes.

(260) AM 2019 101875 A

(800) 1451770

(151) 2018 12 14

(891) 2018 12 14

(731) MAR-KO FLEISCHWAREN GMBH & CO.  
KG  
Waldecker Str. 15, 99444 Blankenhain,  
Germany

(540)



(591) Black, white

(531) 25.03.03; 25.03.25; 27.05.10

(511)

29 – Meat, fish, poultry and game, including ham, all aforementioned goods also further processed into charcuterie, also in preserved form; meat products, meatballs, sausages, charcuterie, uncooked charcuterie, also to be stored unrefrigerated; long-life charcuterie; salami in various forms, in particular mini salami; snacks made from the aforementioned products; beef-based snack products; meat extracts.

30 – Ready-made pastry rolls and/or dumplings and/or pita bread, filled and/or topped with meat and/or charcuterie and/or ham and/or vegetables and/or sauces; ready-baked pastry rolls made of wheat flour dough filled with salami or salami-like sausage; snacks based on pasta products.

(260) AM 2019 101876 A

(800) 1451825

(151) 2019 01 02

(891) 2019 01 02

(731) ZHEJIANG AUARIT PNEUMATIC TOOLS  
L.L.C  
CHANGLE INDUSTRIAL ZONE,  
RUOHENG, WENLING CITY, ZHEJIANG,  
China

(540)

**Auarita**

(591) Black, white

(531) 27.05.01; 27.05.22

(511)

7 – Compressed air machines; pumps (machines); insecticide sprayers (machines); hand-held tools, other than hand-operated; spray guns for paint; valves (parts of machines); aerocondensers; engines, other than for land vehicles; dynamos.

(260) AM 2019 101877 A

(800) 1451828

(151) 2018 12 27

(891) 2018 12 27

(731) BIONORICA SE  
Kerschensteinerstrasse 11-15, 92318  
Neumarkt, Germany

(540)

**Bronxipret**

(591) Black, white

(511)

5 – Pharmaceuticals; medicine; dietetic preparations and food supplements; nutritional supplements for humans; nutritional supplements for animals; medicinal preparations; veterinary preparations.

(260) AM 2019 101878 A

(800) 1451844

(151) 2018 12 31

(891) 2018 12 31

(731) HUAWEI TECHNOLOGIES CO., LTD  
Administration Building Huawei,  
Technologies Co., Ltd., Bantian, Longgang  
District, Shenzhen, China

(540)

**HWA**

(591) Black, white

(531) 27.05.01; 27.05.22; 27.05.23

(511)

9 – Notebook computers; tablet computers; laptop computers; computer programs (downloadable software); smartphones; cameras; wearable activity trackers; smartwatches; television apparatus; virtual reality headsets; downloadable computer software applications; earphones; electronic book readers; audio and video receivers; sound reproduction apparatus; sound transmitting apparatus; headphones; portable media players; wireless loudspeakers; stereo apparatus for vehicles; cabinets for loudspeakers; computer programs for editing images, sounds and videos; computer programs for video and computer games; encoding and decoding apparatus; computer software for controlling the operation of audio and video devices; central processing units for processing information, data, sounds or images; computer software for organizing and viewing digital images and photographs; software for processing images, graphics and texts; software for controlling and improving sound quality of stereo apparatus; computer software for processing digital images; computer software for creating and editing music and sounds; set-top boxes; learning machines; audio loudspeakers for vehicles; digital sound processors; portable sound reproduction apparatus; MP4 players; audio transmitters.

(260) AM 2019 101879 A

(800) 1451856

(151) 2019 01 02

(891) 2019 01 02

(731) ZHEJIANG UNIVIEW TECHNOLOGIES CO., LTD.  
2/F, AREA B, BUILDING 2, 1-3/F, AREA A, BUILDING 2 AND 1-11/F, SOUTH TOWER, BUILDING 10, NO.88, JIANGLING ROAD, XIXING STREET, BINJIANG DISTRICT, HANGZHOU, ZHEJIANG, China

(540)

uniarch

(591) Black, white

(531) 26.11.01; 26.11.12; 27.05.01

(511)

9 – 3d spectacles; led monitors; protection devices for personal use against accidents; switchboards; sensors; diaphragms [photography]; optical data media; optical lenses; intercommunication apparatus; printed circuit boards; video baby monitors; electric installations for the remote control of industrial operations; computer operating programs, recorded; computer programs, recorded; tablet computers; slides [photography]; video recorders; microprocessors; shutters [photography]; camcorders; enlarging apparatus [photography]; data processing apparatus; quantity indicators; smartphones; smartglasses; speed measuring apparatus [photography]; filters [photography]; fire-extinguishing apparatus; shutter releases [photography]; cameras [photography]; phototelegraphy apparatus; transmitters of electronic signals; theft prevention installations, electric; electrified fences; materials for electricity mains [wires, cables]; television cameras; television apparatus; monitors [computer hardware]; monitors [computer programs]; magnetic data media; magnetic encoders; disks, magnetic; equipment for communication network; weighing machines; video screens; video monitors; computers; computer peripheral devices; computer memory devices; disk drives for computers; computer programs [downloadable software]; computer software, recorded; couplers [data processing equipment]; remote control apparatus; measures; blinkers [signalling lights]; flash-bulbs [photography]; flashlights [photography]; closed circuit television cameras; integrated circuit cards [smart cards]; audio- and video-receivers; central processing units [processors].

35 – Presentation of goods on communication media, for retail purposes; personnel recruitment; relocation services for businesses; business auditing; sponsorship search; advertising; sales promotion for others; organization of exhibitions for commercial or advertising purposes; retail services for pharmaceutical, veterinary and sanitary preparations and medical supplies; systemization of information into computer databases; on-line advertising on a computer network.

37 – Heating equipment installation and repair; upholstery; construction consultancy; interference suppression in electrical apparatus; fire alarm installation and repair; repair of cameras; electric appliance installation and repair; laying of cable; repair or maintenance of video machine; installation, maintenance and repair of computer hardware; burglar alarm installation and repair.

(260) AM 2019 101892 A

(800) 1133845

(151) 2012 06 11

(891) 2019 01 08

(731) SUNNY CARS GMBH

Paul-Gerhardt-Allee 42, 81245 München, Germany

(540)



(591) Yellow and green

(531) 26.01.02; 26.01.20; 29.01.12

(511)

39 – Rental and providing of vehicles, in particular automobiles; travel arrangement; booking of travel through tourist offices; vehicle leasing (rental and hire) in particular for automobiles.

(260) AM 2019 101944 A

(800) 1452231

(151) 2018 10 23

(891) 2018 10 23

(731) CERRAD Spółka z ograniczoną,

Odpowiedzialnością  
ul. Radomska 49b, PL-27-200 Strachowice,  
Poland

(540)



(591) Orange, black and white

(531) 05.03.13; 05.03.14; 26.04.03; 27.05.01;  
29.01.13

(511)

19 – Ceramic tiles, glazed tiles, terracotta, clinker floor tiles, elevation tiles, stair tiles, sill tiles.

(260) AM 2019 101947 A

(800) 1452298

(151) 2018 11 19

(891) 2018 11 19

(731) NESTLÉ SKIN HEALTH SA  
Avenue Gratta Paille 2, CH-1018 Lausanne,  
Switzerland

(540)  
**NUTRADERM**

(591) Black, white  
(531) 27.05.01  
(511)  
3 – Cosmetic preparations for skin, hair and nail care.

5 – Dietary supplements for human beings.

10 – Medical device.

44 – Hygienic and beauty care for human beings.

(260) AM 2019 101949 A  
(800) 1452312  
(151) 2018 12 18  
(891) 2018 12 18  
(731) SWISS PHARMA INTERNATIONAL AG  
Waldmannstrasse 8, CH-8001 Zürich,  
Switzerland

(540)



(591) Dark blue (Pantone 2747 C) and light blue  
(Pantone 278 C)  
(531) 26.01.12; 26.02.01; 26.02.07; 27.05.01;  
29.01.04  
(511)  
3 – Soaps; perfumery, essential oils, cosmetics, hair  
lotions; dentifrices; all the aforesaid goods of Polish  
origin.

(260) AM 2019 101965 A  
(800) 1452501  
(151) 2018 11 19  
(891) 2018 11 19  
(731) RICHTER GEDEON NYRT.  
Gyömrői út 19-21, H-1103 Budapest, Hungary

(540)  
**REMITRIN**

(591) Black, white  
(511)  
5 – Pharmaceutical preparations.

(260) AM 2019 101966 A  
(800) 1452503  
(151) 2018 12 03  
(891) 2018 12 03

(731) RICHTER GEDEON NYRT.  
Gyömrői út 19-21, H-1103 Budapest, Hungary

(540)  
**Миллента**

(591) Black, white  
(531) 28.05  
(511)  
5 – Pharmaceutical preparations.

(260) AM 2019 101967 A  
(800) 1452505  
(151) 2018 12 03  
(891) 2018 12 03  
(731) RICHTER GEDEON NYRT.  
Gyömrői út 19-21, H-1103 Budapest, Hungary

(540)  
**Реминтер**

(591) Black, white  
(531) 28.05  
(511)  
5 – Pharmaceutical preparations.

(260) AM 2019 101968 A  
(800) 1452510  
(151) 2018 07 17  
(891) 2018 07 17  
(731) UTAIR AVIATION  
Aeroport, Khanty-Mansiysk, Tumenskaya  
oblast, RU-628012 Khanty-Mansiyskiy  
avtonomniy okrug., Russian Federation

(540)



(591) Blue and light blue  
(531) 27.05.21; 29.01.04  
(511)  
9 – 3D spectacles; DVD players; ticket dispensers;  
coin-operated musical automata [juke boxes]; fire  
engines; answering machines; electrical adapters;  
batteries for electronic cigarettes; accumulators, el-  
ectric; accumulators, electric, for vehicles; accelero-  
meters; actinometers; alidades; altimeters; ammeters;  
anemometers; anodes; antennas; anticathodes; aper-  
tometers [optics]; high-frequency apparatus; testing  
apparatus not for medical purposes; remote control  
apparatus; electro-dynamic apparatus for the remote

control of railway points; electro-dynamic apparatus for the remote control of signals; monitoring apparatus, electric; sound recording apparatus; Global Positioning System [GPS] apparatus; distillation apparatus for scientific purposes; diffraction apparatus [microscopy]; air analysis apparatus; apparatus to check franking; sound transmitting apparatus; apparatus for fermentation [laboratory apparatus]; breathing apparatus for underwater swimming; breathing apparatus, except for artificial respiration; apparatus and installations for the production of X-rays, not for medical purposes; cash registers; electric apparatus for commutation; intercommunication apparatus; stills for laboratory experiments; projection apparatus; fire extinguishing apparatus; radiological apparatus for industrial purposes; X-ray apparatus not for medical purposes; blueprint apparatus; flashing lights [luminous signals]; stereoscopic apparatus; telephone apparatus; facsimile machines; phototelegraphy apparatus; igniting apparatus, electric, for igniting at a distance; acid hydrometers; salinometers; acidimeters for batteries; aerometers; battery jars; barometers; anode batteries; galvanic batteries; batteries for lighting; solar batteries; solar panels for the production of electricity; batteries, electric; balances [steelyards]; betatrons; binoculars; biochips; electronic tags for goods; lens hoods; magnetic tape units for computers; computer memory devices; fire hose nozzles; encoded identification bracelets, magnetic; connected bracelets [measuring instruments]; safety tarpaulins; electronic key fobs being remote control apparatus; bullet-proof clothing; beacons, luminous; signalling buoys; life buoys; marking buoys; vacuum gauges; electrolyzers; variometers; verniers; scales; baby scales; bathroom scales; letter scales; weighbridges; precision balances; scales with body mass analysers; levelling staffs [surveying instruments]; camcorders; video baby monitors; video cassettes; video telephones; video screens; viewfinders, photographic; sockets, plugs and other contacts [electric connections]; micrometer screws for optical instruments; viscosimeters; circuit closers; wavemeters; voltmeters; mechanical signs; signs, luminous; switchboxes [electricity]; current rectifiers; gas testing instruments; gasometers [measuring instruments]; galvanometers; hands-free kits for telephones; heliographic apparatus; hygrometers; hydrometers; weights; peepholes [magnifying lenses] for doors; holograms; plotters; sounding leads; plumb bobs; range finders; densimeters; optical goods; detectors; smoke detectors; infrared detectors; counterfeit [false] coin detectors; joysticks for use with computers, other than for video games; transparencies [photography]; slide projectors; diaphragms [photography]; dictating machines; dynamometers; light-emitting diodes [LED]; floppy disks; sound recording discs; optical discs; circular slide rules; disk drives for computers; juke boxes for computers;

DNA chips; electronic interactive whiteboards; electronic notice boards; bullet-proof waistcoats [vests (Am.)]; life jackets; reflective safety vests; identification threads for electric wires; nose clips for divers and swimmers; locks, electric; bells [warning devices]; alarm bells, electric; electric door bells; signal bells; audio interfaces; acoustic conduits; mirrors for inspecting work; road signs, luminous or mechanical; marine depth finders; probes for scientific purposes; buzzers; needles for surveying compasses; needles for record players; measures; pressure measuring apparatus; simulators for the steering and control of vehicles; inverters [electricity]; pressure indicators; temperature indicators; incubators for bacteria culture; measuring instruments; cosmographic instruments; mathematical instruments; levelling instruments; instruments containing eyepieces; surveying instruments; azimuth instruments; interfaces for computers; ionization apparatus not for the treatment of air or water; spark-guards; coaxial cables; fibre [fiber (Am.)] optic cables; cables, electric; calipers; slide calipers; screw-tapping gauges; calorimeters; calculating machines; pocket calculators; decompression chambers; cinematographic cameras; thermal imaging cameras; mouth guards for sports; life-saving capsules for natural disasters; electronic pens [visual display units]; holders for electric coils; identity cards, magnetic; video game cartridges; toner cartridges, unfilled, for printers and photocopiers; memory cards for video game machines; encoded magnetic cards; riding helmets; protective helmets; carriers for dark plates [photography]; automated teller machines [ATM]; cathodes; spools [photography]; choking coils [impedance]; coils, electric; electromagnetic coils; cinematographic film, exposed; computer keyboards; solenoid valves [electromagnetic switches]; wire connectors [electricity]; encoded key cards; electronic book readers; electronic agendas; push buttons for bells; mouse pads; magnetic encoders; anti-glare visors; collectors, electric; calibrating rings; smart rings; protective suits for aviators; commutators; compact discs [audio-video]; compact discs [read-only memory]; comparators; directional compasses; marine compasses; computers; laptop computers; tablet computers; notebook computers; condensers [capacitors]; contacts, electric; wind socks for indicating wind direction; traffic cones; branch boxes [electricity]; distribution boxes [electricity]; junction boxes [electricity]; battery boxes; cabinets for loudspeakers; diving suits; galena crystals [detectors]; reflecting discs for wear, for the prevention of traffic accidents; covers for electric outlets; logs [measuring instruments]; lasers, not for medical purposes; lactodensimeters; lactometers; vacuum tubes [radio]; darkroom lamps [photography]; thermionic tubes; amplifying tubes; flashlights [photography]; head cleaning tapes [recording]; magnetic tapes; videotapes; surveying chains; fire escapes; rulers [measuring instruments]; square



rulers for measuring; slide-rules; contact lenses; correcting lenses [optics]; close-up lenses; optical lenses; optical condensers; sounding lines; electricity conduits; measuring spoons; magnifying glasses [optics]; thread counters; magnets; decorative magnets; crash test dummies; resuscitation mannequins [teaching apparatus]; mouse [computer peripheral]; pressure gauges; security tokens [encryption devices]; divers' masks; solderers' helmets; protective masks; respiratory masks, other than for artificial respiration; materials for electricity mains [wires, cables]; voting machines; money counting and sorting machines; material testing instruments and machines; furniture especially made for laboratories; megaphones; portable media players; diaphragms [acoustics]; diaphragms for scientific apparatus; metal detectors for industrial or military purposes; digital weather stations; metronomes; rules [measuring instruments]; carpenters' rules; dressmakers' measures; mechanisms for coin-operated apparatus; mechanisms for counter-operated apparatus; coin-operated mechanisms for television sets; shutter releases [photography]; micrometers; microprocessors; microscopes; microtomes; microphones; audio mixers; modems; lightning conductors [rods]; monitors [computer hardware]; monitors [computer programs]; selfie sticks [hand-held monopods]; terminals [electricity]; junction sleeves for electric cables; teeth protectors; temperature indicator labels, not for medical purposes; knee-pads for workers; headphones; surveyors' levels; sound recording carriers; magnetic data media; optical data media; electronic sheet music, downloadable; computer software, recorded; sheaths for electric cables; identification sheaths for electric wires; weighing machines; computer hardware; punched card machines for offices; life saving apparatus and equipment; objectives [lenses] [optics]; lenses for astrophotography; egg-candlers; fire extinguishers; electrified fences; limiters [electricity]; clothing for protection against accidents, irradiation and fire; clothing for protection against fire; asbestos clothing for protection against fire; clothing especially made for laboratories; ozonisers [ozonators]; octants; eyepieces; ohmmeters; wrist rests for use with computers; eyeglass frames; oscillographs; plumb lines; mirrors [optics]; eyeglasses; sunglasses; goggles for sports; electronic collars to train animals; signalling panels, luminous or mechanical; radio pagers; pince-nez; electronic pocket translators; transmitters [telecommunication]; telephone transmitters; transmitters of electronic signals; switches, electric; periscopes; gloves for divers; gloves for protection against accidents; gloves for protection against X-rays for industrial purposes; asbestos gloves for protection against accidents; furnaces for laboratory use; pipettes; pyrometers; planimeters; plane tables [surveying instruments]; plates for batteries; wafers for integrated circuits; printed circuit boards; compact disc players; cassette players; protective films

adapted for computer screens; protective films adapted for smartphones; sound recording strips; X-ray films, exposed; films, exposed; life-saving rafts; laboratory trays; digital signs; semi-conductors; polarimeters; fire pumps; measuring glassware; life belts; fuses; circuit breakers; converters, electric; telerupters; food analysis apparatus; diagnostic apparatus, not for medical purposes; distance recording apparatus; distance measuring apparatus; speed measuring apparatus [photography]; appliances for measuring the thickness of leather; apparatus for measuring the thickness of skins; speed checking apparatus for vehicles; teaching apparatus; time recording apparatus; apparatus and instruments for astronomy; surveying apparatus and instruments; weighing apparatus and instruments; nautical apparatus and instruments; navigational instruments; optical apparatus and instruments; apparatus and instruments for physics; chemistry apparatus and instruments; measuring apparatus; measuring devices, electric; boiler control instruments; meteorological instruments; naval signalling apparatus; observation instruments; navigation apparatus for vehicles [on-board computers]; satellite navigational apparatus; regulating apparatus, electric; precision measuring apparatus; audio- and video-receivers; prisms [optics]; computer software applications, downloadable; printers for use with computers; retorts' stands; apparatus for changing record player needles; drainers for use in photography; cleaning apparatus for sound recording discs; fire beaters; telescopic sights for firearms; telescopic sights for artillery; test tubes; pressure indicator plugs for valves; magnetic wires; telegraph wires; telephone wires; wires, electric; conductors, electric; copper wire, insulated; fuse wire; computer programmes [programs], recorded; computer game software; computer programs [downloadable software]; computer operating programs, recorded; record players; processors [central processing units]; rods for water diviners; electronic publications, downloadable; distribution consoles [electricity]; control panels [electricity]; radar apparatus; baby monitors; masts for wireless aerials; transmitting sets [telecommunication]; radios; vehicle radios; sprinkler systems for fire protection; frames for photographic transparencies; screens for photoengraving; flowmeters; walkie-talkies; voltage surge protectors; voltage regulators for vehicles; stage lighting regulators; light dimmers [regulators], electric; speed regulators for record players; cell switches [electricity]; washing trays [photography]; marking gauges [joinery]; T-squares for measuring; time switches, automatic; relays, electric; safety restraints, other than for vehicle seats and sports equipment; X-ray photographs, other than for medical purposes; rheostats; respirators for filtering air; retorts; refractometers; refractors; grids for batteries; humanoid robots with artificial intelligence; speaking tubes; horns for loudspeakers; subwoofers; saccharometers; optical fibers

[fibres] [light conducting filaments]; traffic-light apparatus [signalling devices]; dog whistles; signalling whistles; sextants; inductors [electricity]; safety nets; nets for protection against accidents; fire alarms; signals, luminous or mechanical; sirens; electronic access control systems for interlocking doors; scanners [data processing equipment]; integrated circuit cards [smart cards]; smartglasses; smartphones; smartwatches; connections for electric lines; couplings, electric; sonars; sound locating instruments; lighting ballasts; resistances, electric; spectrograph apparatus; spectrometers; speed indicators; alcoholmeters; satellites for scientific purposes; protection devices for personal use against accidents; audiovisual teaching apparatus; charging stations for electric vehicles; radiotelegraphy sets; radiotelephony sets; spectacle lenses; anti-glare glasses; optical glass; personal stereos; stereoscopes; stands for photographic apparatus; stroboscopes; fire boats; sulfimeters; bags adapted for laptops; drying racks [photography]; spherometers; integrated circuits; printed circuits; counters; parking meters; kilometer recorders for vehicles; revolution counters; abacuses; egg timers [sandglasses]; taximeters; ear plugs for divers; tachometers; television apparatus; telegraphs [apparatus]; telescopes; teleprompters; teleprinters; cellular phones; cordless telephones; theodolites; interactive touch screen terminals; thermo-hygrometers; thermometers, not for medical purposes; thermostats; thermostats for vehicles; crucibles [laboratory]; tone arms for record players; totalizers; transistors [electronic]; transponders; protractors [measuring instruments]; transformers [electricity]; step-up transformers; vehicle breakdown warning triangles; triodes; starter cables for motors; discharge tubes, electric, other than for lighting; capillary tubes; neon signs; Pitot tubes; X-ray tubes not for medical purposes; telephone receivers; squares for measuring; gauges; quantity indicators; automatic indicators of low pressure in vehicle tires [tyres]; gasoline gauges; water level indicators; electric loss indicators; light-emitting electronic pointers; slope indicators; levels [instruments for determining the horizontal]; mercury levels; spirit levels; urinometers; amplifiers; particle accelerators; electric installations for the remote control of industrial operations; steering apparatus, automatic, for vehicles; balancing apparatus; video recorders; sound reproduction apparatus; invoicing machines; tape recorders; protection devices against X-rays, not for medical purposes; railway traffic safety appliances; data processing apparatus; oxygen transvasing apparatus; theft prevention installations, electric; film cutting apparatus; drying apparatus for photographic prints; optical character readers; centering apparatus for photographic transparencies; dosage dispensers; battery chargers; chargers for electric batteries; chargers for electronic cigarettes; acoustic alarms; sounding apparatus and machines; editing appliances for cinematographic films; catho-

dic anti-corrosion apparatus; couplers [data processing equipment]; wearable activity trackers; anti-theft warning apparatus; computer peripheral devices; anti-interference devices [electricity]; demagnetizing apparatus for magnetic tapes; acoustic couplers; alarms; fog signals, non-explosive; whistle alarms; adding machines; readers [data processing equipment]; heat regulating apparatus; photocopiers [photographic, electrostatic, thermic]; electric and electronic effects units for musical instruments; bar code readers; downloadable ring tones for mobile phones; downloadable image files; downloadable music files; animated cartoons; filters [photography]; filters for respiratory masks; filters for ultraviolet rays, for photography; USB flash drives; magic lanterns; optical lamps; signal lanterns; cameras [photography]; glazing apparatus for photographic prints; shutters [photography]; darkrooms [photography]; photometers; flash-bulbs [photography]; digital photo frames; enlarging apparatus [photography]; photovoltaic cells; containers for contact lenses; eyeglass cases; containers for microscope slides; cases for smartphones; cases especially made for photographic apparatus and instruments; chromatography apparatus for laboratory use; chronographs [time recording apparatus]; laboratory centrifuges; eyeglass chains; cyclotrons; compasses for measuring; frequency meters; time clocks [time recording devices]; petri dishes; sleeves for laptops; covers for personal digital assistants [PDAs]; covers for tablet computers; covers for smartphones; fire blankets; chips [integrated circuits]; jigs [measuring instruments]; pedometers; meteorological balloons; electrified rails for mounting spot lights; asbestos screens for firemen; fire hose; virtual reality headsets; protective helmets for sports; head guards for sports; cell phone straps; eyeglass cords; tripods for cameras; switchboards; distribution boards [electricity]; equalizers [audio apparatus]; screens [photography]; workmen's protective face-shields; projection screens; radiology screens for industrial purposes; fluorescent screens; exposure meters [light meters]; ducts [electricity]; galvanic cells; epidiascopes; ergometers; armatures [electricity]; black boxes [data recorders].

12 – Motor buses; motor coaches; motor homes; driverless cars [autonomous cars]; motor racing cars; cars; sports cars; concrete mixing vehicles; refrigerated vehicles; caravans; shock absorbers for automobiles; suspension shock absorbers for vehicles; space vehicles; aircraft; aeronautical apparatus, machines and appliances; air cushion vehicles; hot air balloons; ski carriers for cars; luggage carriers for vehicles; bumpers for automobiles; vehicle bumpers; tires for vehicle wheels; barges; brake shoes for vehicles; tailboard lifts [parts of land vehicles]; armored vehicles; buffers for railway rolling stock; wagons; tilt trucks; carriages [railways]; sleeping cars; dining cars; refrigerated wagons [railroad vehicles];

transmission shafts for land vehicles; bicycles; electric bicycles; valves for vehicle tires [tyres]; helicopters [vehicles]; automobile hoods; stroller hoods; hoods for vehicles; oars; paddles for canoes; sculls; screws [propellers] for ships; hydroplanes; seaplanes; flanges for railway wheel tires [tyres]; trucks; horns for vehicles; treads for vehicles [tractor type]; doors for vehicles; bicycle motors; motorcycle engines; engines for land vehicles; jet engines for land vehicles; driving motors for land vehicles; screw-propellers; screw-propellers for boats; dirigible balloons [airships]; brake discs for vehicles; telfer railways [cable cars]; dredgers [boats]; trolleys; military drones; civilian drones; adhesive rubber patches for repairing inner tubes; bicycle bells; rearview mirrors; side view mirrors for vehicles; portholes; cars for cable transport installations; inner tubes for pneumatic tires [tyres]; inner tubes for bicycle tires; canoes; hoods for vehicle engines; crankcases for land vehicle components, other than for engines; boats; caissons [vehicles]; bicycle wheels; vehicle wheels; mine cart wheels; steering wheels for vehicles; casters for trolleys [vehicles] [carts (Am.)]; brake pads for automobiles; hub caps; strollers; side cars; prams; brake linings for vehicles; ships; baskets adapted for bicycles; gear boxes for land vehicles; ship hulls; panniers adapted for bicycles; panniers adapted for motorcycles; fenders for ships; bands for wheel hubs; ejector seats for aircraft; wheelchairs; caps for vehicle petrol [gas] tanks; boat hooks; automobile bodies; tipping bodies for lorries [trucks]; bodies for vehicles; treads for retreading tires [tyres]; locomotives; masts for boats; golf carts [vehicles]; sprinkling trucks; propulsion mechanisms for land vehicles; mopeds; motor scooters; motorcycles; tyre mousse inserts; fitted footmuffs for pushchairs; fitted footmuffs for prams; freewheels for land vehicles; clutches for land vehicles; repair outfits for inner tubes; air pumps [vehicle accessories]; pumps for bicycle tires; upholstery for vehicles; rims for bicycle wheels; rims for vehicle wheels; windows for vehicles; omnibuses; engine mounts for land vehicles; axles for vehicles; headlight wipers; parachutes; ferry boats; bicycle pedals; ashtrays for automobiles; gearing for land vehicles; carts; headrests for vehicle seats; bicycle kickstands; vehicle running boards; air bags [safety devices for automobiles]; ski lifts; chairlifts; casings for pneumatic tires [tyres]; sleeping berths for vehicles; pontoons; torque converters for land vehicles; cigar lighters for automobiles; non-skid devices for vehicle tires [tyres]; anti-glare devices for vehicles; anti-theft devices for vehicles; sun-blinds adapted for automobiles; balance weights for vehicle wheels; shock absorbing springs for vehicles; bicycle frames; motorcycle frames; spars for ships; reduction gears for land vehicles; safety belts for vehicle seats; security harness for vehicle seats; vehicle suspension springs; rudders; bicycle handlebars; motorcycle handlebars; ve-

hicle joysticks; bicycle cranks; aeroplanes; amphibious airplanes; sleighs [vehicles]; kick sledges; brake segments for vehicles; bicycle saddles; luggage nets for vehicles; dress guards for bicycles; fitted stroller mosquito nets; anti-theft alarms for vehicles; reversing alarms for vehicles; safety seats for children, for vehicles; vehicle seats; bellows for articulated buses; hydraulic circuits for vehicles; push scooters [vehicles]; mobility scooters; snowmobiles; rolling stock for railways; rolling stock for funicular railways; spokes for bicycle wheels; vehicle wheel spokes; spoilers for vehicles; air vehicles; vehicles for locomotion by land, air, water or rail; ambulances; autonomous underwater vehicles for seabed inspections; water vehicles; remotely operated vehicles for underwater inspections; remote control vehicles, other than toys; electric vehicles; tricycles; delivery tricycles; inclined ways for boats; windscreens; windshield wipers; hubs for bicycle wheels; hubs for vehicle wheels; bags adapted for pushchairs; saddlebags adapted for bicycles; railway couplings; trailer hitches for vehicles; couplings for land vehicles; wheelbarrows; handling carts; two-wheeled trolleys; shopping trolleys [carts (Am.)]; hose carts; bogies for railway cars; casting carriages; tilting-carts; forklift trucks; cleaning trolleys; bicycle brakes; brakes for vehicles; torsion bars for vehicles; tractors; tractors; transmissions for land vehicles; military vehicles for transport; aerial conveyors; trailers [vehicles]; funnels for ships; funnels for locomotives; cleats [nautical]; turbines for land vehicles; direction indicators for bicycles; direction signals for vehicles; rowlocks; disengaging gear for boats; steering gears for ships; cable transport apparatus and installations; spoke clips for wheels; tipping apparatus, parts of trucks and waggons; funiculars; vans [vehicles]; automobile chains; bicycle chains; motorcycle chains; driving chains for land vehicles; anti-skid chains; transmission chains for land vehicles; structural parts for helicopters; structural parts for aircraft; undercarriages for vehicles; stroller covers; spare wheel covers; covers for vehicle steering wheels; saddle covers for bicycles; saddle covers for motorcycles; seat covers for vehicles; vehicle covers [shaped]; automobile chassis; vehicle chassis; connecting rods for land vehicles, other than parts of motors and engines; axle journals; gears for bicycles; tubeless tires for bicycles; bicycle tyres; automobile tires [tyres]; pneumatic tires; solid tires for vehicle wheels; spikes for tires; davits for boats; launches; timbers [frames] for ships; mudguards; bicycle mudguards; motors, electric, for land vehicles; yachts.

16 – Fountain pens; aquarelles; albums; almanacs; document laminators for office use; mimeograph apparatus and machines; atlases; posters; banknotes; banners of paper; paper bows; table linen of paper; tickets; forms, printed; announcement cards [stationery]; note books; pads [stationery]; drawing pads; loose-leaf binders; wristbands for the retention of

writing instruments; pamphlets; booklets; paper; paper sheets [stationery]; waxed paper; paper for recording machines; paper for radiograms; electrocardiograph paper; drawer liners of paper, perfumed or not; wood pulp paper; carbon paper; copying paper [stationery]; parchment paper; writing paper; rice paper; luminous paper; Xuan paper for Chinese painting and calligraphy; toilet paper; wrapping paper; filter paper; blotters; newsletters; rollers for typewriters; house painters' rollers; composing sticks; modelling wax, not for dental purposes; signboards of paper or cardboard; sewing patterns; bunting of paper; newspapers; electrotypes; hectographs; modelling clay; polymer modelling clay; terrestrial globes; drawing sets; engravings; slate pencils; pencil leads; document holders [stationery]; pencil holders; chalk holders; holders for checkbooks [cheque books]; holders for stamps [seals]; page holders; diagrams; table runners of paper; engraving plates; writing slates; blackboards; galley racks [printing]; drawing boards; advertisement boards of paper or cardboard; duplicators; punches [office requisites]; cream containers of paper; magazines [periodicals]; money clips; tags for index cards; pen clips; book-markers; etching needles; tracing needles for drawing purposes; periodicals; printed publications; paper shredders for office use; graphic representations; credit card imprinters, non-electric; graining combs; drawing instruments; calendars; tracing paper; tracing cloth; tracing patterns; gums [adhesives] for stationery or household purposes; lithographic stones; ink stones [ink reservoirs]; pencils; pencil lead holders; charcoal pencils; pictures; transfers [decalcomanias]; paintings [pictures], framed or unframed; cardboard; wood pulp board [stationery]; hat boxes of cardboard; files [office requisites]; cards; index cards [stationery]; geographical maps; paper tapes and cards for the recordal of computer programmes; trading cards, other than for games; perforated cards for Jacquard looms; catalogues; spools for inking ribbons; covers of paper for flower pots; paintbrushes; painters' brushes; writing brushes; typewriter keys; glue for stationery or household purposes; isinglass for stationery or household purposes; gluten [glue] for stationery or household purposes; starch paste [adhesive] for stationery or household purposes; printing blocks; books; manifolds [stationery]; comic books; drawing pins; cigar bands; envelopes [stationery]; boxes of paper or cardboard; cases for stamps [seals]; paint boxes [articles for use in school]; correcting fluids [office requisites]; printed coupons; stencils [stationery]; French curves; paper ribbons; typewriter ribbons; gummed tape [stationery]; adhesive bands for stationery or household purposes; correcting tapes [office requisites]; inking ribbons; inking ribbons for computer printers; adhesive tapes for stationery or household purposes; self-adhesive tapes for stationery or household purposes; square rulers for drawing; drawing rulers; flyers; ab-

sorbent sheets of paper or plastic for foodstuff packaging; humidity control sheets of paper or plastic for foodstuff packaging; viscose sheets for wrapping; sheets of reclaimed cellulose for wrapping; plastic bubble packs for wrapping or packaging; steel letters; type [numerals and letters]; lithographs; paint trays; architects' models; postage stamps; plastics for modelling; graphic prints; modelling materials; teaching materials [except apparatus]; sealing compounds for stationery purposes; adhesives [glues] for stationery or household purposes; stuffing of paper or cardboard; bookbinding material; packing [cushioning, stuffing] materials of paper or cardboard; packaging material made of starches; filtering materials [paper]; addressing machines; pencil sharpening machines, electric or non-electric; bookbinding apparatus and machines [office equipment]; typewriters, electric or non-electric; covers [stationery]; franking machines for office use; chalk for lithography; writing chalk; tailors' chalk; marking chalk; spray chalk; bags [envelopes, pouches] of paper or plastics, for packaging; garbage bags of paper or of plastics; plastic bags for pet waste disposal; painters' easels; hand-rests for painters; printing sets, portable [office requisites]; bibs of paper; stickers [stationery]; finger-stalls [office requisites]; writing cases [stationery]; cords for bookbinding; paper knives [cutters] [office requisites]; printed sheet music; numbering apparatus; bottle envelopes of paper or cardboard; sealing wafers; passport holders; plastic cling film, extensible, for palletization; embroidery designs [patterns]; handwriting specimens for copying; oleographs; musical greeting cards; greeting cards; postcards; etchings; conical paper bags; bags for microwave cooking; palettes for painters; ink sticks; pantographs [drawing instruments]; folders for papers; papier mâché; pastels [crayons]; modelling paste; pen cases; pen wipers; office perforators; pens [office requisites]; nibs of gold; nibs; steel pens; drawing pens; song books; seals [stamps]; sealing stamps; clipboards; address plates for addressing machines; handkerchiefs of paper; plastic film for wrapping; desk mats; letter trays; trays for sorting and counting money; coasters of paper; bookends; stamp stands; mats for beer glasses; stands for pens and pencils; photograph stands; obliterating stamps; inking pads; stamp pads; binding strips [bookbinding]; towels of paper; inking sheets for document reproducing machines; inking sheets for duplicators; bookbinding cloth; gummed cloth for stationery purposes; printers' blankets, not of textile; portraits; paperweights; writing cases [sets]; inkstands; office requisites, except furniture; writing materials; writing instruments; drawing materials; school supplies [stationery]; adhesive tape dispensers [office requisites]; hand labelling appliances; printed matter; lithographic works of art; prospectuses; printed timetables; ledgers [books]; printers' reglets; indexes; rubber erasers; elastic bands for of-

fices; T-squares for drawing; graphic reproductions; penholders; marking pens [stationery]; tissues of paper for removing make-up; face towels of paper; place mats of paper; tablemats of paper; tablecloths of paper; paper clasps; document files [stationery]; scrapers [erasers] for offices; paper-clips; staples for offices; erasing products; biological samples for use in microscopy [teaching materials]; histological sections for teaching purposes; steatite [tailor's chalk]; writing board erasers; composing frames [printing]; sealing wax; arithmetical tables; placards of paper or cardboard; writing or drawing books; fabrics for bookbinding; stationery; pencil sharpeners, electric or non-electric; transparencies [stationery]; stencil plates; cardboard tubes; Indian inks; moisteners [office requisites]; moisteners for gummed surfaces [office requisites]; squares for drawing; chart pointers, non-electronic; bottle wrappers of paper or cardboard; envelope sealing machines for offices; sealing machines for offices; vignetting apparatus; apparatus for mounting photographs; stapling presses [office requisites]; manuals [handbooks]; figurines [statuettes] of papier mâché; paper coffee filters; flags of paper; silver paper; molds for modelling clays [artists' materials]; photo-engravings; photographs [printed]; stencil cases; canvas for painting; chromolithographs [chromos]; compasses for drawing; numbers [type]; artists' watercolor saucers; ink; correcting ink [heliography]; inkwells; blueprints; stencils; erasing shields; balls for ballpoint pens; cabinets for stationery [office requisites]; printing type; address stamps; stamps [seals]; shields [paper seals]; prints [engravings]; labels of paper or cardboard.

25 – Wimples; bandanas [neckerchiefs]; underwear; sweat-absorbent underwear; berets; overalls; boas [necklets]; teddies [underclothing]; boxer shorts; ankle boots; ski boots; boots for sports; breeches for wear; trousers; football boots; brassieres; valenki [felted boots]; collars [clothing]; detachable collars; shirt yokes; veils [clothing]; gabardines [clothing]; galoshes; neckties; ascots; leggings [leg warmers]; gaiters; boot uppers; corselets; jerseys [clothing]; vests; sports jerseys; hosiery; heels; hoods [clothing]; hat frames [skeletons]; pockets for clothing; neck scarfs [mufflers]; kimonos; visors [headwear]; cap peaks; tights; slips [underclothing]; combinations [clothing]; wet suits for water-skiing; bodices [lingerie]; corsets [underclothing]; suits; bathing suits; masquerade costumes; beach clothes; leotards; jackets [clothing]; stuff jackets [clothing]; fishing vests; leggings [trousers]; liveries; camisoles; sports singlets; cuffs; short-sleeve shirts; mantillas; coats; sleep masks; furs [clothing]; mittens; miters [hats]; muffs [clothing]; footmuffs, not electrically heated; heelpieces for footwear; bibs, not of paper; fur stoles; hairdressing capes; ear muffs [clothing]; socks; sweat-absorbent socks; footwear; beach shoes; sports shoes; clothing; paper clothing; outerclothing;

ready-made clothing; motorists' clothing; cyclists' clothing; clothing for gymnastics; clothing of imitations of leather; clothing of leather; waterproof clothing; uniforms; fittings of metal for footwear; maniples; overcoats; panties; parkas; pelerines; gloves [clothing]; ski gloves; pajamas; bathing trunks; shirt fronts; scarfs; pocket squares; dresses; headbands [clothing]; garters; sock suspenders; stocking suspenders; ready-made linings [parts of clothing]; dress shields; soles for footwear; braces for clothing [suspenders]; half-boots; lace boots; pullovers; ponchos; girdles; belts [clothing]; money belts [clothing]; layettes [clothing]; non-slipping devices for footwear; heelpieces for stockings; welts for footwear; chasubles; shirts; wooden shoes; sandals; bath sandals; boots; jumper dresses; saris; sarongs; footwear uppers; inner soles; albs; bath slippers; togas; knitwear [clothing]; underpants; shoes; gymnastic shoes; slippers; skull caps; turbans; headgear for wear; aprons [clothing]; judo uniforms; karate uniforms; tee-shirts; dressing gowns; bath robes; top hats; tips for footwear; stockings; sweat-absorbent stockings; shawls; caps [headwear]; paper hats [clothing]; shower caps; bathing caps; sashes for wear; studs for football boots; hats; babies' pants [underwear]; trouser straps; pelisses; esparto shoes or sandals; skirts; petticoats.

35 – Arranging subscriptions to telecommunication services for others; import-export agency services; commercial information agency services; advertising agency services; cost price analysis; rental of advertising space; business auditing; business intermediary services relating to the matching of potential private investors with entrepreneurs needing funding; employment agency services; computerized file management; book-keeping; invoicing; demonstration of goods; transcription of communications [office functions]; opinion polling; market studies; business information; business investigations; business research; marketing research; personnel recruitment; business management and organization consultancy; business organization consultancy; business management consultancy; personnel management consultancy; professional business consultancy; layout services for advertising purposes; marketing; business management of performing artists; business management of sports people; writing of résumés for others; scriptwriting for advertising purposes; news clipping services; updating and maintenance of information in registries; updating and maintenance of data in computer databases; updating of advertising material; word processing; organization of exhibitions for commercial or advertising purposes; arranging newspaper subscriptions for others; organization of fashion shows for promotional purposes; organization of trade fairs for commercial or advertising purposes; shop window dressing; design of advertising materials; business appraisals; payroll preparation; data search in computer

files for others; sponsorship search; business management assistance; commercial or industrial management assistance; commercial intermediation services; providing business information via a web site; provision of commercial and business contact information; provision of an on-line marketplace for buyers and sellers of goods and services; web indexing for commercial or advertising purposes; presentation of goods on communication media, for retail purposes; economic forecasting; auctioneering; retail or wholesale services for pharmaceutical, veterinary and sanitary preparations and medical supplies; sales promotion for others; production of teleshopping programmes; production of advertising films; office machines and equipment rental; rental of advertising time on communication media; publicity material rental; rental of billboards [advertising boards]; rental of vending machines; rental of sales stands; rental of photocopying machines; publication of publicity texts; radio advertising; distribution of samples; dissemination of advertising matter; direct mail advertising; registration of written communications and data; writing of publicity texts; advertising; publicity; on-line advertising on a computer network; billposting; advertising by mail order; television advertising; document reproduction; compilation of statistics; compilation of information into computer databases; business inquiries; systemization of information into computer databases; advisory services for business management; negotiation of business contracts for others; negotiation and conclusion of commercial transactions for third parties; compiling indexes of information for commercial or advertising purposes; tax preparation; drawing up of statements of accounts; telemarketing services; psychological testing for the selection of personnel; outsourced administrative management for companies; business management of hotels; business management for freelance service providers; business project management services for construction projects; commercial administration of the licensing of the goods and services of others; business management of reimbursement programs for others; administration of consumer loyalty programs; administration of frequent flyer programs; administrative processing of purchase orders; public relations; services of retail and wholesale outlets; retail and wholesale services via Internet web-sites; appointment reminder services [office functions]; web site traffic optimization; relocation services for businesses; tax filing services; search engine optimization for sales promotion; appointment scheduling services [office functions]; price comparison services; pay per click advertising; secretarial services; procurement services for others [purchasing goods and services for other businesses]; shorthand; outsourcing services [business assistance]; telephone answering for unavailable subscribers; photocopying services; business efficiency expert services.

36 – Credit bureau services; debt collection agency services; real estate agency services; financial analysis; rental of apartments; rental of real estate; rental of offices [real estate]; rental of offices for co-working; rental of farms; lease-purchase financing; savings bank services; accommodation bureau services [apartments]; rent collection; issuance of travelers' checks; issuance of credit cards; issuance of tokens of value; capital investment; insurance information; financial information; clearing, financial; insurance consultancy; financial consultancy; debt advisory services; stock exchange quotations; lending against security; business liquidation services, financial; brokerage; financial management; exchanging money; online banking; processing of debit card payments; processing of credit card payments; factoring; organization of collections; arranging finance for construction projects; antique appraisal; jewelry appraisal; financial evaluation of standing timber; stamp appraisal; real estate appraisal; numismatic appraisal; art appraisal; financial evaluation of wool; financial evaluation [insurance, banking, real estate]; repair costs evaluation [financial appraisal]; electronic funds transfer; surety services; securities brokerage; real estate brokerage; brokerage of carbon credits; insurance brokerage; providing rebates at participating establishments of others through use of a membership card; loans [financing]; pawnbrokerage; providing financial information via a web site; check verification; investment of funds; charitable fund raising; stocks and bonds brokerage; financial sponsorship; mortgage banking; instalment loans; insurance underwriting; life insurance underwriting; health insurance underwriting; accident insurance underwriting; marine insurance underwriting; fire insurance underwriting; apartment house management; real estate management; financial management of reimbursement payments for others; actuarial services; banking; stock brokerage services; retirement payment services; bail-bonding; trusteeship; provident fund services; financial customs brokerage services; mutual funds; financing services; safe deposit services; deposits of valuables; fiscal valuation.

39 – Air transport; aircraft rental; booking of seats for travel; delivery of newspapers; message delivery; parcel delivery; delivery of goods; delivery of goods by mail order; traffic information; transportation information; transportation logistics; arranging of travel tours; removal services; transport of travellers; passenger transport; providing driving directions for travel purposes; rental of aircraft engines; stevedoring; unloading cargo; escorting of travellers; transport; transport services for sightseeing tours.

(260) AM 2019 101969 A  
 (800) 1452515  
 (151) 2018 11 19  
 (891) 2018 11 19

(731) RICHTER GEDEON NYRT.  
Gyömrői út 19-21, H-1103 Budapest, Hungary  
(540)

**VULLINA**

(591) Black, white  
(511)  
5 – Pharmaceutical preparations.

---

(260) AM 2019 101970 A  
(800) 1452516  
(151) 2018 12 03  
(891) 2018 12 03  
(731) RICHTER GEDEON NYRT.  
Gyömrői út 19-21, H-1103 Budapest, Hungary  
(540)

**Ремитрин**

(591) Black, white  
(531) 28.05  
(511)  
5 – Pharmaceutical preparations.

---

(260) AM 2019 101971 A  
(800) 1452533  
(151) 2018 08 28  
(891) 2018 08 28  
(731) WIZZ AIR HUNGARY LTD.  
Kőér u. 2/A. B. ép. II-V, H-1103 Budapest,  
Hungary  
(540)

**WIZ**

(591) Black, white  
(531) 27.05.23  
(511)  
10 – Ear plugs.

16 – Paper and paper products; pens; pencils; stationery; gift stationery; colouring books; colouring pencils; pastels [crayons]; printed gift vouchers, not encoded; magazines [periodicals]; inflight magazines; printed periodicals in the field of tourism; printed advertisements; brochures, printed matter.

18 – Baggage, travel baggage.

20 – Cushions; inflatable pillows; neck support cushions, for medical purposes; inflatable neck support cushions.

24 – Lap blankets; travelling rugs [lap robes]; bed blankets.

25 – Clothing; footwear; headgear; sports headgear [other than helmets]; sports clothing; sports footwear; sleep masks.

28 – Toys; toy aircraft; inflatable toys resembling air vehicles; toy dolls; toys, games, playthings and novelties; sporting articles and equipment.

35 – Retail services in relation to toiletries; retail services relating to jewellery; retail services in relation to toys; retail services in relation to watches; retail services in relation to electronic devices; loyalty scheme services; management of customer loyalty, incentive or promotional schemes; advertising; magazine advertising; providing advertising space in periodicals, newspapers and magazines; online advertising; preparing advertisements for others; dissemination of advertising matter.

36 – Financial consultancy in the field of contributory benefit scheme services; bail bonding services; issuance of coupons of value; issuance of electronic payment cards in connection with bonus and reward schemes; issuance of vouchers; issuance of travel vouchers; issuance of tokens of value in the nature of gift vouchers; issuance of payment gift vouchers; provision of loans; instalment loans; financing of personal loans.

39 – Airline services; transport; transport of passengers; transport of goods; travel arrangements; travel booking agency services; organising of travel tours; operating of travel tours; airline transport; priority boarding, check-in, seating and reservation services for frequent air travellers; booking of air tickets; airline bookings; airline ticket services; booking of airport parking; booking and arranging of access to airport lounges; car parking; car parking [valet] services; vehicle parking and storage; car rental; rental of car parking spaces; providing information relating to car rental services.

41 – Entertainment; magazine publishing; publication of electronic magazines; training; pilot and cabin crew training; training services provided via simulators.

43 – Food and drink catering; temporary accommodation; hotel reservations; hotel information; hotel services; booking of hotel accommodation; hotels, hostels and boarding houses, holiday and tourist accommodation.

---

(260) AM 2019 101972 A  
(800) 1452601  
(151) 2018 11 23  
(891) 2018 11 23  
(731) AVON PRODUCTS, INC.  
601 Midland Avenue, Rye New York 10580,  
USA  
(540)

**SUPERSONIC**

(591) Black, white  
(511)  
3 – Non-medicated soaps; perfumery; essential oils; non-medicated cosmetics; non-medicated hair lotions.

(260) AM 2019 101973 A  
 (800) 1452609  
 (151) 2018 07 25  
 (891) 2018 07 25  
 (731) SAUDI CERAMICS COMPANY  
 King Fahd Road, Olaya Quarter, 12213  
 RIYADH, Saudi Arabia  
 (540)



(591) Black, white  
 (531) 01.15.15; 27.03.12; 27.05.21  
 (511)  
 11 – Apparatus for lighting, heating, steam generating, cooking, refrigerating, drying, ventilating, water supply and sanitary purposes.

(260) AM 2019 101974 A  
 (800) 1452628  
 (151) 2018 11 19  
 (891) 2018 11 19  
 (731) RICHTER GEDEON NYRT.  
 Gyömrői út 19-21, H-1103 Budapest, Hungary  
 (540)

**PYDIOLA**

(591) Black, white  
 (511)  
 5 – Pharmaceutical preparations.

(260) AM 2019 101975 A  
 (800) 1452640  
 (151) 2019 01 29  
 (891) 2019 01 29  
 (731) SIFI SPA  
 Via Ercole Patti, 36, Fraz. Lavinaio, I-95025  
 ACI SANT'ANTONIO, Italy  
 (540)

**AVS RETINA**

(591) Black, white  
 (511)  
 5 – Dietary supplements and dietetic preparations.

(260) AM 2019 101976 A  
 (800) 1452698  
 (151) 2018 10 15  
 (891) 2018 10 15

(731) THE CANDY PLUS SWEET FACTORY,  
 S.R.O.  
 Vítězná 200/6, CZ-696 01 Rohatec, Czech  
 Republic  
 (540)

*That's*  
**FRUTÉE**

(591) Black, white  
 (531) 05.03.11; 05.03.13; 05.03.15; 05.07.11;  
 05.07.22; 27.05.19  
 (526)  
 (511) 30 – Jelly beans (confectionery), gelatin-based  
 chewy candies, fruit gums (other than for medical  
 use).

(260) AM 2019 101977 A  
 (800) 1452730  
 (151) 2018 08 22  
 (891) 2018 08 22  
 (731) BERARDI BULLONERIE S.R.L.  
 Via San Carlo, 1 – Loc. Poggio Piccolo,  
 I-40023 CASTEL GUELFO DI BOLOGNA  
 (Bologna), Italy  
 (540)

**BERARDI**

(591) Black, white  
 (531) 27.05.01; 27.05.17  
 (511)  
 6 – Metal screws; metal bolts; metal springs; goods  
 of common metal.

(260) AM 2019 101979 A  
 (800) 1452793  
 (151) 2018 12 18  
 (891) 2018 12 18  
 (731) DAVINES S.p.A.  
 Via Ravasini, 9/A, I-43100 PARMA, Italy  
 (540)

**VIEW**

(591) Black, white  
 (531) 27.01.12  
 (511)  
 3 – Cosmetics; shampoo; hair balm; conditioning  
 preparations for the hair; hair texturizers; hair pre-  
 parations and treatments; cosmetic preparations for  
 hair care; brightening agents for hair; hair lighteners;



hair dye; hair dyes; semi-permanent hair dyes; hair powder; oils for hair conditioning; hair masks; hair care lotions; hair spray; hair creams; soaps; perfumery; essential oils.

(260) AM 2019 101981 A

(800) 1452838

(151) 2018 12 20

(891) 2018 12 20

(731) SIMPLON.CO

55 RUE DE VINCENNES, F-93100

MONTREUIL, France

(540)

**SIMPLON.CO**

(591) Black, white

(531) 24.17.02; 27.05.01

(511)

35 – Advertising; commercial business management; commercial administration; office functions; dissemination of advertising material (leaflets, prospectuses, printed matter, samples); newspaper subscription services (for others); arranging subscriptions to telecommunication services for others; presentation of goods on all communication media, for retail purposes; business management and organization consultancy; accounting; document reproduction; employment agencies; computer file management; organization of exhibitions for commercial or advertising purposes; online advertising on a computer network; rental of advertising time on all communication media; publication of advertising texts; rental of advertising space; dissemination of advertisements; public relations; company audits (commercial analyses).

41 – Education; training; entertainment; sporting and cultural activities; information relating to entertainment or education; vocational retraining; provision of recreational facilities; publication of books; book lending; videotape film production; rental of motion pictures; rental of sound recordings; rental of video cassette recorders or of radio and television sets; rental of show scenery; videotape editing; photography services; organization of competitions (education or entertainment); organization and conducting of colloquiums, conferences or congresses; organization of exhibitions for cultural or educational purposes; booking of seats for shows; game services provided on-line from a computer network; gambling service; electronic publication of books and journals online; electronic desktop publishing.

42 – Evaluations and assessments in the fields of science and technology provided by engineers; scientific and technical research; design and development of computers and software; research and development of new products for others; technical project study; architecture; design of interior decor; development (design), installation, maintenance, upda-

ting or rental of software; computer programming; computer system analysis; computer system design; consultancy relating to computers; digitization of documents; software as a service (SaaS); information technology (IT) consultancy; hosting of servers; vehicle roadworthiness testing; graphic arts design services; styling (industrial design); authentication of works of art; energy auditing.

(260) AM 2019 101982 A

(800) 1452856

(151) 2018 12 04

(891) 2018 12 04

(731) POGOSYAN SEMEN AMAYAKOVITCH

46, Tavridyana oul., Erevan, Armenia

(540)

AAA

*Cigaronne*

(591) Black, white

(531) 27.05.09; 27.05.22

(511)

34 – Tobacco, tobacco products; cigarettes; electronic cigarettes; cigarillos; cigars; matches; tobacco pipes; cigarette filters; lighters for smokers.

(260) AM 2019 101983 A

(800) 1452862

(151) 2018 12 25

(891) 2018 12 25

(731) PEINTE WATCH CO., LIMITED

RM308, NO.831 XICHA ROAD, BAIYUN

DISTRICT, GUANGZHOU CITY, 510000

GUANGDONG PROVINCE, China

(540)

**PEINTE**

(591) Black, white

(531) 27.05.01

(511)

14 – Wristwatches; clocks and watches, electric; watch bands; movements for clocks and watches; chronometrical instruments; jewelry; paste jewellery; charms [jewellery, jewelry (Am.)].

(260) AM 2019 101984 A

(800) 1452906

(151) 2018 10 05

(891) 2018 10 05

(731) BYBLOS S.r.l.

Viale Monte Grappa, 3/5, I-20124 Milano,  
Italy

(540)



(591) Black, white  
 (531) 27.05.01; 27.05.22  
 (511)

9 – Scientific, nautical, surveying, photographic, cinematographic, weighing, measuring, signaling, checking (supervision), life-saving and teaching apparatus and instruments; apparatus and instruments for conducting, distributing, transforming, accumulating, regulating or controlling electricity; apparatus for recording, transmission or reproduction of sound or images; magnetic recording media, acoustic disks; compact disks, DVDs and other digital recording media; mechanisms for prepayment devices; cash registers, calculating machines, data processing equipment, computers; software; fire extinguishers.

35 – Advertising; business management; business administration; office work.

(260) AM 2019 101985 A  
 (800) 1452932  
 (151) 2018 09 23  
 (891) 2018 09 23  
 (731) APPLE INC.

One Apple Park Way, Cupertino CA 95014,  
 USA

(540)



(591) Red, white and black  
 (531) 02.09.01; 27.05.09; 29.01.13  
 (511)

38 – Providing access to electronic databases relating to patient medical records.

42 – Computer software consulting services; electronic data storage; cloud computing services; providing online non-downloadable software in the field of health care, medicine, patient care, and medical records; data encryption services.

44 – Providing health care information; providing health care information via a website.

(260) AM 2019 101997 A  
 (800) 1453313  
 (151) 2018 11 23  
 (891) 2018 11 23

(731) SHANGHAI CONWOOD  
 INTERNATIONAL CO., LTD.  
 Room 301-306, Building No. 1, No.2112  
 Yanggao Middle Road, China (Shanghai) Pilot  
 Free Trade Zone, Shanghai, China

(540)



(591) Black, white  
 (531) 26.01.01; 26.01.06; 26.01.24  
 (511)

18 – Bags made of canvas; valises; pocket wallets; attaché cases; travelling bags; backpacks; travelling sets [leatherware]; trunks [luggage]; travelling trunks; imitation leather cases.

(260) AM 2019 101998 A  
 (800) 1453317  
 (151) 2018 11 23  
 (891) 2018 11 23  
 (731) WER LIEFERT WAS? GMBH  
 ABC-Straße 21, 20354 Hamburg, Germany  
 (540)

## Visable

(591) Black, white  
 (511)

35 – Collecting, systemisation, updating of economic data and economic information and/or business data and business information; providing of information relating to economic data and economic information and/or business data and business information; advertising; advertising services provided via the internet; dissemination of advertising for others via the internet; marketing services; marketing the goods and services of others; marketing assistance; sales promotion; marketing consultancy for business people and businesses; advertising and marketing consultancy; promoting the goods and services of others over the internet; search engine marketing services; search engine optimization; search engine optimization for sales promotion; planning of marketing strategies; planning of marketing activities; mediation of trade business for third parties; arranging contracts for the buying and selling of goods

for others; advertising, for others, via online electronic communications networks; arranging and rental of advertising space, in particular on the internet and other new media; updating and maintenance of data in computer databases via global computer networks (the internet); systemisation and compilation of data relating to the supply and demand for company data, goods and services in computer databases; collating and systematic ordering of data in a computer database; business information on the internet relating to economic data and economic information; dissemination of advertising matter, including via the internet; presentation of companies on the internet, on the companies' websites and in other media/on the websites of others; provision of an online marketplace for buyers and sellers of goods and services; organization of exhibitions for commercial or advertising purposes; online advertising on a computer network; arranging of trading and economical contacts, also over the internet; services relating to advertising space; business consultancy and advisory services; business management consultancy via the internet; consultancy relating to marketing, in particular to search engine marketing; marketing consultancy for companies in relation to improved discoverability of the companies on the internet; compilation of directories for publication on the internet; search engine optimization for sales promotion; website traffic optimization.

38 – Telecommunications services, in particular data, image and speech transmission services; network telecommunication; providing access to data and information on computer networks; computer transmission of data and images; data transmission via the internet; computer-aided transmission of messages and images; dissemination of data or images via a global computer network; transmission of information and user-generated content via the internet; internet services, namely the providing of access to information on the internet; providing access to databases on computer networks; data transmission; leasing of access time to a computer database for downloading information via electronic media (the internet); providing access to software on data networks for internet access; providing access to information on the internet; providing user access to computer programmes in data networks; telecommunication services provided via internet platforms and portals; providing access to databases; provision of online forums; electronic bulletin board services [telecommunications services]; installing webpages on the internet, for others.

42 – Electronic storage of economic and/or business data and information; updating of database software; rental of software for data monitoring, updating, control; providing search engines for the internet; providing (programming) of webspace for advertising goods and services; development, maintenance and

updating of search engines for telecommunications networks; programming of websites and consultancy relating thereto; website development and maintenance; hosting computer sites; hosting of digital content on the internet; hosting web portals; hosting platforms on the internet; consultancy relating to the creation of homepages and internet pages; consultancy relating to the design of homepages and internet pages; providing electronic memory space on the internet; providing internet search engines with specific search options; providing search engines for obtaining data via communications networks.

---

(260) AM 2019 102016 A

(800) 1290944

(151) 2015 12 21

(891) 2018 12 21

(731) THE NIKKA WHISKY DISTILLING CO., LTD.

4-31, Minami-Aoyama, 5 chome, Minato-ku, Tokyo 107-8616, Japan

(540)

**NIKKA**

(591) Black, white

(531) 27.05.17

(511)

43 – Bar and restaurant services; providing of food and drink.

---

(260) AM 2019 102017 A

(800) 1291066

(151) 2015 12 21

(891) 2018 12 21

(731) THE NIKKA WHISKY DISTILLING CO., LTD.

4-31, Minami-Aoyama, 5 chome, Minato-ku, Tokyo 107-8616, Japan

(540)

**NIKKA WHISKY**

**SINGLE MALT**

**YOICHI**

**余市**

(591) Black, white

(531) 28.03

(511)

33 – Whisky.

---

(260) AM 2019 102018 A

(800) 1332479

(151) 2016 11 18

(891) 2018 09 27  
 (731) BECREO TECHNOLOGIES SPÓŁKA Z  
 OGRANICZONĄ  
 ODPOWIEDZIALNOŚCIĄ  
 Plac Andersa 7, PL-61-894 Poznań, Poland  
 (540)

## Scottie Go!

(591) Black, white  
 (511)  
 9 – Teaching apparatus and instruments for children; instructional and teaching apparatus and instruments for children, science sets for children being teaching apparatus; science sets for children being instructional apparatus.  
 28 – Toys, games, playthings and novelties.  
 41 – Educational services provided for children; education services relating to the development of children's mental faculties; training in computer programming for children; educational services relating to the writing of computer programs for children class.

(260) AM 2019 102019 A  
 (800) 1400799  
 (151) 2018 02 27  
 (891) 2019 02 11  
 (731) DIFA COOPER S.p.A.  
 Via Milano, 160, I-21042 Caronno Pertusella  
 (Varese), Italy  
 (540)

## DIFA COOPER

(591) Black, white  
 (511)  
 3 – Soaps; perfumery, essential oils; preparations for the care of the skin, face, body, hair; makeup preparations.

(260) AM 2019 102020 A  
 (800) 1436330  
 (151) 2017 11 21  
 (891) 2019 01 21  
 (731) WMF Group GmbH  
 Eberhardstraße 35, 73312 Geislingen/Steige,  
 Germany  
 (540)



(591) Black, white  
 (531) 27.05.01; 27.05.22  
 (511)  
 7 – Food and beverage processing and preparation machines and apparatus, all the aforesaid goods included in this class; electric food processors for domestic use; electric kitchen machines for food preparation [other than cooking]; electric baby food processors; electric kitchen appliances for chopping, mixing, pressing; electric kitchen mixers; food processors, electric; electric grinders for food preparation; electric peeling machines for use in the preparation of food; vegetable spiralizers, electric; electric vegetable peelers; electric salad makers (machine) for household purposes; electric apparatus for cutting vegetables for household purposes; electric salad drainers for household purposes; electric hand blender for household purposes; electric food blenders (for household purposes); beaters being electric appliances; electric food blenders; whisks, electric, for household purposes; electrical squeezers for fruit and vegetable; fruit presses, electric, for household purposes; electric fruit peelers; electric fruit squeezers; electric fruit grinders; apparatus for aerating beverages for household purposes; electric egg beaters for household purposes; electric dough kneading machines; electric pasta makers for domestic use; kneaders (electric kitchen machines); pasta cutters (machines) for household purposes; noodle and pasta making machines for household purposes; electric kitchen knives; electric kitchen tools; machines for slicing food (electric, kitchen) for household purposes; electric ice crushing machines for household purposes; bread cutting machines for household purposes; electric pizza cutters; grating machines for household use; peelers (electric machines) for household purposes; mincers (electric) for household use; electric coffee frothers for household purposes; power-operated coffee grinders for household purposes; electrical appliances used in kitchen for milling; electric mixers for household purposes; electric milk frothers; kitchen grinders, electric; power-operated coffee grinders; electric pepper mills; electric salt mills; electric graters; beverage making machines for household purposes; mills for household purposes, other than hand-operated; electric machine for making smoothies (pre-mixed beverages of fruits, vegetables and/or milk products).

8 – Hand-operated vegetable cutters; apple corers; vegetable corers; butter curlers; meat tenderizers in the form of pronged instruments for pounding meat; grapefruit spoons; meat tenderizers in the form of pronged instruments for pounding meat.

11 – Food and beverage cooking, heating, cooling and treatment equipment; raclette apparatus; electric fondue pots (cooking apparatus); electric domestic deep fryers; popcorn makers; sandwich makers (toasters); sandwich toasters; electric toasters; cotton

candy making machines; table top ovens; waffle irons, electric; microwave ovens for domestic use; air fryers; induction cookers; portable induction cookers, electric; electric cooking ovens for household use; electric bread cookers; home bread makers; domestic bread toasters (electric); electric egg cookers for household purposes; electric bottle heaters; electric outdoor grills; electric indoor grills; stands and tables designed to hold electric grills; electric panini makers; electric griddles (cooking appliances); electric toaster ovens; electric tea warmers; machines for making ice cream; electric espresso machines; electric coffee filters; electric chocolate makers; electric beverage heaters; electric wireless coffeepots; electrical coffee pots incorporating percolators; electric coffee makers for household use; electric coffee roasters for household purposes; electric tea makers; kettles, electric; water heaters, electric; heaters, electric, for feeding bottles; baby food warmers, electric; sterilisers for babies' feeding bottles; electric appliances for making yogurt; electric house apparatus for cooking; autoclaves, electric, for cooking; electric steaming apparatus for cooking; electric food steamer; autoclaves, electric, for cooking; electric skillets; electric broilers; hot pots (electrically heated); electric casseroles; electric kitchen apparatus for cooking for household purposes; electric stew-pots; electric food dehydrators for household purposes; electric griddles (cooking appliances); electric rice cookers; electric woks; electromagnetic induction cookers (for household purposes); domestic cooking ovens; domestic stoves for household purposes; domestic plate warmers; hot plates; heated display cabinets; refrigerated food counters; heating and cooling apparatus for dispensing hot and cold beverages; electric wine coolers for household purposes; electric hot plates; electric refrigerators (for household purposes); electric heated urns.

21 – Flower pots; flower pot holders; plant pots and saucers; planters of glass and precious metal/ stainless steel; pots for herbs; plant pots for home gardening, namely for herbs; spice sets; spice racks; spice jars; non-electric spice grinders; cruet sets for oil and vinegar; shakers for spices; fitted covers for buckets or pails; flower bowls of stainless steel; tableware, cookware and containers for household purposes; glasses, drinking vessels and barware; mixing bowls; oven-to-table tableware; cups and mugs; serving platters; serving ladles; plates; knife rests for the table; chopstick rests; ramekins; oven to table racks; baking utensils; bakeware; baking dishes; bread boards; butter-dish covers; steamer baskets; wire baskets [cooking utensils]; egg cups; finger bowls; plates for hors d'oeuvre; coffee mugs; coffee pots; coffee services of precious metal; casseroles [dishes]; saucepan lids; cake tins; cake molds [moulds]; knife rests for the table; cream jugs; salad bowls; gravy boats; chocolate molds; dish covers; dishes; trivets [table utensils]; serving bowls; butlers'

trays; serving pots; soufflé dishes; soup bowls; tableware, other than knives, forks and spoons; teapots; tea services [tableware]; tea cups; drip mats for tea; pie pans; cake domes; portable cooking kits for outdoor use; coasters (tableware); saucers; cocktail glasses; household containers of stainless steel; buckets for household use; litter baskets of metal; storage jars of metal; storage jars; beverageware; candy boxes; bowls for candy; bread bins; bread baskets for household purposes; butter dishes; stainless steel boxes for household use; containers for ice; ice cube molds [moulds]; cruet stands of precious metal; oil cruets of precious metal; bottles; bottle stands; cookie jars; vegetable racks, namely spice racks; stands for dishes; drinks containers for household use; non-electric coffee servers of precious metal; jars; kitchen containers; fruit cups; pepper pots; lunch boxes; salt cellars; bowls [basins] for kitchen and household use; syrup jugs; dispensers for cling film [other than fixed]; straw dispensers; dispensers for serviettes; mug racks; teapot stands; tea caddies; toast racks; cake stands; pedal bins; food storage containers; water bottles; toothpick holders, in particular of stainless steel; sugar bowls, in particular of stainless steel; sugar bowls; stands of precious metal and glass for serving marmalade; support for table numbers; racks of metal for supporting buffet tableware; support for lanterns of metal and glass; butter coolers; double heat insulated containers for food; bottle coolers [receptacles]; beverage coolers [containers]; vacuum flasks for holding food; non-electric vacuum jugs; caviar coolers; heaters for feeding bottles, non-electric; coolers [non-electric containers]; portable beverage coolers; coolers for wine; stainless steel stands for coolers for wine; lemon squeezers [non-electric]; crushers for kitchen use, non-electric; beaters, non-electric; whisks, non-electric, for household purposes; non-electric garlic peelers; non-electric grinders; non-electrical coffee grinders; non-electric coffee drippers for brewing coffee; coffeepots, non-electric; fruit presses, non-electric, for household purposes; rolling pins, domestic, in particular for dough for noodles and pasta, hand-operated; cutting machines for dough, in particular for noodles and pasta, hand-operated; non-electric pasta makers for domestic use; non-electric milk frothers; heaters for feeding bottles, non-electric; mugs for making yogurt for household purposes; mills for household purposes, hand-operated; blenders for food [non-electric]; kitchen grinders, non-electric; non-electric ice crushers; vegetable mashers; hand-operated garlic presses; hand-operated food grinders; coffee grinders, hand-operated; pepper mills, hand-operated; potato ricers; rotary cheese graters; cherry pitters; graters for kitchen use; mortars for kitchen use; food mashers; non-electric meat grinders; graters; roasting dishes; non-electric skillets; frying pan lids; cooking skewers of metal; roasting dishes; double boilers; hot pots, not elec-

trically heated; steamers [cookware]; closures for pot lids; deep fryer baskets for non-electric deep fryers; non-electric griddles; grills [cooking utensils]; cooking molds [moulds]; cauldrons; saucepan lids; cooking utensils for use with domestic barbecues; non-electric canners [pressure cookers]; deep fryers, non-electric; cooking utensils for use with domestic barbecues; pressure cookers, non-electric; non-electric rice cooking pots; non-electric slow cookers; non-electric autoclaves for household use; earthenware saucepans; pot lids; woks; autoclaves, non-electric, for cooking; food steamers, non-electric; molds [moulds] for muesli bar making for household purposes; containers for household or kitchen use; bento boxes; lunch boxes; strainers for household purposes; cruets; ice cube molds for refrigerators; hand-operated salad drainers; thermal insulated containers for food or beverage; insulated cups with lids; thermally insulated flasks for household use; freezer containers for household purposes; cooking pots and pans [non-electric]; blenders (non-electric); mills for household purposes, hand-operated; pepper mills, hand-operated, and salt mills, non-electric; rice cookers, non-electric; sandwich boxes; trays [household]; household or kitchen utensils; colanders for household use; draining trays; dish drying racks; fitted dispensers for wiping, drying, polishing and cleaning paper; cookie [biscuit] cutters; bread tongs; cocktail sticks; cocktail sticks; egg separators, non-electric, for household purposes; ice cream scoops; fish scoops; bottle stands; vegetable tongs; basting spoons [cooking utensils]; barbecue forks; barbecue tongs; hand-operated implements for cracking lobsters; hand-operated sushi makers; noodle machines, hand-operated; meal trays; honey servers; coffee scoops; candelabra [candlesticks]; candlesticks with wind protection; candle extinguishers; basting brushes; scrapers (kitchen implements); cooking funnels; corn cob holders; flour sifters; knife blocks; mixing spoons [kitchen utensils]; non-electric egg crackers for household use; tortilla presses, non-electric [kitchen utensils]; waffle irons, non-electric; nutcrackers; spatulas; non-electric beaters for kitchen use; mixing spoons [kitchen utensils]; salad tongs; scoops for household purposes; slotted spoons; basting spoons [cooking utensils]; serving forks; serving spoons; serving tongs; napkin holders and rings; spaghetti tongs; asparagus tongs; non-electric ice cream makers; skewers (cooking utensil); tea balls; tea light candle holders; tea strainers; pastry cutters; dumpling moulds for household use; place card holders; tablecloth holders; pan scrapers; pot stands; pie servers; tortilla presses; carving forks; funnels; dish drying racks; wine drip collars specially adapted for use around the top of wine bottles to stop drips; spatulas for kitchen use; lemon squeezers; sugar scoops; sugar tongs; cocktail shakers; chopsticks; coffee pots; coffee filters, not of paper, being

part of non-electric coffee makers; non-electric coffee frothers; coffeepots, non-electric; coffee filters, non-electric; non-electric plunger style coffee makers; coffee percolators, non-electric; coffee makers, non-electric; kettles, non-electric; non-electric milk frothers; whistling kettles; tea infusers.

(260) AM 2019 102084 A

(800) 1453735

(151) 2018 12 03

(891) 2018 12 03

(731) RICHTER GEDEON NYRT.

Gyömrői út 19-21, H-1103 Budapest, Hungary

(540)

**АМВЕНОН**

(591) Black, white

(531) 28.05

(511)

5 – Pharmaceutical preparations.

(260) AM 2019 102085 A

(800) 1453760

(151) 2018 12 10

(891) 2018 12 10

(731) SPH Liaoning Herbapex Pharmaceutical

(GROUP) Co., Ltd

No.6 Taishan Road, Wunvshan economic development zone, Huanren County, Benxi, Liaoning, China

(540)

**好护士**

(591) Black, white

(531) 28.03

(511)

5 – Medicines for human purposes; capsules for medicines; pharmaceutical preparations; traditional Chinese medicines; medicines for veterinary purposes; insect repellents; preparations to facilitate teething.

(260) AM 2019 102086 A

(800) 1453782

(151) 2018 11 02

(891) 2018 11 02

(731) ORIFLAME COSMETICS AG

c/o Oriflame Global Management AG,  
Bleicheplatz 3, CH-8200 Schaffhausen,  
Switzerland

(540)

**ORIFLAME ACTIVEELLE**

(591) Black, white

(511)

3 – Non-medicated conditioning and care preparations for application to the hair, scalp, skin and nails; shampoos; hair conditioner; soaps; perfumes; perfumery; eau de cologne; toilet waters; essential and herbal oils; cosmetics; make-up; make-up preparations; lipsticks; nail varnishes; nail varnish removers; eyeliner; mascara; non-medicated toilet preparations; hair lotions; hair sprays and hair gels; preparations for use in the bath or shower; bath and shower oils, gels, creams and foams; face and body masks; face and body scrubs; facial washes; skin cleansers and hydrators; skin toners; skin moisturizers; blemish creams and blemish gels; deodorants; antiperspirants; preparations for use before shaving and after shaving; shaving soaps; shaving creams; shaving gels; after-shave preparations; pre-shave preparations; talcum powders; toiletries; dentifrices; toothpastes; foot care preparations (non-medicated).

(260) AM 2019 102087 A

(800) 1453791

(151) 2018 12 07

(891) 2018 12 07

(731) RICHTER GEDEON NYRT.

Gyömrői út 19-21, H-1103 Budapest, Hungary

(540)

# ЮЗИНА

(591) Black, white

(531) 28.05

(511)

5 – Pharmaceutical preparations.

(260) AM 2019 102088 A

(800) 1453793

(151) 2018 12 03

(891) 2018 12 03

(731) RICHTER GEDEON NYRT.

Gyömrői út 19-21, H-1103 Budapest, Hungary

(540)

# Боринтон

(591) Black, white

(531) 28.05

(511)

5 – Pharmaceutical preparations.

(260) AM 2019 102099 A

(800) 1454099

(151) 2018 12 17

(891) 2018 12 17

(731) ZHEJIANG TRUST HOUSEWARES CO., LTD.

Fanrong Street, Yuanqiao, Huangyan,

Taizhou, Zhejiang Province, China

(540)



(591) Black, white

(531) 03.05.09; 03.05.24

(511)

21 – Ice cube molds; cleaning cloths for clean rooms; brooms; mops; dusting cloths [rags]; dustbins; buttonhooks; flower pots.

(260) AM 2019 102100 A

(800) 1454108

(151) 2018 11 30

(891) 2018 11 30

(731) ADP GAUSELMANN GMBH

Merkur-Allee 1-15, 32339 Espelkamp,

Germany

(540)

# DRAGON MARBLES

(591) Black, white

(511)

9 – Computer software; coin-operated mechanisms; computer and video games software; games software in particular for use on any computer platform, including electronic entertainment and games consoles; computer game programs; video games (software); computer games provided through a global computer network or supplied by means of multi-media electronic broadcast or through telecommunications or electronic transmission or via the internet; computer games, leisure and recreational software, video games and computer software, all being provided in the form of storage media; programs for operating electric and electronic apparatus for games, amusement and/or entertainment purposes; computer software for computer games on the internet; online games (software), in particular for online betting games, online prize games, online gambling games, online games of skill and online casino games; computer software in the form of an app for mobile devices and computers; calculating apparatus in coin-operated machines and parts for the aforesaid goods; electric, electronic, optical or automatic apparatus, for identifying data carriers, identity cards and credit cards, bank notes and coins; software in particular for casino and/or amusement arcade games, for gaming machines and/or slot machines each one with or without prize payouts; gaming software that generates or displays wager outcomes of gaming machi-

nes; operational computer games software; computer software for managing of games (game collection); computer programs for video games; video game software.

28 – Games; toys; gaming apparatus (including coin-operated apparatus); coin-operated arcade games (machines); games for amusement arcades (included in this class); coin-operated video gaming apparatus; video games apparatus adapted for use with external screens or monitors only; casino fittings, namely roulette tables, roulette wheels; coin-operated automatic gaming machines and gaming machines, in particular for gaming arcades, with or without a prize payout; electronic or electrotechnical gaming apparatus, automatic gaming machines, gaming machines, slot machines operated by coins, tokens, banknotes, tickets or by means of electronic, magnetic or biometric storage media, in particular for commercial use in casinos and amusement arcades, with or without a prize payout; automatic gaming machines and gaming machines, in particular for commercial use in casinos and gaming arcades, with or without a prize payout; coin-operated gaming machines and/or electronic money-based gaming apparatus (machines), with or without prizes; housings adapted for gaming machines, gaming apparatus and automatic gaming machines, operated by means of coins, tokens, tickets or by means of electronic, magnetic or biometric storage media, in particular for commercial use in casinos and gaming arcades, with or without a prize payout; electronic games; electronic game entertainment apparatus and parts thereof; video output game machines; drawing apparatus for prize games and lotteries, draws or raffles; housings of metal, plastic and/or wood for coin-operated automatic machines; apparatus for games (including video games), other than adapted for use with external screens or monitors only; electropneumatic and electric slot machines with pulling handles (gaming machines); gaming tables, in particular for table football, billiards, sliding games; flying discs (toys) and darts; gaming machines, namely electric, electronic or electromechanical apparatus for bingo games, lotteries or video lottery games and for betting offices, connected or unconnected to a computer network; LCD games consoles; automatic gaming machines; all the aforesaid automatic gaming machines operating in networks; apparatus and devices for accepting and storing money, being fittings for the aforesaid automatic machines, included in this class; automatic lottery machines.

(260) AM 2019 102101 A  
 (800) 1454117  
 (151) 2018 12 17  
 (891) 2018 12 17  
 (731) GLARIE ELEVATOR CO., LTD.  
 No.9, Xuqing RD. National New&Hi/tech

Industrial; Development Zone, Suzhou,  
 Jiangsu, China

(540)

**GLARIE**

(591) Black, white  
 (531) 26.03.23; 27.01.25  
 (511)

7 – Lifts, other than ski-lifts; elevator chains [parts of machines]; lifting apparatus; elevator operating apparatus/lift operating apparatus; elevators [lifts]; elevator belts/lift belts; moving staircases [escalators]/escalators; moving walkways/moving sidewalks; elevator operating apparatus/lift operating apparatus; three-dimensional garage with lifting equipment.

(260) AM 2019 102102 A  
 (800) 1454128  
 (151) 2018 09 05  
 (891) 2018 09 05  
 (731) FARHAD BROMAND-GOHAR  
 Am Rapohl 34, 50859 Köln, Germany  
 (540)

**Jeluce**

(591) Red, Blue, Yellow, Black and White  
 (531) 27.05.03; 27.05.17; 27.05.19; 29.01.15  
 (511)

29 – Flavored milk powder for the preparation of beverages; Yoghurt-based beverages; Jellies; Jellies, jams, compotes, fruit and vegetable spreads; konjac root jelly [Konnyaku]; Jellies for food; Dried jelly slices; beverages based on peanut milk; beverages based on yoghurt; beverages based on coconut milk; beverages based on almond milk; beverages based on milk products; beverages based on dairy products; Soy-based beverages as milk substitute; beverages made of yoghurt; beverages out of milk or milk-containing beverages; beverages made of thickened milk [yoghurt]; beverages made of yoghurt; Yoghurt [beverages]; creamers for beverages; Coconut milk [beverages]; dairy creamers for beverages; White pudding [sausages with added oatmeal].

30 – Flavorings [except essential oils] for beverages; Flavorings, [herbal] for beverages, excluding essential oils; Flavorings, other than essential oils, for beverages; Flavorings to be added to beverages (excluding essential oils); Flavorings for beverages; Flavor additives for beverages; Coffee-based beverages; Cocoa-based beverages; Powdered effervescent [co-



nfectionery]; Effervescent powder [confectionery]; Dessert mousses [confectionery]; dragées [non-medicinal confectionery]; Aromatic substances for beverages, excluding essential oils; Transparent jelly gums [sugar confectionery]; Coffee extracts as drink flavoring; fruit jellies [confectionery]; Frozen sweets [confectionery]; Frozen confectionery; Frozen confectionery lollies; Frozen confectionery with ice cream; Royal jelly; Jelly beans; beverages based on coffee substitutes; Tea-based beverages; beverages based on fruit-flavored tea; Chocolate-based beverages with milk; beverages made of coffee; beverages made of cocoa; beverages made of chocolate; beverages with added chocolate; Chocolate-flavored beverages; Instant pudding mixes; Cocoa to be used for preparing beverages; Cocoa extracts as flavoring in beverages; Cocoa-containing beverages; Cocoa preparations for preparing beverages; Low-carb sweets; Carbonated beverages based on coffee, cocoa or chocolate; Korean traditional confectionery pressed into molds [Dasik]; Granulated sugar [excluding confectionery]; Crystal sugar pieces [confectionery]; Herbal flavors for beverages; Herbal honey pastilles [confectionery]; Herbal preparations for beverages; Cake decorations made of confectionery; Licorice [confectionery]; Licorice sticks [confectionery]; Lollipops [confectionery]; Lozenges [confectionery]; Powdered corn starch derivatives for the preparation of beverages; Maltodextrin frosting for confectionery; Almond flavors for foods or beverages; Marshmallow confectionery; Mixes to be used for making frozen confectionery; Mixes to be used for making pudding; Marshmallows [sweets]; Non-medicinal frozen confectionery; Tea-based non-medicinal beverages; Non-medicinal confectionery in jelly form; Non-medicinal chocolate confectionery made of flour; Non-medicinal sweets; Non-medicinal sweets made of flour with a chocolate substitute coating; Non-medicinal confectionery made of flour with chocolate coating; Non-medicinal egg-shaped confectionery; Non-medicinal pastille confectionery; Non-medicinal confectionery containing milk; Non-medicinal confectionery with milk flavor; Non-medicinal candy with mint flavor; Non-medicinal confectionery containing chocolate; Non-medicinal sweets containing toffee fillings; Non-medicinal confectionery appropriate for a calorie-controlled diet; Pastila [confectionery]; Pastilles [confectionery]; Vegetable flavorings for beverages, excluding essential oils; preparations for cocoa-based beverages; preparations for tea-based beverages; Chocolate-flavored preparations to be used in beverages; Pudding; Powdered pudding; Rice-based pudding desserts; Custard powder; Puddings as desserts; Powdered sugar for the preparation of isotonic beverages; Powdered cocoa preparations for beverages; Chocolate decorations for confectionery; Chocolate essences for the preparation of beverages; Chocolate extracts for the preparation of beverages; Chocolate syrups for the

preparation of chocolate-based beverages; zephyr [Confectionery]; Snack bars containing a mixture of cereal grains, nuts and dried fruit [confectionery]; salts, condiments, seasonings, flavorings for beverages; Substances as flavorings for beverages [excluding essential oils]; Substances as flavorings to be added to beverages [except essential oils]; Sweets, candy bars and chewing gum; Sweets [cakes]; Sweets [non-medicinal]; Sweets as Christmas tree decorations; Orange-based confectionery; Confectionery made of potato flour; Sweets made of corn; Sweets for non-medical purposes; Confectionery in liquid form; Confectionery in the form of pastilles; Frozen confectionery; Sweets containing liquid fruit fillings; Sweets containing liquid schnapps fillings; Confectionery containing jelly; Confectionery with liquorice flavor; Confectionery containing jam; Confectionery containing wine fillings; Peanut butter confectionery chips; Confectionery chips for baking; Confectionery bars; Cake decorations made of confectionery; Ready-made cocoa and cocoa-based beverages; Yorkshire pudding; Lemon flavoring [excluding essential oils] for food or beverages; Sugar for jelly production; Sugarfree confectionery; Sugar mass [confectionery]; beverages consisting predominantly of coffee; beverages consisting predominantly of cocoa; beverages consisting predominantly of chocolate; Coated nuts [sweets].

(260) AM 2019 102103 A

(800) 1454151

(151) 2018 11 28

(891) 2018 11 28

(731) OMNIREs Sp. z o.o.

ul. Kleszczowa 18, PL-02-485 Warszawa,  
Poland

(540)



(591) Black, white

(531) 01.15.15

(511)

11 – Sanitary and bathroom installations and plumbing fittings; sanitary and bathroom fittings; overhead showers; bathroom and kitchen taps; stand pipes for bathroom taps; bathtubs with accessories; hydromassage bathtubs; decorative covers for bathtub legs; washbasins; sinks; toilet bowls; toilet seats; urinals; bidets; water flushing devices and tanks thereof; shower installations; shower cubicles; shower

doors and shower side walls; bathtub screens; shower seats being components of shower cubicles; steam bath cubicles; sauna installations; bathing showers; showers and their accessories; shower pans; bathroom traps; sink waste strainers; wastes for washbasin traps; water conditioning apparatus; bath fittings; elements and installations for distribution of drinking water, water for sanitary purposes, and water for central heating; pipes of plastic for central heating and water installations; electric water heaters; electric and gas hot-water heaters; bathroom heating stoves; shower hoses; boiler pipes for heating installations; pipes being parts of sanitary installations; pipe elbows and adapters of plastic for installation of heaters; central heating boilers; gas boilers; boilers and heaters; water heaters; valves for regulating the level of water in tanks; mixing valves for water pipes; air vent valves; thermostatic valves; water non-return valves; combined valves being parts of sanitary installations; distribution valves and cut-off valves; filters for water installations; water strainer filters of brass; filters for use with heating apparatus; hand dryers; hair dryers; clothes dryers; dispensers of disinfectants for bathrooms; holders for hand showers; cistern lever handles; heated towel rails; washstand lamps; sconces as electric light fixtures.

21 – Toilet paper dispensers; soap trays; soap dispensers; bathroom cups; holders for bathroom glasses; towel racks and railings as bathroom accessories; holders and stands for toilet paper; bathroom baskets; holders for kitchen paper towels; tissue boxes as bathroom accessories; perfume sprayers [sold empty]; toilet brushes and cleaning brushes; toilet brush stands; containers and sorting baskets for garbage; waste baskets; detergent dispensers; drying racks and baskets for kitchen; plastic bath racks [caddies].

35 – Commercial intermediation services; sales promotion; consumer advice services; import and export services; wholesale and retail sales services of the following goods: sanitary and bathroom installations and plumbing fittings, sanitary and bathroom fittings, overhead showers, bathroom and kitchen taps, stand pipes for bathroom taps, bathtubs with accessories, hydromassage bathtubs, decorative covers for bathtub legs, shelves of plastics for bathtubs, washbasins, sinks, toilet bowls, toilet seats, urinals, bidets, water flushing devices and tanks therefor, shower installations; wholesale and retail sales services of the following goods: shower cubicles, shower doors and shower side walls, bathtub screens, shower seats being components of shower cubicles, steam bath cubicles, sauna installations, bathing showers, showers and their accessories, shower pans, bathroom traps, sink waste strainers, wastes for washbasin traps, water conditioning apparatus, bath fittings; wholesale and retail sales services of the fol-

lowing goods: elements and installations for distribution of drinking water, water for sanitary purposes and water for water central heating, pipes of plastic for central heating and water installations, hooks of plastic, holders and clips for fastening the aforesaid pipes, compensating muffers for central heating pipes, electric water heaters, electric and gas hot-water heaters, bathroom heating stoves; wholesale and retail sales services of the following goods: shower hoses, boiler pipes for heating installations, pipes being parts of sanitary installations, pipe elbows and adapters of plastic for installation of heaters, central heating boilers, gas boilers, boilers and heaters, water heaters, valves for regulating the level of water in tanks, mixing valves for water pipes, air vent valves, thermostatic valves, water non-return valves, combined valves; wholesale and retail sales services of the following goods: distribution valves and cut-off valves, filters for water installations, water strainer filters of brass; wholesale and retail sales services of the following goods: filters for use with heating apparatus, hand dryers, hair dryers, clothes dryers, dispensers of disinfectants for bathrooms, holders for hand showers, cistern lever handles, heated towel rails, washstand lamps, sconces as electric light fixtures, shelves for body wash products, toilet paper dispensers, soap trays, soap dispensers, bathroom cups; wholesale and retail sales services of the following goods: holders for bathroom glasses, towel racks and railings as bathroom accessories, holders and stands for toilet paper, bathroom hooks hangers for towels, bathroom baskets, holders for kitchen paper towels, tissue boxes as bathroom accessories, fragrance sprays sold empty, toilet brushes and cleaning brushes, toilet brush stands; wholesale and retail sales services of the following goods: containers and sorting baskets for garbage, waste baskets, detergent dispensers, drying racks and baskets for kitchen, bathroom furniture, mirrors, anti-slip mats, bathroom mats and carpets, shower loudspeakers.

(260) AM 2019 102104 A

(800) 1454189

(151) 2018 08 17

(891) 2018 08 17

(731) D ET VE ET ÜRÜNLERİ GIDA  
PAZARLAMA TİCARET ANONİM  
ŞİRKETİ  
Dikilitaş Mahallesi, Üzengi Sokak, No:8,  
Beşiktaş, İstanbul, Turkey

(540)



(591) Black and red are the feature of the mark  
 (531) 26.01.03; 26.01.24; 26.11.02; 26.11.12;  
 26.13.01; 27.05.01; 27.05.09; 27.05.10;  
 27.05.11; 29.01.13

(511)  
 43 – Services for providing of food and drink; restaurant services; self-service restaurant services; cafeterias; cafés, canteen services, cocktail lounges, snack bars, catering, pubs; rental of food service equipment used in services providing food and drink; arranging temporary housing accommodations, namely hotels, motels, holiday camps, boarding houses, rental of tents, youth hostel services, room reservation services; reservation of temporary accommodation, rental of banquet and social function facilities for special occasions, namely, wedding receptions, conferences and meetings; providing day care centers for children, the disabled or the elderly; pet day care services, pet and animal boarding services.

(260) AM 2019 102105 A  
 (800) 1454194  
 (151) 2018 09 18  
 (891) 2018 09 18  
 (731) Tovarichtchestvo s ogranichennoy  
 otvetstvennostyu "BRONIX"  
 ulitsa Furmanova, dom 77, n.p. No. 139,  
 050000 gorod Almaty, Kazakhstan

(540)

**Bronix**  
**Броникс**

(591) Black, white  
 (531) 27.05.01; 28.05  
 (511)

39 – Air transport; motor coach rental; boat rental; garage rental; rental of vehicle roof racks; aircraft rental; parking place rental; rental of warehouses; booking of seats for travel; travel reservation; transport reservation; towing; bottling services; bottling services; water distribution; delivery of newspapers; message delivery; parcel delivery; delivery of goods; delivery of goods by mail order; flower delivery; launching of satellites for others; traffic information; transportation information; storage information; transportation logistics; travel arrangement; rescue operations [transport]; arranging of cruises; armored-car transport; hauling; carting; transport and storage of trash; transporting furniture; lighterage services; ferry-boat transport; removal services; transport of travellers; guarded transport of valuables; bus transport; car transport; barge transport; boat transport; railway transport; marine transport; passenger transport; river transport; portage; refloating of ships; vehicle breakdown towing services;

shipbrokerage; transport brokerage; freight brokerage [forwarding]; car rental; railway truck rental; rental of diving bells; rental of diving suits; rental of motor racing cars; rental of aircraft engines; railway coach rental; rental of wheelchairs; rental of storage containers; horse rental; rental of freezers; refrigerator rental; vehicle rental; stevedoring; unloading cargo; electricity distribution; distribution of energy; packaging of goods; ice-breaking; piloting; water supplying; escorting of travellers; ambulance transport; streetcar transport; transport by pipeline; wrapping of goods; operating canal locks; car parking; chauffeur services; pleasure boat transport; courier services [messages or merchandise]; transport; salvaging; salvage of ships; underwater salvage; taxi transport; franking of mail; freight [shipping of goods]; freighting; physical storage of electronically stored data or documents; boat storage; storage of goods; storage; organization of excursions; freight forwarding.

(260) AM 2019 102106 A  
 (800) 1454195  
 (151) 2018 10 18  
 (891) 2018 10 18  
 (731) Obshchestvo s ogranichennoy  
 otvetstvennostyu "KOS Development"  
 ul. Dovatora, d. 6/6, korp. 8, pom. V, kom. 6,  
 RU-119048 Moscow, Russian Federation

(540)



(591) Black, white  
 (531) 03.13.01; 03.13.24; 27.05.17  
 (511)

9 – Scientific, nautical, surveying, photographic, cinematographic, optical, weighing, measuring, signalling, checking [supervision], life-saving and teaching apparatus and instruments; apparatus and instruments for conducting, switching, transforming, accumulating, regulating or controlling electricity; apparatus for recording, transmission or reproduction of sound or images; magnetic data carriers, recording discs; compact discs, DVDs and other digital recording media; mechanisms for coin-operated apparatus; cash registers, calculating machines, data processing equipment, computers; computer software; fire-extinguishing apparatus; 3D spectacles; DVD players; ticket dispensers; coin-operated musical automata [juke boxes]; fire engines; answering machines; batteries for electronic cigarettes; accumulators, electric; accumulators, electric, for vehicles; actinometers; alidades; altimeters; ammeters; anemometers; anodes; antennas; anticathodes; apertometers [optics]; high-frequency apparatus; testing apparatus not for medical purposes; remote control apparatus; electro-dynamic apparatus for the remote

control of railway points; electro-dynamic apparatus for the remote control of signals; monitoring apparatus, other than for medical purposes; sound recording apparatus; Global Positioning System [GPS] apparatus; distillation apparatus for scientific purposes; diffraction apparatus [microscopy]; air analysis apparatus; apparatus to check franking; sound transmitting apparatus; apparatus for fermentation [laboratory apparatus]; breathing apparatus for underwater swimming; breathing apparatus, except for artificial respiration; apparatus and installations for the production of X-rays, not for medical purposes; cash registers; electric apparatus for commutation; magnetic resonance imaging [MRI] apparatus, not for medical purposes; intercommunication apparatus; stills for laboratory experiments; projection apparatus; fire extinguishing apparatus; radiological apparatus for industrial purposes; X-ray apparatus not for medical purposes; blueprint apparatus; flashing lights [luminous signals]; stereoscopic apparatus; telephone apparatus; facsimile machines; phototelegraphy apparatus; igniting apparatus, electric, for igniting at a distance; acid hydrometers; salinometers; acidimeters for batteries; aerometers; beacons, luminous; battery jars; barometers; anode batteries; galvanic batteries; batteries for lighting; solar batteries; solar panels for the production of electricity; batteries, electric; balances [steelyards]; betatrons; binoculars; biochips; electronic tags for goods; lens hoods; magnetic tape units for computers; computer memory devices; fire hose nozzles; encoded identification bracelets, magnetic; connected bracelets [measuring instruments]; safety tarpaulins; electronic key fobs being remote control apparatus; bullet-proof clothing; signalling buoys; life buoys; marking buoys; directional compasses; vacuum gauges; electrolyzers; variometers; verniers; scales; baby scales; bathroom scales; letter scales; weighbridges; precision balances; scales with body mass analysers; levelling staffs [surveying instruments]; camcorders; video baby monitors; video cassettes; video telephones; video screens; viewfinders, photographic; plugs, sockets and other contacts [electric connections]; micrometer screws for optical instruments; viscosimeters; circuit closers; wavemeters; voltmeters; mechanical signs; signs, luminous; switchboxes [electricity]; current rectifiers; gas testing instruments; gasometers [measuring instruments]; galvanometers; hands-free kits for telephones; heliographic apparatus; hygrometers; hydrometers; weights; peepholes [magnifying lenses] for doors; holograms; plotters; sounding leads; plumb bobs; range finders; densimeters; densitometers; detectors; smoke detectors; infrared detectors; counterfeit coin detectors; joysticks for use with computers, other than for video games; transparencies [photography]; slide projectors; diaphragms [photography]; dictating machines; dynamometers; light-emitting diodes [LED]; floppy disks; sound recording discs; disks, magnetic; optical discs;

circular slide rules; disk drives for computers; juke boxes for computers; wearable video display monitors; electronic numeric displays; DNA chips; electronic interactive whiteboards; electronic notice boards; electric wire harnesses for automobiles; bullet-proof waistcoats; life jackets; reflective safety vests; identification threads for electric wires; nose clips for divers and swimmers; locks, electric; alarm bells, electric; electric door bells; signal bells; bells [warning devices]; audio interfaces; acoustic conduits; mirrors for inspecting work; road signs, luminous or mechanical; marine depth finders; probes for scientific purposes; buzzers; needles for surveying compasses; needles for record players; eyewear; reflective articles for wear, for the prevention of accidents; measures; pressure measuring apparatus; simulators for the steering and control of vehicles; inverters [electricity]; pressure indicators; temperature indicators; incubators for bacteria culture; measuring instruments; cosmographic instruments; mathematical instruments; levelling instruments; instruments containing eyepieces; surveying instruments; azimuth instruments; interfaces for computers; ionization apparatus not for the treatment of air or water; satellite finder meters; spark-guards; coaxial cables; fiber optic cables; cables, electric; calipers; slide calipers; screw-tapping gauges; calorimeters; calculating machines; pocket calculators; decompression chambers; rearview cameras for vehicles; cinematographic cameras; thermal imaging cameras; mouth guards for sports; life-saving capsules for natural disasters; electronic pens [visual display units]; holders for electric coils; identity cards, magnetic; video game cartridges; toner cartridges, unfilled, for printers and photocopiers; memory cards for video game machines; encoded magnetic cards; riding helmets; protective helmets; carriers for dark plates [photography]; automated teller machines [ATM]; cathodes; choking coils [impedance]; spools [photography]; coils, electric; electromagnetic coils; cinematographic film, exposed; computer keyboards; solenoid valves [electromagnetic switches]; wire connectors [electricity]; thin client computers; encoded key cards; electronic book readers; electronic agendas; push buttons for bells; mouse pads; magnetic encoders; visors for helmets; collectors, electric; loudspeakers; calibrating rings; smart rings; ring sizers; protective suits for aviators; commutators; compact discs [audio-video]; compact discs [read-only memory]; comparators; marine compasses; computers; wearable computers; laptop computers; tablet computers; notebook computers; condensers [capacitors]; contacts, electric; wind socks for indicating wind direction; traffic cones; branch boxes [electricity]; distribution boxes [electricity]; junction boxes [electricity]; battery boxes; cabinets for loudspeakers; diving suits; galena crystals [detectors]; covers for electric outlets; logs [measuring instruments]; lasers, not for medical purposes; lactodensimeters; lac-

tometers; vacuum tubes [radio]; flashlights [photography]; darkroom lamps [photography]; thermionic tubes; amplifying tubes; head cleaning tapes [recording]; magnetic tapes; videotapes; surveying chains; fire escapes; rulers [measuring instruments]; square rulers for measuring; slide-rules; optical condensers; contact lenses; correcting lenses [optics]; optical lenses; electricity conduits; sounding lines; measuring spoons; magnifying glasses [optics]; thread counters; magnets; decorative magnets; close-up lenses; crash test dummies; resuscitation mannequins [teaching apparatus]; mouse [computer peripheral]; pressure gauges; security tokens [encryption devices]; divers' masks; solderers' helmets; protective masks; respiratory masks, other than for artificial respiration; materials for electricity mains [wires, cables]; voting machines; money counting and sorting machines; material testing instruments and machines; furniture especially made for laboratories; megaphones; portable media players; diaphragms [acoustics]; diaphragms for scientific apparatus; metal detectors for industrial or military purposes; digital weather stations; metronomes; carpenters' rules; rules [measuring instruments]; dressmakers' measures; mechanisms for counter-operated apparatus; coin-operated mechanisms for television sets; shutter releases [photography]; micrometers; microprocessors; microscopes; microtomes; microphones; audio mixers; modems; lightning rods; monitors [computer hardware]; monitors [computer programs]; selfie sticks [hand-held monopods]; terminals [electricity]; junction sleeves for electric cables; teeth protectors; temperature indicator labels, not for medical purposes; kneepads for workers; headphones; surveyors' levels; sound recording carriers; magnetic data media; optical data media; electronic sheet music, downloadable; computer software, recorded; sheaths for electric cables; identification sheaths for electric wires; weighing machines; computer hardware; punched card machines for offices; life saving apparatus and equipment; shoes for protection against accidents, irradiation and fire; lenses for astrophotography; selfie lenses; objectives [lenses] [optics]; egg-candlers; fire extinguishers; rescue laser signalling flares; electrified fences; limiters [electricity]; clothing for protection against accidents, irradiation and fire; clothing for protection against fire; asbestos clothing for protection against fire; clothing especially made for laboratories; ozonisers [ozonators]; octants; eyepieces; ohmmeters; wrist rests for use with computers; eyeglass frames; oscillographs; plumb lines; mirrors [optics]; eyeglasses; sunglasses; goggles for sports; electronic collars to train animals; finger sizers; signalling panels, luminous or mechanical; radio pagers; pince-nez; electronic pocket translators; transmitters [telecommunication]; telephone transmitters; transmitters of electronic signals; switches, electric; periscopes; gloves for divers; gloves for protection against accidents; gloves for protection

against X-rays for industrial purposes; asbestos gloves for protection against accidents; furnaces for laboratory use; pipettes; pyrometers; planimeters; plane tables [surveying instruments]; plates for batteries; computer software platforms, recorded or downloadable; wafers for integrated circuits; printed circuit boards; compact disc players; cassette players; protective films adapted for computer screens; protective films adapted for smartphones; sound recording strips; X-ray films, exposed; films, exposed; life-saving rafts; laboratory trays; digital signs; semi-conductors; polarimeters; personal digital assistants [PDAs]; fire pumps; measuring glassware; life belts; fuses; circuit breakers; converters, electric; telerupters; food analysis apparatus; diagnostic apparatus, not for medical purposes; distance recording apparatus; distance measuring apparatus; speed measuring apparatus [photography]; appliances for measuring the thickness of leather; apparatus for measuring the thickness of skins; speed checking apparatus for vehicles; teaching apparatus; time recording apparatus; hemline markers; measuring apparatus; measuring devices, electric; apparatus and instruments for astronomy; surveying apparatus and instruments; weighing apparatus and instruments; nautical apparatus and instruments; navigational instruments; optical apparatus and instruments; apparatus and instruments for physics; chemistry apparatus and instruments; boiler control instruments; meteorological instruments; naval signalling apparatus; observation instruments; navigation apparatus for vehicles [on-board computers]; satellite navigational apparatus; regulating apparatus, electric; telecommunication apparatus in the form of jewellery; precision measuring apparatus; audio- and video-receivers; prisms [optics]; computer software applications, downloadable; printers for use with computers; retorts' stands; apparatus for changing record player needles; drainers for use in photography; cleaning apparatus for sound recording discs; fire beaters; telescopic sights for firearms; telescopic sights for artillery; test tubes; pressure indicator plugs for valves; magnetic wires; telegraph wires; telephone wires; wires, electric; conductors, electric; copper wire, insulated; fuse wire; computer programs, recorded; computer screen saver software, recorded or downloadable; computer game software; computer programs [downloadable software]; computer operating programs, recorded; record players; processors [central processing units]; rods for water diviners; electronic publications, downloadable; distribution consoles [electricity]; control panels [electricity]; radar apparatus; masts for wireless aerials; transmitting sets [telecommunication]; radios; vehicle radios; sprinkler systems for fire protection; frames for photographic transparencies; screens for photoengraving; flowmeters; walkie-talkies; voltage surge protectors; voltage regulators for vehicles; stage lighting regulators; light dimmers [regulators], electric; speed regulators for

record players; cell switches [electricity]; washing trays [photography]; marking gauges [joinery]; T-squares for measuring; time switches, automatic; relays, electric; safety restraints, other than for vehicle seats and sports equipment; X-ray photographs, other than for medical purposes; rheostats; respirators for filtering air; retorts; refractometers; refractors; grids for batteries; security surveillance robots; laboratory robots; teaching robots; humanoid robots with artificial intelligence; speaking tubes; horns for loudspeakers; subwoofers; saccharometers; optical fibers [light conducting filaments]; traffic-light apparatus [signalling devices]; dog whistles; signalling whistles; sports whistles; sextants; inductors [electricity]; safety nets; nets for protection against accidents; fire alarms; signals, luminous or mechanical; sirens; electronic access control systems for interlocking doors; scanners [data processing equipment]; hand-held electronic dictionaries; couplings, electric; connectors [electricity]; sonars; sound locating instruments; lighting ballasts; resistances, electric; spectrograph apparatus; spectroscopes; speed indicators; alcoholmeters; satellites for scientific purposes; protection devices for personal use against accidents; audiovisual teaching apparatus; charging stations for electric vehicles; radiotelegraphy sets; radiotelephony sets; spectacle lenses; anti-glare glasses; optical glass; personal stereos; stereoscopes; stands for photographic apparatus; stroboscopes; fire boats; sulfotometers; bags adapted for laptops; drying racks [photography]; spherometers; integrated circuits; printed circuits; counters; parking meters; kilometer recorders for vehicles; revolution counters; abacuses; egg timers [sandglasses]; taximeters; ear plugs for divers; tachometers; television apparatus; telegraphs [apparatus]; telescopes; teleprompters; teleprinters; cordless telephones; cellular phones; theodolites; interactive touch screen terminals; thermo-hygrometers; thermometers, not for medical purposes; thermostats; thermostats for vehicles; crucibles [laboratory]; tone arms for record players; totalizators; transistors [electronic]; transponders; protractors [measuring instruments]; step-up transformers; transformers [electricity]; resuscitation training simulators; vehicle breakdown warning triangles; triodes; starter cables for motors; discharge tubes, electric, other than for lighting; capillary tubes; neon signs; Pitot tubes; X-ray tubes not for medical purposes; telephone receivers; squares for measuring; gauges; quantity indicators; automatic indicators of low pressure in vehicle tires; gasoline gauges; water level indicators; electric loss indicators; light-emitting electronic pointers; slope indicators; levels [instruments for determining the horizontal]; mercury levels; spirit levels; urinometers; amplifiers; particle accelerators; electric installations for the remote control of industrial operations; baby monitors; steering apparatus, automatic, for vehicles; balancing apparatus; video recorders; sound reproduction apparatus; invoicing

machines; tape recorders; protection devices against X-rays, not for medical purposes; railway traffic safety appliances; data processing apparatus; oxygen transvasing apparatus; theft prevention installations, electric; film cutting apparatus; drying apparatus for photographic prints; optical character readers; centering apparatus for photographic transparencies; dosage dispensers; battery chargers; chargers for electric batteries; chargers for electronic cigarettes; acoustic alarms; sounding apparatus and machines; apparatus for editing cinematographic film; cathodic anti-corrosion apparatus; couplers [data processing equipment]; wearable activity trackers; anti-theft warning apparatus; computer peripheral devices; anti-interference devices [electricity]; demagnetizing apparatus for magnetic tapes; acoustic couplers; alarms; fog signals, non-explosive; whistle alarms; adding machines; readers [data processing equipment]; bar code readers; heat regulating apparatus; photocopiers [photographic, electrostatic, thermic]; electric and electronic effects units for musical instruments; downloadable ring tones for mobile phones; downloadable image files; downloadable music files; animated cartoons; filters for respiratory masks; filters for ultraviolet rays, for photography; filters [photography]; USB flash drives; magic lanterns; signal lanterns; optical lamps; cameras [photography]; glazing apparatus for photographic prints; shutters [photography]; darkrooms [photography]; photometers; flash-bulbs [photography]; digital photo frames; enlarging apparatus [photography]; photovoltaic cells; containers for contact lenses; eyeglass cases; containers for microscope slides; cases for smartphones; cases especially made for photographic apparatus and instruments; chromatography apparatus for laboratory use; chronographs [time recording apparatus]; laboratory centrifuges; eyeglass chains; cyclotrons; compasses for measuring; frequency meters; time clocks [time recording devices]; Petri dishes; sleeves for laptops; covers for personal digital assistants [PDAs]; covers for tablet computers; covers for smartphones; fire blankets; chips [integrated circuits]; jigs [measuring instruments]; pedometers; meteorological balloons; electrified rails for mounting spot lights; asbestos screens for firemen; fire hose; virtual reality headsets; protective helmets for sports; head guards for sports; snorkels; cell phone straps; eyeglass cords; tripods for cameras; switchboards; distribution boards [electricity]; equalizers [audio apparatus]; workmen's protective face-shields; projection screens; radiology screens for industrial purposes; fluorescent screens; screens [photography]; exposure meters [light meters]; ducts [electricity]; galvanic cells; downloadable graphics for mobile phones; epidiascopes; ergometers; armatures [electricity]; black boxes [data recorders].

(260) AM 2019 102107 A  
 (800) 1454197  
 (151) 2018 10 30  
 (891) 2018 10 30  
 (731) ALLIED BRANDS S.R.L.  
 Corso Venezia, 36, I-20121 Milano, Italy  
 (540)



(591) Dark green, grey, red, white and black  
 (531) 05.03.20; 05.05.23; 25.01.06; 27.05.10;  
 29.01.15  
 (511)  
 33 – Alcoholic beverages.

(260) AM 2019 102120 A  
 (800) 1454585  
 (151) 2018 06 22  
 (891) 2018 06 22  
 (731) PHARMANUTRA S.P.A.  
 Via delle Lenze, 216/b, I-56122 Pisa (PI), Italy  
 (540)

## SUCROSOMIAL

(591) Black, white  
 (511)  
 1 – Chemical products for industrial use, in particular amino acids, proteins, vitamins, mineral salts, carbohydrates, esters, lipids, fatty acid esters, inorganic acids, saturated or unsaturated fatty acids, omega-3 and omega-6 fatty acids; chemical additives for use in the manufacture and preparation of pharmaceutical preparations, foodstuffs, nutraceuticals, supplements and dietary substances for humans and animals; chemical substances, chemical materials and chemical preparations; chemical compounds for the preparation and manufacture of pharmaceutical preparations, foodstuffs, nutraceuticals, supplements and dietary substances for humans and animals; raw materials and semi-finished products for the formulation and preparation of pharmaceutical preparations, foodstuffs, nutraceuticals, supplements and dietary substances for humans and animals containing in particular amino acids, proteins, vitamins, microelements, mineral salts, carbohydrates, esters, lipids, fatty acid esters, inorganic acids, saturated or unsaturated fatty acids, omega-3 e omega-6 fatty acids.

5 – Pharmaceutical and parapharmaceutical products and preparations, including gynecological, urological, gastroenterologic, immunologic, cardio-vascu-

lar, dermatological, oral hygiene and osteo-articular preparations and products; sanitary and hygienic products and preparations for medical purposes; nutraceuticals, symbiotics, nutritional, probiotic, prebiotic and homeopathic pharmaceuticals; veterinary products and preparations; food and dietary supplements (for medical purposes and not); nutritional supplements for medical and not for medical use; mineral, dietetic (for medical use), nutraceutical, vitamin, antioxidant, saprophytic bacterial flora and homeopathic substances and preparations; dietary supplements of enzymes and proteins; food and dietary supplements for people with special dietary needs; herbal dietary supplements for persons with special dietary requirements; dietetic supplement drinks; nutritional supplements for medical use; complementary feedingstuffs for the diet of human beings for medical purposes; food and dietetic supplements including food and dietetic supplements for babies; dietetic food supplements not for medical purposes; cultures of microorganisms for medical use; cultures of saprophytic bacteria for medical use; preparations of micro-organisms for medical purposes; preparations of useful bacteria cultures for medical use; dietary supplements for animals; protein supplements for animals; mineral supplements for livestock feed; fungicides, herbicides, insecticides; disinfectants; microorganisms (nutritive substances for -).

(260) AM 2019 102123 A  
 (800) 1454696  
 (151) 2018 12 03  
 (891) 2018 12 03  
 (731) AYDIN KURUYEMİŞ SANAYİ VE  
 TİCARET ANONİM ŞİRKETİ  
 Cebeci Mahallesi, Atatürk Bulvarı,  
 2488 Sokak, No:36 Sultançiftlik,  
 Sultangazi – İstanbul, Turkey  
 (540)

## wownuts

(591) Black, white  
 (526) nuts  
 (511)  
 29 – Meat, fish, poultry and game; processed meat products; dried pulses; soups, bouillon; processed olives, olive paste; milk and milk products, butter; edible oils; dried, preserved, frozen, cooked, smoked or salted fruits and vegetables; tomato paste; prepared nuts and dried fruits as snacks; processed and roasted nuts; processed and roasted chickpeas; processed sunflower seeds; roasted sunflower seeds; processed pistachio nuts; processed peanuts; processed walnuts; processed and roasted almonds; hazelnut spreads and peanut butter; tahini (sesame seed paste); eggs and powdered eggs; potato chips.

(260) AM 2019 102186 A  
 (800) 1455201  
 (151) 2018 11 16  
 (891) 2018 11 16  
 (731) PepsiCo. Inc., (a North Carolina corporation)  
 700 Anderson Hill Road, Purchase NY 10577,  
 USA

(540)



(591) Black, white  
 (531) 05.03.13; 05.03.14; 27.05.02; 27.05.07;  
 27.05.10; 27.05.17; 27.05.19

(511)  
 32 – Aperitifs, non-alcoholic; aerated water; mineral water [beverages]; waters [beverages]; table waters; kvass [non-alcoholic beverage]; cocktails, non-alcoholic; lemonades; non-alcoholic beverages; isotonic beverages; non-alcoholic honey-based beverages; non-alcoholic fruit juice beverages; fruit nectars, non-alcoholic; orgeat; powders for effervescing beverages; sarsaparilla [non-alcoholic beverage]; syrups for lemonade; syrups for beverages; smoothies; vegetable juices [beverages]; fruit juices; cider, non-alcoholic; preparations for making aerated water; preparations for making beverages; sherbets [beverages]; non-alcoholic fruit extracts; essences for making beverages.

(260) AM 2019 102196 A  
 (800) 1455436  
 (151) 2018 12 17  
 (891) 2018 12 17  
 (731) Shanghai ASA Ceramic Co., Ltd.  
 No.3988, Hongmei South Road, Minhang  
 District, 201100 Shanghai, China

(540)



(591) Black, white  
 (531) 28.03  
 (511)  
 19 – Bricks; ceramic tiles; wall tiles, not of metal; floor tiles, not of metal.

(260) AM 2019 102206 A  
 (800) 1455606  
 (151) 2018 10 24

(891) 2018 10 24  
 (731) MONUS d.o.o.  
 Aleksandra Dubčeka 14, 11080 Beograd-  
 Zemun, Serbia

(540)

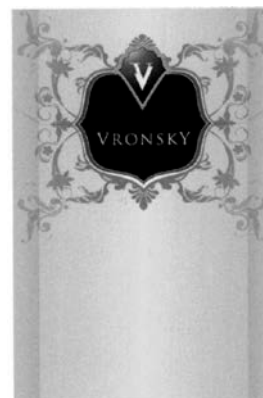

(591) Gray, black and white  
 (531) 05.05.20; 05.13.25; 25.01.10; 25.01.25;  
 26.05.02; 26.05.06; 26.05.18; 27.05.10;  
 27.05.24

(511)  
 34 – Tobacco; rolling tobacco; tobacco products; chewing tobacco; smokers' articles; cigarette filters; matches; cigarettes; cigars.

(260) AM 2019 102208 A  
 (800) 1455750  
 (151) 2018 12 28  
 (891) 2018 12 28  
 (731) JIANGXI BLUESTAR XINGHUO  
 SILICONES, CO., LTD  
 Yang Jialing, Yongxiu County, Jinjiang  
 City, Jiangxi Province, China

(540)

# Starsil

(591) Black, white  
 (531) 27.05.01  
 (511)  
 1 – Silicon; industry silicon; silica gel; silicones; silicone resins; silastomer; organic silicone resins; silicon ethide; glue for industrial purposes; printing and dyeing auxiliaries.

(260) AM 2019 102210 A  
 (800) 1455771  
 (151) 2018 10 11  
 (891) 2018 10 11  
 (731) EGIS GYÓGYSZERGYÁR ZRT.  
 Keresztúri út 30-38., H-1106 Budapest, Hungary

(540)

# REPARON

(591) Black, white



(511)  
3 – Cosmetics, personal sanitary preparations.

(260) AM 2019 102219 A

(800) 1455911

(151) 2018 12 29

(891) 2018 12 29

(731) CAPRI SUN AG

Neugasse 22 CH-6300 Zug, Switzerland

(540)



The logo for Capri-Sun FUN ALARM features the brand name 'Capri-Sun' in a stylized, rounded font with a slight shadow effect. Below it, the words 'FUN ALARM' are written in a bold, blocky, uppercase font.

(591) Black, white

(531) 27.01.12; 27.05.02; 27.05.03; 27.05.10;  
27.05.24

(511)

32 – Non-alcoholic fruit nectars; non-alcoholic beverages; flavored water; essences for making non-alcoholic beverages, included in this class; fruit drinks; fruit juices; functional water-based beverages; vegetable juice drinks; vegetable juices; water-based beverages containing tea extracts; isotonic beverages; mineral water [beverages]; syrups for making non-alcoholic beverages, included in this class; smoothies; juices; part frozen slush drinks.

(260) AM 2019 102275 A

(800) 1456235

(151) 2019 02 06

(891) 2019 02 06

(731) TRAXXAS, L.P.

6250 Traxxas Way, McKinney TX 75070,  
USA

(540)



The TRAXXAS logo is rendered in a bold, stylized, italicized font with a jagged, aggressive appearance, characteristic of the brand's branding.

(591) Black, white

(531) 27.05.01; 27.05.19

(511)

28 – Radio-controlled model vehicles and parts therefor, sold as a unit.

(260) AM 2019 102276 A

(800) 1456262

(151) 2018 12 31

(891) 2018 12 31

(731) BERVİN DIŞ TİCARET LİMİTED ŞİRKETİ

Karamehmet Mah. Avrupa Serbest,  
Bölgesi Avrasya Bulvarı No:22/1,  
(131 Ada 19 Parsel), Ergene, Tekirdağ,  
Turkey

(540)



The Hausberg logo features the brand name 'Hausberg' in a bold, serif font. Above the letter 'g', there are three small, stylized mountain peaks represented by three short horizontal lines.

(591) Black, white

(531) 26.02.03; 26.04.01; 26.04.09; 26.04.12;  
26.04.24; 27.05.01; 27.05.11

(511)

7 – Electric kitchen machines for chopping, grinding, crushing, mixing and mincing foodstuff, washing machines, laundry washing machines, dishwashers, spin driers (not heated), electric cleaning machines for cleaning floors, carpets or floorings, vacuum cleaners and parts thereof.

8 – Forks, spoons, knives and non-electric cutters, slicers, peelers for kitchen use, including those made of precious metals; side arms and blades (weapons); tools and apparatus included in this class for personal beauty care use: tools and apparatus included in this class for shaving, epilation, manicure and pedicure, electric hand implements for straightening and curling hair, scissors; electric or non-electric irons; steam irons.

(260) AM 2019 102277 A

(800) 1456264

(151) 2018 09 28

(891) 2018 09 28

(731) IEGOROV ARTEM YURIIOVYCH

prosp. Moskovskiyi, bud. 57/63, kv. 53,  
m. Kharkiv 61050, Ukraine;

OLEKSIENKO VALERII

MYKHAILOVYCH

vul. Pohrebniaka, bud. 13, kv. 96,

s. Chubynske, Boryspil'skiy r-n, Kyiv'ska obl.  
08231, Ukraine;

MAZUNIN OLEKSANDR

VOLODYMYROVYCH

vul. Maiakovskoho, bud. 20, kv. 134,

m. Kyiv 02230, Ukraine

(540)



The КВИНОЛ logo is written in a large, bold, serif font. The letters are thick and have a slightly distressed or hand-drawn appearance.

(591) Black, white

(531) 28.05

(511)

5 – Pharmaceuticals, medical and veterinary preparations; sanitary preparations for medical purposes; dietetic food and substances adapted for medical or veterinary use, food for babies; dietary supplements for humans and animals; plasters, materials for dressings; disinfectants; adjuvants for medical purposes; nutritional supplements; albumin dietary supplements; alginate dietary supplements; amino acids for medical purposes; analgesics; anaesthetics; antibiotics; anti-oxidants for pharmaceutical purposes; multi-vitamin preparations; germicides; balms for

medical purposes; medicinal herbs, fruits and roots; balms for medical use; balsamic preparations for medical purposes; royal jelly for pharmaceutical purposes; albuminous preparations for medical purposes; albuminous dietary supplements; albuminous foodstuffs for medical purposes; biological preparations for medical purposes; veterinary and pharmaceutical substances; decoctions for pharmaceutical purposes; vitamin fortified beverages for medical purposes; vitamin and mineral preparations; dietary fiber; homeopathic medicines; homogenized food adapted for medical purposes; dietary supplements for humans; dietary supplements for reducing fatigue evidences during exercises and mental work loads; dietary supplements with antioxidant and general tonic properties for humans; dietary supplements that contribute to normalization of the functioning of gastrointestinal tract, fat metabolism improvement, immunity improvement, improvement of vision acuity, ageing process inhibition for humans; dietary supplements that normalize metabolism and cholesterol level; royal jelly dietary supplements; glucose dietary supplements; pollen dietary supplements; dietary supplements with a cosmetic effect; linseed dietary supplements; linseed oil dietary supplements; acai powder dietary supplements; propolis dietary supplements; wheat germ dietary supplements; dietary supplements based on plant and natural ingredients; dietary supplements intended to supplement a normal diet or to have health benefits; dietetic beverages adapted for medical purposes; dietetic substances adapted for medical use; dietetic foods adapted for medical purposes; yeast dietary supplements; plant extracts for pharmaceutical purposes; herbal extracts for medical purposes; elixirs (pharmaceutical preparations); enzyme dietary supplements; enzyme preparations for medical purposes; gastrointestinal adsorbents; febrifuges; meal replacement and dietary supplement drink mixes for medical purposes; nervines; immunobiological preparations for medical purposes; immunomodulating preparations for medical purposes; immunostimulants; casein dietary supplements; barks for pharmaceutical purposes; depuratives; starch for dietetic or pharmaceutical purposes; lecithin dietary supplements; medicines for human purposes; medicated toiletry preparations; medicinal roots; medicinal tea; mineral waters for medical purposes; medicated dentifrices; medicinal drinks; medicinal oils; herbal preparations for medical purposes; medicinal herbs; therapeutic drugs and agents; liniments; mineral food supplements; vitamin supplement patches; linseed for pharmaceutical purposes; tinctures for medical purposes; pastilles for pharmaceutical purposes; antioxidant pills; by-products of the processing of cereals for dietetic or medical purposes; nutritional supplements; antioxidant pills; pre-filled syringes for medical purposes; bath preparations for medical purposes; preparations for facilitating sexual coupling;

preparations for the treatment and the prevention of various diseases, including cardiovascular diseases, diffuse diseases of the connective tissue and joints, diseases of female and male genital zone, diseases of endocrine system and endocrine disorders, brain disorders, nervous emotional disturbances, diseases of the nervous system, diseases of the digestive system, urinary diseases, diseases of the respiratory system, upper respiratory tract diseases, blood diseases, immunologic diseases, ophthalmological diseases, dermatological diseases, viral infections, inflammatory conditions, impotency and sterility, allergic manifestations and others; opotherapy preparations; preparations for increasing concentration and endurance strength (medicinal preparations); preparations of trace elements for human and animal use; preparations to accelerate rehabilitation process during recovery for medical purposes; preparations to normalize blood pressure; preparations to improve work of nervous system and to improve memory and attention (medicinal preparations); preparations to restore muscle work after strenuous exercise for medical purposes; preparations to normalize metabolism and cholesterol level (medicinal preparations); preparations to improve vision (medicinal preparations); preparations to improve heart function; propolis for pharmaceutical purposes; protein dietary supplements; asthmatic tea; antivirals; anti-inflammatories; antiparasitic preparations; antitumor drugs; syrups for pharmaceutical purposes; sorbents for pharmaceutical purposes; sport nutrition (dietary supplements); freeze-dried meat adapted for medical purposes; therapeutic preparations for the bath; tonics (medicines); herbal teas for medicinal purposes; pharmaceuticals; phytocomposites for medical purposes; phytotherapy preparations for medical purposes; dietary and nutritional supplements; candy, medicated; candy for medical purposes.

(260) AM 2019 102278 A

(800) 1456279

(151) 2018 12 06

(891) 2018 12 06

(731) NN -Tel d.o.o.

Ljubice Ravasi 29, 21000 Novi Sad, Serbia

(540)



(591) Red, dark red, burgundy, blue, light blue, dark blue, turquoise, white, black, brown, yellow, light yellow, dark yellow, gold and orange  
 (531) 03.07.06; 03.07.24; 08.01.14; 11.03.05; 26.04.16; 26.04.22; 27.05.09; 27.05.10; 29.01.15  
 (511)  
 30 – Crackers; salted biscuits; snack mixes consisting of crackers.

(260) AM 2019 102279 A  
 (800) 1456291  
 (151) 2019 02 15  
 (891) 2019 02 15  
 (731) UNIFI, INC.  
 7201 W. Friendly Avenue, Greensboro NC  
 27410, USA  
 (540)



(591) Black, white  
 (531) 24.15.02; 24.15.13; 26.01.18; 26.01.24; 27.05.21; 27.05.24  
 (511)  
 1 – Recycled polymers for use in the manufacture of industrial products, packaging and consumer and household products.

(260) AM 2019 102280 A  
 (800) 1456310  
 (151) 2018 11 26  
 (891) 2018 11 26  
 (731) TAN-ALİZE KOZMETİK VE TEMİZLİK  
 ÜRÜNLERİ SANAYİ VE TİCARET  
 ANONİM ŞİRKETİ  
 Ömerli Beldesi Fabrikalar Yolu, No:43  
 Ümraniye, TR-81730 Ümraniye, İstanbul,  
 Turkey  
 (540)

**DR.C.TUNA**

(591) Black, white  
 (511)  
 3 – Bleaching preparations for household use; cleaning preparations; perfumery; cosmetics; cosmetic preparations for eyelashes; cosmetic preparations for bath; cosmetic preparations for skin care; cosmetic creams; cosmetic kits comprised of lipstick, shampoo, beauty masks, aromatic oils, essential oils, al-

mond soap, antiperspirant soap, cakes of soap, deodorant soap, massage gels, other than for medical purposes, sun-tanning preparations, cosmetic preparations for eyelashes, cosmetic creams, skin whitening creams, lotions for cosmetic purposes, hair lotions, make-up powder, mascara, nail polish, perfumes, eyebrow pencils, eyeliner, shaving soap, after-shave lotions; aromatics in the nature of essential oils for personal use; deodorants for human beings; skin soap, bar soap, body cream soap, non-medicated cosmetic soap, non-medicated beauty soap, non-medicated bath soap, non-medicated body soap, non-medicated liquid soap; dental bleaching gels; dentifrices; denture polishes; polishing preparations for leather, vinyl, metal and wood, polishes and creams for leather, vinyl, metal and wood, wax for polishing.

5 – Pharmaceutical and veterinary preparations for medical purposes; chemical preparations for medical and veterinary purposes, chemical reagents for pharmaceutical and veterinary purposes; dietary supplements for pharmaceutical and veterinary purposes; dietary supplements; nutritional supplements; medical preparations for slimming purposes; food for babies; herbs and herbal beverages adapted for medicinal purposes; dental preparations and articles; teeth filling material, dental impression material, dental adhesives and material for repairing teeth; sanitary preparations for medical use; hygienic pads; hygienic tampons; medical and surgical plasters; materials for dressings; diapers, including those made of paper and textiles; preparations for destroying vermin; fungicides, herbicides; deodorants, other than for human beings or for animals; air deodorizing preparations; disinfectants; antiseptics; detergents for medical purposes.

(260) AM 2019 102293 A  
 (800) 1456607  
 (151) 2018 09 20  
 (891) 2018 09 20  
 (731) LLC YALOGA-NT  
 ulitsa Salyutovskaya, dom 31, office 224,  
 gorod, Izhevsk, RU-426053 Resp.  
 Udmurtskaya, Russian Federation  
 (540)

**КРЕДА**

**KREDA**

(591) Black, white  
 (531) 28.05  
 (511)  
 2 – Annatto [dyestuff]; auramine; Canada balsam; white lead; paper for dyeing Easter eggs; dyes; binding preparations for paints; glazes [paints, lacqu-

ers]; litharge; primers; gamboge for painting; gum-lac; titanium dioxide [pigment]; repositionable paint patches; indigo [colorant]; gum resins; colophony; caramel [food colorant]; carbonyl [wood preservative]; cochineal carmine; toner cartridges, filled, for printers and photocopiers; copal; alizarine dyes; aniline dyes; ink for leather; colorants for liqueurs; colorants for beverages; shoe dyes; colorants for beer; colorants for butter; ink for skin-dressing; dyewood; malt colorants; food colorants; colorants; toner [ink] for photocopiers; aluminium paints; asbestos paints; bactericidal paints; wood stains; ceramic paints; marking ink for animals; distempers; fireproof paints; printing ink; engraving ink; enamels for painting; paints; creosote for wood preservation; turmeric [colorant]; black japan; bitumen varnish; bronzing lacquers; copal varnish; lacquers; anti-corrosive bands; anti-rust oils; oils for the preservation of wood; mastic [natural resin]; lime wash; cobalt oxide [colorant]; zinc oxide [pigment]; silver paste; printers' pastes [ink]; pigments; coatings [paints]; coatings for roofing felt [paints]; wood coatings [paints]; undercoating for vehicle chassis; anti-fouling paints; varnishes; aluminium powder for painting; bronze powder for painting; silvering powders; metals in powder form for use in painting, decorating, printing and art; anti-corrosive preparations; protective preparations for metals; wood mordants; mordants for leather; mordants; thinners for paints; thinners for lacquers; whitewash; soot [colorant]; carbon black [pigment]; lamp black [pigment]; sandarac; thickeners for paints; sienna earth; siccatives [drying agents] for paints; anti-rust greases; natural resins, raw; malt caramel [food colorant]; badigeon; anti-tarnishing preparations for metals; anti-rust preparations; wood preservatives; sumac for varnishes; minium; turpentine [thinner for paints]; fixatives [varnishes]; fixatives for watercolors; metal foil for use in painting, decorating, printing and art; yellow-wood [colorant]; saffron [colorant]; dyewood extracts; enamels [varnishes]; silver emulsions [pigments].

3 – Abrasives; amber [perfume]; descaling preparations for household purposes; antistatic preparations for household purposes; aromatics [essential oils]; air fragrancing preparations; cake flavorings [essential oils]; flavorings for beverages [essential oils]; breath freshening sprays; canned pressurized air for cleaning and dusting purposes; balms, other than for medical purposes; lip glosses; polishing stones; abrasive paper; emery paper; polishing paper; petroleum jelly for cosmetic purposes; shoe polish; cobblers' wax; cotton wool for cosmetic purposes; sachets for perfuming linen; drying agents for dishwashing machines; adhesives for cosmetic purposes; scented water; Javelle water; lavender water; toilet water; wax for clothes; floor wax; non-slipping wax for floors; depilatory wax; mustache wax; tailors' wax; creams for leather; polish for furniture and flooring; shoe-

makers' wax; polishing wax; massage gels, other than for medical purposes; heliotropine; dental bleaching gels; geraniol; make-up; deodorants for pets; deodorants for human beings; depilatory preparations; scented wood; perfumes; non-slipping liquids for floors; windshield cleaning liquids; greases for cosmetic purposes; volcanic ash for cleaning; toilet-ry preparations; perfumery; decorative transfers for cosmetic purposes; ionone [perfumery]; shaving stones [astringents]; smoothing stones; eyebrow pencils; cosmetic pencils; silicon carbide [abrasive]; carbides of metal [abrasives]; alum stones [astringents]; tripoli stone for polishing; adhesives for affixing false eyelashes; adhesives for affixing false hair; hair conditioners; quillaia bark for washing; corundum [abrasive]; beard dyes; colorants for toilet purposes; cosmetic dyes; laundry starch; laundry glaze; shoe cream; polishing creams; cosmetic creams; skin whitening creams; polishing rouge; incense; hair spray; nail polish; hair lotions; lotions for cosmetic purposes; after-shave lotions; beauty masks; oils for perfumes and scents; oils for cosmetic purposes; oils for toilet purposes; essential oils; essential oils of cedar-wood; essential oils of lemon; essential oils of citron; oils for cleaning purposes; bergamot oil; gaultheria oil; jasmine oil; lavender oil; almond oil; rose oil; oil of turpentine for degreasing; whitening; cleaning chalk; almond milk for cosmetic purposes; cleansing milk for toilet purposes; musk [perfumery]; soap; deodorant soap; shaving soap; soap for brightening textile; cakes of toilet soap; antiperspirant soap; soap for foot perspiration; almond soap; mint for perfumery; cosmetic kits; emery; nail art stickers; false nails; eau de Cologne; bases for flower perfumes; joss sticks; pastes for razor strops; dentifrices; pumice stone; lipstick cases; hydrogen peroxide for cosmetic purposes; breath freshening strips; abrasive cloth; glass cloth [abrasive cloth]; lipsticks; pomades for cosmetic purposes; shaving preparations; cosmetic preparations for baths; bath preparations, not for medical purposes; hair straightening preparations; hair waving preparations; laundry soaking preparations; grinding preparations; cleansers for intimate personal hygiene purposes, non medicated; personal deodorants; smoothing preparations [starching]; color-removing preparations; leather bleaching preparations; polishing preparations; denture polishes; mouthwashes, not for medical purposes; cosmetic preparations for slimming purposes; starch glaze for laundry purposes; refurbishing preparations; fabric softeners for laundry use; laundry bleach; dry-cleaning preparations; paint stripping preparations; lacquer-removing preparations; make-up removing preparations; floor wax removers [scouring preparations]; varnish-removing preparations; rust removing preparations; nail care preparations; cleaning preparations; preparations for cleaning dentures; wallpaper cleaning preparations; preparations for unblocking drain pipes; laundry preparations; aloe vera pre-

parations for cosmetic purposes; sunscreen preparations; color-brightening chemicals for household purposes [laundry]; shining preparations [polish]; make-up powder; diamantine [abrasive]; stain removers; scouring solutions; false eyelashes; tissues impregnated with cosmetic lotions; tissues impregnated with make-up removing preparations; safrol; laundry blueing; turpentine for degreasing; potpourris [fragrances]; bleaching soda; washing soda, for cleaning; bath salts, not for medical purposes; bleaching salts; fumigation preparations [perfumes]; preservatives for leather [polishes]; ammonia [volatile alkali] [detergent]; astringents for cosmetic purposes; eyebrow cosmetics; make-up preparations; sun-tanning preparations [cosmetics]; hair dyes; neutralizers for permanent waving; preparations to make the leaves of plants shiny; cosmetic preparations for eyelashes; cosmetic preparations for skin care; shoe wax; cosmetics; cosmetics for animals; mascara; detergents, other than for use in manufacturing operations and for medical purposes; degreasers, other than for use in manufacturing processes; bleaching preparations [decolorants] for cosmetic purposes; antiperspirants [toilettries]; talcum powder, for toilet use; terpenes [essential oils]; emery cloth; cloths impregnated with a detergent for cleaning; henna [cosmetic dye]; shampoos; shampoos for pets; dry shampoos; sandpaper; soda lye; extracts of flowers [perfumes]; ethereal essences; badian essence; mint essence [essential oil].

(260) AM 2019 102302 A

(800) 1456768

(151) 2018 11 21

(891) 2018 11 21

(731) KNORR-NÄHRMITTEL  
AKTIENGESELLSCHAFT  
Bahnhofstrasse 19, CH-8240 Thayngen,  
Switzerland

(540)



(591) Green

(531) 01.15.11; 05.03.13; 05.03.14; 27.05.01;  
29.01.12

(511)

29 – Prepared snacks and meals; cooked dishes; cooked and preserved foodstuffs; chilled and deep-frozen ready-made dishes; cooked dishes and prepared meals; all the aforesaid goods mainly consisting of vegetables and/or fruits and/or processed soya beans and/or meat and/or substitutes of meat and/or fish and/or poultry and as long as included in class 29;

meat extracts; preserved fish, seafood, meat, meat substitutes, fruit, vegetables and processed soya beans; soups and consommés, including paste consommés and granulated consommés; frozen, dried and cooked fruits and vegetables; instant, dried and frozen soups; stocks including stock cubes cubes, broth pastes and stock granules; vegetable purees including tomato puree; vegetable pastes, including tomato paste and herb paste; gherkins.

30 – Chilled and deep-frozen ready-made dishes; prepared snacks and meals; prepared mixtures for the preparation of food and sauces; cooked dishes, dried, cooked and preserved foodstuffs; all the aforesaid goods mainly consisting of pasta and/or rice and/or cereal products and as long as included in class 30; rice and potato-based dishes; frosting; soup preparations, namely croûtons (cubes of roasted bread), crackers and processed herbs and herbal mixtures; flavourings and condiments, including in the form of dehydrated powder and pastes; marinades; aromatic preparations for food in the form of paste; mixtures for sauces (seasoning); tacos; tortillas and noodles; rice; pasta including filled pasta; crackers; poppadums (fried bread made from lentil-flour); sauces including deep-frozen, liquid and dried sauces; mixtures for prepared dried sauces; gravy mixes.

41 – Education, organization of training and workshops in the field of food and nutrition.

43 – Provision of food and beverages in restaurants and bars.

(260) AM 2019 102303 A

(800) 1456769

(151) 2019 01 10

(891) 2019 01 10

(731) Obshchestvo s ogranichennoy  
otvetstvennostyu "BIOTEHNOS"  
pr-kt Andropova, d.18, korp. 6, pom. XI,  
kom. 7, RU-115432 Moscow, Russian  
Federation

(540)

**АЛФЛУТОП**

(591) Black, white

(531) 28.05

(511)

35 – Business management; business administration; office functions.

(260) AM 2019 102305 A

(800) 1456796

(151) 2018 12 21

(891) 2018 12 21

(731) BAUSCH & LOMB INCORPORATED  
1400 North Goodman Street, Rochester,  
New York 14609, USA

(540)

**MICROVAULT**

(591) Black, white

(531) 27.05.01; 27.05.17

(511)

9 – Contact lenses, scleral lenses; containers for contact lenses.

42 – Scientific and technological services and research and design relating thereto in the field of contact lenses; industrial design in the field of contact lenses.

(260) AM 2019 102307 A

(800) 1456897

(151) 2018 12 10

(891) 2018 12 10

(731) EURASIA DUTY FREE TRADE LIMITED

Unit 04, 7/F, Bright way tower, No.33 Mong  
Kok road, Kowloon; Hong-Kong, China

(540)

**TRON**

(591) Black, white

(531) 27.05.17

(511)

34 – Flavorings, other than essential oils, for tobacco; flavorings, other than essential oils, for use in electronic cigarettes; gas containers for cigar lighters; absorbent paper for tobacco pipes; cigarette paper; tobacco pouches; books of cigarette papers; humidors; matchboxes; firestones; cigar cutters; cigar holders; cigarette holders; mouthpieces for cigarette holders; tips of yellow amber for cigar and cigarette holders; ashtrays for smokers; spittoons for tobacco users; pipe racks for tobacco pipes; pipe cleaners for tobacco pipes; liquid solutions for use in electronic cigarettes; electronic cigarettes; cigarettes; cigarettes containing tobacco substitutes, not for medical purposes; cigarillos; cigars; tobacco jars; match holders; matches; oral vaporizers for smokers; chewing tobacco; snuff; snuff boxes; herbs for smoking; tobacco pipes; pocket machines for rolling cigarettes; cigarette filters; cigarette tips; cigar cases; cigarette cases; lighters for smokers; smoking tobacco.

(260) AM 2019 102308 A

(800) 1456911

(151) 2019 01 18

(891) 2019 01 18

(731) Public Joint-stock Company "ARNEST COMPANY"

ul. Kombinatskaya, 6, g. Nevinnomyssk,  
RU-357111 Stavropolsky Krai, Russian  
Federation

(540)



(591) Black, white

(531) 24.13.01; 26.01.03; 27.05.11

(511)

3 – Abrasives; amber [perfume]; descaling preparations for household purposes; antistatic preparations for household purposes; aromatics [essential oils]; air fragrancing preparations; cake flavorings [essential oils]; flavorings for beverages [essential oils]; food flavorings [essential oils]; breath freshening sprays; canned pressurized air for cleaning and dusting purposes; balms, other than for medical purposes; lip glosses; polishing stones; abrasive paper; emery paper; polishing paper; petroleum jelly for cosmetic purposes; shoe polish; cobblers' wax; cotton wool for cosmetic purposes; sachets for perfuming linen; drying agents for dishwashing machines; adhesives for cosmetic purposes; scented water; Javelle water; lavender water; toilet water; wax for parquet floors; floor wax; non-slipping wax for floors; depilatory wax; mustache wax; tailors' wax; creams for leather; polish for furniture and flooring; shoemakers' wax; polishing wax; massage gels, other than for medical purposes; heliotropine; dental bleaching gels; geraniol; make-up; deodorants for pets; deodorants for human beings or for animals; depilatory preparations; air fragrance reed diffusers; scented wood; perfumes; non-slipping liquids for floors; windshield cleaning liquids; greases for cosmetic purposes; volcanic ash for cleaning; perfume; decorative transfers for cosmetic purposes; ionone [perfumery]; shaving stones [astringents]; smoothing stones; eyebrow pencils; cosmetic pencils; silicon carbide [abrasive]; carbides of metal [abrasives]; alum stones [astringents]; tripoli stone for polishing; adhesives for affixing false eyelashes; adhesives for affixing false hair; hair conditioners; quillaia bark for washing; corundum [abrasive]; beard dyes; colorants for toilet purposes; cosmetic dyes; laundry starch; laundry glaze; shoe cream; polishing creams; cosmetic creams; skin whitening creams; polishing rouge; incense; hair spray; nail polish; hair lotions; lotions for cosmetic purposes; after-shave lotions; beauty masks; oils for perfumes and scents; oils for cosmetic purposes; oils for toilet purposes; essential oils; essential oils of cedarwood; essential oils of lemon; essential oils of citron; oils for cleaning purposes; bergamot oil; gaultheria oil; jasmine oil; lavender oil; almond oil; rose oil; oil of turpentine for degreasing; whitening; cleaning chalk; almond milk for

cosmetic purposes; cleansing milk for toilet purposes; musk [perfumery]; deodorant soap; shaving soap; soap for brightening textile; cakes of toilet soap; antiperspirant soap; soap for foot perspiration; soap; almond soap; mint for perfumery; cosmetic kits; emery; nail art stickers; false nails; eau de Cologne; bases for flower perfumes; joss sticks; pastes for razor stroops; non-medicated dentifrices; pumice stone; lipstick cases; hydrogen peroxide for cosmetic purposes; breath freshening strips; teeth whitening strips; abrasive cloth; glass cloth [abrasive cloth]; lipsticks; pomades for cosmetic purposes; shaving preparations; cosmetic preparations for baths; bath preparations, not for medical purposes; hair straightening preparations; hair waving preparations; laundry soaking preparations; grinding preparations; smoothing preparations [starching]; color-removing preparations; leather bleaching preparations; polishing preparations; denture polishes; mouthwashes, not for medical purposes; cosmetic preparations for slimming purposes; starch glaze for laundry purposes; refurbishing preparations; eye-washes, not for medical purposes; fabric softeners for laundry use; laundry bleach; dry-cleaning preparations; paint stripping preparations; lacquer-removing preparations; make-up removing preparations; floor wax removers [scouring preparations]; varnish-removing preparations; rust removing preparations; nail care preparations; cleaning preparations; preparations for cleaning dentures; wallpaper cleaning preparations; preparations for unblocking drain pipes; chemical cleaning preparations for household purposes; collagen preparations for cosmetic purposes; bleaching preparations [decolorants] for household purposes; laundry preparations; aloe vera preparations for cosmetic purposes; sunscreen preparations; color-brightening chemicals for household purposes [laundry]; breath freshening preparations for personal hygiene; shining preparations [polish]; make-up powder; diamantine [abrasive]; stain removers; nail varnish removers; vaginal washes for personal sanitary or deodorant purposes; scouring solutions; false eyelashes; tissues impregnated with cosmetic lotions; tissues impregnated with make-up removing preparations; saffrol; massage candles for cosmetic purposes; laundry blueing; turpentine for degreasing; potpourris [fragrances]; bleaching soda; washing soda, for cleaning; bath salts, not for medical purposes; bleaching salts; fumigation preparations [perfumes]; preservatives for leather [polishes]; ammonia [volatile alkali] [detergent]; astringents for cosmetic purposes; eyebrow cosmetics; make-up preparations; sun-tanning preparations [cosmetics]; hair dyes; neutralizers for permanent waving; preparations to make the leaves of plants shiny; cosmetic preparations for eyelashes; cosmetic preparations for skin care; shoe wax; cosmetics; cosmetics for children; cosmetics for animals; mascara; cleansers for intimate personal hygiene purposes, non medicated; douching preparati-

ons for personal sanitary or deodorant purposes [toiletries]; detergents, other than for use in manufacturing operations and for medical purposes; degreasers, other than for use in manufacturing processes; bleaching preparations [decolorants] for cosmetic purposes; antiperspirants [toiletries]; toiletry preparations; phytocosmetic preparations; talcum powder, for toilet use; cotton sticks for cosmetic purposes; terpenes [essential oils]; emery cloth; cloths impregnated with a detergent for cleaning; henna [cosmetic dye]; shampoos for animals [non-medicated grooming preparations]; shampoos for pets [non-medicated grooming preparations]; dry shampoos; shampoos; sandpaper; soda lye; herbal extracts for cosmetic purposes; extracts of flowers [perfumes]; ethereal essences; badian essence; mint essence [essential oil].

8 – Razors, electric or non-electric; shaving tools; holders, cassettes, razor heads, cartridges and dispensers, all specifically designed for and containing razor blades; depilation appliances, electric and non-electric; razor blades; shaving cases; razor cases.

(260) AM 2019 102309 A

(800) 1456932

(151) 2019 02 06

(891) 2019 02 06

(731) Public Joint-stock Company "ARNEST COMPANY"

ul. Kombinatskaya, 6, g. Nevinnomyssk,  
RU-357107 Stavropolsky Krai, Russian  
Federation

(540)

# Bioni

(591) Black, white

(511)

3 – Abrasives; amber [perfume]; descaling preparations for household purposes; antistatic preparations for household purposes; aromatics [essential oils]; air fragrancing preparations; cake flavorings [essential oils]; flavorings for beverages [essential oils]; breath freshening sprays; canned pressurized air for cleaning and dusting purposes; balms, other than for medical purposes; lip glosses; polishing stones; abrasive paper; emery paper; polishing paper; petroleum jelly for cosmetic purposes; shoe polish; cobblers' wax; cotton wool for cosmetic purposes; sachets for perfuming linen; drying agents for dishwashing machines; adhesives for cosmetic purposes; scented water; Javelle water; lavender water; toilet water; laundry wax; floor wax; non-slipping wax for floors; depilatory wax; mustache wax; tailors' wax; polish for furniture and flooring; shoemakers' wax; polishing wax; massage gels, other than for medical purposes; heliotropine; dental bleaching gels; geraniol; make-up; deodorants for pets; deodorants for human

beings or for animals; scented wood; perfumes; non-slipping liquids for floors; windshield cleaning liquids; greases for cosmetic purposes; volcanic ash for cleaning; perfumery; decorative transfers for cosmetic purposes; ionone [perfumery]; shaving stones [astringents]; smoothing stones; eyebrow pencils; cosmetic pencils; silicon carbide [abrasive]; carbides of metal [abrasives]; alum stones [astringents]; tripoli stone for polishing; adhesives for affixing false eyelashes; adhesives for affixing false hair; quillaia bark for washing; corundum [abrasive]; beard dyes; colorants for toilet purposes; cosmetic dyes; laundry starch; laundry glaze; creams for leather; polishing creams; cosmetic creams; skin whitening creams; polishing rouge; incense; hair spray; nail polish; hair lotions; lotions for cosmetic purposes; after-shave lotions; beauty masks; oils for perfumes and scents; oils for cosmetic purposes; oils for toilet purposes; essential oils; essential oils of cedarwood; essential oils of lemon; essential oils of citron; oils for cleaning purposes; bergamot oil; gaultheria oil; jasmine oil; lavender oil; almond oil; rose oil; oil of turpentine for degreasing; whitening; cleaning chalk; almond milk for cosmetic purposes; cleansing milk for toilet purposes; musk [perfumery]; soap; deodorant soap; shaving soap; soap for brightening textile; cakes of toilet soap; antiperspirant soap; soap for foot perspiration; almond soap; mint for perfumery; cosmetic kits; emery; nail art stickers; false nails; eau de Cologne; bases for flower perfumes; cotton sticks for cosmetic purposes; joss sticks; pastes for razor strops; non-medicated dentifrices; pumice stone; hydrogen peroxide for cosmetic purposes; breath freshening strips; abrasive cloth; glass cloth [abrasive cloth]; lipsticks; pomades for cosmetic purposes; shaving preparations; cosmetic preparations for baths; toiletries; hair waving preparations; laundry soaking preparations; grinding preparations; douching preparations for personal sanitary or deodorant purposes [toiletries]; smoothing preparations [starching]; color-removing preparations; leather bleaching preparations; polishing preparations; denture polishes; mouthwashes, not for medical purposes; cosmetic preparations for slimming purposes; starch glaze for laundry purposes; refurbishing preparations; fabric softeners for laundry use; laundry bleach; dry-cleaning preparations; paint stripping preparations; lacquer-removing preparations; make-up removing preparations; floor wax removers [scouring preparations]; varnish-removing preparations; rust removing preparations; nail care preparations; cleaning preparations; preparations for cleaning dentures; wallpaper cleaning preparations; preparations for unblocking drain pipes; laundry preparations; aloe vera preparations for cosmetic purposes; sunscreen preparations; color-brightening chemicals for household purposes [laundry]; shining preparations [polish]; make-up powder; diamantine [abrasive]; stain removers; scouring solutions; false eyelashes; tissues im-

pregnated with cosmetic lotions; safrol; laundry blueing; turpentine for degreasing; potpourris [fragrances]; bleaching soda; washing soda, for cleaning; bath salts, not for medical purposes; bleaching salts; fumigation preparations [perfumes]; preservatives for leather [polishes]; ammonia [volatile alkali] [detergent]; astringents for cosmetic purposes; eyebrow cosmetics; make-up preparations; sun-tanning preparations [cosmetics]; hair dyes; neutralizers for permanent waving; preparations to make the leaves of plants shiny; cosmetic preparations for eyelashes; depilatory preparations; cosmetic preparations for skin care; shoe wax; cosmetics; cosmetics for animals; mascara; detergents, other than for use in manufacturing operations and for medical purposes; degreasers, other than for use in manufacturing processes; bleaching preparations [decolorants] for cosmetic purposes; antiperspirants [toiletries]; talcum powder, for toilet use; terpenes [essential oils]; emery cloth; cloths impregnated with a detergent for cleaning; henna [cosmetic dye]; shampoos; shampoos for pets [non-medicated grooming preparations]; dry shampoos; sandpaper; soda lye; extracts of flowers [perfumes]; ethereal essences; badian essence; mint essence [essential oil].

(260) AM 2019 102310 A

(800) 1456961

(151) 2018 09 26

(891) 2018 09 26

(731) EURO GAMES TECHNOLOGY LTD.

"Maritsa" Str. 4, "Vranya-Lozen-Triugulnika",  
BG-1151 Sofia, Bulgaria

(540)



The logo features the letters 'AWP' in a large, bold, green, 3D-style font. Below 'AWP', the text 'MULTI-2' is written in a smaller, green, sans-serif font with a slight shadow effect.

(591) Black, white, gray and green

(531) 27.05.02; 27.05.03; 27.05.09; 27.05.10;

27.05.17; 27.07.11; 29.01.14

(511)

9 – Software; computer gaming software; computer software packages; computer operating system software; computer software, recorded; software drivers; virtual reality software; games software; entertainment software for computer games; computer programs for network management; operating computer software for mainframe computers; monitors (computer hardware); computer hardware; apparatus for recording images; monitors (computer programs); computer game programs; computer programs for recorded games; apparatus for recording, transmission or reproduction of sound or images; communications servers [computer hardware]; electronic components for gambling machines; computer appli-



cation software featuring games and, gaming; computer software for the administration of on-line games and gaming; computer hardware for games and gaming; electronic components and computer software for gambling, gambling machines, gambling games on the internet and via telecommunication network.

28 – Gaming machines for gambling; chips for gambling; mah-jong; arcade games; gambling machines operating with coins, notes and cards; games; electronic games; parlor games; gaming chips; gaming tables; slot machines [gaming machines]; LCD game machines; slot machines and gaming devices; coin-operated amusement machines; roulette chips; poker chips; chips and dice [gaming equipment]; equipment for casinos; roulette tables; gaming roulette wheels; casino games; gambling machines and amusement machines, automatic and coin-operated; coin-operated amusement machines and/or electronic coin-operated amusement machines with or without the possibility of gain; boxes for coin-operated machines, slot machines and gaming machines; electronic or electrotechnical amusement machines and apparatus, gaming machines, coin-operated entertainment machines; housings for coin-operated machines, gaming equipment, gaming machines, machines for gambling; electropneumatic and electrical slot machines (gaming machines for gambling).

41 – Gambling; services related to gambling; gaming services for entertainment purposes; casino, gaming and gambling services; training in the development of software systems; provision of equipment for gambling halls; providing casino equipment [gambling]; gaming machine entertainment services; providing casino facilities [gambling]; gaming hall services; amusement arcade services; games equipment rental; rental of gaming machines; providing amusement arcade services; rental of gaming machines with images of fruits; editing or recording of sounds and images; sound recording and video entertainment services; hire of sound reproducing apparatus; provision of gaming equipment for casinos; providing of casino facilities; online gambling services; casino, gaming and gambling services; provision of gaming establishments, gaming halls, Internet casinos, online gaming services.

(260) AM 2019 102337 A  
(800) 1266688  
(151) 2015 06 08  
(891) 2019 02 12  
(731) THE BODY SHOP INTERNATIONAL LIMITED  
Watersmead, Littlehampton, West  
Sussex BN17 6LS, United Kingdom  
(540)

## THE BODY SHOP DROPS OF LIGHT

(591) Black, white  
(511)

3 – Bath preparations, not medicated; bath salts, not for medical purposes; non-medicated bath salts; cosmetics in the form of milks; cosmetics in the form of lotions; cosmetics in the form of creams; after-sun gels; body creams; oils for the body; essential oils; skin moisturisers; cosmetics in the form of oils; cosmetics in the form of gels, sun barriers; non-medicated cosmetics; after-sun oils.

(260) AM 2019 102339 A  
(800) 1302605  
(151) 2016 03 31  
(891) 2019 02 12  
(731) THE BODY SHOP INTERNATIONAL LIMITED  
Watersmead, Littlehampton, West  
Sussex BN17 6LS, United Kingdom

(540)

## THE BODY SHOP ROOTS OF STRENGTH

(591) Black, white  
(511)

3 – Cosmetics, skin care preparations, hair care preparations, nail care preparations; foundation, concealer, mascara, eye shadow, eye and/or brow liners, lipstick, lip liner, lip balm, face powder, bronzer, blusher, moisturizers, make-up remover, non-medicated body powder; skin soaps, bath gel, bath oils, bath salts, bath beads, effervescent bath preparations; skin lotions, creams, cleansers, scrubs, masks and toners for the skin; shampoos, conditioners, finishing hair spray and hair gels; personal deodorants, sun-tanning preparations, sunscreen oils and lotions, shaving preparations, dentifrices, perfumes, eau de toilette, essential oils for personal use, perfume oils, nail enamel, pumice stone, cotton sticks and wool swabs for non-medical purposes for use on the body, room fragrances, incense sticks, potpourri and sachets, powdered cosmetic tissues, tissues impregnated with cosmetic lotions; kits and gift sets containing skin, hair and/or nail care preparations.

(260) AM 2019 102340 A  
(800) 1385126  
(151) 2017 11 15  
(891) 2019 02 12  
(731) THE BODY SHOP INTERNATIONAL LIMITED  
Watersmead, Littlehampton, West  
Sussex BN17 6LS, United Kingdom  
(540)



SPA OF THE WORLD

(591) Black, white  
 (531) 01.15.23; 26.01.22; 26.11.12  
 (511)  
 3 – Cosmetics; make-up preparations; skin care preparations; body cream, body milk, moisturising body lotion (cosmetic); facial moisturisers (cosmetic).

(260) AM 2019 102414 A  
 (800) 1457768  
 (151) 2019 01 30  
 (891) 2019 01 30  
 (731) ABBOTT PRODUCTS OPERATIONS AG  
 Hegenheimermattweg 127, CH-4123  
 Allschwil, Switzerland

(540)  
**КОЛДБАРЬЕР**

(591) Black, white  
 (531) 28.05  
 (511)  
 5 – Pharmaceutical products and medical preparations; sanitary preparations for medical purposes; dietetic food and substances adapted for medical use, dietary and nutritional supplements for humans; vitamin preparations; plasters, materials for dressings.  
 10 – Aerosol dispensers and vaporizers for medical purposes.

(260) AM 2019 102415 A  
 (800) 1457778  
 (151) 2018 11 15  
 (891) 2018 11 15  
 (731) Joint stock company "TATSPIRTPROM"  
 Baumana str., 44/8, Kazan, RU-420111  
 Republic of Tatarstan, Russian Federation

(540)  
**RODRIGO ALEGRE**

(591) Black, white  
 (511)  
 33 – Alcoholic beverages (except beers).

(260) AM 2019 102416 A  
 (800) 1457804  
 (151) 2019 01 30  
 (891) 2019 01 30  
 (731) ABBOTT PRODUCTS OPERATIONS AG  
 Hegenheimermattweg 127, CH-4123  
 Allschwil, Switzerland

(540)  
**ОРВИАКТИВ**

(591) Black, white  
 (531) 28.05  
 (511)  
 5 – Pharmaceutical products and medical preparations; sanitary preparations for medical purposes;

dietetic food and substances adapted for medical use, dietary and nutritional supplements for humans; vitamin preparations; plasters, materials for dressings.

10 – Aerosol dispensers and vaporizers for medical purposes.

(260) AM 2019 102417 A  
 (800) 1457805  
 (151) 2019 01 28  
 (891) 2019 01 28  
 (731) Public Joint Stock Company "KRASNYJ  
 OCTYABR"  
 ul. Malaya Krasnoselskaya, d. 7, str. 24,  
 RU-107140 Moscow, Russian Federation

(540)



(591) White, black, yellow, dark yellow, brown, light brown, dark brown, green, light green, dark green, red, orange, pink and blue  
 (531) 03.04.02; 03.04.24; 05.05.04; 07.01.09; 07.01.13; 08.01.09; 08.01.19; 19.03.01; 19.03.05; 27.01.12; 28.05; 29.01.15

(511)  
 30 – Confectionery.

(260) AM 2019 102418 A  
 (800) 1457821  
 (151) 2019 02 15  
 (891) 2019 02 15  
 (731) APPLE INC.  
 One Apple Park Way, Cupertino CA 95014,  
 USA

(540)

**SMART KEYBOARD  
 FOLIO**

(591) Black, white  
 (526) KEYBOARD  
 (511)

9 – Accessory for a handheld mobile digital electronic device that functions as a protective and decorative case and a stand and incorporates a keyboard; cases adapted for computers; covers for tablet computers.

(260) AM 2019 102419 A  
 (800) 1457822  
 (151) 2018 09 26

(891) 2018 09 26

(731) EURO GAMES TECHNOLOGY LTD.

"Maritsa" Str. 4, "Vranya-Lozen-Triugulnika",  
BG-1151 Sofia, Bulgaria

(540)

(591) Black, white, gray, red, dark red, burgundy  
and dark burgundy(531) 27.05.02; 27.05.03; 27.05.09; 27.05.10;  
27.05.19; 27.07.11; 29.01.15

(511)

9 – Software; computer gaming software; computer software packages; computer operating system software; computer software, recorded; software drivers; virtual reality software; games software; entertainment software for computer games; computer programs for network management; operating computer software for mainframe computers; monitors (computer hardware); computer hardware; apparatus for recording images; monitors (computer programs); computer game programs; computer programs for recorded games; apparatus for recording, transmission or reproduction of sound or images; communications servers [computer hardware]; electronic components for gambling machines; computer application software featuring games and, gaming; computer software for the administration of on-line games and gaming; computer hardware for games and gaming; electronic components and computer software for gambling, gambling machines, gambling games on the internet and via telecommunication network.

28 – Gaming machines for gambling; chips for gambling; mah-jong; arcade games; gambling machines operating with coins, notes and cards; games; electronic games; parlor games; gaming chips; gaming tables; slot machines [gaming machines]; LCD game machines; slot machines and gaming devices; coin-operated amusement machines; roulette chips; poker chips; chips and dice [gaming equipment]; equipment for casinos; roulette tables; gaming roulette wheels; casino games; gambling machines and amusement machines, automatic and coin-operated; coin-operated amusement machines and/or electronic coin-operated amusement machines with or without the possibility of gain; boxes for coin-operated machines, slot machines and gaming machines; electronic or electrotechnical amusement machines and apparatus, gaming machines, coin-operated entertainment machines; housings for coin-operated machines, gaming equipment, gaming machines, machines for gambling; electropneumatic and electrical slot machines (gaming machines for gambling).

41 – Gambling; services related to gambling; gaming services for entertainment purposes; casino, gaming and gambling services; training in the development of software systems; provision of equipment for gambling halls; providing casino equipment [gambling]; gaming machine entertainment services; providing casino facilities [gambling]; gaming hall services; amusement arcade services; games equipment rental; rental of gaming machines; providing amusement arcade services; rental of gaming machines with images of fruits; editing or recording of sounds and images; sound recording and video entertainment services; hire of sound reproducing apparatus; provision of gaming equipment for casinos; providing of casino facilities; online gambling services; casino, gaming and gambling services; provision of gaming establishments, gaming halls, Internet casinos, online gaming services.

(260) AM 2019 102420 A

(800) 1457827

(151) 2018 09 28

(891) 2018 09 28

(731) EGIS GYÓGYSZERGYÁR ZRT.

Keresztúri út 30-38., H-1106 Budapest,  
Hungary

(540)

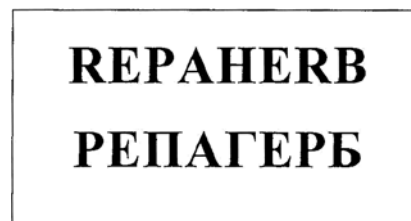

(591) Black, white

(531) 26.04.22; 28.05

(511)

3 – Cosmetics, personal sanitary preparations.

(260) AM 2019 102441 A

(800) 1458532

(151) 2018 07 24

(891) 2018 07 24

(731) GUMENIUK MYKOLA IVANOVYCH

vul. Klinichna, 23-25, ap. 173, Kyiv 03110,  
Ukraine;

DERKACH NATALIYA MYKOLAIVNA

vul. Klinichna, 23-25, ap. 173, Kyiv 03110,  
Ukraine

(540)

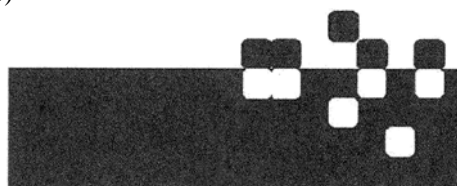

(591) Black, white

(531) 26.04.08; 26.04.09; 26.04.24

(511)

5 – Absorbent cotton; acai powder dietary supplements; acaricides; acetates for pharmaceutical purposes; acids for pharmaceutical purposes; acne treatment preparations; aconitine, adhesive plasters, adhesives for dentures; adhesive tapes for medical purposes; adjuvants for medical purposes; air deodorising preparations; air purifying preparations; albumin dietary supplements; albuminous foodstuffs for medical purposes; albuminous preparations for medical purposes; alcohol for pharmaceutical purposes; aldehydes for pharmaceutical purposes; algicides; alginate dietary supplements; alginates for pharmaceutical purposes; alkaline iodides for pharmaceutical purposes; alkaloids for medical purposes; alloys of precious metals for dental purposes; almond milk for pharmaceutical purposes; aloe vera preparations for pharmaceutical purposes, aluminium acetate for pharmaceutical purposes; amino acids for medical purposes; amino acids for veterinary purposes; anaesthetics; analgesics; angostura bark for medical purposes; animal washes [insecticides]; antibacterial handwashes; antibacterial soap; antibiotics; anticryptogamic preparations; antioxidant pills; antiparasitic collars for animals; antiparasitic preparations; antiseptic cotton; antiseptics; anti-uric preparations; appetite suppressant pills; appetite suppressants for medical purposes; aseptic cotton; asthmatic tea; astringents for medical purposes; babies' diaper-pants; babies' diapers; bacterial poisons; bacterial preparations for medical and veterinary use; bacteriological preparations for medical and veterinary use; balms for medical purposes; balsamic preparations for medical purposes; bandages for dressings; barks for pharmaceutical purposes; bath preparations for medical purposes; bath salts for medical purposes; bicarbonate of soda for pharmaceutical purposes; biocides; biological preparations for medical purposes; biological preparations for veterinary purposes; biological tissue cultures for medical purposes; biological tissue cultures for veterinary purposes; bismuth preparations for pharmaceutical purposes; bismuth subnitrate for pharmaceutical purposes; blood for medical purposes; blood plasma; bone cement for surgical and orthopaedic purposes; breast-nursing pads; bromine for pharmaceutical purposes; bronchodilating preparations; bunion pads; by-products of the processing of cereals for dietetic or medical purposes; cachets for pharmaceutical purposes; cachou for pharmaceutical purposes; calomel [fungicide]; camphor for medical purposes; camphor oil for medical purposes; candy for medical purposes; candy, medicated; capsules for medicines; carbolineum [parasiticide]; casein dietary supplements; castor oil for medical purposes; cattle washes [insecticides]; caustic pencils; caustics for pharmaceutical purposes; cedar wood for use as an insect repellent; cellulose esters for pharmaceutical purposes; cellulose ethers for

pharmaceutical purposes; cement for animal hooves; charcoal for pharmaceutical purposes; chemical conductors for electrocardiograph electrodes; chemical contraceptives; chemical preparations for medical purposes; chemical preparations for pharmaceutical purposes; chemical preparations for the diagnosis of pregnancy; chemical preparations for treating phylloxera; chemical preparations for veterinary purposes; chemical preparations to treat mildew; chemical preparations to treat wheat blight; chemical reagents for medical or veterinary purposes; chemico-pharmaceutical preparations; chewing gum for medical purposes; chilblain preparations; chinoline for medical purposes; chloroform; cocaine; cod liver oil; collagen for medical purposes; collodion for pharmaceutical purposes; collyrium; compresses; condurango bark for medical purposes; contact lens cleaning preparations; cooling sprays for medical purposes; corn remedies; corn rings for the feet; cotton for medical purposes; cotton sticks for medical purposes; cream of tartar for pharmaceutical purposes; creosote for pharmaceutical purposes; croton bark; cultures of microorganisms for medical or veterinary use; curare; decoctions for pharmaceutical purposes; dental abrasives; dental amalgams; dental amalgams of gold; dental cements; dental impression materials; dental lacquer; dental mastics; deodorants for clothing and textiles; deodorants, other than for human beings or for animals; depuratives; detergents for medical purposes; diabetic bread adapted for medical use; diagnostic biomarker reagents for medical purposes; diagnostic preparations for medical purposes; diagnostic preparations for veterinary purposes; diapers for incontinents; diapers for pets; diastase for medical purposes; dietary fiber; dietary supplements for animals; dietary supplements with a cosmetic effect; dietetic beverages adapted for medical purposes; dietetic foods adapted for medical purposes; dietetic substances adapted for medical use; digestives for pharmaceutical purposes; digitalin; dill oil for medical purposes; disinfectants; disinfectants for chemical toilets; disinfectants for hygiene purposes; disinfectant soap; dog washes [insecticides]; douching preparations for medical purposes; dressings, medical; drugs for medical purposes; elixirs [pharmaceutical preparations]; enzyme dietary supplements; enzyme preparations for medical purposes; enzyme preparations for veterinary purposes; enzymes for medical purposes; enzymes for veterinary purposes; ergot for pharmaceutical purposes; esters for pharmaceutical purposes; ethers for pharmaceutical purposes; eucalyptol for pharmaceutical purposes; eucalyptus for pharmaceutical purposes; extracts of hops for pharmaceutical purposes; febrifuges; eyepatches for medical purposes; fennel for medical purposes; ferments for pharmaceutical purposes; first-aid boxes, filled; fish meal for pharmaceutical purposes; flour for pharmaceutical purposes; flowers of sulfur for pharmaceutical purposes; fly catching

paper; fly destroying preparations; fly glue; food for babies; formic aldehyde for pharmaceutical purposes; freeze-dried food adapted for medical purposes; freeze-dried meat adapted for medical purposes; frostbite salve for pharmaceutical purposes; fumigating sticks; fumigation preparations for medical purposes; fungicides; gallic acid for pharmaceutical purposes; gamboge for medical purposes; gases for medical purposes; gauze for dressings; gelatine for medical purposes; gentian for pharmaceutical purposes; germicides; glucose dietary supplements; glucose for medical purposes; glycerine for medical purposes; glycerophosphates; greases for medical purposes; greases for veterinary purposes; guaiacol for pharmaceutical purposes; gum for medical purposes; gurjun balsam for medical purposes; hematogen; hemoglobin; hemorrhoid preparations; hemostatic pencils; herbal extracts for medical purposes; herbal teas for medicinal purposes; herbicides; homogenized food adapted for medical purposes; hormones for medical purposes; hydrastine; hydrastinine; hydrated chloral for pharmaceutical purposes; hydrogen peroxide for medical purposes; immunostimulants; infant formula; insecticidal animal shampoo; insecticidal veterinary washes; insecticides; insect repellent incense; insect repellents; iodides for pharmaceutical purposes; iodine for pharmaceutical purposes; iodoform; Irish moss for medical purposes; isotopes for medical purposes; jalap; jujube, medicated; lacteal flour for babies; lactose for pharmaceutical purposes; larvae exterminating preparations; laxatives; lead water; lecithin dietary supplements; lecithin for medical purposes; leeches for medical purposes; lice treatment preparations [pediculicides]; lime-based pharmaceutical preparations; liniments; linseed dietary supplements; linseed for pharmaceutical purposes; linseed meal for pharmaceutical purposes; linseed oil dietary supplements; lint for medical purposes; liquorice for pharmaceutical purposes; lotions for pharmaceutical purposes; lotions for veterinary purposes; lupulin for pharmaceutical purposes; magnesia for pharmaceutical purposes; malted milk beverages for medical purposes; malt for pharmaceutical purposes; mangrove bark for pharmaceutical purposes; media for bacteriological cultures; medical preparations for slimming purposes; medicated after-shave lotions; medicated animal feed; medicated dentifrices; medicated dry shampoos; medicated eye-washes; medicated hair lotions; medicated massage candles; medicated shampoos; medicated shampoos for pets; medicated soap; medicated toiletry preparations; medicinal alcohol; medicinal drinks; medicinal hair growth preparations; medicinal herbs; medicinal infusions; medicinal mud; medicinal oils; medicinal roots; medicinal tea; medicine cases, portable, filled; medicines for alleviating constipation; medicines for dental purposes; medicines for human purposes; medicines for veterinary purposes; melissa water for pharmaceutical purposes; menthol; mercu-

rial ointments; milk ferments for pharmaceutical purposes; milking grease; mineral food supplements; mineral water salts; mineral waters for medical purposes; mint for pharmaceutical purposes; molding wax for dentists; moleskin for medical purposes; mothproofing paper; mothproofing preparations; mouthwashes for medical purposes; mud for baths; mustard for pharmaceutical purposes; mustard oil for medical purposes; mustard plasters; myrobalan bark for pharmaceutical purposes; narcotics; nervines; nicotine gum for use as an aid to stop smoking; nicotine patches for use as aids to stop smoking; nutraceutical preparations for therapeutic or medical purposes; nutritional supplements; nutritive substances for microorganisms; oil of turpentine for pharmaceutical purposes; ointments for pharmaceutical purposes; opiates; opium; opodeldoc; ophotherapy preparations; oxygen baths; oxygen for medical purposes; pants, absorbent, for incontinents; panty liners [sanitary]; paper for mustard plasters; parasiticides; pastilles for pharmaceutical purposes; pearl powder for medical purposes; pectin for pharmaceutical purposes; pediculicidal shampoos; pepsins for pharmaceutical purposes; peptones for pharmaceutical purposes; personal sexual lubricants; pesticides; petroleum jelly for medical purposes; pharmaceutical preparations; pharmaceutical preparations for skin care; pharmaceutical preparations for treating dandruff; pharmaceutical preparations for treating sunburn; pharmaceuticals; phenol for pharmaceutical purposes; phosphates for pharmaceutical purposes; phytotherapy preparations for medical purposes; plant extracts for pharmaceutical purposes; poisons; pollen dietary supplements; pomades for medical purposes; porcelain for dental prostheses; potassium salts for medical purposes; poultices; powdered milk for babies; powder of cantharides; pre-filled syringes for medical purposes; preparations for callouses; preparations for destroying dry rot fungus; preparations for destroying mice; preparations for destroying noxious animals; preparations for reducing sexual activity; preparations for the treatment of burns; preparations of microorganisms for medical or veterinary use; preparations of trace elements for human and animal use; preparations to facilitate teething; propolis dietary supplements; propolis for pharmaceutical purposes; protein dietary supplements; protein supplements for animals; purgatives; pyrethrum powder; quassia for medical purposes; quebracho for medical purposes; quinine for medical purposes; quinquina for medical purposes; radioactive substances for medical purposes; radiological contrast substances for medical purposes; radium for medical purposes; reagent paper for veterinary purposes; remedies for foot perspiration; remedies for perspiration; repellents for dogs; rhubarb roots for pharmaceutical purposes; royal jelly dietary supplements; royal jelly for pharmaceutical purposes; rubber for dental pur-

poses; salts for medical purposes; salts for mineral water baths; sanitary panties; sanitary tampons; sanitary towels; sarsaparilla for medical purposes; scapulars for surgical purposes; sea water for medicinal bathing; sedatives; semen for artificial insemination; serotherapeutic medicines; serums; sexual stimulant gels; siccatives [drying agents] for medical purposes; slimming pills; slug exterminating preparations; smelling salts; smoking herbs for medical purposes; sodium salts for medical purposes; soil-sterilising preparations; solutions for contact lenses; solvents for removing adhesive plasters; soporifics; starch for dietetic or pharmaceutical purposes; stem cells for medical purposes; stem cells for veterinary purposes; sterilising preparations; steroids; stick liquorice for pharmaceutical purposes; strychnine; styptic preparations; sugar for medical purposes; sulfonamides [medicines]; sulfur sticks [disinfectants]; sunburn ointments; suppositories; surgical dressings; surgical glues; surgical implants comprised of living tissues; syrups for pharmaceutical purposes; tanning pills; tartar for pharmaceutical purposes; teeth filling material; therapeutic preparations for the bath; thermal water; thymol for pharmaceutical purposes; tincture of iodine; tinctures for medical purposes; tissues impregnated with pharmaceutical lotions; tobacco extracts [insecticides]; tobacco-free cigarettes for medical purposes; tonics [medicines]; transplants [living tissues]; turpentine for pharmaceutical purposes; vaccines; vaginal washes for medical purposes; vermifuges; vermin destroying preparations; vesicants; veterinary preparations; vine disease treating chemicals; vitamin preparations; vitamin supplement patches; vulnerary sponges; wadding for medical purposes; wart pencils; wheat germ dietary supplements; yeast dietary supplements; yeast for pharmaceutical purposes.

10 – Abdominal belts; abdominal corsets; abdominal pads; acupuncture needles; aerosol dispensers for medical purposes; air beds for medical purposes; air cushions for medical purposes; air mattresses for medical purposes; air pillows for medical purposes; ambulance stretchers; anaesthetic apparatus; anaesthetic masks; analysers for bacterial identification for medical purposes; anti-nausea wristbands; anti-rheumatism bracelets; anti-rheumatism rings; apparatus and installations for the production of X-rays, for medical purposes; apparatus for acne treatment; apparatus for artificial respiration; apparatus for DNA and RNA testing for medical purposes; apparatus for the regeneration of stem cells for medical purposes; apparatus for the treatment of deafness; appliances for washing body cavities; arch supports for footwear; armchairs for medical or dental purposes; artificial breasts; artificial eyes; artificial jaws; artificial limbs; artificial skin for surgical purposes; artificial teeth; babies' pacifiers [teats]; baby feeding dummies; balling guns; bandages, elastic; basins for medical purposes; bed pans; beds specially made for

medical purposes; bed vibrators; belts, electric, for medical purposes; belts for medical purposes; biodegradable bone fixation implants; blankets, electric, for medical purposes; blood testing apparatus; body composition monitors; body fat monitors; body rehabilitation apparatus for medical purposes; boots for medical purposes; bracelets for medical purposes; brain pacemakers; breast pumps; brushes for cleaning body cavities; cannulae; cases fitted for medical instruments; castrating pincers; catgut; catheters; childbirth mattresses; clips, surgical; clothing especially for operating rooms; commode chairs; compression garments; compressors [surgical]; condoms; containers especially made for medical waste; contraceptives, non-chemical; cooling pads for first aid purposes; cooling patches for medical purposes; corn knives; corsets for medical purposes; crutches; cupping glasses; cushions for medical purposes; defibrillators; dental apparatus and instruments; dental apparatus, electric; dental burs; dentists' armchairs; dentures; diagnostic apparatus for medical purposes; dialyzers; douche bags; drainage tubes for medical purposes; draw-sheets for sick beds; dropper bottles for medical purposes; droppers for medical purposes; ear picks; ear plugs [ear protection devices]; ear trumpets; elastic stockings for surgical purposes; electric acupuncture instruments; electrocardiographs; electrodes for medical use; endoscopy cameras for medical purposes; enema apparatus for medical purposes; esthetic massage apparatus; feeding bottles; feeding bottle teats; feeding bottle valves; filters for ultraviolet rays, for medical purposes; finger guards for medical purposes; forceps; fumigation apparatus for medical purposes; furniture especially made for medical purposes; galvanic belts for medical purposes; galvanic therapeutic appliances; gastroscopes; gloves for massage; gloves for medical purposes; hair prostheses; hearing aids; hearing protectors; heart pacemakers; heart rate monitoring apparatus; heating cushions, electric, for medical purposes; hemocytometers; hot air therapeutic apparatus; hot air vibrators for medical purposes; hydrogen inhalers; hydrostatic beds for medical purposes; hypodermic syringes; hypogastric belts; ice bags for medical purposes; implantable subcutaneous drug delivery devices; incontinence sheets; incubators for babies; incubators for medical purposes; inhalers; injectors for medical purposes; instrument cases for use by doctors; insufflators; invalids' hoists; knee bandages, orthopaedic; knives for surgical purposes; lamps for medical purposes; lancets; lasers for medical purposes; lenses [intraocular prostheses] for surgical implantation; lice combs; love dolls [sex dolls]; magnetic resonance imaging [MRI] apparatus for medical purposes; masks for use by medical personnel; massage apparatus; maternity belts; medical apparatus and instruments; medical guidewires; menstrual cups; microdermabrasion apparatus; mirrors for dentists; mirrors for surgeons; nasal aspira-

tors; needles for medical purposes; nursing appliances; obstetric apparatus; obstetric apparatus for cattle; operating tables; ophthalmometers; ophthalmoscopes; orthodontic appliances; orthodontic rubber bands; orthopaedic belts; orthopaedic footwear; orthopaedic soles; orthopedic articles; pads for preventing pressure sores on patient bodies; pessaries; physical exercise apparatus for medical purposes; physiotherapy apparatus; pins for artificial teeth; plaster bandages for orthopaedic purposes; portable hand-held urinals; probes for medical purposes; protection devices against X-rays, for medical purposes; pulse meters; pumps for medical purposes; quad canes for medical purposes; quartz lamps for medical purposes; radiological apparatus for medical purposes; radiology screens for medical purposes; radiotherapy apparatus; radium tubes for medical purposes; receptacles for applying medicines; respirators for artificial respiration; respiratory masks for artificial respiration; resuscitation apparatus; saws for surgical purposes; scalpels; scissors for surgery; sex toys; slings [supporting bandages]; soporific pillows for insomnia; sphygmomanometers; spirometers [medical apparatus]; spittoons for medical purposes; splints, surgical; spoons for administering medicine; stents; sterile sheets, surgical; stethoscopes; stockings for varices; strait jackets; stretchers, wheeled; supportive bandages; supports for flat feet; surgical apparatus and instruments; surgical bougies; surgical cutlery; surgical drapes; surgical implants comprised of artificial materials; surgical robots; surgical sponges; suspensory bandages; suture materials; suture needles; syringes for injections; syringes for medical purposes; teething rings; teeth protectors for dental purposes; temperature indicator labels for medical purposes; testing apparatus for medical purposes; thermal packs for first aid purposes; thermo-electric compresses [surgery]; thermometers for medical purposes; thread, surgical; tips for crutches; toe separators for orthopaedic purposes; tomographs for medical purposes; tongue depressors for medical purposes; tongue scrapers; traction apparatus for medical purposes; trocars; trusses; ultraviolet ray lamps for medical purposes; umbilical belts; urethral probes; urethral syringes; urinals [vessels]; urological apparatus and instruments; uterine syringes; vaginal syringes; vaporizers for medical purposes; veterinary apparatus and instruments; vibromassage apparatus; walking frames for disabled persons; walking sticks for medical purposes; water bags for medical purposes; wheeled walkers to aid mobility; X-ray apparatus for medical purposes; X-ray photographs for medical purposes; X-ray tubes for medical purposes.

35 – Administration of consumer loyalty programs; administration of frequent flyer programs; administrative assistance in responding to calls for tenders; administrative processing of purchase orders; advertising; advertising agency services; advertising by

mail order; advisory services for business management; appointment reminder services [office functions]; appointment scheduling services [office functions]; arranging newspaper subscriptions for others; arranging subscriptions to telecommunication services for others; auctioneering; bill-posting; book-keeping; business appraisals; business auditing; business efficiency expert services; business information; business inquiries; business intermediary services relating to the matching of potential private investors with entrepreneurs needing funding; business investigations; business management and organization consultancy; business management assistance; business management consultancy; business management for freelance service providers; business management of hotels; business management of performing artists; business management of reimbursement programs for others; business management of sports people; business organization consultancy; business project management services for construction projects; business research; commercial administration of the licensing of the goods and services of others; commercial information agency services; commercial information and advice for consumers in the choice of products and services; commercial intermediation services; commercial or industrial management assistance; competitive intelligence services; compilation of information into computer databases; compilation of statistics; compiling indexes of information for commercial or advertising purposes; computerized file management; consultancy regarding advertising communication strategies; consultancy regarding public relations communication strategies; cost price analysis; data search in computer files for others; demonstration of goods; design of advertising materials; direct mail advertising; dissemination of advertising matter; distribution of samples; document reproduction; drawing up of statements of accounts; economic forecasting; employment agency services; financial auditing; gift registry services; import-export agency services; interim business management; invoicing; layout services for advertising purposes; marketing; marketing in the framework of software publishing; marketing research; market intelligence services; market studies; modelling for advertising or sales promotion; negotiation and conclusion of commercial transactions for third parties; negotiation of business contracts for others; news clipping services; office machines and equipment rental; on-line advertising on a computer network; online retail services for downloadable and pre-recorded music and movies; online retail services for downloadable digital music; online retail services for downloadable ring tones; opinion polling; organization of exhibitions for commercial or advertising purposes; organization of fashion shows for promotional purposes; organization of trade fairs for commercial or advertising purposes; outdoor advertising; outsourced administrative mana-

gement for companies; outsourcing services [business assistance]; pay per click advertising; payroll preparation; personnel management consultancy; personnel recruitment; photocopying services; presentation of goods on communication media, for retail purposes; price comparison services; procurement services for others [purchasing goods and services for other businesses]; production of advertising films; production of teleshopping programmes; professional business consultancy; promotion of goods and services through sponsorship of sports events; providing business information via a web site; provision of an on-line marketplace for buyers and sellers of goods and services; provision of commercial and business contact information; psychological testing for the selection of personnel; publication of publicity texts; publicity material rental; public relations; radio advertising; registration of written communications and data; relocation services for businesses; rental of advertising space; rental of advertising time on communication media; rental of billboards [advertising boards]; rental of photocopying machines; rental of sales stands; rental of vending machines; retail services for pharmaceutical, veterinary and sanitary preparations and medical supplies; retail services for works of art provided by art galleries; sales promotion for others; scriptwriting for advertising purposes; search engine optimization for sales promotion; secretarial services; shop window dressing; shorthand; sponsorship search; systemization of information into computer databases; targeted marketing; tax filing services; tax preparation; telemarketing services; telephone answering for unavailable subscribers; television advertising; transcription of communications [office functions]; typing; updating and maintenance of data in computer databases; updating and maintenance of information in registries; updating of advertising material; web indexing for commercial or advertising purposes; web site traffic optimization; wholesale services for pharmaceutical, veterinary and sanitary preparations and medical supplies; word processing; writing of publicity texts; writing of resumes for others.

44 – Aerial and surface spreading of fertilizers and other agricultural chemicals; alternative medicine services; animal breeding; animal grooming; aquaculture services; aromatherapy services; artificial insemination services; beauty salon services; blood bank services; body piercing; chiropractic; convalescent home services; dentistry services; depilatory waxing; farming equipment rental; flower arranging; gardening; hairdressing; hair implantation; health care; health center services; health counselling; health spa services; horticulture; hospice services; hospital services; human tissue bank services; in vitro fertilization services; landscape design; landscape gardening; lawn care; manicuring; massage; medical advice for individuals with disabilities; medical assistance; medical clinic services; medical equipment

rental; midwife services; nursing home services; nursing, medical; opticians' services; orthodontic services; palliative care; pest control services for agriculture, aquaculture, horticulture and forestry; pet grooming; pharmacy advice; physical therapy; plant nursery services; plastic surgery; preparation of prescriptions by pharmacists; public bath services for hygiene purposes; reforestation services; rehabilitation for substance abuse patients; rental of sanitation facilities; rest home services; sanatorium services; sauna services; services of a psychologist; solarium services; speech therapy; tattooing; telemedicine services; therapy services; tree planting for carbon offsetting purposes; tree surgery; Turkish bath services; vermin exterminating for agriculture, aquaculture, horticulture and forestry; veterinary assistance; visagists' services; weed killing; wreath making.

---

(260) AM 2019 102445 A

(800) 1458556

(151) 2019 01 25

(891) 2019 01 25

(731) LUCAS INDUSTRIES LIMITED  
Stratford Road, Solihull B90 4LAX,  
United Kingdom

(540)

## GIRLING

(591) Black, white

(511)

12 – Vehicles; apparatus for locomotion by land, air or water; parts and fittings for vehicles; brake systems and brake parts for vehicles; brakes; brake pads and brake shoes; brake discs; brake drums; brake linings; brake boosters; brake cylinders; suspension systems for vehicles; parts of suspension systems for vehicles; suspension ball joints; torsion dampers for vehicles and shock absorbers; steering systems for vehicles; steering wheels for vehicles; steering columns for vehicles; steering joints; steering racks; chassis for land vehicles; axles and drive shafts for vehicles; gear boxes and clutches for land vehicles; wheels, wheel rims for vehicles; bumpers, mudguards for vehicles; hydraulic, pneumatic, electrical or mechanical springs for shock absorbers; lifting cars; direction signals for vehicles; turn signals for vehicles; inner and outer tires for vehicles; tire repair kits, patches for repairing inner tubes; valves for vehicle tires; windows for vehicles; windshield wipers; fuel tanks for vehicles; anti-skid chains for vehicles; driving chains for land vehicles; air pumps for vehicles, namely tire inflating pumps; horns and anti-theft alarms for vehicles; rear view mirrors; side mirrors; window glass and mirrors for use on vehicles including covers and housings adapted therefor; glass windows for vehicles [finished goods].

---



(260) AM 2019 102467 A

(800) 1458800

(151) 2018 11 15

(891) 2018 11 15

(731) EMIRATES

Emirates Group Headquarters, PO Box 686,  
Dubai, United Arab Emirates

(540)

 The logo for 'FLY BETTER' features the words 'FLY BETTER' in a bold, italicized, sans-serif font. A thick black swoosh underline starts under the 'F' and curves around the bottom of the text.

(591) Black, white

(531) 26.11.01; 26.11.12; 27.05.08

(511)

39 – Airline services; air transportation services, aircraft chartering services; airport check-in services; courier services for cargo and passengers; cargo handling services; chauffeur and limousine services; delivery of goods by air; escorting of travellers; freight and mail forwarding agency services; freight brokerage and freight forwarding services; guarded transport services; travel guide services; air navigation services; air traffic control services; packing and storage of goods; operating and organizing travel tours; booking and reservation agencies for travel; booking of seats for travel; warehousing services; information services relating to travel services and travel, including that provided on-line from a computer database or the Internet; route planning services; providing information relating to the planning and booking of airline travel, via electronic means; airport services relating to the management of transport functioning of airports; information and advisory services relating to all the aforesaid services; provision of airport facilities for passenger aviation; all included in this class.

(260) AM 2019 102480 A

(800) 207666

(151) 1958 02 24

(891) 2019 02 05

(731) HENKEL AG &amp; CO. KGAA

Henkelstrasse 67, 40589 Düsseldorf, Germany

(540)

## SILHOUETTE

(591) Black, white

(511)

3 – Essential oils, bleaching preparations, substances for washing hair, cosmetics, perfumery goods, soaps, washing products.

(260) AM 2019 102481 A

(800) 882927

(151) 2006 02 10

(891) 2019 02 12

(731) THE BODY SHOP INTERNATIONAL  
LIMITEDWatersmead; Littlehampton, West  
Sussex BN17 6LS, United Kingdom

(540)

## LOVE YOUR BODY

(591) Black, white

(511)

35 – Organisation, operation and supervision of customer loyalty schemes.

36 – Issuing of tokens of value in relation to customer loyalty.

(260) AM 2019 102483 A

(800) 1219150

(151) 2014 04 07

(891) 2019 02 08

(731) Open Joint Stock Company, "MOLOCHNY  
KOMBINAT VORONEGSKY"45 Strelkovoy Divizi, 259, RU-394016  
Voroneg, Russian Federation

(540)

 The logo for 'ВКУШОТеево' features the brand name in a stylized, rounded font. The letters are white with a red outline, set against a red, cloud-like background shape.

(591) Red and white

(531) 01.15.11; 29.01.12

(511)

5 – Acaricides; aconitine; alkaloids for medical purposes; alginates for pharmaceutical purposes; algicides; aldehydes for pharmaceutical purposes; dental amalgams of gold; dental amalgams; amino acids for veterinary purposes; amino acids for medical purposes; analgesics; anaesthetics; antibiotics; antiseptics; medicine cases, portable, filled; first-aid boxes, filled; aluminium acetate for pharmaceutical purposes; acetates for pharmaceutical purposes; germicides; balms for medical purposes; bandages for dressings; biocides; bracelets for medical purposes; anti-rheumatism bracelets; bromine for pharmaceutical purposes; paper for mustard plasters; fly catching paper; reagent paper for medical or veterinary purposes; mothproofing paper; petroleum jelly for medical purposes; vaccines; oxygen baths; antiseptic cotton; aseptic cotton; absorbent cotton; wadding for medical purposes; cotton for medical purposes; dietetic substances adapted for medical use; radiological contrast substances for medical purposes; nutritive substances for microorganisms; radioactive substances for medical purposes; bismuth subnitrate for pharmaceutical purposes; melissa water for pharma-

ceutical purposes; sea water for medicinal bathing; mineral waters for medical purposes; thermal water; dietary fiber; molding wax for dentists; gases for medical purposes; guaiacol for pharmaceutical purposes; hematogen; hemoglobin; hydrastine; hydrastinine; glycerine for medical purposes; glycerophosphates; glucose for medical purposes; gentian for pharmaceutical purposes; hormones for medical purposes; mustard for pharmaceutical purposes; mustard plasters; mud for baths; medicinal mud; gamboge for medical purposes; gurjun [gurjon, gurjan] balsam for medical purposes; air deodorising preparations; deodorants, other than for human beings or for animals; deodorants for clothing and textiles; diastase for medical purposes; digitalin; mineral food supplements; nutritional supplements; albumin dietary supplements; dietary supplements for animals; alginate dietary supplements; glucose dietary supplements; casein dietary supplements; lecithin dietary supplements; linseed oil dietary supplements; propolis dietary supplements; protein dietary supplements; protein supplements for animals; royal jelly dietary supplements; pollen dietary supplements; wheat germ dietary supplements; linseed dietary supplements; enzyme dietary supplements; yeast for pharmaceutical purposes; gelatine for medical purposes; cod liver oil; isotopes for medical purposes; insecticides; iodine for pharmaceutical purposes; iodides for pharmaceutical purposes; alkaline iodides for pharmaceutical purposes; iodoform; calomel; cream of tartar for pharmaceutical purposes; tartar for pharmaceutical purposes; camphor for medical purposes; capsules for medicines; cachets for pharmaceutical purposes; hemostatic pencils; wart pencils; caustic pencils; headache pencils; carbolineum [parasiticide]; caustics for pharmaceutical purposes; cachou for pharmaceutical purposes; quassia for medical purposes; quebracho for medical purposes; oxygen for medical purposes; gallic acid for pharmaceutical purposes; acids for pharmaceutical purposes; adhesives for dentures; surgical glues; adhesive tapes for medical purposes; stem cells for veterinary purposes; stem cells for medical purposes; cocaine; collodion for pharmaceutical purposes; corn rings for the feet; anti-rheumatism rings; candy, medicated; angostura bark for medical purposes; barks for pharmaceutical purposes; cedar wood for use as an insect repellent; condurango bark for medical purposes; croton bark; mangrove bark for pharmaceutical purposes; myrobalan bark for pharmaceutical purposes; quinquina for medical purposes; medicinal roots; rhubarb roots for pharmaceutical purposes; lint for medical purposes; starch for dietetic or pharmaceutical purposes; creosote for pharmaceutical purposes; blood for medical purposes; cultures of microorganisms for medical and veterinary use; curare; dental lacquer; liquorice for pharmaceutical purposes; lactose for pharmaceutical purposes; candy for medical purposes; adhesive plasters; medici-

nes for alleviating constipation; lecithin for medical purposes; lotions for veterinary purposes; dog lotions; lotions for pharmaceutical purposes; personal sexual lubricants; lupulin for pharmaceutical purposes; magnesia for pharmaceutical purposes; liniments; ointments for pharmaceutical purposes; sunburn ointments; mercurial ointments; frostbite salve for pharmaceutical purposes; gauze for dressings; medicinal oils; mustard oil for medical purposes; camphor oil for medical purposes; castor oil for medical purposes; oil of turpentine for pharmaceutical purposes; dill oil for medical purposes; dental mastics; dental abrasives; dental impression materials; teeth filling material; dressings, medical; surgical dressings; drugs for medical purposes; medicines for veterinary purposes; serotherapeutic medicines; medicines for human purposes; medicines for dental purposes; menthol; medicinal drinks; moleskin for medical purposes; milk of almonds for pharmaceutical purposes; royal jelly for pharmaceutical purposes; milk ferments for pharmaceutical purposes; Irish moss for medical purposes; flour for pharmaceutical purposes; linseed meal for pharmaceutical purposes; fish meal for pharmaceutical purposes; fly glue; mint for pharmaceutical purposes; dietetic beverages adapted for medical purposes; malted milk beverages for medical purposes; narcotics; medicinal infusions; tincture of iodine; eucalyptol for pharmaceutical purposes; tinctures for medical purposes; opium; opodeldoc; decoctions for pharmaceutical purposes; antiparasitic collars for animals; stick liquorice for pharmaceutical purposes; sulfur sticks [disinfectants]; pastilles for pharmaceutical purposes; pectin for pharmaceutical purposes; pepsins for pharmaceutical purposes; peptones for pharmaceutical purposes; hydrogen peroxide for medical purposes; pesticides; food for babies; leeches for medical purposes; blood plasma; eyepatches for medical purposes; poultices; compresses; scapulars for surgical purposes; diapers [babies' napkins]; diapers for pets; bunion pads; breast-nursing pads; pomades for medical purposes; powder of cantharides; pyrethrum powder; belts for sanitary napkins [towels]; anti-uric preparations; bacterial preparations for medical and veterinary use; bacteriological preparations for medical and veterinary use; balsamic preparations for medical purposes; albuminous preparations for medical purposes; biological preparations for veterinary purposes; biological preparations for medical purposes; veterinary preparations; bismuth preparations for pharmaceutical purposes; vitamin preparations; diagnostic preparations for medical purposes; therapeutic preparations for the bath; hemorrhoid preparations; preparations for callouses; preparations to facilitate teething; preparations for the treatment of burns; fumigation preparations for medical purposes; opotherapy preparations; air purifying preparations; eye-washes; bronchodilating preparations; preparations for reducing sexual activity; sterilising preparations;

soil-sterilising preparations; corn remedies; pharmaceutical preparations for treating dandruff; preparations for destroying noxious animals; herbicides; preparations for destroying dry rot fungus; larvae exterminating preparations; fly destroying preparations; preparations for destroying mice; slug exterminating preparations; vermin destroying preparations; pharmaceutical preparations for skin care; contact lens cleaning preparations; preparations of lime for pharmaceutical purposes; medicinal hair growth preparations; opiates; anticryptogamic preparations; aloe vera preparations for pharmaceutical purposes; preparations of trace elements for human and animal use; sulfonamides [medicines]; pharmaceutical preparations; sunburn preparations for pharmaceutical purposes; enzyme preparations for veterinary purposes; enzyme preparations for medical purposes; chemico-pharmaceutical preparations; chemical preparations for veterinary purposes; chemical preparations for the diagnosis of pregnancy; chemical preparations for medical purposes; chemical preparations to treat wheat blight [smut]; vine disease treating chemicals; chemical preparations to treat mildew; chemical preparations for treating phylloxera; chemical preparations for pharmaceutical purposes; chilblain preparations; mothproofing preparations; collyrium; lead water; chemical conductors for electrocardiograph electrodes; albuminous foodstuffs for medical purposes; dietetic foods adapted for medical purposes; by-products of the processing of cereals for dietetic or medical purposes; sanitary towels; napkins for incontinents; sanitary pads; panty liners [sanitary]; propolis for pharmaceutical purposes; pearl powder for medical purposes; radium for medical purposes; hydrated chloral for pharmaceutical purposes; solvents for removing adhesive plasters; vaginal washes; solutions for contact lenses; chemical reagents for medical or veterinary purposes; gum for medical purposes; rubber for dental purposes; chewing gum for medical purposes; insect repellents; insect repellent incense; repellents for dogs; tissues impregnated with pharmaceutical lotions; sarsaparilla for medical purposes; sugar for medical purposes; asthmatic tea; fumigating sticks; suppositories; linseed for pharmaceutical purposes; tobacco-free cigarettes for medical purposes; siccatives [drying agents] for medical purposes; syrups for pharmaceutical purposes; turpentine for pharmaceutical purposes; milking grease; greases for veterinary purposes; greases for medical purposes; lacteal flour for babies; soporifics; bicarbonate of soda for pharmaceutical purposes; bath salts for medical purposes; salts for mineral water baths; salts for medical purposes; potassium salts for medical purposes; sodium salts for medical purposes; smelling salts; mineral water salts; malt for pharmaceutical purposes; semen for artificial insemination; alcohol for pharmaceutical purposes; medicinal alcohol; alloys of precious metals for dental purposes; ergot for phar-

maceutical purposes; cooling sprays for medical purposes; adjuvants for medical purposes; styptic preparations; vermifuges; disinfectants; disinfectants for hygiene purposes; disinfectants for chemical toilets; douching preparations for medical purposes; appetite suppressants for medical purposes; medical preparations for slimming purposes; parasiticides; mouth-washes for medical purposes; febrifuges; depuratives; animal washes; detergents for medical purposes; cattle washes; dog washes; vesicants; articles for headache; purgatives; remedies for perspiration; remedies for foot perspiration; chemical contraceptives; antiparasitic preparations; sedatives; laxatives; tonics [medicines]; digestives for pharmaceutical purposes; nervines; media for bacteriological cultures; steroids; strychnine; serums; tanning pills; appetite suppressant pills; slimming pills; yeast dietary supplements; jujube, medicated; antioxidant pills; sanitary tampons; vulnerary sponges; thymol for pharmaceutical purposes; biological tissue cultures for veterinary purposes; surgical cloth [tissues]; smoking herbs for medical purposes; medicinal herbs; surgical implants [living tissues]; pants, absorbent, for incontinents; sanitary panties; babies' napkin-pants [diaper-pants]; charcoal for pharmaceutical purposes; fennel for medical purposes; porcelain for dental prostheses; phenol for pharmaceutical purposes; enzymes for veterinary purposes; enzymes for medical purposes; ferments for pharmaceutical purposes; formic aldehyde for pharmaceutical purposes; phosphates for pharmaceutical purposes; fungicides; quinine for medical purposes; chinoline for medical purposes; diabetic bread adapted for medical use; chloroform; flowers of sulfur for pharmaceutical purposes; cement for animal hooves; bone cement for surgical and orthopaedic purposes; dental cements; medicinal tea; herbal teas for medicinal purposes; eucalyptus for pharmaceutical purposes; tobacco extracts [insecticides]; extracts of hops for pharmaceutical purposes; elixirs [pharmaceutical preparations]; ethers for pharmaceutical purposes; esters for pharmaceutical purposes; cellulose esters for pharmaceutical purposes; cellulose ethers for pharmaceutical purposes; rat poison; poisons; bacterial poisons; jalap.

29 – Ajvar [preserved peppers]; aloe vera prepared for human consumption; alginates for culinary purposes; anchovy; peanuts, prepared; albumen for culinary purposes; white of eggs; beans, preserved; soya beans, preserved, for food; bouillon; ginger jam; ham; fatty substances for the manufacture of edible fats; toasted laver; edible birds' nests; peas, preserved; mushrooms, preserved; game, not live; gelatine; meat jellies; jellies for food; fruit jellies; yolk of eggs; coconut fat; bone oil, edible; lard; suet for food; edible fats; fruit-based snack food; charcuterie; raisins; caviar; fish roe, prepared; yogurt; sauerkraut; kephir [milk beverage]; kimchi [fermented vegetable dish]; isinglass for food; clams, not

live; milk shakes; black pudding [blood sausage]; compotes; meat, tinned [canned (Am.)]; vegetables, tinned [canned (Am.)]; fish, tinned [canned (Am.)]; fruits, tinned [canned (Am.)]; bouillon concentrates; gherkins; shrimps, not live; prawns, not live; buttercream; croquettes; silkworm chrysalis, for human consumption; kumys [kumyss] [milk beverage]; spiny lobsters, not live; lecithin for culinary purposes; salmon; onions, preserved; margarine; piccalilli; marmalade; edible oils; peanut butter; cocoa butter; coconut oil; coconut butter; corn oil; sesame oil; linseed oil for culinary purposes; olive oil for food; palm oil for food; palm kernel oil for food; sunflower oil for food; colza oil for food; butter; shellfish, not live; almonds, ground; animal marrow for food; mussels, not live; milk; condensed milk; albumin milk; soya milk [milk substitute]; fish meal for human consumption; vegetable mousses; fish mousses; fruit pulp; meat; meat, preserved; milk beverages, milk predominating; vegetables, preserved; vegetables, dried; vegetables, cooked; potato fritters; olives, preserved; lobsters, not live; coconut, desiccated; nuts, prepared; tomato purée; liver pâté; pectin for culinary purposes; liver; pickles; jams; powdered eggs; milk products; foods made from fish; prostokvasha [soured milk]; poultry, not live; pollen prepared as foodstuff; cranberry sauce [compote]; apple purée; crayfish, not live; crustaceans, not live; fish, preserved; fish, not live; salted fish; ryazhenka [fermented baked milk]; vegetable salads; fruit salads; bacon; sardines; pork; herrings; seeds, prepared; sunflower seeds, prepared; cream [dairy products]; whipped cream; fat-containing mixtures for bread slices; smetana [sour cream]; tomato juice for cooking; vegetable juices for cooking; salted meats; sausages; sausages in batter; preparations for making bouillon; preparations for making soup; tripe; soups; vegetable soup preparations; whey; cheese; tahini [sesame seed paste]; tofu; sea-cucumbers, not live; truffles, preserved; tuna fish; oysters, not live; milk ferments for culinary purposes; rennet; fish fillets; dates; crystallized fruits; frozen fruits; fruit, preserved; fruit preserved in alcohol; fruit, stewed; potato flakes; hummus [chickpea paste]; fruit peel; preserved garlic; lentils, preserved; potato chips; low-fat potato chips; fruit chips; non-alcoholic eggnog; seaweed extracts for food; meat extracts; eggs.

32 – Aperitifs, non-alcoholic; lithia water; seltzer water; soda water; waters [beverages]; aerated water; mineral water [beverages]; table waters; kvass [non-alcoholic beverage]; cocktails, non-alcoholic; lemonades; peanut milk [non-alcoholic beverage]; milk of almonds [beverage]; non-alcoholic beverages; isotonic beverages; non-alcoholic honey-based beverages; aloe vera drinks, non-alcoholic; whey beverages; non-alcoholic fruit juice beverages; fruit nectars, non-alcoholic; orgeat; beer; ginger beer; malt beer; powders for effervescing beverages; sarsaparilla [non-alcoholic beverage]; syrups for lemonade;

syrups for beverages; smoothies; tomato juice [beverage]; cider, non-alcoholic; vegetable juices [beverages]; fruit juices; preparations for making aerated water; preparations for making liqueurs; preparations for making mineral water; preparations for making beverages; must; grape must, unfermented; beer wort; malt wort; pastilles for effervescing beverages; sherbets [beverages]; fruit extracts, non-alcoholic; extracts of hops for making beer; essences for making beverages.

35 – Arranging subscriptions to telecommunication services for others; import-export agencies; commercial information agencies; advertising agencies; cost price analysis; rental of advertising space; business auditing; employment agencies; computerized file management; book-keeping; invoicing; demonstration of goods; transcription of communications [office functions]; opinion polling; marketing studies; business information; commercial information and advice for consumers [consumer advice shop]; business investigations; business research; marketing research; personnel recruitment; business management and organization consultancy; business organization consultancy; business management consultancy; personnel management consultancy; professional business consultancy; layout services for advertising purposes; marketing; business management of performing artists; business management of sports people; news clipping services; updating of advertising material; updating and maintenance of data in computer databases; word processing; organization of exhibitions for commercial or advertising purposes; arranging newspaper subscriptions for others; organization of fashion shows for promotional purposes; organization of trade fairs for commercial or advertising purposes; shop window dressing; business appraisals; payroll preparation; data search in computer files for others; sponsorship search; business management assistance; commercial or industrial management assistance; commercial intermediation services; provision of commercial and business contact information; providing business information via a web site; presentation of goods on communication media, for retail purposes; economic forecasting; auctioneering; retail or wholesale services for pharmaceutical, veterinary and sanitary preparations and medical supplies; sales promotion for others; production of advertising films; office machines and equipment rental; rental of advertising time on communication media; publicity material rental; rental of vending machines; rental of sales stands; rental of photocopying machines; publication of publicity texts; radio advertising; bill-posting; distribution of samples; dissemination of advertising matter; direct mail advertising; writing of publicity texts; advertising; online advertising on a computer network; advertising by mail order; television advertising; document reproduction; compilation of statistics; compilation of information into computer databases;

business inquiries; systemization of information into computer databases; advisory services for business management; negotiation and conclusion of commercial transactions for third parties; tax preparation; drawing up of statements of accounts; telemarketing services; psychological testing for the selection of personnel; business management of hotels; business management for freelance service providers; commercial administration of the licensing of the goods and services of others; business project management services for construction projects; administrative processing of purchase orders; public relations; modelling for advertising or sales promotion; typing; relocation services for businesses; price comparison services; pay per click advertising; secretarial services; procurement services for others [purchasing goods and services for other businesses]; shorthand; outsourcing services [business assistance]; telephone answering for unavailable subscribers; photocopying services; business efficiency expert services.

43 – Accommodation bureaux [hotels, boarding houses]; rental of temporary accommodation; rental of meeting rooms; tourist homes; hotel reservations; boarding house bookings; temporary accommodation reservations; hotels; retirement homes; snack-bars; cafés; cafeterias; motels; boarding houses; boarding for animals; rental of cooking apparatus; rental of chairs, tables, table linen, glassware; rental of lighting apparatus other than for theatrical sets or television studios; rental of tents; rental of transportable buildings; rental of drinking water dispensers; restaurants; self-service restaurants; food sculpting; canteens; holiday camp services [lodging]; bar services; providing campground facilities; food and drink catering; day-nurseries [crèches].

(260) AM 2019 102582 A

(800) 1459178

(151) 2019 02 14

(891) 2019 02 14

(731) Nefis SRL

Calea Mosilor nr.15, MD-2024 Chişinău,  
Republic of Moldova

(540)

**ZIKOS**

(591) Black, white

(511)

30 – Coffee, tea, cocoa, sugar, rice, tapioca, sago, artificial coffee; flour and preparations made from cereals, bread, pastry and confectionery, ice-cream; honey, treacle; yeast, baking-powder; salt, mustard; vinegar, sauces (condiments); spices; ice (frozen water).

(260) AM 2019 102584 A

(800) 1459190

(151) 2018 12 04

(891) 2018 12 04

(731) Aktsionernoe obshchestvo "SEVER MINERALS"

Pulkovskoye shosse, 40, korp. 4, lit. D,  
office C4070, RU-196158 Saint Petersburg,  
Russian Federation

(540)



(591) White and gray

(531) 06.01.02; 06.01.04

(511)

37 – Building construction; repair; installation services; rebuilding engines that have been worn or partially destroyed; rebuilding machines that have been worn or partially destroyed; repair information; construction information; construction consultancy; rental of drainage pumps; quarrying services; pump repair; pipeline construction and maintenance; factory construction; machinery installation, maintenance and repair.

(260) AM 2019 102585 A

(800) 1459205

(151) 2018 12 28

(891) 2018 12 28

(731) MOROZOV VICTOR ALEXANDROVICH

Kosmonavtov street, 5, block G, apt 40,  
RU-344092 Rostov-on-Don, Russian  
Federation

(540)



(591) White and grey-blue-green

(531) 26.11.25; 26.13.25

(511)

30 – Coffee, tea, cocoa and artificial coffee; rice, pasta and noodles; tapioca and sago; flour and preparations made from cereals; bread, pastries and confectionery; chocolate; ice cream, sorbets and other edible ices; sugar, honey, treacle; yeast, baking-powder; salt, seasonings, spices, preserved herbs; vinegar, sauces and other condiments; ice (frozen water); aromatic preparations for food; star aniseed; pancakes; buns; bread rolls; vanillin [vanilla substitute]; waffles; vermicelli [noodles]; natural sweeteners; sausage binding materials; mustard; yeast; thickening agents for cooking foodstuffs; artificial coffee; vegetal preparations for use as coffee substitutes; confectionery for decorating Christmas trees; fruit jellies [confectionery]; peanut confectionery;

almond confectionery; pasta; pasties; cocoa; capers; gruel, with a milk base, for food; gluten prepared as foodstuff; sweetmeats [candy]; peppermint sweets; coffee; unroasted coffee; starch for food; crackers; hominy grits; groats for human food; corn, milled; corn, roasted; farinaceous foods; noodles; ice for refreshment; ice, natural or artificial; edible ices; candy; rice cakes; maltose; hominy; honey; ice cream; fruit ice cream; muesli; mint for confectionery; cocoa beverages with milk; coffee beverages with milk; coffee-based beverages; chocolate beverages with milk; chocolate-based beverages; cocoa-based beverages; infusions, not medicinal; crushed oats; husked oats; nutmegs; pastilles [confectionery]; molasses for food; pepper; cookies; pies; pizzas; fondants [confectionery]; popcorn; pralines; condiments; meat tenderizers for household purposes; cereal preparations; pastries; oat-based food; propolis; gingerbread; ravioli; rice; sugar; aniseed; confectionery; salt for preserving foodstuffs; cooking salt; celery salt; spaghetti; seasonings; preparations for stiffening whipped cream; rusks; breadcrumbs; sushi; sandwiches; tapioca; almond paste; garden herbs, preserved [seasonings]; vinegar; ferments for pastes; halvah; bread; unleavened bread; tea; iced tea; sponge cakes; vanilla flavorings for culinary purposes; coffee flavorings; binding agents for ice cream; sea water for cooking; glucose for culinary purposes; rice-based snack food; cereal-based snack food; cakes; frozen yogurt [confectionery ices]; prepared cocoa beverages; cocoa powder; cocoa mixes; caramels [candy]; quiches; liquorice [confectionery]; meat pies; turmeric; couscous [semolina]; marzipan; custard; royal jelly for human consumption, not for medical purposes; barley meal; soya flour; rice flour; wheat flour; flour; nut flours; corn flour; potato flour; tapioca flour; buckwheat flour; bean meal; tea-based beverages; powders for making ice cream; puddings; chewing gum, not for medical purposes; spring rolls; cake dough; baking soda [bicarbonate of soda for cooking purposes]; tacos; tortillas; malt extract for food; chicory [coffee substitute]; essences for foodstuffs, except etheric essences and essential oils; chips [cereal products]; fruit cakes; tabbouleh.

35 – Advertising; business management; business administration; office functions; arranging subscriptions to telecommunication services for others; import-export agency services; commercial information agency services; advertising agency services; cost price analysis; rental of advertising space; account auditing; employment agency services; computerized file management; invoicing; demonstration of goods; opinion polling; market studies; business information; business investigations; business management and organization consultancy; personnel recruitment; business organization consultancy; business management consultancy; professional business consultancy; layout services for advertising purposes; business management of performing artists; news

clipping services; updating of advertising material; word processing; shorthand; organization of exhibitions for commercial or advertising purposes; organization of trade fairs for commercial or advertising purposes; shop window dressing; business appraisals; payroll preparation; sponsorship search; business management assistance; commercial or industrial management assistance; economic forecasting; auctioneering; office machines and equipment rental; publicity material rental; rental of vending machines; rental of photocopying machines; publication of publicity texts; radio advertising; bill-posting; distribution of samples; dissemination of advertising matter; writing of publicity texts; on-line advertising on a computer network; advertising by mail order; television advertising; document reproduction; compilation of statistics; business inquiries; systemization of information into computer databases; tax preparation; drawing up of statements of accounts; commercial administration of the licensing of the goods and services of others; public relations; modelling for advertising or sales promotion; relocation services for businesses; price comparison services; procurement services for others [purchasing goods and services for other businesses]; business efficiency expert services; book-keeping; transcription of communications [office functions]; commercial information and advice for consumers in the choice of products and services; marketing research; secretarial and clerical services; arranging newspaper subscriptions for others; data search in computer files for others; sales promotions at point of purchase or sale, for others; rental of advertising time on communication media; typing; photocopying services; telephone answering for unavailable subscribers; administrative processing of purchase orders; business management of hotels; compilation of information into computer databases; psychological testing for the selection of personnel; copywriting; presentation of goods on communication media, for retail purposes.

(260) AM 2019 102586 A

(800) 1459208

(151) 2018 11 21

(891) 2018 11 21

(731) DTN, LLC

9110 W. Dodge Road, Suite 200, Omaha  
NE 68114, USA

(540)



(591) The color(s) blue, green and white is/are claimed as a feature of the mark.

(531) 26.01.03; 29.01.13

(511)

9 – Computer software for use in displaying, managing, storing, tracking, distributing and analyzing news, information, data, weather information and forecasts, market prices, commodity prices, commentary, and survey results in the fields of agriculture, agribusiness and energy; computer software for use in managing business operations and managing and tracking inventory, production, market positions, purchases and sales in the fields of agriculture, agribusiness and energy; computer software for use in displaying and tracking weather information and forecasts in the fields of aviation, construction, transportation, sports and public safety; cameras for use with insect traps, namely, internet-enabled cameras for use in detecting, distinguishing, counting and reporting insects; software for use in managing, tracking and monitoring crop production, use of pesticides and the presence of insects.

16 – Printed periodical publication providing news and information of interest to farmers and livestock producers.

21 – Insect traps; insect traps containing a camera integrated into the insect trap.

35 – Providing business information, data analysis, and market research surveys to those in the agriculture, agribusiness and energy fields; providing an online marketplace for buyers and sellers of agricultural inputs, agricultural outputs, commodities and fuels.

36 – Providing financial and financial market news, information, and information in the form of pricing and quotes to agricultural producers, fuel suppliers and fuel producers; online brokerage in the field of agricultural goods and commodities; providing stock/securities market news and information for those in the agriculture, agribusiness and energy industries; providing financial news and information, and data in the form of commodity quotations to those in the agriculture, agribusiness, and energy industries.

38 – Communication and data transmission services, namely, providing customizable data and video streams of news, information, weather information and forecasts, market prices and commodity prices related to agriculture.

42 – Providing temporary use of non-downloadable software for use in displaying, managing, storing, tracking, distributing and analyzing news, information, data, weather information and forecasts, market prices, commodity prices, commentary and survey results in the fields of agriculture, agribusiness and energy; providing temporary use of non-downloa-

dable software for use in displaying and tracking weather information and forecasts in the fields of aviation, construction, transportation, sports and public safety; providing temporary use of non-downloadable software for use in managing business operations and management and tracking inventory, production, market positions, purchases and sales in the fields of agriculture, agribusiness and energy; weather forecasting, reporting and information services; design and development of software and hardware for agriculture; providing weather information and forecasts.

(260) AM 2019 102587 A

(800) 1459241

(151) 2019 01 22

(891) 2019 01 22

(731) DR. THEISS NATURWAREN GMBH

Michelinstr. 10, 66406 Homburg, Germany

(540)



(591) Grey, silver

(531) 26.01.01; 26.01.06; 26.01.18; 26.01.24;  
26.11.01; 26.11.08; 26.15.01; 27.05.09;  
27.05.10; 27.05.11

(511)

3 – Bleaching preparations and laundry preparations; Cleaning, polishing, scouring and abrasive preparations; Perfumery, essential oils, non-medicated cosmetics, including non-medicated skin cleaning and skin care preparations, and hair care preparations; Non-medicated dentifrices.

5 – Pharmaceutical and veterinary preparations; Medicines for human purposes; Medicines for veterinary purposes; Sanitary preparations for medical purposes; Dietetic foodstuffs and substances adapted for medical use; Nutritional supplements for humans and animals; Vitamin preparations.

(260) AM 2019 102588 A

(800) 1459253

(151) 2018 12 13

(891) 2018 12 13

(731) MAR-KO FLEISCHWAREN GMBH & CO.  
KG

Waldecker Straße 15, 99444 Blankenhain,  
Germany

(540)



# Salamini

(591) Black, white

(531) 25.03.01; 27.05.09; 27.05.10

(511)

29 – Meat, fish, poultry and game, including ham, all aforementioned goods also further processed into charcuterie, also in preserved form; meat products, meatballs, sausages, charcuterie, uncooked charcuterie, also to be stored unrefrigerated; long-life charcuterie; salami in various forms, in particular mini salami; snacks made from the aforementioned products; beef-based snack products; meat extracts.

30 – Ready-made pastry rolls filled or topped with meat, charcuterie, ham, vegetables, sauces; ready-made dumplings filled or topped with meat, charcuterie, ham, vegetables, sauces; ready-made pita bread filled or topped with meat, charcuterie, ham, vegetables, sauces; ready-baked pastry rolls made of wheat flour dough filled with salami or salami-like sausage; snacks based on pasta products.

(260) AM 2019 102589 A

(800) 1459305

(151) 2018 11 02

(891) 2018 11 02

(731) "KONTI-RUS" JOINT STOCK COMPANY

ul. Zolotaia, 13, RU-305000 Kursk, Russian Federation

(540)



(591) Blue, purple, violet, white, green, yellow, light brown, red, dark red, light red.

(531) 01.01.02; 01.01.10; 01.15.17; 05.01.10; 05.03.16; 05.05.20; 05.13.15; 25.03.01; 26.01.03; 26.01.12; 26.01.15; 26.01.16; 26.01.21; 26.15.01; 28.05; 29.01.15

(511)

30 – Confectionery.

(260) AM 2019 102590 A

(800) 1459310

(151) 2018 12 13

(891) 2018 12 13

(731) TOVARYSTVO Z OBMEZHENOYU VIDPOVIDALNISTYU "TESPRO"

vul. Vasylia Kasiyana, budynok 2/1, nezhylye prymisshenia 1, 2, m. Kyiv 03191, Ukraine

(540)

# COTONIC

(591) Black, white

(531) 01.15.15; 05.11.14; 27.03.01; 27.03.11

(511)

3 – Non-medicated cosmetics and toiletry preparations; non-medicated dentifrices; perfumery; essential oils; bleaching preparations and other substances for laundry use; cleaning, polishing, scouring and abrasive preparations; abrasive cloth; abrasive paper; abrasives; adhesives for affixing false eyelashes; adhesives for affixing false hair; adhesives for cosmetic purposes; after-shave lotions; air fragrance reed diffusers; air fragrancing preparations; almond milk for cosmetic purposes; almond oil; almond soap; aloe vera preparations for cosmetic purposes; alum stones [astringents]; amber [perfume]; ammonia [volatile alkali] [detergent]; antiperspirant soap; antiperspirants [toilettries]; antistatic preparations for household purposes; aromatics [essential oils]; astringents for cosmetic purposes; badian essence; balms, other than for medical purposes; bases for flower perfumes; bath preparations, not for medical purposes; bath salts, not for medical purposes; beard dyes; beauty masks; bergamot oil; bleaching preparations [decolorants] for cosmetic purposes; bleaching preparations [decolorants] for household purposes; bleaching salts; bleaching soda; breath freshening preparations for personal hygiene; breath freshening sprays; breath freshening strips; cake flavorings [essential oils]; cakes of toilet soap; canned pressurized air for cleaning and dusting purposes; carbides of metal [abrasives]; chemical cleaning preparations for household purposes; cleaning chalk; cleaning preparations; cleansers for intimate personal hygiene purposes, non medicated; cleansing milk for toilet purposes; cloths impregnated with a detergent for cleaning; cobblers' wax; collagen preparations for cosmetic purposes; colorants for toilet purposes; color-brightening chemicals for household purposes [laundry]; color-removing preparations; corundum [abrasive]; cosmetic creams; cosmetic dyes; cosmetic kits; cosmetic pencils; cosmetic preparations for baths; cosmetic preparations for eyelashes; cosmetic preparations for skin care; cosmetic preparations for slimming purposes; cosmetics; cosmetics for animals; cosmetics for children; cotton sticks for cosmetic purposes; cotton wool for cosmetic purposes; creams for leather; decorative transfers for cosmetic purposes; degreasers, other than for use in manufac-



turing processes; dental bleaching gels; dentifrices; denture polishes; deodorants for human beings or for animals; deodorants for pets; deodorant soap; depilatory preparations; depilatory wax; descaling preparations for household purposes; detergents, other than for use in manufacturing operations and for medical purposes; diamantine [abrasive]; douching preparations for personal sanitary or deodorant purposes [toiletries]; dry-cleaning preparations; drying agents for dishwashing machines; dry shampoos; eau de Cologne; emery; emery cloth; emery paper; essential oils; essential oils of cedarwood; essential oils of citron; essential oils of lemon; ethereal essences; extracts of flowers [perfumes]; eyebrow cosmetics; eyebrow pencils; eye-washes, not for medical purposes; fabric softeners for laundry use; false eyelashes; false nails; flavorings for beverages [essential oils]; floor wax; floor wax removers [scouring preparations]; food flavorings [essential oils]; fumigation preparations [perfumes]; refurbishing preparations; gaultheria oil; geraniol; glass cloth [abrasive cloth]; greases for cosmetic purposes; grinding preparations; hair conditioners; hair dyes; hair lotions; hair spray; hair straightening preparations; hair waving preparations; heliotropine; henna [cosmetic dye]; herbal extracts for cosmetic purposes; hydrogen peroxide for cosmetic purposes; incense; ionone [perfumery]; jasmine oil; Javelle water; joss sticks; lacquer-removing preparations; laundry bleach; laundry blueing; laundry glaze; laundry preparations; laundry soaking preparations; laundry starch; lavender oil; lavender water; leather bleaching preparations; lip glosses; lipstick cases; lipsticks; lotions for cosmetic purposes; make-up; make-up powder; make-up preparations; make-up removing preparations; mascara; massage candles for cosmetic purposes; massage gels, other than for medical purposes; mint essence [essential oil]; mint for perfumery; mouthwashes, not for medical purposes; musk [perfumery]; mustache wax; nail art stickers; nail care preparations; nail polish; nail varnish removers; neutralizers for permanent waving; non-slipping liquids for floors; non-slipping wax for floors; oil of turpentine for degreasing; oils for cleaning purposes; oils for cosmetic purposes; oils for perfumes and scents; oils for toilet purposes; paint stripping preparations; pastes for razor strops; perfumery; perfumes; petroleum jelly for cosmetic purposes; phytocosmetic preparations; polish for furniture and flooring; polishing creams; polishing paper; polishing preparations; polishing rouge; polishing stones; polishing wax; pomades for cosmetic purposes; potpourris [fragrances]; preparations for cleaning dentures; preparations for unblocking drain pipes; preparations to make the leaves of plants shiny; preservatives for leather [polishes]; pumice stone; quillaia bark for washing; rose oil; rust removing preparations; sachets for perfuming linen; safrol; sandpaper; scented water; scented wood; scouring solutions; shampoos; shampoos for ani-

mals [non-medicated grooming preparations]; shampoos for pets [non-medicated grooming preparations]; shaving preparations; shaving soap; shaving stones [astringents]; shining preparations [polish]; shoe cream; shoemakers' wax; shoe polish; shoe wax; silicon carbide [abrasive]; skin whitening creams; smoothing preparations [starching]; smoothing stones; soap; soap for brightening textile; soap for foot perspiration; soda lye; stain removers; starch glaze for laundry purposes; sunscreen preparations; sun-tanning preparations [cosmetics]; tailors' wax; talcum powder, for toilet use; teeth whitening strips; terpenes [essential oils]; tissues impregnated with cosmetic lotions; tissues impregnated with make-up removing preparations; toiletry preparations; toilet water; tripoli stone for polishing; turpentine for degreasing; vaginal washes for personal sanitary or deodorant purposes; varnish-removing preparations; volcanic ash for cleaning; wallpaper cleaning preparations; washing soda, for cleaning; wax for parquet floors; whitening; windshield cleaning liquids.

5 – Pharmaceuticals, medical and veterinary preparations; sanitary preparations for medical purposes; dietetic food and substances adapted for medical or veterinary use, food for babies; dietary supplements for humans and animals; plasters, materials for dressings; material for stopping teeth, dental wax; disinfectants; preparations for destroying vermin; fungicides, herbicides; absorbent cotton; acai powder dietary supplements; acaricides; acetates for pharmaceutical purposes; acids for pharmaceutical purposes; acne treatment preparations; aconitine; adhesive plasters; adhesives for dentures; adhesive tapes for medical purposes; adjuvants for medical purposes; air deodorising preparations; air purifying preparations; albumin dietary supplements; albuminous foodstuffs for medical purposes; albuminous preparations for medical purposes; alcohol for pharmaceutical purposes; aldehydes for pharmaceutical purposes; algicides; alginate dietary supplements; alginates for pharmaceutical purposes; alkaline iodides for pharmaceutical purposes; alkaloids for medical purposes; alloys of precious metals for dental purposes; almond milk for pharmaceutical purposes; aloe vera preparations for pharmaceutical purposes; aluminium acetate for pharmaceutical purposes; amino acids for medical purposes; amino acids for veterinary purposes; anaesthetics; analgesics; angostura bark for medical purposes; animal washes [insecticides]; antibacterial handwashes; antibacterial soap; antibiotics; anticryptogamic preparations; antioxidant pills; antiparasitic collars for animals; antiparasitic preparations; antiseptic cotton; antiseptics; anti-uric preparations; appetite suppressant pills; appetite suppressants for medical purposes; aseptic cotton; asthmatic tea; astringents for medical purposes; babies' diaper-pants; babies' diapers; bacterial poisons; bacterial preparations for medical and veterinary use; bacteriological preparations for medical and veteri-

nary use; balms for medical purposes; balsamic preparations for medical purposes; bandages for dressings; barks for pharmaceutical purposes; bath preparations for medical purposes; bath salts for medical purposes; bicarbonate of soda for pharmaceutical purposes; biocides; biological preparations for medical purposes; biological preparations for veterinary purposes; biological tissue cultures for medical purposes; biological tissue cultures for veterinary purposes; bismuth preparations for pharmaceutical purposes; bismuth subnitrate for pharmaceutical purposes; blood for medical purposes; blood plasma; bone cement for surgical and orthopaedic purposes; breast-nursing pads; bromine for pharmaceutical purposes; bronchodilating preparations; bunion pads; by-products of the processing of cereals for dietetic or medical purposes; cachets for pharmaceutical purposes; cachou for pharmaceutical purposes; calomel [fungicide]; camphor for medical purposes; camphor oil for medical purposes; candy for medical purposes; candy, medicated; capsules for medicines; carbolineum [parasiticide]; casein dietary supplements; castor oil for medical purposes; cattle washes [insecticides]; caustic pencils; caustics for pharmaceutical purposes; cedar wood for use as an insect repellent; cellulose esters for pharmaceutical purposes; cellulose ethers for pharmaceutical purposes; cement for animal hooves; charcoal for pharmaceutical purposes; chemical conductors for electrocardiograph electrodes; chemical contraceptives; chemical preparations for medical purposes; chemical preparations for pharmaceutical purposes; chemical preparations for the diagnosis of pregnancy; chemical preparations for treating phylloxera; chemical preparations for veterinary purposes; chemical preparations to treat mildew; chemical preparations to treat wheat blight; chemical reagents for medical or veterinary purposes; chemico-pharmaceutical preparations; chewing gum for medical purposes; chilblain preparations; chinoline for medical purposes; chloroform; cocaine; cod liver oil; collagen for medical purposes; collodion for pharmaceutical purposes; collyrium; compresses; condurango bark for medical purposes; contact lens cleaning preparations; cooling sprays for medical purposes; corn remedies; corn rings for the feet; cotton for medical purposes; cotton sticks for medical purposes; cream of tartar for pharmaceutical purposes; creosote for pharmaceutical purposes; croton bark; cultures of microorganisms for medical or veterinary use; curare; decoctions for pharmaceutical purposes; dental abrasives; dental amalgams; dental amalgams of gold; dental cements; dental impression materials; dental lacquer; dental mastics; deodorants for clothing and textiles; deodorants, other than for human beings or for animals; depuratives; detergents for medical purposes; diabetic bread adapted for medical use; diagnostic biomarker reagents for medical purposes; diagnostic preparations for medical purposes; diagnostic pre-

parations for veterinary purposes; diapers for incontinents; diapers for pets; diastase for medical purposes; dietary fiber; dietary supplements for animals; dietary supplements with a cosmetic effect; dietetic beverages adapted for medical purposes; dietetic foods adapted for medical purposes; dietetic substances adapted for medical use; digestives for pharmaceutical purposes; digitalin; dill oil for medical purposes; disinfectants; disinfectants for chemical toilets; disinfectants for hygiene purposes; disinfectant soap; dog washes [insecticides]; douching preparations for medical purposes; dressings, medical; drugs for medical purposes; elixirs [pharmaceutical preparations]; enzyme dietary supplements; enzyme preparations for medical purposes; enzyme preparations for veterinary purposes; enzymes for medical purposes; enzymes for veterinary purposes; ergot for pharmaceutical purposes; esters for pharmaceutical purposes; ethers for pharmaceutical purposes; eucalyptol for pharmaceutical purposes; eucalyptus for pharmaceutical purposes; extracts of hops for pharmaceutical purposes; eyepatches for medical purposes; febrifuges; fennel for medical purposes; ferments for pharmaceutical purposes; first-aid boxes, filled; fish meal for pharmaceutical purposes; flour for pharmaceutical purposes; flowers of sulfur for pharmaceutical purposes; fly catching paper; fly destroying preparations; fly glue; food for babies; formic aldehyde for pharmaceutical purposes; freeze-dried food adapted for medical purposes; freeze-dried meat adapted for medical purposes; frostbite salve for pharmaceutical purposes; fumigating sticks; fumigation preparations for medical purposes; fungicides; gallic acid for pharmaceutical purposes; gamboge for medical purposes; gases for medical purposes; gauze for dressings; gelatine for medical purposes; gentian for pharmaceutical purposes; germicides; glucose dietary supplements; glucose for medical purposes; glycerine for medical purposes; glycerophosphates; greases for medical purposes; greases for veterinary purposes; guaiacol for pharmaceutical purposes; gum for medical purposes; gurjun balsam for medical purposes; hematogen; hemoglobin; hemorrhoid preparations; hemostatic pencils; herbal extracts for medical purposes; herbal teas for medicinal purposes; herbicides; homogenized food adapted for medical purposes; hormones for medical purposes; hydrastine; hydrastinine; hydrated chloral for pharmaceutical purposes; hydrogen peroxide for medical purposes; immunostimulants; infant formula; insecticidal animal shampoo; insecticidal veterinary washes; insecticides; insect repellent incense; insect repellents; iodides for pharmaceutical purposes; iodine for pharmaceutical purposes; iodoform; Irish moss for medical purposes; isotopes for medical purposes; jalap; jujube, medicated; lacteal flour for babies; lactose for pharmaceutical purposes; larvae exterminating preparations; laxatives; lead water; lecithin dietary supplements; lecithin for medical purposes;

leeches for medical purposes; lice treatment preparations [pediculicides]; lime-based pharmaceutical preparations; liniments; linseed dietary supplements; linseed for pharmaceutical purposes; linseed meal for pharmaceutical purposes; linseed oil dietary supplements; lint for medical purposes; liquorice for pharmaceutical purposes; lotions for pharmaceutical purposes; lotions for veterinary purposes; lupulin for pharmaceutical purposes; magnesia for pharmaceutical purposes; malted milk beverages for medical purposes; malt for pharmaceutical purposes; mangrove bark for pharmaceutical purposes; media for bacteriological cultures; medical preparations for slimming purposes; medicated after-shave lotions; medicated animal feed; medicated dentifrices; medicated dry shampoos; medicated eye-washes; medicated hair lotions; medicated massage candles; medicated shampoos; medicated shampoos for pets; medicated soap; medicated toiletry preparations; medicinal alcohol; medicinal drinks; medicinal hair growth preparations; medicinal herbs; medicinal infusions; medicinal mud; medicinal oils; medicinal roots; medicinal tea; medicine cases, portable, filled; medicines for alleviating constipation; medicines for dental purposes; medicines for human purposes; medicines for veterinary purposes; melissa water for pharmaceutical purposes; menthol; mercurial ointments; milk ferments for pharmaceutical purposes; milking grease; mineral food supplements; mineral water salts; mineral waters for medical purposes; mint for pharmaceutical purposes; molding wax for dentists; moleskin for medical purposes; mothproofing paper; mothproofing preparations; mouthwashes for medical purposes; mud for baths; mustard for pharmaceutical purposes; mustard oil for medical purposes; mustard plasters; myrobalan bark for pharmaceutical purposes; narcotics; nervines; nicotine gum for use as an aid to stop smoking; nicotine patches for use as aids to stop smoking; nutraceutical preparations for therapeutic or medical purposes; nutritional supplements; nutritive substances for microorganisms; oil of turpentine for pharmaceutical purposes; ointments for pharmaceutical purposes; opiates; opium; opodeldoc; opotherapy preparations; oxygen baths; oxygen for medical purposes; pants, absorbent, for incontinents; panty liners [sanitary]; paper for mustard plasters; parasiticides; pastilles for pharmaceutical purposes; pearl powder for medical purposes; pectin for pharmaceutical purposes; pediculicidal shampoos; pepsins for pharmaceutical purposes; peptones for pharmaceutical purposes; personal sexual lubricants; pesticides; petroleum jelly for medical purposes; pharmaceutical preparations; pharmaceutical preparations for skin care; pharmaceutical preparations for treating dandruff; pharmaceutical preparations for treating sunburn; pharmaceuticals; phenol for pharmaceutical purposes; phosphates for pharmaceutical purposes; phytotherapy preparations for medical purposes; plant extracts for pharmaceutical

purposes; poisons; pollen dietary supplements, pomades for medical purposes; porcelain for dental prostheses; potassium salts for medical purposes; poultices; powdered milk for babies; powder of cantarides; pre-filled syringes for medical purposes; preparations for callouses; preparations for destroying dry rot fungus; preparations for destroying mice; preparations for destroying noxious animals; preparations for reducing sexual activity; preparations for the treatment of burns; preparations of microorganisms for medical or veterinary use; preparations of trace elements for human and animal use; preparations to facilitate teething; propolis dietary supplements; propolis for pharmaceutical purposes; protein dietary supplements; protein supplements for animals; purgatives; pyrethrum powder; quassia for medical purposes; quebracho for medical purposes; quinine for medical purposes; quinquina for medical purposes; radioactive substances for medical purposes; radiological contrast substances for medical purposes; radium for medical purposes; rat poison; reagent paper for medical purposes; reagent paper for veterinary purposes; remedies for foot perspiration; remedies for perspiration; repellents for dogs; rhubarb roots for pharmaceutical purposes; royal jelly dietary supplements; royal jelly for pharmaceutical purposes; rubber for dental purposes; salts for medical purposes; salts for mineral water baths; sanitary panties; sanitary tampons; sanitary towels; sarsaparilla for medical purposes; scapulars for surgical purposes; sea water for medicinal bathing; sedatives; semen for artificial insemination; serotherapeutic medicines; serums; sexual stimulant gels; siccatives [drying agents] for medical purposes; slimming pills; slug exterminating preparations; smelling salts; smoking herbs for medical purposes; sodium salts for medical purposes; soil-sterilising preparations; solutions for contact lenses; solvents for removing adhesive plasters; soporifics; starch for dietetic or pharmaceutical purposes; stem cells for medical purposes; stem cells for veterinary purposes; sterilising preparations; steroids; stick liquorice for pharmaceutical purposes; strychnine; styptic preparations; sugar for medical purposes; sulfonamides [medicines]; sulfur sticks [disinfectants]; sunburn ointments; suppositories; surgical dressings; surgical glues; surgical implants comprised of living tissues; syrups for pharmaceutical purposes; tanning pills; tartar for pharmaceutical purposes; teeth filling material; therapeutic preparations for the bath; thermal water; thymol for pharmaceutical purposes; tincture of iodine; tinctures for medical purposes; tissues impregnated with pharmaceutical lotions; tobacco extracts [insecticides]; tobacco-free cigarettes for medical purposes; tonics [medicines]; transplants [living tissues]; turpentine for pharmaceutical purposes; vaccines; vaginal washes for medical purposes; vermifuges; vermin destroying preparations; vesicants; veterinary preparations; vine disease treating

chemicals; vitamin preparations; vitamin supplement patches; vulnerary sponges; wadding for medical purposes; wart pencils; wheat germ dietary supplements; yeast dietary supplements; yeast for pharmaceutical purposes.

10 – Surgical, medical, dental and veterinary apparatus and instruments; artificial limbs, eyes and teeth; apparatus for acne treatment; apparatus for artificial respiration; apparatus for DNA and RNA testing for medical purposes; apparatus for the regeneration of stem cells for medical purposes; apparatus for the treatment of deafness; appliances for washing body cavities; arch supports for footwear; armchairs for medical or dental purposes; artificial breasts; artificial eyes; artificial jaws; artificial limbs; artificial skin for surgical purposes; artificial teeth; babies' pacifiers [teats]; baby feeding dummies; balling guns; bandages, elastic; basins for medical purposes; bed pans; beds specially made for medical purposes; bed vibrators; belts, electric, for medical purposes; belts for medical purposes; biodegradable bone fixation implants; blankets, electric, for medical purposes; blood testing apparatus; body composition monitors; body fat monitors; body rehabilitation apparatus for medical purposes; boots for medical purposes; bracelets for medical purposes; brain pacemakers; breast pumps; brushes for cleaning body cavities; canulae; cases fitted for medical instruments; castrating pincers; catgut; catheters; childbirth mattresses; clips, surgical; clothing especially for operating rooms; commode chairs; compression garments; compressors [surgical]; condoms; containers especially made for medical waste; contraceptives, non-chemical; cooling pads for first aid purposes; cooling patches for medical purposes; corn knives; corsets for medical purposes; crutches; cupping glasses; cushions for medical purposes; defibrillators; dental apparatus and instruments; dental apparatus, electric; dental burs; dentists' armchairs; dentures; diagnostic apparatus for medical purposes; dialyzers; douche bags; drainage tubes for medical purposes; draw-sheets for sick beds; dropper bottles for medical purposes; droppers for medical purposes; ear picks; ear plugs [ear protection devices]; ear trumpets; elastic stockings for surgical purposes; electric acupuncture instruments; electrocardiographs; electrodes for medical use; endoscopy cameras for medical purposes; enema apparatus for medical purposes; esthetic massage apparatus; feeding bottles; feeding bottle teats; feeding bottle valves; filters for ultraviolet rays, for medical purposes; finger guards for medical purposes; forceps; fumigation apparatus for medical purposes; furniture especially made for medical purposes; galvanic belts for medical purposes; galvanic therapeutic appliances; gastroscopes; gloves for massage; gloves for medical purposes; hair prostheses; hearing aids; hearing protectors; heart pacemakers; heart rate monitoring apparatus; heating cushions, electric, for medical purposes; hemocytometers; hot

air therapeutic apparatus; hot air vibrators for medical purposes; hydrogen inhalers; hydrostatic beds for medical purposes; hypodermic syringes; hypogastric belts; ice bags for medical purposes; implantable subcutaneous drug delivery devices; incontinence sheets; incubators for babies; incubators for medical purposes; inhalers; injectors for medical purposes; instrument cases for use by doctors; insufflators; invalids' hoists; knee bandages, orthopaedic; knives for surgical purposes; lamps for medical purposes; lancets; lasers for medical purposes; lenses [intraocular prostheses] for surgical implantation; lice combs; love dolls [sex dolls]; magnetic resonance imaging [MRI] apparatus for medical purposes; masks for use by medical personnel; massage apparatus; maternity belts; medical apparatus and instruments; medical guidewires; menstrual cups; microdermabrasion apparatus; mirrors for dentists; mirrors for surgeons; nasal aspirators; needles for medical purposes; nursing appliances; obstetric apparatus; obstetric apparatus for cattle; operating tables; ophthalmometers; ophthalmoscopes; orthodontic appliances; orthodontic rubber bands; orthopaedic belts; orthopaedic footwear; orthopaedic soles; orthopedic articles; pads for preventing pressure sores on patient bodies; pessaries; physical exercise apparatus for medical purposes; physiotherapy apparatus; pins for artificial teeth; plaster bandages for orthopaedic purposes; portable hand-held urinals; probes for medical purposes; protection devices against X-rays, for medical purposes; pulse meters; pumps for medical purposes; quad canes for medical purposes; quartz lamps for medical purposes; radiological apparatus for medical purposes; radiology screens for medical purposes; radiotherapy apparatus; radium tubes for medical purposes; receptacles for applying medicines; respirators for artificial respiration; respiratory masks for artificial respiration; resuscitation apparatus; saws for surgical purposes; scalpels; scissors for surgery; sex toys; slings [supporting bandages]; soporific pillows for insomnia; sphygmomanometers; spirometers [medical apparatus]; orthopedic articles; suture materials; therapeutic and assistive devices adapted for the disabled; massage apparatus; apparatus, devices and articles for nursing infants; sexual activity apparatus, devices and articles; abdominal belts; abdominal corsets; abdominal pads; acupuncture needles; aerosol dispensers for medical purposes; air beds for medical purposes; air cushions for medical purposes; air mattresses for medical purposes; air pillows for medical purposes; ambulance stretchers; anaesthetic apparatus; anaesthetic masks; analysers for bacterial identification for medical purposes; anti-nausea wristbands; anti-rheumatism bracelets; anti-rheumatism rings; apparatus and installations for the production of X-rays, for medical purposes; apparatus for spittoons for medical purposes; splints, surgical; spoons for administering medicine; stents; sterile sheets, surgical; stet-

hosscopes; stockings for varices; strait jackets; stretchers, wheeled; supportive bandages; supports for flat feet; surgical apparatus and instruments; surgical bougies; surgical cutlery; surgical drapes; surgical implants comprised of artificial materials; surgical robots; surgical sponges; suspensory bandages; suture materials; suture needles; syringes for injections; syringes for medical purposes; teething rings; teeth protectors for dental purposes; temperature indicator labels for medical purposes; testing apparatus for medical purposes; thermal packs for first aid purposes; thermo-electric compresses [surgery]; thermometers for medical purposes; thread, surgical; tips for crutches; toe separators for orthopaedic purposes; tomographs for medical purposes; tongue depressors for medical purposes; tongue scrapers; traction apparatus for medical purposes; trocars; trusses; ultraviolet ray lamps for medical purposes; umbilical belts; urethral probes; urethral syringes; urinals [vessels]; urological apparatus and instruments; uterine syringes; vaginal syringes; vaporizers for medical purposes; veterinary apparatus and instruments; vibromassage apparatus; walking frames for disabled persons; walking sticks for medical purposes; water bags for medical purposes; wheeled walkers to aid mobility; X-ray apparatus for medical purposes; X-ray photographs for medical purposes; X-ray tubes for medical purposes.

(260) AM 2019 102591 A

(800) 1459349

(151) 2018 11 29

(891) 2018 11 29

(731) HALEWOOD INTERNATIONAL BRANDS LIMITED

The Sovereign Distillery, Wilson Road,  
Huyton Business Park, Liverpool L36 6AD,  
United Kingdom

(540)

**CARIBBEAN TWIST**

(591) Black, white

(511)

33 – Alcoholic beverages (except beer); spirits; rum; whisky; gin; vodka.

(260) AM 2019 102592 A

(800) 1459407

(151) 2018 11 22

(891) 2018 11 22

(731) KALLEH AMOL DAIRY PRODUCTS PRODUCING CO. (SHERKAT TOLIDE FARAVARDEHAYE LABANI KALLEH) No:103 East, Azarbayjan Sharghi Ave, Beyne Daneshgah and Farvardin St, Tehran, Islamic Republic of Iran

(540)



(591) Brown

(531) 27.05.01; 28.01

(511)

29 – Meat, fish, poultry and game, meat extracts, preserved, frozen, dried and cooked fruits and vegetables, jellies, jams, compotes, eggs, milk and milk products, edible oils and fats.

30 – Coffee, tea, cocoa and artificial coffee, rice, tapioca and sago, flour and preparations made from cereal, bread, pastry and confectionery, ices, sugar, honey, treacle, yeast, baking powder, salt, mustard, vinegar, sauces (condiments, spices, ice), chocolate.

32 – Mineral and aerated waters and other non-alcoholic beverages, fruit beverages and fruit juices, syrups and other preparations for making beverages.

(260) AM 2019 102671 A

(800) 1460959

(151) 2018 12 21

(891) 2018 12 21

(731) GRINDEKS, AS

Krustpils iela 53, LV-1057 Rīga, Latvia

(540)

**APIDRIVE АПИДРАЙВ**

(591) Black, white

(531) 27.05.01; 28.05

(511)

3 – Cosmetics; cosmetic preparations for skin care; cosmetics on basis of royal jelly; cosmetics containing royal jelly.

5 – Veterinary preparations; vitamin preparations; dietary supplements; food supplements; nutraceutical supplements; food for babies and infant formula; nutraceutical supplements comprising royal jelly.

(260) AM 2019 102672 A

(800) 1460972

(151) 2018 12 21

(891) 2018 12 21

(731) GRINDEKS, AS

Krustpils iela 53, LV-1057 Rīga, Latvia

(540)

**APIMUNOL АПИМУНОЛ**

(591) Black, white

(531) 27.05.01; 28.05

(511)

3 – Cosmetics; cosmetic preparations for skin care; cosmetics on basis of royal jelly; cosmetics containing royal jelly.

5 – Pharmaceutical preparations; veterinary preparations; vitamin preparations; biological preparations for medical purposes; dietary supplements; food supplements; nutraceutical supplements; topical gels for medical and therapeutic use; antibacterial gels; pharmaceuticals and natural remedies; pharmaceutical preparations for the stimulation of tissue regeneration; pharmaceutical preparations and nutritional supplements for lactation; medicinal substances for medical or veterinary purposes; food for babies and infant formula; nutraceutical preparations for therapeutic or medical purposes; pharmaceutical preparations comprising royal jelly; nutraceutical supplements comprising royal jelly; pharmaceutical and medical gels, ointments and creams.

(260) AM 2019 102673 A

(800) 1460981

(151) 2019 02 26

(891) 2019 02 26

(731) GUANGZHOU XIN JUE NENG  
ELECTRONIC LIMITED  
ROOM 4B001, 4/F, NO.28,30,32, XIDI  
ERMA ROAD, LIWAN DISTRICT,  
GUANGZHOU, GUANGDONG, China

(540)

(591) Black, white

(531) 27.01.16; 27.05.09; 27.05.10

(511)

9 – Electronic notice boards; batteries, electric; chargers for electric batteries; transformers.

(260) AM 2019 102674 A

(800) 1461017

(151) 2019 01 18

(891) 2019 01 18

(731) PHILIP MORRIS PRODUCTS S.A.  
Quai Jeanrenaud 3, CH-2000 Neuchâtel,  
Switzerland

(540)

(591) Black, white

(531) 05.03.14; 27.05.01

(511)

9 – Batteries for electronic cigarettes; batteries for electronic devices that are used for heating tobacco, chargers for electronic devices that are used for heating

tobacco; USB chargers for electronic devices that are used for heating tobacco; car chargers for electronic cigarettes; car chargers for devices that are used for heating tobacco; battery chargers for electronic cigarettes; charging docks and charging stations for electronic devices that are used for heating tobacco; charging docks and charging stations for electronic cigarettes; portable power supplies for electronic devices that are used for heating tobacco; portable power supplies for electronic cigarettes.

34 – Wired vaporizers for electronic cigarettes and electronic smoking devices; tobacco, raw or manufactured; tobacco products, including cigars, cigarettes, cigarillos, tobacco for roll-your-own cigarettes, pipe tobacco, chewing tobacco, snuff tobacco, kretek; snus; tobacco substitutes (not for medical purposes); smokers' articles, including cigarette paper and tubes, cigarette filters, tobacco tins, cigarette cases and ashtrays, pipes, pocket apparatus for rolling cigarettes, lighters; matches; tobacco sticks, tobacco products for the purpose of being heated, electronic devices and their parts for the purpose of heating cigarettes or tobacco in order to release nicotine-containing aerosol for inhalation; liquid nicotine solutions for use in electronic cigarettes; electronic smoking devices; electronic cigarettes; electronic cigarettes as substitutes for traditional cigarettes; electronic devices for the inhalation of nicotine-containing aerosol; oral vaporizing devices for smokers, tobacco products and tobacco substitutes; smokers' articles for electronic cigarettes; parts and fittings for the aforesaid products included in class 34; devices for extinguishing heated cigarettes and cigars as well as heated tobacco sticks; electronic rechargeable cigarette cases; protective cases, decorative covers and carrying cases for electronic cigarettes, tobacco heating devices and electronic smoking devices; in-car cradles and in-car holders for electronic cigarettes, tobacco heating devices and electronic smoking devices; containers for the disposal of used tobacco sticks; cleaners, cleaning utensils and cleaning brushes for electronic cigarettes, tobacco heating devices and electronic smoking devices.

(260) AM 2019 102675 A

(800) 203699

(151) 1957 10 01

(891) 2019 02 28

(731) C. Bechstein Pianoforte AG  
Kantstrasse 17, 10623 Berlin, Germany

(540)

(591) Black, white

(531) 27.05.01

(511)

15 – Pianos, small pianos, grand pianos.

(260) AM 2019 102679 A  
 (800) 984591  
 (151) 2008 11 04  
 (891) 2019 02 28  
 (731) LIAO YONG

Room 2602, No.2 Huanyue Street, Haizhu  
 District, Guangzhou, Guangdong, China

(540)

**rialli**

(591) Black, white  
 (531) 27.05.01  
 (511)

7 – Control mechanisms for machines, engines or motors; valves (parts of machines); pumps (parts of machines, engines or motors); bearings (parts of machines); bicycle assembling machines; fuel conversion apparatus for internal combustion engines; jacks (machines); springs (parts of machines); aerators; belt conveyors.

(260) AM 2019 102680 A  
 (800) 1066522  
 (151) 2010 12 15  
 (891) 2019 03 13

(731) VAN DRIE HOLDING B.V.  
 Nijverheidsweg 11, NL-3641 RP  
 Mijdrecht, Netherlands

(540)



(591) Red, blue, white.  
 (531) 03.04; 26.04; 29.01  
 (511)

29 – Meat, fish, poultry and game; meat extracts; preserved, dried and cooked fruits and vegetables; jellies, jams; eggs, milk and milk products; edible oils and fats; preserved food as far as not included in other classes; pickles.

(260) AM 2019 102681 A  
 (800) 1097048  
 (151) 2011 09 21  
 (891) 2019 03 21

(731) INCYTE HOLDINGS CORPORATION  
 1801 Augustine Cut-Off, Wilmington  
 DE 19803, USA

(540)



(591) Black, white  
 (531) 26.01.06  
 (511)

5 – Pharmaceutical preparations for the treatment of viral, hematological, oncological, auto-immune, inflammatory, metabolic, and dermatological disorders.

16 – Printed medical publications namely reports, manuals, brochures, newsletters, leaflets.

42 – Scientific and medical research relating to viral, hematological, oncological, auto-immune, inflammatory, metabolic, and dermatological disorders.

44 – Providing information relating to viral, hematological, ontological, auto-immune, inflammatory, metabolic and dermatological disorders via a web site.

(260) AM 2019 102773 A  
 (800) 1461914  
 (151) 2018 12 20  
 (891) 2018 12 20

(731) MJÓLKURSAMSALAN EHF.  
 Bítruhálsi 1, IS-110 Reykjavík, Iceland

(540)

**ísey**  
**SKYR**

(591) Black, white  
 (531) 27.05.09; 27.05.10  
 (511)  
 29 – Milk and milk products.

(260) AM 2019 102774 A  
 (800) 1461926  
 (151) 2019 02 26  
 (891) 2019 02 26

(731) C.P.C. Creative Perfume Company Holding SA  
 c/o Lenhill Partners SA, Rue du Mont-de-Sion  
 8 CH-1206 Genève, Switzerland

(540)

**VILHELM**  
**PARFUMERIE**

(591) Black, white

(511)

3 – Amber [perfume]; aromatics [essential oils]; air fragrancing preparations; cake flavorings [essential oils]; flavorings for beverages [essential oils]; food flavorings [essential oils]; breath freshening sprays; balms, other than for medical purposes; lip glosses; sachets for perfuming linen; scented water; Javelle water; lavender water; toilet water; depilatory wax; mustache wax; massage gels, other than for medical purposes; heliotropine; make-up; deodorants for pets; deodorants for human beings or for animals; depilatory preparations; air fragrance reed diffusers; scented wood; perfumes; perfumery; decorative transfers for cosmetic purposes; ionone [perfumery]; eyebrow pencils; cosmetic pencils; adhesives for affixing false eyelashes; adhesives for affixing false hair; hair conditioners; beard dyes; cosmetic dyes; cosmetic creams; skin whitening creams; incense; hair spray; nail polish; hair lotions; lotions for cosmetic purposes; after-shave lotions; beauty masks; oils for perfumes and scents; oils for cosmetic purposes; oils for toilet purposes; essential oils; essential oils of cedarwood; essential oils of lemon; essential oils of citron; oils for cleaning purposes; bergamot oil; gaultheria oil; jasmine oil; lavender oil; almond oil; rose oil; almond milk for cosmetic purposes; cleansing milk for toilet purposes; musk [perfumery]; deodorant soap; shaving soap; soap for brightening textile; cakes of toilet soap; antiperspirant soap; soap for foot perspiration; soap; almond soap; mint for perfumery; cosmetic kits; eau de Cologne; bases for flower perfumes; joss sticks; dentifrices; lipstick cases; breath freshening strips; teeth whitening strips; lipsticks; pomades for cosmetic purposes; shaving preparations; cosmetic preparations for baths; bath preparations, not for medical purposes; hair straightening preparations; hair waving preparations; color-removing preparations; leather bleaching preparations; mouthwashes, not for medical purposes; cosmetic preparations for slimming purposes; make-up removing preparations; nail care preparations; collagen preparations for cosmetic purposes; aloe vera preparations for cosmetic purposes; sunscreen preparations; breath freshening preparations for personal hygiene; make-up powder; nail varnish removers; vaginal washes for personal sanitary or deodorant purposes; tissues impregnated with cosmetic lotions; tissues impregnated with make-up removing preparations; massage candles for cosmetic purposes; potpourris [fragrances]; bath salts, not for medical purposes; fumigation preparations [perfumes]; astringents for cosmetic purposes; eyebrow cosmetics; make-up preparations; sun-tanning preparations [cosmetics]; hair dyes; neutralizers for permanent waving; cosmetic preparations for eyelashes; cosmetic preparations for skin care; cosmetics; cosmetics for children; cosmetics for animals; mascara; cleansers for intimate personal hygiene purposes,

non medicated; douching preparations for personal sanitary or deodorant purposes [toiletries]; bleaching preparations [decolorants] for cosmetic purposes; antiperspirants [toiletries]; toiletry preparations; phytocosmetic preparations; talcum powder, for toilet use; terpenes [essential oils]; henna [cosmetic dye]; shampoos for animals [non-medicated grooming preparations]; shampoos for pets [non-medicated grooming preparations]; dry shampoos; shampoos; herbal extracts for cosmetic purposes; extracts of flowers [perfumes]; ethereal essences; badian essence; mint essence [essential oil].

4 – Nightlights [candles]; perfumed candles; Christmas tree candles; candles.

(260) AM 2019 102775 A

(800) 1461945

(151) 2018 12 17

(891) 2018 12 17

(731) SICHUAN HONGYA COUNTY YAOMAZI FOOD CO., LTD.

Wulong Village, Zhige Town, Hongya County, Meishan City, Sichuan Province, China

(540)

**么麻子**  
**YAO MA ZI**

(591) Black, white

(531) 28.03

(511)

29 – Meat; fish-based foodstuffs; vegetables, tinned; fruit, preserved; vegetables, preserved; eggs; oils for food; nuts, prepared; dried edible mushroom; bean curd products.

30 – Tea; sugar; pastries; cereal preparations; noodles; starch for food; condiments; seasonings; food flavourings, other than essential oils; yeast.

35 – Publicity; on-line advertising on a computer network; providing business information via a web site; presentation of goods on communication media, for retail purposes; commercial administration of the licensing of the goods and services of others; import-export agency services; sales promotion for others; provision of an on-line marketplace for buyers and sellers of goods and services; web site traffic optimization; rental of vending machines.

43 – Restaurant services; hotel service; canteen services; food and drink catering; cafe services; teahouse services; bar services; food sculpting; providing campground facilities; rental of cooking apparatus.



(260) AM 2019 102776 A

(800) 1461966

(151) 2018 09 14

(891) 2018 09 14

(731) Obshchestvo s ogranichennoj otvetstvennost'yu "STIL TEKHNOLODZHI" ul. Angarskaya, vl. 8, str. 11, g. Mytishchi, d. Gribki, RU-141044 Moskovskaya oblast', Russian Federation

(540)



The logo for 'StopMoss' features the word 'Stop' in a white, rounded, sans-serif font with a thick orange outline. The word 'Moss' is in a bold, dark green, sans-serif font with a thick orange outline. The two words are joined together.

(591) White, green and orange

(531) 27.05.02; 27.05.17; 27.05.24; 29.01.13

(511)

6 – Fittings of metal for building; hardware of metal, small; building materials of metal; framework of metal for building; buildings of metal; hooks of metal for roofing slates; sheets and plates of metal; small items of metal hardware; roof flashing of metal; wall linings of metal for building; tiles of metal for building; slabs of metal for building; roof coverings of metal; cladding of metal for building; linings of metal for building; pantiles of metal; roofing tiles of metal; roofing of metal; canopies [building structures] of metal; steel buildings.

35 – Rental of advertising space; demonstration of goods; updating of advertising material; organization of exhibitions for commercial or advertising purposes; organization of trade fairs for commercial or advertising purposes; shop window dressing; design of advertising materials; provision of an on-line marketplace for buyers and sellers of goods and services; sales promotion for others; rental of vending machines; rental of sales stands; publication of publicity texts; radio advertising; bill-posting; distribution of samples; dissemination of advertising matter; direct mail advertising; writing of publicity texts; advertising; on-line advertising on a computer network; advertising by mail order; television advertising; procurement services for others [purchasing goods and services for other businesses]; outsourcing services [business assistance]; retail store services, wholesale of goods, services of retail delivery trade (terms considered too vague by the International Bureau – rule 13 (2) (b) of the Common Regulations); retail sale services of goods using television stores or Internet sites; commercial information and advice for consumers in the choice of products and services; presentation of goods on communication media, for retail purposes; rental of signs for advertising purposes; retail services provided by means of mail order catalogs.

37 – Construction information; repair information; construction consultancy; roofing services; masonry;

underwater repair; construction; providing information relating to the construction, repair and maintenance of buildings.

42 – Construction drafting; styling [industrial design]; architectural research; architectural and engineering services; architectural design; computer-aided design services relating to architecture; architectural planning and consultancy services.

(260) AM 2019 102777 A

(800) 1461970

(151) 2019 01 10

(891) 2019 01 10

(731) IWI AG

INDUSTRIESTRASSE 13-C, CH-6302

ZUG, Switzerland

(540)

**blackwood**

(591) Black, white

(511)

21 – Floss for dental purposes; toothbrushes; toothbrushes, electric.

(260) AM 2019 102778 A

(800) 1461992

(151) 2018 11 15

(891) 2018 11 15

(731) YVES SAINT LAURENT

37-39 rue de Bellechasse F-75007 PARIS, France

(540)

**SAINT LAURENT RIVE DROITE**

(591) Black, white

(511)

9 – Spectacle frames, spectacles [optics], sunglasses, spectacle cases; apparatus for recording, transmission, reproduction of data, sound or images; telephones, cellular phones, smartphones, tablets, personal digital assistants and MP3 players; accessories for telephones, cellular phones, smartphones, tablets, personal digital assistants and MP3 players, in particular hands-free kits for telephones, batteries, covers, cases, shells, facades, chargers, straps for cellular phones, wrist straps or neck straps; electronic device accessories for wireless transmission of data and/or voice signals, namely batteries, car kits, chargers and charging cradles, virtual reality headsets, fasteners/cases for belt attachment, headsets, adapters, adapter cases, docking stations, laptop cases and covers, sheaths, battery covers; magnetic recording media, acoustic disks, compact disks, DVDs, USB keys and other digital recording media; digital audio players; headphones for music; wired or wireless acoustic speakers for music.

14 – Precious metals and their alloys; works of art (made of precious metal); jewellery (including costume jewellery) of precious metals and their alloys and plated therewith, namely rings, earrings, cuff links, bracelets, brooches, pendants, charms, chains, watch chains, necklaces, medals, medallions; semi-precious and precious stones; horological and chronometric instruments, watches, watch bands and watch cases; key rings of precious metals and their alloys or plated therewith; boxes and cases for horological articles; jewellery boxes and cases.

16 – Paper, cardboard and products made from these materials, not included in other classes namely paper or cardboard posters, adhesives [sticky materials] for stationery or the household, albums, almanacs, atlases, tickets, paper or cardboard boxes, cards, binders, covers [stationery], paper flower-pot holders, document folders, paper bags and packs [envelopes, clutch bags], notebooks, calendars, booklets, pattern cases, flyers/leaflets, paper tablecloth, paper hand towels, round paper place mats; printing products; bookbinding products; materials for artists; brushes; catalogues, newspapers, magazines, prospectus and manuals, books, brochures; photographs [printed]; stationery products, posters; stickers (stationery products); paper wrapping and cardboard wrapping; paper wrapping bags [envelopes, clutch bags]; booklets; plastic material for wrapping, in particular bags, packs and clutch bags; subscription cards (non-magnetic), pens, pencils, pencil holders, writing instruments, tools necessary for writing (writing cases), their suitable cases, notepads, desk pads, business cards, check books, planners, post cards; engraved, lithographed works of art; portraits; embroidery patterns; pitcher coasters (of paper), paper place mats, paper napkins; paper tablecloths; cardboard hat boxes; paper cutters [office supplies]; envelopes [stationery]; non-fabric labels; letter paper; bookmarks for directories.

18 – Leather and imitation leather, animal skins and imitation animal skins; handbags, shoulder bags, tote bags, luggage, wallets, money purses, purses, cardholders (wallets), document holders, briefcases, attaché cases, schoolbags, satchels, beach bags, sport bags, waist bags, carrying bags, suitcases, trunks (luggage), travel bags, backpacks, shopping bags, clutch bags, vanity cases (not fitted), toilet kit bags (empty), garment bags for travel, travel sets namely sets of coordinated luggage for travel, key cases (leather ware), umbrellas, parasols, walking sticks; animal harnesses, whips, saddlery.

20 – Furniture, chests of drawers, wardrobes; dressers, shelves, bookcases, tables, computer desks; armchairs, sofas, chairs, deck chairs; bedding (except bed linen), mattresses, box springs, bed frames; mirrors, frames; art objects made of wood, wax, plaster, cork, reed, rush, wicker, horn, bone, ivory, whalebone, shell, amber, mother-of-pearl, meerschaum, sub-

stitutes for any of these materials or plastics; covers for clothing (wardrobe); cushions; wooden and plastic boxes; caskets; magazine racks, umbrella stands, hat and coat stands, towel stands.

21 – Metal paper towel dispensers, toothbrush holders; soap boxes, tooth glasses, brushes (except paintbrushes); bath sponges; sponge holders; soap dishes; liquid soap dispensers; small bottles not made of precious metal sold empty; kitchen utensils and containers (not made of precious metal or coated therewith); tableware; kitchen glassware; porcelain, namely porcelain items for the kitchen; porcelain art objects; earthenware, namely earthenware items for the kitchen; earthenware art objects.

24 – Fabrics and textile products, in particular bath linen (except clothing); bed linen; household linen; table linen (of textile materials); cushion covers; lap robes; bed and table covers.

25 – Clothing, belts (clothing), gloves (clothing), footwear and headgear.

28 – Skateboards; roller skates; scooters; ice skates; snowboards; skis; ski poles; windsurfing boards; bodyboards; surfboards; wakeboards; kitesurf boards; swimming flippers; protective sports equipment, namely wrist guards, knee pads, elbow guards, chin protectors, chest protectors, ankle supports; covers designed especially for surfboards, skis, snowboards, bodyboards, wakeboards, kitesurf boards, skateboards and roller skates; straps for surfboards; games; toys; gymnastics and sports articles.

30 – Pastry and confectionery, chocolates, chocolate bars, cereal bars.

34 – Smokers' articles, ashtrays for smokers, cigar holders, cigarette holders, lighters for smokers, cigar boxes, cigarette boxes; matches; match boxes; cigar cases; cigar cutters; cigar box sets; portable devices for rolling cigarettes; cigarette cases; cigarette mouthpieces; cigar mouthpieces; pipes; match holders; tobacco jars; snuff boxes.

35 – Retail and online retail services for eyewear, phone and tablet accessories, jewellery, watch making, paper and stationery, leather goods, furniture and home decor, small household utensils, tableware, table linen, bath linen, bed linen, clothing, footwear, headgear, gymnastics and sports articles, confectionery, smokers' articles; advertising.

(260) AM 2019 102779 A

(800) 1461999

(151) 2019 02 22

(891) 2019 02 22

(731) SHANGHAI HUGONG ELECTRIC  
(GROUP) CO., LTD.

7177 WAIQINGSONG HWY, QINGPU  
DISTRICT, 201700 SHANGHAI, China

(540)

**HUGONG**

(591) Black, white

(531) 27.05.17

(511)

7 – Cutting machines; handling machines, automatic [manipulators]; industrial robots; electric welding apparatus; electric arc cutting apparatus; welding machines, electric; cutting blow pipes, gas-operated; dynamos; soldering apparatus, gas-operated; soldering lamps.

(260) AM 2019 102794 A

(800) 1462271

(151) 2018 03 02

(891) 2018 03 02

(731) IDEMIA FRANCE

2 Place Samuel de Champlain, F-92400  
COURBEVOIE, France

(540)



(591) Violet C

(531) 26.03.23; 29.01.05

(511)

9 – Electronic apparatus for checking the authenticity of cards, badges, passports, visas, namely electronic systems attesting to the authorization of entry into a territory and secure documents bearing a seal which afford entry into a territory, drivers' licenses, biometric identity cards or identification documents, electronic detectors for banknotes or access passes; apparatus and instruments for authenticating banknotes, access passes and payment documents; chips [integrated circuits]; computer chips; computer chips; semiconductor chips; electronic chips for manufacturing integrated circuits; semi-conductors; semi-conductor wafers; electronic semi-conductors; magnetic or electronic cards and badges, contact or contact-free, intended for use as payment, credit, debit, remote payment or loyalty cards and electronic wallets, including those with dynamic codes for securing all transactions online; electronic systems attesting to the authorization of entry into a territory, namely, cards, badges, passports, visas, driving licenses, electronic or biometric of identity or identification papers, all of the aforesaid goods having optical effect security to fight unauthorized reproduction, forgery and counterfeiting; magnetic or electronic cards and badges intended for use as cards and

badges for access, transport, single or multiple access to services and/or transport networks, subscription to transport services; electronic or magnetic cards for use as health cards, cards for access to pay television channels, games, and/or multimedia, or data banks, and, databases; biometric apparatus, instruments, terminals, readers and scanners for fingerprints, palm prints, features of the iris, veins, voices, facial features or other biometric features; integrated circuit cards; chip cards; integrated circuit cards (smart cards); memory cards; programmable cards; remote programmable cards; transmitter-receiver cards and badges; radio frequency cards and badges; infrared cards and badges; cards for access to telecommunications and/or computer networks; encoded cards; pre-recorded data cards, computer programs, and software; telecommunication cards; control cards for communication; magnetic or chip-based cards with units of credit; mobile telephone cards with magnetic code; electronic cards for secure access, to computer and/or telecommunications networks; electronic cards used for accessing services and/or performing operations and transactions on telecommunications and/or computer networks; computer programs; software; biometric identification and control systems; computers and computer software for biometric systems for the identification and authentication of persons; software for biometric systems for the identification and authentication of persons; software for detecting persons; software for interpreting finger or palm prints, features of the iris, veins, voice, facial features or other biometric features; computer programs and software for use with cards; computer programs and software recorded on cards or to be recorded on cards and/or telecommunications apparatus; software for providing access to electronic mail services; messaging software; software for providing access to electronic communication networks; software for providing access to the Internet and/or Internet sites; software for telecommunications, software for navigation (browsing); software for operations and, transactions by cards, namely, chip-based cards; integrated circuits; electronic chips; electronic signature support software, encryption software; encryption keys; electronic apparatus for checking the authenticity of cards; computer programs and software for storage, retrieval and secure transmission of information or data; computer programs and software for identifying and authenticating persons and/or electronic signatures for accessing networks, payment, operations and transactions, including online e-commerce; traceability software for the management and securing of documents and/or printed matter; computer servers, in particular for the downloading, distribution and management of applications on cards, including chip cards; computer programs and software for communication between chip-based cards and chip card readers and/or computer terminals; computer prog-

rams and software for transmitting, displaying and storing identification and/or operations and transactions data or information, particularly online; computer software for processing electronic payments and transferring funds to and from others; authentication software for controlling access to computers and computer networks and controlling communication between computers and computer networks; software, and, databases for the issue and/or management of cards, namely, chip-based cards, and, for the verification of the management of such cards; apparatus for the storage, conversion, processing and transmission of data, information and signals; scientific, photographic, cinematographic, optical, measuring, signaling and checking apparatus and instruments; electronic and/or computer apparatus, instruments and equipment for securing premises, including anti-theft warning apparatus, alarms; apparatus and instruments for the identification, access control using biometric data; electric locks; traffic control apparatus; apparatus for measuring speed; infrared cameras; apparatus for playing films; radars; software for capturing and processing data provided via the aforesaid apparatus and instruments; magnetic card encoding readers; data encoders; data decoders; computers and computer peripherals for use in connection with cards and/or telecommunications apparatus; microcomputers; portable computers; hand-held computers; apparatus for controlling secure access to computer and/or telecommunications networks; coded credit cards; encoded payment cards.

16 – Photographs; paper, printed materials; printed matter; printed matter which by the composition of paper, ink or printing methods used are aimed at combating unauthorized reproduction, falsification and counterfeiting; banknotes; checks (means of payment); bank checks; voucher checks; gift certificates; holiday checks; passports [identification document not magnetically encoded]; secure papers affixed with a seal enabling entry into a territory, namely, visas; unencrypted ID cards with optical effect security to fight unauthorized reproduction, forgery, counterfeiting; non-coded identification or access cards and badges (control, authentication, authorization) for sporting, cultural and recreational events or shows; printed matters, namely, driving license; printed matters, namely, social security cards; printed matters, namely, treasury bills; financial securities; tax stamps; scratch cards; printed materials, namely, shares (securities); labels; paper banners; passenger tickets; letters communicating a confidential code; printed matter for home use in connection with payment for services; prepaid telephone calling cards, not magnetically encoded; engraving plates for the aforesaid goods.

35 – Business management and company administration including personnel management; services provided by consultants and business management

advice, provision of advice relating to company management and business operations; compilation and analysis of data and information relating to business management; assistance and consultancy in the field of the business management of companies; assistance with the management of commercial activities or functions for an industrial or commercial company; company management and services provided by consultants in connection with commercial affairs; services provided by consultants regarding human resources; human resources management; advertising; advertising by mail order; radio advertising; television advertising; commercial business management; commercial administration; commercial information and advice for consumers in the field of identity, security and in the field of banking; dissemination of advertising material (leaflets, prospectuses, printed matter, samples); distribution of advertising material (leaflets, prospectuses, printed matter, samples); arranging newspaper subscriptions for others; arranging of telecommunication service subscriptions for others; updating and maintenance of data in computer databases; data search in computer files for others; web site traffic optimization; organization of exhibitions, trade fairs for commercial or advertising purposes; online advertising on a computer network; advertising mail; updating of advertising material; rental of advertising time on all communication media; publication of advertising texts; rental of advertising space; dissemination of advertisements; public relations; opinion polling; company audits (commercial analyses); commercial intermediation services; promotion of the goods of others, namely, provision of information about discounts, coupons, price reductions, vouchers and special offers for the goods of others; promotion of the goods and services of others by providing hyperlinks to the websites of others; promotion of the goods and services of others by providing websites with links to the online retail websites of others; services provided by business consultants in the field of online payments; administrative services, namely, management and monitoring of credit cards, immediate debit cards, electronic checks, prepaid cards, payment cards and other forms of payment transactions via electronic communication networks for business purposes; business information management, namely, business analysis e-reports regarding payment processing, authentication, tracking and invoicing; business management, namely, payment optimization for companies.

36 – Banking, financial and monetary affairs; insurance services; consultancy and information relating to financial, monetary and banking matters; consultancy and information relating to insurance underwriting; financial services, namely the electronic transfer of funds; clearing and reconciling of financial transactions; providing a wide range of payment and financial services, namely credit card services, issu-

ance of credit cards, payment cards and credit lines, processing and transmission of bills and payments thereof, bill payment services with guaranteed provision of payment, and brokerage of money market funds, all via global communication networks; processing of transactions carried out by credit card and immediate debit card; reimbursement of funds for disputed items in the field of purchasing via electronic payment; provision of purchase protection for goods and services purchased by others via global computer and wireless networks; processing of credit card transactions; credit services, namely, provision of revolving credit account services; bill payment services; provision of mobile electronic payment services for others; credit card and payment processing services; processing of payments through electronic foreign exchange operations; payment processing services, namely providing transaction processing services in virtual currency for others, deposits of valuables, deposits in safe boxes; issuing of travelers' checks, holiday vouchers and payment orders in general; financing of loans for security and surveillance systems.

38 – Telecommunications; telephone services; telephone exchange services; communications by telephone; computerized telephony services; electronic messaging services; telephone voice messaging services; information on telecommunications; communications by computer terminals or by fiber-optic networks; communications by radio or telephone; cellular telephone communication services; transmission of data via telephone lines; providing telecommunications connections for hotlines and call centers; broadcasting of multimedia content via the Internet; streaming of audio, visual and audiovisual content via a global computer network; multimedia, audio and video dissemination via the Internet and other communication networks; dissemination of data; provision of user access to global computer networks; provision of access to a web portal, messaging services; provision of on-line forums; provision of access to chat lines, chat rooms and forums on the Internet, including the mobile Internet; provision of access to electronic information, communication and transaction platforms on the Internet; transfer of all types of messages to Internet addresses [web messaging]; provision of access to databases; electronic bulletin board services (telecommunication services); connection by telecommunications to a global computer network; news or information agencies; rental of telecommunication apparatus; broadcasting and transmission of radio and television programs; teleconferencing or videoconferencing services; rental of access time to global computer networks; Transmission of information, data or software via telephone line, telecommunications and/or computer networks, cable, satellite, radio relay; downloading of data or software on cards and badges, including payment cards, remote payment,

electronic cash, intended for securing transactions by code, particularly online; information concerning the aforesaid services.

40 – Printing; printing of documents or printed matter to combat unauthorized reproduction, falsification and counterfeiting; photocomposition; photogravure; information and advice relating to printing; engraving; information and advice relating to engraving; services for etching a sequence of identifiable numbers onto automobile windows with a view to identification in case of theft.

42 – Computer engineering; technical consultancy relating to computers and/or telecommunications; design, development, maintenance and updating of software and databases; design and development of computers; development (design), installation, maintenance, updating or rental of software; computer programming; computer and software consultancy; programming for microprocessor cards and badges; lending and rental of computers, computer peripheral devices, computer programs and software; design, development, maintenance and updating of software for managing, securing and transferring cash; design, development of systems for the identification, authentication of the person; technical assistance, technical advice for the implementation of systems of identification and the authentication of persons; design, development and updating of programs and computer software for interpreting fingerprints, palm prints, features of the iris, veins, the voice, facial features or other biometric features in the field of access control and the authentication of persons; design, development and updating of cards and badges, including payment cards, remote payment, electronic cash, intended for securing all transactions by code, particularly online; design and development of currency, payment documents, access passes, identification documents, cards, badges, banners and labels; design, development and updating of cards and card readers; information and advice relating to design and development of currency, payment documents, access passes, identification documents, cards, badges, banners and labels; lending and leasing of cards and badges, including payment cards, remote payment, electronic cash intended for securing all transactions by code, particularly online; loan and rental of cards and keys for access to telecommunication systems and networks and computer systems and networks; the aforesaid services available for consultation or made available by means of data transmission or on telecommunication or computer networks; Design and development of data acquisition systems in connection with documents or printed matter to combat unauthorized reproduction, falsification and counterfeiting; design, development of ink, watermarks, paper, and software products, electronic chips for authentication, customization, protection against unauthorized reproduction, forgery, counterfeiting of documents, printed matter; design

and development of processes for protection against unauthorized reproduction, falsification, counterfeiting, processes for authentication, customization of documents by inking, watermarking, guilloche ornamentation, marking; hosting, development and design of networks and servers for the processing and management of a customer's computer system; provision of temporary use of non-downloadable online software for processing electronic payments; provision of temporary use of non-downloadable online authentication software for controlling access to computers and computer networks as well as for controlling communication between computers and computer networks; computer programming and development; development of computer software, especially for processing data collected using traffic control apparatus; checks and certification of the quality of traffic control apparatus and computer software relating to traffic control; research and analysis of technical data relating to theoretical situations relating to traffic; technological consulting services to improve traffic safety; reports, studies, analyses, evaluations, estimates, diagnostics, recommendations, consultancy and research in scientific and technological fields provided by engineers; technical project studies; research in the field of semiconductor processing technology; creation of databases; certification, testing, analysis and evaluation of products and services of others with the aim of issuing certification; research and development of new products for others; services of a graphics studio; expert reports and studies relating to telecommunications; expert reports, studies, consultancy and technical advice relating to computer technology and/or management systems and/or securing the transfer of funds; electronic security consultancy; expert reports, studies, technical consulting and advice, in the field of electronic card management systems; design, development and customization of documents and printed matter, money, payment orders, documents for access, for identification, cards, badges, banderoles and labels; design and development of anti-intrusion, anti-sabotage, anti-destruction and anti-theft systems for premises or industrial facilities.

45 – Security services for the protection of property and individuals (excluding the transport thereof); night guard services; security agent services for the protection of property and individuals; providing information, advice and consultancy services relating to security services for the protection of property and individuals; security inspection services for others; authentication of personal identification information [identity verification services]; inspection of luggage for security purposes or in the field of transport, trade, regulated or unauthorized goods; information and consultancy relating to security for protection in the field of the transport of funds or valuables, luggage inspection; personal body guarding; surveillan-

ce and security for premises and industrial facilities; surveillance of anti-intrusion, anti-sabotage, anti-destruction and anti-theft and security alarms; verification services for alarms and intervention subsequent to the triggering thereof; fingerprinting and fingerprint registration; assignment of identification numbers to affix to valuables to facilitate their recovery following loss or theft [security services]; Locating stolen goods; stolen vehicle tracking; tracking services with a view to the recovery of encoded products; fraud detection services in the field of credit cards used for on-line shopping.

(260) AM 2019 102797 A

(800) 1462341

(151) 2018 11 15

(891) 2018 11 15

(731) YVES SAINT LAURENT

37-39 rue de Bellechasse, F-75007 PARIS,  
France

(540)

**SAINT LAURENT**  
■ RIVE DROITE

(591) Black, white

(531) 26.04.01; 26.04.05; 26.04.24; 27.05.01

(511)

9 – Spectacle frames, spectacles [optics], sunglasses, spectacle cases; apparatus for recording, transmission, reproduction of data, sound or images; telephones, cellular phones, smartphones, tablets, personal digital assistants and MP3 players; accessories for telephones, cellular phones, smartphones, tablets, personal digital assistants and MP3 players, in particular hands-free kits for telephones, batteries, covers, cases, shells, facades, chargers, straps for cellular phones, wrist straps or neck straps; electronic device accessories for wireless transmission of data and/or voice signals, namely batteries, car kits, chargers and charging cradles, virtual reality headsets, fasteners/cases for belt attachment, headsets, adapters, adapter cases, docking stations, laptop cases and covers, sheaths, battery covers; magnetic recording media, acoustic disks, compact disks, DVDs, USB keys and other digital recording media; digital audio players; headphones for music; wired or wireless acoustic speakers for music.

14 – Precious metals and their alloys; works of art (made of precious metal); jewellery (including costume jewellery) of precious metals and their alloys and plated therewith, namely rings, earrings, cuff links, bracelets, brooches, pendants, charms, chains, watch chains, necklaces, medals, medallions; semi-precious and precious stones; horological and chronometric instruments, watches, watch bands and watch cases; key rings of precious metals and their

alloys or plated therewith; boxes and cases for horological articles; jewellery boxes and cases.

16 – Paper, cardboard and products made from these materials, not included in other classes namely paper or cardboard posters, adhesives (sticky materials) for stationery or the household, albums, almanacs, atlases, tickets, paper or cardboard boxes, cards, binders, covers (stationery), paper flower-pot holders, document folders, paper bags and packs (envelopes, clutch bags), notebooks, calendars, booklets, pattern cases, flyers/leaflets, paper tablecloth, paper hand towels, round paper place mats; printing products; bookbinding products; materials for artists; brushes; catalogues, newspapers, magazines, prospectus and manuals, books, brochures; photographs [printed]; stationery products, posters; stickers (stationery products); paper wrapping and cardboard wrapping; paper wrapping bags [envelopes, clutch bags]; booklets; plastic material for wrapping, namely bags, packs and clutch bags; subscription cards (non-magnetic), pens, pencils, pencil holders, writing instruments, tools necessary for writing (writing cases), their suitable cases, notepads, desk pads, business cards, check books, planners, post cards; engraved, lithographed works of art; portraits; embroidery patterns; pitcher coasters (of paper), paper place mats, paper napkins; paper tablecloths; cardboard hat boxes; paper cutters [office supplies]; envelopes [stationery]; non-fabric labels; letter paper; book-marks for directories.

18 – Leather and imitation leather, animal skins and imitation animal skins; handbags, shoulder bags, tote bags, luggage, wallets, money purses, purses, cardholders (wallets), document holders, briefcases, attaché cases, schoolbags, satchels, beach bags, sport bags, waist bags, carrying bags, suitcases, trunks (luggage), travel bags, backpacks, shopping bags, clutch bags, vanity cases (not fitted), toilet kit bags (empty), garment bags for travel, travel sets namely sets of coordinated luggage for travel, key cases (leather ware), umbrellas, parasols, walking sticks; animal harnesses, whips, saddlery.

20 – Furniture, chests of drawers, wardrobes; dressers, shelves, bookcases, tables, computer desks; armchairs, sofas, chairs, deck chairs; bedding (except bed linen), mattresses, box springs, bed frames; mirrors, frames; art objects made of wood, wax, plaster, cork, reed, rush, wicker, horn, bone, ivory, whalebone, shell, amber, mother-of-pearl, meerschaum, substitutes for any of these materials or plastics; covers for clothing (wardrobe); cushions; wooden and plastic boxes; caskets; magazine racks, umbrella stands, hat and coat stands, towel stands.

21 – Metal paper towel dispensers, toothbrush holders; soap boxes, tooth glasses, brushes (except paintbrushes); bath sponges; sponge holders; soap dishes; liquid soap dispensers; small bottles not ma-

de of precious metal sold empty; kitchen utensils and containers (not made of precious metal or coated therewith); tableware; kitchen glassware; porcelain, namely porcelain items for the kitchen; porcelain art objects; earthenware, namely earthenware items for the kitchen; earthenware art objects.

24 – Fabrics and textile products, in particular bath linen (except clothing); bed linen; household linen; table linen (of textile materials); cushion covers; lap robes; bed and table covers.

25 – Clothing, belts (clothing), gloves (clothing), footwear and headgear.

28 – Skateboards; roller skates; scooters; ice skates; snowboards; skis; ski poles; windsurfing boards; bodyboards; surfboards; wakeboards; kitesurf boards; swimming flippers; protective sports equipment, namely wrist guards, knee pads, elbow guards, chin protectors, chest protectors, ankle supports; covers designed especially for surfboards, skis, snowboards, bodyboards, wakeboards, kitesurf boards, skateboards and roller skates; straps for surfboards; games; toys; gymnastics and sports articles.

30 – Pastry and confectionery, chocolates, chocolate bars, cereal bars.

34 – Smokers' articles, ashtrays for smokers, cigar holders, cigarette holders, lighters for smokers, cigar boxes, cigarette boxes; matches; match boxes; cigar cases; cigar cutters; cigar box sets; portable devices for rolling cigarettes; cigarette cases; cigarette mouthpieces; cigar mouthpieces; pipes; match holders; tobacco jars; snuff boxes.

35 – Retail and online retail services for eyewear, phone and tablet accessories, jewellery, watch making, paper and stationery, leather goods, furniture and home decor, small household utensils, tableware, table linen, bath linen, bed linen, clothing, footwear, headgear, gymnastics and sports articles, confectionery, smokers' articles; advertising.

(260) AM 2019 102800 A

(800) 1141653

(151) 2012 09 27

(891) 2019 03 29

(731) CARIMALI S.p.A.

Via Monte Grappa, 7, I-24121 BERGAMO,  
Italy

(540)

**CARIMALI**

(591) Black, white

(511)

7 – Electric coffee grinders, electric grinder-dosers, washing machines for dishes, glasses and cups, electric fruit juice extractors, automatic dispensers of coffee and other drinks.

11 – Electric coffee machines, electric espresso machines, electric cappuccino machines, automatic coffee machines, electric coffee filters, water softening apparatus, refrigerators, electric heaters for cups, electric heaters for water, electric hot chocolate makers, electric bar machines such as small cooking ovens, cooking apparatus, toasters, electric cooking skewers.

21 – Non-electric coffee machines, non-electric coffee filters, non-electric coffee pots, coffee glasses, coffee stirrers, coffee sets, coffee cups.

(260) AM 2019 102885 A

(800) 1463244

(151) 2018 09 04

(891) 2018 09 04

(731) CHINA RAILWAY CONSTRUCTION CORPORATION LIMITED

No.40 Fuxing Road, Beijing, China

(540)



**中国铁建**

(591) Blue, red and black

(531) 01.05.02; 01.05.06; 27.05.11; 28.03; 29.01.13

(511)

37 – Upholstery repair; heating equipment installation and repair; installation and maintenance of medical devices; shoe repair; knife sharpening; pump repair; parasol repair; artificial snow-making services; installation and maintenance of entertainment or sports apparatus; vehicle cleaning; strong-room maintenance and repair; retreading of tyres; fire alarm installation and repair; umbrella repair; tuning of musical instruments; repair of power lines; rental of dish washing machines; disinfecting; burglar alarm installation and repair; telephone installation and repair; restoration of works of art; swimming-pool maintenance; rental of drainage pumps; maintenance of jewellery ornaments; construction; photographic apparatus repair; rustproofing; furniture maintenance; renovation of clothing; elevator installation and repair; restoration of musical instruments; rental of dish drying machines; repairing hand tools; construction information; mining extraction; installation, maintenance and repair of computer hardware; interference suppression in electrical apparatus; clock and watch repair.

39 – Carting; vehicle breakdown towing services; storage of goods; rental of diving suits; travel reservation; transport; packaging of goods; piloting; ma-

rine transport; railway truck rental; rental of wheelchairs; launching of satellites for others; parcel delivery; electricity distribution; operating canal locks; bottling services.

42 – Quality evaluation of standing timber; biological research; meteorological information; construction drafting; dress designing; weighing goods for others; geological surveys; chemical research; material testing; industrial design; cartography services; computer system design; handwriting analysis [graphology]; engineering drawing; authenticating works of art; graphic arts design; cloud seeding.

(260) AM 2019 102886 A

(800) 1463317

(151) 2018 12 28

(891) 2018 12 28

(731) HALK HİJYENİK ÜRÜNLER DETERJAN SANAYİ VE TİCARET ANONİM ŞİRKETİ

Adana Organize Sanayi Bölgesi, Baklalı Caddesi No:19, Sarıçam, Adana, Turkey

(540)



(591) Purple, white, light blue

(531) 27.05.02; 27.05.09; 27.05.10; 27.05.24; 29.01.13

(511)

5 – Pharmaceutical and veterinary preparations for medical purposes; chemical preparations for medical and veterinary purposes, chemical reagents for pharmaceutical and veterinary purposes; medicated cosmetics; dietary supplements for pharmaceutical and veterinary purposes; dietary supplements; nutritional supplements; medical preparations for slimming purposes; food for babies; herbs and herbal beverages adapted for medicinal purposes; dental preparations and articles: teeth filling material, dental impression material, dental adhesives and material for repairing teeth; sanitary preparations for medical use; hygienic pads; hygienic tampons; plasters; materials for dressings; diapers made of paper and textiles for babies, adults and pets; preparations for destroying vermin; herbicides, fungicides, preparations for destroying rodents; deodorants, other than for human beings or for animals; air purifying preparations; air deodorising preparations; disinfectants; antiseptics; detergents for medical purposes; medicated soaps; disinfectant soaps; antibacterial hand lotions.

(260) AM 2019 102888 A

(800) 1463380

(151) 2019 02 18



(891) 2019 02 18  
 (731) SICHUAN YIBIN WULIANGYE GROUP  
 CO., LTD  
 #150, Minjiang West Road, Yibin, Sichuan,  
 China

(540)



(591) Black, white  
 (531) 28.03  
 (511)  
 33 – Alcoholic beverages, except beer.

(260) AM 2019 102889 A  
 (800) 1463446  
 (151) 2019 01 21  
 (891) 2019 01 21  
 (731) ZHEJIANG JUMI CULTURE  
 COMMUNICATION CO., LTD.  
 Bldg 3A, Lugang E-commerce Town,  
 Yiwu City, Zhejiang Province, China

(540)



(591) Black, white  
 (531) 27.05.01; 28.03  
 (511)  
 3 – Facial cleansers; washing powder; perfumes;  
 dentifrices; essential oils, shampoos; hair condition-  
 ers; cakes of toilet soap; cosmetics.

(260) AM 2019 102890 A  
 (800) 1463494  
 (151) 2018 12 28  
 (891) 2018 12 28  
 (731) LIMA VEHICLE GROUP CO., LTD.  
 Pengjie Industry Zone, Luqiao Area,  
 Taizhou City, Zhejiang, China

(540)



**LIMA 立马**

(591) Black, white  
 (531) 24.01.03; 24.01.07; 27.05.01; 28.03

(511)  
 12 – Motorcycles; electric bicycles; electric tricycle;  
 bicycles; motor tricycle; motors, electric, for land  
 vehicles; clutches for land vehicles; engines for land  
 vehicle cars; electric vehicle.

(260) AM 2019 102891 A  
 (800) 1463501  
 (151) 2019 02 28  
 (891) 2019 02 28  
 (731) BROOKSBURNETT INVESTMENTS LTD.  
 Sofias Tsirou 9, Toulla Court 3, 2nd Floor,  
 Flat/Office 22, CY-3021 Limassol, Cyprus

(540)

**MALEMI**

(591) Black, white  
 (511)  
 25 – Underwear; sweat-absorbent underwear; ted-  
 dies [underclothing]; tights; socks; sweat-absorbent  
 socks; panties; garters; sock suspenders; stocking  
 suspenders; girdles; sweat-absorbent stockings; stoc-  
 kings; leggings [trousers]; slippers [underclothing]; kni-  
 tted underwear; gussets for underwear [parts of clot-  
 hing]; legwear garments; underpants; brassieres.

(260) AM 2019 102892 A  
 (800) 1463526  
 (151) 2018 11 14  
 (891) 2018 11 14  
 (731) BRENDSON COMPANY LIMITED  
 Dimitrakopoulou, 3, 2nd floor, Office 203,  
 1090, P.O. Box 23313, CY-1681 Nicosia,  
 Cyprus

(540)

**Сердце семьи**

(591) Black, white  
 (531) 28.05  
 (511)  
 3 – Non-medicated cosmetics and toiletry prepara-  
 tions; non-medicated dentifrices; essential oils; blea-  
 ching preparations and other substances for laundry  
 use; cleaning, polishing, scouring and abrasive pre-  
 parations; abrasives; sandcloth; abrasive cloth; glass  
 cloth (abrasive cloth); abrasive paper; breath freshe-  
 ning sprays; amber (perfume); antiperspirants (toilet-  
 ries); antistatic preparations for household purposes;  
 potpourris (fragrances); balms, other than for medi-  
 cal purposes; bergamot oil; whitening; lip glosses; va-  
 ginal washes for personal sanitary or deodorant pur-  
 poses; petroleum jelly for cosmetic purposes; cotton  
 wool for cosmetic purposes; cotton sticks for cos-  
 metical purposes; bleaching soda; laundry bleach; blea-  
 ching preparations (decolorants) for cosmetic pur-

poses; bleaching preparations (decolorants) for household purposes; bleaching salts; decorative transfers for cosmetic purposes; shoe wax; moustache wax; depilatory wax; wax for parquet floors; floor wax; waxes for leather; volcanic ash for cleaning; astringents for cosmetic purposes; cloths impregnated with a detergent for cleaning; dental bleaching gels; sharpening preparations; make-up; lipsticks; deodorants for pets; deodorants for human beings or for animals; deodorant soap; extracts of flowers (perfumes); herbal extracts for cosmetic purposes; ethereal essences; ethereal oils; essential oils of cedarwood; essential oils of lemon; essential oils of citron; jasmine oil; greases for cosmetic purposes; hair colorants; colorants for toilet purposes; preservatives for leather (polishes); color-removing preparations; degreasers, other than for use in manufacturing processes; dentifrices; ionone (perfumery); shaving stones (astringents); adhesives for cosmetic purposes; collagen preparations for cosmetic purposes; hair conditioners; quillaia bark for washing; cosmetics; eyebrow cosmetics; cosmetics for children; cosmetics for animals; beauty masks; cosmetic preparations for baths; hair straightening preparations; cosmetic preparations for eyelashes; cosmetic preparations for skin care; cosmetic preparations for slimming purposes; shoe cream; cream for whitening the skin; creams for leather; polishing creams; cosmetic creams; jewellers' rouge; starch glaze for laundry purposes; laundry starch; cakes of toilet soap; lavender water; lavender oil; hair spray; nail polish; hair lotions; lotions for cosmetic purposes; after-shave lotions; massage gels, other than for medical purposes; massage candles for cosmetic purposes; almond oil; almond soap; almond milk for cosmetic ap for brightening textile; cakes of soap; antiperspirant soap; soap for foot perspiration; soap; musk (perfumery); cosmetic kits; eau de Cologne; eyebrow pencils; cosmetic pencils; oils for toilet purposes; oils for perfumes and scents; oils for cosmetic purposes; oils for cleaning purposes; oil of turpentine for degreasing; mouthwashes, not for medical purposes; drying agents for dishwashing machines; cleansing milk for toilet purposes; cleansers for intimate personal hygiene purposes, non medicated; furnishing preparations; scouring solutions; perfumery; toiletry preparations; perfumes; pumice stone; hydrogen peroxide for cosmetic purposes; polishing wax; polishing paper; polishing rouge; polishing stones; polishing preparations; shoe polish; polish for furniture and flooring; pomades for cosmetic purposes; fabric softeners for laundry use; laundry blueing; laundry preparations; air fragrancing preparations; bath preparations, not for medical purposes; rust removing preparations; descaling preparations for household purposes; stain removers; shaving preparations; depilatory preparations; nail care preparations; hair waving preparations; laundry soaking preparations; sun-tanning preparations (cosmetics); ma-

ke-up removing preparations; make-up preparations; shining preparations (polish); laundry glaze; breath freshening preparations for personal hygiene; preparations for unblocking drain pipes; smoothing preparations (starching); dry-cleaning preparations; wall-paper cleaning preparations; aloe vera preparations for cosmetic purposes; air fragrance reed diffusers; make-up powder; nail polish removers; sachets for perfuming linen; tissues impregnated with cosmetic lotions; tissues impregnated with make-up removing preparations; breath freshening strips; bath salts, not for medical purposes; sunscreen preparations; douching preparations for personal sanitary or deodorant purposes (toiletries); dry shampoos; talcum powder, for toilet use; terpenes (essential oils); rose oil; toilet water; mascara; beard dyes; hair dyes; cosmetic dyes; phytocosmetic preparations; henna (cosmetic dye); cleaning preparations; chemical cleaning preparations for household purposes; shampoos for pets (non-medicated grooming preparations); shampoos for animals (non-medicated grooming preparations); shampoos; false eyelashes; false nails.

4 – Industrial oils and greases, wax; lubricants; dust absorbing, wetting and binding compositions; illuminants; candles and wicks for lighting; perfumed candles; beeswax; beeswax for use in the manufacture of cosmetics; petroleum jelly for industrial purposes; wax (raw material); wax for skis; belting wax; wool grease; grease for leather; greases for the preservation of leather; grease for belts; tallow; grease for footwear; moistening oil; carnauba wax; lanolin; lanolin for use in the manufacture of cosmetics; lignite; ligroin; oils for the preservation of leather; lubricating oil; lubricating graphite; lubricating grease; lubricants; cutting fluids; nightlights (candles); paper spills for lighting; paraffin; dust removing preparations; soya bean oil preparations for non-stick treatment of cooking utensils; non-slipping preparations for belts; fish oil, not edible; castor oil for industrial purposes; lighting fuel; illuminating wax; gas for lighting; illuminating grease; tapers; Christmas tree candles; candles; sunflower oil for industrial purposes; dust absorbing compositions; dust binding compositions for sweeping; dust laying compositions; textile oil.

5 – Sanitary preparations for medical purposes; food for babies; plasters, materials for dressings; disinfectants; preparations for destroying vermin; fungicides, herbicides; absorbent cotton; absorbent wadding; anaesthetics; antibacterial soap; antibacterial handwashes; antiseptics; antiseptic cotton; aseptic cotton; cotton for medical purposes; germicides; bacterial poisons; bandages for dressings; wadding for medical purposes; cotton sticks for medical purposes; mud for baths; medicinal sediment (mud); disinfectant soap; disinfectants; disinfectants for chemical toilets; disinfectants for hygiene purposes; deodorants for clothing and textiles; infant formula;

fly catching adhesives; breast-nursing pads; sticking plasters; fly catching paper; corn remedies; remedies for perspiration; remedies for foot perspiration; medicated hair lotions; medicated after-shave lotions; medicated toiletry preparations; medicinal hair growth preparations; medicated shampoos; medicated shampoos for pets; lotions for pharmaceutical purposes; sunburn ointments; ointments for pharmaceutical purposes; frostbite salve for pharmaceutical purposes; gauze for dressings; menstruation tampons; sea water for medicinal bathing; paper for mustard plasters; mothproofing paper; babies' diapers; napkins for incontinents; diapers for pets; babies' napkins; diapers for incontinents; babies' diaper-pants; babies' napkin-pants; preparations for callouses; chilblain preparations; air deodorizing preparations; mothproofing preparations; preparations for destroying dry rot fungus; larvae exterminating preparations; preparations for destroying mice; fly destroying preparations; slug exterminating preparations; preparations for destroying noxious plants; weedkillers; preparations for destroying noxious animals; vermin destroying preparations; acne treatment preparations; preparations for the treatment of burns; lice treatment preparations (pediculicides); air purifying preparations; aloe vera preparations for pharmaceutical purposes; poultices; food for babies; sanitary napkins; propolis for pharmaceutical purposes; corn rings for the feet; antiparasitic collars for animals; antiparasitic preparations; solvents for removing adhesive plasters; sanitary towels; tissues impregnated with pharmaceutical lotions; salts for mineral water baths; bath salts for medical purposes; mineral water salts; pants, absorbent, for incontinents; pharmaceutical preparations for treating dandruff; pharmaceutical preparations for skin care; pharmaceutical preparations for treating sunburn; pediculicidal shampoos; panty liners (sanitary).

6 – Small items of metal hardware; metal containers for storage or transport; aluminium foil; packaging containers of metal; tanks of metal; reservoirs of metal; hardware of metal, small; towel dispensers, fixed, of metal; tinplate packings; reservoirs of metal; chests of metal; tool chests of metal, empty; foils of metal for wrapping and packaging; ice moulds of metal; bins of metal.

8 – Hand tools and implements, hand-operated; cutlery; razors; razors, electric or non-electric; table forks; depilation appliances, electric and non-electric; nail clippers, electric or non-electric; razor blades; spoons; manicure sets; manicure sets, electric; beard clippers; hair clippers for personal use, electric and non-electric; pedicure sets; emery boards; shaving cases; manicure scissors; vegetable slicers; vegetable knives; vegetable shredders; vegetable choppers; vegetable spiralizers, hand-operated; vegetable peelers (hand tools); nail files; nail files, electric;

hair-removing tweezers; nail buffers, electric or non-electric; fruit corers; fruit segmenters; hair braiders, electric; cheese slicers, non-electric; table knives, forks and spoons for babies; table knives, forks and spoons of plastic; tableware (knives, forks and spoons); cuticle nippers; curling tongs; nail nippers; eyelash curlers; egg slicers, non-electric.

11 – Apparatus for lighting, heating, steam generating, cooking, drying, sterilization; hot air apparatus; fabric steamers; rotisseries; hot water bottles; warming pans; footwarmers, electric or non-electric; bed warmers; disinfectant apparatus; disinfectant apparatus for medical purposes; deodorising apparatus, not for personal use; disinfectant dispensers for toilets; stills; electrically heated carpets; pocket warmers; blankets, electric, not for medical purposes; curling lamps; nail lamps; heaters, electric, for feeding bottles; air reheaters; heating plates; stoves (heating apparatus); light-emitting diodes (LED) lighting apparatus; air dryers; steam boilers, other than parts of machines; pasteurisers; sterilizers; water sterilizer; air sterilizers; kettles, electric.

16 – Paper and cardboard; stationery and office requisites, except furniture; plastic sheets, films and bags for wrapping and packaging; toilet paper; hygienic paper; bibs, sleeved, of paper; bibs of paper; stationery; adhesive bands for stationery or household purposes; adhesive tapes for stationery or household purposes; sheets of reclaimed cellulose for wrapping; absorbent sheets of paper or plastic for foodstuff packaging; humidity control sheets of paper or plastic for foodstuff packaging; garbage bags of paper or of plastics; plastic bags for pet waste disposal; handkerchiefs of paper; bags for microwave cooking; bottle envelopes of paper or cardboard; paper bags for use in the sterilisation of medical instruments; packing (cushioning, stuffing) materials of paper or cardboard; wrapping paper; packing paper; plastic film for wrapping; padding materials of paper or cardboard; blotters; face towels of paper; towels of paper; self-adhesive tapes for stationery or household purposes; table napkins of paper; tissues of paper for removing make-up; tablecloths of paper; table linen of paper; paper ribbons, other than haberdashery or hair decorations; bags (envelopes, pouches) of paper or plastics, for packaging.

17 – Unprocessed and semi-processed gutta-percha, gum and substitutes for all these materials; plastics and resins in extruded form for use in manufacture; packing, stopping and insulating materials; anti-dazzle films for windows (tinted films); anti-glare films for windows (tinted films); reinforcing materials, not of metal, for pipes; cellulose acetate, semi-processed; balata; canvas hose pipes; cotton wool for packing (caulking); viscose sheets, other than for wrapping; rubber stoppers; dielectrics (insulators); soundproofing materials; insulating paper; foils of metal for insulating; mineral wool (insulator); pac-

king (cushioning, stuffing) materials of rubber or plastics; plastic sheeting for agricultural purposes; plastic film, other than for wrapping; cords of rubber.

21 – Household or kitchen utensils and containers; cookware and tableware, except forks, knives and spoons; sponges; brushes, except paintbrushes; brush-making materials; articles for cleaning purposes; unworked or semi-worked glass, except building glass; abrasive pads for kitchen purposes; cookie jars; inflatable bath tubs for babies; baby baths, portable; carpet beaters (hand instruments); cookie (biscuit) cutters; ceramics for household purposes; ice buckets; ice pails; buckets; mop wringer buckets; cotton waste for cleaning; towel rails and rings; boxes for dispensing paper towels; containers for household or kitchen use; tea caddies; thermally insulated containers for food; lunch boxes; furniture dusters; dusting cloths (rags); cloth for washing floors; polishing cloths; cloths for cleaning; abrasive sponges for scrubbing the skin; make-up sponges; sponges for household purposes; toilet sponges; deodorising apparatus for personal use; soap dispensers; toilet paper dispensers; cutting boards for the kitchen; bread boards; washing boards; ironing boards; plug-in diffusers for mosquito repellents; toothpicks; cleaning tow; boxes for sweetmeats; boxes of glass; cosmetic utensils; cosmetic spatulas; waste paper baskets; refuse bins; bread baskets for household purposes; fitted picnic baskets, including dishes; baskets for household purposes; bulb basters; tea balls; kitchen utensils; kitchen containers; kitchen mitts; funnels; ice cream scoops; mixing spoons (kitchen utensils); lint removers, electric or non-electric; steel wool for cleaning; soap boxes; soap holders; mills for household purposes, hand-operated; pepper mills, hand-operated; saucepan scourers of metal; fly swatters; fly traps; cruet sets for oil and vinegar; cake decorating tips and tubes; isothermic bags; chopsticks; cocktail stirrers; insect traps; make-up brushes; trays of paper, for household purposes; place mats, not of paper or textile; feather-dusters; plates to prevent milk boiling over; make-up removing appliances; drying racks for laundry; potholders; clothes-pegs; clothes-pins; glass stoppers; powder compacts; perfume vaporizers; perfume sprayers; powder puffs; sprinklers; syringes for watering flowers and plants; sprinklers for watering flowers and plants; foam toe separators for use in pedicures; candle rings; gloves for household purposes; barbecue mitts; car washing mitts; gardening gloves; salt cellars; salt shakers; coin banks; currycombs; garbage cans; straws for drinking; tableware, other than knives, forks and spoons; portable coolers, non-electric; disposable table plates; paper plates; insulating flasks; vacuum bottles; hot pots, not electrically heated; graters for kitchen use; pestles for kitchen use; sponge holders; toothpick holders; dishes for soap; toilet paper holders; table napkin holders; drinking

straws; toilet utensils; litter boxes for pets; litter trays for pets; trash cans; urns; moulds (kitchen utensils); cake moulds; ice cube moulds; strainers for household purposes; sugar bowls; garlic presses (kitchen utensils); tea infusers; tea strainers; cups of paper or plastic; cleaning instruments, hand-operated; mops; brushes for footwear; carpet sweepers; dishwashing brushes; toilet brushes; brushes for cleaning tanks and containers; scrubbing brushes; toothbrushes; brushes.

22 – Sacks for the transport and storage of materials in bulk; padding, cushioning and stuffing materials, except of paper, cardboard, rubber or plastics; cotton tow; raw cotton; wadding for padding and stuffing upholstery; wadding for filtering; hammocks; tow; sacks for the transport and storage of materials in bulk; body bags; mesh bags for washing laundry; string; packing string; packing (cushioning, stuffing) materials, not of rubber, plastics, paper or cardboard; wrapping or binding bands, not of metal; stuffing, not of rubber, plastics, paper or cardboard; nets; ladder tapes for Venetian blinds; bags (envelopes, pouches) of textile, for packaging; vehicle covers, not fitted; drop cloths; twine for nets.

(260) AM 2019 102947 A

(800) 1463920

(151) 2019 02 04

(891) 2019 02 04

(731) TOVARYSTVO Z OBMEZHENOIU  
VIDPOVIDALNISTIU "PU DEVELOPERS"  
Vul. Kazymyra Malevycha, 86 D, Of. 3.2,  
M. Kyiv 03150, Ukraine

(540)

## Post Scriptum Paracosm

(591) Black, white

(511)

9 – Steering apparatus, automatic, for vehicles; accumulators, electric; remote control apparatus; data processing apparatus; Global Positioning System [GPS] apparatus; audio- and video-receivers; audio-visual teaching apparatus; audio interfaces; batteries, electric; cordless telephones; computer memory devices; connected bracelets [measuring instruments]; measuring instruments; measures; high-frequency apparatus; video screens; camcorders; video baby monitors; video telephones; hands-free kits for telephones; virtual reality headsets; dictating machines; disk drives for computers; telerupters; transparencies [photography]; screens [photography]; electro-dynamic apparatus for the remote control of signals; electronic publications, downloadable; electronic pocket translators; electronic tags for goods; encoded identification bracelets, magnetic; electronic agendas; battery chargers; sound alarms; sound recording carriers; sound recording apparatus; sound transmitting apparatus; connections, electric; buzzers; readers

[data processing equipment]; bar code readers; interfaces for computers; cables, electric; integrated circuit cards [smart cards]; cinematographic cameras; computers; computer hardware; computer game software including parts thereof; computer software including parts thereof, recorded; joysticks for use with computers, other than for video games; computer keyboards; computer peripheral devices; printers for use with computers; magnetic tape units for computers; computer programs [downloadable software] including parts thereof; computer programs, recorded including parts thereof; computer operating programs, recorded including parts thereof; counters; magnetic data media; videotapes; materials for electricity mains [wires, cables]; portable media players; mouse [computer peripheral]; microprocessors; mobile telephones; monitors [computer hardware]; monitors [computer programs]; notebook computers; limiters [electricity]; eyeglasses; optical data media; selfie sticks [hand-held monopods]; transmitters of electronic signals; switchboxes [electricity]; amplifiers; tablet computers; DVD players; computer software applications, downloadable including parts thereof; weighing apparatus and instruments; video recorders; electronic book readers; record players; theft prevention installations, electric; central processing units [processors]; control panels [electricity]; radio pagers; downloadable ring tones for mobile phones; life saving apparatus and equipment; subwoofers; light-emitting diodes [LED]; alarms; scanners [data processing equipment]; smartwatches; smart rings; smartglasses; smartphones; solar batteries; bags adapted for laptops; television apparatus; telephone apparatus; transistors [electronic]; tripods for cameras; downloadable music files; USB flash drives; cameras [photography]; sleeves for laptops.

28 – Games, toys and playthings; video game apparatus; video game machines; drones [toys]; remote-controlled toy vehicles; building games; board games; portable games with liquid crystal displays; apparatus for games; slot machines [gaming machines].

35 – Administrative processing of purchase orders; auctioneering, web indexing for commercial or advertising purposes; demonstration of goods; compilation of information into computer databases; computerized file management; marketing; provision of an on-line marketplace for buyers and sellers of goods and services; writing of publicity texts; updating and maintenance of data in computer databases; web site traffic optimisation; organization of exhibitions for commercial or advertising purposes; organization of trade fairs for commercial or advertising purposes; shop window dressing; procurement services for others [purchasing goods and services for other businesses]; data search in computer files for others; presentation of goods on communication media, for retail purposes; direct mail advertising; radio

advertising; advertising; pay per click advertising; outdoor advertising; bill-posting; advertising by mail order; on-line advertising on a computer network; design of advertising materials; the bringing together, for the benefit of others, of a variety of goods such as steering apparatus, automatic, for vehicles, accumulators, electric, remote control apparatus, data processing apparatus, Global Positioning System [GPS] apparatus, audio- and video-receivers, audiovisual teaching apparatus, audio interfaces, batteries, electric, cordless telephones, computer memory devices, connected bracelets [measuring instruments], measuring instruments, measures, high-frequency apparatus, video screens, camcorders, video baby monitors, video telephones, hands-free kits for telephones, virtual reality headsets, dictating machines, disk drives for computers, telerupters, transparencies [photography], screens [photography], electro-dynamic apparatus for the remote control of signals, electronic publications, downloadable, electronic pocket translators, electronic tags for goods, encoded identification bracelets, magnetic, electronic agendas, battery chargers, sound alarms, sound recording carriers, sound recording apparatus, sound transmitting apparatus, connections, electric, buzzers, readers [data processing equipment], bar code readers, interfaces for computers, cables, electric, integrated circuit cards [smart cards], cinematographic cameras, computers, computer hardware, computer game software including parts thereof, computer software including parts thereof, recorded, joysticks for use with computers, other than for video games, computer keyboards, computer peripheral devices, printers for use with computers, magnetic tape units for computers, computer programs [downloadable software] including parts thereof, computer programs, recorded including parts thereof, computer operating programs, recorded including parts thereof, counters, magnetic data media, videotapes, materials for electricity mains [wires, cables], portable media players, mouse [computer peripheral], microprocessors, mobile telephones, monitors [computer hardware], monitors [computer programs], notebook computers, limiters [electricity], eyeglasses, optical data media, selfie sticks [hand-held monopods], transmitters of electronic signals, switchboxes [electricity], amplifiers, tablet computers, DVD players, computer software applications, downloadable including parts thereof, weighing apparatus and instruments, video recorders, electronic book readers, record players, theft prevention installations, electric, central processing units [processors], control panels [electricity], radio pagers, downloadable ring tones for mobile phones, life saving apparatus and equipment, subwoofers, light-emitting diodes [LED], alarms, scanners [data processing equipment], smartwatches, smart rings, smartglasses, smartphones, solar batteries, bags adapted for laptops, television apparatus, telephone apparatus, transistors [electronic], tripods

for cameras, downloadable music files, USB flash drives, cameras [photography], sleeves for laptops, games, toys and playthings, video game apparatus, video game machines, drones [toys], remote-controlled toy vehicles, building games, board games, portable games with liquid crystal displays, apparatus for games, slot machines [gaming machines] (excluding the transportation thereof), enabling customers to conveniently view and purchase those goods; systemization of information into computer databases; sales promotion for others; production of teleshopping programs; production of advertising films; television advertising; telemarketing services.

41 – Providing on-line videos, not downloadable; providing on-line electronic publications, not downloadable; providing on-line music, not downloadable; providing television programs, not downloadable, via video-on-demand services; providing films, not downloadable, via video-on-demand services; game services provided on-line from a computer network; toy rental; games equipment rental; on-line publication of electronic books and journals; entertainment services; production of radio and television programmes; film production, other than advertising films.

42 – Computer system analysis; recovery of computer data; off-site data backup; duplication of computer programs; electronic data storage; providing information on computer technology and programming via a web site; providing search engines for the internet; installation of computer software; computer programming; conversion of data or documents from physical to electronic media; conversion of computer programs and data, other than physical conversion; computer technology consultancy; computer software consultancy; computer security consultancy; consultancy in the design and development of computer hardware; information technology [IT] consultancy; web site design consultancy; monitoring of computer systems for detecting unauthorized access or data breach; monitoring of computer systems to detect breakdowns; monitoring of computer systems by remote access; maintenance of computer software; updating of computer software; data encryption services; computer virus protection services; software as a service [SaaS]; computer software design; rental of web servers; computer rental; rental of computer software; unlocking of mobile phones; hosting computer sites [web sites]; computer system design; creating and maintaining web sites for others; creating and designing website-based indexes of information for others [information technology services]; technological consultancy; cloud computing; server hosting.

(260) AM 2019 102948 A  
(800) 1463928  
(151) 2018 11 21

(891) 2018 11 21

(731) BIO-THERA SOLUTIONS, LTD.  
Floor 5, Building A6, Science Enterprise Accelerator, 11 Kaiyuan Avenue, High-tech Industrial Development Zone, Science City, Guangzhou, Guangdong Province, China

(540)

# ICHALIG

(591) Black, white

(531) 27.05.01

(511)

5 – Pharmaceutical preparations; chemico-pharmaceutical preparations; drugs for medical purposes; biological preparations for medical purposes; chemical preparations for pharmaceutical purposes; medicines for human purposes; chemical preparations for medical purposes; injectable pharmaceutical preparations; crude drug; biochemical drug.

(260) AM 2019 102949 A

(800) 1463949

(151) 2019 01 21

(891) 2019 01 21

(731) ALCHEM INTERNATIONAL PRIVATE LIMITED

201, empire plaza, mehrauli gurgaon road, sultanpur, New delhi 110030, India

(540)

# EPIQUE

(591) Black, white

(531) 27.05.01

(511)

3 – Bleaching preparations and other substances for laundry use, cleaning, polishing, scouring and abrasive preparations, soaps, perfumery, essential oils, cosmetics, hair lotions, dentifrices.

(260) AM 2019 102950 A

(800) 1463957

(151) 2019 03 29

(891) 2019 03 29

(731) APPLE INC.

One Apple Park Way, Cupertino CA 95014, USA

(540)

# IPAD AIR

(591) Black, white

(511)

28 – Hand-held consoles for playing video games; hand-held units for playing electronic games; hand-held game consoles.

(260) AM 2019 102951 A  
 (800) 1463984  
 (151) 2019 03 29  
 (891) 2019 03 29  
 (731) ZARA SUISSE, SARL  
 Rue Louis-d'Affry 6, CH-1700 Fribourg,  
 Switzerland  
 (540)

**ZARA**

(591) Black, white  
 (511)  
 43 – Services for providing food and beverages; temporary accommodation; restaurant services; self-service restaurant services; catering services; cafeteria services; bar services; snack bar services; coffee shop services; canteen services; hotel services; tourist home services; motel services; boarding house services; day-care centers; rental of meeting rooms; rental of chairs, tables, table linen and glassware.

(260) AM 2019 103054 A  
 (800) 1465588  
 (151) 2019 03 07  
 (891) 2019 03 07  
 (731) DR. THEISS NATURWAREN GMBH  
 Michelinstr. 10, 66406 Homburg, Germany  
 (540)



(591) Grey  
 (531) 26.01.06; 26.01.20; 26.01.24; 27.05.10;  
 27.05.11  
 (511)  
 3 – Bleaching preparations and laundry preparations; Cleaning, polishing, scouring and abrasive preparations; Perfumery, essential oils, non-medicated cosmetics, including non-medicated skin cleaning and skin care preparations, and hair care preparations; Non-medicated dentifrices.  
 5 – Pharmaceutical and veterinary preparations; Medicines for human purposes; Medicines for veterinary purposes; Sanitary preparations for medical purposes; Dietetic foodstuffs and substances adapted for medical use; Nutritional supplements for humans and animals; Vitamin preparations.

(260) AM 2019 103631 A  
 (800) 1472194  
 (151) 2018 11 09

(891) 2018 11 09  
 (731) TRATON AG  
 Dachauer Str. 641, 80995 München, Germany  
 (540)

**TRATON**

(591) Black, white  
 (511)  
 12 – Vehicles; apparatus for locomotion on land, air and water; commercial vehicles; vehicles for use on land; electric vehicles, electric hybrid vehicles, plug-in hybrid vehicles, and parts, replacement parts and accessories for the aforesaid goods; motors, drives and parts therefor for utility vehicles; buses, vans, coaches, trucks; tractors, towing trucks, and parts, replacement parts and accessories for the aforesaid goods; motors and electric motors for land vehicles, and parts, replacement parts and accessories for the aforesaid goods, in particular alarm installations for vehicles, trailers, drive trains and transmission shafts for land vehicles, transmission shafts for land vehicles, drive sprockets for land vehicles, armrests, mounts for land vehicles, differentials, balance weights for vehicle wheels, brake systems, brake linings, brakes, brake pads, brake callipers, brake discs, brake shoes, roof racks, anti-theft devices for vehicles, diesel engines for land vehicles, electric motors for land vehicles, vehicle chassis, direction signals for vehicles, undercarriages, vehicle axles, bodies for vehicles, vehicle wheels, springs, rims and complete wheels, windows, window lifters, brake fluid containers, windshield wiper fluid container, fuel tanks for vehicles, accelerator pedals, luggage carriers and luggage nets, gear boxes, for land vehicles, gearbox shafts for land vehicles, anti-skid chains, door handles, horns, brake cylinders and motors, hydraulic brake parts, bodies, head-rests, mudguards, shaft couplings, steering linkages, steering wheels, steering columns for vehicles, air pumps, engine mounts for land vehicles, vehicle wheel hubs, upholstery, wheels, pneumatic tyres, spare wheel carriers, rear-view mirrors, semi-trailers for motor vehicles, manual gear boxes for land vehicles, windscreen wipers, sliding roofs, mudguards, snow chains, protective covers, power steering equipment, safety belts, safety restraints, safety seats for infants, signal horns, seats, ski racks, mirrors, starter pinions for land vehicles; stowage compartments, storage compartments, steering wheels, suspension shock absorbers, bumpers, torsion bars for vehicle engines, transmission belts for land vehicles, doors, cladding panels for vehicle bodies, selector switches as parts of for change-speed gear boxes for land vehicles, indicators, tow bars, lorries and parts therefor; buses with diesel, gas, hydrogen or electric drive units, and parts therefor; driving machines, namely all-wheel drives for land vehicles; motors and engines for land vehicles, in particular gas/diesel engines; chassis including sports utility chassis and luggage racks and luggage carriers for vehicles; bodies and frame parts

for motor vehicles; gears for land vehicles, in particular gears for tracked vehicles; couplings and clutches for rail vehicles; sprockets, couplings, clutches, slide bearings and torque converters for land vehicles, sprockets for water vehicles and industrial machines, slide bearings for land vehicles and water vehicles; transport tracks; high-speed diesel engines, in particular for locomotives; marine propellers.

35 – Advertising; business management; business administration; office functions; business management consulting; accounting; import and export services; economic forecasting; marketing services; public relations services; business appraisal; negotiation and conclusion of commercial transactions for third parties; merchandising, organizational management of vehicle fleets; arranging contracts for leasing of replacement vehicles.

36 – Insurance; financial affairs; monetary affairs; stock exchange quotations; financial analysis; financial consultancy and sponsorship; financing and funding services; evaluation (repair costs -) [financial appraisal]; finance services; financing and funding services, in particular lease-purchase financing, sales and investment financing; insurance, in particular insurance brokerage; real estate management and rental, brokerage, leasing (facility management); rental (real estate) of industrial installations; automobile lease-purchase financing; providing sponsorship schemes services.

38 – Telecommunication services; providing access to databases; providing access to data and information on the Internet via providing access to Internet platforms; providing access to telecommunications networks and multimedia networks; digital processing of logistic and transport orders; electronic exchange of messages via chat lines, chat rooms and Internet forums; providing of access to apps, in particular mobile apps [computer software]; broadcasting or transmission of streamed and downloadable digital audio and video content via computer and telecommunications networks; all aforementioned services in the field of logistic, commercial vehicles and mobility.

39 – Tracking of automobile fleets using electronic navigation and locating devices.

42 – Technical project studies; conducting technical tests and checks, technical measurements and scientific investigations; research and development in the field of technology and mechanical engineering; installation of software; configuring computer networks by means of software; material testing and quality control; design and development of computer hardware and software, computer programming, in particular troubleshooting; technical consultancy regarding the application of EDP installations and programmes in the field of engineering; engineering services; conducting of technical analyses for monito-

ring fuel consumption; installation and maintenance of software for toll logging and toll billing apparatus; design and development of vehicles; hosting of computer sites (websites); software as a service [SaaS]; rental of software; cloud-computing; scientific and technological services and research, in particular in the fields of communications between road users, both intercommunications, and communications with the road traffic infrastructure, in particular vehicle-vehicle communications and vehicle-infrastructure communications; all aforementioned services in the field of logistic, commercial vehicles and mobility; mapping services, in particular mapping of logistic and transport orders; design, creation, hosting and maintenance of Internet sites for third parties; managing websites for others.



---

**INTERNATIONAL TRADEMARKS PROTECTED IN GEORGIA**

(260) AM 2019 97055 A  
(800) 1394192  
(151) 2017 12 14  
(181) 2027 12 14  
(891) 2017 12 14  
(511) 03, 05

---

(260) AM 2019 99810 A  
(800) 1427304  
(151) 2018 04 23  
(181) 2028 04 23  
(891) 2018 04 23  
(511) 11

---

(260) AM 2019 98087 A  
(800) 1406620  
(151) 2018 03 19  
(181) 2028 03 19  
(891) 2018 03 19  
(511) 09

---

(260) AM 2019 99811 A  
(800) 1427326  
(151) 2018 07 26  
(181) 2028 07 26  
(891) 2018 07 26  
(511) 30

---

(260) AM 2019 99208 A  
(800) 1420324  
(151) 2018 03 30  
(181) 2028 03 30  
(891) 2018 03 30  
(511) 05

---

(260) AM 2019 99814 A  
(800) 1427394  
(151) 2018 07 13  
(181) 2028 07 13  
(891) 2018 07 13  
(511) 42

---

(260) AM 2019 99721 A  
(800) 1426350  
(151) 2018 08 01  
(181) 2028 08 01  
(891) 2018 08 01  
(511) 01

---

(260) AM 2019 99816 A  
(800) 1427460  
(151) 2018 05 17  
(181) 2028 05 17  
(891) 2018 05 17  
(511) 30

---

(260) AM 2019 99728 A  
(800) 1426513  
(151) 2018 06 26  
(181) 2028 06 26  
(891) 2018 06 26  
(511) 32

---

(260) AM 2019 99817 A  
(800) 1427462  
(151) 2018 07 17  
(181) 2028 07 17  
(891) 2018 07 17  
(511) 34

---

(260) AM 2019 99742 A  
(800) 1053550  
(151) 2010 02 10  
(181) 2020 02 10  
(891) 2018 09 19  
(511) 06, 20

---

(260) AM 2019 99818 A  
(800) 1427480  
(151) 2018 02 01  
(181) 2028 02 01  
(891) 2018 02 01  
(511) 35

---

(260) AM 2019 99809 A  
(800) 1427295  
(151) 2017 09 05  
(181) 2027 09 05  
(891) 2017 09 05  
(511) 07, 09, 10

---

(260) AM 2019 99819 A  
(800) 1427513  
(151) 2018 07 16  
(181) 2028 07 16  
(891) 2018 07 16  
(511) 29, 30, 32

---

(260) AM 2019 99825 A  
(800) 1427753  
(151) 2018 08 27  
(181) 2028 08 27  
(891) 2018 08 27  
(511) 05

---

(260) AM 2019 99833 A  
(800) 1428000  
(151) 2018 08 02  
(181) 2028 08 02  
(891) 2018 08 02  
(511) 09

---

(260) AM 2019 99834 A  
(800) 1428005  
(151) 2018 05 22  
(181) 2028 05 22  
(891) 2018 05 22  
(511) 07

---

(260) AM 2019 99840 A  
(800) 1428159  
(151) 2017 12 27  
(181) 2027 12 27  
(891) 2017 12 27  
(511) 02

---

(260) AM 2019 99841 A  
(800) 1428179  
(151) 2018 06 15  
(181) 2028 06 15  
(891) 2018 06 15  
(511) 03, 44

---

(260) AM 2019 100104 A  
(800) 1428535  
(151) 2018 08 14  
(181) 2028 08 14  
(891) 2018 08 14  
(511) 25, 35

---

(260) AM 2019 100105 A  
(800) 1428548  
(151) 2017 11 29  
(181) 2027 11 29  
(891) 2017 11 29  
(511) 18, 25, 35

---

(260) AM 2019 100106 A  
(800) 1428553  
(151) 2018 02 02  
(181) 2028 02 02

(891) 2018 02 02  
(511) 01, 05, 35

---

(260) AM 2019 100108 A  
(800) 1428670  
(151) 2018 09 14  
(181) 2028 09 14  
(891) 2018 09 14  
(511) 05

---

(260) AM 2019 100109 A  
(800) 1428697  
(151) 2018 07 12  
(181) 2028 07 12  
(891) 2018 07 12  
(511) 07

---

(260) AM 2019 100111 A  
(800) 1428756  
(151) 2018 04 12  
(181) 2028 04 12  
(891) 2018 04 12  
(511) 29, 30, 32

---

(260) AM 2019 100130 A  
(800) 1429215  
(151) 2016 12 09  
(181) 2026 12 09  
(891) 2016 12 09  
(511) 09, 16, 18, 21, 25, 26, 28, 41

---

(260) AM 2019 100135 A  
(800) 1429255  
(151) 2018 03 23  
(181) 2028 03 23  
(891) 2018 03 23  
(511) 12

---

(260) AM 2019 100136 A  
(800) 1429307  
(151) 2018 07 06  
(181) 2028 07 06  
(891) 2018 07 06  
(511) 30

---

(260) AM 2019 100137 A  
(800) 1429341  
(151) 2018 04 10  
(181) 2028 04 10  
(891) 2018 04 10  
(511) 09, 18, 25, 28, 35

---

(260) AM 2019 100139 A  
(800) 1429365  
(151) 2018 05 31  
(181) 2028 05 31  
(891) 2018 05 31  
(511) 07

---

(260) AM 2019 100140 A  
(800) 1429366  
(151) 2018 07 15  
(181) 2028 07 15  
(891) 2018 07 15  
(511) 25, 35

---

(260) AM 2019 100142 A  
(800) 1429395  
(151) 2018 09 24  
(181) 2028 09 24  
(891) 2018 09 24  
(511) 14

---

(260) AM 2019 100144 A  
(800) 1429437  
(151) 2018 06 15  
(181) 2028 06 15  
(891) 2018 06 15  
(511) 09, 28

---

(260) AM 2019 100145 A  
(800) 1429496  
(151) 2018 06 19  
(181) 2028 06 19  
(891) 2018 06 19  
(511) 25

---

(260) AM 2019 100147 A  
(800) 1429547  
(151) 2018 05 31  
(181) 2028 05 31  
(891) 2018 05 31  
(511) 21, 27, 28

---

(260) AM 2019 100148 A  
(800) 1429584  
(151) 2018 08 02  
(181) 2028 08 02  
(891) 2018 08 02  
(511) 09

---

(260) AM 2019 100149 A  
(800) 1429586  
(151) 2018 08 02  
(181) 2028 08 02

(891) 2018 08 02  
(511) 33

---

(260) AM 2019 100150 A  
(800) 1429593  
(151) 2018 08 24  
(181) 2028 08 24  
(891) 2018 08 24  
(511) 10

---

(260) AM 2019 100151 A  
(800) 1429672  
(151) 2018 08 19  
(181) 2028 08 19  
(891) 2018 08 19  
(511) 35

---

(260) AM 2019 100175 A  
(800) 1430194  
(151) 2018 07 26  
(181) 2028 07 26  
(891) 2018 07 26  
(511) 25

---

(260) AM 2019 100176 A  
(800) 1430232  
(151) 2018 09 25  
(181) 2028 09 25  
(891) 2018 09 25  
(511) 28

---

(260) AM 2019 100177 A  
(800) 1430249  
(151) 2018 04 16  
(181) 2028 04 16  
(891) 2018 04 16  
(511) 05

---

(260) AM 2019 100182 A  
(800) 1430410  
(151) 2018 09 26  
(181) 2028 09 26  
(891) 2018 09 26  
(511) 01, 02, 19

---

(260) AM 2019 100185 A  
(800) 1430468  
(151) 2018 04 26  
(181) 2028 04 26  
(891) 2018 04 26  
(511) 30

---

(260) AM 2019 100186 A  
(800) 1430497  
(151) 2018 08 19  
(181) 2028 08 19  
(891) 2018 08 19  
(511) 40

---

(260) AM 2019 100190 A  
(800) 1430584  
(151) 2018 08 17  
(181) 2028 08 17  
(891) 2018 08 17  
(511) 03, 35

---

(260) AM 2019 100192 A  
(800) 1430631  
(151) 2018 09 13  
(181) 2028 09 13  
(891) 2018 09 13  
(511) 09, 41

---

(260) AM 2019 100193 A  
(800) 1430635  
(151) 2018 07 10  
(181) 2028 07 10  
(891) 2018 07 10  
(511) 03, 04, 05, 12

---

(260) AM 2019 100194 A  
(800) 1430642  
(151) 2018 08 20  
(181) 2028 08 20  
(891) 2018 08 20  
(511) 12, 16, 35

---

(260) AM 2019 100195 A  
(800) 1430644  
(151) 2018 08 10  
(181) 2028 08 10  
(891) 2018 08 10  
(511) 30

---

(260) AM 2019 100196 A  
(800) 1430651  
(151) 2018 07 17  
(181) 2028 07 17  
(891) 2018 07 17  
(511) 30

---

(260) AM 2019 100197 A  
(800) 1430659  
(151) 2018 03 20

(181) 2028 03 20  
(891) 2018 03 20  
(511) 01, 07, 19, 31

---

(260) AM 2019 100198 A  
(800) 1430670  
(151) 2018 09 13  
(181) 2028 09 13  
(891) 2018 09 13  
(511) 14, 16, 28, 42

---

(260) AM 2019 100199 A  
(800) 1430684  
(151) 2018 01 30  
(181) 2028 01 30  
(891) 2018 01 30  
(511) 02, 19, 35

---

(260) AM 2019 100200 A  
(800) 1430685  
(151) 2018 02 02  
(181) 2028 02 02  
(891) 2018 02 02  
(511) 01, 05, 35

---

(260) AM 2019 100201 A  
(800) 1430717  
(151) 2018 06 12  
(181) 2028 06 12  
(891) 2018 06 12  
(511) 09, 35, 36, 41, 42, 45

---

(260) AM 2019 100218 A  
(800) 1203257  
(151) 2014 02 06  
(181) 2024 02 06  
(891) 2018 08 30  
(511) 30, 43

---

(260) AM 2019 100219 A  
(800) 1224316  
(151) 2014 07 28  
(181) 2024 07 28  
(891) 2018 06 21  
(511) 32

---

(260) AM 2019 100220 A  
(800) 1366499  
(151) 2016 10 27  
(181) 2026 10 27  
(891) 2018 09 28  
(511) 03, 07, 09, 11, 38

---

(260) AM 2019 100223 A  
(800) 1431025  
(151) 2018 08 11  
(181) 2028 08 11  
(891) 2018 08 11  
(511) 35, 38, 39, 42

---

(260) AM 2019 100224 A  
(800) 1431027  
(151) 2018 08 24  
(181) 2028 08 24  
(891) 2018 08 24  
(511) 10

---

(260) AM 2019 100227 A  
(800) 1431060  
(151) 2018 04 26  
(181) 2028 04 26  
(891) 2018 04 26  
(511) 30

---

(260) AM 2019 100231 A  
(800) 1431122  
(151) 2018 06 12  
(181) 2028 06 12  
(891) 2018 06 12  
(511) 09, 35, 36, 41, 42, 45

---

(260) AM 2019 100254 A  
(800) 1431493  
(151) 2018 09 24  
(181) 2028 09 24  
(891) 2018 09 24  
(511) 30

---

(260) AM 2019 100255 A  
(800) 1431512  
(151) 2018 09 19  
(181) 2028 09 19  
(891) 2018 09 19  
(511) 12

---

(260) AM 2019 100256 A  
(800) 1431517  
(151) 2018 09 24  
(181) 2028 09 24  
(891) 2018 09 24  
(511) 30

---

(260) AM 2019 100273 A  
(800) 1431806  
(151) 2018 07 19

(181) 2028 07 19  
(891) 2018 07 19  
(511) 10, 11, 21

---

(260) AM 2019 100274 A  
(800) 1431807  
(151) 2018 08 09  
(181) 2028 08 09  
(891) 2018 08 09  
(511) 03

---

(260) AM 2019 100275 A  
(800) 1431823  
(151) 2018 05 28  
(181) 2028 05 28  
(891) 2018 05 28  
(511) 09, 11, 42

---

(260) AM 2019 100276 A  
(800) 1431824  
(151) 2018 07 13  
(181) 2028 07 13  
(891) 2018 07 13  
(511) 16, 25, 41

---

(260) AM 2019 100278 A  
(800) 1431970  
(151) 2018 07 26  
(181) 2028 07 26  
(891) 2018 07 26  
(511) 42

---

(260) AM 2019 100279 A  
(800) 1431974  
(151) 2018 09 10  
(181) 2028 09 10  
(891) 2018 09 10  
(511) 01, 27

---

(260) AM 2019 100280 A  
(800) 1431982  
(151) 2018 07 03  
(181) 2028 07 03  
(891) 2018 07 03  
(511) 29, 30

---

(260) AM 2019 100332 A  
(800) 1432900  
(151) 2017 12 11  
(181) 2027 12 11  
(891) 2017 12 11  
(511) 30

---

(260) AM 2019 100333 A  
(800) 1432925  
(151) 2018 07 06  
(181) 2028 07 06  
(891) 2018 07 06  
(511) 30

---

(260) AM 2019 100335 A  
(800) 1432938  
(151) 2018 09 26  
(181) 2028 09 26  
(891) 2018 09 26  
(511) 14

---

(260) AM 2019 100336 A  
(800) 1432954  
(151) 2018 06 05  
(181) 2028 06 05  
(891) 2018 06 05  
(511) 03

---

(260) AM 2019 100337 A  
(800) 1432970  
(151) 2018 06 07  
(181) 2028 06 07  
(891) 2018 06 07  
(511) 29, 30, 35

---

(260) AM 2019 100339 A  
(800) 1433012  
(151) 2018 06 05  
(181) 2028 06 05  
(891) 2018 06 05  
(511) 03, 44

---

(260) AM 2019 100340 A  
(800) 1433013  
(151) 2018 08 07  
(181) 2028 08 07  
(891) 2018 08 07  
(511) 01

---

(260) AM 2019 100469 A  
(800) 1433726  
(151) 2018 07 18  
(181) 2028 07 18  
(891) 2018 07 18  
(511) 01, 05, 30

---

(260) AM 2019 100478 A  
(800) 1433867  
(151) 2018 09 21

(181) 2028 09 21  
(891) 2018 09 21  
(511) 03

---

(260) AM 2019 100479 A  
(800) 1433896  
(151) 2018 05 31  
(181) 2028 05 31  
(891) 2018 05 31  
(511) 09

---

(260) AM 2019 100494 A  
(800) 1434340  
(151) 2018 08 09  
(181) 2028 08 09  
(891) 2018 08 09  
(511) 43

---

(260) AM 2019 100495 A  
(800) 1434348  
(151) 2018 09 26  
(181) 2028 09 26  
(891) 2018 09 26  
(511) 12

---

(260) AM 2019 100496 A  
(800) 1434425  
(151) 2018 03 16  
(181) 2028 03 16  
(891) 2018 03 16  
(511) 03, 09, 14, 16, 18, 24, 25, 35

---

(260) AM 2019 100497 A  
(800) 1434431  
(151) 2018 08 10  
(181) 2028 08 10  
(891) 2018 08 10  
(511) 43

---

(260) AM 2019 100498 A  
(800) 1434436  
(151) 2018 08 10  
(181) 2028 08 10  
(891) 2018 08 10  
(511) 07

---

(260) AM 2019 100499 A  
(800) 1434446  
(151) 2018 09 20  
(181) 2028 09 20  
(891) 2018 09 20  
(511) 09

---

(260) AM 2019 100500 A  
(800) 1434452  
(151) 2018 04 03  
(181) 2028 04 03  
(891) 2018 04 03  
(511) 12

---

(260) AM 2019 100501 A  
(800) 1434520  
(151) 2018 08 10  
(181) 2028 08 10  
(891) 2018 08 10  
(511) 09, 35, 42

---

(260) AM 2019 100502 A  
(800) 1434538  
(151) 2018 08 10  
(181) 2028 08 10  
(891) 2018 08 10  
(511) 09, 35, 36, 38, 42

---

(260) AM 2019 100503 A  
(800) 1434567  
(151) 2018 03 29  
(181) 2028 03 29  
(891) 2018 03 29  
(511) 01, 04, 37

---

(260) AM 2019 100555 A  
(800) 1435642  
(151) 2018 09 24  
(181) 2028 09 24  
(891) 2018 09 24  
(511) 03, 05, 09, 11, 14, 16, 20, 21, 24, 28, 29, 30,  
31, 32, 35, 41, 44, 45

---

(260) AM 2019 100556 A  
(800) 1435643  
(151) 2018 09 26  
(181) 2028 09 26  
(891) 2018 09 26  
(511) 30

---

(260) AM 2019 100557 A  
(800) 1435654  
(151) 2018 09 24  
(181) 2028 09 24  
(891) 2018 09 24  
(511) 01, 02, 03, 04, 07, 08, 09, 11, 12, 17

---

(260) AM 2019 100558 A  
(800) 1435685  
(151) 2018 07 03

(181) 2028 07 03  
(891) 2018 07 03  
(511) 31

---

(260) AM 2019 100559 A  
(800) 1435686  
(151) 2018 09 12  
(181) 2028 09 12  
(891) 2018 09 12  
(511) 44

---

(260) AM 2019 100565 A  
(800) 1435901  
(151) 2018 07 26  
(181) 2028 07 26  
(891) 2018 07 26  
(511) 09, 35

---

(260) AM 2019 100566 A  
(800) 1435936  
(151) 2018 09 21  
(181) 2028 09 21  
(891) 2018 09 21  
(511) 09

---

(260) AM 2019 100567 A  
(800) 1435961  
(151) 2018 05 04  
(181) 2028 05 04  
(891) 2018 05 04  
(511) 06, 07, 08, 09, 37

---

(260) AM 2019 100568 A  
(800) 1435980  
(151) 2018 05 20  
(181) 2028 05 20  
(891) 2018 05 20  
(511) 20, 21, 35, 39

---

(260) AM 2019 100619 A  
(800) 1436368  
(151) 2018 08 14  
(181) 2028 08 14  
(891) 2018 08 14  
(511) 33, 35

---

(260) AM 2019 100620 A  
(800) 1436559  
(151) 2018 06 21  
(181) 2028 06 21  
(891) 2018 06 21  
(511) 09, 28

---

(260) AM 2019 100626 A  
(800) 1436686  
(151) 2018 11 06  
(181) 2028 11 06  
(891) 2018 11 06  
(511) 03

---

(260) AM 2019 100627 A  
(800) 1436716  
(151) 2018 06 26  
(181) 2028 06 26  
(891) 2018 06 26  
(511) 10

---

(260) AM 2019 100628 A  
(800) 1436831  
(151) 2018 08 10  
(181) 2028 08 10  
(891) 2018 08 10  
(511) 30

---

(260) AM 2019 100629 A  
(800) 1436989  
(151) 2018 10 11  
(181) 2028 10 11  
(891) 2018 10 11  
(511) 14

---

(260) AM 2019 100630 A  
(800) 1437003  
(151) 2018 05 22  
(181) 2028 05 22  
(891) 2018 05 22  
(511) 03, 09, 18, 20, 21, 24, 25, 29, 30, 32, 35

---

(260) AM 2019 100749 A  
(800) 1151776  
(151) 2012 11 01  
(181) 2022 11 01  
(891) 2018 11 09  
(511) 01

---

(260) AM 2019 100857 A  
(800) 1392667  
(151) 2017 08 02  
(181) 2027 08 02  
(891) 2018 11 19  
(511) 12

---

(260) AM 2019 100940 A  
(800) 1438526  
(151) 2018 08 20

(181) 2028 08 20  
(891) 2018 08 20  
(511) 09, 28

---

(260) AM 2019 100941 A  
(800) 1438544  
(151) 2018 07 20  
(181) 2028 07 20  
(891) 2018 07 20  
(511) 30

---

(260) AM 2019 100942 A  
(800) 1438562  
(151) 2018 06 21  
(181) 2028 06 21  
(891) 2018 06 21  
(511) 09, 28

---

(260) AM 2019 100943 A  
(800) 1438564  
(151) 2018 08 22  
(181) 2028 08 22  
(891) 2018 08 22  
(511) 09, 28

---

(260) AM 2019 100944 A  
(800) 1438579  
(151) 2018 04 23  
(181) 2028 04 23  
(891) 2018 04 23  
(511) 09, 10, 14, 18, 25

---

(260) AM 2019 100952 A  
(800) 1438669  
(151) 2018 09 10  
(181) 2028 09 10  
(891) 2018 09 10  
(511) 34

---

(260) AM 2019 100953 A  
(800) 1438670  
(151) 2018 09 04  
(181) 2028 09 04  
(891) 2018 09 04  
(511) 06

---

(260) AM 2019 100954 A  
(800) 1438678  
(151) 2018 09 12  
(181) 2028 09 12  
(891) 2018 09 12  
(511) 34

---



(260) AM 2019 100955 A  
(800) 1438687  
(151) 2018 09 21  
(181) 2028 09 21  
(891) 2018 09 21  
(511) 34

---

(260) AM 2019 101030 A  
(800) 1441150  
(151) 2018 07 30  
(181) 2028 07 30  
(891) 2018 07 30  
(511) 01, 02, 19

---

(260) AM 2019 101032 A  
(800) 1441200  
(151) 2018 08 15  
(181) 2028 08 15  
(891) 2018 08 15  
(511) 32

---

(260) AM 2019 101033 A  
(800) 1441208  
(151) 2018 06 14  
(181) 2028 06 14  
(891) 2018 06 14  
(511) 03

---

(260) AM 2019 101044 A  
(800) 1441372  
(151) 2018 11 09  
(181) 2028 11 09  
(891) 2018 11 09  
(511) 32

---

(260) AM 2019 101047 A  
(800) 1441422  
(151) 2018 06 21  
(181) 2028 06 21  
(891) 2018 06 21  
(511) 09, 28

---

(260) AM 2019 101051 A  
(800) 1441610  
(151) 2018 06 14  
(181) 2028 06 14  
(891) 2018 06 14  
(511) 03

---

(260) AM 2019 101054 A  
(800) 1441666  
(151) 2018 07 30  
(181) 2028 07 30

(891) 2018 07 30  
(511) 35

---

(260) AM 2019 101055 A  
(800) 1441677  
(151) 2018 11 12  
(181) 2028 11 12  
(891) 2018 11 12  
(511) 05

---

(260) AM 2019 101056 A  
(800) 703997  
(151) 1998 12 02  
(181) 2028 12 02  
(891) 2018 12 06  
(511) 07

---

(260) AM 2019 101057 A  
(800) 824808  
(151) 2004 05 13  
(181) 2024 05 13  
(891) 2018 12 06  
(511) 32

---

(260) AM 2019 101059 A  
(800) 907298A  
(151) 2006 09 15  
(181) 2026 09 15  
(891) 2018 10 26  
(511) 18, 25

---

(260) AM 2019 101061 A  
(800) 1321669  
(151) 2016 10 27  
(181) 2026 10 27  
(891) 2018 11 29  
(511) 32

---

(260) AM 2019 101062 A  
(800) 1345570  
(151) 2016 10 11  
(181) 2026 10 11  
(891) 2018 12 10  
(511) 06, 19, 20

---

(260) AM 2019 101063 A  
(800) 1423081  
(151) 2018 07 11  
(181) 2028 07 11  
(891) 2018 11 13  
(511) 03

---

---

# OFFICIAL NOTIFICATION

## INVENTIONS

### EXPIRATION OF PATENT RESTORATION

(21) AP 2009 11256  
**(11) P 2011 5286 B**  
(73) Devi Vasadze  
(54) **NOTIFICATION SYSTEM OF AIR-RAID PRECAUTIONS**  
DATE OF CANCELLATION OF PATENT: 2019 05 15  
DATE OF RESTORATION OF PATENT: 2019 11 25

---

(21) AP 2011 12424  
**(11) P 2013 5740 B**  
(73) Allied Global Tobacco Limited  
(54) **CIGARETTE WITHOUT FILTER**  
DATE OF CANCELLATION OF PATENT: 2019 10 24  
DATE OF RESTORATION OF PATENT: 2019 11 25

---

(21) AP 2014 14131  
**(11) P 2018 6850 B**  
(73) CAPBRAN HOLDINGS LLC  
(54) **BLENDER**  
DATE OF CANCELLATION OF PATENT: 2019 10 06  
DATE OF RESTORATION OF PATENT: 2019 11 25

---

(21) AP 2003 7158  
**(11) P 2018 3374 B**  
(73) LTD "KAMELIN"  
(54) **MEDICINAL MEANS ON THE BASE OF HONEY, THEIR USE AND METHOD FOR PRODUCTION THEREOF**  
DATE OF CANCELLATION OF PATENT: 2019 10 17  
DATE OF RESTORATION OF PATENT: 2019 11 25

---

### ABOLITION OF PATENTS WITH THE RIGHT TO RESTORE

(21) AP 2007 11341  
**(11) P 2011 5179 B**  
(73) JSC "OLAINFARM"  
(54) **METHOD FOR PREPARING HIGH PURITY 3-CARBOXY-N,N,N-TRIMETHYL-1-PROPANAMINIUM HYDROXIDE INNER SALT**  
DATE OF CANCELLATION OF PATENT: 2019 11 01  
LIMIT DATE OF RESTORATION OF PATENT: 2020 11 01

---

(21) AP 2012 12880  
**(11) P 2014 6048 B**  
(73) Sopia Burjanadze

(54) **CAVITATION-ELECTROLYSIS DEVICE FOR HYDROGEN GENERATION**

DATE OF CANCELLATION OF PATENT: 2019 10 26

LIMIT DATE OF RESTORATION OF PATENT: 2020 10 26

---

(21) AP 2011 13101

**(11) P 2015 6315 B**

(73) LUPIN LIMITED

(54) **OXAZOLINE AND ISOXAZOLINE DERIVATIVES AS CRAC MODULATORS**

DATE OF CANCELLATION OF PATENT: 2019 10 31

LIMIT DATE OF RESTORATION OF PATENT: 2020 10 31

---

(21) AP 2013 13282

**(11) P 2015 6308 B**

(73) LES LABORATOIRES SERVIER

(54) **NEW PROCESS FOR SYNTHESIS OF (2E)-3-(3,4-DIMETHOXYPHENYL) PROP-2-ENENITRILE, AND APPLICATION IN SYNTHESIS OF IVABRADINE AND ADDITION SALTS THEREWITH PHARMACEUTICALLY ACCEPTABLE ACID**

DATE OF CANCELLATION OF PATENT: 2019 11 05

LIMIT DATE OF RESTORATION OF PATENT: 2020 11 05

---

(21) AP 2012 13476

**(11) P 2017 6787 B**

(73) AKZO NOBEL CHEMICALS INTERNATIONAL B.V.

(54) **DEICING COMPOSITION**

DATE OF CANCELLATION OF PATENT: 2019 11 02

LIMIT DATE OF RESTORATION OF PATENT: 2020 11 02

---

(21) AP 2012 13485

**(11) P 2018 6880 B**

(73) BOEHRINGER INGELHEIM INTERNATIONAL GMBH

(54) **HETEROCYCLIC COMPOUNDS, MEDICAMENTS CONTAINING SAID COMPOUNDS, USE THEREOF AND PROCESSES FOR THE PREPARATION THEREOF**

DATE OF CANCELLATION OF PATENT: 2019 10 29

LIMIT DATE OF RESTORATION OF PATENT: 2020 10 29

---

(21) AP 2013 13706

**(11) P 2017 6747 B**

(73) Latvian Institute of Organic Synthesis

(54) **PHARMACEUTICAL COMPOSITION FOR REDUCING THE TRIMETHYLAMINE N-OXIDE LEVEL**

DATE OF CANCELLATION OF PATENT: 2019 10 24

LIMIT DATE OF RESTORATION OF PATENT: 2020 10 24

---

(21) AP 2013 13832

**(11) P 2017 6717 B**

(73) VALERIA RESEARCH S.R.L.;  
GNOSIS S.P.A.

(54) **FIBRINOLYTIC COMPOSITIONS COMPRISING BROMELAIN AND NATTOKINASE FOR PREVENTION AND TREATMENT OF PHLEBOTHROMBOTIC STATES**

DATE OF CANCELLATION OF PATENT: 2019 11 06

LIMIT DATE OF RESTORATION OF PATENT: 2020 11 06

---

---

(21) AP 2013 13843  
**(11) P 2017 6777 B**  
(73) THALES ALENIA SPACE ITALIA S.P.A. CON UNICO SOCIO  
(54) **LARGE DEPLOYABLE REFLECTOR FOR SATELLITE ANTENNA**  
DATE OF CANCELLATION OF PATENT: 2019 11 04  
LIMIT DATE OF RESTORATION OF PATENT: 2020 11 04

---

(21) AP 2015 13978  
**(11) P 2019 6965 B**  
(73) Georgian Technical University  
(54) **METHOD FOR GETTING METALLIC MANGANESE FROM LOW-GRADE MANGANESE ORES**  
DATE OF CANCELLATION OF PATENT: 2019 10 28  
LIMIT DATE OF RESTORATION OF PATENT: 2020 10 28

---

(21) AP 2016 14313  
**(11) P 2017 6796 B**  
(73) LEPL "Institute of Micro and Nanoelectronics"  
(54) **METHOD FOR CREATING OXIDE FILMS ON METAL SURFACE**  
DATE OF CANCELLATION OF PATENT: 2019 10 31  
LIMIT DATE OF RESTORATION OF PATENT: 2020 10 31

---

## EXPIRATION OF TERM OF RESTORATION OF PATENTS

(21) AP 2009 11528  
**(11) P 2011 5338 B**  
(73) Lali Ghurtchumelia  
(54) **FIRE EXTINGUISHING POWDERS BASED ON ZEOLITES AND SHALY CLAY**  
DATE OF CANCELLATION OF PATENT: 2018 10 26  
THE TERM OF RESTORATION OF PATENT VALIDITY HAS EXPIRED: 2019 10 26

---

(21) AP 2009 11545  
**(11) P 2013 5729 B**  
(73) LES LABORATOIRES SERVIER  
(54) **USAGE OF IVABRADINE AS DIAGNOSTIC AGENT IN CORONARY ANGIOGRAPHY METHOD BY MULTISLICE COMPUTED TOMOGRAPHY**  
DATE OF CANCELLATION OF PATENT: 2018 11 05  
THE TERM OF RESTORATION OF PATENT VALIDITY HAS EXPIRED: 2019 11 05

---

(21) AP 2008 11841  
**(11) P 2012 5526 B**  
(73) Aziende Chimiche Riunite Angelini Francesco A.C.R.A.F. S.p.A.  
(54) **DRUG ACTIVE IN NEUROPATHIC PAIN**  
DATE OF CANCELLATION OF PATENT: 2018 11 06  
THE TERM OF RESTORATION OF PATENT VALIDITY HAS EXPIRED: 2019 11 06

---

(21) AP 2010 11982  
**(11) P 2012 5620 B**  
(73) Archil Prangishvili;

Levan Imnaishvili;  
Maguli Bedineishvili

(54) **BIOMETRIC IDENTIFICATION AND REGISTRATION SYSTEM OF PEDAGOGUES**

DATE OF CANCELLATION OF PATENT: 2018 10 26

THE TERM OF RESTORATION OF PATENT VALIDITY HAS EXPIRED: 2019 10 26

---

(21) AP 2013 13257

**(11) P 2015 6377 B**

(73) LTD "GeoMax International"

(54) **METHOD FOR BLUEBERRY MICROPLANT GROW STIMULATION**

DATE OF CANCELLATION OF PATENT: 2018 11 06

THE TERM OF RESTORATION OF PATENT VALIDITY HAS EXPIRED: 2019 11 06

---

(21) AP 2012 13463

**(11) P 2017 6656 B**

(73) Pfizer Inc.

(54) **2-THIOPYRIMIDINONES**

DATE OF CANCELLATION OF PATENT: 2018 10 28

THE TERM OF RESTORATION OF PATENT VALIDITY HAS EXPIRED: 2019 10 28

---

(21) AP 2012 13478

**(11) P 2016 6434 B**

(73) MERCK SHARP & DOHME CORP.

(54) **FUSED BICYCLIC OXAZOLIDINONE CETP INHIBITOR**

DATE OF CANCELLATION OF PATENT: 2018 10 25

THE TERM OF RESTORATION OF PATENT VALIDITY HAS EXPIRED: 2019 10 25

---

## UTILITY MODEL

### ABOLITION OF PATENTS WITH THE RIGHT TO RESTORE

(21) AU 2016 14309

**(11) U 2018 1963 Y**

(73) Temur Chakhunashvili;

Teimuraz Rokva;

Zhuli Keadze;

Zinaida Vatsadze

(54) **ELECTROLYTIC BATH FOR RECEIVING MANGANESE DIOXIDE**

DATE OF CANCELLATION OF PATENT: 2019 10 27

LIMIT DATE OF RESTORATION OF MODEL: 2020 10 27

---

---

**DESIGNS****TRANSFER OF RIGHT****(11) D 2017 716 S**

New Owner: GRAFE (GE)  
Nushi St. 7, 0178, Tbilisi Georgia (GE)  
Former owner: David Ramazashvili (GE)  
Nushi St. 7, 0178, Tbilisi Georgia (GE)

(54) **1.-5. FORMS OF TATARA**

(58) 2019 11 15

---

**EXTENSION OF REGISTRATION OF INTERNATIONAL DESIGNS****(11) DM/64807**

(15) 2004 01 14  
(24) 2004 01 14  
(18) 2024 01 14  
(28) 2  
(28') 2  
(54) Wristwatches

---

**(11) DM/64808**

(73) SWATCH AG (SWATCH SA) (SWATCH LTD.)  
94, Rue Jakob Stämpfli BIENNE CH-2502 (CH)  
(15) 2004 01 14  
(24) 2004 01 14  
(18) 2024 01 14  
(28) 2  
(28') 2  
(54) Wristwatches

---

**(11) DM/64811**

(73) SWATCH AG (SWATCH SA) (SWATCH LTD.)  
94, Rue Jakob Stämpfli BIENNE CH-2502 (CH)  
(15) 2004 01 14  
(24) 2004 01 14  
(18) 2024 01 14  
(28) 2  
(28') 1  
(54) Wristwatches

---

**(11) DM/64812**

(73) SWATCH AG (SWATCH SA) (SWATCH LTD.)  
94, Rue Jakob Stämpfli BIENNE CH-2502 (CH)  
(15) 2004 01 14  
(24) 2004 01 14  
(18) 2024 01 14  
(28) 1

---

(28') 1  
(54) Wristwatch

---

**(11) DM/64818**

(73) ROLEX SA  
Rue François-Dussaud 3-5-7 Genève 24 CH-1211 (CH)  
(15) 2004 01 05  
(24) 2004 01 05  
(18) 2024 01 05  
(28) 1  
(28') 1  
(54) Watch case

---

**(11) DM/64823**

(73) SWATCH AG (SWATCH SA) (SWATCH LTD.)  
94, Rue Jakob Stämpfli BIENNE CH-2502 (CH)  
(15) 2004 01 14  
(24) 2004 01 14  
(18) 2024 01 14  
(28) 1  
(28') 1  
(54) Wristwatch

---

**(11) DM/64824**

(73) SWATCH AG (SWATCH SA) (SWATCH LTD.)  
94, Rue Jakob Stämpfli BIENNE CH-2502 (CH)  
(15) 2004 01 14  
(24) 2004 01 14  
(18) 2024 01 14  
(28) 1  
(28') 1  
(54) Wristwatch

---

**(11) DM/64840**

(73) SWATCH AG (SWATCH SA) (SWATCH LTD.)  
94, Rue Jakob Stämpfli BIENNE CH-2502 (CH)  
(15) 2004 01 19  
(24) 2004 01 19  
(18) 2024 01 19  
(28) 1  
(28') 1  
(54) Wristwatch

---

**(11) DM/64841**

(73) SWATCH AG (SWATCH SA) (SWATCH LTD.)  
94, Rue Jakob Stämpfli BIENNE CH-2502 (CH)  
(15) 2004 01 19  
(24) 2004 01 19  
(18) 2024 01 19  
(28) 1  
(28') 1  
(54) Watch band

---

**(11) DM/64878**

(73) SWATCH AG (SWATCH SA) (SWATCH LTD.)

94, Rue Jakob Stämpfli BIENNE CH-2502 (CH)

(15) 2004 01 19

(24) 2004 01 19

(18) 2024 01 19

(28) 1

(28') 1

(54) Wristwatch

**(11) DM/64936**

(73) SWATCH AG (SWATCH SA) (SWATCH LTD.)

94, Rue Jakob Stämpfli BIENNE CH-2502 (CH)

(15) 2004 02 11

(24) 2004 02 11

(18) 2024 02 11

(28) 6

(28') 2

(54) Wristwatches

**(11) DM/64954**

(73) MONTRES BREGUET S.A.

L'ABBAYE CH-1344 (CH)

(15) 2004 02 06

(24) 2004 02 06

(18) 2024 02 06

(28) 2

(28') 2

(54) Watches

**(11) DM/64963**

(73) TISSOT S.A.

Chemin Des Tourelles 17 LE LOCLE CH-2400 (CH)

(15) 2004 02 11

(24) 2004 02 11

(18) 2024 02 11

(28) 1

(28') 1

(54) Wristwatch

**(11) DM/64975**

(73) OMEGA SA (OMEGA AG) (OMEGA LTD.)

Jakob-Stämpfli-Strasse 96, CH-2502 Biel/Bienne (CH)

(15) 2004 02 17

(24) 2004 02 17

(18) 2024 02 17

(28) 1

(28') 1

(54) Cuff links

**(11) DM/64980**

(73) MONTRES BREGUET S.A.

L'ABBAYE CH-1344 (CH)

(15) 2004 02 12



(24) 2004 02 12  
(18) 2024 02 12  
(28) 3  
(28') 3  
(54) Jewellery, namely: ring and pendants

---

**(11) DM/65002**

(73) TISSOT S.A.  
Chemin Des Tourelles 17 Le Locle CH-2400 (CH)  
(15) 2004 01 27  
(24) 2004 01 27  
(18) 2024 01 27  
(28) 2  
(28') 2  
(54) Watch cases with bracelets

---

**(11) DM/65010**

(73) SWATCH AG (SWATCH SA) (SWATCH LTD.)  
94, Rue Jakob Stämpfli BIENNE CH-2502 (CH)  
(15) 2004 02 17  
(24) 2004 02 17  
(18) 2024 02 17  
(28) 1  
(28') 1  
(54) Wristwatch

---

**(11) DM/65012**

(73) SWATCH AG (SWATCH SA) (SWATCH LTD.)  
94, Rue Jakob Stämpfli BIENNE CH-2502 (CH)  
(15) 2004 02 17  
(24) 2004 02 17  
(18) 2024 02 17  
(28) 1  
(28') 1  
(54) Wristwatch

---

**(11) DM/65026**

(73) SWATCH AG (SWATCH SA) (SWATCH LTD.)  
94, Rue Jakob Stämpfli BIENNE CH-2502 (CH)  
(15) 2004 02 04  
(24) 2004 02 04  
(18) 2024 02 04  
(28) 1  
(28') 1  
(54) Wristwatch

---

**(11) DM/65056**

(73) SWATCH AG (SWATCH SA) (SWATCH LTD.)  
94, Rue Jakob Stämpfli BIENNE CH-2502 (CH)  
(15) 2004 02 26  
(24) 2004 02 26  
(18) 2024 02 26  
(28) 2  
(28') 2  
(54) Watch bracelets

---

**(11) DM/65058**

(73) SOCRATES D. CONSTANTINOU & SON S.A.

5 Km. National Road Thessaloniki-Katerini, GR-541 10 Thessaloniki (Kalochori) (GB)

(15) 2004 01 19

(24) 2004 01 19

(18) 2024 01 19

(28) 19

(28') 19

(54) Articles of tableware (porcelain) namely: porcelain cups, porcelain plates, porcelain platter, porcelain salad bowl, porcelain sugar box, porcelain coffee pot, porcelain tea pot, porcelain milk pot, porcelain consommé cup, porcelain pepper and salt shaker.

---

**(11) DM/65071**

(73) SWATCH AG (SWATCH SA) (SWATCH LTD.)

94, Rue Jakob Stämpfli BIENNE CH-2502 (CH)

(15) 2004 02 26

(24) 2004 02 26

(18) 2024 02 26

(28) 4

(28') 1

(54) Wristwatches

---

**(11) DM/65570**

(73) BOUCARD DANIEL YVES PAUL

Case Postale 26 Duillier CH-1266 (CH)

(15) 2004 02 17

(24) 2004 02 17

(18) 2024 02 17

(28) 2

(28') 2

(54) Jewels

---

**(11) DM/65587**

(73) SWATCH AG (SWATCH SA) (SWATCH LTD.)

94, Rue Jakob Stämpfli BIENNE CH-2502 (CH)

(15) 2004 07 19

(24) 2004 07 19

(18) 2024 07 19

(28) 1

(28') 1

(54) Watch bracelet

---

**(11) DM/65590**

(73) SWATCH AG (SWATCH SA) (SWATCH LTD.)

94, Rue Jakob Stämpfli BIENNE CH-2502 (CH)

(15) 2004 07 20

(24) 2004 07 20

(18) 2024 07 20

(28) 1

(28') 1

(54) Wristwatch

---

**(11) DM/65598**

(73) SWATCH AG (SWATCH SA) (SWATCH LTD.)

94, Rue Jakob Stämpfli BIENNE CH-2502 (CH)

(15) 2004 07 20

(24) 2004 07 20

(18) 2024 07 20

(28) 2

(28') 2

(54) Wristwatches

---

**(11) DM/65603**

(73) SWATCH AG (SWATCH SA) (SWATCH LTD.)

94, Rue Jakob Stämpfli BIENNE CH-2502 (CH)

(15) 2004 07 19

(24) 2004 07 19

(18) 2024 07 19

(28) 1

(28') 1

(54) Wristwatch

---

**(11) DM/65698**

(73) BRAUN GMBH

Frankfurter Strasse 145 Kronberg 61476 (DE)

(15) 2004 03 04

(24) 2004 03 04

(18) 2024 03 04

(28) 6

(28') 6

(54) Toothbrush heads

---

**(11) DM/65724**

(73) MCCORMICK FRANCE S.A.S.

Site Agroparc, 315, Rue Marcel Demonque Avignon Cedex 9 F-84917 (FR)

(15) 2004 07 23

(24) 2004 07 23

(18) 2024 07 23

(28) 4

(28') 4

(54) Spice mills

---

**(11) DM/65954**

(73) RENAULT S.A.S. SOCIÉTÉ PAR ACTIONS SIMPLIFIÉE

BOULOGNE-BILLANCOURT F-92100 (FR)

(15) 2004 05 28

(24) 2004 05 28

(18) 2024 05 28

(28) 19

(28') 19

(54) 1. Motor vehicle; 2. vehicle hood; 3. vehicle front right door; 4. vehicle front left door; 5. vehicle rear right door; 6. vehicle rear left door; 7. vehicle front right wing; 8. vehicle front left wing; 9. vehicle rear right wing; 10. vehicle rear left wing; 11. vehicle boot; 12. vehicle front bumper; 13. vehicle rear bumper; 14. vehicle ventilation grille 15. vehicle right rearview mirror; 16. vehicle left rearview mirror; 17. vehicle windscreen; 18. vehicle rear window; 19. vehicle hubcap

---

**(11) DM/83298**

(73) SWATCH AG (SWATCH SA) (SWATCH LTD.)  
Jakob-Stämpfli-Strasse 94, CH-2502 Biel/Bienne (CH)  
(15) 2014 04 03  
(24) 2014 04 03  
(18) 2024 04 03  
(28) 6  
(28') 6  
(54) Wristwatches

---

**(11) DM/83300**

(73) SWATCH AG (SWATCH SA) (SWATCH LTD.)  
Jakob-Stämpfli-Strasse 94, CH-2502 Biel/Bienne (CH)  
(15) 2014 04 03  
(24) 2014 04 03  
(18) 2024 04 03  
(28) 9  
(28') 9  
(54) Wristwatches

---

**(11) DM/83301**

(73) SWATCH AG (SWATCH SA) (SWATCH LTD.)  
Jakob-Stämpfli-Strasse 94, CH-2502 Biel/Bienne (CH)  
(15) 2014 04 03  
(24) 2014 04 03  
(18) 2024 04 03  
(28) 1  
(28') 1  
(54) Display unit

---

**(11) DM/83302**

(73) SWATCH AG (SWATCH SA) (SWATCH LTD.)  
Jakob-Stämpfli-Strasse 94, CH-2502 Biel/Bienne (CH)  
(15) 2014 04 03  
(24) 2014 04 03  
(18) 2024 04 03  
(28) 5  
(28') 5  
(54) Watch bracelets

---

**(11) DM/83303**

(73) SWATCH AG (SWATCH SA) (SWATCH LTD.)  
Jakob-Stämpfli-Strasse 94, CH-2502 Biel/Bienne (CH)  
(15) 2014 04 03  
(24) 2014 04 03  
(18) 2024 04 03  
(28) 5  
(28') 5  
(54) Wristwatches

---

**(11) DM/83304**

(73) SWATCH AG (SWATCH SA) (SWATCH LTD.)  
Jakob-Stämpfli-Strasse 94, CH-2502 Biel/Bienne (CH)  
(15) 2014 04 03

---

(24) 2014 04 03  
(18) 2024 04 03  
(28) 3  
(28') 3  
(54) Wristwatches

---

**(11) DM/83313**

(73) INTERNATIONAL CO-OPERATIVE ALLIANCE, AISBL 1030 Schaarbeek, null Milcampslaan 105, Belgium (BE)  
(15) 2014 03 20  
(24) 2014 03 20  
(18) 2024 03 20  
(28) 1  
(28') 1  
(54) Logo

---

**(11) DM/83324**

(73) SWATCH AG (SWATCH SA) (SWATCH LTD.)  
Jakob-Stämpfli-Strasse 94, CH-2502 Biel/Bienne (CH)  
(15) 2014 04 03  
(24) 2014 04 03  
(18) 2024 04 03  
(28) 6  
(28') 6  
(54) Wristwatches

---

**(11) DM/83333**

(73) SWATCH AG (SWATCH SA) (SWATCH LTD.)  
Jakob-Stämpfli-Strasse 94, CH-2502 Biel/Bienne (CH)  
(15) 2014 04 08  
(24) 2014 04 08  
(18) 2024 04 08  
(28) 9  
(28') 9  
(54) Wristwatches

---

**(11) DM/83334**

(73) SWATCH AG (SWATCH SA) (SWATCH LTD.)  
Jakob-Stämpfli-Strasse 94, CH-2502 Biel/Bienne (CH)  
(15) 2014 04 08  
(24) 2014 04 08  
(18) 2024 04 08  
(28) 5  
(28') 5  
(54) Wristwatches

---

**(11) DM/83337**

(73) SWATCH AG (SWATCH SA) (SWATCH LTD.)  
Jakob-Stämpfli-Strasse 94, CH-2502 Biel/Bienne (CH)  
(15) 2014 04 08  
(24) 2014 04 08  
(18) 2024 04 08  
(28) 5  
(28') 5  
(54) Wristwatches

---

**(11) DM/83338**

(73) SWATCH AG (SWATCH SA) (SWATCH LTD.)  
Jakob-Stämpfli-Strasse 94, CH-2502 Biel/Bienne (CH)  
(15) 2014 04 08  
(24) 2014 04 08  
(18) 2024 04 08  
(28) 1  
(28') 1  
(54) Wristwatch

---

**(11) DM/83370**

(73) SWATCH AG (SWATCH SA) (SWATCH LTD.)  
Jakob-Stämpfli-Strasse 94, CH-2502 Biel/Bienne (CH)  
(15) 2014 04 15  
(24) 2014 04 15  
(18) 2024 04 15  
(28) 1  
(28') 1  
(54) Wristwatch

---

**(11) DM/83390**

(73) HARRY WINSTON SA  
Chemin du Tourbillon 8, CH-1228 Plan-les-Ouates (CH)  
(15) 2014 04 10  
(24) 2014 04 10  
(18) 2024 04 10  
(28) 9  
(28') 9  
(54) Bracelet,Earring,Finger ring,Jewelry article

---

**(11) DM/83392**

(73) SWATCH AG (SWATCH SA) (SWATCH LTD.)  
Jakob-Stämpfli-Strasse 94, CH-2502 Biel/Bienne (CH)  
(15) 2014 04 17  
(24) 2014 04 17  
(18) 2024 04 17  
(28) 2  
(28') 2  
(54) Wristwatches

---

**(11) DM/83396**

(73) MONTRES BREGUET S.A.  
The Swatch Group SA (The Swatch Group AG) (The Swatch Group Ltd.) (CH)  
(15) 2014 03 21  
(24) 2014 03 21  
(18) 2024 03 21  
(28) 4  
(28') 4  
(54) Earrings,Finger ring,Necklace,Pendant necklace

---

**(11) DM/83478**

(73) MAGIC PRODUCTION GROUP S.A.  
Findel Business Center, Complexe B, Rue de Trèves, L-2632 (BX)  
(15) 2014 04 30

---

(24) 2014 04 30  
(18) 2024 04 30  
(28) 8  
(28') 8  
(54) Toy balls

---

**(11) DM/83490**

(73) BIOFARMA, 50 rue Carnot  
F-92284 SURESNES CEDEX (FR)  
(15) 2014 04 30  
(24) 2014 04 30  
(18) 2024 04 30  
(28) 17  
(28') 17  
(54) Product packagings

---

**(11) DM/83494**

(73) SWATCH AG (SWATCH SA) (SWATCH LTD.)  
Jakob-Stämpfli-Strasse 94, CH-2502 Biel/Bienne (CH)  
(15) 2014 04 25  
(24) 2014 04 25  
(18) 2024 04 25  
(28) 1  
(28') 1  
(54) Wristwatch

---

**(11) DM/83496**

(73) SWATCH AG (SWATCH SA) (SWATCH LTD.)  
Jakob-Stämpfli-Strasse 94, CH-2502 Biel/Bienne (CH)  
(15) 2014 04 25  
(24) 2014 04 25  
(18) 2024 04 25  
(28) 1  
(28') 1  
(54) Watch strap

---

**(11) DM/83517**

(73) SAVERGLASS  
3 rue de la Gare, F-60960 FEUQUIERES (FR)  
(15) 2014 05 07  
(24) 2014 05 07  
(18) 2024 05 07  
(28) 4  
(28') 4  
(54) Bottles

---

**(11) DM/83567**

(73) HARRY WINSTON SA  
Chemin du Tourbillon 8, CH-1228 Plan-les-Ouates (CH)  
(15) 2014 05 07  
(24) 2014 05 07  
(18) 2024 05 07  
(28) 5  
(28') 5  
(54) Earring,Necklace, Ring

---

**(11) DM/83580**

(73) SWATCH AG (SWATCH SA) (SWATCH LTD.)  
Jakob-Stämpfli-Strasse 94, CH-2502 Biel/Bienne (CH)  
(15) 2014 05 09  
(24) 2014 05 09  
(18) 2024 05 09  
(28) 1  
(28') 1  
(54) Wristwatch

---

**(11) DM/83596**

(73) ETA SA MANUFACTURE HORLOGÈRE SUISSE  
Schild-Rust-Strasse 17, CH-2540 Grenchen (CH)  
(15) 2014 04 25  
(24) 2014 04 25  
(18) 2024 04 25  
(28) 2  
(28') 2  
(54) Wristwatches

---

**(11) DM/83608**

(73) HARRY WINSTON SA  
Chemin du Tourbillon 8, CH-1228 Plan-les-Ouates (CH)  
(15) 2014 03 25  
(24) 2014 03 25  
(18) 2024 03 25  
(28) 4  
(28') 4  
(54) Wristwatches

---

**(11) DM/83634**

(73) HARRY WINSTON SA  
Chemin du Tourbillon 8, CH-1228 Plan-les-Ouates (CH)  
(15) 2014 05 22  
(24) 2014 05 22  
(18) 2024 05 22  
(28) 6  
(28') 6  
(54) Bracelet,Earring,Necklace,Pendant necklace

---

**(11) DM/83682**

(73) SWATCH AG (SWATCH SA) (SWATCH LTD.)  
Jakob-Stämpfli-Strasse 94, CH-2502 Biel/Bienne (CH)  
(15) 2014 05 26  
(24) 2014 05 26  
(18) 2024 05 26  
(28) 1  
(28') 1  
(54) Wristwatch

---

**(11) DM/83684**

(73) HARRY WINSTON SA  
Chemin du Tourbillon 8, CH-1228 Plan-les-Ouates (CH)  
(15) 2014 05 27



(24) 2014 05 27  
(18) 2024 05 27  
(28) 6  
(28') 6  
(54) Earring,Earrings,Finger ring,Finger rings

---

**(11) DM/83735**

(73) MONTRES JAQUET DROZ SA (MONTRES JAQUET DROZ AG) (MONTRES JAQUET DROZ LTD.)  
Allée du Tourbillon 2, CH-2300 La Chaux-de-Fonds (CH)  
(15) 2014 03 24  
(24) 2014 03 24  
(18) 2024 03 24  
(28) 1  
(28') 1  
(54) Signing machine

---

**(11) DM/83826**

(73) NOVESTA, A.S.  
Nitrianska 503/60, SK-958 01 Partizánske (EM)  
(15) 2014 06 12  
(24) 2014 06 12  
(18) 2024 06 12  
(28) 5  
(28') 5  
(54) Sports shoes

---

**(11) DM/83840**

(73) ALPLA WERKE ALWIN LEHNER GMBH & CO. KG  
Allmendstrasse, A-6971 Hard (EM)  
(15) 2014 06 04  
(24) 2014 06 04  
(18) 2024 06 04  
(28) 14  
(28') 14  
(54) Bottles

---

**(11) DM/83862**

(73) EQUIVALENZA MANUFACTORY, S.L.  
Calle Salvador Espriu, 13-15, E-08908 L'HOSPITALET DE LLOBREGAT (Barcelona) (ES)  
(15) 2014 03 26  
(24) 2014 03 26  
(18) 2024 03 26  
(28) 2  
(28') 2  
(54) Containers for perfumery liquids

---

# TRADEMARKS

## RENEWAL OF REGISTRATIONS

|   |   |
|---|---|
| (111) M 2000 13160 R2<br>(156) 2000 03 01<br>(186) 2030 03 01<br>(732) CHEVRON INTELLECTUAL PROPERTY<br>LLC, a State of Delaware, Limited Liability<br>Company<br>6001 Bollinger Canyon Road, San Ramon,<br>California 94583, USA | 1 St James's Square, London SW1Y 4PD,<br>United Kingdom   |
| (111) M 2000 13243 R2<br>(156) 2000 04 14<br>(186) 2030 04 14<br>(732) F. HOFFMANN - LA ROCHE AG<br>CH-4002 Basel, Switzerland  | (111) M 2000 13202 R2<br>(156) 2000 03 29<br>(186) 2030 03 29<br>(732) BP P.L.C.<br>1 St James's Square, London SW1Y 4PD,<br>United Kingdom   |
| (111) M 1999 12193 R2<br>(156) 1999 05 13<br>(186) 2029 05 13<br>(732) LTD "SHROSHANI"<br>Iosebidi St. 53, ap. 38, 0160, Tbilisi, Georgia   | (111) M 2000 13116 R2<br>(156) 2000 01 31<br>(186) 2030 01 31<br>(732) JACK DANIEL'S PROPERTIES, INC.<br>4040 Civic Center Drive, Suite 528 San<br>Rafael, California 94903, USA        |
| (111) M 1999 12850 R2<br>(156) 1999 10 22<br>(186) 2029 10 22<br>(732) CBS BROADCASTING INC.<br>(NY Corporation)<br>51 West 52 nd Street, New York, New York<br>10019-6119, USA   | (111) M 2000 13151 R2<br>(156) 2000 03 01<br>(186) 2030 03 01<br>(732) WARNACO U.S., INC., a Delaware<br>Corporation<br>470 Wheelers Farms Road, Milford,<br>Connecticut 06460, USA     |
| (111) M 2000 13387 R2<br>(156) 2000 06 30<br>(186) 2030 06 30<br>(732) CBS BROADCASTING INC.<br>(NY Corporation)<br>51 West 52 nd Street, New York, New York<br>10019-6119, USA   | (111) M 2009 19949 R1<br>(156) 2009 11 18<br>(186) 2029 11 18<br>(732) LTD "Ras Al Khaima Investment Authority<br>Georgia"<br>Baratashvili St. 2, 0105, Tbilisi, Georgia                |
| (111) M 1999 12980 R2<br>(156) 1999 11 29<br>(186) 2029 11 29<br>(732) KIMBERLY-CLARK WORLDWIDE, INC.<br>NEENAH, WI 54956, USA  | (111) M 2009 19479 R1<br>(156) 2009 06 29<br>(186) 2029 06 29<br>(732) Various, Inc., a California Corporation<br>910 E. Hamilton Avenue, 6th Floor,<br>Campbell, California 95008, USA |
| (111) M 2000 13201 R2<br>(156) 2000 03 29<br>(186) 2030 03 29<br>(732) BP P.L.C.  | (111) M 2009 19480 R1<br>(156) 2009 06 29<br>(186) 2029 06 29<br>(732) Various, Inc., a California Corporation<br>910 E. Hamilton Avenue, 6th Floor,<br>Campbell, California 95008, USA |

(111) M 2009 19939 R1  
 (156) 2009 11 02  
 (186) 2029 11 02  
 (732) CPT Holdings, Ink., a Delaware corporation  
 10202 W. Washington Boulevard, Culver  
 City, California 90232, USA

(111) M 2009 19959 R1  
 (156) 2009 11 18  
 (186) 2029 11 18  
 (732) VINCCI LADIES' SPECIALTIES CENTRE  
 SDN BHD  
 No.21, Jalan Jurunilai U1/20, Hicom  
 Glenmarie Industrial Park, 40000 Shah Alam,  
 Selangor Darul Ehsan, Malaysia

(111) M 2009 19960 R1  
 (156) 2009 11 18  
 (186) 2029 11 18  
 (732) VINCCI LADIES' SPECIALTIES CENTRE  
 SDN BHD  
 No.21, Jalan Jurunilai U1/20, Hicom  
 Glenmarie Industrial Park, 40000 Shah Alam,  
 Selangor Darul Ehsan, Malaysia

(111) M 2009 19961 R1  
 (156) 2009 11 18  
 (186) 2029 11 18  
 (732) VINCCI LADIES' SPECIALTIES CENTRE  
 SDN BHD  
 No.21, Jalan Jurunilai U1/20, Hicom  
 Glenmarie Industrial Park, 40000 Shah Alam,  
 Selangor Darul Ehsan, Malaysia

(111) M 2009 19729 R1  
 (156) 2009 09 08  
 (186) 2029 09 08  
 (732) SOIRA INVESTMENTS LIMITED  
 3076 Sir Francis Drake's Highway, P.O.  
 Box 3463, Road Town, Tortola, Virgin  
 Islands (British)

(111) M 2009 20114 R1  
 (156) 2009 12 28  
 (186) 2029 12 28  
 (732) SOIRA INVESTMENTS LIMITED  
 3076 Sir Francis Drake's Highway, P.O.  
 Box 3463, Road Town, Tortola, Virgin  
 Islands (British)

(111) M 2009 19899 R1  
 (156) 2009 10 16  
 (186) 2029 10 16

(732) Various, Inc., a California Corporation  
 910 E. Hamilton Avenue, 6th Floor,  
 Campbell, California 95008, USA

(111) M 2009 19860 R1  
 (156) 2009 09 30  
 (186) 2029 09 30  
 (732) JSC "LOMISI"  
 Ksnis Sanapiro St. 1, 0600, Daba Akhalgori,  
 Georgia

(111) M 2009 19902 R1  
 (156) 2009 10 16  
 (186) 2029 10 16  
 (732) JSC "LOMISI"  
 Ksnis Sanapiro St. 1, 0600, Daba Akhalgori,  
 Georgia

(111) M 2009 19903 R1  
 (156) 2009 10 16  
 (186) 2029 10 16  
 (732) JSC "LOMISI"  
 Ksnis Sanapiro St. 1, 0600, Daba Akhalgori,  
 Georgia

(111) M 2009 20132 R1  
 (156) 2009 12 28  
 (186) 2029 12 28  
 (732) OLEINA SA  
 13 Route de Florissant, 1206 GENEVE,  
 Switzerland

(111) M 2009 20133 R1  
 (156) 2009 12 28  
 (186) 2029 12 28  
 (732) OLEINA SA  
 13 Route de Florissant, 1206 GENEVE,  
 Switzerland

(111) M 2010 20244 R1  
 (156) 2010 02 15  
 (186) 2030 02 15  
 (732) Amouage SAOC  
 P.O. Box 307, CPO 111, Seeb, Oman

(111) M 2010 20213 R1  
 (156) 2010 01 26  
 (186) 2030 01 26  
 (732) BAYER INTELLECTUAL PROPERTY GMBH  
 Alfred-Nobel-Strasse 10, 40789 Monheim  
 am Rhein, Germany

(111) M 2010 20382 R1  
(156) 2010 04 15  
(186) 2030 04 15  
(732) S.C. Johnson & Son, Inc., a Wisconsin  
Corporation  
1525 Howe Street, Racine, Wisconsin  
53403-2236, USA

---

(111) M 1999 12016 R2  
(156) 1999 05 10  
(186) 2029 05 10  
(732) PVH Corp.  
200 Madison Avenue, New York, New  
York 10016, USA

---

(111) M 2000 13211 R2  
(156) 2000 03 29  
(186) 2030 03 29  
(732) WD - 40 COMPANY LIMITED  
Brick Close, Kiln Farm, Milton Keynes,  
MK11 3LF, United Kingdom

---

(111) M 1999 12911 R2  
(156) 1999 11 03  
(186) 2029 11 03  
(732) W.L. GORE & Associates GmbH  
22, Hermann-Oberth-Strasse, D-85640  
Putzbrunn, Germany

---

## COMPLETE TRANSFER OF RIGHTS

(111) M 2006 16566 R  
(732) I/E Mosesov Vladimir Vladimirovich  
Ul. M. TulsKaya, Dom 2/1, korp. 20, kv. 544,  
115191 Moscow, Russian Federation  
(770) LTD "Kompaniya Prodimpeks"  
Ul. M.TulsKaya, dom 2/1, str. 20, kv. 544,  
115191, Moscow, Russian Federation  
(580) 04 11 2019

---

(111) M 1996 2399 R  
(732) AMALIE AOC LTD, a Florida limited  
Partnership  
1601 McClosKEY Blvd., Tampa,  
FL 33605, USA  
(770) AOCLSC. Inc., a Florida corporation  
1601 McClosKEY Blvd., Tampa,  
FL 33605, USA  
(580) 05 11 2019

---

(111) M 1996 2399 R  
(732) Lubricating Specialties Company,  
a California corporation  
8015 Paramount Boulevard, Pico Rivera,  
California 90660, USA  
(770) INFINEUM INTERNATIONAL LIMITED  
Corporate Centre, P.O. Box 1, Milton  
Hill, Abingdon, Oxfordshire, OX13  
6 BB, United Kingdom  
(580) 05 11 2019

---

(111) M 1996 2399 R  
(732) AOCLSC. Inc., a Florida corporation  
1601 McClosKEY Blvd., Tampa,  
FL 33605, USA  
(770) Lubricating Specialties Company  
a California corporation  
8015 Paramount Boulevard, Pico Rivera,  
California 90660, USA  
(580) 05 11 2019

---

(111) M 2011 22182 R  
(732) I/E Mosesov Vladimir Vladimirovich  
Ul. M. TulsKaya, Dom 2/1, korp. 20, kv. 544,  
115191 Moscow, Russian Federation  
(770) LTD "Kompaniya Prodimpeks"  
Ul. M.TulsKaya, dom 2/1, str. 20, kv. 544,  
115191, Moscow, Russian Federation  
(580) 04 11 2019

---

---

**CHANGES OF NAMES AND/OR ADDRESS OF OWNERS**

(111) M 1995 478 R  
(732) DWK Laife Science GmbH  
Otto-Schott-Strasse 21, 97877 Wertheim,  
Germany  
(770) DURAN Group GmbH  
Otto-Schott-Strasse 21, 97877 Wertheim,  
Germany  
(580) 06 11 2019

---

(111) M 2009 19479 R  
(732) Various, Inc., a California Corporation  
910 E. Hamilton Avenue, 6th Floor,  
Campbell, California 95008, USA  
(770) Various, Inc., a California Corporation  
220 Humboldt Ct., Sunnyvale,  
California 94089, USA  
(580) 07 10 2019

---

(111) M 2009 19480 R  
(732) Various, Inc., a California Corporation  
910 E. Hamilton Avenue, 6th Floor,  
Campbell, California 95008, USA  
(770) Various, Inc., a California Corporation  
220 Humboldt Ct., Sunnyvale,  
California 94089, USA

---

(111) M 2009 19899 R  
(732) Various, Inc., a California Corporation  
910 E. Hamilton Avenue, 6th Floor,  
Campbell, California 95008, USA  
(770) Various, Inc., a California Corporation  
220 Humboldt Ct., Sunnyvale,  
California 94089, USA  
(580) 07 10 2019

---

(111) M 1999 12016 R  
(732) PVH Corp.  
200 Madison Avenue, New York, New York  
0016, USA  
(770) PHILLIPS-VAN HEUSEN CORPORATION  
200 Madison Avenue, New York, New York  
10016, USA  
(580) 11 11 2019

---

## TERMINATION OF TRADEMARKS REGISTRATIONS

(111) M 1999 11939 R

(151) 1999 04 30

(732) REVLON (SUISSE) S.A.

Badenerstrasse 116, 8952 Schlieren,  
Switzerland

(141) 2019 11 07

(851) Non-payment of invoice for extension of  
registration validity

---

(111) M 1999 11899 R

(151) 1999 04 27

(732) DR. THEISS NATURWAREN GmbH

Michelinstrasse 10, 66424 Homburg,  
Germany

(141) 2019 11 05

(851) Non-payment of invoice for extension of  
registration validity

---

(111) M 1999 11900 R

(151) 1999 04 27

(732) DR. THEISS NATURWAREN GmbH

Michelinstrasse 10, 66424 Homburg,  
Germany

(141) 2019 11 05

(851) Non-payment of invoice for extension of  
registration validity

---

(111) M 1999 11911 R

(151) 1999 04 30

(732) OPEN JOINT STOCK COMPANY

BRITISH AMERICAN TOBACCO-YAVA"  
9, Tretya Ulitsa Yamskogo Polya, Moscow  
125124, Russian Federation

(141) 2019 11 07

(851) Non-payment of invoice for extension of  
registration validity

---

(111) M 1999 11912 R

(151) 1999 04 30

(732) OJSC "British American Tobacco-Yava"

9, Tretya Ulitsa Yamskogo Polya, Moscow  
125124, Russian Federation

(141) 2019 11 07

(851) Non-payment of invoice for extension of  
registration validity

---

(111) M 1999 11913 R

(151) 1999 04 30

(732) OJSC "British American Tobacco-Yava"

9, Tretya Ulitsa Yamskogo Polya, Moscow  
125124, Russian Federation

(141) 2019 11 07

(851) Non-payment of invoice for extension of  
registration validity

---

(111) M 1999 11989 R

(151) 1999 05 10

(732) JOHNSON & JOHNSON

a New Jersey Corporation  
One Johnson & Johnson Plaza, New  
Brunswick, New Jersey, USA

(141) 2019 11 18

(851) Non-payment of invoice for extension of  
registration validity

---

(111) M 1999 11906 R

(151) 1999 04 27

(732) ARZNEIMITTELWERK DRESDEN GMBH

Meissner strasse 35, 01445 Radebeul, Germany

(141) 2019 11 05

(851) Non-payment of invoice for extension of  
registration validity

---

(111) M 1999 11918 R

(151) 1999 04 30

(732) BRITISH AMERICAN TOBACCO  
(BRANDS) LIMITED

Globe House, 4 Temple Place, London,  
WC2R 2PG, United Kingdom

(141) 2019 11 07

(851) Non-payment of invoice for extension of  
registration validity

---

(111) M 1999 11996 R

(151) 1999 05 10

(732) Würth International AG

Aspermonstrasse 1, 7000 Chur, Switzerland

(141) 2019 11 18

(851) Non-payment of invoice for extension of  
registration validity

---

(111) M 1999 11907 R

(151) 1999 04 27

(732) PREPARADOS ALIMENTICIOS, S.A.

Josep Tarradellas, 38, E-08029 Barcelona,  
Spain

(141) 2019 11 05

(851) Non-payment of invoice for extension of  
registration validity

---

(111) M 1999 11924 R  
(151) 1999 04 30  
(732) WYETH LLC  
Five Giralda Farms, Madison, New Jersey,  
07940, USA  
(141) 2019 11 07  
(851) Non-payment of invoice for extension of  
registration validity

---

(111) M 1999 11926 R  
(151) 1999 04 30  
(732) ZOHAR WATERWORKS, LLC  
265 North Hamilton Road, Columbus,  
Ohio 43213, USA  
(141) 2019 11 07  
(851) Non-payment of invoice for extension of  
registration validity

---

(111) M 1999 11932 R  
(151) 1999 04 30  
(732) WM.WRIGLEY JR.COMPANY  
410 North Michigan Avenue, Chicago,  
Illinois 60611, USA  
(141) 2019 11 07  
(851) Non-payment of invoice for extension of  
registration validity

---

(111) M 1999 11936 R  
(151) 1999 04 30  
(732) BRITISH AMERICAN TOBACCO  
(BRANDS) LIMITED  
Globe House, 4 Temple Place, London,  
WC2R 2PG, United Kingdom  
(141) 2019 11 07  
(851) Non-payment of invoice for extension of  
registration validity

---

(111) M 1999 11898 R  
(151) 1999 04 27  
(732) GEOX S.P.A.  
Via Feltrina Centro 16, Montebelluna  
(Treviso), Frazione Biadene 31044, Italy  
(141) 2019 11 05  
(851) Non-payment of invoice for extension of  
registration validity

---

(111) M 2009 19248 R  
(151) 2009 04 29  
(732) CATERPILLAR INC.  
100 N.E. Adams Street, PEORIA,  
IL 61629, USA  
(141) 2019 11 07  
(851) Non-payment of invoice for extension of  
registration validity

---

(111) M 2009 19251 R  
(151) 2009 04 29  
(732) LTD "SARKE STUDIA"  
Vazha-Pshavela Av. 45, 0177, Tbilisi,  
Georgia  
(141) 2019 11 07  
(851) Non-payment of invoice for extension of  
registration validity

---

(111) M 2009 19258 R  
(151) 2009 04 29  
(732) BAYER CONSUMER CARE AG  
Peter Merian-Str. 84, 4052 Basel, Switzerland  
(141) 2019 11 07  
(851) Non-payment of invoice for extension of  
registration validity

---

(111) M 2009 19253 R  
(151) 2009 04 29  
(732) GVANTSA GEGELIA  
Didi Dighomi, III mkr., bl. 14, ap. 12, 0131,  
Tbilisi, Georgia  
(141) 2019 11 07  
(851) Non-payment of invoice for extension of  
registration validity

---

(111) M 2009 19255 R  
(151) 2009 04 29  
(732) Payless Shoesource Worldwide Inc.  
Jayhawk Towers, 700 SW Jackson Street,  
Suite 202, Topeka, KS 66603, USA  
(141) 2019 11 07  
(851) Non-payment of invoice for extension of  
registration validity

---

(111) M 2009 19256 R  
(151) 2009 04 29  
(732) Payless Shoesource Worldwide Inc.  
Jayhawk Towers, 700 SW Jackson Street,  
Suite 202, Topeka, KS 66603, USA  
(141) 2019 11 07  
(851) Non-payment of invoice for extension of  
registration validity

---

(111) M 2009 19260 R  
(151) 2009 04 29  
(732) BAYER CONSUMER CARE AG  
Peter Merian-Str. 84, 4052 Basel, Switzerland  
(141) 2019 11 07  
(851) Non-payment of invoice for extension of  
registration validity

---



(111) M 2009 19269 R  
(151) 2009 04 29  
(732) LTD "G P C"  
K. Marjanishvili St. 26, 0102, Tbilisi, Georgia  
(141) 2019 11 07  
(851) Non-payment of invoice for extension of  
registration validity

---

(111) M 2009 19270 R  
(151) 2009 04 29  
(732) LTD "G P C"  
K. Marjanishvili St. 26, 0102, Tbilisi, Georgia  
(141) 2019 11 07  
(851) Non-payment of invoice for extension of  
registration validity

---

(111) M 2009 19271 R  
(151) 2009 04 29  
(732) LTD "G P C"  
K. Marjanishvili St. 26, 0102, Tbilisi, Georgia  
(141) 2019 11 07  
(851) Non-payment of invoice for extension of  
registration validity

---

(111) M 2009 19272 R  
(151) 2009 04 29  
(732) LTD "G P C"  
K. Marjanishvili St. 26, 0102, Tbilisi, Georgia  
(141) 2019 11 07  
(851) Non-payment of invoice for extension of  
registration validity

---

(111) M 2009 19273 R  
(151) 2009 04 29  
(732) L'OREAL-SOCIETE ANONYME  
14, rue Royal, F-75008, Paris, France  
(141) 2019 11 07  
(851) Non-payment of invoice for extension of  
registration validity

---

(111) M 2009 19274 R  
(151) 2009 04 29  
(732) LTD "G P C"  
K. Marjanishvili St. 26, 0102, Tbilisi, Georgia  
(141) 2019 11 07  
(851) Non-payment of invoice for extension of  
registration validity

---

(111) M 2009 19275 R  
(151) 2009 04 29  
(732) Global Hotels & Resorts IP BV  
Pietermaai 15, Curacao, Netherlands Antilles  
(141) 2019 11 07

(851) Non-payment of invoice for extension of  
registration validity

---

(111) M 2009 19276 R  
(151) 2009 04 29  
(732) AXN Network, Inc., New-York Corporation  
10202 W. Washington Boulevard,  
Culver-City, California 90232, USA  
(141) 2019 11 07  
(851) Non-payment of invoice for extension of  
registration validity

---

(111) M 2009 19279 R  
(151) 2009 04 29  
(732) Hyatt International Corporation, a Delaware  
Corporation  
71 South Wacker Drive, 14 th Floor,  
Chicago, Illinois 60606, USA  
(141) 2019 11 07  
(851) Non-payment of invoice for extension of  
registration validity

---

(111) M 2009 19280 R  
(151) 2009 04 29  
(732) HFC Prestige International Holding  
Switzerland Sàrl  
Chemin Louis-Hubert 1-3, 1213 Petit-Lancy,  
Switzerland  
(141) 2019 11 07  
(851) Non-payment of invoice for extension of  
registration validity

---

(111) M 2009 19283 R  
(151) 2009 04 29  
(732) LTD "SANSET VILLAGE"  
Gamrekeli St. 19, 0160, Tbilisi, Georgia  
(141) 2019 11 07  
(851) Non-payment of invoice for extension of  
registration validity

---

(111) M 2009 19282 R  
(151) 2009 04 29  
(732) LTD " SANSET VILLAGE"  
Gamrekeli St. 19, 0160, Tbilisi, Georgia  
(141) 2019 11 07  
(851) Non-payment of invoice for extension of  
registration validity

---

(111) M 2009 19284 R  
(151) 2009 04 29  
(732) LTD "PROGECT CAPITAL"  
Ul. Smirnovskaya, dom 10, stroenie 3, 109052  
Moskow, Russian Federation

(141) 2019 11 07  
(851) Non-payment of invoice for extension of  
registration validity

---

(111) M 2009 19290 R  
(151) 2009 04 29  
(732) LTD "ALFACREDIT"  
Davit Agmasheneblis Av. 150, 0112,  
Tbilisi, Georgia  
(141) 2019 11 07  
(851) Non-payment of invoice for extension of  
registration validity

---

(111) M 1999 11952 R  
(151) 1999 05 06  
(732) GLAXO GROUP LIMITED  
980 Great West Road, Brentford, Middlesex  
TW8 9GS, United Kingdom  
(141) 2019 11 15  
(851) Non-payment of invoice for extension of  
registration validity

---

(111) M 1999 11953 R  
(151) 1999 05 06  
(732) GLAXO GROUP LIMITED  
980 Great West Road, Brentford, Middlesex  
TW8 9GS, United Kingdom  
(141) 2019 11 15  
(851) Non-payment of invoice for extension of  
registration validity

---

(111) M 1999 11955 R  
(151) 1999 05 06  
(732) J.&P. COATS, Limited  
1 George Square, Glasgow G2 1AL,  
Scotland, United Kingdom  
(141) 2019 11 15  
(851) Non-payment of invoice for extension of  
registration validity

---

(111) M 1999 11956 R  
(151) 1999 05 06  
(732) J.&P. COATS, Limited  
1 George Square, Glasgow G2 1AL,  
Scotland, United Kingdom  
(141) 2019 11 15  
(851) Non-payment of invoice for extension of  
registration validity

---

## LICENSE AGREEMENT

(800) 895250  
(732) Carlsberg Breweries A/S  
Ny Carlsberg Vej 100, DK-1760 Copenhagen  
V, Denmark  
(791) LTD "Pivovarennaya Kompaniya "Balrika"  
194292 194292 St. Petersburg, 6-verkhniy  
Pereulok 3, Russian federation  
(793) 1589  
(793) Exclusive  
(793) 18 04 2018 – 31 12 2022  
(793) 32

---

(800) 895250  
(800) 895250  
(732) Carlsberg Breweries A/S  
Ny Carlsberg Vej 100, DK-1760 Copenhagen  
V, Denmark  
(791) LTD "Pivovarennaya Kompaniya "Balrika"  
194292 194292 St. Petersburg, 6-verkhniy  
Pereulok 3, Russian federation  
(793) 1588  
(793) Exclusive  
(793) 01 05 2012 – 31 12 2022  
(793) 32

---

# CLASSIFICATION INDEXES

## INVENTIONS

### CONCORDANCE TABLE OF INTERNATIONAL CLASSIFICATION INDEX AND PUBLICATION NUMBERS

| INTERNATIONAL CLASSIFICATION INDEXES<br>(51)  | NUMBER OF PUBLISHED APPLICATION<br>(10) |
|---|---|
| A 47 L 1/00   | AP 2019 14878 A                         |
| B 22 F 3/11; B 22 F 3/23; C 22 C 1/08   | AP 2019 14732 A                         |
| C 07 D 405/14; C 07 D 413/14; C 07 D 401/04; C 07 D 401/12;<br>C 07 D 405/12; C 07 D 471/10; C 07 D 493/10; C 07 D 498/10;<br>C 07 D 515/10; C 07 D 401/14  | AP 2019 14688 A                         |
| C 07 D 413/14; C 07 D 213/82; C 07 D 231/14; C 07 D 333/38;<br>C 07 D 333/40; C 07 D 407/12; C 07 D 409/12; C 07 D 417/12;<br>C 07 D 417/14; C 07 D 285/08; C 07 D 285/135; A 61 K 31/421;<br>A 61 K 31/166 | AP 2019 14320 A                         |
| C 07 F 9/576; A 61 P 19/02; A 61 K 31/675   | AP 2019 14203 A                         |
| F 42 B 7/06; F 42 B 77/08   | AP 2019 14636 A                         |

### CONCORDANCE TABLE OF PUBLICATION NUMBERS AND INTERNATIONAL CLASSIFICATION INDEX

| NUMBER OF PUBLISHED APPLICATION<br>(10) | INTERNATIONAL CLASSIFICATION INDEXES<br>(51)  |
|---|---|
| AP 2019 14203 A                         | C 07 F 9/576; A 61 P 19/02; A 61 K 31/675   |
| AP 2019 14320 A                         | C 07 D 413/14; C 07 D 213/82; C 07 D 231/14; C 07 D 333/38;<br>C 07 D 333/40; C 07 D 407/12; C 07 D 409/12; C 07 D 417/12;<br>C 07 D 417/14; C 07 D 285/08; C 07 D 285/135; A 61 K 31/421;<br>A 61 K 31/166 |
| AP 2019 14636 A                         | F 42 B 7/06; F 42 B 77/08   |
| AP 2019 14688 A                         | C 07 D 405/14; C 07 D 413/14; C 07 D 401/04; C 07 D 401/12;<br>C 07 D 405/12; C 07 D 471/10; C 07 D 493/10; C 07 D 498/10;<br>C 07 D 515/10; C 07 D 401/14  |
| AP 2019 14732 A                         | B 22 F 3/11; B 22 F 3/23; C 22 C 1/08   |
| AP 2019 14878 A                         | A 47 L 1/00   |

### CONCORDANCE TABLE OF INTERNATIONAL CLASSIFICATION INDEX, PATENT NUMBERS AND PUBLICATION NUMBERS

| INTERNATIONAL CLASSIFICATION INDEX<br>(51)                  | NUMBER OF PATENT<br>(11) | NUMBER OF PUBLISHED APPLICATION<br>(10) |
|---|--------------------------|---|
| A 61 K 31/496; A 61 P 19/04; A 61 P 19/02;<br>C 07 D 403/06 | P 2019 7043 B            | AP 2019 14546 A                         |
| C 03 B 5/235; C 03 B 5/237; F 27 D 17/00                    | P 2019 7042 B            | AP 2019 14660 A                         |
| E 01 B 11/54  | P 2019 7045 B            | AP 2019 14537 A                         |
| H 05 B 7/08; C 22 B 9/187                                   | P 2019 7044 B            | AP 2019 14147 A                         |

**CONCORDANCE TABLE OF PATENT NUMBERS,  
PUBLICATION NUMBERS AND INTERNATIONAL CLASSIFICATION INDEX**

| NUMBER OF PATENT (11) | NUMBER OF PUBLISHED APPLICATION (10) | INTERNATIONAL CLASSIFICATION INDEX (51)                  |
|-----------------------|--------------------------------------|--|
| P 2019 7042 B         | AP 2019 14660 A                      | C 03 B 5/235; C 03 B 5/237; F 27 D 17/00                 |
| P 2019 7043 B         | AP 2019 14546 A                      | A 61 K 31/496; A 61 P 19/04; A 61 P 19/02; C 07 D 403/06 |
| P 2019 7044 B         | AP 2019 14147 A                      | H 05 B 7/08; C 22 B 9/187                                |
| P 2019 7045 B         | AP 2019 14537 A                      | E 01 B 11/54   |

**CONCORDANCE TABLE OF APPLICATION NUMBERS, PUBLICATION NUMBERS  
AND PATENTS**

| NUMBER OF APPLICATION (21) | NUMBER OF PUBLISHED APPLICATION (10) | NUMBER OF PATENT (11) |
|----------------------------|--------------------------------------|-----------------------|
| AP 2015 14546              | AP 2019 14546 A                      | P 2019 7043 B         |
| AP 2016 14660              | AP 2019 14660 A                      | P 2019 7042 B         |
| AP 2017 14537              | AP 2019 14537 A                      | P 2019 7045 B         |
| AP 2016 14147              | AP 2019 14147 A                      | P 2019 7044 B         |

## UTILITY MODELS

**CONCORDANCE TABLE OF INTERNATIONAL CLASSIFICATION INDEX  
AND PUBLICATION NUMBERS**

| INTERNATIONAL CLASSIFICATION INDEXES (51) | NUMBER OF PUBLISHED APPLICATION (10) |
|---|--------------------------------------|
| E 04 B 1/01                               | AU 2019 14993 U                      |

**CONCORDANCE TABLE OF PUBLICATION NUMBERS  
AND INTERNATIONAL CLASSIFICATION INDEX**

| NUMBER OF PUBLISHED APPLICATION (10) | INTERNATIONAL CLASSIFICATION INDEXES (51) |
|--------------------------------------|---|
| AU 2019 14993 U                      | E 04 B 1/01                               |

**CONCORDANCE TABLE OF INTERNATIONAL CLASSIFICATION INDEX,  
PATENT NUMBERS AND PUBLICATION NUMBERS**

| INTERNATIONAL CLASSIFICATION INDEX<br>(51) | NUMBER OF PATENT<br>(11) | NUMBER OF PUBLISHED APPLICATION<br>(10) |
|--|--------------------------|---|
| B 21 F 1/04                                | U 2019 2023 Y            | AU 2019 14944 U                         |

**CONCORDANCE TABLE OF PATENT NUMBERS,  
PUBLICATION NUMBERS AND INTERNATIONAL CLASSIFICATION INDEX**

| NUMBER OF PATENT<br>(11) | NUMBER OF PUBLISHED APPLICATION<br>(10) | INTERNATIONAL CLASSIFICATION INDEX<br>(51) |
|--------------------------|---|--|
| U 2019 2023 Y            | AU 2019 14944 U                         | B 21 F 1/04                                |

**CONCORDANCE TABLE OF APPLICATION NUMBERS, PUBLICATION NUMBERS  
AND PATENTS**

| NUMBER OF APPLICATION<br>(21) | NUMBER OF PUBLISHED APPLICATION<br>(10) | NUMBER OF PATENT<br>(11) |
|-------------------------------|---|--------------------------|
| AU 2018 14944                 | AU 2019 14944 U                         | U 2019 2023 Y            |

## DESIGNS

**CONCORDANCE TABLE OF INTERNATIONAL CLASSIFICATION INDEX,  
PATENT NUMBERS AND PUBLICATION NUMBERS**

| INTERNATIONAL CLASSIFICATION INDEX<br>(51) | NUMBER OF PATENT<br>(11) | NUMBER OF PUBLISHED APPLICATION<br>(10) |
|--|--------------------------|---|
| 07-06                                      | D 2019 827 S             | AD 2019 1083 S                          |
| 09-01                                      | D 2019 826 S             | AD 2019 1079 S                          |
| 19-08                                      | D 2019 828 S             | AD 2019 1085 S                          |

**CONCORDANCE TABLE OF PATENT NUMBERS,  
PUBLICATION NUMBERS AND INTERNATIONAL CLASSIFICATION INDEX**

| NUMBER OF PATENT<br>(11) | NUMBER OF PUBLISHED APPLICATION<br>(10) | INTERNATIONAL CLASSIFICATION INDEX<br>(51) |
|--------------------------|---|--|
| D 2019 826 S             | AD 2019 1079 S                          | 09-01                                      |
| D 2019 827 S             | AD 2019 1083 S                          | 07-06                                      |
| D 2019 828 S             | AD 2019 1085 S                          | 19-08                                      |

CONCORDANCE TABLE OF APPLICATION NUMBERS, PUBLICATION NUMBERS  
AND PATENTS

| NUMBER<br>OF APPLICATION<br>(21) | NUMBER OF PUBLISHED<br>APPLICATION<br>(10) | NUMBER OF PATENT<br>(11) |
|----------------------------------|--|--------------------------|
| AD 2019 1083                     | AD 2019 1083 S                             | D 2019 827 S             |
| AD 2019 1079                     | AD 2019 1079 S                             | D 2019 826 S             |
| AD 2019 1085                     | AD 2019 1085 S                             | D 2019 828 S             |

## TRADEMARKS

### CONCORDANCE TABLE OF REGISTRATION NUMBERS, APPLICATION NUMBERS, PUBLICATION NUMBERS AND BULLETIN NUMBERS

| NUMBER OF<br>REGISTRATION<br>(111) | NUMBER OF<br>APPLICATIONS<br>(210) | NUMBER OF<br>PUBLISHED<br>APPLICATIONS<br>(260) | NUMBER OF<br>BULLETIN |
|------------------------------------|------------------------------------|---|-----------------------|
| M 2019 31970 R                     | AM 105555                          | –   | 22(530)2019           |
| M 2019 31971 R                     | AM 95355                           | AM 2018 95355 A                                 | 14(498)2018           |
| M 2019 31972 R                     | AM 100048                          | AM 2019 100048 A                                | 12(520)2019           |
| M 2019 31973 R                     | AM 100380                          | AM 2019 100380 A                                | 11(519)2019           |
| M 2019 31974 R                     | AM 100586                          | AM 2019 100586 A                                | 13(521)2019           |
| M 2019 31975 R                     | AM 100587                          | AM 2019 100587 A                                | 12(520)2019           |
| M 2019 31976 R                     | AM 100701                          | AM 2019 100701 A                                | 14(522)2019           |
| M 2019 31977 R                     | AM 100702                          | AM 2019 100702 A                                | 13(521)2019           |
| M 2019 31978 R                     | AM 100818                          | AM 2019 100818 A                                | 13(521)2019           |
| M 2019 31979 R                     | AM 100908                          | AM 2019 100908 A                                | 14(522)2019           |
| M 2019 31980 R                     | AM 100914                          | AM 2019 100914 A                                | 14(522)2019           |
| M 2019 31981 R                     | AM 100929                          | AM 2019 100929 A                                | 14(522)2019           |
| M 2019 31982 R                     | AM 100932                          | AM 2019 100932 A                                | 14(522)2019           |
| M 2019 31983 R                     | AM 101231                          | AM 2019 101231 A                                | 14(522)2019           |
| M 2019 31984 R                     | AM 101232                          | AM 2019 101232 A                                | 14(522)2019           |
| M 2019 31985 R                     | AM 101370                          | AM 2019 101370 A                                | 14(522)2019           |
| M 2019 31986 R                     | AM 101407                          | AM 2019 101407 A                                | 14(522)2019           |
| M 2019 31987 R                     | AM 101408                          | AM 2019 101408 A                                | 14(522)2019           |
| M 2019 31988 R                     | AM 80925                           | AM 2019 80925 A                                 | 14(522)2019           |
| M 2019 31989 R                     | AM 98672                           | AM 2019 98672 A                                 | 7(515)2019            |
| M 2019 31990 R                     | AM 99173                           | AM 2019 99173 A                                 | 8(516)2019            |
| M 2019 31991 R                     | AM 99482                           | AM 2019 99482 A                                 | 7(515)2019            |
| M 2019 31992 R                     | AM 99501                           | AM 2019 99501 A                                 | 9(517)2019            |
| M 2019 31993 R                     | AM 99792                           | AM 2019 99792 A                                 | 8(516)2019            |
| M 2019 31994 R                     | AM 99895                           | AM 2019 99895 A                                 | 10(518)2019           |
| M 2019 31995 R                     | AM 99896                           | AM 2019 99896 A                                 | 10(518)2019           |
| M 2019 31996 R                     | AM 99897                           | AM 2019 99897 A                                 | 11(519)2019           |
| M 2019 31997 R                     | AM 99898                           | AM 2019 99898 A                                 | 10(518)2019           |
| M 2019 31998 R                     | AM 99899                           | AM 2019 99899 A                                 | 10(518)2019           |
| M 2019 31999 R                     | AM 99900                           | AM 2019 99900 A                                 | 10(518)2019           |
| M 2019 32000 R                     | AM 99901                           | AM 2019 99901 A                                 | 10(518)2019           |
| M 2019 32001 R                     | AM 99902                           | AM 2019 99902 A                                 | 10(518)2019           |
| M 2019 32002 R                     | AM 99903                           | AM 2019 99903 A                                 | 10(518)2019           |
| M 2019 32003 R                     | AM 99904                           | AM 2019 99904 A                                 | 10(518)2019           |
| M 2019 32004 R                     | AM 99905                           | AM 2019 99905 A                                 | 10(518)2019           |
| M 2019 32005 R                     | AM 99906                           | AM 2019 99906 A                                 | 10(518)2019           |
| M 2019 32006 R                     | AM 105540                          | –   | 22(530)2019           |
| M 2019 32007 R                     | AM 105638                          | –   | 22(530)2019           |
| M 2019 32008 R                     | AM 105560                          | –   | 22(530)2019           |
| M 2019 32009 R                     | AM 105657                          | –   | 22(530)2019           |
| M 2019 32010 R                     | AM 105658                          | –   | 22(530)2019           |
| M 2019 32011 R                     | AM 105645                          | –   | 22(530)2019           |
| M 2019 32012 R                     | AM 105738                          | –   | 22(530)2019           |



CONCORDANCE TABLE OF PUBLICATION NUMBERS  
AND APPLICATION NUMBERS

| NUMBER OF<br>PUBLISHED<br>APPLICATION<br>(260) | NUMBER OF<br>APPLICATION<br>(210) | 1                | 2         |
|--|-----------------------------------|------------------|-----------|
| 1  | 2                                 |                  |           |
| AM 2019 99069 A                                | AM 99069                          | AM 2019 102706 A | AM 102706 |
| AM 2019 99884 A                                | AM 99884                          | AM 2019 102710 A | AM 102710 |
| AM 2019 99885 A                                | AM 99885                          | AM 2019 102712 A | AM 102712 |
| AM 2019 99886 A                                | AM 99886                          | AM 2019 102716 A | AM 102716 |
| AM 2019 99959 A                                | AM 99959                          | AM 2019 102717 A | AM 102717 |
| AM 2019 100065 A                               | AM 100065                         | AM 2019 102723 A | AM 102723 |
| AM 2019 102360 A                               | AM 102360                         | AM 2019 102729 A | AM 102729 |
| AM 2019 102361 A                               | AM 102361                         | AM 2019 102731 A | AM 102731 |
| AM 2019 102371 A                               | AM 102371                         | AM 2019 102735 A | AM 102735 |
| AM 2019 102383 A                               | AM 102383                         | AM 2019 102736 A | AM 102736 |
| AM 2019 102403 A                               | AM 102403                         | AM 2019 102812 A | AM 102812 |
| AM 2019 102516 A                               | AM 102516                         | AM 2019 102815 A | AM 102815 |
| AM 2019 102523 A                               | AM 102523                         | AM 2019 102826 A | AM 102826 |
| AM 2019 102524 A                               | AM 102524                         | AM 2019 102833 A | AM 102833 |
| AM 2019 102535 A                               | AM 102535                         | AM 2019 102835 A | AM 102835 |
| AM 2019 102545 A                               | AM 102545                         | AM 2019 102836 A | AM 102836 |
| AM 2019 102547 A                               | AM 102547                         | AM 2019 102837 A | AM 102837 |
| AM 2019 102561 A                               | AM 102561                         | AM 2019 102838 A | AM 102838 |
| AM 2019 102697 A                               | AM 102697                         | AM 2019 102839 A | AM 102839 |
| AM 2019 102701 A                               | AM 102701                         | AM 2019 102840 A | AM 102840 |
|  |                                   | AM 2019 102841 A | AM 102841 |
|  |                                   | AM 2019 102916 A | AM 102916 |
|  |                                   | AM 2019 102917 A | AM 102917 |
|  |                                   | AM 2019 102920 A | AM 102920 |
|  |                                   | AM 2019 103093 A | AM 103093 |

CONCORDANCE TABLE OF INDEX OF GOODS AND/OR SERVICES  
AND APPLICATION NUMBERS

| INDEX OF GOODS<br>AND/OR SERVICES<br>(511) | NUMBER OF<br>PUBLISHED<br>APPLICATIONS<br>(26) | 1  | 2                |
|--|--|----|------------------|
| 1  | 2  | 30 | AM 2019 102516 A |
| 2  | AM 2019 102383 A                               | 30 | AM 2019 102535 A |
| 3  | AM 2019 102736 A                               | 30 | AM 2019 102547 A |
| 3  | AM 2019 102840 A                               | 30 | AM 2019 102736 A |
| 3  | AM 2019 102841 A                               | 30 | AM 2019 102840 A |
| 4  | AM 2019 102383 A                               | 31 | AM 2019 102731 A |
| 5  | AM 2019 99884 A                                | 31 | AM 2019 102840 A |
| 5  | AM 2019 99885 A                                | 32 | AM 2019 99884 A  |
| 5  | AM 2019 99886 A                                | 32 | AM 2019 99885 A  |
| 5  | AM 2019 102523 A                               | 32 | AM 2019 99886 A  |
| 5  | AM 2019 102524 A                               | 32 | AM 2019 102535 A |
| 5  | AM 2019 102535 A                               | 32 | AM 2019 102535 A |
| 5  | AM 2019 102731 A                               | 32 | AM 2019 102697 A |
| 5  | AM 2019 102835 A                               | 32 | AM 2019 102701 A |
| 5  | AM 2019 102836 A                               | 32 | AM 2019 102706 A |
| 5  | AM 2019 102837 A                               | 32 | AM 2019 102736 A |
| 5  | AM 2019 102838 A                               | 32 | AM 2019 102840 A |
| 5  | AM 2019 102839 A                               | 32 | AM 2019 102916 A |
| 5  | AM 2019 102917 A                               | 32 | AM 2019 102916 A |
| 7  | AM 2019 102712 A                               | 33 | AM 2019 100065 A |
| 7  | AM 2019 102717 A                               | 33 | AM 2019 102403 A |
| 9  | AM 2019 99069 A                                | 33 | AM 2019 102815 A |
| 9  | AM 2019 102371 A                               | 33 | AM 2019 102833 A |
| 9  | AM 2019 102535 A                               | 33 | AM 2019 102833 A |
| 9  | AM 2019 102717 A                               | 35 | AM 2019 99884 A  |
| 9  | AM 2019 102920 A                               | 35 | AM 2019 99885 A  |
| 10   | AM 2019 102731 A                               | 35 | AM 2019 99886 A  |
| 11   | AM 2019 102712 A                               | 35 | AM 2019 102360 A |
| 11   | AM 2019 102717 A                               | 35 | AM 2019 102361 A |
| 14   | AM 2019 102371 A                               | 35 | AM 2019 102371 A |
| 16   | AM 2019 102535 A                               | 35 | AM 2019 102535 A |
| 16   | AM 2019 102840 A                               | 35 | AM 2019 102716 A |
| 18   | AM 2019 102371 A                               | 35 | AM 2019 102723 A |
| 19   | AM 2019 102729 A                               | 35 | AM 2019 102723 A |
| 20   | AM 2019 102841 A                               | 35 | AM 2019 102729 A |
| 21   | AM 2019 102535 A                               | 35 | AM 2019 102729 A |
| 21   | AM 2019 102841 A                               | 35 | AM 2019 102735 A |
| 24   | AM 2019 102535 A                               | 35 | AM 2019 102812 A |
| 25   | AM 2019 102371 A                               | 35 | AM 2019 102836 A |
| 25   | AM 2019 102535 A                               | 35 | AM 2019 102841 A |
| 25   | AM 2019 102710 A                               | 36 | AM 2019 102710 A |
| 25   | AM 2019 102841 A                               | 36 | AM 2019 102716 A |
| 27   | AM 2019 102535 A                               | 36 | AM 2019 102723 A |
| 28   | AM 2019 102535 A                               | 36 | AM 2019 102723 A |
| 28   | AM 2019 102710 A                               | 36 | AM 2019 102812 A |
| 29   | AM 2019 102535 A                               | 37 | AM 2019 102729 A |
| 29   | AM 2019 102736 A                               | 37 | AM 2019 102729 A |
| 29   | AM 2019 102826 A                               | 37 | AM 2019 102812 A |
| 29   | AM 2019 102840 A                               | 38 | AM 2019 102561 A |
|  |  | 39 | AM 2019 102360 A |
|  |  | 39 | AM 2019 102361 A |
|  |  | 39 | AM 2019 102716 A |
|  |  | 39 | AM 2019 102723 A |
|  |  | 41 | AM 2019 102535 A |
|  |  | 41 | AM 2019 102545 A |
|  |  | 41 | AM 2019 102710 A |
|  |  | 43 | AM 2019 103093 A |
|  |  | 44 | AM 2019 99959 A  |
|  |  | 44 | AM 2019 102735 A |

CONCORDANCE TABLE OF INDEX OF GOODS AND/OR SERVICES  
AND NUMBERS OF TRADEMARKS REGISTERED ACCORDING  
TO THE ACCELERATED PROCEDURE

| INDEX OF GOODS AND/OR SERVICES<br>(511) | NUMBERS OF REGISTERED ACCORDING<br>TO THE ACCELERATED PROCEDURE<br>(111) |
|---|--|
| 5                                       | M 2019 32009 R   |
| 5                                       | M 2019 32010 R   |
| 14                                      | M 2019 32007 R   |
| 18                                      | M 2019 32007 R   |
| 24                                      | M 2019 32006 R   |
| 25                                      | M 2019 32007 R   |
| 33                                      | M 2019 32008 R   |
| 33                                      | M 2019 32012 R   |
| 35                                      | M 2019 31970 R   |
| 35                                      | M 2019 32007 R   |
| 35                                      | M 2019 32008 R   |
| 44                                      | M 2019 32011 R   |

# OFFICIAL BULLETIN OF THE INDUSTRIAL PROPERTY

INVENTIONS  
UTILITY MODELS  
DESIGNS  
TRADEMARKS

**22(530)**

EDITOR-IN-CHIEF: N. Bebrishvili

EDITOR-TRANSLATOR: E. Gabunia

PROOFREADER: A. Shikhashvili

COMPUTER LAYOUT: M. Ordenidze  
K. Svanidze

[www.sakpatenti.gov.ge](http://www.sakpatenti.gov.ge)

E-mail: [info@sakpatenti.org.ge](mailto:info@sakpatenti.org.ge)