



**NATIONAL INTELLECTUAL PROPERTY CENTER OF GEORGIA
SAKPATENTI**

**OFFICIAL BULLETIN
OF THE INDUSTRIAL PROPERTY**

23(507)

**2018
TBILISI**

INID CODES FOR IDENTIFICATION OF BIBLIOGRAPHIC DATA

INVENTIONS, UTILITY MODELS

- (10) Number of publication for application, which has been examined
- (11) Number of patent and kind of document
- (21) Serial number of application
- (22) Date of filing of the application
- (23) Date of exhibition or the date of the earlier filing and the number of application, if any
- (24) Date from which patent may have effect
- (31) Number of priority application
- (32) Date of filing of priority application
- (33) Code of the country or regional organization allotting priority application number
- (44) Date of publication of application not granted, but examined and number of bulletin
- (45) Date of publication of registered document
- (51) International Patent Classification Index
- (54) Title of the invention
- (57) Abstract
- (60) Number of examined patent document granted by foreign patent office, date from which patent has effect and country code
- (62) Number of the earlier application and in case of divided application, date of filing an application
- (71) Name, surname and address of applicant (country code)
- (72) Name, surname of inventor (country code)
- (73) Name, surname and address of patent owner (country code)
- (74) Name, surname of representative or patent attorney
- (85) Date of commencement of the national phase of International Application
- (86) Number and date of filing of international application
- (87) Number and date of publication of international application

DESIGNS

- (10) Number of publication for application
- (11) Number of patent and kind of document or number of registration
- (15) Date of registration/Date of patent renewal
- (18) Expected expiration date of patent or registration
- (21) Serial number of application
- (22) Date of filing of the application
- (23) Date of exhibition or the date of the earlier filing and the number of application, if any
- (24) Date from which patent may have effect
- (28) Number of designs included in the application
- (30) Data relating to priority (number of application, date of filing of application, two-letter code identifying the authority with whom the priority application was made)
- (31) Number of priority application
- (32) Date of filing of priority application
- (33) Code of the country or regional organization allotting priority application number
- (34) Two-letter code according to WIPO St.3 identifying the authority with which the priority application was made
- (44) Date of publication of design and number of bulletin (the first publication)
- (45) Date of publication of design registered by WIPO and number of bulletin
- (51) International Classification for designs (class and subclass of the Locarno Classification)
- (54) Title of the invention
- (55) Reproduction of the design
- (57) Description of characteristic features of the design including indication of colors
- (58) Date of recording of any kind of amendment in the Register
- (62) Number of the earlier application, registration and document number and if available the date of filing an application in case of divided application
- (71) Name, surname and address of applicant (country code)
- (72) Name, surname of creator (country code)
- (73) Name, surname and address of patent owner (country code)
- (74) Name, surname of representative or patent attorney
- (81) Contracting states concerned
 - II designated contracting states according to the 1960 Act
 - III designated contracting states according to the 1999 Act
- (85) Owner's permanent address
- (86) Owner's nationality
- (87) Owner's residence
- (88) State in which the owner has a real and effective industrial or commercial establishment

TRADEMARKS

- (111) - Number of registration
- (151) - Date of registration
- (156) - Date of the renewal
- (181) - Expected expiration date of registration
- (186) - Renewal expiration date of registration
- (141) - Date of cancel of duration of the mark
- (210) - Serial number of application
- (220) - Date of filing of the application
- (230) - Date concerning exhibition
- (260) - Number of application, for which favorable decision of examination about registration has been taken (publication number)
- (310) - Number of the first application
- (320) - Date of filing of the first application
- (330) - Code, identifying national or regional Office where the first application was made
- (511) - International Classification of Goods and Services for the purposes of registration of trade marks and/or list of goods and/or services classified according thereto
- (531) - Description of figurative elements of Trade Marks according to the International Classification of the Figurative Elements of Marks
- (540) - Reproduction of Trade Mark
- (550) - Nature and kind of Trade Mark
- (580) - Date of recording of any kind changes in respect of applications or registrations
- (591) - Information concerning colors claimed
- (731) - Name and address of the applicant
- (732) - Name and address of the holder of the registration
- (740) - Name and address of the representative
- (750) - Address for correspondence
- (770) - Name and address of the previous applicant or holder in case of change in ownership
- (771) - Previous name and address of the applicant or holder in case of change in ownership
- (791) - Name and address of the licensee
- (793) - Indication of conditions and/or restrictions under the license (Type of license, number of license agreement, data of license, data of validity of license)
- (800) - Certain data relating to the international registration of Trade Marks under the Protocol Relating to Madrid Agreement (International registration number)

CODES FOR PUBLICATION IN BULLETIN

- (21) AP 0000 000000 - serial number of application for invention
- (10) AP 0000 0000 A - number of published application for invention (first publication)
- (11) P 0000 0000 B - number of patent for invention (second publication)
- (21) API 0000 000000 - number of application for imported patent
- (11) PI 0000 0000 A - number of imported patent (first publication)
- (21) AU 0000 000000 - serial number of application for utility model
- (10) AU 0000 000 U - number of published application for utility model (first publication)
- (11) U 0000 000 Y - number of patent for utility model (second publication)
- (21) AD 0000 000000 - serial number of application for design
- (10) AD 0000 000 S - number of published application for design (first publication)
- (11) D 0000 000 S - number of patent for design (second publication)

INTERNATIONAL PATENT CLASSIFICATION FOR INVENTIONS AND UTILITY MODELS

- SECTION A - HUMAN NECESSITIES
- SECTION B - PERFORMING OPERATIONS; TRANSPORTING
- SECTION C - CHEMISTRY; METALLURGY
- SECTION D - TEXTILES; PAPER
- SECTION E - FIXED CONSTRUCTIONS
- SECTION F - MECHANICAL ENGINEERING; LIGHTING; HEATING; WEAPONS; BLASTING
- SECTION G - PHYSICS
- SECTION H - ELECTRICITY

-
- M - Trade Mark
 - (210) AM 0000 000000 - Serial number of application;
 - (260) AAM 0000 00000 A - Publication number of application;
 - (111) M 0000 00000 R - Number of registration;
 - (111) MMM0000 00000 Rn - Number of renewals, in which n=1,2,3;
 - (111) M 0000 00000 R(P) - Number of registration under partial assignment of rights
-

LIST OF CODES, IN ALPHABETIC SEQUENCE, AND THE CORRESPONDING (SHORT) NAMES OF STATES, OTHER ENTITIES AND INTERGOVERNMENTAL ORGANIZATIONS
(WIPO STANDARD ST.3)

AD	Andorra				
AE	United Arab Emirates				
AF	Afghanistan				
AG	Antigua and Barbuda				
AI	Anguilla				
AL	Albania				
AM	Armenia				
AN	Netherlands Antilles				
AO	Angola				
AP	African Regional Intellectual Property Organization (ARIPO)				
AR	Argentina				
AT	Austria				
AU	Australia				
AW	Aruba				
AZ	Azerbaijan				
BA	Bosnia and Herzegovina				
BB	Barbados				
BD	Bangladesh				
BE	Belgium				
BF	Burkina Faso				
BG	Bulgaria				
BH	Bahrain				
BI	Burundi				
BJ	Benin				
BM	Bermuda				
BN	Brunei Darussalam				
BO	Bolivia				
BR	Brazil				
BS	Bahamas				
BT	Bhutan				
BV	Bouvet Island				
BW	Botswana				
BX	Benelux Office for Intellectual Property (BOIP)				
BY	Belarus				
BZ	Belize				
CA	Canada				
CD	Democratic Republic of the Congo				
CF	Central African Republic				
CG	Congo				
CH	Switzerland				
CI	Cote d'Ivoire				
CK	Cook Islands				
CL	Chile				
CM	Cameroon				
CN	China				
CO	Colombia				
CR	Costa Rica				
CU	Cuba				
CV	Cape Verde				
CY	Cyprus				
CZ	Czech Republic				
DE	Germany				
DJ	Djibouti				
DM	Dominica				
DO	Dominican Republic				
DZ	Algeria				
EA	Eurasian Patent Organization (EAPO)				
EC	Ecuador				
EE	Estonia				
EG	Egypt				
EH	Western Sahara				
EM	Office for Harmonization in the Internal Market (Trademarks and Designs)(OHIM)				
EP	European Patent Office (EPO)				
ER	Eritrea				
ES	Spain				
ET	Ethiopia				
FI	Finland				
FJ	Fiji				
FK	Falkland Islands (Malvinas)				
FO	Faroe Islands				
FR	France				
GA	Gabon				
GB	United Kingdom				
GC	Patent Office of the Cooperation Council for the Arab States of the Gulf (GCC)				
GD	Grenada				
GG	Guernsey				
GH	Ghana				
GI	Gibraltar				
GT	Guatemala				
GW	Guinea- Bissau				
GY	Guyana				
HK	The Hong Kong Special Administrative Region of the People's Republic of China				
HN	Honduras				
HR	Croatia				
HT	Haiti				
HU	Hungary				
IB	International Bureau of the World Intellectual Property Organization (WIPO)				
ID	Indonesia				
IE	Ireland				
IL	Israel				
IM	Isle of Man				
IN	India				
IQ	Iraq				
ID	Indonesia				
IE	Ireland				
IL	Israel				
IM	Isle of Man				
IN	India				
IQ	Iraq				
IR	Iran (Islamic Republic of)				
IS	Iceland				
IT	Italy				
JE	Jersey				
JM	Jamaica				
JO	Jordan				
JP	Japan				
KE	Kenya				
KG	Kyrgyzstan				
KH	Cambodia				
KI	Kiribati				
KM	Saint Kitts and Nevis				
KP	Democratic People's Republic of Korea				
KR	Republic of Korea				
KW	Kuwait				
KY	Cayman Islands				
KZ	Kazakhstan				
LA	Lao People's Democratic Republic				
LB	Lebanon				
LC	Saint Lucia				
LI	Liechtenstein				
LK	Sri Lanka				
LR	Liberia				
LS	Lesotho				
LT	Lithuania				
LU	Luxembourg				
LV	Latvia				
LY	Libyan Arab Jamahiriya				
MA	Morocco				
MC	Monaco				
MD	Republic of Moldova				
ME	Montenegro				
MG	Madagascar				
MK	The former Yugoslav Republic of Macedonia				
ML	Mali				
MM	Myanmar				
MN	Mongolia				
MO	Macao				
MP	Northern Mariana Islands				
MR	Mauritania				
MS	Montserrat				
MT	Malta				
MU	Mauritius				
MV	Maldives				
MW	Malawi				
MX	Mexico				
MY	Malaysia				
MZ	Mozambique				
NA	Namibia				
NE	Niger				
NG	Nigeria				
NI	Nicaragua				
NL	Netherlands				
NO	Norway				
NP	Nepal				
NR	Nauru				
NZ	New Zealand				
OA	African Intellectual Property Organization (OAPI)				
OM	Oman				
PA	Panama				
PE	Peru				
PG	Papua New Guinea				
PH	Philippines				
PK	Pakistan				
PL	Poland				
PT	Portugal				
PW	Palau				
PY	Paraguay				
QA	Qatar				
QZ	Community Plant Variety Office (European Community) (CPVO)				
RO	Romania				
RS	Serbia				
RU	Russian Federation				
RW	Rwanda				
SA	Saudi Arabia				
SB	Solomon Islands				
SC	Seychelles				
SD	Sudan				
SG	Singapore				
SH	Saint Helena				
SI	Slovenia				
SK	Slovakia				
SL	Sierra Leone				
SM	San Marino				
SN	Senegal				
SO	Somalia				
SR	Suriname				
ST	Sao Tome and Principe				
SV	El Salvador				
SY	Syrian Arab Republic				
SZ	Swaziland				
TC	Turks and Caicos Islands				
TD	Chad				
TG	Togo				
TH	Thailand				
TJ	Tajikistan				
TL	Timor-Leste				
TM	Turkmenistan				
TN	Tunisia				
TO	Tonga				
TR	Turkey				
SE	Sweden				
TT	Trinidad and Tobago				
TV	Tuvalu				
TW	Taiwan, Province of China				
TZ	United Republic of Tanzania				
UA	Ukraine				
UG	Uganda				
US	United States of America				
UY	Uruguay				
UZ	Uzbekistan				
VA	Holy See				
VC	Saint Vincent and the Grenadines				
VE	Venezuela				
VG	Virgin Islands (British)				
VN	Viet Nam				
VU	Vanuatu				
WO	World Intellectual Property Organization (WIPO)				
WS	Samoa				
XN	Nordic Patent Institute (NPI)				
YE	Yemen				
ZA	South Africa				
ZM	Zambia				
ZW	Zimbabwe				

**NATIONAL INTELLECTUAL PROPERTY CENTER OF GEORGIA
SAKPATENTI**

**OFFICIAL BULLETIN
OF THE INDUSTRIAL PROPERTY**

23(507)

**INVENTIONS
UTILITY MODELS
DESIGNS
TRADEMARKS**

**DATE OF PUBLICATION
2018 12 10**

CONTENTS

PUBLISHED TITLES OF PROTECTION	3
INVENTIONS	
▪ APPLICATIONS APPROVED FOR GRANTING PATENTS	4
▪ PATENTED INVENTIONS	6
UTILITY MODELS	
▪ APPLICATIONS APPROVED FOR GRANTING PATENT	8
▪ PATENTED UTILITY MODELS	9
DESIGNS	
▪ APPLICATIONS APPROVED FOR REGISTRATION	10
▪ REGISTERED DESIGNS	12
▪ DESIGNS REGISTERED ACCORDING TO THE ACCELERATED PROCEDURE	13
▪ DESIGNS, WHICH HAVE BEEN REGISTERED WITH THE INTERNATIONAL BUREAU CLAIMING PRIORITY ON THE TERRITORY OF GEORGIA	18
TRADEMARKS	
▪ APPLICATIONS FILED UNDER THE NATIONAL PROCEDURE APPROVED FOR REGISTRATION	62
▪ REGISTERED TRADEMARKS	69
▪ TRADEMARKS REGISTERED ACCORDING TO THE ACCELERATED PROCEDURE	77
▪ INTERNATIONAL TRADEMARKS FOR WHICH A DECISION ON GRANTING PROTECTION IS TAKEN	79
▪ INTERNATIONAL TRADEMARKS PROTECTED IN GEORGIA	115
OFFICIAL NOTIFICATIONS	
INVENTIONS	
▪ RENEWAL OF PATENTS	126
▪ CANCELLATION OF PATENTS	126
UTILITY MODELS	
▪ RENEWAL OF PATENTS	128
▪ CANCELLATION OF PATENTS	128
DESIGNS	
RENEWAL OF REGISTRATIONS	129
TRADEMARKS	
▪ RENEWAL OF REGISTRATIONS	130
▪ COMPLETE TRANSFER OF RIGHT	136
▪ CHANGES IN NAMES AND/OR ADDRESSES OF OWNERS	138
▪ INVALIDATION OF TRADEMARK REGISTRATIONS	139
▪ CHANGE OF THE LIST OF GOODS AND/OR SERVICES OF TRADEMARKS	139
CLASSIFICATION INDEXES	
INVENTIONS	140
UTILITY MODELS	141
DESIGNS	142
TRADEMARKS	145

PUBLISHED TITLES OF PROTECTION

INVENTIONS

- **APPLICATIONS APPROVED FOR GRANTING PATENT:**
14515; 14143; 14481
- **PATENTED INVENTIONS:**
6930-6934

UTILITY MODELS

- **APPLICATIONS APPROVED FOR GRANTING PATENTS:**
14419; 14353
- **PATENTED UTILITY MODELS:**
1995-1996

DESIGNS

- **APPLICATIONS APPROVED FOR REGISTRATION:**
1042, 1043
- **REGISTERED DESIGNS:**
789-793
- **DESIGNS REGISTERED ACCORDING TO THE ACCELERATED PROCEDURE:**
787, 788; 794
- **DESIGNS WHICH HAVE BEEN REGISTERED WITH THE INTERNATIONAL BUREAU CLAIMING PRIORITY ON THE TERRITORY OF GEORGIA:**
100177; 100181; 100183; 100185; 100219; 100256; 102492; 100318; 100324; 102154, 102155; 102701, 102702; 102774, 102775; 102820

TRADEMARKS

- **APPLICATIONS FILED UNDER THE NATIONAL PROCEDURE APPROVED FOR REGISTRATION:**
96272; 96284; 96860; 96894; 96973; 97025; 97174; 97179; 97181, 97182; 97187; 97194; 97207; 97210, 97211; 97224; 97229-97232; 97376; 97389; 97392, 97393; 97395; 97397; 97410; 97433; 97438; 97456; 97459; 97461; 97469; 97471; 97473; 97687; 97797-97803; 97900, 97901
- **REGISTERED TRADEMARKS:**
30472-30556
- **TRADEMARKS REGISTERED ACCORDING TO THE ACCELERATED PROCEDURE:**
30467-30471; 30557-30561
- **INTERNATIONAL TRADEMARKS FOR WHICH A DECISION ON GRANTING PROTECTIONS IS TAKEN:**
93385*; 93645*; 94943, 94944; 95913, 95914; 96334, 96335; 96337; 96340, 96341; 96375; 96389; 96401; 96405, 96406; 96408; 96411-96413; 96436-96438; 96440-96442; 96445, 96446; 96450; 96476; 96478-96481; 96483, 96484; 96492, 96493; 96547-96549; 96552; 96581-96583; 96606; 96609-96614; 96617-96619; 96630- 96637; 96641; 96647; 96658; 96675, 96676; 96686; 96691; 96700, 96701; 96703, 96704; 96712; 96714, 96715; 96722; 96773, 96774; 96792, 96793; 96831-96838; 96853; 96855-96857; 96870-96872; 96952; 96955, 96956; 97133; 97144-97146; 97148, 97149; 97151, 97152; 97163
- **INTERNATIONAL TRADEMARKS PROTECTED IN GEORGIA:**
89141; 89569; 90949; 91044; 91048; 91091; 91250; 91300; 91954; 93340; 93367; 93392; 93398; 93446; 93489; 93597; 94284; 94432; 94485, 94486; 94503; 94511; 94542; 94606; 94628-94630; 94633; 94650; 94652; 94765; 94767; 94801; 94807; 94812; 94814; 94818; 94841; 94884-94886; 94888; 94892; 94894; 94899, 94900; 94917; 94929; 94932, 94933; 94942; 94945; 94947, 94948; 94950-94953; 94955; 94964-94970; 94993-94995; 94997, 94998; 95000, 95001; 95003-95005; 95016; 95055; 95060; 95064; 95075; 95084, 95085; 95089; 95092; 95094; 95096-95098; 95100; 95271; 95277- 95279; 95282, 95283; 95286; 95288; 95290; 95292; 95295; 95300; 95307, 95308; 95312; 95448; 95474; 95476; 95479; 95481-95483; 95641; 95644- 95649; 95652, 95653; 95702; 95704; 95721; 95723; 95734; 95804-95811; 95821; 95823-95826; 96022, 96023; 96025-96030; 96194; 96199-96203; 96205-96208; 96269; 96271; 96273

INVENTIONS

APPLICATIONS APPROVED FOR GRANTING PATENTS

The decision can be appealed at the Chamber of Appeal of Sakpatenti within 3 months from the publication or at the Mtskheta District Court Administrative Cases Board (Address: №17, Samkhedro str., Mtskheta), within 1 month following the publication.

PART A

A 61

- (10) AP 2018 14515 A (51) Int. Cl. (2006)
A 61 K 31/53
C 07 D 253/08
- (21) AP 2015 14515 (22) 2015 11 19
(31) 62/082,539; 62/184,729
(32) 2014 11 20; 2015 06 25
(33) US; US
(71) TAKEDA PHARMACEUTICAL COMPANY LIMITED (JP)
1-1, Doshomachi 4-chome Chuo-ku,
Osaka-shi, Osaka 541-0045 (JP)
(72) HITCHCOCK, Stephen (US);
REICHARD, Holly (US);
MONENSCHHEIN, Holger (US);
LAM, Betty (US)
(74) Aleksandre Gegechkori
(85) 2017 06 13
(86) PCT/US2015/061607; 2015 11 19
(54) **4 4-OXO-3,4-DIHYDRO-1, 2, 3-BENZOTRIAZINES AS MODULATORS OF GPR139**
(57) An invention relates to oxobenzo [d] [1,2,3] triazine acetamides of formula (II),

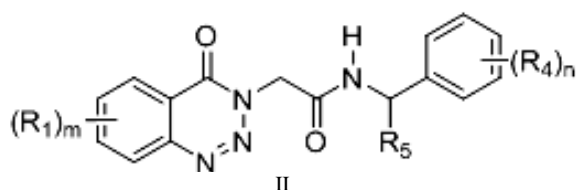

containing pharmaceutical compositions thereof, and their usage for the treatment of diseases related to GPR139.

Claims: 10 independent
26 dependent

PART C

C 30

- (10) AP 2018 14143 A (51) Int. Cl. (2006)
C 30 B 15/00
H 01 L 21/263
- (21) AP 2016 14143 (22) 2016 05 11
(71) LEPL – Ferdinand Tavadze Institute of Metallurgy And Materials Science (GE)
Mindelis q. 10, 0186, Tbilisi (GE)
(72) Nodar Kekelidze (GE);
Davit Kekelidze (GE);
Elza Khutsishvili (GE);
Bela Kvirkvelia (GE)
(74) Elza Khutsishvili
(54) **METHOD FOR IMPROVING QUALITY OF PHOSPHIDE CRYSTALS INDIA (InP)**
(57) A method for improving phosphide crystals India (InP) provides treatment of phosphide crystals India heterogeneity by exposure with fast neutrons $F=2 \cdot 10^{18}n/cm^2$ flow; at that, after exposure the electrons mobility is increased to 100%, particularly from $741 cm^2/sec$ up to $1490 cm^2/sec$.
Claims: 1 independent

PART G

G 10

- (10) AP 2018 14481 A (51) Int. Cl. (2006)
G 10 L 19/008
- (21) AP 2015 14481 (22) 2015 10 28
(31) 62/073,462; 62/167,711
(32) 2014 10 31; 2015 05 28
(33) US; US
(71) DOLBY INTERNATIONAL AB (NL)
Apollo Building, 3E Herikerbergweg 1-35,
NL-1101 CN Amsterdam (NL)
(72) VILLEMOS, Lars (SE);
PURNHAGEN, Heiko (SE);
LEHTONEN, Heidi-Maria (SE)
(74) Larisa Amirkhanyan

(85) 2017 04 25

(86) PCT/EP2015/075022, 2015 10 28

(54) **PARAMETRIC MIXING OF AUDIO SIGNALS**

(57) In an encoding section, a downmix section forms first and second channels of a downmix signal as linear combinations of first and second groups of channels, respectively, of an M-channel audio signal; and an analysis section determines upmix parameters for parametric reconstruction of the audio signal, and mixing parameters. In a decoding section, a decorrelating section outputs a decorrelated signal based on the downmix signal; and a mixing section determines mixing coefficients based on the mixing parameters or the upmix parameters, and forms a K-channel output signal as a linear combination of the downmix signal and the decorrelated signal in accordance with the mixing coefficients. The channels of the output signal approximate linear combinations of K groups of channels, respectively, of the audio signal. The K groups constitute a different partition of the audio signal than the first and second groups.

Claims: 6 independent

34 dependent

Fig.: 16

PATENTED INVENTIONS

PART A

A 01

- (11) P 2018 6931 B** **(51) Int. Cl. (2006)**
A 01 C 7/02
 (10) AP 2017 14267 A (44) 23(483)/2017
 (21) AP 2016 14267
 (22) 2016 09 14
 (24) 2016 09 14
 (73) Tea Kenkadze (GE)
 Temka, III mkr., IV kvart., korp. 59, b. 40,
 0172, Tbilisi (GE)
 (72) Tea Kenkadze (GE)
(54) HAND DEVICE FOR SOWING

A 61

- (11) P 2018 6932 B** **(51) Int. Cl. (2006)**
A 61 K 9/14
A 61 K 9/20
C 12 Q 1/68
A 61 K 9/28
 (10) AP 2018 14304 A (44) 15(499)/2018
 (21) AP 2015 14304
 (22) 2015 03 26
 (24) 2015 03 26
 (31) 36.046; 162/2015; 62/048,527; 61/970,595
 (32) 2015 03 25; 2015 03 25; 2015 03 25;
 2014 03 26
 (33) UY; PK; US; US
 (86) PCT/US2015/022792, 2015 03 26
 (73) MILLENNIUM PHARMACEUTICALS INC.
 40 Landsdowne Street, Cambridge,
 MA, 02139 (US)
 (72) BRAKE, Rachael, L. (US);
 BOZON, Viviana (US);
 CHOW, Ching-kuo, J. (US);
 DINUNZIO, James, C. (US);
 GALVIN, Katherine, M. (US);
 KANNAN, Karuppiah (US);
 KODONO, Yuki (JP);
 XU, Qunli (US)
 (74) Shalva Gvaramadze
(54) PHARMACEUTICAL FORMULATIONS
OF PAN-RAF KINASE INHIBITOR,
PROCESSES FOR THEIR PREPARA-
TION, AND METHODS OF USE

- (11) P 2018 6930 B** **(51) Int. Cl. (2006)**
A 61 K 47/26
A 61 K 9/08
A 61 K 9/10
A 61 K 31/444
A 61 K 47/36
A 61 P 27/00
 (10) AP 2018 14194 A (44) 15(499)/2018
 (21) AP 2014 14194
 (22) 2014 12 25
 (24) 2014 12 25
 (31) 2013-266567
 (32) 2013 12 25
 (33) JP
 (86) PCT/JP2014/084289, 2014 12 25
 (73) SANTEN PHARMACEUTICAL CO., LTD
 (JP)
 9-19, Shimoshin Jo 3-chome, Higashiiodogava-
 ku, Osaka-shi, Osaka 5338651 (JP)
 (72) OKI, Kenji (JP);
 YAMADA, Kazuhito (JP);
 MIYAZAKI, Tatsuya (JP);
 OKABE, Komei (JP);
 HABASHITA, Sayo (JP);
 ENOMOTO, Hiroshi (JP);
 YOSHII, Kenta (JP)
 (74) Shalva Gvaramadze
(54) INJECTABLE AGENT AND DEPOT
FORMATION METHOD

PART C

C 07

- (11) P 2018 6933 B** **(51) Int. Cl. (2006)**
C 07 D 401/14
C 07 D 405/14
C 07 D 401/06
A 61 K 31/47
A 61 P 35/00
 (10) AP 2018 14347 A (44) 15(499)/2018
 (21) AP 2015 14347
 (22) 2015 06 05
 (24) 2015 06 05
 (31) 62/013,410; 62/156,533
 (32) 2014 06 17; 2015 05 04
 (33) US; US

UTILITY MODELS

APPLICATIONS APPROVED FOR GRANTING PATENTS

The decision can be appealed at the Chamber of Appeal of Sakpatenti within 3 months from the publication or at the Mtskheta District Court Administrative Cases Board (Address: №17, Samkhedro str., Mtskheta), within 1 month following the publication.

PART A

A 01

(10) AU 2018 14419 U (51) Int. Cl. (2006)
A 01 C 23/00

(21) AU 2017 14419 (22) 2017 02 10

(71) Lukhum Tchelidze (GE)

Nikeas q. 32/3, 4600, Kutaisi (GE);

Rani Tchabukiani (GE)

Solomon I, shes. I, No. 3, 4600, Kutaisi (GE);

Soso Tavberidze (GE)

Gugunavas q. 22, 4600, Kutaisi (GE);

Emzar Kilasonia (GE)

Leselidzis q. 1, 4600, Kutaisi (GE)

(72) Lukhum Tchelidze (GE);

Rani Tchabukiani (GE);

Soso Tavberidze (GE);

Emzar Kilasonia (GE)

(74) Archil Geguchadze

(54) **DEVICE FOR SOIL FERTILIZING
BETWEEN PLANT STEMS**

(57) A device includes basic frame 1 and side frames 2 connected thereto hingedly. The bars 5 for operating fluid with a tank 7 are fastened on all frames, and the sprayers 4 are disposed on said bars. Arched probes 3 are fastened on side frame ends by means of vertical hinges rotatable and fixable relative thereto. The bars fastened on side frames by means of springs 6 are springed relative to bar fastened onto basic frame.

Claims: 1 independent

Fig.: 2

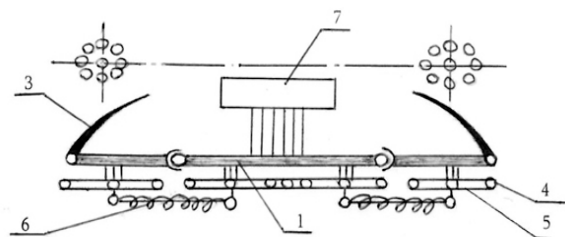

Fig. 1

PART G

G 01

(10) AU 2018 14353 U (51) Int. Cl. (2006)
G 01 N 27/00

(21) AU 2016 14353 (22) 2016 12 19

(71) GEORGIAN TECHNICAL

UNIVERSITY (GE)

Kostavas q.77, 0175, Tbilisi (GE)

(72) Archil Prangishvili (GE);

Tamaz Dzagania (GE);

Elguja Butskhrikidze (GE)

(74) Givi Sibashvili

(54) **ELECTROCHEMICAL SENSOR
DETERMINING CONCENTRATION
OF OXYGEN IN SOLUTIONS OR
GASES**

(57) Electrochemical sensor determining concentration of oxygen in solutions or gases includes a case with installed therein electrode system formed from an electrolyte and two being in contact with electrode electrolyte, separating said system from tested medium the gas-permeable membrane made of fluoroplastic; at that, one of sensor electrodes – a cathode is made of thin layer of platinum deposited on rough glass surface, and second electrode – an anode, is made of metallic silver metal wrapped around glass tube; at that, the body is made of material identical to separating gas-permeable membrane.

Claims: 1 independent

Fig.: 2

PATENTED UTILITY MODELS**PART B****B 03**

- (11) U 2018 1996 Y (51) Int. Cl. (2006)**
B 03 B 7/00
- (10) AU 2018 14496 U (44) 15 (499) 2018
(21) AU 2017 14496
(22) 18 05 2017
(24) 18 05 2017
(31) U201700965
(32) 2017 02 02
(33) UA
(73) LIMITED LIABILITY COMPANY
"UKRMINING" (UA)
Ul. Geroev Chernobilya 106, 53201, Nikopol
Dnipropetrovsk (UA)
(72) Maxim Mazurenko (UA)
(74) Liliana Darakhvelidze
(54) **LINE FOR MANGANESE
CONCENTRATES PREPARATION
WITH MANGANESE ORE PRIMARY
ENRICHMENT WITHDRAWAL**
-

B 23

- (11) U 2018 1995 Y (51) Int. Cl. (2006)**
B 23 K 9/18
- (10) AU 2018 14550 U (44) 14 (498) 2018
(21) AU 2017 14550
(22) 21 07 2017
(24) 21 07 2017 07 21
(73) Giorgi Kutelia (GE)
Nostes q. 7, 0101, Tbilisi (GE)
(72) Giorgi Kutelia (GE)
(54) **DEVICE FOR DETAL RESTORATION
BY MEANS OF ELECTRIC-ARC
WELDING UNDER FLUX**
-

DESIGNS

APPLICATIONS APPROVED FOR REGISTRATION

The decision can be appealed at the Chamber of Appeal of Sakpatenti within 3 months from the publication or at the Mtskheta District Court Administrative Cases Board (Address: №17, Samkhedro str., Mtskheta), within 1 month following the publication.

- (10) **AD 2018 1042 S** (51) **32-00**
(21) AD 2018 1042 (22) 2018 06 27
(28) 2
(71) ALLIED GLOBAL TOBACCO LTD (GB)
 Wey Court West, Union Rd., Surrey GU9 7PT, Farnham (GB)
(72) Mariam Gurgenzidze (GE)
(74) Givi Akopasahvili (GE)
(54) **GRAPHIC SYMBOL**
(55)



- (10) **AD 2018 1043 S** (51) **32-00**
(21) AD 2018 1043 (22) 2018 06 27
(28) 2
(71) HARRINGTON DEVELOPMENT INC. (PA)
 Elvira Mendez Str., Valarino bldg., floor 3, Panama (PA)
(72) Mariam Gurgenidze (GE)
(74) Givi Akopasahvili (GE)
(54) **GRAPHIC SYMBOL**
(55)



1.1



2.1

REGISTERED DESIGNS**(11) D 2018 790 S (51) 07-01**

(10) AD 2018 1025 S (44) 2018 08 27 №16
(21) AD 2018 1025
(22) 2018 03 06
(24) 2018 03 06
(28) 1
(18) 2023 03 06
(73) Tamaz Bochorishvili (GE)
I. Chavchavadzis gamz. 62, b.17, 4600,
Kutaisi (GE)
(72) Tamaz Bochorishvili (GE)
(54) **CUP**

(11) D 2018 791 S (51) 12-08

(10) AD 2018 1028 S (44) 2018 08 27 №16
(21) AD 2018 1028
(22) 2018 03 14
(24) 2018 03 14
(28) 1
(18) 2023 03 14
(31) 3-2017-01932
(32) 2017 09 25
(33) VN
(73) VINFAST & PRODUCTION COMPANY
LLC (VN)
7, Bang Lang 1 Str., Vinhomes Riverside
Ecological Urban Area, Viet Hang Word,
Long Bien District, Hanoi Site (VN)
(72) Filippo Perini (IT)
(74) Shalva Gvaramadze (GE)
(54) **CAR**

(11) D 2018 792 S (51) 12-08

(10) AD 2018 1029 S (44) 2018 08 27 №16
(21) AD 2018 1029
(22) 2018 03 14
(24) 2018 03 14
(28) 1
(18) 2023 03 14
(31) 3-2017-01933
(32) 2017 09 25
(33) VN
(73) VINFAST & PRODUCTION COMPANY
LLC (VN)
7, Bang Lang 1 Str., Vinhomes Riverside
Ecological Urban Area, Viet Hang Word,
Long Bien District, Hanoi Site (VN)
(72) Filippo Perini (IT)
(74) Shalva Gvaramadze (GE)
(54) **CAR**

(11) D 2018 793 S (51) 19-04

(10) AD 2018 1034 S (44) 2018 08 27 №16
(21) AD 2018 1034
(22) 2018 04 26
(24) 2018 04 26
(28) 1
(18) 2023 04 26
(73) LEPL PUBLIC SERVICE DEVELOPMENT
AGENCY (GE)
A. Tseretlis gamz. 67a, 0154, Tbilisi (GE)
(72) Salome Bakradze (GE)
(54) **BOOK WITH CASE**

(11) D 2018 789 S (51) 25-03

(10) AD 2018 1033 S (44) 2018 08 27 №16
(21) AD 2018 1033
(22) 2018 04 25
(24) 2018 04 25
(28) 3
(18) 2023 04 25
(73) Gela Gamtkitsulashvili (GE)
Telavi Municipality, Napareuli, 2211 (GE);
Gia Gamtkitsulashvili (GE)
Telavi Municipality, Napareuli, 2211 (GE)
(72) Gela Gamtkitsulashvili (GE);
Gia Gamtkitsulashvili (GE)
(74) Davit Dzamukashvili (GE)
(54) **1.-3. BUILDING**

DESIGNS REGISTERED ACCORDING TO THE ACCELERATED PROCEDURE

The decision can be appealed at the Chamber of Appeal of Sakpatenti within 3 months from the publication.

- (11) D 2018 787 S (51) 09-01
 (21) AD 2018 1062 (22) 2018 11 05
 (24) 2018 11 05
 (28) 10
 (18) 2023 11 05
 (73) Giorgi Zautashvili (GE)
 D.Tavdadebulis q. 3, 4800, Kvareli (GE)
 (72) Giorgi Zautashvili (GE)
 (74) Giorgi Kartvelishvili (GE)
 (54) BOTTLE
 (55)





- (11) D 2018 794 S** **(51) 09-03**
(21) AD 2018 1060 (22) 2018 10 03
(24) 2018 10 03
(28) 1
(18) 2023 10 03
(73) GEORGIAN BAKERS LLC (GE)
Gorgaslis q. 115, 0114, Tbilisi (GE)
(72) Mikheil Parulava (GE)
(74) GEORGIAN BAKERS LLC (GE)
(54) **PACKING FOR STICKS LIKE CONFECTIONERY**
(55)



1.1

(11) D 2018 788 S

(51) 09-05

(21) AD 2018 1058

(22) 2018 09 21

(24) 2018 09 21

(28) 4

(18) 2023 09 21

(73) CHERRY LTD (GE)

Didi Lilo, nakv. 726, 0198, Tbilisi (GE)

(72) Tinatin Lomtadze (GE)

(54) 1.-4. ALUMINUM CAPSULES FOR COFFEE, WITH ALUMINUM FOIL CAP

(55)



1.1



2.1



3.1



4.1

DESIGNS, WHICH HAVE BEEN REGISTERED WITH THE INTERNATIONAL BUREAU CLAIMING PRIORITY ON THE TERRITORY OF GEORGIA

The decision can be appealed at the Chamber of Appeal of Sakpatenti within 3 months from the publication or at the Mtskheta District Court Administrative Cases Board (Address: №17, Samkhedro Str., Mtskheta), within 1 month following the publication.

(11) DM/100177

(51) 10-01

(15) 2018 03 02

(45) 2018/35 (2018 09 07)

(22) 2018 03 02

(28) 1

(73) HARRY WINSTON SA

Chemin du Tourbillon 8, CH-1228 Plan-les-Ouates (CH)

(85) CH

(86) CH

(87) CH

(88) CH

(89) CH

(81) II. BZ, MA III. AL, AM, AZ, BA, CH, EM, GE, KG, LI, MC, MD, ME, MK, MN, NO, OM, SG, TN, TR, UA

(72) Emmanuelle DOMINGUEZ

285 Rue de la Luchette, F-74580 Viry, France

(54) 1. Alarm clock

(55)

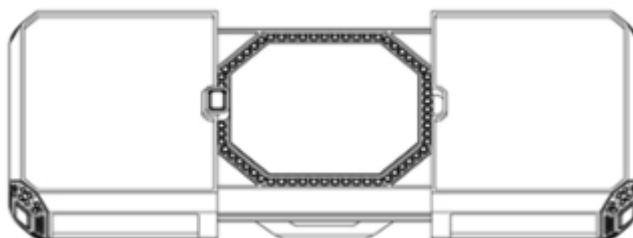
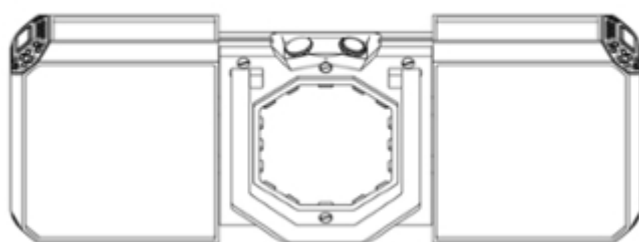
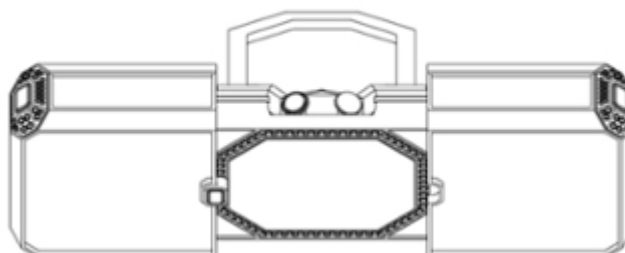
1.1**1.2****1.3****1.4****1.5**

1.6

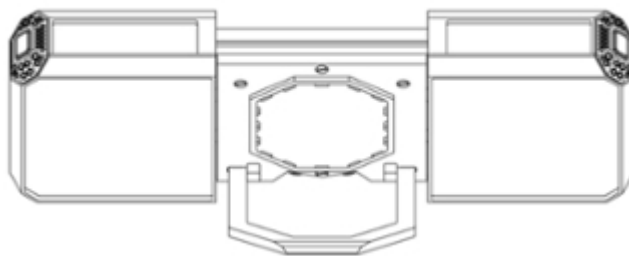

1.7

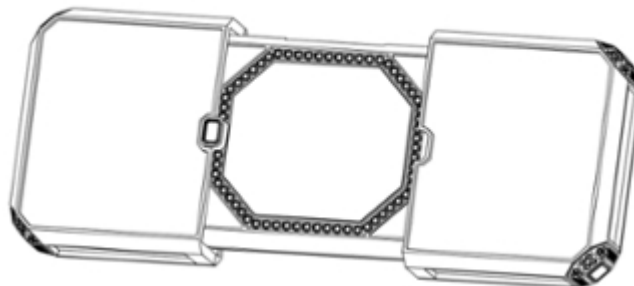

1.8

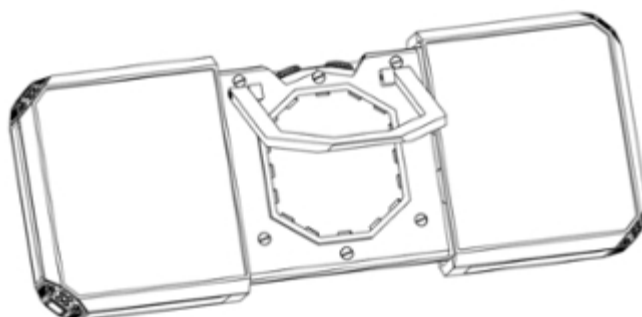

1.9

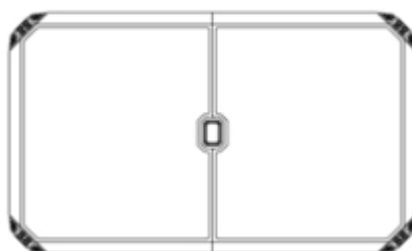

(11) DM/100181

(51) 10-07

(15) 2018 03 02

(45) 2018/35 (2018 09 07)

(22) 2018 03 02

(28) 1

(73) BLANCPAIN SA

Le Rocher 12, CH-1348 LE BRASSUS (CH)

(85) CH

(86) CH

(87) CH

(88) CH

(89) CH

(81) II. BZ, MA III. AL, AM, AZ, BA, CH, EM, GE, KG, LI, MC, MD, ME, MK, MN, NO, OM, SG, TN, T
R, UA

(72) Fabien HENRIET

57A Impasse de la Colombière, F-74200 Marin, France

(54) 1. Dial

(55)

1.1



1.2



(11) DM/100183**(51) 10-07**

(15) 2018 03 05

(45) 2018/35 (2018 09 07)

(22) 2018 03 05

(28) 4

(73) OMEGA SA (OMEGA AG) (OMEGA LTD.)

Jakob-Stämpfli-Strasse 96, CH-2502 Biel/Bienne (CH)

(85) CH

(86) CH

(87) CH

(88) CH

(89) CH

(81) II. BZ, MA III. AL, AM, AZ, BA, CH, EM, GE, KG, LI, MC, MD, ME, MK, MN, NO, OM, SG, TN, TR, UA

(72) Jean-Claude Monachon

Rue Alice-de-Chambrier 1, 2022 Bevaix, Suisse

(54) 1.-2. Dials; 3. Watch case; 4. Dial

(55)

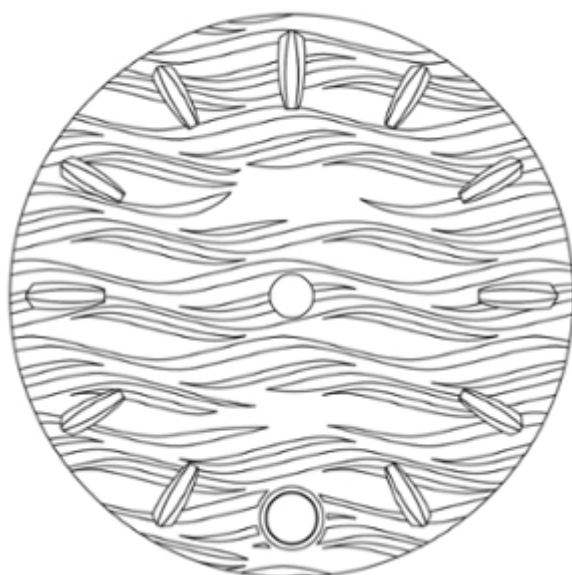
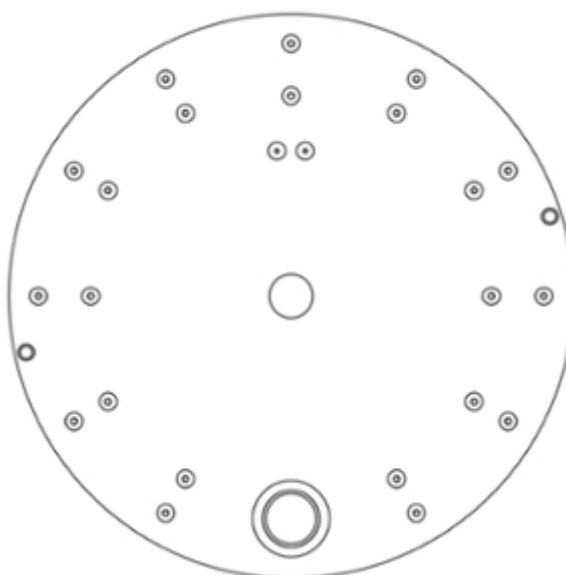
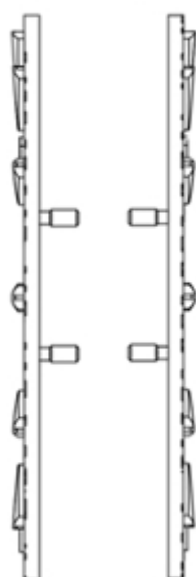
1.1**1.2****1.3****1.4****1.5**

1.6



1.7

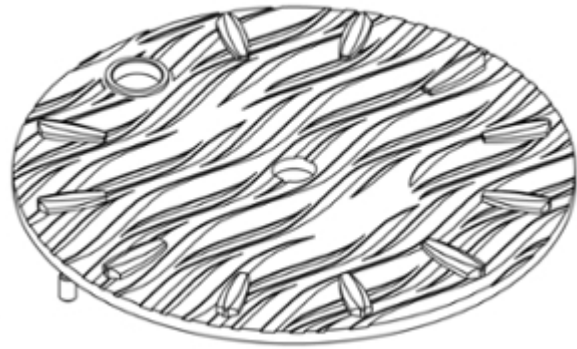

2.1

1.8

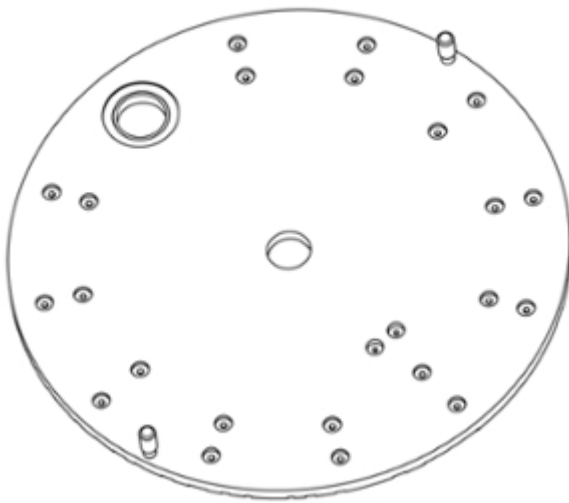

2.2

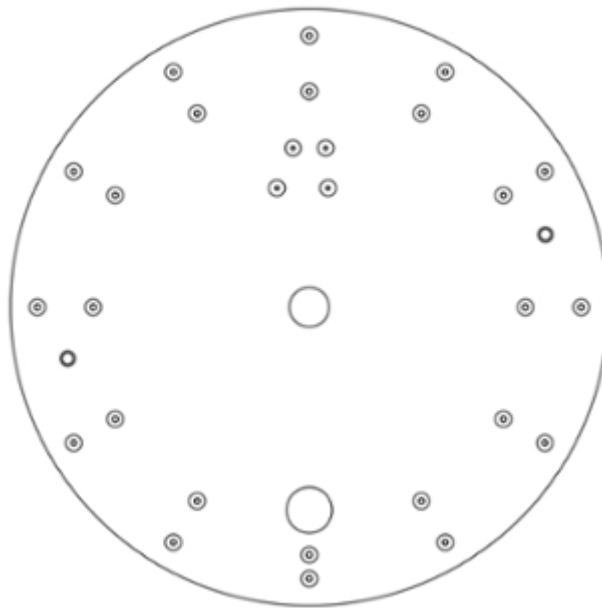

2.3 2.4

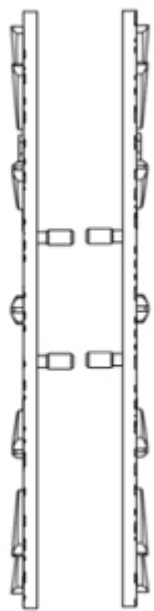

2.5



2.6



2.7



2.8

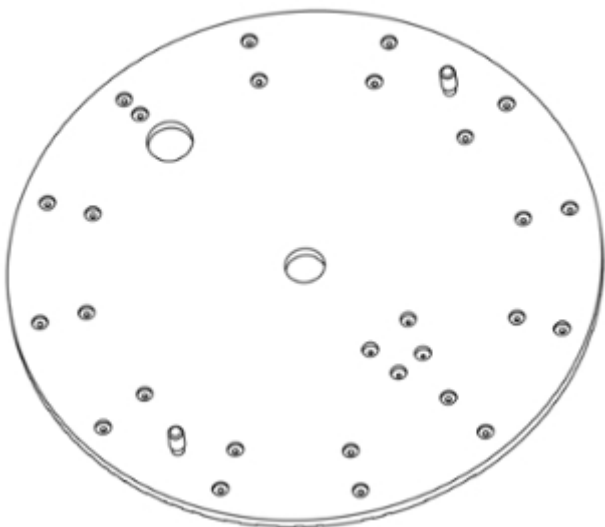

3.1

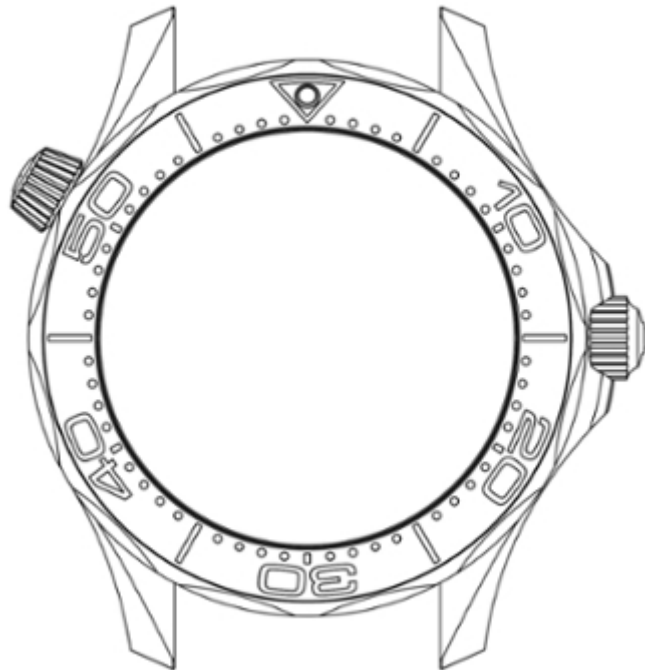

3.2

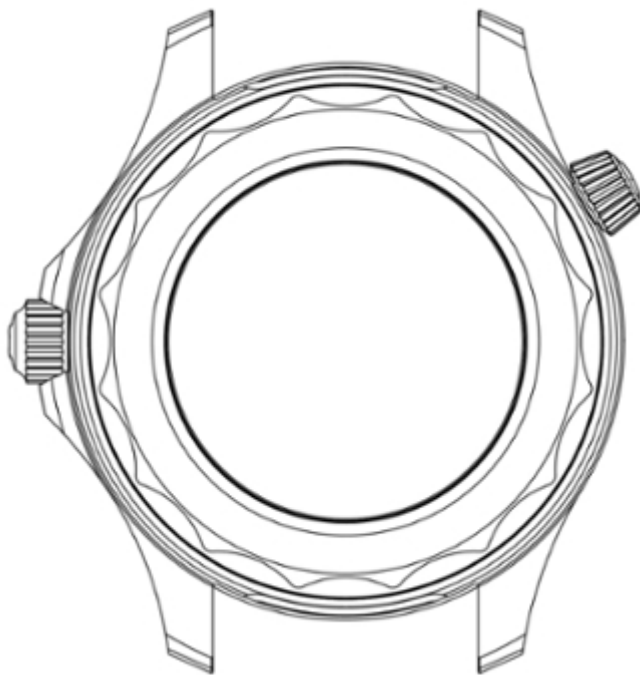

3.3

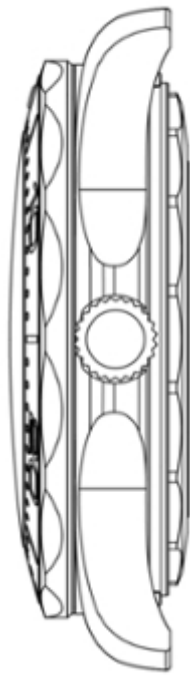

3.4

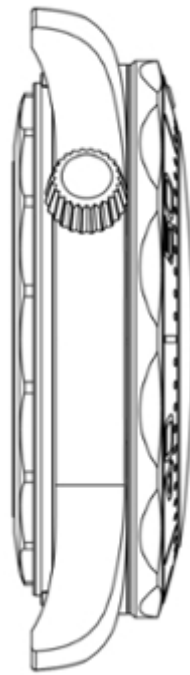

3.5

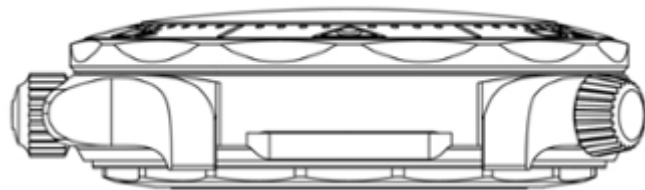

3.6

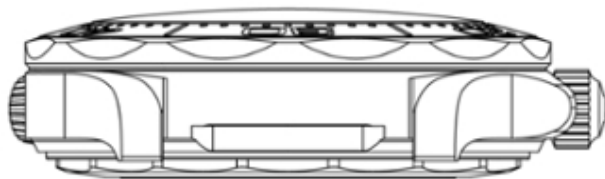

3.7

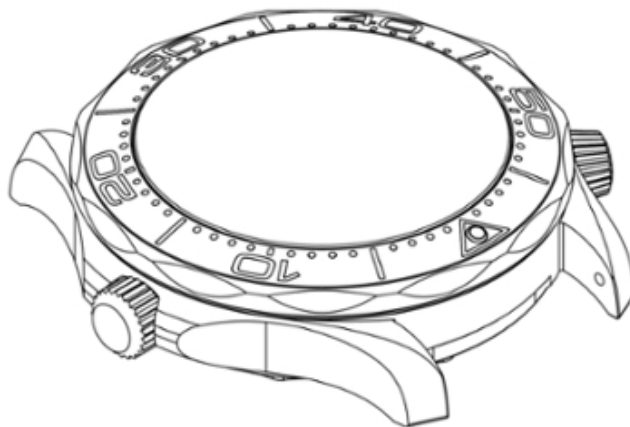

3.8

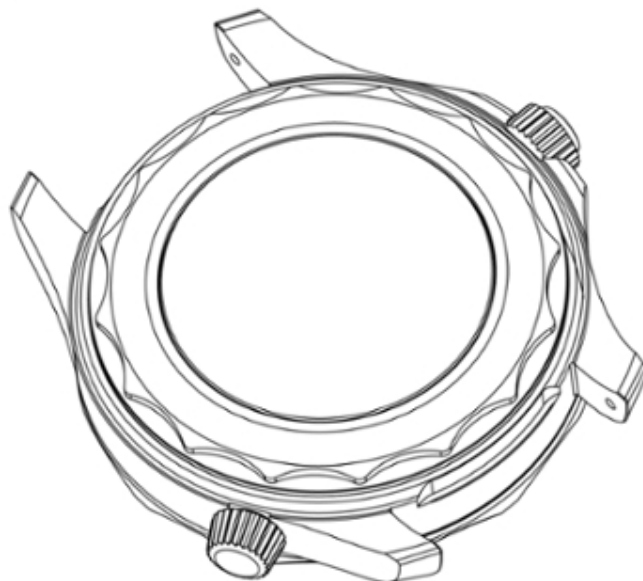

4.1



4.2

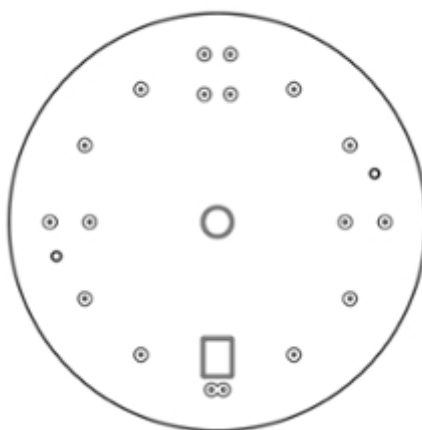

4.3 4.4

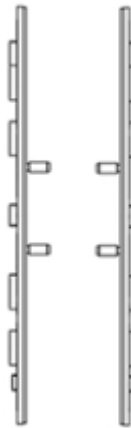

4.5



4.6



4.8

4.7

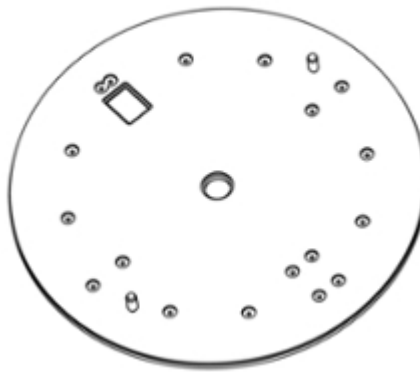

(11) DM/100185

(15) 2018 03 05

(22) 2018 03 05

(28) 1

(73) MONTRES BREGUET S.A.

Place de la Tour 23, CH-1344 L'ABBAYE (CH)

(85) CH

(86) CH

(87) CH

(88) CH

(89) CH

(81) II. BZ, MA III. AL, AM, AZ, BA, CH, EM, GE, KG, LI, MC, MD, ME, MK, MN, NO, OM, SG, TN, TR, UA

(72) Christian CHAUDOT

Route du Risoud 41, CH-1348 Le Brassus, Suisse

(54) 1. Watch movement part

(55)

(51) 10-07

(45) 2018/35 (2018 09 07)

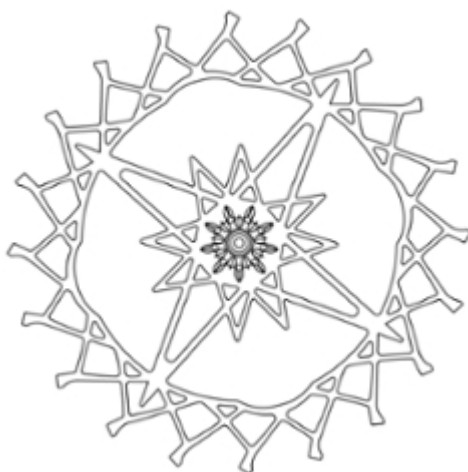
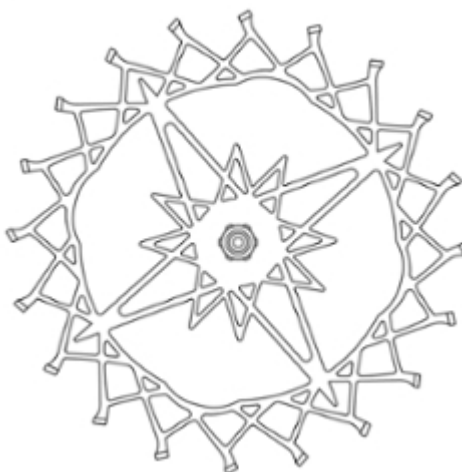
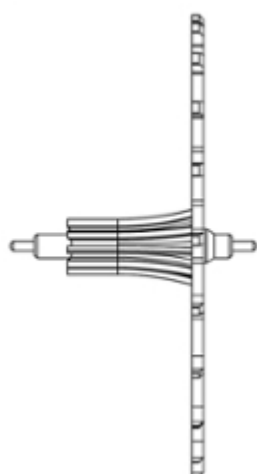
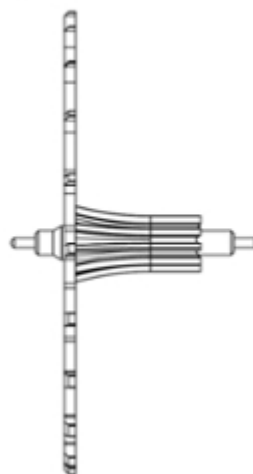
1.1**1.2****1.3****1.4**

1.5

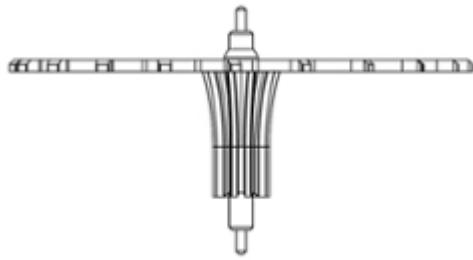

1.6

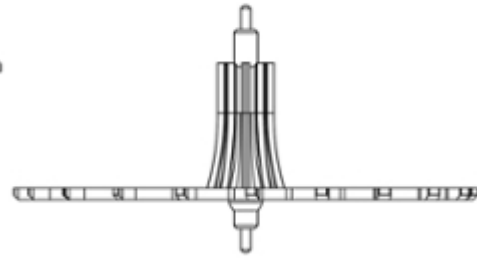

1.7

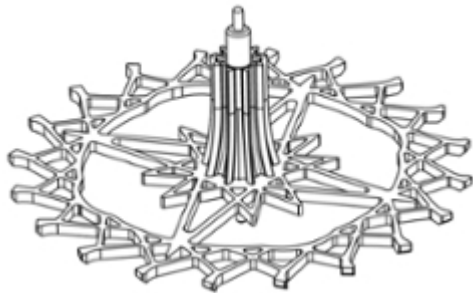

1.8

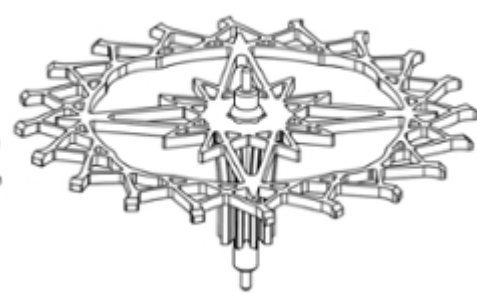

(11) DM/100219

(15) 2018 03 02

(22) 2018 03 02

(28) 1

(73) HARRY WINSTON SA

Chemin du Tourbillon 8, CH-1228 Plan-les-Ouates (CH)

(85) CH

(86) CH

(87) CH

(88) CH

(89) CH

(81) II. BZ, MA III. AL, AM, AZ, BA, CH, EM, GE, KG, LI, MC, MD, ME, MK, MN, NO, OM, SG, TN, TR, UA

(72) Coralie BLOOTACKER

45 route du Battoir, Le hameau des Templiers, F-74520 Vulbens, France

(54) 1. Signing machine

(55)

(51) 19-06

(45) 2018/35 (2018 09 07)

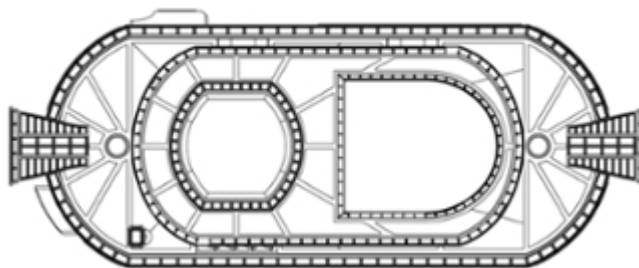
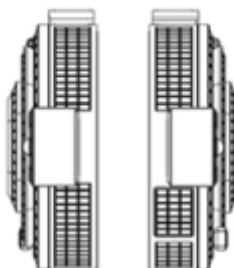
1.1**1.2****1.3****1.4****1.5**

1.6



1.7

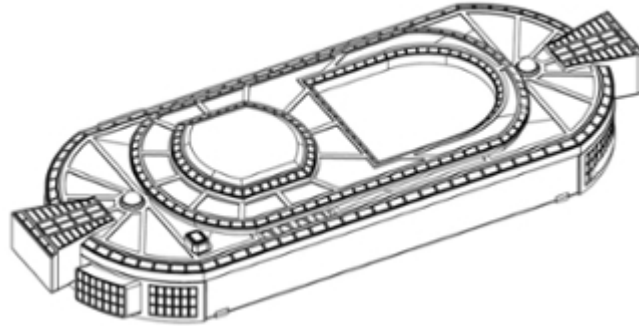

1.8

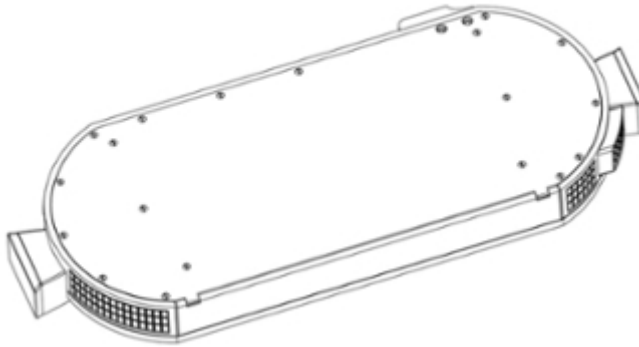

1.9

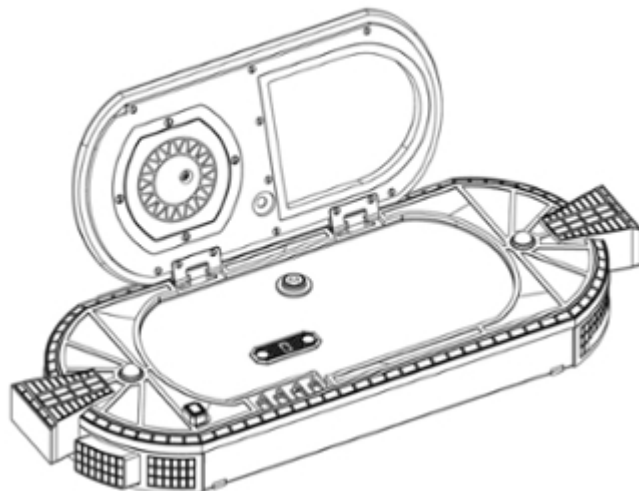

(11) DM/100256

(51) 25-03

(15) 2018 03 07

(45) 2018/35 (2018 09 07)

(22) 2018 03 07

(28) 6

(30) No. 4: 07.09.2017; 6018222; GB; No. 5: 07.09.2017; 6018223; GB; No. 6: 07.09.2017; 6018224; GB

(73) RE-POWER INTERNATIONAL LIMITED

9 Argyll Street, London W1F 7TG (GB)

(85) –

(86) –

(87) –

(88) EM

(89) EM

(81) III. AM, AZ, EM, GE, KG, KR, MD, NO, RU, TJ, TM, UA, US

(72) John Corby

Sixth floor 9 Argyll Street, W1F 7TG London, United Kingdom;

Paul Anthony Jarvis

Sixth Floor 9 Argyll Street, W1F 7TG London, United Kingdom;

Vadim Opeskin

Sixth Floor 9 Argyll Street, W1F 7TG London, United Kingdom;

Mark G Deverell

Sixth Floor 9 Argyll Street, W1F 7TG London, United Kingdom;

Andrew Rowley McLelland

Sixth Floor 9 Argyll Street, W1F 7TG London, United Kingdom

(54) 1.-6. Carports

(55)

1.1

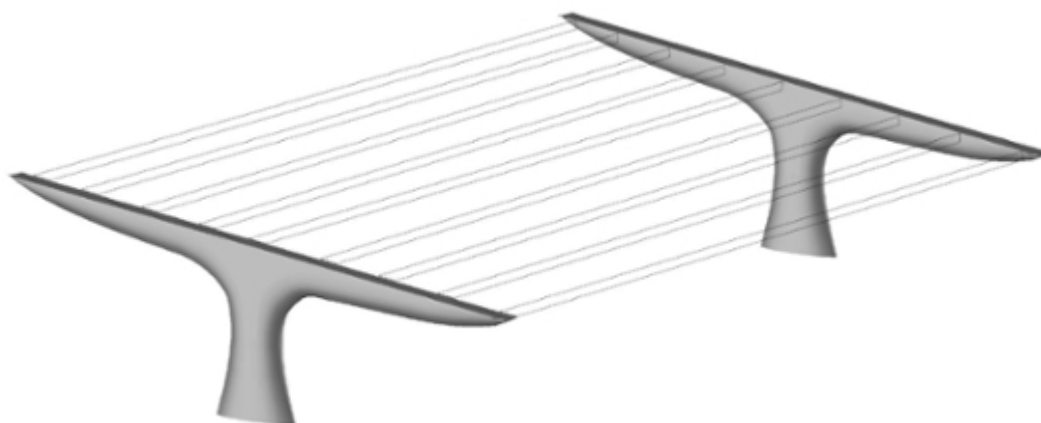

1.2

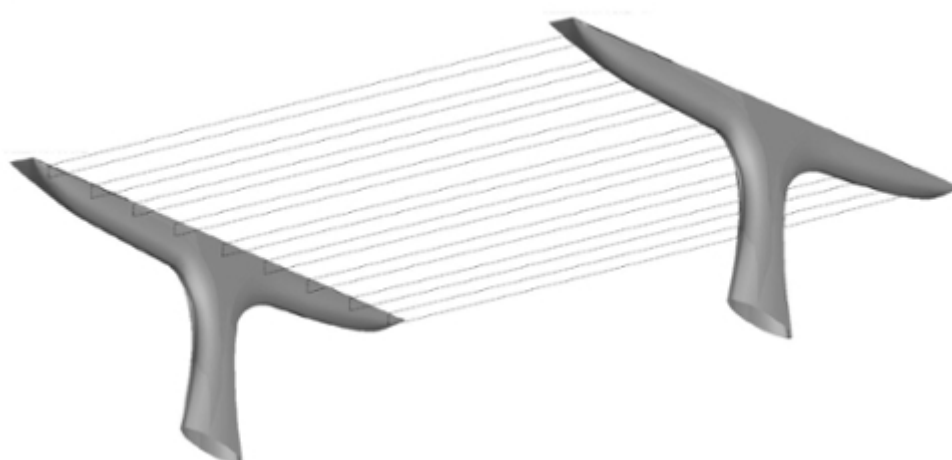

1.3

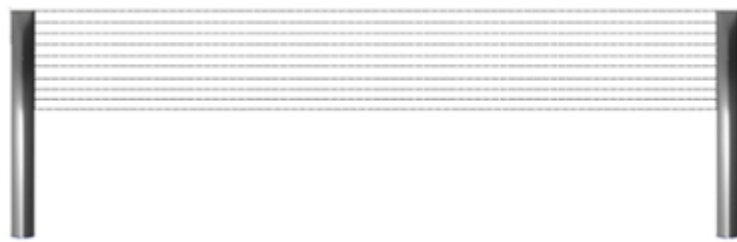

1.4

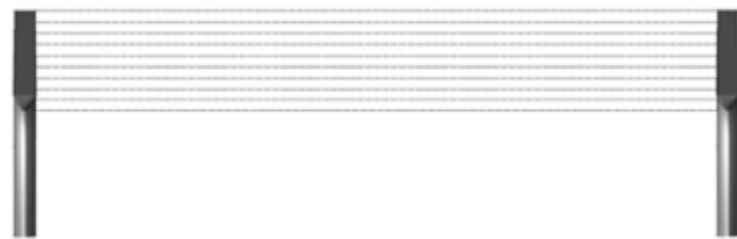

1.5



1.6



2.1

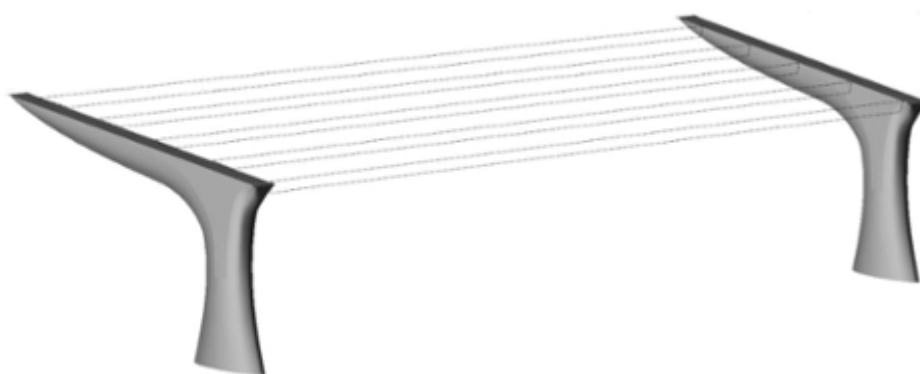

2.2



2.3



2.4



2.5



2.6



3.1



3.2

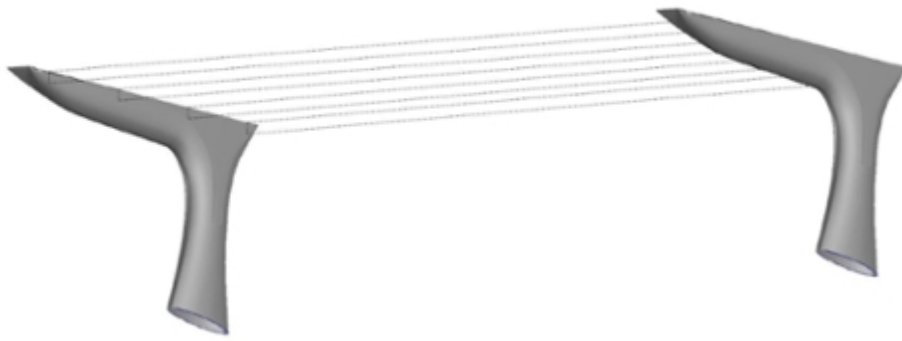

3.3

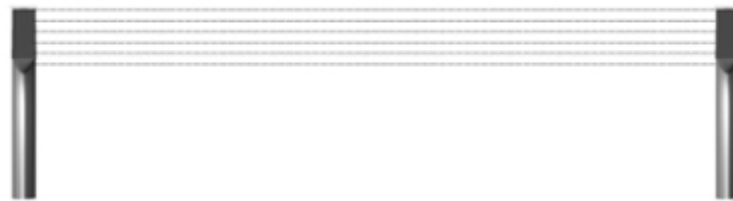

3.4



3.5



3.6



4.1

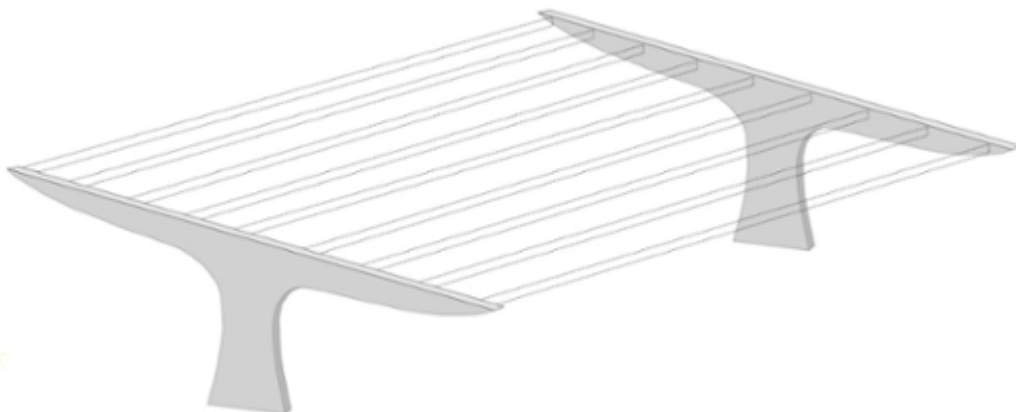

4.2

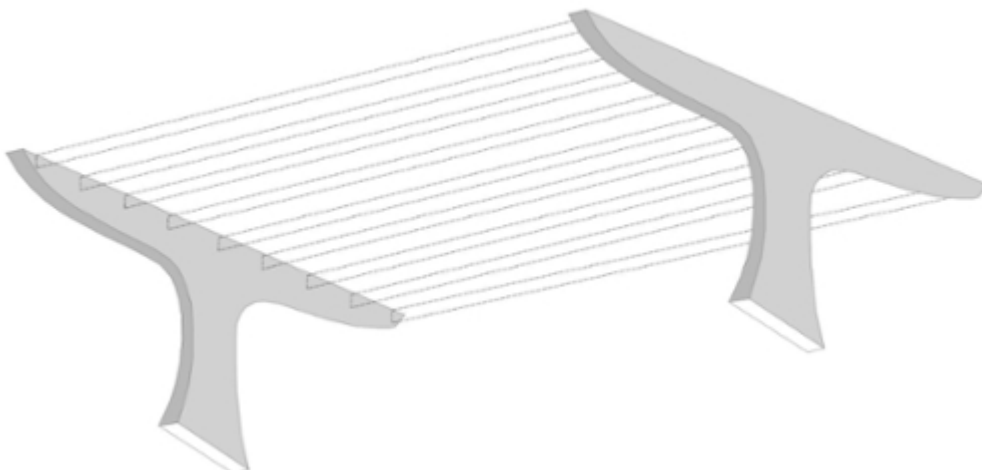

4.3

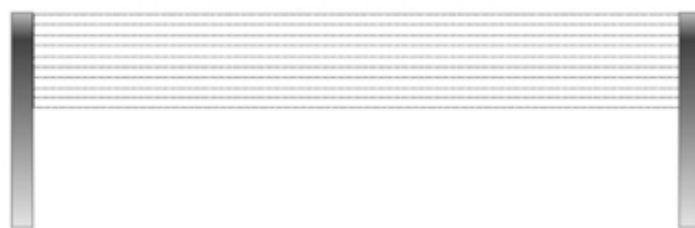

4.4

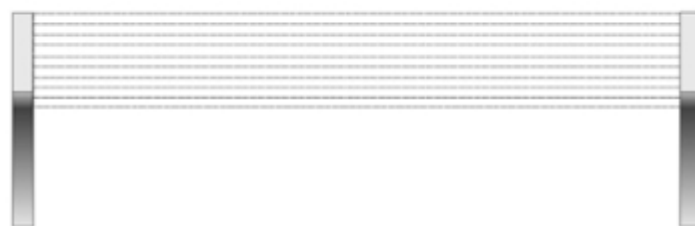

4.5



4.6



5.1

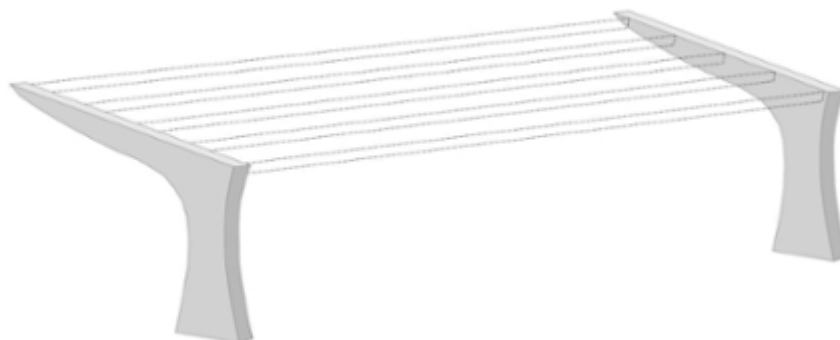

5.2

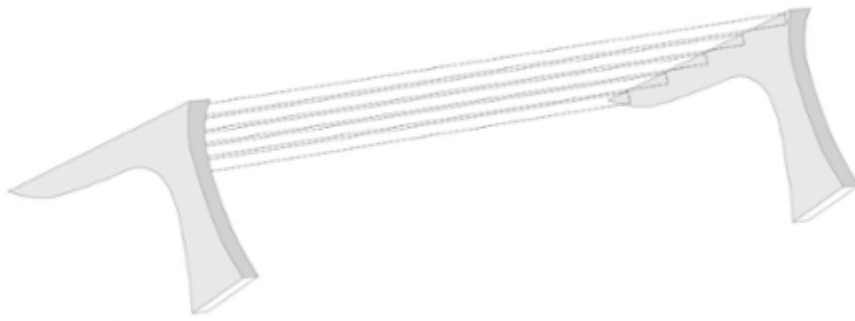

5.3



5.4

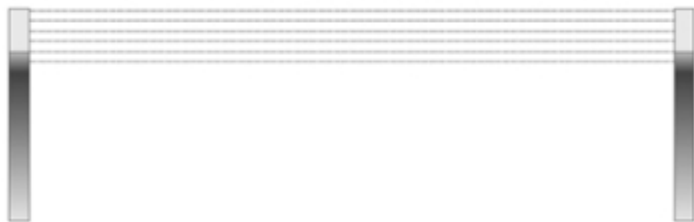

5.5



6.1

5.6

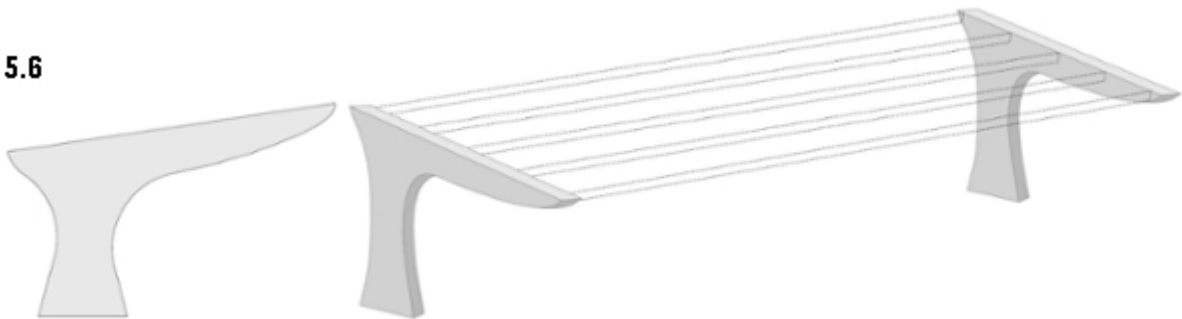

6.2



6.3



6.4



6.5



6.6



(11) DM/102492

(51) 15-05

(15) 2018 08 16

(45) 2018/35 (2018 09 07)

(22) 2018 08 16

(28) 2

(73) TOLKAR MAKİNA SANAYİ VE TİCARET ANONİM ŞİRKETİ (Hakan PEHLIVAN)

10036 Sokak No: 6 Aosb Çigli, İzmir (TR)

(85) –

(86) –

(87) –

(88) TR

(89) TR

(81) III. AZ, BA, EG, EM, GE, KH, RS, RU, TJ, TM, TN, UA

(72) Tolkar Hasan KARACE

10036 Sok., No:6, I.A.O.S.B. Cigli, Izmir, TURKEY, 35620 Izmir, Turkey

(54) 1.-2. Washing machine drums

(55)

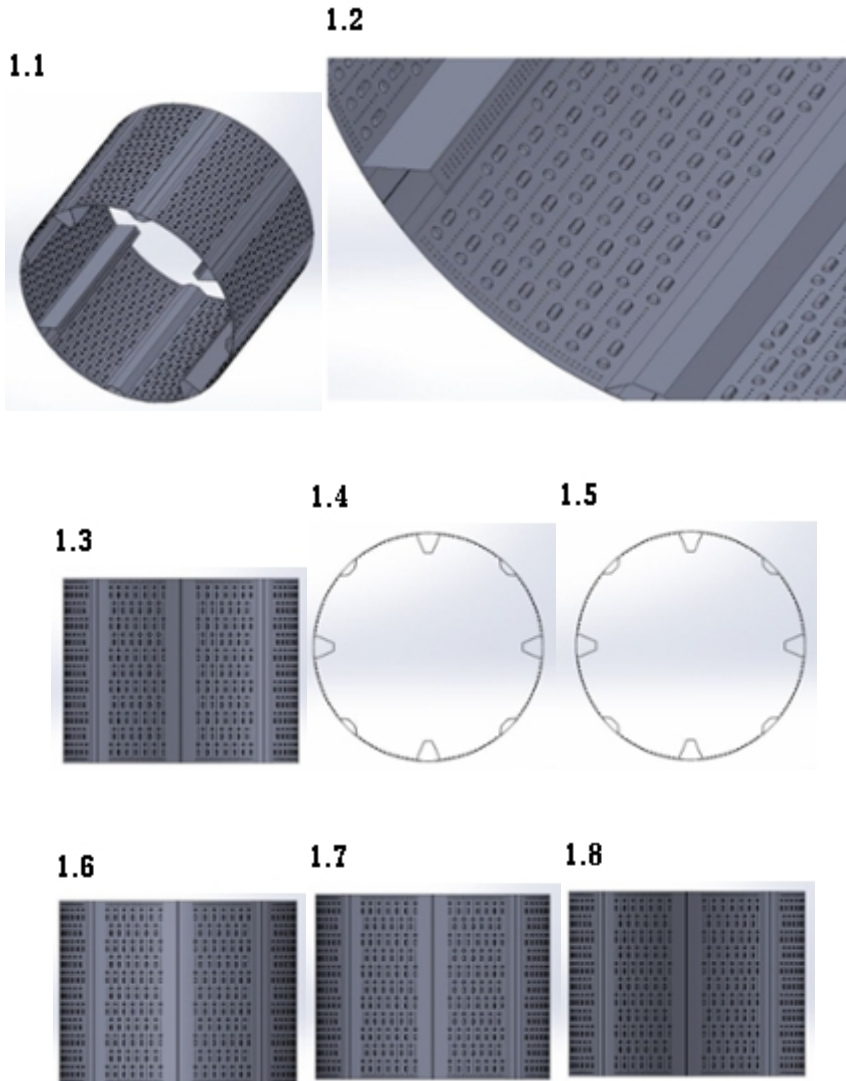

2.1

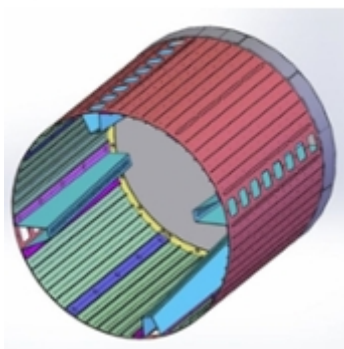

2.2

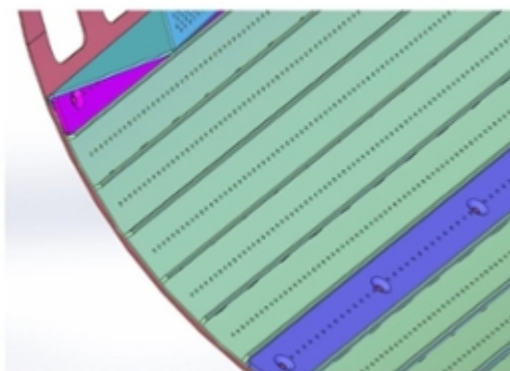

2.3

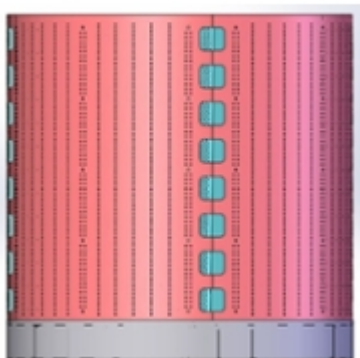

2.4

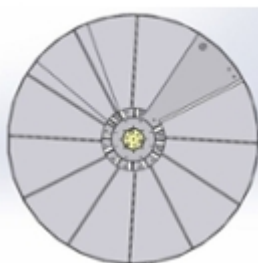

2.5

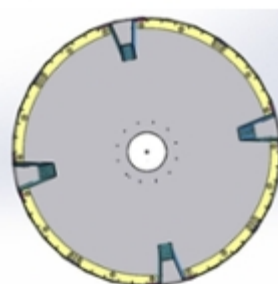

2.7

2.6

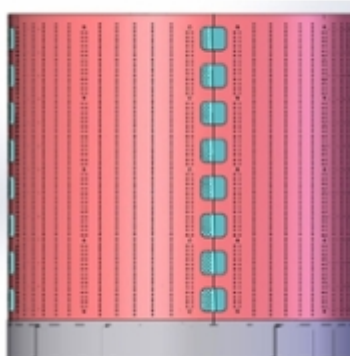
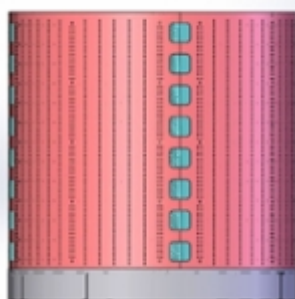

2.8

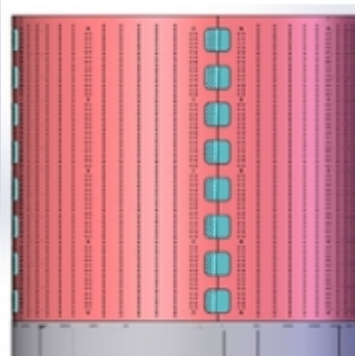

(11) DM/100318

(51) 10-07

(15) 2018 03 14

(45) 2018/36 (2018 09 14)

(22) 2018 03 14

(28) 4

(73) MONTRES JAQUET DROZ SA (MONTRES JAQUET DROZ AG) (MONTRES JAQUET DROZ LTD
Allée du Tourbillon 2, CH-2300 La Chaux-de-Fonds (CH)

(85) CH

(86) CH

(87) CH

(88) CH

(89) CH

(81) II. BZ, MA III. AL, AM, AZ, BA, CH, EM, GE, KG, LI, MC, MD, ME, MK, MN, NO, OM, SG, TN,
TR, UA

(72) Christian Lattmann

Chemin du Château-Neuf 17, CH-1125 Monnaz, Suisse;

1-3: Thanh Le Ngoc

1 rue du Clos de la Fontaine, F-25500 Le Belieu, France

4: Yann Leiggener

Rue du Nord 47, CH-2300 La Chaux-de-Fonds, Suisse;

(54) 1.-2. Watch cases; 3. Watch case part; 4. Dial

(55)

1.1

1.2

1.3

1.4

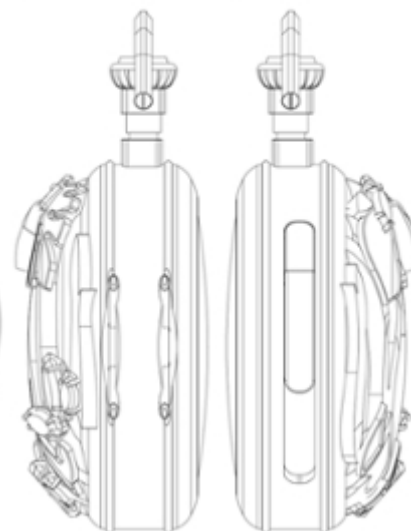
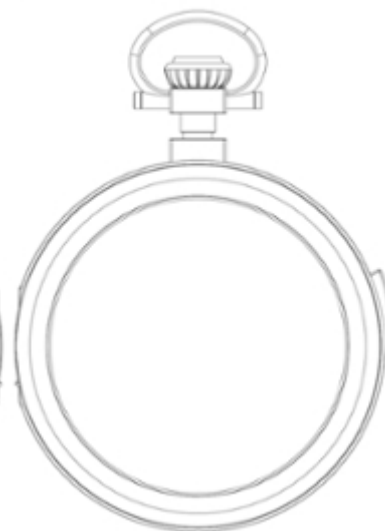

1.7

1.5

1.6



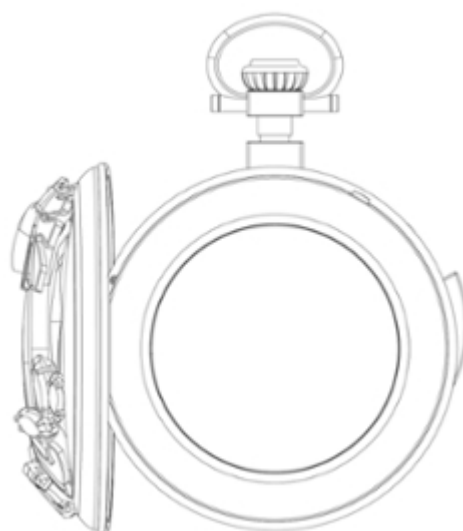
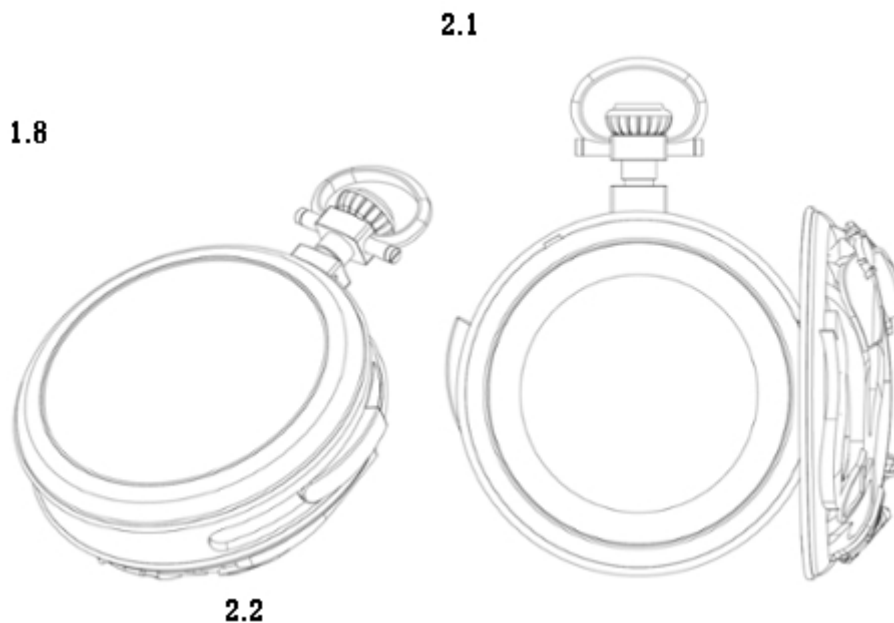

2.4

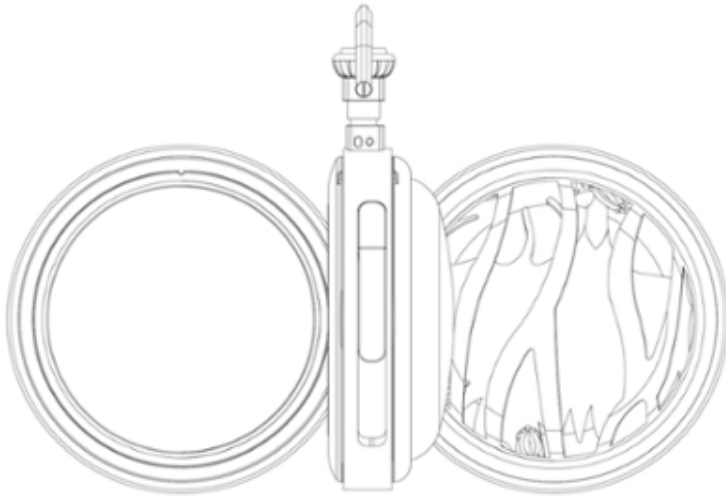

2.5



2.6

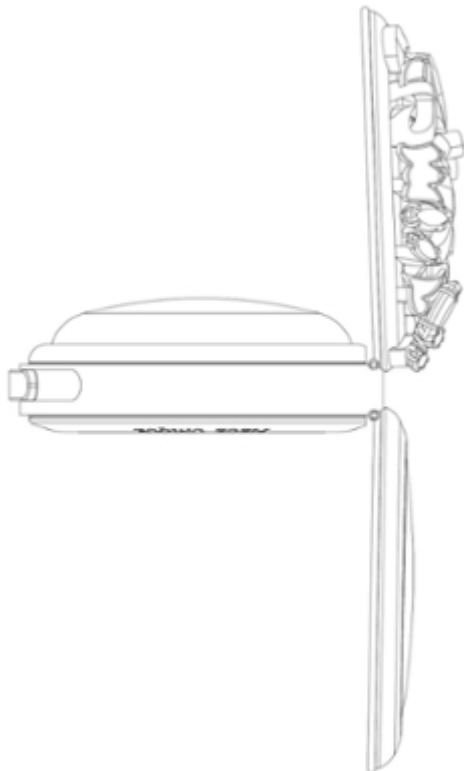

2.7

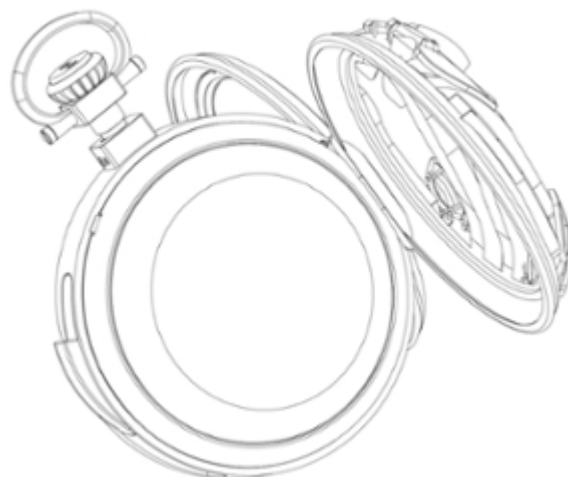

2.8

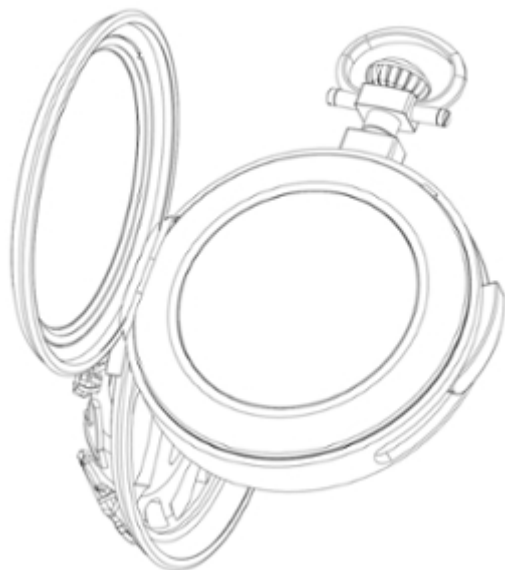

3.1



3.2



3.3



3.4



3.5



3.7

3.6



3.8



4.1



4.2



4.3



4.4



4.5



4.6



4.7



4.8



(11) DM/100324**(51) 19-06**

(15) 2018 03 19

(45) 2018/37 (2018 09 21)

(22) 2018 03 19

(28) 2

(73) MONTRES JAQUET DROZ SA (MONTRES JAQUET DROZ AG) (MONTRES JAQUET DROZ LTD)
Allée du Tourbillon 2, CH-2300 La Chaux-de-Fonds (CH)

(85) CH

(86) CH

(87) CH

(88) CH

(89) CH

(81) II. BZ, MA III. AL, AM, AZ, BA, CH, EM, GE, KG, LI, MC, MD, ME, MK, MN, NO, OM, SG, TN,
TR, UA

(72) Christian LATTMANN

Chemin de Château-Neuf 17, 1125 Monnaz, Suisse;

Yann LEIGGENER

Rue du Nord 47, 2300 La Chaux-de-Fonds, Suisse

(54) 1.-2. Signing machines

(55)

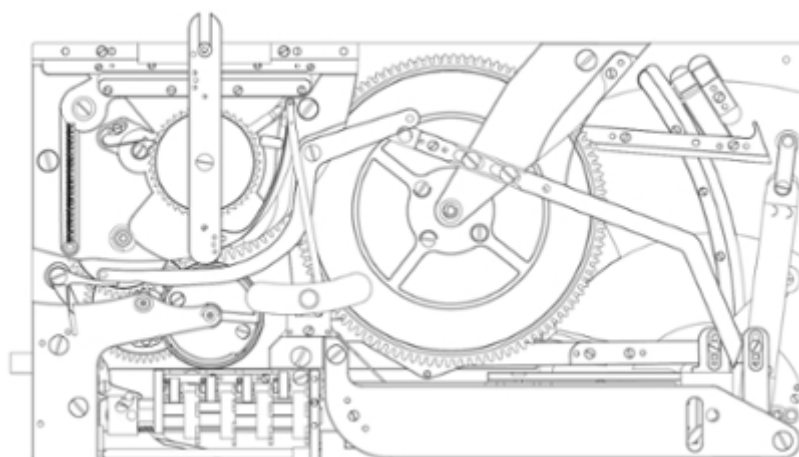
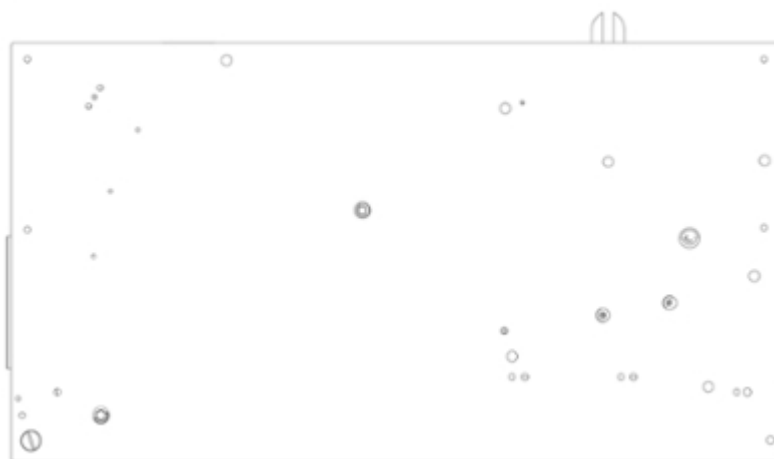
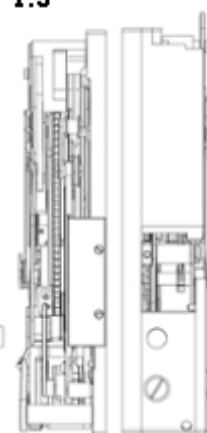
1.1**1.2****1.3****1.4****1.5**

1.6



1.7

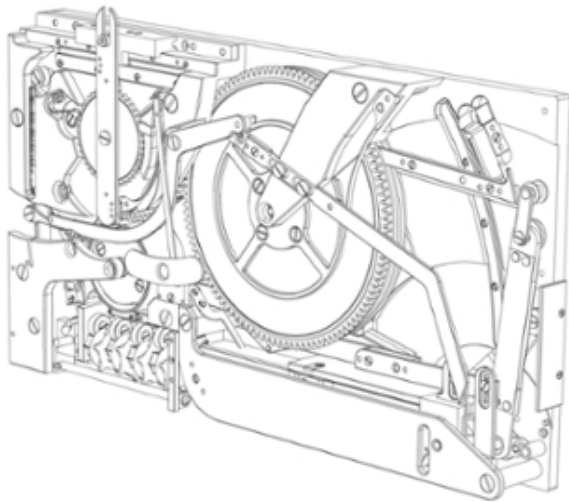

1.8

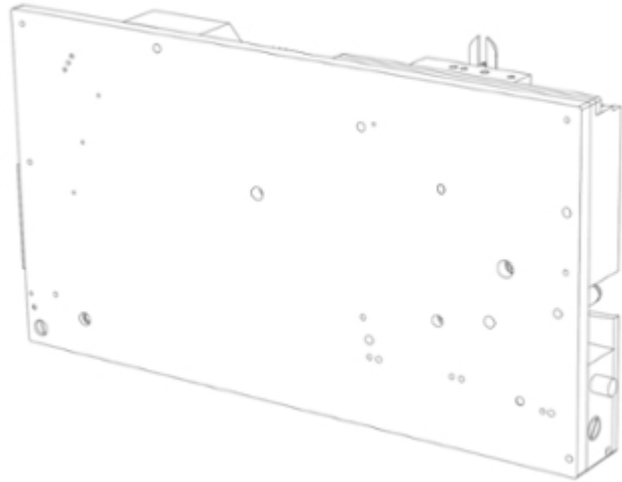

2.1



2.2



2.3



2.4



2.5



2.6



2.7



2.8



(11) DM/102154

(51) 17-05

(15) 2018 03 19

(45) 2018/37 (2018 09 21)

(22) 2018 03 19

(28) 1

(73) MONTRES JAQUET DROZ SA (MONTRES JAQUET DROZ AG) (MONTRES JAQUET DROZ LTD)
Allée du Tourbillon 2, CH-2300 La Chaux-de-Fonds (CH)

(85) CH

(86) CH

(87) CH

(88) CH

(89) CH

(81) II. BZ, MA III. AL, AM, AZ, BA, CH, EM, GE, KG, LI, MC, MD, ME, MK, MN, NO, OM, SG, TN,
TR, UA

(72) Christian LATTMANN

Chemin de Château-Neuf 17, 1125 Monnaz, Suisse;

Yann LEIGGENER

Rue du Nord 47, 2300 La Chaux-de-Fonds, Suisse

(54) 1. Whistling machine

(55)

1.1

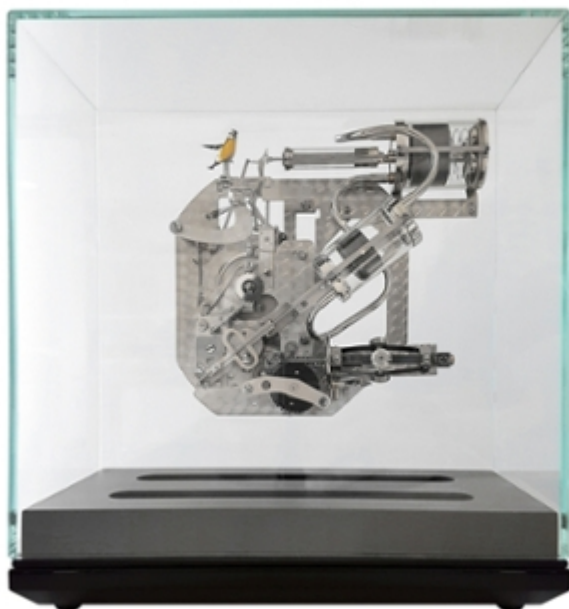

1.2

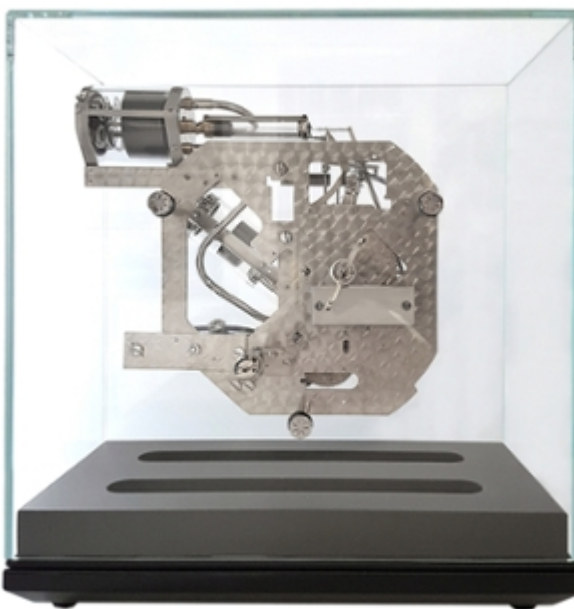

1.3



1.4



1.5



1.6



1.7

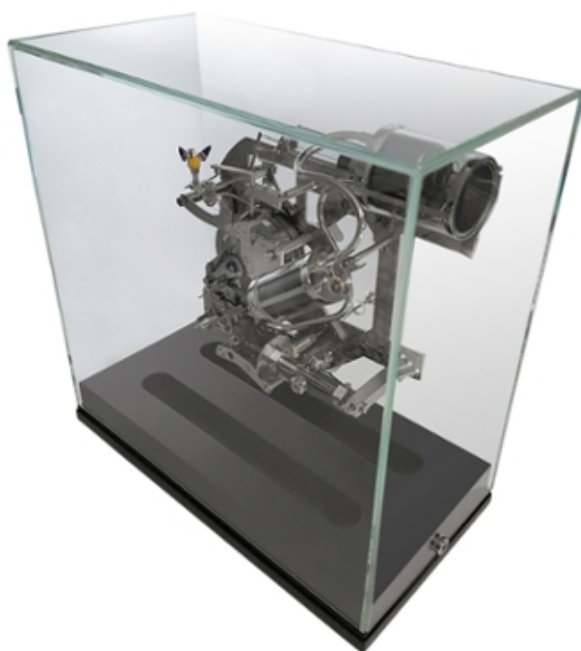

1.8



(11) DM/102155

(51) 11-02

(15) 2018 07 03

(45) 2018/37 (2018 09 21)

(22) 2018 07 03

(28) 1

(73) MONTRES JAQUET DROZ SA (MONTRES JAQUET DROZ AG) (MONTRES JAQUET DROZ LTD)
Allée du Tourbillon 2, CH-2300 La Chaux-de-Fonds (CH)

(85) CH

(86) CH

(87) CH

(88) CH

(89) CH

(81) II. BZ, MA III. AL, AM, AZ, BA, CH, EM, GE, KG, LI, MC, MD, ME, MK, MN, NO, OM, SG, TN,
TR, UA

(72) Christian LATTMANN

Chemin de Château-Neuf 17, 1125 Monnaz, Suisse;

Yann LEIGGENER

Rue du Nord 47, 2300 La Chaux-de-Fonds, Suisse

(54) 1. Ornamental object

(55)

1.1



1.2



1.3



1.4



1.5



1.6



1.7



1.8



(11) DM/102701

(15) 2018 08 31

(22) 2018 08 31

(28) 1

(30) No. 1: 29.05.2018; 005287356-0001; EM

(73) SAVERGLASS

3 rue de la Gare, F-60960 FEUQUIERES (FR)

(85) FR, EM

(86) FR, EM

(87) FR, EM

(88) FR, EM

(89) FR

(81) III. AM, CH, GE, JP, MC, SG, TR, UA

(54) 1. Bottle

(55)

(51) 09-01

(45) 2018/37 (2018 09 21)

1.1

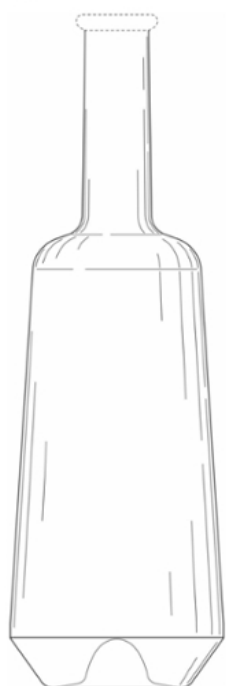

1.2

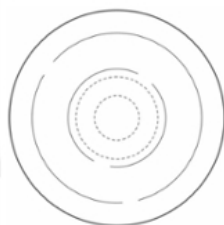

1.3

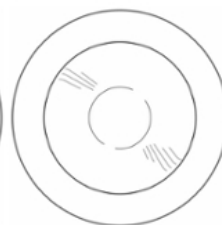

1.4



(11) DM/102702

(15) 2018 08 31

(22) 2018 08 31

(28) 1

(30) No. 1: 29.05.2018; 005287356-0002; EM

(73) SAVERGLASS

3 rue de la Gare, F-60960 FEUQUIERES (FR)

(85) FR, EM

(86) FR, EM

(87) FR, EM

(88) FR, EM

(89) FR

(81) III. AM, CH, GE, JP, MC, SG, TR, UA

(54) 1. Bottle

(55)

1.1



1.2

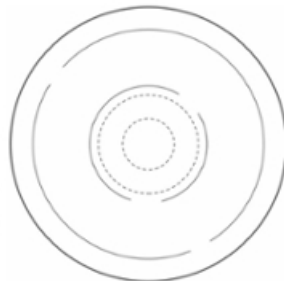

1.3

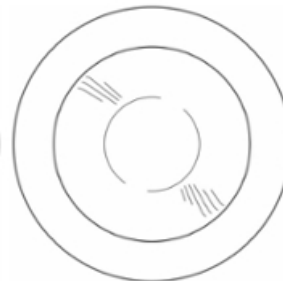

1.4



(11) DM/102774

(15) 2018 08 31

(22) 2018 08 31

(28) 1

(73) VALENTINO S.P.A.

Via Turati, 16/18, I-20121 Milano (IT)

(85) –

(86) IT, EM

(87) IT, EM

(88) IT, EM

(89) EM

(81) III. AZ, EM, GE, JP, KG, KR, RU, TJ, TR, UA, US

(54) 1. Shoe

(55)

(51) 02-04

(45) 2018/37 (2018 09 21)

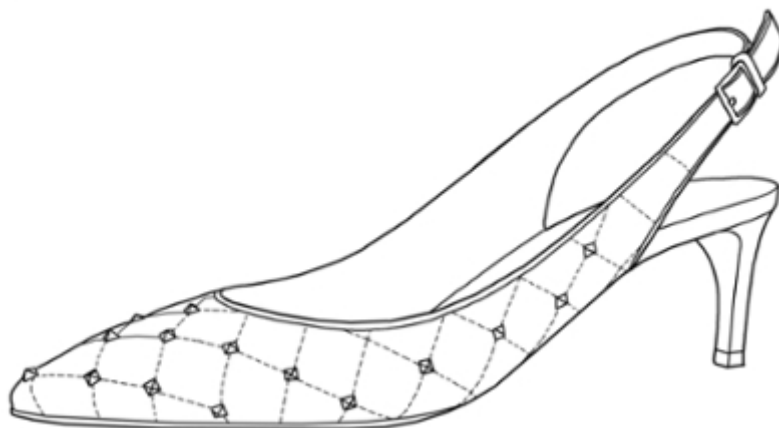
1.1**1.2****1.3**

1.4

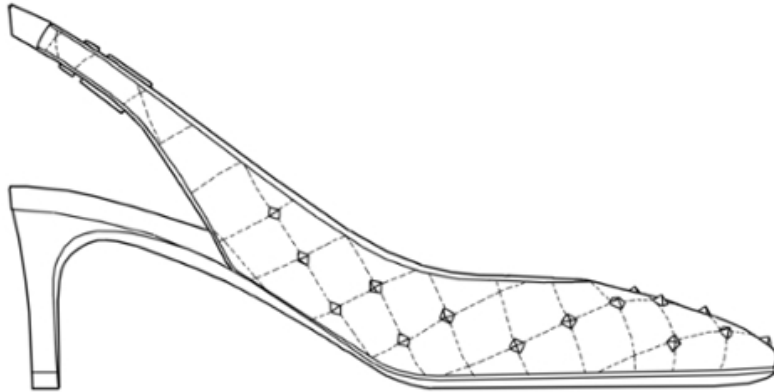

1.5

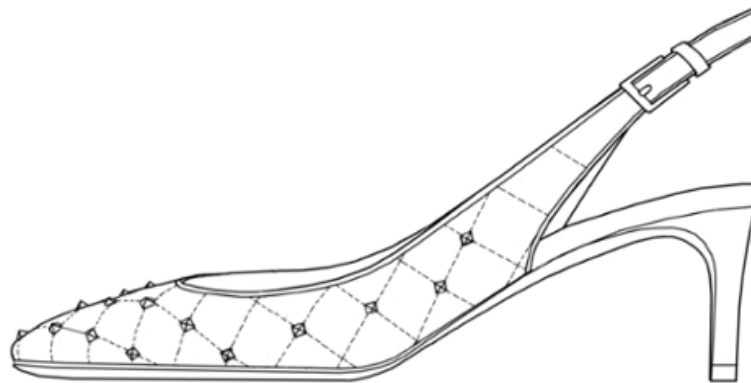

1.6

1.7

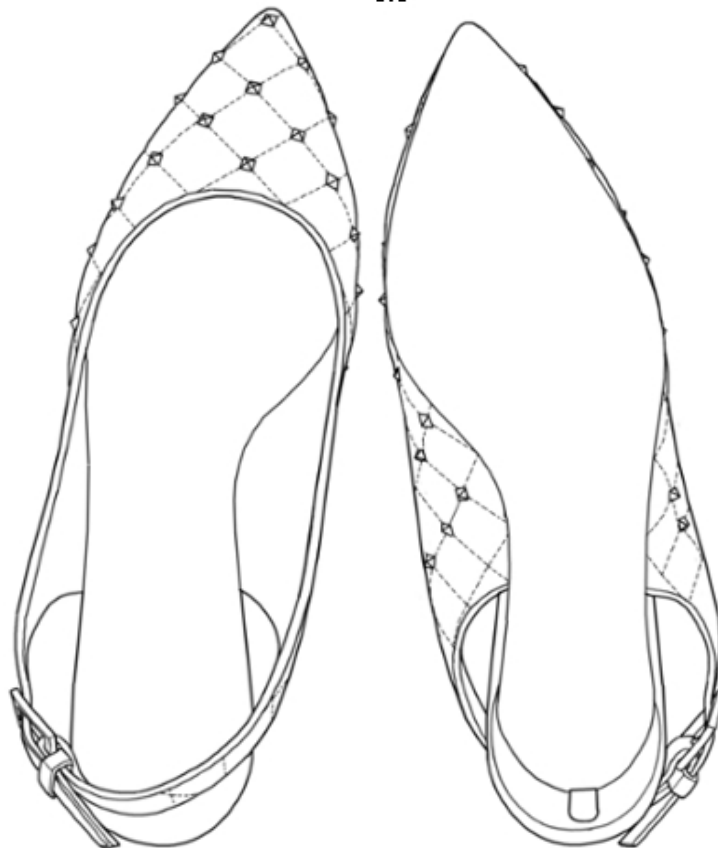

(11) DM/102775

(15) 2018 08 31

(22) 2018 08 31

(28) 1

(73) VALENTINO S.P.A.

Via Turati, 16/18, I-20121 Milano (IT)

(85) –

(86) IT, EM

(87) IT, EM

(88) IT, EM

(89) EM

(81) III. AZ, EM, GE, JP, KG, KR, RU, TJ, TR, UA, US

(72) SASSI Stefano

c/o VALENTINO S.p.A., Via Turati, 16/18, I-20121 Milano, Italy

(54) 1. Bag

(55)

(51) 03-01

(45) 2018/37 (2018 09 21)

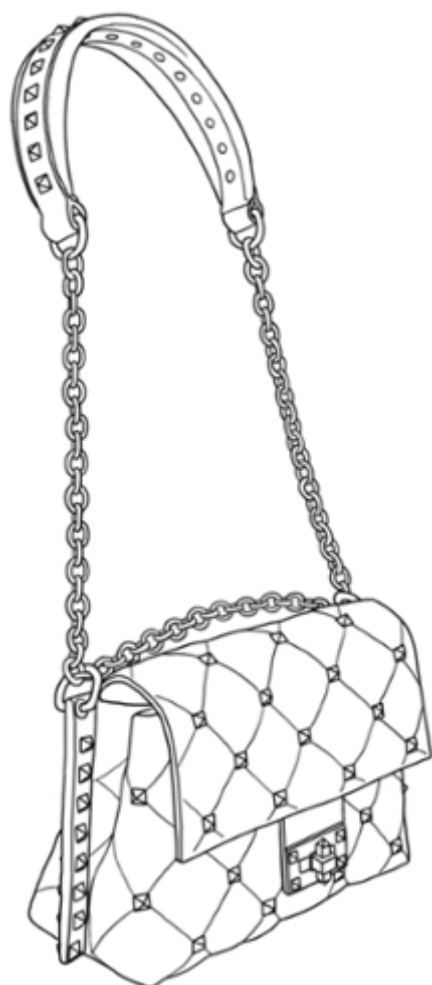
1.1**1.2**

1.3



1.4



1.5



1.6

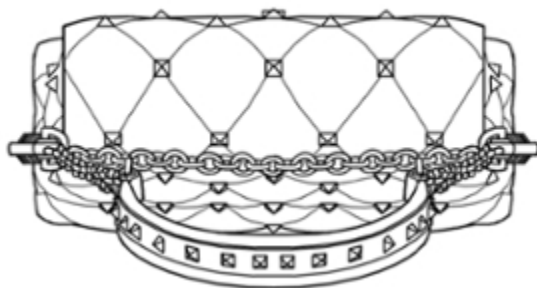

1.7

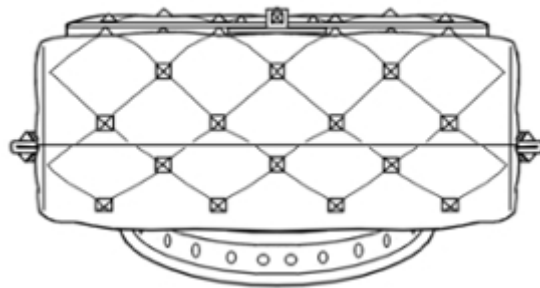

- (11) DM/102820 (51) 09-03
(15) 2018 08 30 (45) 2018/38 (2018 09 28)
(22) 2018 08 30
(28) 7
(73) AMADEUS ALS GMBH
Wipplingerstrasse 1/2/Top 1, A-1010 Wien (AT)
(85) –
(86) –
(87) –
(88) UA
(89) UA
(81) III. AM, AZ, GE, RS, TR
(72) Sukhyi Sergii Olexandrovysh
Proyizd Pidlisnyi 10, 25018 KROPYVNYTSKYI, Ukraine
(54) 1.-7. Boxes [packaging]
(55)

1



2



3



4



5



6



7



TRADEMARKS

APPLICATIONS FILED UNDER THE NATIONAL PROCEDURE APPROVED FOR REGISTRATION

The decision can be appealed at the Chamber of Appeal of Sakpatenti within 3 months from the publication or at the Mtskheta District Court Administrative Cases Board (Address: №17, Samkhedro St., Mtskheta), within 1 month following the publication.

(260) AM 2018 96272 A
(210) AM 96272
(220) 07 02 2018
(731) GELA BEZARASHVILI
Tamar Mepis q.10, 1500, Gurjaani, Georgia
(540)



(591) White, black, pink, orange, green, red,
grey
(531) 03.01.15; 05.11.13; 26.01.01; 26.01.15;
27.05.02; 28.19; 29.01.15
(511) 35

(260) AM 2018 96284 A
(210) AM 96284
(220) 08 02 2018
(731) LTD "Georgian Wines"
I. Chavchavadzis gamz. 29-31-33, b. 72,
0179, Tbilisi, Georgia
(740) GIORGI MODEBADZE
(540)

Rare
რარე

(591) Black, white
(511) 33

(260) AM 2018 96860 A
(210) AM 96860
(220) 15 03 2018
(731) INPHA LLP Representative Lobbyist Office
in Georgia
Besikis q. 4-is Mimdebaed (nakveti 46/10),
0108, Tbilisi, Georgia
(740) Keso Antelidze

(540)

Resvagit
რესვაგილი
Ресвагил

(591) Black, white
(511) 5

(260) AM 2018 96894 A
(210) AM 96894
(220) 19 03 2018
(731) LTD "CASHFLOW"
Akhvledianis q. 20, 0103, Tbilisi, Georgia
(540)



(591) Yellow, orange
(531) 27.05.02; 27.05.19; 28.19; 29.01.14
(511) 30, 35

(260) AM 2018 96973 A
(210) AM 96973
(220) 21 03 2018
(731) LTD "KHIRSA"
Debi Ishkhnelebis q. 2, 4600, Kutaisi, Georgia
(540)



(591) Black, white
 (531) 06.19.07; 07.01.03; 25.01.19; 26.05.03;
 26.05.24; 28.19
 (526) "წმ. სტეფანე ხორსელის მამათა
 მონასტრის ჭაჭა"
 (511) 33

(260) AM 2018 97025 A
 (210) AM 97025
 (220) 28 03 2018
 (731) RUBIK'S BRAND LIMITED
 7 Lambton Place, London W112SH, England,
 United Kingdom
 (740) Giorgi Taktakishvili
 (540)

RUBIK'S

(591) Black, white
 (511) 28

(260) AM 2018 97174 A
 (210) AM 97174
 (220) 02 04 2018
 (731) ASAHI CHEMICAL EUROPE S.R.O.
 Lužná 591/4, Vokovice, 160 00 Praha 6,
 Czech Republic
 (740) Merab Kvimsadze
 (540)



(591) Black, white
 (531) 26.01.02; 26.01.03; 26.01.20; 26.11.12; 28.19
 (511) 1, 5

(260) AM 2018 97179 A
 (210) AM 97179
 (220) 03 04 2018
 (731) LTD "GEORGIAN WINE"
 Besikis II Shesakhvevi 6, Mtatsmindis Raioni,
 0108, Tbilisi, Georgia
 (540)



(591) Black, white
 (531) 02.01.23; 02.03.23; 02.07.23; 19.09.02;
 27.05.17
 (511) 29, 30, 32, 33

(260) AM 2018 97181 A
 (210) AM 97181
 (220) 03 04 2018
 (731) PHARMACEUTICAL CHEMICALCOSME-
 TIC INDUSTRY ALKALOID AD SKOPJE
 Bul. Aleksandar Makedonski, 12, Skopje,
 1000, Macedonia (the former Yugoslav
 Republic of)
 (740) Vakhtang Torotadze
 (540)

Tyrez

(591) Black, white
 (511) 5

(260) AM 2018 97182 A
 (210) AM 97182
 (220) 03 04 2018
 (731) PHARMACEUTICAL CHEMICALCOSME-
 TIC INDUSTRY ALKALOID AD SKOPJE
 Bul. Aleksandar Makedonski, 12, Skopje,
 1000, Macedonia (the former Yugoslav
 Republic)
 (740) Vakhtang Torotadze
 (540)

Bulnexo

(591) Black, white
 (511) 5

(260) AM 2018 97187 A
 (210) AM 97187
 (220) 04 04 2018
 (731) MOPED DEPOT
 Irakli Abashidzis q. 21, b.7, 0179, Tbilisi,
 Georgia
 (740) Giorgi Arveladze
 (540)



მოპედ დეპო

საქართველოს რესპუბლიკა

(591) Black, red, white
 (531) 02.09.01; 13.01.16; 18.01.05; 28.19; 29.01.13
 (511) 35, 37

(260) AM 2018 97194 A
 (210) AM 97194
 (220) 10 04 2018

(731) LTD "ASKANELI GROUP"
Kakhetis gzat. 110a, (nakv. 01/016), 0190,
Tbilisi, Georgia
(740) Giorgi Taktakishvili
(540)



DAREJANI

დარეჯანი

(591) White, red, golden, gray, black
(531) 23.01.01; 24.01.03; 24.01.05; 24.01.13;
24.01.17; 24.09.07; 25.01.09; 25.01.10;
25.01.19; 25.01.25; 27.05.01; 28.19; 29.01.14
(511) 33

(260) AM 2018 97207 A
(210) AM 97207
(220) 10 04 2018
(731) PHILIP MORRIS PRODUCTS S.A.
Quai Jeanrenaud 3, 2000 Neuchâtel,
Switzerland
(740) Shalva Gvaramadze
(540)

FEEL THE DIFFERENCE

(591) Black, white
(511) 34

(260) AM 2018 97210 A
(210) AM 97210
(220) 10 04 2018
(731) PFIZER IRELAND PHARMACEUTICALS
(2011 PIP)
Operations Support Group, Ringaskiddy,
Co. Cork, Ireland
(740) Shalva Gvaramadze
(540)

ZAVICEFTA

(591) Black, white
(511) 5

(260) AM 2018 97211 A
(210) AM 97211
(220) 10 04 2018
(731) NOVARTIS AG

4002 Basel, Switzerland
(740) Pavle Meipariani
(540)

COMBIPROS

(591) Black, white
(511) 5

(260) AM 2018 97224 A
(210) AM 97224
(220) 12 04 2018
(731) JSC "LAMARIA CAPITAL"
Sh. Nutsubidzis Perdobi, IV Mkr., korp. 14,
b. 25, 0183, Tbilisi, Georgia
(540)

ლამარია

(591) Black, white
(511) 35, 43

(260) AM 2018 97229 A
(210) AM 97229
(220) 15 04 2018
(731) LTD "GMP"
Sop. Ponitchala 65, 0165, Tbilisi, Georgia
(740) Nugzar Ksovreli
(540)

ლოსაკორდი
ЛОСАКОРД
LOSACORD

(591) Black, white
(511) 5

(260) AM 2018 97230 A
(210) AM 97230
(220) 15 04 2018
(731) LTD "GMP"
Sop. Ponitchala 65, 0165, Tbilisi, Georgia
(740) Nugzar Ksovreli
(540)

იბანდრიქსი
ИБАНДРИКС
IBANDRIX

(591) Black, white
(511) 5

(260) AM 2018 97231 A
(210) AM 97231
(220) 16 04 2018

- (731) LTD "AISI"
I. Evdoshvilis q. 37, 1500, Gurjaani, Georgia
(740) Eter Mdivani
(540)

ნაყინი შავი ღვინის -
ყარაჩობელი

- (591) Black, white
(511) 30

- (260) AM 2018 97232 A
(210) AM 97232
(220) 16 04 2018
(731) LTD "MAKRATELI"
Stalinis q., shesak. 18, Tskneti, Tbilisi,
Georgia

(540)

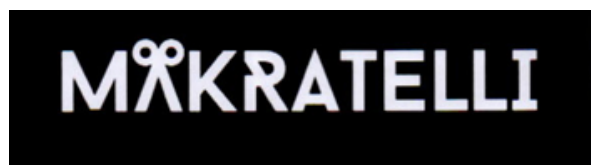

- (591) Black, white
(531) 14.07.20; 27.03.15; 27.05.24
(511) 25, 35

- (260) AM 2018 97376 A
(210) AM 97376
(220) 19 04 2018
(731) LTD "IVERIA"
S. Chikovanis q. 31, 0171, Tbilisi,
Georgia

(740) Nugzar Ksovreli

(540)



- (591) Red, white
(531) 06.03.10; 06.03.11; 06.07.08; 06.07.11;
07.01.09; 27.05.01; 29.01.12
(511) 29

- (260) AM 2018 97389 A
(210) AM 97389
(220) 24 04 2018
(731) "RK KODI"
Ioane Petritsis q. 2, Akhaltsikhe, 0800,
Georgia

(540)



- (591) Yellow, black
(531) 01.15.15; 03.13.04; 03.13.05; 06.01.01;
06.01.04; 26.05.01; 26.05.15; 28.19; 29.01.12
(511) 30

- (260) AM 2018 97392 A
(210) AM 97392
(220) 24 04 2018
(731) "RK HONEY KOLKHURI"
Sop. Didinedzi, 2115, Zugdidi, Georgia
(540)



- (591) Yellow, black
(531) 03.13.04; 24.09.07; 28.19; 29.01.13
(511) 30

- (260) AM 2018 97393 A
(210) AM 97393
(220) 24 04 2018
(731) "RK MOUNTAIN FRAGRANCE "
Sop. Dzveli, 0506, Aspindza, Georgia
(540)



(591) Green, white, yellow
 (531) 03.13.04; 05.05.04; 05.05.20; 06.01.02;
 26.01.15; 26.02.07; 28.19; 29.01.13
 (511) 30

(260) AM 2018 97395 A
 (210) AM 97395
 (220) 24 04 2018
 (731) SCHOOLAND INVESTMENTS NV
 Lendhuis Ionchi, Kava Richard J. Bojon Z/n,
 S.k. 837, Uilemsted, Kiurasao, Netherlands
 Antilles
 (740) Tamaz Shilakadze
 (540)

CADMUS[®]
 INTERNATIONAL SCHOOL

(591) Purple
 (531) 27.05.01; 27.05.10; 29.01.05
 (511) 16, 25, 41

(260) AM 2018 97397 A
 (210) AM 97397
 (220) 24 04 2018
 (731) SCHOOLAND INVESTMENTS NV
 Lendhuis Ionchi, Kava Richard J. Bojon Z/n,
 S.k. 837, Uilemsted, Kiurasao, Netherlands
 Antilles
 (740) Tamaz Shilakadze
 (540)

 **SABIS[®]**

(591) Green
 (531) 05.01.03; 05.01.05; 05.01.16; 26.01.15;
 26.01.17; 29.01.12
 (511) 16, 25, 41

(260) AM 2018 97410 A
 (210) AM 97410
 (220) 26 04 2018
 (731) TIENS GROUP CO., LTD
 WU QING DEVELOPMENT ZONE, TIAN-
 JIN NEW TECH INDUSTRIAL PARK,
 TIANJIN, 301700, China
 (740) Giorgi Taktakishvili
 (540)

TIENS

(591) Black, white

(531) 27.05.17
 (511) 3, 5, 10, 35, 44

(260) AM 2018 97433 A
 (210) AM 97433
 (220) 30 04 2018
 (731) HILTON WORLDWIDE MANAGE
 LIMITED
 Maple Court Central Park, Reeds Crescent,
 Watford WD24 4QQ, United Kingdom
 (740) Tamaz Shilakadze
 (540)

LXR

(591) Black, white
 (511) 35, 36, 41, 43, 44

(260) AM 2018 97438 A
 (210) AM 97438
 (220) 02 05 2018
 (731) LTD "SOTO"
 Z. Paliashvili-Kavsadzis q. 70/7, b. 11, Tbilisi,
 Georgia
 (540)



(591) Crimson
 (531) 26.04.02; 26.04.05; 26.04.22; 27.05.01; 28.19;
 29.01.01
 (511) 43

(260) AM 2018 97456 A
 (210) AM 97456
 (220) 04 05 2018
 (731) INPHA LLP Representative Lobbyist Office
 in Georgia
 Besikis q. 4-is Mimdebared (nakveti 46/10),
 0108, Tbilisi, Georgia

(740) Keso Antelidze
 (540)

"Ceftrix ცეფტრიქსო Цефтрикс"
 (511) 5

(260) AM 2018 97459 A
 (210) AM 97459
 (220) 04 05 2018
 (731) INPHA LLP Representative Lobbyist Office
 in Georgia
 Besikis q. 4-is Mimdebared (nakveti 46/10),
 0108, Tbilisi, Georgia

(740) Keso Antelidze

(540)

"Allerol ალეროლი Аллерол"

(511) 5

(260) AM 2018 97461 A

(210) AM 97461

(220) 04 05 2018

(731) INPHA LLP Representative Lobbyist Office
in GeorgiaBesikis q. 4-is Mimdebare (nakveti 46/10),
0108, Tbilisi, Georgia

(740) Keso Antelidze

(540)

**"Гепатолак ჰეპატოლაკი
Hepatolak"**

(511) 5

(260) AM 2018 97469 A

(210) AM 97469

(220) 08 05 2018

(731) LTD "№12"

Khodashenis q. 12, 3700, Tbilisi, Georgia

(540)



(591) Black, white

(531) 02.03.01; 27.05.10

(511) 43

(260) AM 2018 97471 A

(210) AM 97471

(220) 08 05 2018

(731) LTD "№12"

Khodashenis q. 12, 3700, Tbilisi, Georgia

(540)



(591) Black, golden

(531) 05.07.10; 27.05.10; 29.01.12

(511) 33, 35, 43

(260) AM 2018 97473 A

(210) AM 97473

(220) 08 05 2018

(731) LTD "№12"

Khodashenis q. 12, 3700, Tbilisi, Georgia

(540)

ლუკმა

(591) Black, white

(511) 43

(260) AM 2018 97687 A

(210) AM 97687

(220) 14 05 2018

(731) LTD "AISI"

Varketili III, I Mkr., korp. 28, b. 26, 0163,
Tbilisi, Georgia

(540)

Bärlitz**ბერლიც**

(591) Black, white

(511) 3, 4

(260) AM 2018 97797 A

(210) AM 97797

(220) 23 05 2018

(731) ZUFA LLK

6650 South Torrey Pines Drive, Las Vegas,
Nevada 89118, USA

(740) Tamaz Shilakadze

(540)

OCTAGON GIRL

(591) Black, white

(511) 25, 27, 41

(260) AM 2018 97798 A

(210) AM 97798

(220) 23 05 2018

(731) ZUFA LLK

6650 South Torrey Pines Drive, Las Vegas,
Nevada 89118, USA

(740) Tamaz Shilakadze

(540)



(591) Black, white
 (531) 26.05.01; 26.05.12; 26.05.24; 26.11.09
 (511) 9, 25, 27, 28

(260) AM 2018 97799 A
 (210) AM 97799
 (220) 23 05 2018
 (731) ZUFA LLK
 6650 South Torrey Pines Drive, Las Vegas,
 Nevada 89118, USA
 (740) Tamaz Shilakadze
 (540)

UFC

(591) Black, white
 (511) 9, 16, 18, 25, 27, 28, 32, 35, 38

(260) AM 2018 97800 A
 (210) AM 97800
 (220) 23 05 2018
 (731) ZUFA LLK
 6650 South Torrey Pines Drive, Las Vegas,
 Nevada 89118, USA
 (740) Tamaz Shilakadze
 (540)

UFC

(591) Black, white
 (531) 27.05.01; 27.05.17; 27.05.23
 (511) 9, 16, 18, 25, 27, 28, 32, 35, 38, 41

(260) AM 2018 97801 A
 (210) AM 97801
 (220) 23 05 2018
 (731) ZUFA LLK
 6650 South Torrey Pines Drive,
 Las Vegas, Nevada 89118, USA
 (740) Tamaz Shilakadze
 (540)

UFC FIGHT PASS

(591) Black, white
 (511) 38

(260) AM 2018 97802 A
 (210) AM 97802
 (220) 23 05 2018
 (731) ZUFA LLK
 6650 South Torrey Pines Drive,
 Las Vegas, Nevada 89118, USA
 (740) Tamaz Shilakadze
 (540)

**ULTIMATE FIGHTING
 CHAMPIONSHIP**

(591) Black, white
 (511) 9, 25, 28, 35

(260) AM 2018 97803 A
 (210) AM 97803
 (220) 23 05 2018
 (731) ZUFA LLK
 6650 South Torrey Pines Drive, Las Vegas,
 Nevada 89118, USA
 (740) Tamaz Shilakadze
 (540)



(591) Black, white
 (531) 01.05.01; 02.01.08; 25.01.05; 27.05.10
 (511) 25

(260) AM 2018 97900 A
 (210) AM 97900
 (220) 31 05 2018
 (731) LTD "GLOBALPHARMI"
 Almasianis q. 13a / Berbutis q. 8, 0171,
 Tbilisi, Georgia
 (740) Giorgi Taktakishvili
 (540)

ველ ჰაუს დიველოპმენტ

**WELL HOUSE DEVELOPMENT
 БЕЛЛ ХАУЗ ДИВЕЛОПМЕНТ**

(591) Black, white
 (511) 35, 36, 37, 43

(260) AM 2018 97901 A
 (210) AM 97901
 (220) 31 05 2018
 (731) LTD "GLOBALPHARMI"
 Almasianis q. 13a / Berbutis q. 8, 0171,
 Tbilisi, Georgia
 (740) Giorgi Taktakishvili
 (540)

**ველ ჰაუსი
 WELL HOUSE
 БЕЛЛ ХАУЗ**

(591) Black, white
 (511) 3, 5, 35, 36, 37, 43

REGISTERED TRADEMARKS

- | | |
|---|--|
| <p>(111) M 2018 30472 R
 (151) 03 12 2018
 (181) 03 12 2028
 (260) AM 2017 91638 A
 (220) 29 12 2017
 (732) DAVIT OSHKHERELI
 Dighmis mas., V kv., korp. 16, b. 65 , 0159,
 Tbilisi, Georgia;
 IRAKLI INASHVILI
 Ir. Abashidzis q. 62, b. 3, 0162, Tbilisi, Georgia;
 ZAZA METREVELI
 Mikatadzis q. 16b, 0101, Tbilisi, Georgia</p> <hr/> <p>(111) M 2018 30473 R
 (151) 03 12 2018
 (181) 03 12 2028
 (260) AM 2017 91962 A
 (220) 04 05 2017
 (732) NATALIA KAPANADZE
 D. Guramishvilis gamz. 12-A , korp. 4,
 b. 29, 0192, Tbilisi, Georgia</p> <hr/> <p>(111) M 2018 30474 R
 (151) 03 12 2018
 (181) 03 12 2028
 (260) AM 2017 92123 A
 (220) 15 05 2017
 (732) LTD "WEST INVEST"
 Kairos q. 13a, 0137, Tbilisi, Georgia</p> <hr/> <p>(111) M 2018 30475 R
 (151) 03 12 2018
 (181) 03 12 2028
 (260) AM 2017 93331 A
 (220) 13 07 2017
 (732) LTD "IARA INVESTMENT QOMFANI"
 San-Zona, korp. 10a, b. 16, 0192, Tbilisi,
 Georgia</p> <hr/> <p>(111) M 2018 30476 R
 (151) 03 12 2018
 (181) 03 12 2028
 (260) AM 2017 93333 A
 (220) 14 07 2017
 (732) LTD "IARA INVESTMENT QOMFANI"
 San-Zona, korp. 10a, b. 16, 0192, Tbilisi,
 Georgia</p> <hr/> <p>(111) M 2018 30477 R
 (151) 03 12 2018
 (181) 03 12 2028</p> | <p>(260) AM 2017 93334 A
 (220) 14 07 2017
 (732) LTD "IARA INVESTMENT QOMFANI"
 San-Zona, korp. 10a, b. 16, 0192, Tbilisi, Georgia</p> <hr/> <p>(111) M 2018 30478 R
 (151) 03 12 2018
 (181) 03 12 2028
 (260) AM 2017 93558 A
 (220) 31 07 2017
 (732) JSC "GOMI SPIRITS and VODKA
 COMPANY"
 Sop. Gomi, Khashuris r-ni, Georgia</p> <hr/> <p>(111) M 2018 30479 R
 (151) 03 12 2018
 (181) 03 12 2028
 (260) AM 2017 93680 A
 (220) 08 08 2017
 (732) LTD "AISI"
 I. Evdoshvilis q. 37, 1500, Gurjaani, Georgia</p> <hr/> <p>(111) M 2018 30480 R
 (151) 03 12 2018
 (181) 03 12 2028
 (260) AM 2017 93681 A
 (220) 08 08 2017
 (732) LTD "AISI"
 I. Evdoshvilis q. 37, 1500, Gurjaani, Georgia</p> <hr/> <p>(111) M 2018 30481 R
 (151) 03 12 2018
 (181) 03 12 2028
 (260) AM 2017 93876 A
 (220) 24 08 2017
 (732)) LTD "CAMELYN"
 Kindzmaraulis q. 7, 0145, Tbilisi, Georgia</p> <hr/> <p>(111) M 2018 30482 R
 (151) 03 12 2018
 (181) 03 12 2028
 (260) AM 2017 94018 A
 (220) 04 09 2017
 (732) ROTMANS OF PEL MEL LIMITED
 Rut De Frans 17, 2926, Boncourt, Switzerland</p> <hr/> <p>(111) M 2018 30483 R
 (151) 03 12 2018
 (181) 03 12 2028</p> |
|---|--|

(260) AM 2017 94019 A
(220) 04 09 2017
(732) ROTMANS OF PEL MEL LIMITED
Rut De Frans 17, 2926, Boncourt, Switzerland

(111) M 2018 30484 R
(151) 03 12 2018
(181) 03 12 2028
(260) AM 2017 94195 A
(220) 15 09 2017
(732) LTD "USAKHELAURI VINEYARDS"
Chonkadzis q. 10a, 0105, Tbilisi, Georgia

(111) M 2018 30485 R
(151) 03 12 2018
(181) 03 12 2028
(260) AM 2017 94310 A
(220) 26 09 2017
(732) HARRINGTON DEVELOPMENT INC.
Elvira Mendesis Striti, Valarino Bldg, Me-3
Sart., Panamis Respublika, Panama

(111) M 2018 30486 R
(151) 03 12 2018
(181) 03 12 2028
(260) AM 2017 94313 A
(220) 26 09 2017
(732) LTD "USAKHELAURI VINEYARDS"
Chonkadzis q. 10a, 0105, Tbilisi, Georgia

(111) M 2018 30487 R
(151) 03 12 2018
(181) 03 12 2028
(260) AM 2017 94323 A
(220) 27 09 2017
(732) ABBOTT POINT OF CARE INC.
(a corporation of the State of Delaware)
400 College Road East, New Jersey,
Princeton, 08540, USA

(111) M 2018 30488 R
(151) 03 12 2018
(181) 03 12 2028
(260) AM 2017 94433 A
(220) 03 10 2017
(732) LTD "MIRA-HOTELS"
Mtkvris Marjvena Sanapiroso da Broses
quchis kutkhe, Tbilisi, Georgia

(111) M 2018 30489 R
(151) 03 12 2018
(181) 03 12 2028
(260) AM 2017 94454 A

(220) 05 10 2017
(732) KAPCI Coatings
Port-said Industrial Zoun, Al-rasva, P.o. Boqs
118, Port-said, Egypt

(111) M 2018 30490 R
(151) 03 12 2018
(181) 03 12 2028
(260) AM 2017 94456 A
(220) 05 10 2017
(732) ABBOTT POINT OF CARE INC.
(a corporation of the State of Delaware)
400 College Road East, New Jersey,
Princeton, 08540, USA

(111) M 2018 30491 R
(151) 03 12 2018
(181) 03 12 2028
(260) AM 2017 94466 A
(220) 06 10 2017
(732) APPLE INC.
1, Infinite Loop, California, Cupertino,
95014, USA

(111) M 2018 30492 R
(151) 03 12 2018
(181) 03 12 2028
(260) AM 2017 94467 A
(220) 06 10 2017
(732) APPLE INC.
1, Infinite Loop, California, Cupertino,
95014, USA

(111) M 2018 30493 R
(151) 03 12 2018
(181) 03 12 2028
(260) AM 2017 94536 A
(220) 09 10 2017
(732) LTD "WINE COMPANY SHUMI"
Sop. Tsinandali, 2200, Telavis r-ni, Georgia

(111) M 2018 30494 R
(151) 03 12 2018
(181) 03 12 2028
(260) AM 2017 94472 A
(220) 06 10 2017
(732) EVREN ARMUTJU
Iesil Tepes dasakhleba, Zia Gokakpis q.,
b. 18, Antalia, Turkey

(111) M 2018 30495 R
(151) 03 12 2018
(181) 03 12 2028

(260) AM 2017 94549 A
 (220) 10 10 2017
 (732) APPLE INC.
 1, Infinite Loop, California, Cupertino,
 95014, USA

(111) M 2018 30496 R
 (151) 03 12 2018
 (181) 03 12 2028
 (260) AM 2017 94571 A
 (220) 12 10 2017
 (732) FREEJ SOWAILEH RESTAURANT
 BRANCH OF SAFEER NIDAA FOR
 GENERAL TRADING
 Salmia, Block 34, Salem Al-Mubarak Street,
 Building 5, Ali Al-Mula complex, Floor 4,
 Office 7&8, Kuwait

(111) M 2018 30497 R
 (151) 03 12 2018
 (181) 03 12 2028
 (260) AM 2017 94602 A
 (220) 13 10 2017
 (732) JIM BEAM BRANDS CO.
 222 W. Merchandise Mart Plaza,
 Suite 1600.Chicago, Illinois, 60654, USA

(111) M 2018 30498 R
 (151) 03 12 2018
 (181) 03 12 2028
 (260) AM 2017 94603 A
 (220) 13 10 2017
 (732) COOLEY DISTILLERY
 Riverstaun, Dandelq, Qaunti Louts, Ireland,
 Ireland

(111) M 2018 30499 R
 (151) 03 12 2018
 (181) 03 12 2028
 (260) AM 2017 94664 A
 (220) 17 10 2017
 (732) PHILIP MORRIS PRODUCTS S.A.
 Quai Jeanrenaud 3, 2000 Neuchâtel,
 Switzerland

(111) M 2018 30500 R
 (151) 03 12 2018
 (181) 03 12 2028
 (260) AM 2017 94717 A
 (220) 20 10 2017
 (732) THE COCA-COLA COMPANY
 One Coca-Cola Plaza, Atlanta, Georgia
 30313, USA

(111) M 2018 30501 R
 (151) 03 12 2018
 (181) 03 12 2028
 (260) AM 2017 94794 A
 (220) 30 10 2017
 (732) KALESAN SAĞLIK VE HİJYEN
 ÜRÜNLERİ SANAYİ VE TİCARET
 LİMİTED ŞİRKETİ
 3. ORGANİZE SANAYİ BÖLGESİ KAMİL
 ŞERBETÇİ BULVARI NO.46, Şehitkamil,
 Gaziantep, Turkey

(111) M 2018 30502 R
 (151) 03 12 2018
 (181) 03 12 2028
 (260) AM 2017 94865 A
 (220) 01 11 2017
 (732) ALAUDDIN FEROUZUDDIN
 P. O. Box 113633, Dubai, United Arab Emirates

(111) M 2018 30503 R
 (151) 03 12 2018
 (181) 03 12 2028
 (260) AM 2017 94977 A
 (220) 07 11 2017
 (732) LTD "Credline"
 Al. Kazbegis gamz. 10, Tbilisi, Georgia

(111) M 2018 30504 R
 (151) 03 12 2018
 (181) 03 12 2028
 (260) AM 2017 94978 A
 (220) 07 11 2017
 (732) LTD "Credline"
 Al. Kazbegis gamz. 10, Tbilisi, Georgia

(111) M 2018 30505 R
 (151) 03 12 2018
 (181) 03 12 2028
 (260) AM 2017 94984 A
 (220) 07 11 2017
 (732) YILDIZ HOLDİNG ANONİM ŞİRKETİ
 Qisikli Mahalesi Cheshme Chiqmazi, Soqaq
 No:6/1 Iusquidar Stamboli, Turkey

(111) M 2018 30506 R
 (151) 03 12 2018
 (181) 03 12 2028
 (260) AM 2017 94985 A
 (220) 07 11 2017
 (732) YILDIZ HOLDİNG ANONİM ŞİRKETİ
 Qisikli Mahalesi Cheshme Chiqmazi, Soqaq
 No:6/1 Iusquidar Stamboli, Turkey

(111) M 2018 30507 R (151) 03 12 2018 (181) 03 12 2028 (260) AM 2017 94986 A (220) 07 11 2017 (732) YILDIZ HOLDİNG ANONİM ŞİRKETİ Qisiqli Mahalesi Cheshme Chiqmazi, Soqaq No:6/1 Iusqiudar Stamboli, Turkey	(111) M 2018 30513 R (151) 03 12 2018 (181) 03 12 2028 (260) AM 2017 95065 A (220) 14 11 2017 (732) DAROINK LIMITED LIABILITY COMPANY 86/1 Sevani Str., 0026, Yerevan, Armenia
(111) M 2018 30508 R (151) 03 12 2018 (181) 03 12 2028 (260) AM 2017 94987 A (220) 07 11 2017 (732) YILDIZ HOLDİNG ANONİM ŞİRKETİ Qisiqli Mahalesi Cheshme Chiqmazi, Soqaq No:6/1 Iusqiudar Stamboli, Turkey	(111) M 2018 30514 R (151) 03 12 2018 (181) 03 12 2028 (260) AM 2017 95073 A (220) 15 11 2017 (732) N(N)LE Eliava Foundation in Georgia Bacteriophage Development Association L. Gotuas q.3, 0160, Tbilisi, Georgia
(111) M 2018 30509 R (151) 03 12 2018 (181) 03 12 2028 (260) AM 2017 95006 A (220) 08 11 2017 (732) LUJOU LAO JIAO KO., LTD. (korporacia Organizebulia Da Arsebobs Chinetis Kanonmdeblobis Shesabamisad) Guo Jiao Sqvea, Lujou, Sichuani, China	(111) M 2018 30515 R (151) 03 12 2018 (181) 03 12 2028 (260) AM 2017 95107 A (220) 16 11 2017 (732) KUMIAI CHEMICAL INDUSTRY CO., LTD 4-26, Ikenohata 1-chome, Taito-ku, Tokio 110-8782, Japan
(111) M 2018 30510 R (151) 03 12 2018 (181) 03 12 2028 (260) AM 2017 95032 A (220) 10 11 2017 (732) ROTHMANS OF PALL MALL LIMITED Rut De Frans 17, Boncourt, 2926, Switzerland	(111) M 2018 30516 R (151) 03 12 2018 (181) 03 12 2028 (260) AM 2017 95108 A (220) 16 11 2017 (732) LTD "WINE COMPANY SHUMI" Lionidzis q. 33, 2200, Telavi, Georgia
(111) M 2018 30511 R (151) 03 12 2018 (181) 03 12 2028 (260) AM 2017 95036 A (220) 10 11 2017 (732) LABORATORIO KEMEX S.A. Nazarre 3446, 1417 C.A.B.A., Argentina	(111) M 2018 30517 R (151) 03 12 2018 (181) 03 12 2028 (260) AM 2017 95148 A (220) 21 11 2017 (732) MAKER'S MARK DISTILLERY, INC. 6200 Dutchman's Lane, Suite 103, Louisville, Kentucky 40205, USA
(111) M 2018 30512 R (151) 03 12 2018 (181) 03 12 2028 (260) AM 2017 95037 A (220) 10 11 2017 (732) LTD "DIAMOND GROUP" Mukhiani, II mkr, korp. 22, b. 52, 0172, Tbilisi, Georgia	(111) M 2018 30518 R (151) 03 12 2018 (181) 03 12 2028 (260) AM 2017 95211 A (220) 28 11 2017 (732) LINKEDIN CORPORATION (a Delaware Corporation) 1000 W. Maude Avenue Sunnyvale, California 94085, USA

(111) M 2018 30519 R
 (151) 03 12 2018
 (181) 03 12 2028
 (260) AM 2017 95212 A
 (220) 28 11 2017
 (732) (732) LINKEDIN CORPORATION
 (a Delaware Corporation)
 1000 W. Maude Avenue Sunnyvale,
 California 94085, USA

(111) M 2018 30520 R
 (151) 03 12 2018
 (181) 03 12 2028
 (260) AM 2017 95235 A
 (220) 29 11 2017
 (732) LTD "INFINIT"
 Besikis q. 4, office 203, 0108, Tbilisi, Georgia

(111) M 2018 30521 R
 (151) 03 12 2018
 (181) 03 12 2028
 (260) AM 2017 95318 A
 (220) 01 12 2017
 (732) AstraZeneca AB
 SE-151 85 Södertälje, Sweden

(111) M 2018 30522 R
 (151) 03 12 2018
 (181) 03 12 2028
 (260) AM 2017 95319 A
 (220) 01 12 2017
 (732) JSC "TSKALI MARGEBELI"
 Sop. Nabeghlavi, 4900, Chokhatauris r-ni
 Georgia

(111) M 2018 30523 R
 (151) 03 12 2018
 (181) 03 12 2028
 (260) AM 2017 95333 A
 (220) 01 12 2017
 (732) DUNHILL TOBACCO OF LONDON
 LIMITED
 Globe House, 4 Temple Place, London
 WC2R 2PG, WC2R 2PG, United Kingdom

(111) M 2018 30524 R
 (151) 03 12 2018
 (181) 03 12 2028
 (260) AM 2017 95334 A
 (220) 02 12 2017
 (732) APPLE INC.
 1, Infinite Loop, California, Cupertino,
 95014, USA

(111) M 2018 30525 R
 (151) 03 12 2018
 (181) 03 12 2028
 (260) AM 2017 95335 A
 (220) 04 12 2017
 (732) MEIKER'Z MARK DISTILERI, INK.
 100 Malard Krik Roud, Suit 151 Luisvili,
 40207, Kentuki, USA

(111) M 2018 30526 R
 (151) 03 12 2018
 (181) 03 12 2028
 (260) AM 2017 95338 A
 (220) 04 12 2017
 (732) PHILIP MORRIS PRODUCTS S.A.
 Ke Janreno 3, Neuchatel, 2000, Switzerland

(111) M 2018 30527 R
 (151) 03 12 2018
 (181) 03 12 2028
 (260) AM 2017 95341 A
 (220) 04 12 2017
 (732) APPLE INC
 1, Infinite Loop, California, Cupertino,
 95014, USA

(111) M 2018 30528 R
 (151) 03 12 2018
 (181) 03 12 2028
 (260) AM 2017 95363 A
 (220) 05 12 2017
 (732) LTD "KARTVELI"
 Kakhetis gzatk. 110a, 0151, Tbilisi, Georgia

(111) M 2018 30529 R
 (151) 03 12 2018
 (181) 03 12 2028
 (260) AM 2017 95365 A
 (220) 05 12 2017
 (732) T.Y.C. BROTHER INDUSTRIAL CO., LTD
 N72-2, Shin Leh Roud, 70248, Tainan,
 Taiwan, Province of China

(111) M 2018 30530 R
 (151) 03 12 2018
 (181) 03 12 2028
 (260) AM 2017 95410 A
 (220) 07 12 2017
 (732) IVYBRIDGE VENTURES LIMITED
 Lampousas 1, Nicosia, 1095, Cyprus

(111) M 2018 30531 R
 (151) 03 12 2018
 (181) 03 12 2028

(260) AM 2017 95411 A
(220) 07 12 2017
(732) VEON Amsterdam BV
Claude Debussylaan 88, 1082 MD
Amsterdam, Netherlands

(111) M 2018 30532 R
(151) 03 12 2018
(181) 03 12 2028
(260) AM 2017 95412 A
(220) 07 12 2017
(732) VEON Amsterdam BV
Claude Debussylaan 88, 1082 MD
Amsterdam, Netherlands

(111) M 2018 30533 R
(151) 03 12 2018
(181) 03 12 2028
(260) AM 2017 95413 A
(220) 07 12 2017
(732) VEON Amsterdam BV
Claude Debussylaan 88, 1082 MD
Amsterdam, Netherlands

(111) M 2018 30534 R
(151) 03 12 2018
(181) 03 12 2028
(260) AM 2017 95414 A
(220) 07 12 2017
(732) LTD "TSISQVILI GROUP"
Beliashvili qucha, Morfologiis inst.-is
mimdebared, 0159, Tbilisi, Georgia

(111) M 2018 30535 R
(151) 04 12 2018
(181) 04 12 2028
(260) AM 2017 95431 A
(220) 08 12 2017
(732) AstraZeneca AB
SE-151 85 Södertälje, Sweden

(111) M 2018 30536 R
(151) 04 12 2018
(181) 04 12 2028
(260) AM 2017 95432 A
(220) 08 12 2017
(732) AstraZeneca AB
SE-151 85 Södertälje, Sweden

(111) M 2018 30537 R
(151) 04 12 2018
(181) 04 12 2028
(260) AM 2017 95433 A

(220) 08 12 2017
(732) AstraZeneca AB
SE-151 85 Södertälje, Sweden

(111) M 2018 30538 R
(151) 04 12 2018
(181) 04 12 2028
(260) AM 2017 95486 A
(220) 11 12 2017
(732) BMJ Industries FZ-LLC
Al-Jazeera Al-Hamra, Ras Al Khaimah,
United Arab Emirates

(111) M 2018 30539 R
(151) 04 12 2018
(181) 04 12 2028
(260) AM 2017 95542 A
(220) 18 12 2017
(732) LTD "AVERSI-PHARMA"
D. Aghmasheneblis gamz. 148/2, 0112, Tbilisi,
Georgia

(111) M 2018 30540 R
(151) 04 12 2018
(181) 04 12 2028
(260) AM 2017 95543 A
(220) 18 12 2017
(732) LTD "AVERSI-PHARMA"
D. Aghmasheneblis gamz. 148/2, 0112, Tbilisi,
Georgia

(111) M 2018 30541 R
(151) 04 12 2018
(181) 04 12 2028
(260) AM 2017 95544 A
(220) 18 12 2017
(732) LTD "AVERSI-PHARMA"
D. Aghmasheneblis gamz. 148/2, 0112, Tbilisi,
Georgia

(111) M 2018 30542 R
(151) 04 12 2018
(181) 04 12 2028
(260) AM 2017 95546 A
(220) 18 12 2017
(732) LTD "AVERSI-PHARMA"
D. Aghmasheneblis gamz. 148/2, 0112, Tbilisi,
Georgia

(111) M 2018 30543 R
(151) 04 12 2018
(181) 04 12 2028
(260) AM 2017 95561 A
(220) 19 12 2017

(732) E. I. DU PONT DE NEMOURS AND
COMPANY
Chestnut Run Plaza, 974 Centre Road,
Wilmington, DE 19805, USA

(111) M 2018 30544 R
(151) 04 12 2018
(181) 04 12 2028
(260) AM 2017 95562 A
(220) 19 12 2017

(732) E. I. DU PONT DE NEMOURS AND
COMPANY
Chestnut Run Plaza, 974 Centre Road,
Wilmington, DE 19805, USA

(111) M 2018 30545 R
(151) 04 12 2018
(181) 04 12 2028
(260) AM 2017 95566 A
(220) 20 12 2017

(732) MARS, INCORPORATED, a Delaware
corporation
6885 Elm Street, Virginia, McLean, 22101,
USA

(111) M 2018 30546 R
(151) 04 12 2018
(181) 04 12 2028
(260) AM 2017 95567 A
(220) 20 12 2017

(732) FITBIT, INC. a Delaware corporation
199 Fremont Street, 14th Floor, California,
San-Francisco, 94105, USA

(111) M 2018 30547 R
(151) 04 12 2018
(181) 04 12 2028
(260) AM 2017 95569 A
(220) 20 12 2017

(732) MASTERCARD INTERNATIONAL
INCORPORATED
2000 Purchase Street, Purchase, New York,
10577, USA

(111) M 2018 30548 R
(151) 04 12 2018
(181) 04 12 2028
(260) AM 2017 95578 A
(220) 21 12 2017

(732) KRAFT FOODS SCHWEIZ HOLDING
GMBH
Chollerstrasse 4, Zug 6301, Switzerland

(111) M 2018 30549 R
(151) 04 12 2018
(181) 04 12 2028
(260) AM 2017 95654 A
(220) 25 12 2017

(732) OUSAMA KAFA
Kiev region, Kyiv-Svyatoshinsky district,
village Petropavlivska Borshagivka, st.
Vishnevaya, 45, 08130, Ukraine

(111) M 2018 30550 R
(151) 04 12 2018
(181) 04 12 2028
(260) AM 2017 95662 A
(220) 25 12 2017

(732) QUALITY IS OUR RECIPE LLC
One Dave Thomas Boulevard Dublin, Ohio
43017, USA

(111) M 2018 30551 R
(151) 04 12 2018
(181) 04 12 2028
(260) AM 2017 95665 A
(220) 25 12 2017

(732) QUALITY IS OUR RECIPE LLC
One Dave Thomas Boulevard Dublin, Ohio
43017, USA

(111) M 2018 30552 R
(151) 04 12 2018
(181) 04 12 2028
(260) AM 2017 95666 A
(220) 25 12 2017

(732) MONSTER ENERGY COMPANY, a Delaware
corporation
1 Monster Way, California, Corona, 92879, USA

(111) M 2018 30553 R
(151) 04 12 2018
(181) 04 12 2028
(260) AM 2018 95847 A
(220) 08 01 2018

(732) LTD "TEGETA MOTORS"
D. Aghmashenebeli Alley 12th km. 5, 0131,
Tbilisi, Georgia

(111) M 2018 30554 R
(151) 04 12 2018
(181) 04 12 2028
(260) AM 2018 95858 A
(220) 08 01 2018

(732) ADIDAS 2015
Todrias q. II chikhi, korp. 7, b. 34, 3700,
Rustavi, Georgia

(111) M 2018 30555 R
(151) 04 12 2018
(181) 04 12 2028
(260) AM 2018 95929 A
(220) 10 01 2018
(732) NORWOOD INDUSTRIES INC.
2667 15/16 Side Road East, Oro-Medonte,
Ontario L0L 1T0, Canada

(111) M 2018 30556 R
(151) 04 12 2018
(181) 04 12 2028
(260) AM 2018 95984 A
(220) 16 01 2018
(732) LTD "DABI"
Pirosmanis q. 6, 0164, Tbilisi, Georgia

TRADEMARKS REGISTERED ACCORDING TO THE ACCELERATED PROCEDURE

The decision can be appealed at the Chamber of Appeal of Sakpatenti within 3 months from the publication.

(111) M 2018 30467 R
(151) 22 11 2018
(181) 22 11 2028
(210) AM 100406
(220) 15 11 2018
(732) W8 SHIPPING
24700 S Main St., Carson, CA 90745, USA
(740) Giorgi Taktakishvili
(540)



(591) Purple
(531) 26.03.23; 26.11.03; 26.11.05; 26.11.22;
26.11.25; 27.05.01; 27.05.17; 29.01.01
(511) 35, 39

(111) M 2018 30468 R
(151) 22 11 2018
(181) 22 11 2028
(210) AM 100090
(220) 07 11 2018
(732) LTD "IG DEVELOPMENT Georgia"
Kostavas q. 47/57, Tbilisi, Georgia
(740) Mariam Guchua
(540)

სოთო ტაუერ
CITY TOWER
CITY TOWER

(591) Black, white
(511) 35, 36, 37

(111) M 2018 30469 R
(151) 22 11 2018
(181) 22 11 2028
(210) AM 100409
(220) 15 11 2018
(732) LTD "CHEMPIONS 111"
I. Chavchavadzis qamz. 29, sart. 5, 0179,
Tbilisi, Georgia

(740) Mariam Meskhi
(540)



(591) Orange, grey
(531) 26.01.01; 26.01.03; 26.01.24; 28.05; 29.01.12
(511) 41

(111) M 2018 30470 R
(151) 27 11 2018
(181) 27 11 2028
(210) AM 100077
(220) 06 11 2018
(732) JSC "TBC BANK"
Marjanishvilis q. 7, 0102, Tbilisi, Georgia
(740) Archil Gabatashvili
(540)



(591) Azure, grey, white
(531) 26.03.03; 26.03.04; 26.03.24; 27.05.23;
29.01.13
(511) 36

(111) M 2018 30471 R
(151) 30 11 2018
(181) 30 11 2028
(210) AM 100417
(220) 16 11 2018
(732) LTD "FALCON"
Melikishvilis q. 49, 0178, Tbilisi, Georgia
(740) Vakhtang Torotadze
(540)



MY WAY

(591) Black, white
 (531) 03.07.24; 26.13.25; 27.05.01
 (511) 16, 35, 39

(111) M 2018 30557 R

(151) 04 12 2018
 (181) 04 12 2028
 (210) AM 100395
 (220) 13 11 2018
 (732) LTD "HOKHBAU"

Inasaridzis q. 18, sart. 22, b .250, Batumi,
 Georgia

(540)



(591) Yellow, red, light gray, dark gray, gray
 (531) 07.01.24; 07.01.25; 26.11.08; 27.05.10;
 27.05.11; 29.01.13
 (511) 37

(111) M 2018 30558 R

(151) 04 12 2018
 (181) 04 12 2028
 (210) AM 100414
 (220) 16 11 2018
 (732) LTD "REDOT"

Chabukianis q. 1, Tbilisi, Georgia

(540)



(591) Blue, white
 (531) 26.01.01; 26.01.18; 26.01.24; 27.05.01;
 27.05.21
 (511) 10

(111) M 2018 30559 R

(151) 04 12 2018
 (181) 04 12 2028
 (210) AM 100444
 (220) 21 11 2018
 (732) LTD "ECO-LAVKA"

A. Tseretlis gamz. 116, Tbilisi,
 Georgia

(740) Tamar Bakhtadze

(540)



(591) Green, yellow
 (531) 05.03.15; 05.03.20; 25.01.10; 25.01.18;
 26.04.04; 27.05.01; 28.19; 29.01.12
 (511) 35

(111) M 2018 30560 R

(151) 04 12 2018
 (181) 04 12 2028
 (210) AM 100397
 (220) 14 11 2018
 (732) LTD "AKURA"

Lortkipanidzis q. 1, b. 2, Tbilisi, Georgia

(540)



AKURELI
 WINERY

(591) Black, white, golden
 (531) 05.01.03; 05.01.08; 07.01.03; 27.05.10;
 29.01.13
 (511) 33

(111) M 2018 30561 R

(151) 06 12 2018
 (181) 06 12 2028
 (210) AM 100669
 (220) 03 12 2018
 (732) SHOVI AIVAZOVI

Sop. Kirach-Mughanlo, Marneuli, Georgia

(540)



(591) Green, white
 (531) 27.05.03; 29.01.03
 (511) 5

INTERNATIONAL TRADEMARKS FOR WHICH A DECISION ON GRANTING PROTECTIONS IS TAKEN

The decision can be appealed at the Chamber of Appeal of Sakpatenti within 3 months from the publication or at the Mtskheta District Court Administrative Cases Board (Address: №17, Samkhedro str., Mtskheta), within 1 month following the publication.

(260) AM 2018 93385 A*
 (800) 1340583
 (151) 2017 01 19
 (891) 2017 05 16
 (731) ADP GAUSELMANN GMBH
 Merkur-Allee 1-15, 32339 Espelkamp,
 Germany
 (540)

King of Luck

(591) Black, white
 (511)
 9 – Computer software; Computer and video games software; Games software for use on any computer platform, including electronic entertainment and games consoles; Computer game programs; Computer games programs; Video games (software); Computer games provided through a global computer network or supplied by means of multimedia electronic broadcast or through telecommunications or electronic transmission or via the internet; Computer games, leisure and recreational software, video games and computer software, all being provided in the form of storage media; Programs for operating electric and electronic apparatus for games, amusement and/or entertainment purposes; Computer software for computer games on the internet; Online games (software), in particular for online betting games, online prize games, online gambling games, online games of skill and online casino games; Computer software in the form of an app for mobile devices and computers; software for casino and amusement arcade games, for gaming machines, slot machines or video lottery gaming machines or games of chance via the internet.

(260) AM 2018 93645 A*
 (800) 1224231
 (151) 2014 02 25
 (891) 2017 06 02
 (731) PRIMARK HOLDINGS
 47 Mary Street Dublin 1, United Kingdom
 (540)

PRIMARK

(591) Black, white
 (511)
 25 – Clothing, footwear, headgear; belts.
 35 – Advertising; business management; business administration; office functions; the bringing toget-

her, for the benefit of others, of a variety of goods namely, clothing, footwear, headgear, lingerie, nightwear, babywear, sportswear, clothing accessories, cosmetics, jewellery, eyewear, homeware and home furnishings, enabling customers to conveniently view and purchase those goods in a department store, in a retail clothing store, in a retail homeware store or in a retail home furnishing store; the bringing together, for the benefit of others, of a variety of goods enabling customers to conveniently view and purchase those goods from a clothing and clothing accessories catalogue by mail order or by means of telecommunications or through an internet website; retail services, mail order services and on-line retail services relating to soaps, perfumery, essential oils, cosmetics, hair lotions, eyewear, sunglasses, goggles, swimming goggles, precious metals and their alloys and goods in precious metals or coated therewith, jewellery, horological and chronometric instruments, hair accessories, printed matter, furniture, mirrors, picture frames, small portable domestic utensils and containers, combs and sponges, brushes (other than paint brushes), instruments and materials for cleaning purposes, glassware, porcelain and earthenware, leather and imitations of leather and goods made of these materials, trunks and travelling bags, umbrellas, parasols, walking sticks, luggage, beach bags, beach umbrellas, parasols, handbags, purses, wallets, belts, bags, cases, backpacks, briefcases, satchels, suitcases, duffle bags, holdalls, rucksacks, belt bags, cases, vanity cases, briefcases, attaché cases, travel bags, portfolios, card holders, pouches, textiles and textile goods, bed and table covers, bed and table linen, towels, beach towels, piece goods, sewing accessories, clothing, footwear, headgear, gloves, underclothing, lingerie, underwear, brassieres, swimwear, bikinis, swimming costumes, swimming shorts, swimming suits, swimming trunks, swimming caps, beachwear, beach caps, beach hats, beach dresses, beach robes, beach shorts, beach wraps, sarongs, kaftans, beach shoes, sandals, flip-flops, home furnishings, toys, games, playthings, and sporting articles.

(260) AM 2018 94943 A
 (800) 1373424
 (151) 2017 09 18
 (891) 2017 09 18
 (731) APPLE INC.

One Apple Park Way Cupertino CA 95014,
USA

(540)

TODAY AT APPLE

(591) Black and white

(511)

41 – Providing seminars, workshops, classes, and training in the fields of music, visual arts, design, photography, videography and filmmaking, business, education, robotics, and technology; providing seminars, workshops, classes, and training in the use and operation of computers, computer software, digital electronic devices, and wearable electronics.

(260) AM 2018 94944 A

(800) 1373425

(151) 2017 09 18

(891) 2017 09 18

(731) APPLE INC.

One Apple Park Way Cupertino CA 95014,
USA

(540)

TODAY AT APPLE

(591) Black and white

(511)

35 – Retail store services featuring computer, electronic, and entertainment products, telecommunications devices, handheld and wearable digital electronic devices, smartphones, smartwatches, audio products, home automation products, computer software, and accessories, peripherals, and parts for such products.

(260) AM 2018 95913 A

(800) 1382798

(151) 2017 11 04

(891) 2017 11 04

(731) TAKEDA AS

Drammensveien 852, N-1372 Asker, Norway

(540)



(591) Yellow, blue, green, orange, gray, white, black
(531) 01.15.19; 05.03.15; 05.07.12; 05.07.22;

17.02.01; 19.13.21; 28.05; 29.01.15

(511)

5 – Pharmaceutical preparations; dietetic food and substances adapted for medical use; dietary supplements for humans; calcium chews for medical use, calcium tablets as a food supplement; food for babies; vitamins and vitamin preparations.

(260) AM 2018 95914 A

(800) 1382799

(151) 2017 11 04

(891) 2017 11 04

(731) TAKEDA AS

Drammensveien 852, N-1372 Asker, Norway

(540)

КАЛЬЦИЙ-Д3 НИКОМЕД

(591) Black and white

(531) 28.05; 28.05

(511)

5 – Pharmaceutical preparations; dietetic food and substances adapted for medical use; dietary supplements for humans; calcium chews for medical use, calcium tablets as a food supplement; food for babies; vitamins and vitamin preparations.

(260) AM 2018 96334 A

(800) 1385983

(151) 2017 08 22

(891) 2017 08 22

(731) ROCKWOOL International A/S

Hovedgaden 584, DK-2640 Hedehusene,
Denmark

(540)



(591) The mark is in green and white.

(531) 26.04.10; 26.05.04; 29.01.12

(511)

1 – Propagating and growing media for seeds and plants consisting wholly or partial of mineral fibres; fertilized preparations/bases of mineral wool for growing plants; boards of mineral wool for use in growing plants; growing substrates of stone wool fibres, namely, blocks and cubes for propagation; unprocessed artificial resins for use in composite rubber, thermoplastic and thermosetting plastic systems; unpro-

cessed plastics; fire extinguishing compositions; preparations for tempering and soldering; adhesives used in industry; chemical fibres for use in the manufacture of paints, especially for strengthening of coatings and paints.

17 – Insulating materials of mineral wool; packing, stopping and insulating materials; insulants in the form of strips, felt, mats, boards, slatted mats, shaped parts for insulation and sealing against heat, cold, fire, sound, vibrations, air, light and humidity/moisture/damp/vapour, including sound absorbing materials for acoustic regulation; acoustic and thermal insulation products and articles; insulation and vapour barrier products and articles; insulation in the form of floor, wall and roof coverings; ceiling panels of mineral wool fibres; mineral wool fibres in the form of matting for insulation; mineral wool/fibres [insulators]; processed mineral fibres for use in the manufacture of seals, sealants, fillers and gaskets; boards of extruded mineral wool, shells of mineral wool, blankets of mineral wool, mineral wool stucco and mineral wool felt, loose or semi-finished granulated mineral wool and loose or semi-finished mineral wool fibres for manufacture of reinforcing and/or filling materials for insulation; insulating mineral wool fibres for use in sealing and gasketing applications in the automotive and building industry; electrical insulating boards; friction materials; mineral wool boards for ventilated constructions, for façade cladding, roofs, soffits and fascias; insulating building materials of mineral wool; wall, floor and ceiling panels, all made of mineral wool and fibres.

19 – Building materials for road and track constructions and for fencing; processed mineral fibres for use in the manufacture of cements and plaster for building purposes; processed mineral fibres for use in the manufacture of asphalt sealants and of sealants for road construction and roofing.

(260) AM 2018 96335 A
 (800) 1386042
 (151) 2017 07 12
 (891) 2017 07 12
 (731) ORIFLAME COSMETICS AG
 c/o Oriflame Global Management AG,
 Bleicheplatz 3, CH-8200 Schaffhausen,
 Switzerland

(540)

ORIFLAME LIVE IN COLOUR

(591) Black, white

(511)

3 – Non-medicated conditioning and care preparations for application to the skin and nails; soaps; perfumes; perfumery; eau de cologne; toilet waters; essential and herbal oils; cosmetics; make-up prepara-

tions; lipsticks; nail varnishes; nail varnish removers; non-medicated toilet preparations; preparations for use in the bath or shower; bath and shower oils, gels, creams and foams; face and body masks; face and body scrubs; facial washes; skin cleansers and hydrators; skin toners; skin moisturizers; blemish creams and blemish gels; deodorants; antiperspirants; preparations for use before shaving and after shaving; shaving soaps; shaving creams; shaving gels; after-shave preparations; pre-shave preparations; talcum powders; toiletries; dentifrices; tooth-pastes.

(260) AM 2018 96337 A

(800) 1386067

(151) 2017 10 03

(891) 2017 10 03

(731) ADP GAUSELMANN GMBH

Merkur-Allee 1-15, 32339 Espelkamp,
Germany

(540)

Raptor Hunter

(591) Black, white

(511)

9 – Computer software; coin-operated mechanisms; computer and video games software; games software in particular for use on any computer platform, including electronic entertainment and games consoles; computer game programs; video games (software); computer games provided through a global computer network or supplied by means of multi-media electronic broadcast or through telecommunications or electronic transmission or via the internet; computer games, leisure and recreational software, video games and computer software, all being provided in the form of storage media; programs for operating electric and electronic apparatus for games, amusement and/or entertainment purposes; automatic lottery machines; computer software for computer games on the internet; online games (software), in particular for online betting games, online prize games, online gambling games, online games of skill and online casino games; computer software in the form of an app for mobile devices and computers; calculating apparatus in coin-operated machines and parts for the aforesaid goods; electric, electronic, optical or automatic apparatus, for identifying data carriers, identity cards and credit cards, bank notes and coins; software in particular for casino and/or amusement arcade games, for gaming machines and/or slot machines each one with or without prize payouts; gaming software that generates or displays wager outcomes of gaming machines; operational computer games software; computer software for managing of games (game collection); video games cartridges.

(260) AM 2018 96340 A
 (800) 1386071
 (151) 2017 10 20
 (891) 2017 10 20
 (731) BETEK BOYA VE KİMYA SANAYİ ANONİM ŞİRKETİ
 Gebze Organize Sanayi Bölgesi, Tembelova Alanı 3200 Sok. No:3206 Gebze Kocaeli, Turkey

(540)

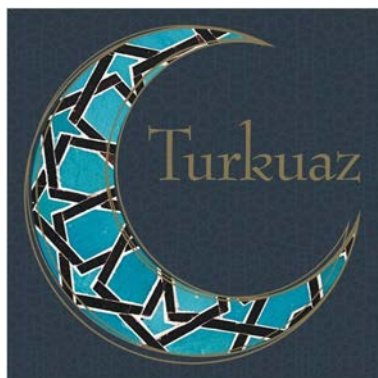

(531) 01.07.06; 25.07.01; 29.01.13

(511)

2 – Paints; varnishes; lacquers; preservatives against rust; preservatives against deterioration of wood; thinners and binders for paints; pigments; preservatives for metals; shoe dyes; printing dyes and ink; toners (including filled toner cartridges); colorants for food, pharmaceuticals and beverages, raw natural resins, metals in foil and powder form for painters, decorators, printers and artists.

(260) AM 2018 96341 A
 (800) 1386074
 (151) 2017 09 29
 (891) 2017 09 29
 (731) ASTELLAS PHARMA INC.
 5-1, Nihonbashi-Honcho 2-chome, Chuo-ku 103-8411 Tokyo, Japan

(540)

VOFICTO

(591) Black, white

(531) 27.05.17

(511)

5 – Pharmaceutical preparations and substances.

(260) AM 2018 96375 A
 (800) 1387154
 (151) 2016 08 11
 (891) 2016 08 11
 (731) SAINT ANDREWS S.P.A.
 Via Ottawa Strada 62, Frazione Bellocchi, I-61032 FANO (PS), Italy

(540)

Sant'Andrea

(591) Black, white

(531) 27.05.01; 27.05.17

(511)

25 – Clothing; hosiery; sweaters; cardigans; waistcoats; dresses; trousers; shorts; jerseys; leather clothing; waterproof clothing; stockings; stocking suspenders; sock suspenders; anoraks [parkas]; ski pants; fur coats; evening coats; overcoats; skirts; suits; jackets; undershirts; t-shirts; clothing for gymnastics; collars; shirts; swimming costumes; bikinis; sundresses; tracksuits; sweat suits; wedding dresses; bath robes; beach robes; underwear; brassieres; corsets; slips; underpants; briefs; nightshirts; housecoats; pyjamas; gloves (clothing); mittens; shawls; head scarves; neckerchiefs; scarves; stoles; cloaks; ties; bow ties; cassocks; layettes [clothing]; cloth bibs; babies' bibs of plastic; sleepwear for babies; aprons [clothing]; masquerade costumes; belts [clothing]; belts made from imitation leather; textile belts [clothing]; belts made from leather or hide; braces; headgear for wear; caps; ear muffs [clothing]; wrist warmers; headbands; shoes; boots; ankle boots; leather shoes; galoshes; rain boots; sports footwear; sandals; slippers; soles for footwear; heels; footwear uppers.

(260) AM 2018 96389 A

(800) 1386414

(151) 2017 11 07

(891) 2017 11 07

(731) RICHTER GEDEON NYRT.

Gyömrői út 19-21, H-1103 Budapest, Hungary

(540)

OVOLAN

(591) Black, white

(511)

5 – Pharmaceutical preparations.

(260) AM 2018 96401 A

(800) 1386598

(151) 2016 12 19

(891) 2016 12 19

(731) KYLE BURNS

La Tour Shibakoen 3010, 3-8-2 Shiba, Minato-ku, Tokyo 105-0014, Japan

(540)

imassage

(591) Black, white

(511)

9 – Application software; computer programs; electronic machines, apparatus and their parts; downloadable image files; recorded video discs and video

tapes; electronic publications, downloadable; telecommunication machines and apparatus.

(260) AM 2018 96405 A

(800) 1386794

(151) 2017 07 19

(891) 2017 07 19

(731) METİN KARAKOYUN

Büsan 4 Fevzi Çakmak Mahallesi, Kupa
Caddesi, 7/A, Karatay Konya, Turkey

(540)



(591) Black, red and gray.

(531) 26.04.03; 26.04.22; 27.05.02; 27.05.11;
29.01.13

(511)

7 – Machines and robotic mechanisms (machines) for use in agriculture; agricultural machines; reapers; reapers and binders; ploughs; disc harrows; balers for agricultural use; lawn mowers; insecticide sprayers [machines].

(260) AM 2018 96406 A

(800) 1387433

(151) 2017 10 27

(891) 2017 10 27

(731) MARKETING DREAM TEAM SRL

Via F.lli Gabba, 1/A, I-20121 Milano, Italy

(540)

Mayday

(591) Black, white

(531) 27.05.17

(511)

5 – Adjuvants for medical purposes; aloe vera preparations for pharmaceutical purposes; alginate dietary supplements; alginates for pharmaceutical purposes; bicarbonate of soda for pharmaceutical purposes; chemical preparations for pharmaceutical purposes; chemical preparations for medical purposes; medicinal drinks.

35 – Retail or wholesale services for pharmaceutical, veterinary and sanitary preparations and medical supplies; sales promotion for others; advertising and publicity; sales promotion for others; rental of sales stands; market studies; marketing research; marketing; outsourcing services [business assistance].

(260) AM 2018 96408 A

(800) 1387436

(151) 2017 11 29

(891) 2017 11 29

(731) WORLD TRIATHLON CORPORATION

3407 W. Dr. Martin Luther King Jr. Blvd,
Suite 100, Tampa FL 33607, USA

(540)

IRONMAN

(591) Black, white

(531) 27.05.08; 27.05.17

(511)

25 – Clothing for men, women and youths, namely, shirts, pants, shorts, t-shirts, hats, caps, swimwear, bicycling shorts, jackets, hoodies, outerwear, namely, pullovers and vests, socks, footwear, headbands, wristbands as clothing, gloves, wetsuits, insoles, heel inserts, belts, athletic sleeves not being compression garments, underwear, bras, sweaters, robes, sweat shirts, visors being headwear marketed in association with contests involving running, swimming and biking; insoles marketed in association with events consisting of running, biking and swimming.

(260) AM 2018 96411 A

(800) 740397

(151) 2000 02 28

(891) 2017 02 28

(731) HAMÉ S.R.O.

Na Draháč 814, CZ-686 04 Kunovice,
Czech Republic

(540)

HAMÉ

(591) Black, white

(511)

5 – Dietetic products, particularly for therapeutic use; food for children, infants and the sick, such as children and infant foodstuffs; food preparations and supplements of all kinds, such as tonic foodstuffs, vitamin preparations, foodstuffs for supplementing slimming diets or preparations for slimming; preparations containing biochemical catalysts, particularly for the physically active, convalescents and the sick; goods for disinfecting, veterinary, pharmaceutical and sanitary products.

29 – Meat and meat products, such as meat pâtés, spreadable pâtés, liver pâtés; fish, poultry and game, meat extracts, fruits, vegetables, mushrooms, preserved and sterilised, canned prepared dishes, dried fruit, jellies, marmalades, jams, compotes, eggs, milk and dairy products, products made with potatoes and starch, edible oils and fats, fruit pulp.

30 – Waffles; sweet products, including sweet products of gum and essences for sweet products; all kinds of pastry goods, coffee, tea, coffee substitutes, honey, molasses, yeast, salt, mustard, vinegar, ket-

chup, ketchup sauces, sauces, spices, cooling ice, cereal flakes.

(260) AM 2018 96412 A

(800) 870654

(151) 2005 11 17

(891) 2017 12 05

(731) PROFUOMO INTERNATIONAL B.V.
Hoofdweg 48 A NL-2908, LC CAPELLE
AAN DEN IJSSEL, Netherlands

(540)

PROFUOMO

(591) Black, white

(511)

25 – Clothing, footwear, headgear.

(260) AM 2018 96413 A

(800) 890406

(151) 2006 05 05

(891) 2017 12 19

(731) CARLSBERG BREWERIES A/S
Ny Carlsberg Vej 100, DK-1760 Copenhagen
V, Denmark

(540)

DraughtMaster

(591) Black, white

(511)

7 – Apparatus for drawing up beer and other beverages under pressure, pumps (machines) for beer and other beverages.

11 – Beverages cooling apparatus.

21 – Collapsible, disposable containers (not of precious metal or coated therewith) for draught beer and other beverages.

32 – Beers, non-alcoholic beverages.

(260) AM 2018 96436 A

(800) 1388076

(151) 2017 09 18

(891) 2017 09 18

(731) GUIRENNIAO CO., LTD.
Goux Industrial Zone, Chendai 362211
Jinjiang City, Fujian Province, China

(540)

GRN

(591) Black, white

(531) 27.05.23

(511)

25 – Clothing; layettes [clothing]; waterproof clothing; shoes; hats; hosiery; gloves [clothing]; wed-

ding dresses; girdles; theatrical costume; swimsuits; neck scarves [mufflers]; chasubles; wimples; manipples; albs; religion garments; sashes for wear; shower caps; sleep masks.

28 – Swimming ring; sports waistband; Christmas trees of synthetic material; twirling batons; camouflage screens [sports articles]; scratch cards for playing lottery games; sweat absorbing bands for rackets' grips; playing cards; knee guards [sports articles]; in-line roller skates; fishing tackle; fairground ride apparatus; counters [discs] for games; puppets; conjuring apparatus; swimming floats; games; foosball tables; toys; chess or any board game; playing balls; body-building apparatus; machines for physical exercises; whistle; swimming pools [play articles]; plastic racetrack; archery implements.

(260) AM 2018 96437 A

(800) 1387500

(151) 2017 11 07

(891) 2017 11 07

(731) RICHTER GEDEON NYRT.
Gyömrői út 19-21, H-1103 Budapest, Hungary

(540)

ALMION

(591) Black, white

(511)

5 – Pharmaceutical preparations.

(260) AM 2018 96438 A

(800) 1387501

(151) 2017 11 07

(891) 2017 11 07

(731) RICHTER GEDEON NYRT.
Gyömrői út 19-21, H-1103 Budapest, Hungary

(540)

FIVOTTA

(591) Black, white

(511)

5 – Pharmaceutical preparations.

(260) AM 2018 96440 A

(800) 1387503

(151) 2017 11 07

(891) 2017 11 07

(731) RICHTER GEDEON NYRT.
Gyömrői út 19-21, H-1103 Budapest, Hungary

(540)

FORTOFIL

(591) Black, white

(511)

5 – Pharmaceutical preparations.

(260) AM 2018 96441 A
 (800) 1387504
 (151) 2017 11 07
 (891) 2017 11 07
 (731) RICHTER GEDEON NYRT.
 Gyömrői út 19-21, H-1103 Budapest, Hungary
 (540)

BLUMIRA

(591) Black, white
 (511)
 5 – Pharmaceutical preparations.

(260) AM 2018 96442 A
 (800) 1387525
 (151) 2017 11 14
 (891) 2017 11 14
 (731) RICHTER GEDEON NYRT.
 Gyömrői út 19-21 H-1103 Budapest, Hungary
 (540)

ЛИПИЛЈА

(591) Black, white
 (511)
 5 – Pharmaceutical preparations.

(260) AM 2018 96445 A
 (800) 1387570
 (151) 2017 12 15
 (891) 2017 12 15
 (731) NOVARTIS CONSUMER HEALTH S.A.
 Route de l'Etraz, CH-1197 Prangins,
 Switzerland
 (540)

ТЕРАФЛЮ

(591) Black, white
 (511)
 5 – Pharmaceutical products.

(260) AM 2018 96446 A
 (800) 1387577
 (151) 2017 09 19
 (891) 2017 09 19
 (731) ADP GAUSELMANN GMBH
 Merkur-Allee 1-15, 32339 Espelkamp, Germany
 (540)

Wishing Tree

(591) Black, white
 (511)
 9 – Computer software; coin-operated mechanisms; computer and video games software; games software in particular for use on any computer platform, including electronic entertainment and games consoles; computer game programs; video games (software); computer games provided through a global computer network or supplied by means of multi-media elec-

tronic broadcast or through telecommunications or electronic transmission or via the internet; computer games, leisure and recreational software, video games and computer software, all being provided in the form of storage media; programs for operating electric and electronic apparatus for games, amusement and/or entertainment purposes; computer software for computer games on the internet; online games (software), in particular for online betting games, online prize games, online gambling games, online games of skill and online casino games; computer software in the form of an app for mobile devices and computers; calculating apparatus in coin-operated machines and parts for the aforesaid goods; electric, electronic, optical or automatic apparatus, for identifying data carriers, identity cards and credit cards, bank notes and coins; software in particular for casino and/or amusement arcade games, for gaming machines and/or slot machines each one with or without prize payouts; gaming software that generates or displays wager outcomes of gaming machines; operational computer games software; computer software for managing of games (game collection); collection of video games software.

28 – Games; toys; gaming apparatus (including coin-operated apparatus); coin-operated arcade games (machines); games for amusement arcades (included in class 28); coin-operated video gaming apparatus; video games apparatus adapted for use with external screens or monitors only; casino fittings, namely roulette tables, roulette wheels; coin-operated automatic gaming machines and gaming machines, in particular for gaming arcades, with or without a prize payout; electronic or electrotechnical gaming apparatus, automatic gaming machines, gaming machines, slot machines operated by coins, tokens, banknotes, tickets or by means of electronic, magnetic or biometric storage media, in particular for commercial use in casinos and amusement arcades, with or without a prize payout; automatic gaming machines and gaming machines, in particular for commercial use in casinos and gaming arcades, with or without a prize payout; coin-operated gaming machines and/or electronic money-based gaming apparatus (machines), with or without prizes; housings adapted for gaming machines, gaming apparatus and automatic gaming machines, operated by means of coins, tokens, tickets or by means of electronic, magnetic or biometric storage media, in particular for commercial use in casinos and gaming arcades, with or without a prize payout; electronic games; electronic game entertainment apparatus and parts thereof; video output game machines; drawing apparatus for prize games and lotteries, draws or raffles; housings of metal, plastic and/or wood for coin-operated automatic machines; apparatus for games (including video games), other than adapted for use with external screens or monitors only; electropneumatic and electric slot machines with levers for pulling (gaming

machines); gaming tables, in particular for table football, billiards, sliding games; flying discs (toys) and darts; gaming machines, namely, electric, electronic or electromechanical apparatus for bingo games, lotteries or video lottery games and for betting offices, connected or not connected to a computer network; LCD games consoles; automatic gaming machines; and all the aforesaid automatic machines, machines and apparatus also operated via computer networks; apparatus and devices for accepting and storing money, being fittings for the aforesaid automatic machines, included in class 28; automatic lottery machines.

(260) AM 2018 96450 A

(800) 1388085

(151) 2017 10 13

(891) 2017 10 13

(731) Tovarishchestvo s ogranitchennoi otvetstvennostyu "ALMOL"
Krasnogvardeiskii trakt, 497, 050030 gorod Almaty, Kazakhstan

(540)

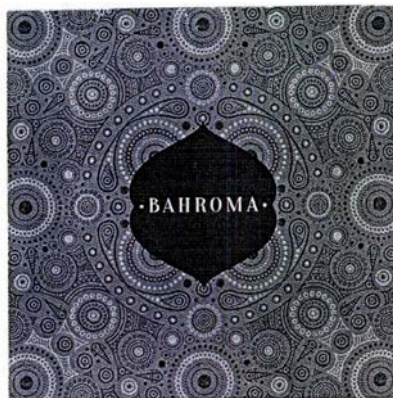

(591) Black, white and grey

(531) 25.01.25; 25.07.25

(511)

29 – Ajvar [preserved peppers]; aloe vera prepared for human consumption; alginates for culinary purposes; anchovy, not live; peanuts, prepared; albumen for culinary purposes; white of eggs; beans, preserved; soya beans, preserved, for food; bouillon; ginger jam; ham; fatty substances for the manufacture of edible fats; toasted laver; edible birds' nests; peas, preserved; mushrooms, preserved; game, not live; gelatine; meat jellies; jellies for food; fruit jellies; yolk of eggs; coconut fat; bone oil, edible; lard; suet for food; edible fats; fruit-based snack food; charcuterie; raisins; caviar; fish roe, processed; yogurt; sauerkraut; kephir [milk beverage]; isinglass for food; clams, not live; milk shakes; black pudding [blood sausage]; compotes; meat, tinned [canned (Am.)]; vegetables, tinned [canned (Am.)]; fish, tinned [canned (Am.)]; fruits, tinned [canned (Am.)]; bouillon concentrates; gherkins; shrimps, not live; prawns, not live; buttercream; croquettes; silkworm chrysalis for human consumption; kumys [kumyss] [milk be-

verage]; spiny lobsters, not live; lecithin for culinary purposes; salmon, not live; onions, preserved; margarine; marmalade; oils for food; peanut butter; cocoa butter for food, coconut oil for food; coconut butter; corn oil for food; sesame oil for food; linseed oil for culinary purposes; olive oil for food; palm oil for food; sunflower oil for food; colza oil for food; butter; shellfish, not live; almonds, ground; animal marrow for food; mussels, not live; milk; condensed milk; albumin milk; soya milk; soya-based beverages used as milk substitutes; fish meal for human consumption; vegetable mousses; fish mousses; fruit pulp; meat; meat, preserved; milk beverages, milk predominating; vegetables, preserved; vegetables, dried; vegetables, cooked; potato fritters; olives, preserved; lobsters, not live; coconut, desiccated; nuts, prepared; tomato puree; liver pate; pectin for culinary purposes; liver; pickles; jams; powdered eggs; milk products; kimchi [fermented vegetable dish]; food products made from fish; curd; prostokvasha [soured milk]; poultry, not live; pollen prepared as foodstuff; cranberry sauce [compote]; apple puree; crayfish, not live; crustaceans, not live; fish, preserved; fish, not live; salted fish; ryazhenka [fermented baked milk]; vegetable salads; fruit salads; bacon; sardines, not live; pork; herrings, not live; seeds, prepared; sunflower seeds, prepared; cream [dairy products]; whipped cream; fat-containing mixtures for bread slices; smetana [sour cream]; tomato juice for cooking; vegetable juices for cooking; salted meats; sausages; sausages in batter; preparations for making bouillon; preparations for making soup; tripe; soups; vegetable soup preparations; whey; cheese; tahini [sesame seed paste]; tofu; sea-cucumbers, not live; truffles, preserved; tuna, not live; oysters, not live; milk ferments for culinary purposes; rennet; fish fillets; dates; crystallized fruits; frozen fruits; fruit, preserved; fruit preserved in alcohol; fruit, stewed; potato flakes; hummus [chickpea paste]; fruit peel; preserved garlic; lentils, preserved; potato chips; low-fat potato chips; fruit chips; non-alcoholic eggnog; seaweed extracts for food; meat extracts; snail eggs for consumption; eggs.

30 – Aromatic preparations for food; flavorings, other than essential oils, for cakes; flavorings, other than essential oils, for beverages; coffee flavorings; food flavorings, other than essential oils; star aniseed; cereal bars; high-protein cereal bars; pancakes; noodle-based prepared meals; buns; bread rolls; vanillin [vanilla substitute]; vanilla flavorings for culinary purposes; waffles; vermicelli [noodles]; natural sweeteners; sausage binding materials; binding agents for ice cream [edible ices]; sea water for cooking; seaweed [condiment]; malt biscuits; cloves [spice]; cake frosting [icing]; glucose for culinary purposes; mustard; gluten additives for culinary purposes; yeast; thickening agents for cooking foodstuffs; leaven; rice-based snack food; cereal-based snack food; artificial coffee; vegetal preparations for

use as coffee substitutes; dressings for salad; fruit jellies [confectionery]; confectionery for decorating Christmas trees; cakes; pastries; peanut confectionery; almond confectionery; pasta; ginger [spice]; frozen yogurt [confectionery ices]; cocoa; capers; caramels [candy]; curry [spice]; gruel, with a milk base, for food; ketchup [sauce]; quiches; gluten prepared as foodstuff; sweetmeats [candy]; liquorice [confectionery]; peppermint sweets; cinnamon [spice]; coffee; unroasted coffee; starch for food; crackers; custard; hominy grits; semolina; oatmeal; crushed barley; groats for human food; corn, milled; corn, roasted; meat pies; turmeric for food; couscous [semolina]; noodles; ice for refreshment; ice, natural or artificial; edible ices; candy; rice cakes; mayonnaise; macarons [pastry]; macaroni; maltose; hominy; marinades; marzipan; honey; royal jelly; ice cream; bean meal; tapioca flour; potato flour; corn flour; flour; wheat flour; soya flour; barley meal; dessert mousses [confectionery]; chocolate mousses; muesli; mint for confectionery; cocoa beverages with milk; coffee beverages with milk; coffee-based beverages; tea-based beverages; chocolate beverages with milk; chocolate-based beverages; cocoa-based beverages; infusions, not medicinal; crushed oats; husked oats; nutmegs; stick liquorice [confectionery]; soya bean paste [condiment]; pastilles [confectionery]; molasses for food; pepper; allspice; peppers [seasonings]; pesto [sauce]; cookies; petit-beurre biscuits; pies; pizzas; meat gravies; fondants [confectionery]; popcorn; powders for making ice cream; baking powder, mustard meal; pralines; condiments; meat tenderizers for household purposes; cereal preparations; oat-based food; propolis; gingerbread; spices; petits fours [cakes]; puddings; cake powder; fruit coulis [sauces]; ravioli; chewing gum; relish [condiment]; rice; wheat germ for human consumption; spring rolls; sago; sugar; palm sugar; aniseed; linseed for culinary purposes [seasoning]; golden syrup; cake dough; confectionery; baking soda [bicarbonate of soda for cooking purposes]; malt for human consumption; salt for preserving foodstuffs; cooking salt; celery salt; sherbets [ices]; ham glaze; soya sauce; tomato sauce; pasta sauce; sauces [condiments]; spaghetti; seasonings; preparations for stiffening whipped cream; rusks; breadcrumbs; sushi; sandwiches; tabbouleh; tacos; tapioca; cream of tartar for culinary purposes; cream of tartar for culinary purposes; tarts; dough; almond paste; tortillas; garden herbs, preserved [seasonings]; vinegar; beer vinegar; ferments for pastes; halvah; bread; unleavened bread; chips [cereal products]; corn flakes; oat flakes; chicory [coffee substitute]; tea; iced tea; chutneys [condiments]; cheeseburgers [sandwiches]; chow-chow [condiment]; saffron [seasoning]; chocolate; malt extract for food; essences for foodstuffs, except etheric essences and essential oils; husked barley; piccalilli.

(260) AM 2018 96476 A
 (800) 1387673
 (151) 2017 11 09
 (891) 2017 11 09
 (731) ADP GAUSELMANN GMBH
 Merkur-Allee 1-15, 32339 Espelkamp,
 Germany
 (540)

Criss Cross

(591) Black, white
 (511)
 9 – Computer software; computer and video games software; games software in particular for use on any computer platform, including electronic entertainment and games consoles; computer game programs; video games (software); computer games provided through a global computer network or supplied by means of multi-media electronic broadcast or through telecommunications or electronic transmission or via the internet; computer games, leisure and recreational software, video games and computer software, all being provided in the form of storage media; programs for operating electric and electronic apparatus for games, amusement and/or entertainment purposes; computer software for computer games on the internet; online games (software), in particular for online betting games, online prize games, online gambling games, online games of skill and online casino games; computer software in the form of an app for mobile devices and computers; operational computer games software; computer software for managing of games (game collection); computer programs for video games.

(260) AM 2018 96478 A
 (800) 1387697
 (151) 2017 11 14
 (891) 2017 11 14
 (731) RICHTER GEDEON NYRT.
 Gyömrői út 19-21, H-1103 Budapest,
 Hungary
 (540)

ФОРТОФИЛ

(591) Black, white
 (511)
 5 – Pharmaceutical preparations.

(260) AM 2018 96479 A
 (800) 1183908
 (151) 2013 09 02
 (891) 2017 12 07
 (731) FILIA ZHEBROVSKA
 vul. Starytskoho, 6, Kyiv 04078,
 Ukraine

(540)

Синарта

(591) Black, white

(511)

5 – Pharmaceutical preparations; medicines for human purposes; medicines that affect the metabolic processes in cartilage.

(260) AM 2018 96480 A

(800) 1217540

(151) 2014 06 17

(891) 2017 12 05

(731) Dochirnie pidpriemstvo "KONDYTERSKA KORPORATSIIA "ROSHEN"

Elektrykiv vul., 26/9, Kyiv 04176, Ukraine

(540)



(531) 05.07.01; 19.03.24; 27.05.01

(511)

30 – Confectionery; caramels [candy]; sweetmeats [candy].

(260) AM 2018 96481 A

(800) 1387698

(151) 2017 11 14

(891) 2017 11 14

(731) RICHTER GEDEON NYRT.

Gyömrői út 19-21, H-1103 Budapest, Hungary

(540)

ФИБИКСИН

(591) Black, white

(511)

5 – Pharmaceutical preparations.

(260) AM 2018 96483 A

(800) 1289688

(151) 2015 07 03

(891) 2017 12 19

(731) BORA – Vertriebs GmbH & Co KG

Innstrasse 1, A-6342 Niederndorf bei Kufstein, Austria

(540)

BORA

(591) Black, white

(511)

9 – Electrical power adapters; electrical adapters; electrical junctions; electrical plugs; electrical terminal boxes; electric couplings; electrical sockets; visual display units; electric power distribution machines; electric and electronic components; components for electric circuits; electric control panels; data processing equipment and accessories (electrical and mechanical); commutators; power switches; electric rotary switches; electrical push switches; electric toggle switches; electrical push button switches; electric domestic switches; electric tactile switches; electric light switches; electric current switches; housings for electrical apparatus; electric skeleton switches; electric cables; electrical power extension cords; electric wiring harnesses; electric cable channels; electric contact blocks; electric contacts; electric power controllers; electric process controlling apparatus; electrical switch assemblies; electrical circuits and circuit boards; electrical outlet plates; electrical control boards; electric control devices for energy management; electrical control circuits; electrical controls; electric control installations, electric circuit closers; electric regulating apparatus; electrical controllers; process controlling apparatus; electric apparatus for commutation; electric sensors; electric safety relays; electric or electronic socket outlets; electrical plugs; remote, electric or electronic control stations.

11 – Apparatus for lighting; apparatus for heating; steam generating apparatus; cooking appliances; refrigerators; drying installations; apparatus for ventilating and water supply installations, apparatus for sanitary purposes; sinks; extractor hoods for kitchens, in particular downdraft extractors for cooktops, and downdraft extractors for worktops; electric heaters for feeding bottles; baking ovens; lava rocks for use in barbecue grills; barbecue grills; wash-hand basins [parts of sanitary installations]; lighting apparatus and installations; lamps; ventilation hoods; ventilation hoods for laboratories; framework of metal for ovens; bread-making machines; toasters; electric pressure cookers [autoclaves]; apparatus for steam generating; steam boilers, other than parts of machines; steam accumulators; overhead lamps; apparatus for dehydrating food waste; disinfectant apparatus; disinfectant dispensers for kitchens; air deodorising apparatus; deodorising apparatus, not for personal use; fruit roasters; roasting jacks; ice making machines; ice boxes; air heating apparatus; sockets for electric lights; filters for air conditioning; filters [parts of household or industrial installations]; water filtering apparatus; electric chip pans; gas burners; deep freezing apparatus; freezers; beverage cooling apparatus; roasting devices; rotisseries; roasting spits; taps [cocks, spigots] faucets for pipes; electric hand drying apparatus for washrooms; hot air apparatus; hot air bath fittings; water heaters; electric heating apparatus; heating plates; fireplaces;

microwave ovens for industrial purposes; electric yoghurt makers; electric coffee filters; electric coffee machines; electric coffee percolators; coffee roasters; air conditioning installations; ventilation [air-conditioning] installations for vehicles; air conditioning apparatus; cooking apparatus and installations; kilns; cooking hobs, hob systems; cooktops; electric cooking utensils; kitchen ranges; cooking rings; kitchen ranges [ovens]; cooling installations for liquids; cooling appliances and installations, water coolers; air cooling apparatus; refrigerating cabinets; refrigerating display cabinets; germicidal lamps for purifying air, water-pipes for sanitary installations; water conduits installations, light diffusers; electric fans for personal use; filters for air conditioning; ventilation systems; air diffuser apparatus; air filtering installations; air purifying apparatus and machines; air sterilisers; ventilation [air-conditioning] installations and apparatus; microwave ovens [cooking apparatus]; mixer taps for water pipes, anti-splash tap nozzles; fire bars, pasteurisers; plate warmers, heat pumps; fumigation apparatus, not for medical purposes; chimney flues; stoves [heating apparatus], regulating and safety accessories for water or gas apparatus and pipes; air driers; water purification devices; apparatus for sanitary purposes; electric pressure cookers [autoclaves]; steam accumulators; heat accumulators; sterilizers; immersion heaters; heating plates; cooling appliances and installations; electric toasters; filters for drinking water; desiccating apparatus; ultraviolet ray lamps, not for medical purposes; air conditioning fans; fans [parts of air-conditioning installations]; electric waffle irons; heat regenerators; heat accumulators; heat exchangers, not parts of machines; electric clothes dryers; water softening apparatus and installations; water supply installations; water conduits installations; hot air ovens; fireplaces; winding pipes [parts of distilling, heating or cooling installations]; exhaust hoods [cooker hoods]; exhaust air systems; fans for exhaust extractors; filters for air extractor hoods; extractors [ventilation or air conditioning]; adjustable coated baffle grease filters [parts of cooker hoods]; barbecues; all goods aforementioned not for motorized land vehicles; flues for ventilating apparatus.

(260) AM 2018 96484 A
 (800) 1290331
 (151) 2016 01 13
 (891) 2018 01 19
 (731) LINARI GMBH
 Jaffestrasse 12, 21109 Hamburg, Germany
 (540)

Linari

(591) Black, white
 (511)
 3 – Toiletries; essential oils and aromatic extracts; cleaning and fragrancings preparations; soap; deodo-

rant soap; perfumery; perfume; scented water; pot-pourris (fragrances); toilet water; room fragrances; air fragrancings preparations; fumigation preparations (perfumes); joss sticks; cosmetic creams; cosmetic preparations for skin care; shaving soap; after-shave lotions; shampoos.

4 – Fuel and illuminants; fragrancings candles; candles for lighting; perfumed candles; illuminating wax.

5 – Hygienic preparations and articles; deodorants for clothing and textiles; air purifying preparations; air deodorizing preparations.

(260) AM 2018 96492 A
 (800) 1347384
 (151) 2017 04 07
 (891) 2018 01 03
 (731) M&G HAUSGERÄTE GMBH
 Potsdamer Straße 92, 10785 Berlin, Germany
 (540)

MG

(591) Black, white
 (511)

7 – Metalworking machines, woodworking machines, machines for processing plastics, electromechanical machines for chemical industry, agricultural machines, haulage apparatus [mining] / extractors for mines, machines for the textile industry, beverage preparation machines, electromechanical, road making machines / road building machines, packaging machines, machine tools; motors, other than for land vehicles / engines, other than for land vehicles; couplings, other than for land vehicles; agricultural implements, other than hand-operated; incubators for eggs; vending machines / distribution machines, automatic.

11 – Apparatus for lighting, heating, steam generating, cooking, refrigerating, drying, ventilating; water supply and sanitary purposes.

(260) AM 2018 96493 A
 (800) 1379342
 (151) 2017 06 10
 (891) 2018 01 08
 (731) KINO-MO LTD
 The Light Bulb, London SW18 4GQ, United Kingdom
 (540)

Hypervsn

(591) Black, white
 (511)

9 – Computer hardware and software; electronic displays and digital signage; LED displays and persistence of vision displays; computer hardware and software to be used for networking LED displays, electronic displays, digital signage and persistence of

vision displays; computer hardware and software to be used for providing access and interaction with software applications using remote devices; computer hardware and software for applications in gaming and entertainment; electronic displays and persistence of vision displays for applications in gaming and entertainment; computer hardware and software for use in advertising, displaying information and/or entertainment.

(260) AM 2018 96547 A

(800) 1388563

(151) 2017 11 02

(891) 2017 11 02

(731) Union des Associations Européennes de Football (UEFA)
Route de Genève 46, CH-1260 Nyon,
Switzerland

(540)

UEFA NATIONS LEAGUE

(591) Black, white

(511)

1 – Sensitized films (unexposed); chemical products used in science and/or photography; tanning materials; artificial sweeteners; chemical products for industrial use; chemical products for use in industry and/or in manufacturing processes; synthetic materials for absorbing oil; detergent additives for motor fuel; chemical additives for fuels, lubricants and greases; adhesives for industrial use; antifreeze; brake fluids; clutch fluids; brazing products; degreasing products used in manufacturing processes; oil dispersants; fluids for hydraulic circuits; chemical preparations for welding; transmission fluids; transmission oils; cutting and milling fluids; coolants; chemical preparations for treating cooling systems; coolant preparations for cutting fluids; dehumidifying fluids; all the aforesaid goods for industrial use; chemical products for preserving foodstuffs.

18 – Leather and imitations of leather; thongs [straps] of leather; umbrellas, parasols; sports bags (other than those adapted for products they are designed to contain); leisure bags; travel bags, backpacks; school bags; bags for hanging on belts; handbags, leather bags; beach bags; garment bags; suitcases; briefcases; belts for suitcases; briefcases (leather goods); cases for toiletry articles known as vanity cases (not fitted); toiletry bags; key cases (leather goods); business card cases; wallets; purses (coin purses); whips; collars for animals; luggage tags of leather.

29 – Meat; fish; poultry; game; meat extracts; canned fish and meat; cooked fruits and vegetables; canned fruits and vegetables; edible oils and fats; potato chips; French fries; processed nuts; jams; marm-

lades and jellies; milk; milk products (milk predominating), dairy products; cheeses; soy milk (milk substitute).

30 – Coffee; tea; cocoa; chocolates; sugar; honey; artificial coffee; flours; cereal preparations; cereals; bread; pastry; pastes (pastry); pasta; cakes; biscuits, cookies; crackers; candy; edible ices; confectionery; rice; dried cereal flakes; mustard; vinegar; sauces (condiments); spices; salt; honey, molasses, yeast, salt, mustard, vinegar or spices; products with added vitamins for culinary use and food additives for culinary use based on coffee, tea, cocoa, sugar, rice, tapioca, sago, flour or cereal preparations, honey, molasses, yeast, salt, mustard, vinegar or spices; salt and salt-based products for preserving foodstuffs; pizzas; fresh pizzas; pizza doughs; burgers inserted in brioche bread, namely hamburgers; hot dogs (sandwiches); sandwiches filled with meat; cheeseburgers (sandwiches); fish sandwiches.

(260) AM 2018 96548 A

(800) 1388570

(151) 2017 11 10

(891) 2017 11 10

(731) TISSOT SA

Chemin des Tourelles 17, CH-2400 Le Locle,
Switzerland

(540)

TISSOT T-WAVE

(591) Black, white

(511)

14 – Precious metals and their alloys and goods made of these materials or coated therewith included in this class, namely figurines, trophies; jewelry, namely rings, earrings, cuff links, bracelets, charms, brooches, chains, necklaces, tie pins, tie clips, jewelry caskets (cases), cases; precious stones, semi-precious stones; timepieces and chronometric instruments, namely chronometers, chronographs, clocks, watches, wristwatches, wall clocks, alarm clocks as well as parts and accessories for the aforesaid goods, namely hands, anchors, pendulums, barrels, watch cases, watch straps, watch dials, clockworks, watch chains, movements for timepieces, watch springs, watch glasses, presentation cases for timepieces, cases for timepieces.

(260) AM 2018 96549 A

(800) 1388579

(151) 2017 11 17

(891) 2017 11 17

(731) NATCOM

16 Bd Camille Pelletan, F-84400 APT,
France

(540)



(591) Pantone 5467 C (dark green) and 5545 C (light green)

(531) 01.15.23; 03.06.03; 27.05.01; 29.01.12

(511)

5 – Pharmaceutical products; veterinary products; sanitary products for medical purposes; disinfectant soaps; medicinal soaps; medicated shampoos; medicated dentifrices; dietetic foods for medical use; dietetic foodstuffs for veterinary use; food for babies; food supplements; medical dressings; teeth filling materials; dental impression materials; disinfectants; antibacterial products for washing hands; products for destroying vermin; fungicides; herbicides; bath preparations for medical use; sanitary panties; sanitary towels; chemical preparations for medical use; chemical preparations for pharmaceutical use; medicinal herbs; herbal teas; parasiticides; alloys of precious metals for dental use.

(260) AM 2018 96552 A

(800) 1388656

(151) 2017 09 29

(891) 2017 09 29

(731) LEDER & SCHUH

AKTIENGESELLSCHAFT

Lastenstraße 11-13, A-8020 Graz, Austria

(540)

HUMANIC

(591) Black, white

(511)

18 – Leather and imitations of leather, and goods made of these materials as far as included in class 18; animal skins and hides; trunks and travelling bags; umbrellas, parasols and walking sticks; whips, harness and saddlery.

25 – Clothing, footwear, headgear.

(260) AM 2018 96581 A

(800) 1389182

(151) 2017 11 30

(891) 2017 11 30

(731) LLP "Kainar-AKB"

Medeu, 1, Taldykorgan, Kazakhstan

(540)

BARS

(591) Black, white

(531) 27.05.17

(511)

9 – Accumulators, electric; accumulators, electric, for vehicles; flashing lights [luminous signals]; acidimeters for batteries; battery jars; batteries for lighting; batteries, electric; simulators for the steering and control of vehicles; cables, electric; wire connectors [electricity]; collectors, electric; commutators; condensers [capacitors]; battery boxes; vehicle radios; voltage regulators for vehicles; grids for batteries; vehicle breakdown warning triangles; battery chargers; chargers for electric batteries.

(260) AM 2018 96582 A

(800) 1389271

(151) 2017 11 20

(891) 2017 11 20

(731) Dr. THEISS Naturwaren GmbH

Michelinstr. 10 66424 Homburg, Germany

(540)

EYELINERmed

(591) Black, white

(511)

3 – Bleaching preparations and other substances for laundry use; cleaning, polishing, scouring and abrasive preparations; soaps; perfumery; essential oils; hair lotions; dentifrices; beauty capsules.

5 – Pharmaceutical and veterinary preparations; medicines for human or veterinary purposes; sanitary preparations for medical purposes; dietetic foodstuffs and substances adapted for medical use; nutritional supplements; vitamin preparations.

(260) AM 2018 96583 A

(800) 1389272

(151) 2017 12 14

(891) 2017 12 14

(731) JANSSEN PHARMACEUTICA NV

Turnhoutseweg 30 Beerse B-2340, Belgium

(540)

SAFLENTO

(591) Black, white

(511)

5 – Human pharmaceutical preparations for the prevention and treatment of viral diseases, auto-immune and inflammatory diseases, cardiovascular diseases, central nervous system diseases, pain, dermatologic diseases, gastro-intestinal diseases, infectious-related diseases, metabolic diseases, oncologic diseases, ophthalmic diseases and respiratory diseases; vaccines.

(260) AM 2018 96606 A

(800) 759770

(151) 2001 04 30

(891) 2017 12 15

(731) ROHDE & SCHWARZ GMBH & CO. KG
Mühlldorfstrasse 15, 81671 München,
Germany

(540)

ROHDE & SCHWARZ

(591) Black, white

(511)

9 – Electric and electronic measuring, signalling, checking (supervision) and testing apparatus and instruments; electric and electronic communications technology equipment; measuring and testing apparatus for sound, image and net communications engineering; high frequency transmitting and receiving apparatus; base stations for radio networks; aerials; automatic sets for testing electromagnetic compatibility; automatic testing devices for the manufacture of mobile communications equipment; radio receivers, telephones; data processing equipment and computers; computer peripherals, equipment for data entry, equipment for data output, equipment for data storage and data transmission equipment; computer programs and computer data bases; computer hardware and software, including computer software for application in the field of the network and system management as well as for the development of further software; computer hardware and software, including computer software for entering and calling up information in the Internet and the worldwide web; computer software downloadable from a global computer network; computer programs for using the Internet and the worldwide web; computer programs retrievable from the Internet and worldwide web; computer hardware and software, in particular for access to Internet systems and for using these systems; operating and user instructions stored in digital form for computers and computer software, in particular on floppy disks or CD-ROM.

37 – Maintenance, repair and calibration of the goods indicated in class 9; installation work.

38 – Telecommunication; electronic data transmission.

41 – Training; organising and conducting of courses, seminars, workshops and colloquia for training and further training.

42 – Computer programming and development of programs for data processing; computer consultation services, technical consultation services relating to electronic data processing, updating computer software, designing computer software; conducting tests and check-ups relating to the goods indicated in class 9; technical testing of products and plants; services rendered in connection with the realisation of production lines for communications equipment, namely planning, setting-up and technical testing of production lines for communications equipment.

(260) AM 2018 96609 A

(800) 1388664

(151) 2017 09 29

(891) 2017 09 29

(731) JOSÉ JUAN CASCÁLES SÁNCHEZ

Polígono Industrial La Capellanía, Parcela
39 E-30600 Archena, Spain

(540)



(591) Black, white

(531) 26.15.01; 27.05.01

(511)

3 – Bleaching preparations and other substances for laundry use; cleaning, polishing, degreasing and abrasive preparations; soaps; perfumery products, essential oils, cosmetics, hair lotions; dentifrices.

(260) AM 2018 96610 A

(800) 1388677

(151) 2017 06 23

(891) 2017 06 23

(731) XIAOMI INC.

Floor 13, Rainbow City Shopping Mall II of
China Resources, No.68 Qinghe Middle
Street, Haidian District Beijing, China

(540)



(591) Black, white

(511)

9 – Data processing apparatus; computer memory devices; computers; disks, magnetic; floppy disks; computer operating programs, recorded; computer peripheral devices; computer software, recorded, couplers [data processing equipment]; magnetic data media; monitors [computer programs]; processors [central processing units]/central processing units [processors]; integrated circuit cards [smart cards]/smart cards [integrated circuit cards]; notebook computers; computer game software; laptop computers; computer software applications, downloadable; computer hardware; interactive touch screen terminals; humanoid robot with artificial intelligence; mobile telephones/cell phones/cellular pho-

nes software applications, downloadable; image, audio and video editing [computer programs]; operating system programs; computer programs for enabling access control; virtual reality game softwares; computer programs for Internet and world-wide-web; quantity indicators; facsimile machines; smartphones; intercommunication apparatus; scales; navigational instruments; wearable activity trackers; audio- and video-receivers; video recorders; cameras [photography]; measuring instruments; inductors [electricity]; mirrors [optics]; wires, electric; chips [integrated circuits]; sensors; time switches, automatic; couplings, electric/connections, electric; theft prevention installations, electric; batteries, electric; chargers for electric batteries; animated cartoons.

(260) AM 2018 96611 A

(800) 1388679

(151) 2017 06 27

(891) 2017 06 27

(731) ALEXANDER WILLER

Agerstraße 26/1, A-4860 Lenzing, Australia

(540)

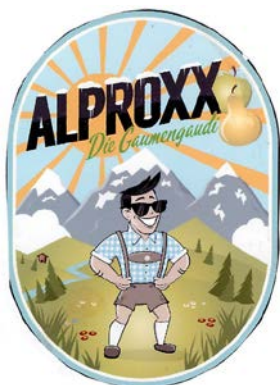

(591) Blue, green, grey, white, yellow, black and rose

(531) 01.03.09; 01.03.15; 01.15.17; 02.01.13;
05.07.15; 06.01.02; 06.01.04; 26.01.13;
27.05.01; 27.05.10; 27.05.17; 29.01.15

(511)

33 – Alcoholic beverages (except beers); fruit extracts alcoholic; alcoholic essences; alcoholic extracts; alcoholic beverages, namely, pear-apple must drinks; refreshing alcoholic musts; alcoholic beverages containing fruit; alcoholic beverages, namely, digesters slightly alcoholic.

(260) AM 2018 96612 A

(800) 1388684

(151) 2017 06 15

(891) 2017 06 15

(731) Public Joint Stock Company "SIBUR Holding"

Eastern Industrial Area, building 30, Block 1,
No.6, Tobolsk RU-626150 Tyumen Region,
Russian Federation

(540)

СИБУР

(591) Turquoise

(531) 28.05; 29.01.04

(511)

1 – Benzene derivatives, namely ethylbenzene and benzene-toluene fraction; surface-active chemical agents; glycol; xylene; xylol; hydrocarbon gases for industrial purposes, namely, isobutane, pentane, isopentane, isobutane, butadiene; dispersions of plastics; detergent additives to gasoline [petrol]; chemical additives to motor fuel, namely, high-octane additive and a petrochemical distillation residue; catalysts; nitric acid; benzoic acid; acids, including acrylic acids; benzene-based acids; adhesives for industrial purposes; unprocessed plastics for industrial purposes, including general-purpose polystyrene, high-impact polystyrene, polymeric alloys used for industrial purposes; polystyrene for industrial purposes; plasticizers; polyvinyl chloride used for industrial purposes; propylene; polypropylene; polyolefins; polyethylene resins, including high-pressure polyethylene and low-density polyethylene; rubber preservatives; acrylic resins, unprocessed, including acrylates; unprocessed artificial resins, namely, foaming polystyrene; unprocessed synthetic resins, including thermoplastic polymers, polypropylene resins, polyvinyl chloride resins, butadiene-styrene copolymers, pyrolysis resins, polycarbonate resins, polyethylene terephthalate in the nature of granulated material, including secondary and amorphous polyethylene terephthalate in the nature of granules; acrylate resins; unprocessed epoxy resins, including ethylene oxide; caustic soda for industrial purposes; salts [chemical preparations]; salts for industrial purposes; ethanol, including ethylene glycols, for industrial purposes; alcohols, including butyl alcohol; isobutyl alcohol and alcohol-ester concentrate; toluene, namely toluene fraction; chemicals for industrial and scientific purposes, including terephthalic acid or acetic acid; polyester-based chemicals; chlorine; chlorides, namely, commercial dichloroethane; ethers; esters, including acrylic acid methyl ester, acrylic acid butyl ester, acrylic acid ethyl ester; fire extinguishing compositions; tempering and soldering preparations; anti-knock substances for internal combustion engines; gas purifying preparations; detergents for use in manufacturing processes; filtering materials [unprocessed plastics]; filtering materials [chemical preparations]; textile-impregnating chemicals; alkalies; glycol ether.

4 – Benzine, namely stable natural petrol; oil-gas, including natural gas liquids; fuel gas, including dry and liquefied hydrocarbon gas; petroleum, raw or refined; naphtha; alcohol [fuel]; heating oil; electrical energy; petroleum ether; ethanol [fuel].

16 – Plastic film for wrapping.

17 – Liquid rubber; synthetic rubber, including butadiene-styrene rubber, butadiene synthetic rubber, butadiene synthetic rubber based on the neodymium catalyst, emulsion butadiene-styrene synthetic rubber, synthetic isoprene rubber, butyl rubber, nitrile rubber, styrene-butadiene-styrene thermo-elasto-plastics, divinyl-styrene synthetic rubber; rubber, raw or semi-worked; synthetic latex [rubber]; insulating tapes; reinforcing materials, not of metal, for pipes; insulating materials; insulating refractory materials; non-conducting materials for retaining heat; filtering materials [semi-processed foams or films of plastic]; bags [envelopes, pouches] of rubber, for packaging; plastic substances, semi-processed; plastic film, other than for wrapping; plastic protecting films for agricultural purposes; plastic protecting sheeting for agricultural purposes; rubber solutions; acrylic resins [semi-finished products]; synthetic resins [semi-finished products]; plastics in extruded form for use in manufacture; plastic fibers [fibres], not for textile use; soundproofing materials; packing [cushioning, stuffing] materials of rubber or plastics; substances for insulating buildings against moisture; insulating fabrics; waterproof packings.

19 – Geotextile, for use in road and railway construction, including, for stabilization of road slopes and slopes of railways; geotextile for use in construction of tunnels and waterways, construction of drainage systems, reclamation, processing and strengthening agricultural soils, filtration and outflow of water; geogrids; framework, not of metal, for building; road marking sheets and strips of synthetic material; reinforcing materials, not of metal, for building; road coating materials; materials for making and coating roads; building materials, not of metal; binding material for road repair; bituminous products for building; pitch; roof coverings, not of metal.

20 – Signboards of wood or plastics; display stands, including racks; packaging containers of plastic; containers, not of metal [storage, transport].

24 – Non-woven textile fabrics; plastic material [substitute for fabrics]; gummed cloth, other than for stationery; curtains of textile or plastic; fabrics for textile use; filtering materials of textile; textile material.

35 – Import-export agency services; marketing; sales promotion for others; advertising; commercial or industrial management assistance; retail or wholesale of petrochemical products, namely fuel and liquefied hydrocarbon gas, fuel gas, chemical additives for motor fuel, base polymers, synthetic rubbers, plastics and synthetic resins [semi-finished products], alcohols, glycols, acids, olefins, semi-processed products; business project management services for construction projects.

36 – Arranging finance for construction projects; investment of funds; charitable fund raising; mutual funds.

37 – Construction information; vehicle service stations [refuelling and maintenance]; construction; installation services.

39 – Transportation information; storage information; transportation logistics; hauling; bus transport; railway transport; transport brokerage; stevedoring; electricity distribution; distribution of energy; transport by pipeline; wrapping of goods; storage; air transport; car transport; boat transport; marine transport; storage of goods.

41 – Practical training [demonstration]; arranging and conducting of colloquiums; arranging and conducting of congresses; arranging and conducting of conferences.

42 – Chemical analysis; material testing; chemical research; research and development of new products; technical research; calibration [measuring]; chemistry services; scientific laboratory services; surveying; scientific research.

(260) AM 2018 96613 A

(800) 1126562

(151) 2012 02 09

(891) 2017 11 22

(731) NAME AND ADDRESS OF THE HOLDER OF THE REGISTRATION TEKNİK METAL SİSTEMLERİ SANAYİ VE TİCARET LTD. Şti. İkitelli Keresteciler, Sanayi Sitesi 15 Sokak 14/A, Blok Başakşehir, İstanbul, Turkey

(540)



(591) Blue, red

(531) 26.04.03; 26.04.09; 26.04.24; 27.05.17; 29.01.12

(526) ®

(511)

6 – Ores of non-precious metal; common metals and their alloys and semi-finished products made of these materials; irons for construction; mats and stirrups of common metals for buildings; common metals in the form of plate, billet, stick, profile, sheet and sheeting; goods and materials of common metal used for storage, wrapping, packaging and sheltering purposes, containers of metal (storage, transport), buildings of metal, frames of metal for building, poles of metal for building, metal boxes, packaging containers of metal, aluminium foil, fences made of metal, guard barriers of metal, metal tubes, storage containers of metal, metal containers for the transportation of goods, ladders of metal; goods of com-

mon metal for filtering and sifting purposes, included in this class; doors, windows, shutters, жалюзи and their cases and fittings of metal; non-electric cables and wires of metal; ironmongery; small hardware of metal; screws of metal; nails; bolts of metal; nuts of metal; pegs of metal; flakes of metal; pitons of metal; metal chains; furniture casters of metal; fittings of metal for furniture; industrial metal wheels; door handles of metal; window handles of metal; hinges of metal; metal latches; metal locks; metal keys for locks; metal rings; metal pulleys; ventilation ducts, vents, vent covers, pipes, chimney caps, manhole covers, grilles of metal for ventilation, heating, sewage, telephone, underground electricity and air conditioning installations; metal panels or boards (non-luminous and non-mechanical) used for signaling, route showing, publicity purposes, signboards of metal, advertisement columns of metal, signaling panels of metal, non-luminous and non-mechanical traffic signs of metal; pipes of metal for transportation of liquids and gas, drilling pipes of metal and their metal fittings, valves of metal, couplings of metal for pipes, elbows of metal for pipes, clips of metal for pipes, connectors of metal for pipes; safes (strong boxes) of metal; metal railway materials, metal rails, metal railway ties, railway switches; bollards of metal, floating docks of metal, mooring buoys of metal, anchors; metal moulds for casting, other than machine parts; works of art made of common metals or their alloys, trophies of common metal; metal closures, bottle caps of metal; metal poles; metal pillars; scaffolding of metal; metal stakes, metal towers; metal pallets and metal ropes for lifting, loading and transportation purposes; metal hangers, ties, straps, tapes and bands used for load-lifting and load-carrying; wheel chocks made primarily of metal; metal profile laths for vehicles for the purposes of decoration.

35 – Advertising, marketing and public relations; organization of exhibitions and trade fairs for commercial or advertising purposes; design for advertising; provision of an online marketplace for buyers and sellers of goods and services; office functions; secretarial services; arranging newspaper subscriptions for others; compilation of statistics; rental of office machines; systemization of information into computer databases; telephone answering for unavailable subscribers; business management, business administration and business consultancy; accounting; commercial consultancy services; personnel recruitment, personnel placement, employment agencies, import-export agencies; temporary personnel placement services; auctioneering; the bringing together, for the benefit of others, of a variety of goods, enabling customers to conveniently view and purchase those goods, such services may be provided by retail stores, wholesale outlets, by means of electronic media or through mail order catalogues.

42 – Scientific and industrial analysis and research services; engineering; engineering and architectural design services; testing services for the certification of quality and standards; computer services, namely, computer programming, computer virus protection services, computer system design, creating, maintaining and updating websites for others, computer software design, updating and rental of computer software, providing search engines for the internet, hosting websites, computer hardware consultancy, rental of computer hardware; industrial design services, other than engineering, computer and architectural design; graphic arts designing; authenticating works of art.

(260) AM 2018 96614 A

(800) 1297919

(151) 2016 02 02

(891) 2017 12 14

(731) TERUMO KABUSHIKI KAISHA (TERUMO CORPORATION)

44-1, 2-chome, Hatagaya, Shibuya-ku, Tokyo
151-0072, Japan

(540)



(591) Black, white

(531) 26.11.12; 27.05.17

(511)

10 – Pacifiers for babies; supportive bandages; catgut; teats; ice bags for medical purposes; nursing appliances; finger guards [for medical purposes]; medical apparatus and instruments; syringes for medical purposes; needles for medical purposes; thermometers for medical purposes; catheters; medical guide-wires; pumps for medical purposes; gloves for medical purposes; urinals [vessels]; bed pans; dental apparatus and instruments; veterinary apparatus and instruments; surgical apparatus and instruments.

(260) AM 2018 96617 A

(800) 1305828

(151) 2016 01 06

(891) 2018 01 16

(731) APPLE INC.

One Apple Park Way, Cupertino CA 95014,
USA

(540)



(591) The colors orange, pink, purple, blue, white are claimed as a feature of the mark. The mark consists of a multi-colored stylized design of a musical note surrounded by a multi-colored circle

(531) 24.17.12; 26.01.16; 29.01.14

(511)

38 – Streaming of audio material featuring music on the Internet, and providing access to digital music on the Internet.

41 – Arranging, organizing, conducting, and presenting concerts, live performances, entertainment special events, arts and cultural events, theatrical entertainment, competitions, contests, fairs, festivals, exhibitions, expositions, and sporting events; production, distribution, and presentation of radio programs, television programs, motion pictures, sound recordings; provision of live entertainment and recorded entertainment, namely, musical performances; providing non-downloadable entertainment, sports, music, informational, news, and current events programming; providing entertainment, sports, music, informational news, current events, and arts and culture programming, through websites and computer applications; providing information in the field of entertainment, music, sports, arts and culture, and news relating thereto, through websites and computer applications; providing non-downloadable computer games, electronic games, interactive games, and video games; providing information, schedules, reviews and personalized recommendations of educational programs, entertainment, motion pictures, theatre, arts and cultural events, concerts, live performances, competitions, fairs, festivals, exhibitions, expositions, and sporting events; ticket reservation and booking services for educational programs, entertainment, motion pictures, theatre, arts and cultural events, concerts, live performances, competitions, fairs, festivals, exhibitions, expositions, and sporting events; publication and presentation of reviews, surveys, and ratings; providing reviews, survey results, and ratings relating to educational programs, entertainment, motion pictures, theatre, arts and cultural events, concerts, live performances, competitions, fairs, festivals, exhibitions, expositions, and sporting events, through interactive websites and computer applications; providing non-downloadable ringtones, pre-recorded music, video, and graphics for use on mobile communications devices; publication of books, periodicals, newspapers, newsletters, manuals, blogs, journals, and other publications; provision of online non-downloadable publications in the nature of books, periodicals, newspapers, newsletters, manuals, blogs, journals, and other publications, through websites and computer applications; news reporting; providing information in the field of fitness and exercise through websites and computer applications.

(260) AM 2018 96618 A

(800) 1388701

(151) 2017 10 05

(891) 2017 10 05

(731) PRIYANKA COMMUNICATIONS INDIA PVT LTD

143, Oshiwara Industrial Centre, Opp. Oshiwara Bus Depot, New Link Road Goregaon West, Mumbai 400104, India

(540)



(591) Black, white

(531) 03.07.16; 26.11.03; 26.11.05; 26.11.13

(511)

38 – Communications by telephone, radio, telephone or other means of electronic communication, telephone services including mobile telephone services; cellular telephone communication, telecommunications by mobile, computer or any other mean, wireless broadcasting.

(260) AM 2018 96619 A

(800) 1360859

(151) 2017 06 20

(891) 2018 01 23

(731) MÄURER & WIRTZ GmbH & Co. KG

Zweifaller Str. 120, 52224 Stolberg, Germany

(540)

Tender Love

(591) Black, white

(511)

3 – Soaps, cosmetics, perfumery, essential oils, hair lotions, dentifrices.

(260) AM 2018 96630 A

(800) 1388897

(151) 2017 12 17

(891) 2017 12 17

(731) SHANGHAI OCTMAMI NETWORK CO., LTD.

Block F, 2nd Floor, No.3 Building, XingXian Road, JiaDing District 201800 Shanghai, China

(540)

octmami

(591) Black, white

(531) 27.05.17

(511)

25 – Clothing; shoes; hats; layettes [clothing]; hosiery; gloves [clothing]; scarfs; leather belts [clothing]; sleep masks; shower caps; wedding dresses.

(260) AM 2018 96631 A

(800) 1388908

(151) 2017 04 10

(891) 2017 04 10

(731) ICB PHARMA Tomasz Świętosławski,
Paweł Świętosławski Spółka Jawna
Moździerzowców 6a., PL-43-602 Jaworzno,
Poland

(540)



Allergoff

(591) Blue, navy blue and white.

(531) 24.01.15; 27.05.17; 27.05.21; 27.05.24;
29.01.13

(511)

3 – Bleaching preparations and other substances for laundry use; cleaning, polishing, scouring and abrasive preparations; soaps; perfumery, essential oils, cosmetics, hair lotions; dentifrices; essential oils and aromatic extracts; animal grooming preparations; toiletries; grinding preparations; ethereal essences and oils; fumigating incenses (kunko); aromatherapy preparations; cosmetics for animals; household fragrances; ammonia [volatile alkali] [detergent]; wipes incorporating cleaning preparations; emulsifying solvent cleaners; detergents; cleaning chalk; starch for cleaning purposes; destainers; oils for cleaning purposes; soda lye; cleaning preparations for cleaning drains; refurbishing preparations; unblocking drain pipes (preparations for -); mould removing preparations; bleaching preparations; washing preparations; fruit and vegetable wash; cleaning preparations for plant leaves; cleaning preparations; caustic cleaning agents; body cleaning and beauty care preparations; deodorants and antiperspirants; soaps and gels; hair removal and shaving preparations; bath preparations; skin care preparations; hair preparations and treatments; moist wipes impregnated with cleaning preparations for personal sanitary and cosmetic purposes; beauty care cosmetics; cosmetics for use on the skin; beauty lotions; washing preparations for personal use; cosmetic nail care preparations; non-medicated beauty preparations; hand cleansers; pumice stones for personal use; hand washes; oral hygiene preparations; make-up pads of cotton wool; cosmetics; baby care products (non-medicated -); non-medicated toiletries; cosmetic kits; pumice stone; beauty products; perfumery; toiletries; cleaning preparations for use in wiping; hypoallergenic body care cosmetics and body washes; hypoallergenic cosmetics; cleaning preparations for neutralising allergens; cleaning preparations for spraying areas

with high levels of house dust allergens; aerosols and sprays for cleaning purposes, for removing and neutralising allergens (including inhalant allergens, house dust allergens, mite and insect allergens, pollen, fungal mould spores, and pet hair and skin); cleaning preparations for removing and neutralising allergens; cleaning preparations for sensitising agents; cleaning preparations for removing sensitising agents; antiallergic laundry, cleaning and washing preparations.

5 – Pharmaceutical and veterinary preparations; sanitary preparations for medical purposes; plasters, materials for dressings; disinfectants; preparations for destroying vermin; fungicides, herbicides; insecticides; insect attractants; insect and vermin repellents; vermin destroying preparations; insecticides for domestic use; antiparasitic preparations; larvicides; insect repellent incense; anti-insect spray; insect repelling tags; medications; medical articles; nutraceuticals, being dietary supplements; herbal preparations and medicinal infusions; herbal medicine; adjuvants for medical purposes; dietary supplements and dietetic preparations; dietetic substances and preparations; nutritional dietetic preparations; dietary foods; infant formula; dressings [medical]; disinfectants; hygienic preparations and articles; medicated dermocosmetics; cosmetics with medical properties; ointments, balms, creams, emulsions, liquids, gels, oils for medicinal and medical purposes; sanitary preparations for medical purposes and personal hygiene; mildew (chemical preparations to treat -); vermin destroying preparations; preparations for destroying noxious animals; algicides; anti-insect spray; flea sprays; powders for killing fleas; mildewcides; preparations for destroying insects; algae removing preparations; larvae exterminating preparations; fungicides for domestic use; fungicides for medical use; fungicides for killing vermin; sporicides; insect attractants; rodenticides; acaricides; parasiticides; nematocides; fungicidal fungal agents; fumigating pastilles; fumigating sticks as disinfectants; veterinary preparations and substances; chemical preparations for medical purposes; detergents for medical purposes; biocides; parasiticides; disinfectants for hygiene purposes; insecticides; larvae exterminating preparations; repellents (insect -); anti-parasitic preparations; medical products for the treatment of parasitic diseases; medical preparations for destroying parasites, microbes, sensitising agents and arthropods; medical preparations for neutralising allergens; adjuvants for use in the treatment of allergies; disinfectants for spraying areas with high levels of house dust allergens; sanitary preparations for spraying areas with high levels of house dust allergens; disinfectant aerosols and sprays for use in relation to allergens (including inhalant allergens, house dust allergens, mite and insect allergens, pollen, fungal mould spores, and pet hair and skin); anti-parasitic sanitary preparations; anti-parasitic

disinfectants; sanitary preparations and disinfectants for use against parasites, microbes, sensitising agents and arthropods; anti-flea and anti-lice preparations; sanitary preparations for neutralising allergens; germicidal detergents; cleaning preparations for destroying parasites, microbes and arthropods.

(260) AM 2018 96632 A

(800) 1388914

(151) 2017 04 14

(891) 2017 04 14

(731) KOMATSU LTD.

3-6, 2-chome, Akasaka, Minato-ku Tokyo
107-8414, Japan

(540)



(591) Black, white

(531) 26.04.12; 26.04.24; 26.11.12

(511)

4 – Mineral oils and greases for industrial purposes [not for fuel]; motor oil; non-mineral oils and greases for industrial purposes [not for fuel]; lubricants; dust absorbing, wetting and binding compositions; fuels (including motor spirit) and illuminants; solid fuels; liquid fuels; gasoline; petrol; gas oil; crude oils; heavy oils; artificial petroleum; kerosene; methylated spirits for fuel [denaturated fuel alcohols]; benzene [fuel]; gasoline fuels.

9 – Electronic machines and apparatus, and their parts and accessories; electronic machines, apparatus and their parts for remote monitoring systems; wireless remote control systems and devices for vehicles; telecommunication machines and apparatus, and their parts and accessories; computer software and computer hardware; computer programs; computer programs for data processing; computer programs for repair or maintenance of metalworking machines and apparatus, construction machines and apparatus, loading-unloading machines and apparatus, mining machines and apparatus, agricultural machines and implements, forest machines and apparatus; computer programs for managing position and battery, operational status and maintenance information of metalworking machines and apparatus, construction machines and apparatus, loading-unloading machines and apparatus, mining machines and apparatus, agricultural machines and implements, forest machines and apparatus; tablet computers, and their parts and accessories; tablet computer terminals to measure the operation status of machine tools and to

collect the operation data of machine tools by installing to the machine tools, and their parts and accessories; electrical control, testing and monitoring apparatus, and their parts and accessories; batteries and cells; battery boxes; capacitors; batteries; battery terminal; vehicle batteries; battery chargers for battery vehicles, and their parts and accessories; measuring or testing machines and instruments, and their parts and accessories; surveying machines and instruments, and their parts and accessories; power distribution or control machines and apparatus; LCD monitors; computer monitors; touchscreen monitors; tablet monitors; electroluminescent display panels; computer display monitors; electronic numeric displays; electrical controlling devices; electrical charge controllers; electronic power controllers; electronic speed controllers; pressure sensors; condensers; capacitance boxes; computer software and programs, recorded; connectors [electricity]; electronic connectors; electric wires and cables; sensors [measurement apparatus], other than for medical use; optical sensors.

(260) AM 2018 96633 A

(800) 1388947

(151) 2017 08 07

(891) 2017 08 07

(731) BAKLAN INAN

Am Oberen Luisenpark 7 68165 Mannheim,
Germany;
Baklan Özgür
Obere Riedstraße 84 68309 Mannheim,
Germany

(540)

BAK

(591) Black, white

(511)

29 – Meat; fish; poultry; game; meat extracts; preserved, frozen, dried and cooked fruits and vegetables; jellies for food; jams; compotes; eggs; milk; milk products; oils for food; edible fats; apple purée; arrangements of processed fruit; black pudding [blood sausage]; broth; bouillon concentrates; butter; buttercream; curd; salted meats; salted fish; albumen for culinary purposes; gherkins; fatty substances for the manufacture of edible fats; fat-containing mixtures for bread slices; fish fillets; fish-based foodstuffs; fish meal for human consumption; broth concentrates / bouillon concentrates; fruit chips; fruit jellies; fruit pulp; fruit salads; fruit-based snack food; gelatine; jellies for food; vegetables, tinned [canned (am.)]; flavored nuts; ginger jam; yogurt; cocoa butter for food; candied nuts; potato chips; potato flakes; potato fritters; cheese; caviar; kephir [milk beverage]; hummus [chickpea paste]; coconut butter; coconut fat; coconut oil for food; evaporated milk; peas, preserved; olives, preserved; mushrooms, preserved; soya beans, preserved, for food; truffles, pre-

served; fish, preserved; preserved garlic; meat, preserved; soups; croquettes; linseed oil for culinary purposes; lentils, preserved; maize oil for food; almond milk for culinary purposes; margarine; milk beverages, milk predominating; milk shakes; whey; fruit salads; olive oil for food; palm kernel oil for food; cranberry sauce [compote]; quark; rape oil for food; raisins; cream [dairy products]; anchovy, not live; sauerkraut; ham; whipped cream; pork; lard; sesame oil for food; soya milk [milk substitute]; sunflower oil for food; bacon; preparations for making soup; tofu; tomato paste; tomato purée; tomato juice for cooking; sunflower seeds, prepared; sausages; charcuterie; onions, preserved; linseed for human consumption; peanut milk; milk beverages.

30 – Coffee; tea; cocoa; artificial coffee; rice; tapioca; sago; flour; cereal preparations; bread; pastries; sweetmeats [candy]; edible ices; sugar; honey; golden syrup; yeast; baking powder; salt; mustard; vinegar; sauces [condiments]; spices; ice for refreshment; aniseed; flavourings, other than essential oils, for beverages; wheat flour; thickening agents for cooking foodstuffs; bean meal; dessert mousses [confectionery]; ice cream; iced tea; edible rice paper; essences for foodstuffs, except etheric essences and essential oils; meat pies; meat gravies; fondants [confectionery]; spring rolls; minced garlic [condiment]; corn, milled; hominy; pearl barley; barley meal; tea-based beverages; chips [cereal products]; cereal bars; cereal-based snack food; condiments; glucose for culinary purposes; semolina; oat flakes; ginger [spice]; frozen yoghurt [confectionery ices]; capers; caramels [candy]; biscuits; ketchups (sauce); crackers; cakes; cake frosting [icing]; cake batter; liquorice [confectionery]; gingerbread; corn flakes; corn flour; macaroni; macarons [pastry]; malt for human consumption; maltose; marinades; marzipan; mayonnaise; creamed rice; chocolate beverages with milk; muesli; oat-based food; natural sweeteners; infusions, not medicinal; noodle-based prepared meals; noodles; chocolate-coated nuts; nut flours; bread crumbs, crumb; pasta sauce; pasties; lozenges [confectionery]; pesto [sauce]; pepper; mint for confectionery; peppermint sweets; pizzas; popcorn; high-protein cereal bars; puddings; ravioli; rice-based snack food; unroasted coffee; dressings for salad; sandwiches; sauces (spices); leaven; chocolate; chocolate-based beverages; soya flour; soya sauce; sherbets [ices]; spaghetti; sushi; tabbouleh; tacos; tomato sauce; tarts; chocolate decorations for cakes; tortillas; waffles; seasonings; rusks.

32 – Beers, in particular non-alcoholic beers, wheat beer, pils, beer from cologne with the protected designation of origin, altbiere (old beer), lagers, ginger beer; beer wort; mineral and aerated waters and other non-alcoholic beverages, in particular flavoured waters, aperitifs, cocktails, lemonades, energy drinks, isotonic beverages, beverages, not being milk

substitutes, kvass, malt beer, whey beverages, sarsaparilla, seltzer water, soda water, table waters, lithia water; fruit drinks; fruit juices; syrups and other preparations for making beverages, in particular powders for effervescing beverages, pastilles for effervescing beverages, concentrates for preparing fruit juices and fruit drinks, preparations for making aerated water, essences for use in making beverages, fruits extracts, extracts of hops for making beer, syrups for lemonade, malt wort, orgeat, preparations for making liqueurs, preparations containing malt for making beverages; vegetable juices [beverages]; smoothies; sherbets [beverages]; must.

33 – Alcoholic beverages (except beer), in particular fruit extracts, alcoholic, alcoholic essences, alcoholic extracts, alcoholic fruit drinks, anise [liqueur]; aperitifs; cider; arrack [arak]; perry; brandy; cognac; curacao; digesters [liqueurs and spirits]; whisky; vodka; gin; kirsch; corn brandy; liqueurs; bitters (liqueurs); mead [hydromel]; peppermint liqueurs; rice alcohol; rum; sake; brandy; tequila; soft spirits; spirits [beverages]; sparkling wines; champagne; sparkling wine; wine, in particular port, sherry wines, piquette, fortified wines, gin, gin, brandy, vermouth, schnapps, sparkling wine, mead [hydromel], fruit wines, fortified wines, rice wines, low-alcohol wine; digestifs and cocktails with a spirit and wine base; beverages (distilled).

35 – Advertising; business management; business administration; office functions; wholesaling and retailing in the field of foodstuffs, alcoholic and non-alcoholic beverages, food for babies, dietetic and dietary foodstuffs, tobacco, smokers' articles.

(260) AM 2018 96634 A

(800) 1388976

(151) 2017 09 06

(891) 2017 09 06

(731) EUROIMMUN Medizinische

Labordiagnostika AG

Seekamp 31, 23560 Lübeck, Germany

(540)

EUROIMMUN

(591) Black, white

(511)

1 – Diagnostic preparations, other than for medical or veterinary purposes; diagnostic preparations and diagnostic substances for scientific purposes, in particular immobilised proteins, nucleic acids, allergens and biological tissue specimens and biological tissue cultures, synthetic resin compounds in the form of microspheres used to incorporate various other substances, chemical test paper, chemically treated test strips, reagents for labeling, sequencing and fragment analysis of nucleic acids and proteins and customized synthesis, and polymeric membrane materials for liquid separation.

5 – Diagnostic preparations, in particular diagnostic preparations for allergies for medical and veterinary purposes; diagnostic preparations for medical and veterinary purposes; diagnostic agents for medical and veterinary purposes, in particular immobilised proteins, nucleic acids, allergens and biological tissue cultures and biological tissue, reagent paper, medical diagnostic test strips, medical diagnostic reagents; biological and chemical preparations and reagents for medical or veterinary purposes, in particular living cells and microorganisms, as well as proteins, peptides and nucleic acids or complexes of these molecules, for medical and veterinary purposes.

9 – Measuring, detecting and monitoring instruments, measuring, detecting and monitoring devices and measuring, detecting and monitoring regulators for preparing, processing and evaluating diagnostic samples, for detecting allergies, sensors and detectors, in particular uv fluorescence and chemiluminescence detectors for preparing, processing and evaluating diagnostic samples; apparatus for recording, transmission or reproduction of diagnostic data, sound or images, in particular cameras, microscopes, photometers, microplate photometers, elisa (enzyme-linked immunosorbent assay) readers, photomultipliers, microplate readers, software, in particular laboratory software; biochips; microtiter plates.

10 – Medical apparatus and instruments for medical examinations and medical diagnosis.

(260) AM 2018 96635 A

(800) 1389043

(151) 2017 11 09

(891) 2017 11 09

(731) ADP GAUSELMANN GMBH

Merkur-Allee 1-15, 32339 Espelkamp,

Germany

(540)

Fat Bill

(591) Black, white

(511)

9 – Computer software for casino and amusement arcade games; coin-operated mechanisms; computer and video games software for casino and amusement arcade games; video games (software) for casino and amusement arcade games; computer games, leisure and recreational software, video games and computer software, all being provided in the form of storage media for casino and amusement arcade games; programs for operating electric and electronic apparatus for games, amusement and/or entertainment purposes; online games (software), in particular for online betting games, online prize games, online gambling games, online games of skill and online casino games; software in particular for casino and/or amusement arcade games, for gaming machines

and/or slot machines each one with or without prize payouts; gaming software that generates or displays wager outcomes of gaming machines; operational computer games software for casino and amusement arcade games.

28 – Games; toys; gaming apparatus (including coin-operated apparatus): coin-operated arcade games (machines); games for amusement arcades (included in this class); coin-operated video gaming apparatus; video games apparatus adapted for use with external screens or monitors only; casino fittings, namely roulette tables, roulette wheels; coin-operated automatic gaming machines and gaming machines, in particular for gaming arcades, with or without a prize payout; electronic or electrotechnical gaming apparatus, automatic gaming machines, gaming machines, slot machines operated by coins, tokens, banknotes, tickets or by means of electronic, magnetic or biometric storage media, in particular for commercial use in casinos and amusement arcades, with or without a prize payout; automatic gaming machines and gaming machines, in particular for commercial use in casinos and gaming arcades, with or without a prize payout; coin-operated gaming machines and/or electronic money-based gaming apparatus (machines), with or without prizes; housings adapted for gaming machines, gaming apparatus and automatic gaming machines, operated by means of coins, tokens, tickets or by means of electronic, magnetic or biometric storage media, in particular for commercial use in casinos and gaming arcades, with or without a prize payout; electronic games; electronic game entertainment apparatus and parts thereof; video output game machines; drawing apparatus for prize games and lotteries, draws or raffles; housings of metal, plastic and/or wood for coin-operated automatic machines; apparatus for games (including video games), other than adapted for use with external screens or monitors only; electropneumatic and electric slot machines with pulling handles (gaming machines); gaming tables, in particular for table football, billiards, sliding games; flying discs (toys) and darts; gaming machines, namely, electric, electronic or electromechanical apparatus for bingo games, lotteries or video lottery games and for betting offices, connected or unconnected to a computer network; LCD games consoles; automatic gaming machines; all the aforesaid automatic gaming machines operating in networks; apparatus and devices for accepting and storing money, being fittings for the aforesaid automatic machines, included in this class; automatic lottery machines.

(260) AM 2018 96636 A

(800) 1389061

(151) 2017 11 27

(891) 2017 11 27

(731) GUANGDONG XINGFA ALUMINIUM

CO., LTD.

No.23 Renhe Rd., Nanzhuang Town, Chancheng District Foshan City, Guangdong Province, China

(540)



(591) Black, white

(531) 26.13.25; 26.13.25; 27.05.17; 27.05.17

(511)

6 – Sheets and plates of metal; tubes of metal; doors of metal; blinds of metal; wall linings of metal for building; window frames of metal; door frames of metal; aluminium; alloys of common metal; laths of metal; framework of metal for building; building materials of metal; partitions of metal; windows of metal; linings of metal for building; metal wallboards; door stops of metal; chains of metal; window pulleys; fittings of metal for windows; door handles of metal; ironmongery; fittings of metal for beds; door fittings of metal; window stops of metal; sliding rails of metal; hinges of metal; padlocks; keys; locks of metal, other than electric; furniture fittings of metal.

(260) AM 2018 96637 A

(800) 1389109

(151) 2017 12 13

(891) 2017 12 13

(731) AHP MERKLE GMBH

Nägelsestraße 39, 79288 Gottenheim, Germany

(540)

AHP

(591) Black, white

(511)

7 – Hydraulic cylinders, in particular standard hydraulic cylinders, hydraulic cylinders with proximity switches, hydraulic cylinders with position sensors, block cylinders, circular block cylinders, flanged cylinders, short-stroke cylinders, cubical cylinders, screw-type cylinders, double pipe cylinders and hydraulic cylinders with external guides; hydraulic sliding units; pivoted chucking cylinders; rotary actuators; core puller units; pressure intensifiers.

12 – Rotary drives for land vehicles.

(260) AM 2018 96641 A

(800) 1389178

(151) 2017 12 11

(891) 2017 12 11

(731) BIONORICA SE

Kerschensteinerstrasse 11-15, 92318 Neumarkt, Germany

(540)



(531) 05.03.13; 05.03.14; 19.11.07; 26.01.15; 26.01.16

(511)

5 – Pharmaceutical products; medicines; medicinal preparations; veterinary preparations; dietary supplements for human beings; dietary supplements for animals.

16 – Paper; cardboard; printed matter; photographs.

(260) AM 2018 96647 A

(800) 1390134

(151) 2017 12 28

(891) 2017 12 28

(731) F. HOFFMANN-LA ROCHE AG

Grenzacherstrasse 124 CH-4070 Basel, Switzerland

(540)

XOFLUZA

(591) Black and white

(511)

5 – Pharmaceutical preparations.

(260) AM 2018 96658 A

(800) 1390291

(151) 2017 11 08

(891) 2017 11 08

(731) SHANXI HUANGTENG CHEMICAL CO., LTD.

No.1 Chemical Industrial Park Area, Ronghe Town, Wanrong County, Yuncheng City Shanxi Province, China

(540)



(591) Black and white

(531) 27.05.11; 27.05.17; 28.03

(511)

1 – Concrete additives.

(260) AM 2018 96675 A

(800) 1390608
 (151) 2017 09 13
 (891) 2017 09 13
 (731) PEPSICO, INC. (a North Carolina corporation)
 700 Anderson Hill Road Purchase NY 10577,
 USA

(540)



(591) White, black, red, brown, blue, dark blue, light brown and yellow
 (531) 05.09.06; 08.01.03; 26.04.06; 27.05.01; 27.05.15; 29.01.15
 (511)
 30 – Cereal bars; cereal-based snack food; crackers; petit-beurre biscuits; oat-based food; rusks.

(260) AM 2018 96676 A
 (800) 1390624
 (151) 2017 11 29
 (891) 2017 11 29
 (731) CHINA TOBACCO JIANGSU INDUSTRIAL CO., LTD.
 No.406-3 Zhongshan North Road, Nanjing,
 210011 Jiangsu, China

(540)

ROMANTIC

(591) Black, white
 (511)
 34 – Cigarette paper; lighters for smokers; matches; ashtrays for smokers; tobacco; electronic cigarettes; cigars; cigarettes containing tobacco substitutes, not for medical purposes; cigarettes; cigarette cases; cigarette filters.

(260) AM 2018 96686 A
 (800) 1128982
 (151) 2012 02 15
 (891) 2018 01 17
 (731) MANCHESTER UNITED FOOTBALL CLUB LIMITED
 Sir Matt Busby Way, Old Trafford,
 Manchester M16 0RA, United Kingdom

(540)



(591) Black, white
 (531) 04.01.04; 04.03.01; 24.11.07
 (511)

14 – Precious metals and their alloys and goods in precious metals or coated therewith, not included in other classes; jewellery, precious stones; horological and chronometric instruments; watches and clocks; watch straps; costume jewellery; imitation jewellery; semi-precious stones; rings; ear rings; bracelets; brooches; necklaces; key rings, trinkets and fobs; key fobs of leather; pins and pendants; jewellery charms; lapel pins; tie pins and tie clips; cuff links; jewellery cases; badges, key chains, cases, boxes, works of art, busts, statues, trophies, hat and shoe ornaments, all of the aforesaid goods being made wholly or principally of precious metal and their alloys or coated therewith; coins and copper tokens; silver jewellery; medals and medallions; parts and fittings for all of the aforesaid goods.

16 – Paper, cardboard and goods made from these materials; printed matter; bookbinding material; photographs; stationery; adhesives for stationery or household purposes; artists' materials; paint brushes; office requisites; instructional and teaching materials (except apparatus); plastic materials for packaging; newspapers; magazines; periodical publications; books, booklets; binders; programme binders; manuals; writing books and pads; drawing books and pads; instruments and/or materials for writing or drawing; cards; birthday cards; greeting cards; postcards; tickets; timetables; note pads, note books; albums; photograph albums; photo engravings; address books; autograph books; almanacs; diaries; personal organisers; pens; pencils; holders, cases and boxes for pens and/or pencils; blotters, jotters; erasers, erasing products; pencil sharpeners; drawing rulers; book markers; book ends; posters; letter trays; calendars; paper weights; paper clips; gift tags; gift bags of paper or plastic; bags for packaging of paper or plastic; gift wrap; packaging paper; envelopes; folders, labels, seals; blackboards; comic books; scrap books; charts; height charts; carrier bags of paper or plastic, garbage bags of paper or plastic; ink, ink wells; paper knives; poster magazines; signs and advertisement boards of paper or cardboard; adhesive tape, dispensers for adhesive

tape; hat boxes; stencils; beer mats; catalogues; trading cards; collectors' cards; stickers; transfers; decalcomanias; diagrams; printed forms; certificates; menus; gift vouchers; philatelic stamps; paint boxes; patterns and embroidery design; engravings and etchings; place mats, coasters, table cloths, napkins, towels, handkerchiefs, all made from paper; paper flags and pennants; paper banners; toilet paper; maps; place mats and coasters of cardboard; prints and pictures; art prints; graphic prints, representations and reproductions; lithographs, lithographic works of art; portraits; money clips; ID card holders.

18 – Leather and imitations of leather, and goods made of these materials and not included in other classes; trunks and travelling bags; umbrellas, parasols and walking sticks; whips, harness and saddlery; articles for luggage; cases; suitcases; garment bags for travel; bags; school bags and satchels; back packs; rucksacks; beach bags; sports bags; athletic bags; gym bags; boot bags; duffel bags; holdalls; toilet bags; valises; attaché cases; brief cases; wallets; purses; key cases; pouches; credit card cases and holders; umbrella covers; walking canes; bands and straps of leather; leather shoe and boot linings; collars and covers for animals; leather trimmings; laces, leads and leashes; parts and fittings for all of the aforesaid goods.

25 – Clothing, footwear, headgear; articles of outer clothing; articles of sports clothing; leisurewear; articles of underclothing; lingerie; hosiery; footwear being articles of clothing; headgear (for wear); shirts; boots; underwear; coats; overalls; collar protectors and collars; ear muffs; football boots and shoes; fittings of metal for boots and shoes; shorts; T-shirts; socks; sweaters; caps; hats; scarves; jackets; dressing gowns; pyjamas; sandals; slippers; footwear; boxer shorts; beach clothes and shoes; baby boots; bibs; romper suits; baby pants and sleep suits; dungarees; braces; belts; berets; wrist bands; track suits; ties; cravats; aprons; bathrobes; bathing caps and suits; bathing trunks; galoshes; garters; gloves and mittens; headbands; jerseys; jumpers and knitwear; leggings; clothes linings; parkas; shawls; singlets; skirts; vests; visors; waistcoats; waterproof clothing.

26 – Badges for wear; ornamental novelty badges; badges of textile materials; embroidered badges; rosettes of textile materials; patches; buttons, ribbons and braid; hairbands and slides; belt clasps; sewing baskets; blouse, clothing and shoe fasteners; needle and pin cushions; hairgrips; hair ornaments; shoe ornaments; sewing thimbles; hat ornaments; shoe laces; numerals or letters for marking linen; hairnets; brooches and buckles; edging for clothing; competitor numbers; cords; embroidery; expanding bands for holding sleeves; fancy goods; frills and fringes; reins for guiding children; tassels.

28 – Games and playthings; toys; gymnastic and sporting articles; decorations for Christmas trees; apparatus for use in sports; balls for sport; playing balls; footballs; miniature footballs; miniature replica football kits; miniature replica football shirts; goal posts; gloves for games; shin guards; knee guards and protective padding for sports; elbow guards; bags adapted for carrying sporting articles; articles for playing golf; golf balls; golf tees; golf ball markers; golf bags; golf club covers; golf gloves; articles for playing darts; darts; articles for playing snooker; snooker tables; pool tables; skis; slides; surfboards; skateboards; snowboards; sleighs; roller skates; in-line skates; fishing tackle; body-building apparatus; exercise apparatus; dice; cups for dice; dominoes; tables for indoor football; skittles; spinning tops; kites; marbles; marionettes and puppets; bathtub toys; inflatable toys; ride-on toys; toy vehicles; mobiles; board games; card games; playing cards; jigsaw puzzles; models in kit form; electronic hand held game units; rattles; teddy bears; dolls and dolls' clothes; dolls' beds; dolls' houses and rooms; masks; party novelty hats; jokes and novelties; confetti; balloons; Christmas crackers; synthetic Christmas trees and stands; parts and fittings for all of the aforesaid goods.

(260) AM 2018 96691 A

(800) 1387858

(151) 2017 10 27

(891) 2018 02 02

(731) N.V. NUTRICIA

Eerste Stationsstraat 186, NL-2712 HM
Zoetermeer, Netherlands

(540)



(591) Blue and light blue.

(531) 26.01.01; 26.01.06; 26.05.01; 26.05.19;

27.05.08; 29.01.13

(511)

5 – Food for special medical purposes; dietetic substances adapted for medical use; food for babies, infants and invalids; food for babies with special nutritional needs; milk for babies and infants; nutritional dietary supplements for medical use; nutritional products for medical usage; cereals for infants; vitamin preparations; food supplements for pregnant, lactating and breast feeding women; fruit, vegetable, and coconut milk based snacks for babies, excluding ice cream, ice milk and frozen yogurt.

29 – Milk and milk products; milk powder; prepared meals for toddlers consisting primarily of meat, fish, poultry, or vegetables; frozen, prepared or packaged hand-held meals consisting primarily of meat, fish, poultry, or vegetables; snack food primarily consisting of fruits and nuts; fruit-based snack foods; fruit and nut butter combination snack foods; yogurt; yogurt-based snack foods; yogurt-based organic snack foods; fruit, vegetable, and coconut milk based snacks for human consumption, excluding ice cream, ice milk and frozen yogurt; yogurt drinks; freeze-dried fruit and yogurt snacks; freeze-dried fruits and vegetables in the form of a chip; fruit purees; milk; flavored milk; fruit-based organic snack foods; vegetable-based organic snack foods; milk for pregnant, lactating and breast feeding women; apple-sauce.

30 – Cereals and preparations made from cereals; breakfast cereals; cereal bars; muesli; snack food, cereal-based; snack food, rice-based; biscuits.

32 – Beverages enriched with additional minerals (not being for medical use); beverages enriched with added vitamins (not for medical purposes); mineral waters; mineral-enriched non-alcoholic beverages; flavoured waters; fruit beverages and fruit juices; vegetable beverages and vegetable juices.

(260) AM 2018 96700 A

(800) 1389717

(151) 2017 11 20

(891) 2017 11 20

(731) SHENZHEN KTC TECHNOLOGY CO., LTD.

1 Floor A District, 2 Floor B District,
Workshop 1, Northern Wuhe Road, Gangtuo
Village, Buji Town, Longgang District,
Shenzhen Guangdong, China

(540)



(591) Black, white

(531) 27.05.01; 27.05.17

(511)

9 – Notebook computers; computer software, recorded; electronic pens [visual display units]; computer memory devices; computer peripheral devices; computer game software; monitors [computer hardware]; data processing apparatus; television apparatus; laptop computers.

(260) AM 2018 96701 A

(800) 1389722

(151) 2017 11 27

(891) 2017 11 27

(731) FUJIAN HOPE CULTURE

COMMUNICATION CO., LTD.

Room 501, No.63, Wanghai Road, Siming

District, Xiamen City Fujian Province

361000, China

(540)



(591) Black, white

(531) 26.11.02; 26.11.06; 26.11.12; 27.07.01;
27.07.17

(511)

35 – Advertising; commercial administration of the licensing of the goods and services of others; sales promotion for others; employment agency services; secretarial services; book-keeping; rental of vending machines; sponsorship search; rental of sales stands.

(260) AM 2018 96703 A

(800) 1389746

(151) 2017 09 22

(891) 2017 09 22

(731) ELVA GROUP" Limited Liability Company
Narimanov district, Hasanoghlu 4A, courtyard
851-852 AZ-1033 Baku, Azerbaijan

(540)



(591) Red

(531) 03.04.13; 03.06.05; 27.05.01; 27.05.04;
27.05.08; 29.01.01

(511)

43 – Services for providing food and drink; temporary accommodation.

(260) AM 2018 96704 A

(800) 1389750

(151) 2017 10 27

(891) 2017 10 27

(731) Obshchestvo s ogranichennoy
otvetstvennostyu "ARGO"
ul. Lenina, dom 34, of. 63 RU-197136
Saint Petersburg, Russian Federation

(540)



(531) 28.05

(511)

9 – Computer game software; computer operating programs, recorded; computer programmes [programs], recorded; computer programs [downloadable software]; computer software applications, downloadable; computer software, recorded; electronic notice boards; electronic publications, downloadable; memory cards for video game machines; monitors [computer programs]; video game cartridges.

35 – Administration of consumer loyalty programs; advertising; publicity; arranging subscriptions to telecommunication services for others; compilation of information into computer databases; design of advertising materials; direct mail advertising; dissemination of advertising matter; layout services for advertising purposes; on-line advertising on a computer network; pay per click advertising; presentation of goods on communication media, for retail purposes; production of advertising films; promotion of sports competitions and events; public relations; publication of publicity texts; publicity material rental; rental of advertising time on communication media; rental of billboards [advertising boards]; sales promotion for others; scriptwriting for advertising purposes; systemization of information into computer databases; updating and maintenance of data in computer databases; updating of advertising material; web indexing for commercial or advertising purposes; writing of publicity texts.

41 – Arranging and conducting of competitions [education or entertainment]; arranging and conducting of games; arranging of competitions via the Internet; arranging of games and competitions via the Internet; conducting of competitions on the Internet; educational and training services relating to games; electronic games services provided by means of a global communication network; electronic games services provided by means of the Internet; electronic games services provided by means of the Internet or other communication network; entertainment information; entertainment services; gambling services; game services provided on-line from a computer network; game services provided via communication networks; gaming; information relating to computer gaming entertainment provided on-line from a computer database or a global communication network; on-line game services; organization and presentation of shows, competitions, games, concerts and entertainment events; organization and provision of games and competitions via the Internet; organization of competitions [education or entertainment]; organization of competitions and award ceremonies; organization of competitions for education or entertainment; organization of educational, entertainment, cultural and sporting competitions; organization of games and competitions; organization of lotteries and other gambling activities; organization of sports competitions; organization of

sports events and competitions; organizing and conducting sports competitions; providing on-line information in the field of computer games entertainment; providing recreation facilities.

(260) AM 2018 96712 A

(800) 1389801

(151) 2017 09 15

(891) 2017 09 15

(731) PHILIPS LIGHTING HOLDING B.V.

High Tech Campus 45, NL-5656 AE

Eindhoven, Netherlands

(540)

SIGNIFY

(591) Black, white

(511)

9 – Control apparatus and computer software programs for lighting apparatus and lighting systems; light control apparatus; lighting control systems; remote control apparatus for controlling lighting; mobile apps for lighting apparatus and lighting systems; projectors; ballasts for lighting installations; light emitting diodes (LEDs), organic light emitting diodes (OLEDs), laser diodes and zener diodes; lasers; electronic components for lighting; sensors and detectors for controlling and switching lighting apparatus and lighting systems; starters for electric lamps; parts of the aforementioned goods.

11 – Apparatus for lighting; lighting fixtures and lighting installations; lamps; light sources [other than for photographic or medical use]; parts of the aforesaid goods.

(260) AM 2018 96714 A

(800) 1389831

(151) 2017 11 27

(891) 2017 11 27

(731) SHENZHEN ROMOSS TECHNOLOGY CO., LTD.

4F, South Yu Yang Building, No. 3 Qimin Rd., Songpingshan, Northern Section, Hi-Tech Industrial Park, Nanshan District Shenzhen, China

(540)



(591) Black, white

(531) 25.05.01; 26.04.04; 26.04.24; 27.05.24

(511)

9 – Computer programs [downloadable software]; bags adapted for laptops; protective films adapted for computer screens; cover for personal digital as-

sistants [PDAs]; smartphone cases; computer network hubs; cell phone cases; cell phone covers; protective cases for smartphones; protective films adapted for smartphones; cabinets for loudspeakers; microphones; sound transmitting apparatus; portable media players; earphones; electronic data recorders for vehicles; selfie stick; flashlights [photography]; materials for electricity mains [wires, cables]; USB cable; sound and image transmission cable; USB cable for mobile phones; plugs, sockets and other contacts [electric connections]; electrical sockets; electric plugs; electric sockets; batteries, electric, for vehicles; battery chargers; batteries; battery chargers; portable power banks [rechargeable batteries].

(260) AM 2018 96715 A

(800) 1389882

(151) 2017 12 06

(891) 2017 12 06

(731) HANKOOK TIRE CO., LTD.

133, Teheran-ro (Yeoksam-dong), Gangnam-gu Seoul, Republic of Korea

(540)

VENTUS PRIME³X

(591) Black, white

(531) 24.17.07; 27.05.17

(511)

12 – Automobile tires; bicycle tires; casings for pneumatic tires; covers for tyres; motorcycle tires; adhesive rubber patches for repairing inner tubes; inner tubes for bicycles; inner tubes for motorcycles; inner tubes for pneumatic tires; inner tubes; inner tubes for tyres; luggage nets for vehicles; pneumatic tires; repair outfits for inner tubes; rims for vehicle wheels; saddle covers for bicycles; saddle covers for motorcycles; safety belts for vehicle seats; brake segments for vehicles; shock absorbers for vehicles; ski carriers for cars; spikes for tires; studs for tires; tires for vehicle wheels; tires, solid, for vehicle wheels; treads for retreading tires; treads for vehicles (roller belts); treads for vehicles (tractor type); tubeless tires for bicycles; tubeless tires for motorcycles; valves for vehicle tires; vehicle wheel tires.

(260) AM 2018 96722 A

(800) 1389947

(151) 2017 10 10

(891) 2017 10 10

(731) TERRA FOOD MANAGEMENT COMPANY LIMITED

Esperidon, 12, 4th floor CY-1087 Nicosia, Cyprus

(540)

MILKLIFE

(591) Black, white

(531) 27.05.17; 27.05.17

(511)

29 – Milk and milk products; albumin milk; peanut butter; peanut milk; peanut milk for culinary purposes; albumen for culinary purposes; white of eggs; cream [dairy products]; oat milk; milk substitutes; whipped cream; condensed milk; yoghurt; kephir [milk beverage]; curd; coconut oil for food; coconut butter; coconut milk; coconut milk for culinary purposes; coconut fat; milk shakes; kumys [kumyss] [milk beverage]; margarine; butter; cocoa butter for food; buttercream; almond milk; almond milk for culinary purposes; milk; powdered milk; milk beverages, milk predominating; milk products; peanut milk-based beverages; coconut milk-based beverages; almond milk-based beverages; prostokvasha [soured milk]; rice milk; rice milk for culinary purposes; ryazhenka [fermented baked milk]; cheese; whey; rennet; smetana [sour cream]; soya milk; milk ferments for culinary purposes.

(260) AM 2018 96773 A

(800) 1391039

(151) 2017 12 05

(891) 2017 12 05

(731) JINJIANGSHI JIALEMEI

UMBRELLA CO., LTD.

Xiaoxia Industrial Area, Dongshi Town,

Jinjiang City 362000 Fujian Province, China

(540)

LANTANA

(591) Black and white

(511)

18 – Travelling bags and travelling trunks; rucksacks; handbags; umbrella covers; umbrella or parasol ribs; umbrella or parasol frames; umbrella sticks; umbrellas; parasols; umbrella handles.

(260) AM 2018 96774 A

(800) 1391415

(151) 2017 10 13

(891) 2017 10 13

(731) EDESMA SOCIETE ANONYME

INDUSTRIAL AND COMMERCIAL-FOOD PRODUCTION AND TRADING trading as EDESMA S.A.

Industrial Area Sindos A5, GR-570 22

Thessaloniki, Greece

(540)



(591) Black, white, green and yellow. The phrase "AMVROSIA" in yellow lettering, with green background, in a rectangled- curved under the letters white and black outline

(531) 25.03.07; 27.05.24

(511)

29 – Meat; fish; fish, preserved; fish, not live; fish mousses; fish paste; processed seafood; seafood, not live; charcuterie; cured meat; meat preserved; processed meat; sausages; meat paste; meat-based spreads; vegetable salads; vegetable-based spreads; egg-plant paste; vegetable marrow paste; cheese spreads; hummus; antipasto salads; fish paste; bean dips; garlic-based spreads; fish roe, prepared; tzatziki.

30 – Mustard; sauces [condiments]; mayonnaise.

31 – Vegetables, fresh; vegetables marrows, fresh.

(260) AM 2018 96792 A

(800) 948219

(151) 2007 10 18

(891) 2018 01 23

(731) APPLE INC.

One Apple Park Way, Cupertino CA 95014,
USA

(540)

ITUNES

(591) Black, white

(511)

38 – Telecommunication access services; communication by computer; provision of telecommunications connections to computer databases and the Internet; transmission of data and of information via electronic communications networks; broadcasting and transmission of radio and television programs; audio broadcasting of spoken word, music, concerts, and radio programs; broadcasting pre-recorded videos featuring music, television programs, motion pictures, news, sports, games, cultural events, and entertainment-related programs via computer and other communications networks; web casting services; electronic transmission of streamed and downloadable audio and video files via computer and other communications networks; electronic transmission of movies, music and video information via an internet-based database; providing on-line chat rooms, bulletin boards and community forums for the transmission of messages among computer users concerning entertainment, music, concerts, videos, motion pictures, radio, television, news, sports, games and cultural events; providing telecommunications connections to a global computer network, namely, provision of connectivity services and access to electronic communications networks, for transmission or reception of audio, video, movies and/or multimedia content; communication services namely, matching users for the transfer of music, video and audio recordings via communication networks; delivery of messages by electronic transmission.

41 – Entertainment services, namely, providing a website and database featuring music, videos, televi-

sion programs, motion pictures, news, sports, games, cultural events, and entertainment-related programs; arranging and conducting of exhibitions, workshops, seminars and video conferences in the field of music, videos, television programs, motion pictures, news, sports, games, cultural events, and entertainment-related programs; educational services in the nature of classes and training services offered over computer networks in the fields of K-12 education, university-level subjects, topics of general interest, namely, entertainment, music, concerts, videos, motion pictures, radio, television, news, sports, games and cultural events, and computer hardware and software applications; providing electronic publications for browsing over computer networks, namely books, pamphlets, brochures, newsletters, journals, and magazines, on the subjects of education, entertainment, computer hardware and software applications, and a wide range of topics of general interest.

42 – Providing search engines for obtaining data via communications networks; providing temporary use of on-line non-downloadable software to enable users to program audio, video, movies, text and other multimedia content; internet services, namely, creating indexes of information, sites and other resources available on global computer networks for others; searching, browsing and retrieving information, sites, and other resources available on global computer networks and other communication networks for others; providing on-line facilities, via a global computer network, to enable users to program audio, video, movies, text and other multimedia content.

(260) AM 2018 96793 A

(800) 1061483

(151) 2010 10 29

(891) 2018 02 13

(731) AGROQUIMICA CODIAGRO SOCIEDAD
COOPERATIVA VALENCIANA LIMITADA
Pol. Ind. Caseta blanca, C/ Albocácer, 6,
E-12194 VALL D'ALBA (CASTELLÓN), Spain

(540)



(591) Orange, light blue, dark blue and white.

(531) 01.13.15; 26.04.02; 26.04.16; 26.04.22;
27.05.02; 29.01.13

(511)

1 – Chemicals used in industry, science and photography, as well as in agriculture, horticulture and forestry; unprocessed artificial resins, unprocessed plastics; manures; fire extinguishing compositions;

tempering and soldering preparations; chemical substances for preserving foodstuffs; tanning substances; adhesives used in industry.

5 – Pharmaceutical and veterinary products; sanitary products for medical purposes; dietetic substances adapted for medical use, food for babies; plasters, materials for dressings; material for dental fillings and dental impressions; disinfectants; pesticides; fungicides, herbicides.

(260) AM 2018 96831 A

(800) 1392026

(151) 2018 01 17

(891) 2018 01 17

(731) SOREMARTEC SA

Findel Business Center, Complexe B, Rue de Trèves L-2632 Findel, Luxembourg

(540)

KINDER A LITTLE A LOT

(591) Black and white

(511)

30 – Pastry and confectionery; chocolate and chocolate products; biscuits; wafers; candy; edible ice creams; cocoa-based beverages.

(260) AM 2018 96832 A

(800) 1392069

(151) 2017 12 22

(891) 2017 12 22

(731) CILAG GMBH INTERNATIONAL

Gubelstrasse 34 CH-6300 Zug, Switzerland

(540)

GO! TABS

(591) Black and white

(511)

3 – Mouthwashes, dentifrice and breath freshener for non-medical use.

30 – Refreshing tablets for non-medical use for freshening breath (confectionery).

(260) AM 2018 96833 A

(800) 1392098

(151) 2018 01 12

(891) 2018 01 12

(731) BIOFARMA

50 rue Carnot F-92284 SURESNES cedex, France

(540)

DETRA-PROKT

(591) Black and white

(511)

5 – Pharmaceutical products, medical and veterinary preparations; sanitary products for medical purposes;

dietetic food and substances for medical or veterinary use, food for babies; food supplements for humans and animals; plasters, materials for dressings; material for dental fillings and dental impressions; disinfectants; products for destroying vermin; fungicides, herbicides.

(260) AM 2018 96834 A

(800) 1392109

(151) 2017 10 27

(891) 2017 10 27

(731) ADP GAUSELMANN GMBH

Merkur-Allee 1-15 32339 Espelkamp, Germany

(540)

Sparta

(591) Black and white

(511)

9 – Computer software; computer and video games software; games software in particular for use on any computer platform, including electronic entertainment and games consoles; computer game programs; video games (software); computer games provided through a global computer network or supplied by means of multi-media electronic broadcast or through telecommunications or electronic transmission or via the Internet; computer games, leisure and recreational software, video games and computer software, all being provided in the form of storage media; programs for operating electric and electronic apparatus for games, amusement and/or entertainment purposes; electronic terminals for generating lottery tickets; computer software for computer games on the Internet; online games (software), in particular for online betting games, online prize games, online gambling games, online games of skill and online casino games; computer software in the form of an app for mobile devices and computers; operational computer games software; computer software for managing of games (game collection); collection of video games.

(260) AM 2018 96835 A

(800) 1392127

(151) 2017 12 20

(891) 2017 12 20

(731) GLOBAL BEVERAGE INDUSTRIES PTE. LTD.

50 Raffles Place, #32-01 Singapore Land Tower Singapore 048623, Singapore

(540)

XAH

(591) Black and white

(511)

30 – Artificial coffee; chocolate; chocolate beverages with milk; chocolate-based beverages; cocoa;

cocoa beverages with milk; cocoa products; cocoa based beverages; coffee; coffee beverages with milk; coffee-based beverages; flavorings, other than essential oils, for beverages; flavourings, other than essential oils, for beverages; iced tea; tea; tea-based beverages; unroasted coffee; vegetal preparations for use as coffee substitutes.

(260) AM 2018 96836 A

(800) 1392129

(151) 2017 12 27

(891) 2017 12 27

(731) VALENTINO S.P.A.

Via Turati, 16/18 I-20121 MILANO, Italy

(540)

ROCKSTUD

(591) Black and white

(511)

3 – Cosmetics, including night and day creams; preparations for cleaning and care of the face and body; bubble bath; shaving foam; aftershave; make-up foundations; nail polish; body deodorants for men and women; hand and body soap; shampoos and hair rinses; hair spray; dentifrices; fragrances, namely perfume, eau de Cologne, and essential oils for personal use for men and women.

(260) AM 2018 96837 A

(800) 1392147

(151) 2018 01 30

(891) 2018 01 30

(731) FOPE SPA

Via Zampieri, 31 I-36100 Vicenza, Italy

(540)

FOPE

(591) Black and white

(511)

14 – Jewellery; jewellery cases; jewellery charms; neck chains; earrings; bracelets; rings [jewelry]; tie clips; cuff links; clocks; clock cases; paste jewellery; rosaries.

(260) AM 2018 96838 A

(800) 1392209

(151) 2017 11 23

(891) 2017 11 23

(731) LABORATOIRES FILORGA

COSMETIQUES

2 – 4 rue de Lisbonne F-75008 PARIS,

France

(540)

FILORGA

(591) Black and white

(531) 27.05.01

(511)

3 – Soaps; perfumery; essential oils; cosmetics; cosmetic preparations; cosmetic creams, lotions, gels and serums for skin, face and neck care and beauty; hair lotions.

5 – Dermatological preparations for medical use; products for medical use designed to be injected under the skin.

10 – Medical and surgical instruments; apparatus and instruments for beauty purposes; dermal implant for medical use for filling out wrinkles or increasing their volume; hypodermic syringes for medical use.

(260) AM 2018 96853 A

(800) 1317299

(151) 2016 02 08

(891) 2018 02 01

(731) ALESSANDRO BIASOTTO

Via Dotti, 48, I-31100 Treviso, Italy

(540)



(591) Red and white. OO are written in red; letter F is written in white color

(531) 27.01.06; 27.05.01; 27.05.17; 27.05.24; 29.01.12

(511)

25 – Clothing; sweaters; undershirts; long-sleeved undershirts; short-sleeved undershirts; shirts; jackets [clothing]; coats; blousons; trousers; denim trousers; denim pants; jeans; blue jeans; trousers for children; short trousers; denim jackets; T-shirts; gloves [clothing]; scarfs; pocket squares; neck scarfs [mufflers]; waist belts; belts made of leather; belts made of textile materials; gilets; cravats; hats; berets; footwear.

(260) AM 2018 96855 A

(800) 1366991

(151) 2017 08 02

(891) 2018 02 15

(731) SEAT, S.A.

Autovia A-2 km.585, E-08760 Martorell

(Barcelona), Spain

(540)

SEAT BORN

(591) Black, white

(511)

12 – Vehicles; apparatus for locomotion by land; cars; vehicle parts and accessories.

(260) AM 2018 96856 A

(800) 1366992

(151) 2017 08 02

(891) 2018 02 15

(731) SEAT, S.A.

Autovia A-2 km.585, E-08760 Martorell
(Barcelona), Spain

(540)

SEAT BORN-E

(591) Black, white

(511)

12 – Vehicles; apparatus for locomotion by land;
cars; vehicle parts and accessories.

(260) AM 2018 96857 A

(800) 1366993

(151) 2017 08 02

(891) 2018 02 15

(731) SEAT, S.A.

Autovia A-2 km.585, E-08760 Martorell
(Barcelona), Spain

(540)

SEAT E-BORN

(591) Black, white

(511)

12 – Vehicles; apparatus for locomotion by land;
cars; vehicle parts and accessories.

(260) AM 2018 96870 A

(800) 1392318

(151) 2017 10 20

(891) 2017 10 20

(731) PRO.MED.CS Praha a.s.

Telčská 1, CZ-140 00 Praha 4, Czech
Republic

(540)

ALSIZA

(591) Black, white

(511)

5 – Pharmaceutical preparations.

(260) AM 2018 96871 A

(800) 1392319

(151) 2017 10 20

(891) 2017 10 20

(731) PRO.MED.CS Praha a.s.

Telčská 1, CZ-140 00 Praha 4, Czech
Republic

(540)

АЛСИЗА

(591) Black, white

(531) 28.05

(511)

5 – Pharmaceutical preparations.

(260) AM 2018 96872 A

(800) 1392389

(151) 2017 10 25

(891) 2017 10 25

(731) BIOMÉRIEUX

F-69280 Marcy l'Etoile, France

(540)

BIOMERIEUX

(591) Black, white

(531) 27.05.01

(511)

35 – Database management; computer compilation
and processing, namely compilation and systemati-
zation of data and scientific and technical docu-
ments in computer databases; updating and correction of
scientific and technical documents and data; advice
in the field of cost reduction, in particular services of
assistance in personnel management, inventories,
procurement of goods and cost control, stock con-
trol, reduction in waste and inefficiency; all these
services dedicated to scientific, medical, veterinary,
diagnostic fields and the field of laboratory and
research techniques.

37 – Installation, servicing, maintenance, repair and
updating of scientific, diagnostic and laboratory ins-
truments.

41 – Training; teaching and education; organization
and conducting of exhibitions, colloquiums, confer-
ences, congresses, seminars, symposiums, forums
and other events for cultural or educational pur-
poses; editing and publishing of books and journals;
electronic publication of online books and journals;
all the aforesaid services provided exclusively in the
scientific, medical, veterinary, diagnostic fields and
in the field of laboratory and research techniques.

42 – Research and development in the scientific, me-
dical, veterinary, diagnostic fields, in the field of
laboratory and research techniques and in the sector
of research and data processing; consulting services
in the scientific, technological, diagnostic and labo-
ratory technique sectors; technical and scientific
consulting and support for customers purchasing sci-
entific, technological, laboratory and diagnostic ap-
paratus; providing scientific information via Internet
portals; providing information in the sector of labo-
ratory technology; technical and scientific services
of a laboratory and health center; analytical labo-
ratory services; biological research laboratory servi-
ces; medical research laboratory services; scientific
laboratory services; laboratory work; development,
design, installation, maintenance, repair, updating,
technical support and rental of computer systems
and software dedicated to scientific, technological,

diagnostic fields and laboratory techniques; software as a service (SaaS), namely providing a software platform for the interconnection and exchange of data between scientific, technological, diagnostic and laboratory apparatus and instruments for the transfer of data, images, messages and audio, visual and audiovisual data; assistance and technical consultancy for connecting computer, electronic and digital systems in a laboratory; technical project studies for installing scientific, technological, diagnostic and laboratory apparatus and instruments, consultancy relating to laboratory interior design, especially the design and optimization of space, technical advice and the implementation of scientific systems or scientific, technological, diagnostic and laboratory combinations of systems adapted to customer requirements; assistance in quality policy in relation to regulations, standards and current directives, namely assistance and consultancy services for quality control for qualifying systems, implementing protocols for the validation of methods, the validation of methods and parameters for laboratory accreditation; introduction or improvement of quality management systems, namely introducing or improving a system to test, authenticate and control the quality of operational procedures, working methods and performance indicators; assistance in tracking laboratory products, namely the introduction of systems and operational procedures to track, recognize, sort, select, read and analyze laboratory products; research, advice, auditing and consultancy relating to the automation and optimization of scientific and industrial laboratory procedures; electronic data storage for others; medical diagnosis and analysis for diagnostics, clinical research and industrial applications; services of scientific and industrial researchers and consultants, especially in the fields of human and veterinary medicine, pharmacology, biology, biotechnology, food and beverage products, cosmetics, pharmaceuticals and environmental technology.

44 – Medical and veterinary consultancy; medical services of a laboratory or health center; medical consulting and support for customers purchasing scientific, technological, laboratory or diagnostic apparatus and instruments; providing medical and veterinary information; rental and placement of scientific, technological, diagnostic, medical and laboratory apparatus, instruments and equipment; medical, veterinary and hospital services.

(260) AM 2018 96952 A

(800) 1393569

(151) 2017 11 24

(891) 2017 11 24

(731) SERGE FERRARI

ZI de la Tour du Pin, F-38110 SAINT-JEAN-DE-SOUDAIN, France

(540)

ALPHALIA

(591) Black, white

(531) 27.05.01

(511)

19 – Non-metallic building materials; transportable buildings not of metal; ceilings (not of metal); false ceilings (not of metal); stretch ceilings; wall panels (not of metal); non-metallic composite structures for coating surfaces.

24 – Fabrics; textiles and fabrics coated or impregnated with plastic materials as well as articles made thereof; textile materials made from composite materials; coated fabrics and cloths, fabrics, especially coated fabrics for making blinds, awnings, wall coverings, panels, suspended acoustic panels, ceiling coverings; canvas, hangings, blinds, banners, of textile materials coated with plastic; composite fabrics and textiles; coated, calendered, impregnated or lined fabrics (woven, knitted, non-woven).

(260) AM 2018 96955 A

(800) 1393344

(151) 2017 11 30

(891) 2017 11 30

(731) LLP "Kainar-AKB"

Medeu, 1 040006 Taldykorgan, Kazakhstan

(540)

KAINAR

(591) Black and white

(531) 27.05.01; 27.05.17

(511)

1 – Sulfuric acid; battery electrolytes.

9 – Accumulators, electric; accumulators, electric, for vehicles; flashing lights [luminous signals]; acidimeters for batteries; battery jars; batteries for lighting; batteries, electric; simulators for the steering and control of vehicles; cables, electric; wire connectors [electricity]; collectors, electric; commutators; condensers [capacitors]; battery boxes; vehicle radios; voltage regulators for vehicles; grids for batteries; vehicle breakdown warning triangles; battery chargers; chargers for electric batteries.

35 – Import-export agency services; demonstration of goods; market studies; business information; commercial information and advice for consumers [consumer advice shop]; business management and organization consultancy; business organization consultancy; business management consultancy; professional business consultancy; marketing; organization of trade fairs for commercial or advertising purposes; business management assistance; commercial or industrial management assistance; presentation of

goods on communication media, for retail purposes; sales promotions at point of purchase or sale, for others; advisory services for business management; commercial administration of the licensing of the goods and services of others; administrative processing of purchase orders; procurement services for others [purchasing goods and services for other businesses]; retail services relating to engineering goods; retail services relating to accumulators, electric, for vehicles; retail services provided by means of mail order catalogs; retail services provided by television stores; computerized on-line retail store services.

(260) AM 2018 96956 A

(800) 1393366

(151) 2018 02 13

(891) 2018 02 13

(731) SCHNADIG INTERNATIONAL

CORPORATION

4200 Tudor Lane Greensboro NC 27410,
USA

(540)

CARACOLE

(591) Black and white

(511)

20 – Furniture.

(260) AM 2018 97133 A

(800) 1395632

(151) 2017 07 21

(891) 2017 07 21

(731) ADP GAUSELMANN GMBH

Merkur-Allee 1-15; 32339 Espelkamp,
Germany

(540)

Dragull

(591) Black, white

(511)

9 – Computer software; coin-operated mechanisms; computer and video games software; games software, in particular for use on any computer platform, including electronic entertainment and games consoles; computer game programs; video games (software); computer games provided through a global computer network or supplied by means of multimedia electronic broadcast or through telecommunications or electronic transmission or via the internet; computer games, leisure and recreational software, video games and computer software, all being provided in the form of storage media; programs for operating electric and electronic apparatus for games, amusement and/or entertainment purposes; computer software for computer games on the internet; online games (software), in particular for on-

line betting games, online prize games, online gambling games, online games of skill and online casino games; computer software in the form of an app for mobile devices and computers; calculating apparatus in coin-operated machines and parts for the aforesaid goods; electric, electronic, optical or automatic apparatus, for identifying data carriers, identity cards and credit cards, bank notes and coins; computer hardware and software for casino and amusement arcade games, for gaming machines, slot machines, video lottery gaming machines with or without prize payout and/or for gaming via telecommunications networks and/or the internet, with or without prize payouts, for gaming with or without prize payouts via the internet or via telecommunications networks, or for gaming with or without prize payouts for use in telecommunications apparatus; gaming software that generates or displays wager outcomes of gaming machines; operational computer games software.

28 – Games; toys; gaming apparatus (including coin-operated apparatus); coin-operated arcade games (machines); games for amusement arcades (included in this class); coin-operated video gaming apparatus; video games apparatus adapted for use with external screens or monitors only; casino fittings, namely roulette tables, roulette wheels; coin-operated automatic gaming machines and gaming machines, in particular for gaming arcades, with or without a prize payout; electronic or electrotechnical gaming apparatus, automatic gaming machines, gaming machines, slot machines operated by coins, tokens, banknotes, tickets or by means of electronic, magnetic or biometric storage media, in particular for commercial use in casinos and amusement arcades, with or without a prize payout; automatic gaming machines and gaming machines, in particular for commercial use in casinos and gaming arcades, with or without a prize payout; coin-operated gaming machines and/or electronic money-based gaming apparatus (machines), with or without prizes; housings adapted for gaming machines, gaming apparatus and automatic gaming machines, operated by means of coins, tokens, tickets or by means of electronic, magnetic or biometric storage media, in particular for commercial use in casinos and gaming arcades, with or without a prize payout; electronic games; electronic game entertainment apparatus and parts thereof; video output game machines; drawing apparatus for prize games and lotteries, draws or raffles; housings of metal, plastic and/or wood for coin-operated automatic machines; apparatus for games (including video games), other than adapted for use with external screens or monitors only; electropneumatic and electric slot machines with pulling handles (gaming machines); gaming tables, in particular for table football, billiards, sliding games; flying discs (toys) and darts; gaming machines, namely, electric, electronic or electromechanical apparatus for bingo games, lotteries or video lottery games and for bet-

ting offices, connected or unconnected to a computer network; LCD games consoles; automatic gaming machines; the aforesaid automatic gaming machines operating in networks; apparatus and devices for accepting and storing money, being fittings for the aforesaid automatic machines, included in this class; automatic lottery machines.

(260) AM 2018 97144 A

(800) 1035326

(151) 2010 03 19

(891) 2018 03 09

(731) MONTRES TUDOR SA

Rue François-Dussaud 3; CH-1211 Genève
26, Switzerland

(540)

TUDOR ADVISOR

(591) Black, white

(511)

14 – Jewelry, timepieces, namely watches, wristwatches, component parts for timepieces and accessories for timepieces not included in other classes; clocks and other chronometric instruments, chronometers, chronographs, apparatus for timing sports events, time measuring and marking apparatus and instruments not included in other classes; dials, boxes, cases and presentation cases for timepieces and jewelry.

(260) AM 2018 97145 A

(800) 1046048

(151) 2010 07 13

(891) 2018 03 07

(731) MONTRES TUDOR SA

Rue François-Dussaud 3; CH-1211 Genève
26, Switzerland

(540)

TUDOR HERITAGE

(591) Black, white

(511)

14 – Jewelry, timepieces, namely watches, wristwatches, component parts for timepieces and accessories for timepieces not included in other classes, clocks and other chronometric instruments, chronometers, chronographs, timing apparatus for sports activities, time measuring and marking apparatus and instruments not included in other classes; dials, boxes and presentation cases for timepieces and jewelry.

(260) AM 2018 97146 A

(800) 1083930

(151) 2011 06 27

(891) 2018 03 06

(731) MONTRES TUDOR SA

Rue François-Dussaud 3; CH-1211 Genève
26, Switzerland

(540)

TUDOR FASTRIDER

(591) Black, white

(511)

14 – Jewelry, timepieces, namely watches, wristwatches, component parts for timepieces and accessories for timepieces not included in other classes, clocks and other chronometric instruments, chronometers, chronographs, apparatus for timing sports events, time measuring and marking apparatus and instruments not included in other classes; dials, hands (timepieces), boxes, cases and presentation cases for timepieces and jewelry.

(260) AM 2018 97148 A

(800) 1118224

(151) 2012 05 10

(891) 2018 03 09

(731) MONTRES TUDOR SA

Rue François-Dussaud 3, CH-1211 Genève
26, Switzerland

(540)

BLACK BAY

(591) Black, white

(511)

14 – Jewelry, timepieces, namely watches, wristwatches, component parts for timepieces and accessories for timepieces not included in other classes, clocks and other chronometric instruments, chronometers, chronographs, apparatus for timing sports events, time measuring and marking apparatus and instruments not included in other classes; dials, clock hands (clock and watch making), boxes, cases and display cases for timepieces and jewelry.

(260) AM 2018 97149 A

(800) 1118225

(151) 2012 05 10

(891) 2018 03 08

(731) MONTRES TUDOR SA

Rue François-Dussaud 3; CH-1211 Genève
26, Switzerland

(540)

PELAGOS

(591) Black, white

(511)

14 – Jewelry, timepieces, namely watches, wristwatches, component parts for timepieces and accessories for timepieces not included in other classes, clocks and other chronometric instruments, chronometers, chronographs, apparatus for timing sports events, time measuring and marking apparatus and instruments not included in other classes; dials,

clock hands (clock and watch making), cases, boxes and presentation cases for timepieces and jewelry.

(260) AM 2018 97151 A

(800) 1145661

(151) 2012 12 11

(891) 2018 02 15

(731) DUVEL MOORTGAT, naamloze

Vennootschap

Breendonkdorp 58, B-2870 PUURS, Belgium

(540)

DUVEL

(591) Black, white

(511)

32 – Beers including porter and ales.

(260) AM 2018 97152 A

(800) 1190751

(151) 2013 12 13

(891) 2018 03 09

(731) Montres Tudor SA

Rue François-Dussaud 3; CH-1211 Genève

26, Switzerland

(540)

TUDOR HERITAGE RANGER

(591) Black, white

(511)

14 – Jewelry, timepieces, namely watches, wristwatches, components of timepieces and accessories for timepieces not included in other classes, clocks and other chronometric instruments, chronometers, chronographs (timepieces), apparatus for timing sports events, time measuring and marking apparatus and instruments not included in other classes; dials (for timepieces), hands (for timepieces), boxes, cases and presentation cases for timepieces and jewelry.

(260) AM 2018 97163 A

(800) 1392762

(151) 2017 07 24

(891) 2018 03 01

(731) VALENTINO S.P.A.

Via Turati, 16/18; I-20121 MILANO, Italy

(540)

VLTN

(591) Black, white

(511)

18 – Leather and imitations of leather; purses; school book bags; bags (nose-) [feed bags]; card wallets [leatherware]; traveling trunks; travelling bags; backpacks; wallets; grocery tote bags; attache cases; beach bags; casual bags; handbags; travel baggage;

handbag frames; purses; document cases; cases made of leather; beauty cases sold empty; key-cases of leather and skins; travel garment covers; sport bags; hat boxes of leather; bags (garment -) for travel; straps (leather shoulder -); straps (leather -); raw skins; dog collars; clothing for pets; umbrellas; walking sticks; walking staffs; whips, harness and saddle; harness fittings.

25 – Clothing; coveralls; underwear; jumpers; shirts; sweaters; tutus; ready-made clothing; breeches; tops [clothing]; articles of knitwear; coats; skirts; petticoats; sweaters; topcoats; jackets [clothing]; quilted jackets; ski jackets; ski trousers; parkas; leather clothing; tee-shirts; chemisettes; trousers; dressing gowns; tights; gilets; jerseys; pajamas (Am.); robes; brassieres; vest tops; bustiers; briefs; children's wear; layettes; swimming caps; swimming costumes; clothing for gymnastics; rainproof clothing; mackintoshes; masquerade costumes; footwear; slippers; bath sandals; boots; boots for sports; riding shoes; galoshes; shoes; beach shoes; sandals; training shoes; gymnastic shoes; overshoes; headgear; hats; berets; visors; socks; stocking suspenders; stockings; garters; gloves [clothing]; fingerless gloves; muffs [clothing]; shawls; neckties; bow ties; scarves, sashes for wear; veils [clothing]; bandanas [neckerchiefs]; furs (clothing); stoles of fur; waist belts; wedding dresses.

INTERNATIONAL TRADEMARKS PROTECTED IN GEORGIA

(260) AM 2018 89141 A
(800) 1300472A
(151) 2016 03 09
(181) 2026 03 09
(891) 2016 06 29
(511) 12

(260) AM 2018 91300 A
(800) 1334555
(151) 2016 09 20
(181) 2026 09 20
(891) 2016 09 20
(511) 16, 35, 41, 45

(260) AM 2018 89569 A
(800) 1319219
(151) 2016 08 03
(181) 2026 08 03
(891) 2016 08 03
(511) 05

(260) AM 2018 91954 A
(800) 1340359
(151) 2016 09 27
(181) 2026 09 27
(891) 2016 09 27
(511) 31

(260) AM 2018 90949 A
(800) 1331603
(151) 2016 09 20
(181) 2026 09 20
(891) 2016 09 20
(511) 16, 35, 41, 45

(260) AM 2018 93340 A
(800) 1355853
(151) 2017 03 20
(181) 2027 03 20
(891) 2017 03 20
(511) 38, 41

(260) AM 2018 91044 A
(800) 1332843
(151) 2016 06 07
(181) 2026 06 07
(891) 2016 06 07
(511) 01, 02, 16, 17, 19, 20, 27, 35, 36, 37, 40, 42

(260) AM 2018 93367 A
(800) 1235618
(151) 2014 04 15
(181) 2024 04 15
(891) 2017 05 01
(511) 29

(260) AM 2018 91048 A
(800) 1332846
(151) 2016 06 07
(181) 2026 06 07
(891) 2016 06 07
(511) 01, 02, 16, 17, 19, 20, 27, 35, 36, 37, 40, 42

(260) AM 2018 93392 A
(800) 1355038
(151) 2016 12 06
(181) 2026 12 06
(891) 2016 12 06
(511) 28

(260) AM 2018 91091 A
(800) 1332844
(151) 2016 06 07
(181) 2026 06 07
(891) 2016 06 07
(511) 19

(260) AM 2018 93398 A
(800) 1355099
(151) 2017 02 24
(181) 2027 02 24
(891) 2017 02 24
(511) 03, 05

(260) AM 2018 91250 A
(800) 1334107
(151) 2016 09 20
(181) 2026 09 20
(891) 2016 09 20
(511) 16, 35, 41, 45

(260) AM 2018 93446 A
(800) 1356690
(151) 2016 12 09
(181) 2026 12 09
(891) 2016 12 09
(511) 03, 09, 14, 18, 25, 26, 28, 35

(260) AM 2018 93489 A
(800) 1357038
(151) 2017 04 11
(181) 2027 04 11
(891) 2017 04 11
(511) 35

(260) AM 2018 93597 A
(800) 1357666
(151) 2017 02 06
(181) 2027 02 06
(891) 2017 02 06
(511) 01, 02, 17, 19

(260) AM 2018 94284 A
(800) 1365600
(151) 2017 07 19
(181) 2027 07 19
(891) 2017 07 19
(511) 35

(260) AM 2018 94432 A
(800) 920460
(151) 2006 12 23
(181) 2026 12 23
(891) 2017 08 18
(511) 30

(260) AM 2018 94485 A
(800) 1368368
(151) 2017 09 01
(181) 2027 09 01
(891) 2017 10 09
(511) 14

(260) AM 2018 94486 A
(800) 1368000
(151) 2017 02 02
(181) 2027 02 02
(891) 2017 02 02
(511) 03, 16, 35

(260) AM 2018 94503 A
(800) 1368026
(151) 2017 04 11
(181) 2027 04 11
(891) 2017 04 11
(511) 16, 25, 28

(260) AM 2018 94511 A
(800) 1367863
(151) 2016 11 16
(181) 2026 11 16

(891) 2016 11 16
(511) 44

(260) AM 2018 94542 A
(800) 1311611
(151) 2015 12 29
(181) 2025 12 29
(891) 2017 06 16
(511) 07, 08, 09

(260) AM 2018 94606 A
(800) 1369793
(151) 2017 09 07
(181) 2027 09 07
(891) 2017 09 07
(511) 36

(260) AM 2018 94628 A
(800) 1369310
(151) 2017 01 27
(181) 2027 01 27
(891) 2017 01 27
(511) 01, 02, 07, 09, 10, 16, 17, 37, 40, 41, 42

(260) AM 2018 94629 A
(800) 1369963
(151) 2017 06 30
(181) 2027 06 30
(891) 2017 06 30
(511) 38, 41

(260) AM 2018 94630 A
(800) 1369984
(151) 2017 07 06
(181) 2027 07 06
(891) 2017 07 06
(511) 19, 27

(260) AM 2018 94633 A
(800) 1369313
(151) 2017 06 05
(181) 2027 06 05
(891) 2017 06 05
(511) 05

(260) AM 2018 94650 A
(800) 1369631
(151) 2017 03 03
(181) 2027 03 03
(891) 2017 03 03
(511) 36

(260) AM 2018 94652 A
(800) 1369706
(151) 2017 09 07
(181) 2027 09 07
(891) 2017 09 07
(511) 09

(260) AM 2018 94765 A
(800) 1370805
(151) 2017 02 27
(181) 2027 02 27
(891) 2017 02 27
(511) 12, 35

(260) AM 2018 94767 A
(800) 1370831
(151) 2017 07 17
(181) 2027 07 17
(891) 2017 07 17
(511) 01, 04

(260) AM 2018 94801 A
(800) 1370102
(151) 2017 06 14
(181) 2027 06 14
(891) 2017 06 14
(511) 08, 16, 20, 24, 35

(260) AM 2018 94807 A
(800) 1370151
(151) 2017 05 24
(181) 2027 05 24
(891) 2017 05 24
(511) 36, 39

(260) AM 2018 94812 A
(800) 1370368
(151) 2016 10 13
(181) 2027 10 13
(891) 2016 10 13
(511) 03, 05, 10, 11, 21

(260) AM 2018 94814 A
(800) 1370432
(151) 2017 06 15
(181) 2027 06 15
(891) 2017 06 15
(511) 32

(260) AM 2018 94818 A
(800) 1372290
(151) 2017 07 31
(181) 2027 07 31

(891) 2017 07 31
(511) 29, 30

(260) AM 2018 94841 A
(800) 962520
(151) 2008 03 11
(181) 2028 03 11
(891) 2017 09 21
(511) 32

(260) AM 2018 94884 A
(800) 1371784
(151) 2017 09 18
(181) 2027 09 18
(891) 2017 09 18
(511) 28

(260) AM 2018 94885 A
(800) 1371796
(151) 2017 06 16
(181) 2027 06 16
(891) 2017 06 16
(511) 29, 43

(260) AM 2018 94886 A
(800) 1371797
(151) 2017 06 09
(181) 2027 06 09
(891) 2017 06 09
(511) 09

(260) AM 2018 94888 A
(800) 1371843
(151) 2017 09 04
(181) 2027 09 04
(891) 2017 09 04
(511) 03

(260) AM 2018 94892 A
(800) 1371867
(151) 2017 09 22
(181) 2027 09 22
(891) 2017 09 22
(511) 09

(260) AM 2018 94894 A
(800) 1371881
(151) 2026 04 04
(181) 2026 04 19
(891) 2016 04 19
(511) 09, 35, 36, 38

(260) AM 2018 94899 A
(800) 1371938
(151) 2017 05 02
(181) 2027 05 02
(891) 2017 05 02
(511) 32, 35, 39

(260) AM 2018 94900 A
(800) 1371958
(151) 2017 07 25
(181) 2027 07 25
(891) 2017 07 25
(511) 18, 25, 35

(260) AM 2018 94917 A
(800) 1372232
(151) 2017 06 23
(181) 2027 06 23
(891) 2017 06 23
(511) 03, 05

(260) AM 2018 94929 A
(800) 1373313
(151) 2017 07 05
(181) 2027 07 05
(891) 2017 07 05
(511) 24

(260) AM 2018 94932 A
(800) 1373344
(151) 2017 07 19
(181) 2027 07 19
(891) 2017 07 19
(511) 03, 05, 10, 35

(260) AM 2018 94933 A
(800) 1373346
(151) 2017 08 29
(181) 2027 08 29
(891) 2017 08 29
(511) 05

(260) AM 2018 94942 A
(800) 1372469
(151) 2017 07 25
(181) 2027 07 25
(891) 2017 07 25
(511) 25

(260) AM 2018 94945 A
(800) 1372504
(151) 2017 09 13
(181) 2017 09 13

(891) 2017 09 13
(511) 10

(260) AM 2018 94947 A
(800) 1372608
(151) 2017 09 01
(181) 2027 09 01
(891) 2017 09 01
(511) 14

(260) AM 2018 94948 A
(800) 1372633
(151) 2017 06 02
(181) 2027 06 02
(891) 2017 06 02
(511) 11, 21, 35

(260) AM 2018 94950 A
(800) 1372647
(151) 2017 06 20
(181) 2027 06 20
(891) 2017 06 20
(511) 08, 16, 24, 26, 28

(260) AM 2018 94951 A
(800) 1373556
(151) 2016 11 14
(181) 2026 11 14
(891) 2016 11 14
(511) 01, 03, 04, 07

(260) AM 2018 94952 A
(800) 1373562
(151) 2017 04 10
(181) 2027 04 10
(891) 2017 04 10
(511) 18, 25

(260) AM 2018 94953 A
(800) 1373566
(151) 2017 07 25
(181) 2027 07 25
(891) 2017 07 25
(511) 07

(260) AM 2018 94955 A
(800) 1373568
(151) 2017 08 14
(181) 2027 08 14
(891) 2017 08 14
(511) 30, 31

(260) AM 2018 94964 A
(800) 1372833
(151) 2017 08 08
(181) 2027 08 08
(891) 2017 08 08
(511) 04, 06, 16, 35, 36, 39, 41, 42, 43, 44

(260) AM 2018 94965 A
(800) 1372844
(151) 2017 08 21
(181) 2027 08 21
(891) 2017 08 21
(511) 11

(260) AM 2018 94966 A
(800) 1049688
(151) 2010 06 11
(181) 2020 06 11
(891) 2017 08 09
(511) 07, 11

(260) AM 2018 94967 A
(800) 1121328
(151) 2012 01 26
(181) 2022 01 26
(891) 2017 10 12
(511) 35, 41, 45

(260) AM 2018 94968 A
(800) 1135152
(151) 2012 08 20
(181) 2022 08 20
(891) 2017 09 21
(511) 32

(260) AM 2018 94969 A
(800) 1237498
(151) 2014 08 27
(181) 2024 08 27
(891) 2017 09 01
(511) 29, 30, 35

(260) AM 2018 94970 A
(800) 1250715
(151) 2014 12 30
(181) 2024 12 30
(891) 2017 04 21
(511) 39

(260) AM 2018 94993 A
(800) 1372885
(151) 2017 05 18
(181) 2027 05 18

(891) 2017 05 18
(511) 01, 05

(260) AM 2018 94994 A
(800) 1372893
(151) 2017 05 31
(181) 2027 05 31
(891) 2017 05 31
(511) 18, 25, 35

(260) AM 2018 94995 A
(800) 1372931
(151) 2017 07 19
(181) 2027 07 19
(891) 2017 07 19
(511) 03, 05, 10

(260) AM 2018 94997 A
(800) 1373125
(151) 2017 08 21
(181) 2027 08 21
(891) 2017 08 21
(511) 09

(260) AM 2018 94998 A
(800) 1373129
(151) 2017 08 29
(181) 2027 08 29
(891) 2017 08 29
(511) 03

(260) AM 2018 95000 A
(800) 1373222
(151) 2017 08 26
(181) 2027 08 26
(891) 2017 04 26
(511) 03, 05, 09, 10, 12, 13, 14, 16, 18, 20, 21, 22,
23, 24, 25, 26, 27, 28, 29, 30, 31, 32, 38, 41,
42, 43

(260) AM 2018 95001 A
(800) 1373225
(151) 2017 05 09
(181) 2027 05 09
(891) 2017 05 09
(511) 12, 35

(260) AM 2018 95003 A
(800) 1373278
(151) 2017 07 10
(181) 2027 07 10
(891) 2017 07 10

(511) 03, 05, 09, 10, 12, 13, 14, 16, 18, 20, 21, 22,
23, 24, 25, 26, 27, 28, 29, 30, 31, 32, 38, 41,
42, 43

(260) AM 2018 95004 A
(800) 1373308
(151) 2017 07 20
(181) 2027 07 20
(891) 2017 07 20
(511) 05, 10

(260) AM 2018 95005 A
(800) 1373309
(151) 2017 07 20
(181) 2027 07 20
(891) 2017 07 20
(511) 05, 10

(260) AM 2018 95016 A
(800) 1374285
(151) 2017 04 14
(181) 2027 04 14
(891) 2017 04 14
(511) 35

(260) AM 2018 95055 A
(800) 833891
(151) 2004 05 21
(181) 2024 05 21
(891) 2017 10 02
(511) 25, 28

(260) AM 2018 95060 A
(800) 1343871
(151) 2017 01 30
(181) 2027 01 30
(891) 2017 09 01
(511) 09

(260) AM 2018 95064 A
(800) 1356110
(151) 2017 05 04
(181) 2027 05 04
(891) 2017 09 15
(511) 12, 36, 37

(260) AM 2018 95075 A
(800) 1373114
(151) 2017 05 19
(181) 2027 05 19
(891) 2017 05 19
(511) 29, 30

(260) AM 2018 95084 A
(800) 1373661
(151) 2017 08 04
(181) 2027 08 04
(891) 2017 08 04
(511) 07

(260) AM 2018 95085 A
(800) 1373754
(151) 2017 07 17
(181) 2027 07 17
(891) 2017 07 17
(511) 05, 29, 30, 31, 32, 35, 39, 43

(260) AM 2018 95089 A
(800) 1373859
(151) 2017 08 18
(181) 2027 08 18
(891) 2017 08 18
(511) 03

(260) AM 2018 95092 A
(800) 1373923
(151) 2017 09 25
(181) 2027 09 25
(891) 2017 09 25
(511) 34

(260) AM 2018 95094 A
(800) 1373945
(151) 2017 07 26
(181) 2027 07 26
(891) 2017 07 26
(511) 01, 04, 07, 09

(260) AM 2018 95096 A
(800) 1373986
(151) 2017 05 12
(181) 2027 05 12
(891) 2017 05 12
(511) 11, 44

(260) AM 2018 95097 A
(800) 1374020
(151) 2017 08 03
(181) 2027 08 03
(891) 2017 08 03
(511) 03, 35

(260) AM 2018 95098 A
(800) 1374059
(151) 2017 08 04

(181) 2027 08 04
(891) 2017 08 04
(511) 03, 05, 09, 12, 13, 15, 16, 18, 24, 25, 28, 29,
30, 31, 32, 35, 36, 39, 40, 41, 42, 43, 44

(260) AM 2018 95100 A
(800) 1374078
(151) 2017 06 08
(181) 2027 06 08
(891) 2017 06 08
(511) 09

(260) AM 2018 95271 A
(800) 1375931
(151) 2017 06 21
(181) 2027 06 21
(891) 2017 06 21
(511) 04, 39, 40

(260) AM 2018 95277 A
(800) 1376115
(151) 2017 05 03
(181) 2027 05 03
(891) 2017 05 03
(511) 16

(260) AM 2018 95278 A
(800) 1376127
(151) 2017 05 24
(181) 2027 05 24
(891) 2017 05 24
(511) 41

(260) AM 2018 95279 A
(800) 1376840
(151) 2017 09 28
(181) 2027 09 28
(891) 2017 09 28
(511) 41

(260) AM 2018 95282 A
(800) 1376136
(151) 2017 06 02
(181) 2027 06 02
(891) 2017 06 02
(511) 01, 09, 41

(260) AM 2018 95283 A
(800) 1376909
(151) 2017 05 15
(181) 2027 05 15
(891) 2017 05 15

(511) 29, 30, 32

(260) AM 2018 95286 A
(800) 1376991
(151) 2017 05 18
(181) 2027 05 18
(891) 2017 05 18
(511) 34, 41, 43

(260) AM 2018 95288 A
(800) 1377019
(151) 2017 07 17
(181) 2027 07 17
(891) 2017 07 17
(511) 35

(260) AM 2018 95290 A
(800) 1376168
(151) 2017 05 31
(181) 2027 05 31
(891) 2017 05 31
(511) 36

(260) AM 2018 95292 A
(800) 1376180
(151) 2017 06 03
(181) 2027 06 03
(891) 2017 06 03
(511) 09

(260) AM 2018 95295 A
(800) 1181662
(151) 2013 07 22
(181) 2023 07 22
(891) 2017 04 04
(511) 01, 05

(260) AM 2018 95300 A
(800) 1376202
(151) 2017 07 19
(181) 2027 07 19
(891) 2017 07 19
(511) 01, 17, 19

(260) AM 2018 95307 A
(800) 1376259
(151) 2017 09 13
(181) 2027 09 13
(891) 2017 09 13
(511) 30

(260) AM 2018 95308 A
(800) 1376308
(151) 2017 10 02
(181) 2027 10 02
(891) 2017 10 02
(511) 09

(260) AM 2018 95312 A
(800) 1376337
(151) 2017 09 05
(181) 2027 09 05
(891) 2017 09 05
(511) 06

(260) AM 2018 95448 A
(800) 1377573
(151) 2017 06 29
(181) 2027 06 29
(891) 2017 06 29
(511) 09, 35, 38, 41, 42, 45

(260) AM 2018 95474 A
(800) 1379072
(151) 2017 10 11
(181) 2027 10 11
(891) 2017 10 11
(511) 05

(260) AM 2018 95476 A
(800) 1379095
(151) 2017 05 06
(181) 2027 05 06
(891) 2017 05 06
(511) 32

(260) AM 2018 95479 A
(800) 1379154
(151) 2017 10 05
(181) 2027 10 05
(891) 2017 10 05
(511) 28, 30, 41

(260) AM 2018 95481 A
(800) 1379159
(151) 2017 09 29
(181) 2027 09 29
(891) 2017 09 29
(511) 05

(260) AM 2018 95482 A
(800) 1379160
(151) 2017 09 29
(181) 2027 09 29

(891) 2017 09 29
(511) 05

(260) AM 2018 95483 A
(800) 1379176
(151) 2016 10 21
(181) 2026 10 21
(891) 2016 10 21
(511) 03, 09, 14

(260) AM 2018 95641 A
(800) 1380323
(151) 2017 10 18
(181) 2027 10 24
(891) 2017 10 18
(511) 03

(260) AM 2018 95644 A
(800) 1380342
(151) 2017 09 06
(181) 2027 09 06
(891) 2017 09 06
(511) 30

(260) AM 2018 95645 A
(800) 1380343
(151) 2017 10 06
(181) 2027 10 06
(891) 2017 10 06
(511) 44

(260) AM 2018 95646 A
(800) 1380344
(151) 2017 06 21
(181) 2027 06 21
(891) 2017 06 21
(511) 34

(260) AM 2018 95647 A
(800) 1380360
(151) 2017 05 03
(181) 2027 05 03
(891) 2017 05 03
(511) 09

(260) AM 2018 95648 A
(800) 1380387
(151) 2017 04 25
(181) 2027 04 25
(891) 2017 04 25
(511) 09, 12, 35, 36, 37, 38, 39, 41, 42, 45

(260) AM 2018 95649 A
(800) 1380365
(151) 2016 08 01
(181) 2027 08 01
(891) 2016 08 01
(511) 03, 05, 06, 14, 16, 18, 20, 25, 26, 35

(260) AM 2018 95652 A
(800) 1380419
(151) 2017 07 31
(181) 2027 07 31
(891) 2017 07 31
(511) 30

(260) AM 2018 95653 A
(800) 1380438
(151) 2017 09 19
(181) 2027 09 19
(891) 2017 09 19
(511) 05

(260) AM 2018 95702 A
(800) 1201858
(151) 2014 01 16
(181) 2024 11 27
(891) 2017 11 27
(511) 03

(260) AM 2018 95704 A
(800) 1293397
(151) 2015 10 02
(181) 2025 10 02
(891) 2017 11 24
(511) 35, 36

(260) AM 2018 95721 A
(800) 1379407
(151) 2017 09 26
(181) 2027 09 26
(891) 2017 09 26
(511) 05

(260) AM 2018 95723 A
(800) 1379413
(151) 2017 10 12
(181) 2027 10 12
(891) 2017 10 12
(511) 25

(260) AM 2018 95734 A
(800) 1379529
(151) 2017 07 14
(181) 2027 07 14

(891) 2017 07 14
(511) 05

(260) AM 2018 95804 A
(800) 1381192
(151) 2017 10 18
(181) 2027 10 18
(891) 2017 10 18
(511) 38

(260) AM 2018 95805 A
(800) 1381220
(151) 2016 05 30
(181) 2026 05 30
(891) 2016 05 30
(511) 07, 09, 37, 38, 41, 42

(260) AM 2018 95806 A
(800) 1381222
(151) 2017 03 31
(181) 2027 03 31
(891) 2017 03 31
(511) 28, 30

(260) AM 2018 95807 A
(800) 1381288
(151) 2017 07 19
(181) 2027 07 19
(891) 2017 07 19
(511) 29, 35

(260) AM 2018 95808 A
(800) 1381329
(151) 2016 12 16
(181) 2026 12 16
(891) 2016 12 16
(511) 05, 30, 32, 33, 35

(260) AM 2018 95809 A
(800) 1381369
(151) 2016 12 29
(181) 2026 12 29
(891) 2016 12 29
(511) 08, 11, 21, 35

(260) AM 2018 95810 A
(800) 1381417
(151) 2017 08 07
(181) 2027 08 07
(891) 2017 08 07
(511) 03, 21

(260) AM 2018 95811 A
(800) 1381438
(151) 2017 09 13
(181) 2027 09 13
(891) 2017 09 13
(511) 12

(260) AM 2018 95821 A
(800) 1208371
(151) 2014 04 07
(181) 2024 04 07
(891) 2017 09 18
(511) 10, 35

(260) AM 2018 95823 A
(800) 1351642
(151) 2017 03 06
(181) 2027 03 06
(891) 2017 10 12
(511) 30

(260) AM 2018 95824 A
(800) 1369400
(151) 2017 07 26
(181) 2027 07 26
(891) 2017 11 16
(511) 05

(260) AM 2018 95825 A
(800) 1369675
(151) 2017 07 26
(181) 2027 07 26
(891) 2017 11 16
(511) 05

(260) AM 2018 95826 A
(800) 1369676
(151) 2017 07 26
(181) 2027 07 26
(891) 2017 11 16
(511) 05

(260) AM 2018 96022 A
(800) 1383799
(151) 2017 03 30
(181) 2027 03 30
(891) 2017 03 30
(511) 35

(260) AM 2018 96023 A
(800) 1383184
(151) 2016 10 20
(181) 2026 10 20

(891) 2016 10 20
(511) 30

(260) AM 2018 96025 A
(800) 1384365
(151) 2017 08 03
(181) 2027 08 03
(891) 2017 08 03
(511) 03

(260) AM 2018 96026 A
(800) 1384150
(151) 2017 11 28
(181) 2027 11 28
(891) 2017 11 28
(511) 05

(260) AM 2018 96027 A
(800) 1384151
(151) 2017 11 28
(181) 2027 11 28
(891) 2017 11 28
(511) 05

(260) AM 2018 96028 A
(800) 1384152
(151) 2017 11 28
(181) 2027 11 28
(891) 2017 11 28
(511) 05

(260) AM 2018 96029 A
(800) 1384154
(151) 2017 10 20
(181) 2027 10 20
(891) 2017 10 20
(511) 34

(260) AM 2018 96030 A
(800) 1384210
(151) 2017 11 03
(181) 2027 11 03
(891) 2017 11 03
(511) 30

(260) AM 2018 96194 A
(800) 1385750
(151) 2017 10 20
(181) 2027 10 20
(891) 2017 10 20
(511) 30

(260) AM 2018 96199 A
(800) 1385362
(151) 2017 09 21
(181) 2027 09 21
(891) 2017 09 21
(511) 25

(260) AM 2018 96200 A
(800) 1385371
(151) 2017 10 25
(181) 2027 10 25
(891) 2017 10 25
(511) 03

(260) AM 2018 96201 A
(800) 1385378
(151) 2017 11 07
(181) 2027 11 07
(891) 2017 11 07
(511) 25

(260) AM 2018 96202 A
(800) 1385404
(151) 2017 01 18
(181) 2027 01 18
(891) 2017 01 18
(511) 03, 05, 09, 10, 11, 38, 42

(260) AM 2018 96203 A
(800) 1385751
(151) 2017 10 20
(181) 2027 10 20
(891) 2017 10 20
(511) 30

(260) AM 2018 96205 A
(800) 1385760
(151) 2017 10 18
(181) 2027 10 18
(891) 2017 10 18
(511) 03

(260) AM 2018 96206 A
(800) 1385423
(151) 2017 06 23
(181) 2027 06 23
(891) 2017 06 23
(511) 30

(260) AM 2018 96207 A
(800) 1385424
(151) 2017 06 26

(181) 2027 06 26
(891) 2017 06 26
(511) 30

(260) AM 2018 96208 A
(800) 1385436
(151) 2017 06 13
(181) 2027 06 13
(891) 2017 06 13
(511) 05, 35

(260) AM 2018 96269 A
(800) 1385853
(151) 2017 09 06
(181) 2027 09 06
(891) 2017 09 06
(511) 33

(260) AM 2018 96271 A
(800) 1385910
(151) 2017 10 13
(181) 2027 10 13
(891) 2017 10 13
(511) 03, 05

(260) AM 2018 96273 A
(800) 433700
(151) 1997 11 04
(181) 2027 11 04
(891) 2017 11 21
(511) 10

OFFICIAL NOTIFICATION

INVENTIONS

RENEWAL OF PATENTS

(21) AP 2016 14211

(11) P 2018 6883 B

(73) LEPL "SCIENTIFIC-RESEARCH CENTER OF AGRICULTUR"

(54) **FRUIT AND VEGETABLE DRYING EQUIPMENT**

DATE OF CANCELLATION OF PATENT: 2018 07 19

DATE OF RESTORATION OF PATENT: 2018 12 10

(21) AP 2003 7158

(11) P 2004 3374 B

(73) LTD "KAMELIN"

(54) **MEDICINAL MEANS ON THE BASE OF HONEY, THEIR USE AND METHOD FOR PRODUCTION THEREOF**

DATE OF CANCELLATION OF PATENT: 2018 10 17

DATE OF RESTORATION OF PATENT: 2018 12 10

CANCELLATION OF PATENTS

(21) AP 2007 10370

(11) P 2009 4696 B

(73) Yuza Vasadze;

Nadezhna Mirotadze;

Lali Goginava;

Natruli Mikadze

(54) **INTENSIVE TYPE METHOD FOR CULTIVATION OF FILBERT INDUSTRIAL GARDENS**

DATE OF PATENT CANCELLATION: 2018 11 14

PATENT RESTORATION IS AVAILABLE: 2019 11 14

(21) AP 2007 11327

(11) P 2012 5570 B

(73) Aziende Chimiche Riunite Angelini Francesco A.C.R.A.F. S.p.A.

(54) **USE OF INDAZOLEMETHO-XYALKANOIC ACID FOR DECREASING LEVELS OF TRIGLYCERIDES, CHOLESTEROL AND GLUCOSE**

DATE OF PATENT CANCELLATION: 2018 11 13

PATENT RESTORATION IS AVAILABLE: 2019 11 13

(21) AP 2009 12221

(11) P 2013 5805 B

(73) WYETH LLC

(54) **1-(ARYLSULFONYL)-4-(PIPERAZIN-1-YL)-1H-BENZIMIDAZOLES AS 5-HYDROXY-TRYPTAMINE-6 LIGANDS**

DATE OF PATENT CANCELLATION: 2018 11 10
PATENT RESTORATION IS AVAILABLE: 2019 11 10

(21) AP 2009 12257
(11) P 2017 6719 B
(73) INTERMUNE Inc.
(54) **PIRFENIDONE TREATMENT FOR PATIENTS WITH ATYPICAL LIVER FUNCTION**
DATE OF PATENT CANCELLATION: 2018 11 09
PATENT RESTORATION IS AVAILABLE: 2019 11 09

(21) AP 2009 12261
(11) P 2012 5724 B
(73) MERCK SHARP & DOHME CORP.
(54) **AMINOTETRAHYDROPYRANS AS DIPEPTIDYL PEPTIDASE-IV INHIBITORS FOR TREATMENT OR PREVENTION OF DIABETES**
DATE OF PATENT CANCELLATION: 2018 11 11
PATENT RESTORATION IS AVAILABLE: 2019 11 11

(21) AP 2010 12738
(11) P 2016 6435 B
(73) IRONWOOD PHARMACEUTICALS INC.
(54) **TREATMENTS FOR GASTROINTESTINAL DISORDERS**
DATE OF PATENT CANCELLATION: 2018 11 09
PATENT RESTORATION IS AVAILABLE: 2019 11 09

(21) AP 2001 6955
(11) P 2005 3461 B
(73) TAKEDA GmbH
(54) **FREEZE-DRIED PANTOPRAZOLE PREPARATION AND PANTOPRAZOLE INJECTION**
DATE OF PATENT CANCELLATION: 2018 11 17
PATENT RESTORATION IS AVAILABLE: 2019 11 17

(21) AP 2004 9412
(11) P 2008 4528 B
(73) Pfaizer Inc.
(54) **5,7-DIAMINOPYRAZOLO [4,3-d] PYRIMIDINES WITH PDE-5 INHIBITING ACTIVITY**
DATE OF PATENT CANCELLATION: 2018 11 12
PATENT RESTORATION IS AVAILABLE: 2019 11 12

(21) AP 2004 9463
(11) P 2008 4547 B
(73) Les Laboratoires Servier
(54) **METHOD FOR SYNTHESIS OF PERINDOPRIL AND PHARMACEUTICALLY ACCEPTABLE SALTS THEREOF**
DATE OF PATENT CANCELLATION: 2018 11 18
PATENT RESTORATION IS AVAILABLE: 2019 11 18

UTILITY MODELS

RENEWAL OF PATENTS

(21) AU 2015 13948
(11) U 2016 1905 Y
(73) LEPL INSTITUTE "OPTIQUE"
(54) **OPTICAL DEVICE LENS FOR NIGHT VISION**
DATE OF CANCELLATION OF PATENT: 2018 10 01
DATE OF RESTORATION OF PATENT: 2018 12 10

(21) AU 2016 14069
(11) U 2017 1928 Y
(73) LEPL INSTITUTE "OPTIQUE"
(54) **HOLOGRAPHIC COLLIMATOR TARGET**
DATE OF CANCELLATION OF PATENT: 2018 02 25
DATE OF RESTORATION OF PATENT: 2018 12 10

CANCELLATION OF PATENTS

(21) AU 2014 13637
(11) U 2015 1873 Y
(73) Lali Latsabidze
(54) **DRYING ROOM FOR LINEN OR CLOTHS WITH PROTECTIVE OVERLAP**
DATE OF PATENT CANCELLATION: 2018 11 17
PATENT RESTORATION IS AVAILABLE: 2019 11 17

(21) AU 2015 13988
(11) U 2018 1977 Y
(73) Zinaida Vatsadze;
Merab Dadunashvili;
Jiuli Keadze;
Teimuraz Rokva;
Temur Chakhunashvili
(54) **ANODE FOR RECEIVING ELECTROLYTIC MANGANESE DIOXIDE**
DATE OF PATENT CANCELLATION: 2018 11 09
PATENT RESTORATION IS AVAILABLE: 2019 11 09

(21) AU 2015 13989
(11) U 2018 1978 Y
(73) Merab Dadunashvili;
Zinaida Vatsadze;
Jiuli Keadze;
Teimuraz Rokva;
Temur Chakhunashvili
(54) **CATHODE FOR RECEIVING ELECTROLYTIC MANGANESE DIOXIDE**

DATE OF PATENT CANCELLATION:2018 11 09
PATENT RESTORATION IS AVAILABLE: 2019 11 09

(21) AU 2016 14321

(11) U 2018 1964 Y

(73) Merab Diasamidze;
Merab Topchiashvili;
Zurab Suladze;
David Suladze

(54) METHOD FOR ARTICLE MANUFACTURE WITH WOOD-POLYMER COMPOSITE

DATE OF PATENT CANCELLATION: 2018 11 14

PATENT RESTORATION IS AVAILABLE: 2019 11 14

DESIGNS

RENEWAL OF REGISTRATIONS

(11) D 2009 405 S

(73) OJSC "OIL COMPANY "ROSSNEFT" (RU)

Sofiiskaya Naberezhnaya, dom 26/1, 115035, Moskow, Russian Federation (RU)

(54) CANISTER WITH LID

(28) 1

(24) 2009 04 27

(18) 2024 04 27

(58) 2018 11 26

(11) D 2009 406 S

(73) OJSC "OIL COMPANY "ROSSNEFT" (RU)

Sofiiskaya Naberezhnaya, dom 26/1, 115035, Moskow, Russian Federation (RU)

(54) CANISTER WITH LID

(28) 1

(24) 2009 04 27

(18) 2024 04 27

(58) 2018 11 26

(11) D 2009 407 S

(73) OJSC "OIL COMPANY "ROSNEFT" (RU)

Sofiiskaya Naberezhnaya, dom 26/1, 115035, Moskow, Russian Federation (RU)

(54) THE ROOF

(28) 1

(24) 2009 04 27

(18) 2024 04 27

(58) 2018 12 03

TRADEMARKS

RENEWAL OF REGISTRATIONS

(111) M 1999 11759 R2
(156) 18 03 1999
(186) 18 03 2029
(732) SANOFI
54, rue La Boétie, 75008 Paris, France

(111) M 1999 11760 R2
(156) 18 03 1999
(186) 18 03 2029
(732) SANOFI
54, rue La Boétie, 75008 Paris, France

(111) M 1998 9996 R2
(156) 09 07 1998
(186) 09 07 2028
(732) BRITISH AMERICAN TOBACCO
WESTERN EUROPE COMMERCIAL
TRADING LIMITED
Globe House, 1 Water Street, London, WC2R
3LA, United Kingdom

(111) M 1998 9803 R2
(156) 23 06 1998
(186) 23 06 2028
(732) CITIZEN TOKEI KABUSHIKI KAISHA
also trading as CITIZEN WATCH CO., LTD.
1-12,6-Chome, Tanashi-cho, Nishi-tokyo-shi,
Tokyo, Japan

(111) M 1998 10885 R2
(156) 23 09 1998
(186) 23 09 2028
(732) IDS BORJOMI BEVERAGES CO. N.V.
Pareraweg 45, Curacao, Netherlands Antilles

(111) M 1998 10886 R2
(156) 23 09 1998
(186) 23 09 2028
(732) IDS BORJOMI BEVERAGES CO. N.V.
Pareraweg 45, Curacao, Netherlands Antilles

(111) M 1998 10887 R2
(156) 23 09 1998
(186) 23 09 2028
(732) IDS BORJOMI BEVERAGES CO. N.V.
Pareraweg 45, Curacao, Netherlands Antilles

(111) M 1998 10888 R2
(156) 23 09 1998
(186) 23 09 2028
(732) IDS BORJOMI BEVERAGES CO. N.V.
Pareraweg 45, Curacao, Netherlands Antilles

(111) M 1998 10889 R2
(156) 23 09 1998
(186) 23 09 2028
(732) IDS BORJOMI BEVERAGES CO. N.V.
Pareraweg 45, Curacao, Netherlands Antilles

(111) M 1998 10793 R2
(156) 15 09 1998
(186) 15 09 2028
(732) BRITISH AMERICAN TOBACCO
WESTERN EUROPE COMMERCIAL
TRADING LIMITED
Globe House, 1 Water Street, London,
WC2R 3LA, United Kingdom

(111) M 1998 10523 R2
(156) 26 08 1998
(186) 26 08 2028
(732) BRITISH AMERICAN TOBACCO
WESTERN EUROPE COMMERCIAL
TRADING LIMITED
Globe House, 1 Water Street, London,
WC2R 3LA, United Kingdom

(111) M 1998 10524 R2
(156) 26 08 1998
(186) 26 08 2028
(732) BRITISH AMERICAN TOBACCO
WESTERN EUROPE COMMERCIAL
TRADING LIMITED
Globe House, 1 Water Street, London,
WC2R 3LA, United Kingdom

(111) M 1998 10529 R2
(156) 26 08 1998
(186) 26 08 2028
(732) BRITISH AMERICAN TOBACCO
WESTERN EUROPE COMMERCIAL
TRADING LIMITED
Globe House, 1 Water Street, London,
WC2R 3LA, United Kingdom

(111) M 1998 10844 R2
 (156) 22 09 1998
 (186) 22 09 2028
 (732) TRISA HOLDING AG
 Kantonsstrasse 31, 6234 Triengen,
 Switzerland

(111) M 1998 10905 R2
 (156) 23 09 1998
 (186) 23 09 2028
 (732) IDS BORJOMI BEVERAGES CO. N.V.
 Pareraweg 45, Curacao, Netherlands Antilles

(111) M 1998 10906 R2
 (156) 23 09 1998
 (186) 23 09 2028
 (732) IDS BORJOMI BEVERAGES CO. N.V.
 Pareraweg 45, Curacao, Netherlands Antilles

(111) M 1998 10907 R2
 (156) 23 09 1998
 (186) 23 09 2028
 (732) IDS BORJOMI BEVERAGES CO. N.V.
 Pareraweg 45, Curacao, Netherlands Antilles

(111) M 1998 10908 R2
 (156) 23 09 1998
 (186) 23 09 2028
 (732) IDS BORJOMI BEVERAGES CO. N.V.
 Pareraweg 45, Curacao, Netherlands Antilles

(111) M 1998 10909 R2
 (156) 23 09 1998
 (186) 23 09 2028
 (732) IDS BORJOMI BEVERAGES CO. N.V.
 Pareraweg 45, Curacao, Netherlands Antilles

(111) M 1998 10910 R2
 (156) 23 09 1998
 (186) 23 09 2028
 (732) IDS BORJOMI BEVERAGES CO. N.V.
 Pareraweg 45, Curacao, Netherlands Antilles

(111) M 1998 10598 R2
 (156) 27 08 1998
 (186) 27 08 2028
 (732) DEMETRIOS LICENSING, LTD
 222, West 37 th Street, New York, USA

(111) M 1998 11163 R2
 (156) 27 11 1998
 (186) 27 11 2028

(732) UENO-SHOKAI Co., LTD
 6-10-17 Ueno, Taito-ku, Tokyo, 110-0005,
 Japan

(111) M 1998 10930 R2
 (156) 23 09 1998
 (186) 23 09 2028
 (732) ZHS IP Worldwide Sàrl
 Avenue Reverdil 14, 1260 Nyon, Switzerland

(111) M 1998 10931 R2
 (156) 23 09 1998
 (186) 23 09 2028
 (732) ZHS IP Worldwide Sàrl
 Avenue Reverdil 14, 1260 Nyon, Switzerland

(111) M 1998 10932 R2
 (156) 23 09 1998
 (186) 23 09 2028
 (732) ZHS IP Worldwide Sàrl
 Avenue Reverdil 14, 1260 Nyon, Switzerland

(111) M 1998 10933 R2
 (156) 23 09 1998
 (186) 23 09 2028
 (732) ZHS IP Worldwide Sàrl
 Avenue Reverdil 14, 1260 Nyon, Switzerland

(111) M 1998 10825 R2
 (156) 15 09 1998
 (186) 15 09 2028
 (732) BRITISH AMERICAN TOBACCO
 WESTERN EUROPE COMMERCIAL
 TRADING LIMITED
 Globe House, 1 Water Street, London,
 WC2R 3LA, United Kingdom

(111) M 1998 10826 R2
 (156) 15 09 1998
 (186) 15 09 2028
 (732) BRITISH AMERICAN TOBACCO
 WESTERN EUROPE COMMERCIAL
 TRADING LIMITED
 Globe House, 1 Water Street, London,
 WC2R 3LA, United Kingdom

(111) M 1998 11032 R2
 (156) 29 10 1998
 (186) 29 10 2028
 (732) BRITISH AMERICAN TOBACCO
 WESTERN EUROPE COMMERCIAL
 TRADING LIMITED

Globe House, 1 Water Street, London,
WC2R 3LA, United Kingdom

(111) M 1998 11033 R2

(156) 29 10 1998

(186) 29 10 2028

(732) BRITISH AMERICAN TOBACCO
WESTERN EUROPE COMMERCIAL
TRADING LIMITED
Globe House, 1 Water Street, London,
WC2R 3LA, United Kingdom

(111) M 1998 11034 R2

(156) 29 10 1998

(186) 29 10 2028

(732) BRITISH AMERICAN TOBACCO
WESTERN EUROPE COMMERCIAL
TRADING LIMITED
Globe House, 1 Water Street, London,
WC2R 3LA, United Kingdom

(111) M 1998 11035 R2

(156) 29 10 1998

(186) 29 10 2028

(732) BRITISH AMERICAN TOBACCO
WESTERN EUROPE COMMERCIAL
TRADING LIMITED
Globe House, 1 Water Street, London,
WC2R 3LA, United Kingdom

(111) M 1998 11069 R2

(156) 09 11 1998

(186) 09 11 2028

(732) GlaxoSmithKline Consumer Healthcare (UK)
IP Limited
980 Great West Road, Brentford, Middlesex
TW8 9GS, United Kingdom

(111) M 1998 11099 R2

(156) 25 11 1998

(186) 25 11 2028

(732) FERRERO S.P.A.
Piazzale Pietro Ferrero 1, 12051 Alba,
Cuneo, Italy

(111) M 1998 11102 R2

(156) 25 11 1998

(186) 25 11 2028

(732) FERRERO S.P.A.
Piazzale Pietro Ferrero 1, 12051 Alba,
Cuneo, Italy

(111) M 1998 11136 R2

(156) 27 11 1998

(186) 27 11 2028

(732) FERRERO S.P.A.
Piazzale Pietro Ferrero 1, 12051 Alba,
Cuneo, Italy

(111) M 1998 11137 R2

(156) 27 11 1998

(186) 27 11 2028

(732) FERRERO S.P.A.
Piazzale Pietro Ferrero 1, 12051 Alba,
Cuneo, Italy

(111) M 1998 11143 R2

(156) 27 11 1998

(186) 27 11 2028

(732) FERRERO S.P.A.
Piazzale Pietro Ferrero 1, 12051 Alba,
Cuneo, Italy

(111) M 1998 11159 R2

(156) 27 11 1998

(186) 27 11 2028

(732) FERRERO S.P.A.
Piazzale Pietro Ferrero 1, 12051 Alba,
Cuneo, Italy

(111) M 1998 11160 R2

(156) 27 11 1998

(186) 27 11 2028

(732) FERRERO S.P.A.
Piazzale Pietro Ferrero 1, 12051 Alba,
Cuneo, Italy

(111) M 1998 11161 R2

(156) 27 11 1998

(186) 27 11 2028

(732) FERRERO S.P.A.
Piazzale Pietro Ferrero 1, 12051 Alba,
Cuneo, Italy

(111) M 1998 11162 R2

(156) 27 11 1998

(186) 27 11 2028

(732) FERRERO S.P.A.
Piazzale Pietro Ferrero 1, 12051 Alba,
Cuneo, Italy

(111) M 1999 11605 R2

(156) 18 02 1999

(186) 18 02 2029

(732) FERRERO S.P.A.
Piazzale Pietro Ferrero 1, 12051 Alba,
Cuneo, Italy

(111) M 1999 11606 R2
(156) 18 02 1999
(186) 18 02 2029

(732) FERRERO S.P.A.
Piazzale Pietro Ferrero 1, 12051 Alba,
Cuneo, Italy

(111) M 1999 11607 R2
(156) 18 02 1999
(186) 18 02 2029

(732) FERRERO S.P.A.
Piazzale Pietro Ferrero 1, 12051 Alba,
Cuneo, Italy

(111) M 1999 11608 R2
(156) 18 02 1999
(186) 18 02 2029

(732) FERRERO S.P.A.
Piazzale Pietro Ferrero 1, 12051 Alba,
Cuneo, Italy

(111) M 1999 11609 R2
(156) 18 02 1999
(186) 18 02 2029

(732) FERRERO S.P.A.
Piazzale Pietro Ferrero 1, 12051 Alba,
Cuneo, Italy

(111) M 1999 11610 R2
(156) 18 02 1999
(186) 18 02 2029

(732) FERRERO S.P.A.
Piazzale Pietro Ferrero 1, 12051 Alba,
Cuneo, Italy

(111) M 1998 11265 R2
(156) 11 12 1998
(186) 11 12 2028

(732) EDGEWELL PERSONAL CARE BRANDS,
LLC
6 Research Drive, Shelton, Connecticut
06484, USA

(111) M 1999 11400 R2
(156) 26 01 1999
(186) 26 01 2029

(732) SANOFI
54, rue La Boétie, 75008 Paris, France

(111) M 1999 12345 R2
(156) 15 06 1999
(186) 15 06 2029

(732) OPUS ONE WINERY LLC
7900 St. Helena Highway, OAKVILLE,
California 94562, USA

(111) M 1999 12346 R2
(156) 15 06 1999
(186) 15 06 2029

(732) OPUS ONE WINERY LLC
7900 St. Helena Highway, OAKVILLE,
California 94562, USA

(111) M 1999 12829 R2
(156) 27 09 1999
(186) 27 09 2029

(732) OPUS ONE WINERY LLC
7900 St. Helena Highway, OAKVILLE,
California 94562, USA

(111) M 2008 18430 R1
(156) 16 05 2008
(186) 16 05 2028

(732) ZHS IP Worldwide Sàrl
Avenue Reverdil 14, 1260 Nyon, Switzerland

(111) M 2008 18431 R1
(156) 16 05 2008
(186) 16 05 2028

(732) ZHS IP Worldwide Sàrl
Avenue Reverdil 14, 1260 Nyon, Switzerland

(111) M 2008 18432 R1
(156) 16 05 2008
(186) 16 05 2028

(732) ZHS IP Worldwide Sàrl
Avenue Reverdil 14, 1260 Nyon, Switzerland

(111) M 2008 18433 R1
(156) 16 05 2008
(186) 16 05 2028

(732) ZHS IP Worldwide Sàrl
Avenue Reverdil 14, 1260 Nyon, Switzerland

(111) M 2008 18434 R1
(156) 16 05 2008
(186) 16 05 2028

(732) ZHS IP Worldwide Sàrl
Avenue Reverdil 14, 1260 Nyon, Switzerland

(111) M 2008 18435 R1
(156) 16 05 2008
(186) 16 05 2028
(732) ZHS IP WORLDWIDE SÀRL
Avenue Reverdil 14, 1260 Nyon, Switzerland

(111) M 2008 18858 R1
(156) 17 11 2008
(186) 17 11 2028
(732) WORLD MEDICINE LIMITED
48 Quenn Anne Street, London W1G9JJ,
United Kingdom

(111) M 2008 18859 R1
(156) 17 11 2008
(186) 17 11 2028
(732) WORLD MEDICINE LIMITED
48 Quenn Anne Street, London W1G9JJ,
United Kingdom

(111) M 2008 18860 R1
(156) 17 11 2008
(186) 17 11 2028
(732) WORLD MEDICINE LIMITED
48 Quenn Anne Street, London W1G9JJ,
United Kingdom

(111) M 2008 18861 R1
(156) 17 11 2008
(186) 17 11 2028
(732) WORLD MEDICINE LIMITED
48 Quenn Anne Street, London W1G9JJ,
United Kingdom

(111) M 2008 18862 R1
(156) 17 11 2008
(186) 17 11 2028
(732) WORLD MEDICINE LIMITED
48 Quenn Anne Street, London W1G9JJ,
United Kingdom

(111) M 2008 18864 R1
(156) 17 11 2008
(186) 17 11 2028
(732) WORLD MEDICINE LIMITED
48 Quenn Anne Street, London W1G9JJ,
United Kingdom

(111) M 2008 18865 R1
(156) 17 11 2008
(186) 17 11 2028
(732) WORLD MEDICINE LIMITED

48 Quenn Anne Street, London W1G9JJ,
United Kingdom

(111) M 2008 18866 R1
(156) 17 11 2008
(186) 17 11 2028
(732) WORLD MEDICINE LIMITED
48 Quenn Anne Street, London W1G9JJ,
United Kingdom

(111) M 2008 18867 R1
(156) 17 11 2008
(186) 17 11 2028
(732) WORLD MEDICINE LIMITED
48 Quenn Anne Street, London W1G9JJ,
United Kingdom

(111) M 2008 18868 R1
(156) 17 11 2008
(186) 17 11 2028
(732) WORLD MEDICINE LIMITED
48 Quenn Anne Street, London W1G9JJ,
United Kingdom

(111) M 2008 18712 R1
(156) 17 09 2008
(186) 17 09 2028
(732) WORLD MEDICINE LIMITED
48 Quenn Anne Street, London W1G9JJ,
United Kingdom

(111) M 2008 18793 R1
(156) 16 10 2008
(186) 16 10 2028
(732) IDS Borjomi Beverages Co. N.V.
Pareraweg 45, Curacao, Netherlands Antilles

(111) M 2008 18798 R1
(156) 16 10 2008
(186) 16 10 2028
(732) IDS Borjomi Beverages Co. N.V.
Pareraweg 45, Curacao, Netherlands Antilles

(111) M 2008 18889 R1
(156) 17 11 2008
(186) 17 11 2028
(732) LTD "AVERSI-FARMA"
Davit Agmasheneblis Gamz 148/2, 0112,
Tbilisi, Georgia

(111) M 2009 19132 R1
(156) 16 03 2009
(186) 16 03 2029
(732) SANOFI
54, rue La Boétie, 75008 Paris, France

(111) M 2009 19466 R1
(156) 29 06 2009
(186) 29 06 2029
(732) HIGER BUS COMPANY LIMITED
288 Suhong East Road, Suzhou Industrial
Park, Suzhou, Jiangsu province, China

(111) M 2009 19549 R1
(156) 13 07 2009
(186) 13 07 2029
(732) WORLD MEDICINE LIMITED
48 Quenn Anne Street, London W1G9JJ,
United Kingdom

(111) M 1998 9351 R2
(156) 19 05 1998
(186) 19 05 2028
(732) ZHS IP Worldwide Sàrl
Avenue Reverdil 14, 1260 Nyon, Switzerland

(111) M 1999 11622 R2
(156) 18 02 1999
(186) 18 02 2029
(732) NOVO NORDISK HEALTH CARE AG
Thurgauerstrasse 36/38, CH-8050 Zürich,
Switzerland

(111) M 1999 11631 R2
(156) 18 02 1999
(186) 18 02 2029
(732) NOVO NORDISK HEALTH CARE AG
Thurgauerstrasse 36/38, CH-8050 Zürich,
Switzerland

COMPLETE TRANSFER OF RIGHTS

(111) M 2005 16077 R
(732) FMC CORPORATION
FMC Tower at Cira Center South, 2929
Walnut Street, Philadelphia, Pennsylvania
19104, USA
(770) E.I. DU PONT DE NEMOURS &
COMPANY
974 Centre Road, Wilmington, Delaware
19805, USA
(580) 30 10 2018

(111) M 2005 16099 R
(732) FMC AGRICULTURAL PRODUCTS
INTERNATIONAL AG
Alpenstrasse 15, Zug 6300, Switzerland
(770) E.I. DU PONT DE NEMOURS &
COMPANY
974 Centre Road, Wilmington, Delaware
19805, USA
(580) 30 10 2018

(111) M 2006 16431 R
(732) FMC AGRICULTURAL PRODUCTS
INTERNATIONAL AG
Alpenstrasse 15, Zug 6300, Switzerland
(770) E.I. DU PONT DE NEMOURS and
COMPANY
974 Centre Road, Wilmington, Delaware
19805, USA
(580) 30 10 2018

(111) M 2006 16464 R
(732) FMC AGRICULTURAL PRODUCTS
INTERNATIONAL AG
Alpenstrasse 15, Zug 6300, Switzerland
(770) E.I. DU PONT de NEMOURS and
COMPANY
974 Centre Road, Wilmington, Delaware
19805, USA
(580) 30 10 2018

(111) M 2006 16466 R
(732) FMC AGRICULTURAL PRODUCTS
INTERNATIONAL AG
Alpenstrasse 15, Zug 6300, Switzerland
(770) E.I. DU PONT de NEMOURS and
COMPANY
974 Centre Road, Wilmington, Delaware
19805, USA
(580) 30 10 2018

(111) M 2006 16469 R
(732) FMC AGRICULTURAL PRODUCTS
INTERNATIONAL AG
Alpenstrasse 15, Zug 6300, Switzerland
(770) E.I. DU PONT de NEMOURS and
COMPANY
974 Centre Road, Wilmington, Delaware
19805, USA
(580) 30 10 2018

(111) M 2006 16471 R
(732) FMC CORPORATION
FMC Tower at Cira Center South, 2929
Walnut Street, Philadelphia, Pennsylvania
19104, USA
(770) E.I. DU PONT de NEMOURS and
COMPANY
974 Centre Road, Wilmington, Delaware
19805, USA
(580) 30 10 2018

(111) M 2006 16487 R
(732) FMC CORPORATION
FMC Tower at Cira Center South, 2929
Walnut Street, Philadelphia, Pennsylvania
19104, USA
(770) E.I. DU PONT DE NEMOURS AND
COMPANY
974 Centre Road, Wilmington, Delaware
19805, USA
(580) 30 10 2018

(111) M 2006 16617 R
(732) FMC AGRICULTURAL PRODUCTS
INTERNATIONAL AG
Alpenstrasse 15, Zug 6300, Switzerland
(770) E.I. DU PONT de NEMOURS and
COMPANY
974 Centre Road, Wilmington, Delaware
19805, USA
(580) 30 10 2018

(111) M 2018 29581 R
(732) FMC AGRICULTURAL PRODUCTS
INTERNATIONAL AG
Alpenstrasse 15, Zug 6300, Switzerland
(770) E. I. du Pont de Nemours and Company
Chestnut Run Plaza, 974 Centre Road,
Wilmington, DE 19805, USA
(580) 30 10 2018

(111) M 2018 29582 R
(732) FMC AGRICULTURAL PRODUCTS
INTERNATIONAL AG
Alpenstrasse 15, Zug 6300, USA
(770) E. I. DU PONT DE NEMOURS AND
COMPANY
Chestnut Run Plaza, 974 Centre Road,
Wilmington, DE 19805, USA
(580) 30 10 2018

(111) M 2018 29805 R
(732) FMC AGRICULTURAL PRODUCTS
INTERNATIONAL AG
Alpenstrasse 15, Zug 6300, Switzerland
(770) E. I. DU PONT DE NEMOURS AND
COMPANY
Chestnut Run Plaza, 974 Centre Road,
Wilmington, DE 19805, USA
(580) 30 10 2018

(111) M 2018 29806 R
(732) FMC AGRICULTURAL PRODUCTS
INTERNATIONAL AG
Alpenstrasse 15, Zug 6300, USA
(770) E. I. DU PONT DE NEMOURS AND
COMPANY
Chestnut Run Plaza, 974 Centre Road,
Wilmington, DE 19805, USA
(580) 30 10 2018

(111) M 2018 29807 R
(732) FMC AGRICULTURAL PRODUCTS
INTERNATIONAL AG
Alpenstrasse 15, Zug 6300, Switzerland
(770) E. I. DU PONT DE NEMOURS AND
COMPANY
Chestnut Run Plaza, 974 Centre Road,
Wilmington, DE 19805, USA
(580) 30 10 2018

CHANGES IN NAMES AND/OR ADDRESSES OF OWNERS

(111) M 1999 11555 R
(732) EMI (IP) LIMITED
364-366 Kensington High Street, Londoni
W14 8NS, United Kingdom
(770) EMI (IP) LIMITED
27 Wrights Lane, W8 5SW London,
United Kingdom
(580) 26 10 2018

(111) M 2005 16077 R
(732) E.I. DU PONT DE NEMOURS &
COMPANY
974 Centre Road, Wilmington, Delaware
19805, USA
(770) E.I. DU PONT DE NEMOURS &
COMPANY
1007 Market Street, Wilmington, Delaware
19898, USA
(580) 30 10 2018

(111) M 2005 16099 R
(732) E.I. DU PONT DE NEMOURS &
COMPANY
974 Centre Road, Wilmington, Delaware
19805, USA
(770) E.I. DU PONT DE NEMOURS &
COMPANY
1007 Market Street, Wilmington, Delaware
19898, USA
(580) 30 10 2018

(111) M 2006 16431 R
(732) E.I. DU PONT de NEMOURS and
COMPANY
974 Centre Road, Wilmington, Delaware
19805, USA
(770) E.I. DU PONT de NEMOURS and
COMPANY
1007 Market Street, Wilmington, Delaware
19898, USA
(580) 30 10 2018

(111) M 2006 16464 R
(732) E.I. DU PONT de NEMOURS and
COMPANY
974 Centre Road, Wilmington, Delaware
19805, USA
(770) E.I. DU PONT de NEMOURS and
COMPANY
1007 Market Street, Wilmington, Delaware
19898, USA
(580) 30 10 2018

(111) M 2006 16466 R
(732) E.I. DU PONT de NEMOURS and
COMPANY
974 Centre Road, Wilmington, Delaware
19805, USA
(770) E.I. DU PONT de NEMOURS and
COMPANY
1007 Market Street, Wilmington, Delaware
19898, USA
(580) 30 10 2018

(111) M 2006 16469 R
(732) E.I. DU PONT de NEMOURS and
COMPANY
974 Centre Road, Wilmington, Delaware
19805, USA
(770) E.I. DU PONT de NEMOURS and
COMPANY
1007 Market Street, Wilmington, Delaware
19898, USA
(580) 30 10 2018

(111) M 2006 16471 R
(732) E.I. DU PONT de NEMOURS and
COMPANY
974 Centre Road, Wilmington, Delaware
19805, USA
(770) E.I. DU PONT de NEMOURS and
COMPANY
1007 Market Street, Wilmington, Delaware
19898, USA
(580) 30 10 2018

(111) M 2006 16487 R
(732) E.I. DU PONT DE NEMOURS AND
COMPANY
974 Centre Road, Wilmington, Delaware
19805, USA
(770) E.I. DU PONT DE NEMOURS AND
COMPANY
1007 Market Street, Wilmington, Delaware
19898, USA
(580) 30 10 2018

(111) M 2006 16617 R
(732) E.I. DU PONT de NEMOURS and
COMPANY
974 Centre Road, Wilmington, Delaware
19805, USA
(770) E.I. DU PONT de NEMOURS and
COMPANY
1007 Market Street, Wilmington, Delaware
19898, USA
(580) 30 10 2018

INVALIDATION OF TRADEMARK REGISTRATIONS

(111) M 2008 18496 R
(151) 27 05 2008
(181) 2018 11 27
(732) SPIRITS INTERNATIONAL B.V.
1A, Rue Thomas Edison, L-1445, Strassen,
Luxembourg

CHANGE OF THE LIST OF GOODS AND/OR SERVICES OF TRADEMARK

(111) M 2017 28913 R
(732) JVC KENWOOD CORPORATION
3-12, Moriyacho, Kanagawa-Ku, Yokohama-
Shi, Kanagawa, Japan
(511) 9, 35, 37

CLASSIFICATION INDEXES

INVENTIONS

CONCORDANCE TABLE OF INTERNATIONAL CLASSIFICATION INDEX AND PUBLICATION NUMBERS

INTERNATIONAL CLASSIFICATION INDEXES (51)	NUMBER OF PUBLISHED APPLICATION (10)
A 61 K 31/53; C 07 D 253/08	AP 2018 14515 A
C 30 B 15/00; H 01 L 21/263	AP 2018 14143 A
G 10 L 19/008	AP 2018 14481 A

CONCORDANCE TABLE OF PUBLICATION NUMBERS AND INTERNATIONAL CLASSIFICATION INDEX

NUMBER OF PUBLISHED APPLICATION (10)	INTERNATIONAL CLASSIFICATION INDEXES (51)
AP 2018 14143 A	C 30 B 15/00; H 01 L 21/263
AP 2018 14481 A	G 10 L 19/008
AP 2018 14515 A	A 61 K 31/53; C 07 D 253/08

CONCORDANCE TABLE OF INTERNATIONAL CLASSIFICATION INDEX, PATENT NUMBERS AND PUBLICATION NUMBERS

INTERNATIONAL CLASSIFICATION INDEX (51)	NUMBER OF PATENT (11)	NUMBER OF PUBLISHED APPLICATION (10)
A 01 C 7/02	P 2018 6931 B	AP 2017 14267 A
A 61 K 47/26; A 61 K 9/08; A 61 K 9/10; A 61 K 31/444; A 61 K 47/36; A 61 P 27/00	P 2018 6930 B	AP 2018 14194 A
A 61 K 9/14; A 61 K 9/20; C 12 Q 1/68; A 61 K 9/28	P 2018 6932 B	AP 2018 14304 A
C 07 D 401/14; C 07 D 405/14; C 07 D 401/06; A 61 K 31/47; A 61 P 35/00	P 2018 6933 B	AP 2018 14347 A
C 07 D 471/04; C 07 D 519/00	P 2018 6934 B	AP 2018 14408 A

CONCORDANCE TABLE OF PATENT NUMBERS, PUBLICATION NUMBERS AND INTERNATIONAL CLASSIFICATION INDEX

NUMBER OF PATENT (11)	NUMBER OF PUBLISHED APPLICATION (10)	INTERNATIONAL CLASSIFICATION INDEX (51)
P 2018 6930 B	AP 2018 14194 A	A 61 K 47/26; A 61 K 9/08; A 61 K 9/10; A 61 K 31/444; A 61 K 47/36; A 61 P 27/00
P 2018 6931 B	AP 2017 14267 A	A 01 C 7/02
P 2018 6932 B	AP 2018 14304 A	A 61 K 9/14; A 61 K 9/20; C 12 Q 1/68; A 61 K 9/28
P 2018 6933 B	AP 2018 14347 A	C 07 D 401/14; C 07 D 405/14; C 07 D 401/06; A 61 K 31/47; A 61 P 35/00
P 2018 6934 B	AP 2018 14408 A	C 07 D 471/04; C 07 D 519/00

**CONCORDANCE TABLE OF APPLICATION NUMBERS, PUBLICATION NUMBERS
AND PATENTS**

NUMBER OF APPLICATION (21)	NUMBER OF PUBLISHED APPLICATION (10)	NUMBER OF PATENT (11)
AP 2014 14194	AP 2018 14194 A	P 2018 6930 B
AP 2016 14267	AP 2017 14267 A	P 2018 6931 B
AP 2015 14304	AP 2018 14304 A	P 2018 6932 B
AP 2015 14347	AP 2018 14347 A	P 2018 6933 B
AP 2015 14408	AP 2018 14408 A	P 2018 6934 B

UTILITY MODELS

**CONCORDANCE TABLE OF INTERNATIONAL CLASSIFICATION INDEX
AND PUBLICATION NUMBERS**

INTERNATIONAL CLASSIFICATION INDEXES (51)	NUMBER OF PUBLISHED APPLICATION (10)
A 01 C 23/00	AU 2018 14419 U
G 01 N 27/00	AU 2018 14353 U

**CONCORDANCE TABLE OF PUBLICATION NUMBERS
AND INTERNATIONAL CLASSIFICATION INDEX**

NUMBER OF PUBLISHED APPLICATION (10)	INTERNATIONAL CLASSIFICATION INDEXES (51)
AU 2018 14353 U	G 01 N 27/00
AU 2018 14419 U	A 01 C 23/00

**CONCORDANCE TABLE OF INTERNATIONAL CLASSIFICATION INDEX,
PATENT NUMBERS AND PUBLICATION NUMBERS**

INTERNATIONAL CLASSIFICATION INDEX (51)	NUMBER OF PATENT (11)	NUMBER OF PUBLISHED APPLICATION (10)
B 03 B 7/00	U 2018 1996 Y	AU 2018 14496 U
B 23 K 9/18	U 2018 1995 Y	AU 2018 14550 U

**CONCORDANCE TABLE OF PATENT NUMBERS,
PUBLICATION NUMBERS AND INTERNATIONAL CLASSIFICATION INDEX**

NUMBER OF PATENT (11)	NUMBER OF PUBLISHED APPLICATION (10)	INTERNATIONAL CLASSIFICATION INDEX (51)
U 2018 1995 Y	AU 2018 14550 U	B 23 K 9/18
U 2018 1996 Y	AU 2018 14496 U	B 03 B 7/00

**CONCORDANCE TABLE OF APPLICATION NUMBERS, PUBLICATION NUMBERS
AND PATENTS**

NUMBER OF APPLICATION (21)	NUMBER OF PUBLISHED APPLICATION (10)	NUMBER OF PATENT (11)
AU 2017 14496	AU 2018 14496 U	U 2018 1996 Y
AU 2018 14550	AU 2018 14550 U	U 2018 1995 Y

DESIGNS

**CONCORDANCE TABLE OF INTERNATIONAL CLASSIFICATION INDEX
AND PUBLICATION NUMBERS**

INTERNATIONAL CLASSIFICATION INDEXES (51)	NUMBER OF PUBLISHED APPLICATION (10)
32-00	AD 2018 1042 S
32-00	AD 2018 1043 S

**CONCORDANCE TABLE OF PUBLICATION NUMBERS
AND INTERNATIONAL CLASSIFICATION INDEX**

NUMBER OF PUBLISHED APPLICATION (10)	INTERNATIONAL CLASSIFICATION INDEXES (51)
AD 2018 1042 S	32-00
AD 2018 1043 S	32-00

**CONCORDANCE TABLE OF INTERNATIONAL CLASSIFICATION INDEX,
PATENT NUMBERS AND PUBLICATION NUMBERS**

INTERNATIONAL CLASSIFICATION INDEX (51)	NUMBER OF PATENT (11)	NUMBER OF PUBLISHED APPLICATION (10)
07-01	D 2018 790 S	AD 2018 1025 S
12-08	D 2018 791 S	AD 2018 1028 S
12-08	D 2018 792 S	AD 2018 1029 S
19-04	D 2018 793 S	AD 2018 1034 S
25-03	D 2018 789 S	AD 2018 1033 S

**CONCORDANCE TABLE OF PATENT NUMBERS,
PUBLICATION NUMBERS AND INTERNATIONAL CLASSIFICATION INDEX**

NUMBER OF PATENT (11)	NUMBER OF PUBLISHED APPLICATION (10)	INTERNATIONAL CLASSIFICATION INDEX (51)
D 2018 789 S	AD 2018 1033 S	25-03
D 2018 790 S	AD 2018 1025 S	07-01
D 2018 791 S	AD 2018 1028 S	12-08
D 2018 792 S	AD 2018 1029 S	12-08
D 2018 793 S	AD 2018 1034 S	19-04

**CONCORDANCE TABLE OF APPLICATION NUMBERS, PUBLICATION NUMBERS
AND PATENTS**

NUMBER OF APPLICATION (21)	NUMBER OF PUBLISHED APPLICATION (10)	NUMBER OF PATENT (11)
AD 2018 1025	AD 2018 1025 S	D 2018 790 S
AD 2018 1028	AD 2018 1028 S	D 2018 791 S
AD 2018 1029	AD 2018 1029 S	D 2018 792 S
AD 2018 1033	AD 2018 1033 S	D 2018 789 S
AD 2018 1034	AD 2018 1034 S	D 2018 793 S

DESIGN REGISTERED ACCORDING TO THE ACCELERATED PROCEDURE

CONCORDANCE TABLE OF INTERNATIONAL CLASSIFICATION INDEX AND PUBLICATION NUMBERS

INTERNATIONAL CLASSIFICATION INDEXES (51)	NUMBER OF PUBLISHED APPLICATION (11)
09-01	D 2018 787 S
09-03	D 2018 794 S
09-05	D 2018 788 S

CONCORDANCE TABLE OF PUBLICATION NUMBERS AND INTERNATIONAL CLASSIFICATION INDEX

NUMBER OF PUBLISHED APPLICATION (11)	INTERNATIONAL CLASSIFICATION INDEXES (51)
D 2018 787 S	09-01
D 2018 788 S	09-05
D 2018 794 S	09-03

CONCORDANCE TABLE OF APPLICATION NUMBERS, PUBLICATION NUMBERS AND PATENTS

NUMBER OF APPLICATION (21)	NUMBER OF PATENT (11)
AD 2018 1058	D 2018 788 S
AD 2018 1060	D 2018 794 S
AD 2018 1062	D 2018 787 S

TRADEMARKS

CONCORDANCE TABLE OF REGISTRATION NUMBERS, APPLICATION NUMBERS,
PUBLICATION NUMBERS AND BULLETIN NUMBERS

NUMBER OF REGISTRATION (111)	NUMBER OF APPLICATIONS (210)	NUMBER OF PUBLISHED APPLICATIONS (260)	NUMBER OF BULLETIN
M 2018 30467 R	AM 100406	-	23(507) 2018
M 2018 30468 R	AM 100090	-	23(507) 2018
M 2018 30469 R	AM 100409	-	23(507) 2018
M 2018 30470 R	AM 100077	-	23(507) 2018
M 2018 30471 R	AM 100417	-	23(507) 2018
M 2018 30472 R	AM 91638	AM 2018 91638 A	14(498)2018
M 2018 30473 R	AM 91962	AM 2018 91962 A	10(494)2018
M 2018 30474 R	AM 92123	AM 2018 92123 A	6(490)2018
M 2018 30475 R	AM 93331	AM 2018 93331 A	6(490)2018
M 2018 30476 R	AM 93333	AM 2018 93333 A	6(490)2018
M 2018 30477 R	AM 93334	AM 2018 93334 A	6(490)2018
M 2018 30478 R	AM 93558	AM 2018 93558 A	10(494)2018
M 2018 30479 R	AM 93680	AM 2018 93680 A	14(498)2018
M 2018 30480 R	AM 93681	AM 2018 93681 A	14(498)2018
M 2018 30481 R	AM 93876	AM 2018 93876 A	7(491)2018
M 2018 30482 R	AM 94018	AM 2018 94018 A	13(497)2018
M 2018 30483 R	AM 94019	AM 2018 94019 A	13(497)2018
M 2018 30484 R	AM 94195	AM 2018 94195 A	7(491)2018
M 2018 30485 R	AM94310	AM 2018 94310 A	9(493)2018
M 2018 30486 R	AM 94313	AM 2018 94313 A	8(492)2018
M 2018 30487 R	AM 94323	AM 2018 94323 A	14(498)2018
M 2018 30488 R	AM 94433	AM 2018 94433 A	13(497)2018
M 2018 30489 R	AM 94454	AM 2018 94454 A	12(496)2018
M 2018 30490 R	AM 94456	AM 2018 94456 A	14(498)2018
M 2018 30491 R	AM 94466	AM 2018 94466 A	14(498)2018
M 2018 30492 R	AM 94467	AM 2018 94467 A	14(498)2018
M 2018 30493 R	AM 94536	AM 2018 94536 A	14(498)2018
M 2018 30494 R	AM 94472	AM 2018 94472 A	14(498)2018
M 2018 30495 R	AM 94549	AM 2018 94549 A	14(498)2018
M 2018 30496 R	AM 94571	AM 2018 94571 A	12(496)2018
M 2018 30497 R	AM 94602	AM 2018 94602 A	14(498)2018
M 2018 30498 R	AM 94603	AM 2018 94603 A	14(498)2018
M 2018 30499 R	AM 94664	AM 2018 94664 A	14(498)2018
M 2018 30500 R	AM 94717	AM 2018 94717 A	14(498)2018
M 2018 30501 R	AM 94794	AM 2018 94794 A	14(498)2018
M 2018 30502 R	AM 94865	AM 2018 94865 A	13(497)2018
M 2018 30503 R	AM 94977	AM 2018 94977 A	15(499)2018
M 2018 30504 R	AM 94978	AM 2018 94978 A	15(499)2018
M 2018 30505 R	AM 94984	AM 2018 94984 A	13(497)2018
M 2018 30506 R	AM 94985	AM 2018 94985 A	13(497)2018
M 2018 30507 R	AM 94986	AM 2018 94986 A	13(497)2018
M 2018 30508 R	AM 94987	AM 2018 94987 A	13(497)2018
M 2018 30509 R	AM 95006	AM 2018 95006 A	13(497)2018
M 2018 30510 R	AM 95032	AM 2018 95032 A	14(498)2018
M 2018 30511 R	AM 95036	AM 2018 95036 A	11(495)2018
M 2018 30512 R	AM 95037	AM 2018 95037 A	14(498)2018
M 2018 30513 R	AM 95065	AM 2018 95065 A	13(497)2018
M 2018 30514 R	AM 95073	AM 2018 95073 A	15(499)2018
M 2018 30515 R	AM 95107	AM 2018 95107 A	14(498)2018

1	2	3	4
M 2018 30516 R	AM 95108	AM 2018 95108 A	14(498)2018
M 2018 30517 R	AM 95148	AM 2018 95148 A	13(497)2018
M 2018 30518 R	AM 95211	AM 2018 95211 A	13(497)2018
M 2018 30519 R	AM 95212	AM 2018 95212 A	13(497)2018
M 2018 30520 R	AM 95235	AM 2018 95235 A	14(498)2018
M 2018 30521 R	AM 95318	AM 2018 95318 A	14(498)2018
M 2018 30522 R	AM 95319	AM 2018 95319 A	14(498)2018
M 2018 30523 R	AM 95333	AM 2018 95333 A	14(498)2018
M 2018 30524 R	AM 95334	AM 2018 95334 A	14(498)2018
M 2018 30525 R	AM 95335	AM 2018 95335 A	14(498)2018
M 2018 30526 R	AM 95338	AM 2018 95338 A	14(498)2018
M 2018 30527 R	AM 95341	AM 2018 95341 A	14(498)2018
M 2018 30528 R	AM 95363	AM 2018 95363 A	14(498)2018
M 2018 30529 R	AM 95365	AM 2018 95365 A	13(497)2018
M 2018 30530 R	AM 95410	AM 2018 95410 A	14(498)2018
M 2018 30531 R	AM 95411	AM 2018 95411 A	14(498)2018
M 2018 30532 R	AM 95412	AM 2018 95412 A	14(498)2018
M 2018 30533 R	AM 95413	AM 2018 95413 A	14(498)2018
M 2018 30534 R	AM 95414	AM 2018 95414 A	14(498)2018
M 2018 30535 R	AM 95431	AM 2018 95431 A	14(498)2018
M 2018 30536 R	AM 95432	AM 2018 95432 A	14(498)2018
M 2018 30537 R	AM 95433	AM 2018 95433 A	14(498)2018
M 2018 30538 R	AM 95486	AM 2018 95486 A	15(499)2018
M 2018 30539 R	AM 95542	AM 2018 95542 A	14(498)2018
M 2018 30540 R	AM 95543	AM 2018 95543 A	14(498)2018
M 2018 30541 R	AM 95544	AM 2018 95544 A	14(498)2018
M 2018 30542 R	AM 95546	AM 2018 95546 A	14(498)2018
M 2018 30543 R	AM 95561	AM 2018 95561 A	14(498)2018
M 2018 30544 R	AM 95562	AM 2018 95562 A	14(498)2018
M 2018 30545 R	AM 95566	AM 2018 95566 A	14(498)2018
M 2018 30546 R	AM 95567	AM 2018 95567 A	14(498)2018
M 2018 30547 R	AM 95569	AM 2018 95569 A	14(498)2018
M 2018 30548 R	AM 95578	AM 2018 95578 A	14(498)2018
M 2018 30549 R	AM 95654	AM 2018 95654 A	14(498)2018
M 2018 30550 R	AM 95662	AM 2018 95662 A	14(498)2018
M 2018 30551 R	AM 95665	AM 2018 95665 A	14(498)2018
M 2018 30552 R	AM 95666	AM 2018 95666 A	14(498)2018
M 2018 30553 R	AM 95847	AM 2018 95847 A	14(498)2018
M 2018 30554 R	AM 95858	AM 2018 95858 A	14(498)2018
M 2018 30555 R	AM 95929	AM 2018 95929 A	14(498)2018
M 2018 30556 R	AM 95984	AM 2018 95984 A	15(499)2018
M 2018 30557 R	AM 100395	-	23(507) 2018
M 2018 30558 R	AM 100414	-	23(507) 2018
M 2018 30559 R	AM 100444	-	23(507) 2018
M 2018 30560 R	AM 100397	-	23(507) 2018
M 2018 30561 R	AM 100669	-	23(507) 2018

**CONCORDANCE TABLE OF PUBLICATION NUMBERS
AND APPLICATION NUMBERS**

NUMBER OF PUBLISHED APPLICATION (260)	NUMBER OF APPLICATION (210)	1	2
1	2		
AM 2018 96272 A	AM 96272	AM 2018 97376 A	AM 97376
AM 2018 96284 A	AM 96284	AM 2018 97389 A	AM 97389
AM 2018 96860 A	AM 96860	AM 2018 97392 A	AM 97392
AM 2018 96894 A	AM 96894	AM 2018 97393 A	AM 97393
AM 2018 96973 A	AM 96973	AM 2018 97395 A	AM 97395
AM 2018 97025 A	AM 97025	AM 2018 97397 A	AM 97397
AM 2018 97174 A	AM 97174	AM 2018 97410 A	AM 97410
AM 2018 97179 A	AM 97179	AM 2018 97433 A	AM 97433
AM 2018 97181 A	AM 97181	AM 2018 97438 A	AM 97438
AM 2018 97182 A	AM 97182	AM 2018 97456 A	AM 97456
AM 2018 97187 A	AM 97187	AM 2018 97459 A	AM 97459
AM 2018 97194 A	AM 97194	AM 2018 97461 A	AM 97461
AM 2018 97207 A	AM 97207	AM 2018 97469 A	AM 97469
AM 2018 97210 A	AM 97210	AM 2018 97471 A	AM 97471
AM 2018 97211 A	AM 97211	AM 2018 97473 A	AM 97473
AM 2018 97224 A	AM 97224	AM 2018 97687 A	AM 97687
AM 2018 97229 A	AM 97229	AM 2018 97797 A	AM 97797
AM 2018 97230 A	AM 97230	AM 2018 97798 A	AM 97798
AM 2018 97231 A	AM 97231	AM 2018 97799 A	AM 97799
AM 2018 97232 A	AM 97232	AM 2018 97800 A	AM 97800
		AM 2018 97801 A	AM 97801
		AM 2018 97802 A	AM 97802
		AM 2018 97803 A	AM 97803
		AM 2018 97900 A	AM 97900
		AM 2018 97901 A	AM 97901

**CONCORDANCE TABLE OF INDEX OF GOODS AND/OR SERVICES
AND APPLICATION NUMBERS**

INDEX OF GOODS AND/OR SERVICES (511)	NUMBER OF PUBLISHED APPLICATIONS (26)	1	2
1	2		
1	AM 2018 97174 A	5	AM 2018 97461 A
3	AM 2018 97410 A	5	AM 2018 97901 A
3	AM 2018 97687 A	9	AM 2018 97798 A
3	AM 2018 97901 A	9	AM 2018 97799 A
4	AM 2018 97687 A	9	AM 2018 97800 A
5	AM 2018 96860 A	9	AM 2018 97802 A
5	AM 2018 97174 A	10	AM 2018 97410 A
5	AM 2018 97181 A	16	AM 2018 97395 A
5	AM 2018 97182 A	16	AM 2018 97397 A
5	AM 2018 97210 A	16	AM 2018 97799 A
5	AM 2018 97211 A	16	AM 2018 97800 A
5	AM 2018 97229 A	18	AM 2018 97799 A
5	AM 2018 97230 A	18	AM 2018 97800 A
5	AM 2018 97410 A	25	AM 2018 97232 A
5	AM 2018 97456 A	25	AM 2018 97395 A
5	AM 2018 97459 A	25	AM 2018 97397 A
		25	AM 2018 97797 A
		25	AM 2018 97798 A
		25	AM 2018 97799 A
		25	AM 2018 97800 A
		25	AM 2018 97802 A

1	2	1	2
25	AM 2018 97803 A	35	AM 2018 97410 A
27	AM 2018 97797 A	35	AM 2018 97433 A
27	AM 2018 97798 A	35	AM 2018 97471 A
27	AM 2018 97799 A	35	AM 2018 97799 A
27	AM 2018 97800 A	35	AM 2018 97800 A
28	AM 2018 97025 A	35	AM 2018 97802 A
28	AM 2018 97798 A	35	AM 2018 97901 A
28	AM 2018 97799 A	36	AM 2018 97433 A
28	AM 2018 97800 A	36	AM 2018 97900 A
28	AM 2018 97802 A	36	AM 2018 97901 A
29	AM 2018 97179 A	37	AM 2018 97187 A
29	AM 2018 97376 A	37	AM 2018 97900 A
30	AM 2018 96894 A	37	AM 2018 97901 A
30	AM 2018 97179 A	38	AM 2018 97799 A
30	AM 2018 97231 A	38	AM 2018 97800 A
30	AM 2018 97389 A	38	AM 2018 97801 A
30	AM 2018 97392 A	41	AM 2018 97395 A
30	AM 2018 97393 A	41	AM 2018 97397 A
32	AM 2018 97179 A	41	AM 2018 97433 A
32	AM 2018 97799 A	41	AM 2018 97797 A
32	AM 2018 97800 A	41	AM 2018 97800 A
33	AM 2018 96284 A	43	AM 2018 97224 A
33	AM 2018 96973 A	43	AM 2018 97433 A
33	AM 2018 97179 A	43	AM 2018 97438 A
33	AM 2018 97194 A	43	AM 2018 97469 A
33	AM 2018 97471 A	43	AM 2018 97471 A
34	AM 2018 97207 A	43	AM 2018 97473 A
35	AM 2018 96272 A	43	AM 2018 97900 A
35	AM 2018 96894 A	43	AM 2018 97901 A
35	AM 2018 97187 A	44	AM 2018 97410 A
35	AM 2018 97224 A	44	AM 2018 97433 A
35	AM 2018 97232 A		

CONCORDANCE TABLE OF INDEX OF GOODS AND/OR SERVICES
AND NUMBERS OF TRADEMARKS REGISTERED ACCORDING
TO THE ACCELERATED PROCEDURE

INDEX OF GOODS AND/OR SERVICES (511)	NUMBERS OF REGISTERED ACCORDING TO THE ACCELERATED PROCEDURE (111)
5	M 2018 30561 R
10	M 2018 30558 R
16	M 2018 30471 R
33	M 2018 30560 R
35	M 2018 30467 R
35	M 2018 30468 R
35	M 2018 30471 R
35	M 2018 30559 R
36	M 2018 30468 R
36	M 2018 30470 R
37	M 2018 30468 R
37	M 2018 30557 R
39	M 2018 30467 R
39	M 2018 30471 R
41	M 2018 30469 R

OFFICIAL BULLETIN OF THE INDUSTRIAL PROPERTY

INVENTIONS
UTILITY MODELS
DESIGNS
TRADEMARKS

23(507)

EDITOR-IN-CHIEF: N. Bebrishvili

EDITOR-TRANSLATOR: E. Gabunia

PROOFREADER: A. Shikhashvili

COMPUTER LAYOUT: M. Ordenidze
K. Svanidze

www.sakpatenti.gov.ge

E-mail: info@sakpatenti.org.ge