

Official Bulletin of the Industrial Property

Inventions

Utility Models

Designs

Trademarks

Appellations of Origin of Goods



საქართველოს ინტელექტუალური
საკუთრების ეროვნული ცენტრი

საქპატენტი

SAKPATENTI

NATIONAL INTELLECTUAL PROPERTY
CENTER OF GEORGIA

www.sakpatenti.gov.ge

Date of Publication – 2022 12 12

23(602)

INID CODES FOR IDENTIFICATION OF BIBLIOGRAPHIC DATA

INVENTIONS, UTILITY MODELS

- (10) Number of publication for application, which has been examined
- (11) Number of patent and kind of document
- (21) Serial number of application
- (22) Date of filing of the application
- (23) Date of exhibition or the date of the earlier filing and the number of application, if any
- (24) Date from which patent may have effect
- (31) Number of priority application
- (32) Date of filing of priority application
- (33) Code of the country or regional organization allotting priority application number
- (44) Date of publication of application not granted, but examined and number of bulletin
- (45) Date of publication of registered document
- (51) International Patent Classification Index

- (54) Title of the invention
- (57) Abstract
- (60) Number of examined patent document granted by foreign patent office, date from which patent has effect and country code
- (62) Number of the earlier application and in case of divided application, date of filing an application
- (71) Name, surname and address of applicant (country code)
- (72) Name, surname of inventor (country code)
- (73) Name, surname and address of patent owner (country code)
- (74) Name, surname of representative or patent attorney
- (85) Date of commencement of the national phase of International Application
- (86) Number and date of filing of international application
- (87) Number and date of publication of international application
- (94) Calculated date of expiry of the SPC or the duration of the SPC

DESIGNS

- (10) Number of publication for application
- (11) Number of patent and kind of document or number of registration
- (15) Date of registration/Date of patent renewal
- (18) Expected expiration date of patent or registration
- (21) Serial number of application
- (22) Date of filing of the application
- (23) Date of exhibition or the date of the earlier filing and the number of application, if any
- (24) Date from which patent may have effect
- (28) Number of designs included in the application
- (30) Data relating to priority (number of application, date of filing of application, two-letter code identifying the authority with whom the priority application was made)
- (31) Number of priority application
- (32) Date of filing of priority application
- (33) Code of the country or regional organization allotting priority application number
- (34) Two-letter code according to WIPO St.3 identifying the authority with which the priority application was made
- (44) Date of publication of design and number of bulletin (the first publication)
- (45) Date of publication of design registered by WIPO and number of bulletin

- (51) International Classification for designs (class and subclass of the Locarno Classification)
- (54) Title of the invention
- (55) Reproduction of the design
- (57) Description of characteristic features of the design including indication of colors
- (58) Date of recording of any kind of amendment in the Register
- (62) Number of the earlier application, registration and document number and if available the date of filing an application in case of divided application
- (71) Name, surname and address of applicant (country code)
- (72) Name, surname of creator (country code)
- (73) Name, surname and address of patent owner (country code)
- (74) Name, surname of representative or patent attorney
- (81) Contracting states concerned
 - II designated contracting states according to the 1960 Act
 - III designated contracting states according to the 1999 Act
- (85) Owner's permanent address
- (86) Owner's nationality
- (87) Owner's residence
- (88) State in which the owner has a real and effective industrial or commercial establishment

TRADEMARKS

- (111) - Number of registration
- (151) - Date of registration
- (156) - Date of the renewal
- (181) - Expected expiration date of registration
- (186) - Renewal expiration date of registration
- (141) - Date of cancel of duration of the mark
- (210) - Serial number of application
- (220) - Date of filing of the application
- (230) - Data concerning exhibition
- (260) - Number of application, for which favorable decision of examination about registration has been taken (publication number)
- (310) - Number of the first application
- (320) - Date of filing of the first application
- (330) - Code, identifying national or regional Office where the first application was made
- (511) - International Classification of Goods and Services for the purposes of registration of trade marks and/or list of goods and/or services classified according thereto
- (526) - Disclaimer
- (531) - Description of figurative elements of Trade Marks according to the International Classification of the Figurative Elements of Marks

- (540) - Reproduction of Trade Mark
- (550) - Nature and kind of Trade Mark
- (551) - Indication to the effect that the mark is a collective mark, a certification mark or a guarantee mark
- (554) - Three-dimensional mark
- (580) - Date of recording of any kind changes in respect of applications or registrations
- (591) - Information concerning colors claimed
- (731) - Name and address of the applicant
- (732) - Name and address of the holder of the registration
- (740) - Name and address of the representative
- (750) - Addreses for correspondence
- (770) - Name and address of the previous applicant or holder in case of change in ownership
- (771) - Previous name and address of the applicant or holder in case of change in ownership
- (791) - Name and address of the licensee
- (793) - Indication of conditions and/or restrictions under the license (Type of license, number of license agreement, data of license, data of validity of license)
- (800) - Certain data relating to the international registration of Trade Marks under the Protocol Relating to Madrid Agreement (International registration number
- (852) - Partial cancellation of the list of goods and services
- (891) - Date of subsequent designation

CODES FOR PUBLICATION IN BULLETIN

- (21) AP 0000 000000 - serial number of application for invention
- (10) AP 0000 0000 A - number of published application for invention (first publication)
- (11) P 0000 0000 B - number of patent for invention (second publication)
- (21) API 0000 000000 - number of application for imported patent
- (11) PI 0000 0000 A - number of imported patent (first publication)
- (21) AU 0000 000000 - serial number of application for utility model
- (10) AU 0000 000 U - number of published application for utility model (first publication)
- (11) U 0000 000 Y - number of patent for utility model (second publication)
- (21) AD 0000 000000 - serial number of application for design
- (10) AD 0000 000 S - number of published application for design (first publication)
- (11) D 0000 000 S - registered design

INTERNATIONAL PATENT CLASSIFICATION FOR INVENTIONS AND UTILITY MODELS

- SECTION A - HUMAN NECESSITIES
- SECTION B - PERFORMING OPERATIONS; TRANSPORTING
- SECTION C - CHEMISTRY; METALLURGY
- SECTION D - TEXTILES; PAPER
- SECTION E - FIXED CONSTRUCTIONS
- SECTION F - MECHANICAL ENGINEERING; LIGHTING; HEATING; WEAPONS; BLASTING
- SECTION G - PHYSICS
- SECTION H - ELECTRICITY

-
- M - Trade Mark
 - (210) AM 0000 000000 - Serial number of application;
 - (260) AAM 0000 00000 A - Publication number of application;
 - (111) M 0000 00000 R - Number of registration;
 - (111) MMM0000 00000 Rn - Number of renewals, in which n=1,2,3;
 - (111) M 0000 00000 R(P) - Number of registration under partial assignment of rights
-

Official Bulletin of the Industrial Property

Inventions

Utility Models

Designs

Trademarks

Appellations of Origin of Goods

CONTENT

PUBLISHED TITLES OF PROTECTION	3
INVENTIONS	
▪ APPLICATIONS APPROVED FOR GRANTING PATENT	4
▪ PATENTED INVENTIONS	6
UTILITY MODELS	
PATENTED UTILITY MODELS	8
DESIGNS	
DESIGNS, WHICH HAVE BEEN REGISTERED WITH THE INTERNATIONAL BUREAU CLAIMING PRIORITY ON THE TERRITORY OF GEORGIA	9
TRADEMARKS	
▪ APPLICATIONS FILED UNDER THE NATIONAL PROCEDURE APPROVED FOR REGISTRATION	17
▪ REGISTERED TRADEMARKS	19
▪ TRADEMARKS REGISTERED ACCORDING TO THE ACCELERATED PROCEDURE	25
▪ INTERNATIONAL TRADEMARKS FOR WHICH A DECISION ON GRANTING PROTECTION IS TAKEN	26
▪ INTERNATIONAL TRADEMARKS PROTECTED IN GEORGIA	126
APPELLATIONS OF ORIGIN OF GOODS	
▪ REGISTERED APPELLATION OF ORIGIN OF GOODS	129
▪ AMENDMENTS IN PDO WINES PRODUCTION SPECIFICATION	130
OFFICIAL NOTIFICATIONS	
INVENTIONS	
▪ RESTORATION OF PATENTS	142
▪ ABOLITION OF PATENTS WITH THE RIGHT TO RESTORE	142
▪ EXPIRATION OF PATENTS RESTORATION DATE	143
▪ EXPIRATION OF TERMS OF PATENT	144
▪ TRANSFER OF RIGHTS	144
UTILITY MODELS	
▪ RESTORATION OF PATENTS	145
▪ ABOLITION OF PATENT WITH THE RIGHT TO RESTORE	145
▪ EXPIRATION OF PATENTS RESTORATION DATE	145
DESIGNS	
▪ EXTENSION OF TERMS OF DESIGNS REGISTRATION	146
▪ CANCELLATION OF DESIGN REGISTRATION	146
▪ CANCELLATION OF INTERNATIONAL DESIGNS REGISTRATION	147
TRADEMARKS	
▪ EXTENSION OF TERMS OF TRADEMARKS REGISTRATION	151
▪ COMPLETE TRANSFER OF RIGHTS	154
▪ CHANGES OF NAMES AND/OR ADDRESSES OF TRADEMARKS	155
▪ CANCELLATION OF TRADEMARKS REGISTRATION	156
CLASSIFICATION INDEXES	
INVENTIONS	158
UTILITY MODELS	159
TRADEMARKS	161

PUBLISHED TITLES OF PROTECTION

INVENTIONS

- **APPLICATIONS APPROVED FOR GRANTING PATENT:**
15389; 15469; 15611; 15448; 15540
- **PATENTED INVENTIONS:**
7444-7450

UTILITY MODELS

- **PATENTED UTILITY MODELS:**
2138-2140

DESIGNS

- **DESIGNS, WHICH HAVE BEEN REGISTERED WITH THE INTERNATIONAL BUREAU CLAIMING PRIORITY ON THE TERRITORY OF GEORGIA:**
223448; 223422; 220001; 223580; 220194; 220213

TRADEMARKS

- **APPLICATIONS FILED UNDER THE NATIONAL PROCEDURE APPROVED FOR REGISTRATION:**
117618, 117619; 117736; 117748; 117801, 117802; 117844; 117905; 117912; 117928; 117977
- **REGISTERED TRADEMARKS:**
36097-36103; 36136-36166; 36168-36173; 36175-36190; 36226
- **TRADEMARKS REGISTERED ACCORDING TO THE ACCELERATED PROCEDURE:**
36254, 36255
- **INTERNATIONAL TRADEMARKS FOR WHICH A DECISION ON GRANTING PROTECTIONS IS TAKEN:**
112808*; 115447; 116345; 116437; 116450; 116460; 116468; 116477; 116503, 116504; 116554, 116555; 116558-116561; 116563; 116571; 116574; 116580; 116586; 116591; 116594, 116595; 116597; 116615-116618; 116674-116676; 116687, 116688; 116707; 116709, 116710; 116714, 116715; 116717-116720; 116722, 116723; 116725-116727; 116768; 116777; 116779-116782; 116785-116788; 116790; 116795; 116798; 116800-116803; 116805; 116807-116811; 116813-116825; 116869; 116875; 116887-116890; 116895-116897; 116903-116909; 116943-116949; 116997, 116998; 117033-117046; 117048-117050; 117120; 117225, 117226; 117235; 117237-117239; 117241-117243; 117397-117412; 117458; 117460, 117461; 117496; 117499-117502; 117516; 117518, 117519; 117563, 117564; 117567-117571; 117628-117632; 117686-117688; 117777-117781
- **INTERNATIONAL TRADEMARKS PROTECTED IN GEORGIA:**
113559; 115158; 115279-115281; 115283, 115284; 115286-115288; 115396; 115398; 115459, 115460; 115462-115464; 115797; 115938; 116094, 116095; 116098-116103; 116213

APPELLATIONS OF ORIGIN OF GOODS

- **REGISTERED APPELLATION OF ORIGIN OF GOODS:**
984
- **AMENDMENTS IN PDO WINES PRODUCTION SPECIFICATION:**
Mukuzani; Tsinandali; Gurjaani; Manavi; Kakheti (Kakhuri); Napareuli; Teliani; Ateni (Atenuri); Sviri; Vazisubani; Kardenakhi; Tibaani; Kvareli; Khashmis Saperavi; Akhmeta (Akhmetis Mtsvane); Kotekhi

INVENTIONS

APPLICATIONS APPROVED FOR GRANTING PATENT

The decision can be appealed at the Chamber of Appeal of Sakpatenti within 3 months from the publication or at the Mtskheta District Court Administrative Cases Board (Address: №17, Samkhedro St., Mtskheta), within 1 month following the publication.

PART A

A 01

- (10) AP 2022 15389 A (51) Int. Cl. (2006)
A 01 N 43/80
C 07 D 261/04
- (21) AP 2018 15389 (22) 2018 12 14
(31) 1721235.8
(32) 2017 12 19
(33) GB
- (71) Syngenta Participations AG (CH)
Rosentalstrasse 67, Basel, 4058,
Switzerland (CH)
- (72) HONE, John (GB);
JONES, Ian, Kevin (GB);
GEORGE, Neil (GB)
- (74) Tamar Kochlamazashvili
(85) 2020 07 15
(86) PCT/EP2018/084957, 2018 12 14
(54) POLYMORPHS
(57) Compound of formula IA,

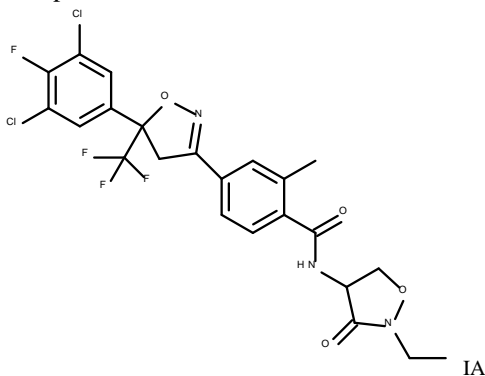

crystalline polymorph characterized with powdery X-ray diffraction diagram, compositions containing said polymorph, and usage thereof as insecticides.

Claims: 6 independents
9 dependents

Fig.: 14

A 61

- (10) AP 2022 15469 A (51) Int. Cl. (2006)
A 61 K 9/00
A 61 K 31/4196
A 61 K 47/34
- (21) AP 2019 15469 (22) 2019 06 12
(31) 18382413.5
(32) 2018 06 12
(33) EP
- (71) Laboratorios Farmacéuticos Rovi S.A. (ES)
C/Julián Camarillo, 35 28037, Madrid,
Spain (ES)
- (72) Guillermo FRANCO RODRÍGUEZ (ES);
GUTIERRO ADURIZ, Ibon (ES)
- (74) Tamaz Shilakadze
(85) 2020 10 15
(86) PCT/EP2019/065318, 2019 06 12
(54) INJECTABLE COMPOSITION
(57) Composition contains 10-500 mg letrozole and
sterile biodegradable thermoplastic polymer of
polylactic acid (FLA).
Claims: 7 independents
2 dependents
Fig.: 9

- (10) AP 2022 15611 A (51) Int. Cl. (2006)
A 61 K 9/16
A 61 K 39/00
- (21) AP 2018 15611 (22) 2018 09 11
(62) AP 2018 15318 2018 09 11
(31) 17192260.2
(32) 2017 09 20
(33) EP
- (71) Tillotts Pharma AG (CH)
Baslerstrasse 15, Rheinfelden, 4310,
Switzerland (CH)
- (72) VON ROCHOW, Laetitia (CH);
WETZEL, Carmen (CH);
BRAVO, Roberto (CH);
VARUM, Felipe (CH)
- (74) Tamar Kochlamazashvili
(85) 2021 04 19
(86) PCT/EP2018/074520, 2018 09 11
(54) PREPARATION OF SOLID DOSAGE
FORMS COMPRISING ANTIBODIES
BY SOLUTION/SUSPENSION
LAYERING

(57) Present invention relates to a method for preparing immediate and sustained release solid dosage forms, comprising antibodies, and functional fragments thereof, by solution/suspension layering, optionally coated with delayed release coating.

Claims: 1 independent
16 dependents

Fig.: 11

(10) AP 2022 15448 A (51) Int. Cl. (2006)
A 61 K 31/00
A 61 K 45/06
A 61 P 35/00
C 07 D 403/12
C 07 D 233/56

(21) AP 2019 15448 (22) 2019 07 30

(31) 201810867251.8

(32) 2018 07 31

(33) CN

(71) Ascentage Pharma (Suzhou) Co., LTD. (CN)
Unit 701, Bldg. B7, 218 XInghu St., Suzhou
Industrial Park,
Suzhou, Jiangsu 215000, People's Republic of
China (CN)

(72) YANG, Dajun (CN);
ZHAI, Yifan (CN);
FANG, Douglas Dong (CN);
WANG, Guangfeng (CN);
ZHAI, Guoqin (CN)

(74) Tamaz Shilakadze

(85) 2020 09 17

(86) PCT/CN2019/098252, 2019 07 30

(54) COMBINATION PRODUCT OF BCL-2
INHIBITOR OR BCL-2/BCL-XL DUAL
INHIBITOR AND BTK INHIBITOR AND
USE THEREOF IN THE PREVENTION
AND/OR TREATMENT OF DISEASES

(57) Combination product comprises Bcl-2 and
BTK inhibitors, and usage therein cancer, autoim-
mune and inflammatory diseases treatment.

Claims: 2 independents
9 dependents

Fig.: 10

(10) AP 2022 15540 A (51) Int. Cl. (2006)
A 61 K 38/00
C 07 K 7/06
C 12 N 9/64

(21) AP 2019 15540 (22) 2019 06 20

(31) 62/687,913

(32) 2018 06 21

(33) US

(71) Merck Sharp & Dohme Corp. (US)
126 East Lincoln Avenue, Rahway,
NJ 07065-0907, USA (US)

(72) WOOD, Harold, B. (US);

JOSIEN, Hubert, B. (US);
TUCKER, Thomas, Joseph (US);
KEREKES, Angela, Dawn (US);
TONG, Ling (US);
WALJI, Abbas, M. (US);
NAIR, Anilkumar, G. (US);
DING, Fa-Xiang (US);
BIANCHI, Elisabetta (IT);
BRANCA, Danila (IT);
WU, Chengwei (US);
XIONG, Yusheng (US);
HA, Sookhee, Nicole (US);
LIU, Jian (US);
BOGA, Sobhana, Babu (US)

(74) Shalva Gvaramadze

(85) 2021 01 20

(86) PCT/US2019/038155, 2019 06 20

(54) PCSK9 ANTAGONIST COMPOUNDS

(57) Compound of formula I,

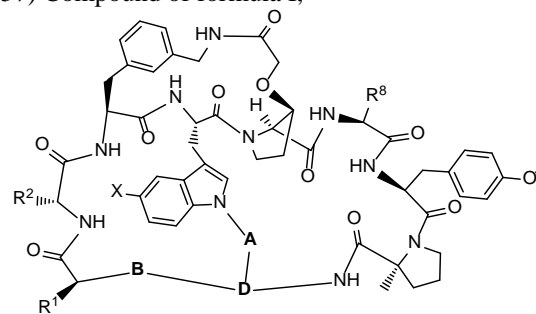

pharmaceutical compositions on the basis thereof, and
usage therein hypercholesterinemia treatment.

Claims: 19 independents
29 dependents

PATENTED IVENTIONS

PART A

A 61

- (11) P 2022 7446 B (51) Int. Cl. (2006)
A 61 K 31/473
A 61 P 25/00
C 07 D 405/12
C 07 D 405/14
- (10) AP 2022 15342 A (44) 13(592)/2022
(21) AP 2018 15342
(22) 2018 11 23
(24) 2018 11 23
(31) PA201700674
(32) 2017 11 24
(33) DK
(86) PCT/EP2018/082361, 2018 11 23
(73) H. LUNDBECK A/S (DK)
Ottliavej 9, DK-2500 Valby, Denmark (DK)
(72) JENSEN, Klaus, Gjervig (DK);
KVÆRNØ, Lisbet (DK);
JUHL, Martin (DK);
MORTEN, Jørgensen (DK)
(74) Tamaz Shilakadze
(54) NEW CATECHOLAMINE PRODRUGS
FOR USE IN TREATMENT OF PARKI-
NSON'S DISEASE

-
- (11) P 2022 7447 B (51) Int. Cl. (2006)
A 61 K 38/17
A 61 K 39/395
C 07 K 14/705
C 07 K 14/47
- (10) AP 2022 15294 A (44) 13(592)/2022
(21) AP 2016 15294
(22) 2016 08 05
(24) 2016 08 05
(62) AP 2016 14720 2016 08 05
(31) 62/202,772; 62/202,775; 62/202,779;
62/265,887; 62/276,801; 62/276,796;
62/346,414
(32) 2015 08 07; 2015 08 07; 2015 08 07;
2015 12 10; 2016 01 08; 2016 01 08;
2016 06 06
(33) US; US; US; US; US; US; US
(86) PCT/US2016/045914, 2016 08 05
(73) Ilex Oncology Inc. (US)
866 Malcolm Rd., Suite 100, Burlingame,
CA 94010, USA (US)
(72) DEMING, Laura (US);
GOODMAN, Corey (US);
KUO, Tracy Chia-Chien (US);
KAUDER, Steven Elliot (US);

- PONS, Jaume (US);
WAN, Hong (US);
SIM, Bang Janet (US)
(74) Tamar Kochlamazashvili
(54) CONSTRUCTS HAVING SIRP-ALPHA
DOMAIN OR VARIANT THEREOF

-
- (11) P 2022 7445 B (51) Int. Cl. (2006)
A 61 K 47/02
A 61 K 9/16
A 61 K 33/26
A 61 K 47/42
A 61 K 9/06
- (10) AP 2022 14903 A (44) 12(591)/2022
(21) AP 2017 14903
(22) 2017 03 15
(24) 2017 03 15
(31) 16160539.9
(32) 2016 03 15
(33) EP
(86) PCT/EP2017/056134, 2017 03 15
(73) Solvotrin Therapeutics LTD (IE)
Inchera Little Island Cork, Co Cork,
Ireland (IE)
(72) WHELEHAN, Michael (IE);
GABOR, Radics (IE);
LEDWIDGE, Mark (IE);
O'FLYNN, Pat (IE);
WANG, Jun (IE);
GILMER, John (IE)
(74) Tamaz Shilakadze
(54) COMPOSITIONS AND METHODS FOR
INCREASING IRON INTAKE IN MAMMAL

PART B

B 29

- (11) P 2022 7449 B (51) Int. Cl. (2006)
B 29 B 17/04
B 29 B 17/00
C 08 J 3/00
C 08 J 3/12
C 08 L 95/00
E 01 C 7/26
- (10) AP 2022 15770 A (44) 16(595)/2022
(21) AP 2020 15770
(22) 2020 05 04
(24) 2020 05 04
(31) 102019000006600
(32) 2019 05 07

- (33) IT
 (86) PCT /EP2020/062260, 2020 05 04
 (73) Iterchimica S.P.A. (IT)
 Via G. Marconi, 21, Suisio 24040, Italy (IT)
 (72) GIANNATTASIO, Federica (IT);
 CISANI, Sergio (IT);
 BERTULETTI, Elisa (IT)
 (74) Nugzar Ksovreli
 (54) PROCESS FOR PRODUCTION OF ADDITIVE
 FOR BITUMINOUS CONGLOMERATES
 WITH HIGH MECHANICAL PERFORMAN-
 CES AND ADDITIVE COMPOSITION

B 66

- (11) P 2022 7444 B (51) Int. Cl. (2006)
 B 66 D 5/26
 (10) AP 2022 15650 A (44) 12(591)/2022
 (21) AP 2021 15650
 (22) 2021 06 04
 (24) 2021 06 04
 (21) AP 2021 15650 (22) 2021 06 04
 (73) Simon Bitsadze (GE)
 Pekini Ave. 31g, app. 29, 0160, Tbilisi,
 Georgia (GE);
 Rusudan Bitsadze (GE)
 Pekini Ave. 31g, app. 29, 0160, Tbilisi,
 Georgia (GE)
 (72) Simon Bitsadze (GE);
 Rusudan Bitsadze (GE)
 (54) MAGNETIC HYDRAULIC PUSHER

H 02

- (11) P 2022 7450 B (51) Int. Cl. (2006)
 H 02 K 19/00
 (10) AP 2022 15722 A (44) 12(591)/2022
 (21) AP 2021 15722
 (22) 2021 08 23
 (24) 2021 08 23
 (73) JSC "Zago Technology" (GE)
 Besiki Str. 4, Business Center in Besiki,
 Office 203, 0108, Tbilisi, Georgia (GE)
 (72) Vyacheslav Zagoruichenko (GE)
 (54) MULTI-DISC INDUCTION GENERATOR
 WITH POWER REGULATION IN
 EXCITATION WINDING

PART H

H 01

- (11) P 2022 7448 B (51) Int. Cl. (2006)
 H 01 L 29/66
 (10) AP 2022 15678 A (44) 12(591)/2022
 (21) AP 2021 15678
 (22) 2021 07 03
 (24) 2021 07 03
 (73) LEPL "Ilia State University" (GE)
 Cholokashvili Ave. 3/5, 0162, Tbilisi,
 Georgia (GE)
 (72) Zakaria Taliashvili (GE);
 Avtandil Tavkheldze (GE)
 (74) Khatuna Imnadze
 (54) SEMICONDUCTOR LIGHT-ABSORBING
 NANOSTRUCTURAL SURFACE

UTILITY MODELS

PATENTED UTILITY MODELS

PART A

A 61

- (11) U 2022 2139 Y (51) Int. Cl. (2006)
A 61 M 1/10
- (10) AU 2022 15543 U (44) 16(595)/2022
- (21) AU 2021 15543
- (22) 2021 01 25
- (24) 2021 01 25
- (73) Nodar Khodeli (GE)
Budapesht Str. 40, Tbilisi, Georgia (GE);
Zurab Chkhaidze (GE)
Marie Brose Str. 2, Tbilisi, Georgia (GE);
Otar Shengelia (GE)
Davit Garejeli Str. 49, Tbilisi, Georgia (GE);
Davit Songhulashvili (GE)
Theodore Tironi Str. 10, Vill. Dighomi,
Tbilisi, Georgia (GE)
- (72) Nodar Khodeli (GE);
Zurab Chkhaidze (GE);
Otar Shengelia (GE);
Davit Songhulashvili (GE)
- (54) PORTABLE DEVICE FOR MANAGEMENT
OF ARTIFICIAL BLOOD FLOW
-

PART F

F 24

- (11) U 2022 2138 Y (51) Int. Cl. (2006)
F 24 H 9/00
- (10) AU 2022 15789 U (44) 15(594)/2022
- (21) AU 2021 15789
- (22) 2021 11 07
- (24) 2021 11 07
- (73) Iuri Kajaia (GE)
Nutsubidze Plateau, IV mcr., Tvaltchrelidze
Str. 16, ap. 3, 0186, Tbilisi, Georgia (GE)
- (72) Iuri Kajaia (GE)
- (74) Khatuna Imnadze
- (54) HEATING BOILER THERMAL INSULATION
CAN
-

PART E

E 02

- (11) U 2022 2140 Y (51) Int. Cl. (2006)
E 02 D 5/56
- (10) AU 2022 15677 U (44) 15(594)/2022
- (21) AU 2020 15677
- (22) 2020 05 22
- (22) 2020 05 22
- (31) 2019115744
- (32) 2019 05 22
- (33) RU
- (86) PCT/RU2020/050106, 2020 05 22
- (73) ZHELTIKOV, Valeriy Vladimirovich (RU)
Zmeinogorskiy Trakt, 102/60, 656045, Barnaul,
Russian Federation (RU)
- (72) ZHELTIKOV, Valeriy Vladimirovich (RU)
- (74) Irakli Gvilia
- (54) SCREW PILE
-

**DESIGNS, WHICH HAVE BEEN REGISTERED WITH THE INTERNATIONAL
BUREAU CLAIMING PRIORITY ON THE TERRITORY OF GEORGIA**

The decision can be appealed at the Chamber of Appeal of Sakpatenti within 3 months from the publication or at the Mtskheta District Court Administrative Cases Board (Address: №17, Samkhedro St., Mtskheta), within 1 month following the publication.

- (11) DM/223 448 (51) 03-01
 (15) 2022 09 05 (44) 38/2022 (2022 09 23)
 (22) 2022 09 05
 (28) 1
 (73) Valentino S.p.A.
 Via Turati, 16/18, I-20121 Milano (EM)
 (85) –
 (86) EM, IT
 (87) EM, IT
 (88) EM, IT
 (89) EM
 (81) III. AZ, EM, GB, GE, JP, KG, KR, RU, TJ, TR, UA, US
 (72) Pierpaolo PICCIOLI
 C/o VALENTINO S.p.A., Via Turati, 16/18, I-20121, Milano (IT)
 (74) Jacobacci & Partners S.p.A. / Matteo Mozzi
 C/o Jacobacci & Partners S.p.A., Via Senato, 8, I-20121 Milano (IT)
 (46) 2022 09 23
 (54) 1. BAG
 (55)

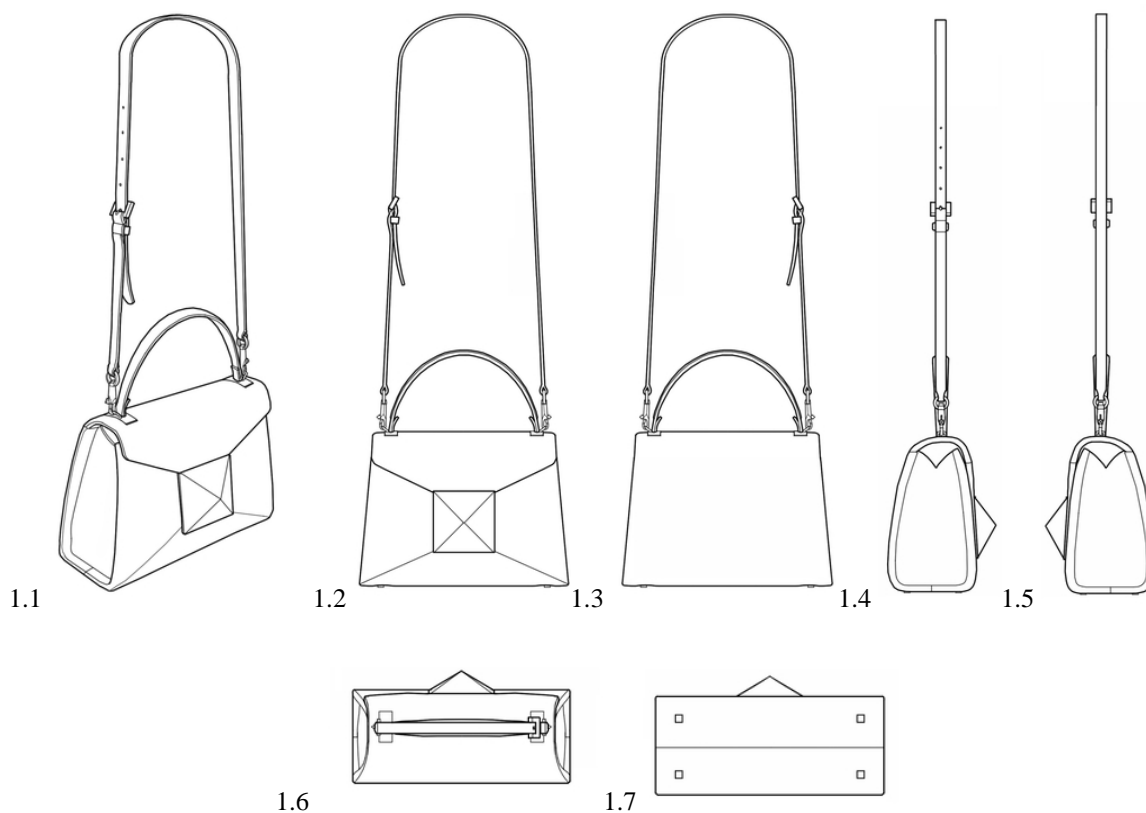

- (11) DM/223 422
- (15) 2022 08 24
- (22) 2022 08 24
- (28) 1
- (30) No1: 02.03.2022; 008875686; EM
- (73) Adp Merkur GmbH
GmbH, Merkur-Allee 1 - 15, 32339 Espelkamp (DE)
- (85) DE
- (86) DE
- (87) DE
- (88) DE
- (89) DE
- (81) III. BA, CH, GB, GE, MA, ME, MK, MX, RO, RS, RU, UA, US
- (72) Dennis Rozyk
Kreuzstrasse 26, 31542, Bad Nenndorf (DE)
- (74) Adp Merkur GmbH
Paul-Gauselmann-Straße 1, 32312 Lübbecke (DE)
- (46) 2022 09 23
- (54) 1. AMUSEMENT APPARATUS
- (55)

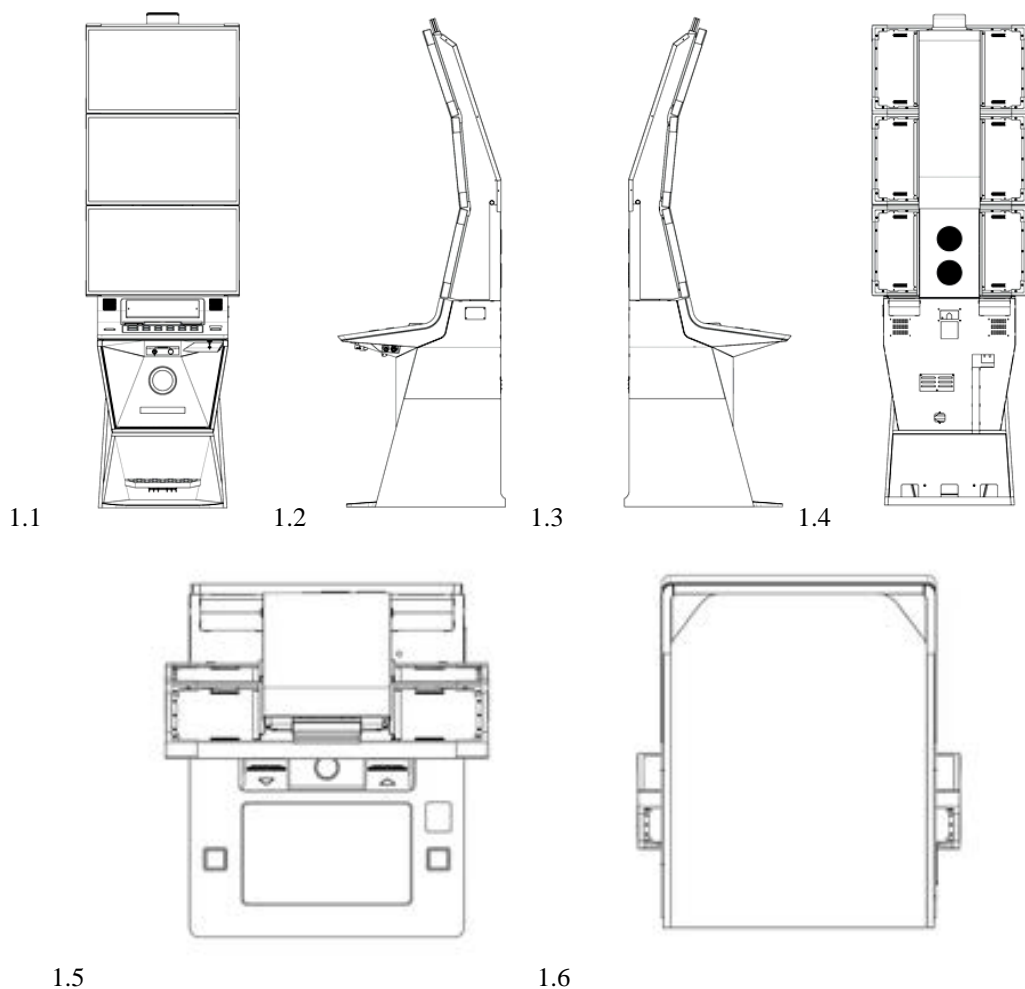

- (11) DM/220 001 (51) 10-07
 (15) 2022 03 31 (44) 39/2022 (2022 09 30)
 (22) 2022 03 31
 (28) 2
 (73) HARRY WINSTON SA
 Chemin du Tourbillon 8, 1228 Plan-les-Ouates (CH)
 (85) CH
 (86) CH
 (87) CH
 (88) CH
 (89) CH
 (81) II. MA III. AL, AM, AZ, BA, BZ, CA, CH, EM, GB, GE, KG, LI, MC, MD, ME, MK, MN, NO, OM, SG,
 TN, TR, UA
 (72) Carole PIERRE
 c/o Harry Winston SA, Chemin du Tourbillon 8, 1228, Plan-les-Ouates (CH)
 (74) The Swatch Group AG (The Swatch Group SA) (The Swatch Group Ltd.)
 Faubourg du Lac 6, 2501 Biel/Bienne (CH)
 (46) 2022 09 30
 (54) 1. WATCH CASE, 2. WATCH DIAL
 (55)

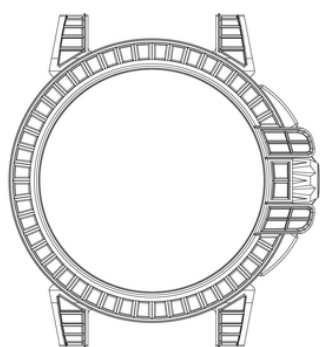

1.1

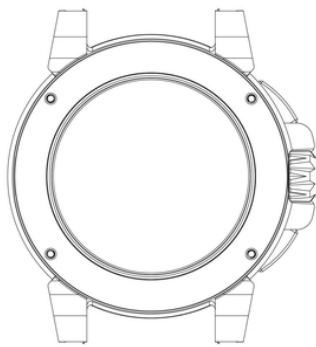

1.2

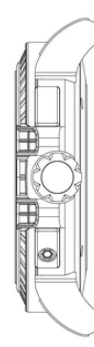

1.3

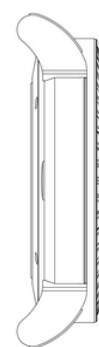

1.4

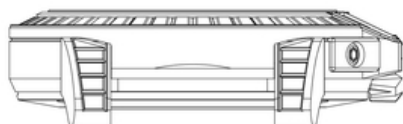

1.5



1.6

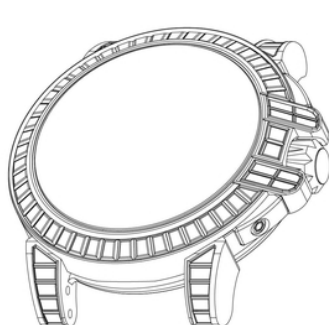

1.7

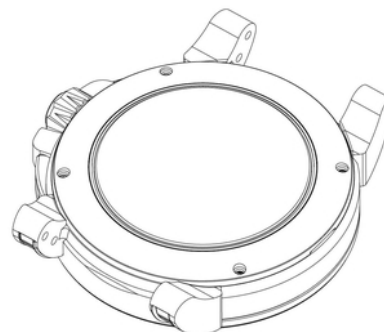

1.8

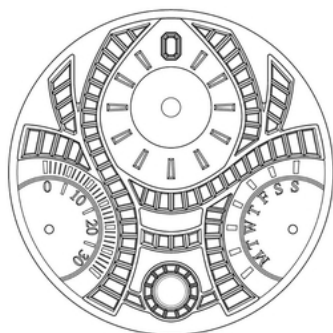

2.1

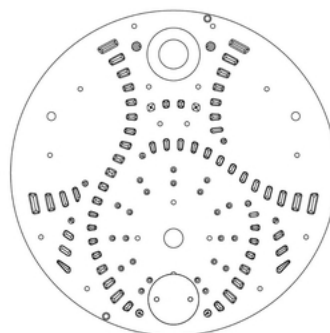

2.2



2.3



2.4



2.5



2.6

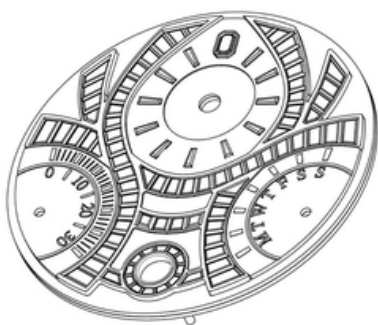

2.7

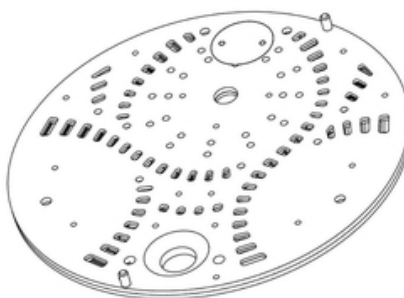

2.8

- (11) DM/223 580
(51) 32-00
(15) 2022 08 11
(44) 39/2022 (2022-09-30)
(22) 2022 08 11
(28) 3
(73) ProCredit Holding AG & Co. KGaA
Rohmerplatz 33-37, 60486 Frankfurt Am Main (DE)
(85) –
(86) DE
(87) DE
(88) DE
(89) EM
(81) III. AL, BA, EM, GE, MD, MK, RS, UA
(72) Danijela Masson-Montibeler (B.A.)
Ferdinand-Haas-Str. 15 C, 55597, Wöllstein (DE)
(46) 2022-09-30
(54) 1.-3. Logo
(55)



- (11) DM/220 194 (51) 10-07
- (15) 2022 04 04 (44) 40/2022 (2022 10 07)
- (22) 2022 04 04
- (28) 1
- (73) HARRY WINSTON SA
Chemin du Tourbillon 8, 1228 Plan-les-Ouates (CH)
- (85) CH
- (86) CH
- (87) CH
- (88) CH
- (89) CH
- (81) II. MA III. AL, AM, AZ, BA, BZ, CA, CH, EM, GB, GE, KG, LI, MC, MD, ME, MK, MN, NO, OM, RU, SG, TN, TR, UA
- (72) Sandra GARSAUD
c/o Harry Winston SA Chemin du Tourbillon 8, 1228, Plan-les-Ouates (CH)
- (74) The Swatch Group AG (The Swatch Group SA) (The Swatch Group Ltd.)
Faubourg du Lac 6, 2501 Biel/Bienne (CH)
- (46) 2022 10 07
- (54) 1. WATCH DIAL
- (55)

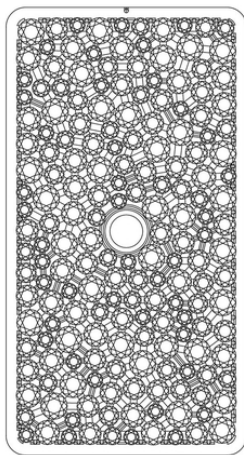

1.1

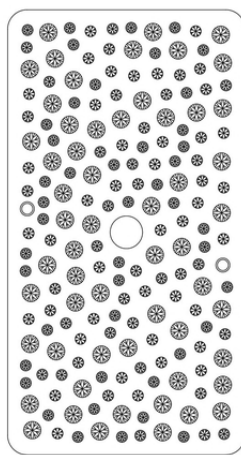

1.2

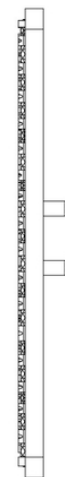

1.3



1.4

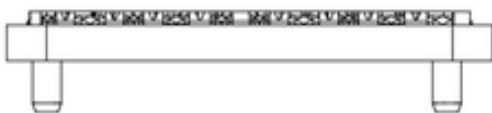

1.5

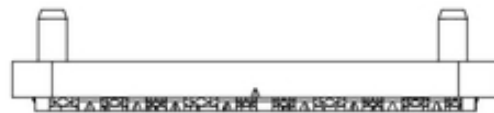

1.6



1.7

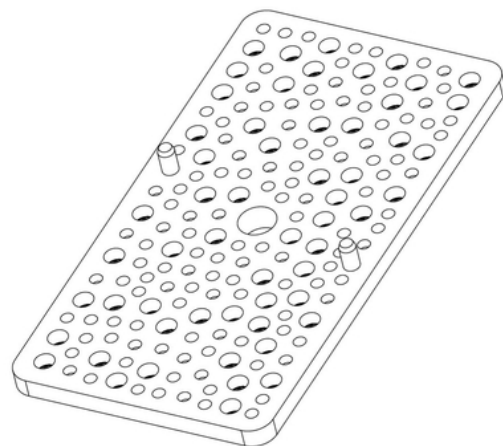

1.8

- (11) DM/220 213 (51) 11-01
 (15) 2022 04 07 (44) 40/2022 (2022 10 07)
 (22) 2022 04 07
 (28) 2
 (73) HARRY WINSTON SA
 Chemin du Tourbillon 8, 1228 Plan-les-Ouates (CH)
 (85) CH
 (86) CH
 (87) CH
 (88) CH
 (89) CH
 (81) II. MA III. AL, AM, AZ, BA, BZ, CA, CH, EM, GB, GE, KG, LI, MC, MD, ME, MK, MN, NO, OM, SG,
 TN, TR, UA
 (72) 1: Tobias WUEST
 c/o Harry Winston Inc. 718 Fifth Avenue, 10019, New York (US);
 2: Delphine ABDOURAHIM
 c/o Harry Winston Inc. 718 Fifth Avenue, 10019, New York (US)
 (74) The Swatch Group AG (The Swatch Group SA) (The Swatch Group Ltd.)
 Faubourg du Lac 6, 2501 Biel/Bienne (CH)
 (46) 2022 10 07
 (54) 1. FINGER RING, 2. WEDDING RING
 (55)



1.1



1.2



1.3



1.4



1.5



1.6



1.7



1.8



2.1



2.2



2.3



2.4



2.5



2.6



2.7



2.8

TRADEMARKS

APPLICATIONS FILED UNDER THE NATIONAL PROCEDURE APPROVED FOR REGISTRATION

The decision can be appealed at the Chamber of Appeal of Sakpatenti within 3 months from the publication or at the Mtskheta District Court Administrative Cases Board (Address: №17, Samkhedro St., Mtskheta), within 1 month following the publication.

(260) AM 2022 117618 A
(210) AM 117618
(220) 2022 04 27
(731) Borisi Berulava
Mukhiani II m/r., bld. 37, ap. 13, 0101, Tbilisi,
Georgia
(540)

Berulava wine
ბერულავას ღვინო

(591) Black-white
(511) 33

(260) AM 2022 117619 A
(210) AM 117619
(220) 2022 04 27
(731) LTD "P-9"
Vill. Tskhramukha, 5708, Khashuri, Georgia
(540)



(591) White, orange, sky-blue, grey
(531) 01.15.15; 27.05.01; 27.05.21; 27.05.24; 28.19;
29.01.14
(511) 32, 33

(260) AM 2022 117736 A
(210) AM 117736
(220) 2022 05 10
(731) Ekaterina Maksimova
Kalinowskiy Street, House 32, Flat 90,
Minsk Region, City of Zhodino, Belarus
(740) Shalva Giorgadze
(540)

Мозгобойня

(591) Black-white
(531) 28.05
(511) 41

(260) AM 2022 117748 A
(210) AM 117748
(220) 2022 05 12
(731) LLC "Linus & Co"
Borough Kazreti, Madneuli Str. 10, Bolnisi,
Georgia
(540)



(591) EF8B34 orange, 1E6B03 green
(531) 05.03.13; 05.03.15; 27.05.01; 27.05.17;
29.01.12
(511) 5, 7, 8, 31, 44

(260) AM 2022 117801 A
(210) AM 117801
(220) 2022 05 13
(731) LLC "Linus & Co"
Borough Kazreti, Madneuli Str. 10, Bolnisi,
Georgia
(540)



(591) EF8B34 orange, 1E6B03 green
(531) 05.03.13; 05.03.15; 27.05.01; 27.05.17;
29.01.12
(511) 1, 2, 6, 11, 16, 17, 22, 35

(260) AM 2022 117802 A
(210) AM 117802
(220) 2022 05 13
(731) LLC "Linus & Co"
Borough Kazreti, Madneuli Str. 10, Bolnisi,
Georgia
(540)

FORCE SHOP

(591) EF8B34 orange
(531) 27.05.01; 27.05.17; 29.01.01
(511) 1, 2, 5, 6, 7, 8, 11, 16, 17, 22, 31, 35, 44

(260) AM 2022 117844 A
 (210) AM 117844
 (220) 2022 05 19
 (731) The Procter & Gamble Company
 One Procter & Gamble Plaza, Cincinnati, Ohio
 45202, USA
 (540)

Naturella

(591) Black-white
 (531) 27.05.01; 27.05.19
 (511) 5

(260) AM 2022 117905 A
 (210) AM 117905
 (220) 2022 05 20
 (731) LTD "GLI"
 Shota Rustaveli Str. 20, 6004, Batumi, Georgia
 (540)



საქართველო

(591) FFFFFFF white, F79813 orange,
 F7071B red, 0EBCED sky-blue,
 F4F40C yellow, 66EF10 green, 1919EA
 blue
 (531) 03.09.15; 03.09.17; 03.09.23; 03.09.24;
 25.07.01; 25.07.05; 26.01.15; 28.19; 29.01.15
 (511) 43

(260) AM 2022 117912 A
 (210) AM 117912
 (220) 2022 05 23
 (731) LTD "Ashki Agro"
 Vazha-Pshavela Ave. 71, floor 1, (Block 4),
 0186, Tbilisi, Georgia
 (540)



(591) Dark lilac, blue, sky-blue, white, yellow, dark
 and light greens, grey
 (531) 01.03.01; 01.03.15; 06.01.02; 06.19.11;
 06.19.13; 26.01.04; 26.01.16; 26.01.19;
 26.01.21; 29.01.14
 (526) OZURGETI, GEORGIA
 (511) 31

(260) AM 2022 117928 A
 (210) AM 117928
 (220) 2022 05 25
 (310) 2021.0905
 (320) 2021 11 29
 (330) TM
 (731) Amazon Technologies Inc.
 410 Terry Avenue North, Seattle, Washington,
 98109, USA
 (740) Tamaz Shilakadze
 (540)

ROBORUNNER

(591) Black-white
 (511) 9, 40, 42

(260) AM 2022 117977 A
 (210) AM 117977
 (220) 2022 05 27
 (310) 018611567
 (320) 2021 11 30
 (330) EUIPO
 (731) Amazon Technologies Inc.
 410 Terry Avenue North, Seattle, Washington,
 98109, USA
 (740) Tamaz Shilakadze
 (540)

FLEETWISE

(591) Black-white
 (511) 9, 35, 38, 42

REGISTERED TRADEMARKS

(111) M 2022 36097 R
 (151) 2022 10 21
 (181) 2032 10 21
 (260) AM 2021 115749 A
 (220) 2021 12 14

(732) Alkaloid AD Skopje
 Blvd. Aleksandar Makedonski 12, 1000
 Skopje, The Republic of North Macedonia

(111) M 2022 36098 R
 (151) 2022 10 21
 (181) 2032 10 21
 (260) AM 2021 115750 A
 (220) 2021 12 14

(732) Alkaloid AD Skopje
 Blvd. Aleksandar Makedonski 12, 1000
 Skopje, The Republic of North Macedonia

(111) M 2022 36099 R
 (151) 2022 10 21
 (181) 2032 10 21
 (260) AM 2021 115756 A
 (220) 2021 12 15

(732) Zongshen Industrial Group Co., LTD
 Chaoyouchang, Huaxizhen, Bananqu,
 Chongqing, People Republic of China

(111) M 2022 36100 R
 (151) 2022 10 21
 (181) 2032 10 21
 (260) AM 2021 115969 A
 (220) 2021 12 24

(732) LTD "Gallery Tbilisi"
 Shota Shota Rustaveli Ave. 2/4, (plot 65/003),
 0108, Tbilisi, Georgia

(111) M 2022 36101 R
 (151) 2022 10 21
 (181) 2032 10 21
 (260) AM 2021 115970 A
 (220) 2021 12 24

(732) LTD "Gallery Tbilisi"
 Shota Rustaveli Ave. 2/4, (plot 65/003), 0108,
 Tbilisi, Georgia

(111) M 2022 36102 R
 (151) 2022 10 21
 (181) 2032 10 21
 (260) AM 2021 115900 A
 (220) 2021 12 23

(732) LTD "Khod"
 11 Str. 4, Vill. Karajala, Telavi, Georgia

(111) M 2022 36103 R
 (151) 2022 10 21
 (181) 2032 10 21
 (260) AM 2022 116313 A
 (220) 2022 01 24

(732) British American Tobacco (Brands) Inc.
 (a Delaware corporation)
 251 Little Falls Drive, Suite 100, Wilmington,
 Delaware, 19808-1674, USA

(111) M 2022 36136 R
 (151) 2022 11 10
 (181) 2032 11 10
 (260) AM 2020 108680 A
 (220) 2020 06 17

(732) LTD "Kartveli"
 Kakheti Highway, 110a, 0151, Isani-Samgori
 District, Tbilisi, Georgia

(111) M 2022 36137 R
 (151) 2022 11 10
 (181) 2032 11 10
 (260) AM 2021 111163 A
 (220) 2021 01 07

(732) Mey Alkollu Ickiler Sanayii Ve Ticaret
 Anonim Sirketi
 Biuiuqdere Qad. Bakhar Soq. №:13 River
 Plaza Kat:25 34394 Shishli, İstanbul, Turkey

(111) M 2022 36138 R
 (151) 2022 11 10
 (181) 2032 11 10
 (260) AM 2021 113417 A
 (220) 2021 06 09

(732) LTD "Bolero & Company"
 Kuchishvili Str. 12-14-16, 0179, Tbilisi, Georgia

(111) M 2022 36139 R
 (151) 2022 11 10
 (181) 2032 11 10
 (260) AM 2021 113990 A
 (220) 2021 07 20

(732) LTD "A-B-F"
 Vill. Martkopi, Vaziani Settlement, Gardabani
 Region, Georgia

(111) M 2022 36140 R
(151) 2022 11 10
(181) 2032 11 10
(260) AM 2021 114125 A
(220) 2021 07 30
(732) LTD "FMG Soft"
V. Dolidze Str. 2, 0171, Tbilisi, Georgia

(111) M 2022 36141 R
(151) 2022 11 10
(181) 2032 11 10
(260) AM 2021 114532 A
(220) 2021 09 03
(732) Beijing DiDi Infinity Technology
Development Co., LTD.
Building 34, No8 Dongbeiwang West Road,
Haidian District, Beijing, Beijing, Public
Republic of China

(111) M 2022 36142 R
(151) 2022 11 10
(181) 2032 11 10
(260) AM 2021 114686 A
(220) 2021 09 21
(732) Dmitro Yakovtsev
Volkova Str. 12, app. 53, Kropivnitzki,
Ukraine

(111) M 2022 36143 R
(151) 2022 11 10
(181) 2032 11 10
(260) AM 2021 115105 A
(220) 2021 10 25
(732) Ekaterine Mgaloblishvili
Tamar Mepe Str. 50, Kutaisi, Georgia

(111) M 2022 36144 R
(151) 2022 11 10
(181) 2032 11 10
(260) AM 2021 115110 A
(220) 2021 10 26
(732) Tornike Kurshitashvili
Givi Svanidze Str. 4, 0101, Tbilisi, Georgia;
Makhare Lepsveridze
Vill. Ikalto, 2206, Telavi, Georgia

(111) M 2022 36145 R
(151) 2022 11 10
(181) 2032 11 10
(260) AM 2021 115117 A
(220) 2021 10 27
(732) Tornike Kurshitashvili
Givi Svanidze Str. 4, 0101, Tbilisi, Georgia;

Makhare Lepsveridze
Vill. Ikalto, 2206, Telavi, Georgia

(111) M 2022 36146 R
(151) 2022 11 10
(181) 2032 11 10
(260) AM 2021 115539 A
(220) 2021 11 26
(732) JSC "TBC Bank"
Kote Marjanishvili Str. 7, 0102, Tbilisi, Georgia

(111) M 2022 36147 R
(151) 2022 11 10
(181) 2032 11 10
(260) AM 2021 115602 A
(220) 2021 11 30
(732) LTD "Snowy Mountains"
Vazisubani Settlement, bld. 18a, app. 11,
Isani-Samgori District, Tbilisi, Georgia

(111) M 2022 36148 R
(151) 2022 11 10
(181) 2032 11 10
(260) AM 2021 115677 A
(220) 2021 12 07
(732)) LTD "TM Group"
S. Tsintsadze Str. 59, app. 39, Tbilisi, Georgia

(111) M 2022 36149 R
(151) 2022 11 10
(181) 2032 11 10
(260) AM 2021 115679 A
(220) 2021 12 07
(732) LTD "TM Group"
S. Tsintsadze Str. 59, app. 39, Tbilisi, Georgia

(111) M 2022 36150 R
(151) 2022 11 10
(181) 2032 11 10
(260) AM 2021 115683 A
(220) 2021 12 07
(732) LTD "Termo Center"
Sh. Gogidze Str. 6, 0159, Tbilisi, Georgia

(111) M 2022 36151 R
(151) 2022 11 10
(181) 2032 11 10
(260) AM 2021 115745 A
(220) 2021 12 12
(732) LLC "Digital Platform"
16 Nestan-Darejan Str. 16, Vill. Dighomi, Tbilisi,
Georgia

(111) M 2022 36152 R (151) 2022 11 10 (181) 2032 11 10 (260) AM 2021 115757 A (220) 2021 12 16 (732) Irakli Bitskinashvili Mosashvili Str. 8, 2200, Telavi, Georgia	No. 8 Changchun Road, Hi-Tech Industrial Park, Zhengzhou, People Republic of China
(111) M 2022 36153 R (151) 2022 11 10 (181) 2032 11 10 (260) AM 2021 115758 A (220) 2021 12 16 (732) Baiadera Menejment Limited Karpenisiou 30, Nicosia, 1660, Cyprus; LTD "Kartveli" Kakheti Highway 110a, 0198, Isani-Samgori District, Tbilisi, Georgia	(111) M 2022 36158 R (151) 2022 11 10 (181) 2032 11 10 (260) AM 2021 115892 A (220) 2021 12 23 (732) Zhengzhou Yutong Group Co., LTD No. 8 Changchun Road, Hi-Tech Industrial Park, Zhengzhou, People Republic of China
(111) M 2022 36154 R (151) 2022 11 10 (181) 2032 11 10 (260) AM 2021 115762 A (220) 2021 12 16 (732) LTD "Kartveli" Kakheti Highway 110a, 0198, Isani-Samgori District, Tbilisi, Georgia	(111) M 2022 36159 R (151) 2022 12 05 (181) 2032 12 05 (260) AM 2021 115893 A (220) 2021 12 23 (732) Yutong Bus Co., LTD Yutong Road, Guancheng District, Zhengzhou, People Republic of China
(111) M 2022 36155 R (151) 2022 11 10 (181) 2032 11 10 (260) AM 2021 115857 A (220) 2021 12 21 (732) American-Cigarette Company (Overseas) Limited Rut De Frans 17, Boncourt, CH-2926, Switzerland	(111) M 2022 36160 R (151) 2022 11 10 (181) 2032 11 10 (260) AM 2021 115894 A (220) 2021 12 23 (732) Yutong Bus Co., LTD Yutong Road, Guancheng District, Zhengzhou, People Republic of China
(111) M 2022 36156 R (151) 2022 11 10 (181) 2032 11 10 (260) AM 2021 115863 A (220) 2021 12 21 (732) Cansino Biologics Inc. 401-420, 4/F, Biomedical Park Of West Zone, 185 South Avenue, Teda West District, Tianjin, 518000, People's Republic of China	(111) M 2022 36161 R (151) 2022 11 10 (181) 2032 11 10 (260) AM 2021 115895 A (220) 2021 12 23 (732) Yutong Bus Co., LTD Yutong Road, Guancheng District, Zhengzhou, People Republic of China
(111) M 2022 36157 R (151) 2022 11 10 (181) 2032 11 10 (260) AM 2021 115891 A (220) 2021 12 23 (732) Zhengzhou Yutong Group Co., LTD	(111) M 2022 36162 R (151) 2022 11 10 (181) 2032 11 10 (260) AM 2021 115973 A (220) 2021 12 24 (732) LTD "Impexpharm" Giorgi Saakadze Str. II Lane 17, 0160, Tbilisi, Georgia
	(111) M 2022 36163 R (151) 2022 11 10 (181) 2032 11 10 (260) AM 2021 115975 A (220) 2021 12 27

(732) LLC "Tfilisis Marani"
Zakaria Paliashvili Str. 33, app. 6, 0179, Tbilisi,
Georgia

Quai Jeanrenaud 3, 2000 Neuchâtel,
Switzerland

(111) M 2022 36164 R
(151) 2022 11 10
(181) 2032 11 10
(260) AM 2021 115989 A
(220) 2021 12 29
(732) LLC "Motoland"
Napareuli Str. 5, Tbilisi, Georgia

(111) M 2022 36171 R
(151) 2022 11 11
(181) 2032 11 11
(260) AM 2021 115003 A
(220) 2021 10 19
(732) LTD "Glokal"
Budapest Str. 13a, app. 7, Vake-Saburtalo
District, Tbilisi, Georgia

(111) M 2022 36165 R
(151) 2022 11 10
(181) 2032 11 10
(260) AM 2021 115990 A
(220) 2021 12 29
(732) LLC "Bikeland"
Kipshidze Str. 7g, app. 56, Vake District,
Tbilisi, Georgia

(111) M 2022 36172 R
(151) 2022 12 05
(181) 2032 12 05
(260) AM 2021 115013 A
(220) 2021 10 20
(732) LTD "Bolero & Company"
Kuchishvili Str. 12-14-16, 0179, Tbilisi, Georgia

(111) M 2022 36166 R
(151) 2022 12 06
(181) 2032 12 06
(260) AM 2021 114694 A
(220) 2021 09 23
(732) Davit Abaiadze
Gamsakhurdia Str., II qu., bld. 6b, app. 18,
Tbilisi, Georgia

(111) M 2022 36173 R
(151) 2022 11 11
(181) 2032 11 11
(260) AM 2021 115100 A
(220) 2021 10 22
(732) Zurab Zarnadze
Akaki Tsereteli Ave. 87-b, app. 15, 0119, Tbilisi,
Georgia

(111) M 2022 36168 R
(151) 2022 12 02
(181) 2032 12 02
(260) AM 2021 114817 A
(220) 2021 10 07
(732) Jacobs Douwe Egberts De GmbH
Langemarckstrasse 4-20, D-281 99 Bremen,
Germany

(111) M 2022 36175 R
(151) 2022 11 11
(181) 2032 11 11
(260) AM 2021 115213 A
(220) 2021 11 01
(732) The Coca-Cola Company
One Coca-Cola Plaza, Atlanta, Georgia, 30313,
USA

(111) M 2022 36169 R
(151) 2022 11 11
(181) 2032 11 11
(260) AM 2021 114914 A
(220) 2021 10 12
(732) Maia Belkania
Sairme Str. 12, app. 32, Tbilisi, Georgia

(111) M 2022 36176 R
(151) 2022 11 11
(181) 2032 11 11
(260) AM 2021 115433 A
(220) 2021 11 17
(732) Viron Therapeutics LLC
1 Boston Place, Suite 2603, Boston,
MA 02108, USA

(111) M 2022 36170 R
(151) 2022 12 05
(181) 2032 12 05
(260) AM 2021 114983 A
(220) 2021 10 15
(732) Philip Morris Products S.A.

(111) M 2022 36177 R
(151) 2022 12 06
(181) 2032 12 06
(260) AM 2021 115585 A
(220) 2021 11 26

(732) LTD "Wine Company Shumi"
Lionidze Str. 33, Telavi, Georgia

Near to Besiki Str. 4, plot 46/10, 0108, Tbilisi,
Georgia

(111) M 2022 36178 R
(151) 2022 12 06
(181) 2032 12 06
(260) AM 2021 115586 A
(220) 2021 11 26
(732) LTD "Wine Company Shumi"
Lionidze Str. 33, Telavi, Georgia

(111) M 2022 36184 R
(151) 2022 11 11
(181) 2032 11 11
(260) AM 2021 115994 A
(220) 2021 12 30
(732) LTD "Folipharm" GmbH
Regensburger Str. N28C, Berlin, 10777,
Germany

(111) M 2022 36179 R
(151) 2022 12 06
(181) 2032 12 06
(260) AM 2021 115587 A
(220) 2021 11 26
(732) LTD "Wine Company Shumi"
Lionidze Str. 33, Telavi, Georgia

(111) M 2022 36185 R
(151) 2022 11 11
(181) 2032 11 11
(260) AM 2021 116000 A
(220) 2021 12 30
(732) LTD "Santrade"
Varketili-3, IIIa mcr., bld. 340, app. 8,
0163, Tbilisi, Georgia

(111) M 2022 36180 R
(151) 2022 11 11
(181) 2032 11 11
(260) AM 2021 115688 A
(220) 2021 12 08
(732) CAN Technologies Inc.
15407 McGinty Road West, Wayzata,
MN 55391, USA

(111) M 2022 36186 R
(151) 2022 11 11
(181) 2032 11 11
(260) AM 2022 116074 A
(220) 2022 01 06
(732) JSC "Corporation Kindzmarauli"
Ilia Chavchavadze Str. 55, 4800, Kvareli,
Georgia

(111) M 2022 36181 R
(151) 2022 11 11
(181) 2032 11 11
(260) AM 2021 115896 A
(220) 2021 12 23
(732) Ministry of Education and Culture of the
Autonomous Republic of Abkhazia
D. Uznadze Str. 68, 0102, Tbilisi, Georgia

(111) M 2022 36187 R
(151) 2022 11 11
(181) 2032 11 11
(260) AM 2022 116075 A
(220) 2022 01 06
(732) JSC "Corporation Kindzmarauli"
Ilia Chavchavadze Str. 55, 4800, Kvareli,
Georgia

(111) M 2022 36182 R
(151) 2022 12 02
(181) 2032 12 02
(260) AM 2021 115902 A
(220) 2021 12 23
(732) LTD "Ortomeli"
Vazha-Pshavela Ave., II qu., bld. 34, Vake-
Saburtalo District, Tbilisi, Georgia

(111) M 2022 36188 R
(151) 2022 11 11
(181) 2032 11 11
(260) AM 2022 116170 A
(220) 2022 01 14
(732) Jack Daniel's Properties Inc.
4040 Civic Center Drive, Suite 528, San Rafael,
California 94903, USA

(111) M 2022 36183 R
(151) 2022 12 02
(181) 2032 12 02
(260) AM 2021 115979 A
(220) 2021 12 28
(732) "INPHA LLP" Representative office in Georgia

(111) M 2022 36190 R
(151) 2022 11 11
(181) 2032 11 11
(260) AM 2022 116302 A

(220) 2022 01 21
(732) JSC "Georgian Beer Company"
Vill. Saguramo, 3311, Mtskheta, Georgia

(111) M 2022 36226 R
(151) 2022 11 29
(181) 2032 11 29
(260) AM 2021 115976 A
(220) 2021 12 27
(732) Illia Mishchenko
Davit Aghmashenebeli Str. 1, Bolnisi, Georgia

TRADEMARKS REGISTERED ACCORDING TO THE ACCELERATED PROCEDURE

The decision can be appealed at the Chamber of Appeal of Sakpatenti within 3 months from the publication.

(111) M 2022 36254 R
(151) 2022 11 30
(181) 2032 11 30
(210) AM 120249
(220) 2022 11 09
(732) LTD "Woodcare Trade"
Socrat Arshba Str. 4/ Zhiuli Shartava Str. 60,
Entrance 1, floor. 6, ap. 24, Tbilisi, Georgia
(540)

The logo for TimberCare features the brand name in a stylized, cursive font. The letters 'T', 'C', and 'e' are rendered in a golden-brown color, while the letters 'i', 'm', 'b', 'e', 'r', and 'a' are in black. A registered trademark symbol (®) is located at the end of the word.

(591) Golden, red, black
(531) 27.05.01; 27.05.03; 29.01.13
(511) 35

(111) M 2022 36255 R
(151) 2022 12 02
(181) 2032 12 02
(210) AM 120171
(220) 2022 11 03
(732) LTD "Europe Plus"
Besiki Str. 1, ap. 9, 5400, Tskaltubo, Georgia
(740) Davit Dzamukashvili
(540)



(591) Pink, green, white, black
(531) 01.15.15; 26.11.03; 26.11.05; 26.11.09;
26.11.11; 29.01.14
(511) 13

INTERNATIONAL TRADEMARKS FOR WHICH A DECISION ON GRANTING PROTECTIONS IS TAKEN

The decision can be appealed at the Chamber of Appeal of Sakpatenti within 3 months from the publication or at the Mtskheta District Court Administrative Cases Board (Address: №17, Samkhedro St., Mtskheta), within 1 month following the publication.

(260) AM 2022 112808 A*

(800) 1588430

(151) 2020 12 31

(891) 2020 12 31

(731) ESSEL SELÜLOZ VE KAĞIT SAN TİC AŞ
Sanayi Mahallesi Kozalı Sokak Çarşı, Yapı
Sitesi. A Blok Apt. No: 10 A/31, İzmit/Kocaeli,
Türkiye

(540)



(591) Blue, white

(531) 27.05.01; 27.05.17; 29.01.04

(511)

16 – Paper and cardboard for packaging and wrapping purposes, cardboard boxes

(260) AM 2022 115447 A

(800) 1626015

(151) 2021 09 15

(891) 2021 09 15

(731) AGF88 HOLDING Srl
Via del Palù 7D, I-35018 SAN MARTINO
DI LUPARI (PD), Italy

(540)

ALTER EGO

(591) Black, white

(511)

3 – Hair care lotions; shampoos; hair balsam; tints for the hair; hair care masks; hair dyes; hair spray; ethereal oils; soap; face cream; body lotion; body lotions; anti-wrinkle cream; cosmetics; beauty masks; soaps in gel form; hand gels; cleansing gels; hand washes; sanitary preparations being toiletries; hand creams; dentifrices; perfumes; deodorants for personal use; nail varnish; cosmetics for nails; bath foam; foams for use in the shower.

(260) AM 2022 116345 A

(800) 1640319

(151) 2021 12 17

(891) 2021 12 17

(731) Obshchestvo s ogranichennoi otvetstvennost'yu
"Laboratoriya sovremennogo zdorovya"

ul. Khimzavodskaya, 11/20, Berdsk,
RU-633004 Novosibirskaya oblast', Russian
Federation

(540)

MEN'S BOX

(591) Black, white

(511)

5 – Acai powder dietary supplements; acne treatment preparations; adhesive bands for medical purposes; adhesive plasters; air deodorising preparations; air purifying preparations; albumin dietary supplements; albuminous foodstuffs for medical purposes; albuminous preparations for medical purposes; alginate dietary supplements; almond milk for pharmaceutical purposes; aloe vera preparations for pharmaceutical purposes; amino acids for medical purposes; anaesthetics; analgesics; antibacterial handwashes; antibacterial soap; antioxidant pills; antiseptic cotton; antiseptics; anti-uric preparations; appetite suppressant pills; appetite suppressants for medical purposes; asthmatic tea; babies' nappies; balms for medical purposes; barks for pharmaceutical purposes; bath salts for medical purposes; biological preparations for medical purposes; cachets for pharmaceutical purposes; capsules for medicines; casein dietary supplements; chemico-pharmaceutical preparations; chewing gum for medical purposes; chilblain preparations; cod liver oil; collagen for medical purposes; collyrium; contact lens cleaning preparations; corn remedies; decoctions for pharmaceutical purposes; deodorants for clothing and textiles; deodorants, other than for human beings or for animals; depuratives; dietary fiber; dietary supplements for animals; dietary supplements with a cosmetic effect; dietetic beverages adapted for medical purposes; dietetic foods adapted for medical purposes; dietetic substances adapted for medical use; digestives for pharmaceutical purposes; disinfectant soap; disinfectants for hygiene purposes; dressings, medical; drugs for medical purposes; elixirs [pharmaceutical preparations]; enzyme dietary supplements; enzyme preparations for medical purposes; eucalyptus for pharmaceutical purposes; febrifuges; ferments for pharmaceutical purposes; first-aid boxes, filled; flour for pharmaceutical purposes; food for babies; frostbite salve for pharmaceutical purposes; fumigation preparations for medical purposes; gauze for dressings; gelatine for medical purposes; glucose dietary supplements; glucose for medical purposes; hematogen; hemostatic pencils; herbal teas for medicinal purposes; homogenised food adapted for medical purposes; im-

munostimulants; infant formula; lacteal flour for babies; lactose for pharmaceutical purposes; laxatives; lecithin dietary supplements; liniments; linseed dietary supplements; linseed for pharmaceutical purposes; linseed oil dietary supplements; lotions for pharmaceutical purposes; lyophilised food adapted for medical purposes; magnesia for pharmaceutical purposes; medical preparations for slimming purposes; medicated after-shave lotions; medicated candies; medicated dry shampoos; medicated eye-washes; medicated hair lotions; medicated shampoos; medicated soap; medicated toiletry preparations; medicated toothpaste; medicinal drinks; medicinal hair growth preparations; medicinal herbs; medicinal infusions; medicinal mud; medicinal oils; medicinal roots; medicinal tea; medicine cases, portable, filled; medicines for alleviating constipation; medicines for human purposes; milk ferments for pharmaceutical purposes; mineral food supplements; mineral waters for medical purposes; mouthwashes for medical purposes; mud for baths; mustard plasters; nervines; nutraceutical preparations for therapeutic or medical purposes; nutritional supplements; ointments for pharmaceutical purposes; organotherapy preparations; panty liners [sanitary]; pastilles for pharmaceutical purposes; pearl powder for medical purposes; personal sexual lubricants; petroleum jelly for medical purposes; pharmaceutical preparations for skin care; pharmaceutical preparations for treating dandruff; pharmaceutical preparations for treating sunburn; pharmaceutical preparations; pharmaceuticals; phytotherapy preparations for medical purposes; plant extracts for pharmaceutical purposes; pollen dietary supplements; pomades for medical purposes; poultices; powdered milk for babies; preparations for the treatment of burns; preparations of trace elements for human and animal use; propolis dietary supplements; propolis for pharmaceutical purposes; protein dietary supplements; protein supplements for animals; purgatives; remedies for perspiration; royal jelly dietary supplements; royal jelly for pharmaceutical purposes; salts for medical purposes; salts for mineral water baths; sanitary napkins; seawater for medicinal bathing; sedatives; tranquillizers; serums; sexual stimulant gels; slimming pills; solutions for contact lenses; styptic preparations; sugar for medical purposes; sunburn ointments; suppositories; syrups for pharmaceutical purposes; tanning pills; therapeutic preparations for the bath; thermal water; tissues impregnated with pharmaceutical lotions; tonics [medicines]; vitamin preparations; vitamin supplement patches; wadding for medical purposes; wheat germ dietary supplements; yeast dietary supplements; yeast for pharmaceutical purposes.

(260) AM 2022 116437 A
 (800) 1641093
 (151) 2021 12 16
 (891) 2021 12 16
 (731) SHENZHEN IVPS TECHNOLOGY CO. LTD.
 Room 201, 76th bldg., Liantang Industrial
 Zone, Tangwei Community, Fenghuang Sub-
 district, Guangming District, Shenzhen, 518000
 Guangdong 518000, China

(540)

SMOK

(591) Black, white

(511)

11 – Lighting apparatus and installations; roasting apparatus; griddles [cooking appliances]; grills [cooking appliances]; refrigerating apparatus and machines; heating apparatus; heating installations; sanitary apparatus and installations; disinfectant apparatus; radiators, electric; air purifying apparatus and machines.

16 – Paper; toilet paper; hygienic paper; catalogues; posters; bookbinding apparatus and machines [office equipment]; printed publications; stationery.

32 – Preparations for making carbonated water; preparations for making aerated water; beer; beer-based cocktails; soya-based beverages, other than milk substitutes; fruit juices; fruit juice; non-alcoholic preparations for making beverages.

41 – Publication of books; film production, other than advertising films; entertainment services; providing sports facilities; conducting guided tours; teaching or educational services; instruction services; teaching or educational services; instruction services; arranging and conducting of colloquiums; zoological garden services.

(260) AM 2022 116450 A

(800) 1641432

(151) 2021 11 23

(891) 2021 11 23

(731) Joint Stock Company Polyus Krasnoyarsk
 ul. Belinskogo, 2-B, g.p. Severo-Yeniseyskiy,
 Severo-Yeniseyskiy r-n, RU-663282
 Krasnoyarsk Krai, Russian Federation

(540)

AUTHENTIC 

(591) Black, white and yellow.

(531) 15.01.13; 27.05.02; 27.05.09; 29.01.13

(511)

1 – Agar-agar for industrial purposes; nitrogen; actinium; alkaloids; alginates for the food industry; alginates for industrial purposes; crotonic aldehyde; ammonium aldehyde; aldehydes; americium; amyl

acetate; ammonia [volatile alkali] for industrial purposes; anhydrous ammonia; ammonia; acetic anhydride; anhydrides; anti-knock substances for internal combustion engines; disincrustants; antioxidants for use in the manufacture of cosmetics; antioxidants for use in the manufacture of food supplements; antioxidants for use in the manufacture of pharmaceuticals; antioxidants for use in manufacture; antistatic preparations, other than for household purposes; antifreeze; size for use in the textile industry; argon; lead arsenate; aspartate; aluminium acetate; lime acetate; lead acetate; acetate of cellulose, unprocessed; acetates [chemicals]; acetylene; acetone; oenological bactericides [chemical preparations for use in wine making]; barium; barytes; albumin [animal or vegetable, raw material]; animal albumen [raw material]; iodised albumen; malt albumen; benzene; benzol; bentonite; berkelium; bicarbonate of soda for chemical purposes; potassium dioxalate; biostimulants for plants; bichromate of potassium; bichromate of soda; bauxite; bromine for chemical purposes; albumenized paper; baryta paper; diazo paper; blueprint paper; test paper, chemical; litmus paper; reagent paper, other than for medical or veterinary purposes; self-toning paper [photography]; nitrate paper; sensitized paper; photometric paper; borax; agglutinants for concrete; gas purifying preparations; polish removing substances; preparations for the separation of greases; substances for preventing runs in stockings; water-softening preparations; limestone hardening substances; tanning substances; adhesives for industrial purposes; tensio-active agents; artificial sweeteners [chemical preparations]; fissionable material for nuclear energy; foundry binding substances; concrete-aeration chemicals; leather-dressing chemicals; chemicals for the manufacture of paints; chemicals for the manufacture of pigments; starch-liquifying chemicals [ungluing agents]; flower preservatives; seed preserving substances; viscose; bismuth; bismuth subnitrate for chemical purposes; vitamins for the food industry; vitamins for use in the manufacture of cosmetics; vitamins for use in the manufacture of food supplements; vitamins for use in the manufacture of pharmaceuticals; witherite; distilled water; seawater for industrial purposes; acidulated water for recharging batteries; heavy water; hydrogen; seaweeds [fertilizers]; grafting wax for trees; gadolinium; getters [chemically active substances]; protective gases for welding; solidified gases for industrial purposes; hydrazine; basic gallate of bismuth; gallium; gambier; helium; electrophoresis gels; genes of seeds for agricultural production; aluminium hydrate; hydrates; hyposulfites; sodium hypochlorite; gypsum for use as a fertilizer; ceramic glazings; glycol; expanded clay for hydroponic plant growing [substrate]; kaolin; alumina; glycerides; glycerine for industrial purposes; glucose for the food industry; glucose for industrial purposes; glucosides; gluten for the food industry; gluten for industrial purposes; holmium; hormones for hastening the ripening of fruit; peat

pots for horticulture; graphene; graphite for industrial purposes; guano; humus; gurjun balsam for use in the manufacture of varnish; dextrin [size]; dendrimer-based polymers for use in the manufacture of capsules for pharmaceuticals; detergents for use in manufacturing processes; defoliants; diastase for industrial purposes; kieselgur; manganese dioxide; titanium dioxide for industrial purposes; zirconia; oil dispersants; petroleum dispersants; dispersions of plastics; dysprosium; bichloride of tin; detergent additives to petrol; ceramic compositions for sintering [granules and powders]; additives, chemical, to drilling muds; additives, chemical, to insecticides; chemical additives for oils; additives, chemical, to motor fuel; additives, chemical, to fungicides; dolomite for industrial purposes; tan-wood; europium; gelatine for photographic purposes; gelatine for industrial purposes; auxiliary fluids for use with abrasives; fluids for hydraulic circuits; liquids for removing sulfates from batteries; power steering fluid; brake fluid; magnetic fluid for industrial purposes; transmission fluid; tree cavity fillers [forestry]; glaziers' putty; moderating materials for nuclear reactors; diatomaceous earth; fuller's earth for use in the textile industry; lime chloride; isotopes for industrial purposes; iodine for industrial purposes; iodine for chemical purposes; aluminium iodide; alkaline iodides for industrial purposes; ion exchangers [chemicals]; ytterbium; yttrium; casein for the food industry; casein for industrial purposes; kainite; potassium; sorrel salt; californium; calomel [mercurous chloride]; gum arabic for industrial purposes; tartar, other than for pharmaceutical purposes; camphor, for industrial purposes; calcium carbide; silicon carbide [raw material]; carbide; lime carbonate; magnesium carbonate; carbonates; cement [metallurgy]; cassiopium [lutetium]; catalysts; biochemical catalysts; catechu; caustics for industrial purposes; alum; ammonia alum; aluminium alum; chrome alum; quebracho for industrial purposes; ketones; cinematographic film, sensitized but not exposed; oxygen for industrial purposes; nitric acid; anthranilic acid; benzoic acid; boric acid for industrial purposes; tartaric acid; tungstic acid; gallic acid for the manufacture of ink; gallotannic acid; glutamic acid for industrial purposes; tannic acid; iodic acid; phenol for industrial purposes; citric acid for industrial purposes; lactic acid; formic acid; persulfuric acid; oleic acid; picric acid; pyrogallic acid; salicylic acid; sebacic acid; sulfuric acid; sulfurous acid; spirits of salt; stearic acid; carbonic acid; spirits of vinegar [dilute acetic acid]; phosphoric acid; hydrofluoric acid; hydrochloric acid; cholic acid; chromic acid; oxalic acid; acids; benzene-based acids; fatty acids; mineral acids; arsenious acid; adhesives for billposting; leather glues; adhesives for wall tiles; adhesives for paperhanging; glue for industrial purposes; cement for mending broken articles; gums [adhesives] for industrial purposes; birdlime; isinglass, other than for stationery, household or alimentary purposes; gluten [glue], other than for stationery or household pur-

poses; starch paste [adhesive], other than for stationery or household purposes; stem cells, other than for medical or veterinary purposes; collagen for industrial purposes; collodion; compost; beer preserving agents; preservatives for use in the pharmaceutical industry; mangrove bark for industrial purposes; tan; starch for industrial purposes; silicon; creosote for chemical purposes; krypton; xenon; xylene; xylol; biological tissue cultures, other than for medical or veterinary purposes; cultures of microorganisms, other than for medical and veterinary use; blue vitriol; copper sulfate [blue vitriol]; curium; lactose [raw material]; lactose for the food industry; lactose for industrial purposes; lanthanum; dry ice [carbon dioxide]; lecithin [raw material]; lecithin for the food industry; lecithin for industrial purposes; lithium; magnesite; manganate; oils for tanning leather; oils for currying leather; oils for preparing leather in the course of manufacture; oils for the preservation of food; transmission oil; carbolineum for the protection of plants; paper pulp; wood pulp; grafting mastic for trees; mastic for leather; mastic for tyres; oil cement [putty]; synthetic materials for absorbing oil; brazing preparations; ceramic materials in particulate form, for use as filtering media; filtering materials of unprocessed plastics; filtering materials of mineral substances; filtering materials of vegetable substances; filtering materials of chemical substances; metalloids; alkaline-earth metals; alkaline metals; methane; methyl benzene; methyl benzol; flour for industrial purposes; tapioca flour for industrial purposes; potato flour for industrial purposes; soap [metallic] for industrial purposes; arsenic; bate for dressing skins; emollients for industrial purposes; animal manure; nanopowders for industrial purposes; sodium; naphthalene; sal ammoniac; toxic gas neutralizers; neodymium; neon; neptunium; ammonium nitrate; uranium nitrate; nitrates; nitrous oxide; baryta; uranium oxide; oxalates; lithia [lithium oxide]; lead oxide; antimony oxide; chromium oxide; cobalt oxide for industrial purposes; mercuric oxide; olivine [silicate mineral]; gallnuts; clarification preparations; wine finings; textile-brightening chemicals; beer-clarifying and preserving agents; must-finishing preparations; reducing agents for use in photography; bases [chemical preparations]; wax-bleaching chemicals; fat-bleaching chemicals; organic digestate [fertilizer]; paste fillers for vehicle bodywork; pectin for the food industry; pectin for industrial purposes; pectin [photography]; perborate of soda; humus top dressing; percarbonates; hydrogen peroxide for industrial purposes; persulfates; perchlorates; foundry sand; plastisols; sensitized plates for offset printing; ferrotype plates [photography]; plasticizers; plastics, unprocessed; X-ray films, sensitized but not exposed; plutonium; chemical coatings for ophthalmic lenses; polonium; potash; potash water; soil for growing; praseodymium; rubber preservatives; masonry preservatives, except paints and oils; brickwork preservatives, except paints and oils; cement preservatives, except

paints and oils; preservatives for tiles, except paints and oils; bacterial preparations, other than for medical and veterinary use; bacteriological preparations for acetification; bacteriological preparations, other than for medical and veterinary use; biological preparations, other than for medical or veterinary purposes; vulcanizing preparations; diagnostic preparations, other than for medical or veterinary purposes; renovating preparations for phonograph records; currying preparations for leather; currying preparations for skins; galvanizing preparations; metal hardening preparations; fixing baths [photography]; opacifiers for glass; opacifiers for enamel; separating and unsticking [ungluing] preparations; metal annealing preparations; metal tempering preparations; preparations for preventing the tarnishing of lenses; preparations for preventing the tarnishing of glass; cement-waterproofing chemicals, except paints; plant growth regulating preparations; wallpaper removing preparations; anti-boil preparations for engine coolants; fulling preparations for use in the textile industry; descaling preparations, other than for household purposes; fertilizing preparations; flashlight preparations; finishing preparations for use in the manufacture of steel; sizing preparations; animal carbon preparations; preparations of microorganisms, other than for medical and veterinary use; corrosive preparations; cryogenic preparations; dehydrating preparations for industrial purposes; degreasing preparations for use in manufacturing processes; gum solvents; oil-bleaching chemicals; decolorants for industrial purposes; meat tenderizers for industrial purposes; preparations for stimulating cooking for industrial purposes; anti-incrustants; preparations of trace elements for plants; moistening [wetting] preparations for use in the textile industry; moistening [wetting] preparations for use in dyeing; moistening [wetting] preparations for use in bleaching; enzyme preparations for the food industry; enzyme preparations for industrial purposes; filtering preparations for the beverages industry; chemical preparations to prevent mildew; chemical preparations to prevent wheat blight; chemical condensation preparations; chemical preparations for smoking meat; chemical substances for analyses in laboratories, other than for medical or veterinary purposes; chemical preparations for scientific purposes, other than for medical or veterinary use; chemical preparations for facilitating the alloying of metals; chemical preparations to prevent diseases affecting vine plants; chemical preparations to prevent diseases affecting cereal plants; engine-decarbonising chemicals; fulling preparations; fuel-saving preparations; coal saving preparations; damp-proofing chemicals, except paints, for masonry; anti-sprouting preparations for vegetables; preparations of the distillation of wood alcohol; by-products of the processing of cereals for industrial purposes; chemical substances for preserving foodstuffs; benzene derivatives; cellulose derivatives [chemicals]; promethium; protactinium; protein [raw material]; proteins

for the food industry; proteins for use in the manufacture of food supplements; proteins for use in manufacture; mordants for metals; radium for scientific purposes; radon; solvents for varnishes; anti-frothing solutions for batteries; drilling muds; galvanizing baths; solutions for cyanotyping; silver salt solutions for silvering; toning baths [photography]; chemical reagents, other than for medical or veterinary purposes; rhenium; mercury; rubidium; carbon black for industrial purposes; soot for industrial or agricultural purposes; lamp black for industrial purposes; samarium; saccharin; selenium; saltpeter; sulfur; silver nitrate; carbon disulfide; silicates; aluminium silicate; silicones; scandium; topsoil; foundry moulding preparations; potting soil; acrylic resins, unprocessed; polymer resins, unprocessed; synthetic resins, unprocessed; epoxy resins, unprocessed; soda ash; calcined soda; caustic soda for industrial purposes; barium compounds; fluorspar compounds; salts [fertilizers]; salts [chemical preparations]; ammoniacal salts; ammonium salts; salts of precious metals for industrial purposes; salts for galvanic cells; salt for preserving, other than for foodstuffs; salts for colouring metal; salts for industrial purposes; iron salts; gold salts; iodised salts; calcium salts; sodium salts [chemical compounds]; salt, raw; salts from rare earth metals; mercury salts; toning salts [photography]; chrome salts; chromic salts; salts of alkaline metals; rock salt; mold-release compounds; fire extinguishing compositions; compositions for the manufacture of phonograph records; compositions for the manufacture of technical ceramics; compositions for repairing inner tubes of tyres; compositions for repairing tyres; acid proof chemical compositions; glutinous tree-grafting preparations; adhesive preparations for surgical bandages; fireproofing preparations; compositions for threading; sauce for preparing tobacco; amyl alcohol; vinic alcohol; wood alcohol; sal ammoniac spirits; ethyl alcohol; alcohol; adjuvants, other than for medical or veterinary purposes; cement for footwear; concrete preservatives, except paints and oils; water glass [soluble glass]; strontium; substrates for soil-free growing [agriculture]; barium sulfate; sulfates; antimony sulfide; sulfides; benzoic sulfimide; sulfonic acids; sumac for use in tanning; superphosphates [fertilizers]; antimony; thallium; talc [magnesium silicate]; tannin; cream of tartar for the food industry; cream of tartar for industrial purposes; cream of tartar for chemical purposes; tellurium; terbium; tetrachlorides; carbon tetrachloride; acetylene tetrachloride; technetium; thymol for industrial purposes; thiocarbanilide; titanite; sensitized cloth for photography; blueprint cloth; toluol; fuel for nuclear reactors; thorium; peat [fertilizer]; gum tragacanth for industrial purposes; thulium; carbonic hydrates; carbon; activated carbon; carbon for filters; animal charcoal; animal carbon; bone charcoal; blood charcoal; fertilizers; nitrogenous fertilizers; fish meal fertilizers; wood vinegar [pyroligneous acid]; uranium; chemical intensifiers for paper; chemical inten-

sifiers for rubber; vulcanization accelerators; enzymes for the food industry; enzymes for industrial purposes; ferments for chemical purposes; milk ferments for the food industry; milk ferments for industrial purposes; milk ferments for chemical purposes; fermium; ferrocyanides; fixing solutions [photography]; flavonoids [phenolic compounds] for industrial purposes; flocculants; soldering fluxes; brazing fluxes; formic aldehyde for chemical purposes; phosphatides; phosphates [fertilizers]; phosphorus; photographic paper; photosensitive plates; sensitized photographic plates; sensitized films, unexposed; photographic developers; photographic sensitizers; chemical preparations for use in photography; photographic emulsions; francium; fluorine; chemicals for use in forestry, except fungicides, herbicides, insecticides and parasiticides; glass-frosting chemicals; leather-renovating chemicals; glass-staining chemicals; enamel-staining chemicals; oil-separating chemicals; water-purifying chemicals; oil-purifying chemicals; welding chemicals; soldering chemicals; condensation-preventing chemicals; stain-preventing chemicals for use on fabrics; anti-tarnishing chemicals for windows; leather-waterproofing chemicals; textile-waterproofing chemicals; chemicals, except pigments, for the manufacture of enamel; radiator flushing chemicals; leather-impregnating chemicals; textile-impregnating chemicals; horticultural chemicals, except fungicides, herbicides, insecticides and parasiticides; agricultural chemicals, except fungicides, herbicides, insecticides and parasiticides; soil conditioning preparations; chimney cleaners, chemical; industrial chemicals; colour-brightening chemicals for industrial purposes; refrigerants; coolants for vehicle engines; chlorine; chlorates; hydrochlorates; aluminium chloride; magnesium chloride; chlorides; palladium chloride; chromates; flowers of sulfur for chemical purposes; caesium; cellulose; cerium; cyanides [prussiates]; calcium cyanamide [fertilizer]; cymene; loam; slag [fertilizers]; size for finishing and priming; spinel [oxide mineral]; alkalis; caustic alkali; tea extracts for the food industry; tea extracts for use in the manufacture of cosmetics; tea extracts for use in the manufacture of pharmaceuticals; radioactive elements for scientific purposes; rare earths; fissionable chemical elements; emulsifiers; erbium; ethane; methyl ether; sulfuric ether; ethyl ether; glycol ether; ethers; esters; cellulose ethers for industrial purposes; cellulose esters for industrial purposes.

4 – Anthracite; benzine; biomass fuel; wood briquettes; combustible briquettes; petroleum jelly for industrial purposes; wax [raw material]; ozokerite; wax for lighting; industrial wax; belting wax; carnauba wax; beeswax; beeswax for use in the manufacture of cosmetics; gas for lighting; oil-gas; fuel gas; petrol; producer gas; solidified gases [fuel]; fuel; lubricating graphite; additives, non-chemical, to motor fuel; firewood; paper spills for lighting fires; cutting fluids; fish oil, not edible; lanolin; wool grease; greases for the preservation of leather; grease for leather; grease

for footwear; tallow; industrial grease; kerosene; coke; lanolin for use in the manufacture of cosmetics; lignoin; wood spills for lighting fires; wax for skis; mazut; fuel oil; oils for the preservation of leather; oils for paints; oils for releasing form work [building]; oils for lighting; oils for the preservation of masonry; textile oil; lubricating oil; industrial oil; moistening oil; coal tar oil; coal naphtha; castor oil for industrial purposes; bone oil for industrial purposes; motor oil; sunflower oil for industrial purposes; rape oil for industrial purposes; lubricants; naphtha; petroleum, raw or refined; nightlights [candles]; oleine; paraffin; dust removing preparations; soya bean oil preparations for non-stick treatment of cooking utensils; non-slipping preparations for belts; coal dust [fuel]; firelighters; perfumed candles; christmas tree candles; candles; grease for arms [weapons]; lubricating grease; grease for belts; vaporized fuel mixtures; dust absorbing compositions; dust binding compositions for sweeping; dust laying compositions; alcohol [fuel]; methylated spirit; stearine; benzene fuel; diesel oil; lighting fuel; xylene fuel; mineral fuel; carburants; fuel with an alcohol base; peat [fuel]; peat briquettes [fuel]; tinder; lignite; hookah charcoal; charcoal [fuel]; coal; coal briquettes; lamp wicks; wicks for candles; ceresine; electrical energy; ethanol [fuel]; petroleum ether.

6 – Aluminium; fittings of metal for compressed air lines; fittings of metal for building; white metal; beacons of metal, non-luminous; vats of metal; beams of metal; girders of metal; joists of metal; bottles [containers] of metal for compressed gas or liquid air; balustrades of metal; preserve tins; reels of metal, non-mechanical, for flexible hoses; swimming pools [structures] of metal; beryllium [glucinium]; arbours [structures] of metal; blooms [metallurgy]; ingots of common metal; anchors; bolts of metal; eye bolts; casks of metal; mooring buoys of metal; barrels of metal; identification bracelets of metal; bronze; bells; bells for animals; letters and numerals of common metal, except type; silos of metal; busts of common metal; vanadium; bird baths [structures] of metal; valves of metal, other than parts of machines; screws of metal; aviaries [structures] of metal; tungsten; hoppers of metal, non-mechanical; gates of metal; sleeves [metal hardware]; ferrules of metal for handles; ferrules of metal; signboards of metal; diving boards of metal; loading gauge rods of metal for railway wagons; nuts of metal; galena [ore]; celtium [hafnium]; nails; tacks [nails]; brads; horseshoe nails; shoe pegs of metal; germanium; vice claws of metal; armoured doors of metal; doors of metal; folding doors of metal; swing doors of metal; chimney pots of metal; towel dispensers, fixed, of metal; door closers of metal, non-electric; prefabricated houses [kits] of metal; memorial plates of metal; chimney shafts of metal; wall plugs of metal; troughs of metal for mixing mortar; packaging containers of metal; containers of metal for storing acids; jalousies of metal; outdoor blinds of

metal; iron, unwrought or semi-wrought; iron strip; roof gutters of metal; street gutters of metal; tinplate; iron slabs; door bolts of metal; window fasteners of metal; bolts, flat; clips of metal for sealing bags; binding screws of metal for cables; cramps of metal [crampons]; wheel clamps [boots]; rivets of metal; box fasteners of metal; locks of metal for bags; locks of metal for vehicles; locks of metal, other than electric; padlocks of metal, other than electronic; spring locks; closures of metal for containers; bungs of metal; plugs of metal; latches of metal; tension links; couplings of metal for chains; road signs, non-luminous and non-mechanical, of metal; registration plates of metal; signs, non-luminous and non-mechanical, of metal; fences of metal; buckles of common metal [hardware]; bronzes [works of art]; works of art of common metal; ironmongery; indium; cabanas of metal; soundproof booths of metal, transportable; telephone booths of metal; cadmium; paint spraying booths of metal; telfer cables; ropes of metal; jerrycans of metal; horticultural frames of metal; greenhouse frames of metal; framework of metal for building; cornices of metal; skating rinks [structures] of metal; cermets; water-pipe valves of metal; drain traps [valves] of metal; metal cages for wild animals; keys of metal; mooring bollards of metal; cobalt, raw; chill-moulds [foundry]; elbows of metal for pipes; bed casters of metal; furniture casters of metal; manifolds of metal for pipelines; door bells of metal, non-electric; casings of metal for oilwells; pillars of metal for building; chimney cowls of metal; bottle caps of metal; sealing caps of metal; tent pegs of metal; pegs of metal; copper rings; split rings of common metal for keys; rings of metal; door fittings of metal; fittings of metal for windows; brackets of metal for building; buildings of metal; buildings, transportable, of metal; steel buildings; oil drainage containers of metal; containers of metal [storage, transport]; check rails of metal for railways; baskets of metal; door frames of metal; door casings of metal; tool boxes of metal, empty; stringers [parts of staircases] of metal; crampons [climbing irons]; taps of metal for casks; tubing of metal; brackets of metal for furniture; roofing of metal; roofing of metal, incorporating photovoltaic cells; turntables [railways]; screw tops of metal for bottles; manhole covers of metal; hooks [metal hardware]; pitons of metal; pot hooks of metal; hooks of metal for roofing slates; sash fasteners of metal for windows; hooks of metal for clothes rails; bag hangers of metal; clothes hooks of metal; chicken-houses of metal; chests of metal; bins of metal; brass, unwrought or semi-wrought; bands of metal for tying-up purposes; scaffolding of metal; staircases of metal; ladders of metal; limonite; steel sheets; cast steel; traps for wild animals; magnesium; manganese; reinforcing materials, of metal, for concrete; reinforcing materials of metal for machine belts; reinforcing materials of metal for pipes; reinforcing materials of metal for building; railway material of metal; materials of metal for funicular railway perma-

nent ways; building materials of metal; refractory construction materials of metal; masts of metal; steel masts; copper, unwrought or semi-wrought; sheets and plates of metal; common metals, unwrought or semi-wrought; pyrophoric metals; metals in powder form; mouldings of metal for building; molybdenum; metal knockers; pipe muffers of metal; shoe dowels of metal; porches [structures] of metal; bronzes for tombstones; tombs of metal; flashing of metal for building; roof flashing of metal; fish plates [rails]; anvils; anvils [portable]; beak-irons; rope thimbles of metal; ferrules of metal for walking sticks; handcuffs; jets of metal; duckboards of metal; belt stretchers of metal; stretchers for metal bands [tension links]; wire stretchers [tension links]; stretchers for iron bands [tension links]; nickel silver; nickel; niobium; grease nipples; binding thread of metal for agricultural purposes; thread of metal for tying-up purposes; house numbers of metal, non-luminous; braces of metal for handling loads; wall claddings of metal for building; mouldings of metal for cornices; enclosures of metal for tombs; laths of metal; barrel hoops of metal; wall linings of metal for building; palings of metal; crash barriers of metal for roads; furnace fireguards of metal; tree protectors of metal; latticework of metal; door stops of metal; stops of metal; window stops of metal; windows of metal; ironwork for doors; ironwork for windows; tin; shuttering of metal for concrete; filings of metal; posts of metal for power lines; props of metal; branching pipes of metal; monuments of metal; monuments of metal for tombs; metal ramps for use with vehicles; acoustic panels of metal; door panels of metal; wainscotting of metal; signalling panels, non-luminous and non-mechanical, of metal; building panels of metal; partitions of metal; lintels of metal; casement windows of metal; strap-hinges of metal; shims; rocket launching platforms of metal; platforms, prefabricated, of metal; wall tiles of metal; floor tiles of metal; tiles of metal for building; anchor plates; paving slabs of metal; grave slabs of metal; tile floorings of metal; slabs of metal for building; lead seals; loading pallets of metal; handling pallets of metal; transport pallets of metal; trays of metal; stakes of metal for plants or trees; firedogs [andirons]; armour-plating of metal; paving blocks of metal; roof coverings of metal; cladding of metal for building; linings of metal for building; fireplace mantles of metal; steel strip; floors of metal; sills of metal; bathtub grab bars of metal; ceilings of metal; gold solder; silver solder; brazing alloys; collars of metal for fastening pipes; winding spools of metal, non-mechanical, for flexible hoses; floating docks of metal, for mooring boats; aluminium wire; iron wire; wire of common metal; wire of common metal alloys, except fuse wire; barbed wire; copper wire, not insulated; soldering wire of metal; steel wire; springs [metal hardware]; rods of metal for welding; rods of metal for brazing and welding; rods of metal for brazing; peeled metal bars; drawn and polished metal bars; bright steel bars; hot-rolled steel

bars; dispensers for dog waste bags, fixed, of metal; window frames of metal; frames of metal for building; crucifixes of common metal, other than jewellery; containers of metal for liquid fuel; containers of metal for compressed gas or liquid air; tanks of metal; floating containers of metal; rails of metal; straps of metal for handling loads; gratings of metal; runners of metal for sliding doors; iron ores; ores of metal; chrome ores; door handles of metal; knobs of metal; sheet piles of metal; pigsties of metal; lead, unwrought or semi-wrought; safes [metal or non-metal]; safes, electronic; insect screens of metal; burial vaults of metal; door scrapers; cable joints of metal, non-electric; junctions of metal for pipes; nozzles of metal; anti-friction metal; silver-plated tin alloys; alloys of common metal; sheaf binders of metal; bindings of metal; bottle closures of metal; shutters of metal; steel alloys; steel, unwrought or semi-wrought; tinfoil; statues of common metal; figurines of common metal; statuettes of common metal; cask stands of metal; tombstone stelae of metal; bars for metal railings; stables of metal; advertisement columns of metal; posts of metal; telegraph posts of metal; railway points; steps [ladders] of metal; slings of metal for handling loads; stair treads [steps] of metal; machine belt fasteners of metal; tombstone plaques of metal; nameplates of metal; step stools of metal; tantalum [metal]; greenhouses of metal, transportable; titanium; wire cloth; tombac; mobile boarding stairs of metal for passengers; cables of metal, non-electric; wire rope; pipework of metal; penstock pipes of metal; water-pipes of metal; gutter pipes of metal; ducts of metal for ventilating and air-conditioning installations; drain pipes of metal; chimneys of metal; pipes of metal; ducts of metal, for central heating installations; steel pipes; turnstiles of metal; angle irons of metal; tinplate packings; door fasteners of metal; bicycle parking installations of metal; window closers of metal, non-electric; door openers of metal, non-electric; window openers of metal, non-electric; wind-driven bird-repelling devices made of metal; tungsten iron; molybdenum iron; silicon iron; titanium iron; chrome iron; flagpoles [structures] of metal; hand-held flagpoles of metal; flanges of metal [collars]; weather- or wind-vanes of metal; aluminium foil; metals in foil or powder form for 3D printers; foils of metal for wrapping and packaging; ice moulds of metal; foundry moulds of metal; fittings of metal for coffins; fittings of metal for beds; fittings of metal for furniture; clips of metal for cables and pipes; chromium; cattle chains; chains of metal; safety chains of metal; zinc; zirconium; pantiles of metal; roofing tiles of metal; cast iron, unwrought or semi-wrought; washers of metal; balls of steel; hinges of metal; poles of metal; safety cashboxes; sash pulleys of metal; window pulleys of metal; pulleys of metal, other than for machines; railway sleepers of metal; window casement bolts; cotter pins of metal; spurs; pins [hardware]; roller blinds of steel; latch bars of metal; badges of metal for vehicles; labels of metal;

lock bolts; cashboxes [metal or non-metal]; tool chests of metal, empty; boxes of common metal; letter boxes of metal.

14 – Agates; diamonds; amulets [jewellery]; anchors [clock- and watchmaking]; barrels [clock- and watchmaking]; bracelets [jewellery]; bracelets made of embroidered textile [jewellery]; watch bands; charms for key rings; jewellery charms; brooches [jewellery]; alarm clocks; pins [jewellery]; ornamental pins; tie pins; jewellery hat pins; beads for making jewellery; pearls made of ambroid [pressed amber]; busts of precious metal; jewellery rolls; jet, unwrought or semi-wrought; jewellery findings; key rings [split rings with trinket or decorative fob]; retractable key rings; pearls [jewellery]; copper tokens; tie clips; cuff links; clasps for jewellery; badges of precious metal; gold, unwrought or beaten; cloisonné jewellery; works of art of precious metal; jewellery; ivory jewellery; jewellery of yellow amber; iridium; cabochons; precious stones; semi-precious stones; spun silver [silver wire]; necklaces [jewellery]; split rings of precious metal for keys; rings [jewellery]; boxes of precious metal; presentation boxes for jewellery; watch cases [parts of watches]; clock cases; pendulums [clock- and watchmaking]; medals; lockets [jewellery]; precious metals, unwrought or semi-wrought; movements for clocks and watches; clockworks; misbaha [prayer beads]; coins; gold thread [jewellery]; threads of precious metal [jewellery]; silver thread [jewellery]; olivine [gems]; peridot; osmium; palladium; platinum [metal]; chronometric instruments; watch springs; crucifixes of precious metal, other than jewellery; crucifixes as jewellery; rhodium; ruthenium; stopwatches; silver, unwrought or beaten; earrings; ingots of precious metals; alloys of precious metal; statues of precious metal; figurines of precious metal; statuettes of precious metal; watch glasses; paste jewellery; watch hands; clock hands; ornaments of jet; shoe jewellery; hat jewellery; presentation boxes for watches; chronographs [watches]; chronometers; chronoscopes; chains [jewellery]; watch chains; dials [clock- and watchmaking]; atomic clocks; watches; sundials; clocks and watches, electric; control clocks [master clocks]; clocks; wristwatches; rosaries; jewellery boxes; spinel [precious stones].

16 – Fountain pens; aquarelles; watercolors [paintings]; watercolours [paintings]; albums; almanacs; document laminators for office use; mimeograph apparatus and machines; atlases; posters; banknotes; banners of paper; paper bows, other than haberdashery or hair decorations; name badges [office requisites]; table linen of paper; tickets; baggage claim check tags of paper; forms, printed; announcement cards [stationery]; glitter for stationery purposes; note books; pads [stationery]; drawing pads; wristbands for the retention of writing instruments; pamphlets; booklets; paper sheets [stationery]; waxed paper; paper for medical examination tables; paper for recor-

ding machines; paper for radiograms; papers for painting and calligraphy; electrocardiograph paper; drawer liners of paper, perfumed or not; wood pulp paper; carbon paper; copying paper [stationery]; parchment paper; writing paper; rice paper; luminous paper; toilet paper; wrapping paper; filter paper; wash; paper; blotters; newsletters; rollers for typewriters; house painters' rollers; composing sticks; modelling wax, not for dental purposes; signboards of paper or cardboard; sewing patterns; bunting of paper; newspapers; electrotypes; hectographs; modelling clay; polymer modelling clay; terrestrial globes; drawing sets; engravings; slate pencils; pencil leads; document holders [stationery]; pencil holders; chalk holders; holders for cheque books; holders for stamps [seals]; page holders; name badge holders [office requisites]; diagrams; table runners of paper; engraving plates; writing slates; blackboards; galley racks [printing]; drawing boards; advertisement boards of paper or cardboard; duplicators; punches [office requisites]; cream containers of paper; magazines [periodicals]; money clips; clips for name badge holders [office requisites]; tags for index cards; pen clips; bookmarks; etching needles; tracing needles for drawing purposes; periodicals; printed publications; paper shredders for office use; graphic representations; credit card imprinters, non-electric; paper creasers [office requisites]; graining combs; drawing instruments; calendars; tracing paper; tracing cloth; tracing patterns; gums [adhesives] for stationery or household purposes; lithographic stones; ink stones [ink reservoirs]; pencils; pencil lead holders; charcoal pencils; pictures; transfers [decalcomanias]; paintings [pictures], framed or unframed; wood pulp board [stationery]; cardboard; hat boxes of cardboard; cards; index cards [stationery]; geographical maps; paper tapes and cards for the recordal of computer programmes; trading cards, other than for games; perforated cards for jacquard looms; catalogues; spools for inking ribbons; flower-pot covers of paper; paintbrushes; painters' brushes; writing brushes; typewriter keys; glue for stationery or household purposes; isinglass for stationery or household purposes; gluten [glue] for stationery or household purposes; starch paste [adhesive] for stationery or household purposes; printing blocks; books; colouring books; manifolds [stationery]; comic books; drawing pins; cigar bands; envelopes [stationery]; boxes of paper or cardboard; cases for stamps [seals]; paint boxes for use in schools; correcting fluids [office requisites]; printed coupons; stencils [stationery]; French curves; paper ribbons, other than haberdashery or hair decorations; gummed tape [stationery]; typewriter ribbons; barcode ribbons; adhesive bands for stationery or household purposes; correcting tapes [office requisites]; inking ribbons; self-adhesive tapes for stationery or household purposes; square rulers for drawing; drawing rulers; flyers; absorbent sheets of paper or plastic for foodstuff packaging; humidity control sheets of paper or plastic for foodstuff packaging; viscose

sheets for wrapping; sheets of reclaimed cellulose for wrapping; plastic bubble packs for wrapping or packaging; steel letters; type [numerals and letters]; lithographs; letter trays; paint trays; architects' models; postage stamps; plastics for modelling; graphic prints; modelling materials; teaching materials [except apparatus]; sealing compounds for stationery purposes; adhesives [glues] for stationery or household purposes; padding materials of paper or cardboard; book-binding material; packing [cushioning, stuffing] materials of paper or cardboard; packaging material made of starches; filtering materials of paper; table place setting mats of paper; addressing machines; pencil sharpening machines, electric or non-electric; book-binding apparatus and machines [office equipment]; typewriters, electric or non-electric; franking machines for office use; chalk for lithography; writing chalk; tailors' chalk; marking chalk; spray chalk; bags [envelopes, pouches] of paper or plastics, for packaging; garbage bags of paper or of plastics; plastic bags for pet waste disposal; painters' easels; hand-rests for painters; printing sets, portable [office requisites]; bibs of paper; bibs, sleeved, of paper; stickers [stationery]; fingerstalls for office use; writing cases [stationery]; cords for bookbinding; paper knives [letter openers]; printed sheet music; numbering apparatus; bottle envelopes of paper or cardboard; sealing wafers; covers [stationery]; passport holders; protective covers for books; plastic cling film, extensible, for palletization; embroidery designs [patterns]; handwriting specimens for copying; oleographs; musical greeting cards; greeting cards; postcards; etchings; conical paper bags; paper bags for use in the sterilization of medical instruments; bags for microwave cooking; palettes for painters; ink sticks; pantographs [drawing instruments]; loose-leaf binders; files [office requisites]; folders for papers; jackets for papers; papier mâché; pastels [crayons]; modelling paste; pen cases; pen wipers; office perforators; pens [office requisites]; nibs of gold; nibs; steel pens; drawing pens; song books; seals [stamps]; sealing stamps; clipboards; address plates for addressing machines; handkerchiefs of paper; plastic film for wrapping; transparencies [stationery]; desk mats; trays for sorting and counting money; coasters of paper; bookends; stamp stands; mats for beer glasses; stands for pens and pencils; photograph stands; obliterating stamps; inking pads; stamp pads; binding strips [bookbinding]; face towels of paper; towels of paper; inking sheets for document reproducing machines; inking sheets for duplicators; cloth for bookbinding; gummed cloth for stationery purposes; printers' blankets, not of textile; portraits; paperweights; writing cases [sets]; inkstands; office requisites, except furniture; writing materials; writing instruments; drawing materials; school supplies [stationery]; adhesive tape dispensers [office requisites]; hand labelling appliances; printed matter; lithographic works of art; prospectuses; printed timetables; ledgers [books]; printers' galleys; indexes; paper cutters [offi-

ce requisites]; rubber erasers; elastic bands for offices; T-squares for drawing; graphic reproductions; retractable reels for name badge holders [office requisites]; penholders; marking pens [stationery]; tissues of paper for removing make-up; paper wipes for cleaning; dental tray covers of paper; place mats of paper; tablemats of paper; tablecloths of paper; paper clasps; document files [stationery]; scrapers [erasers] for offices; paper-clips; clips for offices; erasing products; biological samples for use in microscopy [teaching materials]; histological sections for teaching purposes; figurines of papier mâché; statuettes of papier mâché; steatite [tailor's chalk]; writing board erasers; composing frames [printing]; sealing wax; arithmetical tables; placards of paper or cardboard; writing or drawing books; fabrics for bookbinding; stationery; pencil sharpeners, electric or non-electric; stencil plates; stencils for decorating food and beverages; cardboard tubes; Indian inks; moisteners [office requisites]; moisteners for gummed surfaces [office requisites]; squares for drawing; chart pointers, non-electronic; bottle wrappers of paper or cardboard; envelope sealing machines for offices; sealing machines for offices; vignetting apparatus; apparatus for mounting photographs; stapling presses [office requisites]; manuals [handbooks]; paper coffee filters; flags of paper; silver paper; moulds for modelling clays [artists' materials]; photo-engravings; photographs [printed]; stencil cases; canvas for painting; chromolithographs [chromos]; animation cels; compasses for drawing; numbers [type]; artists' watercolour saucers; correcting ink [heliography]; ink; inkwells; blueprints; stencils; erasing shields; balls for ball-point pens; desktop cabinets for stationery [office requisites]; printing type; address stamps; stamps [seals]; shields [paper seals]; prints [engravings]; labels of paper or cardboard.

18 – Mountaineering sticks; slings for carrying infants; luggage tags; pocket wallets; saddlecloths for horses; business card cases; reins; reins for guiding children; sling bags for carrying infants; harness fittings; credit card cases being wallets; parts of rubber for stirrups; chamois leather, other than for cleaning purposes; umbrellas; parasols; saddlery; frames for umbrellas or parasols; handbag frames; card cases [notecases]; cases of leather or leatherboard; valves of leather; whips; imitation leather; leather, unworked or semi-worked; leatherboard; casings, of leather, for springs; umbrella rings; hat boxes of leather; boxes of leather or leatherboard; boxes of vulcanized fibre; boxes of vulcanized fiber; purses; chain mesh purses; fastenings for saddles; butts [parts of hides]; saddle trees; bags [envelopes, pouches] of leather, for packaging; moleskin [imitation of leather]; travelling sets [leatherware]; knee-pads for horses; muzzles; halters; vanity cases, not fitted; furniture coverings of leather; clothing for pets; covers for animals; trimmings of leather for furniture; collars for animals; hiking sticks; conference folders; music cases; goldbeaters' skin; cat

o' nine tails; leather leashes; pads for horse saddles; horseshoes; girths of leather; leathercloth; horse blankets; garment bags for travel; shoulder belts [straps] of leather; briefcases; traces [harness]; fur; randsels [Japanese school satchels]; haversacks; leather straps; straps for soldiers' equipment; harness straps; straps for skates; straps of leather [saddlery]; chin straps, of leather; stirrup leathers; umbrella handles; walking stick handles; suitcase handles; grips for holding shopping bags; rucksacks; backpacks for carrying infants; travelling bags; riding saddles; net bags for shopping; umbrella or parasol ribs; stirrups; bags for climbers; tool bags, empty; handbags; beach bags; saddlebags; compression cubes adapted for luggage; bags for sports; bags for campers; shopping bags; wheeled shopping bags; school bags; bags; pouch baby carriers; travelling trunks; trunks being luggage; nose bags [feed bags]; bridoons; umbrella sticks; walking stick seats; walking sticks; tefillin [phylacteries]; bits for animals [harness]; bridles [harness]; harness for animals; key cases; horse collars; suitcases; motorized suitcases; suitcases with wheels; valises; attaché cases; covers for horse saddles; umbrella covers; kid; curried skins; animal skins; cattle skins; leather cord; blinkers [harness]; labels of leather; game bags [hunting accessories].

19 – Aquaria [structures]; alabaster; door frames, not of metal; asbestos cement; asphalt; beams, not of metal; balustrades, not of metal; huts; swimming pools [structures], not of metal; silos, not of metal; arbours [structures], not of metal; concrete; bitumen; plastic landscape edgings; joists, not of metal; telephone booths, not of metal; beacons, not of metal, non-luminous; building paper; busts of stone, concrete or marble; bird baths [structures], not of metal; binding agents for making briquettes; binding material for road repair; stained-glass windows; felt for building; aviaries [structures], not of metal; gates, not of metal; diving boards, not of metal; geotextiles; gypsum [building material]; plaster; potters' clay; earth for bricks; clay; roofing shingles; gravel; aquarium gravel; granite; armoured doors, not of metal; doors, not of metal; swing doors, not of metal; accordion doors, not of metal; folding doors, not of metal; coal tar; chimney pots, not of metal; prefabricated houses [kits], not of metal; parquet floor boards; memorial plaques, not of metal; wood for making household utensils; veneer wood; mouldable wood; chimney shafts, not of metal; outdoor blinds, not of metal and not of textile; jalousies, not of metal; roof gutters, not of metal; street gutters, not of metal; agglomerated bagasses of cane [building material]; road signs, non-luminous and non-mechanical, not of metal; non-luminous and non-mechanical signs, not of metal; limestone; lime; fences, not of metal; works of stonemasonry; works of art of stone, concrete or marble; cabanas, not of metal; soundproof booths, transportable, not of metal; stone; rubble; artificial stone; building stone; paint spraying booths, not of metal; gravestones; reeds for building;

horticultural frames, not of metal; framework, not of metal, for building; greenhouse frames, not of metal; cornices, not of metal; bitumen paper for building; wood pulp board for building; paperboard for building; skating rinks [structures], not of metal; quartz; caissons for construction work under water; bricks; firebricks; water-pipe valves, not of metal or plastic; drain traps [valves], not of metal or plastic; cask wood; mooring bollards, not of metal; cement posts; pillars, not of metal, for building; chimney cowl, not of metal; brackets, not of metal, for building; buildings, not of metal; buildings, transportable, not of metal; stringers [parts of staircases], not of metal; silica [quartz]; roofing, not of metal; roofing, not of metal, incorporating photovoltaic cells; manhole covers, not of metal; xylolith; chicken-houses, not of metal; manufactured timber; sawn timber; building timber; lumber; wood, semi-worked; staircases, not of metal; road marking sheets and strips of synthetic material; reinforcing materials, not of metal, for building; bituminous products for building; tar; road coating materials; materials for making and coating roads; fireclay; pitch; building materials, not of metal; refractory construction materials, not of metal; masts [poles], not of metal; raw chalk; calcareous marl; mosaics for building; moldings, not of metal, for building; mouldings, not of metal, for building; marble; slate powder; porches [structures], not of metal; tombs, not of metal; flashing, not of metal, for building; roof flashing, not of metal; perches; duckboards, not of metal; wall claddings, not of metal, for building; mouldings, not of metal, for cornices; coatings [building materials]; tomb or grave enclosures, not of metal; grave or tomb enclosures, not of metal; laths, not of metal; wood panelling; wall linings, not of metal, for building; palings, not of metal; crash barriers, not of metal, for roads; latticework, not of metal; windows, not of metal; olivine for building; shuttering, not of metal, for concrete; posts, not of metal, for power lines; props, not of metal; rubber bearings for seismic isolation of buildings; branching pipes, not of metal; fair huts; tombs [monuments], not of metal; monuments, not of metal; acoustic panels, not of metal; wainscoting, not of metal; signalling panels, non-luminous and non-mechanical, not of metal; building panels, not of metal; parquet flooring; partitions, not of metal; lintels, not of metal; casement windows, not of metal; aquarium sand; silver sand; sand, except foundry sand; sandstone for building; tarred strips for building; planks of wood for building; rocket launching platforms, not of metal; platforms, prefabricated, not of metal; wall tiles, not of metal; floor tiles, not of metal; tiles, not of metal, for building; paving slabs, not of metal; cement slabs; grave slabs, not of metal; tile floorings, not of metal; slabs, not of metal, for building; scaffolding, not of metal; armour-plating, not of metal; asphalt paving; wood paving; paving blocks, not of metal; luminous paving blocks; macadam; fireproof cement coatings; bituminous coatings for roo-

fing; roof coverings, not of metal; wooden floor boards; cladding, not of metal, for building; linings, not of metal, for building; fireplace mantles, not of metal; door panels, not of metal; floors, not of metal; sills, not of metal; porphyry [stone]; ceilings, not of metal; floating docks, not of metal, for mooring boats; agglomerated cork for building; window frames, not of metal; mortar for building; asbestos mortar; tanks of masonry; scantlings [carpentry]; furrings of wood; vinyl siding; pilings, not of metal; pigsties, not of metal; insect screens, not of metal; burial vaults, not of metal; schists; shutters, not of metal; statues of stone, concrete or marble; statuettes of stone, concrete or marble; alabaster glass; safety glass; glass granules for road marking; window glass for building; window glass, other than vehicle window glass; building glass; plate glass [windows] for building; insulating glass for building; enamelled glass, for building; tombstone stelae, not of metal; non-metal stables; advertisement columns, not of metal; posts, not of metal; telegraph posts, not of metal; hips for roofing; stair-treads [steps], not of metal; tombstone plaques, not of metal; greenhouses, transportable, not of metal; terra-cotta [building material]; penstock pipes, not of metal; water-pipes, not of metal; gutter pipes, not of metal; ducts, not of metal, for ventilating and air-conditioning installations; drain pipes, not of metal; chimneys, not of metal; rigid pipes, not of metal, for building; sandstone pipes; turnstiles, not of metal; tufa; angle irons, not of metal; lengthening pieces, not of metal, for chimneys; bicycle parking installations, not of metal; plywood; flagpoles [structures], not of metal; foundry moulds, not of metal; rock crystal; cement for blast furnaces; cement for furnaces; magnesia cement; cement; pantiles, not of metal; roofing tiles, not of metal; slate; roofing slates; slag [building material]; slag stone; railway sleepers, not of metal; wood veneers; clinker ballast; concrete building elements; letter boxes of masonry.

24 – Frieze [cloth]; banners of textile or plastic; velvet; household linen; diapered linen; bath linen, except clothing; bed linen; table linen, not of paper; cot bumpers [bed linen]; buckram; fustian; sleeping bag liners; felt; bunting of textile or plastic; gauze [cloth]; damask; jersey [fabric]; table runners, not of paper; drugget; shower curtains of textile or plastic; curtains of textile or plastic; net curtains; zephyr [cloth]; canvas for tapestry or embroidery; bolting cloth; baby buntings; crepe [fabric]; crepon; marabouts [cloth]; furniture coverings of textile; fabrics for textile use; filtering materials of textile; wall hangings of textile; non-woven textile fabrics; plastic material [substitute for fabrics]; textile material; tablemats of textile; bivouac sacks being covers for sleeping bags; sleeping bags; sleeping bags for babies; moleskin [fabric]; muslin fabric; pillowcases; mattress covers; bed blankets; blankets for household pets; brocades; diaper changing cloths for babies; handkerchiefs of textile; picnic blankets; travelling rugs [lap robes]; coasters of texti-

le; bed valances; linings [textile]; hat linings, of textile, in the piece; curtain holders of textile material; bed covers; bed covers of paper; furniture coverings of plastic; face towels of textile; towels of textile; hemp cloth; gummed cloth, other than for stationery purposes; printers' blankets of textile; cloth; door curtains; sheets [textile]; eiderdowns [down covers]; bath mitts; shrouds; glass cloths [towels]; cloths for removing make-up; place mats of textile; table napkins of textile; mosquito nets; calico; oilcloth for use as tablecloths; tablecloths, not of paper; billiard cloth; taffeta [cloth]; ticks [mattress covers]; tick [linen]; lingerie fabric; fabric, impervious to gases, for aeronautical balloons; jute fabric; fabric for footwear; ramie fabric; esparto fabric; rayon fabric; fibreglass fabrics for textile use; adhesive fabric for application by heat; linen cloth; upholstery fabrics; hemp fabric; lining fabric for footwear; traced cloths for embroidery; chenille fabric; printed calico cloth; knitted fabric; cotton fabrics; silk fabrics for printing patterns; woollen cloth; elastic woven material; fabric; fabric imitating animal skins; haircloth [sackcloth]; cheese cloth; tulle; flags of textile or plastic; flannel [fabric]; trellis [cloth]; covers for cushions; fitted toilet lid covers of fabric; covers [loose] for furniture; pillow shams; chevots [cloth]; silk [cloth]; labels of textile.

25 – Wimples; bandanas [neckerchiefs]; underwear; sweat-absorbent underwear; berets; overalls; boas [necklets]; teddies [underclothing]; boxer shorts; ankle boots; ski boots; boots for sports; breeches for wear; trousers; football shoes; brassieres; adhesive bras; valenki [felted boots]; mittens; collars [clothing]; detachable collars; shirt yokes; veils [clothing]; gabardines [clothing]; galoshes; neckties; ascots; chaps; spats; leggings [leg warmers]; leg warmers; boot uppers; corselets; jerseys [clothing]; waistcoats; sports jerseys; hosiery; heels; heelpieces for footwear; hoods [clothing]; hat frames [skeletons]; pockets for clothing; scarves; caps being headwear; kimonos; cap peaks; visors being headwear; tights; slips [underclothing]; combinations [clothing]; wet suits for water-skiing; bodices [lingerie]; corsets [underclothing]; suits; bathing suits; masquerade costumes; beach clothes; headscarfs; headscarves; leotards; jackets [clothing]; stuff jackets [clothing]; fishing vests; leggings [trousers]; liveries; camisoles; sports singlets; cuffs; short-sleeve shirts; mantillas; coats; sleep masks; furs [clothing]; fingerless gloves; mitres [hats]; muffs [clothing]; footmuffs, not electrically heated; bibs, not of paper; bibs, sleeved, not of paper; fur stoles; hairdressing capes; heel protectors for shoes; ear muffs [clothing]; socks; sweat-absorbent socks; gymnastic shoes; beach shoes; sports shoes; footwear; paper clothing; outerclothing; embroidered clothing; ready-made clothing; motorists' clothing; cyclists' clothing; clothing for gymnastics; clothing of imitations of leather; latex clothing; clothing of leather; waterproof clothing; clothing incorporating LEDs; uniforms; clothing; clothing containing slimming substances; fit-

tings of metal for footwear; maniples; overcoats; knickers; parkas; pelerines; gloves [clothing]; ski gloves; pyjamas; bathing trunks; shirt fronts; pocket squares; dresses; headbands [clothing]; garters; sock suspenders; stocking suspenders; ready-made linings [parts of clothing]; dress shields; soles for footwear; braces for clothing [suspenders]; half-boots; lace boots; ponchos; girdles; belts [clothing]; sashes for wear; money belts [clothing]; layettes [clothing]; non-slip-ping devices for footwear; sweaters; pullovers; jumpers [pullovers]; heelpieces for stockings; welts for footwear; chasubles; shirts; wooden shoes; sandals; bath sandals; boots; jumper dresses; saris; sarongs; footwear uppers; inner soles; albs; bath slippers; togas; knitwear [clothing]; underpants; slippers; shoes; skull caps; turbans; headwear; aprons [clothing]; judo uniforms; karate uniforms; tee-shirts; rash guards; dressing gowns; bath robes; top hats; tips for footwear; stockings; sweat-absorbent stockings; shawls; paper hats [clothing]; shower caps; bathing caps; neck tube scarves; studs for football shoes; hats; babies' pants [underwear]; gaiter straps; pelisses; esparto shoes or sandals; skirts; petticoats; skorts.

35 – Arranging subscriptions to telecommunication services for others; import-export agency services; commercial information agency services; advertising agency services; cost price analysis; rental of office equipment in co-working facilities; rental of advertising space; business auditing; financial auditing; business intermediary services relating to the matching of potential private investors with entrepreneurs needing funding; employment agency services; computerized file management; book-keeping; invoicing; demonstration of goods; transcription of communications [office functions]; opinion polling; market studies; business investigations; business research; marketing research; personnel recruitment; business management and organization consultancy; business organization consultancy; business management consultancy; personnel management consultancy; professional business consultancy; consultancy regarding advertising communication strategies; consultancy regarding public relations communication strategies; layout services for advertising purposes; marketing; marketing in the framework of software publishing; targeted marketing; business management of performing artists; business management of sports people; writing of curriculum vitae for others; scriptwriting for advertising purposes; news clipping services; updating and maintenance of information in registries; updating and maintenance of data in computer databases; updating of advertising material; word processing; online retail services for downloadable and pre-recorded music and movies; online retail services for downloadable ring tones; online retail services for downloadable digital music; organization of exhibitions for commercial or advertising purposes; arranging newspaper subscriptions for others; organization of fashion shows for promotional purposes; organization

of trade fairs; shop window dressing; business appraisals; payroll preparation; data search in computer files for others; sponsorship search; administrative assistance in responding to calls for tenders; business management assistance; commercial or industrial management assistance; commercial intermediation services; providing business information; providing business information via a website; providing commercial and business contact information; providing commercial information and advice for consumers in the choice of products and services; provision of an on-line marketplace for buyers and sellers of goods and services; providing user reviews for commercial or advertising purposes; web indexing for commercial or advertising purposes; providing user rankings for commercial or advertising purposes; presentation of goods on communication media, for retail purposes; media relations services; economic forecasting; auctioneering; wholesale services for pharmaceutical, veterinary and sanitary preparations and medical supplies; retail services for works of art provided by art galleries; retail services for pharmaceutical, veterinary and sanitary preparations and medical supplies; sales promotion for others; wholesale or retail services; wholesale or retail store services; on-line wholesale and retail store services; promotion of goods and services through sponsorship of sports events; production of teleshopping programmes; production of advertising films; office machines and equipment rental; rental of advertising time on communication media; publicity material rental; rental of billboards [advertising boards]; rental of vending machines; rental of sales stands; rental of photocopying machines; consumer profiling for commercial or marketing purposes; publication of publicity texts; radio advertising; development of advertising concepts; bill-posting; distribution of samples; dissemination of advertising matter; direct mail advertising; registration of written communications and data; writing of publicity texts; advertising; online advertising on a computer network; advertising by mail order; television advertising; compilation of statistics; compilation of information into computer databases; business inquiries; systemization of information into computer databases; administrative services for medical referrals; advisory services for business management; corporate communications services; negotiation of business contracts for others; negotiation and conclusion of commercial transactions for third parties; compiling indexes of information for commercial or advertising purposes; tax preparation; drawing up of statements of accounts; telemarketing services; psychological testing for the selection of personnel; interim business management; outsourced administrative management for companies; business management of hotels; business management for freelance service providers; business project management services for construction projects; commercial administration of the licensing of the goods and services of others; business management of reim-

bursement programmes for others; administration of consumer loyalty programs; administration of frequent flyer programs; administrative processing of purchase orders; administrative services for the relocation of businesses; public relations; commercial lobbying services; competitive intelligence services; modelling for advertising or sales promotion; typing; market intelligence services; appointment reminder services [office functions]; website traffic optimization; appointment scheduling services [office functions]; tax filing services; search engine optimization for sales promotion; retail services relating to bakery products; gift registry services; price comparison services; pay per click advertising; secretarial services; procurement services for others [purchasing goods and services for other businesses]; shorthand; outsourcing services [business assistance]; telephone answering for unavailable subscribers; telephone switchboard services; photocopying services; business efficiency expert services.

37 – Asphaltting; drilling of deep oil or gas wells; drilling of wells; rebuilding engines that have been worn or partially destroyed; rebuilding machines that have been worn or partially destroyed; renovation of clothing; retreading of tyres; vulcanization of tyres [repair]; building sealing; linen ironing; pressing of clothing; disinfecting; mining extraction; vehicle battery charging; charging of electric vehicles; knife sharpening; building insulating; bricklaying; riveting; construction consultancy; varnishing; re-tinning; installation of utilities in construction sites; scaffolding; road paving; window cleaning; vehicle washing; building construction supervision; tuning of musical instruments; upholstering; rustproofing; anti-rust treatment for vehicles; sanding; pumicing; strong-room maintenance and repair; vehicle maintenance; paper hanging; painting or repair of signs; cleaning of buildings [exterior surface]; vehicle polishing; vehicle breakdown repair services; providing information relating to repairs; providing construction information; rental of bulldozers; rental of drainage pumps; rental of dish drying machines; rental of road sweeping machines; rental of cleaning machines; rental of cranes [construction equipment]; rental of dishwashing machines; rental of laundry washing machines; rental of construction equipment; rental of excavators; laying of cable; plumbing; masonry; roofing services; painting, interior and exterior; carpentry services; underwater repair; plastering; quarrying services; repair of security locks; umbrella repair; parasol repair; motor vehicle maintenance and repair; burner maintenance and repair; film projector repair and maintenance; airplane maintenance and repair; safe maintenance and repair; clock and watch repair; repair of power lines; pump repair; upholstery repair; shoe repair; clothing repair; photographic apparatus repair; furniture restoration; restoration of musical instruments; restoration of works of art; vehicle greasing; demolition of buildings; warehouse construction and repair; vehicle

service stations [refuelling and maintenance]; sterilization of medical instruments; washing; washing of linen; pier breakwater building; pipeline construction and maintenance; underwater construction; harbour construction; factory construction; building of fair stalls and shops; construction; shipbuilding; cleaning of buildings [interior]; snow removal; street cleaning; vermin exterminating, other than for agriculture, aquaculture, horticulture and forestry; housekeeping services [cleaning services]; tyre balancing; pest control services, other than for agriculture, aquaculture, horticulture and forestry; hydraulic fracturing services; refilling of toner cartridges; refilling of ink cartridges; cell phone battery charging services; artificial snow-making services; laundering; services of electricians; installation of doors and windows; irrigation devices installation and repair; elevator installation and repair; installation and repair of flood protection equipment; heating equipment installation and repair; burglar alarm installation and repair; furnace installation and repair; telephone installation and repair; installation and repair of air-conditioning apparatus; fire alarm installation and repair; freezing equipment installation and repair; electric appliance installation and repair; kitchen equipment installation; installation, maintenance and repair of computer hardware; machinery installation, maintenance and repair; office machines and equipment installation, maintenance and repair; interference suppression in electrical apparatus; swimming-pool maintenance; furniture maintenance; chimney sweeping; boiler cleaning and repair; cleaning of clothing; dry cleaning; vehicle cleaning; diaper cleaning; leather care, cleaning and repair; fur care, cleaning and repair.

38 – News agency services; wireless broadcasting; television broadcasting; cable television broadcasting; electronic bulletin board services [telecommunications services]; providing user access to global computer networks; providing access to databases; providing internet chatrooms; providing telecommunications connections to a global computer network; providing telecommunication channels for teleshopping services; video-on-demand transmission; transmission of podcasts; transmission of greeting cards online; message sending; computer aided transmission of messages and images; transmission of telegrams; transmission of digital files; providing information in the field of telecommunications; providing online forums; videoconferencing services; rental of message sending apparatus; rental of access time to global computer networks; rental of modems; rental of telecommunication equipment; rental of smartphones; rental of telephones; rental of facsimile apparatus; radio broadcasting; radio communications; transmission of electronic mail; communications by fibre optic networks; communications by cellular phones; communications by computer terminals; satellite transmission; communications by telegrams; communications by telephone; facsimile transmission; paging services [radio, telep-

hone or other means of electronic communication]; teleconferencing services; telex services; voice mail services; telecommunications routing and junction services; streaming of data; telegraph services; telephoning services.

39 – Air transport; motor coach rental; boat rental; garage rental; rental of vehicle roof racks; aircraft rental; parking place rental; rental of electric wine cellars; rental of warehouses; rental of tractors; booking of seats for travel; travel reservation; transport reservation; towing; vehicle breakdown towing services; bottling services; water distribution; water supplying; delivery of newspapers; message delivery; parcel delivery; delivery of goods; delivery of goods by mail order; flower delivery; replenishment of vending machines; launching of satellites for others; transportation logistics; rescue operations [transport]; arranging of cruises; arranging of passenger transportation services for others via an online application; arranging of transportation for travel tours; arranging for travel visas and travel documents for persons travelling abroad; armoured-car transport; hauling; carting; transport and storage of waste; transporting furniture; lighterage services; ferry-boat transport; removal services; transport of travellers; guarded transport of valuables; bus transport; car transport; barge transport; boat transport; railway transport; marine transport; passenger transport; river transport; ambulance transport; tram transport; portage; piloting of civilian drones; re-floating of ships; cash replenishment of automated teller machines; shipbrokerage; transport brokerage; freight brokerage [forwarding (Am.)]; providing driving directions for travel purposes; providing traffic information; providing information relating to storage services; providing transportation information; car rental; railway truck rental; rental of diving bells; rental of diving suits; rental of motor racing cars; rental of aircraft engines; railway coach rental; rental of storage containers; rental of wheelchairs; horse rental; rental of freezers; rental of navigational systems; refrigerator rental; vehicle rental; stevedoring; unloading cargo; electricity distribution; distribution of energy; packaging of goods; collection of recyclable goods [transport]; carpooling services; ice-breaking; piloting; escorting of travellers; transport by pipeline; wrapping of goods; operating canal locks; car parking; chauffeur services; pleasure boat transport; car sharing services; courier services [messages or merchandise]; salvaging; salvage of ships; gift wrapping; underwater salvage; taxi transport; transport; transport services for sightseeing tours; luggage storage; franking of mail; freight [shipping of goods]; freighting; physical storage of electronically stored data or documents; boat storage; storage of goods; storage; freight forwarding.

40 – Paper finishing; applying finishes to textiles; beer brewing for others; upcycling [waste recycling]; vulcanization [material treatment]; skin dressing; fruit

crushing; embroidering; galvanization; electroplating; engraving; decontamination of hazardous materials; air deodorizing; stripping finishes; tanning; metal tempering; freezing of foods; gilding; gold plating; cadmium plating; permanent-press treatment of fabrics; food and drink preservation; consultancy in the field of wine making; food smoking; leather staining; fur dyeing; shoe staining; textile dyeing; cloth dyeing; laminating; lithographic printing; metal casting; fur glossing; tin plating; boilermaking; taxidermy; magnetization; nickel plating; abrasion; paper treating; water treating; woodworking; processing of cinematographic films; leather working; cloth edging; metal treating; fur conditioning; fur mothproofing; waste treatment [transformation]; textile mothproofing; cloth waterproofing; crease-resistant treatment for clothing; cloth fireproofing; textile treating; wool treating; framing of works of art; air freshening; fabric bleaching; air purification; soldering; pasteurizing of food and beverages; clothing alteration; recycling of waste and trash; processing of oil; pattern printing; photographic printing; offset printing; metal plating; printing; burnishing by abrasion; flour milling; dress-making; providing information relating to material treatment; wine making for others; custom manufacturing of bread; rental of boilers; knitting machine rental; rental of generators; rental of air-conditioning apparatus; rental of space heating apparatus; photographic film development; pottery firing; blacksmithing; custom assembling of materials for others; bookbinding; welding services; glass-blowing; saddlery working; grinding; cloth cutting; sawing of materials; refining services; timber felling and processing; fur satining; silver plating; incineration of waste and trash; laser scribing; warping [looms]; sorting of waste and recyclable material [transformation]; photo-composing services; quilting; planing of materials; fulling of cloth; tinting of car windows; window tinting treatment being surface coating; slaughtering of animals; destruction of waste and trash; cloth pre-shrinking; custom 3D printing for others; services of a dental technician; cryopreservation services; key cutting; dyeing services; sandblasting services; production of energy; custom tailoring; custom fashioning of fur; photogravure; millworking; chromium plating; colour separation services; silkscreen printing; optical glass grinding.

42 – Water analysis; computer system analysis; handwriting analysis [graphology]; chemical analysis; rental of meters for the recording of energy consumption; energy auditing; recovery of computer data; business card design; graphic design of promotional materials; interior design; industrial design; graphic arts design; computer virus protection services; oil-field surveys; geological surveys; engineering; installation of computer software; meteorological information; clinical trials; material testing; textile testing; bacteriological research; biological research; geological research; research in the field of environmental

protection; cosmetic research; mechanical research; research in the field of welding; research in the field of building construction; research in the field of telecommunications technology; research in the field of physics; chemical research; research and development of new products for others; medical research; scientific and technological research relating to patent mapping; scientific and technological research in the field of natural disasters; scientific research; analysis for oil-field exploitation; underwater exploration; technological research; calibration [measuring]; website design consultancy; computer security consultancy; information technology [IT] consultancy; computer technology consultancy; consultancy in the design and development of computer hardware; architectural consultancy; internet security consultancy; computer software consultancy; data security consultancy; technological consultancy; oil-well testing; quality control; vehicle roadworthiness testing; land surveying; dress designing; updating of computer software; monitoring of computer systems to detect breakdowns; monitoring of computer systems for detecting unauthorized access or data breach; monitoring of computer systems by remote access; electronic monitoring of credit card activity to detect fraud via the internet; electronic monitoring of personally identifying information to detect identity theft via the internet; software as a service [SaaS]; maintenance of computer software; authenticating works of art; design of interior decor; quality evaluation of standing timber; quality evaluation of wool; digitization of documents [scanning]; conversion of data or documents from physical to electronic media; urban planning; providing information relating to computer technology and programming via a website; providing scientific information, advice and consultancy relating to carbon offsetting; providing search engines for the internet; platform as a service [PaaS]; conversion of computer programs and data, other than physical conversion; conducting technical project studies; computer system design; rental of web servers; computer rental; rental of computer software; unlocking of mobile phones; geological prospecting; oil prospecting; hosting computer sites [web sites]; server hosting; development of computer platforms; construction drafting; computer software design; software development in the framework of software publishing; cloud seeding; consultancy in the field of energy-saving; creating and designing website-based indexes of information for others [information technology services]; creating and maintaining websites for others; computer programming; technical writing; copying of computer programs; cloud computing; architectural services; information technology services provided on an outsourcing basis; chemistry services; packaging design; off-site data backup; telecommunications technology consultancy; scientific laboratory services; user authentication services using single sign-on technology for online software applications; user authentication services using

technology for e-commerce transactions; weather forecasting; styling [industrial design]; cartography services; exploration services in the field of the oil, gas and mining industries; data encryption services; electronic data storage; surveying.

45 – Marriage agency services; detective agency services; night guard services; adoption agency services; arbitration services; leasing of internet domain names; rental of safes; legal compliance auditing; regulatory compliance auditing; embalming services; funerary undertaking; lost property return; releasing doves for special occasions; security screening of baggage; genealogical research; legal research; intellectual property consultancy; physical security consultancy; legal consultancy relating to patent mapping; legal advice in responding to calls for tenders; bereavement counselling; monitoring intellectual property rights for legal advisory purposes; monitoring of burglar and security alarms; crematorium services; licensing [legal services] in the framework of software publishing; licensing of intellectual property; licensing of computer software [legal services]; organization of political meetings; organization of religious meetings; opening of security locks; planning and arranging of wedding ceremonies; missing person investigations; kimono dressing assistance; litigation services; babysitting; pet sitting; conducting religious ceremonies; conducting funeral ceremonies; inspection of factories for safety purposes; evening dress rental; rental of fire extinguishers; clothing rental; rental of fire alarms; registration of domain names [legal services]; personal letter writing; personal background investigations; fire-fighting; astrology consultancy; spiritual consultancy; personal wardrobe styling consultancy; chaperoning; horoscope casting; copyright management; legal administration of licences; legal advocacy services; tarot card reading services for others; cartomancy services; dating services; concierge services; guard services; alternative dispute resolution services; dog walking services; tracking of stolen property; legal document preparation services; house sitting; mediation; burial services; online social networking services; lifeguard services; personal bodyguarding; legal services in the field of immigration; legal services in relation to the negotiation of contracts for others; legal watching services.

(260) AM 2022 116460 A

(800) 1641523

(151) 2021 12 17

(891) 2021 12 17

(731) Limited liability company

"STROYTECHNOCOM"

Kolomyazhsky pr-kt, 10, pom. 3N, kab.
204-3N, RU-197348 Sankt-Petersburg,
Russian Federation

(540)

VKVADRATE**ВКВАДРАТЕ**

(591) Black, white

(531) 28.05

(511)

27 – Artificial turf; floor mats, fire-resistant, for fireplaces and barbecues; carpets; wall hangings, not of textile; carpets for automobiles; bath mats; non-slip mats; linoleum; mats of woven rope for ski slopes; wallpaper; textile wallpaper; carpet underlay; gymnasium mats; vinyl floor coverings; door mats; floor coverings; mats; reed mats.

(260) AM 2022 116468 A

(800) 1641611

(151) 2021 09 10

(891) 2021 09 10

(731) LES LABORATOIRES SERVIER

50 rue Carnot, F-92284 Suresnes Cedex,
France

(540)

MOVED BY YOU

(591) Black, white

(511)

5 – Pharmaceutical products, medical and veterinary preparations; hygienic products for medicine; dietetic substances and foodstuffs for medical or veterinary use, food for babies; food supplements for humans and animals; plasters, materials for dressings; material for dental fillings and dental impressions; disinfectants; products for destroying vermin; fungicides, herbicides.

9 – Scientific, optical, weighing, measuring, signaling, checking (inspecting), life-saving and teaching apparatus and instruments; apparatus and instruments for conducting, switching, transforming, accumulating, regulating or controlling electricity; apparatus for recording, transmission or reproduction of sound or images; magnetic recording media; sound recording disks; digital recording media; data and information processing apparatus and equipment; software; computer programs; computers; software recorded on magnetic media or downloaded from a remote computer network; downloadable computer software applications; telecommunication equipment for use with mobile networks; personal digital assistant; electronic signal transmitters; connected bracelets (measuring instruments); connected scales; connected watches (measuring instruments); video cameras; electronic sensors; mobile applications; digital applications; algorithms (software); artificial intelligence software; computer platforms in the form of information sharing

software; connected self-measurement tools; electronic chips connected to an information system; downloadable applications for mobile devices; artificial intelligence software; spectacles; contact lenses; smart glasses; in-ear headphones; downloadable telemedicine applications for mobile devices; augmented reality software; virtual reality computer programs; analysis systems based on artificial intelligence (software); medical image analysis systems based on artificial intelligence; virtual reality headsets.

10 – Medical, surgical, dental and veterinary apparatus, instruments and equipment, artificial limbs, organs, eyes and teeth; orthopedic articles; surgical instruments for use in orthopedic surgery; medical, surgical and orthopedic implants made of artificial materials; suture material; compression stockings, tights and socks; stockings, tights and socks for varicose veins; bandages for compression dressing; medical apparatus, instruments and equipment for introduction of pharmaceutical preparations into the human body, particularly for the prolonged, controlled or immediate release of active substances; infusion devices and syringes for medical use; medical measuring instruments, in particular instruments able to directly transmit data to a database, in particular instruments to measure fevers, heart rate monitors; apparatus, instruments and equipment derived from robotics for medical use; nanobots for medical use; apparatus, instruments and equipment derived from bionics for medical use; bio-materials for medical use; connected materials for medical use; smart materials for medical use; allergy testing tools; blood testing apparatus; medical devices intended for ingestion; endoscopic video capsules; medical apparatus for measuring biochemical changes in blood; blood biomarker devices; medical endoscopy apparatus; inhalers; blood pressure monitors; physiological monitoring and measuring apparatus for medical use; telemetry apparatus for medical use; acupuncture equipment; hearing aids; automatic analyzers for medical use; medical imaging apparatus; massage apparatus.

42 – Scientific and technological services as well as research and design services relating thereto; industrial analysis and research services; scientific research services for medical purposes; design and development of computer hardware and software; research, design and development of tools for monitoring, diagnosis, prediction, analysis; clinical trials; scientific laboratory services; evaluation, scientific and technical project studies; cloud computing; rental of computer software; updating of software; programming for computers; research and development of new products for third parties; electronic data storage; hosting platforms on the Internet, hosting Web portals, temporary provision of non-downloadable software applications accessible via an Internet site; design of websites on the Internet, particularly collaborative platforms; engi-

neering services relating to robotics; development of software intended for patients.

44 – Medical services; veterinary services; hygienic and beauty care for human beings or animals; health counseling; pharmacy consultation; health services; telemedicine services; therapeutic services; medical diagnosis services; home care services; individualized medical prescription services; online medical prescription services; providing support in the monitoring of patients receiving medical treatment; advice relating to home medical treatment; advice relating to self-medication; provision of medical information to patients; remote medical examination services; advice related to personal wellbeing [health]; medical monitoring of patients including remote monitoring.

(260) AM 2022 116477 A

(800) 1641970

(151) 2021 08 17

(891) 2021 08 17

(731) Pharmalys Laboratories SA
Schochenmühlestrasse 2, CH-6340 Baar,
Switzerland

(540)

PRIMALAC ULTIMA

(591) Black, white

(511)

5 – Food for babies; plasters, materials for dressings; disinfectants; powdered milk for babies; food for infants; food preparations for infants.

29 – Milk and dairy products; powdered milk; almond milk; almond milk for culinary use; processed almonds; peanut milk; peanut milk for food; coconut-milk-based beverages; almond-milk-based beverages; compotes; beverages consisting primarily of milk; coconut milk powder; coconut milk powder; milk substitutes; creamers for coffee which can be used for other beverages; milk-based beverages containing fruits; milk-based beverages containing fruit juice; unsweetened condensed milk; rice milk; soy milk; milks-hakes; yogurt; beverages made from yogurt; beverages consisting primarily of milk; dairy-based beverages; oils and fats for food; dairy products, namely butter, cheese, cream (dairy product), yogurt, quark, powdered milk and milk proteins for food; food bars with fruit, based on fruit and cereals, based on nuts and sugar; fruit-based snack food; milk-based desserts and fruit-based desserts.

30 – Tea, cocoa; rice; tapioca and sago; flour and preparations made from cereals, bread, pastry and confectionery; edible ices; sugar, honey; salt; sauces (condiments); spices; malt for human consumption; malt extract for food; processed cereals; cereal bars; ice milk bars; high-protein cereal bars; flapjacks (oat bars); chocolate tablets; cereal-based snacks; rice-based snacks; chocolate beverages with milk; ice milk;

cocoa beverage with milk; soy flour; spicy soya sauce.

(260) AM 2022 116503 A

(800) 1642644

(151) 2021 12 15

(891) 2021 12 15

(731) Amusnet Interactive Ltd
Garitage Park, Building No. 4, Floor 2,
2 Donka Ushlina Str., BG-1766 Sofia,
Bulgaria

(540)



(591) Red, yellow, gold, orange and white

(531) 27.05.01; 27.05.02; 27.05.03; 27.05.17;
27.05.25; 27.07.01; 27.07.02; 27.07.03;
27.07.25; 29.01.13

(511)

9 – Computer software for the administration of on-line games and gaming; computer application software featuring games and gaming; betting software; gaming software that generates or displays wager outcomes of gaming machines.

28 – Slot machines [gaming machines]; gaming machines for gambling.

41 – Providing of casino and gaming facilities; betting services.

(260) AM 2022 116504 A

(800) 1642656

(151) 2021 11 10

(891) 2021 11 10

(731) LIMITED LIABILITY COMPANY
«AQUANT»
Pokhodny pr. 14, floor/premises/office
5/II/No.5, RU-125373 Moscow,
Russian Federation

(540)



(591) Purple and gray-green

(531) 02.09.14; 27.05.01; 29.01.12

(511)

20 – Bumper guards for cots, other than bed linen; pulleys of plastics for blinds; bolts, not of metal; mooring buoys, not of metal; casks, not of metal; barrels, not of metal; sideboards; busts of wood, wax, plaster or plastic; valet stands; coatstands; shoulder poles [yokes]; screws, not of metal; signboards of wood or plastics; nuts, not of metal; curtain holders, not of textile material; plugs [dowels], not of metal; containers, not of metal, for liquid fuel; troughs, not of metal, for

mixing mortar; oil drainage containers, not of metal; packaging containers of plastic; clips of plastic for sealing bags; rivets, not of metal; locks, not of metal, for vehicles; padlocks, other than electronic, not of metal; door bolts, not of metal; bottle closures, not of metal; closures, not of metal, for containers; latches, not of metal; numberplates, not of metal; jerrycans, not of metal; plastic keys; bed casters, not of metal; furniture casters, not of metal; brush mountings; door bells, not of metal, non-electric; bottle caps, not of metal; bassinets; tent pegs, not of metal; curtain rings; console tables; containers, not of metal [storage, transport]; floating containers, not of metal; bakers' bread baskets; baskets, not of metal; Moses baskets; tool boxes, not of metal, empty; taps, not of metal, for casks; brackets, not of metal, for furniture; screw tops, not of metal, for bottles; table tops; sash fasteners, not of metal, for windows; coathooks, not of metal; curtain hooks; clothes hooks, not of metal; bag hangers, not of metal; beds for household pets; ladders of wood or plastics; playpens for babies; tailors' dummies; runners, not of metal, for sliding doors; legs for furniture; door stops, not of metal or rubber; window stops, not of metal or rubber; plastic ramps for use with vehicles; freestanding partitions [furniture]; trestles [furniture]; magazine racks; book rests [furniture]; racks [furniture]; furniture shelves; shelves for storage; towel stands [furniture]; bathtub grab bars, not of metal; counters [tables]; corks for bottles; sealing caps, not of metal; flower-pot pedestals; door handles, not of metal; knobs, not of metal; bath seats for babies; benches [furniture]; vats, not of metal; plugs, not of metal; statues of wood, wax, plaster or plastic; trolleys for computers [furniture]; dressing tables; steps [ladders], not of metal; step stools, not of metal; chairs [seats]; shower chairs; chests, not of metal; stools; decorations of plastic for foodstuffs; window closers, not of metal, non-electric; door openers, not of metal, non-electric; window openers, not of metal, non-electric; winding spools, not of metal, non-mechanical, for flexible hoses; hand-held flagpoles, not of metal; door fittings, not of metal; bed fittings, not of metal; furniture fittings, not of metal; window fittings, not of metal; hinges, not of metal; screens [furniture]; luggage lockers; filing cabinets; medicine cabinets; plate racks; meat safes; labels of plastic; lockers; drawers for furniture; chests for toys; tool chests, not of metal, empty; boxes of wood or plastic; letter boxes, not of metal or masonry; bottle racks.

21 – Indoor aquaria; wine aerators; buckets; cookie jars; candle jars [holders]; china ornaments; dishes; vegetable dishes; saucers; mugs; boxes for sweets; bottles; demijohns; busts of porcelain, ceramic, earthenware, terra-cotta or glass; vases; epergnes; fruit bowls; bird baths; baby baths, portable; plungers for clearing blocked drains; waffle irons, non-electric; ice buckets; mop wringer buckets; buckets made of woven fabrics; whisks, non-electric, for household purposes; cooking skewers of metal; towel rails and

rings; clothing stretchers; hair for brushes; funnels; carpet beaters [hand instruments]; signboards of porcelain or glass; candle extinguishers; flower pots; chamber pots; glue-pots; cruets; decanters; large-toothed combs for the hair; combs for animals; tea cosies; abrasive sponges for scrubbing the skin; make-up sponges; sponges for household purposes; toilet sponges; sponge holders; stands for portable baby baths; toothpick holders; soap holders; table napkin holders; holders for flowers and plants [flower arranging]; tea bag rests; shaving brush stands; toilet paper holders; toilet paper dispensers; soap dispensers; ironing boards; cutting boards for the kitchen; bread boards; washing boards; strainers for household purposes; smoke absorbers for household purposes; containers for household or kitchen use; kitchen containers; heat-insulated containers; heat-insulated containers for beverages; thermally insulated containers for food; glass flasks [containers]; closures for pot lids; chamois leather for cleaning; toothpicks; ceramics for household purposes; majolica; kitchen grinders, non-electric; cleaning instruments, hand-operated; cabarets [trays]; stew-pans; flower-pot covers, not of paper; shaving brushes; baking mats; ladles for serving wine; polishing leather; hot pots, not electrically heated; glass bulbs [receptacles]; napkin rings; poultry rings; rings for birds; coin banks; bread baskets for household purposes; baskets for household purposes; waste paper baskets; feeding troughs; mangers for animals; lunch boxes; tea caddies; washtubs; earthenware saucepans; cauldrons; coffee percolators, non-electric; coffeepots, non-electric; coffee grinders, hand-operated; beer mugs; tankards; rat traps; pot lids; aquarium hoods; butter-dish covers; dish covers; cheese-dish covers; buttonhooks; jugs; perfume burners; watering cans; insect traps; ice cream scoops; mixing spoons [kitchen utensils]; basting spoons [cooking utensils]; pie servers; spatulas for kitchen use; litter boxes for pets; butter dishes; material for brush-making; polishing materials for making shiny, except preparations, paper and stone; noodle machines, hand-operated; polishing apparatus and machines, for household purposes, non-electric; pepper mills, hand-operated; mills for household purposes, hand-operated; feather-dusters; brooms; isothermic bags; confectioners' decorating bags [pastry bags]; bowls [basins]; pet feeding bowls; mosaics of glass, not for building; saucepan scourers of metal; soap boxes; mouse traps; cooking pot sets; nozzles for watering cans; pouring spouts; wine pourers; nozzles for watering hose; fitted picnic baskets, including dishes; toilet cases; floss for dental purposes; fibreglass thread, other than for textile use; cookie [biscuit] cutters; pastry cutters; sprinklers; syringes for watering flowers and plants; egg yolk separators; cotton waste for cleaning; wool waste for cleaning; cleaning tow; cold packs for chilling food and beverages; chopsticks; cocktail stirrers; pepper pots; gloves for household purposes; polishing gloves; gardening gloves; pestles for kitchen use; droppers for

household purposes; wine-tasting pipettes; droppers for cosmetic purposes; plates to prevent milk boiling over; dripping pans; trays for household purposes; trays of paper, for household purposes; lazy susans; heaters for feeding bottles, non-electric; candelabra [candlesticks]; trivets [table utensils]; coasters, not of paper or textile; grill supports; menu card holders; knife rests for the table; flat-iron stands; egg cups; abrasive pads for kitchen purposes; scouring pads; drinking troughs; serving ladles; pottery; pots; cooking pots; painted glassware; tableware, other than knives, forks and spoons; porcelain ware; earthenware; crystal [glassware]; cosmetic utensils; toilet utensils; trouser presses; toothpaste tube squeezers; deodorizing apparatus for personal use; cruet sets for oil and vinegar; make-up removing appliances; spice sets; apparatus for wax-polishing, non-electric; glove stretchers; boot jacks; crumb trays; tie presses; clothes-pegs; glass stoppers; powder compacts, empty; perfume vaporizers; powder puffs; dusting apparatus, non-electric; combs; electric combs; grills [cooking utensils]; sifters [household utensils]; drinking horns; shoe horns; candle drip rings; salad bowls; sugar bowls; beaters, non-electric; egg separators, non-electric, for household purposes; services [dishes]; coffee services [tableware]; liqueur sets; tea services [tableware]; sieves [household utensils]; cinder sifters [household utensils]; tea strainers; siphon bottles for carbonated water; rolling pins, domestic; squeegees [cleaning instruments]; steel wool for cleaning; currycombs; blenders, non-electric, for household purposes; fruit presses, non-electric, for household purposes; straws for drinking; salt cellars; drinking vessels; vessels of metal for making ices and iced drinks; refrigerating bottles; cups of paper or plastic; glasses [receptacles]; drinking glasses; glass for vehicle windows [semi-finished product]; plate glass [raw material]; opal glass; glass, unworked or semi-worked, except building glass; opaline glass; glass incorporating fine electrical conductors; glass wool, other than for insulation; vitreous silica fibres, other than for textile use; fibreglass, other than for insulation or textile use; portable cool boxes, non-electric; soup bowls; drying racks for laundry; rotary washing lines; basins [receptacles]; table plates; disposable table plates; graters for kitchen use; insulating flasks; indoor terrariums [plant cultivation]; indoor terrariums [vivariums]; roller tubes for peeling garlic; cloth for washing floors; polishing cloths; cloths for cleaning; dusting cloths [rags]; furniture dusters; aerosol dispensers, not for medical purposes; wax-polishing appliances, non-electric, for shoes; water apparatus for cleaning teeth and gums; electric devices for attracting and killing insects; watering devices; utensils for household purposes; kitchen utensils; cooking utensils, non-electric; coffee filters, non-electric; flasks; hip flasks; drinking bottles for sports; boot trees; moulds [kitchen utensils]; egg poachers; cake moulds; ice cube moulds; cookery moulds; deep fryers, non-electric; comb cases; bread bins; fly swatters; tea-

pots; kettles, non-electric; cups; ironing board covers, shaped; tea infusers; mops; mop wringers; cocktail shakers; cosmetic spatulas; animal bristles [brushware]; brushes; dishwashing brushes; brushes for cleaning tanks and containers; lamp-glass brushes; horse brushes; scrubbing brushes; toothbrushes; toothbrushes, electric; basting brushes; carpet sweepers; shoe brushes; tar-brushes, long handled; toilet brushes; electric brushes, except parts of machines; eyebrow brushes; nail brushes; eyelash brushes; nutcrackers; ice tongs; salad tongs; sugar tongs; nest eggs, artificial; boxes for dispensing paper towels; dustbins; window-boxes; boxes of glass.

(260) AM 2022 116554 A

(800) 1642766

(151) 2021 12 13

(891) 2021 12 13

(731) Ningbo Kaabo Technology CO., LTD

4th Floor, No. 1 Building, 885 Chunhua Road,
Wangchun Industrial Park, Haishu District,
Ningbo, Zhejiang, China

(540)



(591) Black, white

(531) 26.13.25

(511)

12 – Tyres for vehicle wheels; pneumatic tyres; suspension shock absorbers for vehicles; bicycles; push scooters [vehicles]; electric bicycles; self-balancing scooters; self-balancing boards; moped; electric motorcycle.

(260) AM 2022 116555 A

(800) 1642769

(151) 2021 11 11

(891) 2021 11 11

(731) HOTEL OPCO S.r.l.

Piazza Eleonora Duse, 2, I-20122 MILANO,
Italy

(540)

BELSTAY

(591) Black, white

(511)

35 – Advertising, marketing and promotional services; business assistance, management and administrative services; consultancy services relating to the administration and management of hotels; business management advisory services relating to franchising;

advisory services (business -) relating to the operation of franchises; assistance in franchised commercial business management; business advertising services relating to franchising; business management of hotels; hotel management for others; business management of resort hotels.

39 – Escorting of travellers; arranging of excursions; services for the arranging of excursions for tourists; arranging and booking of excursions; motorcycle rental; rental of cycles; car rental; arranging of car hire; hired car transport; transportation logistics; travel and transport reservation services; tour organising.

43 – Providing hotel information via a website; accommodation bureau services [hotels, boarding houses]; hotel services; information relating to hotels; provision of hotel accommodation; hotel restaurant services; booking of hotel accommodation; resort hotel services; travel agency services for booking accommodation; hotels, hostels and boarding houses, holiday and tourist accommodation.

(260) AM 2022 116558 A

(800) 1642794

(151) 2021 09 28

(891) 2021 09 28

(731) S.C. LOOP PRODUCTIONS S.R.L.

Str. Ion Tuculescu, nr. 19, Sector 3, 031611

Bucuresti, Romania

(540)



(591) Black, white

(531) 01.03.02; 28.05

(511)

41 – Production of radio and television programs; production of shows; providing television programs, not downloadable, via video-on-demand services; providing online videos, not downloadable; television entertainment; entertainment services; entertainer services; presentation of variety shows; presentation of live performances.

(260) AM 2022 116559 A

(800) 1642795

(151) 2021 09 28

(891) 2021 09 28

(731) S.C. LOOP PRODUCTIONS S.R.L.

Str. Ion Tuculescu, nr. 19, Sector 3, 031611

Bucuresti, Romania

(540)

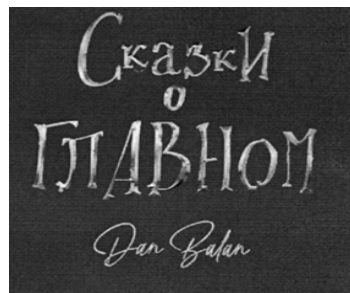

(591) Black, white

(531) 27.05.13; 28.05

(511)

16 – Paper and cardboard; printed matter; bookbinding material; photographs; stationery and office requisites, except furniture; adhesives for stationery or household purposes; drawing materials and materials for artists; paintbrushes; instructional and teaching materials; plastic sheets, films and bags for wrapping and packaging; printers' type, printing blocks.

41 – Production of radio and television programs; production of shows; providing television programs, not downloadable, via video-on-demand services; providing online videos, not downloadable; television entertainment; entertainment services; entertainer services; presentation of variety shows; presentation of live performances.

(260) AM 2022 116560 A

(800) 1642810

(151) 2021 12 08

(891) 2021 12 08

(731) Design Fishing Spółka z ograniczoną

Odpowiedzialnością

Szosa Szubińska 2, PL-86-005 Kruszyn

Krajeński, Poland

(540)



(591) Black, white

(531) 27.05.01

(511)

28 – Fishing tackle.

31 – Ground bait [live or natural]; foodstuffs for fish.

(260) AM 2022 116561 A

(800) 1642816

(151) 2021 12 10

(891) 2021 12 10

(731) Joint Stock Company "Azot-Vzryv"

ul. Mozhayskiy Val, d. 8, et. 11, pomeshch.

LXXXI, kom. 7, of. 15, mun. okrug,

Dorogomilovo vn. ter. g., RU-121151 Moscow,

Russian Federation

(540)

AVidet

(591) Black, white

(531) 27.05.01

(511)

13 – Explosives for industrial use; ammonium nitrate explosives for industrial use; primings [fuses] for industrial use; detonators for industrial use; detonating fuses for explosives for industrial use.

(260) AM 2022 116563 A

(800) 1642843

(151) 2021 12 15

(891) 2021 12 15

(731) CORDIER

1 rue de la Seiglière, F-33800 Bordeaux,
France

(540)

FOLIZ

(591) Black, white

(511)

33 – Wines and alcoholic beverages (excluding beers).

(260) AM 2022 116571 A

(800) 1642946

(151) 2021 12 17

(891) 2021 12 17

(731) Limited Liability Company "Consortium-PIQ"

Oruzheyniy pereulok, d. 25, str. 1, pomesch.
I/etazh 1/komnata 21, RU-125047 Moscow,
Russian Federation

(540)

КОВАЗИС

(591) Black, white

(531) 28.05

(511)

5 – Preparations for destroying vermin; herbicides.

(260) AM 2022 116574 A

(800) 1642996

(151) 2021 12 17

(891) 2021 12 17

(731) Obschestvo s ogranichennoi otvetstvennost'yu

"Laboratoriya sovremennogo zdorovya"
ul. Khimzavodskaya, 11/20, Berdsk,
RU-633004 Novosibirskaya oblast', Russian
Federation

(540)

DAILY BOX

(591) Black, white

(511)

5 – Acai powder dietary supplements; acne treatment preparations; adhesive bands for medical purposes; adhesive plasters; air deodorising preparations; air purifying preparations; albumin dietary supplements; albuminous foodstuffs for medical purposes; albuminous preparations for medical purposes; alginate dietary supplements; almond milk for pharmaceutical purposes; aloe vera preparations for pharmaceutical purposes; amino acids for medical purposes; anaesthetics; analgesics; antibacterial handwashes; antibacterial soap; antioxidant pills; antiseptic cotton; antiseptics; anti-uric preparations; appetite suppressant pills; appetite suppressants for medical purposes; asthmatic tea; babies' nappies; balms for medical purposes; barks for pharmaceutical purposes; bath salts for medical purposes; biological preparations for medical purposes; cachets for pharmaceutical purposes; capsules for medicines; casein dietary supplements; chemico-pharmaceutical preparations; chewing gum for medical purposes; chilblain preparations; cod liver oil; collagen for medical purposes; collyrium; contact lens cleaning preparations; corn remedies; decoctions for pharmaceutical purposes; deodorants for clothing and textiles; deodorants, other than for human beings or for animals; depuratives; dietary fiber; dietary supplements for animals; dietary supplements with a cosmetic effect; dietetic beverages adapted for medical purposes; dietetic foods adapted for medical purposes; dietetic substances adapted for medical use; digestives for pharmaceutical purposes; disinfectant soap; disinfectants for hygiene purposes; dressings, medical; drugs for medical purposes; elixirs [pharmaceutical preparations]; enzyme dietary supplements; enzyme preparations for medical purposes; eucalyptus for pharmaceutical purposes; febrifuges; ferments for pharmaceutical purposes; first-aid boxes, filled; flour for pharmaceutical purposes; food for babies; frostbite salve for pharmaceutical purposes; fumigation preparations for medical purposes; gauze for dressings; gelatine for medical purposes; glucose dietary supplements; glucose for medical purposes; hematogen; hemostatic pencils; herbal teas for medicinal purposes; homogenised food adapted for medical purposes; immunostimulants; infant formula; lacteal flour for babies; lactose for pharmaceutical purposes; laxatives; lecithin dietary supplements; liniments; linseed dietary supplements; linseed for pharmaceutical purposes; linseed oil dietary supplements; lotions for pharmaceutical purposes; lyophilised food adapted for medical purposes; magnesia for pharmaceutical purposes; medical preparations for slimming purposes; medicated after-shave lotions; medicated candies; medicated dry shampoos; medicated eye-washes; medicated hair lotions; medicated shampoos; medicated soap; medicated toiletry preparations; medicated toothpaste; medicinal drinks; medicinal hair growth preparations; medicinal herbs; medicinal infusions; medicinal mud; medicinal oils; medicinal roots; medicinal tea; medici-

ne cases, portable, filled; medicines for alleviating constipation; medicines for human purposes; milk ferments for pharmaceutical purposes; mineral food supplements; mineral waters for medical purposes; mouthwashes for medical purposes; mud for baths; mustard plasters; nervines; nutraceutical preparations for therapeutic or medical purposes; nutritional supplements; ointments for pharmaceutical purposes; organotherapy preparations; panty liners [sanitary]; pastilles for pharmaceutical purposes; pearl powder for medical purposes; personal sexual lubricants; petroleum jelly for medical purposes; pharmaceutical preparations for skin care; pharmaceutical preparations for treating dandruff; pharmaceutical preparations for treating sunburn; pharmaceutical preparations; pharmaceuticals; phytotherapy preparations for medical purposes; plant extracts for pharmaceutical purposes; pollen dietary supplements; pomades for medical purposes; poultices; powdered milk for babies; preparations for the treatment of burns; preparations of trace elements for human and animal use; propolis dietary supplements; propolis for pharmaceutical purposes; protein dietary supplements; protein supplements for animals; purgatives; remedies for perspiration; royal jelly dietary supplements; royal jelly for pharmaceutical purposes; salts for medical purposes; salts for mineral water baths; sanitary napkins; seawater for medicinal bathing; sedatives; tranquillizers; serums; sexual stimulant gels; slimming pills; solutions for contact lenses; styptic preparations; sugar for medical purposes; sunburn ointments; suppositories; syrups for pharmaceutical purposes; tanning pills; therapeutic preparations for the bath; thermal water; tissues impregnated with pharmaceutical lotions; tonics [medicines]; vitamin preparations; vitamin supplement patches; wadding for medical purposes; wheat germ dietary supplements; yeast dietary supplements; yeast for pharmaceutical purposes.

(260) AM 2022 116580 A

(800) 1643235

(151) 2021 11 25

(891) 2021 11 25

(731) Schweizerische Eidgenossenschaft v.d.

Bundesamt für Rüstung armasuisse

Eidgenössisches Departement für Verteidigung,

Bevölkerungsschutz und Sport, Guisanplatz 1,

CH-3003 Bern, Switzerland

(540)

SWISS AIR FORCE

(591) Black, white

(511)

3 – Cosmetics and toiletries; skin care preparations; sunscreen preparations; shampoos and conditioners for pets (nonmedicated grooming preparations, other than for veterinary use); deodorants for pets; all the aforesaid goods of Swiss origin.

9 – Binoculars; safety helmets; cell and battery chargers; external batteries; batteries (cells); electric cells (batteries); accumulator boxes; dry cells; electric cells and batteries; anode batteries; batteries for mobile telephones; fuel cells; solar batteries; cases for mobile telephones; leather cases for portable telephones; bags for laptop computers; transport cases for tablet computers; electric sockets; USB flash drives; plug connectors; jack cables; converters for electric plugs; holders for mobile telephones; all the aforesaid goods of Swiss origin.

18 – Key cases; cases for toiletries; business card cases; collars, leashes and clothing for animals; bags for carrying animals; clothing for pets; electronic pet collars; all the aforesaid goods of Swiss origin.

20 – Beds and cots for indoor animals; portable beds for pets; pet cushions; transport boxes for pets; game houses for pets; nesting boxes for household pets; kennels for household pets; pet grooming tables; all the aforesaid goods of Swiss origin.

21 – Drinking bottles for sports (of plastic materials or of metal); drinking bottles for sporting activities; non-electric kettles; glassware, porcelain and earthenware; cups; heat-insulated containers; feeding bowls for pets; animal grooming gloves; cages for household pets; all the aforesaid goods of Swiss origin.

24 – Blankets for outdoor use, picnic blankets; bed covers, lap robes, bed blankets, duvets of textile materials; bed throws, terry-cloth bedspreads; tablecloths of textile; felt and nonwoven textile fabrics; woolen cloths; cotton fabrics; bed throws; blankets for household pets; all the aforesaid goods of Swiss origin

30 – Chocolate, chocolate bars, chocolate-based beverages; cereal bars; muesli bars; all the aforesaid goods of Swiss origin.

(260) AM 2022 116586 A

(800) 1643466

(151) 2021 08 19

(891) 2021 08 19

(731) Limited Liability Company "NATURPRO"

Shevchenko str. 10 B, of. 3, Dnipro 49044,

Ukraine

(540)



(591) Black, white

(531) 26.04.05; 26.04.24; 26.11.09; 26.11.11;
27.05.01

(511)

3 – Abrasives; sandcloth; glass cloth [abrasive cloth]; abrasive paper; breath freshening sprays; diamantine [abrasive]; alum stones [astringents]; amber [perfume]; ammonia [volatile alkali] [detergent]; antiperspirants [toiletries]; antistatic preparations for household purposes; flavourings for beverages [essential oils]; cake flavourings [essential oils]; food flavourings [essential oils]; joss sticks; aromatics [essential oils]; potpourris [fragrances]; balms, other than for medical purposes; basma [cosmetic dye]; bergamot oil; whitening; lip glosses; nail glitter; body glitter; badian essence; vaginal washes for personal sanitary or deodorant purposes; petroleum jelly for cosmetic purposes; cotton wool for cosmetic purposes; cotton wool impregnated with make-up removing preparations; cotton swabs for cosmetic purposes; bleaching soda; laundry bleach; bleaching preparations [decolorants] for cosmetic purposes; bleaching preparations [decolorants] for household purposes; bleaching salts; decorative transfers for cosmetic purposes; shoe wax; moustache wax; depilatory wax; wax for parquet floors; floor wax; waxes for leather; volcanic ash for cleaning; astringents for cosmetic purposes; cloths impregnated with a detergent for cleaning; gaultheria oil; dental bleaching gels; heliotropine; geraniol; sharpening preparations; make-up; lipsticks; deodorants for pets; deodorants for human beings or for animals; scented wood; detergents, other than for use in manufacturing operations and for medical purposes; scented water; extracts of flowers [perfumes]; herbal extracts for cosmetic purposes; ethereal essences; essential oils; essential oils of cedarwood; essential oils of lemon; essential oils of citron; Javelle water; jasmine oil; greases for cosmetic purposes; colorants for toilet purposes; colorants for toilet purposes; leather preservatives [polishes]; colour-removing preparations; degreasers, other than for use in manufacturing processes; ionone [perfumery]; shaving stones [astringents]; silicon carbide [abrasive]; carbides of metal [abrasives]; adhesives for affixing false eyelashes; adhesives for affixing false hair; adhesives for cosmetic purposes; collagen preparations for cosmetic purposes; hair conditioners; quillia bark for washing; corundum [abrasive]; cosmetics; eyebrow cosmetics; cosmetics for children; cosmetics for animals, beauty masks; cosmetic preparations for baths; cosmetic preparations for eyelashes; cosmetic preparations for skin care; cosmetic preparations for slimming purposes; tailors' wax; shoe cream; skin whitening creams; creams for leather; polishing creams; cosmetic creams; jewellers' rouge; starch glaze for laundry purposes; starch for laundry purposes; lavender water; lavender oil; incense; hair spray; nail varnish; hair lotions; lotions for cosmetic purposes; after-shave lotions; massage gels, other than for medical purposes; massage candles for cosmetic purposes; non-slipping wax for floors; almond oil; almond milk for cosmetic purposes; washing soda, for cleaning; deodorant soap; shaving soap; soap for brightening te-

xtile; cakes of soap; cakes of toilet soap; almond soap; antiperspirant soap; soap for foot perspiration; soap; micellar water; musk [perfumery]; mint for perfumery; mint essence [essential oil]; cosmetic kits; emery; emery cloth; emery paper; nail art stickers; neutralizers for permanent waving; fumigation preparations [perfumes], eau de Cologne; eyebrow pencils; cosmetic pencils; oils for toilet purposes; oils for perfumes and scents; oils for cosmetic purposes; oils for cleaning purposes; oil of turpentine for degreasing; mouthwashes, not for medical purposes; bases for flower perfumes; drying agents for dishwashing machines; cleansing milk for toilet purposes, starch glaze for laundry purposes; scouring solutions; perfumery; pastes for razor strops; toothpaste; gel eye patches for cosmetic purposes; pumice stone; hydrogen peroxide for cosmetic purposes; polishing wax; polishing paper; polishing rouge; polishing stones; polishing preparations; polish for furniture and flooring; pomades for cosmetic purposes; fabric softeners for laundry use; laundry blueing; laundry preparations; air fragrancing preparations; bath preparations, not for medical purposes; leather bleaching preparations; floor wax removers [scouring preparations]; rust removing preparations; varnish-removing preparations; paint stripping preparations; descaling preparations for household purposes; stain removers; lacquer-removing preparations; hair straightening preparations; shaving preparations; depilatory preparations; nail care preparations, hair waving preparations; laundry soaking preparations; sun-tanning preparations [cosmetics]; make-up removing preparations; make-up preparations; shining preparations [polish]; laundry glaze, preparations to make the leaves of plants shiny; breath freshening preparations for personal hygiene; shoe polish; denture polishes; preparations for unblocking drain pipes; smoothing preparations [starching]; dry-cleaning preparations; dentifrices; preparations for cleaning dentures; wallpaper cleaning preparations; aloe vera preparations for cosmetic purposes; toiletry preparations; air fragrance reed diffusers, make-up powder; nail varnish removers; windscreen cleaning liquids; non-slipping liquids for floors; eye-washes, not for medical purposes; safrol; sachets for perfuming linen; baby wipes impregnated with cleaning preparations; antistatic dryer sheets; tissues impregnated with cosmetic lotions; tissues impregnated with make-up removing preparations; colour run prevention laundry sheets; turpentine for degreasing; teeth whitening strips; breath freshening strips; soda lye; bath salts, not for medical purposes; sunscreen preparations; douching preparations for personal sanitary or deodorant purposes [toiletries]; canned pressurized air for cleaning and dusting purposes; double eyelid tapes; talcum powder, for toilet use; terpenes [essential oils]; tripoli stone for polishing; rose oil; toilet water; mascara; beard dyes; hair dyes; liquid latex body paint for cosmetic purposes; body paint for cosmetic purposes, cosmetic dyes; phytocosmetic prepara-

tions; lipstick cases, colour-brightening chemicals for household purposes [laundry]; henna [cosmetic dye]; cleaning chalk; cleaning preparations; chemical cleaning preparations for household purposes; shampoos for pets [non-medicated grooming preparations]; shampoos for animals [non-medicated grooming preparations]; dry shampoos; shampoos; cobblers' wax; shoemakers' wax; sandpaper; abrasive cloth, smoothing stones; grinding preparations; false eyelashes; false nails.

35 – Wholesale services for non-medical cosmetics and non-medical perfumery and cosmetics, non-therapeutic drugs for brushing teeth, perfumery, essential oils, bleaching preparations and detergents; retail services for non-medicated cosmetics and non-medicated perfumes and cosmetics, non-therapeutic drugs for brushing teeth, perfumery, essential oils; search engine optimization for sales promotion; presentation of goods on communication media, for retail purposes.

(260) AM 2022 116591 A

(800) 1643530

(151) 2021 11 05

(891) 2021 11 05

(731) HANGZHOU TUYA INFORMATION TECHNOLOGY CO., LTD.

Room 701, Building 3, More Center, No.87
Gudun Road, Xihu District, Hangzhou City,
Zhejiang, China

(540)



(591) Tangerine and orange

(531) 26.04.04; 26.04.07; 26.04.09; 26.11.22;

27.05.09; 27.05.24; 29.01.14

(511)

7 – Agricultural machines; aerating pumps for aquaria; disintegrators; milking machines; hair cutting machines for animals; saws [machines]; papermaking machines; machines for the manufacture of paper diapers; printing presses; machines for the textile industry; sizing machines; tea manufacturing machines; agitators; brewing machines; cigarette machines for industrial purposes; leather-working machines; sewing machines; bicycle assembling machines; potters' wheels; engraving machines; batteries machinery; cord making machines; enamel making machinery; light bulb making machines; wrapping machines; honeycomb-shaped briquette making machines; washing machines [laundry]; mills [machines]; machines for

processing plastics; glass-working machines; fertilizer manufacturing machines; electromechanical machines for chemical industry; rinsing machines; cutters [machines]; drilling rigs, floating or non-floating; road rollers; conveyors [machines]; metalworking machines; foundry machines; steam engines; igniting devices for internal combustion engines; hydraulic turbines; paper clip making machines; zipper making machines; industrial robots; electric wire and cable manufacturing machines; hand-held tools, other than hand-operated; machines for the electronic industry; optical cold working machines; gas separating installations; spray paint machines; dynamos; driving motors, other than for land vehicles; pumps [machines]; hydraulic controls for machines, motors and engines; compressors [machines]; hydraulic couplers; window openers, electric; bearings [parts of machines]; belts for conveyors; welding machines, electric; machines and apparatus for cleaning, electric; filter presses; curtain drawing devices, electrically operated; drums [parts of machines]; 3D printers; shoe polishers, electric; racket stringing machines; automatic vending machines; robotic exoskeleton suits, other than for medical purposes; liquid tanks [parts of machines].

9 – Internet servers; humanoid robots with artificial intelligence; computer software applications, downloadable; digital voice signal processors; smart cards [integrated circuit cards]; smartwatches [data processing apparatus]; smartglasses [data processing apparatus]; computer software, recorded; couplers [data processing equipment]; pedometers; apparatus to check stamping mail; money counting and sorting machines; automatic ticket dispensers; voting machines; face recognition apparatus; punched card machines for offices; measures; signal lanterns; wireless routers; network communication devices; security surveillance robots; webcams; television apparatus; digital photo frames; headsets; digital projectors; multimedia projectors; cameras [photography]; meters; air analysis apparatus; kilometer recorders for vehicles; food analysis apparatus; calorimeters; chemistry apparatus and instruments; inductors [electricity]; electricity meters; probes for scientific purposes; optical apparatus and instruments; wires, electric; semi-conductors; micro-controllers; integrated circuits; coils, electric; switches, electric; fuses; circuit breakers; infrared sensors; climate control digital thermostats; alarm sensors; distribution consoles [electricity]; light dimmers; LED drivers; lighting control apparatus; video screens; optical fibers; automation installations for power stations; lightning conductors; electrolyzers; fire extinguishing apparatus; X-ray apparatus not for medical purposes; protection devices for personal use against accidents; alarms; digital door locks; anti-theft warning apparatus; eyeglasses; batteries, electric, for vehicles; X-ray photographs, other than for medical purposes; egg-candlers; electrified fences; electronic collars to train animals; sports whistles; decorative magnets; weighing apparatus and instruments.

11 – Lighting fixtures; lamps; lights for vehicles; germicidal lamps for purifying air; curling lamps; oil lamps; air fryers; electric cooking pots; electric cookers; lava rocks for use in barbecue grills; refrigerating appliances and installations; air conditioners; fans [air-conditioning]; humidifiers; dehumidifiers for household purposes; air purifiers; ventilation [air-conditioning] installations and apparatus; hair dryers; heat accumulators; fog machines; heating installations; watering installations, automatic; heaters for baths; toilets [water-closets]; disinfectant apparatus; pocket warmers; radiators, electric; lighters; installations for processing nuclear fuel and nuclear moderating material.

21 – Kitchen utensils; utensils for household purposes; glass flasks [containers]; ceramics for household purposes; china ornaments; drinking vessels; clothes drying racks; drying racks for laundry; aromatic oil diffusers, other than reed diffusers, electric and non-electric; combs; brushes; material for brush-making; toothbrushes; toothpicks; cosmetic utensils; thermally insulated containers for food; cleaning instruments, hand-operated; crystal [glassware]; animal activated animal feeders; cat litter boxes; pet feeding bowls; indoor terrariums [plant cultivation]; insect traps.

28 – Games; apparatus for games; swings; toys; toy robots; scooters [toys]; draughts [games]; playing balls; body-training apparatus; archery implements; machines for physical exercises; hunting game calls; swimming pools [play articles]; protective paddings [parts of sports suits]; roller skates; Christmas trees of synthetic material; fishing tackle; twirling batons; camouflage screens for hunting purposes; scratch cards for playing lottery games; grip tapes for sports.

(260) AM 2022 116594 A
(800) 1643655
(151) 2021 12 15
(891) 2021 12 15
(731) Amusnet Interactive Ltd.

Garitage Park, Building No. 4, Floor 2, 2 Donka Ushlinova Str., BG-1766 Sofia, Bulgaria

(540)

40 POWER HOT

(591) White, orange, yellow and gold
(531) 25.12.03; 27.05.02; 27.07.02; 29.01.14
(511)

9 – Computer software for the administration of on-line games and gaming; computer application software featuring games and gaming; betting software; gaming software that generates or displays wager outcomes of gaming machines.

28 – Slot machines [gaming machines]; gaming machines for gambling.

41 – Providing of casino and gaming facilities; betting services.

(260) AM 2022 116595 A
(800) 1643656
(151) 2021 12 15
(891) 2021 12 15
(731) Amusnet Interactive Ltd.

Garitage Park, Building No. 4, Floor 2 2 Donka Ushlinova Str. BG-1766 Sofia, Bulgaria

(540)

POWER HOT

(591) White, orange, yellow and gold
(531) 25.12.03; 27.05.02; 29.01.14
(511)

9 – Computer software for the administration of on-line games and gaming; computer application software featuring games and gaming; betting software; gaming software that generates or displays wager outcomes of gaming machines.

28 – Slot machines [gaming machines]; gaming machines for gambling.

41 – Providing of casino and gaming facilities; betting services.

(260) AM 2022 116597 A
(800) 1643773
(151) 2021 12 15
(891) 2021 12 15
(731) Amusnet Interactive Ltd.

Garitage Park, Building No. 4, Floor 2 2 Donka Ushlinova Str. BG-1766 Sofia, Bulgaria

(540)

SHINING MINE

(591) Black, brown, green, yellow, gold and grey
(531) 07.15.08; 27.05.25; 29.01.15
(511)

9 – Computer software for the administration of on-line games and gaming; computer application software featuring games and gaming; betting software; gaming software that generates or displays wager outcomes of gaming machines.

28 – Slot machines [gaming machines]; gaming machines for gambling.

41 – Providing of casino and gaming facilities; betting services.

(260) AM 2022 116615 A

(800) 1519518

(151) 2020 01 27

(891) 2022 01 26

(731) Nunhems B.V.

Napoleonsweg 152, NL-6083 AB Nunhem,
Netherlands

(540)



(591) Black, white

(531) 05.03.13; 05.03.15; 27.05.17

(511)

29 – Preserved, dried, cooked and frozen vegetables and fruits; jellies, jams, compotes.

31 – Agricultural, horticultural and forestry products and grains not included in other classes; seedlings and seeds; fresh fruits and vegetables; fresh herbs; natural plants and flowers; living plants and associated genetic material, such as propagation materials, plant cuttings, young living plants and plant tissue cultures for agricultural and horticultural purposes.

44 – Agricultural and horticultural services; advice and consultancy related to the cultivation of propagation material, such as plant cuttings, young living plants and plant tissue cultures for agricultural and horticultural purposes; plant breeding and selection.

(260) AM 2022 116616 A

(800) 1525004

(151) 2019 11 11

(891) 2021 12 06

(731) SAMSUN SEGMAN VE GÖMLEK SANAYİ
TİCARET LİMİTED ŞİRKETİ

Şabanolu O.S.B. Mahallesi, Kızılırmak
Caddesi, No:3, Merkez Köyü / Merkez Bucağı
Tekkeköy -, Samsun, Türkiye

(540)



(591) Blue and red

(531) 27.05.11; 29.01.12

(526) PISTON RINGS

(511)

7 – Machines, machine tools and industrial robots for processing and shaping wood, metals, glass, plastics and minerals, 3D printers; construction machines and robotic mechanisms (machines) for use in construction, bulldozers, diggers (machines), excavators, road construction and road paving machines, drilling ma-

chines, rock drilling machines, road sweeping machines; lifting, loading and transmission machines and robotic mechanisms (machines) for lifting, loading and transmission purposes; elevators, escalators and cranes; machines and robotic mechanisms (machines) for use in agriculture and animal breeding, machines and robotic mechanisms (machines) for processing cereals, fruits, vegetables and food; beverage preparation machines, electromechanical; beverage processing machines; engines and motors, other than for land vehicles, parts and fittings therefor, hydraulic and pneumatic controls for engines and motors, brakes other than for vehicles, brake linings for engines, crankshafts, transmission gears for machines, cylinders for engines, pistons for engines, turbines, not for land vehicles, filters for engines and motors, oil, air and fuel filters for land vehicle engines, exhausts for land vehicle engines, exhaust manifolds for land vehicle engines, engine cylinders for land vehicles, engine cylinder heads for land vehicles, pistons for land vehicle engines, carburetors for land vehicles, fuel conversion apparatus for land vehicle engines, injectors for land vehicle engines, fuel economisers for land vehicle engines, pumps for land vehicle engines, valves for land vehicle engines, starters for motors and engines, dynamos for land vehicle engines, sparking plugs for land vehicle engines; bearings (parts of machines), roller or ball bearings; machines for mounting and detaching tires; alternators, current generators, electric generators, current generators operated with solar energy; painting machines, automatic spray guns for paint, electric, hydraulic and pneumatic punching machines and guns, electric adhesive tape dispensers (machines), electric guns for compressed gas or liquid spraying machines, electric hand drills, electric hand saws, electric jigsaw machines, spiral machines, compressed air machines, compressors (machines), vehicle washing installations, robotic mechanisms (machines) with the abovementioned functions; electric and gas-operated welding apparatus, electric arc welding apparatus, electric soldering apparatus, electric arc cutting apparatus, electrodes for welding machines, industrial robots (machines) with the abovementioned functions; printing machines; packaging machines, filling, plugging and sealing machines, labellers (machines), sorting machines, industrial robots (machines) with the abovementioned functions, electric packing machines for plugging and sealing of plastics; machines for textile processing, sewing machines, industrial robots (machines) with the abovementioned functions; pumps [machines], self-regulating fuel pumps; electric kitchen machines for chopping, grinding, crushing, mixing and mincing foodstuff, washing machines, laundry washing machines, dishwashers, spin driers (not heated), electric cleaning machines for cleaning floors, carpets or floorings, vacuum cleaners and parts thereof; automatic vending machines; galvanizing and electroplating machines; electric door openers and closers; joints (parts of engines);

piston rings; piston rings being engine parts; marine engines and parts and fittings therefor; generators for land vehicles; air compressors for vehicles; compressors as parts of machines, motors and engines.

12 – Motor land vehicles, motorcycles, mopeds; engines and motors for land vehicles; clutches for land vehicles; transmissions, transmission belts and transmission chains for land vehicles; gearing for land vehicles; brakes, brake discs and brake linings for land vehicles; vehicle chassis, automobile bonnets, vehicle suspension springs, shock absorbers for automobiles, gearboxes for land vehicles, steering wheels for vehicles, rims for vehicle wheels; bicycles and their bodies; handlebars and mudguards for bicycles; vehicle bodies; tipping bodies for trucks; trailers for tractors; frigorific bodies for land vehicles; trailer hitches for vehicles; vehicle seats; head-rests for vehicle seats; safety seats for children, for vehicles; seat covers for vehicles; vehicle covers (shaped); sun-blinds adapted for vehicles; direction signals and arms for direction signals for vehicles; windscreen wipers and wiper arms for vehicles; inner and outer tires for vehicle wheels; tubeless tires; tire-fixing sets comprised of tire patches and tire valves for vehicles; windows for vehicles, safety windows for vehicles, rearview mirrors and wing mirrors for vehicles; anti-skid chains for vehicles; luggage carriers for vehicles; bicycle and ski carriers for cars; saddles for bicycles or motorcycles; air pumps for vehicles, for inflating tires; anti-theft alarms for vehicles, horns for vehicles; safety belts for vehicle seats, air bags (safety devices for automobiles); baby carriages, wheelchairs, pushchairs; wheelbarrows; shopping carts; single or multi-wheeled wheelbarrows; shopping trolleys; grocery carts; handling carts; rail vehicles; locomotives; trains; trams; waggon; cable cars; chairlifts; vehicles for locomotion by water and their parts, other than their motors and engines; vehicles for locomotion by air and their parts, other than their motors and engines; brakes for vehicles.

(260) AM 2022 116617 A
(800) 1576513
(151) 2020 10 13
(891) 2022 01 11
(731) Sarepta Therapeutics, Inc.
215 First Street, Cambridge MA 02142, USA
(540)

ELEVIDYS

(591) Black, white
(511)
5 – Pharmaceutical preparations for the treatment of neuromuscular diseases and disorders, muscular dystrophies, central nervous system diseases and disorders, genetic diseases and disorders; pharmaceutical preparations based on morpholino oligomer technology platform for the treatment of neuromuscular disea-

ses and disorders, muscular dystrophies, central nervous system diseases and disorders, genetic diseases and disorders, and for the regulation of protein production; pharmaceutical preparations that modulate rna expression for the treatment of neuromuscular diseases and disorders, muscular dystrophies, central nervous system diseases and disorders, genetic diseases and disorders, and for the regulation of protein production; gene therapy products, namely, gene delivery pharmaceuticals; pharmaceutical preparations for gene therapy, gene editing, and genome editing; gene therapy products for the treatment of neuromuscular diseases and disorders, muscular dystrophies, central nervous system diseases and disorders, genetic diseases and disorders; biological preparations for the treatment of neuromuscular diseases and disorders, muscular dystrophies, central nervous system diseases and disorders, genetic diseases and disorders; viruses, viral vectors and viral constructs, all of the foregoing used as delivery agents, for the treatment of neuromuscular diseases and disorders, muscular dystrophies, central nervous system diseases and disorders, genetic diseases and disorders; pharmaceutical preparations, biological preparations and gene therapy products in the nature of pharmaceutical and biological preparations for the treatment of genetic disorders and diseases.

(260) AM 2022 116618 A
(800) 1585178
(151) 2021 02 24
(891) 2022 01 13
(731) Accriva Diagnostics, Inc.
6260 Sequence Drive, San Diego CA 92121, USA
(540)

HEMOCHRON

(591) Black, white
(511)
9 – Blood coagulation and other chemical and physical reaction analyzers.

(260) AM 2022 116674 A
(800) 1644445
(151) 2021 05 31
(891) 2021 05 31
(731) Maximilien Lejeune
Rue Paul Wemaere 20, B-1150 Bruxelles, Belgium
(540)



(591) Blue and yellow

(531) 01.01.02; 01.01.10; 27.05.01; 27.05.09;
29.01.12

(511)

16 – Travel guides.

39 – Organized trips; travel planning; travel organization; travel agencies; travel services; transport of travelers; travel reservations; air travel services; organization of travel tours; air transport of travelers; booking of tickets for travel; travel guide services; ticket services for travel; land transport of travelers; road transport of travelers; railway transport of travelers; booking of seats for travel; travel booking agencies; organizing of coach trips; arranging of air travel; organization of business travels; travel organization services; travel information; issuing of travel tickets; travel planning services; travel agency services for arranging travel; organizing of holiday travels; issuing of travel tickets; transport and passenger services; travel reservation services; reservation of berths for travel; transport of travelers by car; organization of escorting services for travelers; tourist trip booking services; travel agency services for business travel organization; travel agency services for arranging holiday travels; travel reservation services; travel information services; agents for travel organization; arranging of travel and cruises; air travel booking services; organization of foreign travel; chartering of vehicles for travel; computerized travel reservation services; booking of seats for travel; tourist information services concerning travel; reservation services for travel by sea; airplane travel reservation services; reservation services for travel by airplane; computerized information services relating to travels; computerized information services relating to travel; reservation services for holiday travel; reservation of seats for travelers; rental of travel ticket issuing machines; travel information and guide services; information services relating to travel routes; reservation services for travel by land; agency services for travel reservation; computer information services concerning travel; travel organized as all-inclusive stays; agency services for arranging travel; reservation services for travel and transport; advisory services relating to travel routes; coordination of travel preparations for individuals and groups; travel reservation services provided by an agency; packaging services for baggage protection during travel; organization of sightseeing tours, excursions, trips and cruises; travel agency services, particularly ticket reservations; travel, sightseeing and excursion organization services; organization and conducting of excursions, sightseeing tours and travel; timetable inquiry services in the framework of travel; escorting non-accompanied minors in the context of travel; agency services for arranging the transportation of travellers' luggage; preparation of visas, passports and travel documents for persons traveling abroad; organization of transfer to and from hotels.

43 – Hotel reservation; hotel reservations; accommodation agencies [hotels, boarding houses]; information relating to hotels; hotel reservation services; information services regarding hotels; hotels, hostels and boarding houses, tourist and holiday accommodation; tourist hotels; travel agency services for hotel reservations.

(260) AM 2022 116675 A

(800) 1644450

(151) 2021 02 07

(891) 2021 02 07

(731) FM World Sp. z o.o.

ul. Żmigrodzka 247, PL-51-129 Wrocław,

Poland

(540)



(591) Black, white

(531) 26.04.01; 26.04.07; 26.04.18; 27.05.22

(511)

3 – Bleaching preparations; laundry detergent; laundry additives; cleaning preparations; polishing preparations; scouring substances; abrasive preparations; soap; perfumery and fragrances; essential oils; cosmetics; hair care lotions; dentifrice; cotton balls for cosmetic purposes; make-up pads of cotton wool.

5 – Pharmaceuticals; veterinary preparations; dietetic substances adapted for medical use; bactericides; salts for mineral water baths; air deodorising preparations; swabs for medical use.

21 – Household or kitchen utensils; kitchen containers; household containers; combs; sponges; make-up brushes; brushes; material for brush-making; cleaning articles; glassware not included in other classes; porcelain ware; ceramics for household purposes; earthenware not included in other classes; works of art made of earthenware; cosmetic utensils; powder compacts [cases]; powder compacts; eyebrow brushes; eyelash combs; mascara brushes; nail brushes; applicators for cosmetics; perfume vaporizers; toilet cases; flasks; make-up removing appliances; comb cases; gloves for household purposes.

28 – Games; toys; gymnastic and sporting articles; decorations for Christmas trees.

30 – Coffee; tea; cocoa; sugar; rice; tapioca; sago; artificial coffee; flour; preparations made from cereals; bread; confectionery; sweetmeats [candy]; ice cream; honey; treacle; yeast; baking powder; salt;

mustard; vinegar; sauces [condiments]; condiments; ice.

(260) AM 2022 116676 A

(800) 1644453

(151) 2021 10 26

(891) 2021 10 26

(731) Ursapharm Arzneimittel GmbH

Industriestr. 35, 66129 Saarbrücken, Germany

(540)

HYLO

(591) Black, white

(511)

5 – Pharmaceuticals; medical preparations; veterinary preparations; sanitary preparations for medical purposes; foodstuffs and dietetic substances for medical or veterinary purposes; food for babies; dietary supplements for human beings and animals; plasters, materials for dressings; dressings, medical; material for stopping teeth, dental wax; disinfectants; preparations for destroying noxious animals; fungicides; herbicides; contact lens wetting solutions; medicated creams; pharmaceutical creams; ophthalmological ointments; eye drops; ophthalmologic preparations.

10 – Surgical, medical, dental and veterinary apparatus and instruments; artificial limbs, eyes and teeth; orthopedic articles; suture materials; therapeutic and assistive devices adapted for persons with disabilities; massage apparatus; apparatus, devices and articles for nursing infants; sexual activity apparatus, devices and articles; containers with dosing devices for dispensing pharmaceutical products; medical instruments; chemically activated hot compresses for medical use; chemically activated hot gel packs for medical use; warmers for medical use.

(260) AM 2022 116687 A

(800) 1644561

(151) 2021 12 01

(891) 2021 12 01

(731) SELO Medical GmbH

Moosham 29, A-5585 Unternberg, Austria

(540)

SELO FEMIN

(591) Black, white

(511)

3 – Cosmetic products (cosmetics).

5 – Medical preparations; nutritional supplements; dietetic foods adapted for medical purposes.

(260) AM 2022 116688 A

(800) 1644572

(151) 2021 12 15

(891) 2021 12 15

(731) Janssen Pharmaceutica NV

Turnhoutseweg 30, B-2340 Beerse, Belgium

(540)



(591) Various shades of blue

(531) 26.05.03; 26.05.04; 26.05.08; 26.15.11; 29.01.11

(511)

5 – Vaccines.

44 – Providing information in the field of vaccines.

(260) AM 2022 116707 A

(800) 1645337

(151) 2021 12 09

(891) 2021 12 09

(731) China State Construction Engineering Corporation Ltd.

No. 15 Sanlihe Road, Haidian District, Beijing, China

(540)



(591) Black, white

(531) 26.04.24; 27.05.10; 27.05.24

(511)

37 – Construction engineering services [construction supervision]; building construction supervision; construction project management services [construction supervision]; construction information; construction consultancy; repair information; installation of doors and windows; warehouse construction and repair; demolition of buildings; scaffolding; laying of cable; plastering; construction of steel structures; harbour construction; factory construction; pipeline construction and maintenance; concrete raising services; construction; renovation and restoration of buildings; rental of construction machines and apparatus; rental of construction equipment; building construction service; building damp-proofing; damp-proofing [building];

building insulating; building reinforcing; building construction; building caulking services; building maintenance and repair; repair of buildings; rental of cranes [construction equipment]; pier breakwater building; riveting; asphaltting; road paving; tile laying, bricklaying or block laying; bricklaying; rental of cleaning machines; furnace installation and repair; grouting services; underwater dredging; underwater repair; rental of bulldozers; rental of excavators; pumicing; masonry; mining extraction; quarrying services; well drilling; drilling of wells; application of slip-resistant safety floor sealers; installation and repair of door frames; window cleaning; cleaning of buildings [interior]; cleaning of buildings [exterior surface]; chimney sweeping; painting, interior and exterior; upholstery; upholstery repair; wallpaper hanging; wallpapering; installation and repair of window blinds; painting services; painting or repair of signs; plastering and painting of building interiors; heating equipment installation and repair; boiler cleaning and repair; heating equipment installation and repair; burner maintenance and repair; office machines and equipment installation, maintenance and repair; information on the maintenance of measuring and test equipment; repair or maintenance of measuring and testing machines and instruments; kitchen equipment installation; electric appliance installation and repair; irrigation devices installation and repair; repair or maintenance of chemical processing machines and apparatus; machinery installation, maintenance and repair; repair or maintenance of integrated circuits manufacturing machines and systems; installation, maintenance and repair of computer hardware; repair or maintenance of construction machines and apparatus; installation, maintenance and repair of apparatus for processing metals; air conditioning apparatus installation and repair; freezing equipment installation and repair; interference suppression in electrical apparatus; repair or maintenance of gas water heaters; installation and maintenance of sanitary apparatus; rebuilding machines that have been worn or partially destroyed; maintenance and repair of medical instruments, apparatus and equipment; installation and maintenance of bathing apparatus; installation and repair of lighting apparatus; automobile reconditioning services; vehicle service stations [refuelling and maintenance]; gasoline refuelling services for motor vehicles; maintenance and repair of land vehicles; motor vehicle maintenance and repair; vehicle maintenance; vehicle battery charging; anti-rust treatment for vehicles; vehicle lubrication [greasing]; vehicle washing; vehicle polishing; information and consultancy services relating to vehicle repair; airplane maintenance and repair; shipbuilding; film projector repair and maintenance; photographic apparatus repair; clock and watch repair; safe maintenance and repair; strong-room maintenance and repair; repair of security locks; rustproofing; retinning; retreading of tires [tyres]; vulcanization of tyres [repair]; rubber tyre repair; furniture maintenance;

furniture restoration; carpentry services; textile laundering; renovation of clothing; maintenance and repair of clothing; dry cleaning; leather care, cleaning and repair; fur care, cleaning and repair; washing of linen; cleaning of clothing; clothing repair; linen ironing; pressing of clothing; vermin exterminating, other than for agriculture, aquaculture, horticulture and forestry; disinfecting; shoes polishing services; cleaning of storage tanks; telephone installation and repair; elevator installation and repair; burglar alarm installation and repair; septic tank cleaning; fire alarm installation and repair; restoration of musical instruments; knife sharpening; rental of drainage pumps; pump repair; artificial snow-making services; repair of hand tools; repair and restoration of books; repair of binoculars; repair of toys or dolls; repair of power lines; rental of dish washing machines; suitcase repair; restoration of works of art; repair of game machines and apparatus; swimming-pool maintenance; installation and maintenance of entertainment or sports apparatus; umbrella repair; jewelry repair.

(260) AM 2022 116709 A

(800) 1645435

(151) 2021 06 24

(891) 2021 06 24

(731) Salewa Sport AG

Route de Préverenges 14, CH-1026 Denges,
Switzerland

(540)

DYNAFIT

(591) Black, white

(531) 27.05.01

(511)

9 – Scientific, research, navigation, surveying, photographic, cinematographic, audiovisual, optical, weighing, measuring, signaling, detecting, testing, inspecting, life-saving and teaching apparatus and instruments; accumulators (batteries); acoustic [sound] alarms; acoustic meters; whistle alarms; application software; application software for mobile telephones; application software in the field of mobile operating systems (mobile application); application software; software used for running applications; application software for mobile devices; application software for mobiles (apps); breathing apparatus except for artificial respiration; protective eyewear; safety helmets; protective clothing (included in this class); spectacles (optics); spectacle frames; spectacle lenses; cases for optical goods; cases for sunglasses and protective eyewear; sunglasses; frames for sunglasses; lenses for sunglasses; chains and cords for sunglasses; straps for sunglasses; sports goggles; ski goggles; glacier goggles; spectacle cords; smart glasses; safety goggles; 3D spectacles; covers adapted or designed for photographic cameras; computer hardware and computer soft-

ware; signal bells; signaling lamps; signaling whistles; measuring apparatus and instruments; avalanche beacons included in this class; sound recording media; MP3 player; electronic data carriers of all types; magnetic data media; Unrecorded electronic, optical and magnetic data carriers of all kinds; loudspeakers; headphones; sound reproduction apparatus; electronic (downloadable) publications available from databases or the Internet; software downloaded on the Internet; digital books downloadable from the Internet; battery chargers for mobile telephones; computer software for 2D or 3D simulation in industrial product design and development; wireless transmitters; devices for navigation by global tracking (GPS); global positioning system (GPS) transmitters; tracking devices and global positioning systems (GPS); cycling helmets; visors for helmets; downloadable computer programs; downloadable electronic books; downloadable software; audio books; covers for portable telephones; hard covers for smartphones; covers for tablet computers; encoded electronic chip cards; prepaid encoded magnetic cards; encoded magnetic cards; encoded smart cards; encoded loyalty cards; directional compasses; headgear as protective helmets; head guards for sports; force sensors; chargers for electric accumulators; weighing scales for milk; sleeves for laptops; bags designed for laptop computers; avalanche probes; magnetic, optical, electric control cards, smart cards, PCMCIA cards; magnetic compasses; global positioning systems; external batteries; reflective apparel and clothing for the prevention of accidents; reflective articles for wear for the prevention of accidents; reflective safety vests; survival blankets; fire escapes; safety nets; safety tarpaulins; oxygen regulating apparatus other than for medical use; protective helmets for sports; protective masks; solar cells; sports whistles; sports training simulators; wearable computers.

18 – Briefcases, document files; backpacks for carrying babies; mountaineering sticks; trekking poles; hiking sticks; hiking sticks; pouches for holding make-up, keys and other personal items; Boston bags; wallets; credit card wallets of leather; card wallets (leatherware); bags for campers; shopping bags; purses; luggage; luggage tags; handbags; hipsacks; garment bags for travel; credit card holders of leather; leather and imitations of leather; carry-all bags; all-purpose sports bags; multi-purpose handbags; toilet bags sold empty; umbrellas; parasols; suitcases [carrying cases]; trunks and suitcases; travel luggage; luggage and transport bags; traveling sets (leatherware); traveling bags; holdalls for sports clothing; barrel bags; backpacks; bags for climbers; rain covers for backpacks and bags; hydration system principally comprising a water reservoir especially adapted for backpacks; key cases; shoe bags for travel; school backpacks; school backpacks; school satchels; shoulder bags; carry-all bags; duffle bags for travel; sports backpacks; sports bags; bags; bags for sports clothing;

shoulder bags; shoulder straps; business card cases; hiking backpacks; hiking bags.

25 – Clothing, footwear, headwear; articles of clothing, footwear and headgear for babies and toddlers; anoraks (parkas); breathable tops and pants; breathable underwear; bandanas (neckerchiefs); baseball caps; mountaineering boots; alpine boots; mountaineering boots; Bermuda shorts; bikinis; brassieres; peaked caps; lingerie for women; down jackets; cycling gloves; cycling footwear; mittens; moisture-wicking tops and pants; moisture-wicking underwear; flip-flops; leisure wear; casual shirts; slacks; tracksuit jackets; leisure wear; leisure footwear; ankle socks; gaiters; padded jackets; money belts (clothing); rubbers (footwear); belts (clothing); neckwear; gloves (clothing); hooded pullovers; trousers; girdles (underwear); tracksuits; infants' footwear; sports clothing; mountaineering boots; knee-high stockings; headwear; headscarves; running pants; running shoes; running shirts; running shorts; leggings (trousers); coats; caps; outer-clothing; ear bands (clothing); ear muffs (clothing); outdoor clothing; outdoor jackets; outdoor shoes; polo shirts; cyclists' clothing; Capri pants; waterproof clothing; rain trousers; rain hats; rain slickers; skirts; sandals; garments for foul weather; snow suits; snow pants; after-ski boots; footwear; footwear for men and women; sweat bands; jackets for technical use; shorts; ski suits; ski suits for competition; clothing for skiing; ski gloves; ski pants; ski jackets; ski balaclavas; ski hats; ski boots; ski boots; parts and accessories for ski boots; bags specially adapted for ski boots; snowboarding suits; snowboard mittens; snowboard gloves; snowboard jackets; snowboard boots; snowboard boots; cap peaks; sun hats; sports clothing; sports bras; short-sleeve sports shirts; sports trousers; sports jackets; sports clothing; sports coats; boots for sports; sports footwear; sports t-shirts; sports shorts; sports socks; jerseys for sports; headbands (clothing); head sweatbands; cardigans; knitted caps; knitwear (clothing); stockings; tights; balaclavas; surfing shorts (beach and swimming wear); pullovers; sweatshirts; sports shorts; sleeveless sweaters; thermal protection clothing; headwear of thermal textile materials; thermal socks; thermal underwear; trail running shoes; trail shoes; tracksuits; trekking shoes; triathlon clothing; jerseys; tee-shirts; scarves (clothing); clothing for gymnastics; sports clothing; overshoes; trekking shoes; walking shorts; trekking shoes; water-resistant clothing; waterproof jackets and pants; vests; weather-resistant outer-clothing; weatherproof clothing; Wind-resistant clothing; wind pants; wind-resistant jackets; wind-resistant jackets; wind vests; winter gloves; winter boots; hosiery.

28 – Articles for gymnastics and sports; appliances for gymnastics; sporting articles and equipment; chalk for climbers; nets (sports articles); climbing harnesses; harnesses (sports articles); mountaineering articles, namely, belts for mountaineering; sports gloves; ski

accessories, namely, adjustment plates for ski bindings, crampons, crampon straps, hook straps for cross-country ski bindings, deep-snow straps to facilitate ski searches in deep snow, ski straps, ski clips, spacers for cross-country ski bindings; sports equipment; sole coverings for skis; bags especially designed for skis; bags especially designed for skis and snowboards; sledges (sports articles); ice skates; snowshoes; sole coverings for skis; ski bindings; skis; ski sticks; ski poles for roller skis; snowboards; snowboard bindings; games, toys.

35 – Advertising; commercial business management; commercial administration; office functions; advertising by mail order; Internet advertising services; advertising services provided via the Internet; online advertising on a computer network; banner advertising; promotion of goods and services by means of sponsorship of sports events; promotional services; public relations services; dissemination of advertising and promotional materials; marketing; online advertising and marketing services; dissemination of advertising, promotional and marketing materials; event marketing services; consultant services relating to company marketing; consultant services relating to company marketing; sponsorship search; organization of exhibitions and trade fairs for commercial or advertising purposes; exhibiting (presenting) goods for promotional purposes; shop window dressing; professional business consultancy; networking service for professional and economic purposes, also on the Internet; wholesale and retail sale; retail sale of goods of all kinds, particularly of clothing, footwear and headgear; retail and mail order services in the field of sports articles and clothing, also via the Internet; presenting goods in mass media for retail trade; retail services concerning and wholesale services concerning protective helmets, safety helmets, protective clothing, spectacles (optics), sunglasses, frames for sunglasses, sports goggles, ski goggles, glacier goggles, avalanche beacons, bicycle helmets, covers for smartphones, covers for tablet computers, sleeves for laptops, bags adapted for laptops, avalanche probes, mountaineering sticks, wallets, luggage, luggage tags, umbrellas, valises, trunks and suitcases, tote bags for sportswear, duffel bags, backpacks, bags for climbers, sports backpacks, sports bags, bags, hiking rucksacks, clothing, footwear, headwear, gymnastic and sports articles, apparatus for gymnastics, sports articles and equipment, sports equipment, chalk for climbers, climbers' harnesses, harnesses (sports articles), mountaineering articles, sole coverings for skis, bags especially designed for skis, snowshoes, sole coverings for skis, ski bindings, skis, ski poles, snowboards, snowboard bindings; online retail services concerning protective helmets, safety helmets, spectacles (optics), sunglasses, frames for sunglasses, sports goggles, ski goggles, avalanche beacons, bicycle helmets, covers for smartphones, covers for tablet computers, sleeves for laptops, bags adapted for laptops, avalanche probes, mountaineering sticks, wa-

llets, luggage, luggage tags, umbrellas, valises, trunks and suitcases, tote bags for sportswear, duffel bags, backpacks, bags for climbers, sports backpacks, sports bags, bags, hiking rucksacks, clothing, footwear, headwear, gymnastic and sports articles, apparatus for gymnastics, sports articles and equipment, sports equipment, chalk for climbers, climbers' harnesses, harnesses (sports articles), mountaineering articles, sole coverings for skis, bags especially designed for skis, snowshoes, sole coverings for skis, ski bindings, skis, ski poles, snowboards, snowboard bindings.

(260) AM 2022 116710 A

(800) 1645486

(151) 2021 01 15

(891) 2021 01 15

(731) TOYOTA JIDOSHA KABUSHIKI KAISHA

(also trading as TOYOTA MOTOR CORPORATION)

1, Toyota-cho, Toyota-shi, Aichi-ken 471-8571, Japan

(540)



(591) Black, white

(531) 09.01.08; 26.04.05; 26.04.12; 26.04.16;
26.04.24; 26.11.06; 26.11.12

(511)

39 – Vehicle transport and rental services; tracking, locating and monitoring of vehicles, maritime vessels and aircraft; arranging of transport and travel; transportation services in relation to events; storage, transport, pick-up, and packing of freight; cargo delivery services; transport, delivery, packaging, and storage of goods and providing information relating thereto; transportation, packaging, storage and delivery of foods and beverages and providing information relating thereto; providing transportation information; providing information relating to the transportation of goods and passengers; food delivery; pick up, delivery and storage of personal property; logistics services consisting of the storage, transportation and delivery of goods; transport and storage of waste and recycling materials; railway transport and provision of information relating thereto; car transport and provision of information relating thereto; transportation of passengers by bus; delivery of goods by lorry; car sharing services; transportation of freight containers by truck; providing information about timetables of vehicle transport; providing information about booking status of vehicle transport; transport by man-powered vehicles; providing road and traffic information; provi-

ding customized driving directions; GPS navigation services; vehicle driving services; packaging and packing services; freight brokerage and providing information relating thereto; cargo handling; removal services and providing information relating thereto; warehousing services; providing information relating to warehousing services; refrigerated warehousing; storage of containers and cargo; storage, distribution and supply of energy and fuel; storage, distribution and supply of hydrogen fuel; temporary safekeeping of personal belongings; temporary storage of deliveries; distribution of gas; distribution of renewable energy; distribution of energy; electricity distribution; distribution of electricity generated by photovoltaic apparatus and installations for generating solar electricity; information and consultancy services relating to distribution of electricity generated by photovoltaic apparatus and installations for generating solar electricity; distribution of electricity generated by fuel cells; information and consultancy services relating to distribution of electricity generated by fuel cells; water supply and distribution services; hot water supply and distribution services; distribution of district heating and cooling; distribution of heat; rental of warehouse space; rental of garages and parking places; provision of car parking facilities; valet parking; car park services and providing information relating thereto; car park services using on-board self-driving and automatic parking systems; operating toll roads; providing vessel mooring facilities; operating parking lots; rental of loading-unloading machines and apparatus; rental of pallets; rental of transport and storage containers; rental of robots for handling loads; vehicle rental; car rental; rental of electric cars; rental of hydrogen cars; rental of tractors; rental of agricultural tractors; rental of bicycles; rental of handling tractors; rental of mechanical parking systems; rental of packing or wrapping machines and apparatus; rental of robots for packaging and wrapping; rental of freezers; refrigerator rental; rental of wheelchairs; on-line trip and travel reservation services; booking of seats for coach travel; reservation of transport for sporting, scientific, political and cultural events; on-line information and booking services in the field of business travel; travel tour conducting; arranging and booking of travel, cruises and sightseeing travel tours; reservation and booking of seats for travel; travel arrangement and reservation services, excluding those for lodging; collection of waste and trash.

42 – Providing weather information; architectural design; surveying; urban planning; designing of machines, apparatus, instruments (including their parts) or systems composed of such machines, apparatus and instruments; engineering services relating to energy supply systems; design and development of energy distribution networks; design and development of fuel cells; design and development of photovoltaic systems; design services; provision of information relating to computer programming; programming of ener-

gy management software; design and development of virtual private network (VPN) operating software; design and development of virtual reality software; design and development of software for control, regulation and monitoring of solar energy systems; testing, research, design and development of computer programs and software for use with partially automated automobiles, buses and trucks; testing, research, design and development of computer programs and software for use with self-driving automobiles, buses and trucks; testing, research, design and development of computer programs and software for use with autonomous automobiles, buses and trucks; testing, research, design and development of partially automated automobiles, buses and trucks; testing, research, design and development of self-driving automobiles, buses and trucks; testing, research, design and development of autonomous automobiles, buses and trucks; technological advice relating to computers, automobiles and industrial machines; testing, inspection and research services in the fields of pharmaceuticals, cosmetics and foodstuffs; providing information relating to testing, inspection and research services in the fields of foodstuffs; consultancy relating to technical research in the field of food and beverages; technical consultancy relating to research services in the field of foods and dietary supplements; research on building construction or city planning; testing and research services in the field of preventing pollution; testing and research services in the field of electricity; testing and research services in the field of civil engineering; research services in the field of energy; consultancy in the field of energy efficiency; scientific research in the field of renewable energy; consultancy in the field of energy-saving; technical consultancy in the field of energy saving and energy efficiency; consultancy relating to technological services in the field of power and energy supply; research and development services relating to solar cells and electricity generation; research and testing in the field of photovoltaic systems; research and testing in the field of fuel cells; technical development of structural elements, devices and systems for solar collectors and photovoltaic plants; testing, inspection and research services in the fields of agriculture, livestock breeding and fisheries; testing and research services relating to machines, apparatus and instruments; providing computer programs on data networks; rental of computers; hosting online web facilities for others for sharing online content; hosting on-line web facilities for others for conducting interactive discussions.

(260) AM 2022 116714 A

(800) 1645581

(151) 2021 09 14

(891) 2021 09 14

(731) TERAPIA S.A.

Str. Fabricii nr.124, jud. Cluj, 400632

Cluj-Napoca, Romania

(540)

ФАРИНГОСЕПТ РАПИД

(591) Black, white

(531) 28.05

(511)

5 – Pharmaceutical, medical and veterinary preparations; sanitary preparations for medical purposes; diet substances and foods adapted for medical or veterinary purposes, food for babies; dietary supplements for human and veterinary use; patches, dressing materials; materials for filling teeth and dental molds; disinfectants; pest destruction products; fungicides, herbicides; chemical-pharmaceutical preparations; chemical preparations for pharmaceutical, medical and veterinary purposes; pills and tablets for pharmaceutical purposes; vitamin preparations; vitamin patch supplements; chemical reagents for medical or veterinary purposes; adjuvants for medical purposes; medicinal sweets and candies; chewing gum for medical purposes; capsules for medicines; caustic substances and pencils for pharmaceutical purposes; hemostatic pencils; pencils against warts; coal for pharmaceutical purposes; depuratives; laxatives, purgatives; diagnostic preparations for medical and veterinary purposes; decoctions for pharmaceutical purposes; elixirs, pharmaceutical preparations; medicinal infusions; tinctures for medical purposes; herbal teas and extracts for medicinal and pharmaceutical purposes; medicinal oils; medicinal herbs and roots; medicinal beverages; syrups for pharmaceutical purposes; mineral waters for medical purposes and mineral water salts; salts for medical purposes; immunostimulants; fibers for medical purposes; dermal filler injection materials; contraceptive sponges; healing sponges; narcotics; opiates; sedatives/ tranquilizers; soporifics; sticks against headaches; serums; suppositories; smoking herbs for medical purposes; tonics (medication); preparations based on oligo-elements for human and veterinary use, vaccines; anthelmintic/deworming preparations; preparations for the destruction of parasites; medicinal shampoos for human and veterinary use; anti-bacterial, disinfectant and medicinal soaps; lotions for pharmaceutical and veterinary purposes, medicinal and anti-bacterial lotions for human and veterinary use, medicinal toothpaste; balms for medical purposes; antiseptics; biocides; detergents for medical purposes; hygienic disinfectants; sterilizing preparations; acne treatment preparations; ointments for pharmaceutical and veterinary use; ointments; ointments for medical purposes; massage gels for medical purposes; pharmaceutical preparations for the care of the skin and for the treatment of burns and sunburns; pediculicides and scabicides; after shave lotions with medicinal content; mouthwash for medical purposes; wipes impregnated with pharmaceutical lotions; meal replacements, diet beverages, adapted for medical or veterinary use; antioxidant pills; appetite suppressants for medical purposes; medical preparations for weight

loss; biological, bacterial, and bacteriological preparations for human and veterinary use; cultures of microorganisms for medical or veterinary use; dietary fiber; digestives for pharmaceutical purposes; enzymatic preparations and supplements for medical and veterinary purposes; ferments for pharmaceutical purposes; nutraceuticals for therapy or medical purposes; deodorants, other than for human or veterinary use; perspiration remedies; sanitary preparations for personal hygiene, other than toiletries; toilet medical preparations; diet supplements with cosmetic effect; diapers for babies and incontinence, diapers for veterinary use.

35 – Advertising; business management; business administration; office functions; the bringing together, for the benefit of others, of a variety of goods (excluding the transport thereof), such services may be provided by retail stores, wholesale outlets, through vending machines, mail order catalogues or by means of electronic media, for example, through web sites or television shopping programmes; retail and wholesale services in relation to medicines, sanitary and veterinary preparations and medical supplies; administrative processing of the purchase orders; keeping the accounting records; invoicing; bidding; administration of consumer loyalty programs, providing commercial information and advice to consumers in choosing goods and services; distribution of samples; presentation of products in the media, for retail purposes; commercial intermediation services, import-export agency services; marketing; media relations services; public relations, corporate communications services, commercial lobbying services; opinion polls, market research; organization of exhibitions for commercial or advertising purposes, organization of trade fairs.

(260) AM 2022 116715 A

(800) 1645585

(151) 2021 09 30

(891) 2021 09 30

(731) A&E Television Networks, LLC

235 East 45th Street, New York NY 10017,
USA

(540)

**HISTORY**

(591) The color(s) yellow, gold, red, white and black is/are claimed as a feature of the mark

(531) 26.11.08; 27.05.10; 27.05.11; 27.05.21;
29.01.13

(511)

9 – Prerecorded digital video discs and DVDs featuring television programs and motion picture films; digital media in the form of downloadable webcasts, podcasts, and audio and video files in the fields of history, current events, politics, entertainment, education, science, television, culture, fine arts and performing arts; downloadable mobile application for sending, downloading, viewing, creating, uploading, storing, and receiving podcasts, webcasts, and audio, digital and video files in the fields of history, current events, politics, entertainment, education, science, television, culture, fine arts and performing arts; downloadable films and movies provided via a video-on-demand service; motion picture films and films for television in the fields of history, current events, politics, entertainment, education, science, television, culture, fine arts and performing arts; computer game software and video game software; downloadable computer and video game software via a global computer network, mobile platforms, and wireless devices for entertainment purposes; downloadable mobile applications for games.

38 – Broadcasting services, including television broadcasting, video broadcasting, internet broadcasting, audio broadcasting and motion picture broadcasting; audio, text and video broadcasting services over the internet and other communications networks featuring audio and video content; subscription-based audio and video broadcasting services; satellite transmission services; electronic transmission of audio, video, graphics, and data via computer networks; transmission and delivery of audiovisual content via the internet; video-on-demand transmission services; wireless communication services, including transmission of television programs and motion pictures to mobile devices; podcasting and webcasting services; streaming of television programs, motion pictures, electronic media, audiovisual content, videos, pictures, images, text, and photos via computer and communication networks.

41 – Entertainment services, namely, providing entertainment via podcasts and webcasts in the fields of history, current events, politics, entertainment, education, science, television, culture, fine arts and performing arts; educational and entertainment services in the nature of ongoing television programs; entertainment services, namely, providing non-downloadable videos and pre-recorded audio-visual content in the fields of history, current events, politics, entertainment, education, science, television, culture, fine arts and performing arts via a global communications network; providing information featuring entertainment, news, blogs and commentary via a website; production, creation and distribution of television programs, motion pictures, podcasts and webcasts; television programming; electronic game services, namely, providing online electronic games by means of the inter-

net, mobile network platforms, and local area computer networks; entertainment services, namely, providing on-line interactive computer and video games.

(260) AM 2022 116717 A

(800) 1645653

(151) 2021 12 01

(891) 2021 12 01

(731) TON a.s.

Michaela Thoneta 148, CZ-768 61 Bystřice pod Hostýnem, Czech Republic

(540)



(591) Black, white

(531) 27.05.01; 27.05.17; 27.05.23

(511)

20 – Furniture of all kinds, in particular wooden and metal furniture.

(260) AM 2022 116718 A

(800) 1645686

(151) 2021 12 02

(891) 2021 12 02

(731) GRUPPO EUROPEO DI ORTODONZIA S.R.L.

VIA CROPANI, 118 A/B, I-00173 ROMA (RM), Italy

(540)

NUVOLA

(591) Black, white

(511)

10 – Teeth aligners; apparatus, instruments, devices and films for tooth alignment; orthodontic appliances; orthodontic machines and instruments [for dental purposes]; artificial teeth; dental caps; aligners for dental use; teeth protectors for dental purposes; parts and accessories for all the aforementioned goods.

40 – Dental technician services; custom manufacture of dental appliances, prosthetics and dental articles; orthodontist laboratories; consultancy relating to the aforementioned services.

44 – Dentistry services; teeth whitening services; orthodontic services; dental services, namely, treatment of patients to straighten and align teeth; dental imaging services; providing a website featuring information for patients in the field of dental health; consultancy relating to the aforementioned services.

(260) AM 2022 116719 A
 (800) 1645758
 (151) 2022 01 04
 (891) 2022 01 04
 (731) University of Miami
 1320 S. Dixie Highway, Suite 1250,
 Coral Gables FL 33146, USA



(591) Black, white
 (531) 25.07.01; 25.07.15; 26.13.25; 27.05.01
 (511)

25 – Clothing, namely, shirts, t-shirts, polo shirts, dresses, skirts, blouses, jackets, coats, fleece pullovers, sweaters, sweatshirts, pants, sweat pants, tank tops, shorts, underwear, briefs, thermal underwear, swim suits, trunks, yoga pants, capri pants, sports bras, bandanas, shoes, belts, caps, hats, beanies, visors.

(260) AM 2022 116720 A
 (800) 1645797
 (151) 2021 12 20
 (891) 2021 12 20
 (731) Zirax LLC
 Svetly Yar workers settlement, bld. 6, md. 4,
 Svetloyarsk district, RU-404171 Volgograd
 region, Russian Federation

(540)

(591) Blue
 (531) 27.05.01; 29.01.04
 (511)

1 – Chemicals for use in industry and science; calcium chloride; calcium chloride for use in the manufacture of food; chemical substances for use in the manufacture of food.

(260) AM 2022 116722 A
 (800) 1108094
 (151) 2011 12 30
 (891) 2022 01 21
 (731) AGROQUÍMICA CODIAGRO, S.L.
 Pol. Ind. Caseta Blanca, C/ Albocácer nº 6,
 E-12194 VALL D'ALBA (CASTELLÓN),
 Spain

(540)



(591) Red, white and green
 (531) 26.11.12; 27.05.01; 29.01.13
 (511)

1 – Chemicals used in industry, science and photography, as well as in agriculture, horticulture and forestry; unprocessed artificial resins, unprocessed plastics; fertilizers; fire extinguishing compositions; tempering and soldering preparations; chemical substances for preserving foodstuffs; tanning substances; adhesives for industrial purposes.

(260) AM 2022 116723 A
 (800) 1136470
 (151) 2012 10 08
 (891) 2022 02 03
 (731) ERAM
 SAINT-PIERRE-MONTLIMART CÉDEX,
 F-49111 MONTREVAULT-SUR-ÈVRE,
 France

(540)

(591) Black, white
 (531) 27.05.01
 (511)

18 – Leather and imitations of leather, leather or imitation leather goods (excluding cases adapted to the products for which they are intended, gloves and belts), briefcases, card holders, purses, wallets, trunks and suitcases, traveling sets, handbags, travel bags, school bags, backpacks, sports bags, wheeled bags, umbrellas, parasols and walking sticks.

25 – Clothing, footwear, headgear; belts (clothing).

35 – Retail sale of footwear, clothing, headgear and leather goods.

(260) AM 2022 116725 A
 (800) 1499332
 (151) 2019 06 07
 (891) 2021 10 05
 (731) Dirk Rossmann GmbH
 Isernhägener Str. 16, 30938 Burgwedel,
 Germany

(540)

Rossmann

(591) Black, white

(511)

3 – Animal grooming preparations; tailors' and cobblers' wax; cleaning and fragrancing preparations; toiletries; essential oils and aromatic extracts; cosmetics; massage gels, other than for medical purposes; cosmetic kits; balms, other than for medical purposes; aloe vera preparations for cosmetic purposes; oral hygiene preparations; perfumery and fragrances; body cleaning and beauty care preparations; make-up preparations; household fragrances; soaps and gels; laundry preparations; leather and shoe cleaning and polishing preparations; skin, eye and nail care preparations; hair preparations and treatments; vehicle cleaning preparations; hair removal and shaving preparations; deodorants and antiperspirants; bath preparations; make-up removing preparations; breath freshening preparations for personal hygiene; essential oils; eyebrow cosmetics; bath preparations, not for medical purposes; pumice stone; laundry bleach; bleaching preparations [decolorants] for cosmetic purposes; bleaching soda; polish for furniture and flooring; deodorants for human beings or for animals; sachets for perfuming linen; depilatory preparations; colorants for toilet purposes; color-removing preparations; shining preparations [polish]; hair dye; hair lotion; hair spray; conditioning preparations for the hair; adhesives for cosmetic purposes; collagen preparations for cosmetic purposes; cosmetic pencils; skincare cosmetics; skin lotion; false nails; lipstick; lip gloss; lotions for cosmetic purposes; cloths impregnated with a detergent for cleaning; tissues impregnated with cosmetic lotions; unblocking drain pipes (preparations for -); douching preparations for personal sanitary or deodorant purposes [toiletries]; mouthwashes, not for medical purposes; nail varnish removers; nail polish; nail care preparations; oils for toilet purposes; oils for cosmetic purposes; oils for cleaning purposes; perfumery; perfume; polishing preparations; dry-cleaning preparations; refurbishing preparations; shaving preparations; cleansing milk for toilet purposes; refurbishing preparations; make-up preparations; make-up preparations; cosmetic masks; boot cream; shoe polish; soaps; shampoo; sunscreen preparations; cosmetics for animals; toiletries; laundry soaking preparations; laundry preparations; cotton sticks for cosmetic purposes; dentifrices; fabric softeners; smoothing preparations [starching]; starch for laundry purposes; laundry blue; fabric softener for laundry; anti-static dryer sheets; laundry blue; laundry liquids; rinsing agents for laundry; laundry balls containing laundry detergent; soap powder; laundry additives for water softening; air fragrance and diffusers.

5 – Absorbent articles for personal hygiene; pharmaceuticals and natural remedies; nappies for babies and incontinents; baby food; feminine hygiene products; deodorizers; diagnostic preparations and materials; disinfectants and antiseptics; dietary supplements and dietetic preparations; hygienic preparations and articles; medicated and sanitising soaps and detergents;

dietary supplements for animals; pest control preparations and articles; medical dressings and medical plasters; dental preparations and articles, and medicated dentifrices; evacuants; lice treatment preparations [pediculicides]; anti-bacterial soap; antiseptics; appetite suppressant pills; medicines for human purposes; medicines for veterinary purposes; asthmatic tea; babies' diaper-pants; infant formula; babies' diapers; bath preparations for medical purposes; fibre (dietary -); balsamic preparations for medical purposes; bandages for dressings; tranquilizers; medicated candy; chemico-pharmaceutical preparations; pregnancy (chemical preparations for the diagnosis of -); chemical preparations for medical purposes; chemical preparations for veterinary purposes; chemical preparations for pharmaceutical purposes; sanitary towels; deodorants for clothing and textiles; disinfectants; disinfectants for hygiene purposes; disinfectant soap; diagnostic preparations; dietetic beverages adapted for medical purposes; dietetic substances adapted for medical use; dietetic foods adapted for medical use; albuminous preparations for medical purposes; enzyme preparations for medical purposes; febrifuges; fly destroying preparations; fly catching paper; fungicides; first-aid boxes, filled; adhesive plasters; remedies for foot perspiration; corn remedies; corn rings for the feet; dog washes [insecticides]; insecticides; insect repellents; personal sexual lubricants; camphor for medical purposes; cachets for pharmaceutical purposes; capsules for medicines; chewing gum for medical purposes; adhesive bands for medical purposes; compresses; herbal extracts for medical purposes; herbal teas for medicinal purposes; solutions for contact lenses; lotions for pharmaceutical purposes; magnesia for pharmaceutical purposes; mice (preparations for destroying -); beverages adapted for medicinal purposes; medicinal herbs; medicinal infusions; medicated soap; medicinal tea; medicated toiletry preparations; medicated dentifrices; powdered milk for babies; mineral food supplements; burns (preparations for the treatment of -); acne treatment preparations; callouses (preparations for -); air deodorising preparations; sanitary pants; mud for baths; mothproofing preparations; mouthwashes for medical purposes; nutritional supplements; nervines; nicotine patches for use as aids to stop smoking; medicinal oils; lozenges for pharmaceutical purposes; pharmaceuticals; pharmaceutical preparations; rat poison; fumigating pastilles; contact lens cleaning preparations; medicine cases, portable, filled; ointments for pharmaceutical purposes; soporifics; serums; panty liners; sunburn ointments; breast-nursing pads; tampons; bath (therapeutic preparations for the -); animal washes [insecticides]; herbicides; vermin destroying preparations; vaginal washes for medical purposes; petroleum jelly for medical purposes; dressings, medical; surgical dressings; digestives for pharmaceutical purposes; veterinary preparations; vitamin preparations; wart pencils; diapers for pets; nappies of paper for incontinents; disposable napkins

for incontinents; pant liners for incontinents; disposable nappies made of cellulose for incontinents.

35 – Business analysis, research and information services; advertising, marketing and promotional services; business assistance, management and administrative services; advertising, marketing and promotional consultancy, advisory and assistance services; loyalty, incentive and bonus program services; organizing and conducting trade shows and exhibitions for commercial or advertising purposes; conducting of trade shows; public relations services; product demonstrations and product display services; distribution of advertising, marketing and promotional material; provision of advertising space, time and media; marketing studies; collection and systematization of business data; cost price analysis; news clipping services; on-line advertising; online retail store services relating to cosmetic and beauty products; arranging commercial transactions, for others, via online shops; provision of an on-line marketplace for buyers and sellers of goods and services; procurement of contracts [for others]; procurement of contracts for others relating to the sale of goods; arranging of contracts for others for the buying and selling of goods; arranging of contracts, for others, for the providing of services; retailing and wholesaling in the fields of body care preparations, body cleansing and body care preparations, perfumery and fragrances, oral hygiene preparations, make-up, soaps and gels, bath and shower preparations, deodorants and antiperspirants, skin care preparations, hair preparations and hair treatments, depilatory and shaving preparations, animal care preparations, cleaning and fragrancing preparations, fuels and illuminants, dietetic preparations and nutritional supplements, food for babies; retailing and wholesaling in the fields of sanitary preparations and articles, materials for dressings, medical covering materials and applicators, medicines and natural remedies, pregnancy tests, hygienic and beauty implements for human beings and animals, hair styling apparatus, manicure and pedicure apparatus, hair cutting and hair removal apparatus, shaving apparatus, utensils for preparing foodstuffs, kitchen utensils, kitchen knives and tableware, recorded data; retailing and wholesaling in the fields of software, information technology and audiovisual apparatus, electronic and electric articles, and accessories therefor, eyeglasses, hearing protectors, feeding aids and dummies, sex aids, medical and veterinary apparatus and instruments, contraceptive devices, diagnostic, examination and monitoring apparatus; retailing and wholesaling in the fields of massage apparatus, lighting, jewellery, clocks and watches, jewellery cases and watch cases, works of art and figurines of paper or cardboard, and architectural models, decorative and artistic materials and media, bags, pouches and goods for packaging, packing and storage purposes of paper or cardboard, stationery, and instructional and teaching materials; retailing and wholesaling in the fields of adhesives for stationery or household

purposes, printed matter, paper and cardboard, disposable paper articles, bags, pouches and goods for packaging, packing and storage purposes of paper or cardboard or plastic, furniture and furnishings, beds, bedding, mattresses, cushions and pads, animal houses and beds, decorations, gardening articles; retailing and wholesaling in the fields of brushes, brooms and brush-making materials, dishes, cooking pot sets and containers, glasses, drinking vessels, cutlery, kitchenware and bar accessories, cleaning apparatus and articles for cleaning purposes, cosmetic and toilet utensils, and bathroom articles, animal husbandry articles, household articles for clothing and footwear, textile goods and substitutes for textiles, headgear, footwear, clothing accessories, sewing machines; retailing and wholesaling in the fields of sewing articles, yarns, textiles and decorative textile articles, hair decorations, hair curlers, hair fastening articles and false hair, sporting articles and equipment, games, toys, playthings and novelties, food, foodstuffs, animal foodstuffs and animal requisites, beverages, tobacco products, smokers' articles, insect repellent and articles; retailing and wholesaling in the fields of articles for babies and infants, furniture for babies and infants, parts and fittings for vehicles, in particular child seats, gift sets, sunscreen and care articles, household goods, mobile telephone accessories and pre-paid cards; commercial services and consumer information in the field of cleaning and fragrancing preparations, body care preparations, beauty care preparations, cleaning preparations, sanitary preparations and articles, medicines and natural remedies, food for babies, nappies for babies and incontinence, dietary supplements, household items for the care of clothing and footwear, cosmetic and toilet utensils, and bathroom articles.

(260) AM 2022 116726 A

(800) 1541527

(151) 2020 06 16

(891) 2022 02 03

(731) GERMAINE DE CAPUCCINI, S.A.

Carretera de Alicante, 86, E-03800 Alcoy
(Alicante), Spain

(540)



GERMAINE DE CAPUCCINI

(591) Black, white

(531) 03.07.06; 03.07.24; 27.05.01

(511)

3 – Cosmetic products; soaps; perfumery, essential oils, hair lotions; dentifrices.

(260) AM 2022 116727 A
 (800) 1593069
 (151) 2021 02 17
 (891) 2022 01 31
 (731) Lumo Education Oy
 Kuusistontie 22, FI-57600 Savonlinna, Finland
 (540)

SISU Schools

(591) Black, white
 (511)
 35 – Advice in the running of establishments as franchises; providing assistance in the management of franchised businesses; business management assistance in the field of franchising; provision of assistance [business] in the establishment of franchises; business assistance relating to the establishment of franchises; provision of assistance [business] in the operation of franchises; assistance in franchised commercial business management.

41 – Setting of educational standards; provision of day-care [educational] units; providing courses of instruction at high school level; teaching at junior high schools; distance learning services provided online; teaching; educational services provided for children; teaching at elementary schools; commercial training services; development of educational materials; school services; provision of online training; training; organisation of training; conducting of correspondence courses; developing educational manuals; setting of training standards; educational services provided by schools; educational and teaching services; provision of training and education; education services for managerial staff; teacher training services; education and training consultancy; providing online training seminars; educational services provided by senior high schools; education services relating to business franchise management; instructional and training services; educational establishments providing courses of instruction (services of -); training of teachers; educating at senior high schools; organisation of teaching activities; provision of education on-line from a computer database or via the internet or extranets; providing of education; provision of training via a global computer network; arranging teaching programmes; education and instruction services; pre-school education.

(260) AM 2022 116768 A
 (800) 1645832
 (151) 2021 08 05
 (891) 2021 08 05
 (731) SOPHARMA AD
 Iliensko shose str. 16, BG-1220 Sofia, Bulgaria
 (540)

sopharma

(591) Black, white
 (531) 27.05.17
 (511)
 3 – Non-medicated cosmetics and toiletry preparations; perfumery, essential oils.

5 – Pharmaceuticals, medical and veterinary preparations; sanitary preparations for medical purposes; dietetic food and substances adapted for medical or veterinary use, food for babies; dietary supplements for human beings and animals; plasters, materials for dressings; food supplements; dietary and nutritional supplements; nutritional supplements; dietary supplements and dietetic preparations; food supplements for non-medical purposes; disinfectants.

35 – Advertising; business management and administration services relating to commercial transactions; commercial administration; sales promotion services of pharmaceutical, sanitary preparations and medical consumables; trade marketing services relating to dietetic preparations; retail services in relation to food supplements; demonstration of goods for advertising purposes by electronic means; electronic commerce services of pharmaceuticals, food supplements and dietetic, vitamin and mineral supplements and preparations; demonstration of goods; presentation of goods on communication media, for retail purposes; shop window dressing; publication of publicity texts; dissemination of advertisements; distribution of samples; computerized file management; online advertising on a computer network; word processing; television advertising; business appraisals.

(260) AM 2022 116777 A
 (800) 1646137
 (151) 2022 01 15
 (891) 2022 01 15
 (731) Avon Products, Inc.
 1 Avon Place, Suffern NY 10901, USA
 (540)

LOCAL NATURE

(591) Black, white
 (511)
 3 – Non-medicated toilet preparations; toiletries; skin care preparations; skin moisturizers; skin toners; body and beauty care preparations; powders, cleansers, creams and lotions, all for the face, hands and body; exfoliating scrubs for cosmetic purposes; cosmetic suntan preparations; sunscreen oils and lotions; soaps; shower and bath preparations; bath gel, bath oils, bath salts, bath beads, and effervescent bath preparations; beauty masks; talcum powder; nail polish; nail polish remover; false nails; adhesives for cosmetic purposes; cosmetics; eye cream; eye gels; eye lotions; eye make-up remover; eye shadow; eye liner; eyebrow cosmetics; mascara; lipstick; lip liner; lip-gloss; lip balm; make-up foundation; facial concealer; blusher; tissues impregnated with cosmetic lotions; powdered cosme-

tic tissues; cotton sticks for cosmetic purposes; cotton wool for cosmetic purposes; pumice stone; preparations for cleaning, moisturising, colouring and styling the hair; shampoos, conditioners, finishing spray, and gels, all for the hair; preparations for cleaning the teeth; shaving and aftershave preparations; perfumes; fragrances; toilet waters; cologne; room fragrances; incense sticks; deodorants for human beings; anti-perspirants for personal use (toiletries); essential oils (cosmetic); oils for perfumes and scents; potpourri; cosmetic kits.

(260) AM 2022 116779 A

(800) 1646190

(151) 2022 01 21

(891) 2022 01 21

(731) FERTIBERIA, S.A.

Calle Agustín de Foxá, 27 Plantas 8-11,
E-28036 Madrid, Spain

(540)



(591) Light green and dark green

(531) 05.05.20; 26.03.23; 26.11.03; 26.11.07;

26.11.12; 27.05.01; 27.05.07; 29.01.11

(511)

1 – Chemical products for use in industry, agriculture, horticulture and forestry; unprocessed artificial resins, unprocessed plastics; fire extinguishing compositions; chemical products for preserving foodstuffs; tanning substances; adhesives for use in industry, manures and fertilizers.

5 – Pharmaceutical, veterinary and sanitary products; dietetic food for medical use, food for babies; plasters, materials for dressings (bandages); material for dental fillings and dental impressions; disinfectants; products for destroying vermin; fungicides and herbicides.

(260) AM 2022 116780 A

(800) 1646248

(151) 2021 10 18

(891) 2021 10 18

(731) Euro Games Technology Ltd.

4, "Maritsa" Str., "Vranya-Lozen-Triugulnika",
BG-1151 Sofia, Bulgaria

(540)

Book of Glory

(591) Black, white

(511)

9 – Software; computer gaming software; computer software packages; computer operating system soft-

ware; computer software, recorded; software drivers; virtual reality software; games software; entertainment software for computer games; computer programs for network management; operating computer software for main frame computers; monitors (computer hardware); computer hardware; apparatus for recording images; monitors (computer programs); computer game programs; computer programs for recorded games; apparatus for recording, transmission or reproduction of sound or images; communications servers [computer hardware]; electronic components for gambling machines; computer application software featuring games and gaming; computer software for the administration of on-line games and gaming; computer hardware for games and gaming; hardware and software for gambling, gambling machines, gambling games on the Internet and via telecommunication network.

28 – Gaming machines for gambling; chips for gambling; mah-jong; arcade games; gambling machines operating with coins, notes and cards; games; electronic games; parlor games; gaming chips; gaming tables; slot machines [gaming machines]; LCD game machines; slot machines and gaming devices; coin-operated amusement machines; roulette chips; poker chips; chips and dice [gaming equipment]; equipment for casinos; roulette tables; gaming roulette wheels; casino games; automats and gambling machines; coin-operated machines and/or electronic coin-operated machines with or without the possibility of gain; boxes for coin-operated machines, slot machines and gaming machines; electronic or electrotechnical gaming devices, automats and machines, coin-operated machines; housings for coin-operated machines, gaming equipment, gaming machines, machines for gambling; electropneumatic and electrical gambling machines (slot machines).

41 – Gambling; services related to gambling; gaming services for entertainment purposes; casino, gaming and gambling services; training in the development of software systems; provision of gaming equipment for gambling halls; providing casino equipment [gambling]; gaming machine entertainment services; providing casino facilities [gambling]; halls with gaming machines; amusement arcade services; games equipment rental; rental of gaming machines; providing amusement arcade services; rental of gaming machines with images of fruits; editing or recording of sounds and images; sound recording and video entertainment services; hire of sound reproducing apparatus; provision of gaming equipment for casinos; providing of casino facilities; online gambling services; casino management services; operation of gaming establishments, gaming halls, internet casinos, online gambling sites.

(260) AM 2022 116781 A
 (800) 1646379
 (151) 2021 11 18
 (891) 2021 11 18
 (731) "NEW MAX HOLDING" mas'uliyati
 cheklangan jamiyati
 Sayram str., h.50 passage 7, M.Ulug'bek
 district, Tashkent c., 100000, Uzbekistan

(540)

MAZZALAK

(591) Black, white
 (531) 27.05.01
 (511)
 5 – Pharmaceuticals, medical and veterinary preparations; sanitary preparations for medical purposes; dietetic food and substances adapted for medical or veterinary use, food for babies; dietary supplements for human beings and animals; plasters, materials for dressings; material for stopping teeth, dental wax; disinfectants; preparations for destroying vermin; fungicides, herbicides.

(260) AM 2022 116782 A
 (800) 1646435
 (151) 2021 12 24
 (891) 2021 12 24
 (731) INDIKA AGRI INTERNATIONAL PRIVATE LIMITED
 15-a, shop n0.- 8, geeta bhawan, basement
 nwa, west punjabi bagh, new delhi-110026,
 India

(540)

MEHNAZ

(591) Black, white
 (531) 27.05.01
 (511)
 30 – Coffee, tea and cocoa and substitutes therefor; rice; spices; dried and fresh pastas, noodles and dumplings; snacks manufactured from cereals; processed grains, starches, and goods made thereof, baking preparations and yeasts; confectionery; bread; chocolates; sugar, honey, treacle; salts, seasonings, flavourings and condiments; preserved herbs; savory sauces, chutneys and pastes; sweets (non-medicated); flour.

(260) AM 2022 116785 A
 (800) 1646467
 (151) 2021 08 31
 (891) 2021 08 31
 (731) Markushevskiy Igor Isaakovych
 Vul. Bolharska, 82, kv. 8, m. Odesa 65005,
 Ukraine;
 Maslenkov Volodymyr Mykolaiovych
 vul. Marshala Hovorova, 1-2, kv. 101, m. Odesa
 65058, Ukraine;

Shmulevych Vitalii Naumovych
 vul. Levanevskoho, 7, kv. 63, m. Odesa 65062,
 Ukraine

(540)

Good Year

(591) Black, white
 (531) 27.05.01
 (511)
 33 – Alcoholic beverages, except beer; aperitif wines; wine; grape wine; digesters [liqueurs and spirits]; brandy; whisky; grape-based alcoholic beverages; gin; arrack [arak]; anisette [liqueur]; anise [liqueur]; mead [hydromel]; vodka; kirsch; perry; cocktails; liqueurs; peppermint liqueurs; distilled beverages; pre-mixed alcoholic beverages, other than beer-based; alcoholic beverages containing fruit; bitters; piquette; rum; cider; spirits [beverages]; alcoholic extracts; alcoholic essences; fruit extracts, alcoholic.

(260) AM 2022 116786 A
 (800) 1646468
 (151) 2021 08 31
 (891) 2021 08 31
 (731) Markushevskiy Igor Isaakovych
 Vul. Bolharska, 82, kv. 8; m. Odesa 65005,
 Ukraine;
 Maslenkov Volodymyr Mykolaiovych
 vul. Marshala Hovorova, 1-2, kv. 101; m. Odesa
 65058, Ukraine;
 Shmulevych Vitalii Naumovych
 vul. Levanevskoho, 7, kv. 63; m. Odesa 65062,
 Ukraine

(540)

SAV'EUR

(591) Black, white
 (531) 27.05.01
 (511)
 33 – Alcoholic beverages, except beer; aperitif wines; wine; grape wine; digesters [liqueurs and spirits]; brandy; whisky; grape-based alcoholic beverages; gin; arrack [arak]; anisette [liqueur]; anise [liqueur]; mead [hydromel]; vodka; kirsch; perry; cocktails; liqueurs; peppermint liqueurs; distilled beverages; pre-mixed alcoholic beverages, other than beer-based; alcoholic beverages containing fruit; bitters; piquette; rum; cider; spirits [beverages]; alcoholic extracts; alcoholic essences; fruit extracts, alcoholic.

(260) AM 2022 116787 A
 (800) 1646470
 (151) 2021 09 28
 (891) 2021 09 28
 (731) S.C. LOOP PRODUCTIONS S.R.L.
 Str. Ion Tuculescu, nr. 19, Sector 3, 031611
 Bucuresti, Romania

(540)



(591) Black, white
 (531) 01.03.02; 01.03.16; 01.15.23; 05.05.20; 28.05
 (511)
 41 – Production of radio and television programs; production of shows; providing television programs, not downloadable, via video-on-demand services; providing online videos, not downloadable; television entertainment; entertainment services; entertainer services; presentation of variety shows; presentation of live performances.

(260) AM 2022 116788 A
 (800) 1646481
 (151) 2021 12 02
 (891) 2021 12 02
 (731) Limited Liability Company "ULTRASTAB"
 50, Grozilovo village, Teykovo district,
 RU-155044 Ivanovo region, Russian
 Federation

(540)



U L T R A N I T

(591) Black, white
 (531) 26.13.25; 27.05.01; 27.05.22
 (511)
 19 – Window frames, not of metal; swimming pools [structures], not of metal; binding material for road repair; geotextiles; prefabricated houses [kits], not of metal; doors, not of metal; roof gutters, not of metal; жалюзи, not of metal; outdoor blinds, not of metal and not of textile; street gutters, not of metal; buildings, not of metal; road marking sheets and strips of synthetic material; reinforcing materials, not of metal, for building; moldings, not of metal, for cornices; moldings, not of metal, for building; materials for making and coating roads; road coating materials; flas-

hing, not of metal, for building; duckboards, not of metal; poles, not of metal, for power lines; posts, not of metal, for power lines; palisading, not of metal; palings, not of metal; laths, not of metal; trellises, not of metal; latticework, not of metal; crash barriers, not of metal, for roads; wall claddings, not of metal, for building; windows, not of metal; wall linings, not of metal, for building; mouldings, not of metal, for cornices; props, not of metal; linings, not of metal, for building; paving blocks, not of metal; signalling panels, non-luminous and non-mechanical, not of metal; building panels, not of metal; wainscoting, not of metal; casement windows, not of metal; roof coverings, not of metal; slabs, not of metal, for building; paving slabs, not of metal; tile floorings, not of metal; door panels, not of metal; floating docks, not of metal, for mooring boats; partitions, not of metal; scaffolding, not of metal; insect screens, not of metal; hips for roofing; advertisement columns, not of metal; safety glass; insulating glass for building; stair-treads [steps], not of metal; rigid pipes, not of metal, for building; drain pipes, not of metal; chimneys, not of metal; penstock pipes, not of metal; gutter pipes, not of metal; water-pipes, not of metal; pantiles, not of metal; angle irons, not of metal; railway sleepers, not of metal; railroad ties, not of metal.

35 – Data search in computer files for others; commercial intermediation services; professional business consultancy; updating of advertising material; distribution of samples; negotiation and conclusion of commercial transactions for third parties; promoting the goods of others; computerized file management; compilation of information into computer databases; provision of commercial and business contact information; presentation of goods on communication media, for retail purposes; systemization of information into computer databases; marketing research; organization of exhibitions for commercial or advertising purposes; procurement services for others [purchasing goods and services for other businesses]; business appraisals; business management and organization consultancy; commercial or industrial management assistance; web site traffic optimization; layout services for advertising purposes; organization of trade fairs for commercial or advertising purposes; business auditing; business investigations; business efficiency expert services; compilation of statistics; business management consultancy; personnel management consultancy; business information; economic forecasting; television advertising; on-line advertising on a computer network; advisory services for business management.

(260) AM 2022 116790 A
 (800) 1646509
 (151) 2021 12 15
 (891) 2021 12 15
 (731) Heineken Brouwerijen B.V.
 Tweede Weteringplantsoen 21, NL-1017 ZD
 Amsterdam, Netherlands

(540)

SILVER

(591) Black, white
 (511)
 32 – Beers; non-alcoholic beers.
 33 – Alcoholic beverages (excluding beers); hard seltzers.

(260) AM 2022 116795 A
 (800) 1646668
 (151) 2022 01 20
 (891) 2022 01 20
 (731) Instrumentation Laboratory Company
 180 Hartwell Road, Bedford MA 01730, USA

(540)

ACL TOP

(591) Black, white
 (511)
 10 – Diagnostic instruments for medical use, namely a coagulation analyzer.

(260) AM 2022 116798 A
 (800) 1646694
 (151) 2022 01 20
 (891) 2022 01 20
 (731) Avon Products, Inc.
 1 Avon Place, Suffern NY 10901, USA

(540)



SCENT MIX

(591) Black, white
 (531) 27.05.01; 27.05.22
 (511)
 3 – Non-medicated toilet preparations; toiletries; skin care preparations; skin moisturizers; skin toners; body and beauty care preparations; powders, cleansers, creams and lotions, all for the face, hands and body; exfoliating scrubs for cosmetic purposes; cosmetic suntan preparations; sunscreen oils and lotions; soaps; shower and bath preparations; bath gel, bath oils, bath salts, bath beads, and effervescent bath preparations; beauty masks; talcum powder; nail polish; nail polish remover; false nails; adhesives for cosmetic purposes; cosmetics; eye cream; eye gels; eye lotions; eye make-up remover; eye shadow; eye liner; eyebrow cos-

metics; mascara; lipstick; lip liner; lip-gloss; lip balm; make-up foundation; facial concealer; blusher; tissues impregnated with cosmetic lotions; powdered cosmetic tissues; cotton sticks for cosmetic purposes; cotton wool for cosmetic purposes; pumice stone; preparations for cleaning, moisturising, colouring and styling the hair; shampoos, conditioners, finishing spray, and gels, all for the hair; preparations for cleaning the teeth; shaving and aftershave preparations; perfumes; fragrances; toilet waters; cologne; room fragrances; incense sticks; deodorants for human beings; antiperspirants for personal use (toiletries); essential oils (cosmetic); oils for perfumes and scents; potpourri; cosmetic kits.

(260) AM 2022 116800 A
 (800) 1646788
 (151) 2021 12 16
 (891) 2021 12 16
 (731) Limited liability company "FINE FLOR RUS"
 Kolomyazhsky pr-kt, 15, k.2, liter A,
 pomeshenie 65-N, RU-197348 Sankt-
 Petersburg, Russian Federation

(540)

КварцВинил QuartzVinyl

(591) Black, white
 (531) 27.05.01; 28.05
 (511)
 35 – Demonstration of goods; market studies; marketing research; presentation of goods on communication media, for retail purposes; sales promotion for others; outdoor advertising; distribution of samples; dissemination of advertising matter; direct mail advertising; advertising; online advertising on a computer network; procurement services for others [purchasing goods and services for other businesses].

(260) AM 2022 116801 A
 (800) 1646833
 (151) 2021 12 13
 (891) 2021 12 13
 (731) Philip Morris Brands Sàrl
 Quai Jeanrenaud 3, CH-2000 Neuchâtel,
 Switzerland

(540)



(591) Red, white and gray
 (531) 03.01.02; 24.07.01; 24.09.03; 24.09.05;
 25.01.06; 26.04.05; 26.04.16; 26.04.18;
 26.13.25; 27.05.01; 27.05.09; 27.05.10;
 27.05.24; 27.05.25; 29.01.13

(511)
 34 – Tobacco, raw or manufactured; tobacco products; cigars, cigarettes, cigarillos, tobacco for roll-your-own cigarettes, pipe tobacco, chewing tobacco, snuff tobacco, kretek; snus; tobacco substitutes (not for medical purposes); electronic cigarettes; tobacco products for the purpose of being heated; electronic devices and their parts for the purpose of heating cigarettes or tobacco in order to release nicotine-containing aerosol for inhalation; liquid nicotine solutions for use in electronic cigarettes; smokers' articles, cigarette paper, cigarette tubes, cigarette filters, tobacco tins, cigarette cases, ashtrays, pipes, pocket apparatus for rolling cigarettes, lighters, matches.

(260) AM 2022 116802 A
 (800) 1646845
 (151) 2021 10 18
 (891) 2021 10 18
 (731) Euro Games Technology Ltd.
 4, "Maritsa" Str., "Vranya-Lozen-Triugulnika",
 BG-1151 Sofia, Bulgaria
 (540)

Book of Flame

(591) Black, white
 (511)
 9 – Software; computer gaming software; computer software packages; computer operating system software; computer software, recorded; software drivers; virtual reality software; games software; entertainment software for computer games; computer programs for network management; operating computer software for main frame computers; monitors (computer hardware); computer hardware, apparatus for recording images; monitors (computer programs); computer game programs; computer programs for recorded games; apparatus for recording, transmission or reproduction of sound or images; communications servers [computer hardware]; electronic components for gambling machines; computer application software featuring games and gaming; computer software for the administration of on-line games and gaming; computer hardware for games and gaming; hardware and software for gambling, gambling machines, gambling games on the Internet and via telecommunication network.

28 – Gaming machines for gambling; chips for gambling; mah-jong; arcade games; gambling machines operating with coins, notes and cards; games; electronic games; parlor games; gaming chips; gaming tables; slot machines [gaming machines]; LCD game machines; slot machines and gaming devices; coin-operated

amusement machines; roulette chips; poker chips; chips and dice [gaming equipment]; equipment for casinos; roulette tables; gaming roulette wheels; casino games; automats and gambling machines; coin-operated machines and/or electronic coin-operated machines with or without the possibility of gain; boxes for coin-operated machines, slot machines and gaming machines; electronic or electrotechnical gaming devices, automats and machines, coin-operated machines; housings for coin-operated machines, gaming equipment, gaming machines, machines for gambling; electropneumatic and electrical gambling machines (slot machines).

41 – Gambling; services related to gambling; gaming services for entertainment purposes; casino, gaming and gambling services; training in the development of software systems; provision of gaming equipment for gambling halls; providing casino equipment [gambling]; gaming machine entertainment services; providing casino facilities [gambling]; halls with gaming machines; amusement arcade services; games equipment rental; rental of gaming machines; providing amusement arcade services; rental of gaming machines with images of fruits; editing or recording of sounds and images; sound recording and video entertainment services; hire of sound reproducing apparatus; provision of gaming equipment for casinos; providing of casino facilities; online gambling services; casino management services; operation of gaming establishments, gaming halls, internet casinos, online gambling sites.

(260) AM 2022 116803 A
 (800) 1646855
 (151) 2020 11 16
 (891) 2020 11 16
 (731) APPLE INC.
 One Apple Park Way, Cupertino CA 95014,
 USA
 (540)



(591) Black, white, and blue
 (531) 01.05.02; 01.15.21; 26.04.04; 26.04.16;
 26.04.24; 27.05.21; 28.03; 29.01.13

(511)
 9 – Computer software used in language translation.

(260) AM 2022 116805 A

(800) 1646883

(151) 2021 07 30

(891) 2021 07 30

(731) SOCAB GmbH

Verner Pantan Straße 2, 79395 Neuenburg,
Germany

(540)



(591) Black, white

(531) 26.01.03; 26.01.11; 26.01.24; 26.04.09

(511)

1 – Flavour improvers for tobacco; preparations for fermenting tobacco; chemicals for fermenting tobacco; sauce for preparing tobacco; antioxidants for use in the manufacture of food and beverages; chemicals for use in fermenting; enzymes for use in flavouring.

34 – Tobacco; leaf tobacco; loose, rolling and pipe tobacco; raw tobacco; manufactured tobacco; smokeless tobacco; shredded tobacco; tobacco and tobacco products (including substitutes); tobacco products; tobacco products for the purpose of being heated; cigarettes containing tobacco substitutes; cigarettes; cigarettes containing tobacco substitutes, not for medical purposes; cigars; cigars for use as an alternative to tobacco cigarettes; cigarettes, cigars, cigarillos and other ready-for-use smoking articles; flavourings, other than essential oils, for tobacco; flavoured tobacco (other than essential oils); hookah tobacco; tobacco tar for use in electronic cigarettes; tobacco free cigarettes, other than for medical purposes; hookahs; shisha pipes; tobacco pipes; electronic smoking pipes; pipe cleaners for tobacco pipes; pipes for smoking mentholated tobacco substitutes; pipe racks for tobacco pipes; cases, not of precious metal for pipes; tobacco containers and humidors; tobacco tins; tobacco pouches; tobacco jars; tobacco filters; tobacco pouches; tobacco pipe scrapers; pipe cleaners for tobacco pipes; absorbent paper for tobacco pipes; cigarette paper; books of cigarette papers; humidifiers for tobacco; devices for heating tobacco substitutes for the purpose of inhalation; inhalers for use as an alternative to tobacco cigarettes; oral vaporizers for smokers; hand held machines for injecting tobacco into paper tubes; pocket machines for rolling cigarettes; tips of yellow amber for cigar and cigarette holders; cigar holders; cigar holders of precious metal; humidors; ashtrays; lighters for smokers [cigarette lighters] (none of the aforesaid goods of precious metal or coated therewith); articles for use with tobacco; matches; flavourings, other than essential oils, for use in electronic cigarettes; chemical flavorings in liquid form used to refill electronic cigarette cartridges; electronic nicotine inhalation devices; electronic devices for the inhalation of nicotine containing aerosol; electronic cigarettes; electronic cigars; replaceable cartridges for electronic cigarettes; inhalable aerosols and liquids for use in tobacco water pipes; liquid solutions for use in electronic cigarettes; electronic cigarette liquid [e-liquid] comprised of flavorings in liquid form used to refill electronic cigarette cartridges; electronic cigarette liquid [e-liquid] comprised of propylene glycol; electronic cigarette liquid [e-liquid] comprised of vegetable glycerin; cartridges sold filled with chemical flavorings in liquid form for electronic cigarettes; refill cartridges for electronic cigarettes; cartridges for electronic cigarettes; smoking sets for electronic cigarettes; tobacco or its substitutes for inhalation using water pipes, in particular flavored tobacco; smokeless cigarette vaporizer pipes; electronic cigarette atomizers; electronic cigarette cartomizers; chewing tobacco; filter-tipped cigarettes; tobacco free cigarettes, other than for medical purposes; cigarillos; lighters for smokers; absorbent paper for tobacco pipes; bags adapted for pipes for smokers; steam stones for hookahs [tobacco substitutes]; electronic hookahs; electronic smoking pipes; devices for heating tobacco for the purpose of inhalation; electronic cigarette cases; devices for extinguishing heated cigarettes, cigars and heated tobacco sticks; holders for electronic cigarettes; Asian long tobacco pipe sheaths; Asian long tobacco pipes (kiseru); mouthpieces for cigarettes; mouthpieces for pipes, namely for tobacco pipes and for water pipes; pipes for smoking mentholated tobacco substitutes; mentholated tobacco; mouthpieces for cigarette holders; tobacco pipe filters; tobacco pipe knives; pipe racks for tobacco pipes; pipe tampers; pipe stems; pipe stoppers [smokers requisites]; pipe stands [smokers requisites]; smokers' articles of precious metal; smokers' articles, not of precious metal; electronic cigarette cleaners; absorbent paper for tobacco; electronic cigarette boxes; spittoons for tobacco users; smoking urns; tobacco pipes of precious metal; tobacco pipes, not of precious metal; cigarette filters; cigarette tubes; cigarette tips; ready-made cigarette tubes with filters; cigarette holders; cigarette holders of precious metal; cigar cutters; cigar pouches; cigar filters.

rette cartridges; electronic nicotine inhalation devices; electronic devices for the inhalation of nicotine containing aerosol; electronic cigarettes; electronic cigars; replaceable cartridges for electronic cigarettes; inhalable aerosols and liquids for use in tobacco water pipes; liquid solutions for use in electronic cigarettes; electronic cigarette liquid [e-liquid] comprised of flavorings in liquid form used to refill electronic cigarette cartridges; electronic cigarette liquid [e-liquid] comprised of propylene glycol; electronic cigarette liquid [e-liquid] comprised of vegetable glycerin; cartridges sold filled with chemical flavorings in liquid form for electronic cigarettes; refill cartridges for electronic cigarettes; cartridges for electronic cigarettes; smoking sets for electronic cigarettes; tobacco or its substitutes for inhalation using water pipes, in particular flavored tobacco; smokeless cigarette vaporizer pipes; electronic cigarette atomizers; electronic cigarette cartomizers; chewing tobacco; filter-tipped cigarettes; tobacco free cigarettes, other than for medical purposes; cigarillos; lighters for smokers; absorbent paper for tobacco pipes; bags adapted for pipes for smokers; steam stones for hookahs [tobacco substitutes]; electronic hookahs; electronic smoking pipes; devices for heating tobacco for the purpose of inhalation; electronic cigarette cases; devices for extinguishing heated cigarettes, cigars and heated tobacco sticks; holders for electronic cigarettes; Asian long tobacco pipe sheaths; Asian long tobacco pipes (kiseru); mouthpieces for cigarettes; mouthpieces for pipes, namely for tobacco pipes and for water pipes; pipes for smoking mentholated tobacco substitutes; mentholated tobacco; mouthpieces for cigarette holders; tobacco pipe filters; tobacco pipe knives; pipe racks for tobacco pipes; pipe tampers; pipe stems; pipe stoppers [smokers requisites]; pipe stands [smokers requisites]; smokers' articles of precious metal; smokers' articles, not of precious metal; electronic cigarette cleaners; absorbent paper for tobacco; electronic cigarette boxes; spittoons for tobacco users; smoking urns; tobacco pipes of precious metal; tobacco pipes, not of precious metal; cigarette filters; cigarette tubes; cigarette tips; ready-made cigarette tubes with filters; cigarette holders; cigarette holders of precious metal; cigar cutters; cigar pouches; cigar filters.

35 – Retail services in relation to tobacco; retail services in relation to articles for use with tobacco; wholesale services in relation to tobacco; wholesale services in relation to articles for use with tobacco; retail services in relation to cigarettes; retailing in relation to articles for use with cigarettes; wholesale services in relation to cigarettes; wholesaling in relation to articles for use with cigarettes; retail services in relation to cigars; retailing in relation to articles for use with cigars; wholesale services in relation to cigars; wholesaling in relation to articles for use with cigars; retailing in relation to smokers' accessories; retailing in relation to articles for use with smokers' accessories; wholesaling in relation to smokers' accessories; who-

lesaling in relation to articles for use with smokers' accessories.

(260) AM 2022 116807 A

(800) 1646899

(151) 2021 09 14

(891) 2021 09 14

(731) Exeger Operations AB

Box 55597, SE-102 04 Stockholm, Sweden

(540)



(591) Black, white

(531) 27.05.01; 27.05.21

(511)

7 – Domestic robots; robots in the field of agriculture; marine robotics; space robots; robots in the field of automobile; robots for construction, robots for industrial use, robots for household and commercial cleaning, robots used in manufacture; solar power generators and peripheral apparatus therefor; electric generators using solar cells and parts and fittings therefor.

9 – Scientific, nautical, surveying, photographic, cinematographic, optical, weighing, measuring, signalling, checking (supervision), life-saving and teaching apparatus and instruments; apparatus and instruments for conducting, switching, transforming, accumulating, regulating or controlling electricity; measuring instruments and measuring and control instruments; apparatus and instruments for storing power; apparatus and instruments for recording, transmission or reproduction of sound or images; solar panels for use in energy generation and recycling; data processing equipment; computers; calculating machines; computer software; photovoltaic apparatus for generating electricity; photovoltaic apparatus for converting solar radiation and light energy into electricity; solar cells for electricity generation, parts for solar cells, included in this class; solar panels; photovoltaic solar modules; solar batteries; solar battery chargers; solar batteries for domestic use; solar-powered rechargeable batteries; solar-powered electronic apparatus and instruments and fittings thereto included in this class; solar-powered portable electronic apparatus and instruments; solar-powered computers; solar-powered computer tablets; solar-powered ear phones; solar-powered electronic sports simulators; portable electronic sports and fitness apparatus, being portable computers; electronic reading and electronic reading apparatus having writing function; wireless communication apparatus; cell phones; cases adapted for mobile phones; tablets; cases for tablet computers; portable computers; sleep-

ves for laptops; wireless headphones; loudspeakers; speakers for wireless use; wireless keyboards; mouse pads; electric signs; light (traffic- -) apparatus [signalling devices]; safety helmets; sports glasses; helmets for use in sports; games software; head protection; goggles; remote control; digital and electronic computer tablets; telecommunication apparatus; video devices; calibrating apparatus and instruments; electronic tracking devices; fitness monitoring devices; remote controls, remote control, controllers for machine tools, management software, control apparatus for software, checking (supervision) apparatus; bags and fittings for the aforesaid goods included in this class; smartwatches; headwear for sporting activities for protection against injury; military and emergency response robots; security robots; humanoid robots; robots for experiments; teaching apparatus in the nature of robots; robots with artificial intelligence; electric power supply units using solar cells.

11 – Solar cell lighting apparatus; solar powered torches; solar energy powered heating installations; solar powered lamps; roof lights [lamps]; solar panels for use in heating; fittings for the aforesaid goods included in this class.

12 – Vehicles; robot vehicles; apparatus for locomotion by land, air or water, and structural parts and fittings therefor, included in this class; transportation robots.

14 – Time instruments; solar clocks and watches; parts and fittings for chronometric instruments; sports watches.

18 – Leather and imitation leather; leatherboard (imitation of leather); imitation leather cases; bags made of imitation leather; imitation leather purses; imitations of leather for furniture; imitations of leather for shoes; shoulder belts, bands and straps of leather or imitation leather; casual bags; fashion handbags; travelling trunks and all-purpose carrying bags; umbrellas and parasols; walking sticks; whips, harness and saddlery; collars, clothing and leashes for animals.

25 – Clothing; footwear; hats; sportswear; athletics shoes; clothing accessories, namely belts [clothing].

28 – Toys; games [intelligence games]; electronic games; sports playthings; robotic toys; handheld video game apparatus; video game controllers; video games accessories; sporting goods, sporting articles, sports equipment and accessories; protectors (sporting articles); bags for sporting goods; protective equipment (sporting articles); gymnastic articles; remote control toys.

40 – Generation of electricity from solar energy; custom assembly of materials for others.

42 – Scientific and technological services and research and design relating thereto; industrial analysis and research; design and development of computer

hardware and software; design and development of software for control, regulation and monitoring of solar energy systems; research and design in the field of solar cell development; consultancy relating to solar cell technology.

(260) AM 2022 116808 A

(800) 1646948

(151) 2021 09 15

(891) 2021 09 15

(731) BCA-Relocation GmbH

Ziegelstr. 2, 10117 Berlin, Germany

(540)



(591) Dark blue, white, light blue and black

(531) 26.04.04; 26.04.24; 27.05.10; 29.01.04

(511)

35 – Headhunting services; employee relocation services; recruitment agency services; placement of staff; career planning consultancy; career advisory services (other than education and training advice).

(260) AM 2022 116809 A

(800) 1647003

(151) 2021 11 17

(891) 2021 11 17

(731) Kaddex

Harju maakond, Lasnamäe linnaosa, Sepapajatu 6, EE-15551 Tallinn, Estonia

(540)

Kaddex

(591) Black, white

(511)

9 – Downloadable computer software for blockchain technology.

36 – Electronic funds transfer provided via blockchain technology; financial transactions via blockchain; monetary exchange; financial exchange; exchange brokerage; financial exchange services; monetary exchange operations; commodities exchange services; monetary exchange services; money exchange services; foreign exchange services; financial exchange of crypto assets.

38 – Electronic data exchange.

42 – Cryptocurrency mining; blockchain as a service [BaaS]; certification of data via blockchain; data authentication via blockchain; user authentication services using blockchain technology; data storage via blockchain.

(260) AM 2022 116810 A

(800) 1647007

(151) 2021 10 22

(891) 2021 10 22

(731) DİA PRO TIBBİ ÜRÜNLER SANAYİ VE TİCARET ANONİM ŞİRKETİ

Tophanelioğlu Caddesi No:70/1A, Altunizade Üsküdar, İstanbul, Türkiye

(540)

Across

(591) Black, white

(531) 27.05.17

(511)

9 – Measuring instruments, instruments, indicators, and laboratory materials, including those for scientific and laboratory use; apparatus for recording, transmission or reproduction of sound or images (including devices for data processing, communication and reproduction, and computer hardware equipment); magnetic and optic data carriers and computer software and programmes recorded thereto, downloadable and recordable electronic publications, encoded magnetic and optic cards, antennas, satellite antennas, amplifiers for antennas, parts of the aforementioned goods; ticket dispensers, automatic teller machines (ATM); electronic components used in the electronic parts of machines and apparatus, counters and quantity indicators for measuring the quantity of consumption, automatic time switches; eyeglasses, sunglasses, optical lenses and cases, containers, parts and components thereof; apparatus and instruments for conducting, transforming, accumulating or controlling electricity, electric plugs, junction boxes [electricity], electrical adapters, battery chargers, electric and electronic cables, batteries, accumulators; alarms and anti-theft alarms, other than for vehicles, electric bells; signalling apparatus and instruments, luminous or mechanical signs for traffic use; fire extinguishing apparatus, fire engines, fire hose and fire hose nozzles; radar apparatus, sonars, night vision apparatus and instruments; decorative magnets; metronomes.

10 – Surgical, medical, dental and veterinary apparatus and instruments; furniture especially made for medical purposes; artificial limbs and prostheses; medical orthopaedic articles; surgical gowns and surgical sterile sheets; adult sexual aids; condoms; babies' bottles; babies' pacifiers; teats; teethers for babies.

44 – Medical services; beauty care services; veterinary services, animal husbandry, animal breeding, shoeing horses [farrier services]; agriculture, horticulture and forestry services, landscape design services; medical advisory services in the field of personnel health.

(260) AM 2022 116811 A
 (800) 1647017
 (151) 2021 11 02
 (891) 2021 11 02
 (731) ARI GIDA SANAYI ANONIM SIRKETI
 Ankara Cad. No:344, KURTKOY, ISTANBUL,
 Türkiye
 (540)



(591) Blue, white and black
 (531) 01.15.21; 27.05.17; 29.01.13
 (511)

5 – Dietary supplements for pharmaceutical and veterinary purposes; dietary supplements; nutritional supplements; medical preparations for slimming purposes; food for babies; herbs and herbal beverages adapted for medicinal purposes, foodstuff for babies.

(260) AM 2022 116813 A
 (800) 1647063
 (151) 2022 01 12
 (891) 2022 01 12
 (731) Association des Opérateurs postaux publics européens AISBL en abrégé POSTEUROP
 Boulevard Brand Whitlock 114, B-1200
 Bruxelles, Belgium
 (540)

PostEurop

(591) Black, blue
 (531) 26.01.03; 27.05.01; 29.01.12
 (511)

35 – Advertising; business management; business administration; office functions; business information and consultancy services; business representative services; business strategy and planning services; commercial lobbying services; promotion of the commercial interests and affairs of the professionals in the sector of transport and delivery of goods provided by an association to its members; developing promotional campaigns for businesses; organization of exhibitions and congresses for commercial or advertising purposes; conducting market studies and market analysis; business consultancy services relating to the management of fund raising campaigns; business consultancy services relating to the promotion of fund raising campaigns.

36 – Financial affairs; fund raising.

39 – Transport; packaging and storage of goods; provision of information and advisory services relating to transport and storage of goods.

41 – Education; providing of training.

45 – Legal services; advisory services relating to regulatory affairs; reviewing standards and practices to assure compliance with laws and regulations; lobbying services, other than for commercial purposes.

(260) AM 2022 116814 A
 (800) 1647099
 (151) 2021 11 29
 (891) 2021 11 29
 (731) YVES SAINT LAURENT
 37-39 rue de Bellechasse, F-75007 PARIS,
 France

(540)

YVES SAINT LAURENT

(591) Black, white
 (531) 27.05.01
 (511)

35 – Services for the retail sale and retail sale online of spectacles, accessories for telephones and tablets, jewelry, horological instruments, bags and small leather goods, namely, wallets, coin purses, card cases (leatherware), banknote holders, document cases, briefcases (leatherware), clutch bags (leatherware), key cases (leatherware), luggage label holders, clothing, footwear, headgear, hosiery, connected clothing, smart clothing, connected shoes, smart shoes; advertising; marketing; organizing, conducting and promoting social events for commercial and advertising purposes; organizing fashion shows for promotional and advertising purposes; shop window dressing; public relations; dissemination (distribution) of samples; sales promotion; dissemination of advertisements (leaflets, prospectuses, printed matter, samples).

(260) AM 2022 116815 A
 (800) 733013
 (151) 2000 04 26
 (891) 2022 02 04
 (731) LOUIS ROYER
 27-29 rue du Chail, F-16200 JARNAC, France
 (540)

LOUIS ROYER

(591) Black, white
 (511)

33 – Alcoholic beverages (except beers).

(260) AM 2022 116816 A

(800) 899419

(151) 2006 01 23

(891) 2022 02 04

(731) Innospec Limited

Innospec Manufacturing Park, Oil Sites Road,
Ellesmere Port, Cheshire CH65 4EY,
United Kingdom

(540)



(591) Red, purple, green, blue and black

(531) 26.03.01; 26.03.10; 27.05.01; 29.01.15

(511)

1 – Chemicals additives to fuel; antioxidants for fuels; industrial detergents and surfactants used in the manufacture of cleaning preparations; combustion catalysts; stabiliser for fuels and dispersants for deposit precursors and insoluble materials found in fuels; chelating agents; defoaming preparations; additives to personal care products; chemical aroma additives for use in the fragrance, pharmaceutical and agrochemical industries; emollients for use in the personal care and cosmetics industries; chemical static dissipators.

2 – Corrosion inhibitors.

4 – Non-chemical additives to fuel; wax coatings.

(260) AM 2022 116817 A

(800) 1105867

(151) 2011 12 19

(891) 2022 01 28

(731) GIFi

Z.I. La Boulbène, BP 40, F-47300
VILLENEUVE SUR LOT, France

(540)



(591) Red, yellow

(531) 26.03.01; 26.03.22; 27.05.02; 29.01.12

(511)

35 – Bringing together (excluding the transport thereof), providing and presenting consumers with goods and services with a view to their sale and purchase, namely musical instruments, playing cards, umbrellas, parasols, walking sticks, sporting goods, decorations for Christmas trees, mats, doormats, soap, perfumery, cosmetics, cosmetic preparations, essential oils, hair lotions, dentifrices, candles and wicks for lighting,

cutlery, forks and spoons, side arms, other than firearms, razors, magnetic data carriers, recording disks, audio and video compact disks, light bulbs, lighting fittings, glasses, jewelry, jewelry items, timepieces and chronometric instruments, printed matter, books, magazines, newspapers, posters, photographs, stationery, postcards, trunks and suitcases, backpacks; handbags, wallets, change purses, furniture, mirrors, picture frames, office desks, settees, chairs, cushions, armchairs, beds, household or kitchen utensils and containers (not of precious metal or coated therewith), glassware, porcelain and earthenware, glass boxes, candelabra, not of precious metal, flower-pot covers, not of paper, figurines of porcelain, wood or glass, mosaics of glass, not for building, opaline glass, vases, not of precious metal, tableware not of precious metal, glasses (receptacles), flasks, not of precious metal, soap holders, napkin holders not of precious metal, powder compacts, not of precious metal, perfume vaporizers, perfume atomizers, natural and artificial flowers, utensils and containers for the bathroom and toilet, curtain rods, net curtains, lighting fittings, toys, small tools for gardening, tools, clothing, footwear headgear, rope, string, tents, awnings, tarpaulins, sails, bed and table covers of textile, ribbon, lace, buttons, pins, games, toys, pastry, confectionery, edible ices, non-alcoholic beverages, beer, alcoholic beverages (except beer); commercial information, assistance and advice for consumers on such goods; advertising, organization of advertising campaigns, dissemination of advertisements, shop-window dressing, demonstration of goods, dissemination of advertising materials, namely leaflets, prospectuses, printed matter, samples; market studies, computer file management, organization of trade fairs and exhibitions for commercial and advertising purposes.

42 – Interior design.

(260) AM 2022 116818 A

(800) 1216739

(151) 2014 01 10

(891) 2022 02 04

(731) Innospec Limited

Innospec Manufacturing Park, Oil Sites Road,
Ellesmere Port, Cheshire CH65 4EY,
United Kingdom

(540)

INNOSPEC

(591) Black, white

(511)

1 – Chemical additives; chemical additives for fuels; chemical additives for crude oil, gas and natural gas liquids; chemicals and lost circulation materials for use in oil and gas drilling fluid additives; surfactants; chelating agents; synthetic ingredients for fragrances; chemicals for use in the agrochemical industry; chemical additives for personal care preparations, cosme-

tic preparations, cleaning preparations and agrochemical preparations; chemical static dissipators; chemical preparations for use as corrosion inhibitors.

2 – Corrosion inhibitors (Terms too vague in the opinion of the International Bureau – Rule 13(2)(b) of the Common Regulations).

4 – Industrial oils and greases; lubricants; fuels; fuel additives; petroleum additives; engine performance protection agents; upper cylinder lubricants; valve rest recession protection agents; low lead and unleaded petrol additives; wax coatings, lubricants for plastics; dust absorbing, wetting and binding compositions; illuminants; candles and wicks for lighting; coating comprising polyethylene waxes or eva copolymer waxes or oxidised polyethylene waxes or oxidised eva-copolymer waxes or any mixture of the aforesaid waxes or any mixture of the aforesaid waxes with other kinds of waxes or any preparation of the aforesaid waxes in solvents or water; compounds comprising polyethylene waxes or eva-copolymer waxes or oxidised polyethylene waxes or oxidised eva-copolymer waxes or any mixture of the aforesaid waxes or any mixture of the aforesaid waxes with other kinds of waxes; wax for use in manufacture; copolymer waxes; polyethylene- and eva-copolymer waxes; oxidised polyethylene waxes; oxidised and non-oxidised copolymer waxes.

(260) AM 2022 116819 A

(800) 1263742

(151) 2015 04 21

(891) 2022 02 01

(731) BEYMEN PERAKENDE VE TEKSTİL
YATIRIMLARI ANONİM ŞİRKETİ
Ayazaga Mah. Azerbaycan Cad., 3A 3 O 3,
Sarıyer, İSTANBUL, Türkiye

(540)



(591) Blue

(531) 27.05.10; 27.05.19; 29.01.04

(511)

18 – Processed or unprocessed leather and hides; artificial leather, kid, leather for lining, goods made of leather, imitations of leather or other materials and not included in other classes, bags, travelling trunks and suitcases, wallets, leather cases, key cases, boxes of leather or kid; umbrellas, parasols, walking sticks; whips, harness, saddlery, saddle straps and stirrup leathers.

25 – Clothing made of all kinds of materials except protective ones, underwear, outer clothing, socks, footwear, headgear.

35 – Advertising services, advertising agencies, dissemination of advertising matters, organization of exhibitions for commercial or advertising purposes, modeling for advertising or sales promotion, marketing studies, sales promotion, show window dressing, questionnaire services, public relations; office functions, secretarial services, business administration services, commercial or industrial management assistance, business management and organization consultancy, accounting, import and export agencies; business management of performing artists; expertise services for evaluation of industrial and commercial goods; auctioneering retail sale services namely bringing together for the benefit of others, of a wide variety of goods enabling customers to view and purchase those goods, such services may be provided by retail stores, wholesale outlets, through mail order catalogues, or by means of electronic media.

(260) AM 2022 116820 A

(800) 1375390

(151) 2017 09 20

(891) 2022 02 04

(731) CHAMPAGNE HENRIOT

81 rue Coquebert, F-51100 REIMS, France

(540)

HEMERA

(591) Black, white

(511)

33 – Sparkling wines.

(260) AM 2022 116821 A

(800) 1553700

(151) 2020 06 19

(891) 2021 12 02

(731) GEN İLAÇ VE SAĞLIK ÜRÜNLERİ
SANAYİ VE TİCARET ANONİM ŞİRKETİ
Mustafa Kemal Mahallesi 2119., Sokak No:3
D:2-3, Çankaya, TR-06520 Ankara, Türkiye

(540)



(591) Copper (7511C), copper (7509 C) and green
(7483 C)

(531) 01.13.01; 27.05.01; 29.01.13

(511)

5 – Pharmaceuticals, medical and veterinary preparations; sanitary preparations for medical purposes; dietetic food and substances adapted for medical or veterinary use, food for babies; dietary supplements for human beings and animals; plasters, materials for dressings; material for stopping teeth, dental wax; disin-

fectants; preparations for destroying vermin; fungicides, herbicides.

(260) AM 2022 116822 A
 (800) 1561426
 (151) 2020 10 07
 (891) 2022 01 27
 (731) MATCH GROUP LLC
 8750 North Central Expressway, Suite 1400,
 Dallas TX 75321, USA
 (540)

TINDER

(591) Black, white
 (511)
 9 – Downloadable software in the nature of a mobile application for internet-based dating and matchmaking; downloadable software in the nature of a mobile application in the field of social media, namely, for sending status updates to subscribers of web feeds, uploading and downloading electronic files to share with others.
 45 – Dating services; internet-based social networking, introduction and dating services.

(260) AM 2022 116823 A
 (800) 1561448
 (151) 2020 10 07
 (891) 2022 01 27
 (731) MATCH GROUP, LLC
 P.O. BOX 25458, DALLAS TX 75225, USA
 (540)

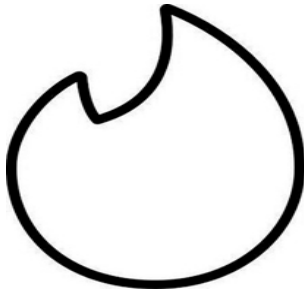

(591) Black, white
 (531) 01.15.05; 26.13.25
 (511)
 9 – Downloadable software in the nature of a mobile application for internet-based dating and matchmaking; downloadable software in the nature of a mobile application in the field of social media, namely, for sending status updates to subscribers of web feeds, uploading and downloading electronic files to share with others.
 45 – Dating services provided via mobile applications; internet-based social networking, introduction and dating services.

(260) AM 2022 116824 A
 (800) 1584574
 (151) 2021 02 19
 (891) 2022 02 09
 (731) P & C S.p.A.
 Via Antonio De Francisco 135/1, I-10036
 Settimo Torinese, Italy
 (540)



(591) Black, white
 (531) 11.03.04; 27.03.15
 (511)
 11 – Empty coffee capsules of plastic.
 30 – Coffee; coffee concentrates; coffee essences; coffee capsules, filled.
 35 – Retail services in relation to coffee; wholesale services in relation to coffee; business assistance relating to franchising; business management advisory services related to franchising; provision of assistance [business] in the operation of franchises.

(260) AM 2022 116825 A
 (800) 1608382
 (151) 2021 07 15
 (891) 2022 02 09
 (731) P & C S.P.A.
 Via Antonio de Francisco 135/1, I-10036
 Settimo Torinese, Italy
 (540)

PAGLIERO

(591) Black, white
 (511)
 30 – Coffee; coffee extracts; mixtures of coffee; artificial coffee; coffee capsules; coffee extracts for use as substitutes for coffee; chocolates.
 35 – Retail services in relation to coffee; wholesale services in relation to coffee.
 43 – Café services; café services.

(260) AM 2022 116869 A
 (800) 1647168
 (151) 2021 02 09
 (891) 2021 02 09
 (731) FM World Sp. z o.o.
 ul. Żmigrodzka 247; PL-51-129 Wrocław,
 Poland

(540)



(591) Black, white

(531) 25.01.25; 27.05.03

(511)

3 – Soaps; perfumery and fragrances; essential oils; deodorants and antiperspirants; cosmetics; cosmetics in the form of creams; cosmetic creams and lotions; cosmetic lotions; skin care preparations; cosmetic masks; cleansing milk for toilet purposes; oils for cosmetic purposes; eyebrow cosmetics; make-up preparations; eyebrow pencils; lipstick; cosmetic preparations for eyelashes; nail polish; hair care lotions; dentifrices; cotton wool pads and wipes for cosmetic purposes; cotton wool pads and tissues impregnated with cosmetics; make-up pads of cotton wool.

5 – Salts for mineral water baths; air deodorising preparations; skin care creams for medical use; creams for dermatological use; skin care creams for medical use.

21 – Combs; sponges; brushes (except paintbrushes); glassware, porcelain and earthenware not included in other classes; cosmetic utensils; powder compacts [cases]; eyebrow brushes; eyelash combs; nail brushes; applicators for cosmetics; perfume vaporizers; toilet cases; flasks; cleaning cotton; pads for cleaning; cleaning rags; make-up removing appliances; comb cases.

(260) AM 2022 116875 A

(800) 1647346

(151) 2021 08 27

(891) 2021 08 27

(731) Ruijie Networks Co., Ltd.

Building 19, Juyuanzhou Industrial Park,
No. 618 Jinshan Avenue, Cangshan District,
Fuzhou City, Fujian Province, China

(540)



(591) Black, white

(531) 28.03

(511)

9 – Communications computers; network servers; computer software applications, downloadable; network routers; switchboards; network communication equip-

ment; radios; monitoring apparatus, other than for medical purposes; camcorders; cables, electric; optical cables.

(260) AM 2022 116887 A

(800) 1647624

(151) 2021 10 20

(891) 2021 10 20

(731) Huo Liang

Room 1003, unit 1, building 1, Hetang Yaju,
Futian street, Yiwu City, Jinhua City,
322000 Zhejiang Province, China

(540)

YENISEI

(591) Black, white

(531) 27.05.01

(511)

16 – Paper; painting paper; towels of paper; paperboard boxes; printed matter; printed publications; pictures; packing paper; book binders; stationery; ink; stamps; writing instruments; gummed tape; drafting instruments; arts and crafts paint kits [school supplies]; electric or non electric typewriter; teaching materials; architectural models.

21 – Kitchenware; glassware; works of art made of crystal; works of art of porcelain, ceramic, earthenware, terra-cotta or glass; drinking vessels; toilet utensils; combs; toothbrushes; cosmetic utensils; heat-insulated containers; cleaning instruments, hand-operated; unworked or semi-worked glass, [except building glass]; feeding troughs for animals; electric device for trapping and killing insects.

28 – Game equipment; toys; board game equipment; sports ball; exercise equipment; archery apparatus; sports equipment; swimming pool (entertainment supplies); elbow guards [sports articles]; decorations for Christmas trees (except lighting items and candy); fishing tackle; grip tapes for rackets; twirling batons; camouflage screens [sports articles]; scratch cards for playing lottery games.

(260) AM 2022 116888 A

(800) 1647646

(151) 2021 12 22

(891) 2021 12 22

(731) MVH I, Inc.

90 State Street, Suite 700, Office 40 Albany
NY 12207, USA

(540)

MYLÉ

(591) Black, white

(511)

35 – Retail store services featuring tobacco products, nicotine-based liquid, liquid nicotine used to fill elec-

tronic cigarettes, pods filled with liquid nicotine for electronic cigarettes, electronic cigarette liquids, chemical flavorings in liquid form used to fill electronic cigarettes, pods filled with chemical flavorings in liquid form for electronic cigarettes, electronic cigarettes, electronic smoking vaporizers, electronic cigarettes, tobacco substitutes in liquid solution form for electronic cigarettes, smoker's and vaper's articles for electric and electronic cigarettes, cases for electronic cigarettes, electronic cigarette accessories, boxes for electronic cigarettes and electronic cigarette accessories, clothing, hats, hoodies, pants, shirts, shorts, sports caps and hats, sweatshirts, t-shirts, food, and beverages; retail department store services; on-line retail and wholesale store services featuring tobacco products, nicotine-based liquid, liquid nicotine used to fill electronic cigarettes, pods filled with liquid nicotine for electronic cigarettes, electronic cigarette liquids, chemical flavorings in liquid form used to fill electronic cigarettes, pods filled with chemical flavorings in liquid form for electronic cigarettes, electronic cigarettes, electronic smoking vaporizers, electronic cigarettes, tobacco substitutes in liquid solution form for electronic cigarettes, smoker's and vaper's articles for electric and electronic cigarettes, cases for electronic cigarettes, electronic cigarette accessories, boxes for electronic cigarettes and electronic cigarette accessories, clothing, hats, hoodies, pants, shirts, shorts, sports caps and hats, sweatshirts, t-shirts, food and beverages; wholesale and on-line retail department store and online marketplace services for wholesale and retail buyers and demonstration and presentation of goods on communication media for wholesale and retail purposes; advertising, marketing, outdoor and indoor advertising, telemarketing and promotion services; on-line advertising and marketing services; digital advertising services whether online or by means of other portable digital devices; sales promotion and activation of search engines for sales promotion, web indexing for commercial advertising purposes; advertising and marketing services provided by means of direct and indirect methods of marketing communications, namely, social media, search engine optimization and marketing, inquiry marketing, internet marketing, mobile marketing, blogging and other forms of passive, sharable or viral communications channels; event planning and management for marketing, branding, promoting and advertising including but not limited to tradeshow advertising and other business to business as well as consumer outlets.

(260) AM 2022 116889 A

(800) 1647691

(151) 2021 10 07

(891) 2021 10 07

(731) Euro Games Technology Ltd.

4, "Maritsa" Str., "Vranya-Lozen-Triugulnika",
BG-1151 Sofia, Bulgaria

(540)



(591) Green, yellow, orange, red and black

(531) 27.05.02; 29.01.14

(511)

9 – Software; computer gaming software; computer software packages; computer operating system software; computer software, recorded; software drivers; virtual reality software; games software; entertainment software for computer games; computer programs for network management; operating computer software for main frame computers; monitors (computer hardware); computer hardware; apparatus for recording images; monitors (computer programs); computer game programs; computer programs for recorded games; apparatus for recording, transmission or reproduction of sound or images; communications servers [computer hardware]; electronic components for gambling machines; computer application software featuring games and gaming; computer software for the administration of on-line games and gaming; computer hardware for games and gaming; hardware and software for gambling, gambling machines, gambling games on the Internet and via telecommunication network.

28 – Gaining machines for gambling; chips for gambling; mah-jong; arcade games; gambling machines operating with coins, notes and cards; games; electronic games; parlor games; gaming chips; gaming tables; slot machines [gaming machines]; LCD game machines; slot machines and gaming devices; coin-operated amusement machines; roulette chips; poker chips; chips and dice [gaming equipment]; equipment for casinos; roulette tables; gaming roulette wheels; casino games; automats and gambling machines; coin-operated machines and/or electronic coin-operated machines with or without the possibility of gain; boxes for coin-operated machines, slot machines and gaming machines; electronic or electrotechnical gaming devices, automats and machines, coin-operated machines; housings for coin-operated machines, gaming equipment, gaming machines, machines for gambling; electropneumatic and electrical gambling machines (slot machines).

41 – Gambling; services related to gambling; gaming services for entertainment purposes; casino, gaming and gambling services; training in the development of software systems; provision of gaming equipment for gambling halls; providing casino equipment [gambling]; gaming machine entertainment services; providing casino facilities [gambling]; halls with gaming machines; amusement arcade services; games equipment rental; rental of gaming machines; providing amusement arcade services; rental of gaming machi-

nes with images of fruits; editing or recording of sounds and images; sound recording and video entertainment services; hire of sound reproducing apparatus; provision of gaming equipment for casinos; providing of casino facilities; online gambling services; casino management services; operation of gaming establishments, gaming halls, internet casinos, online gambling sites.

(260) AM 2022 116890 A

(800) 1647721

(151) 2021 12 20

(891) 2021 12 20

(731) EcoFlow Inc.

Plant A202, Founder Technology Industrial Park, Shiyan Subdistrict, Bao'an District, Shenzhen, 518000 Guangdong, China

(540)



(591) Black, white

(531) 27.05.01; 27.05.10

(511)

7 – Agricultural machines; lawnmowers [machines]; electric hedge trimmers; mechanical lawn mowers; washing machines [laundry]; kitchen machines, electric; pneumatic machines and instruments; wind-powered installations for generating electricity [wind farms]; industrial robots; alternators; dynamos; dynamos and parts thereof; direct current generators; air compressors; alternating current servo motors; vacuum cleaners powered by rechargeable batteries; road sweeping machines, self-propelled; emergency power generators; portable electric power generators.

(260) AM 2022 116895 A

(800) 1647863

(151) 2022 01 14

(891) 2022 01 14

(731) Autowini Inc.

(Dogok-dong, Handok building) 3F, 2645, Nambusunhwan-ro, Gangnam-gu, Seoul 06271, Republic of Korea

(540)

Partswini

(591) Black, white

(531) 27.05.01

(511)

35 – Used automobiles sales agency; heavy equipment sales agency; sales arranging of used automobi-

les; sales arranging of heavy equipment; business intermediary services relating to used automobiles; automobiles sales agency; sales agency of parts and fittings for automobiles; business intermediary services relating to automobiles; business intermediary services relating to parts and fittings for automobiles; business intermediary services relating to heavy equipment; bicycles sales agency; sales arranging of bicycles; sales agency of parts and fittings for bicycles; sales arranging of parts and fittings for bicycles; business intermediary services relating to parts and fittings for bicycles; tires sales agency; sales arranging of tires; business intermediary services relating to tires; automobiles auctioneering; advertising on the internet for others; publication of publicity texts; marketing consulting; consultancy relating to public relations; business management of hotels; business management consultancy; systemization of information into computer databases; management and compilation of computerised databases; import-export agency services; sales promotion for others through membership card schemes; sales promotion for others through membership card schemes involving discounts and purchase points; auctioneering; auctioneering provided on the internet.

(260) AM 2022 116896 A

(800) 1647915

(151) 2021 10 07

(891) 2021 10 07

(731) Euro Games Technology Ltd.

4, "Maritsa" Str., "Vranya-Lozen-Triugulnika", BG-1151 Sofia, Bulgaria

(540)



(591) Green, light green, yellow, orange, red and brown

(531) 27.05.03; 27.05.17; 29.01.15

(511)

9 – Software; computer gaming software; computer software packages; computer operating system software; computer software, recorded; software drivers; virtual reality software; games software; entertainment software for computer games; computer programs for network management; operating computer software for main frame computers; monitors (computer hardware); computer hardware; apparatus for recording images; monitors (computer programs); computer game programs; computer programs for recorded games; apparatus for recording, transmission or reproduction of sound or images; communications servers [computer hardware]; electronic components

for gambling machines; computer application software featuring games and gaming; computer software for the administration of on-line games and gaming; computer hardware for games and gaming; hardware and software for gambling, gambling machines, gambling games on the Internet and via telecommunication network.

28 – Gaming machines for gambling; chips for gambling; mah-jong; arcade games; gambling machines operating with coins, notes and cards; games; electronic games; parlor games; gaming chips; gaming tables; slot machines [gaming machines]; LCD game machines; slot machines and gaming devices; coin-operated amusement machines; roulette chips; poker chips; chips and dice [gaming equipment]; equipment for casinos; roulette tables; gaming roulette wheels; casino games; automats and gambling machines; coin-operated machines and/or electronic coin-operated machines with or without the possibility of gain; boxes for coin-operated machines, slot machines and gaming machines; electronic or electrotechnical gaming devices, automats and machines, coin-operated machines; housings for coin-operated machines, gaming equipment, gaming machines, machines for gambling; electropneumatic and electrical gambling machines (slot machines).

41 – Gambling; services related to gambling; gaming services for entertainment purposes; casino, gaming and gambling services; training in the development of software systems; provision of gaming equipment for gambling halls; providing casino equipment [gambling]; gaming machine entertainment services; providing casino facilities [gambling]; halls with gaming machines; amusement arcade services; games equipment rental; rental of gaming machines; providing amusement arcade services; rental of gaming machines with images of fruits; editing or recording of sounds and images; sound recording and video entertainment services; hire of sound reproducing apparatus; provision of gaming equipment for casinos; providing of casino facilities; online gambling services; casino management services; operation of gaming establishments, gaming halls, internet casinos, online gambling sites.

(260) AM 2022 116897 A

(800) 1647918

(151) 2021 12 20

(891) 2021 12 20

(731) EcoFlow Inc.

Plant A202, Founder Technology Industrial Park, Shiyan Sub-district, Bao'an District, Shenzhen 518000 Guangdong, China

(540)

ECOFLOW

(591) Black, white

(531) 27.05.01

(511)

7 – Agricultural machines; lawnmowers [machines]; electric hedge trimmers; mechanical lawn mowers; washing machines [laundry]; kitchen machines, electric; pneumatic machines and instruments; wind-powered installations for generating electricity [wind farms]; industrial robots; alternators; dynamos; dynamos and parts thereof; direct current generators; air compressors; alternating current servo motors; vacuum cleaners powered by rechargeable batteries; road sweeping machines, self-propelled; emergency power generators; portable electric power generators.

(260) AM 2022 116903 A

(800) 1647965

(151) 2022 01 19

(891) 2022 01 19

(731) BAUSCH + LOMB IRELAND LIMITED

3013 Lake Drive, Citywest Business Campus, Dublin 24, Ireland

(540)

EYELUMA

(591) Black, white

(511)

10 – Ophthalmic microsurgical apparatus and instruments for use in ocular or eye-related procedures.

(260) AM 2022 116904 A

(800) 1647995

(151) 2021 12 03

(891) 2021 12 03

(731) KELME SPORTS PRODUCTS CO., LTD

No.12 Fuxing Road, Shangguo Community, Xintang Street, Jinjiang City, Quanzhou City, Fujian Province, China

(540)



KELME

(591) Black, white

(531) 03.06.03; 27.05.17

(511)

25 – Clothing; sports jerseys; sports shoes; shoes; football shoes; hats; hosiery; gloves [clothing]; scarves; girdles.

(260) AM 2022 116905 A
 (800) 1648007
 (151) 2022 01 28
 (891) 2022 01 28
 (731) Beats Electronics, LLC
 8600 Hayden Place, Culver City CA 90232,
 USA

(540)

BEATS FIT PRO

(591) Black, white
 (511)
 9 – Earphones; electric charging cables for use with headphones and earphones; carrying case for earphones; protective case for earphones; microphone.

(260) AM 2022 116906 A
 (800) 1648011
 (151) 2021 12 29
 (891) 2021 12 29
 (731) Broadfar (Shanghai) Management Consulting Co., LTD.
 Room 2453, Floor 2, No. 1420 South Zhongshan Rd., Huangpu District, 200001 Shanghai, China

(540)

INMATE

(591) Black, white
 (531) 27.05.01
 (511)
 11 – Cooling appliances and installations; heating apparatus; heating apparatus, electric; heating elements; evaporators; lighters; steam generating installations; sterilizers; air cooling apparatus; cooling installations for tobacco; pocket warmers; heating apparatus for solid, liquid or gaseous fuels.

34 – Hand-rolling tobacco; matches; tobacco; electronic cigarettes; cigarette filters; flavourings, other than essential oils, for tobacco; cigarettes; lighters for smokers; devices for heating tobacco for the purpose of inhalation; tobacco substitutes, not for medical purposes.

(260) AM 2022 116907 A
 (800) 1648028
 (151) 2021 12 03
 (891) 2021 12 03
 (731) Chanel SARL
 Quai du Général-Guisan 24, CH-1204 Genève,
 Switzerland

(540)

CHANEL

(591) Black, white

(511)
 28 – Games, toys and playthings; video game apparatus; gymnastic and sporting articles; Christmas tree decorations; sports equipment; play balloons; balloons; billiard balls; marbles for games; building blocks [toys]; bodyboards; snow globes; play balls; water wings; soap bubbles [toys]; twirling batons; playing cards; kites; targets; bells for Christmas trees; golf sticks [golf clubs]; dice; figurines [toys]; nets for sports; gloves [accessories for games]; baseball gloves; boxing gloves; golf gloves; fencing gauntlets; batting gloves [accessories for games]; swimming jackets; dumbbells; barbells; rattles; covers specially designed for sports equipment; bags especially designed for skis and surfboards; counters [discs] for games; chips for gambling; checkers [games]; dominos; chess games; surf skis; sledges [sports articles]; mah-jong; puppets; masks [toys]; toy masks; theatrical masks; archery implements; teddy bears; flippers for swimmers; ice skates; roller skates; in-line roller skates; plush toys; skateboards; sailboards; surfboards; roulette wheels; dolls; elbow guards [sports articles]; knee guards [sports articles]; punching bags; jigsaw puzzles; rackets; cricket bags; golf bags, with or without wheels; surfboard leashes; skis; waterskis; snowboards; slide [game]; spinning tops [toys]; trampolines; scooters [toys]; dolls' clothes; shuttlecocks; boomerangs; confetti; fishing tackle; flippers for diving; ski sticks; toys for household pets.

(260) AM 2022 116908 A
 (800) 1648129
 (151) 2021 07 02
 (891) 2021 07 02
 (731) ANB METAL SANAYI VE TICARET A.S
 Buyuksehir Mah. Cumhuriyet Cad., Ekinoks
 E1- E2 No:1/100, Beylikduzu, Istanbul,
 Türkiye

(540)



(591) The diamond on the left is red and darkens from left to right. The upper diamond is blue and darkens from right to left. The bottom diamond is gray and darkens from right to left. The letter A is red and darkens from left to right. The letter N is dark blue. The letter B is gray color.
 (531) 26.04.03; 26.04.04; 26.04.09; 27.05.01;
 27.05.02; 27.05.03; 27.05.09; 27.05.22

(511)
 6 – Ores of non-precious metal; common metals and their alloys and semi-finished products made of these materials; irons for construction; mats and stirrups of common metals for buildings; common metals in the form of plate, billet, stick, profile, sheet and sheeting;

goods and materials of common metal used for storage, wrapping, packaging and sheltering purposes, containers of metal (storage, transport), buildings of metal, frames of metal for building, poles of metal for building, metal boxes, packaging containers of metal, aluminium foil, fences made of metal, guard barriers of metal, metal tubes, storage containers of metal, metal containers for the transportation of goods, ladders of metal; grates of metal; doors, windows, shutters, jalousies and their cases and fittings of metal; non-electric cables and wires of metal; ironmongery; small hardware of metal; screws of metal; nails; bolts of metal; nuts of metal; pegs of metal; flakes of metal; pitons of metal; metal chains; furniture casters of metal; fittings of metal for furniture; industrial metal wheels; door handles of metal; window handles of metal; hinges of metal; metal latches; metal locks; metal keys for locks; metal rings; metal pulleys; ventilation ducts, vents, vent covers, pipes, chimney caps, manhole covers, grilles of metal for ventilation, heating, sewage, telephone, underground electricity and air conditioning installations; metal panels or boards (non-luminous and non-mechanical) used for signalling, route showing, publicity purposes, signboards of metal, advertisement columns of metal, signaling panels of metal, non-luminous and non-mechanical traffic signs of metal; pipes of metal for transportation of liquids and gas, drilling pipes of metal and their metal fittings, valves of metal, couplings of metal for pipes, elbows of metal for pipes, clips of metal for pipes, connectors of metal for pipes; safes (strong boxes) of metal; metal railway materials, metal rails, metal railway ties, railway switches; bollards of metal, floating docks of metal, mooring buoys of metal, anchors; metal moulds for casting, other than machine parts; works of art made of common metals or their alloys, trophies of common metal; metal closures, bottle caps of metal; metal poles; metal pillars; scaffolding of metal; metal stakes; masts of metal; metal pallets and metal ropes for lifting, loading and transportation purposes; metal hangers, ties, straps, tapes and bands used for loadlifting and load-carrying; wheel chocks made primarily of metal; metal profile laths for vehicles for the purposes of decoration.

(260) AM 2022 116909 A

(800) 1648148

(151) 2021 01 15

(891) 2021 01 15

(731) TOYOTA JIDOSHA KABUSHIKI KAISHA

(also trading as TOYOTA MOTOR CORPORATION)

1, Toyota-cho, Toyota-shi, Aichi-ken 471-8571, Japan

(540)

WOVEN CITY

(591) Black, white

(511)

39 – Vehicle transport and rental services; tracking, locating and monitoring of vehicles, maritime vessels and aircraft; arranging of transport and travel; transportation services in relation to events; storage, transport, pick-up, and packing of freight; cargo delivery services; transport, delivery, packaging, and storage of goods and providing information relating thereto; transportation, packaging, storage and delivery of foods and beverages and providing information relating thereto; providing transportation information; providing information relating to the transportation of goods and passengers; food delivery; pick up, delivery and storage of personal property; logistics services consisting of the storage, transportation and delivery of goods; transport and storage of waste and recycling materials; railway transport and provision of information relating thereto; car transport and provision of information relating thereto; transportation of passengers by bus; delivery of goods by lorry; car sharing services; transportation of freight containers by truck; providing information about timetables of vehicle transport; providing information about booking status of vehicle transport; transport by man-powered vehicles; providing road and traffic information; providing customized driving directions; GPS navigation services; vehicle driving services; packaging and packing services; freight brokerage and providing information relating thereto; cargo handling; removal services and providing information relating thereto; warehousing services; providing information relating to warehousing services; refrigerated warehousing; storage of containers and cargo; storage, distribution and supply of energy and fuel; storage, distribution and supply of hydrogen fuel; temporary safekeeping of personal belongings; temporary storage of deliveries; distribution of gas; distribution of renewable energy; distribution of energy; electricity distribution; distribution of electricity generated by photovoltaic apparatus and installations for generating solar electricity; information and consultancy services relating to distribution of electricity generated by photovoltaic apparatus and installations for generating solar electricity; distribution of electricity generated by fuel cells; information and consultancy services relating to distribution of electricity generated by fuel cells; water supply and distribution services; hot water supply and distribution services; distribution of district heating and cooling; distribution of heat; rental of warehouse space; rental of garages and parking places; provision of car parking facilities; valet parking; car park services and providing information relating thereto; car park services using on-board self-driving and automatic parking systems; operating toll roads; providing vessel mooring facilities; operating parking lots; rental of loading-unloading machines and apparatus; rental of pallets; rental of transport and storage containers; rental of robots for handling loads; vehicle rental; car rental; rental of electric cars; rental of hydrogen cars; rental

of tractors; rental of agricultural tractors; rental of bicycles; rental of handling tractors; rental of mechanical parking systems; rental of packing or wrapping machines and apparatus; rental of robots for packaging and wrapping; rental of freezers; refrigerator rental; rental of wheelchairs; on-line trip and travel reservation services; booking of seats for coach travel; reservation of transport for sporting, scientific, political and cultural events; on-line information and booking services in the field of business travel; travel tour conducting; arranging and booking of travel, cruises and sightseeing travel tours; reservation and booking of seats for travel; travel arrangement and reservation services, excluding those for lodging; collection of waste and trash.

42 – Providing weather information; architectural design; surveying; urban planning; designing of machines, apparatus, instruments (including their parts) or systems composed of such machines, apparatus and instruments; engineering services relating to energy supply systems; design and development of energy distribution networks; design and development of fuel cells; design and development of photovoltaic systems; design services; provision of information relating to computer programming; programming of energy management software; design and development of virtual private network (VPN) operating software; design and development of virtual reality software; design and development of software for control, regulation and monitoring of solar energy systems; testing, research, design and development of computer programs and software for use with partially automated automobiles, buses and trucks; testing, research, design and development of computer programs and software for use with self-driving automobiles, buses and trucks; testing, research, design and development of computer programs and software for use with autonomous automobiles, buses and trucks; testing, research, design and development of partially automated automobiles, buses and trucks; testing, research, design and development of self-driving automobiles, buses and trucks; testing, research, design and development of autonomous automobiles, buses and trucks; technological advice relating to computers, automobiles and industrial machines; testing, inspection and research services in the fields of pharmaceuticals, cosmetics and foodstuffs; providing information relating to testing, inspection and research services in the fields of foodstuffs; consultancy relating to technical research in the field of food and beverages; technical consultancy relating to research services in the field of foods and dietary supplements; research on building construction or city planning; testing and research services in the field of preventing pollution; testing and research services in the field of electricity; testing and research services in the field of civil engineering; research services in the field of energy; consultancy in the field of energy efficiency; scientific research in

the field of renewable energy; consultancy in the field of energy-saving; technical consultancy in the field of energy saving and energy efficiency; consultancy relating to technological services in the field of power and energy supply; research and development services relating to solar cells and electricity generation; research and testing in the field of photovoltaic systems; research and testing in the field of fuel cells; technical development of structural elements, devices and systems for solar collectors and photovoltaic plants; testing, inspection and research services in the fields of agriculture, livestock breeding and fisheries; testing and research services relating to machines, apparatus and instruments; providing computer programs on data networks; rental of computers; hosting online web facilities for others for sharing online content; hosting on-line web facilities for others for conducting interactive discussions.

(260) AM 2022 116943 A
 (800) 1265213
 (151) 2014 12 19
 (891) 2022 02 15
 (731) Vitabiotics Ltd
 1 Apsley Way, London NW2 7HF, United Kingdom
 (540)

IMMUNACE

(591) Black, white
 (511)
 5 – Pharmaceutical preparations; vitamin and mineral preparations; food preparations for infants and invalids.

(260) AM 2022 116944 A
 (800) 1518747
 (151) 2020 01 17
 (891) 2022 01 25
 (731) Bolt Technology OÜ
 Vana-Lõuna tn 15, EE-10134 Tallinn, Estonia
 (540)

Bolt Food

(591) Black, white
 (511)
 39 – Transport; delivery services; food delivery services; delivery of food by restaurants; delivery of food and drink prepared for consumption; delivery of groceries; courier services [messages or merchandise]; packaging and storage of goods; temporary storage of deliveries; packaging of food and beverages; parcel delivery.
 43 – Provision of information relating to restaurants; making reservations and bookings for restaurants and meals; contract food services; take-away food and drink services; reservation services for booking meals;

mobile catering services; consultancy services in the field of food and drink catering; services for providing food and drink.

(260) AM 2022 116945 A
(800) 1568208
(151) 2020 09 07
(891) 2022 02 07
(731) ÖZDUMAN TARIM MAKİNALARI SANAYİ VE TİCARET ANONİM ŞİRKETİ
1. Organize Sanayi Bölgesi, Bayrampaşa Caddesi, Güvençli Sokak, No:9, Selçuklu, Konya, Türkiye

(540)

The logo for Özduman features a red circular emblem with a white wheat stalk inside, followed by the brand name 'Özduman' in a bold, red, sans-serif font.

(591) Red and white
(531) 05.07.02; 27.07.04; 29.01.12
(511)
7 – Machines and robotic mechanisms (machines) for use in agriculture and animal breeding, machines and robotic mechanisms (machines) for processing cereals, fruits, vegetables and food; agricultural seed planting machines; cultivators [machines], agricultural cultivators.

(260) AM 2022 116946 A
(800) 1588961
(151) 2021 03 05
(891) 2022 02 15
(731) Vitabiotics Ltd
1 Apsley Way, London NW2 7HF, United Kingdom

(540)

WELLWOMAN

(591) Black, white
(511)
5 – Food supplements, vitamin and mineral preparations in solid, powder and liquid forms, all designed for women; all included in class 5.

(260) AM 2022 116947 A
(800) 1590116
(151) 2021 03 05
(891) 2022 02 15
(731) Vitabiotics Ltd
1 Apsley Way, London NW2 7HF, United Kingdom

(540)

WELLBABY

(591) Black, white
(511)
5 – Pharmaceutical preparations, vitamin and mineral preparations, nutritional supplements, all for infants and babies.

(260) AM 2022 116948 A
(800) 1607169
(151) 2021 03 05
(891) 2022 02 15
(731) Vitabiotics Ltd
1 Apsley Way, London NW2 7HF, United Kingdom

(540)

FEROGLOBIN

(591) Black, white
(511)
5 – Pharmaceutical preparations, vitamin and mineral preparations, all for infants and invalids, all included in this class and containing iron.

(260) AM 2022 116949 A
(800) 1642780
(151) 2021 06 08
(891) 2022 01 28
(731) SANTE A. Kowalski Sp.j.
ul. Jagiellońska 55A, PL-03-301 Warszawa, Poland

(540)

LOVEGE

(591) Black, white
(511)
5 – Dietary supplements and dietetic preparations; nutritional supplement meal replacement bars for boosting energy; infant formula; dietary fiber to aid digestion; vitamin supplements; vitamin and mineral supplements; mineral food supplements; vitamin drinks; dietary supplemental drinks; bread products for diabetics; appetite suppressants; artificial sweeteners adapted for diabetics; food supplements; vitamin tablets; cod liver oil; vitamins and vitamin preparations; gummy vitamins; food for diabetics; prenatal vitamins.

29 – Birds eggs and egg products; meats; dairy products and dairy substitutes; oils and fats; processed fruits, fungi and vegetables (including nuts and pulses); fish, seafood and molluscs; nut-based food bars; consommés; vegetable burgers; soy chips; potato chips; potato sticks; banana chips; cooked dish consisting primarily of rich soybean paste and tofu (cheonggukjang-jjigae); cooked dish consisting primarily of chicken and ginseng (samgyetang); cooked dish consisting primarily of soybean paste and tofu (doenjang-jjigae); cooked dish consisting primarily of fermented vegetable, pork and tofu (kimchi-jjigae); yoghurt desserts; artificial milk based desserts; fruit desserts; desserts made from milk products; cheese dips, dairy-based dips, meat-based dips; extracts for soups; falafel; french fries; prepared meat dishes; prepared meals consisting substantially of seafood; stews; stewed apples; edible birds' nests; potato dumplings; stock cubes; soup cubes; soup concentrates; fish cakes; onion rings; mixes for making soup; frozen french fries; ve-

getable marrow paste; eggplant paste; soup pastes; potato fritters; roast chestnuts; potato snacks; soy-based snack foods; fruit-based snack food; cooked meat dishes; faggots [food]; pollen prepared as foodstuff; potato flakes; broth [soup]; prepared salads; soya [prepared]; foods consisting principally of meats, cheeses, fruits or vegetables; fish stock; vegetable stock; bouillon; casseroles [foods consisting principally of meats, fish, cheeses, or vegetables]; soups; preparations for making soup; soup powders; canned soups; chilled foods consisting predominately of fish.

30 – Sugars, natural sweeteners, sweet coatings and fillings, bee products; coffee, teas and cocoa and substitutes therefor; ice, ice creams, frozen yogurts and sorbets; salts, seasonings, flavourings and condiments; baked goods, confectionery, chocolate and desserts; processed grains, starches, and goods made thereof, baking preparations and yeasts; cereals; pasta; carbohydrate preparations for food; preparations made from cereals; food preparations based on grains; chocolate-based ready-to-eat food bars; filled baguettes; cheeseburgers [sandwiches]; chips [cereal products]; vegetable flavoured corn chips; seaweed flavoured corn chips; tortilla chips; taco chips; puffed corn snacks; rice crisps; cheese curls [snacks]; crisps made of cereals; filled bread rolls; pies [sweet or savoury]; pies containing meat; rice biscuits; flapjacks; rice crackers [senbei]; egg pies; mincemeat pies; prepared rice dishes; prepared pizza meals; ready to eat savory snack foods made from maize meal formed by extrusion; prepared meals containing [principally] rice; hamburgers contained in bread rolls; sandwiches; hot dog sandwiches; candy coated popcorn; canapes; rice crackers; crackers made of prepared cereals; corn, roasted; fried corn; pizzas; pies; flavoured popcorn; pretzels; rice-based snack food; tortilla snacks; cereal-based snack food; snack food products made from potato flour; sesame seeds [seasonings]; roasted and ground sesame seeds; snack foods consisting principally of bread; snack foods consisting principally of extruded cereals; snack food products consisting of cereal products; snack foods prepared from maize; snacks manufactured from muesli; pies containing fish; stir-fried rice; rice salad; savory pastries; pasta salad; macaroni salad; spaghetti and meatballs; pizza bases; french toast; rice cakes; pies containing vegetables; wrap [sandwich]; dried seaweed rolls [gimbap]; tamales.

32 – Non-alcoholic beverages; beer and brewery products; preparations for making beverages.

(260) AM 2022 116997 A

(800) 1648663

(151) 2021 12 10

(891) 2021 12 10

(731) MBM LLC

Manandyan 33/21, Yerevan, Armenia

(540)

TULIP

(591) Black, white

(531) 05.05.03; 05.05.20; 05.05.21; 27.05.01

(511)

3 – Cosmetic preparations for baths; beauty masks; skin whitening creams; cream for whitening the skin; nail polish; nail varnish; hair lotions; hair dyes; hair colorants; false eyelashes; cosmetic preparations for eyelashes; cosmetic kits; cosmetics; cotton wool for cosmetic purposes; cosmetic pencils; cosmetic creams; make-up removing preparations; lacquer-removing preparations; depilatory wax; essential oils; etheral oils; petroleum jelly for cosmetic purposes; greases for cosmetic purposes; lotions for cosmetic purposes; cleansing milk for toilet purposes; toiletries preparations; eyebrow cosmetics; shampoos; perfumes; nail care preparations; cosmetic preparations for skin care; lipsticks; pomades for cosmetic purposes; make-up powder; eyebrow pencils; talcum powder for toilet use; cosmetic dyes; antiperspirants [toiletries]; sun-tanning preparations [cosmetics]; tissues impregnated with cosmetic lotions; hair spray; mascara; douching preparations for personal sanitary or deodorant purposes [toiletries]; lip glosses; balms, other than for medical purposes; sunscreen preparations; bath preparations, not for medical purposes; hair conditioners; tissues impregnated with make-up removing preparations; phytocosmetic preparations; nail glitter; micellar water; body paint for cosmetic purposes; blush; eye shadow; toning creams [cosmetics]; eye pencil for cosmetic purposes; eyeliner for cosmetic purposes; lip liner for cosmetic purposes; makeup setting sprays; bath gel; liquid soaps; hand creams; body and face creams; vaginal washes for personal sanitary or deodorant purposes; depilatory preparations; depilatories; shaving soap; shaving preparations; after-shave lotions; eau de cologne; scented water; toilet water.

(260) AM 2022 116998 A

(800) 1648667

(151) 2021 12 23

(891) 2021 12 23

(731) Joint Stock Company United Chemical

Company Uralchem

Presnenskaya nab., 6, bld. 2, RU-123112

Moscow, Russian Federation

(540)

УРАЛХИМ

(591) Black, white

(531) 28.05

(511)

1 – Chemicals for use in industry, science and photography, as well as in agriculture, horticulture and forestry; fertilizers.

5 – Acaricides; dietary supplements for animals; insecticides; pesticides; vitamin preparations; preparations for repelling and destroying vermin; preparations for destroying noxious animals; slug exterminating preparations; preparations of trace elements for human and animal use; fungicides; herbicides.

9 – Software.

35 – Advertising; business management services; business administration services.

37 – Construction; repair; installation services.

39 – Transport; packaging and storage of goods.

42 – Scientific and technological services and research and design relating thereto; industrial analysis and industrial research services; design and development of computer hardware and software.

(260) AM 2022 117033 A

(800) 1649381

(151) 2021 12 24

(891) 2021 12 24

(731) Ark Technologies Pty Ltd

Level 40, 140 William Street, Melbourne
VIC 3000, Australia

(540)

CETTIRE

(591) Black, white

(511)

3 – Non-medicated cosmetics and toiletry preparations; non-medicated dentifrices; perfumery, essential oils; soap; bath gel; make-up; shampoo and conditioner; nail varnish; room fragrance; bleaching preparations and other substances for laundry use; cleaning, polishing, scouring and abrasive preparations.

9 – Scientific, research, navigation, surveying, photographic, cinematographic, audiovisual, optical, weighing, measuring, signalling, detecting, testing, inspecting, life-saving and teaching apparatus and instruments; apparatus and instruments for conducting, switching, transforming, accumulating, regulating or controlling the distribution or use of electricity; apparatus and instruments for recording, transmitting, reproducing or processing sound, images or data; recorded and downloadable media, computer software, blank digital or analogue recording and storage media; downloadable software applications; electronic publications; downloadable podcasts; mechanisms for coin-operated apparatus; cash registers, calculating devices; computers and computer peripheral devices; wearable computers; diving suits, divers' masks, ear plugs for divers, nose clips for divers and swimmers, gloves for divers, breathing apparatus for underwater swimming; fire-extinguishing apparatus; clothing that protects against serious or life-threatening injuries, for example, clothing for protection against accidents, irradiation and fire, bullet-proof clothing, protective

helmets, head guards for sports, mouth guards for sports, protective suits for aviators, knee-pads for workers; magnets; sunglasses; optical apparatus and instruments including eyeglasses, contact lenses, magnifying glasses, mirrors for inspecting work, peepholes; batteries and chargers for electronic cigarettes; electric and electronic effects units for musical instruments; laboratory robots, teaching robots, security surveillance robots, humanoid robots with artificial intelligence; automated teller machines, invoicing machines, material testing instruments and machines; eyeglass cases, cases for smartphones, cases especially made for photographic apparatus and instruments; joysticks for use with computers, other than for video games, virtual reality headsets, smartglasses; encoded cards including gift cards, credit cards, smart cards and debit cards; parts, fittings and accessories for the aforesaid.

12 – Vehicles; apparatus for locomotion by land, air or water; drones; motors and engines for land vehicles; couplings and transmission components for land vehicles; air cushion vehicles; remote control vehicles, other than toys; parts of vehicles, for example, bumpers, windscreens, steering wheels, tyres for vehicle wheels, as well as treads for vehicles; parts, fittings and accessories for the aforesaid.

14 – Precious metals and their alloys; jewellery, precious and semi-precious stones; horological and chronometric instruments; jewellery, including imitation jewellery, for example, paste jewellery; cuff links, tie pins, tie clips; key rings, key chains and charms therefor; wristwatches; electronic clocks and watches; jewellery charms; jewellery boxes; component parts for jewellery, clocks and watches, for example, clasps and beads for jewellery, movements for clocks and watches, clock hands, watch springs, watch crystals; works of art of precious metal; ornaments, made of or coated with precious or semi-precious metals or stones; parts, fittings and accessories for the aforesaid.

16 – Advertisements (printed matter); cardboard or paper boxes; printed matter; record tokens, not encoded; diaries; printed publications; poster magazines; posters; adhesive printed stickers; adhesive stickers; sticker activity books; stickers (stationery); calendars; desk calendars; stationery; anniversary cards; photographs; photography books; birthday cards; blank cards; cards; greeting cards; printed cards (other than magnetic or encoded); trading cards, other than for games; gift wrap; periodical publications; paper knives and paper cutters; cases, covers and devices for holding or securing paper, for example, document files, money clips, holders for cheque books, paper-clips, passport holders, scrapbooks; certain office machines, for example, typewriters, duplicators, franking machines for office use, pencil sharpeners; painting articles for use by artists and interior and exterior painters, for example, artists' watercolour saucers, painters' easels and palettes, paint rollers and trays; certain

disposable paper products, for example, bibs, handkerchiefs and table linen of paper; certain goods made of paper or cardboard not otherwise classified by function or purpose, namely paper bags, envelopes and containers for packaging, statues, figurines and works of art of paper or cardboard, such as figurines of papier mache, framed or unframed lithographs, paintings and watercolours; tags and labels for packaging; parts, fittings and accessories for the aforesaid.

18 – Leather and imitations of leather; animal skins and hides; fur; luggage and carrying bags, for example, suitcases, trunks, travelling bags, sling bags for carrying infants, school bags; umbrellas and parasols; walking sticks; whips, harness and saddlery; collars, leashes and clothing for animals; carrying cases for documents, suit cases, carry-ons, leather goods, handbags and all manner of bags; luggage or baggage tags; business card cases and pocket wallets; boxes and cases of leather or leatherboard; parts, fittings and accessories for the aforesaid.

20 – Furniture, mirrors, picture frames; soft furnishings [cushions]; containers, not of metal, for storage or transport; unworked or semi-worked bone, horn, whalebone or mother-of-pearl; shells; meerschaum; yellow amber; metal furniture, furniture for camping, gun racks, newspaper display stands; indoor window blinds and shades; bedding, for example, mattresses, bed bases, pillows; mirrors; looking glasses; registration plates, not of metal; small items of hardware, not of metal, for example, bolts, screws, dowels, furniture casters, collars for fastening pipes; letter boxes, not of metal or masonry; baskets, not of metal; mannequins; coffins and funerary urns; clothes stands; plastic key cards, not encoded and not magnetic; parts, fittings and accessories for the aforesaid.

21 – Household or kitchen utensils and containers; cookware and tableware, except forks, knives and spoons; combs and sponges; brushes, except paintbrushes; brush-making materials; articles for cleaning purposes; unworked or semi-worked glass, except building glass; glassware, porcelain and earthenware; works of art made of materials such as porcelain, earthenware, terracotta or glass, included in this class; household and kitchen utensils, for example, fly swatters, clothes-pegs, mixing spoons, basting spoons and corkscrews, as well as serving utensils, for example, sugar tongs, ice tongs, pie servers and serving ladles; household, kitchen and cooking containers, for example, vases, bottles, piggy banks, pails, cocktail shakers, cooking pots and pans, and non-electric kettles and pressure cookers; small hand-operated kitchen apparatus for mincing, grinding, pressing or crushing, for example, garlic presses, nutcrackers, pestles and mortars; dish stands and decanter stands; cosmetic and toilet utensils, for example, electric and non-electric combs and toothbrushes, cosmetic brushes, dental floss, foam toe separators for use in pedicures, powder puffs, fitted vanity cases; gardening articles, for ex-

ample, gardening gloves, window-boxes, buckets, watering cans and nozzles for watering hose; fitted picnic baskets; boot brushes; grooming articles; hip flasks; indoor aquaria, terrariums and vivariums; parts, fittings and accessories for the aforesaid.

24 – Textiles and substitutes for textiles; household linen; curtains of textile or plastic; sleeping bags, sleeping bag liners; place mats; table covers; textile covers for furniture; wall hangings; face towels; bath towels; beach towels; parts, fittings and accessories for the aforesaid.

25 – Clothing, footwear, headgear; parts of clothing, footwear and headwear, for example, cuffs, pockets, ready-made linings, heels and heelpieces, cap peaks, hat frames (skeletons); clothing and footwear for sports, for example, ski gloves, sports singlets, cyclists clothing, judo and karate uniforms, football shoes, gymnastic shoes, ski boots; masquerade costumes; paper clothing, paper hats for use as clothing; bibs, not of paper; pocket squares; footmuffs, not electrically heated; undergarments, swimwear, active wear; parts, fittings and accessories for the aforesaid.

26 – Heating adhesives patches for repairing textile articles.

27 – Carpets, rugs, mats and matting, linoleum and other materials for covering existing floors; wall hangings, not of textile; automobile carpets; mats being floor coverings, for example, bath mats, door mats, gymnastic mats, yoga mats; artificial turf; wallpaper, including textile wallpaper; parts, fittings and accessories for the aforesaid.

28 – Games, toys and playthings; video game apparatus; gymnastic and sporting articles; decorations for christmas trees; sporting goods; sporting balls; apparatus for gymnastics; novelties for parties and party favours; playing cards; balloons; amusement and game apparatus, including controllers therefor; novelty toys; hunting and fishing tackle; clothing for toys; sporting articles for wear adapted for use in a specific sport (other than helmets); parts, fittings and accessories for the aforesaid.

33 – Alcoholic beverages, except beers; alcoholic preparations for making beverages; wines, fortified wines; alcoholic cider, perry; spirits, liqueurs; alcoholic essences, alcoholic fruit extracts, bitters.

35 – Retail services and online trading services for users to purchase or exchange goods and services provided by any means, including in connection with personal goods, sporting goods and equipment, fitness goods and equipment, luxury goods, household goods, electronic goods, consumable goods, digital goods, vehicles for use on land, air and water and goods and accessories therefor, clothing and accessories for pets, consumable goods for pets, cleaning products, hair care products, health care products, skincare products, dental care products, laundry products, storage, party

supplies, balloons, sewing products, craft products, garden products, outdoor decor, indoor decor, leisure goods, uniforms, maternity clothing, maternity products, umbrellas, candles, tableware, alcoholic beverages, bedding, furnishings, jets, boats, posters, paintings, prints, photography, drawing, sculptures and other works for art, commemorative and collectible coins and money, toy figurines, books, clothing, headgear, footwear, jewellery, ornaments, watches, fashion accessories, textiles, undergarments, swimwear, active wear, clothing patches, pens, writing implements, notebooks, stationery, furniture, homewares, mobile telephone accessories, mobile telephone cases, face plates for mobile telephones, mobile telephone decorations, stickers, cars, kitchen appliances, toys, games, playthings, brooches, pins, hair accessories, gloves, cosmetics, non-medicated toilet preparations, eye wear, eyewear frames, carrying cases, suit cases, carry-ons, leather goods, handbags and all manner of bags; the bringing together, for the benefit of others, of a variety of goods, including the aforesaid goods, and enabling customers to conveniently view and purchase such goods; retail of third-party vouchers, deals and packages, including, in connection with accommodation, traveling, cruises, activities and experiences; the bringing together, for the benefit of others, of a variety of services, enabling people to easily view and procure those services; operating and providing on-line marketplaces for sellers and buyers of goods and services; provision of advice and assistance in the selection and purchase of third-party goods and services; advertising for others; sales promotions for third party goods and services; organisation, operation and supervision of customer loyalty schemes; provision of advice and assistance in the selection of goods and services; consumer product consultancy; price comparison services; arranging and conducting exhibitions for advertising, commercial or trade purposes; providing of business or commercial information, marketing studies and researches; cost price analysis; business management assistance; business management and organisation consultancy; business research; business consultancy concerning franchisees and licensees; information, advisory and consultancy services in relation to the aforesaid; retail services, including retail services connected with clothing, headgear, footwear, jewellery, watches, fashion accessories, textiles, undergarments, swimwear, active wear, clothing patches, pens, writing implements, notebooks, stationery, furniture, homewares, mobile telephone accessories, mobile telephone cases, face plates for mobile telephones, mobile telephone decorations, stickers, cars, kitchen appliances, toys, games, playthings, brooches, pins, hair accessories, gloves, cosmetics, non-medicated toilet preparations, eye wear, carrying cases, suit cases, carry-ons, leather goods, handbags and all manner of bags; retailing of goods by any means, including retailing of clothing, headgear, footwear, jewellery, watches, fashion accessories, textiles,

undergarments, swimwear, active wear, clothing patches, pens, writing implements, notebooks, stationery, furniture, homewares, mobile telephone accessories, mobile telephone cases, face plates for mobile telephones, mobile telephone decorations, stickers, cars, kitchen appliances, toys, games, playthings, brooches, pins, hair accessories, gloves, cosmetics, non-medicated toilet preparations, eye wear, carrying cases, suit cases, carry-ons, leather goods, handbags and all manner of bags by any means; on-line trading services, including on-line trading services connected with clothing, headgear, footwear, jewellery, watches, fashion accessories, textiles, undergarments, swimwear, active wear, clothing patches, pens, writing implements, notebooks, stationery, furniture, homewares, mobile telephone accessories, mobile telephone cases, face plates for mobile telephones, mobile telephone decorations, stickers, cars, kitchen appliances, toys, games, playthings, brooches, pins, hair accessories, gloves, cosmetics, non-medicated toilet preparations, eye wear, carrying cases, suit cases, carry-ons, leather goods, handbags and all manner of bags; the bringing together for the benefit of others of goods and enabling customers to conveniently view and purchase such goods, including the bringing together for the benefit of others of clothing, headgear, footwear, jewellery, watches, fashion accessories, textiles, undergarments, swimwear, active wear, clothing patches, pens, writing implements, notebooks, stationery, furniture, homewares, mobile telephone accessories, mobile telephone cases, face plates for mobile telephones, mobile telephone decorations, stickers, cars, kitchen appliances, toys, games, playthings, brooches, pins, hair accessories, gloves, cosmetics, non-medicated toilet preparations, eye wear, carrying cases, suit cases, carry-ons, leather goods, handbags and all manner of bags; the bringing together for the benefit of others of goods and enabling customers to conveniently view and purchase such goods, including the bringing together for the benefit of others of clothing, headgear, footwear, jewellery, watches, fashion accessories, textiles, undergarments, swimwear, active wear, clothing patches, pens, writing implements, notebooks, stationery, furniture, homewares, mobile telephone accessories, mobile telephone cases, face plates for mobile telephones, mobile telephone decorations, stickers, cars, kitchen appliances, toys, games, playthings, brooches, pins, hair accessories, gloves, cosmetics, non-medicated toilet preparations, eye wear, carrying cases, suit cases, carry-ons, leather goods, handbags and all manner of bags and enabling customers to conveniently view and purchase such clothing, headgear, footwear, jewellery, watches, fashion accessories, textiles, undergarments, swimwear, active wear, clothing patches, pens, writing implements, notebooks, stationery, furniture, homewares, mobile telephone accessories, mobile telephone cases, face plates for mobile telephones, mobile telephone decorations, stickers, cars, kitchen appliances, toys, games, playthings, brooches, pins, hair accessories, gloves, cosmetics, non-medicated toilet preparations, eye wear, carrying cases, suit cases, carry-ons, leather goods, handbags and all manner of bags; the provision of retail services via a mail order catalogue, including the provision of retail services via a mail order catalogue for clothing, headgear, footwear, jewellery, watches, fashion accessories, textiles, undergarments, swimwear, active wear, clothing patches, pens, writing implements, notebooks, stationery, furniture, homewares, mobile telephone accessories, mobile telephone cases, face plates for mobile telephones, mobile telephone decorations, stickers, cars, kitchen appliances, toys, games, playthings, brooches, pins, hair accessories, gloves, cosmetics, non-medicated toilet preparations, eye wear, carrying cases, suit cases, carry-ons, leather goods, handbags and all manner of bags;

ted toilet preparations, eye wear, carrying cases, suit cases, carry-ons, leather goods, handbags and all manner of bags; the provision of on-line retail services from an internet website, including the provision of on-line retail services from an internet website for clothing, headgear, footwear, jewellery, watches, fashion accessories, textiles, undergarments, swimwear, active wear, clothing patches, pens, writing implements, notebooks, stationery, furniture, homewares, mobile telephone accessories, mobile telephone cases, face plates for mobile telephones, mobile telephone decorations, stickers, cars, kitchen appliances, toys, games, playthings, brooches, pins, hair accessories, gloves, cosmetics, non-medicated toilet preparations, eye wear, carrying cases, suit cases, carry-ons, leather goods, handbags and all manner of bags; the provision of retail services via a television channel, including provision of retail services connected with clothing, headgear, footwear, jewellery, watches, fashion accessories, textiles, undergarments, swimwear, active wear, clothing patches, pens, writing implements, notebooks, stationery, furniture, homewares, mobile telephone accessories, mobile telephone cases, face plates for mobile telephones, mobile telephone decorations, stickers, cars, kitchen appliances, toys, games, playthings, brooches, pins, hair accessories, gloves, cosmetics, non-medicated toilet preparations, eye wear, carrying cases, suit cases, carry-ons, leather goods, handbags and all manner of bags via a television channel; the provision of retail services via a telephone, mobile phone, portable internet-enabled device, or other telecommunications device, including the provision of retail services connected with clothing, headgear, footwear, jewellery, watches, fashion accessories, textiles, undergarments, swimwear, active wear, clothing patches, pens, writing implements, notebooks, stationery, furniture, homewares, mobile telephone accessories, mobile telephone cases, face plates for mobile telephones, mobile telephone decorations, stickers, cars, kitchen appliances, toys, games, playthings, brooches, pins, hair accessories, gloves, cosmetics, non-medicated toilet preparations, eye wear, carrying cases, suit cases, carry-ons, leather goods, handbags and all manner of bags provided via a telephone, mobile phone, portable internet-enabled device, or other telecommunications device; the provision of retail services by way of direct marketing, including the provision of retail services connected with clothing, headgear, footwear, jewellery, watches, fashion accessories, textiles, undergarments, swimwear, active wear, clothing patches, pens, writing implements, notebooks, stationery, furniture, homewares, mobile telephone accessories, mobile telephone cases, face plates for mobile telephones, mobile telephone decorations, stickers, cars, kitchen appliances, toys, games, playthings, brooches, pins, hair accessories, gloves, cosmetics, non-medicated toilet preparations, eye wear, carrying cases, suit cases, carry-ons, leather goods, handbags and all manner of bags by way of direct

marketing; the provision of information and advice in relation to retail services; provision of advice and assistance in the selection of goods.

36 – Financial, monetary and banking services; insurance services; real estate affairs; financial transaction and payment services; electronic funds transfer; exchanging money; processing of credit card and debit card payments; issuance of travellers cheques; financial management and research; cheque verification; financial appraisals; crowdfunding; issuing credit cards; loans; financial sponsorship; brokerage services; real estate agency services; real estate management, rental of apartments, rent collection; providing information, consultancy and advisory services for the aforesaid.

39 – Transport; packaging and storage of goods; travel arrangement; vehicle rental; rental services related to transport, storage and travel; chauffeur and piloting services; packaging, bottling, wrapping and delivery of goods; distribution of energy and electricity; distribution and supply of water; providing information, consultancy and advisory services for the aforesaid; travel reservation.

40 – Bespoke tailoring; made to measure clothing; recycling of clothing; treatment of materials; recycling of waste and trash; air purification and treatment of water; printing services; food and drink preservation; custom manufacturing of goods to the order and specification of others; providing information, consultancy and advisory services for the aforesaid.

41 – Education; providing of training; entertainment; sporting and cultural activities; publishing services; online publishing services; photography; sports and fitness training services; online gaming services; organising of games, competitions, festivals, musical events, ceremonial events, seminars, symposia, tournaments and training courses; ticket reservation and booking services for entertainment, educational and sporting events; amusements; screenplay writing, songwriting; multimedia production services; news and current affairs programs; providing information, consultancy and advisory services for the aforesaid; nightclub services [entertainment].

42 – Scientific and technological services and research and design relating thereto; dress designing; industrial analysis, industrial research and industrial design services; quality control and authentication services (verification of the attributes of goods); design and development of computer hardware and software; design services; leasing, rental and hire of computer software, computer programming; application service provider services; software as a service; database as a service; platform as a service; providing temporary use of on-line non-downloadable software; quality testing; authentication, issuance and validation of digital certificates; data encryption services; database design; hosting computer sites; hosting of databases; in-

formation technology (it) consultancy; information technology (it) services (computer hardware, software and peripherals design and technical consultancy); internet portal services (designing or hosting); consultancy services relating to the use of computer hardware and software; hosting a digital customer self-service portal; advisory services relating to the use of computer hardware and software; providing information, consultancy and advisory services for the aforesaid.

43 – Services for providing food and drink; temporary accommodation; room booking; rental of meeting rooms; rental of cutlery, furniture, furnishings, glassware, cooking apparatus, domestic lighting, linen and marquees; restaurant services; bar services; arranging of wedding receptions; day care services; travel agency services for booking hotels; providing information, consultancy and advisory services for the aforesaid.

45 – Hire of clothing; hire of fashion accessories; hire of jewellery; hire of fashion leather goods; legal services; security services for the physical protection of tangible property and individuals; surveillance services relating to the physical safety of persons; security services; personal and social services rendered by others to meet the needs of individuals; online social networking services; dating and matchmaking services; lost property services; personal shopper services; identity verification; meditation services for spiritual purposes; mentoring (spiritual); personal care services (non-medicated caregiving services); providing information, consultancy and advisory services for the aforesaid.

(260) AM 2022 117034 A

(800) 1649393

(151) 2021 09 21

(891) 2021 09 21

(731) Euro Games Technology Ltd.

4, "Maritsa" Str., "Vranya-Lozen-Triugulnika",
BG-1151 Sofia, Bulgaria

(540)

CROWN

(591) Black, white

(511)

9 – Software related to gaming, gambling and/or games of chance; computer gaming software; computer software packages related to gaming, gambling and/or games of chance; computer operating system software; computer software, recorded, related to gaming, gambling and/or games of chance; software drivers; virtual reality software; games software; entertainment software for computer games; computer programs for network management; operating computer software for main frame computers; monitors (computer hardware) related to gaming, gambling and/or games of chance; computer hardware related to ga-

ming, gambling and/or games of chance; apparatus for recording images; monitors (computer programs) related to gaming, gambling and/or games of chance; computer game programs; computer programs for recorded games; apparatus for recording, transmission or reproduction of sound or images, related to gaming, gambling and/or games of chance; communications servers [computer hardware] related to gaming, gambling and/or games of chance; electronic components for gambling machines; computer application software featuring games and gaming; computer software for the administration of on-line games and gaming; computer hardware for games and gaming; electronic components and computer software for gambling, gambling machines, gambling games on the Internet and via telecommunication network.

28 – Gaming machines for gambling; chips for gambling; mah-jong; arcade games; gambling machines operating with coins, notes and cards; games; electronic games; parlor games; gaming chips; gaming tables; slot machines [gaming machines]; LCD game machines; slot machines and gaming devices; coin-operated amusement machines; roulette chips; poker chips; chips and dice [gaming equipment]; gaming equipment for casinos; roulette tables; gaming roulette wheels; casino games; gambling machines and amusement machines, automatic and coin-operated; coin-operated amusement machines and/or electronic coin-operated amusement machines with or without the possibility of gain; boxes for coin-operated machines, slot machines and gaming machines; electronic or electrotechnical amusement machines and apparatus, gaming machines, coin-operated entertainment machines; housings for coin-operated machines, gaming equipment, gaming machines, machines for gambling; electropneumatic and electrical gambling machines (slot machines).

41 – Gambling; entertainment services related to gambling; gaming services for entertainment purposes; casino, gaming and gambling services; training in the development of software systems; provision of gaming equipment for gambling halls; providing casino equipment [gambling]; gaming machine entertainment services; providing casino facilities [gambling]; gaming hall services; amusement arcade services; games equipment rental; rental of gaming machines; providing amusement arcade services; rental of gaming machines with images of fruits; editing or recording of sounds and images; sound recording and video entertainment services; hire of sound reproducing apparatus; provision of gaming equipment for casinos; providing of casino facilities; online gambling services; casino, gaming and gambling services; provision of gaming facilities, gaming hall facilities, internet casinos and online gambling services.

(260) AM 2022 117035 A
 (800) 1649394
 (151) 2021 09 24
 (891) 2021 09 24
 (731) P&C Technologic Zártkörűen Működő,
 Részvénytársaság
 Bajcsy-Zsilinszky út 48. 2. em., H-1054
 Budapest, Hungary

(540)



(591) Black, white
 (531) 26.13.25; 27.05.01; 27.05.22
 (511)
 7 – Juice extractors; vacuum cleaners; electric vacuum cleaners; robotic vacuum cleaners; ironing machines.
 8 – Flat irons.

9 – Amplifiers; bags adapted for laptops; cameras [photography]; cases for smartphones; computers; cordless telephones; covers for tablet computers; headphones; laptop computers; loudspeakers; mouse pads; photocopiers [photographic, electrostatic, thermic]; pocket calculators; printers for use with computers; radios; scanners [data processing equipment]; sleeves for laptops; smartphones; tablet computers; television apparatus; USB flash drives; vehicle radios.

(260) AM 2022 117036 A
 (800) 1649400
 (151) 2021 11 23
 (891) 2021 11 23
 (731) Mercedes-Benz Group AG
 Mercedesstraße 120, 70372 Stuttgart,
 Germany

(540)

MB.OS

(591) Black, white
 (511)
 9 – Computer software; games software; sensory software; software for electronic driving assistance systems; artificial intelligence software for vehicles; artificial intelligence software for driverless cars; software for monitoring, analysing, controlling and running physical world operations; computer operating systems.
 12 – Motor vehicles and parts thereof (as far as included in class 12).
 42 – Software development; maintenance and updating of computer software; design, maintenance and

updating of computer software; design and development of operating system software.

(260) AM 2022 117037 A
 (800) 1649432
 (151) 2022 02 10
 (891) 2022 02 10
 (731) Narbutas International, UAB
 Ukmerges st. 308, LT-12110 Vilnius, Lithuania

(540)

JOBBOX

(591) Black, white
 (511)
 20 – Furniture; console tables; office furniture; drafting tables; work benches; vice benches [furniture]; filing cabinets; shelves for file cabinets; bookcases; racks [furniture]; tables of metal; portable desks; desks; writing desks; cupboards; tables; standing desks; office armchairs; upholstered furniture; furniture partitions of wood; freestanding partitions [furniture].

(260) AM 2022 117038 A
 (800) 1649457
 (151) 2021 11 16
 (891) 2021 11 16
 (731) MESUT CEYHAN
 KUŞÇAĞIZ MAHALLESİ KALBUR,
 CADDESİ
 :313, KEÇİÖREN /ANKARA, Türkiye;
 MEHMET HADİ UÇAR
 OVACIK MAHALLESİ, 333.CADDESİ
 NO:5/19, KEÇİÖREN/ANKARA, Türkiye

(540)



(591) Black, white, green
 (531) 05.03.13; 05.03.15; 26.11.03; 26.11.05;
 26.11.06; 26.11.12; 27.05.01; 27.05.04;
 27.05.09; 27.05.10; 29.01.12
 (511)
 3 – Bleaching and cleaning agents: detergents, bleaches, fabric softeners, stain removers, dishwashing agents; perfumery; cosmetics, fragrances for personal use (including deodorants for humans and animals; excluding cosmetics containing pharmaceuticals); soaps (except medicated soaps); dental care products: toothpastes, tooth polishing and whitening agents, non-medical mouthwashes; abrasive products: emery cloths, emery papers, pumice stones, abrasive pastes;

polishing and care products for leather, vinyl, metal and wood: varnishes, care creams, wax for polishing purposes.

(260) AM 2022 117039 A

(800) 1649469

(151) 2021 09 29

(891) 2021 09 29

(731) "Hasdent" LTD

12, Eldar Tagizade str., apt. 7, Nasimi district,
AZ-1007 Baku, Azerbaijan

(540)



(591) Black, white

(531) 01.15.05; 27.05.01; 27.05.07

(511)

18 – Travel briefcases for clothes, bags.

24 – Patterned linen cloth; bath linen (except clothing).

25 – Clothes, footwear and hats.

(260) AM 2022 117040 A

(800) 1649471

(151) 2021 09 02

(891) 2021 09 02

(731) Limited Liability Company "BMS"

Krutisky Val, 28, Fl. M, Pr. VI, Room 10,
RU-109044 Moscow, Russian Federation

(540)

LILOPHOTO

(591) Black, white

(511)

7 – 3d printers; vending machines; galvanizing machines; printing machines for use on sheet metal; printing machines; type-setting machines [photocomposition]; printing presses; typographic presses; swaging machines.

9 – Ticket dispensers; apparatus for processing electronic payments; encoded cards; encoded magnetic cards; automated teller machines [ATM]; credit screening software; electronic payment terminals; card readers for credit cards; card readers for magnetically encoded cards; chip card readers; bar code readers; chip cards; mains chargers; electronic load modules; battery chargers for cellular phones; chargers for electric batteries; SIM cards; mechanisms for coin-operated apparatus; phototelegraphy apparatus; viewfinders, photographic; slides [photography]; diaphragms [photography]; shutters for cameras; ink cartridges,

unfilled, for photocopiers; toner cartridges, unfilled, for printers and photocopiers; ink cartridges, unfilled, for printers and photocopiers; carriers for dark plates [photography]; spools [photography]; computer software to enable the transmission of photographs to cellular phones; flashlights [photography]; darkroom lamps [photography]; shutter releases [photography]; photographic negatives; photographic equipment; speed measuring apparatus [photography]; photographic and cinematographic apparatus and instruments; photo printers; photographic racks; screens for photoengraving; washing trays [photography]; stands for photographic apparatus; bags specially adapted for cameras and photographic equipment; drying racks [photography]; drying apparatus for photographic prints; photocopiers [photographic, electrostatic, thermic]; filters for ultraviolet rays, for photography; filters for use in photography; cameras [photography]; glazing apparatus for photographic prints; shutters [photography]; darkrooms [photography]; photometers; flash-bulbs [photography]; camera film, exposed; digital photo frames; enlarging apparatus [photography]; tripods for cameras; screens [photography]; photographic exposure meters.

16 – Fountain pens; albums; mini photograph albums; almanacs; document laminators for office use; forms, printed; paper for printing photographs [not chemically sensitized]; photograph stands; photograph mounts of paper or cardboard; apparatus for mounting photographs; photograph albums; photo-engravings; photographs.

35 – Retail services for works of art provided by art galleries; office machines and equipment rental; rental of vending machines; rental of sales stands; rental of photocopying machines; on-line ordering services; procurement services for others [purchasing goods and services for other businesses]; photocopying services.

38 – Electronic delivery of images and photographs via a global computer network; transmission of greeting cards online; computer aided transmission of messages and images; transmission of digital files; electronic transmission of images and photographs via a global computer network; providing access to Internet platforms for the purpose of exchanging digital photographs; electronic transmission of photographs; electronic transmission of images, photographs, graphic images and illustrations over a global computer network.

40 – Paper finishing; applying finishes to textiles; rental of machines and apparatus for developing, printing and enlarging photographs; photographic restoration; processing of photographic slides and prints; processing of photographic films; photographic printing; printing of digitally stored pictures and photographs; providing information relating to photographic printing services; photographic film development; photo-

graphic retouching; photocomposing services; photographic preservation; photographic enlarging; photofinishing; photographic processing; custom 3d printing for others; photogravure; silkscreen printing.

41 – Editing of photographs; providing online music, not downloadable; providing online electronic publications, not downloadable; coaching [training]; photographic library services; photography; photographic reporting.

(260) AM 2022 117041 A

(800) 1649495

(151) 2021 12 08

(891) 2021 12 08

(731) DAW SE

Roßdörfer Str. 50, 64372 Ober-Ramstadt,
Germany

(540)



(591) Blue, turquoise, green, yellow, orange, red, pink and purple

(531) 26.04.08; 26.04.09; 26.04.10; 26.04.18;
26.05.01; 27.05.09; 29.01.15

(511)

2 – Paints, varnishes, lacquers, glazes, coatings, preservatives against rust; primers; colorants, dyestuffs, dye pastes, mordants; paint thickeners; fixatives for paints; siccatives for paints; raw natural resins; thinning and binding preparations for paints and lacquers; solvents for thinning paints; preparations for preserving wood, wood mordants and wood preserving oils; paints, including structuring paints; bactericidal and/or fungicidal paints; anti-corrosion preparations; protective preparations for metals; metals in foil and powder form for painters, decorators, printers and artists.

7 – Machine tools; hand-held tools, other than hand-operated, all for paint works and builder; mixing machines for paints, lacquers and coatings; compressed air guns for the extrusion of mastics; spray guns for paints; painting machines.

19 – Building materials, not of metal or mainly not of metal, in particular profile rails and corner irons, finishing profiles; adjusting and levelling parts, spacers for building, sills, all not of metal or mainly not of metal; natural and artificial stone; mortar (building materials); quartz; plaster [building materials]; coatings (building materials); wall and ceiling panels (not of metal or mainly not of metal, for building); fabric embedding compounds for building; fillers (building mate-

rials); fabrics for building, not of metal or mainly not of metal, in particular stabilising fabrics.

(260) AM 2022 117042 A

(800) 1649508

(151) 2021 11 24

(891) 2021 11 24

(731) Sutara SA

c/o TRUSTNET SA, Via Serafino Balestra 10,
CH-6900 Lugano, Switzerland

(540)



(591) Black, white

(531) 26.13.25; 27.05.01

(511)

5 – Pharmaceuticals, medical and veterinary preparations; sanitary preparations for medical purposes; dietetic food and substances adapted for medical or veterinary use, food for babies; dietary supplements for human beings and animals; plasters, materials for dressings; disinfectants; adjuvants for medical purposes; cooling sprays for medical purposes; albumin dietary supplements; alginate dietary supplements; amino acids for medical purposes; amino acid preparations for medical purposes; analgesics; anaesthetics; vermifuges; anti-uric preparations; antibacterial pharmaceuticals; antiseptics; autonomic drugs for medical purposes; germicides; balms for medical purposes; balsamic preparations for medical purposes; albuminous preparations for medical purposes; albuminous foodstuffs for medical purposes; activated charcoal dietary supplements; biological preparations for medical purposes; bronchodilating preparations; vaccines; vitamin preparations; vitamin and mineral preparations; lead water; mineral waters for medical purposes; dietary fibre; herbal remedies; homogenized food adapted for medical purposes; disinfectants for hygiene purposes; diagnostic preparations for medical purposes; dietary supplements; nutritional and dietary supplements for stress relief; antioxidants [dietary supplements]; anti-cancer preparations; nutritional and dietary supplements for strengthening the immune system; dietary supplements intended to supplement a normal diet or to have health benefits; dietary supplements consisting of vitamins; royal jelly dietary supplements; glucose dietary supplements; pollen dietary supplements; dietary supplements with a cosmetic effect; linseed dietary supplements; linseed oil dietary supplements; acai powder dietary supplements; propolis dietary supplements; wheat germ dietary supplements; natural dietary supplements for treatment of claustrophobia; dietetic beverages adapted for medical purposes; dietetic substances adapted for me-

dical use; dietetic foods adapted for medical purposes; yeast dietary supplements; plant extracts for pharmaceutical purposes; herbal extracts for medical purposes; elixirs [pharmaceutical preparations]; enzyme dietary supplements; febrifuges; carbohydrate-based dietary supplements; blood substitutes for medical or veterinary purposes; nervines; drugs for medical purposes; recombinant drug-metabolizing enzyme being biochemical preparations for veterinary purposes; immunostimulants; casein dietary supplements; acids for pharmaceutical purposes; medicinal roots; depuratives; lecithin dietary supplements; medicines for human purposes; medicated candy; lotions for pharmaceutical purposes; magnesia for pharmaceutical purposes; medicated soap; mineral food supplements; vitamins; vitamin supplement patches; medicinal drinks; medicinal infusions; tinctures for medical purposes; nutraceutical preparations for therapeutic or medical purposes; fumigating sticks; fumigation preparations for medical purposes; medicinal oils; mouthwashes for medical purposes; headache relief sticks; antioxidant pills; by-products of the processing of cereals for dietetic or medical purposes; nutritional supplements; preparations for increasing sexual prowess; human immune globulin; therapeutic drugs and agents; pre-filled syringes for medical purposes; bath preparations for medical purposes; dietary supplements for animals; pharmaceutical preparations for the treatment and prevention of influenza; opotherapy preparations; preparations of trace elements for human and animal use; medicated toiletry preparations; freeze-dried food adapted for medical purposes; protein dietary supplements; soy protein dietary supplements; antivirals; antiarrhythmic drugs; anti-inflammatories; antiepileptic drugs; antitumor drugs; sedatives; tissues impregnated with pharmaceutical lotions; syrups for pharmaceutical purposes; salts for mineral water baths; mineral water salts; vegan protein for use as a nutritional supplement in ready-to-drink beverages; pastilles for pharmaceutical purposes; therapeutic preparations for the bath; thermal water; tonics [medicines]; medicinal herbs; pharmaceuticals; pharmaceutical substances; ferments for pharmaceutical purposes; diarrhoea medication; phytotherapy preparations for medical purposes; dietary food supplements for medical purposes; medicated sweets; medicinal tea; asthmatic tea; herbal teas for medicinal purposes; medicated shampoos; medicated dry shampoos.

(260) AM 2022 117043 A

(800) 1649531

(151) 2022 01 04

(891) 2022 01 04

(731) LIMITED LIABILITY COMPANY "ASKONA LIFE GROUP"
BOULEVARD ZVEZDNIY, building 1, room 19, 2 floor, DOBROGRAD, KOVROVSKY district, RU-601967 Vladimir region, Russian Federation

(540)



(591) Red, white

(531) 26.04.05; 26.04.22; 26.04.24; 27.05.24;
29.01.12

(511)

20 – Bumper guards for cots, other than bed linen; sideboards; bolsters; coatstands; divans; kennels for household pets; indoor window blinds; mirrors; mats for infant playpens; cradles; chests of drawers; Moses baskets; armchairs; beds; waterbeds, not for medical purposes; bedsteads of wood; air beds, not for medical purposes; cots for babies; edgings of plastic for furniture; playpens for babies; mattresses; air mattresses, not for medical purposes; camping mattresses; sleeping mats; upholstered furniture; furniture of metal; inflatable furniture; office furniture; school furniture; furniture; pillows; cushions; head support cushions for babies; anti-roll cushions for babies; air cushions, not for medical purposes; air pillows, not for medical purposes; head positioning pillows for babies; tables; steps, not of metal; seats; high chairs for babies; furniture fittings, not of metal; infant walkers; chaise lounges; screens; chests for toys; children's furniture; bedroom furniture; modular furniture; garden furniture; outdoor furniture; cupboards being furniture.

24 – Household linen; bed linen; cot bumpers [bed linen]; sleeping bag liners; baby buntings; furniture coverings of textile; sleeping bags; sleeping bags for babies; pillowcases; mattress covers; bed blankets; blankets for household pets; picnic blankets; travelling rugs; bed covers; bed covers of paper; furniture coverings of plastic; sheets; door curtains; upholstery fabrics; covers for cushions; loose covers for furniture; pillow shams; eiderdowns; drapes; household textiles.

25 – Underwear; sweat-absorbent underwear; hosiery; slippers [underclothing]; sleep masks; clothing; pajamas; bath slippers; headwear; tee-shirts; dressing gowns; shower caps; footwear; nightgowns; baby doll pajamas; pajamas for children.

35 – Computerized file management; demonstration of goods; opinion polling; market studies; personnel management consultancy; marketing; providing business information via a website; rental of sales stands; advertising; online advertising on a computer network; administrative processing of purchase orders; procurement services for others [purchasing goods and services for other businesses]; wholesale or retail store services; publicity and sales promotion relating

to non-food goods, namely household goods; on-line ordering services.

(260) AM 2022 117044 A
 (800) 1649537
 (151) 2022 01 27
 (891) 2022 01 27
 (731) CHATLINGUAL, INC.
 1801 Wewatta Street, Suite 11, Denver CO
 80202, USA
 (540)

CHALINGUAL

(591) Black, white
 (511)
 41 – Translation services; providing translation services via the Internet.
 42 – Providing online non-downloadable software for language translation and sending translated messages.

(260) AM 2022 117045 A
 (800) 1649600
 (151) 2021 11 02
 (891) 2021 11 02
 (731) Atelier Oblique GmbH
 Almstadtstr. 5, 10119 Berlin, Germany
 (540)

Atelier Oblique

(591) Black, white
 (511)
 3 – Soaps and gels; perfumery and fragrances; household fragrances; deodorants and antiperspirants; body and facial creams [cosmetics]; essential oils and aromatic extracts; hair removal and shaving preparations.

(260) AM 2022 117046 A
 (800) 1649635
 (151) 2021 07 27
 (891) 2021 07 27
 (731) BOTANIC ART IKE
 ANTITORPILIKOU VELOUS 3 St., GR-104
 47 ATHENS, Greece
 (540)

Athonites

(591) Black, white
 (531) 10.03.10; 27.05.01
 (511)
 3 – Perfumes; non-pharmaceutical oils for body care; essential oils for cosmetic purposes; ointments for cosmetic use; perfumed lotions; balsams (non-phar-

maceutical); perfumery and fragrances, oils for cosmetic purposes, cosmetics for personal use; non-medicated cosmetics; non-medicated lotions; massage creams non-medicated; non-medicated lotions; cosmetics for children; body cleaning and beauty care preparations.

5 – Vitamins; vitamin preparations; dietary supplements; dietary and nutritional preparations; lice treatment preparations.

30 – Flavourings, other than essential, for beverages; herbal tea (other than for medicinal use); honey; royal jelly, propolis.

31 – Unprocessed agricultural products; unprocessed forestry products; unprocessed vegetable products.

(260) AM 2022 117048 A
 (800) 1649715
 (151) 2022 01 25
 (891) 2022 01 25
 (731) Bolt Technology OÜ
 Vana-Lõuna tn 15, EE-10134 Tallinn, Estonia
 (540)

Bolt Food

(591) Black, white
 (511)
 9 – Downloadable software in the form of a mobile application for ordering and delivering food; courier software; retail software; downloadable mobile applications for ordering and delivering consumer goods.

35 – Ordering services for third parties in relation to the following fields: retail trade services, restaurant, web-based sales platforms, home delivery of goods, transportation services; retail and wholesale services in relation to: foods and drinks, infant formula, baby products, foodstuffs for domestic animals and pet products, household articles, sanitary articles, games and playthings, gymnastic and sporting articles, cookery equipment, electronic media apparatus, home appliances, cosmetics, cleaning preparations, buffing preparations, polishing preparations, abrading preparations, hair treatment preparations, dentifrices, sanitary preparations, pharmacy goods, medical preparations and veterinary preparations, nutritional supplements and vitamins; retail and wholesale services in relation to: sauna accessories and bath preparations, horticultural products, art equipment, crafts machines, modelling machines, handicraft objects, prints, books and stationery via the internet, horological and chronometric instruments, furniture, building material, hand tools for building, paints and varnishes, mordants, disinfectants, preparations for destroying vermin, fungicides, herbicides, tableware, razors, transport means, retailing and wholesaling of musical instruments, luggage and carrying bags, umbrellas and parasols; wholesaling and retailing of clothing, footwear and headgear;

retailing and wholesaling in relation to the following goods: tobacco and smokers' articles.

(260) AM 2022 117049 A

(800) 1649760

(151) 2022 01 19

(891) 2022 01 19

(731) Industrial Minerals SA

Rue de la Croix d'Or 10, CH-1204 Geneva,
Switzerland

(540)



(591) Black and green

(531) 26.03.01; 26.03.19; 26.03.24; 27.05.01;

27.05.08; 27.05.10; 29.01.12

(511)

1 – Industrial minerals; unprocessed artificial and synthetic resins; starches for manufacturing and industrial use; unprocessed plastic materials; salts for industrial use; sealants and pastes for industrial use; growing media for plants, manures and chemical products for use in agriculture, horticulture and forestry; filtering materials [chemical, mineral, vegetable and other unprocessed materials]; detergents for manufacturing and industrial use; chemical substances, chemical materials and chemical products; chemical materials and products for photography, films and printing; chemical and organic compounds for use in the manufacture of food and beverages; adhesives for industrial use.

6 – Unwrought or semi-worked common metals; ores; hardware of metal; unprocessed and semi-processed materials of metal, for unspecified use; statues and works of art made of common metal; doors, gates, windows and window coverings of metal; containers of metal for storage, transport and packaging; building components and materials of metal; metal structures and transportable buildings of metal.

(260) AM 2022 117050 A

(800) 1649802

(151) 2021 11 01

(891) 2021 11 01

(731) Oriflame Cosmetics AG

Bleicheplatz 3, CH-8200 Schaffhausen,
Switzerland

(540)

ORIFLAME WAUNT

(591) Black, white

(511)

3 – Non-medicated conditioning and care preparations for application to the hair, scalp, skin and nails; shampoos; hair conditioner; soaps; perfumes; perfumery; eau de cologne; toilet waters; essential oils and herbal

cosmetics in the form of oils; cosmetics; make-up; make-up preparations; make-up removers; lipsticks; nail varnishes; nail varnish removers; eyeliner; mascara; non-medicated toilet preparations; hair lotions; hair sprays and hair gels; preparations for use in the bath or shower; bath and shower oils, gels, creams and foams; face and body masks; face and body scrubs; facial washes; skin cleansers and hydrators; skin toners; skin moisturizers; blemish creams and blemish gels; deodorants; antiperspirants; shaving soaps; shaving creams; shaving gels; after-shave preparations; pre-shave preparations; talcum powders; toiletries; dentifrices; toothpastes; mouth washes; foot care preparations (non-medicated); cotton for cosmetic purposes; cotton wool, cotton sticks, cotton buds, cotton swabs, cotton puffs, cotton balls and cotton pads for cosmetic purposes; cotton wool in the form of wipes for cosmetic use; cotton puffs and pads impregnated with make-up removing preparations.

(260) AM 2022 117120 A

(800) 1650140

(151) 2022 02 03

(891) 2022 02 03

(731) Limited Liability Company "Consortium-PIQ"

Oruzheyniy pereulok, d. 25, str. 1, pomesch.
I/etazh 1/komnata 21, RU-125047 Moscow,
Russian Federation

(540)

KOVAZIS

(591) Black, white

(511)

5 – Preparations for destroying vermin; herbicides.

(260) AM 2022 117225 A

(800) 1651917

(151) 2021 10 01

(891) 2021 10 01

(731) Egis Gyógyszergyár Zrt.

Keresztúri út 30-38.; H-1106 Budapest,
Hungary

(540)

ЭРАЗЕДЕРМ

(591) Black, white

(531) 28.05

(511)

3 – Cosmetics and cosmetic preparations.

5 – Human pharmaceutical preparations (term considered linguistically incorrect by the International Bureau – rule 13 (2) (b) of the Regulations); dietetic substances adapted for medical use; dietary supplements; medicinal ointments; medicated skin creams; plasters, materials for dressings.

(260) AM 2022 117226 A
 (800) 1651918
 (151) 2021 10 01
 (891) 2021 10 01
 (731) Egis Gyógyszergyár Zrt.
 Keresztúri út 30-38., H-1106 Budapest,
 Hungary
 (540)

АЗЕЛЕАЛ

(591) Black, white
 (531) 28.05
 (511)
 3 – Cosmetics and cosmetic preparations.

5 – Human pharmaceutical preparations (term considered linguistically incorrect by the International Bureau – rule 13 (2) (b) of the Regulations); dietetic substances adapted for medical use; dietary supplements; medicinal ointments; medicated skin creams; plasters, materials for dressings.

(260) AM 2022 117235 A
 (800) 1652108
 (151) 2021 11 03
 (891) 2021 11 03
 (731) IVECO S.P.A.
 VIA PUGLIA 35, I-10156 TORINO, Italy
 (540)

IVECO • GROUP

(591) Blue and dark grey
 (531) 24.17.02; 27.05.01; 29.01.12
 (511)

12 – Vehicles; land vehicles; industrial vehicles; commercial vehicles; vans; buses; minibuses; coaches; trucks; pickup trucks; military vehicles; armoured vehicles; armoured land vehicles; amphibious vehicles; amphibious armoured vehicles; tracked vehicles; tracked armoured vehicles; military vehicles for transport; electric vehicles; electrically powered vehicles; hybrid vehicles; hydrogen powered vehicles; fuel cell electric vehicles; engines for land vehicles, industrial vehicles, commercial vehicles, vans, buses, minibuses, coaches, trucks, pickup trucks, armoured vehicles, armoured land vehicles, amphibious vehicles, amphibious armoured vehicles, tracked vehicles, tracked armoured vehicles, military vehicles for transport; electric motors for land vehicles; gas engines for land vehicles; transmissions for land vehicles; transmissions (parts of land vehicles); driving cabs for land vehicles; rescue vehicles; motors for land vehicles; engines for railway vehicles; engines for military land vehicles; parts and fittings of the aforesaid goods.

(260) AM 2022 117237 A
 (800) 1652144
 (151) 2020 09 29
 (891) 2020 09 29
 (731) Tempus Közalapítvány
 Kéthly Anna tér 1, H-1077 Budapest, Hungary
 (540)



(591) Light blue, orange, green and dark blue
 (531) 24.15.03; 27.05.10; 29.01.14
 (511)
 41 – Education information; education and instruction; accreditation of educational services; film demonstrations for instructional purposes; organisation of congresses and conferences for cultural and educational purposes; organisation and holding of exhibitions for cultural or educational purposes; career information and advisory services (educational and training advice).

(260) AM 2022 117238 A
 (800) 1652150
 (151) 2021 08 24
 (891) 2021 08 24
 (731) ALFA PARF GROUP S.P.A.
 Via Cesare Cantù, 1, I-20123 MILANO (MI),
 Italy
 (540)



(591) Black, white
 (531) 01.01.01; 01.01.05; 26.01.04; 26.01.22;
 27.05.10
 (511)

3 – Non-medicated cosmetics and toiletry preparations, non-medicated cosmetic preparations for cleansing and washing the face, including creams, granular creams and scrubs, exfoliating creams, emulsions, mousses, gels, serums, tonics, masks; non-medicated cosmetic preparations for dermatologic use, non-medicated hydrating cosmetic preparations, non-medicated moisturizing cosmetic preparations, non-medicated nourishing cosmetic preparations, non-medicated lightening cosmetic preparations, non-medicated anti-stain cosmetic preparations, non-medicated defatiguing cosmetic preparations, non-medicated restructu-

ring cosmetic preparations, non-medicated filling cosmetic preparations, non-medicated firming cosmetic preparations, non-medicated anti-pollution cosmetic preparations, non-medicated detergent cosmetic preparations, non-medicated toning cosmetic preparations, non-medicated exfoliating cosmetic preparations, non-medicated purifying cosmetic preparations, non-medicated deep cleansing cosmetic preparations, non-medicated soothing cosmetic preparations all for the care and the beauty of the face and the body, including creams, granular creams, mousses, masks, gels, serums, lotions, milks, peelings, scrubs, tonics, oils, micellar waters, mineral waters from spa and termæ, conditioners and lotions to restore the PH of the skin, sprays, mineral bath salts and shower gels; non-medicated anti-aging cosmetic preparations, non-medicated remodeling cosmetic preparations, non-medicated fillers and restructuring cosmetic preparations all for the care and beauty of the face and body including creams, eye contour creams, lip contour creams, mousses, gels, shower gels, serums, lotions, oils, masks and mineral waters from spas and termæ; non-medicated slimming, remodelling and weighting-loss cosmetic preparations; non-medicated anti-cellulite cosmetic preparations; non-medicated draining and anti-stretch mark cosmetic preparations, including gel-soaps, gels, capsules, masks, oils, creams, message creams and message serums, non-medicated cosmetic preparations for hand care and hand beauty, including hand creams, hand masks, hand cleaners, granular hand creams; non-medicated cosmetic preparations for foot care and foot beauty, including foot creams, soothing foot gels, foot masks, foot cleansers, granular foot creams; hair removal preparations including waxes, oils, emulsions and serums; non-medicated cosmetic eye preparations including calming and soothing eye lotions; non-medicated tanning preparations [cosmetic] and sun screens preparations, including sun milks, sun gels, sun oils and after-sun preparations (cosmetics), makeup and cosmetic preparations for make-up including foundation creams, blusher, concealers for the face, eyeshadow, pencils for cosmetic use, eyebrow pencils, eyebrow cosmetics, false eyelashes, face powders, mascara, adhesives for cosmetic use, lip gloss, lip balms, lipsticks, lipstick cases, cosmetic make-up removal preparations, including make-up removing milk, gels, lotions and creams, tissues impregnated with make-up removing preparations, eye make-up removers; nail care and nail makeup preparations including nail polishes, cosmetic nail creams, lotions for strengthening the nails, fingernail polish removers, false nails, decorative nail stickers, adhesives for affixing false nails; non-medicated trichological preparations for the care and the beauty of the hair and the scalp, including shampoos, mousses, hair foams, hair conditioners, spray leave-in hair conditioners, hair masks, non-medicated hair lotions, non-medicated scalp and hair creams and serums, scalp protector and soothing serums, scalp restorer

preparations, nourishing hair conditioners; preparations for waving the hair, preparations for the permanent wave of the hair, hair straightening preparations, hair dyes and colorants, hair bleaching preparations, hair smoothing preparations, hair detangling preparations, hair rehydrating preparations, hair detoxifying preparations, hair anti-breakage preparations, hair reparative preparations, hair restructuring and rebuilder preparations, hair cleansing preparations, keratin and collagen refills, hair gels and glows, hair sprays, hair lacquers, hair styling preparations, hair lighteners; hair leave-in oils, essential oils for the hair, perfums for the hair, fragrances for the hair, beard dyes, after-shave lotions; soaps; perfumery, antiperspirants and deodorants for personal use; essential oils.

(260) AM 2022 117239 A

(800) 1652153

(151) 2021 07 09

(891) 2021 07 09

(731) YILDIZ ENTEGRE AĞAÇ SANAYİ VE
TİCARET ANONİM ŞİRKETİ
Arslanbey OSB Mahallesi 1, Cadde No:13,
TR-41285 Kartepe Kocaeli, Türkiye

(540)

BodenClick

(591) Red, yellow and black

(531) 27.05.11; 29.01.13

(511)

19 – Sand, gravel, crushed stone, asphalt, bitumen, cement, gypsum, plaster, concrete, marble blocks for construction, included in this class, building materials (as finished products) made of concrete, gypsum, clay, potters' clay, stone, marble, wood, plastics and synthetic materials for building, construction, road construction purposes, included in this class; non-metallic buildings, non-metallic building materials, poles not of metal for power lines, barriers not of metal; natural and synthetic coatings in the form of panels and sheets, being building materials; bitumen cardboard coatings for roofing; bitumen coating for roofing; doors and windows of wood and synthetic materials, traffic signs not of metal, non-luminous and non-mechanical, for roads, monuments and statuettes of stone, concrete and marble, building glass, prefabricated swimming pools not of metal (structures), aquarium sand.

20 – Furniture, made of any kind of material, mattresses, pillows, air mattresses and cushions, not for medical purposes, water beds, not for medical purposes (except for sleeping bags for camping), mirrors, beehives, artificial honeycombs and sections of wood for honeycombs, bouncing chairs for babies, playpens for babies, cradles, infant walkers, display boards, frames for pictures and paintings, identification plates, identi-

fication tags, nameplates, identification labels made of wood or synthetic materials, packaging containers of wood or plastics, casks for use in transportation or storage, barrels, not of metal, storage drums, tanks, not of metal nor of masonry, boxes, storage containers of plastic for commercial or industrial use, transportation containers, chests, loading pallets and closures for the aforementioned goods, of wood or plastics, small hardware goods of wood or synthetic materials included in this class, furniture fittings, of wood or synthetic materials, opening and closing mechanisms of wood or synthetic materials in the nature of non-metal latches, ornaments and decorative goods of wood, cork, reed, cane, wicker, horn, bone, ivory, whalebone, shell, amber, mother-of-pearl, meerschaum, beeswax, plastic or plaster, included in this class, namely figurines, holiday ornaments for walls and sculptures and sports cups made of these materials, non-metal baskets, fishing baskets, kennels, nesting boxes and beds for household pets, portable ladders and mobile boarding stairs of wood or synthetic materials, bamboo curtains, roller indoor blinds [for interiors], slatted indoor blinds, strip curtains in the nature of bamboo curtains, bead curtains for decoration, curtain hooks, curtain rings, curtain tie-backs, curtain rods, non-metal wheel chocks.

35 – Advertising, marketing and public relations; organization of exhibitions and trade fairs for commercial or advertising purposes, office functions; secretarial services; arranging newspaper subscriptions for others; compilation of statistics; rental of office machines; systemization of information into computer databases; telephone answering for unavailable subscribers, business management, business administration and business consultancy; accounting; commercial consultancy services; personnel recruitment, personnel placement, employment agencies, import-export agencies; temporary personnel placement services, auctioneering, the bringing together, for the benefit of others, of a variety of goods, namely sand, gravel, crushed stone, asphalt, bitumen, cement, gypsum, plaster, concrete, marble blocks for construction, building materials (as finished products) made of concrete, gypsum, clay, potters' clay, stone, marble, wood, plastics and synthetic materials for building, construction, road construction purposes, non-metallic buildings, non-metallic building materials, poles not of metal for power lines, barriers not of metal, natural and synthetic coatings in the form of panels and sheets, being building materials, bitumen cardboard coatings for roofing, bitumen coating for roofing, doors and windows of wood and synthetic materials, traffic signs not of metal, non-luminous and non-mechanical, for roads, monuments and statuettes of stone, concrete and marble, building glass, prefabricated swimming pools not of metal (structures), aquarium sand, furniture, made of any kind of material, mattresses, pillows, air mattresses and cushions, not for medical purposes, water beds, not for medical pur-

poses (except for sleeping bags for camping), mirrors, beehives, artificial honeycombs and sections of wood for honeycombs, bouncing chairs for babies, playpens for babies, cradles, infant walkers, display boards, frames for pictures and paintings, identification plates, identification tags, nameplates, identification labels made of wood or synthetic materials, packaging containers of wood or plastics, casks for use in transportation or storage, barrels, storage drums, tanks, boxes, storage containers, transportation containers, chests, loading pallets and closures for the aforementioned goods, of wood or plastics, small hardware goods of wood or synthetic materials, furniture fittings, of wood or synthetic materials, opening and closing mechanisms of wood or synthetic materials, ornaments and decorative goods of wood, cork, reed, cane, wicker, horn, bone, ivory, whalebone, shell, amber, mother-of-pearl, meerschaum, beeswax, plastic or plaster, namely figurines, holiday ornaments for walls and sculptures and sports cups made of these materials, baskets, fishing baskets, kennels, nesting boxes and beds for household pets, portable ladders and mobile boarding stairs of wood or synthetic materials, bamboo curtains, roller indoor blinds [for interiors], slatted indoor blinds, strip curtains, bead curtains for decoration, curtain hooks, curtain rings, curtain tie-backs, curtain rods, non-metal wheel chocks enabling customers to conveniently view and purchase those goods, such services may be provided by retail stores, wholesale outlets, by means of electronic media or through mail order catalogues.

(260) AM 2022 117241 A

(800) 1652185

(151) 2021 10 26

(891) 2021 10 26

(731) Merz North America, Inc.

6501 Six Forks Road, Raleigh NC 27615,
USA

(540)



(591) Black, white

(531) 27.05.21

(511)

5 – Cosmetic restoration and augmentation preparations, namely, biocompatible injections consisting of dermal fillers for use as treatment alternatives to plastic surgery and internal augmentation, all the aforesaid for medical use; filled syringes for medical purposes.

10 – Medical devices, apparatus and instruments used for cosmetic purposes for restoration and augmentation, namely injection devices.

(260) AM 2022 117242 A

(800) 1652292

(151) 2022 01 13

(891) 2022 01 13

(731) FERRERO S.P.A.

PIAZZALE PIETRO FERRERO 1, I-12051

ALBA, CUNEO, Italy

(540)



(591) Light green, dark green, white and black

(531) 05.03.13; 05.03.14; 25.07.08; 26.04.04;

26.04.05; 26.04.18; 26.04.24; 27.05.01;

27.05.08; 27.05.24; 29.01.13

(511)

30 – Coffee, tea, cocoa and coffee substitutes; rice, pasta and noodles; tapioca and sago; flour and preparations made from cereals; bread, pastry and confectionery; chocolate; ice creams, sorbets and other edible ice creams; sugar, honey, molasses syrup; yeast, baking powder; salt, seasonings, spices, preserved herbs; vinegar, sauces and other condiments; ice [frozen water]; candies, sugar-free candies, chewing gum, sugar-free chewing gum, tea-based beverages, cocoa-based beverages, biscuits, chocolate-based products.

(260) AM 2022 117243 A

(800) 1652327

(151) 2022 02 10

(891) 2022 02 10

(731) Co-Diagnostics Inc.

Suite D, 2401 South Foothill Drive,

Salt Lake City UT 84109, USA

(540)

COPRIMERS

(591) Black, white

(511)

1 – Polynucleotide primers and probes for the amplification of DNA; polynucleotide primers and probes for the amplification of cDNA; polynucleotide primers and probes for the amplification of DNA using the polymerase chain reaction (PCR); polynucleotide primers and probes for the amplification of cDNA using the polymerase chain reaction (PCR); polynucleotide primers and probes for the identification of DNA.

(260) AM 2022 117397 A

(800) 1654724

(151) 2021 12 13

(891) 2021 12 13

(731) Innovative IP Holdings LLC

STE R, 30 N Gould St, Sheridan WY 82801,

USA

(540)

PHAT

(591) Black, white

(511)

35 – Negotiation of business contracts for others; abstracting services in the nature of extracting and summarizing information from financial records; connecting buyers and sellers of financial assets.

36 – Banking; banking consultation; banking services; fiduciary representatives; fiduciary services, namely, fiduciary representative services; financial research and information services; financial services, namely, debt settlement; financial services, namely, microfinance lending services; financial services, namely, money lending; financial services, namely, wealth management services; financial advice and consultancy services; financial advisory and consultancy services; financial advisory and consultancy services, namely, the creation of personalized strategies to achieve financial independence; financial affairs and monetary affairs, namely, financial information, management and analysis services; financial analysis and research services; financial and investment services, namely, asset and investment acquisition, consultation, advisory and development; financial consultation in the field of cryptocurrency; financial consultation in the field of environmental management, namely, advising business and individuals on issues of portfolio planning and investment planning; financial consulting services, namely, expert analysis in finance; financial counseling services, namely, helping others build a better working relationship with their money; financial credit scoring services; financial custody services, namely, maintaining possession of financial assets for others for financial management purposes; financial information and advisory services; financial information provided by electronic means; financial management of reimbursement payments for others; financial planning and investment advisory services; financial portfolio analysis services; financial restructuring services; financial retirement plan consulting services; financial services in the nature of an investment security; financial services, namely, providing on-line stored value accounts in an electronic environment; lending consultant services; trust management accounts; trust services, namely, investment and trust company services; consumer lending services; debt settlement negotiation services; financial trust administration; financial trust planning; insurance and financial information and consultancy services; online banking; providing banking information; providing fi-

financial services with respect to securities and other financial instruments and products, namely, money management services; providing financial advice via a website; providing financial information via a website; providing information and research in the field of finance and financial investments; strategic financial advisory services.

45 – Arbitration; arbitration services; litigation support in economics, accounting and finance; legal services in relation to the negotiation of contracts for others; legal services, namely, providing customized legal information, counseling, advice, and litigation services in all areas of law to people and families of modest incomes; providing information in the field of business law, litigation and intellectual property.

(260) AM 2022 117398 A

(800) 1654784

(151) 2022 02 25

(891) 2022 02 25

(731) OBSCHESTVO S OGRANICHENNOY OTVETSTVENNOSTYU "MARKA"
ul. Marshala Govorova, 35, korp. 4,
liter I, pomeshenie 30-N, RU-198095
Sankt-Peterburg, Russian Federation

(540)



(591) Black, white

(531) 08.05.15; 26.11.02; 26.11.12; 28.05

(511)

29 – Albumen for culinary purposes; bouillon; fatty substances for the manufacture of edible fats; laver, preserved; jellies for food; caviar; fish roe, prepared; isinglass for food; fish, tinned; bouillon concentrates; shrimps, not live; buttercream; salmon, not live; margarine; oils for food; mussels, not live; molluscs, not live; fish mousses; lobsters, not live; liver pastes; fish-based foodstuffs; crayfish, not live; crustaceans, not live; fish, preserved; fish, not live; salted fish; sardines, not live; herrings, not live; fat-containing mixtures for bread slices; preparations for making bouillon; preparations for making soup; sea-cucumbers, not live; tuna, not live; oysters, not live; fish fillets; seaweed extracts for food.

(260) AM 2022 117399 A

(800) 1654816

(151) 2021 08 27

(891) 2021 08 27

(731) ALPER OZTAS

Terazidere MH. Ciftehavuzlar Cad., Rüya
Sokak no:3 Bayrampaşa, İstanbul, Türkiye

(540)

CONFEO

(591) Black, white

(531) 27.05.01

(511)

25 – Clothing, including underwear and outer clothing, other than special purpose protective clothing; socks, mufflers [clothing], shawls, bandanas, scarves, belts [clothing]; footwear, shoes, slippers, sandals; headgear, hats, caps with visors, berets, caps [headwear], skull caps.

35 – Provision of an online marketplace for buyers and sellers of goods and services; the bringing together, for the benefit of others, of a variety of goods, clothing, including underwear and outer clothing, other than special purpose protective clothing, socks, mufflers [clothing], shawls, bandanas, scarves, belts [clothing], footwear, shoes, slippers, sandals, headgear, hats, caps with visors, berets, caps [headwear], skull caps, perfumery, non-medicated cosmetics, jewellery, imitation jewellery, gold, precious stones and jewellery made thereof, cufflinks, tie pins, clocks, watches, sunglasses, goods made of leather, imitations of leather or other materials, bags, wallets, candles, decorative candles, textile goods for household use, not included in other classes, curtains, bed covers, sheets (textile), pillowcases, blankets, quilts, towels, hair pins, enabling customers to conveniently view and purchase those goods, such services may be provided by retail stores, wholesale outlets, by means of electronic media or through mail order catalogues.

(260) AM 2022 117400 A

(800) 1654820

(151) 2021 09 03

(891) 2021 09 03

(731) ELFATEK ELEKTRONİK MAKİNA VE
OTOMASYONU SANAYİ TİCARET
LİMİTED ŞİRKETİ

Ankara Yolu Üzeri Modesa, Sanayi Sitesi

10735. Sokak No:10, Karatay Konya, Türkiye

(540)

elfatek

(591) Blue and white

(531) 27.05.01; 29.01; 29.01.04

(511)

9 – Measurement apparatus and equipment including those for scientific, nautical, topographic, meteorologic, industrial and laboratory purposes, thermometers, not for medical purposes, barometers, ammeters, voltmeters, hygrometers, testing apparatus not for medical purposes, telescopes, periscopes, directional compasses, speed indicators, laboratory apparatus, microscopes, magnifying glasses, binoculars, ovens

and furnaces for laboratory experiments; apparatus for recording, transmission or reproduction of sound or images, cameras, photographic cameras, television apparatus, video recorders, CD and DVD players and recorders, MP3 players, computers, desktop computers, tablet computers, wearable technological devices, namely, smart watches, wristbands, head-mounted devices; microphones, loudspeakers, earphones, telecommunications apparatus, apparatus for the reproduction of sound or images, computer peripheral devices, cell phones, covers for cell phones, telephone apparatus, computer printers, scanners [data processing equipment], photocopiers; magnetic and optic data carriers and computer software and programmes recorded thereto, downloadable and recordable electronic publications, encoded magnetic and optic cards, movies, tv series and video music clips recorded on magnetic, optical and electronic media; antennas, satellite antennas, amplifiers for antennas, parts of the aforementioned goods; ticket dispensers, automatic teller machines (ATM); electronic components used in the electronic parts of machines and apparatus, semi-conductors, electronic circuits, integrated circuits, chips [integrated circuits], diodes, transistors [electronic], magnetic heads for electronic apparatus, electronic locks, photocells, remote control apparatus for opening and closing doors, optical sensors; counters and quantity indicators for measuring the quantity of consumption, automatic time switches; clothing for protection against accidents, irradiation and fire, safety vests and life-saving apparatus and equipment; eyeglasses, sunglasses, optical lenses and cases, containers, parts and components thereof; apparatus and instruments for conducting, transforming, accumulating or controlling electricity, electric plugs, junction boxes [electricity], electric switches, circuit breakers, fuses, lighting ballasts, battery starter cables, electrical circuit boards, electric resistances, electric sockets, transformers [electricity], electrical adapters, battery chargers, electric door bells, electric and electronic cables, batteries, electric accumulators, solar panels for production of electricity; alarms and anti-theft alarms, other than for vehicles, electric bells; signalling apparatus and instruments, luminous or mechanical signs for traffic use; fire extinguishing apparatus, fire engines, fire hose and fire hose nozzles; radar apparatus, sonars, night vision apparatus and instruments; decorative magnets; metronomes.

(260) AM 2022 117401 A
 (800) 1654838
 (151) 2021 12 02
 (891) 2021 12 02
 (731) GRUPPO EUROPEO DI ORTODONZIA
 S.R.L.
 VIA CROPANI, 118 A/B, I-00173 ROMA
 (RM), Italy

(540)



(591) Black, white
 (531) 26.03.06; 26.03.24; 27.05.21
 (511)

10 – Teeth aligners; apparatus, instruments, devices and films for tooth alignment; orthodontic appliances; orthodontic machines and instruments [for dental purposes]; artificial teeth; dental caps; aligners for dental use; teeth protectors for dental purposes; parts and accessories for all the aforementioned goods.

40 – Dental technician services; custom manufacture of dental appliances, prosthetics and dental articles; services of orthodontic technicians; consultancy relating to the aforementioned services.

44 – Dentistry services; teeth whitening services; orthodontic services; dental services, namely, treatment of patients with straighten and align teeth; dental imaging services; providing information for patients in the field of dental health via a website; consultancy relating to the aforementioned services.

(260) AM 2022 117402 A
 (800) 1654870
 (151) 2022 01 11
 (891) 2022 01 11
 (731) UBUY HOLDING COMPANY SPC (KW)
 Mazaya Tower 3, Floor 22, Office 3, Khalid
 Bin Waleed Street, Sharq, 1320 Kuwait,
 Kuwait

(540)

UBUY

(591) Black, white
 (511)

35 – Business assistance, management and administrative services; advertising, marketing and promotional services; business management services relating to electronic commerce; advertising services for the promotion of e-commerce; provision of information and advisory services relating to e-commerce; provision of an online marketplace for buyers and sellers of goods and services; promoting the goods and services of others; customer loyalty services for commercial, promotional and/or advertising purposes; customer relationship management; sales promotion through customer loyalty programs; arranging business introductions relating to the buying and selling of products; arranging of contracts for others for the buying and selling of goods; business intermediary and ad-

visory services in the field of selling products and rendering services; providing consumer information relating to goods and services; comparison shopping services; procurement services; administrative support and data processing services; administrative processing of computerized purchase orders; providing an on-line commercial information directory on the internet; advertising services; advertising services relating to the sale of goods; import and export agencies; import and export agencies services; advisory and consultancy services relating to import-export agencies; database management services; providing a searchable online advertising guide featuring the goods and services of online vendors; providing searchable online advertising guides; wholesale ordering services; online ordering services; arranging commercial transactions, for others, via online shops; online retail services relating to cosmetics; online retail services relating to clothing; online retail services relating to beauty products; online retail services relating to handbags; online retail services relating to jewellery; online retail services relating to toys; online retail services relating to luggage; online retail services relating to musical instruments; online retail services relating to office products; online retail service relating to sports; online retail service relating to tools; online retail services relating to personal care; online retail service relating to furniture; online retail services relating to electronics; online retail services relating to books; online retail services relating to pet supplies; online retail services relating to automotive; online retail services relating to home goods; online retail services relating to products for babies and toddlers; online retail services relating to cell phone and accessories.

(260) AM 2022 117403 A

(800) 1654880

(151) 2021 12 24

(891) 2021 12 24

(731) China Kweichow Moutai Distillery (Group) Co., Ltd.

No.4 East Mountain Lane, East Road of Outside Loop, Guiyang City, 200030 Guizhou Province, China

(540)



(591) Blue, red, white

(531) 01.01.01; 03.07.17; 20.07.01; 26.01.03; 26.11.13; 27.05.03; 27.05.24; 29.01.13

(511)

30 – Ice cream; candy; instant rice; cereal preparations; condiments; bread, pastries and confectionery; wheat flour; starch for food; yeast.

32 – Whey beverages; beers; fruit juice; waters [beverages]; non-alcoholic beverages; syrups and other preparations for making beverages.

35 – Demonstration of goods; advertising; publicity agencies; business management assistance; organization of exhibitions for commercial or advertising purposes; sales promotion for others; personnel management consultancy; office machines and equipment rental; accounting.

43 – Accommodation bureaux [hotels, boarding houses]; day-nurseries [crèches]; retirement homes; hotels; snack-bars; rental of transportable buildings; rental of meeting rooms; rental of chairs, tables, table linen, glassware; cafés; services for providing food and drink.

(260) AM 2022 117404 A

(800) 1654980

(151) 2022 02 25

(891) 2022 02 25

(731) OBSHESTVO S OGRANICHENNOY OTVETSTVENNOSTYU "MARKA"

ul. Marshala Govorova, 35, korp. 4, liter I, pomeshenie 30-N, RU-198095 Sankt-Peterburg, Russian Federation

(540)

БУТЕРФИШ

(591) Black, white

(531) 28.05

(511)

29 – Ajvar [preserved peppers]; aloe vera prepared for human consumption; alginates for culinary purposes; anchovy, not live; peanuts, prepared; artichokes, preserved; albumen for culinary purposes; white of eggs; beans, preserved; soya beans, preserved, for food; bouillon; ginger jam; ham; fatty substances for the manufacture of edible fats; laver, preserved; edible birds' nests; sea-cucumbers, not live; peas, preserved; mushrooms, preserved; guacamole; game, not live; gelatine; meat jellies; jellies for food; fruit jellies; yolk of eggs; coconut fat; bone oil for food; lard; suet for food; edible fats; curd; fruit-based snack food; milk substitutes; soya patties; tofu patties; charcuterie; raisins; caviar; eggplant paste; vegetable marrow paste; fish roe, prepared; yogurt; sauerkraut; kephir; kimchi; isinglass for food; clams, not live; potato-based dumplings; klipfish [salted and dried cod]; milk shakes; black pudding; onion rings; arrangements of processed fruit; compotes; meat, tinned; vegetables, tinned; fish, tinned; fruits, tinned; bouillon concentrates; corn dogs; gherkins; shrimps, not live; prawns, not

live; buttercream; croquettes; silkworm chrysalis for human consumption; sweet corn, processed; kumys; spiny lobsters, not live; lecithin for culinary purposes; salmon, not live; onions, preserved; margarine; marmalade; oils for food; peanut butter; cocoa butter for food; coconut oil for food; coconut butter; corn oil for food; sesame oil for food; linseed oil for food; extra virgin olive oil for food; olive oil for food; palm oil for food; palm kernel oil for food; sunflower oil for food; colza oil for food; butter; soya bean oil for food; mussels, not live; almonds, ground; animal marrow for food; molluscs, not live; milk; peanut milk; peanut milk for culinary purposes; coconut milk; coconut milk for culinary purposes; almond milk; almond milk for culinary purposes; oat milk; rice milk; rice milk for culinary purposes; albumin milk; condensed milk; soya milk; powdered milk; fish meal for human consumption; vegetable mousses; fish mousses; fruit pulp; meat; meat, preserved; freeze-dried meat; milk beverages, milk predominating; peanut milk-based beverages; coconut milk-based beverages; almond milk-based beverages; edible insects, not live; sausage casings, natural or artificial; freeze-dried vegetables; vegetables, dried; vegetables, cooked; potato fritters; olives, preserved; lobsters, not live; flavoured nuts; candied nuts; coconut, desiccated; nuts, prepared; tomato paste; pressed fruit paste; liver pastes; pectin for culinary purposes; liver; pickles; jams; powdered eggs; milk products; fish-based foodstuffs; prostokvasha [soured milk]; poultry, not live; bulgogi; pollen prepared as foodstuff; cranberry compote; tomato purée; apple purée; crayfish, not live; crustaceans, not live; fish, preserved; fish, not live; salted fish; ryazhenka [fermented baked milk]; vegetable salads; fruit salads; bacon; sardines, not live; pork; herrings, not live; seeds, prepared; sunflower seeds, prepared; cream [dairy products]; whipped cream; vegetable-based cream; fat-containing mixtures for bread slices; smetana; lemon juice for culinary purposes; tomato juice for cooking; vegetable juices for cooking; salted meats; sausages; sausages in batter; hot dog sausages; preparations for making bouillon; preparations for making soup; nut-based spreads; tripe; soups; vegetable soup preparations; whey; cottage cheese fritters; cheese; tagine [prepared meat, fish or vegetable dish]; tahini; tofu; truffles, preserved; tuna, not live; oysters, not live; falafel; milk ferments for culinary purposes; rennet; fish fillets; dates; crystallized fruits; frozen fruits; fruit, preserved; fruit preserved in alcohol; fruit, stewed; hazelnuts, prepared; potato flakes; hummus; fruit peel; preserved garlic; lentils, preserved; low-fat potato chips; fruit chips; non-alcoholic eggnog; seaweed extracts for food; meat extracts; tofu skin; berries, preserved; eggs; snail eggs for consumption; yakitori.

(260) AM 2022 117405 A

(800) 1654989

(151) 2021 08 12

(891) 2021 08 12

(731) UNION DES ASSOCIATIONS

EUROPEENNES DE FOOTBALL (UEFA)

Route de Genève 46, CH-1260 Nyon,

Switzerland

(540)



(591) Black, white

(531) 04.05.05; 26.01.14; 26.01.16

(511)

25 – Clothing; shoes and footwear; headwear; shirts; knitwear (clothing); pullovers; slipovers; T-shirts; vests; jerseys; sleeveless jerseys, dresses; skirts; underwear, functional underwear, brassieres; swimsuits; bathrobes; shorts; trousers; sweaters; stocking caps; caps; hats; long scarves; scarves, shawls; peaked caps; tracksuits; sweatshirts; jackets, sports jackets, stadium jackets (jumpers); blazers; waterproof clothing; coats; uniforms; neckties; wrist bands; headbands; gloves; aprons; bibs (not of paper); pajamas; play suits for infants and children; socks and stockings; tights and leggings, garters; belts; suspenders; sandals; sports shoes, namely, shoes for outdoor sports, basketball shoes, multi-sport shoes, cycling shoes, indoor sports shoes, track and field shoes, football shoes (indoor and outdoor), canvas shoes, tennis shoes, sneakers, sailing shoes, shoes for aerobics; hiking boots; flip-flops; sportswear, namely, fleece tops, jogging suits, knitted sportswear, casual sports pants, polo shirts, sweat shirts, sweat pants football shirts, rugby shirts, bathing suits, sports jerseys, leotards, ski suits, ski jackets, ski trousers; wrist bands [clothing].

28 – Games and toys; sports balls; play balloons; board games; tables for indoor football; dolls and plush toys; vehicles (toys); jigsaw puzzles; balloons; inflatable toys; play disks (pogs); playing cards; confetti; gymnastic and sporting articles; football equipment, namely balls for football, gloves, knee guards, elbow guards, shoulder guards, shin guards; football goals; sports bags and containers (adapted to objects) for carrying sports articles; party hats (toys); small electronic games designed for use with a television set; video game apparatus; game consoles, electronic games other than those adapted for use with television receivers only; steering wheels for video games and mats for video games (for dancing upon); hands made of rubber or foam (toys); entertainment robots; appliances for gymnastics; kites; roller skates; scooters;

skateboards; coin-operated video games for game halls (arcade games); electronic games with liquid crystal display; joysticks for video games, manually or voice-activated joysticks for video games; lottery tickets; lottery cards, scratch tickets for lottery games; toys for household pets; computer game joysticks; voice-activated or manually operated computer game joysticks.

41 – Education; training; entertainment; organization of lotteries, raffles and competitions; betting and gaming services in connection with sports; provision of entry tickets and information brochures on sports for VIPs, as well as guiding and gathering VIPs for sports or entertainment events, provision of online information in the field of sports or sports events from a computer database or the Internet; customer reception services (entertainment services) including provision of access tickets during sports or entertainment events; entertainment services relating to sporting events; entertainment services in the form of public gatherings during the retransmission of sports events; sporting and cultural activities; organization of sporting and cultural events and activities; amusement park services; sports club services [health and fitness training]; organization of sports competitions; organization of events in the field of football; sports camp services; providing sports facilities; rental of video and audio-visual installations; production, presentation, distribution and/or rental of film recordings and sound and video recordings; presentation, distribution and/or rental of interactive educational and entertainment products, interactive compact disks, CD-ROMs, and computer games; radio and television coverage of sporting events; production services for radio, television programs and video films; ticket reservation services and information services for sports or entertainment events; timing services relating to sports events; organization of beauty contests; interactive entertainment; on-line betting and gaming services on the Internet or on any wireless electronic communication network; information in the field of entertainment (including in the field of sports), provided on-line from a computer database or via the Internet or via any wireless electronic communication network; electronic game services transmitted via the Internet or on mobile telephones; editing of books; publication of books and electronic journals on-line; audio and video recording services; production of animated cartoons for the cinema, production of animated cartoons for television; rental of sound and image recordings for entertainment purposes; information in the field of education provided on-line from a computer database or via the Internet or any wireless electronic communication network; translation services; photography services; provision of entertainment infrastructure; ticket agencies in connection with sports events; entertainment information in the field of sports; provision of information in the field of sports events; publication of statistics; publication of statistics and information on sports perfor-

mances; provision of entertainment infrastructure, namely VIP boxes and boxes inside and outside stadiums.

(260) AM 2022 117406 A

(800) 1655085

(151) 2021 12 03

(891) 2021 12 03

(731) COTTON CLUB INVESTMENT LLC

1'st Lipovy per., vl. 4, d. Soboliha, g. Balashiha,
RU-143985 Moscow obl., Russian Federation

(540)



(591) Grey and white

(531) 04.05.05; 04.05.15; 27.05.24

(511)

3 – Antistatic preparations for household purposes; air fragrancng preparations; breath freshening sprays; canned pressurized air for cleaning and dusting purposes; lip glosses; nail glitter; body glitter; sachets for perfuming linen; drying agents for dishwashing machines; scented water; micellar water; toilet water; wax for parquet floors; floor wax; non-slipping wax for floors; non-slipping liquids for floors; windscreen cleaning liquids; cosmetic pencils; hair conditioners; quillaia bark for washing; body paint for cosmetic purposes; beauty masks; oils for cleaning purposes; cleaning chalk; toothpaste; cosmetic preparations for baths; laundry soaking preparations; starch glaze for laundry purposes; fabric softeners for laundry use; laundry bleach; dry-cleaning preparations; paint stripping preparations; lacquer-removing preparations; make-up removing preparations; rust removing preparations; cleaning preparations; chemical cleaning preparations for household purposes; collagen preparations for cosmetic purposes; laundry preparations; aloe vera preparations for cosmetic purposes; sunscreen preparations; colour-brightening chemicals for household purposes [laundry]; breath freshening preparations for personal hygiene; shining preparations [polish]; bleaching soda; washing soda, for cleaning; bath salts, not for medical purposes; bleaching salts; cosmetic preparations for skin care; shoe wax; dentifrices; cosmetics for children; cosmetics for animals; cleansers for intimate personal hygiene purposes, non medicated; detergents, other than for use in manufacturing operations and for medical purposes; degreasers, other than for use in manufacturing processes; phytocosmetic preparations; cloths impregnated with a detergent for cleaning; dry shampoos; herbal extracts for cosmetic purposes.

5 – Dietetic substances adapted for medical use; dental impression materials; teeth filling material; dressings, medical; food for babies; veterinary preparations; preparations for destroying noxious animals; pharmaceutical preparations; sanitary towels; panty liners [sanitary]; tissues impregnated with pharmaceutical lotions; disinfectants; disinfectants for hygiene purposes; sanitary tampons; pants, absorbent, for incontinence; fungicides; sanitary preparations for medical purposes; plasters; herbicides; tissues impregnated with pharmaceutical lotions for feminine hygiene; tissues impregnated with pharmaceutical lotions for personal hygiene; disposable training pants of paper, cellulose or cotton; disposable pads of paper, cellulose and cotton for incontinence; disposable training pants of paper or cellulose or compounds of these materials; disposable pads of paper or cellulose or compounds of these materials.

(260) AM 2022 117407 A

(800) 614557

(151) 1994 01 25

(891) 2022 02 18

(731) DOKA GMBH

Josef Umdasch Platz 1, A-3300 Amstetten,
Austria

(540)

Eurex

(591) Black, white

(531) 27.05.01; 27.05.17

(511)

6 – Stays of metal, particularly of steel.

(260) AM 2022 117408 A

(800) 1125984

(151) 2011 12 06

(891) 2022 03 11

(731) Joint Stock Company "Microgen Scientific,
Industrial Company for Immunobiological
Medicines"

1st Dubrovskaya str., 15, building 2,
RU-115088 Moscow, Russian Federation

(540)

Секстафар

(591) Black, white

(531) 28.05

(511)

5 – Bacterial preparations for medical and veterinary use.

(260) AM 2022 117409 A

(800) 1208979

(151) 2014 02 25

(891) 2022 02 10

(731) CAROLL INTERNATIONAL

10 Impasse du Grand Jardin, Zac de la
Moinerie, F-35400 Saint-Malo, France

(540)

CAROLL

(591) Black, white

(511)

18 – Goods of leather and imitations of leather, namely traveling bags and sets, garment bags for travel, trunks, suitcases, unfitted vanity cases, backpacks, handbags, beach bags, school bags, suitcases (carrying cases), travel sets (leather goods), document holders, briefcases, satchels, clutch bags, leather goods particularly wallets, purses (coin purses) not of precious metal, key cases (leather goods), card cases (wallets); umbrellas, parasols, sunshades, walking sticks.

25 – Clothing, sashes for wear, shawls, scarves, gloves, neckties, belts (clothing), footwear (except orthopedic footwear), namely shoes, sandals, boots, half-boots, boot liners, slippers; hats, berets, caps.

35 – Retail sale services and sales via the Internet, for clothing, footwear, leather goods and headgear; advertising; business management; business administration; office functions.

(260) AM 2022 117410 A

(800) 1549962

(151) 2020 07 17

(891) 2022 03 18

(731) Roche Diagnostics GmbH

Sandhofer Strasse 116, 68305 Mannheim,
Germany

(540)

ELECSYS

(591) Black, white

(511)

9 – Computer software for use in the field of diagnostics; computer software featuring algorithms for laboratory test data analysis; computer software having processing algorithm used to identify, filter, analyze, visualize and manage data from biological information; software for the design of assays and reagents for use in the medical and life sciences fields.

42 – Design and development of software for use in the field of diagnostics; providing temporary use of non-downloadable computer software featuring algorithms for laboratory test data analysis; providing

temporary use of non-downloadable computer software for viewing, analyzing, managing, reporting, and archiving data for use in the field of medicine, medical research and clinical research.

(260) AM 2022 117411 A
 (800) 1568915
 (151) 2020 12 01
 (891) 2022 03 18
 (731) Jack Daniel's Properties, Inc.
 4040 Civic Center Drive, Suite 528,
 San Rafael CA 94903, USA

(540)

JACK DANIEL'S

(591) Black, white
 (511)
 30 – Sauces.

(260) AM 2022 117412 A
 (800) 1615249
 (151) 2021 05 28
 (891) 2022 02 15
 (731) IQNet Association-The International
 Certification Network
 Bollwerk 31, CH-3011 Bern, Switzerland

(540)



(591) Black, white
 (531) 26.01.06; 26.01.24; 27.05.01; 27.05.17
 (511)

42 – Verification and control services in the field of activities dedicated to the granting of certification to goods and services; certification services related to coordination of activities performed by several organizations.

(260) AM 2022 117458 A
 (800) 1655151
 (151) 2022 03 04
 (891) 2022 03 04
 (731) SOREMARTEC S.A.
 16, route de Trèves, L-2633 Senningerberg,
 Luxembourg

(540)



(591) Purple and white
 (531) 01.01.05; 01.15.07; 01.15.09; 26.04.02;
 26.04.09; 26.04.18; 26.04.24; 27.05.02;
 27.05.03; 27.05.04; 27.05.08; 27.05.17;
 27.05.19; 27.05.24; 29.01.13

(511)

30 – Pastry and confectionery; biscuits and cookies; cakes; chocolate and chocolate-based products; candy; chewing gum; edible ices.

(260) AM 2022 117460 A
 (800) 1655254
 (151) 2021 10 25
 (891) 2021 10 25
 (731) SPANISH TILE FROM NULES, S.A.
 Carretera Nules-Villavieja, km 1,6, E-12520
 Nules (Castellón), Spain

(540)

PORCELARTtech

(591) Black, white
 (531) 27.05.09
 (511)

19 – Non-metallic building materials; paving blocks, not of metal; non-metallic coverings for walls and floors, sandstone, porcelain; raw materials for decorated ceramics; ceramic tiles and slabs.

(260) AM 2022 117461 A
 (800) 1655272
 (151) 2022 03 09
 (891) 2022 03 09
 (731) China Post Communications Equipment Co.,
 Ltd.
 6 / F, Block D, No.156, Fuxingmennei Street,
 Xicheng District, 100031 Beijing, China

(540)

Hi nova

(591) Black, white

(511)

38 – Television broadcasting; cable television broadcasting; message sending; communications by cellular phones; satellite transmission; providing telecommunications connections to a global computer network; providing access to databases; streaming of data; computer aided transmission of messages and images; rental of telecommunication equipment; providing internet chatrooms; videoconferencing services; providing online forums; telephone services; communications by telephone; providing information in the field of telecommunications; providing user access to global computer networks; radio communications.

(260) AM 2022 117496 A

(800) 1656056

(151) 2021 12 07

(891) 2021 12 07

(731) Shiva manufacturing company

Ferdowsi Blvd., Main town., Amirieh Industrial town, Central part, Firoozkooch City, Tehran province, Islamic Republic of Iran

(540)

SHIBABA

(591) Black, white

(511)

29 – Marmalade; milk products; cocoa milk powder; banana compote; milk; jams; tomato powder; kefir (milk drink); jellies for food; tomato juice for cooking; fruit jellies; gelatine for food; coffee milk powder; fruits, tinned [canned (Am.)]; frozen fruits; meat jellies; coconut powder; milk powder; fried fish powder; chickpea powder; dairy-based desserts; fruit jellies (jams); compotes; fruit-based desserts; processed dates.

30 – Cookies; mustard; chocolate powder; malt biscuits; chocolate cream; chocolate candy; ready ice cream powder; sohan (sweets); chocolate with nuts; sauces [condiments]; ice cream cake; caramels [candy]; powders for ice cream; confectionery chocolate; biscuits; coffee beverages with milk; cocoa beverages with milk; kebab sauce; meat pies; cocoa-based beverages; malt biscuits; golden syrup; cakes; cake powder; cream (ice -); salad dressing; royal jelly for human consumption [not for medical purposes]; pastries; white chocolate powder; crackers; coffee powder; instant chocolate mix; frozen candy; flakes (candy); ketchup [sauce]; layered cake; jellies (fruit -) [confectionery]; sherbets [ices]; semi-prepared cake powder; cake flour; macarons [pastry]; soy coffee; rusks; fondants [confectionery]; soy sauce; powder (cake-); dragee (chocolate pills); chocolate-based beverages; candy for food; mayonnaise; sweets made from cereals; coffee flavorings [flavourings]; cool eucalyptus candy; pepper sauce; wholemeal biscuits; cocoa products; coffee flavorings; chocolate; coffee (artificial-); chocolate beverages with milk; cookie; winter ice cre-

am; mixed coffee; paste (cake-); cocoa; coffee-based beverages; cake with nuts; lollipop; rice cakes; instant coffee; saffron gum; hot chocolate powder; cacao powder; pancake; chicken breadcrumbs; chocolate cream; meat gravies; onion powder; shrimp breadcrumbs; roasting powder; ice cream; chocolate-coated nuts; sauces (condiments); caramels (sweets); coffee; chocolate-based beverages; tea beverages; candy cake; chocolate candies; bread; salad sauce; pasta sauce.

(260) AM 2022 117499 A

(800) 1656226

(151) 2021 12 14

(891) 2021 12 14

(731) Bright Star Studios ApS

Filmbyen 19, DK-8000 Århus C, Denmark

(540)

EMBER SWORD

(591) Black, white

(511)

9 – Computer software; games software; software programs for games, including computer games, video games and electronic games for use on mobile phones, tablet computers, wireless communication devices and handheld electronic devices; games software, including recorded and interactive computer game programs and computer game programs downloaded via the internet [software]; application software (downloadable) with games for computers, tablet computers and mobile phones; computers; data processing equipment; computer mice, including wireless computer mice; 3D glasses; smart glasses; cameras (photography); webcams; computer joysticks.

41 – Education; providing of training; entertainment; sporting and cultural activities; provision of on-line computer games; providing games; arranging of games; organization of games; game services provided on-line from a computer network; electronic games services, including provision of computer games on-line or by means of a global computer network; providing interactive multi-player computer games via the internet and electronic communication networks; provision of instruction relating to computer programming; training services concerned with the use of computer software; providing on-line information in the field of computer gaming entertainment; providing information on-line relating to computer games and computer enhancements for games; providing information to game players about the ranking of their scores of games through a web site; rental of computer games; rental of electronic game equipment; entertainment by film; services for the production, presentation or rental of films, including motion pictures, tv-films and animated cartoons; organisation of games and competitions, including via the internet; fan club services (entertainment).

42 – Design and development of computer hardware and software; computer programming of computer games; design, development, testing, implementation, maintenance, adaptation, upgrading and repair of computer game software, video game software and virtual reality software; hosting services and software as a service and rental of software, including software for computer games; computer games software consultancy; providing temporary use of web-based software; providing temporary use of web-based applications; providing temporary use of non-downloadable software applications accessible via a website; consulting services in the field of gaming technology and graphics software; information and consultancy services relating to all the aforesaid services; graphic design; visual design; computer design; programming of computer animations; rental of computer game programs.

(260) AM 2022 117500 A

(800) 1656228

(151) 2021 12 14

(891) 2021 12 14

(731) Ferring B.V.

Polarisavenue 144, NL-2132 JX Hoofddorp,
Netherlands

(540)

FERRING

(591) Black, white

(511)

42 – Medical and clinical research services; scientific research for medical purposes; providing scientific information in the field of medical disorders and their treatment; provision of information and data relating to medical research and development; pharmaceutical research and development services; pharmaceutical products development; research of pharmaceuticals; conducting clinical trials for pharmaceutical products; information technology services for the pharmaceutical and healthcare industries; design and development of software for use in the medical and pharmaceutical field; Software as a Service [SaaS] services for use in the medical and pharmaceutical field; Platform as a Service [PaaS] services for use in the medical and pharmaceutical field.

44 – Human healthcare services; providing information in the field of human health care; medical services, consultancy, information and advisory services in the field of pharmaceutical products and treatments; medical and health care information services.

(260) AM 2022 117501 A

(800) 1656256

(151) 2021 11 11

(891) 2021 11 11

(731) Vingroup Joint Stock Company

No. 7, Bang Lang 1 Street, Vinhomes
Riverside Ecological Urban Area, Viet Hung
Ward, Long Bien District, Hanoi City,
Viet Nam

(540)

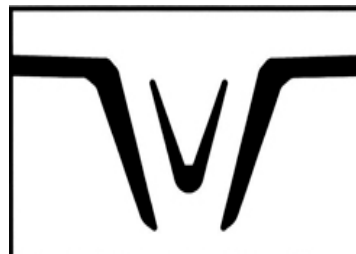

(591) Black, white

(531) 03.07.17; 26.03.23; 26.04.02; 26.13; 26.13.25

(511)

12 – Land vehicles; automobiles; off road light sport utility vehicles; motorcycles; motor scooters [vehicles]; three-wheeled motorcycles; three-wheeled motor scooters [vehicles]; mopeds; bicycles; electric bicycles; electrically assisted bicycles, with pedals; all-terrain vehicles (ATV); snowmobiles; golf cars; engines for land vehicles; cars; sports cars; electrically powered motor vehicles; tricycles not being toys; vehicles for locomotion by rail; structural parts and component parts for all the aforesaid goods.

35 – Advertising services for others; retail store services or wholesale store services featuring automobiles and their parts, fuels, lubricating oil, lubricating grease.

37 – Installation, maintenance and repair of land vehicles, automobiles, motorcycles; automobile cleaning; automobile polishing.

42 – Design of automobiles and parts thereof; design services for the interiors of automobiles; vehicle roadworthiness testing; quality control [for others]; mechanical research; research and development of new products relating to automobiles for others.

(260) AM 2022 117502 A

(800) 1656281

(151) 2022 01 21

(891) 2022 01 21

(731) GMM S.p.A.

Via Nuova 155/B, I-28883 Gravellona Toce
(VB), Italy

(540)

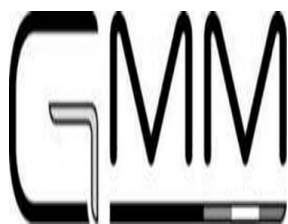

(591) Black, white

(531) 26.11.01; 26.11.08; 27.05.01; 27.05.10;
27.05.11; 27.05.23

(511)

7 – Mechanical saws for stone materials and artificially reconstructed plates; machines powered with abrasive tools for stone materials and artificially reconstructed plates; block cutter machines with blades for stone materials and artificially reconstructed plates; block cutter machines with threads for stone materials and artificially reconstructed plates; single-head industrial cleaning machines [polishers] for stone materials and artificially reconstructed plates; flat polishers for stone materials and artificially reconstructed plates; flat calibrating machines for stone materials and artificially reconstructed plates; vertical and horizontal spine polishers for stone materials and artificially reconstructed plates; straight and inclined chamfering machines for stone materials and artificially reconstructed plates; cutting tables for stone materials and artificially reconstructed plates; lathes [machine tools] for stone materials and artificially reconstructed plates; equipment for moving and handling for stone materials and artificially reconstructed plates; industrial robots for handling workpieces for stone materials and artificially reconstructed plates; materials handling conveyors for stone materials and artificially reconstructed plates; grippers [machines] for stone materials and artificially reconstructed plates; grippers for cranes; collets [parts of machines] and suction cups [parts of machines] for stone materials and artificially reconstructed plates; waterjet cutting machines for stone materials and artificially reconstructed plates; cutting centres [machines] for stone materials and artificially reconstructed plates; cross-cutting stations for stone materials and artificially reconstructed plates; chamfering machines for stone materials and artificially reconstructed plates; calibrating machines for stone materials and artificially reconstructed plates; multi-spindle machines for stone materials and artificially reconstructed plates; contour grinding machines for stone materials and artificially reconstructed plates.

(260) AM 2022 117516 A

(800) 1166645

(151) 2013 05 24

(891) 2022 03 02

(731) Mühlbauer Technology GmbH

Elbgaustraße 248, 22547 Hamburg, Germany

(540)

DMG

(591) Black, white

(511)

5 – Dental material for stopping teeth, dental fastening materials and dental impression materials; pharmaceutical products and preparations for dental purposes.

10 – Dental instruments; syringes for medical purposes.

(260) AM 2022 117518 A

(800) 1270198

(151) 2015 06 24

(891) 2021 12 20

(731) URSA Salgótarján Glass Wool Close Co.,
Ltd.Szépvölgyi út 41, 2/2, H-1037 Budapest,
Hungary

(540)



(591) Blue and red

(531) 03.01.14; 27.05.10; 27.05.11; 29.01.12

(511)

17 – Insulating, soundproofing and stopping materials; fabrics, webs, plates, panels and sheets made from insulation material; padding and stuffing materials of rubber or plastics; mineral wool, glass wool, stone wool, rock wool, slag wool and fiber glass for thermal or acoustic insulation; glass fibers; blow wool, glass wool blankets and panels; plastic insulation materials, especially foamed plastic materials; insulation boards, made from polystyrene, especially made from extruded polystyrene; extruded polythene sheeting of high light transmission [other than for packaging]; plastic film, other than for packaging purposes; substances for insulating buildings against moisture; sealant compounds for joints; insulating paper, insulating tape and band, rubber, gutta-percha, gum, asbestos, mica; plastics in extruded form for use in manufacture; packing materials, flexible pipes; membranes and other materials for air tightness and vapor barriers (membrane for moisture protection); insulating adhesives; insulating material for buildings and/or to glass mineral wool for insulation purposes together with the respective fixing material for fastening the insulation material and/or mineral wool to the construction of a building; insulating panels and sheets of mineral fibers (especially fiber glass) for buildings.

19 – Building materials (non-metallic); ducts for air conditioning; woven materials (non-metallic) for use in buildings; non-metallic rigid pipes for building; asphalt, pitch and bitumen; non-metallic transportable buildings; monuments, not of metal; composite structures containing insulation material, waterproof claddings and mounting devices (bars and fillets, clips, glues and tapes) for attaching components of the composite structure to walls.

(260) AM 2022 117519 A

(800) 1270199

(151) 2015 06 24

(891) 2021 12 20

(731) URSA Salgótarján Glass Wool Close Co., Ltd.
Szépvölgyi út 41, 2/2, H-1037 Budapest,
Hungary

(540)



(591) Blue, red and white

(531) 03.01.14; 26.01.24; 27.05.10; 27.05.11;
29.01.13

(511)

17 – Insulating, soundproofing and stopping materials; fabrics, webs, plates, panels and sheets made from insulation material; padding and stuffing materials of rubber or plastics; mineral wool, glass wool, stone wool, rock wool, slag wool and fiber glass for thermal or acoustic insulation; glass fibers; blow wool, glass wool blankets and panels; plastic insulation materials, especially foamed plastic materials; insulation boards, made from polystyrene, especially made from extruded polystyrene; extruded polythene sheeting of high light transmission [other than for packaging]; plastic film, other than for packaging purposes; substances for insulating buildings against moisture; sealant compounds for joints; insulating paper, insulating tape and band, rubber, gutta-percha, gum, asbestos, mica; plastics in extruded form for use in manufacture; packing materials, flexible pipes; membranes and other materials for air tightness and vapor barriers (membrane for moisture protection); insulating adhesives; insulating material for buildings and/or to glass mineral wool for insulation purposes together with the respective fixing material for fastening the insulation material and/or mineral wool to the construction of a building; insulating panels and sheets of mineral fibers (especially fiber glass) for buildings.

19 – Building materials (non-metallic); ducts for air conditioning; woven materials (non-metallic) for use in buildings; non-metallic rigid pipes for building; asphalt, pitch and bitumen; non-metallic transportable buildings; monuments, not of metal; composite structures containing insulation material, waterproof claddings and mounting devices (bars and fillets, clips, glues and tapes) for attaching components of the composite structure to walls.

(260) AM 2022 117563 A

(800) 1656638

(151) 2022 02 28

(891) 2022 02 28

(731) Amusnet Interactive Ltd.

Garitage Park, Building No. 4, Floor 2, 2 Donka
Ushlinova Str., BG-1766 Sofia, Bulgaria

(540)

Mystery Cards

(591) Black, white

(511)

9 – Computer software for the administration of on-line games and gaming; computer application software featuring games and gaming; betting software; gaming software that generates or displays wager outcomes of gaming machines.

28 – Gaming machines for gambling; slot machines [gaming machines].

(260) AM 2022 117564 A

(800) 1656639

(151) 2022 02 28

(891) 2022 02 28

(731) Amusnet Interactive Ltd.

Garitage Park, Building No. 4, Floor 2, 2 Donka
Ushlinova Str., BG-1766 Sofia, Bulgaria

(540)

Richness Factory

(591) Black, white

(511)

9 – Computer software for the administration of on-line games and gaming; computer application software featuring games and gaming; betting software; gaming software that generates or displays wager outcomes of gaming machines.

28 – Gaming machines for gambling; slot machines [gaming machines].

41 – Providing of casino and gaming facilities; betting services.

(260) AM 2022 117567 A
 (800) 1656701
 (151) 2021 12 29
 (891) 2021 12 29
 (731) Armacell Enterprise GmbH & Co. KG
 Zeppelinstraße 1, 12529 Schönefeld OT
 Waltersdorf, Germany
 (540)

ArmaClad

(591) Black, white
 (511)
 6 – Metal materials for building and construction; pipes and tubes of metal; cladding of metal for construction and building; casings of metal for construction and building; pipe jackets of metal; metal foil.
 17 – Unprocessed and semi-processed rubber, gutta-percha, gum, asbestos, mica and substitutes for all these materials; plastics and resins in extruded form for use in manufacture; packing, stopping and insulating materials; flexible pipes, tubes and hoses, not of metal; insulating materials for technical equipment and technical installations; pipe jackets, not of metal; insulation jackets for pipes; pipe insulating sleeves; metal foil for insulation.
 19 – Building materials, not of metal, for building and construction; non-metal cladding for construction and building; casings, not of metal, for construction and building.

(260) AM 2022 117568 A
 (800) 1656750
 (151) 2022 03 18
 (891) 2022 03 18
 (731) ISHA FOUNDATION, INC.
 951 Isha Lane, McMinnville TN 37110, USA
 (540)

INNER ENGINEERING

(591) Black, white
 (511)
 41 – Yoga instruction.

(260) AM 2022 117569 A
 (800) 1656764
 (151) 2021 12 21
 (891) 2021 12 21
 (731) Bestway Inflatables & Material Corporation
 No. 208 Jinyuanwu Road, 201812 Shanghai,
 China
 (540)



(591) Black, white
 (531) 27.05.01
 (511)
 35 – On-line wholesale and retail store services and web-based catalog services featuring air beds, not for medical purposes, air cushions, not for medical purposes, air mattresses, not for medical purposes, air pillows, not for medical purposes, air pumps, hand-operated, all-purpose sport bags, awnings of synthetic materials specially adapted for use with inflatables and recreational equipment, namely, air floats, backpacks, all-purpose carrying bags, bags especially designed for skis and surfboards, bath tubs, beach bags, canoes, central vacuum cleaning installations, chairs, chemical test paper, compressed air machine components, namely, valves, compressed air pumps, disinfectant dispensers for swimming pools and bath tubs, divers' masks, breathing apparatus for underwater swimming, ear plugs and nose clips for divers and swimmers, filters for non-medical respiratory mask, frames for supporting swimming pools, hammocks, horizontal and vertical tube connectors, hydro massage bath apparatus, inflatable bathtubs for babies, inflatable boats, inflatable floats for swimming pool, inflatable furniture, inflatable pools for recreational use, inflatable ride-on toys, inflatable sofas, inflatable swimming pools, inflatable toys and structures for recreational use, inflatable water and playground slides, machines and apparatus for cleaning pools, electric, namely, automatic swimming pool vacuums and cleaners, mast for sailboards, metal swimming pools, non-metal floating containers for storage, non-metal swimming pools, oars, paddleboards, play balloons, pumps for counter-current swimming, respiratory masks for non-medical purposes, sleeping bags for camping, sleeping bags for kids, sleeping pads, sleeping mats, spas in the nature of heated pools, surf skis, surfboards, swim caps, swimming accessories, swimming pool air floats, swimming pool chlorinating apparatus, swimming pool water cleaning and filtering units, swimsuits, travelling bags, vacuum pumps, valves as machine components, water filtering apparatus.

(260) AM 2022 117570 A
 (800) 1656767
 (151) 2022 03 18
 (891) 2022 03 18
 (731) ISHA FOUNDATION, INC.
 951 Isha Lane, McMinnville TN 37110, USA
 (540)

ISHA

(591) Black, white
 (511)
 35 – Charitable services, namely, organizing and conducting volunteer programs and community service projects for relief and support of initiatives for personal wellbeing.

41 – Yoga instruction; education services, namely, providing classes and seminars in the field of personal wellness.

(260) AM 2022 117571 A

(800) 1656771

(151) 2022 03 02

(891) 2022 03 02

(731) ISU ABXIS CO., LTD

C-5F, Global R&D Center, 22,

Daewangpangyo-ro 712beon-gil, Bundang-gu,

Seongnam-si, Gyeonggi-do 13488, Republic of

Korea

(540)

Фабгал

(591) Black, white

(531) 28.05

(511)

5 – Acaricides; aconitine; alkaloids for medical purposes; alginates for pharmaceutical purposes; algicides; aldehydes for pharmaceutical purposes; dental amalgams of gold; dental amalgams; amino acids for veterinary purposes; amino acids for medical purposes; analgesics; anaesthetics; antibiotics; antiseptics; medicine cases, portable, filled; first-aid boxes, filled; aluminium acetate for pharmaceutical purposes; acetates for pharmaceutical purposes; germicides; oxygen cylinders, filled, for medical purposes; balms for medical purposes; bandages for dressings; diagnostic biomarker reagents for medical purposes; biocides; bracelets impregnated with insect repellent; bromine for pharmaceutical purposes; paper for mustard plasters; fly catching paper; reagent paper for veterinary purposes; reagent paper for medical purposes; moth-proofing paper; petroleum jelly for medical purposes; vaccines; oxygen baths; antiseptic cotton; aseptic cotton; absorbent cotton; wadding for medical purposes; cotton for medical purposes; dietetic substances adapted for medical use; radiological contrast substances for medical purposes; nutritive substances for microorganisms; radioactive substances for medical purposes; melissa water for pharmaceutical purposes; seawater for medicinal bathing; mineral waters for medical purposes; thermal water; dietary fibre; moulding wax for dentists; gases for medical purposes; guaiacol for pharmaceutical purposes; massage gels for medical purposes; sexual stimulant gels; haematogen; haemoglobin; hydrastine; hydrastinine; glycerine for medical purposes; glycerophosphates; glucose for medical purposes; gentian for pharmaceutical purposes; hormones for medical purposes; mustard for pharmaceutical purposes; mustard plasters; mud for baths; medicinal mud; contraceptive sponges; gamboge for medical purposes; gurjun balsam for medical purposes; deodorizers for litter trays; deodorants for clothing and textiles; air deodorizing preparations; deodo-

rants, other than for human beings or for animals; diastase for medical purposes; digitalin; vitamin supplement patches; mineral dietary supplements; nutritional supplements; albumin dietary supplements; dietary supplements for animals; yeast dietary supplements; alginate dietary supplements; glucose dietary supplements; casein dietary supplements; lecithin dietary supplements; linseed oil dietary supplements; brewer's yeast dietary supplements; propolis dietary supplements; protein dietary supplements; protein supplements for animals; royal jelly dietary supplements; pollen dietary supplements; wheat germ dietary supplements; linseed dietary supplements; whey protein dietary supplements; enzyme dietary supplements; yeast for pharmaceutical purposes; gelatine for medical purposes; cod liver oil; isotopes for medical purposes; immunostimulants; insecticides; iodine for pharmaceutical purposes; iodides for pharmaceutical purposes; alkaline iodides for pharmaceutical purposes; iodoform; calomel [fungicide]; tartar for pharmaceutical purposes; camphor for medical purposes; cannabidiol for medical use; capsules for medicines; cachets for pharmaceutical purposes; capsules made of dendrimer-based polymers, for pharmaceuticals; haemostatic pencils; wart pencils; caustic pencils; carbolineum [parasiticide]; caustics for pharmaceutical purposes; cachou for pharmaceutical purposes; quassia for medical purposes; quebracho for medical purposes; oxygen for medical purposes; gallic acid for pharmaceutical purposes; acids for pharmaceutical purposes; adhesives for dentures; surgical glues; stem cells for veterinary purposes; stem cells for medical purposes; cocaine for medical purposes; collagen for medical purposes; collodion for pharmaceutical purposes; corn rings for the feet; cannabis for medical purposes; medicated sweets; barks for pharmaceutical purposes; cedar wood for use as an insect repellent; croton bark; mangrove bark for pharmaceutical purposes; myrobalan bark for pharmaceutical purposes; quinquina for medical purposes; medicated animal feed; medicinal roots; rhubarb roots for pharmaceutical purposes; lint for medical purposes; starch for dietetic or pharmaceutical purposes; creosote for pharmaceutical purposes; blood for medical purposes; biological tissue cultures for veterinary purposes; biological tissue cultures for medical purposes; cultures of microorganisms for medical or veterinary use; curare; dental lacquer; liquorice for pharmaceutical purposes; milk sugar for pharmaceutical purposes; adhesive plasters; medicines for alleviating constipation; adhesive tapes for medical purposes; lecithin for medical purposes; lotions for veterinary purposes; medicated hair lotions; lotions for pharmaceutical purposes; medicated after-shave lotions; personal sexual lubricants; lupulin for pharmaceutical purposes; magnesium for pharmaceutical purposes; liniments; ointments for pharmaceutical purposes; sunburn ointments; mercurial ointments; frostbite salve for pharmaceutical purposes; gauze for dressings; medicinal oils; mustard oil for medical pur-

poses; camphor oil for medical purposes; castor oil for medical purposes; oil of turpentine for pharmaceutical purposes; dill oil for medical purposes; dental mastics; dental abrasives; dental impression materials; teeth filling material; dressings, medical; surgical dressings; drugs for medical purposes; medicines for veterinary purposes; serotherapeutic medicines; medicines for human purposes; medicines for dental purposes; menthol; medicinal drinks; moleskin for medical purposes; almond milk for pharmaceutical purposes; powdered milk for babies; royal jelly for pharmaceutical purposes; milk ferments for pharmaceutical purposes; Irish moss for medical purposes; flour for pharmaceutical purposes; linseed meal for pharmaceutical purposes; fish meal for pharmaceutical purposes; fly glue; antibacterial soap; disinfectant soap; medicated soap; freeze-dried meat adapted for medical purposes; mint for pharmaceutical purposes; dietetic beverages adapted for medical purposes; malted milk beverages for medical purposes; injectable dermal fillers; bone void fillers comprised of living tissues; narcotics; medicinal infusions; tincture of iodine; eucalyptol for pharmaceutical purposes; tinctures for medical purposes; opium; opodeldoc; aromatic deodorizers for toilets; decoctions for pharmaceutical purposes; antiparasitic collars for animals; stick liquorice for pharmaceutical purposes; sulfur sticks [disinfectants]; pastilles for pharmaceutical purposes; medicated toothpaste; pectin for pharmaceutical purposes; pepsins for pharmaceutical purposes; peptones for pharmaceutical purposes; hydrogen peroxide for medical purposes; pesticides; food for babies; leeches for medical purposes; blood plasma; nicotine patches for use as aids to stop smoking; eyepatches for medical purposes; poultices; compresses; scapulars for surgical purposes; babies' diapers; diapers for pets; swim diapers, reusable, for babies; swim diapers, disposable, for babies; diapers for incontinence; disposable absorbent pads for lining pet crates; diaper changing mats, disposable, for babies; disposable house training pads for pets; bunion pads; breast-nursing pads; diagnostic strips for testing breast milk for medical purposes; pomades for medical purposes; powder of cantharides; pyrethrum powder; anti-uric preparations; bacterial preparations for medical and veterinary use; bacteriological preparations for medical and veterinary use; balsamic preparations for medical purposes; albuminous preparations for medical purposes; biological preparations for veterinary purposes; biological preparations for medical purposes; veterinary preparations; bismuth preparations for pharmaceutical purposes; vitamin preparations; diagnostic preparations for medical purposes; bath preparations for medical purposes; therapeutic preparations for the bath; haemorrhoid preparations; preparations for callouses; lice treatment preparations [pediculicides]; acne treatment preparations; preparations to facilitate teething; preparations for the treatment of burns; fumigation preparations for medical purposes; opotherapy preparations; air purifying pre-

parations; bronchodilating preparations; preparations for reducing sexual activity; sterilizing preparations; soil-sterilizing preparations; corn remedies; pharmaceutical preparations for treating dandruff; vermin destroying preparations; preparations for destroying noxious animals; herbicides; preparations for destroying dry rot fungus; larvae exterminating preparations; fly destroying preparations; preparations for destroying mice; slug exterminating preparations; pharmaceutical preparations for skin care; contact lens cleaning preparations; preparations of microorganisms for medical or veterinary use; lime-based pharmaceutical preparations; medicated eye-washes; medicinal hair growth preparations; nutraceutical preparations for therapeutic or medical purposes; opiates; anticryptogamic preparations; aloe vera preparations for pharmaceutical purposes; preparations of trace elements for human and animal use; sulfonamides [medicines]; pharmaceutical preparations; pharmaceutical preparations for treating sunburn; enzyme preparations for veterinary purposes; enzyme preparations for medical purposes; phytotherapy preparations for medical purposes; chemico-pharmaceutical preparations; chemical preparations for veterinary purposes; chemical preparations for the diagnosis of pregnancy; chemical preparations for medical purposes; chemical preparations for treating diseases affecting cereal plants; chemical preparations for treating wheat blight; chemical preparations for treating diseases affecting vine plants; chemical preparations for treating mildew; chemical preparations for treating phyloxera; chemical preparations for pharmaceutical purposes; chilblain preparations; mothproofing preparations; collyrium; lead water; chemical conductors for electrocardiograph electrodes; albuminous foodstuffs for medical purposes; dietetic foods adapted for medical purposes; by-products of the processing of cereals for dietetic or medical purposes; homogenized food adapted for medical purposes; freeze-dried food adapted for medical purposes; pharmaceuticals; sanitary towels; panty liners [sanitary]; propolis for pharmaceutical purposes; pearl powder for medical purposes; radium for medical purposes; hydrated chloral for pharmaceutical purposes; solvents for removing adhesive plasters; vaginal washes for medical purposes; solutions for contact lenses; chemical reagents for medical or veterinary purposes; gum for medical purposes; rubber for dental purposes; chewing gum for medical purposes; nicotine gum for use as an aid to stop smoking; insect repellents; insect repellent incense; repellents for dogs; tissues impregnated with pharmaceutical lotions; sarsaparilla for medical purposes; sugar for medical purposes; crystallized rock sugar for medical purposes; asthmatic tea; fumigating sticks; massage candles for therapeutic purposes; linseed for pharmaceutical purposes; tobacco-free cigarettes for medical purposes; siccatives [drying agents] for medical purposes; syrups for pharmaceutical purposes; turpentine for pharmaceutical purposes; greases for vete-

rinary purposes; greases for medical purposes; lacteal flour for babies; infant formula; soporifics; bicarbonate of soda for pharmaceutical purposes; bath salts for medical purposes; salts for mineral water baths; salts for medical purposes; potassium salts for medical purposes; sodium salts for medical purposes; smelling salts; mineral water salts; malt for pharmaceutical purposes; semen for artificial insemination; alcohol for pharmaceutical purposes; medicinal alcohol; alloys of precious metals for dental purposes; ergot for pharmaceutical purposes; cooling sprays for medical purposes; antibacterial handwashes; adjuvants for medical purposes; astringents for medical purposes; vermifuges; disinfectants; disinfectants for hygiene purposes; disinfectants for chemical toilets; appetite suppressants for medical purposes; medical preparations for slimming purposes; parasiticides; mouthwashes for medical purposes; medicated dentifrices; febrifuges; depuratives; animal washes [insecticides]; detergents for medical purposes; cattle washes [insecticides]; dog washes [insecticides]; insecticidal veterinary washes; vesicants; purgatives; remedies for perspiration; remedies for foot perspiration; anti-inflammatories; chemical contraceptives; antiparasitic preparations; sedatives; laxatives; tonics [medicines]; medicated toiletry preparations; digestives for pharmaceutical purposes; nervines; bouillons for bacteriological cultures; steroids; headache relief sticks; strychnine; suppositories; serums; tanning pills; appetite suppressant pills; jujube, medicated; antioxidant pills; sanitary tampons; vulnerable sponges; tetrahydrocannabinol [THC] for medical use; thymol for pharmaceutical purposes; smoking herbs for medical purposes; medicinal herbs; surgical implants comprised of living tissues; pants, absorbent, for incontinence; sanitary panties; babies' diaper-pants; charcoal for pharmaceutical purposes; porcelain for dental prostheses; phenol for pharmaceutical purposes; enzymes for veterinary purposes; enzymes for medical purposes; ferments for pharmaceutical purposes; formic aldehyde for pharmaceutical purposes; phosphates for pharmaceutical purposes; fungicides; quinine for medical purposes; chinoline for medical purposes; diabetic bread adapted for medical use; chloroform; flowers of sulfur for pharmaceutical purposes; cement for animal hooves; bone cement for surgical and orthopaedic purposes; dental cements; medicinal tea; herbal teas for medicinal purposes; bath tea for therapeutic purposes; insecticidal animal shampoos; medicated shampoos; medicated shampoos for pets; pediculicidal shampoos; medicated dry shampoos; pre-filled syringes for medical purposes; eucalyptus for pharmaceutical purposes; herbal extracts for medical purposes; tobacco extracts [insecticides]; extracts of hops for pharmaceutical purposes; elixirs [pharmaceutical preparations]; ethers for pharmaceutical purposes; esters for pharmaceutical purposes; cellulose esters for pharmaceutical purposes; rat poison; poisons; bacterial poisons; jalap; bismuth subnitrate for pharmaceutical purposes; cre-

am of tartar for pharmaceutical purposes; angostura bark for medical purposes; condurango bark for medical purposes; cotton swabs for medical purposes; diagnostic preparations for veterinary purposes; douching preparations for medical purposes; milking grease; slimming pills; transplants [living tissues]; fennel for medical purposes; cellulose ethers for pharmaceutical purposes; acai powder dietary supplements; dietary supplements with a cosmetic effect; hemostatics for medical purposes; plant extracts for pharmaceutical purposes.

(260) AM 2022 117628 A

(800) 1657891

(151) 2022 03 01

(891) 2022 03 01

(731) Dart Industries Inc.

14901 S. Orange Blossom Trail, Orlando
FL 32837, USA

(540)

TUPPERWARE AMAZING

(591) Black, white

(511)

8 – Kitchen knives; bread knives; utility knives; paring knives; chef knives; kitchen knife with serrated edges; household knives.

(260) AM 2022 117629 A

(800) 1657905

(151) 2022 03 14

(891) 2022 03 14

(731) Beijing Smartmi Technology Co., Ltd.

Room 6312, Floor 3, Building 6, Xueqing
Road 18, Haidian District, 100085 Beijing,
China

(540)

SMARTMI

(591) Black, white

(531) 27.05.01

(511)

7 – Central vacuum cleaning installations; dust exhausting installations for cleaning purposes; dust removing installations for cleaning purposes; machines and apparatus for cleaning, electric; vacuum cleaners; cleaning appliances utilizing steam; electric sweepers; machines and apparatus for carpet shampooing, electric.

11 – Radiators, electric; table lamps; electric fans; air purifying apparatus and machines; air humidifiers; electric kettles for household purposes; refrigerators; electric hot water dispensers; sterilizers; disinfectant apparatus; air-conditioning installations; dehumidifiers

for household purposes; water filtering apparatus; ventilation [air-conditioning] installations and apparatus.

(260) AM 2022 117630 A

(800) 1657918

(151) 2021 12 06

(891) 2021 12 06

(731) Kolesnyk Andrii Mykolaiovych
prosp. 40-rychchia Zhovtnia, 88, kv. 58,
m. Kyiv 03040, Ukraine

(540)

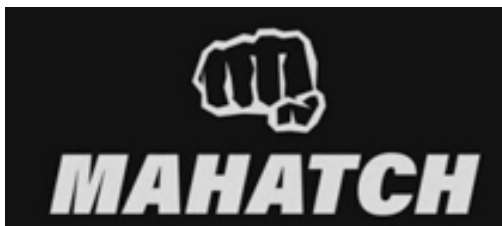

(591) Black, white

(531) 02.09.14; 26.04.05; 26.04.14; 26.04.24;
26.04.24; 26.05.18; 27.05.17; 27.05.24

(511)

35 – Advertising; business management, organization and administration; office functions; administration of consumer loyalty programs; administration of frequent flyer programs; administrative assistance in responding to calls for tenders; administrative processing of purchase orders; administrative services for medical referrals; administrative services for the relocation of businesses; advertising; advertising agency services; advertising by mail order; production of advertising films; rental of advertising space; rental of advertising time on communication media; appointment reminder services [office functions]; appointment scheduling services [office functions]; auctioneering; billposting; rental of billboards [advertising boards]; book-keeping; advisory services for business management; business appraisals; business auditing; business efficiency expert services; business inquiries; business intermediary services relating to the matching of potential private investors with entrepreneurs needing funding; business investigations; business management and organization consultancy; business management assistance; business management consultancy; business management for freelance service providers; business management of hotels; business management of performing artists; business management of reimbursement programmes for others; business management of sports people; business organization consultancy; business project management services for construction projects; business research; professional business consultancy; providing business information; providing business information via a website; commercial administration of the licensing of the goods and services of others; commercial information agency services; commercial intermediation services; com-

mercial lobbying services; commercial or industrial management assistance; providing commercial and business contact information; providing commercial information and advice for consumers in the choice of products and services; competitive intelligence services; compilation of information into computer databases; compilation of statistics; compiling indexes of information for commercial or advertising purposes; computerized file management; consultancy regarding advertising communication strategies; consultancy regarding public relations communication strategies; consumer profiling for commercial or marketing purposes; corporate communications services; cost price analysis; data search in computer files for others; demonstration of goods; development of advertising concepts; direct mail advertising; dissemination of advertising matter; distribution of samples; drawing up of statements of accounts; economic forecasting; employment agency services; organization of exhibitions for commercial or advertising purposes; organization of fashion shows for promotional purposes; financial auditing; gift registry services; import-export agency services; interim business management; invoicing; layout services for advertising purposes; market intelligence services; market studies; marketing; marketing in the framework of software publishing; marketing research; media relations services; modelling for advertising or sales promotion; negotiation and conclusion of commercial transactions for third parties; negotiation of business contracts for others; news clipping services; arranging newspaper subscriptions for others; office machines and equipment rental; rental of office equipment in co-working facilities; online advertising on a computer network; online retail services for downloadable and pre-recorded music and movies; online retail services for downloadable digital music; online retail services for downloadable ring tones; provision of an online marketplace for buyers and sellers of goods and services; opinion polling; outdoor advertising; outsourced administrative management for companies; outsourcing services [business assistance]; pay per click advertising; payroll preparation; personnel management consultancy; personnel recruitment; photocopying services; rental of photocopying machines; presentation of goods on communication media, for retail purposes; price comparison services; procurement services for others [purchasing goods and services for other businesses]; promotion of goods and services through sponsorship of sports events; psychological testing for the selection of personnel; public relations; publication of publicity texts; publicity material rental; radio advertising; registration of written communications and data; retail services for pharmaceutical, veterinary and sanitary preparations and medical supplies; retail services for works of art provided by art galleries; retail services relating to bakery products; rental of sales stands; sales promotion for others; scriptwriting for

advertising purposes; search engine optimization for sales promotion.

41 – Education; providing of training; entertainment; sporting and cultural activities; academies [education]; aikido instruction; amusement park services; providing amusement arcade services; animal training; rental of artwork; rental of audio equipment; organization of balls; arranging of beauty contests; boarding school education; booking of seats for shows; calligraphy services; providing casino facilities [gambling]; cinema presentations; rental of cinematographic apparatus; club services [entertainment or education]; coaching [training]; arranging and conducting of colloquiums; organization of competitions [education or entertainment]; arranging and conducting of concerts; arranging and conducting of conferences; arranging and conducting of congresses; correspondence courses; organization of cosplay entertainment events; cultural, educational or entertainment services provided by art galleries; disc jockey services; discotheque services; dubbing; educational examination; educational examination for users to qualify to pilot drones; educational services provided by schools; educational services provided by special needs assistants; electronic desktop publishing; entertainer services; entertainment services; organization of exhibitions for cultural or educational purposes; face painting; organization of fashion shows for entertainment purposes; film directing, other than advertising films; film distribution; film production, other than advertising films; providing films, not downloadable, via video-on-demand services; conducting fitness classes; gambling services; game services provided online from a computer network; games equipment rental; providing golf facilities; conducting guided climbing tours; conducting guided tours; gymnastic instruction; health club services [health and fitness training]; holiday camp services [entertainment]; arranging and conducting of in-person educational forums; rental of indoor aquaria; providing information in the field of education; providing information in the field of entertainment; providing information relating to recreational activities; judo instruction; karaoke services; know-how transfer [training]; language interpretation; layout services, other than for advertising purposes; lending library services; lighting technician services for events; rental of lighting apparatus for theatrical sets or television studios; organization of lotteries; microfilming; mobile library services; modelling for artists; rental of motion pictures; movie studio services; providing museum facilities [presentation, exhibitions]; music composition services; production of music; news reporters services; nightclub services [entertainment]; nursery schools; online publication of electronic books and journals; providing online electronic publications, not downloadable; providing online music, not downloadable; providing online videos, not downloadable; orchestra services; party planning [entertainment]; personal trainer services [fitness training]; photographic

reporting; photography; physical education; physical fitness assessment services for training purposes; practical training [demonstration]; presentation of circus performances; presentation of live performances; presentation of variety shows; publication of books; publication of texts, other than publicity texts; production of radio and television programmes; radio entertainment; rental of radio and television sets; recording studio services; providing recreation facilities; religious education; sado instruction [tea ceremony instruction]; screenplay writing; scriptwriting, other than for advertising purposes; arranging and conducting of seminars; rental of show scenery; organization of shows [impresario services]; production of shows; sign language interpretation; rental of skin diving equipment; songwriting; rental of sound recordings; sound engineering services for events; sport camp services; organization of sports competitions; providing sports facilities; rental of sports equipment, except vehicles; rental of sports grounds; rental of stadium facilities; rental of stage scenery; subtitling; arranging and conducting of symposiums; teaching/educational services; providing television programmes, not downloadable, via video-on-demand services; television entertainment; rental of tennis courts; theatre productions; ticket agency services [entertainment]; timing of sports events; toy rental; rental of training simulators; training services provided via simulators; translation; tutoring; providing user rankings for entertainment or cultural purposes; providing user reviews for entertainment or cultural purposes; rental of video cameras; rental of video cassette recorders; video editing services for events; videotape editing; rental of videotapes; videotaping; vocational guidance [education or training advice]; vocational retraining; arranging and conducting of workshops [training]; writing of texts; zoological garden services.

(260) AM 2022 117631 A
 (800) 1657932
 (151) 2022 03 22
 (891) 2022 03 22
 (731) Incyte Holdings Corporation
 1801 Augustine Cut-Off, Wilmington
 DE 19803, USA
 (540)

FORLIWU

(591) Black, white
 (511)

5 – Pharmaceutical preparations for the treatment of cancer; pharmaceutical preparations for the treatment of immunological disorders; pharmaceutical preparations for the treatment of hematological disorders; pharmaceutical preparations for the treatment of hypophosphatemia disorders; pharmaceutical preparations for the treatment of myeloproliferative disorders; pharmaceutical preparations for the treatment of ske-

letal or chondrocyte disorders; pharmaceutical preparations for the treatment of dermatological disorders.

16 – Brochures, newsletters, and pamphlets relating to medical issues, procedures, disease symptoms, patient support and community building.

44 – Providing a medical information to healthcare providers and patients relating to viral, hematological, auto-immune, inflammatory, metabolic and dermatological disorders.

(260) AM 2022 117632 A

(800) 1657990

(151) 2021 12 22

(891) 2021 12 22

(731) DESOKKO LIMITED

48 Themistokli Dervi Street, Centennial

Building, office 303, CY-1066 Nicosia, Cyprus

(540)

MAMA KNOWS

(591) Black, white

(531) 27.05.01

(511)

5 – Almond milk for pharmaceutical purposes; food for babies; dietetic beverages adapted for medical purposes; dietetic foods adapted for medical purposes; milk ferments for pharmaceutical purposes; powdered milk for babies.

29 – Agar-agar for culinary purposes; albumen for culinary purposes; albumin milk; alginates for culinary purposes; almond milk; almond milk for culinary purposes; almond milk-based beverages; almonds, ground; aloe vera prepared for human consumption; anchovy, not live; andouillettes; animal marrow for food; edible ant larvae, prepared; apple purée; arrangements of processed fruit; artichokes, preserved; aubergine paste; bacon; beans, preserved; berries, preserved; berry soup; berry-based fool; edible birds' nests; black pudding; bone oil for food; preparations for making bouillon; bouillon; bouillon concentrates; bulgogi; butter; buttercream; cabbage rolls stuffed with meat; candied nuts; cassoulet; caviar; charcuterie; cheese; choucroute garnie; clams, not live; cocoa butter for food; coconut butter; coconut fat; coconut milk; coconut milk for culinary purposes; coconut milk-based beverages; coconut oil for food; coconut, desiccated; compotes; condensed milk; corn dogs; cottage cheese; cottage cheese fritters; cranberry compote; crayfish, not live; cream [dairy products]; croquettes; crustaceans, not live; crystallized fruits; crystallized ginger; curd; dates; duck confits; eggs; extra virgin olive oil for food; falafel; fat-containing mixtures for bread slices; edible fats; fatty substances for the manufacture of edible fats; fermented baked milk; fish fillets; fish meal for human consumption; fish mousses; fish roe, prepared; fish, not live; fish, preserved; fish, tinned; fish-based foodstuffs; flavoured

nuts; edible flowers, dried; freeze-dried meat; freeze-dried vegetables; fruit chips; fruit peel; fruit preserved in alcohol; fruit pulp; fruit salads; fruit, preserved; fruit, processed; fruit, stewed; fruit jelly spreads; fruit-based concentrate for cooking; fruit-based snack food; frozen fruits; fruits, tinned; game, not live; preserved garlic; gelatine; gherkins; ginger jam; ginger, preserved; guacamole; ham; hash browns; hazelnuts, prepared; herrings, not live; hot dog sausages; hummus; edible insects, not live; isinglass for food; jams; jellies for food; kefir; kimchi; klipfish [salted and dried cod]; kumys; lactic acid drinks; lard; laver, preserved; lecithin for culinary purposes; lemon juice for culinary purposes; lentils, preserved; linseed oil for food; liver; liver pastes; lobsters, not live; low-fat potato chips; corn oil for food; margarine; marmalade; meat; meat extracts; meat jellies; meat, preserved; meat, tinned; milk; milk beverages, milk predominating; milk ferments for culinary purposes; milk products; milk shakes; milk substitutes; molluscs, not live; mushrooms, preserved; mussels, not live; non-alcoholic eggnog; nut-based spreads; nuts, prepared; oat milk; oils for food; olive oil for food; olives, preserved; omelettes; onion rings; onions, preserved; oysters, not live; palm kernel oil for food; palm oil for food; peanut butter; peanut milk; peanut milk for culinary purposes; peanut milk-based beverages; peanuts, prepared; peas, preserved; pectin for culinary purposes; preserved peppers; pickled ginger; pickles; pollen prepared as foodstuff; pork; potato chips; potato flakes; potato fritters; potato-based dumplings; poultry, not live; powdered eggs; powdered milk; prawns, not live; pressed fruit paste; quark; raisins; rape oil for food; ratatouille; rennet; rice milk; rice milk for culinary purposes; salmon, not live; salted fish; salted meats; sardines, not live; satay; sauerkraut; sausage casings, natural or artificial; sausages; sausages in batter; sea-cucumbers, not live; seaweed extracts for food; seeds, prepared; sesame oil for food; shellfish, not live; shrimps, not live; silkworm chrysalis for human consumption; smetana; snail eggs for consumption; preparations for making soup; soups; soured milk; soya bean oil for food; soya beans, preserved, for food; soya milk; soya patties; spiny lobsters, not live; suet for food; sunflower oil for food; sunflower seeds, prepared; sweet corn, processed; tahini; tajine [prepared meat, fish or vegetable dish]; tempeh; tofu; tofu patties; tofu skin; tomato juice for cooking; tomato paste; tomato purée; tripe; truffles, preserved; tuna, not live; vegetable juices for cooking; vegetable marrow paste; vegetable mousses; vegetable salads; vegetable soup preparations; vegetable-based concentrate for cooking; vegetable-based cream; vegetable-based spreads; vegetable-based prepared meals for toddlers; vegetables, cooked; vegetables, dried; vegetables, preserved; vegetables, processed; vegetables, tinned; vegetable juice for culinary purposes; whey; whipped cream; white of eggs; white pudding; yakitori; yoghurt; yolk of eggs.

32 – Aloe vera drinks, non-alcoholic; aperitifs, non-alcoholic; barley wine [beer]; beer; beer wort; beer-based cocktails; carbonated water; preparations for making carbonated water; cider, non-alcoholic; cocktails, non-alcoholic; energy drinks; extracts of hops for making beer; fruit juices; fruit nectars, non-alcoholic; ginger beer; grape must, unfermented; isotonic beverages; kvass; lemonades; lithia water; malt beer; malt wort; mineral water [beverages]; must; non-alcoholic beverages; non-alcoholic beverages flavored with coffee; non-alcoholic beverages flavored with tea; non-alcoholic dried fruit beverages; non-alcoholic essences for making beverages; non-alcoholic fruit extracts; non-alcoholic fruit juice beverages; non-alcoholic honey-based beverages; preparations for making non-alcoholic beverages; orgeat; pastilles for effervescing beverages; powders for effervescing beverages; protein-enriched sports beverages; rice-based beverages, other than milk substitutes; sarsaparilla [non-alcoholic beverage]; seltzer water; shandy; sorbets [beverages]; smoothies; soda water; soft drinks; soya-based beverages, other than milk substitutes; starch-based dry mixes for beverage preparation; syrups for beverages; syrups for lemonade; table waters; tomato juice [beverage]; vegetable juices [beverages]; waters [beverages]; whey beverages.

(260) AM 2022 117686 A

(800) 1659384

(151) 2021 12 15

(891) 2021 12 15

(731) Euro Games Technology Ltd.

4, "Maritsa" Str., "Vranya-Lozen-Triugulnika",
BG-1151 Sofia, Bulgaria

(540)



(591) Red, orange, yellow, pink, white, black and brown

(531) 27.05.01; 27.05.03; 27.05.09; 27.05.10;

27.05.24; 27.07.01; 27.07.03; 27.07.11;

29.01.15

(511)

9 – Software; computer gaming software; computer software packages; computer operating system software; computer software, recorded; software drivers; virtual reality software; games software; entertainment software for computer games; computer programs for network management; operating computer software for main frame computers; monitors (computer hardware); computer hardware; apparatus for recording images; monitors (computer programs); computer game programs; computer programs for recorded games; apparatus for recording, transmission or reproduction of sound or images; communications servers [computer hardware]; electronic components for gambling machines; computer application software featuring games and gaming; computer software for

the administration of on-line games and gaming; computer hardware for games and gaming; hardware and software for gambling, gambling machines, gambling games on the Internet and via telecommunication network.

28 – Gaming machines for gambling; chips for gambling; mah-jong; arcade games; gambling machines operating with coins, notes and cards; games; electronic games; parlor games; gaming chips; gaming tables; slot machines [gaming machines]; LCD game machines; slot machines and gaming devices; coin-operated amusement machines; roulette chips; poker chips; chips and dice [gaming equipment]; gaming equipment for casinos; roulette tables; gaming roulette wheels; casino games; gambling machines and amusement machines, automatic and coin-operated; coin-operated amusement machines and/or electronic coin-operated amusement machines with or without the possibility of gain; boxes for coin-operated machines, slot machines and gaming machines; electronic or electrotechnical amusement machines and apparatus, gaming machines, coin-operated entertainment machines; housings for coin-operated machines, gaming equipment, gaming machines, machines for gambling; electropneumatic and electrical gambling machines (slot machines).

41 – Gambling; entertainment services related to gambling; gaming services for entertainment purposes; casino, gaming and gambling services; training in the development of software systems; provision of gaming equipment for gambling halls; providing casino equipment [gambling]; gaming machine entertainment services; providing casino facilities [gambling]; gaming hall services; amusement arcade services; games equipment rental; rental of gaming machines; providing amusement arcade services; rental of gaming machines with images of fruits; editing or recording of sounds and images; sound recording and video entertainment services; hire of sound reproducing apparatus; provision of gaming equipment for casinos; providing of casino facilities; online gambling services; casino, gaming and gambling services; provision of gaming facilities, gaming hall facilities, Internet casinos and online gambling services.

(260) AM 2022 117687 A

(800) 1659385

(151) 2021 12 16

(891) 2021 12 16

(731) Euro Games Technology Ltd.

4, "Maritsa" Str., "Vranya-Lozen-Triugulnika",
BG-1151 Sofia, Bulgaria

(540)



(591) Red, orange, yellow, pink, green, white, black and brown

(531) 01.01.02; 01.01.10; 01.01.25; 27.03.12; 27.05.01; 27.05.02; 27.05.03; 29.01.15

(511)

9 – Software; computer gaming software; computer software packages; computer operating system software; computer software, recorded; software drivers; virtual reality software; games software; entertainment reality software for computer games; computer programs for network management; operating computer software for main frame computers; monitors (computer hardware); computer hardware; apparatus for recording images; monitors (computer programs); computer game programs; computer programs for recorded games; apparatus for recording, transmission or reproduction of sound or images; communications servers [computer hardware]; electronic components for gambling machines; computer application software featuring games and gaming; computer software for the administration of on-line games and gaming; computer hardware for games and gaming; hardware and software for gambling, gambling machines, gambling games on the Internet and via telecommunication network.

28 – Gaming machines for gambling; chips for gambling; mah-jong; arcade games; gambling machines operating with coins, notes and cards; games; electronic games; parlor games; gaming chips; gaming tables; slot machines [gaming machines]; LCD game machines; slot machines and gaming devices; coin-operated amusement machines; roulette chips; poker chips; chips and dice [gaming equipment]; gaming equipment for casinos; roulette tables; gaming roulette wheels; casino games; gambling machines and amusement machines, automatic and coin-operated; coin-operated amusement machines and/or electronic coin-operated amusement machines with or without the possibility of gain; boxes for coin-operated machines, slot machines and gaming machines; electronic or electrotechnical amusement machines and apparatus, gaming machines, coin-operated entertainment machines; housings for coin-operated machines, gaming equipment, gaming machines, machines for gambling; electropneumatic and electrical gambling machines (slot machines).

41 – Gambling; entertainment services related to gambling; gaming services for entertainment purposes; casino, gaming and gambling services; training in the development of software systems; provision of gaming equipment for gambling halls; providing casino equipment [gambling]; gaming machine entertainment services; providing casino facilities [gambling]; gaming hall services; amusement arcade services; games equipment rental; rental of gaming machines; providing amusement arcade services; rental of gaming machines with images of fruits; editing or recording of sounds and images; sound recording and video en-

tertainment services; hire of sound reproducing apparatus; provision of gaming equipment for casinos; providing of casino facilities; online gambling services; casino, gaming and gambling services; provision of gaming facilities, gaming hall facilities, Internet casinos and online gambling services.

(260) AM 2022 117688 A

(800) 1659424

(151) 2022 04 04

(891) 2022 04 04

(731) Chongqing Dezhuang Industry (Group) Co. LTD

No. 10 Chang Dian Road, Nan An District, Chongqing City, China

(540)

DE ZHUANG

(591) Black, white

(531) 28.03

(511)

30 – Gluten prepared as foodstuff; wheat germ for human consumption; condiments; ice cream; honey; cereal-based snack food; instant rice; sugar; tea; coffee.

43 – Rental of cooking apparatus; retirement home services; rental of tents; providing campground facilities; restaurant services; hotel accommodation services; teahouse services; holiday hotel services; rental of chairs, tables, table linen, glassware; rental of lighting apparatus.

(260) AM 2022 117777 A

(800) 1660976

(151) 2022 01 25

(891) 2022 01 25

(731) Fédération Internationale de Ski

CH-3653 Oberhofen am Thunersee, Switzerland

(540)

FIS GAMES

(591) Black, white

(511)

9 – Scientific, nautical, surveying, photographic, cinematographic, optical, weighing, measuring, signaling, checking (supervision), emergency (life-saving) and teaching apparatus and instruments; apparatus and instruments for conducting, switching, transforming, accumulating, regulating or controlling electricity; apparatus for sound or image recording, transmission and reproduction; magnetic recording media, sound

recording disks; compact disks, DVDs and other digital recording media; memory cards (smart cards); flash memory cards; mechanisms for coin-operated apparatus; cash registers; calculating machines; computer hardware; equipment for data processing and computers; software; application software; application software for mobile telephones; fire extinguishers; downloadable electronic publications; protective helmets for sports; helmets for skiing and snowboarding; glasses, sunglasses, sports goggles; ski and snowboard masks; life-saving devices in the event of an avalanche, namely locating apparatus and instruments, signaling whistles and signal alarms; electronic display boards and timing sensors; game software; computer game software for mobile telephone receivers; laptop computers; tablet computers; fire, heat and smoke alarms and detectors; headphones; video cameras; filming cameras; portable electronic devices for voice, video, data and image communications; batteries, dry cells, rechargeable batteries, apparatus for charging electric cells; cellular mobile telephones; cases for cellular mobile telephones; global positioning system receivers; smart watches; magnetic cards and memory cards, in particular customer cards, loyalty cards (included in this class) and payment cards (included in this class); electronic wallets; humanoid robots with artificial intelligence for scientific research purposes.

12 – Vehicles; apparatus for locomotion by land, air or water; bikes.

14 – Precious metals and their alloys; jewelry, precious and semi-precious stones; timepieces and chronometric instruments.

25 – Clothing, footwear, headwear; sports clothing; sports footwear; ski and snowboard anoraks; after-ski boots; stocking caps; hoods; ski and snowboard boots; ski and snowboard suits; ski and snowboard gloves; ski and snowboard pants; bags specially designed for ski and snowboard boots; protective sports vests.

28 – Games, toys; video game apparatus; gymnastic and sporting articles not included in other classes; Christmas tree decorations; playing cards; plush toys; scratch cards for playing lottery games; ski sticks; ski poles for roller skis; ski bindings; bags especially designed for skis; skis; snowboards; roller skis; vests, elbow and knee pads for sports.

32 – De-alcoholized beverages; syrups and powders for making non-alcoholic beverages; waters (beverages); mineral and aerated waters; non-alcoholic beverages; isotonic beverages; fruit and vegetable-based beverages; fruit and vegetable juices; iced fruit beverages; beers; highly fermented strong dark beers; light beers and high fermentation beers, low alcohol or alcohol-free beers.

35 – Advertising; dissemination of advertising matter via all media, in particular in the form of thematic me-

ssages centered on human values; advertising by sponsoring; online advertising and marketing services; commercial business management; commercial administration; office functions; advertising services, namely, advertising promotion of third-party goods and services by means of contractual agreements, especially partnership [sponsoring] and licenses with regard to the transfer of reputation, image and sympathy derived from cultural and sporting events, especially winter sports events and competitions; advertising services, namely, promoting the goods and services of others by the means referred to as the initial interest factor driving the public to consider goods or services that are presented to them with specific signs, emblems or messages for attracting their attention; advertising services, namely, promoting the goods and services of others by the means referred to as image transfer; rental of advertising space of all type and on all media, whether digital or not; commercial administration of the participation of teams in winter sports competitions, and promotion to the public and interested media of support for said teams; business administration consultancy services; data input and processing services; organization of exhibitions for commercial or advertising purposes; advertising promotion of sporting competitions and events for use by others; advertising promotion of concerts and of cultural events for others; provision of documentation, namely direct mail advertising, distribution of advertising material, distribution of samples, reproduction of documents; computer file management, namely digital file management comprising a portfolio of images and video sequences intended for use under license in traditional advertising and in the advertising promotion of behavior (moral advertising); business management relating to e-commerce, namely providing information on products via telecommunication networks for advertising and sales purposes; retail services or wholesale services for clothing, footwear, headgear; retail services or wholesale services for sports goods; retail or wholesale services for jewelry, timepieces, fashion accessories, bags, souvenirs (memorabilia); maintenance of computerized databases.

38 – Telecommunications; broadcasting of television programs and televised shows (live or recorded); streaming of audio and video content on the Internet; streaming of winter sports competitions; broadcasting of winter sports competitions via satellite or by cable networks; news agency services; providing access to a commercial site on the Internet; television broadcasting services provided via the Internet; providing access to chat lines, chat rooms and forums on the Internet, including the mobile Internet; streaming of data; providing access to an Internet site for information in the field of winter sports.

41 – Education; providing of training; entertainment; sporting and cultural activities; televised cultural and sporting entertainment; organization of winter sports

competitions and in particular skiing and snowboarding; entertainment in the nature of live winter sports competitions; entertainment in the nature of live events and shows relating to winter sports; entertainment services provided at sports events or in relation to sports events; organization of real or virtual sports competitions, in particular winter sports competitions; interactive entertainment services; providing sports entertainment via an interactive website; digital video, audio and multimedia entertainment publishing services; betting and gambling services in connection with or in relation to sports; on-line betting services; organization of sporting and cultural events and activities; organization of exhibitions for cultural or educational purposes; radio and television coverage of sporting events; ticket booking services for shows and sporting events; timing of sports events; information regarding entertainment or education, provided online from a data bank or the Internet; electronic game services on the Internet; virtual reality game services provided online from a computer network; providing on line electronic publications; publication of texts (other than advertising texts), including regulations, norms and standards with respect to winter sports and Nordic skiing; providing sporting results; information services concerning sports and sporting events; organizing and conducting award ceremonies and gala ceremonies for entertainment purposes.

42 – Scientific and technological services as well as research and design services relating thereto; hosting weblogs [blogs]; hosting and providing electronic platforms for sharing and transmitting data; hosting of computer sites [websites]; providing, via an Internet platform, interactive computer applications enabling users to experience virtual reality sports entertainment; providing, via an Internet platform, interactive computer applications enabling users to note (personal evaluation) the performance of an athlete, to vote for an athlete, as well as record their comments, and also enabling them to consult ratings, votes and comments from other users; hosting and providing an Internet platform enabling users to identify themselves and vote for athletes participating in a winter sports competition; technical consultancy for the creation and configuration of ski slopes for competition and courses of freestyle skiing and freestyle snowboarding.

(260) AM 2022 117778 A

(800) 1660978

(151) 2022 01 25

(891) 2022 01 25

(731) Fédération Internationale de Ski
CH-3653 Oberhofen am Thunersee,
Switzerland

(540)

FIS WORLD CUP

(591) Black, white

(511)

9 – Scientific, nautical, surveying, photographic, cinematographic, optical, weighing, measuring, signaling, checking (supervision), emergency (life-saving) and teaching apparatus and instruments; apparatus and instruments for conducting, switching, transforming, accumulating, regulating or controlling electricity; apparatus for sound or image recording, transmission and reproduction; magnetic recording media, sound recording disks; compact disks, DVDs and other digital recording media; memory cards (smart cards); flash memory cards; mechanisms for coin-operated apparatus; cash registers; calculating machines; computer hardware; equipment for data processing and computers; software; application software; application software for mobile telephones; fire extinguishers; downloadable electronic publications; protective helmets for sports; helmets for skiing and snowboarding; glasses, sunglasses, sports goggles; ski and snowboard masks; life-saving devices in the event of an avalanche, namely locating apparatus and instruments, signaling whistles and signal alarms; electronic display boards and timing sensors; game software; computer game software for mobile telephone receivers; laptop computers; tablet computers; fire, heat and smoke alarms and detectors; headphones; video cameras; filming cameras; portable electronic devices for voice, video, data and image communications; batteries, dry cells, rechargeable batteries, apparatus for charging electric cells; cellular mobile telephones; cases for cellular mobile telephones; global positioning system receivers; smart watches; magnetic cards and memory cards, in particular customer cards, loyalty cards (included in this class) and payment cards (included in this class); electronic wallets; humanoid robots with artificial intelligence for scientific research purposes.

12 – Vehicles; apparatus for locomotion by land, air or water; bikes.

14 – Precious metals and their alloys; jewelry, precious and semi-precious stones; timepieces and chronometric instruments.

25 – Clothing, footwear, headwear; sports clothing; sports footwear; ski and snowboard anoraks; after-ski boots; stocking caps; hoods; ski and snowboard boots; ski and snowboard suits; ski and snowboard gloves; ski and snowboard pants; bags specially designed for ski and snowboard boots.

28 – Games, toys; video game apparatus; gymnastic and sporting articles not included in other classes; Christmas tree decorations; playing cards; plush toys; scratch cards for playing lottery games; ski sticks; ski poles for roller skis; ski bindings; bags especially designed for skis; skis; snowboards; roller skis; vests, elbow and knee pads for sports.

32 – De-alcoholized beverages; syrups and powders for making non-alcoholic beverages; waters (bevera-

ges); mineral and aerated waters; non-alcoholic beverages; isotonic beverages; fruit and vegetable-based beverages; fruit and vegetable juices; iced fruit beverages; beers; highly fermented strong dark beers; light beers and high fermentation beers, low alcohol or alcohol-free beers.

35 – Advertising; dissemination of advertising matter via all media, in particular in the form of thematic messages centered on human values; advertising by sponsoring; online advertising and marketing services; commercial business management; commercial administration; office functions; advertising services, namely, advertising promotion of third-party goods and services by means of contractual agreements, especially partnership [sponsoring] and licenses with regard to the transfer of reputation, image and sympathy derived from cultural and sporting events, especially winter sports events and competitions; advertising services, namely, promoting the goods and services of others by the means referred to as the initial interest factor driving the public to consider goods or services that are presented to them with specific signs, emblems or messages for attracting their attention; advertising services, namely, promoting the goods and services of others by the means referred to as image transfer; rental of advertising space of all type and on all media, whether digital or not; commercial administration of the participation of teams in winter sports competitions, and promotion to the public and interested media of support for said teams; business administration consultancy services; data input and processing services; organization of exhibitions for commercial or advertising purposes; advertising promotion of sporting competitions and events for use by others; advertising promotion of concerts and of cultural events for others; provision of documentation, namely direct mail advertising, distribution of advertising material, distribution of samples, reproduction of documents; computer file management, namely digital file management comprising a portfolio of images and video sequences intended for use under license in traditional advertising and in the advertising promotion of behavior (moral advertising); business management relating to e-commerce, namely providing information on products via telecommunication networks for advertising and sales purposes; retail services or wholesale services for clothing, footwear, headgear; retail services or wholesale services for sports goods; retail or wholesale services for jewelry, timepieces, fashion accessories, bags, souvenirs (memorabilia); maintenance of computerized databases.

38 – Telecommunications; broadcasting of television programs and televised shows (live or recorded); streaming of audio and video content on the Internet; streaming of winter sports competitions; broadcasting of winter sports competitions via satellite or by cable networks; news agency services; providing access to a commercial site on the Internet; television broadcast-

ing services provided via the Internet; providing access to chat lines, chat rooms and forums on the Internet, including the mobile Internet; streaming of data; providing access to an Internet site for information in the field of winter sports.

41 – Education; providing of training; entertainment; sporting and cultural activities; televised cultural and sporting entertainment; organization of winter sports competitions and in particular skiing and snowboarding; entertainment in the nature of live winter sports competitions; entertainment in the nature of live events and shows relating to winter sports; entertainment services provided at sports events or in relation to sports events; organization of real or virtual sports competitions, in particular winter sports competitions; interactive entertainment services; providing sports entertainment via an interactive website; digital video, audio and multimedia entertainment publishing services; betting and gambling services in connection with or in relation to sports; on-line betting services; organization of sporting and cultural events and activities; organization of exhibitions for cultural or educational purposes; radio and television coverage of sporting events; ticket booking services for shows and sporting events; timing of sports events; information regarding entertainment or education, provided online from a data bank or the Internet; electronic game services on the Internet; virtual reality game services provided online from a computer network; providing on line electronic publications; publication of texts (other than advertising texts), including regulations, norms and standards with respect to winter sports and Nordic skiing; providing sporting results; information services concerning sports and sporting events; organizing and conducting award ceremonies and gala ceremonies for entertainment purposes.

42 – Scientific and technological services as well as research and design services relating thereto; hosting weblogs [blogs]; hosting and providing electronic platforms for sharing and transmitting data; hosting of computer sites [websites]; providing, via an Internet platform, interactive computer applications enabling users to experience virtual reality sports entertainment; providing, via an Internet platform, interactive computer applications enabling users to note (personal evaluation) the performance of an athlete, to vote for an athlete, as well as record their comments, and also enabling them to consult ratings, votes and comments from other users; hosting and providing an Internet platform enabling users to identify themselves and vote for athletes participating in a winter sports competition; technical consultancy for the creation and configuration of ski slopes for competition and courses of freestyle skiing and freestyle snowboarding.

(260) AM 2022 117779 A

(800) 1661020

(151) 2022 03 29

(891) 2022 03 29

(731) Japan Tobacco Inc.

1-1 Toranomon 4-chome, Minato-ku, Tokyo,
Japan

(540)

LEGEND BLUE

(591) Black, white

(511)

34 – Tobacco, raw or manufactured; smoking tobacco, pipe tobacco, rolling tobacco, chewing tobacco, snus; cigarettes, electronic cigarettes, liquid for electronic cigarettes, tobacco vaporizer, cigars, cigarillos; snuff; smokers' articles included in class 34; cigarette paper, cigarette tubes and matches.

(260) AM 2022 117780 A

(800) 1661027

(151) 2021 10 05

(891) 2021 10 05

(731) PRIVATE JOINT-STOCK COMPANY "MHP"

vul. Elevatorna, 1, m. Myronivka 08800,
Myronivskiyi r-n, Kyivska obl., Ukraine

(540)



(591) Green, light green, brown and white

(531) 03.07.03; 03.07.24; 24.03.07; 24.17.25;

25.01.06; 27.01.12; 27.05.01; 27.05.09;

27.05.10; 27.05.24; 29.01.13

(511)

29 – Poultry, not live; extracts from chicken meat; eggs; oils for food and edible fats; albumen for culinary purposes; white of eggs; broth / bouillon; broth concentrates / bouillon concentrates; broths (meat decoctions) made of chicken; broth concentrates made of chicken; meat jellies; jellies for food; bone oil for food; suet for food; chicken suet for food; fatty substances for the manufacture of edible fats; fat-containing mixtures for bread slices; yolk of eggs; chicken yolk of eggs; black pudding / blood sausage; white pudding; charcuterie; chicken charcuterie; cutlets; chicken cutlets; croquettes; chicken croquettes; chicken meat extracts; poultry extracts; canned poultry meat; meat; chicken meat; poultry meat; chicken meat, preserved; sausage casings, natural or artificial; liver pâté; chicken liver pâté; poultry, not live including chicken; fresh frozen poultry; preparations for making bouillon; sausages; hot dog sausages; sausages in ba-

ter; chicken sausages; hot dog chicken sausages; chicken sausages in batter; chicken nuggets; freeze-dried meat; preparations for making soups; soups; animal marrow for food; tripe; chicken tripe; edible fats; oils for food; chicken eggs.

35 – Advertising; administrative processing of purchase orders; administration of consumer loyalty programs; cost price analysis; invoicing; payroll preparation; tax preparation; demonstration of goods; providing user reviews for commercial or advertising purposes; providing user rankings for commercial or advertising purposes; compilation of statistics; web indexing for commercial or advertising purposes; computerized file management; marketing; targeted marketing; marketing research; provision of an online marketplace for buyers and sellers of goods and services; scriptwriting for advertising purposes; word processing; updating of advertising material; organization of exhibitions for commercial or advertising purposes; organization of trade fairs; organizing and conducting various events, promotional events, campaigns, media promotions, surveys, contests and presentations for commercial or advertising purposes; rental of advertising space; shop window dressing; layout services for advertising purposes; price comparison services; market intelligence services; procurement services for others [purchasing goods and services for other businesses]; sponsorship search; search engine optimization for sales promotion; presentation of goods on communication media, for retail purposes; publicity material rental; rental of advertising time on communication media; rental of sales stands; direct mail advertising; publication of publicity texts; radio advertising; pay per click advertising; outdoor advertising; advertising by mail order; online advertising on a computer network; bill-posting; distribution of samples; dissemination of advertising matter; development of advertising concepts; drawing up of statements of accounts; compiling indexes of information for commercial or advertising purposes; consumer profiling for commercial or marketing purposes; promotion of goods and services through sponsorship of sports events; production of advertising films; production of teleshopping programmes; television advertising; telemarketing services; publication of advertizing materials online and advertizing information on the list of goods and services, which allows customers to view conveniently, order and buy these goods and services from websites on the Internet and receive the necessary information about these goods and services; placement in one place, for the benefit of others, the range of goods (except for their transportation), which allows customers to conveniently inspect and buy these goods in supermarkets, hypermarkets, department stores, retail stores, shopping centers – all the above services related to the introduction in the civil turnover of meat products; retail services related to foodstuffs, namely: poultry meat, including processed meat products, meat products and

semi-finished products, canned food, fresh frozen poultry, chicken, cutlets, sausages, nuggets, snacks, eggs, charcuterie, pelmeni (dumplings), vareniki, pizzas, pies; wholesale services related to foodstuffs, namely: poultry meat, including processed meat products, meat products and semi-finished products, canned food, fresh frozen poultry, chicken, cutlets, sausages, nuggets, snacks, eggs, charcuterie, pelmeni (dumplings), vareniki, pizzas, pies.

(260) AM 2022 117781 A

(800) 1661042

(151) 2022 01 17

(891) 2022 01 17

(731) SIRCA S.p.A.

Viale Roma, 85, I-35010 MASSANZAGO,
Frazione San Dono (PD), Italy

(540)

PROVOCAZION!

(591) Black, white

(531) 24.17.04; 27.03.15

(511)

1 – Synthetic resins, unprocessed; acrylic resins, unprocessed; artificial resins, unprocessed; solvents for varnishes; organic solvents for stains, varnishes and paints; nitro-solvents for stains, varnishes and paints; glaziers' putty; mordants for metal; putties [fillers]; moulding preparations (foundry -); mould-release preparations; chemicals for the manufacture of paints; chemicals for use in industry, science and photography, as well as in agriculture, horticulture and forestry; unprocessed plastics; fire extinguishing compositions and fire prevention compositions; tempering and soldering preparations; substances for tanning animal skins and hides; adhesives used in industry; putties and other paste fillers; biological preparations for use in industry and science; drying agents for putties.

2 – Paints, varnishes, lacquers; preservatives against rust and against deterioration of wood; colorants; dyes; inks for printing, marking and engraving; raw natural resins; metals in foil and powder form for use in painting, decorating, printing and art; non insulating varnishes; pigments; protective coatings (gel coats) in the nature of paints for composite materials of fiber glass reinforced plastics; metal protective agents; dye pastes; antifouling paint; non insulating anti-fouling varnishes; mordants not for metals; mordants not for metals used in the home improvement and builder's supplies sector; mordants for exterior and interior use on a variety of substrates except for metals; gum resins; wood stains; thinners for stains, lacquers, varnishes and paints; binding agents for stains; varnishes and paints; enamels (varnishes); enamels for paints; drying agents for paints; exterior surface protective coatings; penetrating sealer coatings

for use on stone, concrete, wood; primers for preparing surfaces to be painted; undercoating for surfaces to be painted; paint sealers; coatings (paints); mastic [natural resin]; natural dyes; paint additives in the nature of balancers, binders, initiators, reducers or tinting colors; thickeners for paints; anti-corrosive preparations; colour bases for paints, namely, primers; colouring matter for plastics; synthetic resin-based colorants; glass stains; polymer-based paints; protective coating compositions [paints]; waterproofing compositions in the nature of paint; preservatives; water based preservatives; water borne paints [other than insulating]; transparent finishes for wood; transparent finishes in the nature of paint; fixatives [varnishes]; color pigments; synthetic resin primers [paints]; coatings; decorating materials in the nature of paints; filler materials in the nature of paint; wood oils; anti-rust oils; exterior paints; interior paint; synthetic resin paints; bactericidal paints; ornamental paints; pigment preparations; protective preparations for metals; plastic priming preparations in the nature of paint; acrylic coatings [paints]; coatings used for furniture finishing; paint for use in the manufacture of furniture; wood coatings [paints]; wall coatings [paint]; interior protective finish coatings [paints]; protective acrylic coatings in the form of paints [other than for insulating purposes]; protective surface coatings for wood; interior decorative finish coatings [paints]; solvents for thinning paints; tints for surface coatings; antiquing treatments; stains for use on floors; architectural paints.

17 – Artificial, acrylic and synthetic resins (semi-finished products); insulating varnishes; insulating paints; mastics; joint sealants; fillers for expansion joints; water based insulating paints; insulating varnishes based on plastics materials; protective acrylic coatings in the form of paints for insulating purposes; insulatory coatings of plastic resin; resins in liquid form [semi-processed]; unprocessed and semi-processed rubber, gutta-percha, gum, asbestos, mica and substitutes for all these materials; plastics and resins in extruded form for use in manufacture; packing, stopping and insulating materials; flexible pipes, not of metal.

INTERNATIONAL TRADEMARKS PROTECTED IN GEORGIA

(260) AM 2022 113559 A
(800) 1597195
(151) 2021 02 09
(181) 2031 02 09
(891) 2021 02 09
(511) 09, 14, 16, 26, 35

(260) AM 2022 115158 A
(800) 1622580
(151) 2021 09 30
(181) 2031 09 30
(891) 2021 09 30
(511) 05, 42

(260) AM 2022 115279 A
(800) 1624304
(151) 2021 06 04
(181) 2031 06 04
(891) 2021 06 04
(511) 06, 29, 30, 32

(260) AM 2022 115280 A
(800) 1624312
(151) 2021 06 30
(181) 2031 06 30
(891) 2021 06 30
(511) 05

(260) AM 2022 115281 A
(800) 1624476
(151) 2021 05 28
(181) 2031 05 28
(891) 2021 05 28
(511) 14, 18, 24, 25, 26, 35, 40, 41, 42

(260) AM 2022 115283 A
(800) 1624503
(151) 2021 07 07
(181) 2031 07 07
(891) 2021 07 07
(511) 03, 35, 41, 44

(260) AM 2022 115284 A
(800) 1624530
(151) 2021 07 20
(181) 2031 07 20
(891) 2021 07 20
(511) 30

(260) AM 2022 115286 A
(800) 1624591
(151) 2021 06 16
(181) 2031 06 16
(891) 2021 06 16
(511) 32, 33, 35, 41, 43

(260) AM 2022 115287 A
(800) 478563
(151) 1983 07 09
(181) 2023 07 09
(891) 2021 10 20
(511) 30

(260) AM 2022 115288 A
(800) 914905A
(151) 2007 01 17
(181) 2027 01 17
(891) 2021 10 19
(511) 07, 11

(260) AM 2022 115396 A
(800) 1396276
(151) 2017 09 26
(181) 2027 09 26
(891) 2021 10 19
(511) 03, 05, 21, 29, 30, 41

(260) AM 2022 115398 A
(800) 1548187
(151) 2020 05 29
(181) 2030 05 29
(891) 2021 10 09
(511) 11

(260) AM 2022 115459 A
(800) 1626342
(151) 2021 07 12
(181) 2031 07 12
(891) 2021 07 12
(511) 06, 11, 21

(260) AM 2022 116094 A
(800) 1637200
(151) 2021 02 02
(181) 2031 02 02
(891) 2021 02 02
(511) 20, 24, 35

(260) AM 2022 115460 A
(800) 1626350
(151) 2021 07 07
(181) 2031 07 07
(891) 2021 07 07
(511) 03, 05, 35

(260) AM 2022 116095 A
(800) 1637222
(151) 2021 05 10
(181) 2031 05 10
(891) 2021 05 10
(511) 12

(260) AM 2022 115462 A
(800) 1626490
(151) 2021 09 14
(181) 2031 09 14
(891) 2021 09 14
(511) 06

(260) AM 2022 116098 A
(800) 1637326
(151) 2021 10 05
(181) 2031 10 05
(891) 2021 10 05
(511) 09

(260) AM 2022 115463 A
(800) 1626549
(151) 2021 05 25
(181) 2031 05 25
(891) 2021 05 25
(511) 09, 10, 18, 25, 28, 35, 41

(260) AM 2022 116099 A
(800) 1637337
(151) 2021 09 08
(181) 2031 09 08
(891) 2021 09 08
(511) 07, 08, 11, 35

(260) AM 2022 115464 A
(800) 1626555
(151) 2021 06 08
(181) 2031 06 08
(891) 2021 06 08
(511) 09, 28, 41

(260) AM 2022 116100 A
(800) 1637350
(151) 2021 10 19
(181) 2031 10 19
(891) 2021 10 19
(511) 29, 30

(260) AM 2022 115797 A
(800) 1633371
(151) 2021 10 19
(181) 2031 10 19
(891) 2021 10 19
(511) 34

(260) AM 2022 116101 A
(800) 1637405
(151) 2021 11 13
(181) 2031 11 13
(891) 2021 11 13
(511) 29, 30, 39, 43

(260) AM 2022 115938 A
(800) 1634984
(151) 2021 10 06
(181) 2031 10 06
(891) 2021 10 06
(511) 05, 10

(260) AM 2022 116102 A
(800) 1637433
(151) 2021 11 23
(181) 2031 11 23
(891) 2021 11 23
(511) 36

(260) AM 2022 116103 A
(800) 1637434
(151) 2021 11 23
(181) 2031 11 23
(891) 2021 11 23
(511) 36

(260) AM 2022 116213 A
(800) 1602531
(151) 2021 05 20
(181) 2031 05 20
(891) 2021 11 24
(511) 09

APPELLATIONS OF ORIGIN OF GOODS
REGISTERED APPELLATION OF ORIGIN OF GOODS

(111) 984

(151) 2022 11 24

(732) N(N)LE "Regional Development Center of Asureti"

Vill. Asureti, Shvabebi Str. 28, Tetrtskaro Municipality, Georgia

(540)

ASURETULI SHALA

(511) 33

AMENDMENTS IN PDO WINES PRODUCTION SPECIFICATIONS

In accordance with the Orders №№10678/06, 10679/06, 10677/06, 10680/06, 10681/06, 10682/06, 10683/06, 10684/06, 10686/06, 10692/06, 10693/06, 10694/06, 10675/06, 10695/06, 10685/06 and 10676/06 of the Acting Head of Department of Trademarks, Geographical Indications and Design of the LEPL National Intellectual Property Center of Georgia – SAKPATENTI, amendments were entered in the production specifications of appellations of origin of the following wines registered at SAKPATENTI: MUKUZANI (Reg. №2; 30.08.2005); TSINANDALI (Reg. №3; 30.08.2005); GURJAANI (Reg. №5; 30.08.2005); MANAVI (Reg. №788; 21.08.2006); KAKHETI (KAKHURI) (Reg. №789; 10.12.2007); NAPAREULI (Reg. №790; 10.12.2007); TELIANI (Reg. №791; 10.12.2007); ATENI (ATENURI) (Reg. №792; 10.12.2007); SVIRI (Reg. №793; 10.12.2007); VAZISUBANI (Reg. №794; 10.12.2007); KARDENAKHI (Reg. №795; 10.12.2007); TIBAANI (Reg. №796; 10.12.2007); KVARELI (Reg. №798; 10.12.2007); SAPERAVI KHASHMI (Reg. №975; 06.04.2018); AKHMETA (AKHMETIS MTSVANE) (Reg. №979; 11.05.2020); KOTEKHI (Reg. №799; 10.12.2007).

In accordance with the Law of Georgia on Appellations of Origin of Goods and Geographical Indications, abovementioned information shall be published in the Official Bulletin of Industrial Property of Georgia, as well as in one central and in one local newspaper.

Within 3 months after the publication of the application materials, the notes and additional information regarding these materials submitted with Sakpatenti shall be sent to the Ministry of Environmental Protection and Agriculture of Georgia for the review. If within 3 months no information is submitted with SAKPATENTI regarding abovementioned materials, the published data shall be reflected in the State Registry of Appellations of Origin and Geographical Indications.

MUKUZANI

"2.3. Physical and Chemical Characteristics of Product.

Red dry wine "Mukuzani" shall satisfy the following requirements:

- Actual volumetric spirit content – no less than 11 %;
- Common volumetric spirit content – no more than 15 %;
- Sugar content – no more than 4 g/l;
- **Titrateable acidity in young wine should be – no less than 4.5 g/l, and in aged wine – no less than 4.0 g/l;**
- Volatile acidity – no more than 1.2 g/l;
- Sulfur dioxide common mass concentration – no more than 150 mg/l;
- Sugar free extract mass concentration – no less than 22 mg/l."

TSINANDALI

"2.3. Physical and Chemical Characteristics of Product.

White dry wine "Tsinandali" shall satisfy the following requirements:

- Actual volumetric spirit content – no less than 11 %;
- Common volumetric spirit content – no more than 15 %;
- Sugar content – no more than 4 g/l;

- **Titratable acidity in young wine should be – no less than 5.0 g/l, in aged wine – no less than 4.3 g/l;**
- Volatile acidity – no more than 1 g/l;
- Sulfur dioxide common mass concentration – no more than 200 mg/l;
- Sugar free extract mass concentration – no less than 16 mg/l.

Red dry wine "Tsinandali" shall satisfy the following requirements:

- Actual volumetric spirit content – no less than 11 %;
- Common volumetric spirit content – no more than 15 %;
- Sugar content – no more than 4 g/l;
- **Titratable acidity in young wine should be – no less than 4.5 g/l, and in aged wine – no less than 4.0 g/l;**
- Volatile acidity – no more than 1.2 g/l;
- Sulfur dioxide common mass concentration – no more than 150 mg/l;
- Sugar free extract mass concentration – no less than 22 mg/l."

GURJAANI

"2.3. Physical and Chemical Characteristics of Product.

White dry wine "Gurjaani" shall satisfy the following requirements:

- Color light straw;
- Aroma and taste - perfect, delicate, soft, harmonic, cheerful, refined, pleasant sweet, with meadow flowers tones, having aroma characterizing location, fruit tones are developed with aging;
- Actual volumetric spirit content – no less than 11 %;
- Common volumetric spirit content – no more than 16 %;
- Sugar content – no more than 4 g/l;
- **Titratable acidity in young wine should be – no less than 5.0 g/l, and in aged wine – no less than 4.3 g/l;**
- Other characteristics shall satisfy requirements established by the Law of Georgia."

MANAVI

"3. Type, Color and General Requirements.

White dry wine "Manavi" shall satisfy the following requirements:

- Color light greenish-straw;
- Aroma and taste - perfect, delicate, soft, harmonic, cheerful, refined, pleasant sweet, with meadow flowers tones, having aroma characterizing location, fruit tones are developed with aging;
- Actual volumetric spirit content – no less than 11 %;
- Common volumetric spirit content – no more than 16 %;
- Sugar content – no more than 4 g/l;
- **Titratable acidity in young wine should be – no less than 5.0 g/l, and in aged wine – no less than 4.3 g/l;**
- Other characteristics shall satisfy requirements established by the Law of Georgia."

KAKHETI (KAKHURI)

"3. Type, Color and General Requirements.

Wine "Kakheti" can be white, red, rosé or amber, dry, naturally demi-sec (semi-dry), demi-doux (semi-sweet) and doux (sweet), in accordance to sugary.

Wine "Kakheti" organoleptic characteristics shall satisfy the following requirements:

- White dry wine is light straw, perfect, delicate, soft, harmonic, cheerful, refined, with meadow flowers tones, having aroma characterizing location, fruit tones are developed with aging;
- Red dry wine is dark red, perfect, full, extracted, velvet, harmonized, cheerful, refined, having aroma characterizing location with meadow flower tones, fruit tones are developed with aging;
- White semi-dry, semi-sweet and sweet wines are light straw, perfect, delicate, soft, harmonic, cheerful, refined, with meadow flowers tones, having aroma characterizing location;
- Red semi-dry, semi-sweet and sweet wines are dark red, perfect, full, extracted, velvet, harmonized, cheerful, refined, having aroma characterizing location;
- Rosé wines are from light to dark pink, perfect, full, extracted, velvet, harmonized, cheerful, refined, having aroma characterizing location;
- Amber wines are from dark amber to tea color, have body, energy, they are extracted, velvet, having aroma characterizing location, with moderate and soft tart taste making them typical, fruit tones are developed with aging, characterized with tart taste because of maceration on chacha;
- Actual volumetric spirit content– no less than 11 %, for dry wine, no less than 12 %, for amber wine, and no less than 10.5 %, for semi-dry, semi-sweet and sweet wines;
- Common volumetric spirit content – no less than 16 g/l, for white and rosé wines, and no less than 22 g/l, for red and amber wines;
- **Titrateable acidity in young wine should be – no less than 3.5 g/l;**
- Other characteristics shall satisfy requirements established by the Law of Georgia."

NAPAREULI

"3. Type, Color and Main Requirements:

"Napareuli" is dry wine, color can be white or red.

White dry wine "Napareuli" shall satisfy the following requirements:

- Color – light straw;
- Aroma and Taste – perfect, delicate, soft, harmonic, cheerful, having aroma characterizing location, with flower tones, and fruit tones are developed with aging;
- Actual volumetric spirit content – no less than 11 %;
- Volumetric spirit content – no less than 11 %;
- Concentration of finished extract mass – no less than 16 g/l;
- Sugar content – no more than 4 g/l;
- **Titrateable acidity in young wine should be –no less than 5.0 g/l, and in aged wine – no less than 4.3 g/l;**
- Other characteristics shall meet requirements provided by the legislation of Georgia. "

Red dry wine "Napareuli" shall satisfy the following requirements:

- Color – dark red;
- Aroma and Taste – perfect, full, masculine, extracted, harmonic, having aroma characterizing location, fruit tones are developed with aging;
- Actual volumetric spirit content – no less than 11 %;
- Concentration of finished extract mass – no less than 22 g/l;
- Sugar content – no more than 4 g/l;
- **Titrateable acidity in young wine should be – no less than 4.5 g/l, and in aged wine – no less than 4.0 g/l;**
- Other characteristics shall meet requirements provided by the legislation of Georgia."

TELIANI

"2.3. Physical and Chemical Characteristics of Product.

Wine "Teliani" shall satisfy the following requirements:

- Actual volumetric spirit content – no less than 11 %;
- Common volumetric spirit content – no more than 15 %;
- Sugar content – no more than 4 g/l;
- **Titrateable acidity in young wine should be – no less than 4.5 g/l, and in aged wine – no less than 4.0 g/l;**
- Volatile acidity – no more than 1.2 g/l;
- Sulfur dioxide common mass concentration – no more than 150 mg/l;
- Sugar free extract mass concentration – no less than 22 mg/l."

ATENI (ATENURI)

"3. Type, Color and Main Requirements:

Wine "Atenuri" can be white dry, white dry sparkling and slightly sparkling.

White dry wine "Atenuri" shall satisfy the following requirements:

- Color – from light straw to straw;
- Aroma and taste – harmonized, pleasant and cheerful, perfect, having aroma characterizing location with meadow flowers tones, and fruit tones are developed with aging; Volumetric spirit content – no less than 11.0 %;
- Concentration of finished extract mass – no less than 16 g/l;
- Sugar content – 4 g/l;
- **Titrateable acidity in young wine should be – no less than 5 g/l, and in aged wine – no less than 4.3 g/l;**
- Other characteristics shall meet requirements provided by the legislation of Georgia."

Sparkling or slightly sparkling wine "Atenuri" shall satisfy the following requirements:

- Color – light straw;
- Aroma and taste – developed aroma, delicate as characterized sparkling wines, full, harmonized;
- Actual volumetric spirit content – no less than 10.5 %;
- Concentration of finished extract mass – no less than 16 g/l;
- Sugar content shall meet requirements provided by the legislation of Georgia;

- **Titrateable acidity should be – no less than 5 g/l;**
- Other characteristics shall meet requirements provided by the legislation of Georgia."

SVIRI

"3. Type, Color and Main Requirements:

White dry wine "Sviri" shall satisfy the following requirements:

- Color – from straw to dark straw, yellowish;
- Aroma and taste - perfect, microbiologically healthful, harmonic, pleasant, cheerful, refined, having aroma characterizing location, with bouquet of fruit tones developed with aging;
- Actual volumetric spirit content – no less than 11 %;
- Concentration of finished extract mass – no less than 19 g/l;
- Sugar content – no more than 4 g/l;
- **Titrateable acidity – no less than 5 g/l in young wine, and no less than 4.3 g/l – in old wine;**
- Other characteristics shall meet requirements provided by the legislation of Georgia."

VAZISUBANI

"3. Type, Color and Main Requirements:

White dry wine "Vazisubani" shall satisfy the following requirements:

- Color – light straw;
- Aroma and taste - perfect, delicate, soft, harmonic, cheerful, refined, having aroma characterizing location, with meadow flowers tones, and bouquet of fruit tones are developed with aging;
- Actual volumetric spirit content – no less than 11 %;
- Concentration of finished extract mass – no less than 16 g/l;
- Sugar content – no more than 4 g/l;
- **Titrateable acidity in young wine should be – no less than 5 g/l, and in aged wine – no less than 4.3 g/l;**
- Other characteristics shall meet requirements provided by the legislation of Georgia."

KARDENAKHI

"3. Type, Color and Main Requirements:

"Kardenakhi" can be amber dry or white fortified wine.

Amber dry wine "Kardenakhi" shall satisfy the following requirements:

- Color – dark amber to straw;
- Aroma and taste – with body, energetic, extracted, velvet, having aroma characterizing location, moderately and softly spicy, making it typical, fruit tones are developed with aging;
- Actual volumetric spirit content – no less than 12 %;
- Concentration of finished extract mass – no less than 22 g/l;
- Sugar content – no more than 4 g/l;
- **Titrateable acidity should be – no less than 3.5 g/l;**
- Other characteristics shall meet requirements provided by the legislation of Georgia."

White fortified wine "Kardenakhi" shall satisfy the following requirements:

- Color – light golden to dark amber;
- Aroma and taste – full, harmonic, having aroma characterizing location, taste of honey;
- Actual volumetric spirit content – no less than 18 ($\pm 0,5$) %;
- Concentration of finished extract mass – no less than 18 g/l;
- Sugar content – no more than 100 ($\pm 0,5$) g/l;
- **Titrateable acidity should be – no less than 4 g/l;**
- Other characteristics shall meet requirements provided by the legislation of Georgia."

TIBAANI

"3. Type, Color and Main Requirements:

Amber dry "Tibaani" shall satisfy the following requirements:

- Color – dark amber to straw;
- Aroma and taste – with body, energetic, extracted, velvet, having aroma characterizing location, moderately and softly tart, making it typical, fruit tones are developed with aging;
- Actual volumetric spirit content – no less than 12 %;
- Concentration of finished extract mass – no less than 22 g/l;
- Sugar content – no more than 4 g/l;
- **Titrateable acidity should be – no less than 3.5 g/l;**
- Other characteristics shall meet requirements provided by the legislation of Georgia."

KVARELI

"3. Type, Color and Main Requirements:

Red dry wine "Kvareli" shall satisfy the following requirements:

- Color – dark red;
- Aroma and taste - perfect, full, extracted, velvet, harmonized, with fruity tones developed with aging;
- Actual volumetric spirit content – no less than 11 %;
- Concentration of finished extract mass – no less than 22 g/l;
- Sugar content – 4 g/l;
- **Titrateable acidity in young wine should be – no less than 4.5 g/l, and in aged wine – no less than 4.0 g/l;**
- Other characteristics shall meet requirements provided by the legislation of Georgia."

SAPERAVI KHASHMI

"3. Type, Color and Main Requirements:

Red dry wine "Saperavi Khashmi" shall satisfy the following requirements:

- Color – dark red, with age – appropriate nuance;
- Aroma and taste – perfect, microbiologically healthy, has body, velvet and harmonic, has sharp grade aroma;
- Actual volumetric spirit content – no less than 12 %;

- Concentration of finished extract mass – no less than 24 g/l;
- Sugar content – 4 g/l;
- **Titratable acidity should be – no less than 4.5 g/l;**
- Other characteristics shall meet requirements provided by the legislation of Georgia."

AKHMETA (AKHMETIS MTSVANE)

"3. Type, Color and Main Requirements:

"Akhmeta" is white or amber wine.

a) In accordance to sugar content the **white "Akhmeta"** can be dry, naturally semi-dry (demi-sec) and naturally semi-sweet (demi-doux). Akhmeta organoleptic and physicochemical characteristics shall satisfy the following requirements:

Dry wine Akhmeta – light straw, perfect, delicate, soft, harmonic, cheerful, having aroma of meadow flowers characterizing the location, and bouquet of fruit tones is developed with aging;

Naturally semi-dry and naturally semi-sweet wines – light greenish golden, perfect, delicate, soft, harmonic, cheerful, having aroma characterizing the location. Semi-dry and semi-sweet wines – no less than 10.5 %;

Actual volumetric spirit content for dry wine – no less than 11 %, and for naturally semi-dry and semi-sweet wines – no less than 10.5 %;

Concentration of finished extract mass – no less than 16 g/l;

Sugar content in dry wine – no more than 4 g/l, 4-18 g/l – in semi-dry wine, and 18-45 g/l – in semi-sweet wine;

Titratable acidity in young dry, semi-dry and semi-sweet wines should be – no less than 5 g/l, and in aged wine – no less than 4.3 g/l;

Other characteristics shall meet requirements provided by the legislation of Georgia."

b) **Amber wine "Akhmeta"** organoleptic and physicochemical characteristics shall satisfy the following requirements:

Color – from dark amber to tea-color;

Aroma and Taste – has a body, energetic, extracted and velvet, having aroma characterizing the location, moderately and softly sharp, making it typical. The bouquet of fruit tones is developed with aging. It is characterized with tanner taste, as a result of maceration on "Chacha" (must);

Volumetric spirit content – no less than 12.0 %;

Concentration of finished extract mass – no less than 22 g/l;

Titratable acidity should be – no less than 3.5 g/l;

Other characteristics shall meet requirements provided by the legislation of Georgia."

KOTEKHI

REGISTRATION No.: 799

DATE OF REGISTRATION: 12/10/2007

PRODUCT NAME: WINE

Geographical Location – Vinery specific zone Kotekhi is located in the middle stream of the river Alazani, on its right bank, with the coordinates of North latitude 41°45' and East longitude 45°48'. The territory of the micro-zone includes the foothill adjacent to the woody slopes of Northern-western inclination of Tsiv-Gombori Range and Alazani Valley, and is located at 250-700 meters above sea level.

Climate – The weather is formed by atmospheric processes developed in subtropical and moderate latitudes and displaced from west to east. Climate is moderately damp here, with hot summer and moderately cold winter.

The annual duration of the sunshine is 2150-2200 hours, varying between 1550-1600 hours in the vegetation period. In the micro-zone, the annual sum of the direct solar radiation on the horizontal surface is 71 kcal/cm², the annual diffused radiation is 49 kcal/cm², and that during the vegetation period is 35 kcal/cm². The annual value of total radiation is 120 kcal/cm², and 90 kcal/cm² during the warm period.

The average annual air temperature is quite high reaching 12,4°. The warmest months are July and August, with the average temperature of 23,6°; the average temperature of the coldest month (January) is +0,9°. The average of the annual absolute minimums is -10°, and the average of absolute maximum is 35°. Extreme temperatures are -22 and +38°.

In most part of the region a stable transfer above the air temperature of 10° takes place in the first decade of the month of April (5.IV) and the fall below 10° takes place at the beginning of the month of November (3.XI). The duration of the vegetation period is 211 days. Approximately 3930° of total active temperatures accumulate during this period.

The annual number of clear days (0-2 points), according to the general and lower cloudiness, is 51 and 132. During the vegetation period, this indicator according to the mentioned levels of cloudiness equals to 36 and 79 days, respectively.

The annual indicator of the cloudy days (8-10 points) is 113 and 59, according to the general and lower cloudiness, and that during the vegetation period is 54 and 26, respectively.

During 85 days from the beginning of summer, the average daily air temperature is over 20°. During this period, for 34 days (10.VII-13.VIII), the average air temperature even reaches and exceeds 23°.

The first night frosts in autumn start in the second decade of November (from 25.XI). Once in every ten years, the frosts may start at the end of October (from 30.X). The last night frosts on average, end from 24.III. Once in every ten years, spring frosts are expected until the middle of April.

The annual sum of atmospheric precipitations is 804 mm, with 578 mm during the vegetation period. Maximum annual precipitation is fixed in May (124 mm), and minimum is fixed in January (32 mm). Precipitations take the form of snow in the last days of December and disappear until the middle of

March. During this period, the decade snow cover of average height of 6-7 cm does not melt for 25 days.

Average relative air humidity is 72%. The highest air humidity (80%) is fixed in November, and is the least humidity (64%) in August.

Average annual number of days with hail is 1,7. The months of May and June have most days with hail (0,6-0,4). In exceptional years, it may hail six times a year.

Following the analysis of temperature isopleths of the depth of alluvial-calcareous soil, at the depth of 5-50 cm, a stable transition of temperature above 10° takes place in the first decade of April, and at higher depths of 50-100 cm, it does not take place until the middle of April.

In the middle of May, the temperature at the depth of 10-120 cm in soil rises over 15°. From the middle of June until the end of September, i.e. for more than 3 months, the temperature at the depth of 5-70 cm is over 20°.

Mainly southern-western (33%) and western (18%) winds prevail here. They are rarely changed for eastern winds (12%). Average annual wind speed is 1,7 m/sec, with its maximum (1,9 m/sec) in March and with its minimum (1,5 m/sec) in December.

According to many-year-long data, the average of absolute minimums of air temperature, as already mentioned, is -10°. Once in every ten years, the minimum temperature is expected to fall to -15° (for a short period) causing only slight damage (<30%) to the vine buds.

Soil – The soils are represented by varieties of brown, dark brown alluvial-dealluvial and alluvial-proalluvial soils:

Brown soils of great thickness, calcareous, slightly skeletal loamy-clay.

Brown soil of average thickness, calcareous, slightly skeletal loamy and clay.

Dark brown (old alluvial) soil of great and average thickness, calcareous, slightly skeletal, clay alluvial-dealluvial of great thickness, calcareous slightly skeletal, loamy.

Alluvial-proalluvial of great thickness, calcareous, slightly skeletal, loamy soils.

Thicknesses of profiles of brown and dark brown soils of great thickness are within the limits of 100-130 cm, and the thickness of humus-containing active layer is within the limits of 60-80 cm. The thickness of profiles of alluvial-proalluvial and alluvial-dealluvial soils is great at every point and is over 100 cm. The thickness of profiles of brown and dark brown soils of average thickness varies between 60-70 cm and 70-80 cm, and that of a humus-containing layer is 50-60 cm. According to the texture, the soils of the upper zone are loamy and clay. Content of physical clay (with fraction <0,01 mm) is up to 40,6-67,4%. As for the soils of the lower zone, which are mainly formed by displaced and drifted materials, their texture is represented by heavy loamy soils, with the same fraction of 60,0%. Their structure in the zone in plantage layers (0-50 cm) of brown soils is granular-cloddy and cloddy-granular, and the structure in the lower layers is weakly expressed. The structure in the section of alluvial soils is cloddy-granular and fine-granular-cloddy, with the lowest layers without structure.

The humus content in the plantage layers of brown and lower alluvial soils is in little and average amounts of 1,54-3,09%. The content of hydrolysis nitrogen in the upper- and lower-zone soils is low not exceeding 5,60 mg in 100 gr. of soil, the content of soluble phosphorus is low not exceeding 2,0 mg in 100 gr. of soil, the content of exchange potassium is also low and constitutes 2,0-7,2 mg in 100 gr. of soil. The content of calcium carbonate in the section of brown soils is average or high

reaching 9,2-20,0%, and not exceeding 8,0% in the lower zone. The reaction of the soil area is weak and average alkaline – pH = 7,1-8,0. The soils are weakly skeletal.

Agro-Technological Regulations

In order to gain the bulk wine "Kotekhi", by considering the soil and climatic conditions, the following agro-technological regulations are to be observed.

Species of "Rkatsiteli":

Growing area: Up to 750 m above sea level.

Plot of planting: 2,0 x 1,5 m; 2,5x 1,5 m;

Height of stem: 80-100 cm

Form of pruning: Free and Georgian two-sided trellis.

Norm of loading per 1 m²: 8-10 buds.

Harvest: 9-10 tons per hectare.

Species of "Saperavi":

Growing area: Up to 750 m above sea level.

Plot of planting: 2,0 x 1,5 m; 2,5x 1,5 m;

Height of stem: 80-100 cm

Form of pruning: Free and Georgian two-sided trellis.

Norm of loading per 1 m²: 8-10 buds.

Harvest: 7-8 tons per hectare.

Soil Cultivation

In the irrigation area the last irrigation cycle of vegetation is to be ended one month before the vintage.

Autumn and spring plough of soil, with minimal land cultivation. Moisture-preservation measures—preserving the soil in a loose state (cultivation, milling, mulching).

Fertilization. Application of organic-mineral fertilizers with regulations.

Phyto-Sanitary Regulations

Principal diseases: Mildew, powdery mildew, rot.

Pests: Tick, western grape worm, mealybug.

Control measures: Application of contact and systematic preparations registered in Georgia.

Agricultural-Technological characterization of Rkatsiteli and Saperavi

Rkatsiteli – Wine species of white grape. It is distinguished by high economic-technological properties, resistance in various conditions and high dignity of production. The species is of average or late period. It is characterized with abundant harvest (average weight of a bunch is about 160-250 gr.). Average harvest is 9-10 tons per hectare.

Saperavi – Georgian, color-grape wine species giving high quality production. Wine made of "Saperavi" is of intense dark red color, with moderate content of alcohol and acidity, with rich and gay race and high taste properties.

The bunch is larger than average with the weight of 140-145 gr. The ripe bunch is of dark blue color, juicy and pulpy with pleasant sweet taste.

The grape ripens in the second half of September. The vine is stronger than of average grow. The harvest per hectare to gain the conditional production varies between 7-8 tons.

Sugar content of the ripe grape reaches 200-260 gr/dm³, with the acidity of 7,5-8,5 gr/dm³.

Wine "Kotekhi" (white) – "Kotekhi" is the highest-grade white dry wine of geographical appellation. It is made of the grapes of "Rkatsiteli" species with fully stopped must.

Wine "Kotekhi" is characterized with a light straw coloring, with species-specific aroma and pleasant taste.

Chemical characteristics of the wine "Kotekhi" should correspond to the following data:

Volumetric spirit-content, % – 10,5-12,0

Mass concentration of sugars no more than 4 gr/dm³

Titratable acidity should be – 5,0 g/l

Volatile acidity of no more than – 1,0 gr/dm³

Mass concentration of finished extract of – no less than 16 gr/dm³

The rest norms should correspond to the legislative acts of Georgia and the EU Directive No. 1493/1999 of May 17, 1999.

Wine "Kotekhi" (red) – "Kotekhi" is the highest-quality red dry wine of Geographical Appellation. It is made of the grapes of "Saperavi" species with fully stopped must.

Wine "Kotekhi" (red) is characterized with red color, species-specific aroma and fine, pleasant taste.

Chemical characteristics of the wine "Kotekhi" should correspond to the following data:

Volumetric spirit-content, % – 10,5-12,0

Mass concentration of sugars no more than 4 gr/dm³

Titratable acidity should be – 4.5 g/l

Volatile acidity of – no more than 1,2 gr/dm³

Mass concentration of finished extract of – no less than 20 gr/dm³

The rest norms should correspond to the legislative acts of Georgia and the EU Directive No. 1493/1999 of May 17, 1999.

Area of Specific Zone

The area of the specific zone "Kotekhi" is approximately 14 km².

The location, the micro-climate, the atmospheric processes developed in subtropical and moderate latitudes (displaced from west to east), the soils and the originality of indigenous species make for special features of "Kotekhi" wines.

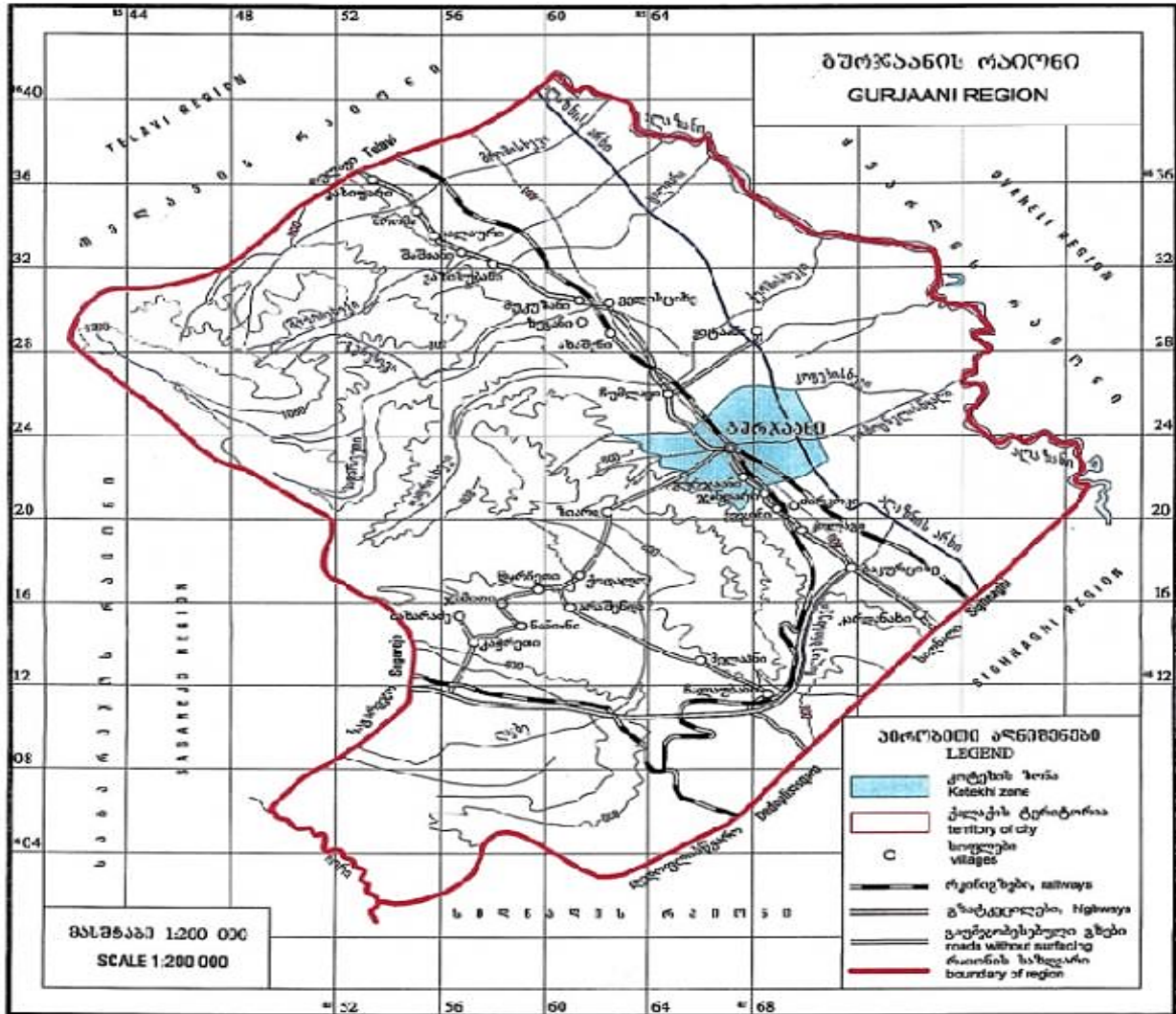

**OFFICIAL NOTIFICATIONS
INVENTIONS
RESTORATION OF PATENTS**

(21) AP 2007 11072
(11) P 2012 5505 B
(73) E.I. Du Pont De Nemours and Company
(54) FUNGICIDAL AZOCYCLIC AMIDES
DATE OF PATENT CANCELLATION: 2022 07 27
DATE OF PATENT RESTORATION: 2022 12 12

(21) AP 2012 12766
(11) P 2013 5987 B
(73) Sarkis Markaryan (Sarkis Markarjan- սկյս ծսճսծս)
(54) METHOD OF WATER COMPLEX DEACTIVATION AND MODULE FOR EXECUTION THEREOF
DATE OF PATENT CANCELLATION: 2022 06 27
DATE OF PATENT RESTORATION: 2022 12 12

(21) AP 2014 14088
(11) P 2018 6904 B
(73) Crystal Lagoons (Curacao) B.V.
(54) FLOATING LAKE AND METHODS OF TREATING WATER WITHIN THE FLOATING LAKE
DATE OF PATENT CANCELLATION: 2022 11 04
DATE OF PATENT RESTORATION: 2022 12 12

(21) AP 2014 14152
(11) P 2018 6854 B
(73) Crystal Lagoons (Curacao) B.V.
(54) SUCTIONING DEVICE FOR LARGE ARTIFICIAL WATER BODIES
DATE OF PATENT CANCELLATION: 2022 11 12
DATE OF PATENT RESTORATION: 2022 12 12

ABOLITION OF PATENTS WITH THE RIGHT TO RESTORE

(21) AP 2014 14152
(11) P 2018 6854 B
(73) Crystal Lagoons (Curacao) B.V.
(54) SUCTIONING DEVICE FOR LARGE ARTIFICIAL WATER BODIES
DATE OF PATENT CANCELLATION: 2022 11 12
LIMITED DATE OF PATENT RESTORATION: 2024 11 12

(21) AP 2016 14762
(11) P 2019 6992 B
(73) Castle Commercial Enterprises Limited
(54) IMPROVED FERMENTER

DATE OF PATENT CANCELLATION: 2022 11 10
LIMITED DATE OF PATENT RESTORATION: 2023 11 10

(21) AP 2019 15218
(11) P 2021 7262 B
(73) Victor Zviadauri;
Merab Tedoshvili;
Merab Chelidze;
LEPL "Shota Rustaveli National Science Foundation"
(54) ELECTROMAGNETIC VIBRATING FEEDER
DATE OF PATENT CANCELLATION: 2022 11 12
LIMITED DATE OF PATENT RESTORATION: 2023 11 12

(21) AP 2018 15262
(11) P 2022 7421 B
(73) LTD "Valenta-Intellect"
(54) L-ENANTIOMER 2-ETHYL-6-METHYL-3-HYDROXYPYRIDINIUM L-HYDROXYBUTANDIOATE
WITH CEREBROPROTECTIVE, HEPATOPROTECTIVE, LIPID-REGULATING, ANTI-ISCHEMIC
AND NEUROTROPIC ACTIVITIES
DATE OF PATENT CANCELLATION: 2022 11 14
LIMITED DATE OF PATENT RESTORATION: 2023 11 14

EXPIRATION OF PATENTS RESTORATION DATE

(21) AP 2007 11309
(11) P 2012 5459 B
(73) Millennium Pharmaceuticals Inc.
(54) COMPOUNDS FOR INHIBITING MITOTIC PROGRESSION
DATE OF PATENT CANCELLATION: 2021 11 14
DATE OF PATENT RESTORATION EXPIRATION: 2022 11 14

(21) AP 2011 13117
(11) P 2015 6346 B
(73) H. Lundbeck A/S
(54) IMIDAZOLE DERIVATIVES AS PDE10A ENZYME INHIBITORS
DATE OF PATENT CANCELLATION: 2021 11 18
DATE OF PATENT RESTORATION EXPIRATION: 2022 11 18

(21) AP 2018 14926
(11) P 2020 7207 B
(73) Goga Chakhaia;
Levan Tsulukidze;
Zurab Lobzhanidze;
Sopio Gogilava;
LTD "High School Academy of Education"
(54) CONSTRUCTION FOR SNOWSLIDE CONTROL
DATE OF PATENT CANCELLATION: 2021 11 16
DATE OF PATENT RESTORATION EXPIRATION: 2022 11 16

EXPIRATION OF TERMS OF PATENT

(21) AP 2012 13321

(11) P 2015 1842 B

(73) Ruhlamat GmbH

(54) SECURITY ELEMENT FOR VALUE DOCUMENTS AND METHOD FOR MANUFACTURING SAME
DATE OF PATENT EXPIRATION: 2022 11 23

TRANSFER OF RIGHTS

(21) AP 2017 14873

(11) P 2020 7190 B

(54) METHODS FOR TREATMENT AND PROPHYLAXIS OF HIV AND AIDS

NAME AND ADDRESS OF NEW PATENT OWNER: Merck Sharp & Dohme LLC (US)

26 East Lincoln Ave., P.O.Box 2000, Rahway,
New Jersey, 07065, USA (US)

NAME AND ADDRESS OF FORMER PATENT OWNER: Merck Sharp & Dohme Corp.

126 East Lincoln Ave., Rahway, New Jersey,
07065-0907, USA (US)

DATE OF REGISTRATION: 2022 12 02

(21) AP 2017 15046

(11) P 2021 7231 B

(54) METHODS FOR TREATMENT AND PROPHYLAXIS OF HIV AND AIDS

NAME AND ADDRESS OF NEW PATENT OWNER: Merck Sharp & Dohme LLC (US)

26 East Lincoln Ave., P.O.Box 2000, Rahway,
New Jersey, 07065, USA (US)

NAME AND ADDRESS OF FORMER PATENT OWNER: Merck Sharp & Dohme Corp.

126 East Lincoln Ave., Rahway, New Jersey,
07065-0907, USA (US)

DATE OF REGISTRATION: 2022 12 02

(21) AP 2021 15678

(11) P 2022 7448 B

(54) SEMICONDUCTOR LIGHT-ABSORBING NANOSTRUCTURAL SURFACE

NAME AND ADDRESS OF NEW PATENT OWNER: LEPL "Ilia State University" (GE)

Cholokashvili Ave. 3/5, 0162, Tbilisi, Georgia (GE)

DATE OF REGISTRATION: 2022 12 02

UTILITY MODELS

RESTORATION OF PATENTS

(21) AU 2015 13986
(11) U 2016 1906 Y
(73) Raul Turmanidze;
Giorgi Popkhadze
(54) POWER SYSTEM ACCUMULATING WIND AND SOLAR ENERGY
DATE OF PATENT CANCELLATION: 2022 11 06
DATE OF PATENT RESTORATION: 2022 12 12

(21) AU 2020 15477
(11) U 2022 2108 Y
(73) Mamuka Verulava
(54) METHOD FOR HOUSEFLY WORM GROWTH
DATE OF PATENT CANCELLATION: 2022 10 27
DATE OF PATENT RESTORATION: 2022 12 12

ABOLITION OF PATENT WITH THE RIGHT TO RESTORE

(21) AU 2019 15217
(11) U 2021 2086 Y
(73) LEPL "Micro and Nanoelectronics Institute"
(54) OPTICAL DEVICE POLYCHROMATOR
DATE OF PATENT CANCELLATION: 2022 11 12
LIMITED DATE OF PATENT RESTORATION: 2023 11 12

EXPIRATION OF PATENTS RESTORATION DATE

(21) AU 2015 13993
(11) U 2017 1920 Y
(73) Khvicha Tvalabeishvili
(54) THERAPEUTIC AGENT FOR LACTOSTASIS, MASTOPATHY, AND MASTITIS TREATMENT
AND/OR PROPHYLAXIS
DATE OF PATENT CANCELLATION: 2021 11 12
DATE OF PATENT RESTORATION EXPIRATION: 2022 11 12

(21) AU 2016 14321
(11) U 2018 1964 Y
(73) Merab Diasamidze;
Merab Topchiashvili;
Zurab Suladze;
David Suladze
(54) METHOD FOR ARTICLE MANUFACTURE WITH WOOD- POLYMER COMPOSITE
DATE OF PATENT CANCELLATION: 2021 11 14
DATE OF PATENT RESTORATION EXPIRATION: 2022 11 14

(21) AU 2018 14927
(11) U 2021 2083 Y
(73) LTD "High School Academy of Education"
Goga Chakhaia;
Zurab Lobzhanidze;
Levan Tsulukidze;
Sopio Gogilava
(54) RADIAL CATCHMENT DRAINAGE
DATE OF PATENT CANCELLATION: 2021 11 16
DATE OF PATENT RESTORATION EXPIRATION: 2022 11 16

DESIGNS

EXTENTION OF TERMS OF DESIGNS REGISTRATION

(11) D 2013 551 S
(73) Gela Gamtkitsulashvili (GE)
Tbilisi Ave. 3, app. 8, 2200, Telavi, Georgia (GE);
Gia Gamtkitsulashvili (GE)
Vazha-Pshavela Ave. 71, b. 7, 0186, Tbilisi, Georgia (GE)
(54) VESSEL
(28) 1
(24) 2012 11 16
(18) 2027 11 16
(58) 2022 11 22

(11) D 2017 718 S
(73) Giorgi Zautashvili (GE)
Meliton Kantaria Str. 10, ap. 2, 0160, Tbilisi, Georgia (GE)
(54) 1.-12. BOTTLE LABEL
(28) 12
(24) 2017 06 07
(18) 2027 06 07
(58) 2022 12 02

CANCELLATION OF DESIGNS REGISTRATION

(11) D 2018 740 S
(73) Data Shishmanashvili (GE)
Gldani, IV mcr., bld. 113, ap. 76, 0137, Tbilisi, Georgia (GE)
(54) LOGO
(18) 2022 05 08
(58) 2022 11 28

(11) D 2018 741 S
(73) LTD "Idea Design Group" (GE)
Shindisi Str. 4/2, 0105, Tbilisi, Georgia (GE)
(54) GRAPHIC DESIGN

(18) 2022 05 10
(58) 2022 11 28

(11) D 2018 744 S
(73) Giorgi Gordeziani (GE)
Kavsadze Str. 4, 0179, Tbilisi, Georgia (GE)
(54) PACKAGING BOX
(18) 2022 05 15
(58) 2022 12 01

CANCELLATION OF INTERNATIONAL DESIGNS REGISTRATION

(11) DM/69477
(73) RADO UHREN AG (RADO WATCH CO. LTD.) (MONTRES RADO SA)
Bielstrasse 45, CH-2543 Lengnau (CH)
(15) 2007 11 27
(24) 2007 11 27
(18) 2027 11 27
(28) 1
(28') 1
(54) WRISTWATCH

(11) DM/69509
(73) MECO SA
Schützengasse 30, CH-2540 Grenchen (CH)
(15) 2007 11 30
(24) 2007 11 30
(18) 2027 11 30
(28) 1
(28') 1
(54) WATCH WINDING CROWN

(11) DM/69556
(73) MECO SA
Schützengasse 30, CH-2540 Grenchen (CH)
(15) 2007 11 30
(24) 2007 11 30
(18) 2027 11 30
(28) 2
(28') 2
(54) WATCH SPRINGS

(11) DM/70031
(73) ISTVÁN BOTOS
Váralja u. 55, H-7800 Siklós (HU)
(15) 2008 01 09
(24) 2008 01 09
(18) 2028 01 09
(28) 1

(28') 1
(54) CLEANING UTENSIL

(11) DM/79166
(73) GEDİK HOLDING ANONİM ŞİRKETİ
Ankara Caddesi No. 306, Şeyhli, TR-34913 PENDİK/İSTANBUL (TR)
(15) 2012 08 20
(24) 2012 08 20
(18) 2027 08 20
(28) 2
(28') 2
(54) PACKAGES

(11) DM/79322
(73) SAVERGLASS
3 rue de la Gare, F-60960 FEUQUIERES (FR)
(15) 2012 10 12
(24) 2012 10 12
(18) 2027 10 12
(28) 8
(28') 4
(54) BOTTLES

(11) DM/79494
(73) İPEK KAĞIT SANAYİ VE TİCARET ANONİM ŞİRKETİ
Kanyon Ofis Büyükdere Cad. No:185, TR-34394 Levent/Istanbul (TR)
(15) 2012 10 23
(24) 2012 10 23
(18) 2027 10 23
(28) 1
(28') 1
(54) TOILET PAPER DISPENSER

(11) DM/79601
(73) SWATCH AG (SWATCH SA)(SWATCH LTD.)
Jakob-Stämpfli-Strasse 94, CH-2502 Biel/Bienne (CH)
(15) 2012 11 21
(24) 2012 11 21
(18) 2027 11 21
(28) 7
(28') 7
(54) WRISTWATCHES WITH DIGITAL DISPLAY

(11) DM/79610
(73) SWATCH AG (SWATCH SA) (SWATCH LTD.)
Jakob-Stämpfli-Strasse 94, CH-2502 BIEL/BIENNE (CH)
(15) 2012 11 30
(24) 2012 11 30
(18) 2027 11 30
(28) 7
(28') 7
(54) WRISTWATCHES

(11) DM/79655
(73) SWATCH AG (SWATCH SA) (SWATCH LTD)
Jakob-Stämpfli-Strasse 94, CH-2502 Biel/Bienne (CH)
(15) 2012 11 28
(24) 2012 11 28
(18) 2027 11 28
(28) 3
(28') 3
(54) WATCHES

(11) DM/79656
(73) TISSOT SA (TISSOT AG) (TISSOT LTD)
Chemin des Tourelles 17, CH-2400 Le Locle (CH)
(15) 2012 11 28
(24) 2012 11 28
(18) 2027 11 28
(28) 2
(28') 2
(54) WATCH CASES WITH BRACELET

(11) DM/97700
(73) SHMULEVYCH VITALII NAUMOVYCH
Vul. Levanevskoho, 7, Kv. 63, 65062, Odesa (UA);
MASLENKOV VOLODYMYR MYKOLAIOVYCH
Vul. M. Hovorova 1-2, Kv. 101, 65058, Odesa (UA);
MARKUSHEVSKYI IGOR ISAAKOVYCH
Vul. Bolharska, 82, Kv. 8, 65005, Odesa (UA)
(15) 2017 09 01
(24) 2017 09 01
(18) 2027 09 01
(28) 1
(28') 1
(54) BOTTLE

(11) DM/98434
(73) BLANCPAIN SA
Le Rocher 12, CH-1348 LE BRASSUS (CH)
(15) 2017 11 06
(24) 2017 11 06
(18) 2027 11 06
(28) 2
(28') 2
(54) DIALS

(11) DM/98535
(73) RADO UHREN AG (RADO WATCH CO. LTD.) (MONTRES RADO SA)
Bielstrasse 45, CH-2543 Lengnau BE (CH)
(15) 2017 11 14
(24) 2017 11 14
(18) 2027 11 14
(28) 1
(28') 1
(54) WRISTWATCH

(11) DM/99386
(73) FICOSOTA SYNTEZ OOD
Madara Blvd. 48, BG-9700 SHUMEN (BG)
(15) 2018 01 12
(24) 2018 01 12
(18) 2028 01 12
(28) 1
(28') 1
(54) DECORATIVE PATTERN FOR SURFACES

(11) DM/99614
(73) SEW-EURODRIVE GMBH & CO KG
Ernst-Blickle-Str. 42, 76646 Bruchsal (DE)
(15) 2018 01 31
(24) 2018 01 31
(18) 2028 01 31
(28) 2
(28') 2
(54) GEAR AND GEARING CASINGS

TRADEMARKS

EXTENSION OF TERMS OF TRADEMARKS REGISTRATION

(111) M 2002 14592 R2

(156) 2002 08 15

(186) 2032 08 15

(732) JSC "Argo"

Lilo, Lotchini Ravine (Plot 05/001), 0151,
Tbilisi, Georgia

David Aghmashenebeli Alley 6th km, 0131,
Tbilisi, Georgia

(111) M 2002 14788 R2

(156) 2002 11 15

(186) 2032 11 15

(732) Janssen Biotech Inc.

800 Ridgeriew Drive, Horsham, Pennsylvania
19044, USA

(111) M 2012 22604 R1

(156) 2012 05 16

(186) 2032 05 16

(732) Cardinal Health 529, LLC

7000 Cardinal Place Dublin, Ohio 43017, USA

(111) M 2002 14708 R2

(156) 2002 10 15

(186) 2032 10 15

(732) Mitsubishi Jidosha Kogyo Kabushiki

Kaisha
1-21, Shibaura 3-chome, Minato-ku, Tokyo
108-8410, Japan

(111) M 2012 23105 R1

(156) 2012 11 29

(186) 2032 11 29

(732) LTD "Clean House"

Temka, X qu., Shopping Center, 0178, Tbilisi,
Georgia

(111) M 2002 14809 R2

(156) 2002 11 28

(186) 2032 11 28

(732) Johnson & Johnson

One Johnson & Johnson Plaza, New
Brunswick, New Jersey 08933, USA

(111) M 2013 23323 R1

(156) 2013 02 12

(186) 2033 02 12

(732) Swedish orphan Biovitrum AB (publ)

SE-112 76 Stockholm, Sweden

(111) M 2002 14836 R2

(156) 2002 11 28

(186) 2032 11 28

(732) Funai Electric Company Limited

7-1, 7-chome, Nakagaito, Daito, Osaka, Japan

(111) M 2013 23609 R1

(156) 2013 04 26

(186) 2033 04 26

(732) LTD "Fina"

Merab Kostava Str., Lane II 2, Tbilisi,
Georgia

(111) M 2003 14935 R2

(156) 2003 01 30

(186) 2033 01 30

(732) Sharp Kabushiki Kaisha also trading as Sharp
Corporation

22-22, Nagaike-Cho, Abeno-ku, Osaka
545-8522, Japan

(111) M 2012 23052 R1

(156) 2012 11 02

(186) 2032 11 02

(732) Abdi İbrahim İlaç Sanayi ve Ticaret Anonim
Şirketi

Reşitpaşa Mahallesi Eski Büyükdere Caddesi
No: 4, 34467 Maslak-Sarıyer-İstanbul, Türkiye

(111) M 2011 21873 R1

(156) 2011 10 17

(186) 2031 10 17

(732) LTD "Winerry Khareba"

(111) M 2012 23053 R1

(156) 2012 11 02

(186) 2032 11 02

(732) Abdi İbrahim İlaç Sanayi ve Ticaret Anonim
Şirketi

Reşitpaşa Mahallesi Eski Büyükdere Caddesi
No: 4, 34467 Maslak-Sarıyer-İstanbul, Türkiye

(111) M 2013 23332 R1 (156) 2013 02 12 (186) 2033 02 12 (732) Merck Sharp & Dohme Corp. One Merck Drive, Whitehouse Station, New Jersey 08889, USA	Sparc, Tandalja, Vadodara - 390 020, Gujarat, India
(111) M 2012 23124 R1 (156) 2012 11 29 (186) 2032 11 29 (732) The Procter & Gamble Company One Procter & Gamble Plaza, Cincinnati, Ohio 45202, USA	(111) M 2013 23395 R1 (156) 2013 02 27 (186) 2033 02 27 (732) Sun Pharmaceuticals Industries Limited Sparc, Tandalja, Vadodara - 390 020, Gujarat, India
(111) M 2012 23060 R1 (156) 2012 11 02 (186) 2032 11 02 (732) Orion Corporation Orionintie 1, 02200 Espoo, Finland	(111) M 2013 23396 R1 (156) 2013 02 27 (186) 2033 02 27 (732) Sun Pharmaceuticals Industries Limited Sparc, Tandalja, Vadodara - 390 020, Gujarat, India
(111) M 2013 23346 R1 (156) 2013 02 12 (186) 2033 02 12 (732) Sun Pharmaceuticals Industries Limited Sparc, Tandalja, Vadodara - 390 020, Gujarat, India	(111) M 2013 23400 R1 (156) 2013 02 27 (186) 2033 02 27 (732) Sun Pharmaceuticals Industries Limited Sparc, Tandalja, Vadodara - 390 020, Gujarat, India
(111) M 2013 23347 R1 (156) 2013 02 12 (186) 2033 02 12 (732) Sun Pharmaceuticals Industries Limited Sparc, Tandalja, Vadodara - 390 020, Gujarat, India	(111) M 2013 23401 R1 (156) 2013 02 27 (186) 2033 02 27 (732) Sun Pharmaceuticals Industries Limited Sparc, Tandalja, Vadodara - 390 020, Gujarat, India
(111) M 2013 23348 R1 (156) 2013 02 12 (186) 2033 02 12 (732) Sun Pharmaceuticals Industries Limited Sparc, Tandalja, Vadodara - 390 020, Gujarat, India	(111) M 2013 23737 R1 (156) 2013 06 07 (186) 2033 06 07 (732) Sun Pharmaceuticals Industries Limited Sparc, Tandalja, Vadodara - 390 020, Gujarat, India
(111) M 2013 23349 R1 (156) 2013 02 12 (186) 2033 02 12 (732) Sun Pharmaceuticals Industries Limited Sparc, Tandalja, Vadodara - 390 020, Gujarat, India	(111) M 2013 23740 R1 (156) 2013 06 07 (186) 2033 06 07 (732) JSC "Silknet" Tsinamdzhvishvili Str. 95, 0112, Tbilisi, Georgia
(111) M 2013 23350 R1 (156) 2013 02 12 (186) 2033 02 12 (732) Sun Pharmaceuticals Industries Limited	(111) M 2013 23629 R1 (156) 2013 04 26 (186) 2033 04 26 (732) Toyota Jidosha Kabushiki Kaisha (also trading as Toyota Motor Corporation) 1, Toyota-Cho, Toyota-Shi, Aichi-Ken, Japan

(111) M 2013 23532 R1
(156) 2013 03 27
(186) 2033 03 27
(732) Philip Morris Brands SàRL.
Quai Jeanrenaud 3, 2000 Neuchâtel,
Switzerland

(111) M 2013 23969 R1
(156) 2013 09 02
(186) 2033 09 02
(732) JSC "Chateau Mukhrani"
Vill. Mukhrani, 3309, Mtskheta,
Georgia

(111) M 2012 22855 R1
(156) 2012 08 03
(186) 2032 08 03
(732) LTD "Winerry Khareba"
David Aghmashenebeli Alley 6th km, 0131,
Tbilisi, Georgia

(111) M 2012 23085 R1
(156) 2012 11 19
(186) 2032 11 19
(732) Revaz Botchorishvili
Rcheulishvili Str., bld. 4, ap. 12, 0179,
Tbilisi, Georgia

(111) M 2013 23660 R1
(156) 2013 05 15
(186) 2033 05 15
(732) Gallaher Limited
Members Hill, Brooklands Road, Weybridge,
Surrey KT13 0QU, United Kingdom

(111) M 2013 23776 R1
(156) 2013 06 17
(186) 2033 06 17
(732) Gallaher Limited
Members Hill, Brooklands Road, Weybridge,
KT13 0QU Surrey, United Kingdom

COMPLETE TRANSFER OF RIGHTS

(111) M 2020 33376 R
(732) LTD "Gvirila Retail"
Permtserta Str., Lane 19, Vake District,
Tbilisi, Georgia
(770) Nikoloz Paiashvili
Varketili 3, IIIa mcr., bld. 338, ap. 173, 0163,
Tbilisi, Georgia
(580) 2022 10 26

(111) M 2022 35737 R
(732) LTD "Gvirila Retail"
Permtserta Str., Lane 19, Vake District,
Tbilisi, Georgia
(770) Nikoloz Paiashvili
Varketili 3, IIIa mcr., bld. 338, ap. 173, 0163,
Tbilisi, Georgia
(580) 2022 10 26

(111) M 2002 14501 R
(732) JSC "Silknet"
Tsinamdzhvrishvili Str. 95, 0112, Tbilisi,
Georgia
(770) LTD Geocell"
Right bank of the river Mtkvari, Gotua
Str. 3, 0160, Tbilisi Georgia Georgia
(580) 2022 09 30

CHANGES OF NAMES AND/OR ADDRESSES OF TRADEMARKS

-
- (111) M 1998 9225 R
(732) WD-40 Manufacturing Company
9715 Businesspark Avenue, San Diego,
California, 92131, USA
(770) WD-40 Manufacturing Company
1061 Cudahy Place, San Diego, California
92110, USA
(580) 2022 10 25
-
- (111) M 1998 9226 R
(732) WD-40 Manufacturing Company
9715 Businesspark Avenue, San Diego,
California, 92131, USA
(770) WD-40 Manufacturing Company
1061 Cudahy Place, San Diego, California
92110, USA
(580) 2022 10 25
-
- (111) M 2003 14922 R
(732) G.G. Properties, LTD
Thistle House, 4 Burnaby Street, Hamilton,
HM 11, United Kingdom
(770) G.G. Properties, LTD
Dorchester House, 7 Church Street, Hamilton,
Bermuda HM 11, United Kingdom
(580) 2022 11 03
-
- (111) M 2008 18325 R
(732) Dotchirne Pidpriemstvo "Konditerska
Korporatzia "Roshen"
1 Nauky Avenue, Building 1, Kyiv 03039,
Ukraine
(770) Dotchirne Pidpriemstvo "Konditerska
Korporatzia "Roshen"
Vul. Elektrikiv, 26/9, Kyiv, 04176, Ukraine
(580) 2022 10 25
-
- (111) M 2012 22946 R
(732) David Asatiani
Mosashvili Str. 6, 0162, Tbilisi, Georgia
(770) David Asatiani
Zhiuli Shartava Str. 35, bld. 1, ap. 40, 0160,
Tbilisi, Georgia, Georgia
(580) 2022 10 24
-
- (111) M 2013 23260 R
(732) Dotchirne pidpriemstvo Konditerska
Korporatzia "Roshen"
1 Nauky Avenue, Building 1, Kyiv 03039,
Ukraine
(770) Dotchirne Pidpriemstvo "Konditerska
Korporatzia "Roshen"
Vul. Elektrikiv, 26/9, Kyiv, 04176, Ukraine
(580) 2022 10 26
-
- (111) M 2016 27672 R
(732) WD-40 Manufacturing Company
9715 Businesspark Avenue, San Diego,
California, 92131, USA
(770) WD-40 Manufacturing Company
1061 Cudahy Place, San Diego,
California 92110, USA
(580) 2022 10 25
-
- (111) M 2016 27673 R
(732) WD-40 Manufacturing Company
9715 Businesspark Avenue, San Diego,
California, 92131, USA
(770) WD-40 Manufacturing Company
1061 Cudahy Place, San Diego, California
92110, USA
(580) 2022 10 25
-
- (111) M 2018 29776 R
(732)) E. Grycan, M. Grycan Spółka Jawna
Ul. Kwitnącej Wisni 2, 05-462 Majdan,
Poland
(770) Grem E. Grycan, M. Grycan Spółka Jawna
Ul. Kwitnącej Wisni 2, 05-462 Majdan,
Poland
(580) 2022 10 18
-

CANCELLATION OF TRADEMARKS REGISTRATION

(111) M 2012 22588 R
(151) 2012 05 16
(732) LTD "Berta"
Vakhtang Gorgasali Str. 115, 0114, Tbilisi,
Georgia
(141) 2022 11 24

(111) M 2012 22590 R
(151) 2012 05 16
(732) LTD "teni"
Davit Gamrekeli Str., bld. I, ap. 52, 0160,
Tbilisi, Georgia
(141) 2022 11 24

(111) M 2012 22600 R
(151) 2012 05 16
(732) Sanofi
54, rue La Boétie, 75008 Paris, France
(141) 2022 11 24

(111) M 2012 22601 R
(151) 2012 05 16
(732) Ninja Textiles FZT
P.O. BOX: 20063, Dubai, United Arab
Emirates
(141) 2022 11 24

(111) M 2012 22602 R
(151) 2012 05 16
(732) Diageo Brands B.V.
Molenwerf 10-12, 1014 BG Amsterdam,
Netherlands
(141) 2022 11 24

(111) M 2012 22603 R
(151) 2012 05 16
(732) LTD "Liberty Security"
Ilia Chavchavadze Ave. 74, 0162, Tbilisi,
Georgia
(141) 2022 11 24

(111) M 2012 22605 R
(151) 2012 05 16
(732) BlackBerry Limited
2200 University Avenue East, Waterloo,
Ontario N2K 0A7, Canada
(141) 2022 11 24

(111) M 2012 22606 R
(151) 2012 05 16
(732) BlackBerry Limited
2200 University Avenue East, Waterloo,
Ontario N2K 0A7, Canada
(141) 2022 11 24

(111) M 2012 22610 R
(151) 2012 05 16
(732) JSC "Hotel and Restaurant Management Group
- M/Group"
Marshal Gelovani Ave. 2, 5th floor, 0159,
Tbilisi, Georgia
(141) 2022 11 24

(111) M 2012 22612 R
(151) 2012 05 16
(732) LTD "A-B-C Pharmacy"
Sanapiro Str. 10a, 0108, Tbilisi, Georgia
(141) 2022 11 24

(111) M 2012 22621 R
(151) 2012 05 16
(732) LTD "Golbi"
Kavtaradze Str. 27, 0186, Tbilisi, Georgia
(141) 2022 11 24

(111) M 2012 22622 R
(151) 2012 05 16
(732) LTD Miso "Capital Credit"
David Aghmashenebeli Ave. 111, bld. 5
0102, Tbilisi, Georgia
(141) 2022 11 24

(111) M 2012 22626 R
(151) 2012 05 16
(732) Ballet Theatre Foundation Inc.
890 Broadway, New York, NY 10003, USA
(141) 2022 11 24

(111) M 2012 22627 R
(151) 2012 05 16
(732) Ballet Theatre Foundation Inc.
890 Broadway, New York, NY 10003, USA
(141) 2022 11 24

(111) M 2012 22628 R
(151) 2012 05 16
(732) Besiki Beridze
Razmadze Str.. 43, 0179, Tbilisi, Georgia
(141) 2022 11 24

(111) M 2012 22633 R
(151) 2012 05 16
(732) LTD "Ecogaz"
Ambrolauri Str. 166, 8/2, 0160, Tbilisi,
Georgia
(141) 2022 11 24

(111) M 2012 22639 R
(151) 2012 05 16
(732) Holland & Barrett Retail Limited
Samuel Ryder House, Barling Way, Eliot Park,
Nuneaton, Warwickshire, CV10 7 RH,
United Kingdom
(141) 2022 11 24

(111) M 2012 22640 R
(151) 2012 05 16
(732) Holland & Barrett Retail Limited
Samuel Ryder House, Barling Way, Eliot Park,
Nuneaton, Warwickshire, CV10 7 RH,
United Kingdom
(141) 2022 11 24

(111) M 2012 22646 R
(151) 2012 05 16
(732) The Priestmen Electronics Corporation
107 Connie Crescent, Concord,
Ontario L4K 1L3, Canada
(141) 2022 11 24

(111) M 2012 22647 R
(151) 2012 05 16
(732) British American Tobacco (Brands) Inc.
(a Delaware corporation)
251 Little Falls Drive, Suite 100, Wilmington,
DE 19808-1674, USA
(141) 2022 11 24

(111) M 2012 22648 R
(151) 2012 05 16
(732) The Gillette Company LLC
One Gillette Park, Boston, Massachusetts
02127, USA
(141) 2022 11 24

(111) M 2012 22585 R
(151) 2012 05 15
(732) LTD "Metskhre Arkhi"
300 Aragveli Str. 1, 0144, Tbilisi, Georgia
(141) 2022 11 24

(111) M 2012 22586 R
(151) 2012 05 16
(732) Ilgar Dushdurov
Vill. Sadakhlo, 3000, Marneuli, Georgia
(141) 2022 11 24

(111) M 2012 22649 R
(151) 2012 05 18
(732) Pao Zaporozjski Abrazivni Kombinat
Ul. dimitrova 44, saporozhie, 69014, Ukraine
(141) 2022 11 28

(111) M 2012 22584 R
(151) 2012 05 15
(732) Limited Liability Company "Barsis"
Arshakuniansi Str. 57/2, Yerevan, Armenia
(141) 2022 11 24

CLASSIFICATION INDEXES

INVENTIONS

CONCORDANCE TABLE OF INTERNATIONAL CLASSIFICATION INDEX AND PUBLICATION NUMBERS

INTERNATIONAL CLASSIFICATION INDEXES (51)	NUMBER OF PUBLISHED APPLICATION (10)
A 01 N 43/80; C 07 D 261/04	AP 2022 15389 A
A 61 K 9/00; A 61 K 31/4196; A 61 K 47/34	AP 2022 15469 A
A 61 K 9/16; A 61 K 39/00	AP 2022 15611 A
A 61 K 31/00; A 61 K 45/06; A 61 P 35/00; C 07 D 403/12; C 07 D 233/56	AP 2022 15448 A
A 61 K 38/00; C 07 K 7/06; C 12 N 9/64	AP 2022 15540 A

CONCORDANCE TABLE OF PUBLICATION NUMBERS AND INTERNATIONAL CLASSIFICATION INDEX

NUMBER OF PUBLISHED APPLICATION (10)	INTERNATIONAL CLASSIFICATION INDEXES (51)
AP 2022 15389 A	A 01 N 43/80; C 07 D 261/04
AP 2022 15448 A	A 61 K 31/00; A 61 K 45/06; A 61 P 35/00; C 07 D 403/12; C 07 D 233/56
AP 2022 15469 A	A 61 K 9/00; A 61 K 31/4196; A 61 K 47/34
AP 2022 15540 A	A 61 K 38/00; C 07 K 7/06; C 12 N 9/64
AP 2022 15611 A	A 61 K 9/16; A 61 K 39/00

CONCORDANCE TABLE OF INTERNATIONAL CLASSIFICATION INDEX, PATENT NUMBERS AND PUBLICATION NUMBERS

INTERNATIONAL CLASSIFICATION INDEX (51)	NUMBER OF PATENT (11)	NUMBER OF PUBLISHED APPLICATION (10)
A 61 K 31/473; A 61 P 25/00; C 07 D 405/12; C 07 D 405/14	P 2022 7446 B	AP 2022 15342 A
A 61 K 38/17; A 61 K 39/395; C 07 K 14/705; C 07 K 14/47	P 2022 7447 B	AP 2022 15294 A
A 61 K 47/02; A 61 K 9/16; A 61 K 33/26; A 61 K 47/42; A 61 K 9/06	P 2022 7445 B	AP 2022 14903 A
B 29 B 17/04; B 29 B 17/00; C 08 J 3/00; C 08 J 3/12; C 08 L 95/00; E 01 C 7/26	P 2022 7449 B	AP 2022 15770 A
B 66 D 5/26	P 2022 7444 B	AP 2022 15650 A
H 01 L 29/66	P 2022 7448 B	AP 2022 15678 A
H 02 K 19/00	P 2022 7450 B	AP 2022 15722 A

**CONCORDANCE TABLE OF PATENT NUMBERS,
PUBLICATION NUMBERS AND INTERNATIONAL CLASSIFICATION INDEX**

NUMBER OF PATENT (11)	NUMBER OF PUBLISHED APPLICATION (10)	INTERNATIONAL CLASSIFICATION INDEX (51)
P 2022 7444 B	AP 2022 15650 A	B 66 D 5/26
P 2022 7445 B	AP 2022 14903 A	A 61 K 47/02; A 61 K 9/16; A 61 K 33/26; A 61 K 47/42; A 61 K 9/06
P 2022 7446 B	AP 2022 15342 A	A 61 K 31/473; A 61 P 25/00; C 07 D 405/12; C 07 D 405/14
P 2022 7447 B	AP 2022 15294 A	A 61 K 38/17; A 61 K 39/395; C 07 K 14/705; C 07 K 14/47
P 2022 7448 B	AP 2022 15678 A	H 01 L 29/66
P 2022 7449 B	AP 2022 15770 A	B 29 B 17/04; B 29 B 17/00; C 08 J 3/00; C 08 J 3/12; C 08 L 95/00; E 01 C 7/26
P 2022 7450 B	AP 2022 15722 A	H 02 K 19/00

**CONCORDANCE TABLE OF APPLICATION NUMBERS,
PUBLICATION NUMBERS AND PATENTS**

NUMBER OF APPLICATION (21)	NUMBER OF PUBLISHED APPLICATION (10)	NUMBER OF PATENT (11)
AP 2017 14903	AP 2022 14903 A	P 2022 7445 B
AP 2016 15294	AP 2022 15294 A	P 2022 7447 B
AP 2018 15342	AP 2022 15342 A	P 2022 7446 B
AP 2021 15650	AP 2022 15650 A	P 2022 7444 B
AP 2021 15678	AP 2022 15678 A	P 2022 7448 B
AP 2021 15722	AP 2022 15722 A	P 2022 7450 B
AP 2020 15770	AP 2022 15770 A	P 2022 7449 B

UTILITY MODELS

**CONCORDANCE TABLE OF INTERNATIONAL CLASSIFICATION INDEX,
PATENT NUMBERS AND PUBLICATION NUMBERS**

INTERNATIONAL CLASSIFICATION INDEX (51)	NUMBER OF PATENT (11)	NUMBER OF PUBLISHED APPLICATION (10)
A 61 M 1/10	U 2022 2139 Y	AU 2022 15543 U
E 02 D 5/56	U 2022 2140 Y	AU 2022 15677 U
F 24 H 9/00	U 2022 2138 Y	AU 2022 15789 U

CONCORDANCE TABLE OF PATENT NUMBERS,
PUBLICATION NUMBERS AND INTERNATIONAL CLASSIFICATION INDEX

NUMBER OF PATENT (11)	NUMBER OF PUBLISHED APPLICATION (10)	INTERNATIONAL CLASSIFICATION INDEX (51)
U 2022 2138 Y	AU 2022 15789 U	F 24 H 9/00
U 2022 2139 Y	AU 2022 15543 U	A 61 M 1/10
U 2022 2140 Y	AU 2022 15677 U	E 02 D 5/56

CONCORDANCE TABLE OF APPLICATION NUMBERS,
PUBLICATION NUMBERS AND PATENTS

NUMBER OF APPLICATION (21)	NUMBER OF PUBLISHED APPLICATION (10)	NUMBER OF PATENT (11)
AU 2021 15543	AU 2022 15543 U	U 2022 2139 Y
AU 2020 15677	AU 2022 15677 U	U 2022 2140 Y
AU 2021 15789	AU 2022 15789 U	U 2022 2138 Y

TRADEMARKS

CONCORDANCE TABLE OF REGISTRATION NUMBERS, APPLICATION NUMBERS, PUBLICATION NUMBERS AND BULLETIN NUMBERS

NUMBER OF REGISTRATION (111)	NUMBER OF APPLICATIONS (210)	NUMBER OF PUBLISHED APPLICATIONS (260)	NUMBER OF BULLETIN
1	2	3	4
M 2022 36097 R	AM 115749	AM 2022 115749 A	13(592)2022
M 2022 36098 R	AM 115750	AM 2022 115750 A	13(592)2022
M 2022 36099 R	AM 115756	AM 2022 115756 A	13(592)2022
M 2022 36100 R	AM 115969	AM 2022 115969 A	13(592)2022
M 2022 36101 R	AM 115970	AM 2022 115970 A	13(592)2022
M 2022 36102 R	AM 115900	AM 2022 115900 A	13(592)2022
M 2022 36103 R	AM 116313	AM 2022 116313 A	13(592)2022
M 2022 36136 R	AM 108680	AM 2022 108680 A	12(591)2022
M 2022 36137 R	AM 111163	AM 2022 111163 A	9(588)2022
M 2022 36138 R	AM 113417	AM 2022 113417 A	8(587)2022
M 2022 36139 R	AM 113990	AM 2022 113990 A	8(587)2022
M 2022 36140 R	AM 114125	AM 2022 114125 A	3(582)2022
M 2022 36141 R	AM 114532	AM 2022 114532 A	8(587)2022
M 2022 36142 R	AM 114686	AM 2022 114686 A	8(587)2022
M 2022 36143 R	AM 115105	AM 2022 115105 A	14(593)2022
M 2022 36144 R	AM 115110	AM 2022 115110 A	9(588)2022
M 2022 36145 R	AM 115117	AM 2022 115117 A	9(588)2022
M 2022 36146 R	AM 115539	AM 2022 115539 A	11(590)2022
M 2022 36147 R	AM 115602	AM 2022 115602 A	13(592)2022
M 2022 36148 R	AM 115677	AM 2022 115677 A	12(591)2022
M 2022 36149 R	AM 115679	AM 2022 115679 A	12(591)2022
M 2022 36150 R	AM 115683	AM 2022 115683 A	12(591)2022
M 2022 36151 R	AM 115745	AM 2022 115745 A	13(592)2022
M 2022 36152 R	AM 115757	AM 2022 115757 A	13(592)2022
M 2022 36153 R	AM 115758	AM 2022 115758 A	14(593)2022
M 2022 36154 R	AM 115762	AM 2022 115762 A	14(593)2022
M 2022 36155 R	AM 115857	AM 2022 115857 A	14(593)2022
M 2022 36156 R	AM 115863	AM 2022 115863 A	14(593)2022
M 2022 36157 R	AM 115891	AM 2022 115891 A	13(592)2022
M 2022 36158 R	AM 115892	AM 2022 115892 A	13(592)2022
M 2022 36159 R	AM 115893	AM 2022 115893 A	13(592)2022
M 2022 36160 R	AM 115894	AM 2022 115894 A	13(592)2022
M 2022 36161 R	AM 115895	AM 2022 115895 A	13(592)2022
M 2022 36162 R	AM 115973	AM 2022 115973 A	14(593)2022
M 2022 36163 R	AM 115975	AM 2022 115975 A	14(593)2022
M 2022 36164 R	AM 115989	AM 2022 115989 A	14(593)2022
M 2022 36165 R	AM 115990	AM 2022 115990 A	14(593)2022
M 2022 36166 R	AM 114694	AM 2022 114694 A	9(588)2022
M 2022 36168 R	AM 114817	AM 2022 114817 A	9(588)2022
M 2022 36169 R	AM 114914	AM 2022 114914 A	9(588)2022
M 2022 36170 R	AM 114983	AM 2022 114983 A	10(589)2022
M 2022 36171 R	AM 115003	AM 2022 115003 A	11(590)2022
M 2022 36172 R	AM 115013	AM 2022 115013 A	9(588)2022
M 2022 36173 R	AM 115100	AM 2022 115100 A	10(589)2022
M 2022 36175 R	AM 115213	AM 2022 115213 A	10(589)2022
M 2022 36176 R	AM 115433	AM 2022 115433 A	12(591)2022

1	2	3	4
M 2022 36177 R	AM 115585	AM 2022 115585 A	12(591)2022
M 2022 36178 R	AM 115586	AM 2022 115586 A	12(591)2022
M 2022 36179 R	AM 115587	AM 2022 115587 A	12(591)2022
M 2022 36180 R	AM 115688	AM 2022 115688 A	14(593)2022
M 2022 36181 R	AM 115896	AM 2022 115896 A	14(593)2022
M 2022 36182 R	AM 115902	AM 2022 115902 A	13(592)2022
M 2022 36183 R	AM 115979	AM 2022 115979 A	14(593)2022
M 2022 36184 R	AM 115994	AM 2022 115994 A	14(593)2022
M 2022 36185 R	AM 116000	AM 2022 116000 A	14(593)2022
M 2022 36186 R	AM 116074	AM 2022 116074 A	14(593)2022
M 2022 36187 R	AM 116075	AM 2022 116075 A	14(593)2022
M 2022 36188 R	AM 116170	AM 2022 116170 A	14(593)2022
M 2022 36190 R	AM 116302	AM 2022 116302 A	14(593)2022
M 2022 36226 R	AM 115976	AM 2022 115976 A	15(594)2022
M 2022 36254 R	AM 120249	–	23(602)2022
M 2022 36255 R	AM 120171	–	23(602)2022

**CONCORDANCE TABLE OF PUBLICATION NUMBERS
AND APPLICATION NUMBERS**

NUMBER OF PUBLISHED APPLICATION (260)	NUMBER OF APPLICATION (210)
AM 2022 117618 A	AM 117618
AM 2022 117619 A	AM 117619
AM 2022 117736 A	AM 117736
AM 2022 117748 A	AM 117748
AM 2022 117801 A	AM 117801
AM 2022 117802 A	AM 117802
AM 2022 117844 A	AM 117844
AM 2022 117905 A	AM 117905
AM 2022 117912 A	AM 117912
AM 2022 117928 A	AM 117928
AM 2022 117977 A	AM 117977

CONCORDANCE TABLE OF INDEX OF GOODS AND/OR SERVICES
AND APPLICATION NUMBERS

INDEX OF GOODS AND/OR SERVICES (511)	NUMBER OF PUBLISHED APPLICATIONS (260)	1	2
1	2	16	AM 2022 117802 A
1	AM 2022 117801 A	17	AM 2022 117801 A
1	AM 2022 117802 A	17	AM 2022 117802 A
2	AM 2022 117801 A	22	AM 2022 117801 A
2	AM 2022 117802 A	22	AM 2022 117802 A
5	AM 2022 117748 A	31	AM 2022 117748 A
5	AM 2022 117802 A	31	AM 2022 117802 A
5	AM 2022 117844 A	31	AM 2022 117912 A
6	AM 2022 117801 A	32	AM 2022 117619 A
6	AM 2022 117802 A	33	AM 2022 117618 A
7	AM 2022 117748 A	33	AM 2022 117619 A
7	AM 2022 117802 A	35	AM 2022 117801 A
8	AM 2022 117748 A	35	AM 2022 117802 A
8	AM 2022 117802 A	35	AM 2022 117977 A
9	AM 2022 117928 A	38	AM 2022 117977 A
9	AM 2022 117977 A	40	AM 2022 117928 A
11	AM 2022 117801 A	41	AM 2022 117736 A
11	AM 2022 117802 A	42	AM 2022 117928 A
16	AM 2022 117801 A	42	AM 2022 117977 A
		43	AM 2022 117905 A
		44	AM 2022 117748 A
		44	AM 2022 117802 A

CONCORDANCE TABLE OF INDEX OF GOODS AND/OR SERVICES
AND NUMBERS OF TRADEMARKS REGISTERED ACCORDING
TO THE ACCELERATED PROCEDURE

INDEX OF GOODS AND/OR SERVICES (511)	NUMBERS OF REGISTERED ACCORDING TO THE ACCELERATED PROCEDURE (111)
13	M 2022 36255 R
35	M 2022 36254 R

OFFICIAL BULLETIN OF THE INDUSTRIAL PROPERTY

INVENTIONS

UTILITY MODELS

DESIGNS

TRADEMARKS

APPELLATIONS OF ORIGIN OF GOODS

23(602)

EDITOR-IN-CHIEF: N. Bebrishvili

EDITOR-TRANSLATOR: E. Gabunia

PROOFREADER: A. Shixashvili

COMPUTER LAYOUT: M. Ordenidze
K. Svanidze

ISSN 2720-8486

info@sakpatenti.gov.ge
www.sakpatenti.gov.ge