



**NATIONAL INTELLECTUAL PROPERTY CENTER OF GEORGIA
SAKPATENTI**

**OFFICIAL BULLETIN
OF THE INDUSTRIAL PROPERTY**

24(484)

**2017
TBILISI**

INID CODES FOR IDENTIFICATION OF BIBLIOGRAPHIC DATA

INVENTIONS, UTILITY MODELS

- (10) Number of publication for application, which has been examined
- (11) Number of patent and kind of document
- (21) Serial number of application
- (22) Date of filing of the application
- (23) Date of exhibition or the date of the earlier filing and the number of application, if any
- (24) Date from which patent may have effect
- (31) Number of priority application
- (32) Date of filing of priority application
- (33) Code of the country or regional organization allotting priority application number
- (44) Date of publication of application not granted, but examined and number of bulletin
- (45) Date of publication of registered document
- (51) International Patent Classification Index
- (54) Title of the invention
- (57) Abstract
- (60) Number of examined patent document granted by foreign patent office, date from which patent has effect and country code
- (62) Number of the earlier application and in case of divided application, date of filing an application
- (71) Name, surname and address of applicant (country code)
- (72) Name, surname of inventor (country code)
- (73) Name, surname and address of patent owner (country code)
- (74) Name, surname of representative or patent attorney
- (85) Date of commencement of the national phase of International Application
- (86) Number and date of filing of international application
- (87) Number and date of publication of international application

DESIGNS

- (10) Number of publication for application
- (11) Number of patent and kind of document or number of registration
- (15) Date of registration/Date of patent renewal
- (18) Expected expiration date of patent or registration
- (21) Serial number of application
- (22) Date of filing of the application
- (23) Date of exhibition or the date of the earlier filing and the number of application, if any
- (24) Date from which patent may have effect
- (28) Number of designs included in the application
- (30) Data relating to priority (number of application, date of filing of application, two-letter code identifying the authority with whom the priority application was made)
- (31) Number of priority application
- (32) Date of filing of priority application
- (33) Code of the country or regional organization allotting priority application number
- (34) Two-letter code according to WIPO St.3 identifying the authority with which the priority application was made
- (44) Date of publication of design and number of bulletin (the first publication)
- (45) Date of publication of design registered by WIPO and number of bulletin
- (51) International Classification for designs (class and subclass of the Locarno Classification)
- (54) Title of the invention
- (55) Reproduction of the design
- (57) Description of characteristic features of the design including indication of colors
- (58) Date of recording of any kind of amendment in the Register
- (62) Number of the earlier application, registration and document number and if available the date of filing an application in case of divided application
- (71) Name, surname and address of applicant (country code)
- (72) Name, surname of creator (country code)
- (73) Name, surname and address of patent owner (country code)
- (74) Name, surname of representative or patent attorney
- (81) Contracting states concerned
 - II designated contracting states according to the 1960 Act
 - III designated contracting states according to the 1999 Act
- (85) Owner's permanent address
- (86) Owner's nationality
- (87) Owner's residence
- (88) State in which the owner has a real and effective industrial or commercial establishment

TRADEMARKS

- (111) – Number of registration
- (151) – Date of registration
- (156) – Date of the renewal
- (181) – Expected expiration date of registration
- (186) – Renewal expiration date of registration
- (141) – Date of cancel of duration of the mark
- (210) – Serial number of application
- (220) – Date of filing of the application
- (230) – Date concerning exhibition
- (260) – Number of application, for which favorable decision of examination about registration has been taken (publication number)
- (310) – Number of the first application
- (320) – Date of filing of the first application
- (330) – Code, identifying national or regional Office where the first application was made
- (511) – International Classification of Goods and Services for the purposes of registration of trade marks and/or list of goods and/or services classified according thereto
- (531) – Description of figurative elements of Trade Marks according to the International Classification of the Figurative Elements of Marks
- (540) – Reproduction of Trade Mark
- (550) – Nature and kind of Trade Mark
- (580) – Date of recording of any kind changes in respect of applications or registrations
- (591) – Information concerning colors claimed
- (731) – Name and address of the applicant
- (732) – Name and address of the holder of the registration
- (740) – Name and address of the representative
- (750) – Address for correspondence
- (770) – Name and address of the previous applicant or holder in case of change in ownership
- (771) – Previous name and address of the applicant or holder in case of change in ownership
- (791) – Name and address of the licensee
- (793) – Indication of conditions and/or restrictions under the license (Type of license, number of license agreement, data of license, data of validity of license)
- (800) – Certain data relating to the international registration of Trade Marks under the Protocol Relating to Madrid Agreement (International registration number)

CODES FOR PUBLICATION IN BULLETIN

- (21) AP 0000 000000 – serial number of application for invention
- (10) AP 0000 0000 A – number of published application for invention (first publication)
- (11) P 0000 0000 B – number of patent for invention (second publication)
- (21) API 0000 000000 – number of application for imported patent
- (11) PI 0000 0000 A – number of imported patent (first publication)
- (21) AU 0000 000000 – serial number of application for utility model
- (10) AU 0000 000 U – number of published application for utility model (first publication)
- (11) U 0000 000 Y – number of patent for utility model (second publication)
- (21) AD 0000 000000 – serial number of application for design
- (10) AD 0000 000 S – number of published application for design (first publication)
- (11) D 0000 000 S – number of patent for design (second publication)

INTERNATIONAL PATENT CLASSIFICATION FOR INVENTIONS AND UTILITY MODELS

- SECTION A – HUMAN NECESSITIES
- SECTION B – PERFORMING OPERATIONS; TRANSPORTING
- SECTION C – CHEMISTRY; METALLURGY
- SECTION D – TEXTILES; PAPER
- SECTION E – FIXED CONSTRUCTIONS
- SECTION F – MECHANICAL ENGINEERING; LIGHTING; HEATING; WEAPONS; BLASTING
- SECTION G – PHYSICS
- SECTION H – ELECTRICITY

-
- M – Trade Mark
 - (210) AM 0000 000000 – Serial number of application;
 - (260) AAM 0000 00000 A – Publication number of application;
 - (111) M 0000 00000 R – Number of registration;
 - (111) MMM0000 00000 Rn – Number of renewals, in which n=1,2,3;
 - (111) M 0000 00000 R(P) – Number of registration under partial assignment of rights
-

LIST OF CODES, IN ALPHABETIC SEQUENCE, AND THE CORRESPONDING (SHORT) NAMES OF STATES, OTHER ENTITIES AND INTERGOVERNMENTAL ORGANIZATIONS
(WIPO STANDARD ST.3)

AD	Andorra				
AE	United Arab Emirates				
AF	Afghanistan				
AG	Antigua and Barbuda				
AI	Anguilla				
AL	Albania				
AM	Armenia				
AN	Netherlands Antilles				
AO	Angola				
AP	African Regional Intellectual Property Organization (ARIPO)				
AR	Argentina				
AT	Austria				
AU	Australia				
AW	Aruba				
AZ	Azerbaijan				
BA	Bosnia and Herzegovina				
BB	Barbados				
BD	Bangladesh				
BE	Belgium				
BF	Burkina Faso				
BG	Bulgaria				
BH	Bahrain				
BI	Burundi				
BJ	Benin				
BM	Bermuda				
BN	Brunei Darussalam				
BO	Bolivia				
BR	Brazil				
BS	Bahamas				
BT	Bhutan				
BV	Bouvet Island				
BW	Botswana				
BX	Benelux Office for Intellectual Property (BOIP)				
BY	Belarus				
BZ	Belize				
CA	Canada				
CD	Democratic Republic of the Congo				
CF	Central African Republic				
CG	Congo				
CH	Switzerland				
CI	Cote d'Ivoire				
CK	Cook Islands				
CL	Chile				
CM	Cameroon				
CN	China				
CO	Colombia				
CR	Costa Rica				
CU	Cuba				
CV	Cape Verde				
CY	Cyprus				
CZ	Czech Republic				
DE	Germany				
DJ	Djibouti				
DM	Dominica				
DO	Dominican Republic				
DZ	Algeria				
EA	Eurasian Patent Organization (EAPO)				
EC	Ecuador				
EE	Estonia				
EG	Egypt				
EH	Western Sahara				
EM	Office for Harmonization in the Internal Market (Trademarks and Designs)(OHIM)				
EP	European Patent Office (EPO)				
ER	Eritrea				
ES	Spain				
ET	Ethiopia				
FI	Finland				
FJ	Fiji				
FK	Falkland Islands (Malvinas)				
FO	Faroe Islands				
FR	France				
GA	Gabon				
GB	United Kingdom				
GC	Patent Office of the Cooperation Council for the Arab States of the Gulf (GCC)				
GD	Grenada				
GG	Guernsey				
GH	Ghana				
GI	Gibraltar				
GT	Guatemala				
GW	Guinea- Bissau				
GY	Guyana				
HK	The Hong Kong Special Administrative Region of the People's Republic of China				
HN	Honduras				
HR	Croatia				
HT	Haiti				
HU	Hungary				
IB	International Bureau of the World Intellectual Property Organization (WIPO)				
ID	Indonesia				
IE	Ireland				
IL	Israel				
IM	Isle of Man				
IN	India				
IQ	Iraq				
ID	Indonesia				
IE	Ireland				
IL	Israel				
IM	Isle of Man				
IN	India				
IQ	Iraq				
IR	Iran (Islamic Republic of)				
IS	Iceland				
IT	Italy				
JE	Jersey				
JM	Jamaica				
JO	Jordan				
JP	Japan				
KE	Kenya				
KG	Kyrgyzstan				
KH	Cambodia				
KI	Kiribati				
KM	Saint Kitts and Nevis				
KP	Democratic People's Republic of Korea				
KR	Republic of Korea				
KW	Kuwait				
KY	Cayman Islands				
KZ	Kazakhstan				
LA	Lao People's Democratic Republic				
LB	Lebanon				
LC	Saint Lucia				
LI	Liechtenstein				
LK	Sri Lanka				
LR	Liberia				
LS	Lesotho				
LT	Lithuania				
LU	Luxembourg				
LV	Latvia				
LY	Libyan Arab Jamahiriya				
MA	Morocco				
MC	Monaco				
MD	Republic of Moldova				
ME	Montenegro				
MG	Madagascar				
MK	The former Yugoslav Republic of Macedonia				
ML	Mali				
MM	Myanmar				
MN	Mongolia				
MO	Macao				
MP	Northern Mariana Islands				
MR	Mauritania				
MS	Montserrat				
MT	Malta				
MU	Mauritius				
MV	Maldives				
MW	Malawi				
MX	Mexico				
MY	Malaysia				
MZ	Mozambique				
NA	Namibia				
NE	Niger				
NG	Nigeria				
NI	Nicaragua				
NL	Netherlands				
NO	Norway				
NP	Nepal				
NR	Nauru				
NZ	New Zealand				
OA	African Intellectual Property Organization (OAPI)				
OM	Oman				
PA	Panama				
PE	Peru				
PG	Papua New Guinea				
PH	Philippines				
PK	Pakistan				
PL	Poland				
PT	Portugal				
PW	Palau				
PY	Paraguay				
QA	Qatar				
QZ	Community Plant Variety Office (European Community) (CPVO)				
RO	Romania				
RS	Serbia				
RU	Russian Federation				
RW	Rwanda				
SA	Saudi Arabia				
SB	Solomon Islands				
SC	Seychelles				
SD	Sudan				
SG	Singapore				
SH	Saint Helena				
SI	Slovenia				
SK	Slovakia				
SL	Sierra Leone				
SM	San Marino				
SN	Senegal				
SO	Somalia				
SR	Suriname				
ST	Sao Tome and Principe				
SV	El Salvador				
SY	Syrian Arab Republic				
SZ	Swaziland				
TC	Turks and Caicos Islands				
TD	Chad				
TG	Togo				
TH	Thailand				
TJ	Tajikistan				
TL	Timor-Leste				
TM	Turkmenistan				
TN	Tunisia				
TO	Tonga				
TR	Turkey				
SE	Sweden				
TT	Trinidad and Tobago				
TV	Tuvalu				
TW	Taiwan, Province of China				
TZ	United Republic of Tanzania				
UA	Ukraine				
UG	Uganda				
US	United States of America				
UY	Uruguay				
UZ	Uzbekistan				
VA	Holy See				
VC	Saint Vincent and the Grenadines				
VE	Venezuela				
VG	Virgin Islands (British)				
VN	Viet Nam				
VU	Vanuatu				
WO	World Intellectual Property Organization (WIPO)				
WS	Samoa				
XN	Nordic Patent Institute (NPI)				
YE	Yemen				
ZA	South Africa				
ZM	Zambia				
ZW	Zimbabwe				

**NATIONAL INTELLECTUAL PROPERTY CENTER OF GEORGIA
SAKPATENTI**

**OFFICIAL BULLETIN
OF THE INDUSTRIAL PROPERTY**

24(484)

INVENTIONS

UTILITY MODELS

DESIGNS

TRADEMARKS

APPELLATIONS OF ORIGIN OG GOODS

DATE OF PUBLICATION

2017 12 25

CONTENTS

PUBLISHED TITLES OF PROTECTION	3
INVENTIONS	
▪ APPLICATIONS APPROVED FOR GRANTING PATENT	4
▪ PATENTED INVENTIONS	8
UTILITY MODELS	
▪ APPLICATIONS APPROVED FOR GRANTING PATENTS	9
DESIGNS	
▪ APPLICATIONS APPROVED FOR REGISTRATION	10
▪ DESIGN REGISTERED ACCORDING TO THE ACCELERATED PROCEDURE	16
▪ DESIGNS, WHICH HAVE BEEN REGISTERED WITH THE INTERNATIONAL BUREAU CLAIMING PRIORITY ON THE TERRITORY OF GEORGIA	18
TRADEMARKS	
▪ APPLICATIONS FILED UNDER THE NATIONAL PROCEDURE APPROVED FOR REGISTRATION	51
▪ REGISTERED TRADEMARKS	57
▪ TRADEMARKS REGISTERED ACCORDING TO THE ACCELERATED PROCEDURE	63
▪ INTERNATIONAL TRADEMARKS FOR WHICH A DECISION ON GRANTING PROTECTION IS TAKEN	65
▪ INTERNATIONAL TRADEMARKS PROTECTED IN GEORGIA	91
APPELLATION OF ORIGIN OF GOODS	
▪ APPELLATION OF ORIGIN OF GOODS FILED IN GEORGIA FOR EXAMINATION UNDER LISBON AGREEMENT, ON THE BASIS OF THE INTERNATIONAL REGISTRATION	100
OFFICIAL NOTIFICATIONS	
INVENTIONS	
▪ RENEWAL OF PATENTS	101
UTILITY MODELS	
▪ RENEWAL OF PATENTS	101
TRADEMARKS	
▪ RENEWAL OF REGISTRATIONS	103
▪ COMPLETE TRANSFER OF RIGHTS	115
▪ CHANGES IN NAMES AND/OR ADDRESSES OF OWNERS	120
▪ INVALIDATION OF TRADEMARKS REGISTRATIONS	125
CLASSIFICATION INDEXES	
INVENTIONS	128
UTILITY MODELS	129
DESIGNS	130
TRADEMARKS	131

PUBLISHED TITLES OF PROTECTION

INVENTIONS

- **APPLICATIONS APPROVED FOR GRANTING PATENT:**
13779; 14469; 14148; 14198; 13818; 14225; 13845; 14164; 12214; 14333
- **PATENTED INVENTIONS:**
6797, 6798

UTILITY MODELS

- **APPLICATIONS APPROVED FOR GRANTING PATENT:**
14421; 14355

DESIGNS

- **APPLICATIONS APPROVED FOR REGISTRATION:**
976; 979
- **DESIGN REGISTERED ACCORDING TO THE ACCELERATED PROCEDURE:**
739
- **DESIGNS, WHICH HAVE BEEN REGISTERED WITH THE INTERNATIONAL BUREAU CLAIMING PRIORITY ON THE TERRITORY OF GEORGIA:**
95276; 95365; 95799; 97514; 95346; 95381; 95386; 95425; 97608; 97700

TRADEMARKS

- **APPLICATIONS FILED UNDER THE NATIONAL PROCEDURE APPROVED FOR REGISTRATION:**
86965*; 91090; 91230; 91678; 91730; 91783; 91846-91849; 91851; 91857, 91858; 91860, 91861; 91866; 91879; 91889; 91957; 91959, 92102, 92103; 92135; 92141; 92143; 92187; 92189; 92190; 92213; 92471; 92473; 92480; 92589
- **REGISTERED TRADEMARKS:**
29139-29202
- **TRADEMARKS REGISTERED ACCORDING TO THE ACCELERATED PROCEDURE:**
29134-29138; 29203-29205
- **INTERNATIONAL TRADEMARKS FOR WHICH A DECISION ON GRANTING PROTECTIONS IS TAKEN:**
87320*; 87517*, 87563*; 90436; 90705; 90759; 90818; 90838-90840, 90844; 90849; 90853; 90887; 90957; 90961; 91008; 91010; 91018; 91033; 91037; 91039; 91047; 91057; 91069; 91073; 91079; 91175; 91233; 91235; 91237-91239, 91242; 91302; 91342, 91343; 91358; 91362; 91457-91460; 91474; 91616; 91631; 91714-91717; 91771; 91773; 91786; 91834; 91840, 91841
- **INTERNATIONAL TRADEMARKS PROTECTED IN GEORGIA:**
84991; 85211; 85318; 85364; 85800; 86417; 87292; 87947; 88140; 88186; 88242; 88268; 88293; 88307; 88601; 88609; 88616; 88620-88622; 88702; 88739; 88742; 88745; 88751-88753; 88767; 88857; 88896, 88897; 88903; 88943-88952; 88955; 88962; 88967; 88969, 88970; 88973; 88991-88993; 89025; 89028; 89119; 89122; 89125; 89127; 89139; 89221; 89250-89256; 89264, 89265; 89270-89272; 89274-89278; 89280; 89282-89284; 89286; 89289; 89294- 89296; 89298-89302; 89304; 89306-89308; 89310; 89312; 89317; 89349; 89351; 89580; 89605; 89607; 89609; 89620; 89630; 89633-89635; 89643-89645; 89647, 89648; 89651; 89653-89655; 89658-89661; 89758; 89763, 89764; 89780; 89796, 89797; 89799-89802

APPELLATION OF ORIGIN OF GOODS

- **APPELLATION OF ORIGIN OF GOODS FILED GEORGIA FOR EXAMINATION UNDER LISBON AGREEMENT, ON THE BASIS OF THE INTERNATIONAL REGISTRATION:**
1453

INVENTIONS

APPLICATIONS APPROVED FOR GRANTING PATENTS

The decision can be appealed at the Chamber of Appeal of Sakpatenti within 3 months from the publication or at the Mtskheta District Court Administrative Cases Board (Address: №17, Samkhedro str., Mtskheta), within 1 month following the publication.

PART A

A 24

(10) AP 2017 13779 A (51) Int. Cl. (2006)
A 24 B 3/12

(21) AP 2015 013779 (22) 2015 03 31
(71) Tariel Iobashvili (GE)
300 Aragvelis q. 17, 2700, Lagodekhi (GE)

(72) Tariel Iobashvili (GE)
(54) **METHOD FOR FERMENT TOBACCO
PRODUCTION**

(57) A method provides yellowing tobacco, fixing color, drying, fermentation and reduction onto condition by technological processes; at that, all technological processes are executed in one building tout with transparent white polyethylene film, wherein accordingly of all perimeter of four sides, up and down, the air gates are disposed, and wherein, at open air gates, the technological processes of yellowing foliage of tobacco are executed.

Claims: 1 independent

Fig.: 2

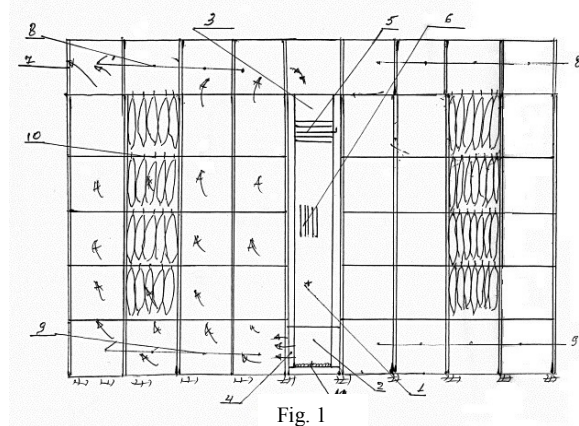

A 61

(10) AP 2017 14469 A (51) Int. Cl. (2006)
A 61 K 36/29
A 61 P 33/00

(21) AP 2017 014469 (22) 2017 04 07
(71) Davit Chachanidze (GE)
Arsenas q. 46, 0108, Tbilisi (GE);

Teimuraz Ghoghoberidze (GE)
Sop. Didi Jikhaishi, 5915, Khoni (GE);
Nino Kuntseva-Gabashvili (GE)
Tamarashvilis q. 17/55, 0177, Tbilisi (GE);
Tsovinar Nazarova (GE)
Mukhianis das. I m/r., V korp., b. 40, 0172,
Tbilisi (GE)

(72) Davit Chachanidze (GE);
Teimuraz Ghoghoberidze (GE);
Nino Kuntseva-Gabashvili (GE);
Tsovinar Nazarova (GE)

(74) Aleksandre Gegetchkori
(54) **REMEDY AGAINST BEE
NOZEMATOSIS**

(57) Homeopathic preparation contains Devil's-apple Podophillum peltatum I spirit extract, and is used for bee nozematosis treatment.

Claims: 1 independent

Table: 2

PART B

B 01

(10) AP 2017 14148 A (51) Int. Cl. (2006)
B 01 D 35/027
B 01 D 61/08
B 01 D 651/10
B 23 P 11/00

(21) AP 2014 014148 (22) 2014 10 16
(31) 14/514, 505; 61/892,785
(32) 2014 10 15; 2013 10 18
(33) US; US

(71) NORTHERN TECHNOLOGIES
INTERNATIONAL CORPORATION (US)
23900 Mercantile Road Beachwood,
Ohio 44122 (US)

(72) LYUBLINSKI, Efim Ya (US);
RAMDAS, Gautam (US);
VAKS, Yefim (US);
NATALE, Terry Alan (US);
POSNER, Monique Humbert (US);
BAKER, Kelly (US);
ROYTMAN, Alexander (US)

(74) Tamaz Shilakadze

(85) 2016 05 18

(86) PCT/US2014/060815, 2014 10 16

(54) SYSTEMS FOR CORROSION PROTECTION OF STORAGE TANK SOIL SIDE BOTTOMS

(57) A system for the corrosion protection of tank soil side bottoms is achieved by providing equipment to existing storage tank as by installing chime delivery system about the perimeter of storage tank bottom plate, and introducing appropriate amount of corrosion inhibitor into chime delivery system, whereby corrosion inhibitor is readily admitted into the spaces between the substrate and tank bottom plate.

Claims: 4 independent

16 dependent

Fig.: 3

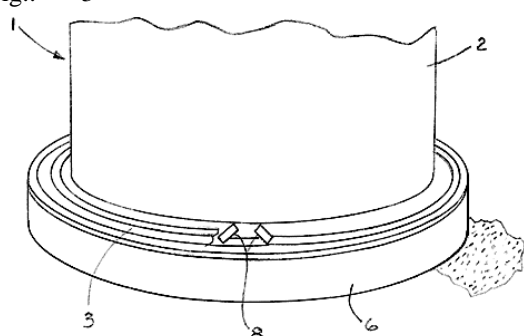

Fig. 1

PART C**C 07****(10) AP 2017 14198 A (51) Int. Cl. (2006)**

C 07 C 45/45

C 07 C 45/65

C 07 C 47/575

C 07 C 309/65

C 07 C 309/66

C 07 C 309/73

C 07 C 233/18

C 07 C 303/28

(21) AP 2014 014198 (22) 2014 12 04

(31) 1362200

(32) 2013 12 05

(33) FR

(71) Les Laboratoires Servier (FR)
35 rue de Verdun F-92284 Suresnes
Sedex (FR)

(72) BRIERE, Jean-François (FR);
LEBEUF, Raphaël (FR);
LEVACHER, Vincent (FR);
HARDOUIN, Christophe (FR);
LECOUVE, Jean-Pierre (FR)

(74) Tamaz Shilakadze

(85) 2016 07 01

(86) PCT/FR2014/053159, 2014 12 04

(54) NOVEL METHOD FOR SYNTHESIS OF 7-METHOXY-NAPHTHALENE-1-CARBALDEHYDE AND USAGE THEREIN SYNTHESIS OF AGOMELATINE

(57) Method for industrial synthesis of compound of formula (I)

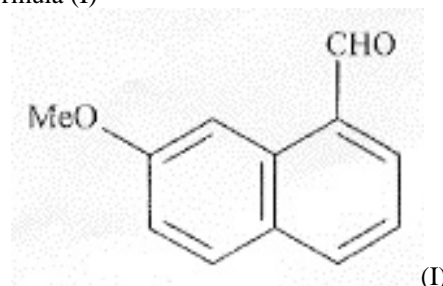

(I)

Claims: 8 independent

14 dependent

(10) AP 2017 13818 A (51) Int. Cl. (2006)

C 07 D 401/14

C 07 D 239/56

C 07 D 403/06

C 07 D 403/14

C 07 D 239/52

C 07 D 239/54

C 07 D 471/04

A 61 K 31/513

A 61 P 31/18

(21) AP 2013 013818 (22) 2013 10 07

(31) PCT/CN2012/001358

(32) 2012 10 08

(33) CN

(71) MERCK SHARP & DOHME CORP. (US)
126 East Lincoln Avenue Rahway,
New Jersey 07065-0907 (US)

(72) ARRINGTON, Kenneth, L. (US);
BURGEY, Christopher (US);
GILFILLAN, Robert (GB);
HAN, Yongxin (CA);
PATEL, Mehul (US);
LI, Chun Sing (CA);
LI, Yaozong (CN);
LUO, Yunfu (CN);
XU, Jiayi (CN)

(74) Shalva Gvaramadze

(85) 2015 05 04

(86) PCT/US2013/063612, 2013 10 07

(54) 5-PHENOXY-3H-PYRIMIDIN-4-ONE DERIVATIVES AND THEIR USAGE AS HIV REVERSE TRANSCRIPTASE INHIBITORS

(57) Compound of formula (I),

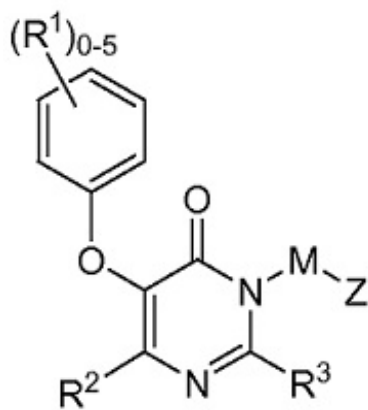

wherein values of substituents L, M, Z, R¹, R² and R³ are provided in the claims or pharmaceutically acceptable salt, pharmaceutical composition on basis thereof and their usage for prevention and the treatment of HIV infectious and AIDS.

Claims: 27 independent
30 dependent

Fig.: 1
Table: 20

(10) AP 2017 14225 A (51) **Int. Cl. (2006)**
C 07 D 403/06
A 61 K 31/506
A 61 K 31/7072
A 61 P 35/00
A 61 P 43/00

(21) AP 2014 014225 (22) 2014 06 17
(62) AP 2014 014034, 2014 06 17 (GE)
(31) 2013-126567
(32) 2013 06 17
(33) JP
(71) TAIHO PHARMACEUTICAL CO., LTD (JP)
1-27 Kandanshiki-cho, Chiyoda-ku, Tokyo
1018444 (JP)
(72) KAZUNO, Hideki (JP);
MUTSUMI, Tomonobu (JP)
(74) Shalva Gvaramadze
(85) 2016 07 27
(86) PCT/JP2014/065985, 2014 06 17

(54) **STABILIZED CRYSTAL OF TIPIRACIL HYDROCHLORIDE, AND CRYSTALLIZATION METHOD FOR SAME**

(57) Hydrochloride crystal of 5-chloro-6-[(2-iminopyrrolidin-1-yl)methyl]pyrimidine-2,4 (1H, 3H)-dione monohydrochloride on which powder X-ray diffraction the peaks are marked at two or more angles selected from 10.5°, 19.6°, 23.7°, 26.2° and 31.2° (20±0.1°) diffraction angle and pharmaceutical composition on basis of said crystal.

Claims: 2 independent
4 dependent

Fig.: 3
Table: 3

(10) AP 2017 13845 A (51) **Int. Cl. (2006)**
C 07 D 453/02

(21) AP 2013 013845 (22) 2013 12 05
(31) 12195891.2; PCT/EP2013/075661
(32) 2012 12 06; 2013 12 05
(33) EP; IB
(71) CHIESI FARMACEUTICI S.P.A. (IT)
Via Palermo, 26/A I-43100 Parma (IT)
(72) RANCATI, Fabio (IT);
LINNEY, Ian (IT)
(74) Tamaz Shilakadze
(85) 2015 06 03
(86) PCT/EP2013/075661, 2013 12 05

(54) **COMPOUNDS HAVING MUSCARINIC RECEPTOR ANTAGONIST AND BETA2 ADRENERGIC RECEPTOR AGONIST ACTIVITY**

(57) 8-hydroxy-2-oxo-1,2 dihydroquinoline derivatives, their pharmaceutically acceptable salts and solvats, and pharmaceutical compositions on basis thereof; usage of said compounds for drug preparation for prevention and the treatment of bronchoobstructive and inflammatory diseases or chronic bronchitis or chronic obstructive pulmonary disease (COPD).

Claims: 5 independent
1 dependent

Table: 15

(10) AP 2017 14164 A (51) **Int. Cl. (2006)**
C 07 D 471/04
C 07 D 487/04
A 61 K 31/4375
A 61 P 35/00

(21) AP 2014 014164 (22) 2014 11 20
(31) 61/912,074
(32) 2013 12 05
(33) US
(71) PFIZER INC. (US)
235 East 42nd Street New York,
NY 10017 (US)
(72) BROWN, Matthew Frank (US);
CASIMIRO-GARCIA, Agustin (MX);
CHE, Ye (CN);
COE, Jotham Wadsworth (US);
FLANAGAN, Mark Edward (US);
GILBERT, Adam Matthew (US);
HAYWARD, Matthew Merrill (US);
LANGILLE, Jonathan David (CA);
MONTGOMERY, Justin Ian (US);
TELLIEZ, Jean-Baptiste (US);
THORARENSEN, Atli (US);
UNWALLA, Rayomand Jal (US);
TRUJILLO, John I (US)
(74) Tamar Kochlamazashvili
(85) 2016 06 03
(86) PCT/IB2014/066202, 2014 11 20

(54) **PYRROLO [2,3-D] PYRIMIDINYL,
PYRROLO [2,3-B] PYRAZINYL AND
PYRROLO [2,3-D] PYRIDINYL
ACRYLAMIDES**

(57) Compound of formula (I),

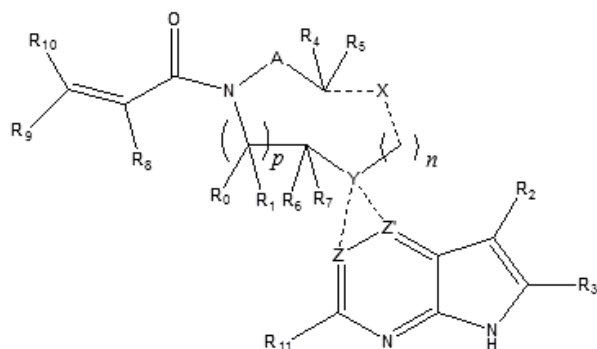

wherein X, Z, Z', A, R₀, R₁, R₂, R₃, R₄, R₅, R₆, R₇, R₈, R₉, R₁₀ values of derivatives and n, p (1) substitutes are provided in the claims or their pharmaceutical salt or solvate or enantiomer or diastereoisomer and pharmaceutical or veterinary composition on basis thereof.

Claims: 3 independent

10 dependent

Table: 14

(10) **AP 2017 12214 A (51) Int. Cl. (2006)
C 07 F 5/02
A 61 K 31/69
A 61 K 35/00**

(21) AP 2009 012214 (22) 2009 09 25

(31) 61/194,614

(32) 2008 09 29

(33) US

(71) **MILLENNIUM PHARMACEUTICALS
INC. (US)**

40 Landsdowne Street Cambridge,
MA 02139 (US)

(72) **FLEMING, Paul, E (US);
LI, Jing (CN)**

(74) Shalva Gvaramadze

(85) 2011 04 29

(86) PCT/US2009/005324, 2009 09 25

(54) **DERIVATIVES OF 1-AMINO-2-
CYCLOBUTYLETHYLBORONIC ACID**

(57) New compounds, pharmaceutical compositions on basis thereof, and their usage for cancer treatment.

Claims: 6 independent

41 dependent

Table: 1

PART G

G 21

(10) **AP 2017 14333 A (51) Int. Cl. (2006)
G 21 B 1/00**

(21) AP 2016 014333 (22) 2016 11 30

(71) Guram Dgebuadze (GE)

Tsinamdzghvrishvilis q. 121, b. 93, 0164,

Tbilisi (GE);

Tamaz Batsikadze (GE)

Ir. Abashidzis q. 63, b. 8, 0179, Tbilisi (GE);

Zurab Razmadze (GE)

Barnovis q. 26, 0108, Tbilisi (GE);

Aleksandre Mikaberidze (GE)

Tamarashvilis q. 11, b. 114, 0162,

Tbilisi (GE)

(72) Guram Dgebuadze (GE);

Tamaz Batsikadze (GE);

Zurab Razmadze (GE);

Aleksandre Mikaberidze (GE)

(54) **FACILITY/MODULE FOR CONTROL-
LED LOWTEMPERATURE NUCLEAR
REACTION EXECUTION**

(57) A facility – "Module Jibladze", for controlled lowtemperature nuclear reaction execution, includes a reactor filled with active chemical elements, heater and heat-eliminating element. The reactor is cylindrical pipe made with especial composition of spalling-resistant ceramics. The heater is executed as sealed two ends ceramical cylindric pipe of metallic corks switched to conduits playing role of electrodes, and heat-eliminating element is executed as metallic shell located on outer surface of ceramical cylindric pipe.

Claims: 1 independent

Fig.: 1

PATENTED INVENTIONS

PART A

A 61

(11) P 2017 6798 B (51) Int. Cl. (2006)

A 61 M 5/315

- (10) AP 2017 13974 A (44) 17(477)/2017
(21) AP 2014 013974
(22) 2014 03 26
(24) 2014 03 26
(31) 1305489.5
(32) 2013 03 26
(33) GB
(86) PCT/GB2014/050965, 2014 03 26
(73) CONSORT MEDICAL PLC (GB)
Ground Floor, Suite D, Breakspear Park,
Breakspear Way, Hemel Hempstead
HP2 4TZ (GB)
(72) ANDERSON, Ian (GB);
EKMAN, Matt (GB);
GLOVER, Robert (GB);
KOPPELMAN, Rachel (GB)
(74) Tamar Kochlamazashvili
(54) **IMPROVED MIXING SYRINGE
ASSEMBLY**
-

PART B

B 62

(11) P 2017 6797 B (51) Int. Cl. (2006)

B 62 M 7/12

- (10) AP 2017 13431 A (44) 16(476)/2017
(21) AP 2011 013431
(22) 2011 08 25
(24) 2011 08 25
(86) PCT/AZ2011/000012, 2011 08 25
(73) GOYTEMIROV, Ramzan Usmanovich (AZ)
Vidadi Str., 50, Baku, AZ1009 (AZ)
(72) GOYTEMIROV, Ramzan Usmanovich (AZ)
(54) **MOTORCYCLE**
-

UTILITY MODELS

APPLICATIONS APPROVED FOR GRANTING PATENTS

The decision can be appealed at the Chamber of Appeal of Sakpatenti within 3 months from the publication or at the Mtskheta District Court Administrative Cases Board (Address: №17, Samkhedro str., Mtskheta), within 1 month following the publication.

PART B

B 62

- (10) AU 2017 14421 U (51) Int. Cl. (2006)
B 62 D 63/06
- (21) AU 2017 014421 (22) 2017 02 10
- (71) Davit Giorgadze (GE);
Solomon Pirvelis q. 4/11, 4600, Kutaisi (GE);
Temur Giorgadze (GE)
G. Abashidzis q. 4/9, 4600, Kutaisi (GE);
Vladimer Ughrelidze (GE)
Khabeishvilis q. 22, 4600, Kutaisi (GE)
- (72) Davit Giorgadze (GE);
Temur Giorgadze (GE);
Vladimer Ughrelidze (GE)
- (74) Archil Geguchadze
- (54) **TRAILER FOR MOTOR CAR AND
MOTOR CULTIVATOR**

(57) A trailer includes mounted onto wheel suspension 1 the frame 2 and a body 3 attached thereto by means of at least one catch, which at that is fixed onto end side 4 and the frame 2, and the vertical columns 7 are fixed onto frame carcass 6 and connected to the frame 2 by means of hinges 8 rotatable around horizontal axis and body dumping. The frame 2 is ended with a towbar 9, and body 3 carcass 6 horizontal axis hinge fixation with the frame 2 is located behind body geometrical center (of gravity).

Claims: 1 independent

Fig.: 6

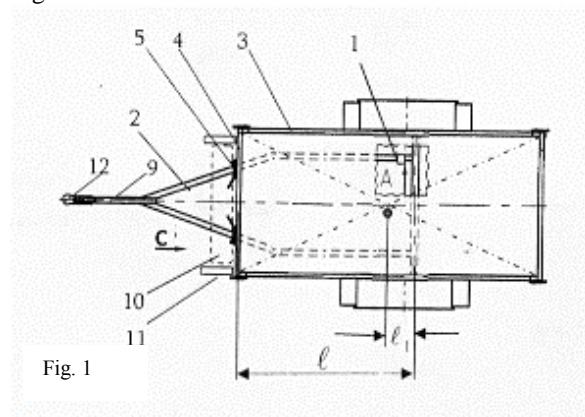

Fig. 1

B 65

- (10) AU 2017 14355 U (51) Int. Cl. (2006)
B 65 D 81/32
B 65 D 25/08
- (21) AU 2016 014355 (22) 2016 12 21
- (71) Sergo Taliuridze (GE)
Akhmetis raioni, 0902, Sop. Zemo
Alvani (GE)
- (72) Sergo Taliuridze (GE)
- (74) Tamaz Shilakadze
- (54) **BOTTLE LID**

(57) A lid includes two parts, hollow part 2 forcing on a bottle and part 3 in a form of capacity connected together rotatable relative to each other; at that, the part in a form of capacity has ring-like ledge 4 fixing partition 5 from inner side, and inner thread 6 coupling thereto corresponding bottle mouth surface is executed on the part forcing on bottle mouth; furthermore, the lid is equipped with the means 8 cutting partition. Forcing part from upper side is equipped with, at least, couple of semicircular inclined ledges 9 and 10. The means 8 cutting partition is executed as a bush capable to slip on the ledges, and from its turn has corresponding, at least, couple of inclined surfaces 11 and 12 having cutting teeth 13 on upper side inclined surface; at that, the means 8 cutting partition has radial ledges 14 and 15 movable axially into radial grooves 16 and 17 created on capacity inner surface.

Claims: 1 independent

4 dependent

Fig.: 12

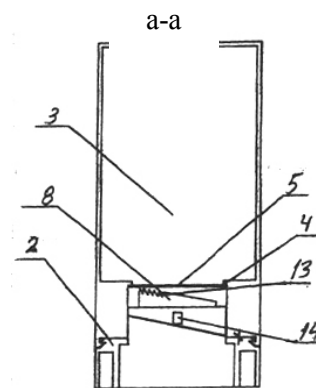

Fig. 3

DESIGNS

APPLICATIONS APPROVED FOR REGISTRATION

The decision can be appealed at the Chamber of Appeal of Sakpatenti within 3 months from the publication or at the Mtskheta District Court Administrative Cases Board (Address: №17, Samkhedro str., Mtskheta), within 1 month following the publication.

- (10) AD 2017 976 S (51) 09-03
(21) AD 2017 976 (22) 2017 08 07
(28) 2
(71) Davit Abramishvili (GE)
Eg. Ninoshvilis q. 12, 5500, Tchiatura (GE)
(72) Davit Abramishvili (GE)
(54) ROASTED SUNFLOWER GRAINS PACKAGE
(55)



1.1

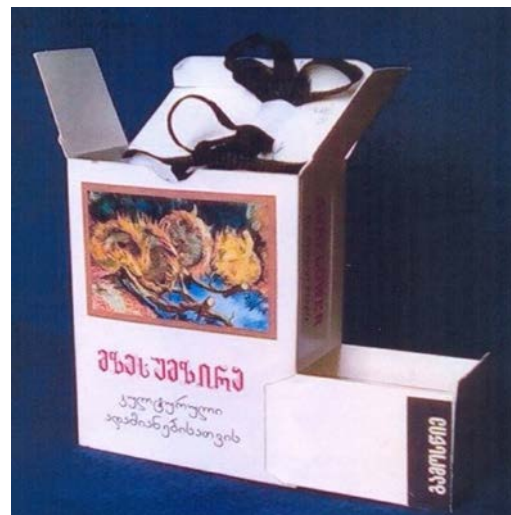

1.2



1.3



1.4

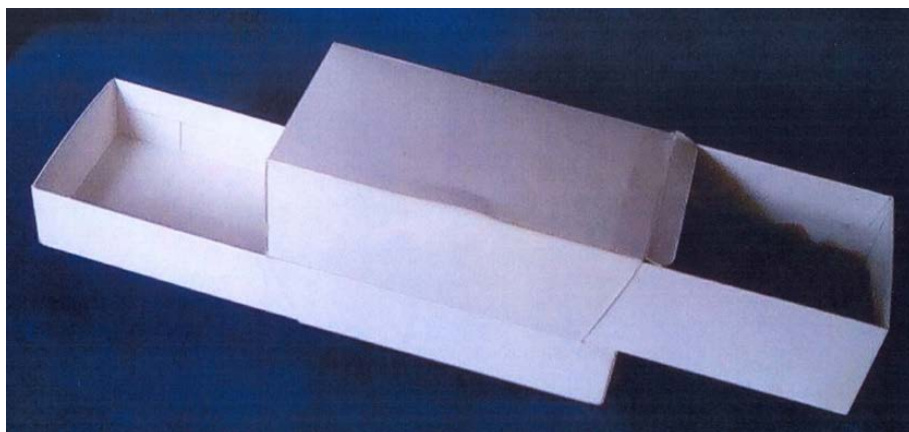

2.1

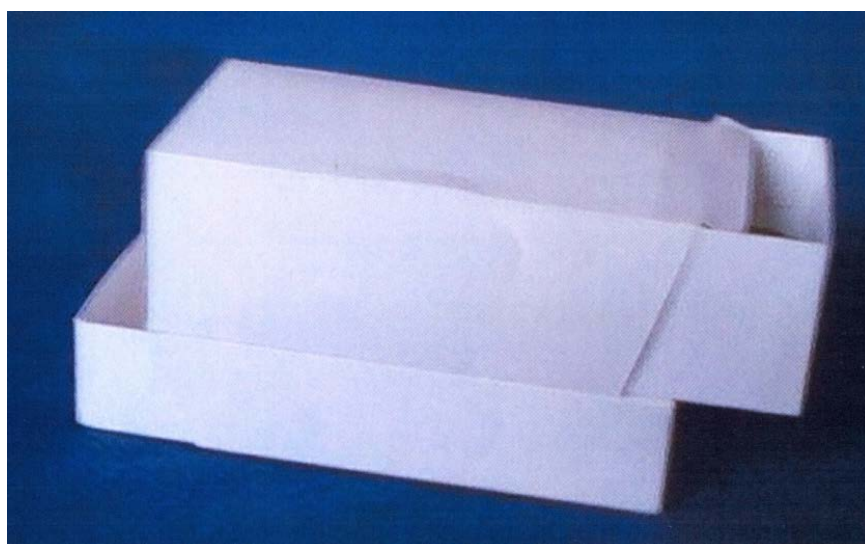

2.2

(10) AD 2017 979 S (51) 21-01
(21) AD 2017 979 (22) 2017 08 10
(28) 2
(71) Givi Saganelidze (GE)
 Gorgaslis q. 25, 1100, Bolnisi (GE)
(72) Givi Saganelidze (GE)
(54) **BACKGAMMON**
(55)

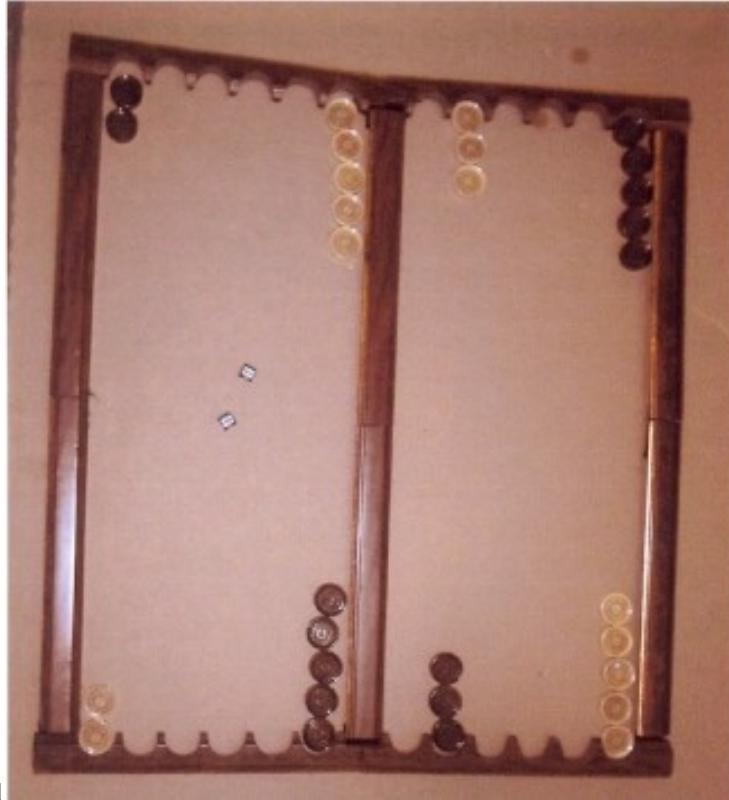

1.1



1.2



1.3



1.4

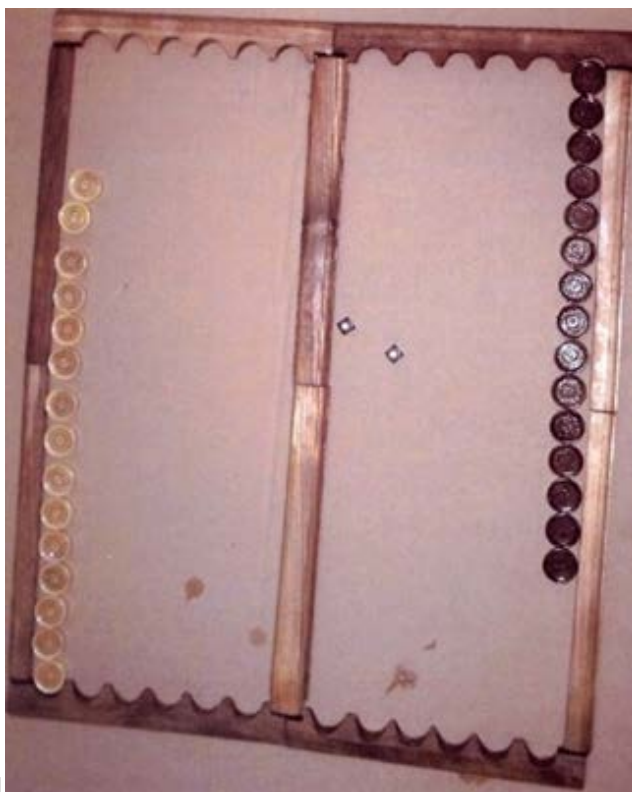

2.1

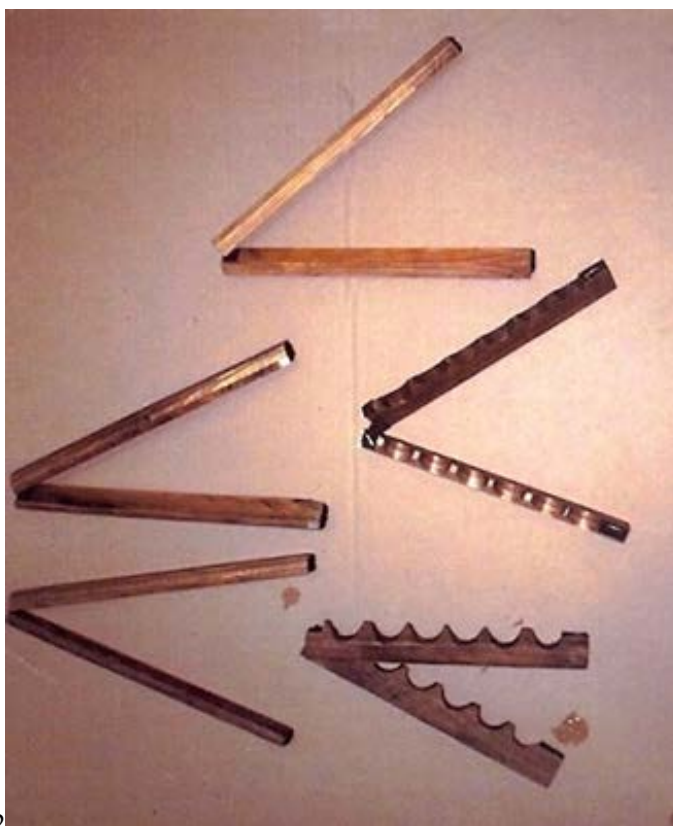

2.2

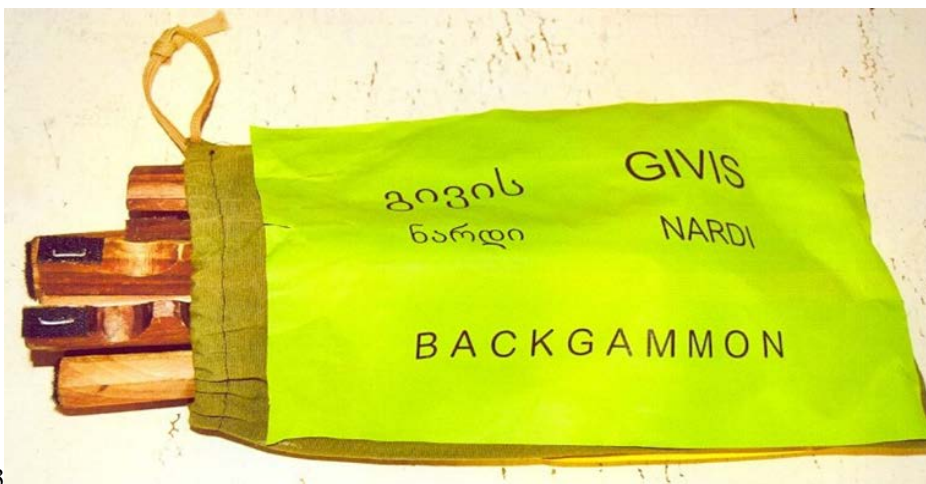

2.3

DESIGN REGISTERED ACCORDING TO THE ACCELERATED PROCEDURE

The decision can be appealed at the Chamber of Appeal of Sakpatenti within 3 months from the publication.

- (11) D 2017 739 S (51) 21-01
(21) AD 2017 996 (22) 2017 10 12
(24) 2017 10 12
(28) 1
(18) 2022 10 12
(73) Karen Vardanyan (AM)
Baironis q. 3, b. 36, Yerevan (AM)
(72) Karen Vardanyan (AM)
(74) Giorgi Taktakishvili (GE)
(54) TOY
(55)





1.5

**DESIGNS, WHICH HAVE BEEN REGISTERED WITH THE INTERNATIONAL
BUREAU CLAIMING PRIORITY ON THE TERRITORY OF GEORGIA**

The decision can be appealed at the Chamber of Appeal of Sakpatenti within 3 months from the publication or at the Mtskheta District Court Administrative Cases Board (Address: №17, Samkhedro Str., Mtskheta), within 1 month following the publication.

- (11) **DM/095276** (51) **11-01**
 (15) 2017 03 10 (45) 2017/36 (2017 09 15)
 (22) 2017 03 10
 (28) 6
 (73) HARRY WINSTON SA
 Chemin du Tourbillon 8, CH-1228 Plan-les-Ouates (CH)
 (85) CH
 (86) CH
 (87) CH
 (88) CH
 (89) CH
 (81) II. BZ, MA III. AL, AM, AZ, BA, CH, EM, GE, KG, LI, MC, MD, ME, MK, MN, NO, OM, SG, TN, TR,
 UA
 (72) Maurice GALLI
 25-10 31st Avenue, Apt. N2J, Long Island City, 11106 New York, États-Unis d'Amérique;
 5-6: Dominique RIVIERE
 360 E. 72nd Street, Apt. Nb1003, 10021 New York, États-Unis d'Amérique
 (54) 1. Bracelet; 2. Finger ring; 3. Necklace; 4. Pendant; 5. Finger ring; 6. Pendant
 (55)

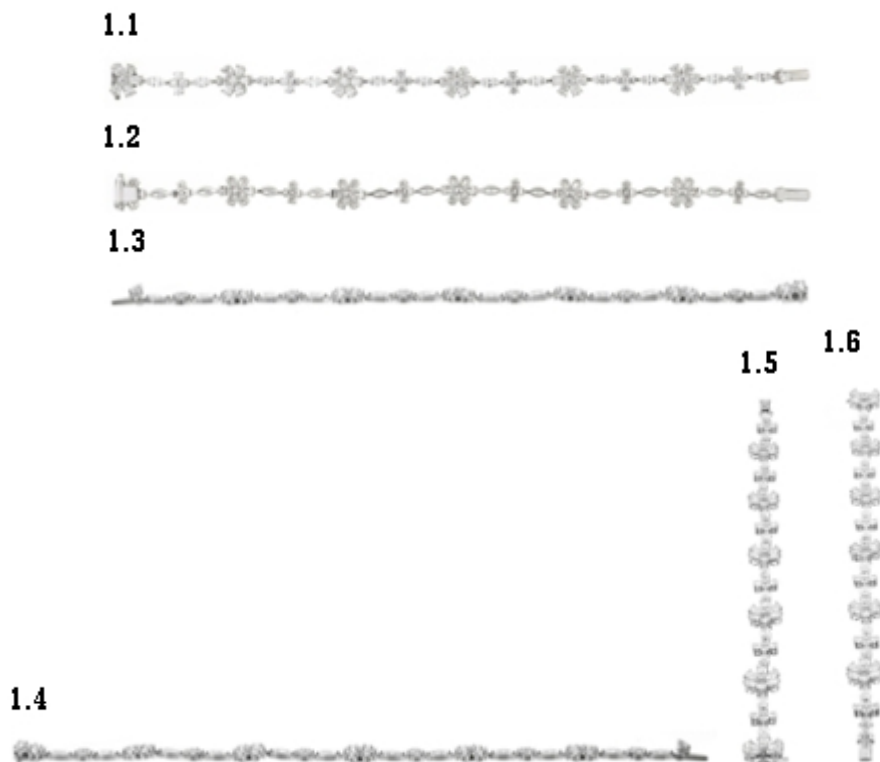

1.7



1.8



2.1



2.2



2.3



2.5



2.6



2.4



2.7



2.8



3.1

3.2



3.3



3.4



3.5



3.6



3.7



4.1



4.2



4.3



3.8



4.4



4.7



4.8



4.5



4.6







- (11) **DM/095365** **(51) 10-02, 07**
- (15) 2017 03 15 (45) 2017/36 (2017 09 15)
- (22) 2017 03 15
- (28) 4
- (73) OMEGA SA (OMEGA AG) (OMEGA LTD.)
Jakob-Stämpfli-Strasse 96, CH-2502 Biel/Bienne (CH)
- (85) CH
- (86) CH
- (87) CH
- (88) CH
- (89) CH
- (81) II. BZ, MA III. AL, AM, AZ, BA, CH, EM, GE, KG, LI, MC, MD, ME, MK, MN, NO, OM, SG, TN, TR, UA
- (72) Jean-Claude Monachon
Rue Alice-de-Chambrier 1, 2022 Bevaix, Suisse
- (54) 1. Dial; 2. Watch; 3. Watch case; 4. Watch bracelet
- (55)

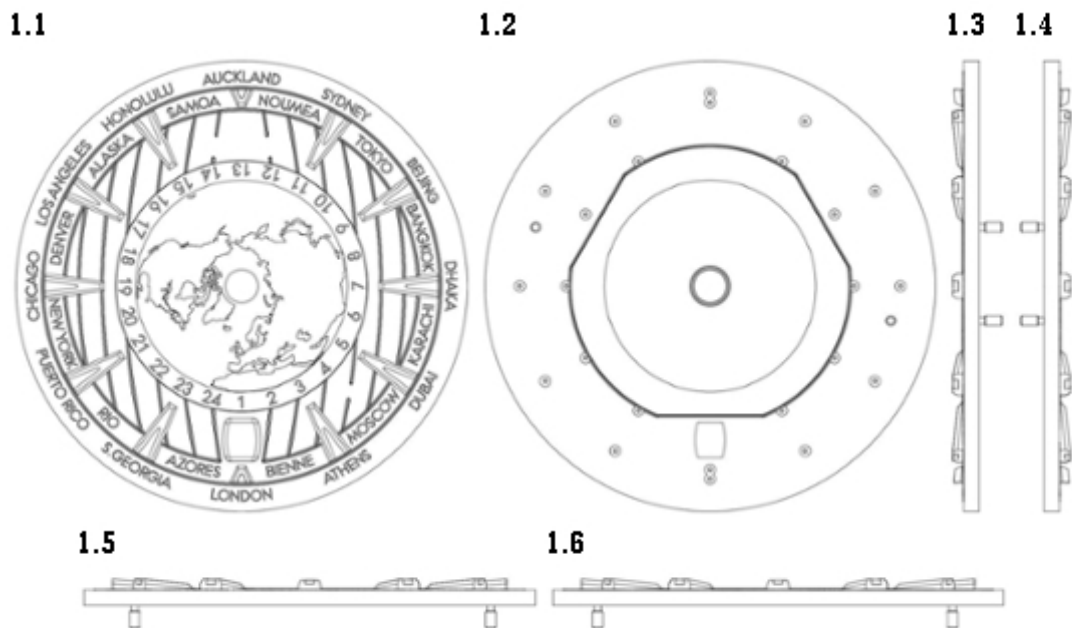

1.8

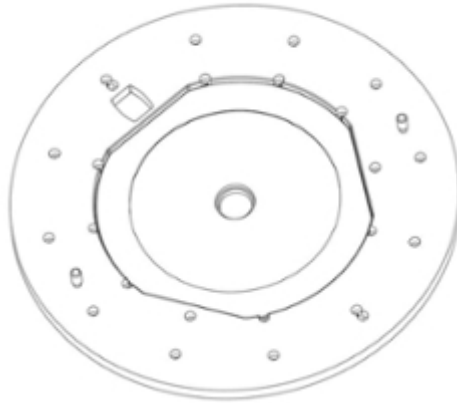

1.7



3.1

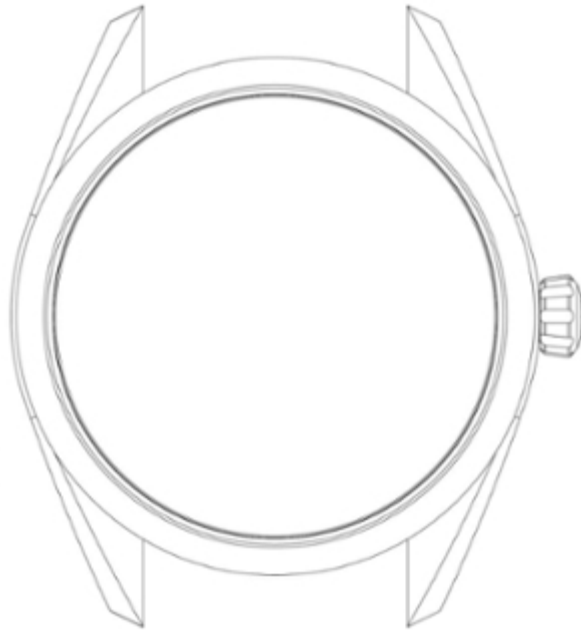

2



3.2

3.3

3.4

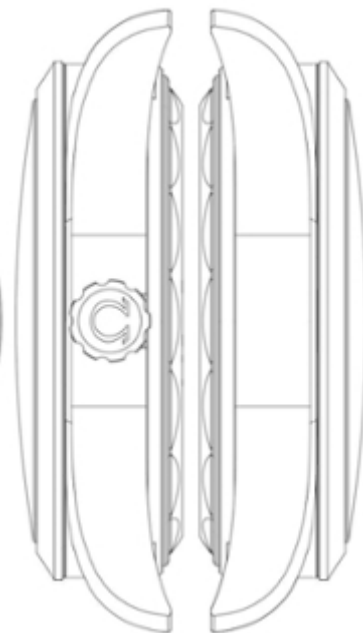
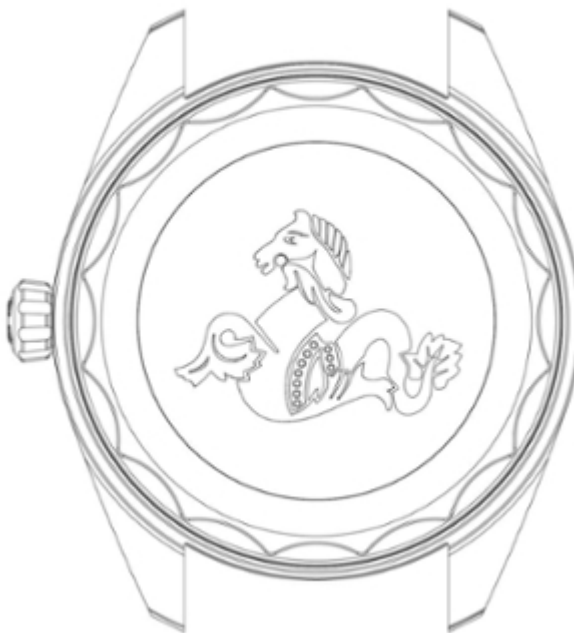

3.5



3.6



3.7

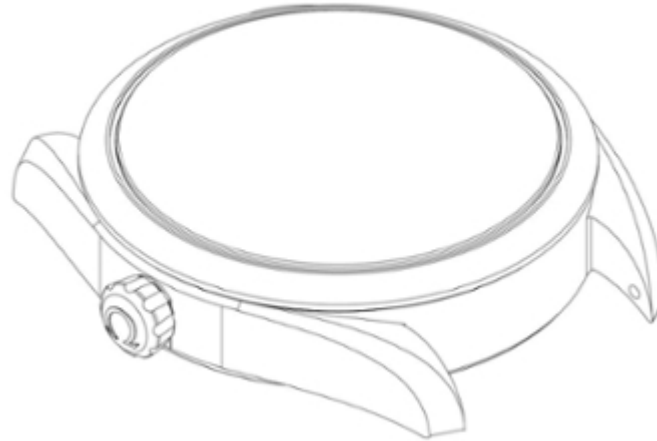

4.1

4.2

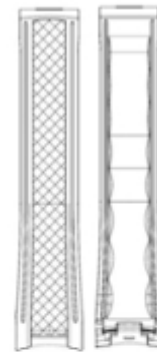

3.8

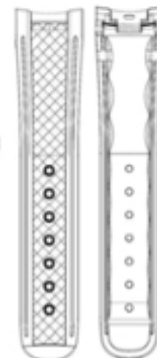
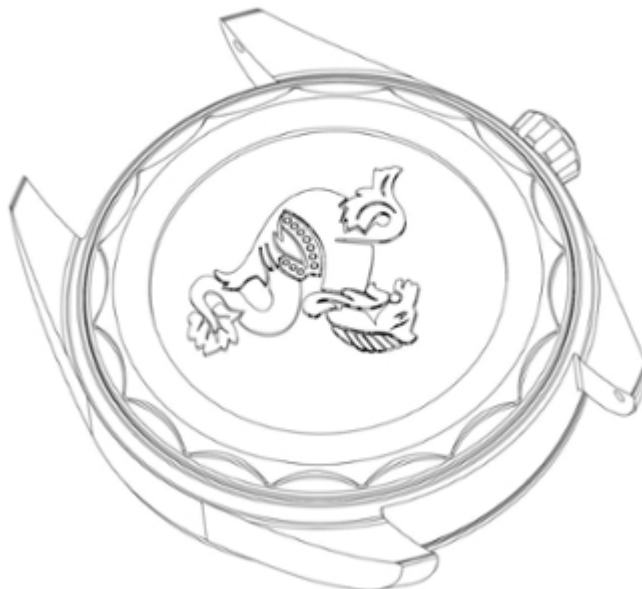

4.3



4.4



4.5



4.6



4.7



4.8



(11) DM/095799

(51) 10-07

(15) 2017 03 15

(45) 2017/36 (2017 09 15)

(22) 2017 03 15

(28) 3

(73) HARRY WINSTON SA

Chemin du Tourbillon 8, CH-1228 Plan-les-Ouates (CH)

(85) CH

(86) CH

(87) CH

(88) CH

(89) CH

(81) II. BZ, MA III. AL, AM, AZ, BA, CH, EM, GE, KG, LI, MC, MD, ME, MK, MN, NO, OM, SG, TN, TR, UA

(72) 1: Emmanuelle DOMINGUEZ

Rue de la Luchette 285, 74580 Viry, France;

2-3: Sophie VALZAN

Rue Jean Violette 30, 1205 Genève, Suisse

(54) 1.-2. Watch cases; 3. Dial

(55)

1.1

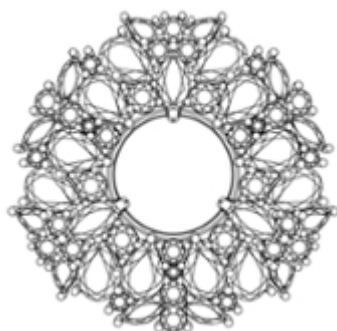

1.2

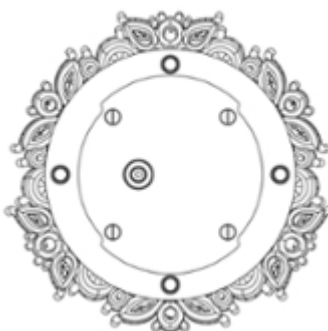

1.3

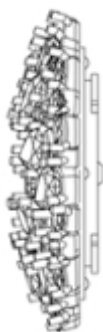

1.4

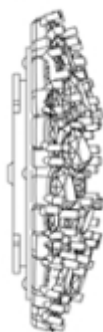

1.5



1.6



1.7

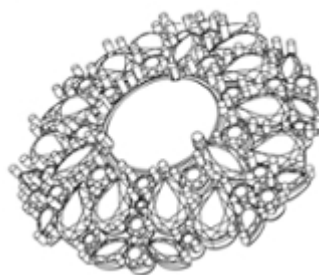

2.1



1.8



2.2



2.3

2.4

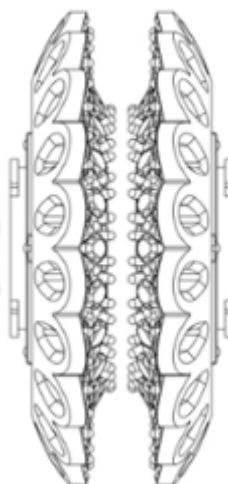

2.5



2.6

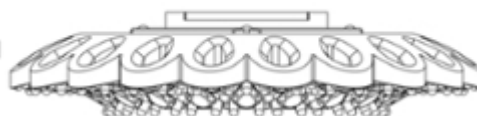

2.7



2.8



3.1



3.2

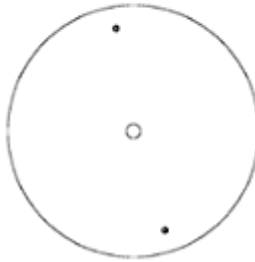

3.3

3.4



3.5



3.6



3.7



3.8

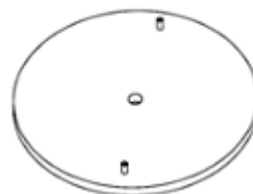

(11) DM/097514

(15) 2017 07 20

(22) 2017 07 20

(28) 2

(73) LIQUI MOLY GMBH

Jerg-Wieland-Str. 4, 89081 Ulm (DE)

(85) DE, EM

(86) DE, EM

(87) DE, EM

(88) DE, EM

(89) DE

(81) II. BZ, MA, ML, SR III. AL, AM, AZ, BA, BN, BW, CH, EG, EM, GE, KG, KH, LI, LV, MC, MD, ME, MN, NA, NO, OA, OM, RS, RW, SG, TJ, TM, TN, TR, UA

(54) 1.-2. Bottles for liquids

(55)

(51) 09-01

(45) 2017/36 (2017 09 15)

1.1



1.2



1.3



1.4



1.5



1.6



1.7



2.1



2.2



2.3



2.4



2.5



2.6



2.7



(11) DM/095346**(51) 10-07**

(15) 2017 03 16

(45) 2017/37 (2017 09 22)

(22) 2017 03 16

(28) 11

(73) TISSOT SA (TISSOT AG) (TISSOT LTD)

Chemin des Tourelles 17, CH-2400 Le Locle (CH)

(85) CH

(86) CH

(87) CH

(88) CH

(89) CH

(81) II. BZ, MA III. AL, AM, AZ, BA, CH, EM, GE, KG, LI, MC, MD, ME, MK, MN, NO, OM, SG, TN, TR, UA

(72) 9-11: Gilles HABEGGER

Rue de l'Oratoire 1, 2000 Neuchâtel, Suisse;

1-3: Albiona LOKAJ

Rue Jean d'Aarberg 12, 2400 Le Locle, Suisse;

1-2,4-7,9,11: Fernando Antonio SOARES

Rue de l'Hôpital 4, 2000 Neuchâtel, Suisse;

3: Pierre-André NOIRJEAN

Chemin du Moulin 3, 2802 Develier, Suisse;

4-8: Laurie SAUNDERS

Ruelle des Vignerons 22, 1787 Môtier, Suisse;

10: Jérémie SENNGEN

Avenue de Montchoisi 25, 1006 Lausanne, Suisse

(54) 1.-4. Watch cases; 5. Watch bracelet; 6.-8. Watch dials; 9.-10. Watch cases; 11. Watch bracelet

(55)

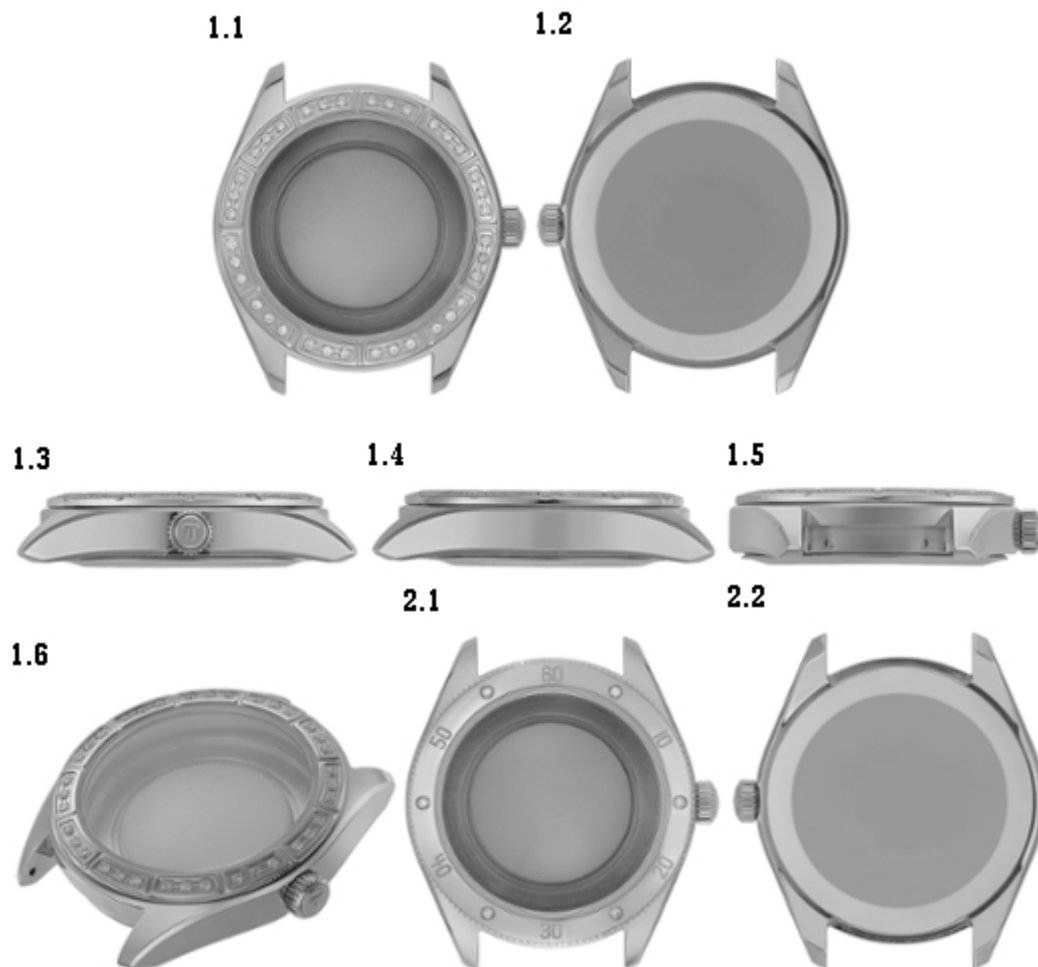

2.3



2.4



2.5



3.1



2.6



3.2



3.3

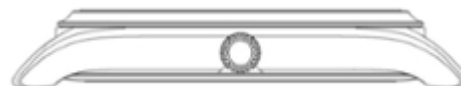

3.4



3.5



3.7

3.6

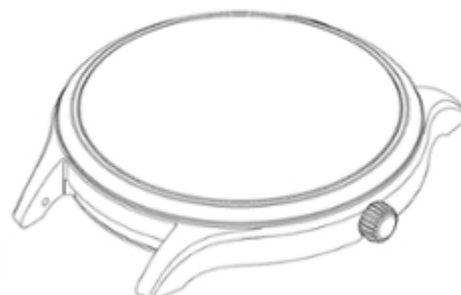

4.1



4.2



4.3



4.6



4.4



4.5



5.1

5.2

5.3



5.4



6.1



6.2



7.1



7.2



8.1

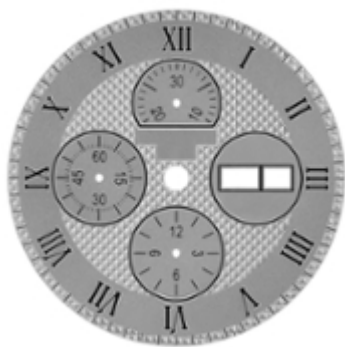

8.2



9.1

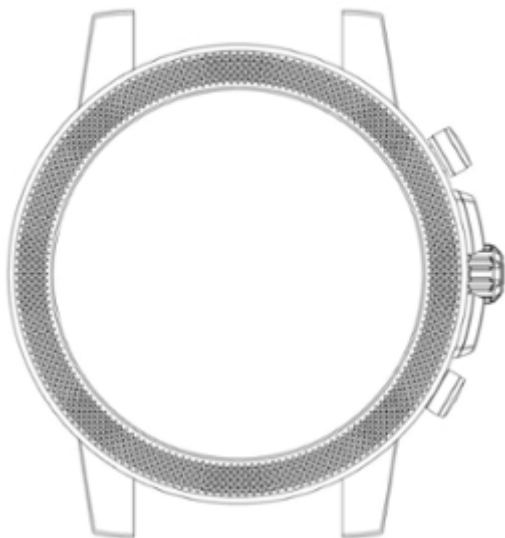

9.2



9.3

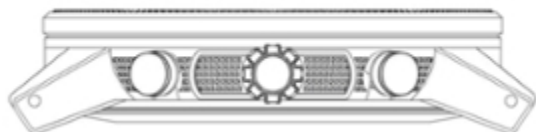

9.4



9.5



9.6



9.7

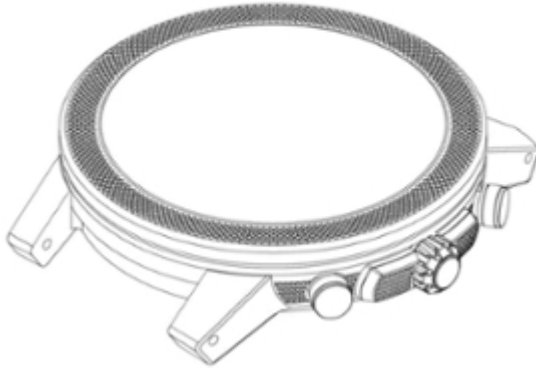

10.1

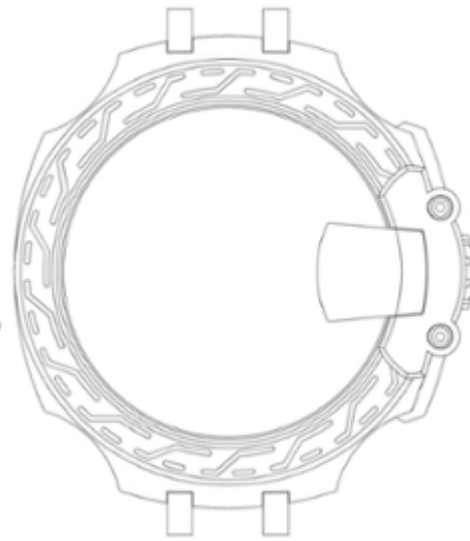

10.2



10.3

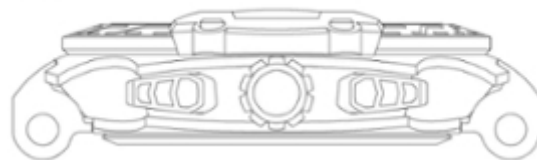

10.4

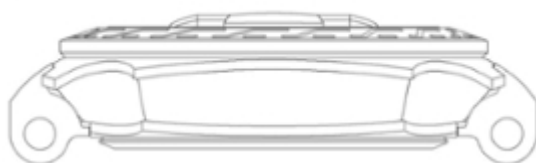

10.5



10.7

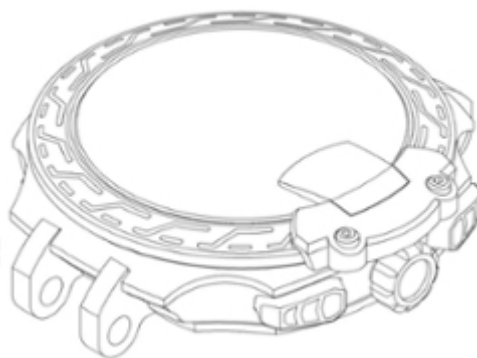

10.6



11.1

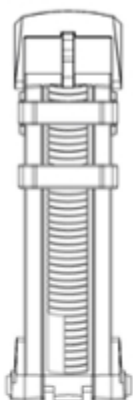

11.2

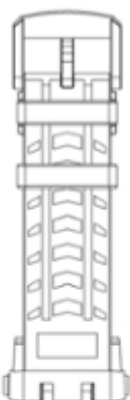

11.3

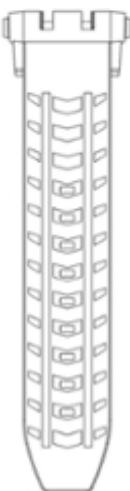
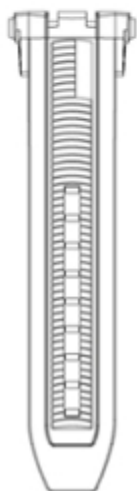

11.4

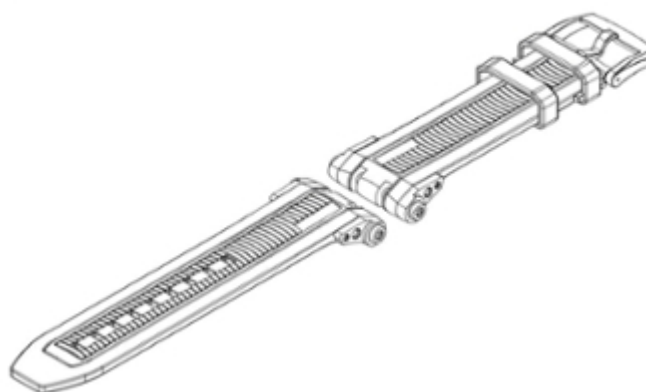

(11) DM/095381

(51) 10-07

(15) 2017 03 20

(45) 2017/37 (2017 09 22)

(22) 2017 03 20

(28) 3

(73) HARRY WINSTON SA

Chemin du Tourbillon 8, CH-1228 Plan-les-Ouates (CH)

(85) CH

(86) CH

(87) CH

(88) CH

(89) CH

(81) II. BZ, MA III. AL, AM, AZ, BA, CH, EM, GE, KG, LI, MC, MD, ME, MK, MN, NO, OM, SG, TN, TR, UA

(72) 1-2: Sophie VALZAN

Rue Jean Violette 30, 1205 Genève, Suisse;

3: Emmanuelle DOMINGUEZ

Rue de la Luchette 285, 74580 Viry, France

(54) 1.-2. Dials; 3. Watch case with strap

(55)

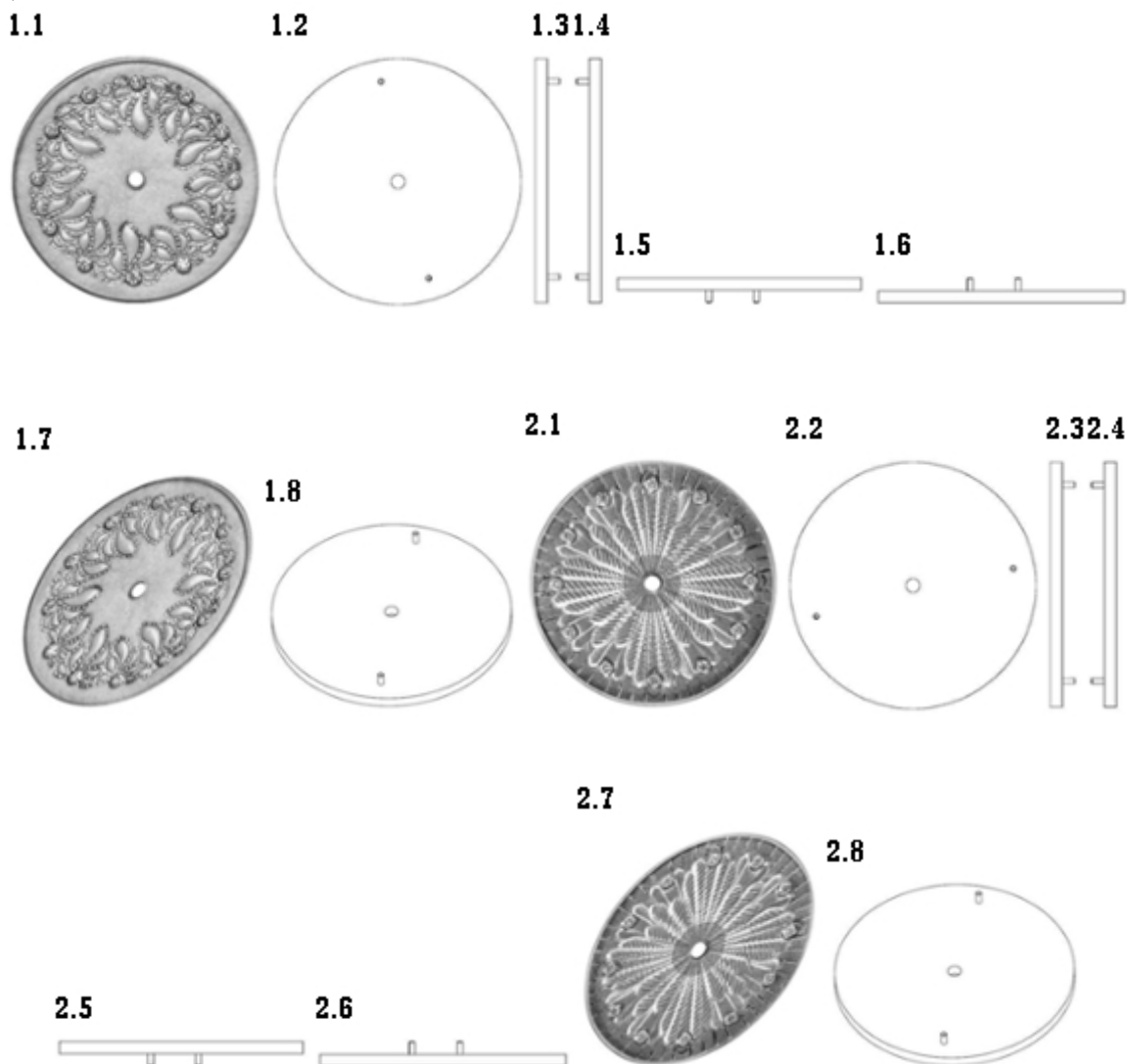

3.1



3.2



3.3



3.4



3.5



3.6



3.7



3.8



(11) DM/095386

(51) 10-02, 07

(15) 2017 03 20

(45) 2017/37 (2017 09 22)

(22) 2017 03 20

(28) 3

(73) THE SWATCH GROUP MANAGEMENT SERVICES AG (THE SWATCH GROUP MANAGEMENT SERVICES SA) (THE SWATCH GROUP MANAGEMENT SERVICES LTD)

Seevorstadt 6, CH-2502 Biel/Bienne (CH)

(85) CH

(86) CH

(87) CH

(88) CH

(89) CH

(81) II. BZ, MA III. AL, AM, AZ, BA, CH, EM, GE, KG, LI, MC, MD, ME, MK, MN, NO, OM, SG, TN, TR, UA

(72) 1: Demur GAIANE

Rue des Cygnes 25, CH-2503 Bienne, Suisse;

2: Lucile GIBELLO

Rue Guillaume Fichet 12, FR-74000 Annecy, France;

3: Fernando SOARES

Rue Fleury 5, CH-2000 Neuchâtel, Suisse

(54) 1. Dial with hands and movement; 2.-3. Wristwatches

(55)

1.1



1.2

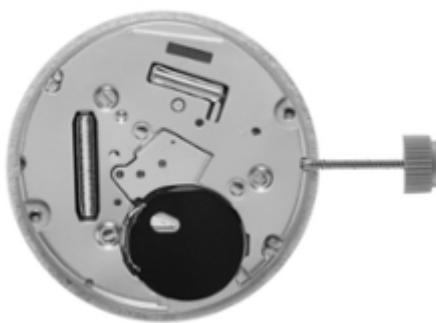

2.1



2.2



1.4



1.3



2.3



2.4



3.1



3.2



3.3



3.4



(11) DM/095425

(15) 2017 03 21

(22) 2017 03 21

(28) 1

(73) HARRY WINSTON SA

Chemin du Tourbillon 8, CH-1228 Plan-les-Ouates (CH)

(85) CH

(86) CH

(87) CH

(88) CH

(89) CH

(81) II. BZ, MA III. AL, AM, AZ, BA, CH, EM, GE, KG, LI, MC, MD, ME, MK, MN, NO, OM, SG, TN, TR, UA

(72) Chaeree KWON

172 North 10th Street 3D, 11211 Brooklyn, NY, États-Unis d'Amérique

(54) 1. Necklace

(55)

(51) 11-01

(45) 2017/37 (2017 09 22)

1.1

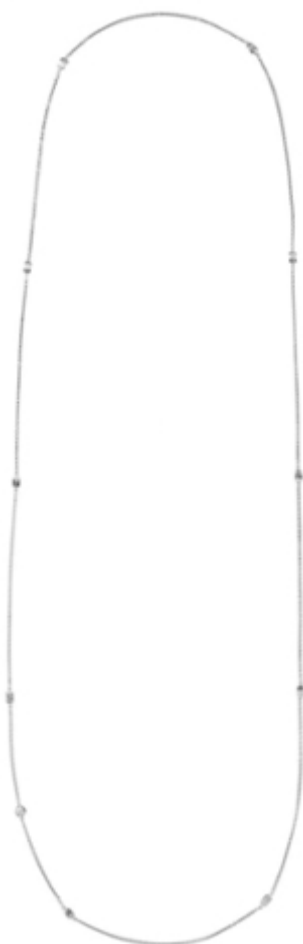

1.2



1.3



1.4



1.5

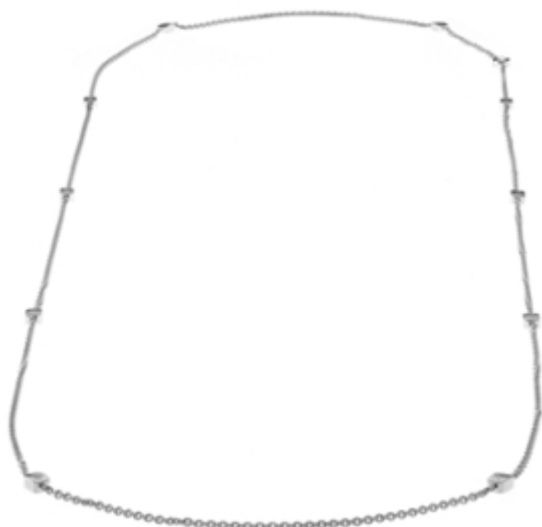

1.6



1.7

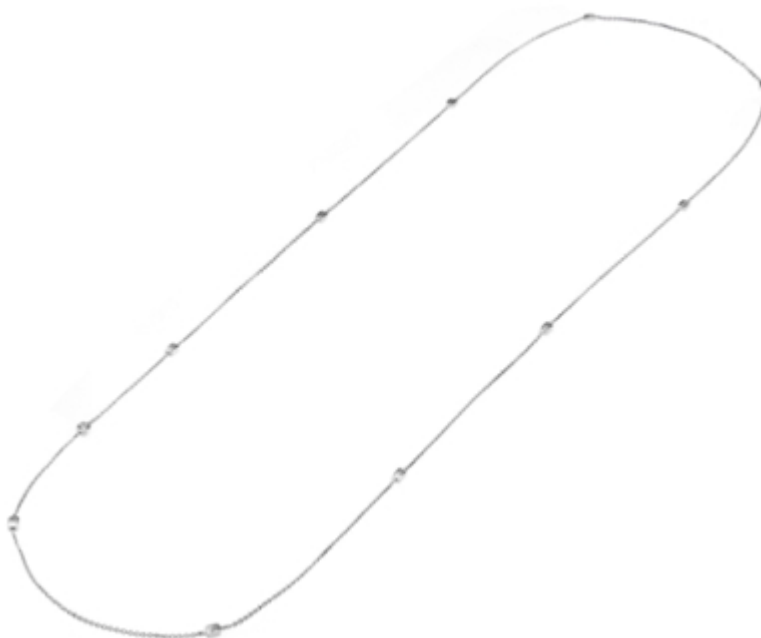

1.8

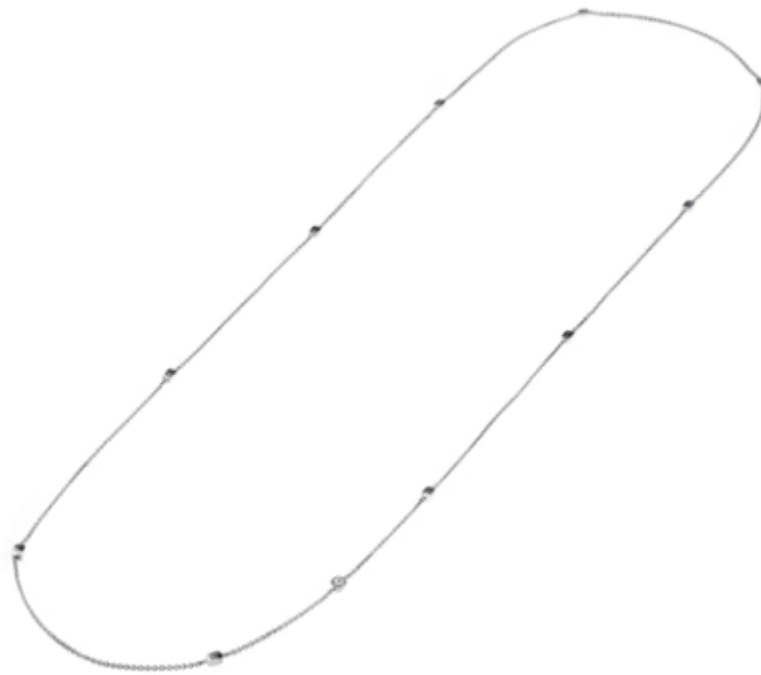

1.9



1.10



(11) DM/097608

(15) 2017 09 01

(22) 2017 09 01

(28) 1

(73) VALENTINO S.P.A.

Via Turati, 16/18, I-20121 Milano (IT)

(85) –

(86) EM, IT

(87) EM, IT

(88) EM, IT

(89) EM, IT

(81) III. AZ, EM, GE, JP, KG, KR, TJ, TR, UA, US

(72) SASSI Stefano

c/o VALENTINO S.p.A. Via Turati, 16/18, I-20121 Milano, Italy

(54) 1. Shoe

(55)

(51) 02-04

(45) 2017/37 (2017 09 22)

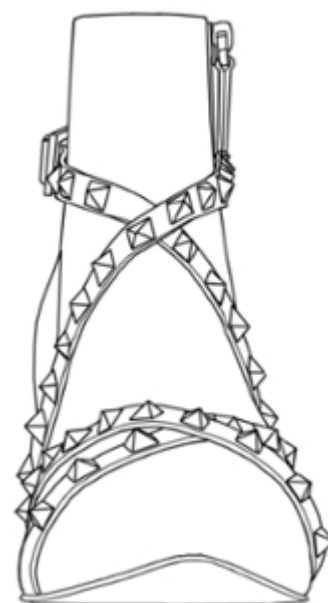
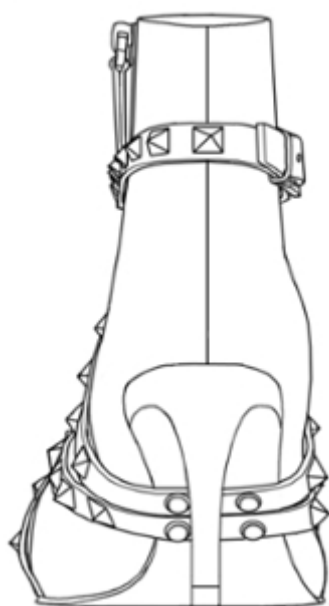
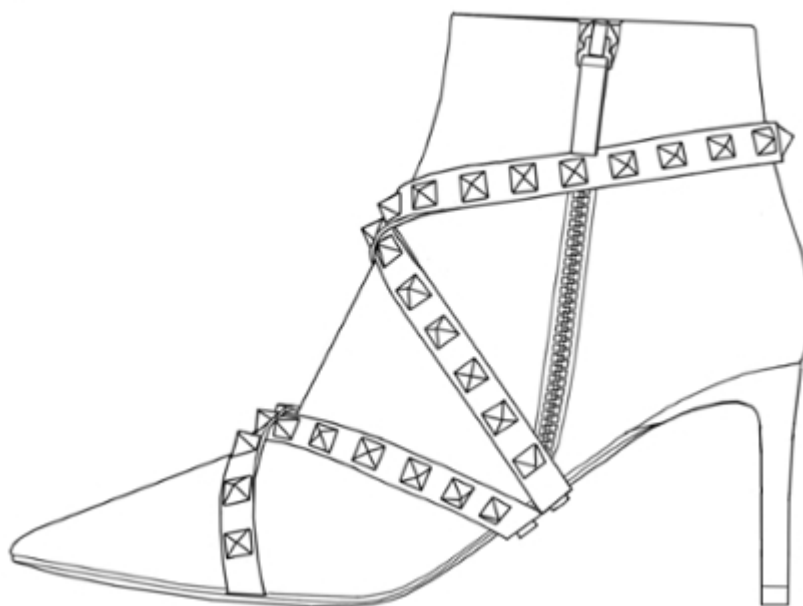
1.1**1.2****1.3****1.4**

1.5



1.6

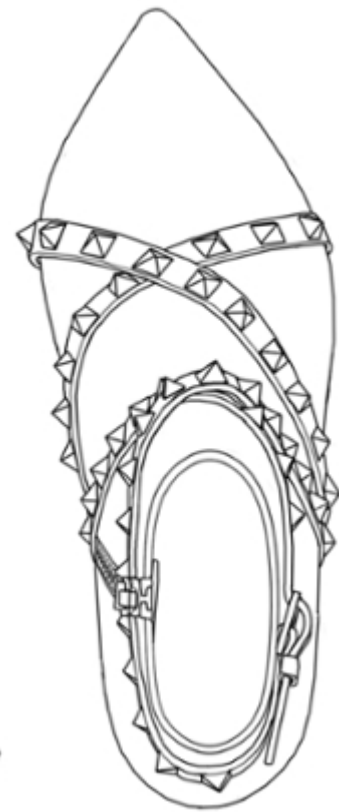

1.7

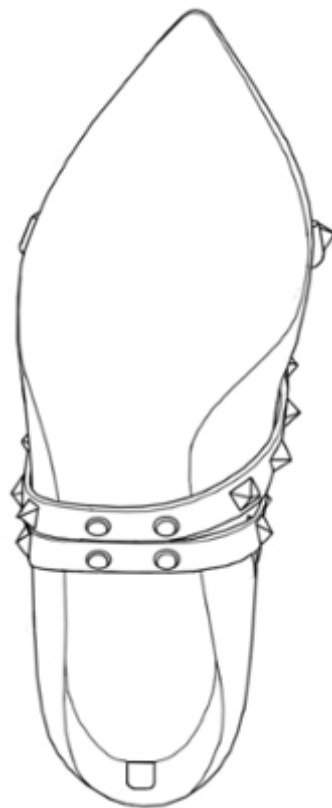

(11) DM/097700

(15) 2017 09 01

(22) 2017 09 01

(28) 1

(73) MARKUSHEVSKYI IGOR ISAAKOVYCH

vul. Bolharska, 82, kv. 8, Odesa 65005 (UA);

MASLENKOV VOLODYMYR MYKOLAIOVYCH

vul. M. Hovorova 1-2, kv. 101, Odesa 65058 (UA);

SHMULEVYCH VITALII NAUMOVYCH

vul. Levanevskoho, 7, kv. 63, Odesa 65062 (UA)

(85) - ; - ; -

(86) UA; UA; UA

(87) - ; - ; -

(88) - ; - ; -

(89) UA; UA; UA

(81) III. AM, AZ, EM, GE, KG

(72) MARKUSHEVSKYI IGOR ISAAKOVYCH

vul. Bolharska, 82, kv. 8, 65005 Odesa, Ukraine;

MASLENKOV VOLODYMYR MYKOLAIOVYCH

vul. M. Hovorova 1-2, kv. 101, 65058 Odesa, Ukraine;

SHMULEVYCH VITALII NAUMOVYCH

vul. Levanevskoho, 7, kv. 63, 65062 Odesa, Ukraine

(54) 1. Bottle

(55)

1.1**1.2**

1.3



1.4

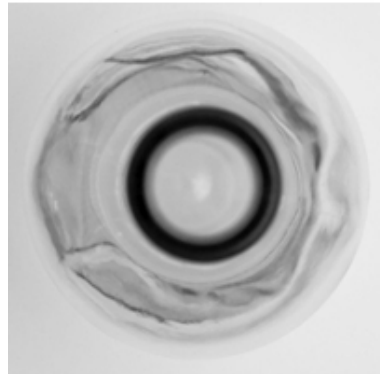

1.5



1.6



TRADEMARKS

APPLICATIONS FILED UNDER THE NATIONAL PROCEDURE APPROVED FOR REGISTRATION

The decision can be appealed at the Chamber of Appeal of Sakpatenti within 3 months from the publication or at the Mtskheta District Court Administrative Cases Board (Address: №17, Samkhedro St., Mtskheta), within 1 month following the publication.

(260) AM 2017 86965 A*
(210) AM 86965
(220) 2016 04 11
(731) HOMAG GROUP AG
Homagstrasse 3-5 D-72296 Schopfloch,
Germany
(740) Tamar Kochlamazashvili
(540)

HOMAG

(511) 7

(260) AM 2017 91090 A
(210) AM 91090
(220) 2017 03 01
(731) "ASPHARMA GEORGIA
PHARMACEUTICAL COMPANY"
Mtskheta q. 8, 0179, Tbilisi, Georgia
(740) Maia Samadashvili
(540)

VESICOFEN
ВЕСИКОФЕН
ვესიკოფენი

(511) 5

(260) AM 2017 91230 A
(210) AM 91230
(220) 2017 03 14
(731) LTD "NUTRIMAX"
Rustavis gzatk. 68a, 0165, Tbilisi,
Georgia
(740) Giorgi Kartvelishvili
(540)



(591) Blue, orange, white
(531) 03.04.18, 03.04.20, 27.05.01, 28.19, 29.01.13
(511) 31

(260) AM 2017 91678 A
(210) AM 91678
(220) 2017 04 12
(731) LTD "MANNA"
I. Abashidzis q. 44, b. 32, 0179, Tbilisi,
Georgia
(540)



(591) PANTONE 568 U
(531) 05.01.16, 05.05.20, 27.05.01, 28.19, 29.01.03
(511) 29, 30, 31

(260) AM 2017 91730 A
(210) AM 91730
(220) 2017 04 14
(731) Diageo Scotland Limited
Edinburgh Park, 5 Lochside Way,
Edinburgh, EH12 9DT, Scotland
(740) Tamar Kochlamazashvili
(540)



(591) Black-white
 (531) 02.01.02; 02.01.04; 19.01.05
 (511) 33

(260) AM 2017 91783 A
 (210) AM 91783
 (220) 2017 04 20
 (731) BLU PRODUCTS, INC.
 10814 NW 33rd St. N100,
 Doral, Florida 33172, USA
 (740) Pavle Meipariani
 (540)

BLU
BOLD LIKE US

(591) Black-white
 (531) 27.05.10
 (511) 9

(260) AM 2017 91846 A
 (210) AM 91846
 (220) 2017 04 26
 (731) LTD "FIERNA"
 L. Gotuas q. 12, 0160, Tbilisi, Georgia
 (740) Giorgi Taktakishvili
 (540)



(591) Red, yellow, green, sky-blue, black
 (531) 26.11.03; 26.11.12; 28.19; 29.01.15
 (511) 1, 5

(260) AM 2017 91847 A
 (210) AM 91847
 (220) 2017 04 26
 (731) LTD "FIERNA"
 L. Gotuas q. 12, 0160, Tbilisi, Georgia
 (740) Giorgi Taktakishvili
 (540)

MONBAND

(591) Black-white
 (531) 27.05.01, 27.05.17
 (511) 1

(260) AM 2017 91848 A
 (210) AM 91848
 (220) 2017 04 26
 (731) LTD "FIERNA"
 L. Gotuas q. 12, 0160, Tbilisi, Georgia

(740) Giorgi Taktakishvili
 (540)

HEBEI MONBAND

(511) 1

(260) AM 2017 91849 A
 (210) AM 91849
 (220) 2017 04 26
 (731) LTD "Kakhetian Traditional Winemaking"
 S. Tsintsadzis q. 12, sart. 3, a/p 3-6, 0160,
 Tbilisi, Georgia
 (740) Ekaterine Gogoladze
 (540)

KTVALLEY

(511) 33

(260) AM 2017 91851 A
 (210) AM 91851
 (220) 2017 04 26
 (731) LTD "FIERNA"
 L. Gotuas q. 12, 0160, Tbilisi, Georgia
 (740) Giorgi Taktakishvili
 (540)

CHELAN

(511) 1

(260) AM 2017 91857 A
 (210) AM 91857
 (220) 2017 04 26
 (731) LTD "VOLI"
 Sop. Tsinubani, 0901, Didi Lilo, Georgia
 (540)

მალზებო
Malzeb
Малзеб

(511) 5

(260) AM 2017 91858 A
 (210) AM 91858
 (220) 2017 04 26
 (731) LTD "VOLI"
 Sop. Tsinubani, 0901, Didi Lilo, Georgia
 (540)

სმერჩი
Smerch
Смерч

(511) 5

(260) AM 2017 91860 A
 (210) AM 91860
 (220) 2017 04 26
 (731) LTD "VOLI"
 Sop. Tsinubani, 0901, Didi Lilo, Georgia
 (540)

ნიფურონი
Nifuron
Нифурон

(511) 5

(260) AM 2017 91861 A
 (210) AM 91861
 (220) 2017 04 26
 (731) LTD "VOLI"
 Sop. Tsinubani, 0901, Didi Lilo, Georgia
 (540)

პენკილერი
Penkiler
Пенкилер

(511) 5

(260) AM 2017 91866 A
 (210) AM 91866
 (220) 2017 04 27
 (731) LTD "ARIC"
 S. Tsintsadzis q. 12, sart. 3, 0160,
 Tbilisi, Georgia
 (740) Tea Iosava
 (540)



(591) Black, sky-blue, orange, green, grey, white
 (531) 01.03.15, 15.07.01, 15.07.03, 27.05.01,
 27.05.10, 28.19
 (511) 29, 31, 32, 33, 35, 37, 39, 41, 42, 43, 44

(260) AM 2017 91879 A
 (210) AM 91879
 (220) 2017 05 01
 (731) LTD "EUROLUX"
 Tchirnakhulis q. 4, 0151, Tbilisi, Georgia
 (740) Sopio Khutchua

(540)

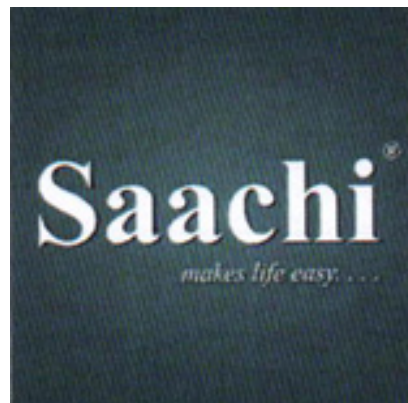

(531) 26.04.22; 26.04.24; 27.05.10; 27.05.24
 (511) 7, 9, 11

(260) AM 2017 91889 A
 (210) AM 91889
 (220) 2017 05 02
 (731) JSC "TBILVINO"
 Sarajishvilis gamz. 2, 0153, Tbilisi, Georgia
 (740) Girogi Taktakishvili
 (540)

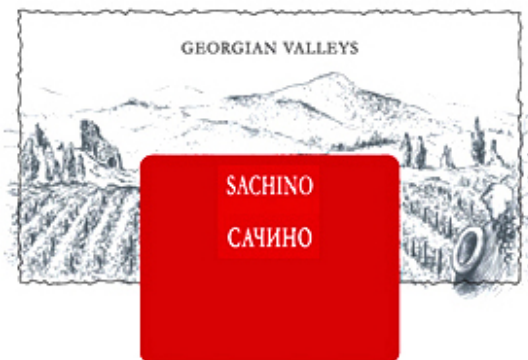

(591) White, red, black
 (531) 06.01.02, 06.19.07, 26.04.22, 26.04.24,
 27.05.24, 29.01.13
 (511) 33

(260) AM 2017 91957 A
 (210) AM 91957
 (220) 2017 05 03
 (731) Yongkang Xulang Industry and Trade Co., Ltd
 No.216 Meilong Roud, Khicheng, Iongkang,
 Jejiang, China
 (740) Shalva Gvaramadze
 (540)

Kzubr

(531) 27.05.17
 (511) 7, 8, 9

(260) AM 2017 91959 A
 (210) AM 91959
 (220) 2017 05 03
 (731) Yongkang Xulang Industry and Trade Co., Ltd
 No.216 Meilong Roud, Khicheng, Iongkang,
 Jejiang, China
 (740) Shalva Gvaramadze
 (540)

ROYCE

(531) 27.05.02
 (511) 7, 8, 9

(260) AM 2017 92102 A
 (210) AM 92102
 (220) 2017 05 11
 (731) Intersun Holding FZCO.
 P.O.Box 61051, Jebel Ali Fri Zon, Dubai,
 United Arab Emirates
 (740) Tamar Kochlamazashvili
 (540)

KƏRƏM

(591) Black-white
 (511) 29, 35

(260) AM 2017 92103 A
 (210) AM 92103
 (220) 2017 05 12
 (731) Meda Consumer Healthcare Inc.
 781 Chestnat Ridj Roudi, EOB 245,
 WV 26505, Morgantown, USA
 (740) Tamar Kochlamazashvili
 (540)

COLD-EEZE

(591) Black-white
 (511) 5

(260) AM 2017 92135 A
 (210) AM 92135
 (220) 2017 05 16
 (731) LTD "OUR FARMER"
 M. Kavtaradzis q. 11, 0180, Tbilisi,
 Georgia
 (740) Melano Gogisvanidze
 (540)



(591) Black, white, sky-blue
 (531) 02.03.04, 20.07.01, 28.19,29.01.13
 (511) 29

(260) AM 2017 92141 A
 (210) AM 92141
 (220) 2017 05 16
 (731) LTD "VOLI"
 Sop. Tsinubani, 0901, Didi Lilo, Georgia
 (540)

დიმანკო
Dimanko
ДИМАНКО

(591) Black-white
 (511) 5

(260) AM 2017 92143 A
 (210) AM 92143
 (220) 2017 05 16
 (731) LTD "VOLI"
 Sop. Tsinubani, 0901, Didi Lilo, Georgia
 (540)

ციმოზებო
Cymozeb
ЦИМОЗЕБ

(591) Black-white
 (511) 5

(260) AM 2017 92187 A
 (210) AM 92187
 (220) 2017 05 17
 (731) Lego Iuris A/s
 Dk-7190 Bilundi, Denmark
 (740) Giorgi Ghvinjilia
 (540)



(591) White, black, red, yellow
 (531) 26.04.22; 26.04.24; 27.05.02; 29.01.14
 (511) 9, 16, 41

(260) AM 2017 92189 A
 (210) AM 92189
 (220) 2017 05 18
 (731) LTD "ORION GROUP"
 I. Chavchavadis gamz. 75, b. 53, 0162,
 Tbilisi, Georgia
 (740) Giorgi Taktakishvili
 (540)



(591) White, lilac
 (531) 26.01.04, 27.05.01, 29.01.13
 (511) 37

(260) AM 2017 92190 A
 (210) AM 92190
 (220) 2017 05 18
 (731) LTD "ORION GROUP"
 I. Chavchavadis gamz. 75, b. 53, 0162,
 Tbilisi, Georgia
 (740) Giorgi Taktakishvili
 (540)



(591) White, lilac
 (531) 26.01.01, 26.01.06, 28.19, 29.01.12
 (511) 37

(260) AM 2017 92213 A
 (210) AM 92213
 (220) 2017 05 18
 (731) Harrington Development Inc.
 Elvira Mendesis Striti, Valarino Bldg,
 3th fl., Panama, Panamis Respublika,
 Panama
 (740) Givi Akopashvili
 (540)

ვილსონი

(591) Black-white
 (511) 34

(260) AM 2017 92471 A
 (210) AM 92471
 (220) 2017 05 30
 (731) INMUSIC BRANDS, INC.
 200 Scenic View Drive Cumberland,
 RI 02864, USA
 (740) Liliana Darakhvelidze
 (540)



(591) Red, white
 (531) 26.04.22, 26.04.24, 27.05.17, 27.05.24,
 29.01.12
 (511) 9, 15

(260) AM 2017 92473 A
 (210) AM 92473
 (220) 2017 05 30
 (731) INMUSIC BRANDS, INC.
 200 Scenic View Drive Cumberland,
 RI 02864, USA
 (740) Liliana Darakhvelidze
 (540)



(591) Black-white
 (531) 27.05.01, 27.05.17
 (511) 9

(260) AM 2017 92480 A
 (210) AM 92480
 (220) 2017 05 30
 (731) INMUSIC BRANDS, INC.
 200 Scenic View Drive Cumberland,
 RI 02864, USA
 (740) Liliana Darakhvelidze
 (540)



(591) Red, white
(531) 26.04.22, 26.04.24, 27.05.10, 27.05.24,
29.01.12
(511) 15

(260) AM 2017 92589 A
(210) AM 92589
(220) 2017 06 07
(731) Mattel, Inc.
333 333 Continental Boulevard, El Segundo,
California 90245, USA
(740) Konstantine Meipariani
(540)



(591) Red, yellow, blue, green, black, white
(531) 26.04.08, 26.04.09, 27.05.02, 27.07.01,
29.01.15
(511) 28

REGISTERED TRADEMARKS

<p>(111) M 2017 29139 R (151) 2017 12 19 (181) 2027 12 19 (260) AM 2016 86027 A (220) 2016 02 08 (732) FENIX OUTDOOR DEVELOPMENT AND CSR AG Industriestrasse 6, 6300 Zug, Switzerland</p> <hr/>	<p>(732) LTD "IVERIA GROUP" Republic Square, Old Tbilisi, 0108, Tbilisi, Georgia</p> <hr/>
<p>(111) M 2017 29140 R (151) 2017 12 19 (181) 2027 12 19 (260) AM 2016 87070 A (220) 2016 04 19 (732) LTD "IVERIA GROUP" Republic Square, Old Tbilisi, 0108, Tbilisi, Georgia</p> <hr/>	<p>(111) M 2017 29145 R (151) 2017 12 19 (181) 2027 12 19 (260) AM 2016 87212 A (220) 2016 05 10 (732) LTD "GEORGIAN WINES HOUSE" Sop. Zegaani, Gurjaanis r-ni, Georgia</p> <hr/>
<p>(111) M 2017 29141 R (151) 2017 12 19 (181) 2027 12 19 (260) AM 2016 87071 A (220) 2016 04 19 (732) LTD "IVERIA GROUP" Republic Square, Old Tbilisi, 0108, Tbilisi, Georgia</p> <hr/>	<p>(111) M 2017 29146 R (151) 2017 12 19 (181) 2027 12 19 (260) AM 2016 87488 A (220) 2016 06 02 (732) LTD "INVINO" M. Lebanidzis q. 17, Tbilisi, Georgia</p> <hr/>
<p>(111) M 2017 29142 R (151) 2017 12 19 (181) 2027 12 19 (260) AM 2016 87072 A (220) 2016 04 19 (732) LTD "IVERIA GROUP" Republic Square, Old Tbilisi, 0108, Tbilisi, Georgia</p> <hr/>	<p>(111) M 2017 29147 R (151) 2017 12 19 (181) 2027 12 19 (260) AM 2016 88158 A (220) 2016 08 03 (732) DÖTERRA HOLDINGS, LLC 389 South 1300 West, Pleasant Grove, Utah 84062, USA</p> <hr/>
<p>(111) M 2017 29143 R (151) 2017 12 19 (181) 2027 12 19 (260) AM 2016 87074 A (220) 2016 04 19 (732) LTD "IVERIA GROUP" Republic Square, Old Tbilisi, 0108, Tbilisi, Georgia</p> <hr/>	<p>(111) M 2017 29148 R (151) 2017 12 19 (181) 2027 12 19 (260) AM 2016 88325 A (220) 2016 08 17 (732) LEPL "GEORGIAN WINE NATIONAL AGENCY" Marshal Gelovanis gamz. 6, 0159, Tbilisi, Georgia</p> <hr/>
<p>(111) M 2017 29144 R (151) 2017 12 19 (181) 2027 12 19 (260) AM 2016 87080 A (220) 2016 04 20</p>	<p>(111) M 2017 29149 R (151) 2017 12 19 (181) 2027 12 19 (260) AM 2016 88345 A (220) 2016 08 19 (732) AMGEN INC. One Amgen Center Drive, Thousand Oaks, California 91320-1799, USA</p> <hr/>

(111) M 2017 29150 R
(151) 2017 12 19
(181) 2027 12 19
(260) AM 2016 88412 A
(220) 2016 08 26
(732) LTD "TETRADA GEORGIA"
Stanislavskis q. 5, 0119, Tbilisi, Georgia

(111) M 2017 29156 R
(151) 2017 12 19
(181) 2027 12 19
(260) AM 2016 88836 A
(220) 2016 10 05
(732) LTD "TSINANDALI OLD CELLAR"
Sop. Tsinandali, Telavi, Georgia

(111) M 2017 29151 R
(151) 2017 12 19
(181) 2027 12 19
(260) AM 2016 88474 A
(220) 2016 09 01
(732) LTD "GEORGIAN VINE AND WINE
COMPANY"
Z. Paliashvilis q. 66, b. 4, 0162, Tbilisi,
Georgia

(111) M 2017 29157 R
(151) 2017 12 19
(181) 2027 12 19
(260) AM 2016 88919 A
(220) 2016 10 11
(732) KIMBERLY-CLARK WORLDWIDE, INC.
Neenah, Wisconsin 54956, USA

(111) M 2017 29152 R
(151) 2017 12 19
(181) 2027 12 19
(260) AM 2016 88475 A
(220) 2016 09 01
(732) LTD "GEORGIAN VINE AND WINE
COMPANY"
Z. Paliashvilis q. 66, b. 4, 0162, Tbilisi,
Georgia

(111) M 2017 29158 R
(151) 2017 12 19
(181) 2027 12 19
(260) AM 2016 89145 A
(220) 2016 10 26
(732) APPLE INC.
1, Infinite Loop, Cupertino, California
95014, USA

(111) M 2017 29153 R
(151) 2017 12 19
(181) 2027 12 19
(260) AM 2016 88675 A
(220) 2016 09 26
(732) KIA MOTORS CORPORATION
231 Yangjae-dong, Seocho-gu, Seoul,
Republic of Korea

(111) M 2017 29159 R
(151) 2017 12 19
(181) 2027 12 19
(260) AM 2016 89243 A
(220) 2016 11 02
(732) AMGEN INC.
One Amgen Center Drive, Thousand Oaks,
California 91320-1799, USA

(111) M 2017 29154 R
(151) 2017 12 19
(181) 2027 12 19
(260) AM 2016 88797 A
(220) 2016 09 30
(732) HIMALAYA GLOBAL HOLDINGS LTD
106 Elizabethan Square, P.O. Box 1162,
Grand Cayman KY1-1102, Cayman Islands

(111) M 2017 29160 R
(151) 2017 12 19
(181) 2027 12 19
(260) AM 2016 89261 A
(220) 2016 11 03
(732) SOIRA INVESTMENTS LIMITED
3076 Sir Francis Drake's Highway, P.O. Box
3463, Road Town, Tortola, British Virgin
Islands

(111) M 2017 29155 R
(151) 2017 12 19
(181) 2027 12 19
(260) AM 2016 88811 A
(220) 2016 10 03
(732) NICOVENTURES HOLDINGS LIMITED
Globe House, 1 Water Street, London,
WC2R 3LA, United Kingdom

(111) M 2017 29161 R
(151) 2017 12 19
(181) 2027 12 19
(260) AM 2016 89266 A
(220) 2016 11 03
(732) PHILIP MORRIS BRANDS SÀRL
Quai Jeanrenaud 3, 2000 Neuchâtel,
Switzerland, Switzerland

(111) M 2017 29162 R
 (151) 2017 12 19
 (181) 2027 12 19
 (260) AM 2016 89268 A
 (220) 2016 11 03

(732) PHILIP MORRIS BRANDS SÀRL
 Quai Jeanrenaud 3, 2000 Neuchâtel,
 Switzerland, Switzerland

(111) M 2017 29168 R
 (151) 2017 12 19
 (181) 2027 12 19
 (260) AM 2016 89489 A
 (220) 2016 11 15

(732) UNIPHARM, INC.
 350 Fifth Avenue, Suite 6701, New York,
 10118, USA

(111) M 2017 29163 R
 (151) 2017 12 19
 (181) 2027 12 19
 (260) AM 2016 89340 A
 (220) 2016 11 08

(732) LTD "MONASTERY GIFT"
 Sop. Ude, 0308, Adigenis r-ni, Georgia

(111) M 2017 29169 R
 (151) 2017 12 19
 (181) 2027 12 19
 (260) AM 2016 89507 A
 (220) 2016 11 16

(732) GULBAHAR TOBACCO INTERNATIONAL
 FZE
 P.O. Box 61401, Jebel Ali Free Zone, Dubai,
 United Arab Emirates

(111) M 2017 29164 R
 (151) 2017 12 19
 (181) 2027 12 19
 (260) AM 2016 89417 A
 (220) 2016 11 10

(732) KIA MOTORS CORPORATION
 231 Yangjae-dong, Seocho-gu, Seoul,
 Republic of Korea

(111) M 2017 29170 R
 (151) 2017 12 19
 (181) 2027 12 19
 (260) AM 2016 89521 A
 (220) 2016 11 17

(732) LTD "FOLOU"
 Z. Panaskerteli-Tsitsishvilis q. 6, b. 37, 0194,
 Tbilisi, Georgia

(111) M 2017 29165 R
 (151) 2017 12 19
 (181) 2027 12 19
 (260) AM 2016 89428 A
 (220) 2016 11 11

(732) LTD "KARTVELI"
 Kakhetis gzat. 110a, Isan-Samgoris r-ni
 Georgia

(111) M 2017 29171 R
 (151) 2017 12 19
 (181) 2027 12 19
 (260) AM 2016 89599 A
 (220) 2016 11 22

(732) LTD "KAKHETIAN TRADITIONAL
 WINEMAKING"
 S. Tsintsadzis q. 12, a/p 3-6, sart. 3, 0160,
 Tbilisi, Georgia

(111) M 2017 29166 R
 (151) 2017 12 19
 (181) 2027 12 19
 (260) AM 2016 89456 A
 (220) 2016 11 15

(732) British American Tobacco (Brands) Inc.
 (a Delaware corporation)
 2711 Centerville Road, Suite 300,
 Wilmington, Delaware 19808, USA

(111) M 2017 29172 R
 (151) 2017 12 19
 (181) 2027 12 19
 (260) AM 2016 89603 A
 (220) 2016 11 22

(732) LTD "KAKHETIAN TRADITIONAL
 WINEMAKING"
 S. Tsintsadzis q. 12, a/ p 3-6, sart. 3, 0160,
 Tbilisi, Georgia

(111) M 2017 29167 R
 (151) 2017 12 19
 (181) 2027 12 19
 (260) AM 2016 89457 A
 (220) 2016 11 15

(732) British American Tobacco (Brands) Inc.
 (a Delaware corporation)
 2711 Centerville Road, Suite 300,
 Wilmington, Delaware 19808, USA

(111) M 2017 29173 R
 (151) 2017 12 19
 (181) 2027 12 19
 (260) AM 2016 89615 A
 (220) 2016 11 24

(732) JSC "INSURANCE COMPANY TAO"

Pushkinis q. 3, Old Tbilisi, 0105, Tbilisi, Georgia	(732) LTD "ASKANGEL ALLIANCE" Sop. Dvabzu, 3500, Ozurgeti, Gerogia
(111) M 2017 29174 R (151) 2017 12 19 (181) 2027 12 19 (260) AM 2016 89617 A (220) 2016 11 24 (732) PHILIP MORRIS PRODUCTS S.A. Quai Jeanrenaud 3, 2000 Neuchâtel, Switzerland	(111) M 2017 29180 R (151) 2017 12 19 (181) 2027 12 19 (260) AM 2016 89962 A (220) 2016 12 13 (732) LTD "SHANGRILA SPA" Mtsvane q. 1, Batumi, Georgia
(111) M 2017 29175 R (151) 2017 12 19 (181) 2027 12 19 (260) AM 2016 89759 A (220) 2016 12 01 (732) ASTRAZENECA AB SE-151 85 Södertälje, Sweden	(111) M 2017 29181 R (151) 2017 12 19 (181) 2027 12 19 (260) AM 2016 89978 A (220) 2016 12 14 (732) LTD "GEORGIAN LEGAL CONSULTING COMPANY" P. Kavtaradzis q. 1a, 0186, Tbilisi, Georgia
(111) M 2017 29176 R (151) 2017 12 19 (181) 2027 12 19 (260) AM 2016 89880 A (220) 2016 12 08 (732) WESTERN DIGITAL TECHNOLOGIES, INC. Delaware corporation 3355 Michelson Drive, Suite 100, Irvine California 92612, USA	(111) M 2017 29182 R (151) 2017 12 19 (181) 2027 12 19 (260) AM 2016 89991 A (220) 2016 12 15 (732) LTD "DELUX GROUP" Ts. Dadianis q. 34, korp. 3, b. 34, 0180, Tbilisi, Georgia
(111) M 2017 29177 R (151) 2017 12 19 (181) 2027 12 19 (260) AM 2016 89895 A (220) 2016 12 12 (732) KRAFT FOODS SCHWEIZ HOLDING GMBH Chollerstrasse 4, Zug 6301, Switzerland	(111) M 2017 29183 R (151) 2017 12 19 (181) 2027 12 19 (260) AM 2016 90011 A (220) 2016 12 19 (732) LTD "NOBLEX" Shanidzis q. 8, 0179, Tbilisi, Georgia
(111) M 2017 29178 R (151) 2017 12 19 (181) 2027 12 19 (260) AM 2016 89896 A (220) 2016 12 12 (732) KRAFT FOODS SCHWEIZ HOLDING GMBH Chollerstrasse 4, Zug 6301, Switzerland	(111) M 2017 29184 R (151) 2017 12 19 (181) 2027 12 19 (260) AM 2016 90035 A (220) 2016 12 21 (732) PHILIP MORRIS BRANDS SÀRL Quai Jeanrenaud 3, 2000 Neuchâtel, Switzerland
(111) M 2017 29179 R (151) 2017 12 19 (181) 2027 12 19 (260) AM 2016 89898 A (220) 2016 12 12	(111) M 2017 29185 R (151) 2017 12 19 (181) 2027 12 19 (260) AM 2016 90044 A (220) 2016 12 22 (732) PHILIP MORRIS BRANDS SÀRL Quai Jeanrenaud 3, 2000 Neuchâtel, Switzerland

(111) M 2017 29186 R (151) 2017 12 19 (181) 2027 12 19 (260) AM 2016 90045 A (220) 2016 12 22 (732) PHILIP MORRIS BRANDS SÀRL Quai Jeanrenaud 3, 2000 Neuchâtel, Switzerland	Akara Bldg., 24 De Castro Street, Wickhams Cay 1, Road Town, Tortola, British Virgin Islands, GB
(111) M 2017 29187 R (151) 2017 12 19 (181) 2027 12 19 (260) AM 2016 90097 A (220) 2016 12 23 (732) INDEVCO LIMITED Akara Bldg., 24 De Castro Street, Wickhams Cay 1, Road Town, Tortola, British Virgin Islands, GB	(111) M 2017 29192 R (151) 2017 12 19 (181) 2027 12 19 (260) AM 2016 90105 A (220) 2016 12 23 (732) INDEVCO LIMITED Akara Bldg., 24 De Castro Street, Wickhams Cay 1, Road Town, Tortola, British Virgin Islands, GB
(111) M 2017 29188 R (151) 2017 12 19 (181) 2027 12 19 (260) AM 2016 90099 A (220) 2016 12 23 (732) INDEVCO LIMITED Akara Bldg., 24 De Castro Street, Wickhams Cay 1, Road Town, Tortola, British Virgin Islands, GB	(111) M 2017 29193 R (151) 2017 12 19 (181) 2027 12 19 (260) AM 2016 90120 A (220) 2016 12 26 (732) CARABAO TAWANDANG COMPANY LIMITED 393 Silom Building, 7th-10th Floor, 393 Silom Road, Silom, Bangrak, Bangkok 10500, Thailand
(111) M 2017 29189 R (151) 2017 12 19 (181) 2027 12 19 (260) AM 2016 90100 A (220) 2016 12 23 (732) INDEVCO LIMITED Akara Bldg., 24 De Castro Street, Wickhams Cay 1, Road Town, Tortola, British Virgin Islands, GB	(111) M 2017 29194 R (151) 2017 12 19 (181) 2027 12 19 (260) AM 2016 90139 A (220) 2016 12 26 (732) ABBOTT LABORATORIES 100 Abbott Park Road, Abbott Park, Illinois, 60064, USA
(111) M 2017 29190 R (151) 2017 12 19 (181) 2027 12 19 (260) AM 2016 90101 A (220) 2016 12 23 (732) INDEVCO LIMITED Akara Bldg., 24 De Castro Street, Wickhams Cay 1, Road Town, Tortola, British Virgin Islands, GB	(111) M 2017 29195 R (151) 2017 12 19 (181) 2027 12 19 (260) AM 2016 90149 A (220) 2016 12 28 (732) Belorussko-Germanskoe Sovmestnoe Predpriyatie "Santa Bremor" Obshchestvo s Ogranichennoy Otvetstvennostyu ul. Katin Bori, 106, Brest, 224025, Belorus republic, Belarus
(111) M 2017 29191 R (151) 2017 12 19 (181) 2027 12 19 (260) AM 2016 90104 A (220) 2016 12 23 (732) INDEVCO LIMITED	(111) M 2017 29196 R (151) 2017 12 19 (181) 2027 12 19 (260) AM 2016 90151 A (220) 2016 12 28 (732) LTD "SHOP.GE" Topurias q. 12, 0186, Tbilisi, Georgia

(111) M 2017 29197 R

(151) 2017 12 19

(181) 2027 12 19

(260) AM 2016 90157 A

(220) 2016 12 28

(732) LTD "DIPLOMAT GEORGIA"

T. Chantladzis q., I shesakh. 10, Tbilisi,

Georgia

(732) KRAFT FOODS SCHWEIZ HOLDING

GMBH

Chollerstrasse 4, Zug 6301, Switzerland

(111) M 2017 29198 R

(151) 2017 12 19

(181) 2027 12 19

(260) AM 2016 90158 A

(220) 2016 12 28

(732) NISSAN JIDOSHA KABUSHIKI KAISHA

(also trading as Nissan Motor Co., Ltd.)

No.2, Takara-cho, Kanagawa-ku, Yokohama-shi,

Kanagawa-ken, Japan

(111) M 2017 29199 R

(151) 2017 12 19

(181) 2027 12 19

(260) AM 2016 90159 A

(220) 2016 12 28

(732) KRAFT FOODS DANMARK

INTELLECTUAL PROPERTY APS

Sondre Ringvej 55, Brøndby DK-2605,

Denmark

(111) M 2017 29200 R

(151) 2017 12 19

(181) 2027 12 19

(260) AM 2016 90160 A

(220) 2016 12 28

(732) KRAFT FOODS DANMARK

INTELLECTUAL PROPERTY APS

Sondre Ringvej 55, Brøndby DK-2605,

Denmark

(111) M 2017 29201 R

(151) 2017 12 19

(181) 2027 12 19

(260) AM 2017 90331 A

(220) 2017 01 09

(732) AMAZON EUROPE CORE S.À R.L.

5, Rue Plaetis, L-2338 Luxembourg,

Luxembourg

(111) M 2017 29202 R

(151) 2017 12 19

(181) 2027 12 19

(260) AM 2017 90372 A

(220) 2017 01 11

TRADEMARKS REGISTERED ACCORDING TO THE ACCELERATED PROCEDURE

The decision can be appealed at the Chamber of Appeal of Sakpatenti within 3 months from the publication.

(111) M 2017 29134 R
(151) 2017 12 08
(181) 2027 12 08
(210) AM 95199
(220) 2017 11 24
(732) LTD "SAMOTSDATSAMETI"
Kiachelis q. 28, Tbilisi, Georgia
(740) Vakhtang Torotadze
(541)

ჰობი ჰობი

(511) 35

(111) M 2017 29135 R
(151) 2017 12 08
(181) 2027 12 08
(210) AM 95343
(220) 2017 12 04
(732) LTD "APTOS"
20/4 of Orbeliani street, 0105, Tbilisi,
Georgia
(540)

APTOS

(591) Black, white
(531) 26.11.12, 27.05.11
(511) 10, 41, 42, 44

(111) M 2017 29136 R
(151) 2017 12 14
(181) 2027 12 14
(210) AM 95303
(220) 2017 11 30
(732) JAPAN TOBACCO INC.
2-2-1 Toranomon, Minato-Ku, Tokyo, Japan
(740) Shalva Gvaramadze
(540)

WINSTON TRUE QUALITY
(511) 34

(111) M 2017 29137 R
(151) 2017 12 15
(181) 2027 12 15
(210) AM 95200
(220) 2017 11 26
(732) ALI SEDIGHI
Lublianas q. 13, Tbilisi, Georgia

(740) Ekaterine Magalashvili
(540)

HUBER

(591) Black, white
(531) 26.11.02, 26.11.08, 27.05.11, 27.05.17
(511) 7

(111) M 2017 29138 R
(151) 2017 12 18
(181) 2027 12 18
(210) AM 95354
(220) 2017 12 05
(732) LTD "ITECHNIC"
I. Khvichias q. 15a, b. 13, 0160, Tbilisi, Georgia
(540)



iTechnics

(591) Black, grey, sky-blue
(531) 26.01.06, 27.05.05, 29.01.13
(511) 35

(111) M 2017 29203 R
(151) 2017 12 19
(181) 2027 12 19
(210) AM 95345
(220) 2017 12 04
(732) LTD "POYRAZ GROUP"
Tchirnakhulis q. 9, 0151, Tbilisi,
Georgia

(540)



(591) Lilac, blue, green, red
 (531) 27.05.03, 29.01.14
 (511) 5

(111) M 2017 29204 R

(151) 2017 12 20

(181) 2027 12 20

(210) AM 95513

(220) 2017 12 12

(732) ALCHAWAF GROUP FOR
 INDUSTRY & TRADE LIMITED Liability
 Company Co. (AL Afrah Detergents)
 P.O. Box 334, Hama, Syrian Arab Republic

(740) Shalva Gvaramadze

(540)

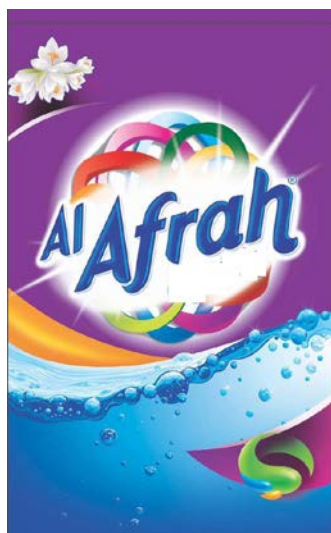

(591) Black, white, yellow, different tons of blue,
 red, orange, green, sky-blue
 (531) 01.15.09, 01.15.15, 01.15.21, 01.15.23,
 05.05.02, 25.01.19, 29.01.15
 (511) 3

(111) M 2017 29205 R

(151) 2017 12 20

(181) 2027 12 20

(210) AM 95514

(220) 2017 12 12

(732) ALCHAWAF GROUP FOR
 INDUSTRY & TRADE LIMITED Liability
 Company Co. (AL Afrah Detergents)
 P.O. Box 334, Hama, Syrian Arab Republic

(740) Shalva Gvaramadze

(540)



(591) Black, white, yellow, different tons of blue,
 red, orange, green, sky-blue
 (531) 01.15.09, 01.15.15, 01.15.21, 01.15.23,
 05.05.04, 25.01.19, 27.05.01, 27.05.02,
 29.01.15
 (511) 3

INTERNATIONAL TRADEMARKS FOR WHICH A DECISION ON GRANTING PROTECTIONS IS TAKEN

The decision can be appealed at the Chamber of Appeal of Sakpatenti within 3 months from the publication or at the Mtskheta District Court Administrative Cases Board (Address: №17, Samkhedro str., Mtskheta), within 1 month following the publication.

(260) AM 2017 87320 A*
 (800) 129727
 (891) 2016 05 12
 (731) FASHION TELEVISION INTERNATIONAL
 S.A. 35a, avenue J-F Kennedy, L-1855
 Luxembourg
 (540)



(591) black and white
 (511)
 38 – Telecommunications, information on telecommunications, satellite transmission, teleconferencing services, audio transmission via the Internet, television program broadcasting, video transmission, Internet transmission [webcasting].
 41 – Entertainment services, editing of radio and television programs, information regarding recreational activities, production of radio and television programs, rental of radio and television sets, television entertainment programs.

(260) AM 2017 87517 A*
 (800) 1298793
 (891) 2016 06 02
 (731) Rigo Trading S.A. Route de Trèves
 6 EBBC, Building, E L-2633 Senningerberg,
 Luxembourg
 (540)

GOLDBÄREN

(511)
 30 – Confectionery.

(260) AM 2017 87563 A*
 (800) 1298788
 (891) 2016 06 02
 (731) RIGO TRADING S.A. ROUTE DE TRÈVES

6 EBBC, Building E L-2633 Senningerberg,
 Luxembourg
 (540)

GOLD-BEARS

(511)
 30 – Confectionery.

(260) AM 2017 90436 A
 (800) 1327172
 (891) 2016 09 30
 (731) KYLE BURNS
 La Tour Shibakoen 3010, 3-8-2 Shiba,
 Minato-ku Tokyo 105-0014, Japan
 (540)

Open Time

(511)
 35 – Advertising and publicity services; business management analysis or business consultancy; marketing research or analysis; providing information concerning commercial sales.

36 – Electronic commerce payment services.

41 – Educational and instruction services relating to arts, crafts, sports or general knowledge; arranging, conducting and organization of seminars; providing electronic publications; publication of books; organization, arranging and conducting of sports competitions; production of videotape film in the field of education, culture, entertainment or sports [not for movies or television programs and not for advertising or publicity]; organization of entertainment events excluding movies, shows, plays, musical performances, sports, horse races, bicycle races, boat races and auto races

42 – Providing computer programs on data networks; computer software design, computer programming, or maintenance of computer software; creation, design, development, and maintenance of websites.

(260) AM 2017 90705 A
 (800) 1329865
 (891) 2016 08 04
 (731) LEONARDO S.P.A.
 Piazza Monte Grappa 4, I-00195 Roma,
 Italy

(540)



(591) Black, white

(511)

35 – Business management in the field of aircraft, helicopters and armoured fighting vehicles; business management in the field of systems, sensors and electronics for defence, security, traffic management and space technology and services; business management in the field of Information and Communications Technology (ICT); business administration in the field of aircraft, helicopters and armoured fighting vehicles; business administration in the field of systems, sensors and electronics for defence, security, traffic management and space technology and services; business administration in the field of Information and Communications Technology (ICT); business management consulting with relation to strategy, financing, marketing, production, personnel and sales matters for companies involved with aircraft, helicopters, armoured fighting vehicles, systems, sensors and electronics for defence, security and traffic management, space technology and services, and Information and Communications Technology (ICT).

37 – Installation, maintenance and repair services (hardware) relating to electronics; installation, maintenance and repair services of air, land and naval defense systems and sensors; installation, maintenance and repair services of traffic management systems; installation, maintenance and repair services of aircraft, helicopters and armored fighting vehicles; providing information relating to the installation, repair or maintenance of aircraft, helicopters, armored fighting vehicles and electronics; installation of aeronautical engines; servicing of aeronautical engines; maintenance and repair of spacecraft; installation, maintenance (hardware) and repair services in the fields of aircraft and helicopters, armored fighting vehicles, systems, sensors and electronics for defence, security and traffic management and space technology and services; installation, maintenance (hardware) and repair services in the field information and communications technology.

38 – Telecommunication services; telecommunication services, namely, transmission of voice, data/ documents and videos/images, in the military, security and civil fields.

41 – Training services in relation to aircraft and helicopters, armoured fighting vehicles, systems, sensors and electronics for defence and security, space

technology and services, traffic management and IT products and services.

42 – Consultation and research in the field of aerospace engineering; technical research in the field of aircraft, electronics for defence and security, aeronautics, defence systems and space technology; development of security systems and contingency planning for information systems; planning and development of electronic communications networks; design and development of electronic data security systems; development of technologies for the fabrication of circuits for wireless communication, electronic data processing, consumer electronic, automotive electronics; technology specification, namely, analysing technology requirements and developing recommendations for the computer software and systems and other technology needed to meet those requirements, in the fields of aircraft, electronics for defence and security, aeronautics, defence systems and space technology; consulting services in the field of testing of electronic components and electronic systems; aircraft design services; design of computer programs and software relating to aircraft; development of aircraft; design and development of electronic database software; development of technologies for the protection of electronic networks; scientific and technological services and research and design relating thereto; industrial analysis and research services; design and development of computer hardware and software; computer programming; scientific and technological services, modelling and development, design and technological consultancy in relation to aircraft and helicopters, armoured fighting vehicles, systems, sensors and electronics for defence and security, space technology and services, traffic management and IT products and services; installation, maintenance and repair of software relating to electronics; installation, maintenance and repair of software; installation and maintenance of software in the fields of aircraft and helicopters, armored fighting vehicles, systems, sensors and electronics for defence, security and traffic management and space technology and services; installation and maintenance of software in the field information and communications technology.

(260) AM 2017 90759 A

(800) 1329532

(891) 2016 11 14

(731) SHANDONG HONGSHENG RUBBER CO., LTD.

Dongzhangzhuang Village, Dawang Town, Guangrao County, Dongying City, 257300 Shandong Province, China

(540)

GRIPBOND

(591) black and white

(511)
12 – Automobile tires; inner tubes for bicycles, cycles; tubeless tires for bicycles, cycles; casings for pneumatic tires; treads for retreading tires; pneumatic tires; tires, solid, for vehicle wheels; vehicle wheel tires; inner tubes for pneumatic tires; bicycle tires.

(260) AM 2017 90818 A
(800) 1329798
(891) 2016 08 16
(731) PHILIP MORRIS PRODUCTS S.A.
Quai Jeanrenaud 3, CH-2000 Neuchâtel,
Switzerland
(540)

STEEM

(511)
9 – Batteries for electronic cigarettes; batteries for electronic devices that are used for heating tobacco, chargers for electronic devices that are used for heating tobacco; USB chargers for electronic devices that are used for heating tobacco; car chargers for electronic cigarettes; car chargers for devices that are used for heating tobacco; battery chargers for electronic cigarettes.

11 – Electronic vaporizers except electronic cigarettes; apparatus for heating liquids; apparatus for generating vapor.

34 – Wired vaporizers for electronic cigarettes and electronic smoking devices; tobacco, raw or manufactured; tobacco products, including cigars, cigarettes, cigarillos, tobacco for roll-your-own cigarettes, pipe tobacco, chewing tobacco, snuff tobacco, kretek; snus; tobacco substitutes (not for medical purposes); smokers' articles, including cigarette paper and tubes, cigarette filters, tobacco tins, cigarette cases and ashtrays, pipes, pocket apparatus for rolling cigarettes, lighters; matches; tobacco sticks, tobacco products for the purpose of being heated, electronic devices and their parts for the purpose of heating cigarettes or tobacco in order to release nicotine-containing aerosol for inhalation; liquid nicotine solutions for use in electronic cigarettes; electronic smoking devices; electronic cigarettes; electronic cigarettes as substitute for traditional cigarettes; electronic devices for the inhalation of nicotine-containing aerosol; oral vaporizing devices for use by smokers, tobacco products and tobacco substitutes; smokers' articles for electronic cigarettes; parts and fittings for the aforesaid products included in this class; extinguishers for heated cigarettes and cigars as well as heated tobacco sticks; electronic rechargeable cigarette cases.

(260) AM 2017 90838 A
(800) 1330341
(891) 2016 09 22

(731) CREADDICT, SARL
161 rue Saint-Honoré, F-75001 Paris, France
(540)

redLine

(591) red
(511)
14 – Jewelry; jewelry; precious stones; precious metals and their alloys; jewelry cases (caskets) or boxes of precious metal; cases of precious metal; bracelets, chains, necklaces; rings (jewelry), earrings, brooches, fancy key rings.

(260) AM 2017 90839 A
(800) 1330044
(891) 2016 09 01
(731) TİM TANITIM ORGANİZASYON İÇ VE
DIS TİCARET ANONİM ŞİRKETİ
Sanayi Caddesi, Dış Ticaret Kompleksi,
B Blok, Yenibosna, Bahçelievler – İstanbul,
Turkey
(540)



(591) Blue, green
(511)
35 – Advertising, marketing and public relations; organization of exhibitions and trade fairs for commercial or advertising purposes; office functions; secretarial services; arranging newspaper subscriptions for others; compilation of statistics; rental of office machines; systemization of information into computer databases; telephone answering for unavailable subscribers; business management, business administration and business consultancy; accounting; commercial consultancy services; personnel recruitment, personnel placement, employment agencies, import-export agencies; temporary personnel placement services; auctioneering.

41 – Education and training; arranging and conducting of conferences, congresses and seminars; sporting and cultural activities; entertainment; ticket reservation and booking services for entertainment, sporting and cultural events, including ticket reservation and booking services for theatres, cinemas, museums and concerts; publication and editing of

printed matter, including magazines, books, newspapers, other than publicity texts; electronic publication services; production of movie films, radio and television programmes; news reporters services; photographic reporting services; photography; translation.

(260) AM 2017 90840 A

(800) 1330050

(891) 2016 08 19

(731) ADP GAUSELMANN GMBH

Merkur-Allee 1-15, 32339 Espelkamp,
Germany

(540)

The Great Scatterino

(511)

9 – Scientific, nautical, surveying, photographic, cinematographic, optical, weighing, measuring, signalling, checking (supervision), life-saving and teaching apparatus and instruments; apparatus and instruments for conducting, switching, transforming, accumulating, regulating or controlling electricity; apparatus for recording, transmission or reproduction of sound or images; magnetic data carriers, recording discs; compact discs, DVDs and other digital recording media; cash registers, calculating machines, data processing equipment, computers; computer software; fire-extinguishing apparatus; musical jukeboxes and parts for the aforesaid automatic machines; automatic cash dispensers, automatic money counting and money changing machines; mechanisms for coin-operated apparatus; computer and video games software; games software for use on any computer platform, including electronic entertainment and games consoles; computer game programs; computer games (programs for-); computer games; video games (software); computer games provided through a global computer network or supplied by means of multimedia electronic broadcast or through telecommunications or electronic transmission or via the internet; computer games, leisure and recreational software, video games and computer software, all provided in the form of storage media; programs for operating electric and electronic apparatus for games, amusement and/or entertainment purposes; automatic lottery machines; computer software for computer games on the internet; online games (software), in particular for online betting games, online prize games, online gambling games, online games of skill and online casino games; computer software in the form of an app for mobile devices and computers; calculating apparatus in coin-operated machines and parts for the aforesaid goods; apparatus for recording, transmission, processing or reproduction of data, including sound or images, including parts for all the aforesaid goods, except radio sets, television receivers, hi-fi systems, video recorders, telephone apparatus, fax machines and telephone answer-

ring machines; computer hardware and software for casino and amusement arcade games, for gaming machines, slot machines or video lottery gaming machines or games of chance via the internet; electric, electronic, optical or automatic apparatus, for identifying data carriers, identity cards and credit cards, bank notes and coins; electric, electronic or optical alarm and monitoring installations, including video cameras and apparatus for image transmission and image processing; data processing equipment and computers, including data processing apparatus and computers being components for data networks and parts facilitating data network communications; electric wiring harnesses; circuit boards, printed board assemblies (electronic components) and combinations thereof being assemblies and equipment parts, included in this class.

28 – Games; toys; gymnastic and sporting articles not included in other classes; decorations for Christmas trees; gaming apparatus (including coin-operated apparatus); coin-operated arcade games (machines); games for amusement arcades (included in this class); coin-operated video gaming apparatus; video games apparatus adapted for use with external screens or monitors only; casino fittings, namely roulette tables, roulette wheels; coin-operated automatic gaming machines and gaming machines, in particular for gaming arcades, with or without a prize payout; electronic or electrotechnical gaming apparatus, gaming machines, gaming machines and slot machines operated by coins, tokens, banknotes, tickets or by means of electronic, magnetic or biometric storage media, in particular for commercial use in casinos and amusement arcades, with or without a prize payout; automatic gaming machines and gaming machines, in particular for commercial use in casinos and gaming arcades, with or without a prize payout; coin-operated gaming machines and/or electronic money-based gaming apparatus (machines), with or without prizes; housings adapted for gaming machines, gaming apparatus and automatic gaming machines, operated by means of coins, tokens, tickets or by means of electronic, magnetic or biometric storage media, in particular for commercial use in casinos and gaming arcades, with or without a prize payout; electronic games; apparatus for electronic games and parts thereof; video output game machines; drawing apparatus for prize games and lotteries, draws or raffles; housings of metal, plastic and/or wood for coin-operated automatic machines; apparatus for games (including video games), other than adapted for use with external screens or monitors only; electropneumatic and electric slot machines with pulling handles (gaming machines); gaming tables, in particular for table football, billiards, sliding games; quoits (playthings) and darts; gaming machines, namely, electric, electronic or electromechanical apparatus for bingo games, lotteries or video lottery games and for betting offices, connected or uncon-

nected to a computer network; LCD games consoles; automatic gaming machines; apparatus and devices for accepting and storing money, being fittings for the aforesaid automatic machines, included in this class.

(260) AM 2017 90844 A

(800) 1330407

(891) 2016 10 26

(731) SATIUS LLC

ofis 192, etaj 2, korp. 3, d. 38, prospect
Andropova, RU-115487 Moscow, Russian
Federation

(540)

PROSTATEST

(591) black and white

(511)

10 – Surgical, medical, dental and veterinary apparatus and instruments; diagnostic apparatus for medical purposes; blood testing apparatus; testing apparatus for medical purposes; diagnostic devices for medical purposes.

(260) AM 2017 90849 A

(800) 1330533

(891) 2016 10 10

(731) APPLE INC.

1 Infinite Loop, Cupertino CA 95014,
United States of America

(540)



(591) pink, yellow, turquoise and black

(511)

9 – Computer software for tracking, storing, viewing, monitoring, displaying, transmitting, managing and sharing data concerning exercise, physical activity, steps taken, distance walked or run, time standing or sitting, calories consumed, calories burned; computer software for tracking, monitoring, managing and sharing information and goals regarding a health and fitness program; computer software for wireless communication devices, wearable wireless communication devices, and mobile digital electronic devices; computer software for social networking.

(260) AM 2017 90853 A

(800) 663678

(891) 2016 10 24

(731) OBO BETTERMANN GMBH. & CO. KG.

52, Hüingser Ring, 58710 Menden, Germany

(540)



(591) Black, white

(531) 26.11.08, 27.05.11, 27.05.23

(511)

6 – Ironware products, weld pins, pin welding components, materials for electrotechnical installations, namely pipe rings and cable clamps, rings for power lines, clamps, shaped rails, slotted bands, parts for cable conduits, metal pins, nails, threaded bolts; materials for television aerial and metric wave installations, namely post fasteners; sanitary installation equipment, namely flanges, pipes, flanges in rows for pipes, gutter hooks, radiator consoles, radiator racks, clips for heating pipes, clips for plastic pipes, pipe mounting devices, structural elements for protection against lightning, namely grounding rings; wall conduits, suspended and underground, preformed in metal for installation purposes, metal cable shelves and guides; metal cable carrier devices for conserving operational functionality in case of fire, metal carrier devices for cables providing protection against earthquakes.

9 – Equipment for electrotechnical installations, namely junction boxes, plugs and junction boxes, crossings for sealed bushings, grounding materials, namely cross-shaped grounding conductors, pipes and soil components; materials for installing television aerials and metric wave installations; installation elements for protection against lightning, namely lightning conductor rods, roof bushing, cable fittings, connection terminals for cables and flat and round conductors, gullies in the ground, connection parts, backflow preventers; electrical devices for voltage surge protection; electrical devices for soldering pins; electrical devices and instruments for measuring, signalling and monitoring, devices for recording, transmission and reproduction of electrical signals; data carriers for magnetic tapes, data processing equipment and computers.

20 – Electrotechnical installation materials, namely plastic clamps for cables and pipes, plastic dowels; plastic cable conduits and cable boxes, preformed for installation purposes; plastic cable shelves and guides for installation purposes; plastic grommets with screws.

(260) AM 2017 90887 A
(800) 1331643
(891) 2016 11 22
(731) APPLE INC.

1 Infinite Loop, Cupertino CA 95014, United States of America

(540)

TAPBACK

(511)

9 – Computer software for use in messaging and communication.

(260) AM 2017 90957 A
(800) 1331112
(891) 2016 09 12
(731) VALIO LTD

Meijeritie 6, FI-00370 Helsinki, Finland

(540)

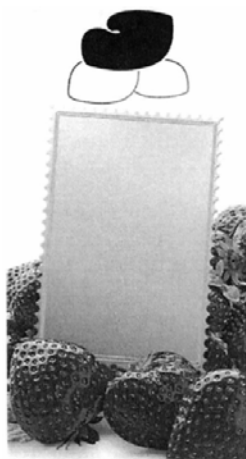

(591) Black, white

(531) 05.07.08, 25.01.01, 26.04.02, 26.13.25

(511)

29 – Meat, fish, poultry and game; meat extracts; preserved, frozen, dried and cooked fruits and vegetables; jellies, jams, compotes; eggs; milk and milk products; edible oils and fats; dairy substitutes; smetana [sour cream]; prostokvasha [soured milk]; whey; milk powders, dried whey products and whey powders, yogurt; yogurt drinks; drinks made from dairy products; cheese; drinking yogurts; whiteners [dairy] for beverages; double cream; milk ferments for culinary purposes; cheese spreads; peanut milk for culinary purposes; beverages made from or containing milk; butter; lactic acid bacteria drinks; fruit purees, vegetable purees; prepared meals and snacks containing any of the aforesaid goods.

(260) AM 2017 90961 A
(800) 1331184
(891) 2016 10 06

(731) LIVISTO Group GmbH

Im Südfeld 9, 48308 Senden-Bösensell, Germany

(540)

LIVISTO
Along with you

(591) Black, white

(531) 26.01.24, 26.04.09, 27.05.01, 27.05.10

(511)

3 – Grooming and cleaning preparations for animals; products for animal body care and animal beauty care; deodorants for animal use; dentifrices for animals; cosmetics for animals; shampoos for animals.

5 – Pharmaceutical and veterinary preparations; dietetic preparations adapted for medical purposes; disinfectants; preparations for destroying noxious animals; medicated animal feed, including animal feed additive for use as a nutritional supplement for medical purposes and supplements for animal feed; animal feed supplements for veterinary purposes; dietetic foods for veterinary use; supplements for animal feed, for non-medical and for medical purposes.

31 – Animal feed.

(260) AM 2017 91008 A
(800) 1331714
(891) 2016 10 21
(731) PRESTIGE-96 AD

98 Nikola Gabrovski str., BG-5000 Veliko Turnovo, Bulgaria

(540)



(591) dark green, light green, green

(531) 24.17.07, 24.17.09, 27.05.03, 27.07.03, 29.01.12

(511)

16 – Paper; cardboard; printed matter; placards of paper or cardboard; pamphlets; viscose sheets for wrapping; labels, not of textile; gummed tape [stationery]; graphic representations; catalogues; flyers; wrappers [stationery]; prospectuses; advertisement boards of paper or cardboard; self-adhesive tapes for stationery or household purposes; self-adhesive bands for stationery or household purposes; bags [envelopes, pouches] of paper or plastics, for packaging.

30 – Coffee, teas and cocoa and substitutes therefor; edible ices; sugar, honey, treacle; flour; preparations made from cereals; bread; pastries; confectionery.

32 – Beers; mineral and aerated waters and other non-alcoholic beverages; fruit beverages and fruit juices; syrups and other preparations for making beverages.

35 – Advertising; business management.

(260) AM 2017 91010 A

(800) 1331717

(891) 2016 12 20

(731) BPC PROPHARMA HOLDING LIMITED
11 Boumpoulinas Street, 1st Floor, CY-1060
Nicosia, Cyprus

(540)

Pravenor

(511)

5 – veterinary preparations; food for babies; vitamin preparations; dietetic substances adapted for medical use; dietetic beverages adapted for medical purposes; dietetic foods adapted for medical purposes; disinfectants for hygiene purposes; dressings, medical; tissues impregnated with pharmaceutical lotions; sticking plasters for medical purposes; herbicides; pesticides.

29 – Albumen for culinary purposes; seaweed extracts for food; nuts, prepared; gelatine for food; yolk of eggs; soya milk [milk substitute]; edible fats; edible oils; fish-based foodstuffs; pollen prepared as foodstuff; milk products; vegetables, preserved; vegetables, cooked; vegetables, dried; fruit chips; fruit, preserved; crystallized fruits; meat; fish, not live.

(260) AM 2017 91018 A

(800) 1331842

(891) 2016 04 14

(731) XIAOMI SINGAPORE PTE. LTD.
12 Marina View, #23-01 Asia Square Tower
2, Singapore 018961, Singapore

(540)



(591) black and white

(531) 27.05.17, 27.05.23

(511)

7 – Draining machines; grinders (machines); milking machines; animal shearing machines; sawing machines; paper machines; printing machines; machines for the textile industry; dyeing machines; tea processing machines; electric food preparation machines; cigarette machines for industrial purposes; leat-

her tanning machines; leather paring machines; ironing machines; bicycling assembling machines; machines for the making of pottery; engraving machine; battery operated spraying machines; mechanical rope reels; machines for coiling ropes; pulleys of metal for use with rope (parts of machines); rope making machines; machines for packing; mixers (machines); dishwashers; soybean reaping cutters (machines); industrial washing machines; washing machines for household purposes; washing machines incorporating drying facilities; machines for glass working; glassware manufacturing machines; electromechanical machines for chemical industry; cutting machines; apparatus for use in drilling; apparatus for lifting; machine tools for use in the maintenance of electric installations; die-casting machines; steam engines; carburetors; wind turbines; industrial sewing machines; knives (parts of machines); industrial robots; electric scissors; bicycle dynamos; machines for cleaning cooling air filters in engines; centrifuges; pressure controllers (regulators) being parts of machines; pressure controllers (valves) being parts of machines; air compressors; door closers, electric; electric gas bearing; electric welding machines; instruments (machines) for cleaning the exterior of vehicles; instruments (machines) for cleaning the interior of vehicles; cleaning machines for industrial installations; cleaning machines for pipelines; cleaning machines for machine tools; electric cleaning machines; apparatus for the removal of dust from buildings; electric dust removing (cleaning apparatus); dust removing installations for cleaning purposes; dust separators; apparatus (machines) for filtering; curtain drawing devices, electrically operated; electric shoe cleaning (polishing) machines; electroplating machines.

11 – Electric lamps; lighting lamps; lighting apparatus and installations; lighting devices for showcases; lampshades; flashlights; apparatus for the lighting of vehicle; germicidal lamps for air purification; electric cookers; cooking apparatus and installations; kitchen stoves; cooking ovens; electric pressure cookers; electric kettles; water heaters; refrigerators; refrigeration installations; refrigeration units; electric air deodorizing apparatus for refrigerators; air filtering apparatus; air conditioning apparatus; air filtration installations; air dryers; clothes dryers; dryers for the hands using a warm air drying stream; drying apparatus; air conditioning fans; electric cooling fans; ventilation (air-conditioning) installations and apparatus; apparatus for ventilating vehicles; electric fans; electric hair dryers; hot water heaters; electric heating apparatus; installations for heating consisting of halogen heating devices; heaters for heating irons; electric heaters; apparatus for water supply purposes; fireplaces, domestic; tap water faucets; apparatus for heating; temperature control apparatus (valves) for central heating radiators; automatic watering installations; bath installations; bath fittings;

sanitary apparatus and installations; toilets [water-closets]; apparatus for disinfection; apparatus for water purification; apparatus for water filtering; machines for the processing (purification) of sewage; water softeners (apparatus); disposable sterilization pouches; portable electric heaters; lighters.

37 – Advisory services for maintenance; electrical apparatus installation; electrical apparatus repair; electrical wiring services; electrical installation services; installation and repair of air conditioning apparatus; air conditioning vent sealing services; installation, maintenance and repair of computer hardware; rebuilding machines that have been worn or partially destroyed; rebuilding engines that have been worn or partially destroyed; office machines and equipment installation, maintenance and repair; machinery installation, maintenance and repair; kitchen equipment installation; installation of sanitary apparatus; installation of lighting systems; repair or maintenance of electric lighting apparatus; repair of bathtubs; vehicle maintenance and repair; car cleaning services; aircraft maintenance and repair; photographic equipment repair; watch repair or maintenance; retreading of tires [tyres]; furniture maintenance; furniture repair; leather care, cleaning and repair; fur care, cleaning and repair; burglar alarm installation and repair; repair or maintenance of telephone apparatus; umbrella repair; remounting of jewellery; repair, maintenance and repair of sporting equipment; interior decoration (installation, renovation or repair services); cleaning of building interiors; lock repair services; locksmithing services being the installation, repair and maintenance of locks and locking systems; spray painting; insecticide spraying, other than for agricultural, horticultural and forestry purposes; vehicle maintenance; maintenance and repair of electronic apparatus; repair or maintenance of medical machines and apparatus.

(260) AM 2017 91033 A

(800) 1332181

(891) 2016 09 09

(731) PHILIP MORRIS BRANDS SÀRL
Quai Jeanrenaud 3, CH-2000 Neuchâtel,
Switzerland

(540)



(591) green and white

(531) 26.04.09, 26.11.12, 27.05.24

(511)

34 – Tobacco, raw or manufactured; tobacco products; cigars, cigarettes, cigarillos, tobacco for roll-your-own cigarettes, pipe tobacco, chewing tobacco, snuff tobacco, kretek; snus; tobacco substitutes (not for medical purposes); electronic cigarettes; tobacco products for the purpose of being heated; electronic devices and their parts for the purpose of heating cigarettes or tobacco in order to release nicotine-containing aerosol for inhalation; liquid nicotine solutions for use in electronic cigarettes; smokers' articles, cigarette paper, cigarette tubes, cigarette filters, tobacco tins, cigarette cases, ashtrays, pipes, pocket apparatus for rolling cigarettes, lighters, matches.

(260) AM 2017 91037 A

(800) 1332213

(891) 2016 07 01

(731) Obshchestvo s ogranichennoy
otvetstvennostyu "KOMPLEKS-BAR"
Stariy Petrovsko-Razumovskiy proezd, 10,
RU-125167 Moscow, Russian Federation

(540)



(591) Cherry, black, white, gray, pale pink

(531) 11.03.02, 11.03.06, 26.01.21, 29.01.15

(511)

8 – Spoons; table cutlery [knives, forks and spoons]; silver plate [knives, forks and spoons]; table forks; cutlery.

16 – Paper; waxed paper; electrocardiograph paper; copying paper [stationery]; parchment paper; writing paper; rice paper; luminous paper; toilet paper; wrapping paper; filter paper; paper sheets [stationery]; paper for recording machines; stuffing of paper or cardboard; placards of paper or cardboard; packing [cushioning, stuffing] materials of paper or cardboard; cardboard; cardboard tubes; signboards of paper or cardboard; boxes of cardboard or paper; bottle envelopes of cardboard or paper; bottle wrappers of cardboard or paper; advertisement boards of paper or cardboard; wood pulp board [stationery]; photographs [printed]; adhesives [glues] for stationery or household purposes; printed matter; catalogues; booklets; pamphlets; envelopes [stationery]; postcards; greeting cards; musical greeting cards; transfers [decalcomanias]; decals; stickers [stationery];

office requisites, except furniture; labels, not of textile; table linen of paper; table napkins of paper; tablemats of paper; handkerchiefs of paper; towels of paper; coasters of paper; mats for beer glasses; bags [envelopes, pouches] of paper or plastics, for packing.

20 – Dinner wagons [furniture]; showcases [furniture]; towel stands [furniture]; benches [furniture]; coatstands; washstands [furniture].

21 – Kitchen utensils; tableware, other than knives, forks and spoons; saucepan scourers of metal; coffee services [tableware]; services [dishes]; tea services [tableware]; cooking pots; earthenware; porcelain ware; pots; pottery; dish covers; mixing spoons [kitchen utensils]; basting spoons [cooking utensils]; spatulas [kitchen utensils]; grills [cooking utensils]; molds [kitchen utensils]; garlic presses [kitchen utensils]; cooking utensils, non-electric; tortilla presses, non-electric [kitchen utensils].

35 – Advertising; procurement services for others [purchasing goods and services for other businesses]; commercial information and advice for consumers [consumer advice shop]; outsourcing services [business assistance]; sales promotion for others; search engine optimization for sales promotion; pay per click advertising; on-line ordering services; all these services relating to serving bars, restaurants.

(260) AM 2017 91039 A

(800) 1332218

(891) 2016 06 23

(731) Otkrytoe aktsionernoe obshchestvo
"NEVSKAYA KOSMETIKA"
prospect Oboukhovskoy oborony, 80,
RU-192029 Saint-Petersburg, Russian
Federation

(540)



(591) Yellow, light purple, green, light blue, dark blue and white.

(531) 26.01.19, 27.05.01, 28.05, 29.01.15

(511)

3 – Abrasives; scale removing preparations for household purposes; aromatics [essential oils]; air fragrancing preparations; breath freshening sprays; canned pressurized air for cleaning and dusting purposes; balms other than for medical purposes; lip glosses; petroleum jelly for cosmetic purposes; cotton wool for cosmetic purposes; sachets for perfuming linen; drying agents for dishwashing machines; toilet

water; laundry wax; massage gels other than for medical purposes; dental bleaching gels; perfumes; windshield cleaning liquids / windscreen cleaning liquids; perfumery; quillaia bark for washing; colorants for toilet purposes; cosmetic dyes; creams for leather; waxes for leather; cosmetic creams; skin whitening creams; hair spray; nail polish; hair lotions; lotions for cosmetic purposes; after-shave lotions; beauty masks; oils for perfumes and scents; oils for cosmetic purposes; oils for toilet purposes; essential oils of citron; oils for cleaning purposes; bergamot oil; gaultheria oil; jasmine oil; lavender oil; almond oil; rose oil; oil of turpentine for degreasing; almond milk for cosmetic purposes; cleansing milk for toilet purposes; soap; disinfectant soap; deodorant soap; shaving soap; cakes of toilet soap; medicated soap; antiperspirant soap; soap for foot perspiration; almond soap; cosmetic kits; cotton sticks for cosmetic purposes; dentifrices; breath freshening strips; lipsticks; pomades for cosmetic purposes; shaving preparations; cosmetic preparations for baths; toiletries; laundry soaking preparations; douching preparations for personal sanitary or deodorant purposes [toiletries]; denture polishes; mouthwashes, not for medical purposes; refurbishing preparations; fabric softeners for laundry use; laundry bleach; dry-cleaning preparations; make-up removing preparations; nail care preparations; cleaning preparations; preparations for cleaning dentures; laundry preparations; aloe vera preparations for cosmetic purposes; sunscreen preparations; scouring solutions; tissues impregnated with cosmetic lotions; potpourris [fragrances]; bleaching soda; washing soda, for cleaning; bath salts, not for medical purposes; bleaching salts; cosmetic preparations for skin care; mascara; detergents other than for use in manufacturing operations and for medical purposes; cloths impregnated with a detergent for cleaning; shampoos; ethereal essences.

5 – Balms for medical purposes; antiseptic cotton; wadding for medical purposes; glycerine for medical purposes; air deodorising preparations; deodorants for clothing and textiles; lotions for pharmaceutical purposes; sunburn ointments; babies' diapers [napkins]; pomades for medical purposes; aloe vera preparations for pharmaceutical purposes; sanitary towels; sanitary pads; panty liners [sanitary]; chewing gum for medical purposes; tissues impregnated with pharmaceutical lotions; mouthwashes for medical purposes; detergents for medical purposes; babies' napkin-pants.

(260) AM 2017 91047 A

(800) 1332500

(891) 2016 05 12

(731) WORLD MEDICINE İLAÇ SANAYİ VE
TİCARET ANONİM ŞİRKETİ
Evren Mah. Camiyolu Cad. No.50 K.1 B

Zemin 4-5-6,GÜNESLI/BAGCILAR/IS-TANBUL, Turkey

(540)

GESTERGEN
ГЕСТЕРГЕН

(591) Black, white

(531) 27.05.01, 28.05

(511)

5 – Medicines for human purposes, medicines for veterinary purposes, vitamin preparations, chemical preparations for medical purposes, dietetic substances adapted for medical use: dietetic foods adapted for medical purposes, baby foods, medicinal herbs, herbal beverages adapted for medical purposes, nutritional supplements, pollen dietary supplements, mineral food supplements, protein dietary supplements; dietary supplements for animals, fodder supplements for veterinary purposes; medicines for dental purposes, hygienic products for medical purposes including sanitary pads, breast-nursing pads and bunion pads, waddings for medical purposes, plasters for medical purposes, dressings for medical purposes, babies' napkins, preparations for destroying noxious plants, preparations for destroying noxious animals, fungicides, deodorants other than for human beings or for animals, air deodorising preparations, disinfectants for hygiene purposes, antiseptics, detergents for medical purposes.

(260) AM 2017 91057 A

(800) 1332573

(891) 2016 11 01

(731) Soulimov Georgiy Yuryevich

Korolenko Street, d. 7, korp. 2, kv. 16,

RU-107076 Moscow, Russian Federation

(540)

PRODETOXON

(511)

5 – Pharmaceutical preparations.

(260) AM 2017 91069 A

(800) 1332635

(891) 2016 05 12

(731) WORLD MEDICINE İLAÇ SANAYİ VE
TİCARET ANONİM ŞİRKETİ

Evren Mah. Camiyolu Cad. No.50 K.1 B

Zemin 4-5-6 GÜNESLI/BAGCILAR/IS-TANBUL, Turkey

(540)

BIRATER
БИРАТЕР

(591) Black, white

(531) 27.05.01, 28.05

(511)

5 – Medicines for human purposes, medicines for veterinary purposes, vitamin preparations, chemical preparations for medical purposes, dietetic substances adapted for medical use; dietetic foods adapted for medical purposes; baby foods, medicinal herbs, herbal beverages adapted for medical purposes, nutritional supplements, pollen dietary supplements, mineral food supplements, protein dietary supplements; dietary supplements for animals; fodder supplements for veterinary purposes, medicines for dental purposes, hygienic products for medical purposes including sanitary pads, breast-nursing pads and bunion pads, waddings for medical purposes, plasters for medical purposes, dressings for medical purposes, babies' napkins, preparations for destroying noxious plants, preparations for destroying noxious animals, fungicides, deodorants other than for human beings or for animals, air deodorising preparations, disinfectants for hygiene purposes, antiseptics, detergents for medical purposes.

(260) AM 2017 91073 A

(800) 1332676

(891) 2016 09 12

(731) VALIO LTD

Meijeritie 6, FI-00370 Helsinki, Finland

(540)



(591) Beige, white, blue, green, brown and red.

(531) 03.04.02, 05.03.06, 06.19.11, 25.01.01,

26.13.25, 29.01.15

(511)

29 – Meat, fish, poultry and game; meat extracts; preserved, frozen, dried and cooked fruits and vegetables; jellies, jams, compotes; eggs; milk and milk products; edible oils and fats; dairy substitutes; smetana [sour cream]; prostokvasha [soured milk]; whey; milk powders, dried whey products and whey powders, yogurt; yogurt drinks; drinks made from dairy products; cheese; drinking yogurts; whiteners [dairy] for beverages; double cream; milk ferments for culinary purposes; cheese spreads; peanut milk for culinary purposes; beverages made from or

containing milk; butter; lactic acid bacteria drinks; fruit purees, vegetable purees; prepared meals and snacks containing any of the aforesaid goods.

(260) AM 2017 91079 A

(800) 1332677

(891) 2016 09 12

(731) VALIO LTD

Meijeritie 6,FI-00370 Helsinki, Finland

(540)

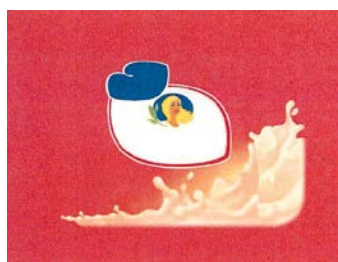

(591) Red, blue, yellow, green, beige and white.

(531) 02.03.01, 08.03.01, 26.04.16, 26.13.25, 29.01.15

(511)

29 – Meat, fish, poultry and game; meat extracts; preserved, frozen, dried and cooked fruits and vegetables; jellies, jams, compotes; eggs; milk and milk products; edible oils and fats; dairy substitutes; smetana [sour cream]; prostokvasha [soured milk]; whey; milk powders, dried whey products and whey powders, yogurt; yogurt drinks; drinks made from dairy products; cheese; drinking yogurts; whiteners [dairy] for beverages; double cream; milk ferments for culinary purposes; cheese spreads; peanut milk for culinary purposes; beverages made from or containing milk; butter; lactic acid bacteria drinks; fruit purees, vegetable purees; prepared meals and snacks containing any of the aforesaid goods.

(260) AM 2017 91175 A

(800) 1333153

(891) 2016 08 09

(731) LABORATOIRES DE BIOLOGIE

VEGETALE YVES ROCHER

La Croix des Archers, F-56200 LA

GACILLY, France

(540)



(591) Black, white

(531) 26.01.18, 26.11.12, 27.05.01, 27.05.22

(511)

3 – Deodorants for personal use; perfumes; perfumery products for cosmetic use; home perfuming products excluding vaporizers.

(260) AM 2017 91233 A

(800) 1333949

(891) 2016 10 20

(731) Tovarishchestvo s ogranichennoy otvetstvennostyu "ASIA SU KOMPANIASY" ul. Kunayeva, 1301, 050010 Almaty, Kazakhstan

(540)



XAOMA

ECOVODKA

(591) Black, white

(531) 24.05.01, 24.15.01, 27.05.10

(511)

33 – Vodka.

(260) AM 2017 91235 A

(800) 1333966

(891) 2016 11 09

(731) Zakrytoe aktsionernoe obshchestvo "KERAMOGNANITNY ZAVOD" Starositnenskoe shosse, vladenie 32, g. Stupino, RU-142800 Moskovskaya oblast, Russian Federation

(540)



(591) Black, white

(531) 27.05.21, 27.05.22, 27.07.17

(511)

19 – Ceramic tiles; tiles of porcelain stoneware; ceramic slabs; porcelain stoneware slabs; non-metallic tiles; wall tiles, not of metal; wall tiles for bathrooms, not of metal; wall tiles for kitchens, not of metal.

(260) AM 2017 91237 A
 (800) 1333984
 (891) 2016 12 08
 (731) GABOR SHOES AKTIENGESELLSCHAFT
 Marienberger Strasse 31, 83024 Rosenheim,
 Germany
 (540)



(591) Blue and black
 (531) 01.15.24, 27.05.10, 29.01.12
 (511)
 25 – Clothing, footwear, in particular women's shoes, headgear.

(260) AM 2017 91238 A
 (800) 1333985
 (891) 2016 12 08
 (731) GABOR SHOES AKTIENGESELLSCHAFT
 Marienberger Strasse 31, 83024 Rosenheim,
 Germany
 (540)



(591) Blue
 (531) 01.15.24, 29.01.04
 (511)
 25 – Clothing, footwear, in particular women's shoes, headgear.

(260) AM 2017 91239 A
 (800) 1334003
 (891) 2016 03 25
 (731) NEXTEV CO., LTD
 Suite 115, 569 Anchi Road, Anting Town,
 Jiading District, 201805 Shanghai, China
 (540)

WE!

(591) Black, white
 (531) 24.17.04

(511)
 12 – Sport cars; cars; motors for land vehicles; tires for vehicle wheels; steering wheels for vehicles.
 37 – Motor vehicle maintenance and repair; car washing; anti-rust treatment for vehicles; vehicle breakdown assistance [repair]; vehicle battery charging.

(260) AM 2017 91242 A
 (800) 1333698
 (891) 2017 01 18
 (731) MERCK KGAA
 Frankfurter Str. 250, 64293 Darmstadt,
 Germany
 (540)

MAVENCLAD

(511)
 5 – Dietetic preparations and dietetic food supplements; hygiene preparations and articles; medical and veterinary preparations and articles; pharmaceutical products.

(260) AM 2017 91302 A
 (800) 1334594
 (891) 2016 02 05
 (731) MOBILE.DE GMBH
 Marktplatz 1, 14532 Europarc Dreilinde,
 Germany
 (540)



(591) Orange, black, white
 (531) 24.17.02, 25.05.01, 26.04.01, 26.04.04, 26.04.22, 27.05.17, 29.01.13
 (511)
 9 – Recorded content; databases (electronic); computer databases; directories [downloadable electronic publications]; computer digital maps; recorded media data [magnetic and electronically]; electronic publications recorded in computer media; instruction manuals and training manuals in electronic format; downloadable image files; electronic publications (downloadable); audio visual recordings; computer software; programs for computers; software downloadable from the internet; interfaces for computers; computer programs for accessing and using the internet; computer programs for use in telecommunications; software for document management, for data processing and for database management; software to facilitate electronic commerce; software for accessing information directories that may be downloaded from the global computer network; software for processing market information; software to enable the searching of data; search engine software; software relating to financial transactions,

monetary matters and finance management; software for creating searchable databases of information and data, software for enterprise resource planning, inventory management and inventory monitoring; software for managing customer data; content management system software; games software; computer operating systems; electronic blackboards; process controlling software; software for facilitating secure credit card transactions; education software; applications (software) for portable communications devices; downloadable web-based applications for portable communications devices or computers; computer software and applications for portable communications devices and computers for creating, editing, publishing, viewing, searching and saving classified advertisements, in particular for an online vehicle market for the purchase and sale of new and used vehicles, vehicle trailers, motorcycles, building and agricultural machines, containers, boats and other water vehicles, and parts and fittings for vehicles, motorcycles, building and agricultural machines, boats and water vehicles; computer software and applications for portable communications devices and computers for creating, editing, publishing, viewing, searching and arranging of automotive vehicle services and of repair services for vehicles, vehicle trailers, motorcycles, building and agricultural machines, containers, boats and other water vehicles; software for comparing of insurances; software for comparing of funds, in particular loans; information technology and audiovisual equipment; communications equipment; computer networking and data communications equipment; apparatus for the transmission of data; point-to-point communications equipment; broadcasting equipment; antennas and aerials as communications apparatus; data storage devices; pre-recorded compact discs, DVDs, HD DVDs, UHD discs and blu-ray discs; USB flash drives; magnetic data carriers; replicating apparatus; photocopiers; printers; image scanners; data processing equipment and accessories (electrical and mechanical); electronic agendas; calculators; ticket dispensers; payment terminals, money dispensing and sorting devices; coin-operated mechanisms; peripherals adapted for use with computers; mouse pads; computers and computer hardware; file and electronic mail servers; computer components and parts; flash memory card; pocket calculators; audio apparatus, visual and photographic devices; radio tuners; car radios; car audio apparatus; display devices, television receivers and film and video devices; image capturing and developing devices; signal cables for IT, AV and telecommunication; magnets, magnetizers and demagnetizers; cathodic anti-corrosion apparatus, electrolyzers, ionization apparatus not for the treatment of air or water, ozonizers [ozonators]; apparatus, instruments and cables for electricity; apparatus and instruments for accumulating and storing electricity; batteries for lighting; apparatus and

instruments for controlling electricity; photovoltaics; electric and electronic components; electric cables and wires, in particular starter cables for motors and jump leads; electric circuits and circuit boards; antennas and aerials as components; optical devices, enhancers and correctors; optical enhancers; lasers; optical goods; corrective eyewear; sunglasses; spectacle cases; safety, security, protection and signalling devices; alarms and warning equipment; access control devices; signalling apparatus; vehicle breakdown warning triangles; head guards for sports and eye protection devices; fire extinguishers and fire drenchers; alarm and warning equipment, namely alarms, alarm systems; signalling apparatus, namely vehicle breakdown warning triangles, warning lamps for vehicles; protection and safety equipment, namely fire blankets; diving equipment; navigation, guidance, tracking, targeting and map making devices; navigation apparatus for vehicles; measuring, detecting and monitoring instruments, indicators and controllers; surveillance apparatus; sensors and detectors; testing and quality control devices; counting, alignment and calibrating instruments; computerized vehicle engine analyzers; diagnostic apparatus, not for medical purposes; controllers (regulators); scientific research and laboratory apparatus, educational apparatus and simulators; vehicle drive training simulators; and parts and fittings of all the aforesaid goods, included in the class.

16 – Works of art and figurines of paper and cardboard, and architects' models; decoration and art materials and media; arts, crafts and modelling equipment; filtering materials of paper; bags and articles for packaging, wrapping and storage of paper, cardboard or plastics; stationery and educational supplies; office requisites, except furniture; writing and stamping implements; correcting and erasing implements; office machines [office requisites]; printing and bookbinding equipment [office requisites]; teaching materials [except apparatus]; photo albums and collectors' albums; glue for stationery or household use; printed matter; transfers [decalcomanias]; tear-off calendars; advent calendars; stickers [stationery], in particular vehicle bumper stickers; newspapers; periodicals; photographs [printed]; books; pamphlets; guide books; computer software operating manuals; forms, printed; paper and cardboard; money holders; disposable paper products; flags of paper; paper pennants; and parts and fittings of all the aforesaid goods, included in the class.

25 – Headgear; hats; clothing; motorists' clothing; gloves [clothing]; rainwear; scarfs; neck scarfs [mufflers]; neckties; ascots; ear muffs [clothing]; tee-shirts; sports jerseys; footwear; and parts and fittings of all the aforesaid goods, included in the class.

28 – Sporting articles and equipment; sportballs; frisbees; festive decorations for Christmas trees and artificial Christmas trees; fairground and playground

apparatus; toys, games, playthings and novelties; racing car games; parlor games; dominoes; board games; card games; chess games; puzzles; balls for games; radio-controlled toy vehicles; scale model vehicles; toy model hobby craft kits; toy vehicles; educational teaching games, in particular electronic educational teaching games for kids; spools for throwing, incorporating coiled string which unwinds and rewinds returning the spool to the hand; kites; play balloons; plush toys; video game apparatus, namely handheld computer games; hand held units for playing video games; and parts and fittings of all the aforesaid goods, included in the class.

35 – Advertising, marketing and promotional services; updating of advertising information in a computer data base; preparing audio-visual presentations for use in advertising; banner advertising; arranging and placing of advertisements (for others); production of advertising material; advertising services provided by the internet; classified advertising, also through portals and platforms on the internet, in particular for the purchase and sale of new and used vehicles, vehicle trailers, motorcycles, building and agricultural machines, containers, boats and other water vehicles and parts and fittings for vehicles, motorcycles, building and agricultural machines, boats and water vehicles; classified advertising, also through portals and platforms on the internet, in particular for automotive vehicle services and for repair services for vehicles, vehicle trailers, motorcycles, building and agricultural machines, containers, boats and other water vehicles; search engine marketing services; web site traffic optimisation; search engine optimisation; pay per click advertising; advertisements (placing of -); collecting and compilation of directories of goods, services, addresses and branches of trade and the information contained therein; advertising of the sale and purchase of vehicles, vehicle trailers, motorcycles, building and agricultural machines, containers, boats and other water vehicles and parts and fittings for vehicles, motorcycles, building and agricultural machines, boats and water vehicles; advertising for automotive vehicle services and for repair services for vehicles, vehicle trailers, motorcycles, building and agricultural machines, containers, boats and other water vehicles; public relations services; product demonstration and product display services; display services for merchandise; presentation of services and sales demonstration [for others]; demonstration of goods and services by electronic means; presentations of companies as well as goods and services on the internet and other analog and digital media [for others]; organization of trade shows and exhibitions for commercial or advertising purposes; conducting, hosting and organizing of exhibitions, fairs, events and shows for commercial, promotional and advertising purposes; loyalty, incentive and bonus program services; provision of advertising space, time

and media, in particular for classified advertising on global computer and wireless networks; provision of computerised advertising services; provision of space in web-sites for advertising goods and services; distribution of advertising, marketing and promotional material; direct mail advertising; dissemination of advertisements and commercial announcements, in particular for others via internet and portable communications devices; advertising, marketing and promotional consultancy, advisory and assistance services; press advertising consultancy; marketing assistance; commercial trading and consumer information services, namely mediation of trade business for third parties, mediation of agreements regarding the sale and purchase of goods, bidding quotation, price comparing services; consumer consultancy in relation to the selection of goods and services, in particular using test and researching results and ratings by third parties; auctioneering services, namely on the internet; rental of vending machines; business contact services; collective buying services; commercial evaluation services; competition arrangements for advertising and commercial purposes; distributorship services; import and export services; administrative ordering services; procurements services for others; subscription services; online and mail order retail services relating to new and used land and water vehicles, vehicle trailers and motorcycles, and vehicle and motorcycle parts; business assistance, management and administrative services; preparations of audio and/or visual displays for business; market reporting services; help in the management of business affairs or commercial functions of an industrial or commercial enterprise; accountancy, book keeping and auditing; financial statement preparation and analysis for businesses; computerised accounting; computerised auditing; computerised accounting; provision of reports relating to accounting information; drawing up of statements of accounts; preparation of accounts; accounting; business accounts management; administrative data processing; computerized file management; computerised business information processing services; information services relating to data processing; automated data processing; consultancy relating to data processing; computerized file management; database management, in particular computerized data processing; data research in computer files for others; on-line data processing services; systemization of information into computer databases; processing of business survey results; human resources management and recruit services; industrial management consultation including cost/yield analysis; business advisory and information services; computerised business promotion; computerised office management; preparation of documents relating to business; company record keeping [for others]; operation of businesses [for others]; outsourcing services [business assistance]; administration of bu-

business affairs; clerical services; secretarial services; business consultancy and advisory services; advice relating to business acquisition; business management consulting in relation to strategy, marketing, production, personnel and public relations services; establishing a network of business contacts (service to assist in -); arranging of business introductions; professional business consulting; business organisational project planning and management services for advertising purposes; presentation of companies on the internet, on portable communications devices and on other electronic media; rental of office machines; addressing of envelopes; document copying services; business document preparation; invoicing; business analysis, research and information services; market information services relating to market statistics and sale of market statistics; provision of on-line business and commercial information; information and expert opinions relating to companies and business; provision of statistical information relating to business; analysis of business statistics; benchmarking services for business management purposes; conducting of business appraisals; providing business information via website; business surveys; provision of computerised business statistics; provision of sales analyses; cost price analysis; provision of visitor statistics, in particular for advertisements on the internet; provision of analyses of relevance and consequences of advertising; conduction market surveys; price analysis services; collection and systematization of business data; acquisition of business information relating to company activities; provision of business data; compilation and systematization of information into computer databases; data compilation and data management for others; compilation of statistics; compilation of mailing lists; compilation of directories for publishing on global computer networks on the internet; business information services provided on-line from a computer database or the internet; business statistical information services; economic analysis for business purposes; business analyses services; professional consultancy relating to data processing; rental, hire and leasing in connection with the aforesaid, included in the class; advice, consultancy and information for the aforesaid, included in the class.

36 – Insurance services; consulting and information concerning insurance; brokerage advisory services relating to insurance; insurance premium rate computing; computerised information services relating to insurance; computerised comparison of insurances, insurance coverages and insurance premiums; provision of insurance premium quotations; insurance brokerage and arranging of insurance, in particular via the internet or portable communications devices; insurance underwriting and appraisals and assessment for insurance purposes; warranty services; real estate services; rent collection; pawnbrokerage; issuance of prepaid cards and tokens; safe deposit ser-

vices; financial and monetary services, and banking; comparison of finance services, in particular credits, hire-purchase contracts, trade-ins and other finance and funding services; banking and financing services; trusteeship representatives; brokerage of finance services; brokerage of arranging the provision of finance, credit and finance services; currency trading and exchange services; securities and commodities trading services; loan and credit, and lease-finance services; lease-purchase financing; financing and lease-purchase financing relating to automobiles; debt recovery and factoring services; financial investment; fund investment; financial underwriting and securities issuance (investment banking); financial transfers and transactions, and payment services; cash, check (cheque) and money order services; tax and duty payment services; financial information, data, advice and consultancy services; computerised financial advisory services; financial rating and credit reports; valuation services; fundraising and sponsorship; valuations and financial appraisal services; evaluation of vehicles, vehicle trailers, motorcycles, building and agricultural machines, containers, boats and other water vehicles; rental, hire and leasing in connection with the aforesaid, included in the class; advice, consultancy and information for the aforesaid, included in the class.

38 – Telecommunication services, in particular computer communication and internet access services; telecommunication services via internet portals; providing access to content, websites and portals for the purchase and sale of vehicles, vehicle trailers, motorcycles, building and agricultural machines, containers, boats and other water vehicles and parts and fittings for vehicles, motorcycles, building and agricultural machines, boats and water vehicles; providing access to portals for the purchase and sale of vehicles, vehicle trailers, motorcycles, building and agricultural machines, containers, boats and other water vehicles and parts and fittings for vehicles, motorcycles, building and agricultural machines, boats and water vehicles via communications devices; providing access to information on the internet about the purchase and sale of vehicles, vehicle trailers, motorcycles, building and agricultural machines, containers, boats and other water vehicles and parts and fittings for vehicles, motorcycles, building and agricultural machines, boats and water vehicles; providing user access to computer programmes in data networks; providing access to databases on the internet via telecommunication, in particular providing access to online databases for placing goods and services with interactive access and possibility of immediate ordering; audio visual and digital communications services; providing access to databases and IT systems; electronic data exchange services; electronic bulletin board services [telecommunications services]; worldwide computer network access services; providing telecommunications con-

nections to a global computer network; providing an electronic mailbox; providing online chat rooms and interactive electronic bulletin boards; computerised communication services and data transmission; internet service provider services; electronic transmission of data; electronic transmission of computer programs via the internet; internet based telecommunications services; telecommunication gateway services; information transmission services via digital networks; transmission of information online; transmission of messages and images; streaming of audio material and video material on the internet; distribution of data or audio visual images via a global computer network or the internet; providing of access to telecommunication warehousing services; email services; message sending, receiving and forwarding; forwarding messages of all kinds to internet addresses [web messaging] and to portable communications devices; transmission of messages and images; transmission of information by data communications for assisting decision making; news agencies; transmission of database information via telecommunications networks; broadcasting services; broadcasting of programmes via the internet; telephone and smartphone services, namely text messaging services and transmission of information via smartphone; provision and rental of telecommunications facilities and equipment; providing third party users with access to telecommunications infrastructure; rental, hire and leasing in connection with the aforesaid, included in the class; advice, consultancy and information for the aforesaid, included in the class.

41 – Publishing and reporting; provision of electronic publishing and online electronic publications; providing publications from a global computer network or the internet which may be browsed; electronic desktop publishing; publication of electronic books and journals on-line; publication of the editorial content of sites accessible via a global computer network; publications of books; writing and publishing of texts, other than publicity texts; education, entertainment and sports; providing a computer game that may be accessed by users in a global computer or telecommunication network and/or the internet; electronic library services for the supply of electronic information (including archive information) in the form of text, audio and/or video information; audio-visual display presentation services for entertainment purposes; provision of on-line entertainment; organization and provision of conferences, seminars, workshops, exhibitions and competitions; gambling; electronic game services provided by means of the internet; photographic reporting and production of documentaries; audio and video production, and photography; sports and fitness; library services; education and instruction; providing online electronic publications in the nature of news articles relating to vehicles, vehicle trailers, motorcycles, bu-

ilding and agricultural machines, containers, boats and other water vehicles and parts and fittings for vehicles, motorcycles, building and agricultural machines, boats and water vehicles for cultural, educational and entertainment purposes; mobile and online library services (including archive library services) with respect to information provided in text, audio and/or video format, particularly regarding supply and demand for goods and services; providing on-line videos, not downloadable; coaching; providing computer assisted courses of instruction, computer education training and further education and instructional training; driving instruction; driving safety training; translation and interpretation; rental, hire and leasing in connection with the aforesaid, included in the class; advice, consultancy and information for the aforesaid, included in the class.

42 – IT services, namely software development, programming and implementation; updating and adapting of computer programs according to user requirements; technical data analysis; consultancy with regard to webpage design; advisory services relating to the use of computer software; providing computer software from a global computer network [non-downloadable]; provision of on-line support services for computer program users; design, conception, creation, hosting, administration and maintenance of websites for others; maintenance of data bases; design and development of web applications for portable communications devices (included in the class); drafting, development, design and hosting of computer software and applications for portable communications devices and for computers to create, edit, publish, view, search and save classified advertising, in particular for a vehicle online marketplace for the purchase and sale of new and used vehicles, vehicle trailers, motorcycles, building and agricultural machines, containers, boats and other water vehicles and parts and fittings for vehicles, motorcycles, building and agricultural machines, boats and water vehicles; drafting, development, design, administration and hosting of computer software and applications for portable communications devices and for computer to create, edit, publish, view, search and arrange automotive vehicle services and repair services for vehicles, vehicle trailers, motorcycles, building and agricultural machines, containers, boats and other water vehicles; computer hardware development; hosting services and software as a service and rental of software; cloud computing services and software as a service relating to computer software for enterprise resource planning, inventory management and inventory monitoring; cloud computing services and software as a service relating to computer software for managing customer data and relating to content management system software; hosting an internet platform for the purchase and sale of vehicles, vehicle trailers, motorcycles, building and agricultural machines, containers, boats and other water vehicles

and parts and fittings for vehicles, motorcycles, building and agricultural machines, boats and water vehicles; creation and provision of web pages to and for third parties; provision of search engines for the internet and portable communications devices and of online searchable and editable data bases, in particular for the search for and the placement of classified advertisements for the purchase and sale of vehicles, vehicle trailers, motorcycles, building and agricultural machines, containers, boats and other water vehicles and parts and fittings for vehicles, motorcycles, building and agricultural machines, boats and water vehicles; cloud computing; data warehousing; application service provider [ASP], namely, hosting computer software applications of others; off-site data backup; hosting of digital content on the internet; server hosting; providing back-up computer programs and facilities; rental of computer hardware and facilities; rental of database servers (to third parties); IT consultancy, advisory and information services; IT security services in the nature of protection and recovery of computer data; data recovery services; data duplication and conversion services, data coding services; cross-platform conversion of digital content into other forms of digital content; computer analysis and diagnostics; IT services, namely research and development, and implementation of computers and computer systems; computer project management services; data mining; digital watermarking; computer services, namely computer development, leasing, engineering, design, programming and rental services; technological services relating to computers; computer network services; updating of computer software for databases; data migration services; updating of websites for others; monitoring of computer systems by remote access; scientific and technological services; preparation of technological reports by experts; testing, authentication and quality control; website usability testing services; inspection of motor vehicles before transport [for roadworthiness]; inspection of motor vehicles [for roadworthiness]; design services; design services for display systems for promotional and presentation purposes; art work design; rental, hire and leasing in connection with the aforesaid, included in the class; advice, consultancy and information for the aforesaid, included in the class.

45 – Safety, rescue, security and enforcement services; personal and social services, namely astrological and spiritual services; detective services; dating agency services; funerary services; religious services; rental of clothing; baby sitting services; house sitting; private investigation services; individual shopping services; lost property services; social networking services; personal letter writing; pet sitting services; political lobbying services; personal reminding services; social escorting services; planning and arranging of wedding ceremonies; legal services; licensing of computer software, computer programs

and applications for portable communications devices [legal services]; licensing industrial property rights; licensing of technology; registration of domain names [legal services]; information services relating to consumer rights and other legal affairs; court reporting; legal information and support services; rental, hire and leasing in connection with the aforesaid, included in the class; advice, consultancy and information for the aforesaid, included in the class.

(260) AM 2017 91342 A

(800) 684550

(891) 2016 12 21

(731) SIKA AG

Zugerstrasse 50, CH-6341 Baar, Switzerland

(540)

SIKALASTIC

(511)

17 – Weatherstripping compositions for use in the building industry.

(260) AM 2017 91343 A

(800) 1335093

(891) 2016 10 11

(731) PURPLE INC.

Corner Hutson & Eyre Street, Blake Building,
Suite 302 Belize, Belize

(540)

 **TRIORA**

(591) Red, yellow, dark blue and black.

(531) 26.13.25, 29.01.14

(511)

19 – Building materials, not of metal; rigid pipes, not of metal, for building; asphalt, pitch and bitumen; buildings, transportable, not of metal; monuments, not of metal; asbestos mortar; asbestos cement; alabaster; bituminous products for building; building stone; building timber; windows, shutters, window frames, not of metal; fire burrs; refractory construction materials, not of metal; trellises, not of metal; latticework, not of metal; gypsum; clay; priming building materials; doors, not of metal; door casings, not of metal; door panels, not of metal; jalousies, not of metal; stone; cornices, not of metal; tiles, not of metal, for building; buildings, not of metal; coatings (building materials); linings, not of metal, for building; mosaics for building; moldings, not of metal, for building; floors, not of metal; planks of wood for building; sills, not of metal; mortar for building; grout for building; wall claddings, not of metal, for building; stair-treads (steps), not of metal; earth for bricks; bricks; cement; roofing tiles, not of metal; schists; spackling compounds; stained-glass windows.

(260) AM 2017 91358 A

(800) 1335144

(891) 2016 12 16

(731) Aktsionernoe obshchestvo

"SLAVYANKA-LUX"

ul. 1-y Konnoy Armii, 65, Stariy Oskol,
RU-309506 Belgorodskaya obl., Russian
Federation

(540)

РОМАНТИКА

(591) Black, white

(531) 28.05

(511)

30 – Chocolate, sweetmeats [candy]; caramels [candy]; pralines; fondants [confectionery]; waffles; cookies; biscuits; pastries, including cakes with waffle layers.

(260) AM 2017 91362 A

(800) 1335146

(891) 2016 12 22

(731) ROSGOSSTRAKH INSURANCE

COMPANY (Public Joint Stock Company)

Parkovaya str., 3, Lyubertsy RU-140002
Moscow Region, Russian Federation

(540)

РОСГОССТРАХ

(591) VINOUS

(531) 28.05, 29.01.01

(511)

36 – Financial analysis; lease-purchase financing; savings bank services; issuance of tokens of value; capital investment; insurance information; financial information; clearing, financial; insurance consultancy; financial consultancy; financial management; exchanging money; online banking; processing of debit card payments; processing of credit card payments; financial evaluation [insurance, banking, real estate]; repair costs evaluation [financial appraisal]; electronic funds transfer; financial sponsorship; insurance; life insurance underwriting; health insurance underwriting; accident insurance underwriting; marine insurance underwriting; fire insurance underwriting; banking; financing services.

(260) AM 2017 91457 A

(800) 664487

(891) 2016 11 01

(731) ALEXANDER BINZEL

SCHWEISSTECHNIK GMBH & CO. KG

Kiesacker, 35418 Buseck, Germany

(540)

ABICOR

(511)

9 – Electric welding torches, electric cutting torches; welding torches with flue gas aspiration (electric welding torches with automatic flue gas aspiration); fittings for these goods, namely stream gas jets; fittings for inert gas welding torches; electrode wire fed apparatus, electric cleaning apparatus for electric welding torches, peripheral equipment for welding robots.

(260) AM 2017 91458 A

(800) 1336043

(891) 2016 09 09

(731) TURKTELL BiLiSim SERVİSLERİ

ANONİM ŞİRKETİ

Aydınevler Mah. İnönü Cad. No:20 Küçükyalı
Ofispark Maltepe İstanbul, Turkey

(540)

fizy

(591) Black, white

(531) 27.05.17

(511)

9 – Measurement apparatus and indicators those for scientific and laboratory purposes; laboratory apparatus; apparatus for recording, transmission or reproduction of sound or images; data processing equipment; computer software for reproduction of sound or images; telecommunications apparatus; computer peripheral devices; magnetic and optic data carriers; antennas, satellite antennas, amplifiers for antennas, parts of the aforementioned goods; ticket dispensers, automatic teller machines (ATM); electronic components used in the electronic parts of machines; counters and quantity indicators for measuring the quantity of consumption; automatic time switches; clothing for protection against accidents, irradiation and fire; safety vests and life-saving apparatus and equipment; eyeglasses, sunglasses, optical lenses and cases, containers, parts and components thereof; apparatus and instruments for conducting, transforming, accumulating or controlling electricity; alarms and anti-theft alarms, other than for vehicles; electric bells; signalling apparatus and instruments, luminous or mechanical signs for traffic use, fire extinguishing apparatus, fire engines, fire hose and fire hose nozzles, radar apparatus, sonars, night vision apparatus and instruments; remote control apparatus for opening and closing doors and optical sensors those for buildings and car doors; magnets and decorative magnets.

15 – Musical instruments and cases for musical instruments.

38 – Radio and television broadcasting services; telecommunication services; providing access to Internet, news agencies.

41 – Education and training; arranging and conducting of conferences, congresses and seminars; sporting and cultural activities; entertainment; publication and editing of printed matter, including magazines, books, newspapers; production of movie films, radio and television programmes; news reporters services; photographic reporting services; photography; translation.

(260) AM 2017 91459 A

(800) 1335777

(891) 2016 07 20

(731) SHOKALO RUSLAN VIKTOROVYCH
vul. Frunze, 18, kv. 3 m. Izium, Kharkivska
obl. 64300, Ukraine

(540)



(591) black and white

(531) 16.03.13, 27.05.01

(511)

9 – 3D spectacles; abacuses; accelerometers; accumulators, electric; acid hydrometers; acidimeters for batteries; acoustic [sound] alarms; acoustic conduits; acoustic couplers; actinometers; electrical adapters; adding machines; aerials; aerometers; air analysis apparatus; alarm bells, electric; alarms; alcoholmeters; alidades; altimeters; ammeters; amplifiers; amplifying tubes; anemometers; animated cartoons; anode batteries; anodes; answering machines; anti-dazzle shades; anti-glare glasses; anti-interference devices [electricity]; anti-theft warning apparatus; anticathodes; apertometers [optics]; armatures [electricity]; asbestos gloves for protection against accidents; asbestos clothing for protection against fire; asbestos screens for firemen; apparatus and instruments for astronomy; audio- and video- receivers; audiovisual teaching apparatus; automated teller machines [ATM]; azimuth instruments; baby monitors; bags adapted for laptops; balances [steelyards]; balancing apparatus; bar code readers; barometers; batteries, electric, for vehicles; batteries for lighting; batteries, electric; battery jars; battery boxes; battery chargers; beacons, luminous; bells [warning devices]; betatrons; binoculars; blueprint apparatus; boiler control instruments; branch boxes [electricity]; breathing apparatus for underwater swimming; breathing apparatus, except for artificial respiration; bullet-proof waistcoats [vests (Am.)]; bullet-proof clothing; buzzers; cabinets for loudspeakers; cables, electric; calculating machines; calibrating rings; calipers; calorimeters; camcorders; cameras [photography]; capillary tubes; carpenters' rules; carriers for

dark plates [photography]; cases especially made for photographic apparatus and instruments; cases for smartphones; cash registers; cassette players; cathodes; cathodic anti-corrosion apparatus; cell switches [electricity]; cell phone straps; centering apparatus for photographic transparencies; apparatus for changing record player needles; chargers for electric batteries; chargers for electronic cigarettes; apparatus to check franking; chemistry apparatus and instruments; chips [integrated circuits]; choking coils [impedance]; chromatography apparatus for laboratory use; chronographs [time recording apparatus]; cinematographic cameras; cinematographic film, exposed; circuit closers; circuit breakers; circular slide rules; cleaning apparatus for phonograph records; close-up lenses; clothing for protection against accidents, irradiation and fire; clothing for protection against fire; clothing especially made for laboratories; coaxial cables; coils, electric; mechanisms for coin-operated apparatus; coin-operated mechanisms for television sets; collectors, electric; electric apparatus for commutation; commutators; compact discs [audio-video]; compact discs [read-only memory]; compact disc players; comparators; computer memory devices; computer programmes [programs], recorded; computer keyboards; computer operating programs, recorded; computer peripheral devices; computer software, recorded; computer programs [downloadable software]; computer game software; computer software applications, downloadable; computer hardware; computers; condensers [capacitors]; conductors, electric; connected bracelets [measuring instruments]; connections for electric lines; contact lenses; contacts, electric; containers for microscope slides; containers for contact lenses; control panels [electricity]; converters, electric; copper wire, insulated; cordless telephones; correcting lenses [optics]; cosmographic instruments; mechanisms for counter-operated apparatus; counterfeit [false] coin detectors; counters; couplers [data processing equipment]; couplings, electric; covers for electric outlets; covers for smartphones; crash test dummies; crucibles [laboratory]; current rectifiers; cyclotrons; darkroom lamps [photography]; darkrooms [photography]; data processing apparatus; decompression chambers; decorative magnets; demagnetizing apparatus for magnetic tapes; densimeters; densitometers; metal detectors for industrial or military purposes; detectors; diagnostic apparatus, not for medical purposes; diaphragms [acoustics]; diaphragms for scientific apparatus; diaphragms [photography]; dictating machines; diffraction apparatus [microscopy]; digital photo frames; digital signs; directional compasses; discharge tubes, electric, other than for lighting; disk drives for computers; disks, magnetic; distance measuring apparatus; distance recording apparatus; distillation apparatus for scientific purposes; distribution boxes [electricity]; distribution boards [electricity]; distribution consoles [electricity]; divers'

masks; diving suits; DNA chips; dog whistles; electric door bells; dosage dispensers; downloadable ring tones for mobile phones; downloadable music files; downloadable image files; drainers for use in photography; dressmakers' measures; drying racks [photography]; drying apparatus for photographic prints; ducts [electricity]; DVD players; dynamometers; ear plugs for divers; editing appliances for cinematographic films; egg timers [sandglasses]; egg-candlers; electricity conduits; materials for electricity mains [wires, cables]; electrified rails for mounting spot lights; electrified fences; electro-dynamic apparatus for the remote control of railway points; electro-dynamic apparatus for the remote control of signals; electrolyzers; electromagnetic coils; electronic pens [visual display units]; electronic agendas; electronic pocket translators; electronic tags for goods; electronic notice boards; electronic publications, downloadable; electronic book readers; electronic collars to train animals; encoded magnetic cards; encoded identification bracelets, magnetic; encoded key cards; enlarging apparatus [photography]; epidiascopes; ergometers; exposure meters [light meters]; eyepieces; instruments containing eyepieces; facsimile machines; apparatus for fermentation [laboratory apparatus]; fibre [fiber (Am.)] optic cables; film cutting apparatus; films, exposed; filters for respiratory masks; filters [photography]; filters for ultraviolet rays, for photography; fire extinguishers; fire alarms; fire beaters; fire escapes; fire hose nozzles; fire engines; fire pumps; fire boats; fire blankets; fire hose; fire extinguishing apparatus; flash-bulbs [photography]; flashing lights [luminous signals]; flashlights [photography]; floppy disks; flowmeters; fluorescent screens; fog signals, non-explosive; food analysis apparatus; frames for photographic transparencies; frequency meters; furnaces for laboratory use; furniture especially made for laboratories; fuse wire; fuses; galena crystals [detectors]; galvanic cells; galvanic batteries; galvanometers; gas testing instruments; gasoline gauges; gasometers [measuring instruments]; gauges; glazing apparatus for photographic prints; Global Positioning System [GPS] apparatus; gloves for protection against accidents; gloves for divers; gloves for protection against X-rays for industrial purposes; goggles for sports; grids for batteries; hands-free kits for telephones; head cleaning tapes [recording]; head guards for sports; headphones; heat regulating apparatus; heliographic apparatus; hemline markers; high-frequency apparatus; holders for electric coils; holograms; horns for loudspeakers; hydrometers; hygrometers; identification threads for electric wires; identification sheaths for electric wires; identity cards, magnetic; igniting apparatus, electric, for igniting at a distance / electric apparatus for remote ignition; incubators for bacteria culture; automatic indicators of low pressure in vehicle tires [tyres]; inductors [electricity]; integrated circuits; integrated circuit cards [smart cards]; inter-

communication apparatus; interfaces for computers; inverters [electricity]; invoicing machines; ionization apparatus not for the treatment of air or water; jigs [measuring instruments]; joysticks for use with computers, other than for video games; juke boxes, musical; juke boxes for computers; junction boxes [electricity]; junction sleeves for electric cables; kneepads for workers; laboratory trays; laboratory centrifuges; lactodensimeters; lactometers; laptop computers; lasers, not for medical purposes; lens hoods; lenses for astrophotography; letter scales; levelling staffs [surveying instruments]; levelling instruments; levels [instruments for determining the horizontal]; life saving apparatus and equipment; life buoys; life jackets; life belts; life-saving rafts; life-saving capsules for natural disasters; light dimmers [regulators], electric; light-emitting electronic pointers; light-emitting diodes [LED]; lighting ballasts; lightning conductors [rods]; limiters [electricity]; locks, electric; logs [measuring instruments]; electric loss indicators; loudspeakers; magic lanterns; magnetic tapes; magnetic wires; magnetic data media; magnetic encoders; magnetic tape units for computers; magnets; magnifying glasses [optics]; marine compasses; marine depth finders; marking gauges [joinery]; marking buoys; masts for wireless aerials; mathematical instruments; measures; appliances for measuring the thickness of leather; measuring apparatus; measuring devices, electric; measuring glassware; measuring instruments; apparatus for measuring the thickness of skins; measuring spoons; megaphones; memory cards for video game machines; mercury levels; meteorological balloons; meteorological instruments; metronomes; micrometer screws for optical instruments; micrometers; microphones; microprocessors; microscopes; microtomes; milage recorders for vehicles; mirrors for inspecting work; mirrors [optics]; mobile telephones; modems; money counting and sorting machines; monitoring apparatus, electric; monitors [computer hardware]; monitors [computer programs]; mouse [computer peripheral]; mouse pads; mouth guards for sports; nautical apparatus and instruments; naval signalling apparatus; navigation apparatus for vehicles [on-board computers]; navigational instruments; needles for record players; neon signs; nets for protection against accidents; nose clips for divers and swimmers; notebook computers; objectives [lenses] [optics]; observation instruments; octants; ohmmeters; optical lanterns; optical lenses; optical goods; optical apparatus and instruments; optical glass; optical fibers [fibres] [light conducting filaments]; optical condensers; optical character readers; optical data media; optical discs; oscillographs; oxygen transvasing apparatus; ozonisers [ozonators]; parking meters; particle accelerators; pedometers; peepholes [magnifying lenses] for doors; periscopes; Petri dishes; phonograph records; photocopiers [photographic, electrostatic, thermic]; photometers; phototelegraphy apparatus; pho-

tovoltaic cells; apparatus and instruments for physics; pince-nez; pipettes; Pitot tubes; plane tables [surveying instruments]; planimeters; plates for batteries; plotters; plumb bobs; plumb lines; pocket calculators; polarimeters; portable media players; precision measuring apparatus; precision balances; pressure indicator plugs for valves; pressure gauges; pressure measuring apparatus; pressure indicators; printed circuits; printed circuit boards; printers for use with computers; prisms [optics]; probes for scientific purposes; processors [central processing units]; projection screens; projection apparatus; protection devices for personal use against accidents; protection devices against X-rays, not for medical purposes; protective suits for aviators; protective helmets; protective masks; protective helmets for sports; protective films adapted for computer screens; protractors [measuring instruments]; punched card machines for offices; push buttons for bells; pyrometers; quantity indicators; radar apparatus; radio pagers; radiological apparatus for industrial purposes; radiology screens for industrial purposes; radios; radiotelegraphy sets; radiotelephony sets; railway traffic safety appliances; range finders; readers [data processing equipment]; record players; reflecting discs for wear, for the prevention of traffic accidents; reflective safety vests; refractometers; refractors; regulating apparatus, electric; relays, electric; electric installations for the remote control of industrial operations; remote control apparatus; resistances, electric; respirators for filtering air, respiratory masks, other than for artificial respiration; resuscitation mannequins [teaching apparatus]; retorts; retorts' stands; revolution counters; rheostats; riding helmets; road signs, luminous or mechanical; rods for water diviners; rulers [measuring instruments]; rules [measuring instruments]; saccharometers; safety nets; safety tarpaulins; safety restraints, other than for vehicle seats and sports equipment; salinometers; satellite navigational apparatus; satellites for scientific purposes; scales; scanners [data processing equipment]; screens [photography]; screens for photoengraving; screw-tapping gauges; selfie sticks [hand-held monopods]; semi-conductors; sextants; sheaths for electric cables; shoes for protection against accidents, irradiation and fire; shutter releases [photography]; shutters [photography]; sighting telescopes for firearms; signal bells; signal lanterns; signalling panels, luminous or mechanical; signalling whistles; signalling buoys; signals, luminous or mechanical; mechanical signs; signs, luminous; simulators for the steering and control of vehicles; sirens; sleeves for laptops; slide calipers; slide projectors; slide-rules; slope indicators; smartglasses; smartphones; smart-watches; smoke detectors; sockets, plugs and other contacts [electric connections]; socks, electrically heated; solar batteries; solar panels for the production of electricity; solderers' helmets; solenoid valves [electromagnetic switches]; sonars; sound recor-

ding carriers; sound recording strips; sound transmitting apparatus; sound recording apparatus; sound reproduction apparatus; sound locating instruments; sounding lines; sounding apparatus and machines; sounding leads; spark-guards; speaking tubes; spectacle chains; spectacle cords; spectacle lenses; spectacle frames; spectacle cases; spectacles [optics]; spectrograph apparatus; spectrosopes; speed checking apparatus for vehicles; speed indicators; speed measuring apparatus [photography]; speed regulators for record players; spherometers; spirit levels; spools [photography]; sprinkler systems for fire protection; stage lighting regulators; stands for photographic apparatus; starter cables for motors; steering apparatus, automatic, for vehicles; step-up transformers; personal stereos; stereoscopes; stereoscopic apparatus; stills for laboratory experiments; stroboscopes; sulfimeters; sunglasses; surveying instruments; surveying chains; surveying apparatus and instruments; surveyors' levels; switchboards; switchboxes [electricity]; switches, electric; tablet computers; tachometers; tape recorders; taximeters; teaching apparatus; teeth protectors; telegraph wires; telegraphs [apparatus]; telephone receivers; telephone apparatus; telephone transmitters; telephone wires; teleprinters; teleprompters; telerupters; telescopes; telescopic sights for artillery; television apparatus; temperature indicators; temperature indicator labels, not for medical purposes; terminals [electricity]; test tubes; material testing instruments and machines; testing apparatus not for medical purposes; theft prevention installations, electric; theodolites; thermionic valves; thermometers, not for medical purposes; thermostats; thermostats for vehicles; thread counters; ticket dispensers; time switches, automatic; time recording apparatus; time clocks [time recording devices]; tone arms for record players; toner cartridges, unfilled, for printers and photocopiers; totalizers; traffic cones; traffic-light apparatus [signalling devices]; transformers [electricity]; transistors [electronic]; transmitters of electronic signals; transmitters [telecommunication]; transmitting sets [telecommunication]; transparencies [photography]; transponders; triodes; tripods for cameras; urinometers; USB flash drives; vacuum gauges; vacuum tubes [radio]; variometers; vehicle radios; vehicle breakdown warning triangles; verniers; video recorders; video cassettes; video game cartridges; video screens; video telephones; video baby monitors; videotapes; viewfinders, photographic; viscosimeters; voltage regulators for vehicles; voltage surge protectors; voltmeters; voting machines; wafers for integrated circuits; walkie-talkies; washing trays [photography]; water level indicators; wavemeters; wearable activity trackers; weighbridges; weighing machines; weighing apparatus and instruments; weights; whistle alarms; wind socks for indicating wind direction; wire connectors [electricity]; wires, electric; workmen's protective face-shields; wrist rests for use with

computers; X-ray tubes not for medical purposes; X-ray apparatus not for medical purposes; X-ray films, exposed; X-ray photographs, other than for medical purposes; apparatus and installations for the production of X-rays, not for medical purposes.

35 – Administration of frequent flyer programs; administration of consumer loyalty programs; administrative processing of purchase orders; advertising; advertising agency services; rental of advertising space; advertising by mail order; rental of advertising time on communication media; production of advertising films; appointment scheduling services [office functions]; appointment reminder services [office functions]; auctioneering; bill-posting; rental of billboards; book-keeping; business management assistance; business inquiries; business auditing; business management and organization consultancy; business management consultancy; business efficiency expert services; business appraisals; business investigations; business organization consultancy; business research; advisory services for business management; professional business consultancy; business information; business management of hotels; business management of performing artists; business management of sports people; business management for freelance service providers; business project management services for construction projects; providing business information via a web site; business management of reimbursement programmes for others/business management of reimbursement programs for others; commercial information agency services; commercial or industrial management assistance; commercial information and advice for consumers [consumer advice shop]; commercial administration of the licensing of the goods and services of others; provision of commercial and business contact information; commercial intermediation services; compilation of information into computer databases; compilation of statistics; computerized file management; cost price analysis; data search in computer files for others; demonstration of goods; design of advertising materials; direct mail advertising; dissemination of advertising matter; distribution of samples; document reproduction; drawing up of statements of accounts; economic forecasting; employment agency services; import-export agency services; invoicing; layout services for advertising purposes; market studies; marketing research; marketing; modelling for advertising or sales promotion; negotiation and conclusion of commercial transactions for third parties; news clipping services; arranging newspaper subscriptions for others; office machines and equipment rental; on-line advertising on a computer network; provision of an on-line marketplace for buyers and sellers of goods and services; opinion polling; organization of exhibitions for commercial or advertising purposes; organization of trade fairs for commercial or advertising purposes; organization of fashion shows for promotional purposes;

outsourced administrative management for companies; outsourcing services [business assistance]; pay per click advertising; payroll preparation; personnel management consultancy; personnel recruitment; photocopying services; rental of photocopying machines; presentation of goods on communication media, for retail purposes; price comparison services; procurement services for others [purchasing goods and services for other businesses]; psychological testing for the selection of personnel; public relations; publication of publicity texts; publicity material rental; radio advertising; relocation services for businesses; retail or wholesale services for pharmaceutical, veterinary and sanitary preparations and medical supplies; sales promotion for others; rental of sales stands; scriptwriting for advertising purposes; search engine optimization for sales promotion; secretarial services; shop window dressing; shorthand; sponsorship search; arranging subscriptions to telecommunication services for others; systemization of information into computer databases; tax preparation; tax filing services; telemarketing services; telephone answering for unavailable subscribers; television advertising; transcription of communications [office functions]; typing; updating of advertising material; updating and maintenance of data in computer databases; rental of vending machines; web site traffic optimization; web indexing for commercial or advertising purposes; word processing; writing of publicity texts; writing of curriculum vitae for others.

41 – Academies [education]; educational services; arranging and conducting of congresses; arranging and conducting of colloquiums; arranging and conducting of conferences; arranging and conducting of concerts; arranging and conducting of in-person educational forums; arranging and conducting of workshops [training]; arranging and conducting of seminars; arranging and conducting of symposiums; electronic desktop publishing; educational examination; correspondence courses; education information; cinema presentations; microfilming; videotape editing; scriptwriting, other than for advertising purposes; writing of texts; organization of exhibitions for cultural or educational purposes; organization of competitions [education or entertainment]; organization of shows [impresario services]; layout services, other than for advertising purposes; coaching [training]; news reporters services; recording studio services; photographic reporting; services of schools [education]; practical training [demonstration]; vocational retraining; vocational guidance [education or training advice]; on-line publication of electronic books and journals; publication of books; production of shows; production of radio and television programmes; production of music; film production, other than advertising films; subtitling; television entertainment.

42 – Recovery of computer data; off-site data backup; bacteriological research; biological research; geological research; cosmetic research; technical research; chemical research; research and development of new products for others; research in the field of environmental protection; physics [research]; duplication of computer programs; electronic data storage; providing information on computer technology and programming via a web site; providing search engines for the internet; cloud seeding; engineering; installation of computer software; clinical trials; computer programming; conversion of data or documents from physical to electronic media; data conversion of computer programs and data [not physical conversion]; computer technology consultancy; telecommunications technology consultancy; information technology [IT] consultancy; computer software consultancy; computer security consultancy; consultancy in the design and development of computer hardware; web site design consultancy; monitoring of computer systems by remote access; scientific research; surveying; maintenance of computer software; updating of computer software; digitization of documents [scanning]; computer virus protection services; software as a service [SaaS]; computer software design; rental of web servers; computer rental; rental of computer software; hosting computer sites [web sites]; computer system design; creating and maintaining web sites for others; technical writing; technological consultancy; cloud computing; server hosting.

44 – Health counseling; massage; medical assistance; health care; medical advice for individuals with disabilities; nursing, medical; plastic surgery; hospital services; medical clinic services; health center services; convalescent home services; opticians' services; therapy services; pharmacy advice; pharmacists' services to make up prescriptions.

(260) AM 2017 91460 A
(800) 985322
(891) 2017 01 17
(731) KURKDJIAN Francis
17 rue Faubourg Saint Martin, F-75010
PARIS, France
(540)

FRANCIS KURKDJIAN

(511)
3 – Soaps, perfumery, perfumes, essential oils, cosmetics, hair lotions, deodorants for personal use (perfumery), dentifrices; scented room fragrances, fragrance substances for scented room fragrance dispensers, perfumed waters, lavender waters, toilet waters, extracts of flowers, bases for flower perfumes, oils as perfumes for the home, oils for perfumes and scents, air freshening products; amber (perfumery), musk (perfumery), patchouli; scented wo-

od, potpourris and perfumed incense, scented paper, bleaching preparations and other substances for laundry use, bleaching preparations, cleaning, polishing, scouring and abrasive preparations, perfumed soap bubbles; sachets for perfuming linen.

(260) AM 2017 91474 A
(800) 1133638
(891) 2017 03 02
(731) RÖTHER BETEILIGUNGS GMBH
Daimlerstraße 71, 74545 Michelfeld, Germany
(540)



(591) Black, white
(531) 01.01.02, 01.01.10, 27.05.02, 27.05.19
(511)
14 – Precious stones.

18 – Leather and imitations of leather and goods made of these materials (included in class 18); umbrellas.

25 – Clothing, footwear, headgear.

(260) AM 2017 91616 A
(800) 1169119
(891) 2017 03 09
(731) Swiss Eyewear Group (International) AG
Freilagerstrasse 39, CH-8047 Zürich,
Switzerland
(540)

INVU

(511)
9 – Sunglasses; ski goggles, contact lenses; eyeglass frames; straps for sunglasses; anti-glare glasses; spectacles (optics); cases for spectacles and sunglasses; spectacle cases; spectacle frames; spectacle lenses; parts and accessories for spectacles; cases for sunglasses and protective eyewear; night vision goggles; optical lenses for sunglasses; protective goggles; goggles for swimming; ski goggles; frames for sunglasses; chains for sunglasses; goggles for sports; magnifying eyeglasses; protective masks; protective helmets; protective helmets for sports; divers' masks; binoculars; optical lenses; optical glass; optical goods; correcting lenses (optics); containers for contact lenses; pince-nez; pince-nez cases; eyeglass cords; telescopes; observation instruments; optical apparatus and instruments; USB flash drives; directional compasses; headphones; magnifying glasses (optics); downloadable image files; objectives (lenses) (optics).

(260) AM 2017 91631 A
 (800) 1317137
 (891) 2017 02 23
 (731) MYLAN EMEA SAS
 117 Allée des Parcs, F-69800 Saint-Priest,
 France

(540)
SIRDUPLA

(591) Black, white
 (531) 27.05.05
 (511)
 5 – Pharmaceutical preparations and substances for
 the treatment of asthma in humans.

10 – Pharmaceutical and medical apparatus and ins-
 truments for the treatment of asthma in humans.

(260) AM 2017 91714 A
 (800) 1337913
 (891) 2016 12 15
 (731) SHISEIDO COMPANY, LIMITED
 7-5-5 Ginza, Chuo-ku, Tokyo 104-0061,
 Japan

(540)

SYNCHRO SKIN

(591) Black, white
 (531) 27.05.15
 (511)
 3 – Soaps and detergents; cosmetics; perfumery; in-
 cense; dentifrices.

(260) AM 2017 91715 A
 (800) 1337942
 (891) 2016 12 20
 (731) JAPAN TOBACCO INC.
 2-2-1 Toranomom, Minato-ku Tokyo, Japan

(540)

(591) Black, white
 (531) 26.04.04, 26.04.24, 26.11.03, 26.11.12
 (511)
 34 – Tobacco, raw or manufactured; smoking tobac-
 co, pipe tobacco, rolling tobacco, chewing tobacco,
 snus; cigarettes, electronic cigarettes, cigars, cigari-
 llos; snuff; smokers' articles included in class 34; ci-
 garette paper, cigarette tubes and matches.

(260) AM 2017 91716 A
 (800) 1337943
 (891) 2016 12 18
 (731) JAPAN TOBACCO INC.
 2-2-1 Toranomom, Minato-ku, Tokyo, Japan

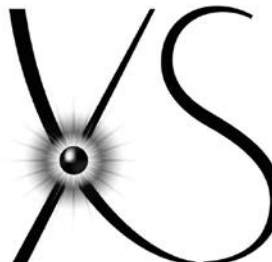
(540)

(591) Black, white
 (531) 01.15.09, 26.15.01, 27.05.08, 27.05.22
 (511)
 34 – Tobacco, raw or manufactured; smoking tobac-
 co, pipe tobacco, rolling tobacco, chewing tobacco,
 snus; cigarettes, electronic cigarettes, cigars, cigari-
 llos; snuff; smokers' articles included in class 34; ci-
 garette paper, cigarette tubes and matches.

(260) AM 2017 91717 A
 (800) 1337951
 (891) 2016 07 08
 (731) GUERLAIN SOCIETE ANONYME
 68 avenue des Champs Elysées, F-75008
 PARIS, France

(540)

(591) Black, white
 (531) 09.03.05
 (511)
 3 – Perfumes; eau de toilette; eau de parfum; eau de
 Cologne; soaps; bath or shower gels and salts for
 cosmetic use; cosmetics for skin, body, face and nail
 care; creams, milks, lotions, gels and powders for
 the face, hands and body for cosmetic use; make-up
 products; body deodorants.

(260) AM 2017 91771 A
 (800) 1339021
 (891) 2017 02 16
 (731) BAHLSEN GMBH & CO. KG
 Podbielskistraße 11, 30163 Hannover,
 Germany

(540)

Bahlser

(591) Black and white

(531) 27.05.01, 27.05.19

(511)

29 – Meats; fish, not live; poultry, not live; game, not live; meat extracts; frozen fruits; fruit, preserved; dried fruit; cooked fruits; frozen vegetables; preserved vegetables; vegetables, dried; vegetables, cooked; jellies; jams; compotes; eggs; milk; milk products; edible oils; edible fats; potato snack foods; raisins; dried nuts; roasted nuts; salted nuts; spiced nuts; dried fruit products; fat-containing mixtures for bread slices.

30 – Coffee; tea; cocoa; sugar; rice; tapioca; sago; coffee substitutes; flour; preparations made from cereals; bread; pastry; confectionery; ices; honey; treacles; yeast; baking powder; salt; mustard; vinegar; sauces [condiments]; spices; ice; cookies; aperitif biscuits; rolled wafers [biscuits]; cakes; chocolate; chocolate based products; chocolate bars; pralines; sugar confectionery; sweets; marzipan; extruded food products made of wheat; extruded food products made of rice; extruded food products made of maize; puffed corn snacks; waffles.

41 – Entertainment; sporting activities; cultural activities.

(260) AM 2017 91773 A

(800) 1339025

(891) 2016 11 18

(731) APPLE INC.

1 Infinite Loop, Cupertino CA 95014,
United States of America

(540)



(591) Silver, white, purple, pink, blue, and green

(531) 01.15.09, 26.01.01, 26.01.06, 26.01.12,
26.01.24, 26.11.03, 26.11.13, 29.01.15

(511)

9 – Computers; computer hardware; handheld computers; smart phones; wireless communication devi-

ces for the transmission of voice, data, images, audio, video, and multimedia content; network communication apparatus; handheld digital electronic devices capable of providing access to the internet and for the sending, receiving, and storing telephone calls, electronic mail, and other digital data; wearable digital electronic devices capable of providing access to the internet, for sending, receiving and storing of telephone calls, electronic mail, and other digital data; smart watches; computer software; computer software for setting up, configuring, operating or controlling computers, mobile devices, mobile telephones, wearable computer hardware, computer peripherals, and audio and video players; computer game software; telephone-based information retrieval software; voice recording and voice recognition apparatus; computer software for personal information management; voice recognition software; speech to text conversion software; voice-enabled software applications; computer software used to process voice commands, and create audio responses to voice commands; computer software for dictation; computer software for scheduling appointments, reminders, and events on an electronic calendar; computer software for storing, organizing, and accessing phone numbers, addresses, and other personal contact information; computer software for global positioning and for providing travel directions; computer software for enabling hands-free use of a mobile phone through voice recognition; computer software for making travel arrangements; computer software for making reservations at hotels and restaurants; microphones; set top boxes; remote controls for controlling computers, mobile telephones, mobile electronic devices, wearable electronic devices, smart watches, smart glasses, audio and video players and recorders, televisions, speakers, amplifiers, home theatre systems, and entertainment systems; wearable devices for controlling computers, mobile telephones, mobile electronic devices, wearable electronic devices, smart watches, smart glasses, audio and video players and recorders, televisions, speakers, amplifiers, home theatre systems, and entertainment systems; computer software for travel and tourism, travel planning, navigation, travel route planning, geographic, destination, transportation and traffic information, driving and walking directions, customized mapping of locations, street atlas information, electronic map display, and destination information; computer software for creating, authoring, distributing, downloading, transmitting, receiving, playing, editing, extracting, encoding, decoding, displaying, storing and organizing text, data, graphics, images, audio, video, and other multimedia content, electronic publications, and electronic games; computer software for use in recording, organizing, transmitting, manipulating, and reviewing text, data, audio files, video files and electronic games in connection with computers, televisions, television

set-top boxes, audio players, video players, media players, telephones, and handheld digital electronic devices; computer software to enable users to program and distribute text, data, graphics, images, audio, video, and other multimedia content via global communication networks and other computer, electronic and communications networks; computer software for identifying, locating, grouping, distributing, and managing data and links between computer servers and users connected to global communication networks and other computer, electronic and communications networks; computer software for use on handheld mobile digital electronic devices, wearable digital devices, and other consumer electronics.

(260) AM 2017 91786 A
 (800) 1339125
 (891) 2016 12 19
 (731) BAYER INTELLECTUAL PROPERTY
 GMBH
 Alfred-Nobel-Str.10, 40789 Monheim am
 Rhein, Germany

(540)
KOHTEKA

(591) Black and white
 (531) 28.05
 (511)
 5 – Pharmaceutical preparations.

(260) AM 2017 91834 A
 (800) 334046
 (891) 2017 03 28
 (731) FERRER INTERNACIONAL, S.A.
 Gran Vía de Carlos III, 94, E-08028
 BARCELONA, Spain

(540)
GAMALATE

(511)
 5 – Chemical products for medical and sanitary purposes, pharmaceutical, veterinary and disinfecting products and specialties.

(260) AM 2017 91840 A
 (800) 1129437
 (891) 2016 12 06
 (731) Open Joint Stock Company
 "NABEREZHNOCHELNINSKY
 HLADOKOMBINAT "CHELNY HOLOD"
 Promkomzona, A-2, Naberezhnye Chelny city,
 RU-423810 the Republic of Tatarstan, Russian
 Federation

(540)

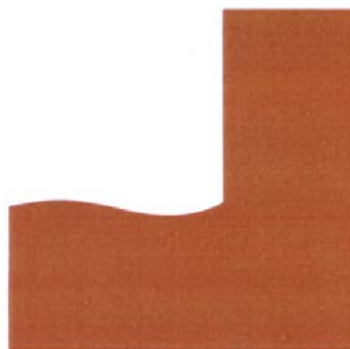

(591) Red
 (531) 26.03.23, 29.01.01

(511)
 30 – Ice cream; fruit ice cream; fruit ice bars; sorbets; ravioli; dumplings, including curd dumplings; fruit dumplings; berry dumplings, vegetable dumplings; mushroom dumplings; cheese dumplings; oriental dumplings, including khinkali; meat dumplings.

(260) AM 2017 91841 A
 (800) 1130269
 (891) 2016 12 06
 (731) Open Joint Stock Company
 "NABEREZHNOCHELNINSKY HLADO-
 KOMBINAT "CHELNY HOLOD"
 Promkomzona, A-2, Naberezhnye Chelny city,
 RU-423810 the Republic of Tatarstan,
 Russian Federation

(540)



(591) Red
 (511)
 30 – Ice cream; fruit ice cream; fruit ice bars; sorbets.

INTERNATIONAL TRADEMARKS PROTECTED IN GEORGIA

(260) AM 2017 84991 A
(800) 1275094
(151) 2015 10 13
(181) 2025 10 13
(891) 2015 10 13
(511) 30

(260) AM 2017 87947A
(800) 1301309
(151) 2016 03 15
(181) 2026 03 15
(891) 2016 03 15
(511) 32

(260) AM 2017 85211 A
(800) 1276573
(151) 2015 10 13
(181) 2025 10 13
(891) 2015 10 13
(511) 30

(260) AM 2017 88140A
(800) 1001303
(151) 2009 03 06
(181) 2019 03 06
(891) 2016 04 27
(511) 05, 29

(260) AM 2017 85318 A
(800) 1277592
(151) 2015 10 13
(181) 2025 10 13
(891) 2015 10 13
(511) 30

(260) AM 2017 88186A
(800) 843333
(151) 2004 11 01
(181) 2014 11 01
(891) 2016 04 08
(511) 10

(260) AM 2017 85364 A
(800) 1279727
(151) 2015 09 29
(181) 2025 09 29
(891) 2015 09 29
(511) 30

(260) AM 2017 88242A
(800) 1304578
(151) 2016 04 01
(181) 2026 04 01
(891) 2016 04 01
(511) 03, 05

(260) AM 2017 85800A
(800) 1250990
(151) 2014 10 01
(181) 2024 10 01
(891) 2015 12 23
(511) 44

(260) AM 2017 88268A
(800) 1305199
(151) 2016 03 31
(181) 2026 03 31
(891) 2016 03 31
(511) 05, 44

(260) AM 2017 86417A
(800) 909544
(151) 2006 08 29
(181) 2016 08 29
(891) 2016 02 09
(511) 10, 35

(260) AM 2017 88293A
(800) 1304949
(151) 2016 04 07
(181) 2026 04 07
(891) 2016 04 07
(511) 32

(260) AM 2017 87292A
(800) 1297535
(151) 2015 11 19
(181) 2025 11 19
(891) 2015 11 19
(511) 32

(260) AM 2017 88307A
(800) 1044195
(151) 2010 05 07
(181) 2020 05 07
(891) 2016 04 19
(511) 16, 42

(260) AM 2017 88601A
(800) 1308132
(151) 2016 08 02
(181) 2026 08 02
(891) 2016 08 02
(511) 20

(260) AM 2017 88609A
(800) 1221605
(151) 2014 02 25
(181) 2024 02 25
(891) 2016 05 30
(511) 05, 10

(260) AM 2017 88616A
(800) 1309259
(151) 2016 05 13
(181) 2026 05 13
(891) 2016 05 13
(511) 30

(260) AM 2017 88620A
(800) 1308537
(151) 2015 09 30
(181) 2025 09 30
(891) 2015 09 30
(511) 12

(260) AM 2017 88621A
(800) 1309272
(151) 2016 04 03
(181) 2026 04 03
(891) 2016 04 03
(511) 11

(260) AM 2017 88622A
(800) 1308541
(151) 2015 12 18
(181) 2025 12 18
(891) 2015 12 18
(511) 09, 35, 37, 42

(260) AM 2017 88702A
(800) 1310180
(151) 2016 03 25
(181) 2026 03 25
(891) 2016 03 25
(511) 12

(260) AM 2017 88739A
(800) 1310181
(151) 2016 03 25

(181) 2026 03 25
(891) 2016 03 25
(511) 12

(260) AM 2017 88742A
(800) 1310183
(151) 2016 03 25
(181) 2026 03 25
(891) 2016 03 25
(511) 12

(260) AM 2017 88745A
(800) 1310185
(151) 2016 03 25
(181) 2026 03 25
(891) 2016 03 25
(511) 12, 37

(260) AM 2017 88751A
(800) 1310292
(151) 2016 04 22
(181) 2026 04 22
(891) 2016 04 22
(511) 18, 25

(260) AM 2017 88752A
(800) 1310320
(151) 2016 05 24
(181) 2026 05 24
(891) 2016 05 24
(511) 32

(260) AM 2017 88753A
(800) 1309998
(151) 2016 02 04
(181) 2026 02 04
(891) 2016 02 04
(511) 16

(260) AM 2017 88767A
(800) 1310179
(151) 2016 03 25
(181) 2026 03 25
(891) 2016 03 25
(511) 12

(260) AM 2017 88857A
(800) 1311106
(151) 2016 02 26
(181) 2026 02 26
(891) 2016 02 26
(511) 07, 12, 37

(260) AM 2017 88896A
(800) 1311971
(151) 2016 07 26
(181) 2026 07 26
(891) 2016 07 26
(511) 08, 13

(260) AM 2017 88897A
(800) 1311972
(151) 2016 07 26
(181) 2026 07 26
(891) 2016 07 26
(511) 08, 13

(260) AM 2017 88903A
(800) 1194342
(151) 2014 02 07
(181) 2024 02 07
(891) 2016 06 03
(511) 05

(260) AM 2017 88943A
(800) 1312036
(151) 2016 02 10
(181) 2026 02 10
(891) 2016 02 10
(511) 07, 12, 37

(260) AM 2017 88944A
(800) 1312069
(151) 2016 04 15
(181) 2026 04 15
(891) 2016 04 15
(511) 09, 28

(260) AM 2017 88945A
(800) 1312082
(151) 2016 04 01
(181) 2026 04 01
(891) 2016 04 01
(511) 09, 16, 35, 38, 41

(260) AM 2017 88946A
(800) 1312086
(151) 2016 05 17
(181) 2026 05 17
(891) 2016 05 17
(511) 09, 11, 34

(260) AM 2017 88947A
(800) 1312145
(151) 2016 07 08

(181) 2026 07 08
(891) 2016 07 08
(511) 05

(260) AM 2017 88948A
(800) 1312193
(151) 2016 05 18
(181) 2026 05 18
(891) 2016 05 18
(511) 05

(260) AM 2017 88949A
(800) 1312197
(151) 2016 07 15
(181) 2026 07 15
(891) 2016 07 15
(511) 04, 07, 09

(260) AM 2017 88950A
(800) 1312205
(151) 2016 05 18
(181) 2026 05 18
(891) 2016 05 18
(511) 05

(260) AM 2017 88951A
(800) 1312222
(151) 2016 05 18
(181) 2026 05 18
(891) 2016 05 18
(511) 05

(260) AM 2017 88952A
(800) 1312249
(151) 2016 02 12
(181) 2026 02 12
(891) 2016 02 12
(511) 39

(260) AM 2017 88955A
(800) 1312260
(151) 2016 04 06
(181) 2026 04 06
(891) 2016 04 06
(511) 03, 21

(260) AM 2017 88962A
(800) 1312311
(151) 2016 06 27
(181) 2026 06 27
(891) 2016 06 27
(511) 05

(260) AM 2017 88967A
(800) 1312330
(151) 2016 06 03
(181) 2026 06 03
(891) 2016 06 03
(511) 05

(260) AM 2017 88969A
(800) 1312411
(151) 2016 06 29
(181) 2026 06 29
(891) 2016 06 29
(511) 09

(260) AM 2017 88970A
(800) 1312416
(151) 2016 06 15
(181) 2026 06 15
(891) 2016 06 15
(511) 01, 02, 17

(260) AM 2017 88973A
(800) 1312417
(151) 2016 06 22
(181) 2026 06 22
(891) 2016 06 22
(511) 05

(260) AM 2017 88991A
(800) 1312432
(151) 2015 08 19
(181) 2025 08 19
(891) 2015 08 19
(511) 03, 09, 14, 18, 20, 21, 24, 25, 28, 35

(260) AM 2017 88992A
(800) 1312443
(151) 2016 03 29
(181) 2026 03 29
(891) 2016 03 29
(511) 07, 11, 12

(260) AM 2017 88993A
(800) 1312477
(151) 2016 04 13
(181) 2026 04 13
(891) 2016 04 13
(511) 07

(260) AM 2017 89025A
(800) 1314046
(151) 2016 07 26

(181) 2026 07 26
(891) 2016 07 26
(511) 16, 35

(260) AM 2017 89028A
(800) 1314055
(151) 2016 05 12
(181) 2026 05 12
(891) 2016 05 12
(511) 14

(260) AM 2017 89119A
(800) 581364
(151) 1992 01 08
(181) 2002 01 08
(891) 2016 06 28
(511) 09, 18, 25

(260) AM 2017 89122A
(800) 876429
(151) 2005 09 19
(181) 2015 09 19
(891) 2016 08 15
(511) 07, 11

(260) AM 2017 89125A
(800) 917245
(151) 2007 02 12
(181) 2017 02 12
(891) 2016 09 27
(511) 18, 25

(260) AM 2017 89127A
(800) 928002
(151) 2007 01 10
(181) 2017 01 10
(891) 2016 06 08
(511) 14

(260) AM 2017 89139A
(800) 1286946
(151) 2015 10 21
(181) 2025 10 21
(891) 2016 07 18
(511) 03, 05

(260) AM 2017 89221A
(800) 1314854
(151) 2016 01 18
(181) 2026 01 18
(891) 2016 01 18
(511) 11

(260) AM 2017 89250A
(800) 1315275
(151) 2016 05 06
(181) 2026 05 06
(891) 2016 05 06
(511) 07

(260) AM 2017 89251A
(800) 1315277
(151) 2016 04 04
(181) 2026 04 04
(891) 2016 04 04
(511) 06, 11, 35

(260) AM 2017 89252A
(800) 1315302
(151) 2015 12 31
(181) 2025 12 31
(891) 2015 12 31
(511) 18, 25

(260) AM 2017 89253A
(800) 1315335
(151) 2016 03 25
(181) 2026 03 25
(891) 2016 03 25
(511) 35

(260) AM 2017 89254A
(800) 1315351
(151) 2016 04 11
(181) 2026 04 11
(891) 2016 04 11
(511) 06, 11, 20

(260) AM 2017 89255A
(800) 1315354
(151) 2016 03 24
(181) 2026 03 24
(891) 2016 03 24
(511) 16

(260) AM 2017 89256A
(800) 429613
(151) 1977 03 31
(181) 1987 03 31
(891) 2016 08 04
(511) 13

(260) AM 2017 89264A
(800) 1315372
(151) 2016 04 13

(181) 2026 04 13
(891) 2016 04 13
(511) 12, 37

(260) AM 2017 89265A
(800) 1315431
(151) 2016 07 05
(181) 2026 07 05
(891) 2016 07 05
(511) 33

(260) AM 2017 89270A
(800) 460486
(151) 1981 04 29
(181) 1991 04 29
(891) 2016 10 10
(511) 10

(260) AM 2017 89271A
(800) 1315437
(151) 2016 07 19
(181) 2026 07 19
(891) 2016 07 19
(511) 05, 10, 44

(260) AM 2017 89272A
(800) 1315438
(151) 2016 07 01
(181) 2026 07 01
(891) 2016 07 01
(511) 05

(260) AM 2017 89274A
(800) 1315453
(151) 2016 07 08
(181) 2026 07 08
(891) 2016 07 08
(511) 05

(260) AM 2017 89275A
(800) 1315454
(151) 2016 07 08
(181) 2026 07 08
(891) 2016 07 08
(511) 05

(260) AM 2017 89276A
(800) 472665
(151) 1982 09 16
(181) 1992 09 16
(891) 2016 07 27
(511) 29, 30

(260) AM 2017 89277A
(800) 1315455
(151) 2016 07 08
(181) 2026 07 08
(891) 2016 07 08
(511) 05

(260) AM 2017 89278A
(800) 1315506
(151) 2016 07 18
(181) 2026 07 18
(891) 2016 07 18
(511) 33

(260) AM 2017 89280A
(800) 1315545
(151) 2016 08 15
(181) 2026 08 15
(891) 2016 08 15
(511) 05

(260) AM 2017 89282A
(800) 1315593
(151) 2016 04 26
(181) 2026 04 26
(891) 2016 04 26
(511) 01, 17, 19

(260) AM 2017 89283A
(800) 1315618
(151) 2016 02 17
(181) 2026 02 17
(891) 2016 02 17
(511) 09, 35, 38, 42

(260) AM 2017 89284A
(800) 1315619
(151) 2016 03 31
(181) 2026 03 31
(891) 2016 03 31
(511) 36

(260) AM 2017 89286A
(800) 1315626
(151) 2016 02 03
(181) 2026 02 03
(891) 2016 02 03
(511) 16

(260) AM 2017 89289A
(800) 1315679
(151) 2016 04 21

(181) 2026 04 21
(891) 2016 04 21
(511) 19

(260) AM 2017 89294A
(800) 1315742
(151) 2016 07 08
(181) 2026 07 08
(891) 2016 07 08
(511) 05, 29

(260) AM 2017 89295A
(800) 1315751
(151) 2016 06 27
(181) 2026 06 27
(891) 2016 06 27
(511) 03, 16

(260) AM 2017 89296A
(800) 1315780
(151) 2016 07 25
(181) 2026 07 25
(891) 2016 07 25
(511) 09, 35, 36, 41, 42

(260) AM 2017 89298A
(800) 1315821
(151) 2016 09 12
(181) 2026 09 12
(891) 2016 09 12
(511) 25

(260) AM 2017 89299A
(800) 1315845
(151) 2016 07 01
(181) 2026 07 01
(891) 2016 07 01
(511) 21, 29, 30

(260) AM 2017 89300A
(800) 1315876
(151) 2015 12 03
(181) 2025 12 03
(891) 2015 12 03
(511) 43

(260) AM 2017 89301A
(800) 1315889
(151) 2016 02 25
(181) 2026 02 25
(891) 2016 02 25
(511) 33

(260) AM 2017 89302A
(800) 1315890
(151) 2016 02 25
(181) 2026 02 25
(891) 2016 02 25
(511) 33

(260) AM 2017 89304A
(800) 1315903
(151) 2016 02 04
(181) 2026 02 04
(891) 2016 02 04
(511) 35

(260) AM 2017 89306A
(800) 1316024
(151) 2016 07 08
(181) 2026 07 08
(891) 2016 07 08
(511) 33

(260) AM 2017 89307A
(800) 1316089
(151) 2016 02 23
(181) 2026 02 23
(891) 2016 02 23
(511) 06, 16, 35

(260) AM 2017 89308A
(800) 1316092
(151) 2016 07 26
(181) 2026 07 26
(891) 2016 07 26
(511) 03

(260) AM 2017 89310A
(800) 1316134
(151) 2015 10 12
(181) 2025 10 12
(891) 2015 10 12
(511) 05

(260) AM 2017 89312A
(800) 1316193
(151) 2016 04 12
(181) 2026 04 12
(891) 2016 04 12
(511) 03

(260) AM 2017 89317A
(800) 1316360
(151) 2015 12 31

(181) 2025 12 31
(891) 2015 12 31
(511) 09, 35

(260) AM 2017 89349A
(800) 1317313
(151) 2016 02 23
(181) 2026 02 23
(891) 2016 02 23
(511) 29

(260) AM 2017 89351A
(800) 1317321
(151) 2016 03 11
(181) 2026 03 11
(891) 2016 03 11
(511) 11, 19, 20

(260) AM 2017 89580A
(800) 1319437
(151) 2016 05 30
(181) 2026 05 30
(891) 2016 05 30
(511) 04

(260) AM 2017 89605A
(800) 1318754
(151) 2016 05 19
(181) 2026 05 19
(891) 2016 05 19
(511) 34

(260) AM 2017 89607A
(800) 1318755
(151) 2016 05 19
(181) 2026 05 19
(891) 2016 05 19
(511) 34

(260) AM 2017 89609A
(800) 1318756
(151) 2016 05 19
(181) 2026 05 19
(891) 2016 05 19
(511) 34

(260) AM 2017 89620A
(800) 1319522
(151) 2016 06 30
(181) 2026 06 30
(891) 2016 06 30
(511) 03

(260) AM 2017 89630A
(800) 984166
(151) 2008 09 08
(181) 2018 09 08
(891) 2016 11 02
(511) 05

(260) AM 2017 89633A
(800) 1020967
(151) 2009 09 02
(181) 2019 09 02
(891) 2016 08 03
(511) 12

(260) AM 2017 89634A
(800) 1045631
(151) 2010 06 02
(181) 2020 06 02
(891) 2016 09 19
(511) 05

(260) AM 2017 89635A
(800) 1147047
(151) 2012 12 18
(181) 2022 12 18
(891) 2016 08 03
(511) 11

(260) AM 2017 89643A
(800) 1318757
(151) 2016 05 19
(181) 2026 05 19
(891) 2016 05 19
(511) 34

(260) AM 2017 89644A
(800) 1318766
(151) 2016 04 18
(181) 2026 04 18
(891) 2016 04 18
(511) 03, 35

(260) AM 2017 89645A
(800) 1318780
(151) 2016 04 15
(181) 2026 04 15
(891) 2016 04 15
(511) 12, 37

(260) AM 2017 89647A
(800) 1318792
(151) 2016 04 15

(181) 2026 04 15
(891) 2016 04 15
(511) 14

(260) AM 2017 89648A
(800) 1318824
(151) 2016 06 27
(181) 2026 06 27
(891) 2016 06 27
(511) 09

(260) AM 2017 89651A
(800) 1318927
(151) 2016 06 17
(181) 2026 06 17
(891) 2016 06 17
(511) 09, 25

(260) AM 2017 89653A
(800) 1319034
(151) 2016 04 07
(181) 2026 04 07
(891) 2016 04 07
(511) 21, 32, 43

(260) AM 2017 89654A
(800) 1319035
(151) 2016 04 27
(181) 2026 04 27
(891) 2016 04 27
(511) 03, 05

(260) AM 2017 89655A
(800) 1319037
(151) 2016 04 21
(181) 2026 04 21
(891) 2016 04 21
(511) 10, 35

(260) AM 2017 89658A
(800) 1319081
(151) 2016 08 18
(181) 2026 08 18
(891) 2016 08 18
(511) 29, 35

(260) AM 2017 89659A
(800) 1319103
(151) 2016 02 03
(181) 2026 02 03
(891) 2016 02 03
(511) 06, 17, 19

(260) AM 2017 89660A
(800) 1319120
(151) 2016 06 20
(181) 2026 06 20
(891) 2016 06 20
(511) 33

(260) AM 2017 89661A
(800) 1319152
(151) 2016 02 03
(181) 2026 02 03
(891) 2016 02 03
(511) 16, 35, 41

(260) AM 2017 89758A
(800) 1319880
(151) 2016 08 01
(181) 2026 08 01
(891) 2016 08 01
(511) 04

(260) AM 2017 89763A
(800) 1320512
(151) 2016 03 10
(181) 2026 03 10
(891) 2016 03 10
(511) 01, 05, 09, 10, 16, 25, 35, 36, 37, 38, 41, 42, 44

(260) AM 2017 89764A
(800) 1320532
(151) 2016 04 02
(181) 2026 04 02
(891) 2016 04 02
(511) 05

(260) AM 2017 89780A
(800) 1320245
(151) 2016 01 18
(181) 2026 01 18
(891) 2016 01 18
(511) 05, 29, 30

(260) AM 2017 89796A
(800) 1321632
(151) 2016 08 31
(181) 2026 08 31
(891) 2016 08 31
(511) 05

(260) AM 2017 89797A
(800) 1321674
(151) 2016 10 28

(181) 2026 10 28
(891) 2016 10 28
(511) 05

(260) AM 2017 89799A
(800) 1321701
(151) 2016 08 04
(181) 2026 08 04
(891) 2016 08 04
(511) 19

(260) AM 2017 89800A
(800) 1321714
(151) 2016 08 09
(181) 2026 08 09
(891) 2016 08 09
(511) 03

(260) AM 2017 89801A
(800) 1321076
(151) 2016 06 06
(181) 2026 06 06
(891) 2016 06 06
(511) 35, 36, 41, 42, 45

(260) AM 2017 89802A
(800) 1321716
(151) 2016 06 28
(181) 2026 06 28
(891) 2016 12 01
(511) 05

APPELLATIONS OF ORIGIN OF GOODS

APPELLATION OF ORIGIN OF GOODS FILED IN GEORGIA FOR EXAMINATION UNDER LISBON AGREEMENT, ON THE BASIS OF THE INTERNATIONAL REGISTRATION

The decision can be appealed at the Chamber of Appeal of Sakpatenti within 3 months from the publication or at the Mtskheta District Court Administrative Cases Board (Address: №17, Samkhedro str., Mtskheta), within 1 month following the publication.

Number of Indication: 1453

Number of International Registration: 1061

Data of International Registration: 2016 11 10

Application Filing Date: 2017 02 10

Appellation of Origin of Goods: **SLOVENSKÝ OPÁL**

The Goods for which the Registration of Appellation of Origin is Required: 14 – Precious stones.

Name and Address of Applicant: OPÁLOVÉ BANE LIBANKA, S. R. O.

Deposits of "Slovensky opal" are found in the "Slanske vrchy" hills between the cities of Presov and Kosice above the village of Cervenica near Presov. The deposit is composed of several mines (underground and open-cast) as follows: Libanka, Simonka Tancoska, Remety, Paseky, Colo, Kamen, Kunderov, Pritok, Dubnik, Pastierka, Lucina (Huviz), Orlovska studnicka, Rublica, Padesat dolky and Schlam, France.

OFFICIAL NOTIFICATIONS

INVENTIONS

RENEWAL OF PATENTS

(11) P 2009 4639 B

(73) ASTRAZENECA AB (SE)

(54) COATED TABLET FORMULATION AND METHOD

DATE OF RENEWAL: 25 12 2017

(11) P 2014 6149 B

(73) Kakhaber Dzodzuashvili (GE)

(54) EQUIPMENT HEATING FOOD PRODUCTS

DATE OF RENEWAL: 25 12 2017

(11) P 2015 6314 B

(73) Merab Poladashvili (GE);

Giorgi Tavadze (GE);

Otar Okrostsvardze (GE);

Zurab Aslamazashvili (GE);

Garegin Khazarov (GE);

Giorgi Oniashvili (GE);

Giorgi Mikaberidze (GE);

Avtandil Khvadagiani (GE)

(54) METHOD OF ARTICLE FROM POWDERED EXOTHERMIC CHARGE

DATE OF RENEWAL: 25 12 2017

UTILITY MODELS

RENEWAL OF PATENT

(11) U 2014 1819 Y

(73) Giorgi Bikov (GE)

(54) POKER TYPE CARD GAME SYSTEM

DATE OF RENEWAL: 25 12 2017

(11) U 2015 1880 Y

(73) Zurab Jokharidze (GE);

Naira Jokharidze (GE);

Sopo Kolomikova (GE)

(54) THERMO - HYGROMETER

DATE OF RENEWAL: 25 12 2017

(11) U 2012 1715 Y

(73) Valeri Bogveradze (GE)

(54) METHOD FOR PREPARATION OF BOGVERADZE CAKE

DATE OF RENEWAL: 25 12 2017

(11) U 2017 1933 Y

(73) Tamaz Kuchava (GE)

(54) INSTRUMENT FOR HAIRCUTTING

DATE OF RENEWAL: 25 12 2017

(11) U 2016 1905 Y

(73) LEPL Institute "OPTICS" (GE)

(54) INSTRUMENT FOR HAIRCUTTING

DATE OF RENEWAL: 25 12 2017

TRADEMARKS

RENEWAL OF REGISTRATIONS

(111) M 1998 10047 R2

(156) 2018 07 09

(186) 2028 07 09

(732) HENKEL AG & Co. KGaA

Henkelstrasse 67, D-40589 Dusseldorf,
Germany

3M Center, 2501 Hudson Road, St. Paul,
Minnesota 55144, USA

(111) M 1998 10150 R2

(156) 2018 08 05

(186) 2028 08 05

(732) 3M COMPANY

3M Center, 2501 Hudson Road, St. Paul,
Minnesota 55144, USA

(111) M 1998 10337 R2

(156) 2018 08 19

(186) 2028 08 19

(732) LUCASFILM LTD. LLC

a California Limited Liability Company
One Letterman Drive, Bldg. B, San
Francisco, California 94129, USA

(111) M 1998 10151 R2

(156) 2018 08 05

(186) 2028 08 05

(732) 3M COMPANY

3M Center, 2501 Hudson Road, St. Paul,
Minnesota 55144, USA

(111) M 1998 10692 R2

(156) 2018 09 10

(186) 2028 09 10

(732) HENKEL AG & Co. KGaA

Henkelstrasse 67, 40589 Dusseldorf,
Germany

(111) M 1998 10152 R2

(156) 2018 08 05

(186) 2028 08 05

(732) 3M COMPANY

3M Center, 2501 Hudson Road, St. Paul,
Minnesota 55144, USA

(111) M 1998 11004 R2

(156) 2018 10 28

(186) 2028 10 28

(732) GUABER S.r.l.

Via Gramsci, 41-Funo di Argelato, Italy

(111) M 1998 10153 R2

(156) 2018 08 05

(186) 2028 08 05

(732) 3M COMPANY

3M Center, 2501 Hudson Road, St. Paul,
Minnesota 55144, USA

(111) M 2007 17486 R1

(156) 2017 12 04

(186) 2027 05 08

(732) RELX Inc.

230 Park Avenue, Seventh Floor, New York,
New York 10169, USA

(111) M 1998 10154 R2

(156) 2018 08 05

(186) 2028 08 05

(732) 3M COMPANY

3M Center, 2501 Hudson Road, St. Paul,
Minnesota 55144, USA

(111) M 2007 17798 R1

(156) 2017 11 03

(186) 2027 09 18

(732) ROTAPHARM LIMITED

23 The Kilns Thaxted Road Saffron Walden
Essex CB10 2UQ, United Kingdom

(111) M 1998 10155 R2

(156) 2018 08 05

(186) 2028 08 05

(732) 3M COMPANY

(111) M 2007 17799 R1

(156) 2017 11 03

(186) 2027 09 18

(732) ROTAPHARM LIMITED

48 Queen Anne Street, London W1G9JJ,
United Kingdom

(111) M 2007 17800 R1
(156) 2017 11 03
(186) 2027 09 18
(732) ROTAPHARM LIMITED
48 Queen Anne Street, London W1G9JJ,
United Kingdom

(111) M 2007 17886 R1
(156) 2017 10 16
(186) 2027 10 10
(732) HSBC GROUP MANAGMENT SERVICES
LIMITED
8 Canada Square, London, E14 5HQ, United
Kingdom

(111) M 2007 17974 R1
(156) 2017 10 29
(186) 2027 10 29
(732) LTD "AVERSI-PHARMA"
Davit Agmasheneblis gamz. 148/2, 0112,
Tbilisi, Georgia

(111) M 2007 17975 R1
(156) 2017 10 29
(186) 2027 10 29
(732) LTD "AVERSI-PHARMA"
Davit Agmasheneblis gamz. 148/2, 0112,
Tbilisi, Georgia

(111) M 2007 18001 R1
(156) 2017 11 13
(186) 2027 11 13
(732) THE PROCTER & GAMBLE COMPANY
One Procter & Gamble Plaza, Cincinnati,
Ohio, USA

(111) M 2007 18005 R1
(156) 2017 11 13
(186) 2027 11 13
(732) THE PROCTER & GAMBLE COMPANY
One Procter & Gamble Plaza, Cincinnati,
Ohio, USA

(111) M 2007 18021 R1
(156) 2017 11 13
(186) 2027 11 13
(732) GSH TRADEMARKS LIMITED
Afroditis, 25, 2nd floor, office 204, Nicosia,
Cyprus

(111) M 2007 18101 R1
(156) 2017 12 14
(186) 2027 12 14
(732) İZOCAM TICARET VE SANAYI ANONİM
ŞİRKETİ
Dilovasi Mevkii, Gebze-Kocaeli, Turkey

(111) M 2007 18120 R1
(156) 2017 12 14
(186) 2027 12 14
(732) PLAYBOY ENTERPRISES
INTERNATIONAL, INC.
680 North Lake Shore Drive, Chicago,
Illinois 60611, USA

(111) M 2007 18121 R1
(156) 2017 12 14
(186) 2027 12 14
(732) PLAYBOY ENTERPRISES
INTERNATIONAL, INC.
680 North Lake Shore Drive, Chicago,
Illinois 60611, USA

(111) M 2007 18127 R1
(156) 2017 12 14
(186) 2027 12 14
(732) MAGNETAR CAPITAL LLC
a Delaware Limited Liability company
1603 Orrington, 13 th Floor, Evanston,
Illinois 60201, USA

(111) M 2007 18128 R1
(156) 2017 12 14
(186) 2027 12 14
(732) MAGNETAR CAPITAL LLC
a Delaware Limited Liability company
1603 Orrington, 13 th Floor, Evanston,
Illinois 60201, USA

(111) M 2007 18137 R1
(156) 2017 12 27
(186) 2027 12 27
(732) GSH Trademarks Limited
Afroditis, 25, 2nd floor, office 204, Nicosia,
Cyprus

(111) M 2007 18139 R1
(156) 2017 12 27
(186) 2027 12 27
(732) COMPAGNIE GERVAIS DANONE
17 Boulevard Haussmann, 75009 Paris,
France

(111) M 2008 18169 R1
(156) 2018 01 16
(186) 2028 01 16
(732) BLACKBERRY LIMITED
2200 University Avenue East, Waterloo,
Ontario N2K 0A7, Canada

(111) M 2008 18170 R1
(156) 2018 01 16
(186) 2028 01 16
(732) BLACKBERRY LIMITED
2200 University Avenue East, Waterloo,
Ontario N2K 0A7, Canada

(111) M 2008 18192 R1
(156) 2018 01 28
(186) 2028 01 28
(732) NOVARTIS AG
4002 Basel, Switzerland

(111) M 2008 18197 R1
(156) 2018 01 28
(186) 2028 01 28
(732) BROWN-FORMAN CORPORATION
850 Dixie Highway, Louisville, Kentucky
40210, USA

(111) M 2008 18271 R1
(156) 2018 02 28
(186) 2028 02 28
(732) UNITED STATES POLO ASSOCIATION
1400 Centrepark Blvd., Suite 200 Wwst
Palm Beach, Florida 33401, USA

(111) M 2008 18272 R1
(156) 2018 02 28
(186) 2028 02 28
(732) UNITED STATES POLO ASSOCIATION
1400 Centrepark Blvd., Suite 200 Wwst
Palm Beach, Florida 33401, USA

(111) M 2008 18352 R1
(156) 2018 04 14
(186) 2028 04 14
(732) COLOREX COMÉRCIO E DESENVOLVI-
MENTO DE PRODUTOS LTDA
Deputado Vicente Penido No: 06, Vila
Guilherme, CEP 02064-120, Sao Paulo/SP,
Brazil

(111) M 2008 18371 R1
(156) 2018 04 14
(186) 2028 04 14

(732) GALLAHER LIMITED
Members Hill, Brooklands Road, Weybridge,
Surrey KT13 0QU, United Kingdom

(111) M 2008 18477 R1
(156) 2018 05 27
(186) 2028 05 27
(732) ASICS CORPORATION
1-1 Minatojima-Nakamachi 7-chome, Chuo-Ku,
Kobe City, Hyogo Prefecture, Japan

(111) M 2008 18478 R1
(156) 2018 05 27
(186) 2028 05 27
(732) ASICS CORPORATION
1-1 Minatojima-Nakamachi 7-chome, Chuo-Ku,
Kobe City, Hyogo Prefecture, Japan

(111) M 2008 18479 R1
(156) 2018 05 27
(186) 2028 05 27
(732) ASICS CORPORATION
1-1 Minatojima-Nakamachi 7-chome, Chuo-Ku,
Kobe City, Hyogo Prefecture, Japan

(111) M 2008 18491 R1
(156) 2018 05 27
(186) 2028 05 27
(732) GALLAHER LIMITED
Members Hill, Brooklands Road, Weybridge,
Surrey KT13 0QU, United Kingdom

(111) M 2008 18524 R1
(156) 2018 06 16
(186) 2028 06 16
(732) THE INDEPENDENT TOBACCO FZE
Warehouse No. FZS1BB04, P.O. Box
261031, Jebel Ali, Dubai, United Arab
Emirates

(111) M 2008 18646 R1
(156) 2018 07 31
(186) 2028 07 31
(732) P.R.S. MEDITERRANEAN LTD
Europe-Israel Tower, 2 Weizmann St., Tel-
Aviv 64239, Israel

(111) M 1997 5178 R2
(156) 2017 04 24
(186) 2027 04 24
(732) ARC HOLDINGS
104, avenue du General de Gaulle, 62510
ARQUES, France

(111) M 1997 5267 R2 (156) 2017 05 01 (186) 2027 05 01 (732) APPLE INC. 1 Infinite loop, Cupertino, California 95014, USA	Industriestraße 1-3, 91074 Herzogenaurach, Germany
(111) M 1997 5744 R2 (156) 2017 06 26 (186) 2027 06 26 (732) VALLOUREC OIL AND GAS FRANCE 54, rue Anatole France, 59620 Aulnoye- Aymeries, France	(111) M 1997 6856 R2 (156) 2017 09 19 (186) 2027 09 19 (732) VALENTINO S.P.A. Via Turati 16/18, Milano, Italy
(111) M 1997 6065 R2 (156) 2017 07 23 (186) 2027 07 23 (732) BODE CHEMIE GMBH 27, Melanchthonstrasse, 22525 Hamburg, Germany	(111) M 1997 6857 R2 (156) 2017 09 19 (186) 2027 09 19 (732) VALENTINO S.P.A. Via Turati 16/18, Milano, Italy
(111) M 1997 6249 R2 (156) 2017 08 04 (186) 2027 08 04 (732) SUMITOMO RUBBER INDUSTRIES, LTD. 6-9, 3-chome, Wakinohamacho, Kobe-651, Japan	(111) M 1997 6932 R2 (156) 2017 09 25 (186) 2027 09 25 (732) LINDAB AB S-269 82 BASTAD, Sweden
(111) M 1997 6335 R2 (156) 2017 08 12 (186) 2027 08 12 (732) ARC HOLDINGS 104, avenue du General de Gaulle, 62510 ARQUES, France	(111) M 1997 7016 R2 (156) 2017 10 01 (186) 2027 10 01 (732) OPEL AUTOMOBILE GMBH Bahnhofplatz, 65423 Rüsselsheim, Germany
(111) M 1997 6391 R2 (156) 2017 08 14 (186) 2027 08 14 (732) OLIVETTI S.p.A. Via Jervis, 77, 10015 IVREA (TO), Italy	(111) M 1997 7042 R2 (156) 2017 10 06 (186) 2027 10 06 (732) WIZARD CO., INC. 6 Sylvan Way, Parsippany, New Jersey 07054, USA
(111) M 1997 6459 R2 (156) 2017 08 20 (186) 2027 08 20 (732) JOHN PLAYER & SONS LIMITED 21 Beckett Way, Park West Nangor Road, Dublin 12, Ireland	(111) M 1997 7043 R2 (156) 2017 10 06 (186) 2027 10 06 (732) WIZARD CO., INC. 6 Sylvan Way, Parsippany, New Jersey 07054, USA
(111) M 1997 6802 R2 (156) 2017 09 17 (186) 2027 09 17 (732) SCHAEFFLER TECHNOLOGIES AG & CO. KG	(111) M 1997 7044 R2 (156) 2017 10 06 (186) 2027 10 06 (732) WIZARD CO., INC. 6 Sylvan Way, Parsippany, New Jersey 07054, USA
	(111) M 1997 7045 R2 (156) 2017 10 07 (186) 2027 10 07

(732) WIZARD CO. INC.
6 Sylvan Way, Parsippany, New Jersey
07054, USA

Route Louis-Braille 10, CH-1763,
GRANGES-PACCOT (Fribourg),
Switzerland

(111) M 1997 7086 R2
(156) 2017 10 08
(186) 2027 10 08
(732) CHIQUITA BRANDS LLC
c/o DCOTA office Center, 1855 Griffin
Road, Suite C-436, Fort Lauderdale, Florida
33004-2275, USA

(111) M 1997 7194 R2
(156) 2017 10 15
(186) 2027 10 15
(732) SIGMA-ALDRICH CO. LLC
3050 Spruce Street, St. Louis, Missouri,
63103, USA

(111) M 1997 7121 R2
(156) 2017 10 09
(186) 2027 10 09
(732) TAMPIKO BEVERAGES INC.
3106 N. Campbell Avenue, Chicago, Illinois
60618, USA

(111) M 1997 7202 R2
(156) 2017 10 15
(186) 2027 10 15
(732) DHL INTERNATIONAL GMBH
Charles-de-Gaulle-Str. 20, 53113 Bonn, Germany

(111) M 1997 7165 R2
(156) 2017 10 13
(186) 2027 10 13
(732) BP P.L.C.
1 St James's Square, London SW1Y 4PD,
United Kingdom

(111) M 1997 7216 R2
(156) 2017 10 16
(186) 2027 10 16
(732) SYNGENTA LIMITED
Fernhurst, Haslemere, Surrey GU27 3JE,
United Kingdom

(111) M 1997 7184 R2
(156) 2017 10 13
(186) 2027 10 13
(732) BATMARK LIMITED
Globe House, 4 Temple Place, London
WC2R 2PG, United Kingdom

(111) M 1997 7335 R2
(156) 2017 10 29
(186) 2027 10 29
(732) LORIS AZZARO B.V.
Kanaalpad 61, 7321 AN Apeldoorn,
Netherlands

(111) M 1997 7189 R2
(156) 2017 10 13
(186) 2027 10 13
(732) SIGMA-ALDRICH CO. LLC
3050 Spruce Street, St. Louis, Missouri,
63103, USA

(111) M 1997 7356 R2
(156) 2017 11 03
(186) 2027 11 03
(732) SPEEDO HOLDINGS B.V.
Claude Debussylaan 24, 1082 MD
Amsterdam, Netherlands

(111) M 1997 7190 R2
(156) 2017 10 13
(186) 2027 10 13
(732) SPECTRUM BRANDS, INC.
3001 Deming way, Middleton, Wisconsin
53562, USA

(111) M 1997 7375 R2
(156) 2017 11 04
(186) 2027 11 04
(732) FIAT GROUP MARKETING &
CORPORATE COMMUNICATION S.P.A.
Via Nizza 250, 10126 Torino, Italy

(111) M 1997 7191 R2
(156) 2017 10 13
(186) 2027 10 13
(732) MC PROJECTS B.V. MAASTRICHT
succursale de Granges-Paccot;

(111) M 1997 7378 R2
(156) 2017 11 05
(186) 2027 11 05
(732) FIAT GROUP MARKETING &
CORPORATE COMMUNICATION S.P.A.
Via Nizza 250, 10126 Torino, Italy

(111) M 1997 7379 R2
 (156) 2017 11 05
 (186) 2027 11 05
 (732) CHIQUITA BRANDS LLC
 c/o DCOTA office Center, 1855 Griffin
 Road, Suite C-436, Fort Lauderdale, Florida
 33004-2275, USA

(111) M 1997 7403 R2
 (156) 2017 11 05
 (186) 2027 11 05
 (732) BP P.L.C.
 1 St James's Square, London SW1Y 4PD,
 United Kingdom

(111) M 1997 7404 R2
 (156) 2017 11 05
 (186) 2027 11 05
 (732) BP P.L.C.
 1 St James's Square, London SW1Y 4PD,
 United Kingdom

(111) M 1997 7405 R2
 (156) 2017 11 07
 (186) 2027 11 07
 (732) BP P.L.C.
 1 St James's Square, London SW1Y 4PD,
 United Kingdom

(111) M 1997 7438 R2
 (156) 2017 11 10
 (186) 2027 11 10
 (732) SIX CONTINENT HOTELS INC.
 3 Ravinia Drive, Atlanta, Georgia 30346,
 USA

(111) M 1997 7440 R2
 (156) 2017 11 11
 (186) 2027 11 11
 (732) SIX CONTINENT HOTELS INC.
 3 Ravinia Drive, Atlanta, Georgia 30346, USA

(111) M 1997 7441 R2
 (156) 2017 11 11
 (186) 2027 11 11
 (732) SIX CONTINENT HOTELS,INC.
 3 Ravinia Drive, Atlanta, Georgia 30346, USA

(111) M 1997 7443 R2
 (156) 2017 11 11
 (186) 2027 11 11

(732) SIX CONTINENT HOTELS INC.
 3 Ravinia Drive, Atlanta, Georgia 30346,
 USA

(111) M 1997 7453 R2
 (156) 2017 11 11
 (186) 2027 11 11
 (732) TAMPIKO BEVERAGES, INC.
 3106 N. Campbell Avenue, Chicago, Illinois
 60618, USA

(111) M 1997 7456 R2
 (156) 2017 11 11
 (186) 2027 11 11
 (732) SPORTSWEAR COMPANY S.P.A.
 Galleria Cavour 4, 40124 Bologna, Italy

(111) M 1997 7457 R2
 (156) 2017 11 11
 (186) 2027 11 11
 (732) TENNECO AUTOMOTIVE OPERATING
 COMPANY INC.
 500 North Field Drive, LAKE FOREST,
 IL 60045, USA

(111) M 1997 7461 R2
 (156) 2017 11 11
 (186) 2027 11 11
 (732) BP P.L.C.
 1 St James's Square, London SW1Y 4PD,
 United Kingdom

(111) M 1997 7495 R2
 (156) 2017 11 13
 (186) 2027 11 13
 (732) Red Diamond Holdings Sàrl
 1B, Heienhaff, L-1736 Senningerberg,
 Luxembourg

(111) M 1997 7538 R2
 (156) 2017 11 17
 (186) 2027 11 17
 (732) THE PROCTER & GAMBLE COMPANY
 One Procter & Gamble Plaza, Cincinnati,
 Ohio, USA

(111) M 1997 7539 R2
 (156) 2017 11 17
 (186) 2027 11 17
 (732) CHOCOLATERIE GUYLIAN N.V.
 Europark-Oost 1, 9100 Sint-Niklaas, Belgium

(111) M 1997 7544 R2
(156) 2017 11 17
(186) 2027 11 17
(732) ADOBE SYSTEMS INCORPORATED
345 Park Avenue, San Jose, California
95110, USA

(111) M 1997 7548 R2
(156) 2017 11 17
(186) 2027 11 17
(732) THE PROCTER & GAMBLE COMPANY
One Procter & Gamble Plaza, Cincinnati,
Ohio, USA

(111) M 1997 7551 R2
(156) 2017 11 18
(186) 2027 11 18
(732) THE PROCTER & GAMBLE COMPANY
One Procter & Gamble Plaza, Cincinnati,
Ohio, USA

(111) M 1997 7567 R2
(156) 2017 11 18
(186) 2027 11 18
(732) ADOBE SYSTEMS INCORPORATED
345 Park Avenue, San Jose, California
95110, USA

(111) M 1997 7568 R2
(156) 2017 11 18
(186) 2027 11 18
(732) ADOBE SYSTEMS INCORPORATED
345 Park Avenue, San Jose, California
95110, USA

(111) M 1997 7569 R2
(156) 2017 11 18
(186) 2027 11 18
(732) ABB ASEA BROWN BOVERI LTD
Affolternstrasse 44, CH-8050 Zurich,
Switzerland

(111) M 1997 7577 R2
(156) 2017 11 18
(186) 2027 11 18
(732) AHLERS AG
Elverdisser Strasse 313, 32052 Herford,
Germany

(111) M 1997 7600 R2
(156) 2017 11 19
(186) 2027 11 19

(732) SYNGENTA PARTICIPATIONS AG
Schwarzwaldallee 215, 4058 Basel,
Switzerland

(111) M 1997 7604 R2
(156) 2017 11 19
(186) 2027 11 19
(732) ABB ASEA BROWN BOVERI LTD
Affolternstrasse 44, CH-8050 Zurich,
Switzerland

(111) M 1997 7605 R2
(156) 2017 11 19
(186) 2027 11 19
(732) ABB ASEA BROWN BOVERI LTD
Affolternstrasse 44, CH-8050 Zurich,
Switzerland

(111) M 1997 7606 R2
(156) 2017 11 19
(186) 2027 11 19
(732) ABB ASEA BROWN BOVERI LTD
Affolternstrasse 44, CH-8050 Zurich,
Switzerland

(111) M 1997 7607 R2
(156) 2017 11 19
(186) 2027 11 19
(732) ABB ASEA BROWN BOVERI LTD
Affolternstrasse 44, CH-8050 Zurich,
Switzerland

(111) M 1997 7610 R2
(156) 2017 11 19
(186) 2027 11 19
(732) NIKE INNOVATE C.V.
One Bowerman Drive, Beaverton, Oregon
97005-6453, USA

(111) M 1997 7622 R2
(156) 2017 11 20
(186) 2027 11 20
(732) THE PROCTER & GAMBLE COMPANY
One Procter & Gamble Plaza, Cincinnati,
Ohio, USA

(111) M 1997 7636 R2
(156) 2017 11 20
(186) 2027 11 20
(732) MEDA PHARMACEUTICALS INC.
a Delaware corporation

265 Davidson Avenue, Suite 300, Somerset, NJ 08873-4120, USA	(111) M 1997 7782 R2 (156) 2017 12 09 (186) 2027 12 09 (732) KRKA, tovarna zdravil, d.d., Novo mesto Smarjeska cesta 6, 8501 Novo mesto, Slovenia
(111) M 1997 7653 R2 (156) 2017 11 21 (186) 2027 11 21 (732) FEDERACION NACIONAL DE CAFETEROS DE COLOMBIA Calle 73 8-13 Bogota, Colombia	(111) M 1997 7783 R2 (156) 2017 12 09 (186) 2027 12 09 (732) KRKA, tovarna zdravil, d.d., Novo mesto Smarjeska cesta 6, 8501 Novo mesto, Slovenia
(111) M 1997 7673 R2 (156) 2017 11 21 (186) 2027 11 21 (732) KRKA, tovarna zdravil, d.d., Novo mesto Smarjeska cesta 6, 8501 Novo mesto, Slovenia	(111) M 1997 7784 R2 (156) 2017 12 09 (186) 2027 12 09 (732) KRKA, tovarna zdravil, d.d., Novo mesto Smarjeska cesta 6, 8501 Novo mesto, Slovenia
(111) M 1997 7773 R2 (156) 2017 12 09 (186) 2027 12 09 (732) KRKA, tovarna zdravil, d.d., Novo mesto Smarjeska cesta 6, 8501 Novo mesto, Slovenia	(111) M 1997 7785 R2 (156) 2017 12 09 (186) 2027 12 09 (732) KRKA, tovarna zdravil, d.d., Novo mesto Smarjeska cesta 6, 8501 Novo mesto, Slovenia
(111) M 1997 7775 R2 (156) 2017 12 09 (186) 2027 12 09 (732) KRKA, tovarna zdravil, d.d., Novo mesto Smarjeska cesta 6, 8501 Novo mesto, Slovenia	(111) M 1997 7786 R2 (156) 2017 12 09 (186) 2027 12 09 (732) KRKA, tovarna zdravil, d.d., Novo mesto Smarjeska cesta 6, 8501 Novo mesto, Slovenia
(111) M 1997 7777 R2 (156) 2017 12 09 (186) 2027 12 09 (732) KRKA, tovarna zdravil, d.d., Novo mesto Smarjeska cesta 6, 8501 Novo mesto, Slovenia	(111) M 1997 7788 R2 (156) 2017 12 09 (186) 2027 12 09 (732) KRKA, tovarna zdravil, d.d., Novo mesto Smarjeska cesta 6, 8501 Novo mesto, Slovenia
(111) M 1997 7778 R2 (156) 2017 12 09 (186) 2027 12 09 (732) KRKA, tovarna zdravil, d.d., Novo mesto Smarjeska cesta 6, 8501 Novo mesto, Slovenia	(111) M 1997 7817 R2 (156) 2017 12 11 (186) 2027 12 11 (732) PITNEY BOWES INC. Stamford, Connecticut, USA
(111) M 1997 7779 R2 (156) 2017 12 09 (186) 2027 12 09 (732) KRKA, tovarna zdravil, d.d., Novo mesto Smarjeska cesta 6, 8501 Novo mesto, Slovenia	(111) M 1997 7837 R2 (156) 2017 12 15 (186) 2027 12 15 (732) MC PROJECTS B.V. MAASTRICHT, succursale de Granges-Paccot

Route Louis-Braille 10, CH-1763, GRAN-
GES-PACCOT (Fribourg), Switzerland

(111) M 1997 7861 R2

(156) 2017 12 16

(186) 2027 12 16

(732) ASPEN GLOBAL INCORPORATED
GBS Plaza, Cnr. La Salette & Royal Roads,
Grand Bay, Mauritius

(111) M 1997 7863 R2

(156) 2017 12 16

(186) 2027 12 16

(732) ASPEN GLOBAL INCORPORATED
GBS Plaza, Cnr. La Salette & Royal Roads,
Grand Bay, Mauritius

(111) M 1997 7864 R2

(156) 2017 12 16

(186) 2027 12 16

(732) ASPEN GLOBAL INCORPORATED
GBS Plaza, Cnr. La Salette & Royal Roads,
Grand Bay, Mauritius

(111) M 1997 7872 R2

(156) 2017 12 16

(186) 2027 12 16

(732) J.&P. COATS, LIMITED
1 George Square, Glasgow G2 1AL,
Scotland, United Kingdom

(111) M 1997 7917 R2

(156) 2017 12 18

(186) 2027 12 18

(732) MASSEY FERGUSON CORP.
4205 River Green Parkway, Duluth, Georgia
30096-2584, USA

(111) M 1997 7928 R2

(156) 2017 12 22

(186) 2027 12 22

(732) OPEL AUTOMOBILE GMBH
Bahnhofsplatz, 65423 Rüsselsheim,
Germany

(111) M 1997 7930 R2

(156) 2017 12 22

(186) 2027 12 22

(732) OPEL AUTOMOBILE GMBH
Bahnhofsplatz, 65423 Rüsselsheim,
Germany

(111) M 1997 7936 R2

(156) 2017 12 22

(186) 2027 12 22

(732) OPEL AUTOMOBILE GMBH
Bahnhofsplatz, 65423 Rüsselsheim,
Germany

(111) M 1997 7943 R2

(156) 2017 12 24

(186) 2027 12 24

(732) ASTELLAS PHARMA EUROPE B.V.
Sylviusweg 62, 2333 BE LEIDEN,
Netherlands

(111) M 1997 7982 R2

(156) 2017 12 26

(186) 2027 12 26

(732) FEDERAL EXPRESS CORPORATION
3620 Hacks Cross Road, Building B, 3rd
Floor, Memphis, Tennessee, USA

(111) M 1997 7998 R2

(156) 2017 12 26

(186) 2027 12 26

(732) MIKASA CORPORATION
1, Kuchi, Asa-cho, Asakita-ku, Hiroshima-
shi, Hiroshima-ken, Japan

(111) M 1997 8004 R2

(156) 2017 12 26

(186) 2027 12 26

(732) GUCCIO GUCCI S.P.A.
Via Tornabuoni 73/R, 50123 Firenze, Italy

(111) M 1998 8041 R2

(156) 2018 01 08

(186) 2028 01 08

(732) MC PROJECTS B.V. MAASTRICHT,
succursale de Granges-Paccot
Route Louis-Braille 10, CH-1763, GRAN-
GES-PACCOT (Fribourg), Switzerland

(111) M 1998 8042 R2

(156) 2018 01 08

(186) 2028 01 08

(732) MC PROJECTS B.V. MAASTRICHT,
succursale de Granges-Paccot
Route Louis-Braille 10, CH-1763, GRAN-
GES-PACCOT (Fribourg), Switzerland

(111) M 1998 8043 R2

(156) 2018 01 08

(186) 2028 01 08

(732) MC PROJECTS B.V. MAASTRICHT,
succursale de Granges-Paccot
Route Louis-Braille 10, CH-1763, GRAN-
GES-PACCOT (Fribourg), Switzerland

(111) M 1998 8053 R2

(156) 2018 01 15

(186) 2028 01 15

(732) HERO AG
CH-5600, Lenzburg 1, Switzerland

(111) M 1998 8063 R2

(156) 2018 01 15

(186) 2028 01 15

(732) J.&P. COATS, LIMITED
1 George Square, Glasgow G2 1AL,
Scotland, United Kingdom

(111) M 1998 8065 R2

(156) 2018 01 15

(186) 2028 01 15

(732) J.&P. COATS, LIMITED
1 George Square, Glasgow G2 1AL,
Scotland, United Kingdom

(111) M 1998 8068 R2

(156) 2018 01 15

(186) 2028 01 15

(732) J.&P. COATS, LIMITED
1 George Square, Glasgow G2 1AL,
Scotland, United Kingdom

(111) M 1998 8069 R2

(156) 2018 01 15

(186) 2028 01 15

(732) J.&P. COATS, LIMITED
1 George Square, Glasgow G2 1AL,
Scotland, United Kingdom

(111) M 1998 8071 R2

(156) 2018 01 15

(186) 2028 01 15

(732) J.&P. COATS, Limited
1 George Square, Glasgow G2 1AL, Scotland,
United Kingdom

(111) M 1998 8072 R2

(156) 2018 01 15

(186) 2028 01 15

(732) COLGATE-PALMOLIVE COMPANY
300 Park Avenue, New York, NY 10022, USA

(111) M 1998 8073 R2

(156) 2018 01 15

(186) 2028 01 15

(732) BRINK'S NETWORK, INCORPORATED
a Delaware corporation
1801 Bayberry Court, Richmond, Virginia
23226, USA

(111) M 1998 8084 R2

(156) 2018 01 20

(186) 2028 01 20

(732) FYFFES INTERNATIONAL
29 North Anne Street, Dublin 7, Ireland

(111) M 1998 8177 R2

(156) 2018 01 29

(186) 2028 01 29

(732) DISCOVER FINANCIAL SERVICES
2500 Lake Cook Road, Riverwoods, State of
Illinois, USA

(111) M 1998 8209 R2

(156) 2018 01 30

(186) 2028 01 30

(732) BAYER INTELLECTUAL PROPERTY
GMBH
Alfred-Nobel-Strasse 10, 40789 Monheim am
Rhein, Germany

(111) M 1998 8219 R2

(156) 2018 02 02

(186) 2028 02 02

(732) ANF Pet, Inc.
1500 Whitehall Lane, St. Helena, California
94574, USA

(111) M 1998 8220 R2

(156) 2018 02 02

(186) 2028 02 02

(732) ANF Pet, Inc.
1500 Whitehall Lane, St. Helena, California
94574, USA

(111) M 1998 8342 R2

(156) 2018 02 17

(186) 2028 02 17

(732) HENKEL AG & Co. KGaA
Henkelstrasse 67, D-40589 Dusseldorf,
Germany

(111) M 1998 8358 R2
(156) 2018 02 18
(186) 2028 02 18
(732) HENKEL AG & Co. KGaA
Henkelstrasse 67, 40589 Dusseldorf,
Germany

(111) M 1998 8361 R2
(156) 2018 02 18
(186) 2028 02 18
(732) BISON INTERNATIONAL B.V.
Dr.A.F. Philipsstraat 9, 4462 EW Goes,
Netherlands

(111) M 1998 8499 R2
(156) 2018 03 02
(186) 2028 03 02
(732) BISON INTERNATIONAL B.V.
Dr.A.F. Philipsstraat 9, 4462 EW Goes,
Netherlands

(111) M 1998 8502 R2
(156) 2018 03 02
(186) 2028 03 02
(732) MARY KAY INC.
16251 N Dallas Parkway, Dallas, Texas
75248, USA

(111) M 1998 8641 R2
(156) 2018 03 12
(186) 2028 03 12
(732) EDELWEISS GMBH & Co.KG
Oberstdorfer Strasse 7, 87435 Kempten,
Germany

(111) M 1998 8733 R2
(156) 2018 03 26
(186) 2028 03 26
(732) ADMARKA SP. Z O.O.
Pieńków 149, 05-152 Czoznów, Poland

(111) M 1998 9225 R2
(156) 2018 05 05
(186) 2028 05 05
(732) WD-40 MANUFACTURING COMPANY
1061 Cudahy Place, San Diego, California
92110, USA

(111) M 1998 9226 R2
(156) 2018 05 05
(186) 2028 05 05

(732) WD-40 MANUFACTURING COMPANY
1061 Cudahy Place, San Diego, California
92110, USA

(111) M 1998 9234 R2
(156) 2018 05 06
(186) 2028 05 06
(732) 3M COMPANY
3M Center, 2501 Hudson Road, St. Paul,
Minnesota 55144, USA

(111) M 1998 9366 R2
(156) 2018 05 20
(186) 2028 05 20
(732) MENELAUS B.V.
Archimedesbaan 18-D, 3439 ME
Nieuwegein, Netherlands

(111) M 1998 9382 R2
(156) 2018 05 20
(186) 2028 05 20
(732) HENKEL AG & Co. KGaA
Henkelstrasse 67, 40589 Dusseldorf,
Germany

(111) M 1998 9401 R2
(156) 2018 05 22
(186) 2028 05 22
(732) PERFETTI VAN MELLE BENELUX B.V.
Zoete Inval 20, 4815 HK Breda, Netherlands

(111) M 1998 9402 R2
(156) 2018 05 22
(186) 2028 05 22
(732) PERFETTI VAN MELLE BENELUX B.V.
Zoete Inval 20, 4815 HK Breda, Netherlands

(111) M 1998 9403 R2
(156) 2018 05 22
(186) 2028 05 22
(732) PERFETTI VAN MELLE BENELUX B.V.
Zoete Inval 20, 4815 HK Breda, Netherlands

(111) M 1998 9610 R2
(156) 2018 06 08
(186) 2028 06 08
(732) HENKEL AG & Co. KGaA
Henkelstrasse 67, 40589 Dusseldorf,
Germany

(111) M 1998 9614 R2
(156) 2018 06 08
(186) 2028 06 08
(732) ALL STAR C.V.
One Bowerman Drive, Beaverton, Oregon
97005, USA

(111) M 1998 9766 R2
(156) 2018 06 15
(186) 2028 06 15
(732) HENKEL AG & Co. KGaA
Henkelstrasse 67, 40589 Dusseldorf,
Germany

(111) M 1998 9864 R2
(156) 2018 06 26
(186) 2028 06 26
(732) 3M COMPANY
3M Center, 2501 Hudson Road, St. Paul,
Minnesota 55144, USA

COMPLETE TRANSFER OF RIGHTS

-
- (111) M 1999 012000 R1
 (732) ADMARKA SP. Z O.O.
 Pieńków 149, 05-152 Czosnów, Poland
 (770) PABIANICKIE ZAKLADY
 FARMACEUTYCZNE
 "POLFA" SPOLKA AKCYJNA
 ul.Marshalka J. Pilsudskiego 5, Pabianice,
 Poland
 (580) 2017 11 29
-
- (111) M 1999 012285 R1
 (732) OPEL AUTOMOBILE GMBH
 Bahnhofplatz, 65423 Rüsselsheim, Germany
 (770) ADAM OPEL GMBH
 Bahnhofplatz, 65423 Rüsselsheim, Germany
 (580) 2017 12 04
-
- (111) M 1999 012674 R1
 (732) OPEL AUTOMOBILE GMBH
 Bahnhofplatz, 65423 Rüsselsheim, Germany
 (770) ADAM OPEL GMBH
 Bahnhofplatz, 65423 Rüsselsheim, Germany
 (580) 2017 12 04
-
- (111) M 1999 012677 R1
 (732) OPEL AUTOMOBILE GMBH
 Bahnhofplatz, 65423 Rüsselsheim, Germany
 (770) ADAM OPEL GMBH
 Bahnhofplatz, 65423 Rüsselsheim, Germany
 (580) 2017 12 04
-
- (111) M 2000 013265 R1
 (732) COMPAGNE GENERALE DES
 ESTABLISSEMENTS MICHELIN
 12, cours Sablon, 63000, Clermont-Ferrand,
 France
 (770) MICHELIN RECHERCHE ET
 TECHNIQUE S.A.
 Route Louis-Braille 10, CH-1763 Granges-
 Paccot, Switzerland
 (580) 2017 12 07
-
- (111) M 2000 013322 R1
 (732) OPEL AUTOMOBILE GMBH
 Bahnhofplatz, 65423 Rüsselsheim, Germany
 (770) ADAM OPEL GMBH
 Bahnhofplatz, 65423 Rüsselsheim, Germany
 (580) 2017 12 04
-
- (111) M 2000 013324 R1
 (732) OPEL AUTOMOBILE GMBH
 Bahnhofplatz, 65423 Rüsselsheim, Germany
 (770) ADAM OPEL GMBH
 Bahnhofplatz, 65423 Rüsselsheim, Germany
 (580) 2017 12 04
-
- (111) M 2000 013325 R1
 (732) OPEL AUTOMOBILE GMBH
 Bahnhofplatz, 65423 Rüsselsheim, Germany
 (770) ADAM OPEL GMBH
 Bahnhofplatz, 65423 Rüsselsheim, Germany
 (580) 2017 12 04
-
- (111) M 2001 014075 R1
 (732) LG CHEM, LTD.
 128, Yeoui-doero, Yeongdeungpo-gu, Seoul,
 Republic of Korea
 (770) LG LIFE SCIENCES, LTD.
 58, Saemunan-ro, Jongno-gu, Seoul,
 Republic of Korea
 (580) 2017 12 04
-
- (111) M 2003 014937 R1
 (732) KELLOGG EUROPE TRADING LIMITED
 Suite 3, One Earlsfort Centre, Lower
 Hatch Street Dublin 2, Ireland
 (770) PRINGLES S.A.R.L.
 560A Rue de Neudorf, Luxembourg, L-2220,
 Luxembourg
 (580) 2017 12 12
-
- (111) M 2007 017486 R1
 (732) RELX INC.
 230 Park Avenue, Seventh Floor, New York,
 New York 10169, USA
 (770) REED ELSEVIER PROPERTIES INC.
 1105 North Market Street, Suite 501,
 Wilmington, Delaware 19801, USA
 (580) 2017 12 11
-
- (111) M 2008 018189 R
 (732) DELL INC.
 One Dell Way, Round Rock, Texas 78682,
 USA
 (770) EMC CORPORATION
 176 South Street, Hopkinton, Massachusetts
 01748, USA
 (580) 2017 12 08
-

- (111) M 2008 018190 R
(732) DELL INC.
One Dell Way, Round Rock, Texas 78682,
USA
(770) EMC CORPORATION
176 South Street, Hopkinton, Massachusetts
01748, USA
(580) 2017 12 08
-
- (111) M 2008 018647 R
(732) REYNOLDS PRESTO PRODUCTS INC.
1900 West Field Court, Lake Forest, Illinois
60045, USA
(770) P.R.S. MEDITERRANEAN LTD
Europe-Israel Tower, 2 Weizmann St.,
Tel-Aviv 64239, Israel
(580) 2017 11 29
-
- (111) M 2008 018781 R
(732) EFES HOLLAND TECHNICAL AND
MANAGEMENT CONSULTANCY B.V.
Strawinskylaan 1229, 1077XX Amsterdam,
Netherlands
(770) JSC Pivovarnya "Moscow-EFES"
Ul. Podolskikh Kursantov, dom 15b,
RU-117546 Moscow, Russian Federation
(580) 2017 12 14
-
- (111) M 2009 019745 R
(732) ADMARKA SP. Z O.O.
Pieńków 149, 05-152 Czosnów, Poland
(770) PABIANICKIE ZAKŁADY
FARMACEUTYCZNE "POLFA" Spółka
Akcyjna
ul. Marszałka J. Piłsudskiego 5, 95-200
Pabianice, Poland
(580) 2017 11 29
-
- (111) M 2009 019746 R
(732) ADMARKA SP. Z O.O.
Pieńków 149, 05-152 Czosnów, Poland
(770) PABIANICKIE ZAKŁADY
FARMACEUTYCZNE "POLFA" Spółka
Akcyjna
ul. Marszałka J. Piłsudskiego 5, 95-200
Pabianice, Poland
(580) 2017 11 29
-
- (111) M 2010 020721 R
(732) BIOMARIN PHARMACEUTICAL INC.
105 Digital Drive, Novato, CA 94949, USA
(770) MERCK KGaA
Frankfurter Strasse 250, 64293 DARMSTADT,
Germany
(580) 2017 12 12
-

- (111) M 1996 002175 R2
(732) SCA HYGIENE PRODUCTS AB
SE-40503 Göteborg, Sweden
(770) GEORGIA-PACIFIC S.a.r.l.
25, route d'Esch, L-1470, Luxembourg
(580) 2017 12 11
-
- (111) M 2013 023945 R
(732) ADMARKA SP. Z O.O.
Pieńków 149, 05-152 Czosnów, Poland
(770) ZAKŁAD FARMACEUTYCZNY
ADAMED PHARMA SPÓLKA
AKCYJNA
Ul. Szkolna 33, 95-054 Ksawerów, Poland
(580) 2017 11 29
-
- (111) M 2013 023946 R
(732) ADMARKA SP. Z O.O.
Pieńków 149, 05-152 Czosnów, Poland
(770) ZAKŁAD FARMACEUTYCZNY
ADAMED PHARMA SPÓLKA
AKCYJNA
Ul. Szkolna 33, 95-054 Ksawerów, Poland
(580) 2017 11 29
-
- (111) M 2013 023947 R
(732) ADMARKA SP. Z O.O.
Pieńków 149, 05-152 Czosnów, Poland
(770) ZAKŁAD FARMACEUTYCZNY
ADAMED PHARMA SPÓLKA
AKCYJNA
Ul. Szkolna 33, 95-054 Ksawerów, Poland
(580) 2017 11 29
-
- (111) M 2013 024087 R
(732) COMPAGNE GENERALE DES
ESTABLISSEMENTS MICHELIN
12, cours Sablon, 63000, Clermont-Ferrand,
France
(770) MICHELIN RECHERCHE ET
TECHNIQUE S.A.
Route Louis-Braille 10, CH-1763 Granges-
Paccot, Switzerland
(580) 2017 12 07
-
- (111) M 2014 024596 R
(732) LTD "AI SI AR FUUD END BEVEREJ"
Vake saburtalos raioni, digmis sastsavlo satsdeli
meurneobis teritoria, sartuli 5, Georgia
(770) LTD "SAERTASHORISO
KORPORATSIA AI SI AR"
Davit Agmasheneblis 173, 0112, Tbilisi, Georgia
(580) 2017 12 07
-

(111) M 2014 025237 R
(732) LG CHEM, LTD.
128, Yeoui-doero, Yeongdeungpo-gu, Seoul,
Republic of Korea
(770) LG LIFE SCIENCES, LTD.
58, Saemunan-ro, Jongno-gu, Seoul,
Republic of Korea
(580) 2017 12 08

(111) M 2014 025238 R
(732) LG CHEM, LTD.
128, Yeoui-doero, Yeongdeungpo-gu, Seoul,
Republic of Korea
(770) LG LIFE SCIENCES, LTD.
58, Saemunan-ro, Jongno-gu, Seoul,
Republic of Korea
(580) 2017 12 08

(111) M 2014 025239 R
(732) LG CHEM, LTD.
128, Yeoui-doero, Yeongdeungpo-gu, Seoul,
Republic of Korea
(770) LG LIFE SCIENCES, LTD.
58, Saemunan-ro, Jongno-gu, Seoul,
Republic of Korea
(580) 2017 12 08

(111) M 2014 025240 R
(732) LG CHEM, LTD.
128, Yeoui-doero, Yeongdeungpo-gu, Seoul,
Republic of Korea
(770) LG LIFE SCIENCES, LTD.
58, Saemunan-ro, Jongno-gu, Seoul,
Republic of Korea
(580) 2017 12 08

(111) M 2015 025795 R
(732) LG CHEM, LTD.
128, Yeoui-doero, Yeongdeungpo-gu, Seoul,
Republic of Korea
(770) LG LIFE SCIENCES, LTD.
58, Saemunan-ro, Jongno-gu, Seoul,
Republic of Korea
(580) 2017 12 08

(111) M 1996 003381 R2
(732) CITIZEN WATCH COMPANY OF
AMERICA, INC.
d/b/a Bulova 350 Fifth Avenue, 29 th Floor,
New York, New York 10118, USA
(770) BULOVA CORPORATION
Empire State Building, 29 th Floor, 350
Fifth Avenue, New York, New York 10118,
USA
(580) 2017 12 07

(111) M 1996 003445 R2
(732) ADMARKA SP. Z O.O.
Pieńków 149, 05-152 Czosnów, Poland
(770) PABIANICKIE ZAKŁADY
FARMACEUTYCZNE "POLFA" Spółka
Akcyjna
ul. Marszałka J. Pilsudskiego 5, Pabianice,
95-200, Poland
(580) 2017 11 29

(111) M 1995 000471 P R2
(732) COMPAGNE GENERALE DES
ESTABLISSEMENTS MICHELIN
12, cours Sablon, 63000, Clermont-Ferrand,
France
(770) MICHELIN RECHERCHE ET
TECHNIQUE S.A.
Route Louis-Braille 10 et 12, CH-1763
Granges-Paccot, Switzerland
(580) 2017 12 07

(111) M 1997 004726 R2
(732) OPEL AUTOMOBILE GMBH,
Bahnhofplatz, 65423 Rüsselsheim,
Germany
(770) ADAM OPEL GMBH,
Bahnhofplatz, 65423 Rüsselsheim,
Germany
(580) 2017 12 04

(111) M 1997 005192 R2
(732) OPEL AUTOMOBILE GMBH
Bahnhofplatz, 65423 Rüsselsheim,
Germany
(770) ADAM OPEL GMBH
Bahnhofplatz, 65423 Rüsselsheim,
Germany
(580) 2017 12 04

(111) M 1997 005195 R2
(732) OPEL AUTOMOBILE GMBH
Bahnhofplatz, 65423 Rüsselsheim,
Germany
(770) ADAM OPEL GMBH
Bahnhofplatz, 65423 Rüsselsheim,
Germany
(580) 2017 12 04

(111) M 1997 006391 R2
(732) OLIVETTI S.p.A.
Via Jervis, 77, 10015 IVREA (TO), Italy
(770) TELECOM ITALIA S.P.A.
Piazza degli Affari 2, Milano, Italy
(580) 2017 12 12

(111) M 1997 006409 R1
(732) CITIZEN WATCH COMPANY OF AMERICA, INC.
d/b/a Bulova 350 Fifth Avenue, 29 th Floor,
New York, New York 10118, USA

(770) BULOVA CORPORATION
One Bulova Avenue, Woodside, New York,
11377-7874, USA
(580) 2017 12 07

(111) M 1997 006478 R2
(732) CITIZEN WATCH COMPANY OF AMERICA, INC.
d/b/a Bulova 350 Fifth Avenue, 29 th Floor,
New York, New York 10118, USA

(770) BULOVA CORPORATION
a NEW YORK CORPORATION
One Bulova Avenue, Woodside, New York,
USA
(580) 2017 12 07

(111) M 1997 007016 R2
(732) OPEL AUTOMOBILE GMBH
Bahnhofplatz, 65423 Rüsselsheim,
Germany

(770) ADAM OPEL GMBH
Bahnhofplatz, 65423 Rüsselsheim,
Germany
(580) 2017 12 04

(111) M 1995 000711 R2
(732) SCA Hygiene Products AB
SE-40503 Göteborg, Sweden
(770) GEORGIA-PACIFIC S.a.r.l.
25, route d'Esch, L-1470, Luxembourg
(580) 2017 12 11

(111) M 1997 007191 R2
(732) MC PROJECTS B.V. MAASTRICHT
succursale de Granges-Paccot
Route Louis-Braille 10, CH-1763,
GRANGES-PACCOT (Fribourg),
Switzerland
(770) MC PROJECTS B.V. Amsterdam succursale
de Granges-Paccot
Route Louis-Braille 10 et 12, CH-1763
Granges-Paccot, Switzerland
(580) 2017 12 13

(111) M 1997 007202 R2
(732) DHL OPERATIONS B.V.
Terminalweg 36, 3821 AJ Amersfoort,
Netherlands
(770) DHL OPERATIONS B.V.

Jozef Israelskade 48G, 1072 SB Amsterdam,
Netherlands
(580) 2017 11 20

(111) M 1997 007202 R2
(732) DHL International GmbH
Charles-de-Gaulle-Str. 20, 53113 Bonn,
Germany
(770) DHL OPERATIONS B.V.
Terminalweg 36, 3821 AJ Amersfoort,
Netherlands
(580) 2017 11 20

(111) M 1997 007837 R2
(732) MC PROJECTS B.V. MAASTRICHT
succursale de Granges-Paccot
Route Louis-Braille 10, CH-1763,
GRANGES-PACCOT (Fribourg),
Switzerland
(770) MC PROJECTS B.V. Amsterdam
succursale de Granges-Paccot
Route Louis-Braille 10 et 12, CH-1763
Granges-Paccot, Switzerland
(580) 2017 12 13

(111) M 1997 007928 R2
(732) OPEL AUTOMOBILE GMBH
Bahnhofplatz, 65423 Rüsselsheim, Germany
(770) ADAM OPEL GMBH
Bahnhofplatz, 65423 Rüsselsheim, Germany
(580) 2017 12 04

(111) M 1997 007930 R2
(732) OPEL AUTOMOBILE GMBH
Bahnhofplatz, 65423 Rüsselsheim, Germany
(770) ADAM OPEL GMBH
Bahnhofplatz, 65423 Rüsselsheim, Germany
(580) 2017 12 04

(111) M 1997 007936 R2
(732) OPEL AUTOMOBILE GMBH
Bahnhofplatz, 65423 Rüsselsheim, Germany
(770) ADAM OPEL GMBH
Bahnhofplatz, 65423 Rüsselsheim, Germany
(580) 2017 12 04

(111) M 1998 008041 R2
(732) MC PROJECTS B.V. MAASTRICHT
succursale de Granges-Paccot
Route Louis-Braille 10, CH-1763, GRAN-
GES-PACCOT (Fribourg), Switzerland
(770) MC PROJECTS B.V. Amsterdam
succursale de Granges-Paccot

Route Louis-Braille 10 et 12, CH-1763
Granges-Paccot, Switzerland
(580) 2017 12 13

(111) M 1998 008042 R2
(732) MC PROJECTS B.V. MAASTRICHT
succursale de Granges-Paccot
Route Louis-Braille 10, CH-1763, GRAN-
GES-PACCOT (Fribourg), Switzerland
(770) MC PROJECTS B.V.
Amsterdam, succursale de Granges-Paccot
Route Louis-Braille 10 et 12, CH-1763
Granges-Paccot, Switzerland
(580) 2017 12 13

(111) M 1998 008043 R2
(732) MC PROJECTS B.V. MAASTRICHT
succursale de Granges-Paccot
Route Louis-Braille 10, CH-1763, GRAN-
GES-PACCOT (Fribourg), Switzerland
(770) MC PROJECTS B.V.
Amsterdam, succursale de Granges-Paccot
Route Louis-Braille 10 et 12, CH-1763
Granges-Paccot, Switzerland
(580) 2017 12 13

(111) M 1994 000081 R2
(732) ITF S.p.A.
Via Tortona, 15, 20144 Milano, USA
(770) PROCTER & GAMBLE INTERNATIONAL
OPERATIONNS SA
Route de Saint-Georges 47, 1213 Petit-
Lancy, Geneva, Switzerland
(580) 2017 12 07

(111) M 1998 008733 R2
(732) ADMARKA SP. Z O.O.
Pieńków 149, 05-152 Czosnów, Poland
(770) PABIANICKIE ZAKLADY
FARMACEUTYCZNE "POLFA "Spółka"
Akcyjna
ul. Marszałka J. Piłsudskiego 5, 95-200
Pabianice, Poland
(580) 2017 11 29

(111) M 1998 009027 R1
(732) LG Chem, Ltd.
128, Yeoui-doero, Yeongdeungpo-gu, Seoul,
Republic of Korea
(770) LG Life Sciences, Ltd.
58, Saemunan-ro, Jongno-gu, Seoul,
Republic of Korea
(580) 2017 12 04

(111) M 1998 009079 R1
(732) CITIZEN HOLDINGS KABUSHIKI
KAISHA ALSO TRADING AS
CITIZEN HOLDINGS CO., LTD.
1-12, 6-Chome, Tanashi-cho, Nishi-tokyo-shi,
Tokyo, Japan
(770) CITIZEN TOKEI KABUSHIKI KAISHA
(CITIZEN WATCH CO., LTD)
1-12,6-Chome, Tanashi-cho, Nishi-tokyo-shi,
Tokyo, Japan
(580) 2017 11 08

(111) M 1998 009192 R1
(732) ITF S.p.A.
Via Tortona, 15, 20144 Milano, USA
(770) PROCTER & GAMBLE INTERNATIONAL
OPERATIONNS SA
Route de Saint-Georges 47, 1213 Petit-
Lancy, Geneva, Switzerland
(580) 2017 12 07

(111) M 1998 009641 R1
(732) COMPAGNIE CHAMPENOISE PH-CH.
PIPER HEIDSIECK-ANCIENNE
MAISON HEIDSIECK FONDEE EN 1785,
12 Allée du Vignoble, 51100 Reims, France
(770) CHAMPAGNES P. & C. HEIDSIECK
12 Allée du Vignoble, 51100 Reims, France
(580) 2017 11 29

(111) M 1998 009730 R1
(732) SANOFI-AVENTIS DEUTSCHLAND
GMBH
Brueningstrasse 50, D-65926 Frankfurt
am Main, Germany
(770) BOEHRINGER INGELHEIM PHARMA
GMBH & CO. KG
55218 Ingelheim, (DE), Germany
(580) 2017 12 12

(111) M 1998 009732 R1
(732) SANOFI-AVENTIS DEUTSCHLAND GMBH
Brueningstrasse 50, D-65926 Frankfurt
am Main, Germany
(770) BOEHRINGER INGELHEIM PHARMA
GMBH & CO. KG
55218 Ingelheim, (DE), Germany
(580) 2017 12 12

CHANGES IN NAMES AND/OR ADDRESSES OF OWNERS

(111) M 1999 011865 R1

(732) HERO AG

CH-5600, Lenzburg 1, Switzerland

(770) HERO (a Joint stock company organized and Existing under the laws of Switzerland)

5600 Lenzburg, Switzerland

(580) 2017 12 06

(111) M 1999 012285 R1

(732) ADAM OPEL GMBH

Bahnhofplatz, 65423 Rüsselsheim, Germany

(770) ADAM OPEL AG

Bahnhofplatz, 65423 Rüsselsheim, Germany

(580) 2017 12 04

(111) M 1999 012674 R1

(732) ADAM OPEL GMBH

Bahnhofplatz, 65423 Rüsselsheim, Germany

(770) ADAM OPEL AG

Bahnhofplatz, 65423 Rüsselsheim, Germany

(580) 2017 12 04

(111) M 1999 012677 R1

(732) ADAM OPEL GMBH

Bahnhofplatz, 65423 Rüsselsheim, Germany

(770) ADAM OPEL AG

Bahnhofplatz, 65423 Rüsselsheim, Germany

(580) 2017 12 04

(111) M 2000 013322 R1

(732) ADAM OPEL GMBH

Bahnhofplatz, 65423 Rüsselsheim, Germany

(770) ADAM OPEL AG

Bahnhofplatz, 65423 Rüsselsheim, Germany

(580) 2017 12 04

(111) M 2000 013324 R1

(732) ADAM OPEL GMBH

Bahnhofplatz, 65423 Rüsselsheim, Germany

(770) ADAM OPEL AG

Bahnhofplatz, 65423 Rüsselsheim, Germany

(580) 2017 12 04

(111) M 2000 013325 R1

(732) ADAM OPEL GMBH

Bahnhofplatz, 65423 Rüsselsheim, Germany

(770) ADAM OPEL AG

Bahnhofplatz, 65423 Rüsselsheim, Germany

(580) 2017 12 04

(111) M 2001 014075 R1

(732) LG LIFE SCIENCES, LTD.

58, Saemunan-ro, Jongno-gu, Seoul,
Republic of Korea

(770) LG LIFE SCIENCES, LTD.

20 Yoido-dong, Youngdungpo-gu, Seoul,
Republic of Korea

(580) 2017 12 04

(111) M 2008 018271 R1

(732) UNITED STATES POLO ASSOCIATION

1400 Centrepark Blvd., Suite 200 Wwst
Palm Beach, Florida 33401, USA

(770) UNITED STATES POLO ASSOCIATION

771 Corporate Drive, Suite 505, Lexington,
Kentucky 40503, USA

(580) 2017 12 12

(111) M 2008 018272 R1

(732) UNITED STATES POLO ASSOCIATION

1400 Centrepark Blvd., Suite 200 Wwst
Palm Beach, Florida 33401, USA

(770) UNITED STATES POLO ASSOCIATION

771 Corporate Drive, Suite 505, Lexington,
Kentucky 40503, USA

(580) 2017 12 12

(111) M 2010 020306 R

(732) WHIRLPOOL EMEA S.p.A.

Via C. Pisacane 1, 20016 Pero (MI), Italy

(770) INDESIT COMPANY S.P.A.

Viale Aristide Merloni, 47, I-60044 Fabriano
(Ancona), Italy

(580) 2017 12 12

(111) M 2013 023992 R

(732) LTD "KAKHELEBI"

Davit Agmasheneblis gamz. 71, 0102, Tbilisi,
Georgia

(770) LTD "SHOPPING HOUSE KAKHELEBI"

Davit Agmasheneblis gamz. 71, 0102, Tbilisi,
Georgia

(580) 2017 12 12

(111) M 2014 024447 R

(732) LTD "დეგა DEGA"

Sop. Tibaani, Signagis Raioni, Georgia

(770) LTD "დეგა DEGA"

Shota Rustavelis q. 32, 3300, Mtskheta, Georgia

(580) 2017 12 05

(111) M 2014 024702 R
 (732) GIORGI ZAUTASHVILI
 Demetre tavidabulis q. 3, 4800, Kvareli,
 Georgia
 (770) GIORGI ZAUTASHVILI
 Jorjiashvilis q. 3, 4800, Kvareli, Georgia
 (580) 2017 12 14

(111) M 2014 024977 R
 (732) GIORGI ZAUTASHVILI
 Demetre tavidabulis q. 3, 4800, Kvareli,
 Georgia
 (770) GIORGI ZAUTASHVILI
 Jorjiashvilis q. 3, 4800, Kvareli, Georgia
 (580) 2017 12 14

(111) M 1996 003543 R2
 (732) INOVA PATENT GmbH
 Konrad-Doppelmayr-Strasse 1, 6922 Wolfurt,
 Austria
 (770) INOVA PATENT GmbH
 Rickenbacherstrasse 8-10, Wolfurt, Austria,
 Austria
 (580) 2017 12 04

(111) M 1997 004726 R2
 (732) ADAM OPEL GmbH
 Adam Opel Haus 65423 Rüsselsheim,
 Germany
 (770) ADAM OPEL AG
 Bahnhofplatz, 65423 Rüsselsheim, Germany
 (580) 2017 12 04

(111) M 1997 005178 R2
 (732) ARC INTERNATIONAL
 104, avenue du General de Gaulle, 62510
 ARQUES, France
 (770) VERRERIE CRISTALLERIE D'ARQUES-
 J.G. DURAND & Cie,
 41, Avenue du General de Gaulle, F-62 510
 ARQUES, France
 (580) 2017 12 11

(111) M 1997 005178 R2
 (732) ARC HOLDINGS
 104, avenue du General de Gaulle, 62510
 ARQUES, France
 (770) ARC INTERNATIONAL
 104, avenue du General de Gaulle, 62510
 ARQUES, France
 (580) 2017 12 11

(111) M 1997 005192 R2
 (732) ADAM OPEL GMBH
 Bahnhofplatz, 65423 Rüsselsheim, Germany
 (770) ADAM OPEL AG
 Bahnhofplatz, 65423 Rüsselsheim, Germany
 (580) 2017 12 04

(111) M 1997 005195 R2
 (732) ADAM OPEL GMBH
 Bahnhofplatz, 65423 Rüsselsheim, Germany
 (770) ADAM OPEL AG
 Bahnhofplatz, 65423 Rüsselsheim, Germany
 (580) 2017 12 04

(111) M 1997 005744 R2
 (732) VALLOUREC OIL AND GAS FRANCE
 54, rue Anatole France, 59620 Aulnoye-
 Aymeries, France
 (770) VALLOUREC MANNESMANN OIL &
 GAS FRANCE
 54, rue Anatole France, 59620 Aulnoye-
 Aymeries, France
 (580) 2017 12 14

(111) M 1997 006065 R2
 (732) BODE CHEMIE GMBH & Co. KG
 27, Melanchthonstrasse, D-2000 HAMBURG
 54, Germany
 (770) BODE CHEMIE GMBH & Co.
 27, Melanchthonstrasse, D-2000 HAMBURG
 54, Germany
 (580) 2017 12 06

(111) M 1997 006065 R2
 (732) BODE CHEMIE GMBH
 27, Melanchthonstrasse, 22525 Hamburg,
 Germany
 (770) BODE CHEMIE GMBH & Co. KG
 27, Melanchthonstrasse, D-2000 HAMBURG
 54, Germany
 (580) 2017 12 06

(111) M 1997 006335 R2
 (732) ARC INTERNATIONAL
 104, avenue du General de Gaulle, 62510
 ARQUES, France
 (770) VERRERIE CRISTALLERIE D
 ARQUES - J.G.DURAND AND CIE
 62510 ARQUES, France
 (580) 2017 12 11

(111) M 1997 006335 R2
 (732) ARC HOLDINGS
 104, avenue du General de Gaulle, 62510
 ARQUES, France

(770) ARC INTERNATIONAL
104, avenue du General de Gaulle, 62510
ARQUES, France
(580) 2017 12 11

(111) M 1997 006459 R2
(732) JOHN PLAYER & SONS LIMITED
21 Beckett Way, Park West Nangor Road,
Dublin 12, Ireland
(770) JOHN PLAYER & SONS LIMITED
56, Park West Road, Nangor Road,
Dublin 12, Ireland
(580) 2017 12 08

(111) M 1997 007016 R2
(732) ADAM OPEL GMBH
Bahnhofsplatz, 65423 Rüsselsheim, Germany
(770) ADAM OPEL AG,
Bahnhofsplatz, 65423 Rüsselsheim, Germany
(580) 2017 12 04

(111) M 1997 007086 R2
(732) CHIQUITA BRANDS, LLC
250 East Fifth Street, Cincinnati, Ohio 45202,
USA
(770) CHIQUITA BRANDS, INC.
250 East Fifth Street, Cincinnati, Ohio 45202,
USA
(580) 2017 12 05

(111) M 1997 007086 R2
(732) CHIQUITA BRANDS, LLC
550 South Coldwell Street, Charlotte,
North Carolina 28202, USA
(770) CHIQUITA BRANDS, LLC
250 East Fifth Street, Cincinnati, Ohio 45202,
USA
(580) 2017 12 05

(111) M 1997 007086 R2
(732) CHIQUITA BRANDS LLC
2051 SE 35th Street, P.O. 22817, Fort
Lauderdale, Florida 33316, USA
(770) CHIQUITA BRANDS, LLC
550 South Coldwell Street, Charlotte,
North Carolina 28202, USA
(580) 2017 12 05

(111) M 1997 007086 R2
(732) CHIQUITA BRANDS LLC
c/o DCOTA office Center, 1855 Griffin
Road, Suite C-436, Fort Lauderdale, Florida
33004-2275, USA

(770) CHIQUITA BRANDS LLC
2051 SE 35th Street, P.O. 22817, Fort
Lauderdale, Florida 33316, USA
(580) 2017 12 05

(111) M 1997 007190 R2
(732) SPECTRUM BRANDS, INC.
3001 Deming way, Middleton, Wisconsin
53562, USA
(770) WEISER LOCK CORPORATION
19701 Da Vinci, Lake Forest, California
92610, USA
(580) 2017 12 12

(111) M 1997 007191 R2
(732) MC PROJECTS B.V. Amsterdam, succursale
de Granges-Paccot
Route Louis-Braille 10 et 12, CH-1763
Granges-Paccot, Switzerland
(770) MC PROJECTS B.V.-Swiss Branch
Route Louis-Braille 10 et 12, CH-1763
Granges-Paccot, Switzerland
(580) 2017 12 13

(111) M 1997 007335 R2
(732) LORIS AZZARO B.V.
Kanaalpad 61, 7321 AN Apeldoorn, Netherlands
(770) LORIS AZZARO B.V.
Laan van Westenenk 64, 7336 AZ Apeldoorn,
Netherlands
(580) 2017 11 21

(111) M 1997 007379 R2
(732) CHIQUITA BRANDS, LLC
250 East Fifth Street, Cincinnati, Ohio
45202, USA
(770) CHIQUITA BRANDS, INC.
250 East Fifth Street, Cincinnati, Ohio
45202, USA
(580) 2017 12 05

(111) M 1997 007379 R2
(732) CHIQUITA BRANDS, LLC
550 South Coldwell Street, Charlotte, North
Carolina 28202, USA
(770) CHIQUITA BRANDS, LLC
250 East Fifth Street, Cincinnati, Ohio
45202, USA
(580) 2017 12 05

(111) M 1997 007379 R2
(732) CHIQUITA BRANDS LLC
2051 SE 35th Street, P.O. 22817, Fort
Lauderdale, Florida 33316, USA

(770) CHIQUITA BRANDS, LLC
550 South Coldwell Street, Charlotte, North
Carolina 28202, USA
(580) 2017 12 05

(111) M 1997 007379 R2
(732) CHIQUITA BRANDS LLC
c/o DCOTA office Center, 1855 Griffin
Road, Suite C-436, Fort Lauderdale, Florida
33004-2275, USA
(770) CHIQUITA BRANDS LLC
2051 SE 35th Street, P.O. 22817, Fort
Lauderdale, Florida 33316, USA
(580) 2017 12 05

(111) M 1997 007413 R2
(732) INOVA PATENT GmbH
Konrad-Doppelmayr-Strasse 1, 6922 Wolfurt,
Austria
(770) INOVA PATENT GmbH
Rickenbacherstrasse 8-10, Wolfurt, Austria
(580) 2017 12 04

(111) M 1997 007569 R2
(732) ABB ASEA BROWN BOVERI LTD
Affolternstrasse 44, CH-8050 Zurich,
Switzerland
(770) ABB ASEA BROWN BOVERI LTD
52, Affolternstrasse, CH-8050 Zurich,
Switzerland
(580) 2017 12 06

(111) M 1997 007604 R2
(732) ABB ASEA BROWN BOVERI LTD
Affolternstrasse 44, CH-8050 Zurich,
Switzerland
(770) ABB ASEA BROWN BOVERI LTD
52, Affolternstrasse, CH-8050 Zurich,
Switzerland
(580) 2017 12 06

(111) M 1997 007605 R2
(732) ABB ASEA BROWN BOVERI LTD
Affolternstrasse 44, CH-8050 Zurich,
Switzerland
(770) ABB ASEA BROWN BOVERI LTD
52, Affolternstrasse, CH-8050 Zurich,
Switzerland
(580) 2017 12 06

(111) M 1997 007606 R2
(732) ABB ASEA BROWN BOVERI LTD
Affolternstrasse 44, CH-8050 Zurich,
Switzerland

(770) ABB ASEA BROWN BOVERI LTD
52, Affolternstrasse, CH-8050 Zurich,
Switzerland
(580) 2017 12 06

(111) M 1997 007607 R2
(732) ABB ASEA BROWN BOVERI LTD
Affolternstrasse 44, CH-8050 Zurich,
Switzerland
(770) ABB ASEA BROWN BOVERI LTD
52, Affolternstrasse, CH-8050 Zurich,
Switzerland
(580) 2017 12 06

(111) M 1997 007653 R2
(732) FEDERACION NACIONAL DE
CAFETEROS DE COLOMBIA
Calle 73 8-13 Bogota, Colombia
(770) FEDERACION NACIONAL DE
CAFETEROS DE COLOMBIA
Apartado Aereo 3938, Bogota, Colombia
(580) 2017 12 06

(111) M 1997 007837 R2
(732) MC PROJECTS B.V. Amsterdam, succursale
de Granges-Paccot,
Route Louis-Braille 10 et 12, CH-1763
Granges-Paccot, Switzerland
(770) MC PROJECTS B.V.-Swiss Branch
Route Louis-Braille 10 et 12, CH-1763
Granges-Paccot, Switzerland
(580) 2017 12 13

(111) M 1997 007861 R2
(732) ASPEN GLOBAL INCORPORATED
GBS Plaza, Cnr. La Salette & Royal Roads,
Grand Bay, Mauritius
(770) ASPEN GLOBAL INCORPORATED
c/o Kross Border Trust Services Ltd,
St. Louis Business Centre, Cnr Desroches
& St. Louis Streets, Port Louis, Mauritius
(580) 2017 12 12

(111) M 1997 007863 R2
(732) ASPEN GLOBAL INCORPORATED
GBS Plaza, Cnr. La Salette & Royal Roads,
Grand Bay, Mauritius
(770) ASPEN GLOBAL INCORPORATED
c/o Kross Border Trust Services Ltd,
St. Louis Business Centre, Cnr Desroches
& St. Louis Streets, Port Louis, Mauritius
(580) 2017 12 13

(111) M 1997 007864 R2
(732) ASPEN GLOBAL INCORPORATED
GBS Plaza, Cnr. La Salette & Royal Roads,
Grand Bay, Mauritius
(770) ASPEN GLOBAL INCORPORATED
c/o Kross Border Trust Services Ltd,
St. Louis Business Centre, Cnr Desroches
& St. Louis Streets, Port Louis, Mauritius
(580) 2017 12 12

(111) M 1997 007928 R2
(732) ADAM OPEL GMBH
Bahnhofplatz, 65423 Rüsselsheim, Germany
(770) ADAM OPEL AG
Bahnhofplatz, 65423 Rüsselsheim, Germany
(580) 2017 12 04

(111) M 1997 007930 R2
(732) ADAM OPEL GMBH
Bahnhofplatz, 65423 Rüsselsheim, Germany
(770) ADAM OPEL AG
Bahnhofplatz, 65423 Rüsselsheim, Germany
(580) 2017 12 04

(111) M 1997 007936 R2
(732) ADAM OPEL GMBH
Bahnhofplatz, 65423 Rüsselsheim, Germany
(770) ADAM OPEL AG
Bahnhofplatz, 65423 Rüsselsheim, Germany
(580) 2017 12 04

(111) M 1998 008041 R2
(732) MC PROJECTS B.V. Amsterdam, succursale
de Granges-Paccot
Route Louis-Braille 10 et 12, CH-1763
Granges-Paccot, Switzerland
(770) MC PROJECTS B.V.-Swiss Branch
Route Louis-Braille 10 et 12, CH-1763
Granges-Paccot, Switzerland
(580) 2017 12 13

(111) M 1998 008042 R2
(732) MC PROJECTS B.V. Amsterdam, succursale
de Granges-Paccot
Route Louis-Braille 10 et 12, CH-1763
Granges-Paccot, Switzerland
(770) MC PROJECTS B.V.-Swiss Branch.
Route Louis-Braille 10 et 12 CH-1763
Granges-Paccot, Switzerland
(580) 2017 12 13

(111) M 1998 008043 R2
(732) MC PROJECTS B.V. Amsterdam, succursale
de Granges-Paccot
Route Louis-Braille 10 et 12, CH-1763
Granges-Paccot, Switzerland
(770) MC PROJECTS B.V.-Swiss Branch
Route Louis-Braille 10 et 12, CH-1763
Granges-Paccot, Switzerland
(580) 2017 12 13

(111) M 1998 008053 R2
(732) HERO AG
CH-5600, Lenzburg 1, Switzerland
(770) HERO
CH-5600, Lenzburg 1, Switzerland
(580) 2017 12 06

(111) M 1998 009027 R1
(732) LG CHEM, LTD.
128, Yeoui-doero, Yeongdeungpo-gu, Seoul,
Republic of Korea
(770) LG LIFE SCIENCES, LTD.
20 Yoido-dong, Youngdungpo-gu, Seoul,
Republic of Korea
(580) 2017 12 04

INVALIDATION OF TRADEMARKS REGISTRATION

(111) M 2007 17512 R
(141) 2017 08 28, The payment for the
prolongation of registration on following
10 years is not payed
(732) ELGUJA BUBUTEISHVILI
Paliashvilis q. 62, 0179, Tbilisi, Georgia

(111) M 2007 17516 R
(141) 2017 08 28, The payment for the
prolongation of registration on following
10 years is not payed
(732) KLASSIKA INTERNATIONAL LIMITED
Office 203, 2nd Floor, Liliana Building,
10 Kyriakou Matsi avenue, Agious
Omologites, PC 1082, Nicosia, CY

(111) M 2007 17517 R
(141) 2017 08 28, The payment for the
prolongation of registration on following
10 years is not payed
(732) SILK ROAD GROUP S.A.
Akara Bldg., 24 De Castro Street, Wickhams
Cay I, Road Town, Tortola, British Virgin
Islands

(111) M 2007 17519 R
(141) 2017 08 28, The payment for the
prolongation of registration on following
10 years is not payed
(732) LTD "GAMA"
Nikeas q.16, 4600, Qutaisi, Georgia

(111) M 2007 17520 R
(141) 2017 08 28, The payment for the
prolongation of registration on following
10 years is not payed
(732) LTD "LONDON HAUSE GEORGIA"
Nutsubidzis me-2 m/r, I kvartali,
VI korpusi, b.6, 0183, Tbilisi, Georgia

(111) M 2007 17521 R
(141) 2017 08 28, The payment for the
prolongation of registration on following
10 years is not payed
(732) LTD "ALIANS VINTNERSI "ML"
Kavsadzis q. 7, 0179, Tbilisi, Georgia

(111) M 2007 17526 R
(141) The payment for the
prolongation of registration on following
10 years is not payed
(732) MERCK SHARP & DOHME CORP.
One Merck Drive, Whitehouse Station,
New Jersey 08889, USA

(111) M 2007 17527 R
(141) 2017 08 28, The payment for the
prolongation of registration on following
10 years is not payed
(732) JSC "SARAJISHVILI"
Sarajishvilis gamz. 4, 0153, Tbilisi, Georgia

(111) M 2007 17528 R
(141) 2017 08 28, The payment for the
prolongation of registration on following
10 years is not payed
(732) OJSC "DONSKOI TABAK"
Ul. Krasnoarmeisskaya 170, 344000,
Rostov na Donu, Russian Federation

(111) M 2007 17529 R
(141) 2017 08 28, The payment for the
prolongation of registration on following
10 years is not payed
(732) LTD "POMEGRANATE"
Budapeshtis q., korp. 6, b. 14, 0160, Tbilisi,
Georgia

(111) M 2007 17531 R
(141) 2017 08 28, The payment for the
prolongation of registration on following
10 years is not payed
(732) THE COCA-COLA COMPANY
a Corporate of the State of Delaware
One Coca-Cola Plaza, Atlanta, Georgia
30313, USA

(111) M 2007 17532 R
(141) 2017 08 28, The payment for the
prolongation of registration on following
10 years is not payed
(732) SOCIÉTÉ DES PRODUITS NESTLÉ S.A.
CH-1800 Vevey, Switzerland

(111) M 2007 17534 R
(141) The payment for the
prolongation of registration on following
10 years is not payed
(732) LTD "TEGETA MOTORSI"
digmis masivi, VI kvart. korp.22 b, 0159,
Tbilisi, Georgia

(111) M 2007 17535 R
(141) 2017 08 28, The payment for the
prolongation of registration on following
10 years is not payed
(732) CANNON INVESTMENTS LIMITED
Hadfield House, Library street, Mezzanine
West, GI

(111) M 2007 17536 R
(141) 2017 08 28, The payment for the
prolongation of registration on following
10 years is not payed
(732) LTD "VANEX"
Saburtalos q. 44/26, 0177, Tbilisi, Georgia

(111) M 2007 17537 R
(141) 2017 08 28, The payment for the
prolongation of registration on following
10 years is not payed
(732) LTD "VANEX"
Saburtalos q. 44/26, 0177, Tbilisi, Georgia

(111) M 1997 4449 R1
(141) 2007 04 30, The payment for the
prolongation of registration on following
10 years is not payed
(732) GLAXO GRROUP LIMITED
980 Great West Road, Brentford, Middlesex
TW8 9GS, United Kingdom

(111) M 1997 5329 R1
(141) 2007 08 21, The payment for the
prolongation of registration on following
10 years is not payed
(732) FUJI JUKOGYO KABUSHIKI KAISHA
(Also trading as FUJI HEAVY
INDUSTRIES LTD)
1-20-8, Ebisu, Shibuya-ku, Tokyo, Japan

(111) M 1997 5335 R1
(141) 2007 08 21, The payment for the
prolongation of registration on following
10 years is not payed

(732) ADAST A.S.
Mirova 2/87, 67904 Adamov, Czech
Republic

(111) M 1997 5337 R1
(141) 2007 08 21, The payment for the
prolongation of registration on following
10 years is not payed
(732) JOHNSON & JOHNSON
One Johnson & Johnson Plaza, New
Brunswick, New Jersey 08933, USA

(111) M 1997 5339 R1
(141) 2007 08 21, The payment for the
prolongation of registration on following
10 years is not payed
(732) JOHNSON & JOHNSON
One Johnson & Johnson Plaza, New
Brunswick, New Jersey 08933, USA

(111) M 1997 5344 R1
(141) 2007 02 28, The payment for the
prolongation of registration on following
10 years is not payed
(732) CIBA-GEIGY AG
CH-4002 Basel, CH

(111) M 1997 5355 R1
(141) 2007 08 28, The payment for the
prolongation of registration on following
10 years is not payed
(732) PROCTER & GAMBLE HOLDING GmbH
Sulzbacher Strasse 40, 65824 Schwalbach
am Taunus, Germany

(111) M 1997 5360 R1
(141) 2007 08 28, The payment for the
prolongation of registration on following
10 years is not payed
(732) BRITISH-AMERICAN TOBACCO
(GERMANY) GmbH
Alsterufer 4, D-20354 Hamburg, Germany

(111) M 1997 5376 R1
(141) 2007 02 28, The payment for the
prolongation of
registration on the following of 10 years
(732) DU PONT DE NEMOURS (FRANCE) S.A.
137, Rue De l'Universite, F-75007 Paris,
France

(111) M 1997 5398 R1
(141) 2007 08 29, The payment for the
prolongation of registration on following
10 years is not payed
(732) CARTIONAJES INTERNATIONAL S.A.
Pedro Texeira 8, 28020 Madrid, ES

(111) M 1997 5400 R1
(141) 2007 08 29, The payment for the
prolongation of registration on following
10 years is not payed
(732) ASTELAS PHARMA INC.
3-11, Nihonbashi-Honcho, 2-Chome
Chuo-Ku, Tokyo, Japan

(111) M 1997 5415 R1
(141) 2007 08 31, The payment for the
prolongation of registration on following
10 years is not payed
(732) BENCARD ALLERGIE GMBH
Messerschmittstrasse 4, 80992 Munich,
Germany

(111) M 1997 5423 R1
(141) 2007 08 31, The payment for the
prolongation of registration on following
10 years is not payed
(732) NUR DIE GmbH
Birkenallee 110-134, 48432 Rheine,
Germany

(111) M 1997 5428 R1
(141) 2007 08 31, The payment for the
prolongation of registration on following
10 years is not payed
(732) MARS Incorporated
6885, Elm Street, McLean, Virginia, USA

CLASSIFICATION INDEXES

INVENTIONS

CONCORDANCE TABLE OF INTERNATIONAL CLASSIFICATION INDEX AND PUBLICATION NUMBERS

INTERNATIONAL CLASSIFICATION INDEXES (51)	NUMBER OF PUBLISHED APPLICATION (10)
A 24 B 3/12	AP 2017 13779 A
A 61 K 36/29; A 61 P 33/00	AP 2017 14469 A
B 01 D 35/027; B 01 D 61/08; B 01 D 651/10; B 23 P 11/00	AP 2017 14148 A
C 07 C 45/45; C 07 C 45/65; C 07 C 47/575; C 07 C 309/65; C 07 C 309/66; C 07 C 309/73; C 07 C 233/18; C 07 C 303/28	AP 2017 14198 A
C 07 D 401/14; C 07 D 239/56; C 07 D 403/06; C 07 D 403/14; C 07 D 239/52; C 07 D 239/54; C 07 D 471/04; A 61 K 31/513; A 61 P 31/18	AP 2017 13818 A
C 07 D 403/06; A 61 K 31/506; A 61 K 31/7072; A 61 P 35/00; A 61 P 43/00	AP 2017 14225 A
C 07 D 453/02	AP 2017 13845 A
C 07 D 471/04; C 07 D 487/04; A 61 K 31/4375; A 61 P 35/00	AP 2017 14164 A
C 07 F 5/02; A 61 K 31/69; A 61 K 35/00	AP 2017 12214 A
G 21 B 1/00	AP 2017 14333 A

CONCORDANCE TABLE OF PUBLICATION NUMBERS AND INTERNATIONAL CLASSIFICATION INDEX

NUMBER OF PUBLISHED APPLICATION (10)	INTERNATIONAL CLASSIFICATION INDEXES (51)
AP 2017 12214 A	C 07 F 5/02; A 61 K 31/69; A 61 K 35/00
AP 2017 13779 A	A 24 B 3/12
AP 2017 13818 A	C 07 D 401/14; C 07 D 239/56; C 07 D 403/06; C 07 D 403/14; C 07 D 239/52; C 07 D 239/54; C 07 D 471/04; A 61 K 31/513; A 61 P 31/18
AP 2017 13845 A	C 07 D 453/02
AP 2017 14148 A	B 01 D 35/027; B 01 D 61/08; B 01 D 651/10; B 23 P 11/00
AP 2017 14164 A	C 07 D 471/04; C 07 D 487/04; A 61 K 31/4375; A 61 P 35/00
AP 2017 14198 A	C 07 C 45/45; C 07 C 45/65; C 07 C 47/575; C 07 C 309/65; C 07 C 309/66; C 07 C 309/73; C 07 C 233/18; C 07 C 303/28
AP 2017 14225 A	C 07 D 403/06; A 61 K 31/506; A 61 K 31/7072; A 61 P 35/00; A 61 P 43/00
AP 2017 14333 A	G 21 B 1/00
AP 2017 14469 A	A 61 K 36/29; A 61 P 33/00

**CONCORDANCE TABLE OF INTERNATIONAL CLASSIFICATION INDEX,
PATENT NUMBERS AND PUBLICATION NUMBERS**

INTERNATIONAL CLASSIFICATION INDEX (51)	NUMBER OF PATENT (11)	NUMBER OF PUBLISHED APPLICATION (10)
A 61 M 5/315	P 2017 6798 B	AP 2017 13974 A
B 62 M 7/12	P 2017 6797 B	AP 2017 13431 A

**CONCORDANCE TABLE OF PATENT NUMBERS,
PUBLICATION NUMBERS AND INTERNATIONAL CLASSIFICATION INDEX**

NUMBER OF PATENT (11)	NUMBER OF PUBLISHED APPLICATION (10)	INTERNATIONAL CLASSIFICATION INDEX (51)
P 2017 6797 B	AP 2017 13431 A	B 62 M 7/12
P 2017 6798 B	AP 2017 13974 A	A 61 M 5/315

**CONCORDANCE TABLE OF APPLICATION NUMBERS, PUBLICATION NUMBERS
AND PATENTS**

NUMBER OF APPLICATION (21)	NUMBER OF PUBLISHED APPLICATION (10)	NUMBER OF PATENT (11)
AP 2011 013431	AP 2017 13431 A	P 2017 6797 B
AP 2014 013974	AP 2017 13974 A	P 2017 6798 B

UTILITY MODELS

**CONCORDANCE TABLE OF INTERNATIONAL CLASSIFICATION INDEX
AND PUBLICATION NUMBERS**

INTERNATIONAL CLASSIFICATION INDEXES (51)	NUMBER OF PUBLISHED APPLICATION (10)
B 62 D 63/06	AU 2017 14421 U
B 65 D 81/32; B 65 D 25/08	AU 2017 14355 U

**CONCORDANCE TABLE OF PUBLICATION NUMBERS
AND INTERNATIONAL CLASSIFICATION INDEX**

NUMBER OF PUBLISHED APPLICATION (10)	INTERNATIONAL CLASSIFICATION INDEXES (51)
AU 2017 14355 U	B 65 D 81/32; B 65 D 25/08
AU 2017 14421 U	B 62 D 63/06

DESIGNS**CONCORDANCE TABLE OF INTERNATIONAL CLASSIFICATION INDEX
AND PUBLICATION NUMBERS**

INTERNATIONAL CLASSIFICATION INDEXES (51)	NUMBER OF PUBLISHED APPLICATION (10)
09-03	AD 2017 976 S
21-01	AD 2017 979 S

**CONCORDANCE TABLE OF PUBLICATION NUMBERS
AND INTERNATIONAL CLASSIFICATION INDEX**

NUMBER OF PUBLISHED APPLICATION (10)	INTERNATIONAL CLASSIFICATION INDEXES (51)
AD 2017 976 S	09-03
AD 2017 979 S	21-01

**DESIGNS REGISTERED ACCORDING TO THE ACCELERATED
PROCEDURE****CONCORDANCE TABLE OF INTERNATIONAL CLASSIFICATION INDEX
AND PUBLICATION NUMBERS**

INTERNATIONAL CLASSIFICATION INDEXES (51)	NUMBER OF PUBLISHED APPLICATION (11)
21-01	D 2017 739 S

**CONCORDANCE TABLE OF PUBLICATION NUMBERS
AND INTERNATIONAL CLASSIFICATION INDEX**

NUMBER OF PUBLISHED APPLICATION (11)	INTERNATIONAL CLASSIFICATION INDEXES (51)
D 2017 739 S	21-01

**CONCORDANCE TABLE OF APPLICATION NUMBERS,
PUBLICATION NUMBERS AND PATENTS**

NUMBER OF APPLICATION (21)	NUMBER OF PATENT (11)
AD 2017 996	D 2017 739 S

TRADEMARKS

CONCORDANCE TABLE OF REGISTRATION NUMBERS, APPLICATION NUMBERS, PUBLICATION NUMBERS AND BULLETIN NUMBERS

NUMBER OF REGISTRATION (111)	NUMBER OF APPLICATIONS (210)	NUMBER OF PUBLISHED APPLICATIONS (260)	NUMBER OF BULLETIN
M 2017 29134 R	AM 95199	-	24(484)2017
M 2017 29135 R	AM 95343	-	24(484)2017
M 2017 29136 R	AM 95303	-	24(484)2017
M 2017 29137 R	AM 95200	-	24(484)2017
M 2017 29138 R	AM 95354	-	24(484)2017
M 2017 29139 R	AM 86027	AM 2016 86027 A	11(471)2017
M 2017 29140 R	AM 87070	AM 2016 87070 A	15(475)2017
M 2017 29141 R	AM 87071	AM 2016 87071 A	15(475)2017
M 2017 29142 R	AM 87072	AM 2016 87072 A	15(475)2017
M 2017 29143 R	AM 87074	AM 2016 87074 A	15(475)2017
M 2017 29144 R	AM 87080	AM 2016 87080 A	15(475)2017
M 2017 29145 R	AM 87212	AM 2016 87212 A	11(471)2017
M 2017 29146 R	AM 87488	AM 2016 87488 A	15(475)2017
M 2017 29147 R	AM 88158	AM 2016 88158 A	9(469)2017
M 2017 29148 R	AM 88325	AM 2016 88325 A	9(469)2017
M 2017 29149 R	AM 88345	AM 2016 88345 A	10(470)2017
M 2017 29150 R	AM 88412	AM 2016 88412 A	10(470)2017
M 2017 29151 R	AM 88474	AM 2016 88474 A	10(470)2017
M 2017 29152 R	AM 88475	AM 2016 88475 A	10(470)2017
M 2017 29153 R	AM 88675	AM 2016 88675 A	12(472)2017
M 2017 29154 R	AM 88797	AM 2016 88797 A	14(474)2017
M 2017 29155 R	AM 88811	AM 2016 88811 A	14(474)2017
M 2017 29156 R	AM 88836	AM 2016 88836 A	12(472)2017
M 2017 29157 R	AM 88919	AM 2016 88919 A	12(472)2017
M 2017 29158 R	AM 89145	AM 2016 89145 A	14(474)2017
M 2017 29159 R	AM 89243	AM 2016 89243 A	11(471)2017
M 2017 29160 R	AM 89261	AM 2016 89261 A	14(474)2017
M 2017 29161 R	AM 89266	AM 2016 89266 A	14(474)2017
M 2017 29162 R	AM 89268	AM 2016 89268 A	14(474)2017
M 2017 29163 R	AM 89340	AM 2016 89340 A	15(475)2017
M 2017 29164 R	AM 89417	AM 2016 89417 A	13(473)2017
M 2017 29165 R	AM 89428	AM 2016 89428 A	14(474)2017
M 2017 29166 R	AM 89456	AM 2016 89456 A	15(475)2017
M 2017 29167 R	AM 89457	AM 2016 89457 A	15(475)2017
M 2017 29168 R	AM 89489	AM 2016 89489 A	12(472)2017
M 2017 29169 R	AM 89507	AM 2016 89507 A	12(472)2017
M 2017 29170 R	AM 89521	AM 2016 89521 A	13(473)2017
M 2017 29171 R	AM 89599	AM 2016 89599 A	15(475)2017
M 2017 29172 R	AM 89603	AM 2016 89603 A	15(475)2017
M 2017 29173 R	AM 89615	AM 2016 89615 A	15(475)2017
M 2017 29174 R	AM 89617	AM 2016 89617 A	14(474)2017
M 2017 29175 R	AM 89759	AM 2016 89759 A	14(474)2017
M 2017 29176 R	AM 89880	AM 2016 89880 A	15(475)2017
M 2017 29177 R	AM 89895	AM 2016 89895 A	14(474)2017
M 2017 29178 R	AM 89896	AM 2016 89896 A	14(474)2017
M 2017 29179 R	AM 89898	AM 2016 89898 A	14(474)2017

1	2	3	4
M 2017 29180 R	AM 89962	AM 2016 89962 A	14(474)2017
M 2017 29181 R	AM 89978	AM 2016 89978 A	14(474)2017
M 2017 29182 R	AM 89991	AM 2016 89991 A	15(475)2017
M 2017 29183 R	AM 90011	AM 2016 90011 A	15(475)2017
M 2017 29184 R	AM 90035	AM 2016 90035 A	14(474)2017
M 2017 29185 R	AM 90044	AM 2016 90044 A	14(474)2017
M 2017 29186 R	AM 90045	AM 2016 90045 A	14(474)2017
M 2017 29187 R	AM 90097	AM 2016 90097 A	15(475)2017
M 2017 29188 R	AM 90099	AM 2016 90099 A	15(475)2017
M 2017 29189 R	AM 90100	AM 2016 90100 A	15(475)2017
M 2017 29190 R	AM 90101	AM 2016 90101 A	15(475)2017
M 2017 29191 R	AM 90104	AM 2016 90104 A	15(475)2017
M 2017 29192 R	AM 90105	AM 2016 90105 A	15(475)2017
M 2017 29193 R	AM 90120	AM 2016 90120 A	15(475)2017
M 2017 29194 R	AM 90139	AM 2016 90139 A	15(475)2017
M 2017 29195 R	AM 90149	AM 2016 90149 A	15(475)2017
M 2017 29196 R	AM 90151	AM 2016 90151 A	15(475)2017
M 2017 29197 R	AM 90157	AM 2016 90157 A	14(474)2017
M 2017 29198 R	AM 90158	AM 2016 90158 A	14(474)2017
M 2017 29198 R	AM 90159	AM 2016 90159 A	14(474)2017
M 2017 29200 R	AM 90160	AM 2016 90160 A	14(474)2017
M 2017 29201 R	AM 90331	AM 2017 90331 A	15(475)2017
M 2017 29202 R	AM 90372	AM 2017 90372 A	15(475)2017
M 2017 29203 R	AM 95345	-	24(484)2017
M 2017 29204 R	AM 95513	-	24(484)2017
M 2017 29205 R	AM 95514	-	24(484)2017

**CONCORDANCE TABLE OF PUBLICATION NUMBERS
AND APPLICATION NUMBERS**

NUMBER OF PUBLISHED APPLICATION (260)	NUMBER OF APPLICATION (210)	1	2
		1	2
AM 2017 86965 A*	AM 86965 A*	AM 2017 91861 A	AM 91861 A
AM 2017 91090 A	AM 91090 A	AM 2017 91866 A	AM 91866 A
AM 2017 91230 A	AM 91230 A	AM 2017 91879 A	AM 91879 A
AM 2017 91678 A	AM 91678 A	AM 2017 91889 A	AM 91889 A
AM 2017 91730 A	AM 91730 A	AM 2017 91957 A	AM 91957 A
AM 2017 91783 A	AM 91783 A	AM 2017 91959 A	AM 91959 A
AM 2017 91846 A	AM 91846 A	AM 2017 92102 A	AM 92102 A
AM 2017 91847 A	AM 91847 A	AM 2017 92103 A	AM 92103 A
AM 2017 91848 A	AM 91848 A	AM 2017 92135 A	AM 92135 A
AM 2017 91849 A	AM 91849 A	AM 2017 92141 A	AM 92141 A
AM 2017 91851 A	AM 91851 A	AM 2017 92143 A	AM 92143 A
AM 2017 91857 A	AM 91857 A	AM 2017 92187 A	AM 92187 A
AM 2017 91858 A	AM 91858 A	AM 2017 92189 A	AM 92189 A
AM 2017 91860 A	AM 91860 A	AM 2017 92190 A	AM 92190 A
		AM 2017 92213 A	AM 92213 A
		AM 2017 92471 A	AM 92471 A
		AM 2017 92473 A	AM 92473 A
		AM 2017 92480 A	AM 92480 A
		AM 2017 92589 A	AM 92589 A

**CONCORDANCE TABLE OF INDEX OF GOODS AND/OR SERVICES
AND APPLICATION NUMBERS**

INDEX OF GOODS AND/OR SERVICES (511)	NUMBER OF PUBLISHED APPLICATIONS (26)	1	2
1	2		
1	AM 2017 91846 A	11	AM 2017 91879 A
1	AM 2017 91847 A	15	AM 2017 92471 A
1	AM 2017 91848 A	15	AM 2017 92480 A
1	AM 2017 91851 A	16	AM 2017 92187 A
5	AM 2017 91090 A	28	AM 2017 92589 A
5	AM 2017 91846 A	29	AM 2017 91678 A
5	AM 2017 91857 A	29	AM 2017 91866 A
5	AM 2017 91858 A	29	AM 2017 92102 A
5	AM 2017 91860 A	29	AM 2017 92135 A
5	AM 2017 91861 A	30	AM 2017 91678 A
5	AM 2017 92103 A	31	AM 2017 91230 A
5	AM 2017 92141 A	31	AM 2017 91678 A
5	AM 2017 92143 A	31	AM 2017 91866 A
7	AM 2017 86965 A*	32	AM 2017 91866 A
7	AM 2017 91879 A	33	AM 2017 91730 A
7	AM 2017 91957 A	33	AM 2017 91849 A
7	AM 2017 91959 A	33	AM 2017 91866 A
8	AM 2017 91957 A	33	AM 2017 91889 A
8	AM 2017 91959 A	34	AM 2017 92213 A
9	AM 2017 91783 A	35	AM 2017 91866 A
9	AM 2017 91879 A	35	AM 2017 92102 A
9	AM 2017 91957 A	37	AM 2017 91866 A
9	AM 2017 91959 A	37	AM 2017 91866 A
9	AM 2017 92187 A	37	AM 2017 92189 A
9	AM 2017 92471 A	37	AM 2017 92190 A
9	AM 2017 92473 A	39	AM 2017 91866 A
		41	AM 2017 91866 A
		41	AM 2017 92187 A
		42	AM 2017 91866 A
		43	AM 2017 91866 A
		44	AM 2017 91866 A

**CONCORDANCE TABLE OF INDEX OF GOODS AND/OR SERVICES
AND NUMBERS OF TRADEMARKS REGISTERED ACCORDING
TO THE ACCELERATED PROCEDURE**

INDEX OF GOODS AND/OR SERVICES (511)	NUMBERS OF REGISTERED ACCORDING TO THE ACCELERATED PROCEDURE (111)
3	M 2017 29204 R
3	M 2017 29205 R
5	M 2017 29203 R
7	M 2017 29137 R
10	M 2017 29135 R
34	M 2017 29136 R
35	M 2017 29134 R
35	M 2017 29138 R
41	M 2017 29135 R
42	M 2017 29135 R
44	M 2017 29135 R

OFFICIAL BULLETIN OF THE INDUSTRIAL PROPERTY

24(484)

EDITOR-IN-CHIEF: N. Bebrishvili

EDITORS-TRANSLATORS: E. Gabunia

PROOFREADER: A. Shikhashvili

COMPUTER LAYOUT: M. Ordenidze
K. Svanidze

www.sakpatenti.gov.ge

E-mail: info@sakpatenti.org.ge