



**NATIONAL INTELLECTUAL PROPERTY CENTER OF GEORGIA
SAKPATENTI**

**OFFICIAL BULLETIN
OF THE INDUSTRIAL PROPERTY**

24(508)

**2018
TBILISI**

INID CODES FOR IDENTIFICATION OF BIBLIOGRAPHIC DATA

INVENTIONS, UTILITY MODELS

- (10) Number of publication for application, which has been examined
- (11) Number of patent and kind of document
- (21) Serial number of application
- (22) Date of filing of the application
- (23) Date of exhibition or the date of the earlier filing and the number of application, if any
- (24) Date from which patent may have effect
- (31) Number of priority application
- (32) Date of filing of priority application
- (33) Code of the country or regional organization allotting priority application number
- (44) Date of publication of application not granted, but examined and number of bulletin
- (45) Date of publication of registered document
- (51) International Patent Classification Index
- (54) Title of the invention
- (57) Abstract
- (60) Number of examined patent document granted by foreign patent office, date from which patent has effect and country code
- (62) Number of the earlier application and in case of divided application, date of filing an application
- (71) Name, surname and address of applicant (country code)
- (72) Name, surname of inventor (country code)
- (73) Name, surname and address of patent owner (country code)
- (74) Name, surname of representative or patent attorney
- (85) Date of commencement of the national phase of International Application
- (86) Number and date of filing of international application
- (87) Number and date of publication of international application

DESIGNS

- (10) Number of publication for application
- (11) Number of patent and kind of document or number of registration
- (15) Date of registration/Date of patent renewal
- (18) Expected expiration date of patent or registration
- (21) Serial number of application
- (22) Date of filing of the application
- (23) Date of exhibition or the date of the earlier filing and the number of application, if any
- (24) Date from which patent may have effect
- (28) Number of designs included in the application
- (30) Data relating to priority (number of application, date of filing of application, two-letter code identifying the authority with whom the priority application was made)
- (31) Number of priority application
- (32) Date of filing of priority application
- (33) Code of the country or regional organization allotting priority application number
- (34) Two-letter code according to WIPO St.3 identifying the authority with which the priority application was made
- (44) Date of publication of design and number of bulletin (the first publication)
- (45) Date of publication of design registered by WIPO and number of bulletin
- (51) International Classification for designs (class and subclass of the Locarno Classification)
- (54) Title of the invention
- (55) Reproduction of the design
- (57) Description of characteristic features of the design including indication of colors
- (58) Date of recording of any kind of amendment in the Register
- (62) Number of the earlier application, registration and document number and if available the date of filing an application in case of divided application
- (71) Name, surname and address of applicant (country code)
- (72) Name, surname of creator (country code)
- (73) Name, surname and address of patent owner (country code)
- (74) Name, surname of representative or patent attorney
- (81) Contracting states concerned
 - II designated contracting states according to the 1960 Act
 - III designated contracting states according to the 1999 Act
- (85) Owner's permanent address
- (86) Owner's nationality
- (87) Owner's residence
- (88) State in which the owner has a real and effective industrial or commercial establishment

TRADEMARKS

- (111) – Number of registration
- (151) – Date of registration
- (156) – Date of the renewal
- (181) – Expected expiration date of registration
- (186) – Renewal expiration date of registration
- (141) – Date of cancel of duration of the mark
- (210) – Serial number of application
- (220) – Date of filing of the application
- (230) – Data concerning exhibition
- (260) – Number of application, for which favorable decision of examination about registration has been taken (publication number)
- (310) – Number of the first application
- (320) – Date of filing of the first application
- (330) – Code, identifying national or regional Office where the first application was made
- (511) – International Classification of Goods and Services for the purposes of registration of trade marks and/or list of goods and/or services classified according thereto
- (531) – Description of figurative elements of Trade Marks according to the International Classification of the Figurative Elements of Marks
- (540) – Reproduction of Trade Mark
- (550) – Nature and kind of Trade Mark
- (580) – Date of recording of any kind changes in respect of applications or registrations
- (591) – Information concerning colors claimed
- (731) – Name and address of the applicant
- (732) – Name and address of the holder of the registration
- (740) – Name and address of the representative
- (750) – Address for correspondence
- (770) – Name and address of the previous applicant or holder in case of change in ownership
- (771) – Previous name and address of the applicant or holder in case of change in ownership
- (791) – Name and address of the licensee
- (793) – Indication of conditions and/or restrictions under the license (Type of license, number of license agreement, data of license, data of validity of license)
- (800) – Certain data relating to the international registration of Trade Marks under the Protocol Relating to Madrid Agreement (International registration number)

CODES FOR PUBLICATION IN BULLETIN

- (21) AP 0000 000000 – serial number of application for invention
- (10) AP 0000 0000 A – number of published application for invention (first publication)
- (11) P 0000 0000 B – number of patent for invention (second publication)
- (21) API 0000 000000 – number of application for imported patent
- (11) PI 0000 0000 A – number of imported patent (first publication)
- (21) AU 0000 000000 – serial number of application for utility model
- (10) AU 0000 000 U – number of published application for utility model (first publication)
- (11) U 0000 000 Y – number of patent for utility model (second publication)
- (21) AD 0000 000000 – serial number of application for design
- (10) AD 0000 000 S – number of published application for design (first publication)
- (11) D 0000 000 S – number of patent for design (second publication)

INTERNATIONAL PATENT CLASSIFICATION FOR INVENTIONS AND UTILITY MODELS

- SECTION A – HUMAN NECESSITIES
- SECTION B – PERFORMING OPERATIONS; TRANSPORTING
- SECTION C – CHEMISTRY; METALLURGY
- SECTION D – TEXTILES; PAPER
- SECTION E – FIXED CONSTRUCTIONS
- SECTION F – MECHANICAL ENGINEERING; LIGHTING; HEATING; WEAPONS; BLASTING
- SECTION G – PHYSICS
- SECTION H – ELECTRICITY

-
- M – Trade Mark
 - (210) AM 0000 000000 – Serial number of application;
 - (260) AAM 0000 00000 A – Publication number of application;
 - (111) M 0000 00000 R – Number of registration;
 - (111) MMM0000 00000 Rn – Number of renewals, in which n=1,2,3;
 - (111) M 0000 00000 R(P) – Number of registration under partial assignment of rights
-

LIST OF CODES, IN ALPHABETIC SEQUENCE, AND THE CORRESPONDING (SHORT) NAMES OF STATES, OTHER ENTITIES AND INTERGOVERNMENTAL ORGANIZATIONS
(WIPO STANDARD ST.3)

AD	Andorra				
AE	United Arab Emirates				
AF	Afghanistan				
AG	Antigua and Barbuda				
AI	Anguilla				
AL	Albania				
AM	Armenia				
AN	Netherlands Antilles				
AO	Angola				
AP	African Regional Intellectual Property Organization (ARIPO)				
AR	Argentina				
AT	Austria				
AU	Australia				
AW	Aruba				
AZ	Azerbaijan				
BA	Bosnia and Herzegovina				
BB	Barbados				
BD	Bangladesh				
BE	Belgium				
BF	Burkina Faso				
BG	Bulgaria				
BH	Bahrain				
BI	Burundi				
BJ	Benin				
BM	Bermuda				
BN	Brunei Darussalam				
BO	Bolivia				
BR	Brazil				
BS	Bahamas				
BT	Bhutan				
BV	Bouvet Island				
BW	Botswana				
BX	Benelux Office for Intellectual Property (BOIP)				
BY	Belarus				
BZ	Belize				
CA	Canada				
CD	Democratic Republic of the Congo				
CF	Central African Republic				
CG	Congo				
CH	Switzerland				
CI	Cote d'Ivoire				
CK	Cook Islands				
CL	Chile				
CM	Cameroon				
CN	China				
CO	Colombia				
CR	Costa Rica				
CU	Cuba				
CV	Cape Verde				
CY	Cyprus				
CZ	Czech Republic				
DE	Germany				
DJ	Djibouti				
DM	Dominica				
DO	Dominican Republic				
DZ	Algeria				
EA	Eurasian Patent Organization (EAPO)				
EC	Ecuador				
EE	Estonia				
EG	Egypt				
EH	Western Sahara				
EM	Office for Harmonization in the Internal Market (Trademarks and Designs)(OHIM)				
EP	European Patent Office (EPO)				
ER	Eritrea				
ES	Spain				
ET	Ethiopia				
FI	Finland				
FJ	Fiji				
FK	Falkland Islands (Malvinas)				
FO	Faroe Islands				
FR	France				
GA	Gabon				
GB	United Kingdom				
GC	Patent Office of the Cooperation Council for the Arab States of the Gulf (GCC)				
GD	Grenada				
GG	Guernsey				
GH	Ghana				
GI	Gibraltar				
GT	Guatemala				
GW	Guinea- Bissau				
GY	Guyana				
HK	The Hong Kong Special Administrative Region of the People's Republic of China				
HN	Honduras				
HR	Croatia				
HT	Haiti				
HU	Hungary				
IB	International Bureau of the World Intellectual Property Organization (WIPO)				
ID	Indonesia				
IE	Ireland				
IL	Israel				
IM	Isle of Man				
IN	India				
IQ	Iraq				
ID	Indonesia				
IE	Ireland				
IL	Israel				
IM	Isle of Man				
IN	India				
IQ	Iraq				
IR	Iran (Islamic Republic of)				
IS	Iceland				
IT	Italy				
JE	Jersey				
JM	Jamaica				
JO	Jordan				
JP	Japan				
KE	Kenya				
KG	Kyrgyzstan				
KH	Cambodia				
KI	Kiribati				
KM	Saint Kitts and Nevis				
KP	Democratic People's Republic of Korea				
KR	Republic of Korea				
KW	Kuwait				
KY	Cayman Islands				
KZ	Kazakhstan				
LA	Lao People's Democratic Republic				
LB	Lebanon				
LC	Saint Lucia				
LI	Liechtenstein				
LK	Sri Lanka				
LR	Liberia				
LS	Lesotho				
LT	Lithuania				
LU	Luxembourg				
LV	Latvia				
LY	Libyan Arab Jamahiriya				
MA	Morocco				
MC	Monaco				
MD	Republic of Moldova				
ME	Montenegro				
MG	Madagascar				
MK	The former Yugoslav Republic of Macedonia				
ML	Mali				
MM	Myanmar				
MN	Mongolia				
MO	Macao				
MP	Northern Mariana Islands				
MR	Mauritania				
MS	Montserrat				
MT	Malta				
MU	Mauritius				
MV	Maldives				
MW	Malawi				
MX	Mexico				
MY	Malaysia				
MZ	Mozambique				
NA	Namibia				
NE	Niger				
NG	Nigeria				
NI	Nicaragua				
NL	Netherlands				
NO	Norway				
NP	Nepal				
NR	Nauru				
NZ	New Zealand				
OA	African Intellectual Property Organization (OAPI)				
OM	Oman				
PA	Panama				
PE	Peru				
PG	Papua New Guinea				
PH	Philippines				
PK	Pakistan				
PL	Poland				
PT	Portugal				
PW	Palau				
PY	Paraguay				
QA	Qatar				
QZ	Community Plant Variety Office (European Community) (CPVO)				
RO	Romania				
RS	Serbia				
RU	Russian Federation				
RW	Rwanda				
SA	Saudi Arabia				
SB	Solomon Islands				
SC	Seychelles				
SD	Sudan				
SG	Singapore				
SH	Saint Helena				
SI	Slovenia				
SK	Slovakia				
SL	Sierra Leone				
SM	San Marino				
SN	Senegal				
SO	Somalia				
SR	Suriname				
ST	Sao Tome and Principe				
SV	El Salvador				
SY	Syrian Arab Republic				
SZ	Swaziland				
TC	Turks and Caicos Islands				
TD	Chad				
TG	Togo				
TH	Thailand				
TJ	Tajikistan				
TL	Timor-Leste				
TM	Turkmenistan				
TN	Tunisia				
TO	Tonga				
TR	Turkey				
SE	Sweden				
TT	Trinidad and Tobago				
TV	Tuvalu				
TW	Taiwan, Province of China				
TZ	United Republic of Tanzania				
UA	Ukraine				
UG	Uganda				
US	United States of America				
UY	Uruguay				
UZ	Uzbekistan				
VA	Holy See				
VC	Saint Vincent and the Grenadines				
VE	Venezuela				
VG	Virgin Islands (British)				
VN	Viet Nam				
VU	Vanuatu				
WO	World Intellectual Property Organization (WIPO)				
WS	Samoa				
XN	Nordic Patent Institute (NPI)				
YE	Yemen				
ZA	South Africa				
ZM	Zambia				
ZW	Zimbabwe				

**NATIONAL INTELLECTUAL PROPERTY CENTER OF GEORGIA
SAKPATENTI**

**OFFICIAL BULLETIN
OF THE INDUSTRIAL PROPERTY**

24(508)

INVENTIONS

UTILITY MODELS

DESIGNS

TRADEMARKS

APPELLATIONS OF ORIGIN OF GOODS

DATE OF PUBLICATION

2018 12 25

CONTENTS

PUBLISHED TITLES OF PROTECTION	3
INVENTIONS	
▪ APPLICATIONS APPROVED FOR GRANTING PATENTS	4
▪ PATENTED INVENTIONS	6
UTILITY MODEL	
▪ PATENTED UTILITY MODEL	8
DESIGNS	
▪ APPLICATION APPROVED FOR REGISTRATION	9
▪ REGISTERED DESIGN	10
▪ DESIGNS, WHICH HAVE BEEN REGISTERED WITH THE INTERNATIONAL BUREAU CLAIMING PRIORITY ON THE TERRITORY OF GEORGIA	11
TRADEMARKS	
▪ APPLICATIONS FILED UNDER THE NATIONAL PROCEDURE APPROVED FOR REGISTRATION	35
▪ REGISTERED TRADEMARKS	46
▪ TRADEMARKS REGISTERED ACCORDING TO THE ACCELERATED PROCEDURE	51
▪ INTERNATIONAL TRADEMARKS FOR WHICH A DECISION ON GRANTING PROTECTION IS TAKEN	54
▪ INTERNATIONAL TRADEMARKS PROTECTED IN GEORGIA	91
APPELLATIONS OF ORIGIN OF GOODS	
▪ APPELLATIONS OF ORIGIN OF GOODS FILED IN GEORGIA FOR EXAMINATION UNDER LISBON AGREEMENT, ON THE BASIS OF THE INTERNATIONAL REGISTRATION	105
OFFICIAL NOTIFICATIONS	
INVENTIONS	
▪ RENEWAL OF PATENTS	107
▪ CANCELLATION OF PATENT	107
UTILITY MODELS	
CANCELLATION OF PATENTS	108
TRADEMARKS	
▪ RENEWAL OF REGISTRATIONS	109
▪ COMPLETE TRANSFER OF RIGHT	112
▪ CHANGES IN NAMES AND/OR ADDRESSES OF OWNERS	115
▪ INVALIDATION OF TRADEMARK REGISTRATIONS	117
▪ CANCELLATION OF LICENSE AGREEMENTS	129
CLASSIFICATION INDEXES	
INVENTIONS	130
UTILITY MODELS	131
DESIGNS	132
TRADEMARKS	134

PUBLISHED TITLES OF PROTECTION

INVENTIONS

- **APPLICATIONS APPROVED FOR GRANTING PATENT:**
13585; 14167; 13377; 14277; 14325
- **PATENTED INVENTIONS:**
6935-6939

UTILITY MODELS

- **PATENTED UTILITY MODEL:**
1997

DESIGNS

- **APPLICATION APPROVED FOR REGISTRATION:**
1050
- **REGISTERED DESIGN:**
795
- **DESIGNS WHICH HAVE BEEN REGISTERED WITH THE INTERNATIONAL BUREAU CLAIMING PRIORITY ON THE TERRITORY OF GEORGIA:**
100900, 100901; 103330; 103284; 103027; 100888

TRADEMARKS

- **APPLICATIONS FILED UNDER THE NATIONAL PROCEDURE APPROVED FOR REGISTRATION:**
91645; 92339; 96489; 96553-96555; 97000; 97380; 97387; 97391; 97394; 97407; 97422; 97425, 97426; 97428, 97429; 97432; 97434; 97441, 97442; 97448; 97451; 97453; 97460; 97462-97464; 97466, 97467; 97481; 97484; 97678; 97683; 97689; 97691, 97692; 97694-97697; 97700, 97701; 97707; 97709, 97710; 97763; 97768; 97770; 97783; 97789, 97790; 97792; 97795; 97888; 97894; 97896; 97899; 97979
- **REGISTERED TRADEMARKS:**
30671-30586; 30589-30623
- **TRADEMARKS REGISTERED ACCORDING TO THE ACCELERATED PROCEDURE:**
30562-30570; 30587, 30588; 30624-30626
- **INTERNATIONAL TRADEMARKS FOR WHICH A DECISION ON GRANTING PROTECTIONS IS TAKEN:**
85248**; 92971*; 94738; 95495; 95691; 95915, 95916; 96059; 96231; 96233; 96318; 96322-96327; 96351; 96354; 96360; 96371-96373; 96387, 96388; 96390-96393; 96400; 96403, 96404; 96426; 96428-96435; 96449; 96477; 96511-96513; 96515, 96516; 96519-96521; 96526; 96596, 96597; 96599; 96602-96604; 96652; 96664; 96677; 96681-96684, 96685; 96687, 96688; 96794, 96795; 96822, 96823; 96829; 96874; 96953; 96957, 96958; 96961-96963; 96965; 96968-96970; 97132; 97150; 97162
- **INTERNATIONAL TRADEMARKS PROTECTED IN GEORGIA:**
90638; 92171; 92247; 92273; 92564; 92757; 92824; 93178; 93293; 93295; 93400; 93446; 93595, 93596; 93649; 93739; 93741; 93788; 93791, 93792; 93947; 93969; 94150; 94235; 94253; 94422; 94607; 94611; 94614; 94617; 94619-94621; 94631; 94649; 94651; 94757; 94781-94784; 94803, 94804; 94808-94811; 94813; 94815; 94817; 94842; 94887; 94890; 94930; 94957, 94958; 94960, 94961; 94963; 94991, 94992; 94996; 94999; 95002; 95024; 95040-95043; 95063; 95082, 95083; 95086; 95090; 95104, 95105; 95111, 95112; 95115-95117; 95153-95156; 95158-95164; 95190, 95191; 95193- 95196; 95225, 95226; 95228-95230; 95232-95234; 95237; 95240-95242; 95254-95258; 95260, 95261; 95265; 95272, 95281; 95284, 95285; 95287; 95289; 95291; 95293; 95296-95299; 95301; 95305; 95311; 95313; 95315, 95316; 95321-95324; 95326; 95329; 95369; 95377-95386; 95424-95426; 95430; 95434-95439; 95477, 95478; 95484; 95500-95504; 95506; 95508; 95510; 95512; 95537; 95591-95595; 95620-95627; 95629; 95701; 95703; 95712; 95720; 95735-95739; 95741, 95742; 95744; 95813; 95822; 95827; 96268

APPELLATIONS OF ORIGIN OF GOODS

- **APPELLATIONS OF ORIGIN OF GOODS FILED IN GEORGIA FOR EXAMINATION UNDER LISBON AGREEMENT, ON THE BASIS OF THE INTERNATIONAL REGISTRATION:**
1495-1500

INVENTIONS

APPLICATIONS APPROVED FOR GRANTING PATENTS

The decision can be appealed at the Chamber of Appeal of Sakpatenti within 3 months from the publication or at the Mtskheta District Court Administrative Cases Board (Address: №17, Samkhedro str., Mtskheta), within 1 month following the publication.

PART A

A 01

(10) AP 2018 13585 A (51) Int. Cl. (2006)

A 01 N 43/40
C 07 D 401/06
C 07 D 213/46
A 01 P 7/00
A 01 N 51/00
A 01 N 43/42
A 01 N 43/56
A 01 N 43/80
A 01 N 47/02
A 01 N 43/76
A 01 N 43/22
A 01 N 47/40
A 01 N 43/707
A 01 N 43/82
A 01 N 37/50

- (21) AP 2013 13585 (22) 2013 02 27
(31) 2012-044514
(32) 2012 02 29
(33) JP
(71) MEIJI SEIKA PHARMA CO., LTD. (JP)
4-16, Kyobashi 2-chome, Chuo-ku, Tokyo
1048002 (JP)
(72) HORIKOSHI, Ryo (JP);
ONOZAKI, Yasumichi (JP);
NAKAMURA, Satoshi (JP);
NOMURA, Masahiro (JP);
MATSUMURA, Makoto (JP);
MITOMI, Masaaki (JP)
(74) Tamar Kochlamazashvili
(85) 2014 09 26
(86) PCT/JP2013/056051, 2013 02 27

(54) **PEST CONTROL COMPOSITION
INCLUDING NOVEL IMINOPYRIDINE
DERIVATIVE**

(57) An invention relates to the composition intended for pest control containing novel iminopyridine derivative and other pest control agents.

Claims: 4 independent
2 dependent

A 47

(10) AP 2018 14167 A (51) Int. Cl. (2006)
A 47 K 10/38
A 47 K 10/32

- (21) AP 2014 14167 (22) 2014 11 17
(31) 2013/13364
(32) 2013 11 18
(33) TR
(71) ECZACIBAŞI TÜKETİM ÜRÜNLERİ
SANAYİ VE TİCARET A.Ş (TR)
Kavacık Ofis. Rüzgarlı Bahçe Mahallesi,
Kavak Sokak No: 20. Beykoz 34805,
İstanbul (TR)
(72) ŞİMŞİR, Boğaç (TR)
(74) Larisa Amirkhanyan
(85) 2016 06 06
(86) PCT/TR2014/000433, 2014 11 17

(54) **DISPENSER COMPRISING PRODUCT
LEVEL INDICATOR**

(57) A dispenser comprises main body (5), a cover (8), inner receptacle (9) in which product slot (1) is placed and a mechanism indicating product level remaining in the dispenser. The product level indicator mechanism comprises the following: product slot (1) provided therein with the product (2) and capable of moving, a spring (3) positioned on lower rear portion of product slot (1), a joint (7) positioned on upper rear portion of product slot (1), a tongue (4) positioned on upper portion of product slot (1) so as to be connected with product slot (1) as the extension thereof, and tongue slot (6) positioned on main body (5).

Claims: 2 independent
4 dependent

Fig.: 4

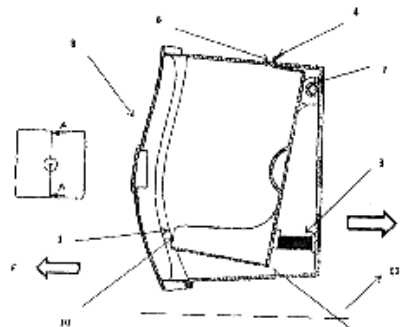

Fig. 4

A 61

(10) **AP 2018 13377 A** (51) **Int. Cl. (2006)**
A 61 K 9/10
A 61 K 9/107
A 61 K 9/08
A 61 K 9/00
A 61 K 31/473
A 61 P 25/16

(21) AP 2012 13377 (22) 2012 07 11
(31) 11290320.8
(32) 2011 07 11
(33) EP
(71) BRITANNIA PHARMACEUTICALS
LTD (GB)
Park View House 65, London Road Newbury,
Berkshire RG14 1JN (GB)
(72) DEY, Michael (GB);
RICHARD, Joel (FR);
BARONNET, Marie-Madeleine (FR);
MONDOLY, Nathalie (FR);
BERTOCCHI, Laurent (FR);
HARNETT, Jeremiah (FR)

(74) Giorgi Ghvinjilia

(85) 2014 02 05

(86) PCT/EP2012/002916, 2012 07 11

(54) **NEW THERAPEUTICAL COMPOSITION
CONTAINING APOMORPHINE AS ACTI-
VE INGREDIENT**

(57) Solution intended for injection, containing apomorphine, co-solvent mixed with water, antioxidant, and water is used for the treatment of Parkinson's disease.

Claims: 1 independent

12 dependent

(10) **AP 2018 14277 A** (51) **Int. Cl. (2006)**
A 61 K 38/17
C 07 K 14/81

(21) AP 2015 14277 (22) 2015 02 23

(31) 61/943,617

(32) 2014 02 24

(33) US

(71) TAKEDA PHARMACEUTICAL COMPANY
LIMITED (JP)
1-1, Doshomachi 4-chome, Chuo-ku Osaka-shi,
Osaka 541-0045 (JP)

(72) CHAMBERLAIN, Aaron (US);

LIU, Qiang (US);

SCHMIDT, Mathias (US)

(74) Aleksandre Gegechkori

(85) 2016 09 22

(86) PCT/US2015/017152, 2015 02 23

(54) **UTI FUSION PROTEINS**

(57) Present invention provides UTI fusion proteins, DNA sequences for producing thereof, and pharmaceutical compositions and methods of their usage.

Claims: 8 independent

2 dependent

PART E**E 02**

(10) **AP 2018 14325 A** (51) **Int. Cl. (2006)**
E 02 B 3/16
E 02 B 3/10
E 00 B 3/12

(21) AP 2015 14325 (22) 2015 04 23

(31) MI2014A000766

(32) 2014 04 24

(33) IT

(71) CARPI TECH B.V. (NL)

Spoorhaven 88 NL-2651 AV Berkelen

Rodenrijs (NL)

(72) SCUERO, Alberto, Maria (NL)

(74) Liliana Darakhvelidze

(85) 2016 11 22

(86) PCT/EP2015/058788, 2015 04 23

(54) **METHOD AND SYSTEM FOR ANCHO-
RING A WATERPROOFING LINER TO
CONCRETE CURBS OF A HYDRAULIC
STRUCTURE**

(57) A method and a system for anchoring a waterproofing liner (13) of thermoplastic material to a longitudinally extending wall (12) of a hydraulic structure (10) of compacted loose material. The waterproofing liner (13) is sealed to a plurality of continuous anchor bands (14) of thermoplastic material, laterally spaced apart from one another, vertically extending in a traverse direction of the wall (12), from an upper to a lower position of the hydraulic structure (10); each continuous anchor band (14) consists of a plurality of axially aligned and partially superimposed modular strips (14'), seamed together and fixed to concrete curbs (15), defining a surface for laying down the waterproofing liner (13), in which the curbs (15) longitudinally and/or transversely extend to the wall (12) of the hydraulic structure (10).

Claims: 2 independent

16 dependent

Fig.: 15

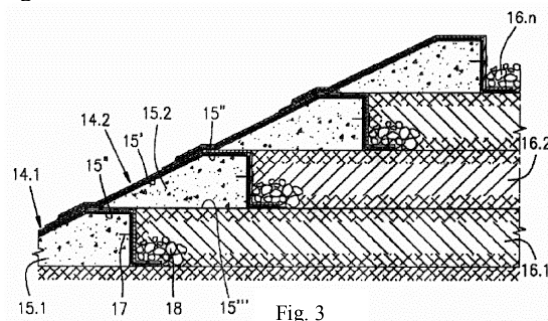

Fig. 3

PATENTED INVENTIONS

PART A

A 01

- (11) P 2018 6939 B** **(51) Int. Cl. (2006)**
A 01 N 43/40
 (10) AP 2018 14459 A (44) 17(501)/2018
 (21) AP 2015 14459
 (22) 2015 08 28
 (24) 2015 08 28
 (31) 62/045,976
 (32) 2014 09 04
 (33) US
 (86) PCT/US2015/047435, 2015 08 28
 (73) HELSINN HEALTHCARE SA (CH)
 Via Pian Scairolo 9 CH-6912 Lugano/
 Pazzallo (CH)
 (72) MANN, William (US);
 FRIEND, John (US);
 POLVINO, William (US);
 ALLEN, Suzan (US);
 LU, Ming (US);
 DUUS, Elizabeth (US);
 GIORGINO, Ruben (CH);
 BARONI, Enrico (IT)
 (74) Shalva Gvaramadze
 (54) **MEDICAL TREATMENTS BASED**
ON ANAMORELIN

A 61

- (11) P 2018 6936 B** **(51) Int. Cl. (2006)**
A 61 C 8/00
 (10) AP 2018 14140 A (44) 17(501)/2018
 (21) AP 2016 14140
 (22) 2016 05 11
 (24) 2016 05 11
 (73) Sergey Manukov (GE)
 Sakanelas q. 37, 0108, Tbilisi (GE)
 (72) Sergey Manukov (GE)
 (74) Karina Manukova
 (54) **INTACT OR DOUBLE PARTIAL**
COMBINED CRYSTAL OR AXIAL
STOMATOLOGICAL IMPLANT, AND
SYSTEM OF DOUBLE OR ONE STAGE
BICORTICAL TOOTH IMPLANTS OF
UPPER JAW OF SECOND TYPE BONE
FOR PREMOLARS AND MOLARS
AREA

PART C

C 07

- (11) P 2018 6938 B** **(51) Int. Cl. (2006)**
C 07 D 471/04
C 07 D 473/02
C 07 D 487/04
A 61 K 31/52
A 61 K 31/519
A 61 P 11/00
A 61 P 37/00
A 61 P 29/00
 (10) AP 2018 14349 A (44) 16(500)/2018
 (21) AP 2015 14349
 (22) 2015 06 16
 (24) 2015 06 16
 (31) 14172764.4
 (32) 2014 06 17
 (33) EP
 (86) PCT/EP2015/063390, 2015 06 16
 (73) CHIESI FARMACEUTICI S.P.A. (IT)
 Via Palermo, 26/A I-43100 Parma (IT)
 (72) BIAGETTI, Matteo (IT);
 ACCETTA, Alessandro (IT);
 CAPELLI, Anna Maria (IT);
 GUALA, Matilde (IT);
 RETINI, Michele (IT)
 (74) Shalva Gvaramadze
 (54) **INDOLIZINE DERIVATIVES AS**
PHOSHOINOSITIDE 3-KINASES
INHIBITORS

PART G

G 01

- (11) P 2018 6935 B** **(51) Int. Cl. (2006)**
G 01 B 5/004
 (10) AP 2018 14457 A (44) 7(491)/2018
 (21) AP 2017 14457
 (22) 2017 03 24
 (24) 2017 03 24
 (73) Merab Shalamberidze (GE)
 Rodzevichis q. 8/2, 4600, Kutaisi (GE);
 GOVERNMENT UNIVERSITY OF AKAKI
 TSERETELI (GE)
 Tamar Mepis q. 59, 4600, Kutaisi (GE)

-
- (72) Merab Shalamberidze (GE);
Zurab Tsintsadze (GE);
Ekaterine Meladze (GE)
- (74) Archil Geguchadze
- (54) **DEVICE FOR SURGICAL FOOTBED
RELIEF DETERMINATION**
-

G 09

- (11) **P 2018 6937 B** (51) **Int. Cl. (2006)**
G 09 B 5/00
B 42 D 3/12
- (10) AP 2018 14344 A (44) 14(498)/2018
- (21) AP 2016 14344
- (22) 2016 12 09
- (24) 2016 12 09
- (73) Elizbar Arsenashvili (GE)
Gotuas q. 20, b. 44, 0160, Tbilisi (GE)
- (72) Elizbar Arsenashvili (GE)
- (54) **SET OF LEARNERS' MANUALS
AND LEARNING SYSTEM WITH
USAGE THEREOF**
-

UTILITY MODEL

PATENTED UTILITY MODEL

PART E

E 05

**(11) U 2018 1997 Y (51) Int. Cl. (2006)
E 05 F 13/04**

(10) AU 2018 14614 U (44) 14(498)/2018

(21) AU 2017 14614

(22) 2017 10 25

(24) 2017 10 25

(73) Mamuka Abralava (GE)
me-11 q. 19, Sop. Lia, 5205,
Tsalenjikhis r-ni (GE)

(72) Mamuka Abralava (GE)

(74) Valeri Abralava

**(54) DEVICE FOR GATE OPENING AND
CLOSING IN DISTANCE**

DESIGNS

APPLICATION APPROVED FOR REGISTRATION

The decision can be appealed at the Chamber of Appeal of Sakpatenti within 3 months from the publication or at the Mtskheta District Court Administrative Cases Board (Address: №17, Samkhedro str., Mtskheta), within 1 month following the publication.

- (10) AD 2018 1050 S (51) 09-01
(21) AD 2018 1050 (22) 2018 08 16
(28) 1
(71) Tamaz Kakhidze (GE)
Didacharis q. 17, 6000, Batumi, Khelvachauri (GE);
Mirian Kakhidze (GE)
Didacharis q. 17, 6000, Batumi, Khelvachauri (GE)
(72) Tamaz Kakhidze (GE);
Mirian Kakhidze (GE)
(54) GLASS CAN
(55)



1.1



1.2



1.3



1.4

REGISTERED DESIGN

- (11) **D 2018 795 S** (51) **31-00**
(10) AD 2018 1020 S (44) 2018 09 10 №17
(21) AD 2018 1020
(22) 2018 02 08
(24) 2018 02 08
(28) 4
(18) 2023 02 08
(31) 29/614,321; 29/614,321; 29/614,321;
29/614,321
(32) 2017 08 17; 2017 08 17; 2017 08 17;
2017 08 17
(33) US; US; US; US
(73) CAPBRAN HOLDINGS, LLC (US)
11601 Wilshire blvd. Suite 2300, Los Angeles,
CA 90025 (US)
(72) Colin Sapphire (US)
(74) Shalva Gvaramadze (GE)
(54) **1. BLENDER, 2. BLENDER CASE**
3. BLENDER CUTTERS HOLDER,
4. BLENDER CONTAINER
-

DESIGNS, WHICH HAVE BEEN REGISTERED WITH THE INTERNATIONAL BUREAU CLAIMING PRIORITY ON THE TERRITORY OF GEORGIA

The decision can be appealed at the Chamber of Appeal of Sakpatenti within 3 months from the publication or at the Mtskheta District Court Administrative Cases Board (Address: №17, Samkhedro Str., Mtskheta), within 1 month following the publication.

(11) DM/100900

(15) 2018 03 29

(22) 2018 03 29

(28) 4

(30) Nos. 1, 2: 15.10.2017; 11394; BG; Nos. 3, 4: 19.02.2018; 11437; BG

(73) BULGARIAN INDUSTRIAL ENGINEERING COMPANY LTD

Shipeto Str. 5, Vladaya village, BG-1641 Sofia-city, Sofia-Municipality (BG)

(85) BG, EM

(86) –

(87) –

(88) –

(89) BG

(81) II. MA III. AM, AZ, BA, EG, EM, GE, MK, OA, RS, TR, UA, US

(72) Emil Ivanov Ivanov

5 Shipeto, Str. Vladaya village, BG1641, Sofia-city Sofia-Municipality, Bulgaria

(54) 1.-2. Ammunition; 3.-4. Grenade launchers with optical sight

(55)

1



2



3



4



(11) DM/100901

(15) 2018 03 29

(22) 2018 03 29

(28) 1

(73) BULGARIAN INDUSTRIAL ENGINEERING COMPANY LTD

Shipeto Str. 5, Vladaya village, BG-1641 Sofia-city, Sofia-Municipality (BG)

(85) BG

(86) –

(87) –

(88) –

(89) BG

(81) II. MA III. AM, AZ, BA, EG, EM, GE, MK, OA, RS, RU, TR, UA, US

(72) Emil Ivanov Ivanov

5 Shipeto, Str. Vladaya village, BG1641, Sofia-city Sofia-Municipality, Bulgaria

(54) 1. Pistol

(55)

(51) 22-01

(45) 2018/39 (2018 10 05)

1.1



1.2



(11) DM/103330

(15) 2018 05 03

(22) 2018 05 03

(28) 7

(73) EUROPCAR INTERNATIONAL

13 Ter Boulevard Berthier, F-75017 Paris (FR)

(85) FR, EM

(86) FR, EM

(87) FR, EM

(88) FR, EM

(89) FR

(81) IL, MA, III, AL, AM, BA, BW, CH, EE, EG, EM, GE, GH, IS, KH, MD, MK, NA, NO, OA, OM, RS, RW, SG, TN, TR

(72) Kathryn Wilson

19 Parkway, Apse Heath, Sandown, PO36 0LN Isle of Wight, United Kingdom

(54) 1.-7. Uniforms

(55)

(51) 02-02

(45) 2018/44 (2018 11 09)

1.1



1.2



1.3



1.4



1.5



1.6



1.7



1.8



2.1



2.2



2.3



2.4



2.5



2.6



2.7



2.8



3.1



3.2



3.3



3.4



3.5



3.6



3.7



3.8



4.1



4.2



4.3



4.4



4.5



4.6



4.7



4.8

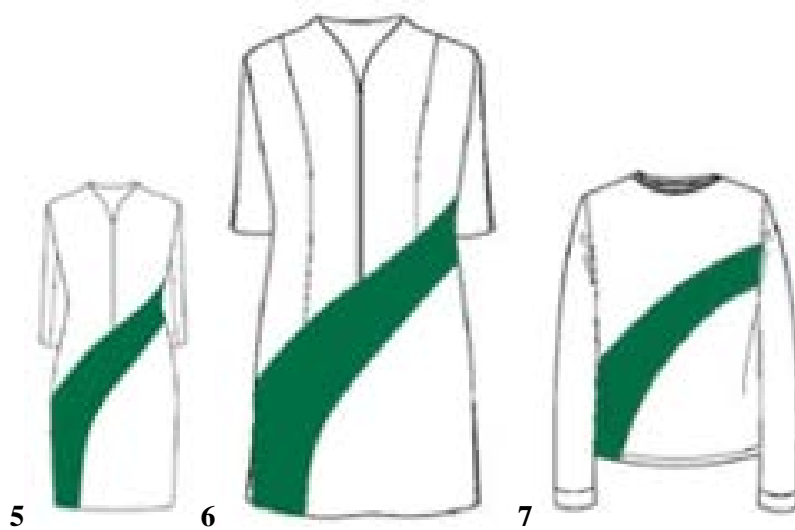

5

6

7

(11) DM/103284

(51) 03-03

(15) 2017 11 14

(45) 2018/42 (2018 10 26)

(22) 2017 11 14

(28) 1

(73) MAZY HOLIDAY

217 Country Club Park #603, Birmingham AL 35213 (US)

(85) –

(86) US

(87) US

(88) –

(89) US

(81) III. AL, AM, AZ, BA, BG, BN, BW, CH, DE, DK, EE, EG, EM, ES, FI, FR, GE, GH, HR, HU, IS, JP, KG, KH, LI, LT, LV, MC, MD, ME, MK, MN, NA, NO, OA, OM, PL, RO, RS, RW, SG, SI, ST, SY, TJ, TM, TN, TR, UA, US

(72) Mazy Holiday

217 Country Club Park N603, Birmingham, AL 35213, United States

(54) 1. Cane

(55)

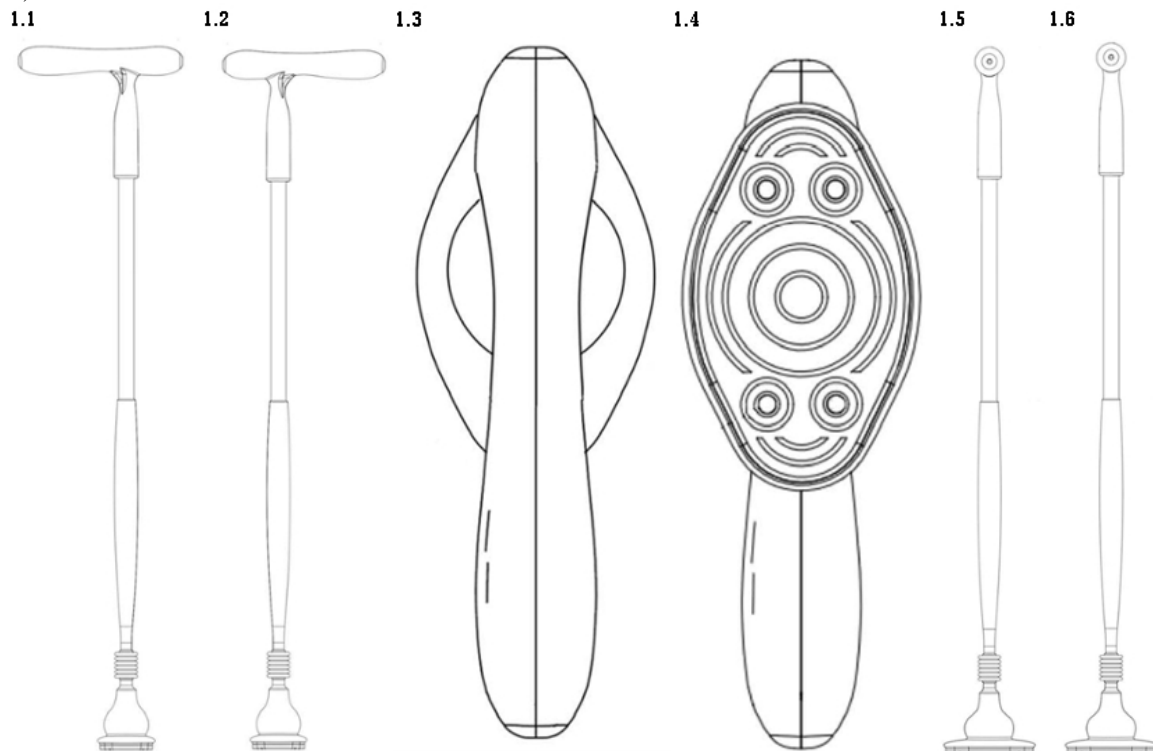

(11) DM/103027 (51) 09-03

(15) 2018 09 07 (45) 2018/40 (2018 10 12)

(22) 2018 09 07 (28) 1

(30) No. 1: 07.03.2018; 20180010; AM

(73) IBARI LLC

Baghramyan 56, apt. 19-20, 0019 Yerevan (AM)

(85) –

(86) –

(87) AM

(88) –

(89) AM

(81) III. CH, EM, GE, RU, TR, UA, US

(72) Stepan Azaryan

Budaghyan str. 1, 0014 Yerevan, Armenia

(54) 1. Packaging for wine bottle

(55)

1.1



1.2



1.3



1.4



1.5



(11) DM/100888

(15) 2018 04 26

(22) 2018 04 26

(28) 7

(73) HARRY WINSTON SA

Chemin du Tourbillon 8, CH-1228 Plan-les-Ouates (CH)

(85) CH

(86) CH

(87) CH

(88) CH

(89) CH

(81) II. BZ, MA III. AL, AM, AZ, BA, CH, EM, GE, KG, LI, MC, MD, ME, MK, MN, NO, OM, SG, TN, TR, UA

(72) Rie YATSUGI-KANG

272 Highland St, Cresskill, NJ, 07626 Cresskill, États-Unis d'Amérique

(54) 1. Necklace; 2. Finger ring; 3. Earring; 4. Necklace; 5. Finger ring; 6. Earring; 7. Necklace

(55)

(51) 11-01

(45) 2018/42 (2018 10 26)

1.1**1.2**

1.3



1.4



1.5



1.6



1.7



1.8



2.1



2.2



2.3



2.4



2.5



2.6



2.7



2.8



3.1



3.2



3.3



3.4



3.5



3.6



3.7



3.8



4.1



4.2



4.3



4.4



4.5



4.6



4.7



4.8



5.2

5.1



5.3



5.4



5.5



5.6



5.7



5.8



6.1



6.2



6.3





7.2



7.3



7.4



7.5



7.6



7.7



7.8



TRADEMARKS

APPLICATIONS FILED UNDER THE NATIONAL PROCEDURE APPROVED FOR REGISTRATION

The decision can be appealed at the Chamber of Appeal of Sakpatenti within 3 months from the publication or at the Mtskheta District Court Administrative Cases Board (Address: №17, Samkhedro St., Mtskheta), within 1 month following the publication.

(260) AM 2018 91645 A
(210) AM 91645
(220) 11 04 2017
(731) LTD "ASPHARMA GEORGIA
PHARMACEUTICAL COMPANY"
Mtskhets q. 8, 0179, Tbilisi, Georgia
(740) Maia Samadashvili
(540)

Ornil
Орнил
ორნილი

(591) Black, white
(511) 5

(260) AM 2018 92339 A
(210) AM 92339
(220) 24 05 2017
(731) LTD "VERA ESTATE"
Makashvils q. 18/Zandukelis q. 22, 0108,
Tbilisi, Georgia
(740) Ekaterine Ekhvaia-Chanturia
(540)



(591) Blue, orange and yellow
(531) 07.01.12; 07.01.24; 26.11.01; 26.11.13;
27.05.01; 29.01.14
(511) 36, 37

(260) AM 2018 96489 A
(210) AM 96489
(220) 21 02 2018
(731) AMAZON EUROPE CORE S.À R.L.

5, Rue Plaetis, L-2338 Luxembourg,
Luxembourg
(740) Tamaz Shilakadze
(540)



(591) Black, white
(531) 24.15.13; 27.05.01; 27.05.17
(511) 9, 38, 41

(260) AM 2018 96553 A
(210) AM 96553
(220) 26 02 2018
(731) VANGUARD TRADEMARK HOLDINGS
USA LLC.
600 Korporeit Park Draivi, Sent-luisi, Misuri
63105, USA
(740) Natela Otardize
(540)

**ალამო ავტომობილების
გაქირავება**

(591) Black, white
(511) 39

(260) AM 2018 96554 A
(210) AM 96554
(220) 26 02 2018
(731) VANGUARD TRADEMARK HOLDINGS
USA LLC.
600 Korporeit Park Draivi, Sent-luisi, Misuri
63105, USA
(740) Natela Otardize
(540)

ალამო

(591) Black, white
(511) 39

(260) AM 2018 96555 A
 (210) AM 96555
 (220) 26 02 2018
 (731) VANGUARD TRADEMARK HOLDINGS
 USA LLC
 600 Korporeit Park Drive, St. Louis, Missouri
 63105, USA
 (740) Natela Otariidze
 (540)

ნეიშენალი

(591) Black, white
 (511) 39

(260) AM 2018 97000 A
 (210) AM 97000
 (220) 23 03 2018
 (731) LTD "GEORGIA TODAY"
 Sul Khan Tsintsadze q. 12, A/P 4-3, 0160,
 Tbilisi, Georgia
 (740) Giorgi Revishvili
 (540)



(591) White, red, black
 (531) 26.04.01; 26.04.05; 26.04.18; 26.04.24;
 27.05.01; 27.05.24; 29.01.13
 (526) GEORGIA
 (511) 9, 16, 35, 38, 41

(260) AM 2018 97380 A
 (210) AM 97380
 (220) 23 04 2018
 (731) LG ELECTRONICS INC.
 128, Yeoui-daero, Yeongdeungpo-gu, Seoul,
 150-721, Republic of Korea
 (740) Tamaz Shilakadze
 (540)

TrueSteam

(591) Black, white
 (511) 7, 11

(260) AM 2018 97387 A
 (210) AM 97387
 (220) 24 04 2018
 (731) LTD "EELI"
 Sh. Nutsubidzis Perdobi IV mkr., korp. 38,
 b. 25, 0183, Tbilisi, Georgia
 (540)



(591) White, light green, red, orange, dark green
 (531) 04.05.01; 04.05.02; 04.05.03; 05.07.11;
 26.04.22; 27.05.01; 27.05.08; 27.05.24;
 27.05.25; 29.01.14
 (511) 29, 30, 35

(260) AM 2018 97391 A
 (210) AM 97391
 (220) 24 04 2018
 (731) RK "NEKTARI-2016"
 G. Chkondideli q. 66, 2100, Zugdidi,
 Georgia
 (540)



(591) Black, cream
 (531) 02.09.14; 02.09.15; 03.13.04; 05.03.20;
 05.05.20; 26.01.14; 26.01.15; 26.07.05; 28.19;
 29.01.12
 (511) 30

(260) AM 2018 97394 A
 (210) AM 97394
 (220) 24 04 2018
 (731) HAKAN AGRO DMCC
 P.O. Box 31489, Dubai, United Arab Emirates
 (740) Tamaz Shilakadze
 (540)



(591) Black, yellow
 (531) 27.05.01; 27.05.04; 29.01.12
 (511) 29

(260) AM 2018 97407 A
 (210) AM 97407
 (220) 26 04 2018
 (731) LLC "UNISSET-M"
 Ul. Iskri, dom 31, 129344, Moscow, Russian
 Federation
 (740) Givi Akopashvili

(540)



(591) Light yellow, brown, black, white, golden
(531) 02.01.04; 02.01.08; 02.03.04; 02.03.08;
25.01.19; 28.05; 28.19; 29.01.14
(511) 33

(260) AM 2018 97422 A
(210) AM 97422
(220) 27 04 2018
(731) LTD "SANUS VITA"
Saakadzis daghmarti. 6, k/p 11, 0160,
Tbilisi, Georgia
(740) Salome Chikovani
(540)

AMINOVIT
ამინოვიტი
АМИНОВИТ

(591) Black, white
(511) 5

(260) AM 2018 97425 A
(210) AM 97425
(220) 27 04 2018
(731) LTD "SANUS VITA"
Saakadzis daghmarti. 6, k/p 11, 0160,
Tbilisi, Georgia
(740) Salome Chikovani

(540)

FEMINION-VITA
ფემინიონ-ვიტა
ФЕМИНИОН-ВИТА

(591) Black, white
(511) 5

(260) AM 2018 97426 A
(210) AM 97426
(220) 27 04 2018
(731) LTD "SANUS VITA"
Saakadzis Daghmarti 6, Commercial
Space 11, 0160, Tbilisi, Georgia
(740) Salome Chikovani
(540)

PENTALGIN
პენტალგინი
ПЕНТАЛГИН

(591) Black, white
(511) 5

(260) AM 2018 97428 A
(210) AM 97428
(220) 27 04 2018
(731) LTD "SANUS VITA"
Saakadzis Daghmarti 6, Commercial
Space 11, 0160, Tbilisi, Georgia
(740) Salome Chikovani
(540)

SPAZMOFILIN
სპაზმოფილინი
СПАЗМОФИЛИН

(591) Black, white
(511) 5

(260) AM 2018 97429 A
(210) AM 97429
(220) 27 04 2018
(731) LTD "SANUS VITA"
Saakadzis Daghmarti 6, Commercial
Space 11, 0160, Tbilisi, Georgia
(740) Salome Chikovani
(540)

HEPTRAZOL
ჰეპტრაზოლი
ГЕПТРАЗОЛ

(591) Black, white
(511) 5

(260) AM 2018 97432 A
(210) AM 97432
(220) 30 04 2018
(731) LTD "J.I. GROUP"
Petre Kavtaradzis q. 19, b. 62, 0186, Tbilisi,
Georgia
(540)



(591) Green, white
(531) 02.09.25; 26.01.07; 26.01.12; 27.05.08;
27.05.15; 27.05.17; 29.01.03
(511) 39

(260) AM 2018 97434 A
(210) AM 97434
(220) 01 05 2018
(731) NIKA GVARAMIA
Abuladzis q. 32, 0162, Tbilisi, Georgia
(740) Dachy Beruchashvili
(540)

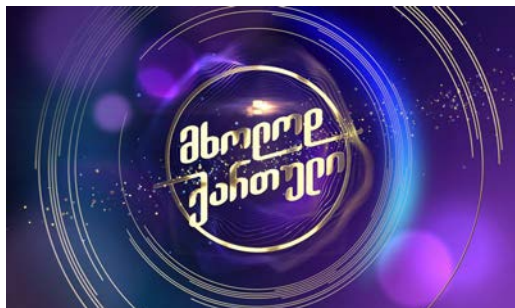

(591) Light purple, dark lilac, blue, golden
(531) 26.01.05; 26.01.20; 28.19; 29.01.15
(511) 41

(260) AM 2018 97441 A
(210) AM 97441
(220) 02 05 2018
(731) DEPARTMENT OF THE ARMY
The Pentagon, Washington, District of
Columbia, 20310, USA
(740) Khatuna Imnadze
(540)

C-ROC

(591) Black, white
(511) 19

(260) AM 2018 97442 A
(210) AM 97442
(220) 03 05 2018
(731) JSC "RAKHAT"
Zenkovis q. 2a, Almati, Kazakhstan
(740) Irakli Gvilia
(540)



(591) Black, white
(531) 27.05.02; 27.05.19; 27.05.22
(511) 5, 20, 29, 30, 35, 36, 37, 39, 43

(260) AM 2018 97448 A
(210) AM 97448
(220) 03 05 2018
(731) Georgian Farmer Association
Ak. Khoravas q., 0107, Tbilisi, Georgia
(540)



ადგილობრივი სთანდარტი

(531) 03.01.06; 03.01.08; 03.01.17; 03.01.24;
03.04.02; 03.17; 05.09.24; 27.03.03; 27.03.11;
27.05.06; 27.05.10; 27.05.21; 29.01.03
(511) 42

(260) AM 2018 97451 A
(210) AM 97451
(220) 04 05 2018
(731) LTD "PORTAL"
D. Gamrekelis q. 19, Tbilisi, Georgia
(540)

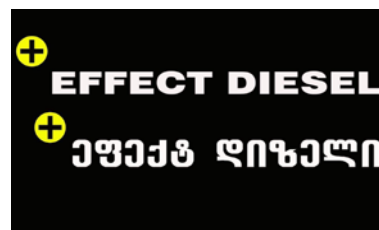

(591) Yellow, black, white
(531) 24.13.22; 26.04.24; 27.05.24; 28.19; 29.01.13
(511) 4

(260) AM 2018 97453 A
 (210) AM 97453
 (220) 04 05 2018
 (731) JSC "RAKHAT"
 Zenkov Str. 2a, Almaty, Kazakhstan
 (740) Irakli Gvilia
 (540)

PAXAT

(591) Black, white
 (511) 5, 20, 29, 30, 35, 36, 37, 39, 43

(260) AM 2018 97460 A
 (210) AM 97460
 (220) 04 05 2018
 (731) LTD "AUTO GALLERY"
 Shalva Nutsubidzis q. 201, 0186, Tbilisi,
 Georgia
 (740) Giorgi Kartvelishvili
 (540)



(591) Red, white
 (531) 26.01.01; 26.01.04; 26.01.05; 26.01.20;
 26.04.10; 26.11.12; 29.01.12
 (526) "AUTO"
 (511) 12

(260) AM 2018 97462 A
 (210) AM 97462
 (220) 04 05 2018
 (731) LTD "ROSTEVANI"
 L. Sharashidzis q. 2/4, 0179, Tbilisi, Georgia
 (540)



(591) Lilac, turquoise, white
 (531) 02.01.01; 26.04.14; 28.19; 29.01.13
 (511) 43

(260) AM 2018 97463 A
 (210) AM 97463
 (220) 04 05 2018
 (731) LTD "LUCKY"
 Vazha-Pshavelas gamz. 36, 0177, Tbilisi,
 Georgia
 (540)



(591) Green
 (531) 05.03.20; 27.05.01; 27.05.03; 29.01.13
 (511) 29, 30, 31, 32, 33

(260) AM 2018 97464 A
 (210) AM 97464
 (220) 07 05 2018
 (731) SENSO VITA PHARMACY
 N. Kipshidzis q. 12b, b. 51, Vake-
 Saburtalos r-ni, Tbilisi, Georgia
 (540)



(591) Green, grey
 (531) 26.11.11; 27.05.01; 27.05.11; 29.01.12
 (511) 5, 35

(260) AM 2018 97466 A
 (210) AM 97466
 (220) 07 05 2018
 (731) LTD "FORMOSA"
 R. Mamisashvilis q. 31a, 0182, Tbilisi,
 Georgia
 (540)

**ჩემო
 Power**

(591) Black, white
 (511) 9

(260) AM 2018 97467 A
 (210) AM 97467
 (220) 07 05 2018
 (731) LTD "AVERSI-PHARMA"
 Davit Aghmasheneblis gamz. 148/2, 0112,
 Tbilisi, Georgia
 (540)

კორვალტაბი
Корвалтаб
Corvaltab

(591) Black, white
 (511) 5

(260) AM 2018 97481 A
 (210) AM 97481
 (220) 10 05 2018
 (731) LTD "PHARMAKINESIS"
 Tsknetis q. 1a, b.39, Vake-Saburtalos r-ni
 0162, Tbilisi, Georgia
 (740) Tamar Dididze
 (540)



(591) White, dark gray, light blue
 (531) 26.01.01; 26.01.03; 26.01.12; 26.11.12;
 27.05.01; 28.19; 29.01.13
 (511) 3, 5, 35

(260) AM 2018 97484 A
 (210) AM 97484
 (220) 10 05 2018
 (731) SCHWEPPEs INTERNATIONAL LIMITED
 7 Albemarle Street, LONDON W1S 4HQ,
 United Kingdom
 (740) Merab Kvimsadze
 (540)



(591) White, blue, light blue, dark blue, yellow,
 orange, light orange, dark orange, gray, light
 gray

(531) 01.15.21; 05.07.11; 05.07.22; 19.07.01;
 25.01.01; 25.01.15; 25.01.17; 25.01.19;
 27.05.02; 27.05.24; 29.01.14
 (511) 32, 33

(260) AM 2018 97678 A
 (210) AM 97678
 (220) 11 05 2018
 (731) LTD "TIFLIS TEKSTIL"
 Gr. Lortkipanidzis q. 81a, 0145, Tbilisi,
 Georgia
 (540)



(591) White, sky-blue
 (531) 01.03.01; 01.03.06; 26.01.13; 26.01.16;
 26.11.08; 27.05.17; 28.19; 29.01.12
 (511) 25

(260) AM 2018 97683 A
 (210) AM 97683
 (220) 13 05 2018
 (731) LTD "MUSEUMSHOP"
 Ir. Abashidzis q. 72, b. 34, 0162, Tbilisi,
 Georgia
 (540)



(591) Yellow, black
 (531) 26.01.06; 26.01.24; 27.05.01; 29.01.12
 (511) 35

(260) AM 2018 97689 A
 (210) AM 97689
 (220) 14 05 2018
 (731) JSC "COPRORATION KINDZMARAUli"
 I. Chavchavadzis q. 55, 4800, Kvareli,
 Georgia
 (540)

კონჭო & კო
Кончо и Ко
Koncho & Co

(591) Black, white
 (511) 33

(260) AM 2018 97691 A
 (210) AM 97691
 (220) 14 05 2018
 (731) CHAMPION PRODUCTS EUROPE
 LIMITED
 Suite 8, Plaza 212, Blanchardstown Corporate
 Park 2, Blanchardstown, Dublin 15, Ireland
 (740) Tamaz Shilakadze
 (540)

Champion

(591) Black, white
 (531) 26.01.02; 26.02.01; 27.05.01; 27.05.19
 (511) 18

(260) AM 2018 97692 A
 (210) AM 97692
 (220) 14 05 2018
 (731) CHAMPION PRODUCTS EUROPE
 LIMITED
 Suite 8, Plaza 212, Blanchardstown Corporate
 Park 2, Blanchardstown, Dublin 15, Ireland
 (740) Tamaz Shilakadze
 (540)



(591) Black, white
 (531) 26.01.02; 26.02.01
 (511) 18

(260) AM 2018 97694 A
 (210) AM 97694
 (220) 15 05 2018
 (731) JOINT STOCK COMPANY "AUGUST" INC.
 142432, Moscow region, Chernogolovka,
 Centralnaya street, 20A, Russian Federation
 (740) Giorgi Ghvinjilia
 (540)

Балий



(591) Black, white
 (531) 05.05.20; 26.04.01; 26.04.04; 26.04.16; 28.05
 (511) 1, 5

(260) AM 2018 97695 A
 (210) AM 97695
 (220) 15 05 2018
 (731) JOINT STOCK COMPANY "AUGUST" INC.
 142432, Moscow region, Chernogolovka,
 Centralnaya street, 20A, Russian Federation
 (740) Giorgi Ghvinjilia
 (540)

Хет-трик



(591) Black, white
 (531) 26.04.01; 26.04.04; 26.04.05; 26.04.16;
 26.13.25; 28.05
 (511) 1, 5

(260) AM 2018 97696 A
 (210) AM 97696
 (220) 15 05 2018
 (731) JOINT STOCK COMPANY "AUGUST" INC.
 142432, Moscow region, Chernogolovka,
 Centralnaya street, 20A, Russian Federation
 (740) Giorgi Ghvinjilia
 (540)

Когорта



(591) Black, white
 (531) 05.05.20; 26.04.01; 26.04.04; 26.04.16; 28.05
 (511) 1, 5

(260) AM 2018 97697 A
 (210) AM 97697
 (220) 15 05 2018
 (731) JOINT STOCK COMPANY "AUGUST" INC.
 142432, Moscow region, Chernogolovka,

Ul. Tsentralnaya, 20A, Russian Federation
 (740) Giorgi Ghvinjilia
 (540)

Плектор



(591) Black, white
 (531) 05.05.20; 26.04.01; 26.04.04; 26.04.16;
 26.13.25; 28.05
 (511) 1, 5

(210) AM 2018 97700 R
 (210) AM 97700
 (220) 15 05 2018
 (731) BIG STAR CO., LTD.
 15 Soi. Rama 2, Soi. 100 Rama 2 Road,
 Samaedam, Bangkhunthien, Bangkok 10150,
 Thailand
 (740) Tamaz Shilakadze
 (540)

SAHAB

(591) Black, white
 (531) 27.05.01; 27.05.17
 (511) 25

(260) AM 2018 97701 A
 (210) AM 97701
 (220) 15 05 2018
 (731) BIG STAR CO., LTD.
 15 Soi. Rama 2, Soi. 100 Rama 2 Road,
 Samaedam, Bangkhunthien, Bangkok 10150,
 Thailand
 (740) Tamaz Shilakadze
 (540)

SAHAB

(591) Black, white
 (531) 26.11.12; 27.05.01; 27.05.17
 (511) 25

(260) AM 2018 97707 A
 (210) AM 97707
 (220) 17 05 2018
 (731) PHILIP MORRIS BRANDS SÀRL

Quai Jeanrenaud 3, 2000 Neuchâtel,
 Switzerland
 (740) Shalva Gvaramadze
 (540)

(591) Black, white
 (531) 27.05.01; 27.05.13; 27.05.19
 (511) 34

(260) AM 2018 97709 A
 (210) AM 97709
 (220) 17 05 2018
 (731) PHILIP MORRIS BRANDS SÀRL
 Quai Jeanrenaud 3, 2000 Neuchâtel,
 Switzerland
 (740) Shalva Gvaramadze
 (540)



(591) White, red, black and different tones blue,
 gray and blue
 (531) 01.15.09; 24.01.15; 25.01.01; 26.03.23;
 27.05.24; 29.01.15
 (511) 34

(260) AM 2018 97710 A
 (210) AM 97710
 (220) 18 05 2018
 (731) MEDAK GEZELSHAFT FIUR KLINISHE
 SPECIALPREPARATE MBH
 Theaterstraße 6, 22880 Wedel, Germany
 (740) Giorgi Taktakishvili
 (540)

Методжект

(591) Black, white
 (511) 5

(260) AM 2018 97763 A
 (210) AM 97763
 (220) 18 05 2018
 (310) 2017-1018

(320) 27 11 2017
 (330) LI
 (731) SVAROWSKI AKTIENGESELLSCHAFT
 Dröschstrasse 15, Triesen, 9495,
 Liechtenstein
 (740) Tamar Kochlamazashvili
 (540)



(591) Black, white
 (531) 03.07.06
 (511) 14, 35

(260) AM 2018 97768 A
 (210) AM 97768
 (220) 21 05 2018
 (731) LTD "SPORT NUTRITION"
 Sop. Ubisa, Kharagauli, Georgia
 (540)



(591) Green, yellow, white, black
 (531) 25.03.05; 26.04.24; 27.05.01; 27.05.10;
 27.05.24; 29.01.14
 (511) 31, 35

(260) AM 2018 97770 A
 (210) AM 97770
 (220) 21 05 2018
 (731) MARINA SHENGELIA
 Pekinis Gamz. 29, b. 8, 0160, Tbilisi, Georgia
 (540)



(591) Black, Golden
 (531) 18.03.02; 18.03.03; 18.03.05; 18.03.09;
 26.01.02; 26.01.21; 28.19; 29.01.12
 (511) 43

(260) AM 2018 97783 A
 (210) AM 97783
 (220) 22 05 2018
 (731) ALEKSANDRE SIMONYAN
 Delisis Me-2 q. 8, 0177, Tbilisi, Georgia
 (740) Salome Kapanadze
 (540)

**flying
 tiger
 copenhagen**

(591) Black, white
 (531) 02.09.04; 27.05.01; 27.05.08; 27.05.10
 (511) 28

(260) AM 2018 97789 A
 (210) AM 97789
 (220) 23 05 2018
 (731) LTD "EURO CAUCASUS SUPLIES"
 Samgoris Chikhi 5, 0144, Tbilisi, Georgia
 (740) Elene Khosroshvili
 (540)



(591) Blue, white, red
 (531) 03.09.16; 26.11.06; 26.11.13; 27.05.24;
 29.01.13
 (511) 29

(260) AM 2018 97790 A
 (210) AM 97790
 (220) 23 05 2018
 (731) LTD "EURO CAUCASUS SUPLIES"
 Samgoris Chikhi 5, 0144, Tbilisi, Georgia
 (740) Elene Khosroshvili
 (540)



(591) Red, light green, dark green
 (531) 01.01.01; 01.01.03; 05.03.13; 05.03.14;
 27.05.01; 27.05.11; 27.05.17; 29.01.13
 (511) 29, 30

(260) AM 2018 97792 A
 (210) AM 97792
 (220) 23 05 2018
 (731) IRFAN COKOVIC
 2802 Sheikh Zaided's Qucha, Dubai, United
 Arab Emirates
 (740) Nino Kukuladze
 (540)

Holiday Factory[®]
the leading tour operator

(591) Yellow, white, gray
 (531) 04.05.02; 04.05.03; 27.03.02; 27.05.01;
 27.05.10; 29.01.12
 (511) 39

(260) AM 2018 97795 A
 (210) AM 97795
 (220) 23 05 2018
 (731) Georgian Wine House
 Sop. Zegaani, 0160, Gurjaanis r-ni, Georgia
 (740) Sopio Vacheishvili
 (540)

ზაზა
ZAZA
3A3A

(511) 33

(260) AM 2018 97888 A
 (210) AM 97888
 (220) 29 05 2018
 (731) NOVARTIS AG
 4002 Basel, Switzerland
 (740) Pavle Meipariani
 (540)

დუტაკომპი

(591) Blue, white
 (531) 28.19; 29.01.04
 (511) 5

(260) AM 2018 97894 A
 (210) AM 97894
 (220) 30 05 2018
 (731) LTD "MAGTICOM"

Politkovskayas q. 7, 0186, Tbilisi, Georgia
 (740) Giorgi Khojevanishvili
 (540)



(591) Yellow, red, blue, brown, white
 (531) 02.05.02; 26.01.18; 28.19; 29.01.15
 (511) 9

(260) AM 2018 97896 A
 (210) AM 97896
 (220) 30 05 2018
 (731) Vadim Evgenievich Pravednikov
 Ul. Vorovskogo d. 4, b. 23, Sochi, Krasno-
 darskiy Kray, 354000, Russian Federation;
 Irakli Tchapandze
 J. Rapavas q. 37, Zugdidi, Georgia
 (740) Shalva Gvaramadze
 (540)

TD
TRUE DICE

(591) Black, white
 (531) 27.05.01; 27.05.22
 (511) 16, 20, 25, 28, 41

(260) AM 2018 97899 A
 (210) AM 97899
 (220) 30 05 2018
 (731) Vadim Evgenievich Pravednikov
 Ul. Vorovskogo d. 4, b. 23, Sochi, Krasno-
 darskiy Kray, 354000, Russian Federation;
 Irakli Tchapandze
 J. Rapavas q. 37, Zugdidi, Georgia

(740) Shalva Gvaramadze
(540)



(591) Black, white
(531) 27.05.01; 27.05.10; 27.05.22
(511) 16, 20, 25, 28, 41

(260) AM 2018 97979 A
(210) AM 97979
(220) 07 06 2018
(731) LLC "ISI ROWALT"
Ul. Ryabinovaya dom 26, stroenie 1, etazh 7,
komnata 4, 121417, Moskow, Russian
Federation
(740) Tamar Kochlamazashvili
(540)

ГОРГЕЛИ
GORGELI
გორგელი

(591) Black, white
(511) 32, 33, 35

REGISTERED TRADEMARKS

(111) M 2018 30571 R
(151) 17 12 2018
(181) 17 12 2028
(260) AM 2017 90932 A
(220) 21 02 2017

(732) N(N)LE "BUSINESSMEDIA GEORGIA"
A. Laistis q., korp. 3, b. 23b, Isani-Samgoris
r/ni, Tbilisi, Georgia

(111) M 2018 30572 R
(151) 17 12 2018
(181) 17 12 2028
(260) AM 2017 90933 A
(220) 21 02 2017

(732) N(N)LE "BUSINESSMEDIA GEORGIA"
A. Laistis q., korp. 3, b. 23b, Isani-Samgoris
r/ni, Tbilisi, Georgia

(111) M 2018 30573 R
(151) 17 12 2018
(181) 17 12 2028
(260) AM 2017 91537 A
(220) 31 03 2017

(732) GULLANE (THOMAS) LIMITED
Maple House, 149 Tottenham Court Road,
London, W1T 7NF, United Kingdom

(111) M 2018 30574 R
(151) 17 12 2018
(181) 17 12 2028
(260) AM 2017 91539 A
(220) 31 03 2017

(732) MATTEL, INC.
333 Continental Boulevard, El Segundo,
California 90245, USA

(111) M 2018 30575 R
(151) 17 12 2018
(181) 17 12 2028
(260) AM 2017 93483 A
(220) 24 07 2017

(732) LTD "LIDER GROUP"
Sop. Kakuti, 6200, Kobuleti, Georgia

(111) M 2018 30576 R
(151) 17 12 2018
(181) 17 12 2028
(260) AM 2017 93533 A
(220) 28 07 2017

(732) HIWIN TECHNOLOGIES CORP.
No.7, Jingke Road, Nantun District, Taichung
City, 40852, Taiwan, Province of China

(111) M 2018 30577 R
(151) 17 12 2018
(181) 17 12 2028
(260) AM 2017 93618 A
(220) 02 08 2017

(732) AMGEN INC.
One Amgen Center Drive, Thousand Oaks,
California 91320-1799, USA

(111) M 2018 30578 R
(151) 17 12 2018
(181) 17 12 2028
(260) AM 2017 93720 A
(220) 14 08 2017

(732) LTD "GMC"
L. Gotuas q. 68, 6000, Batumi, Georgia

(111) M 2018 30579 R
(151) 17 12 2018
(181) 17 12 2028
(260) AM 2017 94056 A
(220) 05 09 2017

(732) LTD "INFINITY"
Besikis q. 4, Old Tbilisi District, 0108,
Tbilisi, Georgia

(111) M 2018 30580 R
(151) 17 12 2018
(181) 17 12 2028
(260) AM 2017 94057 A
(220) 05 09 2017

(732) LTD "INFINITY"
Besikis q. 4, Old Tbilisi District, 0108,
Tbilisi, Georgia

(111) M 2018 30581 R
(151) 17 12 2018
(181) 17 12 2028
(260) AM 2017 94079 A
(220) 07 09 2017

(732) HANKOOK TIRE WORLDWIDE CO., LTD
N647-15, Yoksam-dong, Kangnam-gu, Seoul,
Korea (Republic of Korea)

(111) M 2018 30582 R (151) 17 12 2018 (181) 17 12 2028 (260) AM 2017 94371 A (220) 29 09 2017 (732) AMGEN INC. One Amgen Center Drive, Thousand Oaks, California 91320-1799, USA	222 W. Merchandise Mart Plaza, Suite 1600 Chicago, Illinois, 60654, USA
(111) M 2018 30583 R (151) 17 12 2018 (181) 17 12 2028 (260) AM 2017 94439 A (220) 03 10 2017 (732) DUNLOP INTERNATIONAL LIMITED Thorncroft Manor, Thorncroft Drive, Dorking Road, Leatherhead, Surrey, KT22 8JB, United Kingdom	(111) M 2018 30590 R (151) 20 12 2018 (181) 20 12 2028 (260) AM 2017 94604 A (220) 13 10 2017 (732) COOLEY DISTILLERY Riverstown, Dundalk, County Louth, Ireland
(111) M 2018 30584 R (151) 17 12 2018 (181) 17 12 2028 (260) AM 2017 94440 A (220) 03 10 2017 (732) DUNLOP INTERNATIONAL LIMITED Thorncroft Manor, Thorncroft Drive, Dorking Road, Leatherhead, Surrey, KT22 8JB, United Kingdom	(111) M 2018 30591 R (151) 20 12 2018 (181) 20 12 2028 (260) AM 2017 94671 A (220) 18 10 2017 (732) LTD "AVERSI-PHARMA" Davit Aghmashenebelis Gamz. 148/2, 0112, Tbilisi, Georgia
(111) M 2018 30585 R (151) 17 12 2018 (181) 17 12 2028 (260) AM 2017 94543 A (220) 10 10 2017 (732) DAR AL ARKAN REAL ESTATE DEVELOPMENT COMPANY Khurais Road, P.O. Box 105633, Riyadh 11656, Saudi Arabia	(111) M 2018 30592 R (151) 20 12 2018 (181) 20 12 2028 (260) AM 2017 94691 A (220) 18 10 2017 (732) LTD "NEW PHARM GROUP" D. Aghmasheneblis Kheiv. XII km., korp. 2, b.43, Vake-Saburtalos r-ni, 0131, Tbilisi, Georgia
(111) M 2018 30586 R (151) 17 12 2018 (181) 17 12 2028 (260) AM 2017 94559 A (220) 11 10 2017 (732) KOBALANGVELADZE Iosebisdz q. 53, b. 54, 0160, Tbilisi, Georgia	(111) M 2018 30593 R (151) 20 12 2018 (181) 20 12 2028 (260) AM 2017 94694 A (220) 18 10 2017 (732) LTD "NEW PHARM GROUP" D. Aghmasheneblis Kheiv. XII km., korp. 2, b.43, Vake-Saburtalos r-ni, 0131, Tbilisi, Georgia
(111) M 2018 30589 R (151) 20 12 2018 (181) 20 12 2028 (260) AM 2017 94601 A (220) 13 10 2017 (732) JIM BEAM BRANDS CO.	(111) M 2018 30594 R (151) 20 12 2018 (181) 20 12 2028 (260) AM 2017 94701 A (220) 18 10 2017 (732) LTD "NEW PHARM GROUP" D. Aghmasheneblis Kheiv. XII km., korp. 2, b.43, Vake-Saburtalos r-ni, 0131, Tbilisi, Georgia
	(111) M 2018 30595 R (151) 20 12 2018 (181) 20 12 2028 (260) AM 2017 94776 A

(220) 25 10 2017
(732) DAVIT SOPROMADZE
Merab Kostavas q. 58, 4600, Kutaisi, Georgia

(111) M 2018 30596 R
(151) 20 12 2018
(181) 20 12 2028
(260) AM 2017 94777 A
(220) 25 10 2017
(732) DAVIT SOPROMADZE
Merab Kostavas q. 58, 4600, Kutaisi, Georgia

(111) M 2018 30597 R
(151) 20 12 2018
(181) 20 12 2028
(260) AM 2017 94877 A
(220) 01 11 2017
(732) LTD "GEORGIAN WATER AND
POWER LLC"
M. Kostavas q., I shes. 33, Old Tbilisi Distict
0179, Tbilisi, Georgia

(111) M 2018 30598 R
(151) 20 12 2018
(181) 20 12 2028
(260) AM 2017 95007 A
(220) 08 11 2017
(732) LTD "MARNISKARI"
Sh. Askuravas q. 17, Tbilisi, Georgia

(111) M 2018 30599 R
(151) 20 12 2018
(181) 20 12 2028
(260) AM 2017 95008 A
(220) 08 11 2017
(732) LTD "MARNISKARI"
Sh. Askuravas q. 17, Tbilisi, Georgia

(111) M 2018 30600 R
(151) 20 12 2018
(181) 20 12 2028
(260) AM 2017 95010 A
(220) 08 11 2017
(732) LTD "MARNISKARI"
Sh. Askuravas q. 17, Tbilisi, Georgia

(111) M 2018 30601 R
(151) 20 12 2018
(181) 20 12 2028
(260) AM 2017 95011 A
(220) 09 11 2017
(732) JSC "GEPHA"
Sanapiros q. 6, 0108, Tbilisi, Georgia

(111) M 2018 30602 R
(151) 20 12 2018
(181) 20 12 2028
(260) AM 2017 95039 A
(220) 13 11 2017
(732) BEKAR MIKABERIDZE
P. Ingorokvas q. 26, 0108, Tbilisi, Georgia

(111) M 2018 30603 R
(151) 20 12 2018
(181) 20 12 2028
(260) AM 2017 95208 A
(220) 28 11 2017
(732) "IWINEHOUSE LTD"
E. Akhvledianis aghmarti 4, 0103, Tbilisi,
Georgia

(111) M 2018 30604 R
(151) 20 12 2018
(181) 20 12 2028
(260) AM 2017 95259 A
(220) 29 11 2017
(732) SHANGHAI YU FLY MILKY WAY
TECHNOLOGY CO., LTD
Room 1418, Building 2, No.700 Jiahao Road,
Jiading District, Shanghai, China

(111) M 2018 30605 R
(151) 20 12 2018
(181) 20 12 2028
(260) AM 2017 95415 A
(220) 07 12 2017
(732) V.G.M. Holding
105 Avenue Charles de Gaulle, Valleroy,
54910, France

(111) M 2018 30606 R
(151) 20 12 2018
(181) 20 12 2028
(260) AM 2017 95458 A
(220) 11 12 2017
(732) XI'AN COOL CHAT INTELLIGENT
TECHNOLOGY CO. LTD
Rm 108, 1/F, Building No.15, Xibuyungu,
Fengxi Xincheng, Xixian new Area, Shanxi
Prov, China

(111) M 2018 30607 R
(151) 20 12 2018
(181) 20 12 2028
(260) AM 2017 95518 A
(220) 13 12 2017
(732) MARRIOTT INTERNATIONAL INC.

10400 Fernwood Road, Bethesda, Maryland
20817, USA

2 Longwalk Road Stockley Park, Uxbridge,
Middlesex, UB11 1BA, United Kingdom

(111) M 2018 30608 R
(151) 20 12 2018
(181) 20 12 2028
(260) AM 2017 95551 A
(220) 18 12 2017
(732) PHILIP MORRIS BRANDS SÀRL
Quai Jeanrenaud 3, Nevshateli, 2000,
Switzerland

(111) M 2018 30614 R
(151) 20 12 2018
(181) 20 12 2028
(260) AM 2018 95920 A
(220) 10 01 2018
(732) LTD "MARNISKARI"
Sh. Apakidzis q. 17, Tbilisi, Georgia

(111) M 2018 30609 R
(151) 20 12 2018
(181) 20 12 2028
(260) AM 2017 95559 A
(220) 19 12 2017
(732) LTD "BESTI"
Iumashevis q. 8, 0151, Tbilisi, Georgia

(111) M 2018 30615 R
(151) 20 12 2018
(181) 20 12 2028
(260) AM 2018 95927 A
(220) 10 01 2018
(732) EXELIXIS, INC. a Delaware corporation
210 East Grand Avenue, South
San Francisco, California 9408, USA

(111) M 2018 30610 R
(151) 20 12 2018
(181) 20 12 2028
(260) AM 2017 95568 A
(220) 20 12 2017
(732) Individual Entrepreneur Malkhaz
Malkhiladze Baghdati's Homes
Chemistry q.5a, b. 91, 0182, Tbilisi, Georgia

(111) M 2018 30616 R
(151) 20 12 2018
(181) 20 12 2028
(260) AM 2018 95932 A
(220) 10 01 2018
(732) LTD "MARNISKARI"
Sh. Apakidzis q. 17, 0101, Tbilisi, Georgia

(111) M 2018 30611 R
(151) 20 12 2018
(181) 20 12 2028
(260) AM 2017 95657 A
(220) 25 12 2017
(732) LTD "NIKIFORE"
Rachis q. 14a, 0104, Tbilisi, Georgia

(111) M 2018 30617 R
(151) 20 12 2018
(181) 20 12 2028
(260) AM 2018 95933 A
(220) 10 01 2018
(732) LTD "MARNISKARI"
Sh. Apakidzis q. 17, 0101, Tbilisi, Georgia

(111) M 2018 30612 R
(151) 20 12 2018
(181) 20 12 2028
(260) AM 2017 95695 A
(220) 28 12 2017
(732) EMIRATES NATIONAL OIL COMPANY
LIMITED (ENOC) LLC
P.O. Box: 6442, Dubai, United Arab Emirates

(111) M 2018 30618 R
(151) 20 12 2018
(181) 20 12 2028
(260) AM 2018 95942 A
(220) 11 01 2018
(732) AIRBUS HELICOPTERS
Aéroport International Marseille Provence,
Marinan Cedex, 13 725, France

(111) M 2018 30613 R
(151) 20 12 2018
(181) 20 12 2028
(260) AM 2017 95709 A
(220) 28 12 2017
(732) BIM SANTORI UK LIMITED

(111) M 2018 30619 R
(151) 20 12 2018
(181) 20 12 2028
(260) AM 2018 96005 A
(220) 16 01 2018
(732) JSC "GEPHA"
Sanapiros q. 6, 0108, Tbilisi, Georgia

(111) M 2018 30620 R
(151) 20 12 2018
(181) 20 12 2028
(260) AM 2018 96069 A
(220) 22 01 2018
(732) KIMBERLY-CLARK WORLDWIDE INC.
Neenah, Wisconsin 54956, USA

(111) M 2018 30621 R
(151) 20 12 2018
(181) 20 12 2028
(260) AM 2018 96071 A
(220) 22 01 2018
(732) GLOBAL BEVERAGE COMPANY LTD
P.O. Box 366, Riyadh, 11383, Saudi Arabia

(111) M 2018 30622 R
(151) 20 12 2018
(181) 20 12 2028
(260) AM 2018 96098 A
(220) 24 01 2018
(732) LTD "TERRASSA GROUP"
Shindisis q. 132, Old Tbilisi district
0105, Tbilisi, Georgia

(111) M 2018 30623 R
(151) 20 12 2018
(181) 20 12 2028
(260) AM 2018 96117 A
(220) 25 01 2018
(732) AL-FURAT FOR TOBACCO&CIGARETTES
INDUSTRY CO.
Al-Basrah Street, Jabal Amman, 5th Circle,
P.O. Box 941936, Amman, 11194, Jordan

TRADEMARKS REGISTERED ACCORDING TO THE ACCELERATED PROCEDURE

The decision can be appealed at the Chamber of Appeal of Sakpatenti within 3 months from the publication.

(111) M 2018 30562 R
(151) 10 12 2018
(181) 10 12 2028
(210) AM 100590
(220) 26 11 2018
(732) LTD "NRG GEORGIA"
Shartavas q. 40, 0160, Tbilisi,
Georgia

(540)

ელვარე

(591) Black, white
(511) 9

(111) M 2018 30563 R
(151) 10 12 2018
(181) 10 12 2028
(210) AM 100611
(220) 29 11 2018
(732) LTD "BUTU"
Andronikashvilis q. 1 Shesak. Chikhi 16,
Tbilisi, Georgia
(740) Teona Iurchenko
(540)



(591) Red, black
(531) 09.01.07; 09.01.10; 24.03.01; 24.03.07;
24.03.17; 24.03.18; 24.03.19; 26.04.18;
29.01.01; 29.01.12
(511) 42

(111) M 2018 30564 R
(151) 10 12 2018
(181) 10 12 2028
(210) AM 100609
(220) 29 11 2018
(732) LTD "GLOBAL BIER GEORGIA"
Sop. Tsilkani, 3319, Mtskhethis ra-ni,
Georgia

(540)

ქერა
Qera
Kera

(591) Black, white
(511) 32

(111) M 2018 30565 R
(151) 12 12 2018
(181) 12 12 2028
(210) AM 100454
(220) 22 11 2018
(732) LTD "LIDER-FOOD"
Kairos q. 42,0145, Tbilisi, Georgia
(740) Davit Dzamukashvili
(540)

ფიგნესი

(591) Black, white
(511) 29

(111) M 2018 30566 R
(151) 12 12 2018
(181) 12 12 2028
(210) AM 100662
(220) 30 11 2018
(732) Andro Besalashvili
Vazha-Pshavelas gamz., III Kvart., korp. 22b,
b. 62, 0165, Tbilisi, Georgia
Beqa Bejashvili
Tamarashvilis q. 13o, Tbilisi, Georgia
(540)



(591) White, blue, black, blue
 (531) 01.11.12; 06.01.02; 06.03.11; 06.03.20;
 27.05.01; 28.19; 29.01.13
 (511) 32

(111) M 2018 30567 R
 (151) 13 12 2018
 (181) 13 12 2028
 (210) AM 100466
 (220) 22 11 2018
 (732) Mamuka Giorgobiani
 Oniashvilis q. 36, Tbilisi, Georgia
 (540)

ონიაშვილის ლობიანი

(591) Black, white
 (511) 30

(111) M 2018 30568 R
 (151) 13 12 2018
 (181) 13 12 2028
 (210) AM 100608
 (220) 29 11 2018
 (732) Qamran Mekhtievi
 12 Mk 20/9, Rustavi, Georgia
 (540)

fitron

(591) Black, white
 (511) 14

(111) M 2018 30569 R
 (151) 14 12 2018
 (181) 14 12 2028
 (210) AM 100663
 (220) 30 11 2018
 (732) LTD "MUSHAMBA 2017"
 Kakhetis Gzat. 112-is Mimdebared, 0151,
 Tbilisi, Georgia
 (740) Teona Kakhidze
 (540)

Mirella

(591) Black, white
 (511) 24

(111) M 2018 30570 R
 (151) 17 12 2018
 (181) 17 12 2028
 (210) AM 97806
 (220) 24 05 2018
 (732) LTD "VAZI +"
 Tsinamdzhvrishvilis q. 4, Zahesi, Gldanis
 r-ni, 0102, Tbilisi, Georgia
 (740) Otar Amilakhvari

(540)

BADIMI

(591) Black, white
 (531) 27.05.01
 (511) 33

(111) M 2018 30587 R
 (151) 19 12 2018
 (181) 19 12 2028
 (210) AM 100610
 (220) 29 11 2018
 (732) TIMUR UMAKHANOV
 Leningradis Prospekti 27, b.7, Moscow,
 125284, Russian Federation;
 DAVIT TOFURIDZE
 Ramaz Chkhikvadzis q.45, Tbilisi, Georgia
 (740) Khatuna Imnadze
 (540)

SABA
საბა
САБА

(591) Black, white
 (511) 33

(111) M 2018 30588 R
 (151) 19 12 2018
 (181) 19 12 2028
 (210) AM 100612
 (220) 29 11 2018
 (732) Timur Umakhanov
 Leningradis Prospekti 27, b.7, Moscow,
 125284, Russian Federation;
 Davit Topuridze
 Ramaz Chkhikvadzis q. 45, Tbilisi, Georgia
 (740) Khatuna Imnadze
 (540)



(591) Black, golden
 (531) 25.01.10; 25.01.25; 26.04.24; 27.05.01;
 27.05.24; 28.19; 29.01.12
 (511) 33

(591) White, green
 (531) 07.01.09; 26.04.04; 26.04.24; 26.05.01;
 26.05.18; 27.01.04; 27.05.01; 27.05.24;
 29.01.13
 (511) 37

(111) M 2018 30624 R
 (151) 20 12 2018
 (181) 20 12 2028
 (210) AM 100420
 (220) 19 11 2018
 (732) LTD "HOLIDAY 1993"
 Sop. Tkhilvana, Khulos r-ni, Georgia
 (740) Faik Khalilov
 (540)



(591) White, blue, golden
 (531) 26.11.13; 27.05.19; 29.01.12
 (511) 3

(111) M 2018 30625 R
 (151) 20 12 2018
 (181) 20 12 2028
 (210) AM 100704
 (220) 07 12 2018
 (732) JSC "TBC Bank"
 Marjanishvils q. 7, 0102, Tbilisi, Georgia
 (740) Archil Gabatashvili
 (540)



(591) Carroty, green, blue, sky-blue, purple, lilac
 (531) 27.05.01; 27.05.17; 29.01.15
 (511) 35, 36

(111) M 2018 30626 R
 (151) 20 12 2018
 (181) 20 12 2028
 (210) AM 100759
 (220) 07 12 2018
 (732) LTD "ECO DEVELOPMENT"
 Gmir Kursantta q. 5, Tbilisi, Georgia
 (540)



INTERNATIONAL TRADEMARKS FOR WHICH A DECISION ON GRANTING PROTECTIONS IS TAKEN

The decision can be appealed at the Chamber of Appeal of Sakpatenti within 3 months from the publication or at the Mtskheta District Court Administrative Cases Board (Address: №17, Samkhedro str., Mtskheta), within 1 month following the publication.

(260) AM 2018 85248 A**

(800) 1277904

(151) 2015 09 22

(891) 2015 09 22

(731) RIGO TRADING S.A.

Route de Trèves 6 EBBC, Building E,

L-2633 Sennigerberg, Luxembourg

(540)

Bloxx

(591) Black, white

(511)

30 – Confectionery.

(260) AM 2018 92971 A*

(800) 1349626

(151) 2017 03 20

(891) 2017 03 20

(731) LABORATOIRE INNOTECH

INTERNATIONAL

22 avenue Aristide Briand F-94110 Arcueil,

France

(540)

ББ тест

(591) Black and white

(531) 28.05

(511)

5 – Diagnostic reagents for pregnancy detection.

(260) AM 2018 94738 A

(800) 1371310

(151) 2017 04 11

(891) 2017 04 11

(731) ALUNNI ROBERTO

Via Marcello, 8, I-00042 ANZIO (RM), Italy

(540)



(591) Background in black; word "golden" in gold;

words "Brasil coffee" in white

(531) 26.04.02; 26.04.05; 26.04.22; 26.04.24;

27.05.02; 27.05.24; 29.01.13

(511)

30 – Coffee flavorings; cocoa-based beverages; coffee-based beverages; chocolate-based beverages; tea-based beverages; cocoa beverages with milk; chocolate beverages with milk; coffee; coffee beverages with milk; unroasted coffee; caramels [candy]; chicory [coffee substitute]; chocolate; aromatic preparations for food; confectionery; natural sweeteners; barley meal; edible ices; ice, natural or artificial; glucose for culinary purposes; honey; crushed barley; husked barley; artificial coffee; artificial tea; tea; iced tea; candy decorations for cakes; sugar; candy; palm sugar.

43 – Providing campground facilities; rental of temporary accommodation; rental of lighting apparatus; rental of cooking apparatus; rental of transportable buildings; rental of drinking water dispensers; rental of meeting rooms; rental of chairs, tables, table linen, glassware; rental of tents; hotel reservations; temporary accommodation reservations; boarding house bookings; food sculpting; hotel services; accommodation bureau services [hotels, boarding houses]; day-nursery [crèche] services; bar services; cafeteria services; holiday camp services [lodging]; retirement home services; tourist home services; food and drink catering; canteen services; motel services; boarding house services; boarding for animals; restaurant services; self-service restaurant services; snack-bar services.

(260) AM 2018 95495 A

(800) 1379221

(151) 2017 06 21

(891) 2017 06 21

(731) IKO Holding GmbH

Franz Josefs Kai 33/7/10 A-1010 Wien, Austria

(540)



(591) Black, white and red

(531) 26.04.22; 26.11.08; 27.05.10; 27.05.11;

29.01.13

(511)

35 – Retail and wholesale services, also online retail and wholesale services, relating to machine oil for earth moving, road construction, mining and quarry machinery; retail and wholesale services, also online retail and wholesale services, relating to spare parts for earth moving, road construction, mining and quarry machinery.

37 – Repair, maintenance and overhaul services for earth-moving, road-construction, mining and quarry machinery.

(260) AM 2018 95691 A

(800) 1380683

(151) 2017 10 10

(891) 2017 10 10

(731) AROMA P. DRANIAK SP. J.

ul. Szkolna 46, A PL-05-816 Michałowice,
Poland

(540)

AMAZINGLY BLACK

(591) Black, white

(511)

3 – Cosmetics, perfumery goods.

(260) AM 2018 95915 A

(800) 1382800

(151) 2017 11 04

(891) 2017 11 04

(731) TAKEDA AS

Drammensveien 852, N-1372 Asker, Norway

(540)



(591) Green, blue, gray, white, black

(531) 01.15.19; 05.03.16; 17.02.02; 19.13.21; 28.05; 29.01.15

(511)

5 – Pharmaceutical preparations; dietetic food and substances adapted for medical use; dietary supplements for humans; calcium chews for medical use,

calcium tablets as a food supplement; food for babies; vitamins and vitamin preparations.

(260) AM 2018 95916 A

(800) 1382801

(151) 2017 11 04

(891) 2017 11 04

(731) TAKEDA AS

Drammensveien 852, N-1372 Asker, Norway

(540)



(591) Orange, blue, green, grey, black, white

(531) 01.15.19; 05.03.16; 05.07.11; 05.07.22; 19.13.21; 28.05; 29.01.15

(511)

5 – Pharmaceutical preparations; dietetic food and substances adapted for medical use; dietary supplements for humans; calcium chews for medical use, calcium tablets as a food supplement; food for babies; vitamins and vitamin preparations.

(260) AM 2018 96059 A

(800) 1384706

(151) 2017 11 29

(891) 2017 11 29

(731) GUESS?, INC.

1444 South Alameda Street, Los Angeles,
CA 90021, USA

(540)

LA DENIM ATELIER

(591) Black, white

(511)

18 – Leather and imitation leather goods; purses, wallets, handbags, luggage, key cases, business card cases, change purses, organizers, backpacks, attaché cases and briefcases.

25 – Men's, women's, boys', girls', children's and infant's apparel, namely, underwear, footwear, swimwear, caps, headwear, robes, pajamas, hosiery, gloves, suspenders, belts, neckties, undershirts, socks, shirts, T-shirts, sweatpants, sweatshirts, knit tops,

skirts, pants, trousers, shorts, sweaters, jeans, vests, coats, jackets, overalls, blazers, dresses, scarves, blouses, cardigans, gowns, golf shirts, jogging suits, turtlenecks, suits and polo shirts; women's panties, bras, tank tops, crop tops, bustiers, camisoles, tap pants and teddies; men's briefs and boxer shorts.

35 – Retail store and online retail store services and advertising in the field of men's, women's and children's apparel and personal accessories.

(260) AM 2018 96231 A

(800) 1385569

(151) 2017 11 09

(891) 2017 11 09

(731) OPTISWISS AG

Lyon-Strasse 26, CH-4053 Basel, Switzerland

(540)

be4ty+ S-Fusion

(591) Black, white

(511)

9 – Spectacle lenses.

(260) AM 2018 96233 A

(800) 1385577

(151) 2017 09 19

(891) 2017 09 19

(731) ADP GAUSELMANN GMBH

Merkur-Allee 1-15, 32339 Espelkamp,
Germany

(540)

Top Four

(591) Black, white

(511)

9 – Computer software; coin-operated mechanisms; computer and video games software; games software in particular for use on any computer platform, including electronic entertainment and games consoles; computer game programs; video games (software); computer games provided through a global computer network or supplied by means of multi-media electronic broadcast or through telecommunications or electronic transmission or via the internet; computer games, leisure and recreational software, video games and computer software, all being provided in the form of storage media; programs for operating electric and electronic apparatus for games, amusement and/or entertainment purposes; computer software for computer games on the internet; online games (software), in particular for online betting games, online prize games, online gambling games, online games of skill and online casino games; computer software in the form of an app for mobile devices and computers; calculating apparatus in coin-operated machines and parts for the aforesaid goods; electric, electronic, optical or automatic apparatus,

for identifying data carriers, identity cards and credit cards, bank notes and coins; software in particular for casino and/or amusement arcade games, for gaming machines and/or slot machines each one with or without prize payouts; gaming software that generates or displays wager outcomes of gaming machines; operational computer games software; computer software for managing of games (game collection); collection of video games software.

28 – Games; toys; gaming apparatus (including coin-operated apparatus); coin-operated arcade games (machines); games for amusement arcades (included in class 28); coin-operated video gaming apparatus; video games apparatus adapted for use with external screens or monitors only; casino fittings, namely roulette tables, roulette wheels; coin-operated automatic gaming machines and gaming machines, in particular for gaming arcades, with or without a prize payout; electronic or electrotechnical gaming apparatus, automatic gaming machines, gaming machines, slot machines operated by coins, tokens, banknotes, tickets or by means of electronic, magnetic or biometric storage media, in particular for commercial use in casinos and amusement arcades, with or without a prize payout; automatic gaming machines and gaming machines, in particular for commercial use in casinos and gaming arcades, with or without a prize payout; coin-operated gaming machines and/or electronic money-based gaming apparatus (machines), with or without prizes; housings adapted for gaming machines, gaming apparatus and automatic gaming machines, operated by means of coins, tokens, tickets or by means of electronic, magnetic or biometric storage media, in particular for commercial use in casinos and gaming arcades, with or without a prize payout; electronic games; electronic game entertainment apparatus and parts thereof; video output game machines; drawing apparatus for prize games and lotteries, draws or raffles; housings of metal, plastic and/or wood for coin-operated automatic machines; apparatus for games (including video games), other than adapted for use with external screens or monitors only; electropneumatic and electric slot machines with levers for pulling (gaming machines); gaming tables, in particular for table football, billiards, sliding games; flying discs (toys) and darts; gaming machines, namely, electric, electronic or electromechanical apparatus for bingo games, lotteries or video lottery games and for betting offices, connected or not connected to a computer network; LCD games consoles; automatic gaming machines; all the aforesaid automatic machines, machines and apparatus also operated via computer networks; apparatus and devices for accepting and storing money, being fittings for the aforesaid automatic machines, included in class 28; automatic lottery machines.

(260) AM 2018 96318 A
 (800) 1386806
 (151) 2017 11 14
 (891) 2017 11 14
 (731) RICHTER GEDEON NYRT.
 Gyömrői út 19-21, H-1103 Budapest, Hungary
 (540)

КЕНЪРАТИН

(591) Black, white
 (511)
 5 – Pharmaceutical preparations.

(260) AM 2018 96322 A
 (800) 1386807
 (151) 2017 11 14
 (891) 2017 11 14
 (731) RICHTER GEDEON NYRT.
 Gyömrői út 19-21, H-1103 Budapest, Hungary
 (540)

АЗИЗАН

(591) Black, white
 (511)
 5 – Pharmaceutical preparations.

(260) AM 2018 96323 A
 (800) 1386808
 (151) 2017 11 14
 (891) 2017 11 14
 (731) RICHTER GEDEON NYRT.
 Gyömrői út 19-21Б H-1103 Budapest,
 Hungary
 (540)

РОНОЛТОН

(591) Black, white
 (511)
 5 – Pharmaceutical preparations.

(260) AM 2018 96324 A
 (800) 1386809
 (151) 2017 11 14
 (891) 2017 11 14
 (731) RICHTER GEDEON NYRT.
 Gyömrői út 19-21, H-1103 Budapest, Hungary
 (540)

БЛУМИРА

(591) Black, white
 (511)
 5 – Pharmaceutical preparations.

(260) AM 2018 96325 A
 (800) 1386810
 (151) 2017 11 14

(891) 2017 11 14
 (731) RICHTER GEDEON NYRT.
 Gyömrői út 19-21, H-1103 Budapest, Hungary
 (540)

ПЕЛВЕНТА

(591) Black, white
 (511)
 5 – Pharmaceutical preparations.

(260) AM 2018 96326 A
 (800) 1386811
 (151) 2017 11 14
 (891) 2017 11 14
 (731) RICHTER GEDEON NYRT.
 Gyömrői út 19-21, H-1103 Budapest, Hungary
 (540)

ОВОЛАН

(591) Black, white
 (511)
 5 – Pharmaceutical preparations.

(260) AM 2018 96327 A
 (800) 1386813
 (151) 2017 11 14
 (891) 2017 11 14
 (731) RICHTER GEDEON NYRT.
 Gyömrői út 19-21Б H-1103 Budapest,
 Hungary
 (540)

БЕДРИНОРМИН

(591) Black, white
 (511)
 5 – Pharmaceutical preparations.

(260) AM 2018 96351 A
 (800) 1386140
 (151) 2017 11 22
 (891) 2017 11 22
 (731) BUMFA GROUP LTD
 Privokzal'naya st. 16, Cherkessk, RU-369000
 Karachay-Cherkess Republic, Russian Federation
 (540)

ПРЕМИАЛ PREMIAL

(591) Black, white
 (531) 27.05.17; 28.05
 (511)
 3 – Abrasives; amber [perfume]; descaling preparations for household purposes; antistatic preparations for household purposes; breath freshening sprays;

shaving stones [astringents]; polishing stones; abrasive paper; emery paper; polishing paper; petroleum jelly for cosmetic purposes; cotton wool for cosmetic purposes; cotton sticks for cosmetic purposes; aromatic essential oils; cake flavorings [essential oils]; flavorings for beverages [essential oils]; sachets for perfuming linen; scented water; javelle water; lavender water; toilet water; laundry wax; floor wax; mustache wax; tailors' wax; polish for furniture and flooring; shoemakers' wax; heliotropine; geraniol; make-up; deodorants for personal use; scented wood; perfumes; windshield cleaning liquids; greases for cosmetic purposes; volcanic ash for cleaning; perfumery; decorative transfers for cosmetic purposes; ionone [perfumery]; smoothing stones; eyebrow pencils; cosmetic pencils; silicon carbide [abrasive]; carbides of metal [abrasives]; alum stones [astringents]; tripoli stone for polishing; adhesives for affixing false eyelashes; adhesives for affixing false hair; quillaia bark for washing; corundum [abrasive]; color- [colour-] brightening chemicals for household purposes [laundry]; beard dyes; colorants for toilet purposes; cosmetic dyes; laundry starch; cosmetic creams; skin whitening creams; creams for leather; polishing rouge; incense; hair spray; nail polish; shaving lotions; hair lotions; lotions for cosmetic purposes; beauty masks; perfume oils; oils for cosmetic purposes; oils for toilet purposes; essential oils; essential oils of cedarwood; essential oils of lemon; oils for cleaning purposes; bergamot oil; gaultheria oil; jasmine oil; lavender oil; almond oil; rose oil; oil of turpentine for degreasing; adhesives for cosmetic purposes; whitening; cleaning chalk; almond milk for cosmetic purposes; cleansing milk for toilet purposes; musk [perfumery]; soap; deodorant soap; shaving soap; soap for brightening textile; cakes of toilet soap; antiperspirant soap; soap for foot perspiration; almond soap; mint for perfumery; cosmetic kits; emery; false nails; eau de Cologne; bases for flower perfumes; abrasive pastes; pastes for razor strops; dentifrices; pumice stone; hydrogen peroxide for cosmetic purposes; abrasive cloth; glass cloth [abrasive cloth]; lipsticks; pomades for cosmetic purposes; shaving preparations; cosmetic preparations for baths; non-medicated toiletries; hair waving preparations; laundry soaking preparations; grinding preparations; smoothing preparations [starching]; leather bleaching preparations; denture polishes; mouthwashes, not for medical purposes; cosmetic preparations for slimming purposes; starch glaze for laundry purposes; fabric softeners for laundry use; laundry bleach; dry-cleaning preparations; paint stripping preparations; lacquer-removing preparations; floor wax removers [scouring preparations]; rust removing preparations; nail care preparations; cleaning preparations; preparations for cleaning dentures; wallpaper cleaning preparations; preparations for unblocking drain pipes; diamantine [abrasive]; scouring solutions; false eyelashes; tissues impreg-

nated with cosmetic lotions; safrol; turpentine for degreasing; potpourris [fragrances]; bleaching soda; washing soda, for cleaning; bath salts, not for medical purposes; bleaching salts; preservatives for leather [polishes]; fumigation preparations [perfumes]; ammonia [volatile alkali] [detergent]; astringents for cosmetic purposes; eyebrow cosmetics; scouring preparations; make-up preparations; sun-tanning preparations [cosmetics]; hair dyes; neutralizers for permanent waving; cosmetic preparations for eyelashes; depilatory preparations; cosmetic preparations for skin care; cosmetics; cosmetics for animals; mascara; detergents, other than for use in manufacturing operations and for medical purposes; degreasers, other than for use in manufacturing processes; bleaching preparations [decolorants] for cosmetic purposes; antiperspirants [toiletries]; talcum powder, for toilet use; terpenes [essential oils]; shampoos; shampoos for pets; sandpaper; soda lye; extracts of flowers [perfumes]; ethereal essences; badian essence; mint essence [essential oil].

5 – Acaricides; aconitine; alkaloids for medical purposes; algicides; aldehydes for pharmaceutical purposes; dental amalgams of gold; dental amalgams; amino acids for veterinary purposes; amino acids for medical purposes; antibiotics; aluminium acetate for pharmaceutical purposes; acetates for pharmaceutical purposes; germicides; balms for medical purposes; bandages for skin wounds; bandages for dressings; biocides; bromine for pharmaceutical purposes; paper for mustard plasters; fly catching paper; mothproofing paper; petroleum jelly for medical purposes; vaccines; oxygen baths; aseptic cotton; absorbent cotton; wadding for medical purposes; dietetic substances adapted for medical use; radiological contrast substances for medical purposes; nutritive substances for microorganisms; radioactive substances for medical purposes; bismuth subnitrate for pharmaceutical purposes; melissa water for pharmaceutical purposes; sea water for medicinal bathing; mineral waters for medical purposes; thermal water; dietary fiber; molding wax for dentists; gases for medical purposes; guaiacol for pharmaceutical purposes; hematogen; hemoglobin; hydrastine; hydrastinine; glycerine for medical purposes; glycerophosphates; glucose for medical purposes; gentian for pharmaceutical purposes; hormones for medical purposes; mustard for pharmaceutical purposes; mustard plasters; mud for baths; medicinal mud; gamboge for medical purposes; gurjun [gurjon, gurjan] balsam for medical purposes; deodorants, other than for human beings or for animals; diastase for medical purposes; digitalin; feed supplements for veterinary purposes; mineral food supplements; nutritional supplements; yeast for pharmaceutical purposes; gelatine for medical purposes; cod liver oil; isotopes for medical purposes; insecticides; iodine for pharmaceutical purposes; iodides for pharmaceutical purposes; alkaline iodides for pharmaceutical purposes;

iodoform; calomel; cream of tartar for pharmaceutical purposes; tartar for pharmaceutical purposes; camphor for medical purposes; capsules for medicines; cachets for pharmaceutical purposes; candy for medical purposes; hemostatic pencils; wart pencils; caustic pencils; carbolineum [parasiticide]; caustics for pharmaceutical purposes; cachou for pharmaceutical purposes; quassia for medical purposes; quebracho for medical purposes; gallic acid for pharmaceutical purposes; acids for pharmaceutical purposes; adhesives for dentures; adhesive tapes for medical purposes; cocaine; collodion for pharmaceutical purposes; corn rings for the feet; candy, medicated; angostura bark for medical purposes; barks for pharmaceutical purposes; cedar wood for use as an insect repellent; condurango bark for medical purposes; croton bark; mangrove bark for pharmaceutical purposes; myrobalan bark for pharmaceutical purposes; quinquina for medical purposes; medicinal roots; rhubarb roots for pharmaceutical purposes; lint for medical purposes; starch for dietetic or pharmaceutical purposes; creosote for pharmaceutical purposes; blood for medical purposes; cultures of microorganisms for medical or veterinary use; curare; dental lacquer; liquorice for pharmaceutical purposes; lactose for pharmaceutical purposes; adhesive plasters; medicines for alleviating constipation; lecithin for medical purposes; lotions for veterinary purposes; dog lotions; lotions for pharmaceutical purposes; lupulin for pharmaceutical purposes; magnesia for pharmaceutical purposes; liniments; ointments for pharmaceutical purposes; sunburn ointments; mercurial ointments; frostbite salve for pharmaceutical purposes; gauze for dressings; anti-horsefly oils; medicinal oils; mustard oil for medical purposes; camphor oil for medical purposes; castor oil for medical purposes; oil of turpentine for pharmaceutical purposes; dill oil for medical purposes; dental mastics; dental abrasives; dental impression materials; teeth filling material; dressings, medical; surgical dressings; drugs for medical purposes; medicines for veterinary purposes; serotherapeutic medicines; medicines for human purposes; medicines for dental purposes; menthol; medicinal drinks; moleskin for medical purposes; almond milk for pharmaceutical purposes; royal jelly for medical purposes; milk ferments for pharmaceutical purposes; Irish moss for medical purposes; flour for pharmaceutical purposes; linseed meal for pharmaceutical purposes; fish meal for pharmaceutical purposes; fly glue; mint for pharmaceutical purposes; dietetic beverages adapted for medical purposes; malted milk beverages for medical purposes; narcotics; medicinal infusions; tincture of iodine; eucalyptol for pharmaceutical purposes; tinctures for medical purposes; opium; opodeldoc; decoctions for pharmaceutical purposes; antiparasitic collars for animals; stick liquorice for pharmaceutical purposes; sulfur sticks [disinfectants]; pants, absorbent, for incontinents; pectin for pharma-

ceutical purposes; incontinence garments; pepsins for pharmaceutical purposes; peptones for pharmaceutical purposes; hydrogen peroxide for medical purposes; leeches for medical purposes; blood plasma; medical plasters; eye bandages for medical purposes; poultices; compresses; scapulars for surgical purposes; bunion pads; breast-nursing pads; pomades for medical purposes; powder of cantharides; pyrethrum powder; belts for sanitary napkins [towels]; anti-uric preparations; bacterial preparations for medical and veterinary use; bacteriological preparations for medical and veterinary use; balsamic preparations for medical purposes; albuminous preparations for medical purposes; biological preparations for veterinary purposes; biological preparations for medical purposes; veterinary preparations; bismuth preparations for pharmaceutical purposes; vitamin preparations; diagnostic preparations for medical purposes; therapeutic preparations for the bath; hemorrhoid preparations; preparations for callouses; preparations to facilitate teething; preparations for the treatment of burns; fumigation preparations for medical purposes; opotherapy preparations; air deodorising preparations; air purifying preparations; bronchodilating preparations; sterilising preparations; soil-sterilising preparations; corn remedies; pharmaceutical preparations for treating dandruff; preparations for destroying noxious animals; herbicides; preparations for destroying dry rot fungus; larvae exterminating preparations; fly destroying preparations; preparations for destroying mice; slug exterminating preparations; vermin destroying preparations; pharmaceutical preparations for skin care; contact lens cleaning preparations; lime-based pharmaceutical preparations; bath preparations for medical purposes; medicinal hair growth preparations; opiates; anticryptogamic preparations; preparations of trace elements for human and animal use; sulfonamides [medicines]; pharmaceutical preparations; pharmaceutical preparations for treating sunburn; enzyme preparations for veterinary purposes; enzyme preparations for medical purposes; chemico-pharmaceutical preparations; chemical preparations for veterinary purposes; chemical preparations for the diagnosis of pregnancy; chemical preparations for medical purposes; chemical preparations to treat wheat blight [smut]; vine disease treating chemicals; chemical preparations to treat mildew; chemical preparations for treating phylloxera; chemical preparations for pharmaceutical purposes; chilblain preparations; mothproofing preparations; collyrium; lead water; chemical conductors for electrocardiograph electrodes; albuminous foodstuffs for medical purposes; food for babies; dietetic foods adapted for medical purposes; by-products of the processing of cereals for dietetic or medical purposes; sanitary pads; sanitary towels; radium for medical purposes; hydrated chloral for pharmaceutical purposes; solvents for removing adhesive plasters; vaginal was-

hes; solutions for contact lenses; chemical reagents for medical or veterinary purposes; gum for medical purposes; rubber for dental purposes; chewing gum for medical purposes; mosquito-repellent incense; insect repellents; repellents for dogs; tissues impregnated with pharmaceutical lotions; sarsaparilla for medical purposes; sugar for medical purposes; asthmatic tea; fumigating sticks; suppositories; linseed for pharmaceutical purposes; tobacco-free cigarettes for medical purposes; siccatives [drying agents] for medical purposes; syrups for pharmaceutical purposes; turpentine for pharmaceutical purposes; milking grease; greases for veterinary purposes; greases for medical purposes; soporifics; bicarbonate of soda for pharmaceutical purposes; salts for mineral water baths; medicated bath salts; salts for medical purposes; potassium salts for medical purposes; sodium salts for medical purposes; smelling salts; mineral water salts; malt for pharmaceutical purposes; semen for artificial insemination; medicinal alcohol; alloys of precious metals for dental purposes; ergot for pharmaceutical purposes; anaesthetics; antiseptic preparations; analgesic preparations; adjuvants for medical purposes; styptic preparations; vermifuges; disinfectants for hygiene purposes; disinfectants for chemical toilets; appetite suppressants for medical purposes; medical preparations for slimming purposes; parasiticides; mouthwashes for medical purposes; febrifuges; depuratives; animal washes; detergents for medical purposes; cattle washes; dog washes; vesicants; articles for headache; remedies for perspiration; remedies for foot perspiration; chemical contraceptives; antiparasitic preparations; laxatives; tonics [medicines]; nervines; digestives for pharmaceutical purposes; media for bacteriological cultures; steroids; strychnine; serums; sal ammoniac lozenges; sanitary tampons; vulnerary sponges; thymol for pharmaceutical purposes; surgical mesh comprised primarily of living tissue; smoking herbs for medical purposes; medicinal herbs; sedatives; surgical implants comprised of living tissues; sanitary panties; charcoal for pharmaceutical purposes; fennel for medical purposes; porcelain for dental prostheses; phenol for pharmaceutical purposes; enzymes for veterinary purposes; enzymes for medical purposes; ferments for pharmaceutical purposes; formic aldehyde for pharmaceutical purposes; phosphates for pharmaceutical purposes; fungicides; quinine for medical purposes; chinoline for medical purposes; diabetic bread adapted for medical use; chloroform; flowers of sulfur for pharmaceutical purposes; cement for animal hooves; bone cement for surgical and orthopaedic purposes; dental cements; herbal teas for medicinal purposes; slimming tea for medicinal purposes; eucalyptus for pharmaceutical purposes; tobacco extracts [insecticides]; extracts of hops for pharmaceutical purposes; elixirs [pharmaceutical preparations]; ethers for pharmaceutical purposes; esters for pharmaceutical purposes; cellulose esters

for pharmaceutical purposes; cellulose ethers for pharmaceutical purposes; jujube, medicated; rat poison; poisons; bacterial poisons; jalap.

16 – Fountain pens; aquarelles; albums; almanacs; document laminators for office use; atlases; posters; paper bows; table linen of paper; tickets; forms, printed; note books; drawing pads; pads [stationery]; loose-leaf binders; wristbands for the retention of writing instruments; pamphlets; booklets; paper sheets [stationery]; waxed paper; paper for recording machines; paper for radiograms; electrocardiograph paper; drawer liners of paper, perfumed or not; wood pulp paper; carbon paper; parchment paper; writing paper; luminous paper; toilet paper; wrapping paper; Xuan paper for Chinese painting and calligraphy; paper; blotters; newsletters; rollers for typewriters; house painters' rollers; composing sticks; modelling wax, not for dental purposes; signboards of paper or cardboard; sewing patterns; newspapers; electrotypes; hectographs; terrestrial globes; engravings; slate pencils; pencil leads; pencil holders; chalk holders; holders for stamps [seals]; holders for checkbooks [cheque books]; diagrams; engraving plates; writing slates; blackboards; galley racks [printing]; drawing boards; punches [office requisites]; cream containers of paper; tags for index cards; pen clips; bookmarkers; etching needles; tracing needles for drawing purposes; printed publications; paper shredders for office use; graphic representations; graining combs; calendars; tear-off calendars; tracing paper; tracing cloth; tracing patterns; gums [adhesives] for stationery or household purposes; lithographic stones; pencils; pencil lead holders; charcoal pencils; pictures; transfers [decalcomanias]; paintings [pictures], framed or unframed; wood pulp board [stationery]; cardboard; hat boxes of cardboard; files [office requisites]; index cards [stationery]; cards; geographical maps; paper tapes and cards for the recordal of computer programmes; perforated cards for Jacquard looms; catalogues; spools for inking ribbons; covers of paper for flower pots; paintbrushes; painters' brushes; writing brushes; typewriter keys; glue for stationery or household purposes; isinglass for stationery or household purposes; starch paste [adhesive] for stationery or household purposes; printing blocks; books; manifolds [stationery]; comic books; drawing pins; cigar bands; envelopes [stationery]; cases for stamps [seals]; boxes of paper or cardboard; paint boxes [articles for use in school]; correcting fluids [office requisites]; French curves; paper ribbons; typewriter ribbons; gummed tape [stationery]; adhesive tapes for stationery purposes; inking ribbons for computer printers; square rulers; viscose sheets for wrapping; plastic bubble packs for wrapping or packaging; steel letters; type [numerals and letters]; lithographs; architects' models; postage stamps; graphic prints; modelling materials; teaching materials [except apparatus]; sealing compounds for stationery purposes; adhesives [glues] for stationery or house-

hold purposes; packaging material made of starches; filtering materials [paper]; addressing machines; bookbinding apparatus and machines [office equipment]; typewriters, electric or non-electric; folders [stationery]; postage meters; chalk for lithography; writing chalk; tailors' chalk; marking chalk; garbage bags of paper or of plastics; painters' easels; hand-rests for painters; printing sets, portable [office requisites]; bibs of paper; stickers [stationery]; finger-stalls [office requisites]; cords for bookbinding; paper knives [cutters] [office requisites]; numbering apparatus; bottle envelopes of paper or cardboard; sealing wafers; covers [stationery]; passport holders; plastic cling film, extensible, for palletization; embroidery designs [patterns]; handwriting specimens for copying; oleographs; musical greeting cards; greeting cards; postcards; etchings; conical paper bags; bags for microwave cooking; palettes for painters; ink sticks; folders for papers; papier mâché; pastels [crayons]; pen cases; bookbindings; pen wipers; office perforators; pens [office requisites]; nibs of gold; steel pens; drawing pens; song books; seals [stamps]; sealing stamps; clipboards; address plates for addressing machines; handkerchiefs of paper; plastic film for wrapping; letter trays; trays for sorting and counting money; coasters of paper; bookends; stamp stands; mats for beer glasses; stands for pens and pencils; photograph stands; stamp pads; binding strips [bookbinding]; towels of paper; gummed cloth for stationery purposes; printers' blankets, not of textile; inking sheets for document reproducing machines; inking sheets for duplicators; portraits; paperweights; writing cases [sets]; drawing materials; obliterating stamps; office requisites, except furniture; writing materials; school supplies [stationery]; adhesive tape dispensers [office requisites]; hand labelling appliances; pencil sharpeners, electric or non-electric; printed matter; prospectuses; printed timetables; printers' galleys; indexes; elastic bands for offices; graphic reproductions; mimeographs; face towels of paper; scrapers [erasers] for offices; staples for offices; erasing products; biological samples for use in microscopy [teaching materials]; figurines [statuettes] of papier mâché; writing board erasers; composing frames [printing]; sealing wax; arithmetical tables; placards of paper or cardboard; writing or drawing books; stationery; transparencies [stationery]; stencil plates; stencils; cardboard tubes; Indian inks; moisteners [office requisites]; moisteners for gummed surfaces [office requisites]; chart pointers, non-electronic; bottle wrappers of paper or cardboard; envelope sealing machines for offices; sealing machines for offices; vignetting apparatus; apparatus for mounting photographs; stapling presses [office requisites]; textbooks; paper coffee filters; flags of paper; silver paper; photo-engravings; photographs [printed]; stencil cases; canvas for painting; chromolithographs [chromos]; artists' watercolor saucers; correcting ink [heliograph];

hy]; ink; inkwells; blueprints; balls for ball-point pens; cabinets for stationery [office requisites]; printing type; address stamps; stamps [seals]; printed advertising boards of paper or cardboard; prints [engravings]; labels of paper or cardboard.

21 – Buckets; china ornaments; dishes; paper plates; saucers; mugs; candy boxes; sandwich boxes; bottles; demijohns; busts of porcelain, ceramic or glass; vases; epergnes; fruit cups; bird baths; baby baths, portable; plungers for clearing blocked drains; waffle irons, non-electric; coolers [ice pails]; coal scuttles; buckets made of woven fabrics; cooking skewers of metal; towel rails; trouser stretchers; clothing stretchers; shirt stretchers; hair for brushes; birdcages; funnels; carpet beaters [hand instruments]; signboards of porcelain or glass; candle extinguishers; flower pots; chamber pots; glue-pots; cruets; decanters; large-toothed combs for the hair; combs for animals; abrasive sponges for scrubbing the skin; sponges for household purposes; toilet sponges; deodorising apparatus for personal use; sponge holders; toothpick holders; soap holders; holders for flowers and plants [flower arranging]; shaving brush stands; ironing boards; cutting boards for the kitchen; bread boards; washing boards; strainers; smoke absorbers for household purposes; containers for household or kitchen use; kitchen containers; glass jars for jams and jellies; glass jars [carboys]; heat-insulated containers for beverages; thermally insulated containers for food; glass flasks [containers]; frying pans; closures for pot lids; chamois leather for cleaning; toothpicks; ceramics for household purposes; majolica; works of art of porcelain, ceramic or glass; brush goods; cleaning instruments, hand-operated; stew-pans; covers, not of paper, for flower pots; shaving brushes; cages for household pets; polishing leather; shoe stretchers of wood; napkin rings; rings for birds; money boxes, not of metal; bread baskets for household purposes; baskets for household purposes; mangers for animals; cookie jars; tea caddies; washtubs; earthenware saucepans; mess-tins; cauldrons; coffee percolators, non-electric; coffeepots, non-electric; coffee grinders, hand-operated; fused silica [semi-worked product], other than for building; beer mugs; tankards; rat traps; pot lids; butter-dish covers; dish covers; cheese-dish covers; buttonhooks; pitchers; perfume burners; portable ice chests, non-electric, for food and beverages; watering cans; insect traps; mixing spoons [kitchen utensils]; basting spoons [cooking utensils]; scoops [tableware]; pie servers; spatulas for kitchen use; butter dishes; material for brush-making; polishing materials for making shiny, except preparations, paper and stone; noodle machines, hand-operated; polishing apparatus and machines, for household purposes, non-electric; pepper mills, hand-operated; feather-dusters; brooms; isothermic bags; confectioners' decorating bags [pastry bags]; bowls [basins]; mosaics of glass, not for built-

ding; saucepan scourers of metal; soap boxes; mouse traps; cooking pot sets; nozzles for watering cans; pouring spouts; nozzles for watering hose; fitted picnic baskets, including dishes; toilet cases; floss for dental purposes; fiberglass thread, not for textile use; cookie [biscuit] cutters; pastry cutters; sprinklers; syringes for watering flowers and plants; cotton waste for cleaning; wool waste for cleaning; cleaning tow; chopsticks; cocktail stirrers; pepper pots; gloves for household purposes; polishing gloves; gardening gloves; plates to prevent milk boiling over; trays for household purposes; trays of paper, for household purposes; lazy susans; vegetable dishes; serving trays; heaters for feeding bottles, non-electric; candelabra [candlesticks]; trivets [table utensils]; coasters, not of paper or textile; menu card holders; knife rests for the table; flat-iron stands; egg cups; grill supports; abrasive pads for kitchen purposes; scouring pads; drinking troughs; powdered glass for decoration; pottery; pots; painted glassware; tableware, other than knives, forks and spoons; porcelain ware; earthenware; crystal [glassware]; cosmetic utensils; toilet utensils; trouser presses; cruet sets for oil and vinegar; spice sets; appliances for removing make-up, non-electric; toilet paper dispensers; apparatus for wax-polishing, non-electric; bottle openers; glove stretchers; bootjacks; crumb trays; tie presses; clothes-pegs; glass stoppers; powder compacts; perfume vaporizers; powder puffs; dusting apparatus, non-electric; dispensers for liquid soap; combs; electric combs; grills [cooking utensils]; sifters [household utensils]; drinking horns; shoe horns; candle rings; salad bowls; sugar bowls; beaters, non-electric; services [dishes]; coffee services [tableware]; liqueur sets; tea services [tableware]; cinder sifters [household utensils]; tea strainers; siphon bottles for carbonated water; pipettes [wine-tasters]; rolling pins, domestic; pressure cookers, non-electric; steel wool for cleaning; curry-combs; food blenders, non-electric; fruit presses, non-electric, for household purposes; salt cellars; drinking vessels; vessels of metal for making ices and iced drinks; refrigerating bottles; cups of paper or plastic; glasses [receptacles]; drinking glasses; statues of porcelain, terra-cotta or glass; figurines [statuettes] of porcelain, ceramic or glass; plate glass [raw material]; opal glass; glass incorporating fine electrical conductors; enamelled glass, not for building; glass, unworked or semi-worked, except building glass; glass wool, other than for insulation; fiberglass, other than for insulation or textile use; vitreous silica fibers [fibres], not for textile use; soup bowls; drying racks for laundry; basins [receptacles]; table plates; graters for kitchen use; insulating flasks; indoor terrariums [plant cultivation]; cloth for washing floors; cloths for cleaning; dusting cloths [rags]; furniture dusters; automatic litter boxes for pets; urns; aerosol dispensers, not for medical purposes; water apparatus for cleaning teeth and gums;

wax-polishing appliances, non-electric, for shoes; utensils for household purposes; kitchen utensils; cooking utensils, non-electric; coffee filters, not of paper, being part of non-electric coffee makers; coffee filters, non-electric; flasks; drinking flasks; molds [kitchen utensils]; ice cube molds [moulds]; cookery molds [moulds]; comb cases; bread bins; fly swatters; teapots; kettles, non-electric; cups; garlic presses [kitchen utensils]; ironing board covers, shaped; tea infusers; glass bowls; mops; cocktail shakers; corkscrews; pig bristles; dishwashing brushes; brushes for cleaning tanks and containers; lamp-glass brushes; horse brushes; scrubbing brushes; toothbrushes; toothbrushes, electric; animal bristles [brushware]; carpet sweepers; brushes for footwear; toilet brushes; electric brushes, except parts of machines; brushes; eyebrow brushes; nail brushes; nest eggs, artificial; boxes of metal, for dispensing paper towels; dustbins.

24 – Frieze [cloth]; velvet; household linen; diapered linen; bath linen, except clothing; bed linen; table linen, not of paper; buckram; fustian; felt; jersey [fabric]; table runners; drugget; shower curtains of textile or plastic; curtains of textile or plastic; net curtains; zephyr [cloth]; banners; canvas for tapestry or embroidery; bolting cloth; crepe [fabric]; crepon; furniture coverings of textile; fabrics for textile use; filtering materials of textile; wall hangings of textile; non-woven textile fabrics; plastic material [substitute for fabrics]; textile material; sleeping bag liners; sackcloth; moleskin [fabric]; pillowcases; mattress covers; bed blankets; eiderdowns [down coverlets]; brocades; handkerchiefs of textile; travelling rugs [lap robes]; hat linings, of textile, in the piece; curtain holders of textile material; bed covers; bed covers of paper; furniture coverings of plastic; towels of textile; hemp cloth; gummed cloth, other than for stationery purposes; printers' blankets of textile; cloth; door curtains; shrouds; cloths for removing make-up; face towels of textile; place mats, not of paper; mosquito nets; tablecloths, not of paper; oilcloth for use as tablecloths; billiard cloth; taffeta [cloth]; tick [linen]; lingerie fabric; fabric, impervious to gases, for aeronautical balloons; jute fabric; fabric for footwear; ramie fabric; esparto fabric; rayon fabric; fiberglass fabrics for textile use; damask; adhesive fabric for application by heat; linen cloth; upholstery fabrics; hemp fabric; textile linings for garments; lining fabric for footwear; traced cloth for embroidery; chenille fabric; printed calico cloth; bunting; knitted fabric; cotton fabrics; marabouts [cloth]; silk fabrics for printing patterns; woollen cloth; elastic woven material; fabric; fabric of imitation animal skins; cheese cloth; tulle; flags of textile or plastic; flannel [fabric]; sanitary flannel; trellis [cloth]; fitted toilet lid covers of fabric; covers [loose] for furniture; pillow shams; chevots [cloth]; labels of textile.

(260) AM 2018 96354 A
 (800) 1386836
 (151) 2017 09 20
 (891) 2017 09 20
 (731) SERGEI VIKTOROVICH KATRAN
 ulitsa Kostyakova, 6/5, kv. 163, RU-125422
 Moskva, Russian Federation

(540)
ЗОЛОТОЙ ШЕЛК

(591) Black, white
 (511)
 3 – Bleaching preparations and other substances for laundry use; cleaning, polishing, scouring and abrasive preparations; soaps; perfumery, essential oils, cosmetics, hair lotions; dentifrices.

(260) AM 2018 96360 A
 (800) 1386876
 (151) 2017 10 05
 (891) 2017 10 05
 (731) ADP GAUSELMANN GMBH
 Merkur-Allee 1-15, 32339 Espelkamp,
 Germany

(540)
Evil Dictator

(591) Black, white
 (511)
 9 – Computer software; games software; games software, in particular for use with computer-aided platforms of all kinds, including entertainment electronics and games consoles; games programs for computers; video games (software); computer games provided through a global computer network or supplied by means of multi-media electronic broadcast or through telecommunications or electronic transmission or via the internet; computer games, leisure and recreational software, video games and computer software, all being provided in the form of storage media; programs for operating electric and electronic apparatus for games, amusement and/or entertainment purposes; automatic lottery machines; computer software for computer games on the internet; online games (software), in particular for online betting games, online prize games, online gambling games, online games of skill and online casino games; computer software in the form of an app for mobile devices and computers; software for operating computer games; computer software for managing games (game collections); video game cartridges.

(260) AM 2018 96371 A
 (800) 1386405
 (151) 2017 11 14
 (891) 2017 11 14
 (731) RICHTER GEDEON NYRT.
 Gyömrői út 19-21, H-1103 Budapest, Hungary

(540)
ОДЕКСАН

(591) Black, white
 (511)
 5 – Pharmaceutical preparations.

(260) AM 2018 96372 A
 (800) 1386406
 (151) 2017 11 14
 (891) 2017 11 14
 (731) RICHTER GEDEON NYRT.
 Gyömrői út 19-21, H-1103 Budapest, Hungary

(540)
ЛАРИССИМА

(591) Black, white
 (511)
 5 – Pharmaceutical preparations.

(260) AM 2018 96373 A
 (800) 1387103
 (151) 2017 07 07
 (891) 2017 07 07
 (731) VARANA UK LTD
 Hillbrow House, Hillbrow Road Esher, Surrey
 KT10 9NW, United Kingdom

(540)
ALMORA

(591) Black, white
 (511)
 3 – Non-medical herbal body oils; non-medical herbal ointments; non-medical herbal skincare oils; non-medical herbal skin lotions; non-medicated lip balm; non-medical herbal soaps; non-medical soap solutions and soap powder; non-medical herbal fragrances; deodorants, not for medical purposes; non-medical body lotions; non-medicated skin lotions; emollients; non-medical herbal massage oils and lotions; non-medical aromatic extracts and essential oils; non-medical herbal cosmetics and perfumery articles; non-medical herbal hair sprays and hair lotions; non-medical shampoos and conditioners; non-medicated, herbal moisturising creams; non-medical antiperspirants; non-medicated douches; non-medical toiletry articles, bath beads and bath lotions; non-medical herbal face powders and skin ointments; non-medical bath foam and skin cleaning preparations; non-medical hand creams and body sprays; non-medical herbal skin toners, skin tonics and cream cleansers; non-medical foot balms; non-medical herbal bath concentrates, bathing oils, bath crystals and foot lotions; non-medicated, plant-based anti-ageing serums; non-medical intimate washing preparations for women; sunscreen preparations; non-medical herbal peels for face and body.

(260) AM 2018 96387 A
 (800) 1387370
 (151) 2017 10 10
 (891) 2017 10 10
 (731) ELENA VLADIMIROVNA TALAGAIEVA
 kv.143, d. 3, Kommunisticheskaya St,
 Ramenskoye, RU-140002 Moskovskaya
 oblast, Russian Federation
 (540)



(591) Green, light-green, dark-green and white
 (531) 01.15.15; 05.03.14; 27.05.07; 27.05.08;
 27.05.24; 29.01.12

(511)
 3 – Lip glosses; petroleum jelly for cosmetic purposes; cotton wool for cosmetic purposes; scented water; lavender water; toilet water; depilatory wax; waxes for leather; creams for leather; massage gels, other than for medical purposes; deodorants for human beings or for animals; perfumes; perfumery; eyebrow pencils; cosmetic pencils; cosmetic dyes; cosmetic creams; cream for whitening the skin; hair spray; nail polish; hair lotions; after-shave lotions; beauty masks; oils for perfumes and scents; oils for cosmetic purposes; almond milk for cosmetic purposes; cleansing milk for toilet purposes; soap; deodorant soap; shaving soap; cakes of toilet soap; cosmetic kits; false nails; eau de Cologne; cotton sticks for cosmetic purposes; dentifrices; lipsticks; pomades for cosmetic purposes; shaving preparations; cosmetic preparations for baths; toiletries; douching preparations for personal sanitary or deodorant purposes [toiletries]; nail care preparations; aloe vera preparations for cosmetic purposes; sunscreen preparations; make-up powder; false eyelashes; eyebrow cosmetics; hair colorants; cosmetic preparations for skin care; cosmetics; henna [cosmetic dye]; shampoos.

35 – Demonstration of goods; organization of exhibitions for commercial or advertising purposes; presentation of goods on communication media, for retail purposes; sales promotion for others; advertising; procurement services for others [purchasing goods and services for other businesses].

(260) AM 2018 96388 A
 (800) 1386413
 (151) 2017 11 07
 (891) 2017 11 07

(731) RICHTER GEDEON NYRT.
 Gyömrői út 19-21, H-1103 Budapest, Hungary
 (540)

ARLINTA

(591) Black, white
 (511)
 5 – Pharmaceutical preparations.

(260) AM 2018 96390 A
 (800) 1386426
 (151) 2017 10 10
 (891) 2017 10 04
 (731) ABLOY OY
 Wahlforssinkatu 20, FI-80100 Joensuu,
 Finland
 (540)



(591) Black, white
 (531) 14.05.01; 14.05.02; 14.05.09
 (511)

6 – Locks and lock cases; lock cylinders; keys; key blanks; lock bodies; striker plates; handles and fittings (made of metal) for doors and windows; door closers and door openers (non-electric); emergency and panic latches for doors and windows (made of metal); door frames, hinges and handles (made of metal); components and accessories for mentioned goods, all made of metal.

9 – Computer software and applications for locking devices and apparatus, safety, security, protection and signaling devices and apparatus and door opening and closing devices and apparatus; electric and electronic safety, security, protection and signaling devices and apparatus; electric, electronic, electromechanical and magnetic locks and control and decoding apparatus for locks; electric, electronic and electromechanical locking devices and apparatus; electric, electronic and electromechanical lock cylinder devices and apparatus; electric, electronic or optical identification apparatus, card readers and identification equipment and their cards; electronic or magnetic keys; access control cards, key cards, smart cards and their readers; control and monitoring systems, namely access control systems, burglar alarms and video surveillance systems.

35 – Wholesale and retail services for locks and lock cases, lock cylinders, keys, key blanks, lock bodies, striker plates, handles and fittings for doors and windows, door closers and door openers, emergency

and panic latches for doors and windows, frames, hinges, handles and components and accessories of mentioned goods; wholesale and retail services for key machines and key machine tools, electric door opening apparatus and door closers and their control systems and door actuating apparatus (hydraulic, pneumatic or electronic); wholesale and retail services for computer software and applications for locking devices and apparatus, safety, security, protection and signaling devices and apparatus or door opening and closing devices and apparatus; wholesale and retail services for electric and electronic safety, security, protection and signaling devices and apparatus; wholesale and retail services for electric, electronic, electromechanical and magnetic locks and control and decoding apparatus for locks; wholesale and retail services for electric, electronic and electromechanical locking devices and apparatus and electric, electronic and electromechanical lock cylinder devices and apparatus; wholesale and retail services for electric, electronic or optical identification apparatus, card readers and identification equipment and their cards; wholesale and retail services for access control cards, key cards, smart cards and their readers; wholesale and retail services for access control systems, burglar alarms and video surveillance systems.

(260) AM 2018 96391 A

(800) 1387373

(151) 2017 10 20

(891) 2017 10 20

(731) REDSTONE HAUTE COUTURE CO., LTD.
Unit B01, Unit B02, Unit B03, Unit B04, 15th
Floor, Anlian Building, No. 4018, Jintian
Road, Futian District, Shenzhen, China

(540)

GIADA

(591) Black, white

(531) 27.05.15

(511)

3 – Cosmetics; perfumes; dentifrices; scented wood; cosmetics for animals; air fragrancing preparations; toilet soap; cleaning preparations; creams for leather; grinding preparations; essential oils.

9 – Ticket dispensers; apparatus to check franking; false coin detectors; time recording apparatus; hemline markers; facsimile machines; weighing machines; measures; electronic notice boards; cordless telephones; cinematographic cameras; detectors; coils, electric; transformers [electricity]; printed circuits; galena crystals [detectors]; remote control apparatus; light conducting filaments [optical fibers [fibres]]; video screens; electro-dynamic apparatus for the remote control of railway points; lightning conductors; electrolyzers; fire extinguishing apparatus; radiologi-

cal apparatus for industrial purposes; protection devices for personal use against accidents; alarms; eyeglass chains; eyeglass cases; eyeglass frames; eyeglasses; spectacle cases; sunglasses; batteries, electric; animated cartoons; egg-candlers.

14 – Precious metals, unwrought or semi-wrought; jewellery boxes; brooches [jewellery]; jewellery charms; jewellery; paste jewelry [costume jewelry]; tie clips; clocks; wristwatches; presentation boxes for watches.

18 – Trimmings of leather for furniture; leather laces; umbrellas; parasols; walking sticks; kid; fur; purses; travelling trunks; rucksacks; shopping bags; attaché cases; handbags; travelling bags; briefcases; valises; trunks [luggage]; vanity cases, not fitted; key cases; pocket wallets; garment bags for travel; suitcases; furniture coverings of leather; clothing for pets.

25 – Clothing; outerclothing; knitwear [clothing]; coats; skirts; shirts; dresses; overcoats; clothing of leather; tee-shirts; dust coats; down jackets; scarfs; belts [clothing]; layettes [clothing]; swimsuits; waterproof clothing; masquerade costumes; footwear; caps [headwear]; hosiery; gloves [clothing]; shawls; babies' pants [underwear]; dancing dress; boots; leather belts [clothing]; chasubles; sashes for wear; wimples; maniples; shower caps; sleep masks; albs; wedding dress; girdles; suits; pajamas.

35 – Outdoor advertising; shop window dressing; publicity; demonstration of goods; business management assistance; sales promotion for others; import-export agency services; personnel management consultancy; relocation services for businesses; computerized file management; word processing; business auditing; rental of sales stands; retail or wholesale services for pharmaceutical, veterinary and sanitary preparations and medical supplies; business management consultancy; rental of vending machines; sponsorship search.

(260) AM 2018 96392 A

(800) 1386442

(151) 2017 09 29

(891) 2017 09 29

(731) BARRY CALLEBAUT AG
Westpark, Pfingstweidstrasse 60, CH-8005
Zürich, Switzerland

(540)

**MONA
LISA**

(591) Black, white

(531) 27.05.01; 27.05.17; 27.05.25

(511)

29 – Nut-based fillings; processed nuts, nut-based buttercream; nut-based decorations for food.

30 – Cocoa and products with cocoa; edible cocoa seeds; chocolate, products with chocolate, cocoa-based beverages and chocolate-based beverages; chocolate-based beverage vending mixes, chocolate-based decorations for food; sweets, namely sweetened pastes and confectionery, sugar-based decorations for food, cake frosting [icing], preparations made from cereals in combination with cocoa and/or chocolate; marzipan.

(260) AM 2018 96393 A

(800) 1386445

(151) 2017 11 07

(891) 2018 11 07

(731) Anastasia Solay SARL

Rue de la Rôtisserie 17, CH-1204 Genève,
Switzerland

(540)

ANASTASIA SOLAY

(591) Black, white

(511)

3 – Bleaching preparations and other substances for laundry use; cleaning, polishing, degreasing and abrasive preparations; soaps; perfumery, essential oils, cosmetics, hair lotions; dentifrices; nail polish; make-up products for the face and body; body soaps; body lotions; care creams and lotions for cosmetic use for face and body; cosmetic creams and lotions for face and body care; face, body, scalp, nail and hair care lotions, creams and preparations; lotions, creams and preparations for face, body, scalp, nail and hair care; cosmetic powders, creams and lotions for the face, hands and body; body deodorants; body deodorants (perfumery products); face and body creams; beauty creams for the body and face; scented body lotions and creams.

9 – Scientific, nautical, surveying, photographic, cinematographic, optical, weighing, measuring, signaling, checking (supervision), emergency (life-saving) and teaching apparatus and instruments; apparatus and instruments for conducting, switching, transforming, accumulating, regulating or controlling electricity; apparatus for recording, transmission or reproduction of sound or images; magnetic recording media, sound recording disks; compact disks, DVDs and other digital recording media; mechanisms for coin-operated apparatus; cash registers, calculating machines, data processing equipment, computers; software; fire extinguishers; compact disks featuring music; compact disks (audio-video); musical video recordings; videodisks; pre-recorded video cassettes featuring music; video cassettes; prerecorded musical compact disks; prerecorded audio discs; audio cassettes; sound file mixers; musical sound recordings;

video recordings; audio recordings featuring music; DVDs.

14 – Precious metals and their alloys; jewelry, precious stones; timepieces and chronometric instruments.

16 – Paper and cardboard; printing products; book-binding material; photographs; stationery; adhesives for stationery or household purposes; artists' materials; paintbrushes; typewriters and office requisites (except furniture); instructional or teaching material (except apparatus); plastic materials for packaging; printing type; printing blocks; printed periodicals in the field of music; sheet music; printed music books; music sheets; stickers (stationery); 3D transfers for use on any surface; 3D decals for use on any surface; transfers (decalcomanias); printed calendars; calendars; programs for specific events; unframed posters; framed posters; posters of paper.

25 – Clothing, footwear, headgear.

41 – Education; training; entertainment; sporting and cultural activities; organization, presentation and production of shows and live performances; organization of live musical performances; organization of shows and concerts; entertainment services in the form of concert performances; music recording services; music recording studio services; production and publishing of music; production of sound, music and video recordings; music production services; provision of information relating to entertainment, music, live performances and entertainment events; providing entertainment services in the form of live musical performances or recorded music.

(260) AM 2018 96400 A

(800) 1386585

(151) 2017 09 18

(891) 2017 09 18

(731) SHENZHEN GOLF & FEIHUANG

TECHNOLOGY CO., LTD

1-4/F, Building C8, Block C, Fuhai Industry

Park, Fuhai Avenue, Fuyong, Bao'An,

Shenzen Guangdong, China

(540)

GOLF SPACE

(591) Black, white

(531) 27.05.17

(511)

9 – Computer peripheral devices; computers; counters; weighing machines; electronic notice boards; cellular phones; cases and covers for mobile telephones; headphones; cameras [photography]; counters; stereoscopic apparatus; materials for electricity mains [wires, cables]; sockets, plugs and other contacts [electric connections]; stable electrical power supplies; protection devices for personal use against acci-

dents; buzzers; 3D spectacles; chargers for electric batteries; batteries, electric; mobile electric power supply units (rechargeable batteries).

(260) AM 2018 96403 A

(800) 1386604

(151) 2017 04 28

(891) 2017 04 28

(731) Drustvo za konsalting proizvodstvo, trgovija i usluzi NJY TEHNOLODJI KONSALTING DOOEL Skopje
ul. "Nereska" br.29,1000 Skopje, Macedonia
(the former Yugoslav Republic of)

(540)

Burning Sky

(591) Black, white

(511)

9 – 3D spectacles; DVD players; global positioning systems [GSP] apparatus; USB flash drives; solenoid valves [electromagnetic switches]; computer gaming software; accumulators, electric; accumulators, electric, for vehicles; accumulator boxes; accumulator jars; computer operating programs recorded; acoustic [sound] alarms; acoustic couplers; acoustic conduits; recorded computer software; alarm bells electric; animated cartoons; breathing apparatus for underwater swimming; distance measuring apparatus; monitors [computer hardware]; satellite navigational apparatus; computer games software; audio-visual teaching apparatus; barometers; video baby monitors; binoculars; locks, electric; computer hardware; push buttons for bells; scales; eyeglass chains; high-frequency apparatus; record players; phonograph records; pocket calculators; monitors [computer programs]; diaphragms [photography]; smoke detectors; apparatus for recording transmission or reproduction of sound or images; DNA chips; dosimeters; electrical adapters; electrolyzers; test tubes; battery chargers; sound alarm; quantity indicators; calorimeters; eyeglasses cases; computer keyboards; contact lenses; diving suits; pedometers; battery boxes; magnets; tape recorders; mathematical instruments; microscopes; modems; mirrors (optics); optical discs; sunglasses; goggles for sport; safety nets; prisms [optics]; radios; radiotelephony sets; rheostats; dog whistles; signal bells; headphones; ear plugs for divers; telescopes; digital signs; bar code readers.

14 – Jewels; necklaces (jewellery); pins being jewelry; rings [jewellery, jewelry (Am.)]; paste jewelry [costume jewelry (Am.)]; cloisonne jewellery [jewelry (Am.)]; jewelry boxes; cases for jewels; pearls [jewellery, jewelry (Am.)]; ivory jewelry; key chains as jewellery [trinkets or fobs]; earrings; bracelets (jewellery).

28 – Climbers' harness; tennis ball throwing apparatus; gaming machines for gambling; baseball gloves;

punching bags; boxing gloves; protective padding for sports; games; leg guards adapted for playing sport; golf gloves; gloves for games; parlor games; draughts [games]; darts; board games; dice; kaleidoscopes; bells for Christmas trees; slot machines [gaming machines]; toy vehicles; dolls; dolls' houses; dolls' beds; nets for sports; tennis nets; paragliders; swimming jackets; plush toys; swimming belts; gaming machines for gambling; fish hooks; landing nets for anglers; skateboards; slot machines and gaming machines; skis; snowshoes; snowboards; surfboards; surf skis; billiard table cushions; body-training apparatus; paper party hats; kites.

41 – Entertainment; organizing entertainment, gambling; fan club services (entertainment); publication of books; services related to gambling; electronic games services, including provision of computer games on-line or by means of a global computer network; theme park services; amusement centre services; ticket agency services [entertainment]; providing casino facilities [gambling]; holiday camp services [entertainment]; presentation of variety shows; videotaping; gymnastic instruction; discoteque services; animal training; arranging of beauty contests; organization of lotteries; orchestra services; providing sports facilities; rental of tennis courts; recreation information; songwriting; conducting fitness classes; conducting guided tours; karaoke services; health club services [health and fitness training]; personal trainer services [fitness training]; nightclub services [entertainment]; coaching [training].

(260) AM 2018 96404 A

(800) 1386704A

(151) 2017 09 27

(891) 2017 09 27

(731) AMAZON EUROPE CORE S.À.R.L.
5, rue Plaetis, Luxembourg, L-2338,
Luxembourg

(540)



(591) Black, white

(531) 24.15.13; 27.05.01; 27.05.17

(511)

9 – Computer software for streaming, broadcasting, transmitting, distributing, reproducing, organizing and sharing music, audio, video, games and other data; computer software for use in authoring, downloading, transmitting, receiving, editing, extracting, encoding, decoding, playing, viewing, storing and organizing text, data, images, and audio and video

files; computer software to enable users to view or listen to audio, video, text and multimedia content; computer software for creating and providing user access to searchable databases of information and data; search engine software; computer software for wireless content delivery; computer software for accessing online information; computer software for online shopping; computer software for facilitating payments and online transactions; computer software that provides retail and ordering services for a wide variety of consumer goods; computer software for use in disseminating advertising for others; computer software for disseminating information regarding consumer product discounts; computer software for use in sharing information about products, services, and deals; computer software for use in barcode scanning and price comparison; computer software for scheduling shipping and deliveries; computer software for electronic storage of data; computer software for storing, organizing, editing and sharing photos; computer software for image and speech recognition; computer software for home automation; computer software for purchasing, accessing and viewing movies, TV shows, videos, music, and multimedia content; game software; Internet browser software; downloadable music files; downloadable films and movies featuring fiction and non-fiction stories on a variety of topics provided via a video-on-demand service; downloadable motion pictures and television shows about featuring fiction and non-fiction stories on a variety of topics, and audio and video recordings featuring fiction and non-fiction stories on a variety of topics; digital media, namely, pre-recorded digital video discs, digital versatile discs; downloadable audio and video recordings, DVDs, and high definition digital discs featuring fiction and non-fiction stories on a variety of topics; downloadable audio files, multimedia files, text files, written documents, audio material, video material and games featuring fiction and non-fiction content on a variety of topics; downloadable fiction books on a variety of topics, downloadable e-books in the field of fiction and non-fiction stories on a variety of topics and audio books in the field of fiction and non-fiction stories on a variety of topics; magnetically encoded gift cards.

16 – Paper gift cards, printed gift certificates; non-magnetically encoded prepaid purchase cards for transferring financial value online via retail computer networks; printed publications, namely, books, magazines, periodicals, brochures, journals, newsletters, and newspapers in fields of general human interest; paper.

35 – Customer loyalty program services featuring rewards in the form of discounted shipping services, early access to retail discounts and offers, access to books and other publications, access to audiobooks, discounted online storage of photos and music, and

discounted music, video and game streaming; administration of a discount program enabling participants to obtain discounts on shipping services, early access to retail discounts and offers, access to books and other publications, access to audiobooks, discounted online storage of photos and music, and discounted music, video and game streaming; retail store services and online retail store services featuring books and magazines, computers and electronics, software, power and hand tools, office supplies, furniture, appliances, linens, bags and luggage, housewares, kitchen products, bath products, dining products, lawn and garden products, clothing and accessories, sporting goods, camping goods, baby goods, toys and games, musical instruments, beauty and health products, vitamins and supplements, art, arts and crafts, automotive goods, pet supplies and industrial supplies; retail store and online retail store services featuring a wide array of consumer goods; online retail store services featuring audio and video recordings, spoken word recordings, electronic books and computer games; online retail store services in the field of groceries, fresh and prepared foods, drug store and general merchandise; retail grocery stores; wholesale distributorship featuring fresh foods and groceries; subscription-based order fulfillment services in the fields of books, audiobooks, music, movies, TV shows, videos and games; advertising services; administration of a discount program enabling participants to obtain discounts on shipping services.

38 – Video-on-demand transmission; Internet protocol television (IPTV) transmission services; streaming of audio and video material on the Internet; streaming of data; streaming of music, movies, TV shows and games on the Internet; broadcasting services; audio and video broadcasting services; subscription-based audio and video broadcasting services over the Internet; Internet broadcasting services; Internet radio broadcasting services; electronic data transmission; electronic transmission and streaming of digital media content for others via global and local computer networks; telecommunication services, namely, transmission of webcasts; transmission of digital files; electronic transmission of digital photo files among Internet users; providing access to digital music websites on the Internet; providing access to online directories, databases, websites, blogs and reference materials; transmission of news; delivery of messages by electronic transmission; electronic transmission of mail and messages; podcasting services; providing on-line chat rooms for social networking; providing Internet chatrooms; providing an on-line forum for transmission of messages among computer users and the transmission of photos, videos, text, data, images and sound; electronic bulletin board services.

39 – Transport of goods; providing information in the field of transportation via a website; shipping,

delivery, and storage of goods; freight transportation by means of truck, train and air; goods warehousing; packaging articles for transportation; merchandise packaging for others; rental of storage containers; mailbox rental; locating and arranging for reservations for storage space for others; courier services; messenger services; distribution services, namely, providing online services which afford customers the ability to select a distribution point for goods purchased on the internet; membership-based truck, train, and air shipping programs; coordinating travel arrangements for individuals and for groups; travel booking agencies; providing travel information and commentary via a website; expedited shipping services, namely, arranging for freight transportation of packages by means of truck and air.

41 – Entertainment services, namely, in the nature of live visual and audio performances, namely, musical, variety, news and comedy shows; publication of printed matter; book, audiobook, newspaper, magazine and web magazine publishing; publishing of electronic publications; providing non-downloadable electronic publications in the nature of books, magazines, periodicals, brochures, journals, newsletters, and newspapers in the fields of art, biography, business, children and young adults, comedy, comics, drama, economics, education, entertainment, fashion, fiction, finance, food, geography, hobbies, history, law, lifestyle, literature, medicine, music, nature, non-fiction, novels, parenting, politics, religion, romance, science, science fiction, technology, self-help, spirituality, sports, style, technology, and travel; loaning and rental of books, audiobooks and other publications; digital imaging services; provision of non-downloadable videos featuring programs on a wide variety of entertainment topics via a video-on-demand service; provision of non-downloadable films, movies and television shows via a video-on-demand service; film and video rental services; film, movie, TV show and video production and distribution; creating and developing concepts for movies and television programs; audio and video recording services; providing online radio programming; digital audio, video and multimedia publishing services; entertainment services, namely, providing non-downloadable prerecorded music and audio programs featuring fiction and non-fiction stories on a variety of topics, and information in the field of music, and commentary and articles about music, all on-line via a global computer network; providing information, news and commentary in the field of music; providing information, news and commentary in the field of reviews of audiobooks for entertainment purposes; presenting live musical concerts and performances; music production services; music publishing services; providing online video games; providing online non-downloadable game software; multimedia publishing of games; production of video; rental of video games; entertainment services, name-

ly, live performances by video game players; entertainment services, namely, providing online non-downloadable videos in the field of video games featuring video games being played by others; entertainment services, namely, providing virtual environments in which users can interact for recreational, leisure or entertainment purposes; entertainment services, namely, providing on-line, non-downloadable virtual clothing, colors, badges, tools and weapons for use in virtual environments created for entertainment purposes; providing online gaming and online electronic games to consumers for recreational computer game playing purposes via an online website portal; arranging and conducting sports competitions and tournaments for video game players; organizing video gaming leagues; providing information online relating to computer games and enhancements for games; publishing of reviews; providing ratings, reviews and recommendations of users in the fields of entertainment and education via a website; providing ratings and reviews of television, movies, videos, music, screenplays, scripts, books and video game content via a web site; entertainment information; providing online news, information and commentary in the field of entertainment; online journals, namely, blogs featuring information about entertainment; entertainment services, namely, profiling of musicians, artists and bands by providing non-downloadable video clips of musical performances over a global computer network; arranging of contests; entertainment services in the nature of sweepstake services; entertainment services in the nature of sweepstake services provided over a global computer network hosting online sweepstakes and contests for others.

42 – Leasing and rental of computers and computer software; computer time-sharing services; computer co-location services, namely, providing facilities for the location of computer servers with the equipment of others; rental of computing and data storage facilities of variable capacity to third parties; computer diagnostic services; technical support services, namely, troubleshooting in the nature of diagnosing computer hardware and software problems; application service provider (ASP), namely, hosting computer software applications for others; providing temporary use of non-downloadable computer software for streaming, broadcasting, transmitting, distributing, reproducing, organizing and sharing music, audio, video, games and other data; providing temporary use of non-downloadable computer software for use in authoring, downloading, transmitting, receiving, editing, extracting, encoding, decoding, playing, viewing, storing and organizing text, data, images, and audio and video files; providing temporary use of non-downloadable computer software to enable users to view or listen to audio, video, text and multimedia content; providing temporary use of non-downloadable computer software for creating

and providing user access to searchable databases of information and data; providing temporary use of non-downloadable search engine software; providing temporary use of non-downloadable computer software for wireless content delivery; providing temporary use of non-downloadable computer software for accessing online information; providing temporary use of non-downloadable computer software for on-line shopping; providing temporary use of non-downloadable computer software for facilitating payments and online transactions; providing temporary use of non-downloadable computer software that provides retail and ordering services for a wide variety of consumer goods; providing temporary use of non-downloadable computer software for use in disseminating advertising for others; providing temporary use of non-downloadable computer software for disseminating information regarding consumer product discounts; providing temporary use of non-downloadable computer software for use in sharing information about products, services, and deals; providing temporary use of non-downloadable computer software for use in barcode scanning and price comparison; providing temporary use of non-downloadable computer software for scheduling shipping and deliveries; providing temporary use of non-downloadable computer software for electronic storage of data; providing temporary use of non-downloadable computer software for storing, organizing, editing and sharing photos; providing temporary use of non-downloadable computer software for image and speech recognition; providing temporary use of non-downloadable computer software for home automation; providing temporary use of non-downloadable computer software for purchasing, accessing and viewing movies, TV shows, videos, music, and multimedia content; electronic data storage; data backup and recovery services; file sharing services, namely, providing technology via a website enabling users to upload and download electronic files; hosting of digital content on the internet; hosting, building and maintaining web sites; computer services, namely, cloud hosting provider services; providing search engines for the internet; computer services, namely, creating computer network-based indexes of information, websites and resources; computer services, namely, hosting on-line web facilities for others for organizing and conducting online meetings, gatherings, and interactive discussions; computer services, namely, uploading music and photos to the Internet for others; computer services, namely, creating an on-line community for registered users to participate in discussions, get feedback from their peers, form virtual communities, and engage in social networking services in the fields of books, TV shows, films, music, entertainment, video games, fiction, and non-fiction; creating an on-line community for connecting video players, teams and leagues for the purpose of organizing game and

sports activities; providing technology via a website that creates personalized movie, TV show, video and music channels for listening, viewing, and sharing; providing non-downloadable music, radio, movies, TV shows, videos and information about music, albums, artists and songs via a subscription based website; providing technology via an online website that enables users to share video game enhancements and game strategies; design of computer game software; development of computer game software.

(260) AM 2018 96426 A
(800) 1387986
(151) 2017 11 14
(891) 2017 11 14
(731) RICHTER GEDEON NYRT.
Gyömrői út 19-21, H-1103 Budapest, Hungary
(540)

АЛЛАМОР

(591) Black, white
(511)
5 – Pharmaceutical preparations.

(260) AM 2018 96428 A
(800) 1387988
(151) 2017 11 14
(891) 2017 11 14
(731) RICHTER GEDEON NYRT.
Gyömrői út 19-21, H-1103 Budapest, Hungary
(540)

ЕУРИСТИН

(591) Black, white
(511)
5 – Pharmaceutical preparations.

(260) AM 2018 96429 A
(800) 1387989
(151) 2017 11 14
(891) 2017 11 14
(731) RICHTER GEDEON NYRT.
Gyömrői út 19-21, H-1103 Budapest, Hungary
(540)

АДМИРЕКС

(591) Black, white
(511)
5 – Gynecological preparations.

(260) AM 2018 96430 A
(800) 1387992
(151) 2017 11 30
(891) 2017 11 30
(731) Zakrytoe aktsionernoe obshchestvo
"RENNА-HOLDING"
ul. Privolnaya, 25, RU-109145 Moscow,
Russian Federation

(540)

МОЛОЧЕЗ

(591) Black, white

(531) 28.05

(511)

29 – Yogurt; kefir [milk beverage]; milk shakes; buttermilk; kumys [kumyss] [milk beverage]; margarine; edible oils and fats; edible oils; sunflower oil for food; butter; milk and milk products; albumin milk; condensed milk; powdered milk; milk beverages, milk predominating; prostokvasha [soured milk]; ryazhenka [fermented baked milk]; cream [dairy products]; whipped cream; smetana [sour cream]; whey; cheese; milk ferments for culinary purposes; rennet.

30 – Mustard; dressings for salad; frozen yogurt [confectionery ices]; ketchup [sauce]; mayonnaise; marinades; ice cream; meat tenderizers, for household purposes; sorbets [ices]; soya sauce; tomato sauce; sauces [condiments]; pasta sauce; vinegar; condiments; pastry and confectionery.

(260) AM 2018 96431 A

(800) 1387999

(151) 2017 12 06

(891) 2017 12 06

(731) BEIERSDORF AG

Unnastr. 48, 20253 Hamburg, Germany

(540)

NIVEA STRONG POWER

(591) Black, white

(511)

3 – Non-medicated cosmetics; cosmetic preparations for the cleansing, care and embellishment of the hair.

(260) AM 2018 96432 A

(800) 1388006

(151) 2017 11 10

(891) 2017 11 10

(731) KANSAI PAINT CO., LTD.

33-1, Kanzaki-cho, Amagasaki-shi, Hyogo

661-8555, Japan

(540)

AlesChar

(591) Black, white

(511)

2 – Paints; varnishes; lacquers; pigments; paint thinners.

(260) AM 2018 96433 A

(800) 1388049

(151) 2017 12 01

(891) 2017 12 01

(731) CHAUX ET ENDUITS DE SAINT ASTIER

Lieudit la Jarthe, F-24110 SAINT-ASTIER, France

(540)



(591) Black, white

(531) 01.01.01; 01.01.05; 01.01.10; 27.05.01

(511)

19 – Lime building materials; building materials, not of metal.

(260) AM 2018 96434 A

(800) 1388061

(151) 2017 07 21

(891) 2017 07 21

(731) 3E OTOMOTİV İÇ VE DIŞ TİCARET

LİMİTED ŞİRKETİ

Yedpa Ticaret Merkezi, H2 Caddesi, No:15,

Ataşehir, İstanbul, Turkey

(540)



(591) Grey and dark blue

(531) 26.11.12; 27.05.01; 27.05.17; 27.05.22;

29.01.12

(511)

6 – Ores of non-precious metal; common metals and their alloys and semi-finished products made of these materials; cast iron for use in building; reinforcing materials of metal for building; common metals in sheet, rod, bar or billet form; goods and materials of common metal used for storage, wrapping, packaging and sheltering purposes, containers of metal (storage, transport), buildings of metal, frames of metal for building, poles of metal for building, metal boxes, packaging containers of metal, aluminium foil, fences made of metal, guard barriers of metal, metal tubes, storage containers of metal, metal containers for the transportation of goods, ladders of metal; drain pipes of metal; doors, windows, shutters, jalousies and their cases and fittings of metal; non-electric cables and wires of metal; ironmongery, small hardware of metal; screws, nails, bolts, nuts of metal, pins [hardware], washers of metal, pitons of metal, metal chains; fittings of metal for furniture; furniture casters of metal; casters of metal; door and window handles of metal, metal hinges, metal espagnolettes, metal locks, metal keys for locks, chains

of common metal for keys, metal hardware, namely, pulleys; ventilation ducts, vents, vent covers, pipes, chimney caps, manhole covers, grilles of metal for ventilation, heating, sewage, telephone, underground electricity and air conditioning installations; metal panels or boards (non-luminous and non-mechanical) used for signalling, route showing, publicity purposes, signboards of metal, advertisement columns of metal, signaling panels of metal, non-luminous and non-mechanical traffic signs of metal; pipes of metal for transportation of liquids and gas, drilling pipes of metal and their metal fittings, valves of metal, couplings of metal for pipes, elbows of metal for pipes, clips of metal for pipes, connectors of metal for pipes; safes (strong boxes) of metal; metal railway materials, metal rails, metal railway ties, railway switches; bollards of metal, floating docks of metal, mooring buoys of metal, anchors; metal moulds for casting, other than machine parts; works of art made of common metals or their alloys; trophies of common metal; metal closures, bottle caps of metal; metal poles; framework of metal for building; pilings of metal, scaffolding towers of metal; metal pallets and metal ropes for lifting, loading and transportation purposes; metal hangers, ties, straps, tapes and bands used for load-lifting and load-carrying; wheel chocks made primarily of metal; decorative metal profiles.

12 – Motor land vehicles, motorcycles, mopeds; engines and motors for land vehicles; clutches for land vehicles; transmissions, transmission belts and transmission chains for land vehicles; gearing for land vehicles; brakes, brake discs and brake linings for land vehicles; vehicle chassis, automobile bonnets, vehicle suspension springs, shock absorbers for automobiles, gearboxes for land vehicles, steering wheels for vehicles, rims for vehicle wheels; bicycles and their bodies; handlebars and mudguards for bicycles; vehicle bodies; tipping bodies for trucks; trailers for tractors; frigorific bodies for land vehicles; trailer hitches for vehicles; vehicle seats; headrests for vehicle seats; safety seats for children, for vehicles; seat covers for vehicles; vehicle covers (shaped); sun-blinds adapted for vehicles; direction signals and arms for direction signals for vehicles; windscreen wipers and wiper arms for vehicles; inner and outer tires for vehicle wheels; tubeless tires; tire-fixing sets comprised of tire patches and tire valves for vehicles; windows for vehicles, safety windows for vehicles, rearview mirrors and wing mirrors for vehicles; anti-skid chains for vehicles; luggage carriers for vehicles; bicycle and ski carriers for cars; saddles for bicycles or motorcycles; air pumps for vehicles, for inflating tires; anti-theft alarms for vehicles, horns for vehicles; safety belts for vehicle seats, air bags (safety devices for automobiles); baby carriages, wheelchairs, pushchairs; wheelbarrows; shopping carts; single or multi-wheeled wheelbarrows; shopping trolleys; grocery carts; han-

dling carts; rail vehicles; locomotives; trains; trams; waggons; cable cars; chairlifts; vehicles for locomotion by water and their parts, other than their motors and engines; vehicles for locomotion by air and their parts, other than their motors and engines.

(260) AM 2018 96435 A
 (800) 1387499
 (151) 2017 11 07
 (891) 2017 11 07
 (731) RICHTER GEDEON NYRT.
 Gyömrői út 19-21, H-1103 Budapest, Hungary
 (540)

FORINDA

(591) Black, white
 (511)
 5 – Pharmaceutical preparations.

(260) AM 2018 96449 A
 (800) 1388082
 (151) 2017 10 02
 (891) 2017 10 02
 (731) LEKHIM Joint Stock Company
 23, Shota Rustaveli str., Kyiv 01033, Ukraine
 (540)



Группа фармацевтических компаний

(591) Black, white
 (531) 01.03.01; 01.03.15; 26.11.08; 28.05
 (526) Группа фармацевтических компаний
 (511)
 44 – Alternative medicine services; animal breeding; animal grooming; dentistry services; health care; health spa services; health centre services; health counseling; hospital services; medical clinic services; medical assistance; medical equipment rental; medical advice for individuals with disabilities; midwife services; nursing home services; nursing, medical; palliative care; pet grooming; pharmacy advice; physiotherapy; plastic surgery; preparation of prescriptions by pharmacists, services of a psychologist; rest home services; rental of sanitation facilities; telemedicine services; therapy services; veterinary assistance.

(260) AM 2018 96477 A
 (800) 1181983
 (151) 2013 06 19
 (891) 2017 12 12
 (731) SOCIÉTÉ AIR FRANCE
 45 rue de Paris, F-95747 ROISSY-CHARLES-DE-GAULLE, France

(540)

AF

(591) Black, white

(531) 27.05.17; 27.05.23

(511)

9 – Apparatus for recording, storing, converting, transmitting, reproducing signals, messages, information, sound or images, magnetic recording media, automatic dispensers, especially of travel tickets, airplane tickets, traveling documents, boarding cards or access cards for waiting lounges, automatic terminals, data processing apparatus and equipment and computers, magnetizing and demagnetizing apparatus for magnetic tapes, magnetic and optical or electronic data carriers, optical reading apparatus and instruments, coded information apparatus and instruments, readers for access codes, memory cards, magnetic cards, identification cards or chip cards, barcode readers, computer diskettes, electronic agendas, ticket dispensers, especially for transport, video cameras, Internet cameras (Web cameras), integrated circuit cards (smart cards), magnetic cards, magnetic identity cards, magnetic cards for capitalizing points, magnetic cards (encoded), magnetic subscription cards, magnetic cards, especially intended for travel assistance for handicapped or reduced mobility persons, magnetic cards for loyalty or for membership of a club or for introduction services for individuals, integrated circuit cards (smart cards), magnetic or chip payment, credit or debit cards, chip cards, headsets, compact disks (audio-video), compact optical disks, optical disks, magnetic disks, video cassettes, audio cassettes, video tapes, DVDs, CD-ROMs, DVD-ROMs, electronic pens for visual display units, time recording apparatus, distance recording apparatus, electronic passenger identification devices, electronic identification and registration devices for luggage or goods, video screens, electronic tags for goods or luggage, data processing apparatus, intercommunication apparatus, computers, computer peripheral devices, computer memories, modems, transmitters of electronic signals, electronic connections, sockets, plugs and other contacts, computer screens, digital screens, display units, keypads for computers or vending machines, electric converters, computer or telematic terminals, microprocessors used especially to access databases, database server centers, signaling panels, luminous or mechanical, mechanical or luminous signs, luminous beacons, apparatus for air traffic safety, satellite navigational apparatus especially intended for air transportation, equipment for fixed, transportable, mobile, hands-free or voice-activated telephones, telephone answering machines, radiopaging apparatus, radios, telephone earphones, audio-video earphones, anti-theft warning apparatus, electronic anti-theft installations,

surveillance cameras, audiovisual teaching and instruction apparatus, video game cartridges, calculating machines, electronic pocket calculators, personal data assistants (PDAs), MP3 players, USB ports, USB (universal serial bus) port keys, precision measuring apparatus, meteorological instruments, observation instruments, altimeters, apparatus and instruments for astronomy, azimuth instruments, barometers, directional compasses, protection devices for personal use against accidents, lifejackets, protective helmets, lifebelts, jumping sheets, special protection suits for aviators, materials testing instruments and machines, binoculars, telescope, magnifying glasses, optical goods, spectacles, sunglasses, anti-glare spectacles, anti-glare visors, spectacle cases, respirators other than for artificial respiration, apparatus for air traffic safety, interfaces for computers, computer software (recorded programs), computer software for transport document reservation, plane tickets and travel tickets, software for connecting individuals especially in the context of travel or transport, software for downloading information via the Internet or other communications networks, game software, computer programs (downloadable software) especially intended for transportation or connecting individuals in the context of transportation services or travel, downloadable electronic publications, electronic display boards, computer mouse pads, electronic pocket translators, pocket calculators, radios, signaling apparatus especially for (inspection) or rescue (lifesaving).

(260) AM 2018 96511 A

(800) 1387787

(151) 2017 12 05

(891) 2017 12 05

(731) HERMANN HARTJE KG

Deichstr. 120 – 122, 27318 Hoya, Germany

(540)

Condura

(591) Black, white

(511)

12 – Bicycles and parts thereof, included in this class; electric bicycles and parts thereof, included in this class; bicycle tyres and inner tubes for bicycle tires.

(260) AM 2018 96512 A

(800) 1387795

(151) 2017 09 28

(891) 2017 09 28

(731) CCIP GMBH

c/o Mercandor AG Unter Altstadt 28,
CH-6300 Zug, Switzerland

(540)

XLNC

(591) Black, white

(511)

35 – Business management, particularly in the field of company risk management and information risk management; business administration, business advice, particularly in the field of process management, business assessments (benchmarking) and strategic business planning, particularly for mergers, purchases and sales of companies, particularly corporate acquisition and merger strategies, franchising, corporate liquidation and bankruptcy, accounting; accounting services; account keeping; computerized accounting services; computerized account keeping; cost-price analyses; planning and developing companies, process management; services provided by consultants relating to company acquisitions; services provided by consultants relating to company acquisitions and mergers; advice in business organization and company organization; business management consulting; services provided by commercial strategy consultants; business networking services; commercial activity appraisal services; commercial business appraisal; relocation services for businesses; relocation services for businesses; services provided by consultants in connection with company marketing; outsourced administrative management of companies; corporate strategic planning services; services for business management consultancy via the Internet; recruitment of applicants for the position of company manager; company evaluation (benchmarking); administrative management of family trusts and foundations; management and administrative management of collective capital investments (particularly investment funds) and companies for administering collective capital investments (particularly investment funds); administrative management of provident institutions, particularly pension funds; preparation of property inventories (in particular for fiscal purposes); office functions, organization of office functions; secretarial services; collection, compilation and systematization of data in computer databases; administrative services for company audits, particularly the compilation and systematization of business data in physical and virtual data spaces (data rooms); accounting, payroll preparation; internal and external auditing, public accounting, economic information, consulting in economic matters, expert appraisals in economic matters; creation of economic forecasts, information concerning economic developments; tax preparation; advice and information regarding office functions, secretarial services, drawing up of statements of accounts, accounting, payroll preparation, internal and external auditing, public accounting, creating economic forecasts and tax preparation; public relations; marketing, information projects for marketing, marketing studies; employment agency services, personnel recruitment, advice relating to personnel management, management services, personnel recruitment and selection; profes-

sional outplacement services; professional business consulting and analysis, particularly relating to founding, buying, selling, transforming, stabilizing, reorganization, merging, succession planning and liquidation of companies; advertising; dissemination of advertising, particularly sales promotion of goods and services for others by placing messages and advertising posters on electronic sites accessible on computer networks (particularly the Internet); arranging and conducting of auction sales and adjudications; organizing, conducting and producing trade fairs, exhibitions, trade shows, congresses, company presentations and other events and occasions for commercial, industrial and/or advertising purposes; banking reviews; providing information on all the other aforesaid services in class 35; consulting services for all the other aforesaid services in class 35.

36 – Financial and monetary affairs, particularly financial services, financial consulting (particularly for pension plan services), consultancy and brokerage for capital investments, strategies for wealth and estate investment, development and brokerage of strategies for wealth and estate investment, consulting for wealth and estate investment, consulting services for wealth and estates, financing, consultancy for investing in private equity funds, procurement of capital investment (private equity), public and private equity financing; financial services by intermediaries (financial nominee services); dummy corporation services for investments; financial services by intermediaries in connection with holding securities for others; financial nominee services for holding assets on behalf of others; drawing up fiscal expert appraisals and estimates, research relating to financial matters, particularly relating to tax, financial services, particularly the distribution of financial products, consulting for wealth and estate investment, particularly the development, creation and presentation of proposals for wealth and estate investment, issuing of negotiable instruments (securitization), securities issuance, financial transactions, corporate finance; consulting relating to wealth and estate investments and brokerage of wealth and estate investments and financial affairs, particularly in the fields of corporate finance and mergers and acquisitions and collective capital investments (particularly investment funds); venture capital financing services for companies; brokerage of financial investments in companies; financial consultancy in corporate mergers and acquisitions; financial management of shares in other companies; capital investment services, financial analysis, banking operations, banking affairs; stock markets, particularly the trading of financial securities, options, derivatives, precious metals, raw materials and currencies, currency exchange; trusteeship; financial administration of provident institutions, particularly pension funds; financial assessment and evaluation of property (in particular companies, assets, estates, real estate, inte-

lectual property rights, licenses); real estate affairs; rental of real estate; consulting on financing and real estate property investments; real estate brokerage services; brokerage of investments in real estate companies; real estate management services; financial consultancy for land development and equipment; consultancy and services relating to the management of real estate property of all kinds and management services; management of property (particularly by trustees), particularly securities (particularly funds and fund securities), security deposits and real estate; financial auditing of banks; collection operations; financial management (asset management); financial and fiscal consulting, particularly relating to founding, buying, selling, transforming, stabilizing, reorganization, merging, succession planning and liquidation of companies; consultancy relating to tax disputes; actuarial services; brokerage; services in the fields of investment and risk management (financial services); financial services of trusts; management of trusts; financial trust management; trusteeship of money, securities, personal property and land; establishment of trusts; financial management of family foundations and trusts; financial sponsorship in the fields of culture, sports, science, education, research and development assistance; research in fiscal matters (financial service); fundraising services; organization of collections; organization of charitable collections; fund raising for charitable purposes; hire-purchase financing (leasing); art appraisal; financial auditing services for companies (financial due diligence); provision of news and information in the fields of finance and monetary affairs as well as financial information; insurance services; financial consultancy relating to tax appraisals; consultancy relating to tax planning; financial advice relating to tax optimization; financial advice relating to dual taxation; information services for the other aforesaid services in class 36, consulting services for all the other aforesaid services in class 36.

45 – Legal services, particularly legal advice, legal representation and litigation services for all legal matters as well as legal expert reports; legal services relating to company formation and registration; legal services relating to debtor management for companies; legal representation in cases of fiscal law and fiscal criminal law, particularly representation in law and in relation to tax authorities; legal advice relating to fiscal law and fiscal criminal law; legal consultancy in corporate mergers and acquisitions; legal advice and representation relating to family law (particularly the drafting of prenuptial agreements); legal advice and representation relating to inheritance law, particularly for drafting the provisions of wills, the division of estates, anticipated inheritance; legal services relating to wills; legal advice on family foundations and trusts; services for the legal auditing of companies (legal due diligence); management and exploitation of intellectual property rights

and other industrial property rights, particularly the licensing of intellectual property rights and other industrial property rights; registration of domain names (legal services); rental of Internet domain names; advice relating to the registration of domain names; exploitation of intellectual property rights and other industrial property rights by licensing (legal services); evaluation of intellectual property rights and other intangible assets; legal research, mediation, supervision; personal and social services rendered by others to meet the needs of individuals, namely detective agencies, consulting in personal development, administrative procedures (except legal representation) for third parties; lobbying services except for economic purposes; promoting the interests of international companies and nonprofit companies in the fields of politics, legislation and regulations (lobbying services); security services for the protection of property and individuals; personal body guard services; security guard services; monitoring of alarms; security inspection services for others; information services for the other aforesaid services in class 45, consulting services for all the other aforesaid services in class 45.

(260) AM 2018 96513 A

(800) 1387803

(151) 2017 12 14

(891) 2017 12 14

(731) DE GRISOGONO SA

Chemin du Champ-des-Filles 39, CH-1228
Plan-les-Ouates, Switzerland

(540)

VORTICE

(591) Black, white

(511)

14 – Precious stones; timepieces and chronometric instruments.

(260) AM 2018 96515 A

(800) 1387878

(151) 2017 11 27

(891) 2017 11 27

(731) DAGI GIYIM SANAYI VE TICARET
ANONIM SIRKETI

Bomonti Birahane, Sk. Unkan Ish. K:1 NO:3
Sisli Istanbul, Turkey

(540)



(591) Black, white

(531) 27.05.01; 27.05.17

(511)

25 – Clothing, including underwear and outerclot-
hing, other than special purpose protective clothing,

namely, pyjamas, tee-shirts, shorts, capri pants, underwears, bikinis, swimsuits, bustiers, garters, pareos (beach wrap), kimonos, underpants, undershirts, socks, hats, sweatsuits, trousers, shirts, sweaters, coats, berets, shoes, sandals, slippers.

(260) AM 2018 96516 A
 (800) 1387910
 (151) 2017 11 09
 (891) 2017 11 09
 (731) MONCIGALE
 Quai de la Paix ,F-30300 BEAUCAIRE,
 France
 (540)



(591) Black, pink, orange and yellow
 (531) 01.03.01; 01.03.15; 01.03.18; 26.01.06;
 26.04.04; 26.04.24; 27.05.10; 27.05.24;
 29.01.15
 (526) Fruits and Wine
 (511)
 33 – Flavored wine-based beverages; wine-based cocktails.

(260) AM 2018 96519 A
 (800) 1387916
 (151) 2017 12 05
 (891) 2017 12 05
 (731) YIWU HONGCHUANG INVESTMENT
 MANAGEMENT CO., LTD.
 4/F, No.128, Shangcheng Avenue, Yiwu City
 Zhejiang Province, China
 (540)

i lahui

(591) Black, white
 (531) 27.05.17
 (511)
 3 – Shampoos; stain removers; polishing wax; essential oils; cosmetics; cotton sticks for cosmetic purposes; perfumes; dentifrices; incense; cosmetics for animals.
 35 – Advertising; business management consultancy; import-export agency services; sales promotion for others; procurement services for others [purchasing goods and services for other businesses]; personnel management consultancy; systemization of in-

formation into computer databases; accounting; sponsorship search; relocation services for businesses.

(260) AM 2018 96520 A
 (800) 1387948
 (151) 2017 09 21
 (891) 2017 09 21
 (731) Tovarishchestvo s ogranitchennoi
 otvetstvennostyu "ALMOL"
 Krasnogvardeiskii trakt, 497, 050030 gorod
 Almaty, Kazakhstan
 (540)



(591) White and grey
 (531) 08.01.18; 25.01.01; 25.01.25; 25.07.25
 (511)
 30 – Binding agents for ice cream [edible ices]; frozen yogurt [confectionery ices]; edible ices; ice cream; powders for making ice cream; sherbets [ices].

(260) AM 2018 96521 A
 (800) 1387958
 (151) 2018 11 27
 (891) 2017 11 27
 (731) SHENZHEN YUNJI INTELLIGENT
 TECHNOLOGY CO., LTD.
 2nd Floor building A2 Silicon Valley Power
 New Material Industrial Park, No.20 The rich
 industrial zone, Guanlan Community, Longhua
 district Shenzhen city Guangdong, China
 (540)

OUKITEL

(591) Black, white
 (531) 27.05.01; 27.05.17
 (511)
 9 – Smartphones; video telephones; telephone apparatus; computer programs [downloadable software]; computer game software; headphones; materials for electricity mains [wires, cables]; batteries, electric; chargers for electric batteries.

(260) AM 2018 96526 A
 (800) 1387970
 (151) 2017 10 31
 (891) 2017 10 31

(731) SHISEIDO COMPANY, LIMITED
7-5-5 Ginza, Chuo-ku 104-0061 Tokyo, Japan
(540)

AURA DEW

(591) Black, white
(531) 27.05.17
(511)
3 – Soaps; cosmetics; perfumery, incenses and fragrances; dentifrices; false nails; false eyelashes.

(260) AM 2018 96596 A
(800) 1389545
(151) 2017 07 27
(891) 2017 07 27
(731) UAB "ATLANTIC DUTY FREE"
Mokyklos g. 1, Mokulu k., LT-68461
Marijampoles sav., Lithuania
(540)

My feelings

(591) Black, white
(511)
29 – Fish, seafood and molluscs; meat; dairy products and dairy substitutes; processed fruits, fungi and vegetables (including nuts and pulses); birds eggs and egg products; oils and fats; pre-packaged dinners consisting primarily of seafood; antipasto salads; stewed apples; eggplant paste; meals consisting primarily of meat, fish, poultry or vegetables, prepared in casseroles; shepherd's pie; bisques; stock; ox bone based broth (seolleongtang); broth [soup]; stock cubes; caesar salad; caponata; chicharron; chile con queso; chili con carne; chop suey; dal [prepared dish]; dairy puddings; artificial milk based desserts; desserts made from milk products; chowder; dairy-based dips; prepared meals consisting substantially of seafood; prepared meals consisting principally of game; instant soup; fish in olive oil; fish and chips; dips; dolmas; condensed tomatoes; steamed egg hotchpotch; stews; roast beef flavoured extract; faggots [food]; falafel; cooked dish consisting primarily of chicken and ginseng (samgyetang); cooked dish consisting primarily of soybean paste and tofu (doenjang-jjigae); cooked dish consisting primarily of rich soybean paste and tofu (cheonggukjang-jjigae); cooked dish consisting primarily of fermented vegetables, pork and tofu (kimchi-jjigae); cooked dish consisting primarily of stir-fried chicken and fermented hot pepper paste (dak-galbi); cooked dish consisting primarily of stired-fried beef and fermented soy sauce (sogalbi); prepared meals made from meat [meat predominating]; prepared meals made from poultry [poultry predominating]; prepared meals containing [principally] eggs; prepared dishes consisting principally of meat; prepared meals containing [principally] chicken; prepared meals containing [principally] bacon; cooked meat dishes; cooked truffles; frozen cooked fish; stock in the

form of granules; chilled dairy desserts; steamed cakes of smashed fish and yam (hampen); fish stock; fish crackers; fish cakes; fish jellies; fish croquettes; steamed or toasted cakes of fish paste (kamaboko); fish sausages; beef bouillon; broth concentrates; meatballs; prepared meat dishes; fruit desserts; chicken salad; frozen pre-packaged entrees consisting primarily of seafood; chile relleños; stuffed olives; bombay mix; instant stew; instant miso soup; custard style yoghurts; yoghurt desserts; chilled meals made from fish; potato fritters; bottled vegetables; vegetable-based entrees; vegetable stock; prepared vegetable dishes; salted nuts; gumbo; scotch eggs; corned beef hash; prepared dishes consisting primarily of fishcakes, vegetables, boiled eggs, and broth (oden); frozen prepared meals consisting principally of vegetables; chicken croquettes; chicken stock; chicken balls; legume salads; meat boiled down in soy sauce (tsukudani meat); bologna; matzo ball soup; powdered milk for food purposes; mixes for making soup; mixes for making broths; vegetable soup preparations; veal stock; potato-based gnocchi; potato fritters; mashed potato; potato salad; radish cubed kimchi (kkakdugi); consommés; mincemeat made from fruits; stuffed cabbage rolls; coconut shrimp; canned pork and beans; soups; croquettes; beef jerky; sugar-coated fruits on a stick; spiced nuts; olives stuffed with feta cheese in sunflower oil; olives stuffed with red peppers; olives stuffed with red peppers and almonds; olives stuffed with almonds; olives stuffed with pesto in sunflower oil; omelets; breaded and fried jalapeno peppers; vegetable marrow paste; quenelles; rhubarb in syrup; beef stew; rosti [fried grated potato cakes]; roast chestnuts; roasted nuts; potato-based salads; meat-based snack foods; soy burger patties; puffed pork rind; canned soups; extracts for soups; soup concentrates; soup pastes; soup (preparations for making -); soup powders; soup cubes; teriyaki chicken; frozen appetizers consisting primarily of chicken; frozen appetizers consisting primarily of seafood; tofu; tofu burger patties; vegetable burgers; vegetarian sausages; clam juice; hazelnuts, prepared; prepared snails [escargot]; tzatziki; prepared salads; preparations for making bouillon; onion rings; stock [prepared]; soya [prepared]; edible birds' nests; ready cooked meals consisting wholly or substantially wholly of meat; ready cooked meals consisting wholly or substantially wholly of game; ready cooked meals consisting wholly or substantially wholly of poultry; pre-cooked miso soup; pre-cooked soup; pre-cooked curry stew; pre-packaged dinners consisting primarily of game; cooked meals consisting principally of fish; chilled foods consisting predominately of fish; prepared meals consisting primarily of meat substitutes; white pudding; sausages in batter; spicy beef broth (yukgaejang).

30 – Coffee, tea, edible salt, seasonings, spices, flavourings for beverages other than essential oils;

sugar, sweeteners (natural -), pineapple fritters; flavoured popcorn; banana fritters; baozi [stuffed buns]; flaky pastry containing ham; pretzels; brioches; bean jam buns; frankfurter sandwiches; burritos; chalupas; cheeseburgers [sandwiches]; chimichanga; chinese steamed dumplings (shumai, cooked); crackers flavoured with cheese; enchiladas; pastries consisting of vegetables and fish; rice-based prepared meals; prepared meals in the form of pizzas; prepared meals containing [principally] pasta; pies containing meat; meat pies; fresh pizza; fresh sausage rolls; egg rolls; spring rolls; prawn crackers; fried corn; chilled pizzas; frozen pastry stuffed with meat; frozen pastry stuffed with vegetables; pasta containing stuffings; chinese stuffed dumplings (gyoza, cooked); filled bread rolls; vegetable pies; rice based dishes; meals consisting primarily of pasta; corn kernels being toasted; toasted sandwiches; toasted cheese sandwich; toasted cheese sandwich with ham; gimbap [korean rice dish]; mincemeat pies; flapjacks; hamburgers being cooked and contained in a bread roll; hamburgers contained in bread rolls; hot sausage and ketchup in cut open bread rolls; millet cakes; hot dog sandwiches; jiaozi [stuffed dumplings]; shrimp dumplings; preserved pizzas; korean-style pasta soup [sujebi]; stir-fried noodles with vegetables (japchae); cheese curls [snacks]; macaroni with cheese; pumpkin porridge (hobakjuk); lasagne; macaroni salad; microwave popcorn; sandwiches containing fish fillet; sandwiches containing meat; steamed buns stuffed with minced meat (niku-manjuh); ready-made dishes containing pasta; noodle-based prepared meals; canned pasta foods; pasta salad; okonomiyaki [japanese savory pancakes]; pasta dishes; pastries consisting of vegetables and meat; pastries consisting of vegetables and poultry; pies containing fish; pies containing poultry; pies containing vegetables; pies containing game; stir-fried rice; savory pastries; prepared pizza meals; pizza; pot pies; popcorn; quiches; ramen [japanese noodle-based dish]; ravioli; prepared ravioli; bibimbap [rice mixed with vegetables and beef]; prepared rice dishes; rice salad; risotto; salted tarts; samosas; sandwiches; sandwiches containing fish; sandwiches containing chicken; sandwiches containing minced beef; sandwiches containing salad; pork pies; spaghetti and meatballs; canned spaghetti in tomato sauce; meals consisting primarily of rice; pre-packaged lunches consisting primarily of rice, and also including meat, fish or vegetables; prepared meals containing [principally] rice; poultry and game meat pies; sausage rolls; prepared foodstuffs in the form of sauces; pasta-based prepared meals.

32 – Beer and beer-based beverages; non-alcoholic beverages; preparations for making beverages.

33 – Alcoholic beverages (except beer); preparations for making alcoholic beverages.

(260) AM 2018 96597 A

(800) 1389609

(151) 2017 10 13

(891) 2017 10 13

(731) EDESMA SOCIETE ANONYME
INDUSTRIAL AND COMMERCIAL-FOOD
PRODUCTION AND TRADING trading as
EDESMA S.A.

Industrial Area Sindos A5, GR-570 22
Thessaloniki, Greece

(540)

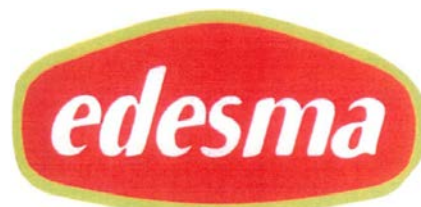

(591) Light green, red and white. The phrase "edesma" in white lettering with red background and oval outline

(531) 26.04.04; 26.04.06; 26.04.22; 26.04.24;
27.05.01; 27.05.17; 29.01.13

(511)

29 – Meat; fish; fish, preserved; fish, not live; fish mousses; fish paste; processed seafood; seafood, not live; charcuterie; cured meat; meat preserved; processed meat; sausages; meat paste; meat-based spreads; vegetable salads; vegetable-based spreads; egg-plant paste; vegetable marrow paste; cheese spreads; hummus; antipasto salads; fish paste; bean dips; garlic-based spreads; fish roe, prepared; tzatziki.

30 – Mustard; sauces [condiments]; mayonnaise.

31 – Vegetables, fresh; vegetables marrows, fresh.

(260) AM 2018 96599 A

(800) 1389618

(151) 2017 09 08

(891) 2017 09 08

(731) ANTON LEONIDOVYCH GLADCHENKO
vul. Velozavodska, 30 A, kv. 137, Kharkiv
61176, Ukraine

(540)



(591) Black, white

(531) 03.13.01; 27.03.03

(511)

5 – Absorbent cotton; acaricides; acetates for pharmaceutical purposes; acids for pharmaceutical purposes; aconitine; adhesive plasters; adhesives for dentures; adhesive tapes for medical purposes; adjuvants for medical purposes; air purifying preparations; albuminous foodstuffs for medical purposes;

albuminous preparations for medical purposes; alcohol for pharmaceutical purposes; aldehydes for pharmaceutical purposes; algicides; alginates for pharmaceutical purposes; alkaline iodides for pharmaceutical purposes; alkaloids for medical purposes; alloys of precious metals for dental purposes; almond milk for pharmaceutical purposes; aloe vera preparations for pharmaceutical purposes; aluminium acetate for pharmaceutical purposes; amino acids for medical purposes; amino acids for veterinary purposes; anaesthetics; analgesics; angostura bark for medical purposes; animal washes [insecticides]; antibiotics; anticryptogamic preparations; antiparasitic collars for animals; antiparasitic preparations; antiseptic cotton; antiseptics; anti-uric preparations; appetite suppressants for medical purposes; aseptic cotton; asthmatic tea; bacterial poisons; bacterial preparations for medical and veterinary use; bacteriological preparations for medical and veterinary use; balms for medical purposes; balsamic preparations for medical purposes; bandages for dressings; barks for pharmaceutical purposes; bath preparations for medical purposes; bath salts for medical purposes; belts for sanitary napkins [towels]; bicarbonate of soda for pharmaceutical purposes; biocides; biological preparations for medical purposes; biological preparations for veterinary purposes; bismuth preparations for pharmaceutical purposes; bismuth subnitrate for pharmaceutical purposes; blood for medical purposes; blood plasma; bone cement for surgical and orthopaedic purposes; breast-nursing pads; bromine for pharmaceutical purposes; bronchodilating preparations; bunion pads; by-products of the processing of cereals for dietetic or medical purposes; cachets for pharmaceutical purposes; cachou for pharmaceutical purposes; calomel [fungicide]; camphor for medical purposes; camphor oil for medical purposes; candy for medical purposes; candy, medicated; capsules for medicines; carbolineum [parasiticide]; castor oil for medical purposes; cattle washes [insecticides]; caustic pencils; caustics for pharmaceutical purposes; cedar wood for use as an insect repellent; cellulose esters for pharmaceutical purposes; cellulose ethers for pharmaceutical purposes; cement for animal hooves; charcoal for pharmaceutical purposes; chemical conductors for electrocardiograph electrodes; chemical contraceptives; chemical preparations for medical purposes; chemical preparations for pharmaceutical purposes; chemical preparations for the diagnosis of pregnancy; chemical preparations for treating phylloxera; chemical preparations for veterinary purposes; chemical preparations to treat mildew; chemical preparations to treat wheat blight [smut]; chemical reagents for medical or veterinary purposes; chemico-pharmaceutical preparations; chewing gum for medical purposes; chilblain preparations; chinoline for medical purposes; chloroform; cocaine; cod liver oil; collodion for pharmaceutical purposes; compresses; condu-

rango bark for medical purposes; contact lens cleaning preparations; corn remedies; corn rings for the feet; cotton for medical purposes; cream of tartar for pharmaceutical purposes; creosote for pharmaceutical purposes; croton bark; cultures of microorganisms for medical or veterinary use; curare; decoctions for pharmaceutical purposes; dental abrasives; dental amalgams; dental amalgams of gold; dental cements; dental impression materials; dental lacquer; dental mastics; deodorants, other than for human beings or for animals; depuratives; detergents for medical purposes; diabetic bread adapted for medical use; diagnostic preparations for medical purposes; diapers for incontinents; diastase for medical purposes; dietetic beverages adapted for medical purposes; dietetic foods adapted for medical purposes; dietetic substances adapted for medical use; digestives for pharmaceutical purposes; digitalin; dill oil for medical purposes; disinfectants for chemical toilets; disinfectants for hygiene purposes; disinfectant soap; dog washes [insecticides]; dressings, medical; elixirs [pharmaceutical preparations]; enzyme preparations for medical purposes; enzyme preparations for veterinary purposes; enzymes for medical purposes; enzymes for veterinary purposes; ergot for pharmaceutical purposes; esters for pharmaceutical purposes; ethers for pharmaceutical purposes; eucalyptol for pharmaceutical purposes; eucalyptus for pharmaceutical purposes; extracts of hops for pharmaceutical purposes; eyepatches for medical purposes; febrifuges; fennel, for medical purposes; ferments for pharmaceutical purposes; first-aid boxes, filled; fish meal for pharmaceutical purposes; flour for pharmaceutical purposes; flowers of sulfur for pharmaceutical purposes; fly catching paper; fly destroying preparations; fly glue; food for babies; formic aldehyde for pharmaceutical purposes; frostbite salve for pharmaceutical purposes; fumigating sticks; fumigation preparations for medical purposes; fungicides; gallic acid for pharmaceutical purposes; gamboge for medical purposes; gases for medical purposes; gauze for dressings; gelatine for medical purposes; gentian for pharmaceutical purposes; germicides; glucose for medical purposes; glycerine for medical purposes; glycerophosphates; greases for medical purposes; greases for veterinary purposes; guaiacol for pharmaceutical purposes; gum for medical purposes; gurjun [gurjon, gurjan] balsam for medical purposes; hematogen; hemoglobin; hemorrhoid preparations; hemostatic pencils; herbal teas for medicinal purposes; herbicides; hormones for medical purposes; hydrastine; hydrastinine; hydrated chloral for pharmaceutical purposes; hydrogen peroxide for medical purposes; immunostimulants; infant formula; insecticidal animal shampoo; insecticidal veterinary washes; insecticides; insect repellent incense; insect repellents; iodides for pharmaceutical purposes; iodine for pharmaceutical purposes; iodoform; Irish moss for medical purposes; isotopes for

medical purposes; jalap; jujube, medicated; lacteal flour for babies; lactose for pharmaceutical purposes; larvae exterminating preparations; laxatives; lead water; lecithin for medical purposes; leeches for medical purposes; lime-based pharmaceutical preparations; liniments; linseed for pharmaceutical purposes; linseed meal for pharmaceutical purposes; lint for medical purposes; liquorice for pharmaceutical purposes; lotions for pharmaceutical purposes; lotions for veterinary purposes; lupulin for pharmaceutical purposes; magnesia for pharmaceutical purposes; malted milk beverages for medical purposes; malt for pharmaceutical purposes; mangrove bark for pharmaceutical purposes; media for bacteriological cultures; medical preparations for slimming purposes; medicated eye-washes; medicated shampoos for pets; medicinal alcohol; medicinal drinks; medicinal hair growth preparations; medicinal herbs; medicinal infusions; medicinal mud; medicinal oils; medicinal roots; medicinal tea; medicine cases, portable, filled; medicines for alleviating constipation; medicines for dental purposes; medicines for human purposes; medicines for veterinary purposes; melissa water for pharmaceutical purposes; menthol; mercurial ointments; milk ferments for pharmaceutical purposes; milking grease; mineral food supplements; mineral water salts; mineral waters for medical purposes; mint for pharmaceutical purposes; molding wax for dentists; moleskin for medical purposes; mothproofing paper; mothproofing preparations; mouthwashes for medical purposes; mud for baths; mustard for pharmaceutical purposes; mustard oil for medical purposes; mustard plasters; myrobalan bark for pharmaceutical purposes; narcotics; nervines; nutritional supplements; nutritive substances for microorganisms; oil of turpentine for pharmaceutical purposes; ointments for pharmaceutical purposes; opiates; opium; opodeldoc; ophotherapy preparations; oxygen baths; oxygen for medical purposes; pants, absorbent, for incontinents; panty liners [sanitary]; paper for mustard plasters; parasiticides; pastilles for pharmaceutical purposes; pectin for pharmaceutical purposes; pepsins for pharmaceutical purposes; peptones for pharmaceutical purposes; pesticides; petroleum jelly for medical purposes; pharmaceutical preparations; pharmaceutical preparations for skin care; pharmaceutical preparations for treating dandruff; pharmaceutical preparations for treating sunburn; pharmaceuticals; phenol for pharmaceutical purposes; phosphates for pharmaceutical purposes; plant extracts for pharmaceutical purposes; poisons; pomades for medical purposes; porcelain for dental prostheses; potassium salts for medical purposes; poultices; powdered milk for babies; powder of cantharides; preparations for callouses; preparations for destroying dry rot fungus; preparations for destroying mice; preparations for destroying noxious animals; preparations for the treatment of burns; preparations of microorganisms for medical or veterinary

use; preparations of trace elements for human and animal use; preparations to facilitate teething; propolis for pharmaceutical purposes; purgatives; pyrethrum powder; quassia for medical purposes; quebracho for medical purposes; quinine for medical purposes; quinquina for medical purposes; radioactive substances for medical purposes; radiological contrast substances for medical purposes; radium for medical purposes; rat poison; remedies for foot perspiration; remedies for perspiration; repellents for dogs; rhubarb roots for pharmaceutical purposes; royal jelly for pharmaceutical purposes; rubber for dental purposes; salts for medical purposes; salts for mineral water baths; sanitary pads; sanitary panties; sanitary tampons; sanitary towels; sarsaparilla for medical purposes; scapulars for surgical purposes; sea water for medicinal bathing; sedatives; semen for artificial insemination; serotherapeutic medicines; serums; siccatives [drying agents] for medical purposes; slug exterminating preparations; smelling salts; smoking herbs for medical purposes; sodium salts for medical purposes; soil-sterilising preparations; solutions for contact lenses; solvents for removing adhesive plasters; soporifics; starch for dietetic or pharmaceutical purposes; sterilising preparations; steroids; stick liquorice for pharmaceutical purposes; strychnine; styptic preparations; sugar for medical purposes; sulfur sticks [disinfectants]; sunburn ointments; suppositories; surgical dressings; surgical implants comprised of living tissues; syrups for pharmaceutical purposes; tartar for pharmaceutical purposes; teeth filling material; therapeutic preparations for the bath; thermal water; thymol for pharmaceutical purposes; tincture of iodine; tinctures for medical purposes; tissues impregnated with pharmaceutical lotions; tobacco extracts [insecticides]; tobacco-free cigarettes for medical purposes; tonics [medicines]; turpentine for pharmaceutical purposes; vaccines; vaginal washes for medical purposes; vermifuges; vermin destroying preparations; vesicants; veterinary preparations; vine disease treating chemicals; vitamin preparations; vulnerary sponges; wadding for medical purposes; wart pencils; yeast for pharmaceutical purposes.

(260) AM 2018 96602 A

(800) 1389647

(151) 2017 11 27

(891) 2017 11 27

(731) HUAWEI TECHNOLOGIES CO., LTD.

Administration Building Huawei

Technologies Co., Ltd., Bantian, Longgang

District, Shenzhen, China

(540)

HUAWEI

(591) Black, white

(511)

9 – Downloadable software for operating, recording, controlling, monitoring and moving robotic systems and devices; software for robot systems; electric monitoring apparatus; electric installations for the remote control of industrial operations; remote control apparatus; audiovisual teaching apparatus; teaching apparatus; black boxes (data recorders); interactive touch screen terminals; humanoid robots with artificial intelligence; electronic sheet music, downloadable; smart rings; recorded computer programmes (programs); protective films adapted for smartphones; audio interfaces; electric and electronic effects units for musical instruments; equalizers (audio apparatus); virtual reality headsets; automobile data recorders; set-top boxes; headphones; digital weather stations; biochips; infrared detectors; electronic key fobs being remote control apparatus; charging stations for electric vehicles; batteries for electronic cigarettes; security tokens (encryption devices); downloadable mobile phone software applications; fingerprint identifiers; human face recognition devices; scales with body mass analyzers; baby scales; bathroom scales; thermal imaging cameras; subwoofers; audio mixers; needles for surveying compasses; pressure indicators; thermo-hygrometers; safety restraints, other than for vehicle seats and sports equipment; respiratory masks, other than for artificial respiration; electronic access control systems for interlocking doors.

(260) AM 2018 96603 A

(800) 1389652

(151) 2017 11 30

(891) 2017 11 30

(731) WORLD TRIATHLON CORPORATION

3407 W. Dr. Martin Luther King Jr. Blvd,
Suite 100, Tampa FL 33607, USA

(540)

IRONMAN

(591) Black, white

(511)

25 – Clothing for men, women and youths namely, shirts, shorts, jackets, swimwear, socks, gloves, hats, headbands, wristbands and wetsuits, marketed in association with contests consisting of running, biking and swimming; clothing for men, women and youths, namely, pants, t-shirts, caps in the nature of headwear, bicycling shorts, hoodies, outerwear in the nature of fleece pullovers, jackets and gloves, footwear, insoles, heel inserts, clothing belts, athletic sleeves, underwear, bras, sweaters, robes, sweat shirts, visors in the nature of headwear marketed in association with contests involving running, swimming and biking.

41 – Entertainment services, namely, organization and presentation of sporting events consisting running, swimming and cycling competitions.

(260) AM 2018 96604 A

(800) 1389705

(151) 2017 12 29

(891) 2017 12 29

(731) GN TOBACCO Sweden AB

Box 537, SE-175 26 Järfälla, Sweden

(540)

Siberia –80°C

(591) Black, white

(511)

34 – Tobacco; tobacco products; cigarillos; smokers' articles; matches; snuff and snuff boxes.

(260) AM 2018 96652 A

(800) 1390160

(151) 2017 11 29

(891) 2027 11 29

(731) AQUASTRONG (SHANGHAI)

INTERNATIONAL TRADING CO., LTD.

Rm 133, Building 5 (South), No.3131

Jinshajiang Road, Jiading District Shanghai,
China

(540)



(591) Black and white

(531) 01.15.15; 02.09.15; 27.05.17

(511)

7 – Alternators; engines for boats; motors for boats; pumps [machines]; vacuum pumps [machines]; compressed air pumps; fuel dispensing pumps for service stations; hydraulic valve actuators; oil pumps for land vehicle engines.

(260) AM 2018 96664 A

(800) 1390383

(151) 2017 11 29

(891) 2017 11 29

(731) YIWU LEWANG STATIONERY CO., LTD.

(Located inside Yiwu Xiao Xin Accessories

Factory), No.22 Ganlin Road, Yiting Town,

Yiwu City Zhejiang Province, China

(540)

(591) Black and white

(531) 27.05.17

(511)
16 – Note books; printed matter; stationery; document files [stationery]; writing instruments; drawing pens; marking pens [stationery]; pencils.

(260) AM 2018 96677 A

(800) 1390727

(151) 2017 11 14

(891) 2017 11 14

(731) SAINT-GOBAIN CORNING

AUTOMOTIVE GLAZING

Immeuble Bayard, 8 rue Clément Bayard,

F-60200 COMPIÈGNE, France

(540)

LITESHIELD

(591) Black, white

(511)

12 – Glazing for vehicles, in particular: windshields, rear windows, side windows, roof glazing, rear quarter panels; all the aforesaid goods for land, rail, sea and air vehicles.

21 – Unworked and semi-worked glass (excluding building glass); glass for vehicle windows; glass incorporating thin electrical conductors other than for construction; thin and extra thin glass other than for construction; laminated glass other than for construction.

37 – Installation, replacement, repair and customization of glazing for vehicles; installation of sunroofs for vehicles; all the aforesaid goods for land, rail, sea and air vehicles.

(260) AM 2018 96681 A

(800) 726176

(151) 1999 12 09

(891) 2018 01 19

(731) EDELMANN GMBH

Steinheimer Str. 45, 89518 Heidenheim,

Germany

(540)

EDELMANN

(591) Black, white

(511)

7 – Machines for the packaging industry, filling machines and capping machines.

16 – Paper, cardboard, stationery and goods of cardboard (included in this class), packaging of paper, cardboard and light corrugated cardboard, also sealed or combined with plastic and/or metallised sheets.

(260) AM 2018 96682 A

(800) 761257

(151) 2001 06 28

(891) 2018 02 05

(731) BIOFARMA

50 rue Carnot, F-92284 SURESNES CEDEX,

France

(540)

ЭНЕРИОН

(591) Black, white

(511)

5 – Pharmaceutical products excluding the ones for the treatment of liver problems.

(260) AM 2018 96683 A

(800) 903358

(151) 2006 08 16

(891) 2018 01 16

(731) B.F.C. S.R.L.

Via Martiri Delle Foibe n. 15, I-31015

SCOMIGO DI CONEGLIANO (TV), Italy

(540)



(591) Black, white

(531) 26.11.12; 27.05.17; 27.05.23

(511)

7 – Electric coffee grinders, dishwashers for plates and glasses.

9 – Measuring devices, automatic vending machines.

11 – Electric coffee machines, espresso and cappuccino machines, automatic coffee machines and their accessories included in this class, electric coffee filters, ice cube makers.

(260) AM 2018 96684 A

(800) 985322

(151) 2008 10 17

(891) 2017 12 11

(731) PARFUM FRANCIS KURKDJIAN

41 rue Etienne Marcel, F-75001 PARIS,

France

(540)

FRANCIS KURKDJIAN

(591) Black, white

(511)

4 – Candles and wicks for lighting, perfumed candles.

(260) AM 2018 96685 A
 (800) 1076165
 (151) 2010 12 03
 (891) 2017 10 31
 (731) "GRAND TOBACCO" LLC
 Shahamiryanneri street 22, 0061 Yerevan,
 Armenia

(540)



(591) Blue, white, red, black and silver
 (531) 19.03.24; 24.01.09; 24.01.15; 25.01.01;
 29.01.14

(526) GOLDEN FLAME and AMERICAN BLEND

(511)

34 – Tobacco; smokers' articles; matches.

(260) AM 2018 96687 A
 (800) 1182147
 (151) 2013 08 05
 (891) 2017 12 20
 (731) MAKYAJ KOZMETIK INSAAT SANAYI
 VE TICARET LIMITED SIRKETI
 Hadımköy Bağlantı Yolu Akçaburgaz Mah.
 No:140, Esenyurt ISTANBUL, Turkey

(540)

NEW WELL

(591) Black, white

(511)

3 – Bleaching preparations and other substances for laundry use; cleaning, polishing, scouring and abrasive preparations; soaps; perfumery, essential oils, cosmetics, hair lotions; dentifrices.

(260) AM 2018 96688 A
 (800) 1203331
 (151) 2014 01 16
 (891) 2017 10 09
 (731) EKIN ENDUSTRIYEL ISITMA SOGUTMA
 SAN. VE TIC. LTD. STI.

Des Sanayi Sitesi 107 Sk. B:14, Blok No:2,
 Umraniye Istanbul, Turkey

(540)



(591) Red and blue (saxe).

(531) 01.01.01; 01.01.02; 01.01.10; 26.11.12;
 27.05.17; 27.05.23; 29.01.12

(511)

11 – Apparatus for lighting, heating, steam generating, cooking, refrigerating, drying, ventilating, water supply and sanitary purposes.

(260) AM 2018 96794 A

(800) 1298811

(151) 2015 11 30

(891) 2018 01 22

(731) CHINA XD ELECTRIC CO.,LTD.

Building A, No.7, Tangxing Road, Xi'an,
 710075 Shaanxi, China

(540)



(591) Black, white

(531) 01.15.03; 27.05.08; 27.05.17; 27.05.23

(511)

9 – Converters, electric; high and low voltage switch boards; power switches; electric reactors; on load tap changer (switches, electric); off circuit tap changer (switches, electric); control cabinet, electric, for electrical control and signal input and output; gas insulated metal enclosed switchgear used for high-voltage power system (electric); electric transformers; circuit breakers; semi-metal enclosed composite apparatus used for high-voltage power system (electrical switching equipment); air insulated open composite apparatus used for power system (electrical switching equipment); regulating apparatus, electric; current rectifiers; power plant DC systems consisting of large battery chargers and dischargers and DC operating power supplies; rectifier device for chemical electrolysis (high-power DC power supply with rectification); semi-conductor devices; current converters; industrial power supplies (DC power); high voltage direct current transmission converter valve for transferring electric energy; static

dynamic reactive power compensation device used for transferring power, enhancing power of industrial power grid and improving voltage fluctuation; power compensation device used for transferring power, enhancing power of industrial power grid and suppressing harmonic wave; reactive power compensation device for improving power grid capacity of power system; compensation sets for improving power grid capacity of power system; filter sets for filtering harmonic wave of power system; filters; capacitors; lightning conductors [rods]; fuses; surveying apparatus and instruments; wires, electric; cables, electric; electric power converters; navigational instruments; coolers for transformers; radiators for transformers; sensors; power chargers for industrial purposes; electric installations for the remote control of industrial operations.

17 – Electrical insulators made of ceramic materials; insulating materials; insulating materials; insulating paint; insulating fabrics; mica, raw or partly processed; insulators; insulating tape; insulating paper; insulating coatings; condenser-type terminal (terms too vague in the opinion of the International Bureau – Rule 13(2)(b) of the Common Regulations).

(260) AM 2018 96795 A

(800) 1325706

(151) 2015 10 21

(891) 2018 02 15

(731) VİKİNG KAĞIT VE SELÜLOZ ANONİM ŞİRKETİ

Hürriyet Caddesi No:474 Aliğa, İzmir, Turkey

(540)



(591) Blue, white

(531) 26.01.02; 26.01.24; 27.05.24; 29.01.12

(511)

3 – Bleaching and cleaning preparations, detergents other than for use in manufacturing operations and for medical purposes, laundry bleach, fabric softeners for laundry use, stain removers, dishwasher detergents; perfumery; cosmetics; fragrances; deodorants for personal use and animals; soaps; dental care preparations: dentifrices, denture polishes, tooth whitening preparations, mouth washes, not for medical purposes; abrasive preparations; emery cloth; sandpaper; pumice stone; abrasive pastes; polishing preparations for leather, vinyl, metal and wood, polishes and creams for leather, vinyl, metal and wood, wax for polishing.

5 – Dietary supplements for pharmaceutical and veterinary purposes; dietary supplements; nutritional supplements; medical preparations for slimming purposes; food for babies; herbs and herbal beverages adapted for medicinal purposes; dental preparations and articles: teeth filling material, dental impression material, dental adhesives and material for repairing teeth; sanitary preparations for medical use; hygienic pads; hygienic tampons; plasters; materials for dressings; diapers, including those made of paper and textiles; preparations for destroying vermin; fungicides, herbicides; deodorants, other than for human beings or for animals; air deodorizing preparations; disinfectants; antiseptics; detergents for medical purposes.

16 – Paper and cardboard; paper and cardboard for packaging and wrapping purposes, cardboard boxes; paper towels; toilet paper; paper napkins; plastic materials for packaging and wrapping purposes; printing blocks and types; bookbinding material; printed publications; printed matter; books, magazines, newspapers, bill books, printed dispatch notes, printed vouchers, calendars; posters; photographs [printed]; paintings; stickers [stationery]; postage stamps; office requisites; paint rollers and paintbrushes for painting; rosaries.

(260) AM 2018 96822 A

(800) 1391363

(151) 2017 07 25

(891) 2017 07 25

(731) SATELLITE INNOVATION LIMITED LIABILITY COMPANY

Shosse Kosmonavtov St, 111/27 Office 301 RU-614066 Perm, Russian Federation

(540)

eocortex



(591) Black, white and orange.

(531) 26.01.10; 26.01.24; 26.03.23; 27.05.17; 29.01.13

(511)

9 – High-frequency apparatus; testing apparatus not for medical purposes; remote control apparatus; electro-dynamic apparatus for the remote control of signals; monitoring apparatus, electric; sound recording apparatus; computer memory devices; camcorders; video baby monitors; viewfinders, photographic; detectors; measures; interfaces for computers; computers; laptop computers; tablet computers; notebook computers; microprocessors; modems; monitors [computer hardware]; monitors [computer programs]; computer software, recorded; computer apparatus; wafers for integrated circuits; distance recording apparatus; distance measuring apparatus; speed

measuring apparatus [photography]; time recording apparatus; measuring apparatus; measuring devices, electric; observation instruments; computer software applications, downloadable; computer programmes [programs], recorded; computer game software; computer programs [downloadable software]; computer operating programs, recorded; processors [central processing units]; integrated circuits; baby monitors; video recorders; sound reproduction apparatus; tape recorders; data processing apparatus; couplers [data processing equipment]; anti-theft warning apparatus; computer peripheral devices; readers [data processing equipment]; chips [integrated circuits].

42 – Computer system analysis; installation of computer software; research and development of new products for others; calibration [measuring]; computer security consultancy; information technology [IT] consultancy; consultancy in the design and development of computer hardware; internet security consultancy; computer software consultancy; data security consultancy; updating of computer software; monitoring of computer systems to detect breakdowns; monitoring of computer systems for detecting unauthorized access or data breach; monitoring of computer systems by remote access; software as a service [SaaS]; maintenance of computer software; providing information on computer technology and programming via a web site; computer system design; rental of web servers; computer rental; rental of computer software; server hosting; duplication of computer programs; computer software design; computer programming; outsource service providers in the field of information technology; off-site data backup; computer technology consultancy; telecommunications technology consultancy; cloud computing; data encryption services; electronic data storage.

(260) AM 2018 96823 A

(800) 1391364

(151) 2017 09 12

(891) 2017 09 12

(731) APPLE INC.

One Apple Park Way, Cupertino CA 95014, USA

(540)

IBOOKS STORE

(591) Black, white

(531) 27.05.01

(526) STORE

(511)

35 – Retail store services featuring electronic publications, for use with proprietary software, provided via the Internet and other communications networks; retail store services featuring electronic publications for use with proprietary software on handheld mo-

bile digital electronic devices and other consumer electronics.

42 – Providing an Internet website portal featuring technology that allows Internet users to preview and download electronic publications, for use with proprietary software, on a wide range of topics of general interest (term considered too vague by the International Bureau – Rule 13.2.b of the Common Regulations).

(260) AM 2018 96829 A

(800) 1391995

(151) 2017 11 10

(891) 2017 11 10

(731) Limited Liability Company Wine and Brandy Factory "ALLIANCE-1892"

Gogolya St., 9 A, Chernyakhovsk RU-238150 Kaliningrad region, Russian Federation

(540)



(591) Brown, golden, yellow, beige, white and light brown

(531) 19.01.05; 19.01.07; 25.01.05; 25.01.19; 26.01.06; 28.05; 29.01.13

(511)

32 – Beers; mineral and aerated waters and other non-alcoholic beverages; fruit beverages and fruit juices; syrups and other preparations for making beverages; aperitifs, non-alcoholic; lithia water; seltzer water; soda water; waters [beverages]; mineral water [beverages]; table waters; kvass [non-alcoholic beverage]; cocktails, non-alcoholic; beer-based cocktails; lemonades; isotonic beverages; non-alcoholic honey-based beverages; rice-based beverages, other than milk substitutes; soya-based beverages, other than milk substitutes; aloe vera drinks, non-alcoholic; whey beverages; protein-enriched sports beverages; soft drinks; non-alcoholic beverages flavoured with coffee; non-alcoholic beverages flavoured with tea; fruit nectars, non-alcoholic; orgeat; ginger beer; malt beer; powders for effervescing beverages; sarsaparilla [non-alcoholic beverage]; syrups for lemonade; syrups for beverages; smoothies; tomato juice [beverage]; cider, non-alcoholic; vegetable juices [beverages]; preparations for making aerated water; preparations for making liqueurs; preparations for making mineral water; must; grape must, unfermented; beer wort; malt wort; pastilles for

effervescing beverages; sherbets [beverages]; non-alcoholic fruit extracts; extracts of hops for making beer; essences for making beverages.

33 – Alcoholic beverages (except beers); aperitifs; arak; baijiu [Chinese distilled alcoholic beverage]; brandy; wine; piquette; whisky; vodka; anisette [liqueur]; kirsch; gin; digesters [liqueurs and spirits]; cocktails; curacao; anise [liqueur]; liqueurs; pre-mixed alcoholic beverages, other than beer-based; alcoholic beverages, except beer; alcoholic beverages containing fruit; spirits [beverages]; distilled beverages; mead [hydromel]; peppermint liqueurs; bitters; nira [sugarcane-based alcoholic beverage]; rum; sake; perry; cider; rice alcohol; alcoholic extracts; fruit extracts, alcoholic; alcoholic essences.

(260) AM 2018 96874 A

(800) 1392475

(151) 2017 02 08

(891) 2017 02 06

(731) VALIO LTD

Meijeritie 6, FI-00370 Helsinki, Finland

(540)

GRAN REGALE

(591) Black, white

(511)

29 – Meat, fish, poultry and game; meat extracts; preserved, frozen, dried and cooked fruits and vegetables; jellies, jams, compotes; eggs; milk and milk products; oils and fats for food; cheese.

(260) AM 2018 96953 A

(800) 1393311

(151) 2017 12 21

(891) 2017 12 21

(731) APPLE INC.

One Apple Park Way, Cupertino CA 95014, USA

(540)

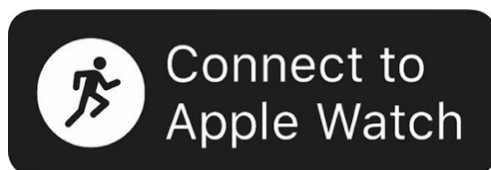

(591) Black and white

(531) 02.01.08; 02.01.23; 02.03.01; 02.03.05; 02.03.23; 26.01.14; 26.04.02; 26.04.04; 26.04.10; 26.04.24; 27.05.24

(526) CONNECT TO

(511)

9 – Computer software, including computer software in the field of health, fitness, exercise, and wellness.

10 – Health, fitness, exercise, and wellness sensors, monitors and displays; medical apparatus and devices.

28 – Fitness and exercise machines and equipment; body-building apparatus.

(260) AM 2018 96957 A

(800) 1393412

(151) 2017 10 31

(891) 2017 10 31

(731) Aktsionernoe obshchestvo "SLAVYANKA PLUS"

ul. 1-y Konnoy Armii, 65, Belgorodskaya obl. RU-309506 g. Stariy Oskol, Russian Federation

(540)



(591) Yellow, light yellow, black, brown, dark red, red, white and gray

(531) 05.07.06; 19.03.24; 25.07.01; 28.05; 29.01.13 (511)

30 – Seaweed [condiment]; pasta; almond paste; aniseed; star aniseed; confectionery for decorating Christmas trees; infusions, not medicinal; coffee flavourings; coffee flavorings; aromatic preparations for food; seasonings; unleavened bread; salt for preserving foodstuffs; rusks; cookies; biscuits; malt biscuits; sweetmeats [candy]; waffles; buns; cocoa; coffee; unroasted coffee; vegetal preparations for use as coffee substitutes; cakes; cinnamon [spice]; capers; caramels [candy]; curry [spice]; cereal preparations; chewing gum; chicory [coffee substitute]; tea; chocolate; marzipan; cloves [spice]; condiments; confectionery; sugar confectionery; corn flakes; maize flakes; popcorn; preparations for stiffening whipped cream; ice cream; pancakes; essences for foodstuffs, except etheric essences and essential oils; cooking salt; thickening agents for cooking foodstuffs; turmeric; natural sweeteners; spices; gingerbread; allspice; flour; meal; bean meal; corn flour; corn meal; maize flour; maize meal; mustard meal; barley meal; soya flour; wheat flour; starch for food; ferments for pastes; fondants [confectionery]; petits fours [cakes]; sugar; flavorings [flavourings], other than essential oils, for cakes; flavorings, other than essential oils, for cakes; flavourings, other than essential oils, for cakes; cake powder; cake dough; cake batter; ginger [spice]; binding agents for ice cream; ice, natural or artificial; ice for refreshment; glucose for culinary purposes; gluten prepared as foodstuff; groats for human food; vinegar; ketchup [sauce]; cocoa beverages with milk; coffee beverages with milk; chocolate beverages with milk; leaven; yeast; sausage

binding materials; macarons [pastry]; macaroni; corn, milled; maize, milled; corn, roasted; maize, roasted; bread; maltose; molasses for food; golden syrup; mint for confectionery; honey; husked barley; mustard; nutmegs; noodles; ribbon vermicelli; pies; crushed barley; sandwiches; pastilles [confectionery]; lozenges [confectionery]; pastries; petit-beurre biscuits; bread rolls; peppers [seasonings]; pizzas; pepper; potato flour; puddings; pralines; ravioli; liquorice [confectionery]; rice; saffron [seasoning]; sago; sauces [condiments]; celery salt; semolina; sherbets [ices]; sorbets [ices]; spaghetti; tapioca; tapioca flour; tarts; vanilla flavourings for culinary purposes; vanilla flavorings for culinary purposes; vanillin [vanilla substitute]; vermicelli [noodles]; meat pies; meat tenderizers for household purposes; edible ices; powders for making ice cream; almond confectionery; peanut confectionery; food flavorings, other than essential oils; food flavourings, other than essential oils; flavourings, other than essential oils, for beverages; flavorings, other than essential oils, for beverages; crushed oats; husked oats; oat-based food; oat flakes; oatmeal; stick liquorice [confectionery]; beer vinegar; coffee-based beverages; cocoa-based beverages; chocolate-based beverages; artificial coffee; candy; chips [cereal products]; chow-chow [condiment]; couscous [semolina]; malt extract for food; malt for human consumption; propolis; bee glue; relish [condiment]; royal jelly; sea water for cooking; sushi; tomato sauce; mayonnaise; crackers; custard; fruit jellies [confectionery]; muesli; rice cakes; soya sauce; frozen yogurt [confectionery ices]; frozen yoghurt [confectionery ices]; chutneys [condiments]; spring rolls; tacos; tortillas; iced tea; tea-based beverages; dressings for salad; breadcrumbs; tabbouleh; halvah; quiches; meat gravies; miso [condiment]; soya bean paste [condiment]; cereal-based snack food; rice-based snack food; hominy; hominy grits; baking powder; baking soda [bicarbonate of soda for cooking purposes]; bicarbonate of soda for cooking purposes [baking soda]; garden herbs, preserved [seasonings]; noodle-based prepared meals; cake frosting [icing]; chocolate mousses; dessert mousses [confectionery]; fruit coulis [sauces]; marinades; cheeseburgers [sandwiches]; pesto [sauce]; ham glaze; linseed for culinary purposes [seasoning]; flaxseed for culinary purposes [seasoning]; wheat germ for human consumption; high-protein cereal bars; cream of tartar for culinary purposes; gluten additives for culinary purposes; pasta sauce; cereal bars; palm sugar; dough; flowers or leaves for use as tea substitutes; pastry dough; vareniki [stuffed dumplings]; pelmeni [dumplings stuffed with meat]; chocolate decorations for cakes; candy decorations for cakes; chocolate-coated nuts; rice pudding; nut flours; minced garlic [condiment]; baozi [stuffed buns]; rice pulp for culinary purposes; jiaozi [stuffed dumplings]; ramen [Japanese noodle-based dish]; okono-

miyaki [Japanese savoury pancakes]; okonomiyaki [Japanese savory pancakes]; batter mixes for okonomiyaki [Japanese savoury pancakes]; batter mixes for okonomiyaki [Japanese savory pancakes]; burritos; gimbap [Korean rice dish]; edible paper; edible rice paper.

(260) AM 2018 96958 A

(800) 1393420

(151) 2017 11 24

(891) 2017 11 24

(731) BALTIC CH OÜ

Mustamäe tee 24 EE-10621 Tallinn, Estonia

(540)



(591) Black and white

(531) 24.17.25; 27.05.10

(511)

11 – Air-conditioners; window, wall and ceiling mounted and portable air conditioners; cartridge systems, canal systems, pole systems, multiple opening systems [air conditioning]; multiple sub-systems [air conditioning]; high-tech air conditioning systems for regulating multi-storeyed buildings; water coolers; water coolers, namely, floor, table, with aeration and filtration built-in system water coolers; apparatus for heating; convectors; fan heaters; infrared heaters; oil fired heaters; humidifiers; ultrasonic and traditional humidifiers; household air cleaners; HEPA, ULPA, UV cleaners; water purification systems.

(260) AM 2018 96961 A

(800) 1393616

(151) 2017 09 22

(891) 2017 09 22

(731) BEYAZ KAĞIT VE HİJYENİK ÜRÜNLER
TEMİZLİK İNŞAAT SANAYİ TİCARET
ANONİM ŞİRKETİ

Hacı Sabancı Organize Sanayi Bölgesi
Anavarza Caddesi No:3 Sarıçam Adana,
Turkey

(540)



(531) 26.11.12; 27.05.01; 29.01.12

(511)

3 – Bleaching and cleaning preparations, detergents other than for use in manufacturing operations and for medical purposes, laundry bleach, fabric softeners for laundry use, stain removers, dishwasher detergents; perfumery; non-medicated cosmetics; fragrances; deodorants for personal use and animals; soaps; dental care preparations: dentifrices, denture polishes, tooth whitening preparations, mouth washes, not for medical purposes; abrasive preparations; emery cloth; sandpaper; pumice stone; abrasive pastes; polishing preparations for leather, vinyl, metal and wood, polishes and creams for leather, vinyl, metal and wood, wax for polishing.

(260) AM 2018 96962 A

(800) 1393500

(151) 2017 12 15

(891) 2017 12 15

(731) BAYER AKTIENGESELLSCHAFT
Kaiser-Wilhelm-Allee 51373 Leverkusen,
Germany

(540)

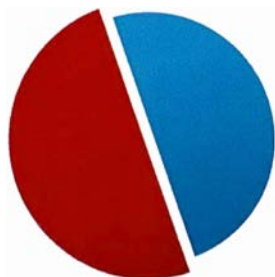

(591) Red and blue

(531) 26.02.07; 29.01.12

(511)

5 – Pharmaceutical preparations for the treatment of pulmonary hypertension.

(260) AM 2018 96963 A

(800) 1393641

(151) 2017 12 27

(891) 2017 12 27

(731) VALENTINO S.P.A.
Via Turati, 16/18, I-20121 MILANO, Italy

(540)

VERY VALENTINO

(591) Black, white

(511)

25 – Clothing; coveralls; underwear; jumpers; shirts; sweaters; tutus; ready-made clothing; breeches; top clothes; knitwear [clothing]; coats; skirts; petticoats; sweaters; topcoats; jackets [clothing]; quilted jackets; ski jackets; ski trousers; parkas; leather clothing; Tee-shirts; chemisettes; trousers; dressing gowns; tights; gilets; jerseys; pajamas (am.); robes; brassieres; vest tops; bustiers; briefs; children's wear; layettes; swimming caps; swimming costumes;

clothing for gymnastics; rainproof clothing; mackintoshes; masquerade costumes; headgear; hats; berets; visors; socks; suspenders for stockings; stockings; garters; muffs [clothing]; shawls; neckties; bow ties; scarves, sashes for wear; veils [clothing]; bandanas [neckerchiefs]; furs (clothing); stoles of fur; wedding dresses.

(260) AM 2018 96965 A

(800) 1393643

(151) 2017 12 05

(891) 2017 12 05

(731) MEGAINPHARM GMBH
Wörthersee-Südferstrasse 163 c5, A-9082
Maria Wörth, Austria

(540)

MYRAMISTIN

(591) Black, white

(531) 27.05.17

(511)

3 – Perfumery; cosmetic creams; beauty masks; oils for cosmetic purposes; oils for toilet purposes; deodorant soap; toiletry preparations; toiletries; tissues impregnated with cosmetic lotions; cosmetics; cosmetic preparations for skin care; lotions for cosmetic purposes; dentifrices; cosmetics for animals.

5 – Pharmaceutical preparations; veterinary preparations; chemico-pharmaceutical preparations; sanitary preparations for medical purposes; disinfectants; disinfectants for hygiene purposes; medicated soap; disinfectant soap; chemical preparations for pharmaceutical purposes; adjuvants for medical purposes; microbicides; germicides; preparations for the treatment of burns; antiseptic preparations; mouthwashes for medical purposes; ointments for pharmaceutical purposes; suppositories; pharmaceutical preparations for skin care; tissues impregnated with pharmaceutical lotions; lotions for pharmaceutical purposes; vulnary sponges; balms for medical purposes; solutions for contact lenses; dressings, medical; medical plasters.

(260) AM 2018 96968 A

(800) 1393644

(151) 2017 12 05

(891) 2017 12 05

(731) MEGAINPHARM GMBH
Wörthersee-Südferstrasse 163 c5, A-9082
Maria Wörth, Austria

(540)

MYRAMISTIN

(591) Magenta

(531) 27.05.02; 27.05.17; 29.01.01

(511)

3 – Perfumery; cosmetic creams; beauty masks; oils for cosmetic purposes; oils for toilet purposes; deodorant soap; toiletry preparations; toiletries; tissues impregnated with cosmetic lotions; cosmetics; cosmetic preparations for skin care; lotions for cosmetic purposes; dentifrices; cosmetics for animals.

5 – Pharmaceutical preparations; veterinary preparations; chemico-pharmaceutical preparations; sanitary preparations for medical purposes; disinfectants; disinfectants for hygiene purposes; medicated soap; disinfectant soap; chemical preparations for medical purposes; chemical preparations for pharmaceutical purposes; adjuvants for medical purposes; microbicides; germicides; preparations for the treatment of burns; antiseptic preparations; mouthwashes for medical purposes; ointments for pharmaceutical purposes; suppositories; pharmaceutical preparations for skin care; tissues impregnated with pharmaceutical lotions; lotions for pharmaceutical purposes; vulnery sponges; balms for medical purposes; solutions for contact lenses; dressings, medical; medical plasters.

(260) AM 2018 96969 A

(800) 1393539

(151) 2017 08 22

(891) 2017 08 22

(731) ROCKWOOL International A/S

Hovedgaden 584 DK-2640 Hedehusene,
Denmark

(540)



(591) Blue and white

(531) 26.04.01; 26.04.05; 26.04.10; 26.05.04;
29.01.12

(511)

6 – Building materials of metal, namely, grids of metal; ceiling systems of metal for attaching ceiling panels.

17 – Insulating materials of mineral wool; packing, stopping and insulating materials; insulants in the form of strips, felt, mats, boards, slatted mats, shaped parts for insulation and sealing against heat, cold, fire, sound, vibrations, air, light and humidity/moisture/damp/vapour, including sound absorbing materials for acoustic regulation; acoustic and thermal insulation products and articles; insulation and vapour barrier products and articles; insulation in the form of floor, wall and roof coverings; ceiling panels

of mineral wool fibres; mineral wool fibres in the form of matting for insulation; mineral wool/fibres [insulators]; processed mineral fibres for use in the manufacture of seals, sealants, fillers and gaskets; boards of extruded mineral wool, shells of mineral wool, blankets of mineral wool, mineral wool stucco and mineral wool felt, loose or semi-finished granulated mineral wool and loose or semi-finished mineral wool fibres for manufacture of reinforcing and/or filling materials for insulation; insulating mineral wool fibres for use in sealing and gasketing applications in the automotive and building industry; electrical insulating boards; friction materials; mineral wool boards for ventilated constructions, for façade cladding, roofs, soffits and fascias; insulating building materials of mineral wool; wall, floor and ceiling panels, all made of mineral wool and fibres.

19 – Building materials for road and track constructions and for fencing; processed mineral fibres for use in the manufacture of cements and plaster for building purposes; processed mineral fibres for use in the manufacture of asphalt sealants and of sealants for road construction and roofing.

(260) AM 2018 96970 A

(800) 1393652

(151) 2017 08 22

(891) 2017 08 22

(731) ROCKWOOL International A/S

Hovedgaden 584, DK-2640 Hedehusene,
Denmark

(540)



(591) The mark is in red and white.

(531) 26.04.01; 26.04.10; 26.05.04; 29.01.12
(511)

6 – Building materials of metal, namely, grids of metal; ceiling systems of metal for attaching ceiling panels.

17 – Insulating materials of mineral wool; packing, stopping and insulating materials; insulants in the form of strips, felt, mats, boards, slatted mats, shaped parts for insulation and sealing against heat, cold, fire, sound, vibrations, air, light and humidity/moisture/damp/vapour, including sound absorbing materials for acoustic regulation; acoustic and thermal insulation products and articles; insulation and vapour barrier products and articles; insulation in the form of floor, wall and roof coverings; ceiling panels of mineral wool fibres; mineral wool fibres in the

form of matting for insulation; mineral wool/fibres [insulators]; processed mineral fibres for use in the manufacture of seals, sealants, fillers and gaskets; boards of extruded mineral wool, shells of mineral wool, blankets of mineral wool, mineral wool stucco and mineral wool felt, loose or semi-finished granulated mineral wool and loose or semi-finished mineral wool fibres for manufacture of reinforcing and/or filling materials for insulation; insulating mineral wool fibres for use in sealing and gasketing applications in the automotive and building industry; electrical insulating boards; friction materials; mineral wool boards for ventilated constructions, for façade cladding, roofs, soffits and fascias; insulating building materials of mineral wool; wall, floor and ceiling panels, all made of mineral wool and fibres.

19 – Building materials for road and track constructions and for fencing; processed mineral fibres for use in the manufacture of cements and plaster for building purposes; processed mineral fibres for use in the manufacture of asphalt sealants and of sealants for road construction and roofing.

(260) AM 2018 97132 A

(800) 1395624

(151) 2018 01 12

(891) 2018 01 12

(731) ACM

17 Rue de Neuilly – Impasse Passoir, F-92110 CLICHY, France

(540)

EAU LAMELLAIRE

(591) Black, white

(511)

3 – Soaps; essential oils; cosmetics; gels, creams, milks, lotions; cosmetic skin care preparations; make-up removing products; make-up removing milks and gels; make-up removing creams; oils for cosmetic use; oils for toilet purposes; cleansing milk for toilet purposes; lotions for cosmetic use; beauty care and body cleaning preparations.

(260) AM 2018 97150 A

(800) 1140438

(151) 2012 10 11

(891) 2018 03 15

(731) BATA BRANDS SA

Avenue d'Ouchy 61, CH-1006 Lausanne, Switzerland

(540)

AW LAB

(591) Black, white

(511)

18 – Bags.

25 – Clothing, footwear, headgear.

35 – Retail sale services related to clothing, footwear, headgear and bags.

(260) AM 2018 97162 A

(800) 1354203

(151) 2016 09 09

(891) 2018 03 02

(731) Joint-Stock Company "VORONEZHSKAYA CONDITERSKAYA FABRIKA"

ul. Koltsovskaya, d. 40, RU-394030

Voronezh, Russian Federation

(540)



(591) Brown, white

(531) 18.03.02; 18.03.03; 26.01.03; 28.05; 29.01.12

(511)

30 – High-protein cereal bars; pancakes; bread rolls; waffles; malt biscuits; fruit jellies [confectionery]; confectionery for decorating Christmas trees; cakes; pastries; peanut confectionery; almond confectionery; cocoa; caramels [candy]; sweetmeats [candy]; liquorice [confectionery]; peppermint sweets; crackers; macaroons [pastry]; muesli; pastilles [confectionery]; cookies; petit-beurre biscuits; pies; fondants [confectionery]; pralines; gingerbread; petits fours [cakes]; confectionery; rusks; halvah; chocolate; tea; coffee.

INTERNATIONAL TRADEMARKS PROTECTED IN GEORGIA

(260) AM 2018 90638 A
(800) 438667
(151) 1978 06 16
(181) 1988 06 16
(891) 2017 01 05
(511) 06, 07, 09, 11

(260) AM 2018 92171 A
(800) 1157474
(151) 2013 03 11
(181) 2023 03 11
(891) 2016 12 22
(511) 3

(260) AM 2018 92247 A
(800) 1343989
(151) 2016 07 12
(181) 2026 07 12
(891) 2016 07 12
(511) 04, 09, 35, 36, 37, 39, 40

(260) AM 2018 92273 A
(800) 1343990
(151) 2017 05 12
(181) 2026 07 12
(891) 2016 07 12
(511) 04, 09, 35, 36, 37, 39, 40

(260) AM 2018 92564 A
(800) 1346029
(151) 2016 11 14
(181) 2026 11 14
(891) 2016 11 14
(511) 05, 10, 44

(260) AM 2018 92757 A
(800) 1347463
(151) 2016 08 08
(181) 2026 08 08
(891) 2016 08 08
(511) 09, 41, 42

(260) AM 2018 92824 A
(800) 1348618
(151) 2017 02 28
(181) 2027 02 28

(891) 2017 02 28
(511) 11

(260) AM 2018 93178 A
(800) 645215
(151) 1995 10 16
(181) 2025 10 16
(891) 2017 05 08
(511) 29

(260) AM 2018 93293 A
(800) 1354287
(151) 2017 02 02
(181) 2027 02 06
(891) 2017 02 02
(511) 29, 30, 31, 32, 33

(260) AM 2018 93295 A
(800) 1354590
(151) 2016 11 22
(181) 2026 11 22
(891) 2016 11 22
(511) 23, 24, 26

(260) AM 2018 93400 A
(800) 1355113
(151) 2017 03 27
(181) 2027 03 27
(891) 2017 03 27
(511) 03

(260) AM 2018 93446 A
(800) 1356690
(151) 2016 12 09
(181) 2026 12 09
(891) 2016 12 09
(511) 03, 09, 14, 18, 25, 26, 28, 35

(260) AM 2018 93595 A
(800) 1357653
(151) 2017 01 26
(181) 2027 01 26
(891) 2017 01 26
(511) 35, 36, 38

(260) AM 2018 93596 A
(800) 1357659
(151) 2017 01 27
(181) 2027 01 27
(891) 2017 01 27
(511) 05, 10

(260) AM 2018 93649 A
(800) 1323526
(151) 2016 04 27
(181) 2026 04 27
(891) 2017 05 11
(511) 14, 18, 25

(260) AM 2018 93739 A
(800) 1359200
(151) 2017 04 21
(181) 2027 04 21
(891) 2027 04 21
(511) 28, 41

(260) AM 2018 93741 A
(800) 1359893
(151) 2016 11 30
(181) 2026 11 30
(891) 2016 11 30
(511) 11, 30

(260) AM 2018 93788 A
(800) 1359422
(151) 2016 11 01
(181) 2026 11 01
(891) 2016 11 01
(511) 08, 16, 21, 35

(260) AM 2018 93791 A
(800) 1359464
(151) 2017 03 16
(181) 2027 03 16
(891) 2017 03 16
(511) 17, 19, 20

(260) AM 2018 93792 A
(800) 1359468
(151) 2017 02 22
(181) 2027 02 22
(891) 2017 02 22
(511) 04, 08, 11, 29, 35, 41, 43

(260) AM 2018 93947 A
(800) 1361306
(151) 2017 04 19
(181) 2027 04 19

(891) 2017 04 19
(511) 09

(260) AM 2018 93969 A
(800) 1361522
(151) 2017 06 19
(181) 2027 06 19
(891) 2017 06 19
(511) 29

(260) AM 2018 94150 A
(800) 1363502
(151) 2016 12 29
(181) 2026 12 29
(891) 2016 12 29
(511) 19

(260) AM 2018 94235 A
(800) 1365265
(151) 2017 04 07
(181) 2027 04 07
(891) 2017 04 07
(511) 09, 28, 41

(260) AM 2018 94253 A
(800) 1365073
(151) 2017 02 07
(181) 2017 02 07
(891) 2017 02 07
(511) 06, 07, 09, 11, 35

(260) AM 2018 94422 A
(800) 1366804
(151) 2017 08 11
(181) 2027 08 11
(891) 2017 08 11
(511) 05

(260) AM 2018 94607 A
(800) 1369809
(151) 2017 07 25
(181) 2027 10 12
(891) 2017 07 25
(511) 03, 05, 21

(260) AM 2018 94611 A
(800) 1369815
(151) 2017 08 01
(181) 2027 08 01
(891) 2017 08 01
(511) 19

(260) AM 2018 94614 A
(800) 1369841
(151) 2017 07 25
(181) 2027 07 25
(891) 2017 07 25
(511) 18, 25

(260) AM 2018 94617 A
(800) 1369851
(151) 2017 07 06
(181) 2027 07 06
(891) 2017 07 06
(511) 05

(260) AM 2018 94619 A
(800) 1369219
(151) 2017 07 14
(181) 2027 07 14
(891) 2017 07 14
(511) 32

(260) AM 2018 94620 A
(800) 1369888
(151) 2017 03 01
(181) 2027 03 01
(891) 2017 03 01
(511) 03, 05

(260) AM 2018 94621 A
(800) 1369254
(151) 2016 11 14
(181) 2026 11 14
(891) 2016 11 14
(511) 05

(260) AM 2018 94631 A
(800) 1370023
(151) 2017 01 11
(181) 2027 01 11
(891) 2017 01 11
(511) 06, 12, 36, 37, 39

(260) AM 2018 94649 A
(800) 1369599
(151) 2017 09 07
(181) 2027 09 07
(891) 2017 09 07
(511) 09

(260) AM 2018 94651 A
(800) 1369638
(151) 2017 05 17
(181) 2027 05 17

(891) 2017 05 17
(511) 03, 04, 21, 26, 28, 31, 35, 44

(260) AM 2018 94757 A
(800) 1356991
(151) 2017 02 09
(181) 2027 02 09
(891) 2027 08 22
(511) 09

(260) AM 2018 94781 A
(800) 1371101
(151) 2017 09 11
(181) 2027 09 11
(891) 2017 09 11
(511) 32

(260) AM 2018 94782 A
(800) 1371113
(151) 2016 12 07
(181) 2026 12 07
(891) 2016 12 07
(511) 35

(260) AM 2018 94783 A
(800) 1371119
(151) 2017 02 13
(181) 2027 02 13
(891) 2017 02 13
(511) 09

(260) AM 2018 94784 A
(800) 1371169
(151) 2017 04 06
(181) 2027 04 06
(891) 2017 04 06
(511) 02, 19, 35

(260) AM 2018 94803 A
(800) 1370134
(151) 2017 01 05
(181) 2027 01 05
(891) 2017 01 05
(511) 29, 30

(260) AM 2018 94804 A
(800) 1370143
(151) 2017 04 17
(181) 2027 04 17
(891) 2017 04 17
(511) 30

(260) AM 2018 94808 A
(800) 1370248
(151) 2017 06 20
(181) 2027 06 20
(891) 2017 06 20
(511) 01, 10

(260) AM 2018 94809 A
(800) 1370277
(151) 2017 03 01
(181) 2027 03 01
(891) 2017 03 01
(511) 03, 05, 10

(260) AM 2018 94810 A
(800) 1370304
(151) 2017 08 09
(181) 2027 08 09
(891) 2017 08 09
(511) 01, 35

(260) AM 2018 94811 A
(800) 1370355
(151) 2017 07 14
(181) 2027 07 14
(891) 2017 07 14
(511) 01, 04, 35

(260) AM 2018 94813 A
(800) 1370387
(151) 2017 02 24
(181) 2027 02 24
(891) 2017 02 24
(511) 35, 41

(260) AM 2018 94815 A
(800) 1370437
(151) 2017 08 04
(181) 2027 08 04
(891) 2017 08 04
(511) 44

(260) AM 2018 94817 A
(800) 1370544
(151) 2017 08 11
(181) 2027 08 11
(891) 2017 08 11
(511) 25

(260) AM 2018 94842 A
(800) 1059042
(151) 2010 09 08
(181) 2020 09 08

(891) 2017 10 11
(511) 03

(260) AM 2018 94887 A
(800) 1371799
(151) 2017 05 25
(181) 2027 05 25
(891) 2017 05 25
(511) 34

(260) AM 2018 94890 A
(800) 1371866
(151) 2017 09 18
(181) 2027 09 18
(891) 2017 09 18
(511) 33

(260) AM 2018 94930 A
(800) 1373321
(151) 2017 08 28
(181) 2027 08 28
(891) 2017 08 28
(511) 25, 41

(260) AM 2018 94957 A
(800) 151605
(151) 1951 02 01
(181) 2021 02 01
(891) 2017 10 12
(511) 05

(260) AM 2018 94958 A
(800) 219151
(151) 1959 04 20
(181) 2019 04 20
(891) 2018 10 17
(511) 31

(260) AM 2018 94960 A
(800) 1372715
(151) 2017 07 25
(181) 2027 07 25
(891) 2017 07 25
(511) 03, 05, 21

(260) AM 2018 94961 A
(800) 1372763
(151) 2017 09 14
(181) 2027 09 14
(891) 2017 09 14
(511) 30, 32

(260) AM 2018 94963 A
(800) 1372802
(151) 2017 08 15
(181) 2027 08 15
(891) 2017 08 15
(511) 09

(260) AM 2018 94991 A
(800) 1372860
(151) 2017 02 22
(181) 2027 02 22
(891) 2017 02 22
(511) 09, 37, 42

(260) AM 2018 94992 A
(800) 1372861
(151) 2017 02 22
(181) 2027 02 22
(891) 2017 02 22
(511) 09, 37, 42

(260) AM 2018 94996 A
(800) 1372980
(151) 2017 07 25
(181) 2027 07 25
(891) 2017 07 25
(511) 35, 42

(260) AM 2018 94999 A
(800) 1373141
(151) 2017 08 01
(181) 2027 08 01
(891) 2017 08 01
(511) 20

(260) AM 2018 95002 A
(800) 1373247
(151) 2017 06 14
(181) 2027 06 14
(891) 2017 06 14
(511) 14, 35

(260) AM 2018 95024 A
(800) 1374531
(151) 2017 06 22
(181) 2027 06 22
(891) 2017 06 22
(511) 01, 04, 06, 07, 35, 36, 37, 42

(260) AM 2018 95040 A
(800) 1374562
(151) 2017 08 23
(181) 2027 08 23

(891) 2017 08 23
(511) 03, 05

(260) AM 2018 95041 A
(800) 1374563
(151) 2017 08 23
(181) 2027 08 23
(891) 2017 08 23
(511) 03, 05

(260) AM 2018 95042 A
(800) 1374597
(151) 2017 09 01
(181) 2027 09 01
(891) 2017 09 01
(511) 25

(260) AM 2018 95043 A
(800) 1374624
(151) 2017 08 01
(181) 2027 08 01
(891) 2017 08 01
(511) 13

(260) AM 2018 95063 A
(800) 1350303
(151) 2017 01 17
(181) 2027 01 17
(891) 2017 09 01
(511) 09

(260) AM 2018 95082 A
(800) 1373588
(151) 2017 08 21
(181) 2027 08 21
(891) 2017 08 21
(511) 40

(260) AM 2018 95083 A
(800) 1373646
(151) 2017 09 26
(181) 2027 09 26
(891) 2017 09 26
(511) 34

(260) AM 2018 95086 A
(800) 1373759
(151) 2017 09 11
(181) 2027 09 11
(891) 2017 09 11
(511) 09

(260) AM 2018 95090 A
(800) 1373888
(151) 2017 07 24
(181) 2027 07 24
(891) 2017 07 24
(511) 30

(260) AM 2018 95104 A
(800) 1374098
(151) 2017 08 30
(181) 2027 08 30
(891) 2017 08 30
(511) 28, 30

(260) AM 2018 95105 A
(800) 1374157
(151) 2017 08 29
(181) 2027 08 29
(891) 2017 08 29
(511) 05, 09, 10, 35, 41, 42, 44

(260) AM 2018 95111 A
(800) 1374183
(151) 2017 04 21
(181) 2027 04 21
(891) 2017 04 21
(511) 03, 09, 35

(260) AM 2018 95112 A
(800) 1374216
(151) 2017 08 08
(181) 2027 08 08
(891) 2017 08 08
(511) 04, 06, 16, 35, 36, 39, 41, 42, 43, 44

(260) AM 2018 95115 A
(800) 1374230
(151) 2016 12 27
(181) 2027 12 27
(891) 2016 12 27
(511) 08, 11, 21

(260) AM 2018 95116 A
(800) 1374282
(151) 2017 03 08
(181) 2027 03 08
(891) 2017 03 08
(511) 25, 35

(260) AM 2018 95117 A
(800) 1374283
(151) 2017 04 19
(181) 2027 04 19

(891) 2017 04 19
(511) 35

(260) AM 2018 95153 A
(800) 1375359
(151) 2017 08 01
(181) 2027 08 01
(891) 2017 08 01
(511) 01, 02, 03, 05, 21, 25, 26

(260) AM 2018 95154 A
(800) 1375363
(151) 2017 08 31
(181) 2027 08 31
(891) 2017 08 31
(511) 09, 11, 34

(260) AM 2018 95155 A
(800) 1375364
(151) 2017 08 31
(181) 2027 08 31
(891) 2017 08 31
(511) 09, 11, 34

(260) AM 2018 95156 A
(800) 1375365
(151) 2017 08 31
(181) 2027 08 31
(891) 2017 08 31
(511) 09, 11, 34

(260) AM 2018 95158 A
(800) 1375368
(151) 2017 09 11
(181) 2027 09 11
(891) 2017 09 11
(511) 05

(260) AM 2018 95159 A
(800) 1375425
(151) 2017 02 07
(181) 2027 02 07
(891) 2017 02 07
(511) 07

(260) AM 2018 95160 A
(800) 1375478
(151) 2017 05 19
(181) 2027 05 19
(891) 2017 05 19
(511) 09, 16, 38, 41, 44

(260) AM 2018 95161 A
(800) 1375486
(151) 2017 04 10
(181) 2027 04 10
(891) 2017 04 10
(511) 18, 25

(260) AM 2018 95162 A
(800) 1375487
(151) 2017 05 04
(181) 2027 05 04
(891) 2017 05 04
(511) 35, 41, 43

(260) AM 2018 95163 A
(800) 1375540
(151) 2017 07 11
(181) 2027 07 11
(891) 2017 07 11
(511) 03, 05, 10, 35

(260) AM 2018 95164 A
(800) 1375613
(151) 2017 08 30
(181) 2027 08 30
(891) 2017 08 30
(511) 05, 42, 44

(260) AM 2018 95190 A
(800) 1375750
(151) 2017 10 01
(181) 2027 10 10
(891) 2017 10 01
(511) 44

(260) AM 2018 95191 A
(800) 1375765
(151) 2017 10 03
(181) 2027 10 03
(891) 2017 10 03
(511) 42

(260) AM 2018 95193 A
(800) 1160961
(151) 2013 03 21
(181) 2023 03 21
(891) 2017 10 31
(511) 05, 10

(260) AM 2018 95194 A
(800) 1174547
(151) 2013 08 07
(181) 2023 08 07

(891) 2017 10 20
(511) 25

(260) AM 2018 95195 A
(800) 1179434
(151) 2013 09 13
(181) 2023 09 13
(891) 2017 10 30
(511) 05

(260) AM 2018 95196 A
(800) 1199746
(151) 2014 01 23
(181) 2024 01 23
(891) 2017 09 07
(511) 05

(260) AM 2018 95225 A
(800) 1374808
(151) 2017 09 18
(181) 2027 09 18
(891) 2017 09 18
(511) 09

(260) AM 2018 95226 A
(800) 1374846
(151) 2017 07 10
(181) 2027 07 10
(891) 2017 07 10
(511) 09, 14, 32

(260) AM 2018 95228 A
(800) 1374850
(151) 2017 09 15
(181) 2027 09 15
(891) 2017 09 15
(511) 09

(260) AM 2018 95229 A
(800) 1374974
(151) 2017 06 14
(181) 2027 06 14
(891) 2016 06 14
(511) 06, 09, 11, 19, 20, 22, 35, 36, 37, 42, 44

(260) AM 2018 95230 A
(800) 1374884
(151) 2017 09 05
(181) 2027 09 05
(891) 2017 09 05
(511) 05

(260) AM 2018 95232 A
(800) 1374886
(151) 2017 09 06
(181) 2027 09 06
(891) 2017 09 06
(511) 31

(260) AM 2018 95233 A
(800) 1374908
(151) 2017 09 25
(181) 2027 09 25
(891) 2017 09 25
(511) 09

(260) AM 2018 95234 A
(800) 1374934
(151) 2017 06 22
(181) 2027 06 22
(891) 2017 06 22
(511) 14, 18

(260) AM 2018 95237 A
(800) 1374953
(151) 2017 10 05
(181) 2027 10 05
(891) 2017 10 05
(511) 29

(260) AM 2018 95240 A
(800) 1374968
(151) 2017 09 25
(181) 2027 09 25
(891) 2017 09 25
(511) 09

(260) AM 2018 95241 A
(800) 1374979
(151) 2017 04 25
(181) 2027 04 25
(891) 2017 04 25
(511) 03

(260) AM 2018 95242 A
(800) 1374980
(151) 2017 05 09
(181) 2027 05 09
(891) 2017 05 09
(511) 05

(260) AM 2018 95254 A
(800) 1375190
(151) 2017 10 19
(181) 2027 10 19

(891) 2017 10 19
(511) 33

(260) AM 2018 95255 A
(800) 1375192
(151) 2017 09 29
(181) 2027 09 29
(891) 2017 09 29
(511) 03

(260) AM 2018 95256 A
(800) 1375282
(151) 2017 06 29
(181) 2027 06 29
(891) 2017 06 29
(511) 09

(260) AM 2018 95257 A
(800) 1375294
(151) 2017 09 20
(181) 2027 09 20
(891) 2017 09 20
(511) 05

(260) AM 2018 95258 A
(800) 1375301
(151) 2017 04 08
(181) 2027 04 08
(891) 2017 04 08
(511) 35

(260) AM 2018 95260 A
(800) 1375307
(151) 2017 04 14
(181) 2027 04 14
(891) 2017 04 14
(511) 28, 30, 41

(260) AM 2018 95261 A
(800) 1375314
(151) 2017 06 08
(181) 2027 06 08
(891) 2017 06 08
(511) 09

(260) AM 2018 95265 A
(800) 1375826
(151) 2017 05 11
(181) 2027 05 11
(891) 2017 05 11
(511) 02, 16, 35, 36, 37, 38, 39, 41, 42

(260) AM 2018 95272 A
(800) 1376826
(151) 2017 09 18
(181) 2027 09 18
(891) 2017 09 18
(511) 03

(260) AM 2018 95272 A
(800) 1376826
(151) 2017 09 18
(181) 2027 09 18
(891) 2017 09 18
(511) 03

(260) AM 2018 95281 A
(800) 1376882
(151) 2017 10 11
(181) 2027 10 11
(891) 2017 10 11
(511) 12

(260) AM 2018 95284 A
(800) 1376976
(151) 2017 05 24
(181) 2027 05 24
(891) 2017 05 24
(511) 03

(260) AM 2018 95285 A
(800) 1376977
(151) 2017 06 02
(181) 2027 06 02
(891) 2017 06 02
(511) 01, 09, 41

(260) AM 2018 95287 A
(800) 1377002
(151) 2017 06 08
(181) 2027 06 08
(891) 2017 06 08
(511) 01, 19

(260) AM 2018 95289 A
(800) 875403
(151) 2005 12 19
(181) 2025 12 19
(891) 2017 10 06
(511) 30

(260) AM 2018 95291 A
(800) 951061
(151) 2007 12 04
(181) 2027 12 04

(891) 2017 09 20
(511) 30

(260) AM 2018 95293 A
(800) 1048944
(151) 2010 08 19
(181) 2020 08 19
(891) 2017 09 18
(511) 19, 20, 37

(260) AM 2018 95296 A
(800) 1204647
(151) 2013 12 27
(181) 2023 12 27
(891) 2017 09 28
(511) 29

(260) AM 2018 95297 A
(800) 1242163
(151) 2014 08 26
(181) 2024 08 26
(891) 2017 01 02
(511) 07

(260) AM 2018 95298 A
(800) 1331847
(151) 2016 05 23
(181) 2026 05 23
(891) 2017 08 22
(511) 06, 07, 35

(260) AM 2018 95299 A
(800) 1337114
(151) 2016 05 20
(181) 2026 05 20
(891) 2017 09 28
(511) 07, 08, 09

(260) AM 2018 95301 A
(800) 1376227
(151) 2017 08 28
(181) 2027 08 28
(891) 2017 08 28
(511) 12, 37

(260) AM 2018 95305 A
(800) 1376244
(151) 2017 08 08
(181) 2027 08 08
(891) 2017 08 08
(511) 16, 21, 29

(260) AM 2018 95311 A
(800) 1376331
(151) 2017 08 31
(181) 2027 08 31
(891) 2017 08 31
(511) 03

(260) AM 2018 95313 A
(800) 1376374
(151) 2017 10 11
(181) 2027 10 11
(891) 2017 10 11
(511) 29, 30, 31

(260) AM 2018 95315 A
(800) 1376451
(151) 2017 09 12
(181) 2027 09 12
(891) 2017 09 12
(511) 03

(260) AM 2018 95316 A
(800) 1376463
(151) 2017 08 31
(181) 2027 08 31
(891) 2017 08 31
(511) 14, 18, 25

(260) AM 2018 95321 A
(800) 1376468
(151) 2017 09 05
(181) 2027 09 05
(891) 2017 09 05
(511) 05

(260) AM 2018 95322 A
(800) 1376469
(151) 2017 09 05
(181) 2027 09 05
(891) 2017 09 05
(511) 05

(260) AM 2018 95323 A
(800) 1376519
(151) 2017 10 10
(181) 2027 10 10
(891) 2017 10 10
(511) 09, 35, 36, 42

(260) AM 2018 95324 A
(800) 1376523
(151) 2017 09 13
(181) 2027 09 13

(891) 2017 09 13
(511) 19

(260) AM 2018 95326 A
(800) 1376558
(151) 2016 10 04
(181) 2026 10 04
(891) 2016 10 04
(511) 05

(260) AM 2018 95329 A
(800) 1376603
(151) 2017 08 29
(181) 2027 08 29
(891) 2017 08 29
(511) 03, 05

(260) AM 2018 95369 A
(800) 1376756
(151) 2017 07 09
(181) 2027 07 09
(891) 2017 07 09
(511) 09

(260) AM 2018 95377 A
(800) 1377760
(151) 2017 10 01
(181) 2027 10 01
(891) 2017 10 01
(511) 36, 41

(260) AM 2018 95378 A
(800) 1377775
(151) 2017 05 29
(181) 2027 05 29
(891) 2017 05 29
(511) 18, 24, 25, 28

(260) AM 2018 95379 A
(800) 1377809
(151) 2017 08 03
(181) 2027 08 03
(891) 2017 08 03
(511) 33

(260) AM 2018 95380 A
(800) 1377814
(151) 2016 12 28
(181) 2026 12 28
(891) 2016 12 28
(511) 01, 02, 03, 04, 05, 06, 07, 08, 09, 10, 11, 12,
13, 14, 15, 16, 17, 18, 19, 20, 21, 22, 23, 24,

25, 26, 27, 28, 29, 30, 31, 32, 33, 34, 35, 36, 37, 38, 39, 40, 41, 42, 43, 44, 45	(260) AM 2018 95425 A (800) 1377423 (151) 2017 09 18 (181) 2027 09 18 (891) 2017 09 18 (511) 25
(260) AM 2018 95381 A (800) 1377835 (151) 2017 09 25 (181) 2027 09 25 (891) 2017 09 25 (511) 39	(260) AM 2018 95426 A (800) 1377429 (151) 2017 09 28 (181) 2027 09 28 (891) 2017 09 28 (511) 03
(260) AM 2018 95382 A (800) 1377858 (151) 2017 09 20 (181) 2017 09 20 (891) 2017 09 20 (511) 05	(260) AM 2018 95430 A (800) 1377433 (151) 2017 10 19 (181) 2027 10 19 (891) 2017 10 19 (511) 43
(260) AM 2018 95383 A (800) 1377899 (151) 2017 06 24 (181) 2027 06 24 (891) 2017 06 24 (511) 07, 12	(260) AM 2018 95434 A (800) 1377474 (151) 2017 06 20 (181) 2027 06 20 (891) 2017 06 20 (511) 16, 20
(260) AM 2018 95384 A (800) 1377922 (151) 2017 09 20 (181) 2027 09 20 (891) 2017 09 20 (511) 05	(260) AM 2018 95435 A (800) 1377476 (151) 2017 05 16 (181) 2027 05 16 (891) 2017 05 16 (511) 18
(260) AM 2018 95385 A (800) 1377923 (151) 2017 09 20 (181) 2027 09 20 (891) 2017 09 20 (511) 05	(260) AM 2018 95436 A (800) 1377490 (151) 2017 09 26 (181) 2027 09 26 (891) 2017 09 26 (511) 33
(260) AM 2018 95386 A (800) 1377939 (151) 2017 11 26 (181) 2027 11 26 (891) 2017 11 26 (511) 29, 30	(260) AM 2018 95437 A (800) 1377497 (151) 2017 09 14 (181) 2027 09 14 (891) 2017 09 14 (511) 11
(260) AM 2018 95424 A (800) 1377410 (151) 2017 03 07 (181) 2027 03 07 (891) 2017 03 07 (511) 06, 07, 40	(260) AM 2018 95438 A (800) 1377504 (151) 2017 11 01

(181) 2027 11 01
(891) 2017 11 01
(511) 25

(260) AM 2018 95439 A
(800) 1377507
(151) 2016 09 29
(181) 2026 09 29
(891) 2016 09 29
(511) 03

(260) AM 2018 95477 A
(800) 1379123
(151) 2017 10 18
(181) 2027 10 18
(891) 2017 10 18
(511) 06, 08, 09, 13, 16, 21

(260) AM 2018 95478 A
(800) 1379124
(151) 2017 10 10
(181) 2027 10 10
(891) 2017 10 10
(511) 03, 35

(260) AM 2018 95484 A
(800) 1379181
(151) 2017 01 18
(181) 2027 01 18
(891) 2017 01 18
(511) 03, 05, 09, 10, 11, 38, 42

(260) AM 2018 95500 A
(800) 926441
(151) 2007 04 23
(181) 2027 04 23
(891) 2017 11 16
(511) 09

(260) AM 2018 95501 A
(800) 926793
(151) 2006 07 17
(181) 2026 07 17
(891) 2017 10 12
(511) 09, 10, 11

(260) AM 2018 95502 A
(800) 977578
(151) 2008 07 24
(181) 2018 07 24
(891) 2017 01 02
(511) 07

(260) AM 2018 95503 A
(800) 1014716
(151) 2009 09 01
(181) 2019 09 01
(891) 2017 10 27
(511) 34

(260) AM 2018 95504 A
(800) 1176269
(151) 2013 08 27
(181) 2023 08 27
(891) 2017 10 12
(511) 08

(260) AM 2018 95506 A
(800) 1228803
(151) 2014 08 27
(181) 2024 08 27
(891) 2017 11 10
(511) 32

(260) AM 2018 95508 A
(800) 1284510
(151) 2015 11 06
(181) 2025 11 06
(891) 2017 09 26
(511) 41

(260) AM 2018 95510 A
(800) 1313134
(151) 2016 02 24
(181) 2026 02 24
(891) 2017 11 16
(511) 01, 05, 09, 10, 42

(260) AM 2018 95512 A
(800) 1371752
(151) 2017 07 12
(181) 2027 07 12
(891) 2017 10 26
(511) 30

(260) AM 2018 95537 A
(800) 1378087
(151) 2017 09 29
(181) 2027 09 29
(891) 2017 09 29
(511) 09

(260) AM 2018 95591 A
(800) 1378230
(151) 2017 09 15

(181) 2027 09 15
(891) 2017 09 15
(511) 30, 35

(260) AM 2018 95592 A
(800) 1378280
(151) 2016 02 25
(181) 2026 02 25
(891) 2016 02 25
(511) 35, 36

(260) AM 2018 95593 A
(800) 1378328
(151) 2017 09 27
(181) 2027 09 27
(891) 2017 09 27
(511) 34

(260) AM 2018 95594 A
(800) 1378329
(151) 2017 09 28
(181) 2027 09 28
(891) 2017 09 28
(511) 34

(260) AM 2018 95595 A
(800) 1378330
(151) 2017 09 26
(181) 2027 09 26
(891) 2017 09 26
(511) 34

(260) AM 2018 95620 A
(800) 1378813
(151) 2017 02 10
(181) 2027 02 10
(891) 2017 02 10
(511) 03, 05, 07, 09, 10, 11, 38, 41, 42

(260) AM 2018 95621 A
(800) 1378536
(151) 2017 05 16
(181) 2027 05 16
(891) 2017 05 16
(511) 39

(260) AM 2018 95622 A
(800) 1378567
(151) 2017 10 02
(181) 2027 10 02
(891) 2017 10 02
(511) 20

(260) AM 2018 95623 A
(800) 1378683
(151) 2017 09 11
(181) 2027 09 11
(891) 2017 09 11
(511) 32, 33

(260) AM 2018 95624 A
(800) 1378819
(151) 2017 02 07
(181) 2027 02 07
(891) 2017 02 07
(511) 18, 25, 28

(260) AM 2018 95625 A
(800) 1378684
(151) 2017 10 06
(181) 2027 10 06
(891) 2017 10 06
(511) 18, 25, 35

(260) AM 2018 95626 A
(800) 1378836
(151) 2017 05 12
(181) 2027 05 12
(891) 2017 05 12
(511) 03

(260) AM 2018 95627 A
(800) 1378786
(151) 2017 10 06
(181) 2027 10 06
(891) 2017 10 06
(511) 05

(260) AM 2018 95629 A
(800) 1378866
(151) 2017 06 23
(181) 2027 06 23
(891) 2017 06 23
(511) 09, 16, 25, 28, 45

(260) AM 2018 95701 A
(800) 1187937
(151) 2013 07 06
(181) 2023 07 06
(891) 2013 07 06
(511) 05, 35, 39

(260) AM 2018 95703 A
(800) 1282366
(151) 2015 12 01

(181) 2025 12 01
(891) 2017 11 29
(511) 18, 25

(260) AM 2018 95712 A
(800) 1344049
(151) 2017 02 06
(181) 2027 02 06
(891) 2017 10 27
(511) 11, 30, 43

(260) AM 2018 95720 A
(800) 1379373
(151) 2017 04 28
(181) 2027 04 28
(891) 2017 04 28
(511) 25, 35

(260) AM 2018 95735 A
(800) 1379548
(151) 2017 08 29
(181) 2027 08 29
(891) 2017 08 29
(511) 10, 20, 22, 24

(260) AM 2018 95736 A
(800) 1379581
(151) 2017 09 01
(181) 2027 09 01
(891) 2017 09 01
(511) 09

(260) AM 2018 95737 A
(800) 1379619
(151) 2017 08 18
(181) 2027 08 18
(891) 2017 08 18
(511) 03

(260) AM 2018 95738 A
(800) 1379715
(151) 2017 06 17
(181) 2027 06 17
(891) 2017 06 17
(511) 29, 30, 32, 35, 39

(260) AM 2018 95739 A
(800) 1379719
(151) 2017 08 03
(181) 2027 08 03
(891) 2017 08 03
(511) 29

(260) AM 2018 95741 A
(800) 1379751
(151) 2017 07 14
(181) 2027 07 14
(891) 2017 07 14
(511) 05

(260) AM 2018 95742 A
(800) 1379768
(151) 2017 09 28
(181) 2027 09 28
(891) 2017 09 28
(511) 06, 07, 10, 12, 18, 20

(260) AM 2018 95744 A
(800) 1379805
(151) 2017 09 27
(181) 2027 09 27
(891) 2017 09 27
(511) 05

(260) AM 2018 95813 A
(800) 1381514
(151) 2017 10 25
(181) 2027 10 25
(891) 2017 10 25
(511) 09

(260) AM 2018 95822 A
(800) 1237318
(151) 2014 11 14
(181) 2024 11 14
(891) 2017 10 25
(511) 33

(260) AM 2018 95827 A
(800) 1369694
(151) 2017 08 24
(181) 2027 08 24
(891) 2017 12 05
(511) 05

(260) AM 2018 96268 A
(800) 1385845
(151) 2017 07 07
(181) 2027 07 07
(891) 2017 07 07
(511) 03

APPELLATIONS OF ORIGIN OF GOODS

APPELLATIONS OF ORIGIN OF GOODS FILED IN GEORGIA FOR EXAMINATION UNDER LISBON AGREEMENT, ON THE BASIS OF THE INTERNATIONAL REGISTRATION

The decision can be appealed at the Chamber of Appeal of Sakpatenti within 3 months from the publication or at the Mtskheta District Court Administrative Cases Board (Address: №17, Samkhedro str., Mtskheta), within 1 month after publication.

Number of Identification: 1495
Number of International Registration: 1079
Data of International Registration: 2017 09 25
Application Filing Date: 2018 06 22
Appellation of Origin of Good: **FREISA DI CHERI**
The Goods for which the Registration
of Appellation of Origin is Required: 33 – Wine
Name and Address of Applicant: Consorzio di tutela e valorizzazione delle DOC Freisa di
Chieri e Collina Torinese
Via Palazzo di Citta, n. 10-10023 Chieri (TO), Italy

Ministero delle Politiche Agricole Alimentari e Forestali
Via XX Settembre, 20-00187 Roma, Italy

Number of Identification: 1496
Number of International Registration: 1080
Data of International Registration: 2017 09 25
Application Filing Date: 2018 06 22
Appellation of Origin of Good: **GRECO DI TUFO**
The Goods for which the Registration
of Appellation of Origin is Required: 33 – Wine
Name and Address of Applicant: Ministero delle Politiche Agricole, Alimentari e Forestali
Via XX Settembre, 20 – 00187 Roma, Italy

Producers or groups of producers entitled to use the appellation of
origin, Italy

Number of Identification: 1497
Number of International Registration: 1081
Data of International Registration: 2017 09 25
Application Filing Date: 2018 06 22
Appellation of Origin of Good: **GRIGNOLINO D'ASTI**
The Goods for which the Registration
of Appellation of Origin is Required: 33 – Wine
Name and Address of Applicant: Ministero delle Politiche Agricole, Alimentari e Forestali
Via XX Settembre, 20 – 00187 Roma, Italy

Producers or groups of producers entitled to use the appellation of
origin, Italy

Number of Identification: 1498
 Number of International Registration: 1082
 Data of International Registration: 2017 09 25
 Application Filing Date: 2018 06 22
 Appellation of Origin of Good: **GRIGNOLINO DEL MONFERRATO CASALESE**
 The Goods for which the Registration of Appellation of Origin is Required: 33 – Wine
 Name and Address of Applicant: Ministero delle Politiche Agricole, Alimentari e Forestali
 Via XX Settembre, 20 – 00187 Roma, Italy
 Producers or groups of producers entitled to use the appellation of origin, Italy

Number of Identification: 1499
 Number of International Registration: 1083
 Data of International Registration: 2017 09 25
 Application Filing Date: 2018 06 22
 Appellation of Origin of Good: **CORTESE DELL'ALTO MONFERRATO**
 The Goods for which the Registration of Appellation of Origin is Required: 33 – Wine
 Name and Address of Applicant: Consorzio tutela Barbera d'Asti e Vini del Monferrato
 Via Morelli, 15 – 14100 Asti, Italy
 Ministero delle Politiche Agricole, Alimentari e Forestali
 Via XX Settembre, 20 – 00187 Roma, Italy

Number of Identification: 1500
 Number of International Registration: 1084
 Data of International Registration: 2017 09 25
 Application Filing Date: 2018 06 22
 Appellation of Origin of Good: **PRIMITIVO DI MANDURIA**
 The Goods for which the Registration of Appellation of Origin is Required: 33 – Wine
 Name and Address of Applicant: Consorzio Primitivo di Manduria DOC C.da Piscine
 S/N – 74020 Uggiano Montefusco – Manduria (TA), Italy
 Ministero delle Politiche Agricole, Alimentari e Forestali
 Via XX Settembre, 20 – 00187 Roma, Italy

OFFICIAL NOTIFICATIONS

INVENTIONS

RENEWAL OF PATENTS

(21) AP 2007 10111

(11) P 2009 4643 B

(73) Devi Vasadze

(54) **REMOTELY OPERATED COMPLEX SYSTEM OF CABLE COMMUNICATION**

DATE OF CANCELLATION OF PATENT: 2018 06 05

DATE OF RESTORATION OF PATENT: 2018 12 25

(21) AP 2004 8200

(11) P 2006 3744 B

(73) Giorgi Kakhiani

(54) **Method for Production of Vaccine against Anthrax**

DATE OF CANCELLATION OF PATENT: 2018 05 10

DATE OF RESTORATION OF PATENT: 2018 12 25

(21) AP 2006 9768

(11) P 2012 5412 B

(73) Ramzan Goitemirov

(54) **INTERNAL COMBUSTION ENGINE**

DATE OF CANCELLATION OF PATENT: 2017 12 15

DATE OF RESTORATION OF PATENT: 2018 12 25

CANCELLATION OF PATENT

(21) AP 2010 12762

(11) P 2015 6312 B

(73) DOW AGROSCIENCES LLC

(54) **IMPROVED PROCESS FOR PREPARING SOLUBLE GRANULES OF SALTS OF
PYRIDINE – CARBOXYLIC ACIDS**

DATE OF CANCELLATION OF PATENT: 2018 11 22

DATE OF RESTORATION OF PATENT: 2019 11 22

UTILITY MODELS

CANCELLATION OF PATENTS

(21) AU 2014 13639

(11) U 2015 1869 Y

(73) Marine Zedgenidze

(54) **SWEET MADE OF DRY FRUITS**

DATE OF CANCELLATION OF PATENT: 2018 11 19

PATENT RESTORATION IS AVAILABLE: 2019 11 19

(21) AU 2016 14330

(11) U 2017 1945 Y

(73) Irine Ugrehelidze;

Jumber Uplisashvili;

Tea Baramashvili;

Giorgi Gabisonia

(54) **TAMPON PRINTING FACILITY**

DATE OF CANCELLATION OF PATENT: 2018 11 25

PATENT RESTORATION IS AVAILABLE: 2019 11 25

TRADEMARKS

RENEWAL OF REGISTRATIONS

(111) M 1998 10712 R2

(156) 10 09 1998

(186) 10 09 2028

(732) LUXOTTICA GROUP S.P.A.

Piazzale Luigi Cadorna 3, Milano, 20123,
Italy

(111) M 1998 11041 R2

(156) 29 10 1998

(186) 29 10 2028

(732) THE H.D. LEE COMPANY INC.,

A DELAWARE CORPORATION
Concord Plaza, 3411 Silversidi Road,
Wilmington, Delaware, USA

(111) M 1998 11020 R2

(156) 28 10 1998

(186) 28 10 2028

(732) GM KOREA COMPANY

Cheongcheon-Dong, 233 Bupyeongdaero,
Bupyeong-Gu, Incheon, 403-714, Republic
of Korea

(111) M 1998 10961 R2

(156) 28 10 1998

(186) 28 10 2028

(732) FIELDPOINT B.V.

Westerdoksdiijk 423,1013 BX Amsterdam,
Netherlands

(111) M 1998 11270 R2

(156) 11 12 1998

(186) 11 12 2028

(732) WARNER-LAMBERT COMPANY LLC

235 East 42nd Street, New York, NY
10017, USA

(111) M 1999 11385 R2

(156) 26 01 1999

(186) 26 01 2029

(732) BIOFARMA

50, rue Carnot, 92284 Suresnes cedex,
France

(111) M 1999 11558 R2

(156) 17 02 1999

(186) 17 02 2029

(732) CHINOIN Gyóyszer-és Vegyészeti Termékek

Gyára Zártkörűen Működő Rt., (CHINOIN
Zrt.);

CHINOIN Pharmaceutical and Chemical
Works Private o., Ltd.; CHINOIN avod
farmaceuticheskkh i khimicheskikh izdelij
Zakritoj A/O., CHINOIN ZA/O
H-1045 Budapest, Tó utca 1-5, Hungary

(111) M 1999 11559 R2

(156) 17 02 1999

(186) 17 02 2029

(732) PPG INDASTRIZ OHAIO, INK.

DELAVERIS SHTATIS KORPORACIA
3800 Vest 143 Strit, Klivlendi, Ohio 44111,
Ashsh, United Kingdom

(111) M 1999 11393 R2

(156) 26 01 1999

(186) 26 01 2029

(732) MERCK SHARP & DOHME CORP.

One Merck Drive, Whitehouse Station,
New Jersey 08889, USA

(111) M 1999 11562 R2

(156) 17 02 1999

(186) 17 02 2029

(732) CHINOIN Gyóyszer-és Vegyészeti Termékek

Gyára Zártkörűen Működő Rt., (CHINOIN
Zrt.);

CHINOIN Pharmaceutical and Chemical
Works Private o., Ltd.; CHINOIN avod
farmaceuticheskkh i khimicheskikh izdelij
Zakritoj A/O., CHINOIN ZA/O
H-1045 Budapest, Tó utca 1-5, Hungary

(111) M 1999 11396 R2

(156) 26 01 1999

(186) 26 01 2029

(732) BIOFARMA

50, rue Carnot, 92284 Suresnes cedex, France

(111) M 1999 11398 R2

(156) 26 01 1999

(186) 26 01 2029

(732) BIOFARMA

50, rue Carnot, 92284 Suresnes cedex, France

(111) M 1999 11457 R2
 (156) 09 02 1999
 (186) 09 02 2029
 (732) WESTIN HOTEL MANAGEMENT L.P.
 One StarPoint, Stamford, CT 06902, USA

(111) M 1999 12297 R2
 (156) 24 05 1999
 (186) 24 05 2029
 (732) HENKEL AG & Co. KgaA
 Henkelstrasse 67, D-40589 Dusseldorf,
 Germany

(111) M 1999 12298 R2
 (156) 24 05 1999
 (186) 24 05 2029
 (732) HENKEL AG & Co. KgaA
 Henkelstrasse 67, D-40589 Dusseldorf,
 Germany

(111) M 2008 18374 R1
 (156) 14 04 2008
 (186) 14 04 2028
 (732) REACH MAGAZINES WORLDWIDE
 LIMITED
 One Canada Square, Canary Wharf, London
 E14 5AP, United Kingdom

(111) M 2008 18418 R1
 (156) 01 05 2008
 (186) 01 05 2028
 (732) REACH MAGAZINES WORLDWIDE
 LIMITED
 One Canada Square, Canary Wharf,
 London E14 5AP, United Kingdom

(111) M 2008 18779 R1
 (156) 16 10 2008
 (186) 16 10 2028
 (732) SALSAS DE JALISCO CACU, S.A. DE
 C.V.
 Calie Guillermo Gonzalez Camarena
 No.800-Piso 4, Colonia Santa Fe, Delegacion
 Alvaro Obregon, Ciudad de Mexico, C.P.
 01210, Mexico

(111) M 2008 18987 R1
 (156) 15 12 2008
 (186) 15 12 2028
 (732) THE H.D. LEE COMPANY, INC
 (a Delaware corporation)
 3411 Silverside Road, Wilmington,
 Delaware, USA

(111) M 2009 19064 R1
 (156) 28 01 2009
 (186) 28 01 2029
 (732) AVENTISUB LLC
 3711 Kennett Pike, Suite 200, Greenville,
 Delaware 19807, USA

(111) M 2009 19142 R1
 (156) 16 03 2009
 (186) 16 03 2029
 (732) SANOFI-AVENTIS DEUTSCHLAND
 GMBH
 Brueningstrasse 50, D-65926 Frankfurt
 am Main, Germany

(111) M 1998 11095 R2
 (156) 25 11 1998
 (186) 25 11 2028
 (732) JANSSEN PHARMACEUTICA N.V.
 Turnhoutseweg 30, B-2340 Beerse,
 Belgium

(111) M 1998 11096 R2
 (156) 25 11 1998
 (186) 25 11 2028
 (732) JANSSEN PHARMACEUTICA N.V.
 Turnhoutseweg 30, B-2340 Beerse,
 Belgium

(111) M 1998 9350 R2
 (156) 19 05 1998
 (186) 19 05 2028
 (732) AMBER IP BRANDS SÀRL
 Avenue Reverdil 14, 1260 Nyon, Switzerland

(111) M 1998 11123 R2
 (156) 27 11 1998
 (186) 27 11 2028
 (732) JOHNSON & JOHNSON
 One Johnson & Johnson Plaza, New
 Brunswick, New Jersey 08933, USA

(111) M 1998 11124 R2
 (156) 27 11 1998
 (186) 27 11 2028
 (732) JOHNSON & JOHNSON
 One Johnson & Johnson Plaza, New
 Brunswick, New Jersey 08933, USA

(111) M 1998 11130 R2
 (156) 27 11 1998
 (186) 27 11 2028

(732) JOHNSON & JOHNSON
One Johnson & Johnson Plaza, New
Brunswick, New Jersey 08933, USA

(111) M 1998 11131 R2
(156) 27 11 1998
(186) 27 11 2028
(732) JOHNSON & JOHNSON
One Johnson & Johnson Plaza, New
Brunswick, New Jersey 08933, USA

(111) M 1999 11710 R2
(156) 16 03 1999
(186) 16 03 2029
(732) SOREMARTEC S.A.
Findel Business Center, Complexe B,
Rue de Treves, L-2632 Findel, Luxembourg

(111) M 1999 11711 R2
(156) 16 03 1999
(186) 16 03 2029
(732) SOREMARTEC S.A.
Findel Business Center, Complexe B,
Rue de Treves, L-2632 Findel, Luxembourg

(111) M 1999 11712 R2
(156) 16 03 1999
(186) 16 03 2029
(732) SOREMARTEC S.A.
Findel Business Center, Complexe B,
Rue de Treves, L-2632 Findel, Luxembourg

(111) M 1999 11640 R2
(156) 18 02 1999
(186) 18 02 2029
(732) PROMINENT GMBH
Im Schumachergewann 5-11, 69123
Heidelberg, Germany

(111) M 1999 12124 R2
(156) 10 05 1999
(186) 10 05 2029
(732) ZIPPO MANUFACTURING COMPANY
33 Barber Street, Bradford, Pennsylvania
16701, USA

COMPLETE TRANSFER OF RIGHTS

(111) M 1998 9602 R

(732) CERVECERIA MODELO DE MEXICO,
S. DE R.L. DE C.V.

Javier Barros Sierra No. 555, Piso 3, Colonia
Zedec Ed Plaza Santa Fe, Delegacion Alvaro
Obregon, C.P. 01210, Mexico City, Mexico

(770) MODELO MKT DE MEXICO, S.DE R.L.
DE C.V.

Lago Alberto N156, Colonia Anahuac,
Mexico, D.F. 11320, Mexico

(580) 09 11 2018

(111) M 1998 9603 R

(732) CERVECERIA MODELO DE MEXICO,
S. DE R.L. DE C.V.

Javier Barros Sierra No. 555, Piso 3, Colonia
Zedec Ed Plaza Santa Fe, Delegacion Alvaro
Obregon, C.P. 01210, Mexico City, Mexico

(770) MODELO MKT DE MEXICO, S.DE R.L.
DE C.V.

Lago Alberto N156, Colonia Anahuac,
Mexico, D.F. 11320, Mexico

(580) 09 11 2018

(111) M 2002 14394 R

(732) CERVECERIA MODELO DE MEXICO,
S. DE R.L. DE C.V.

Javier Barros Sierra No. 555, Piso 3, Colonia
Zedec Ed Plaza Santa Fe, Delegacion Alvaro
Obregon, C.P. 01210, Mexico City, Mexico

(770) MODELO MKT DE MEXICO, S.DE R.L.
DE C.V.

Lago Alberto N156, Colonia Anahuac,
Mexico, D.F. 11320, Mexico

(580) 09 11 2018

(111) M 2002 14395 R

(732) CERVECERIA MODELO DE MEXICO,
S. DE R.L. DE C.V.

Javier Barros Sierra No. 555, Piso 3, Colonia
Zedec Ed Plaza Santa Fe, Delegacion Alvaro
Obregon, C.P. 01210, Mexico City, Mexico

(770) MODELO MKT DE MEXICO, S.DE R.L.
DE C.V.

Lago Alberto N156, Colonia Anahuac,
Mexico, D.F. 11320, Mexico

(580) 09 11 2018

(111) M 1997 4392 R

(732) ARLANXEO DEUTSCHLAND GmbH
Alte Heerstr. 2, 41540 Dormagen, Germany

(770) LANXESS DEUTSCHLAND GmbH

51369 Leverkusen, Germany

(580) 10 12 2018

(111) M 1995 670 R

(732) ARLANXEO DEUTSCHLAND GmbH

Alte Heersht. 2, 41540 Dormagen, Germany

(770) LANXESS DEUTSCHLAND GmbH

51369 Leverkusen, Germany

(580) 10 12 2018

(111) M 1996 2116 R

(732) CARDINAL HEALTH IRELAND
UNLIMITED COMPANY

2nd Floor, 1-2 Victoria Buildings,
Haddington Road, Dublin 4, D04 XN32, Ireland

(770) COVIDIEN AG

Victor von Bruns-Strasse 19, 8212
Neuhausen am Rheinfall, Switzerland

(580) 16 11 2018

(111) M 1995 674 R

(732) ARLANXEO DEUTSCHLAND GmbH

Alte Heerstr. 2, 41540 Dormagen, Germany

(770) BAYER AG

D-51368 Leverkusen, Germany

(580) 10 12 2018

(111) M 1996 3730 R

(732) ARLANXEO DEUTSCHLAND GmbH

Alte Heerstr. 2, 41540 Dormagen, Germany

(770) LANXESS DEUTSCHLAND GmbH

51369 Leverkusen, Germany

(580) 10 12 2018

(111) M 2009 19031 R

(732) IDILIA FOODS, S.L.

LEPANTO 410-414, 08025 BARCELONA,
Spain

(770) NUTMARK, LDA.

Av. Arriaga, 30 3H, 9000 FUNCHAL
MADEIRA, Portugal

(580) 05 11 2018

(111) M 2011 22001 R

(732) TAKEDA FARMASIUTIKALZ
INTERNEISHNL AG

Thurgauersstrasse 130, 8152 Glattpark-
Opfikon (Ziurich), Switzerland

(770) UNIPHARM, INC.
350 Fifth Avenue, Suite 6701, New York,
N.Y. 10118, USA
(580) 06 03 2018

(111) M 2013 23912 R
(732) SMIK SPOLKA AKCIJNA
Domaniewska 48, 02-672 Warszawa, Poland
(770) SMYK GLOBAL ASSETS GMBH
K.O. Haeusermann + Partner AG
Schwanengasse 5/7, 3011 Bern, Switzerland
(580) 19 11 2018

(111) M 1997 7824 R
(732) CERVECERIA MODELO DE MEXICO,
S. DE R.L. DE C.V.
Javier Barros Sierra No. 555, Piso 3, Colonia
Zedec Ed Plaza Santa Fe, Delegacion Alvaro
Obregon, C.P. 01210, Mexico City, Mexico
(770) MODELO BRANDS DEL PACIFICO,
S. DE R.L. DE C.V.
Calzada Gabriel Leyva y Melchor Ocampo
s/n, Col. Centro, 82000 Mazatlan, Sinaloa,
Mexico
(580) 06 11 2018

(111) M 1997 5157 R
(732) CERVECERIA MODELO DE MEXICO,
S. DE R.L. DE C.V.
Javier Barros Sierra No. 555, Piso 3, Colonia
Zedec Ed Plaza Santa Fe, Delegacion Alvaro
Obregon, C.P. 01210, Mexico City, Mexico
(770) MODELO MKT DE MEXICO,
S.DE R.L. DE C.V.
Lago Alberto N156, Colonia Anahuac,
Mexico, D.F. 11320, Mexico
(580) 09 11 2018

(111) M 1997 5158 R
(732) CERVECERIA MODELO DE MEXICO,
S. DE R.L. DE C.V.
Javier Barros Sierra No. 555, Piso 3, Colonia
Zedec Ed Plaza Santa Fe, Delegacion Alvaro
Obregon, C.P. 01210, Mexico City, Mexico
(770) MODELO MKT DE MEXICO, S.DE R.L.
DE C.V.
Lago Alberto N156, Colonia Anahuac,
Mexico, D.F. 11320, Mexico
(580) 09 11 2018

(111) M 1997 5159 R
(732) CERVECERIA MODELO DE MEXICO,
S. DE R.L. DE C.V.
Javier Barros Sierra No. 555, Piso 3, Colonia

Zedec Ed Plaza Santa Fe, Delegacion Alvaro
Obregon, C.P. 01210, Mexico City, Mexico
(770) MODELO MKT DE MEXICO,
S.DE R.L. DE C.V.
Lago Alberto N156, Colonia Anahuac,
Mexico, D.F. 11320, Mexico
(580) 09 11 2018

(111) M 1997 7825 R
(732) CERVECERIA MODELO DE MEXICO,
S. DE R.L. DE C.V.
Javier Barros Sierra No. 555, Piso 3, Colonia
Zedec Ed Plaza Santa Fe, Delegacion Alvaro
Obregon, C.P. 01210, Mexico City, Mexico
(770) MODELO MKT DE MEXICO,
S.DE R.L. DE C.V.
Lago Alberto N156, Colonia Anahuac,
Mexico, D.F. 11320, Mexico
(580) 09 11 2018

(111) M 1998 10575 R
(732) COTY FRANCE S.A.S.
14 rue du Quatre Septembre, 75002 Paris,
France
(770) BOURJOIS
12-14, rue Victor Noir, F-92200 Neuilly-
sur-Seine, France
(580) 07 12 2018

(111) M 1998 10576 R
(732) COTY FRANCE S.A.S.
14 rue du Quatre Septembre, 75002 Paris,
France
(770) BOURJOIS
12-14, rue Victor Noir, F-92200 Neuilly-
sur-Seine, France
(580) 07 12 2018

(111) M 2016 27594 R
(732) LTD "PROTEIN JORJIA"
Didubis raioni, Ak. Tseretlis gamz.113, b.40,
Tbilisi, Georgia
(770) VAJA IMNADZE
Makhaldianis q.16 (askuravas q), 0101,
Tbilisi, Georgia
(580) 19 11 2018

(111) M 2016 27823 R
(732) SWIMC LLC
101 West Prospect Avenue, Cleveland,
Ohio 44115, USA
(770) THE SHERWIN-WILLIAMS
HEADQUARTERS COMPANY

101 West Prospect Avenue, Cleveland,
Ohio 44115, USA
(580) 16 11 2018

(111) M 2016 27823 R
(732) THE SHERWIN-WILLIAMS
HEADQUARTERS COMPANY
101 West Prospect Avenue, Cleveland,
Ohio 44115, USA
(770) THE SHERWIN-WILLIAMS COMPANY,
AN OHIO CORPORATION
101 W. Prospect Avenue, Cleveland,
Ohio 44115-1075, USA
(580) 16 11 2018

(111) M 1996 2445 R
(732) BARCLAYS PLC
1 Cherchil Pleisi, Londoni E14 5HP,
United Kingdom
(770) BARCLAYS CAPITAL INC.,
a Connecticut Corporation
CT Corporation System, 67 Burnside
Avenue, Iast Hartford, Connecticut 06108,
USA
(580) 06 11 2018

CHANGES IN NAMES AND/OR ADDRESSES OF OWNERS

- | | |
|---|--|
| <p>(111) M 1998 10712 R
 (732) LUXOTTICA GROUP S.P.A.
 Piazzale Luigi Cadorna 3, Milano,
 20123, Italy
 (770) LUXOTTICA GROUP S.P.A.
 Via Cesare Cantu, 2-20123 Milano
 (MI), Italy
 (580) 05 11 2018</p> <hr/> <p>(111) M 1998 10802 R
 (732) CANDY HOOVER GROUP S.R.L.
 Via Comolli, 16, 20861 Brugherio,
 Monza e Brianza, Italy
 (770) CANDY ELETTRODOMESTICI S.r.l.
 Via Comolli, 16, Brugherio (Milano), Italy
 (580) 27 11 2018</p> <hr/> <p>(111) M 1998 11020 R
 (732) GM KOREA COMPANY
 Cheongcheon-Dong, 233 Bupyeongdaero,
 Bupyeong-Gu, Incheon, 403-714, Republic
 of Korea
 (770) GM KOREA COMPANY
 199-1, Cheongcheon-2 Dong, Bupyeong-Gu,
 Incheon, Republic of Korea
 (580) 26 09 2018</p> <hr/> <p>(111) M 1998 10961 R
 (732) FIELDPOINT B.V.
 Westerdoksdijk 423,1013 BX Amsterdam,
 Netherlands
 (770) FIELDPOINT B.V.
 Veembroederhof 109, 1019 HD Amsterdam,
 Netherlands
 (580) 26 10 2018</p> <hr/> <p>(111) M 1998 11323 R
 (732) ONDULINE
 24 Quai Gallieni, 92150 Suresnes, France
 (770) ONDULINE
 35 rue Baudin, 92300 Levallois Perret,
 France
 (580) 21 11 2018</p> <hr/> <p>(111) M 1998 11324 R
 (732) ONDULINE
 24 Quai Gallieni, 92150 Suresnes, France
 (770) ONDULINE
 35 rue Baudin, 92300 Levallois Perret,
 France
 (580) 21 11 2018</p> <hr/> | <p>(111) M 1998 11325 R
 (732) ONDULINE
 24 Quai Gallieni, 92150 Suresnes, France
 (770) ONDULINE
 35 rue Baudin, 92300 Levallois Perret,
 France
 (580) 21 11 2018</p> <hr/> <p>(111) M 1998 11079 R
 (732) ONDULINE
 24 Quai Gallieni, 92150 Suresnes, France
 (770) ONDULINE
 35 rue Baudin, 92300 Levallois Perret,
 France
 (580) 21 11 2018</p> <hr/> <p>(111) M 1998 11329 R
 (732) ONDULINE
 24 Quai Gallieni, 92150 Suresnes, France
 (770) ONDULINE
 35 rue Baudin, 92300 Levallois Perret,
 France
 (580) 21 11 2018</p> <hr/> <p>(111) M 1998 11270 R
 (732) WARNER-LAMBERT COMPANY LLC
 235 East 42nd Street, New York,
 NY 10017, USA
 (770) WARNER-LAMBERT COMPANY LLC
 201 Tabor Road, Morris Plains,
 New Jersey 07950, USA
 (580) 16 11 2018</p> <hr/> <p>(111) M 2008 18374 R
 (732) REACH MAGAZINES WORLDWIDE
 LIMITED
 One Canada Square, Canary Wharf,
 London E14 5AP, United Kingdom
 (770) TRINITY MIRROR WORLDWIDE
 LIMITED
 One Canada Square, Canary Wharf,
 London E14 5AP, United Kingdom
 (580) 12 10 2018</p> <hr/> <p>(111) M 2008 18418 R
 (732) REACH MAGAZINES WORLDWIDE
 LIMITED
 One Canada Square, Canary Wharf,
 London E14 5AP, United Kingdom
 (770) TRINITY MIRROR WORLDWIDE
 LIMITED</p> <hr/> |
|---|--|

One Canada Square, Canary Wharf,
London E14 5AP, United Kingdom
(580) 12 10 2018

Blanchardstown Corporate Park Unit 4B,
Block 2, 1st Floor, Blanchardstown Dublin
15, Ireland
(580) 29 11 2018

(111) M 2008 18779 R
(732) SALSAS DE JALISCO CACU, S.A. DE
C.V.
Calie Guillermo Gonzalez Camarena
No.800-Piso 4, Colonia Santa Fe, Delegacion
Alvaro Obregon, Ciudad de Mexico, C.P.
01210, Mexico
(770) SALSAS DE JALISCO CACU, S.A. DE
C.V.
Rio Churubusco No. 213, Colonia Granjas
Mexico, Mexico, D.F. 08400, Mexico
(580) 26 09 2018

(111) M 1996 3113 R
(732) Kraft Foods Belgium Intellectual Property
BVBA (Sprl)
De Beukelaer-Pareinlaan 1, 2200 Herentals,
Belgium
(770) Kraft Foods Belgium Intellectual Property
BVBA (Sprl)
Brusselsesteenweg 450, 1500 Halle, Belgium
(580) 17 09 2018

(111) M 1998 11103 R
(732) ELEKTRA ENTERTAINMENT GROUP
INC.
1633 Broadway, New York, New York
10019, USA
(770) ELEKTRA ENTERTAINMENT GROUP
INC.
75 Rockefeller plaza, New York, New York
10019, USA
(580) 07 12 2018

(111) M 1996 3114 R
(732) Kraft Foods Belgium Intellectual Property
BVBA (Sprl)
De Beukelaer-Pareinlaan 1, 2200 Herentals,
Belgium
(770) Kraft Foods Belgium Intellectual Property
BVBA (Sprl)
Brusselsesteenweg 450, 1500 Halle, Belgium
(580) 17 09 2018

(111) M 1998 10569 R
(732) LABORATOIRES EXPANSCIENCE
1 Place des Saisons, 92048 PARIS LA
DEFENSE CEDEX, France
(770) LABORATOIRES EXPANSCIENCE
10 avenue de l'Aerch 92400 Courbevoie,
France
(580) 07 12 2018

(111) M 2017 28571 R
(732) NISSAN CHEMICAL CORPORATION
5-1, Nihonbashi 2-chome, Chuo-ku, Tokyo,
Japan
(770) NISSAN CHEMICAL INDUSTRIES, LTD.
7-1, Kanda-Nishiki-cho 3-chome, Chiyoda-ku,
Tokyo, 101-0054, Japan
(580) 19 11 2018

(111) M 1998 10579 R
(732) CANDY HOOVER GROUP S.R.L.
Via Comolli, 16, 20861 Brugherio,
Monza e Brianza, Italy
(770) CANDY ELETTRDOMESTICI S.r.l.
Via Comolli, 16, 20047 Brugherio (Milano),
Italy
(580) 14 08 2018

(111) M 1997 6937 R
(732) Kraft Foods Belgium Intellectual Property
BVBA (Sprl)
De Beukelaer-Pareinlaan 1, 2200 Herentals,
Belgium
(770) Kraft Foods Belgium Intellectual Property
BVBA (Sprl)
Brusselsesteenweg 450, 1500 Halle, Belgium
(580) 17 09 2018

(111) M 1997 5442 R
(732) CHAMPION PRODUCTS EUROPE
LIMITED
Buite 8, Plaza 212, Blanchardstown
Corporate Park 2, Blanchardstown Dublin 15,
Ireland
(770) CHAMPION PRODUCTS EUROPE
LIMITED

(111) M 1996 2445 R
(732) BARCLAYS CAPITAL INC
a Connecticut Corporation
CT Corporation System, 67 Burnside Avenue,
Iast Hartford, Connecticut 06108, USA
(770) BARCLAYS CAPITAL INC
a Connecticut Corporation
745 Seventh Avenue New York, New York
10019, USA
(580) 06 11 2018

INVALIDATION OF TRADEMARK REGISTRATIONS

(111) M 1998 9567 R

(151) 04 06 1998

(181) 2018 12 04

(732) Rolex SA

Rue Francois-Dussaud 3-5-7, Geneva,
Switzerland

(111) M 1998 9164 R

(151) 04 05 1998

(181) 2018 11 04

(732) TRESMONTES LUCCHETTI S.A.

Los Conquistadores 2345, Providencia,
Santiago, Chile

(111) M 1998 9417 R

(151) 25 05 1998

(181) 2018 11 25

(732) Zakrytoe aktsionernoe obshchestvo "Europa plus" (ZAO "EUROPA PLUS"), (CLOSED JOINT-STOCK COMPANY "EUROPA PLUS")

bldg.5, d.21, Stanislavskogo str., Moscow
RU-109004, Russian Federation

(111) M 1998 9165 R

(151) 04 05 1998

(181) 2018 11 04

(732) AVENTIS-PHARMA DEUTSCHLAND

GmbH
Brüningstrasse 50, 65926 Frankfurt am Main,
Germany

(111) M 1998 9349 R

(151) 19 05 1998

(181) 2018 11 19

(732) SPIRITS INTERNATIONAL B.V.

1A, Rue Thomas Edison, L-1445 Strassen,
Luxemburg, Luxembourg

(111) M 1998 9167 R

(151) 04 05 1998

(181) 2018 11 04

(732) GRUPO EMPRESARIAL DE TABACOS

DE CUBA t/a TABACUBA
Calle 19 no. 102 esq. M, Vedado, Plaza,
Ciudad de la Habana, Cuba

(111) M 1998 9136 R

(151) 30 04 1998

(181) 2018 10 30

(732) CARRERAS LIMITED

Globe House, 4 Temple Place, London
WC2R 2PG, United Kingdom

(111) M 1998 9173 R

(151) 04 05 1998

(181) 2018 11 04

(732) ROTHMANS OF PALL MALL LIMITED

Route de France 17, Boncourt, 2926,
Switzerland

(111) M 1998 9250 R

(151) 06 05 1998

(181) 2018 11 06

(732) JEANJER, LTD

1400 Broadway, 15th Floor, New York,
NY 10018, USA

(111) M 1998 9185 R

(151) 04 05 1998

(181) 2018 11 04

(732) L.F.P., INC.

a California corporation
8484 Wilshire Boulevard, Beverly Hills,
California, USA

(111) M 1998 9139 R

(151) 30 04 1998

(181) 2018 10 30

(732) CALVIN KLEIN TRADEMARK TRUST

Rodney Square North, 1100 North Market
Street, Wilmington, DE 19890, USA

(111) M 1998 9205 R

(151) 05 05 1998

(181) 2018 11 05

(732) MARS, INCORPORATED

6885, Elm Street, McLean, Virginia, USA

(111) M 1998 9141 R

(151) 30 04 1998

(181) 2018 10 30

(732) DEUTSCHE TELEKOM AG

Friedrich-Ebert-Allee 140, 53113 Bonn,
Germany

(111) M 1998 9208 R

(151) 05 05 1998

(181) 2018 11 05

(732) NOVARTIS VACCINES AND

DIAGNOSTICS LIMITED A BRITISH
COMPANY

Florey House, Robert Robinson Avenue,
The Oxford Science Park, Oxford,
Oxfordshire OX4 4GA, United Kingdom

Carretera de Albalat, s/n 46600 Alcira,
Valencia, Spain

(111) M 1998 9209 R
(151) 05 05 1998
(181) 2018 11 05
(732) MARS, INC.
6885 Elm Street, McLean, Virginia
22101-3883, USA

(111) M 1998 9040 R
(151) 29 04 1998
(181) 2018 10 29
(732) R & A BAILEY & CO
Nangor House, Western Estate, Dublin 12,
Ireland

(111) M 1998 9223 R
(151) 05 05 1998
(181) 2018 11 05
(732) MICROSOFT CORPORATION
One Microsoft Way, Redmond, Washington
98052-6399, USA

(111) M 1998 9046 R
(151) 29 04 1998
(181) 2018 10 29
(732) CALVIN KLEIN TRADEMARK TRUST
Rodney Square North, 1100 North
Market Street, Wilmington, DE 19890,
USA

(111) M 1998 9224 R
(151) 05 05 1998
(181) 2018 11 05
(732) MICROSOFT CORPORATION
One Microsoft Way, Redmond, Washington
98052-6399, USA

(111) M 1998 9047 R
(151) 29 04 1998
(181) 2018 10 29
(732) CALVIN KLEIN TRADEMARK TRUST
Rodney Square North, 1100 North Market
Street, Wilmington, DE 19890, USA

(111) M 1998 9230 R
(151) 06 05 1998
(181) 2018 11 06
(732) W & LT Sefranec + Co
Industriestrasse 15A, CH-6300 Zug,
Switzerland

(111) M 1998 9051 R
(151) 29 04 1998
(181) 2018 10 29
(732) CALVIN KLEIN TRADEMARK TRUST
Rodney Square North, 1100 North
Market Street, Wilmington, DE 19890,
USA

(111) M 1998 9231 R
(151) 06 05 1998
(181) 2018 11 06
(732) W & LT Sefranec + Co
Industriestrasse 15A, CH-6300 Zug,
Switzerland

(111) M 1998 9052 R
(151) 29 04 1998
(181) 2018 10 29
(732) BRITISH AMERICAN TOBACCO
(BRANDS) INC.
2711 Centerville Road, Suite 3000,
Wilmington, Delaware 19808, USA

(111) M 1998 9232 R
(151) 06 05 1998
(181) 2018 11 06
(732) W & LT Sefranec + Co
Industriestrasse 15A, CH-6300 Zug,
Switzerland

(111) M 1998 9059 R
(151) 29 04 1998
(181) 2018 10 29
(732) AGAN CHEMICAL MANUFACTURES
LTD.
P.O. Box 262, Northern Industrial Zone,
Ashdod, Israel

(111) M 1998 9127 R
(151) 30 04 1998
(181) 2018 10 30
(732) GREGORI PEREPEREZ, AGUCTIN,
GREGORI PEREPEREZ, ALFRED AND
GREGORI PEREPEREZ, JOSE

(111) M 1998 9063 R
(151) 29 04 1998
(181) 2018 10 29

(732) BRITISH AMERICAN TOBACCO
(BRANDS) LIMITED
Globe House, 4 Temple Place, London
WC2R 2PG, United Kingdom

(111) M 1998 9072 R
(151) 29 04 1998
(181) 2018 10 29
(732) MARS, INCORPORATED
6885, Elm Street, McLean, Virginia, USA

(111) M 1998 9575 R
(151) 04 06 1998
(181) 2018 12 04
(732) JAE WOO PARK
Chong-Ro-ku, Myong-Ryun-Dong 2 Ga 8-5,
Seoul, Republic of Korea

(111) M 1998 9082 R
(151) 30 04 1998
(181) 2018 10 30
(732) GLAXOSMITHKLINE CONSUMER
HEALTHCARE (UK) IP LIMITED
980 Great West Road, Brentford, Middlesex
TW8 9GS, United Kingdom

(111) M 1998 9088 R
(151) 30 04 1998
(181) 2018 10 30
(732) MARS, INCORPORATED
6885, Elm Street, McLean, Virginia, USA

(111) M 1998 9093 R
(151) 30 04 1998
(181) 2018 10 30
(732) ORACLE AMERICA, INC.
500 Oracle Parkway, Redwood Shores,
California 94065, USA

(111) M 1998 9582 R
(151) 04 06 1998
(181) 2018 12 04
(732) JENAPHARM GmbH & Co. KG
15, Otto-Schott-Strasse, D-07745 Jena,
Germany

(111) M 1998 9583 R
(151) 04 06 1998
(181) 2018 12 04
(732) AVENTIS PHARMA S.A.
20, avenue Raymond Aron, 92160 Antony,
France

(111) M 1998 9590 R
(151) 04 06 1998
(181) 2018 12 04
(732) JANSSEN BIOTECH, INC.
800 Ridgeriew Drive, Horsham, Pennsylvania
19044, USA

(111) M 1998 9591 R
(151) 04 06 1998
(181) 2018 12 04
(732) JANSSEN BIOTECH, INC.
800 Ridgeriew Drive, Horsham, Pennsylvania
19044, USA

(111) M 1998 9593 R
(151) 04 06 1998
(181) 2018 12 04
(732) KRAFT FOODS SCHWEIZ HOLDING
GMBH
Chollerstrasse 4, 6301 Zug, Switzerland

(111) M 1998 9594 R
(151) 04 06 1998
(181) 2018 12 04
(732) KRAFT FOODS SCHWEIZ HOLDING
GMBH
Chollerstrasse 4, 6301 Zug, Switzerland

(111) M 1998 9424 R
(151) 25 05 1998
(181) 2018 11 25
(732) MFG LICENSING GMBH
Fabrikweg 16, 5033 BUCHS (AG), Switzerland

(111) M 1998 9426 R
(151) 25 05 1998
(181) 2018 11 25
(732) E.R. SQUIBB & SONS. L.L.C.,
The Corporation Trust Company
1209 Orange Street, Wilmington, New
Castle Country, 19801 Delaware, USA

(111) M 1998 9601 R
(151) 04 06 1998
(181) 2018 12 04
(732) BOLTON ALIMENTARI S.P.A.
Via Einaudi 18, 22072 Cermenate (Como),
Italy

(111) M 1998 9496 R
(151) 01 06 1998
(181) 2018 12 01

(732) Solidaruli pasukhismgeblobis sazogadoeba
"SHALGO"
Lermontovis q. 6, 383650, Khashuri, Georgia

(111) M 1998 9427 R
(151) 25 05 1998
(181) 2018 11 25

(732) CHIQUITA BRANDS, INC.
250 E.Fifth Street, Cincinnati, Ohio 45202,
USA

(111) M 1998 9438 R
(151) 27 05 1998
(181) 2018 11 27

(732) AHLERS AG
Elverdisser Strasse 313, 32052 Herford,
Germany

(111) M 1998 9456 R
(151) 28 05 1998
(181) 2018 11 28

(732) BROWN-FORMAN POLSKA SP. Z.O.O.
Ul. Postepu 21, 02-676, Warsaw, Poland

(111) M 1998 9458 R
(151) 28 05 1998
(181) 2018 11 28

(732) BROWN-FORMAN POLSKA SP. Z.O.O.
Ul. Postepu 21, 02-676, Warsaw, Poland

(111) M 1998 9459 R
(151) 28 05 1998
(181) 2018 11 28

(732) BROWN-FORMAN POLSKA SP. Z.O.O.
Ul. Postepu 21, 02-676, Warsaw, Poland

(111) M 1998 9558 R
(151) 03 06 1998
(181) 2018 12 03

(732) TOBACCO INTERNATIONAL
RICHMOND, INC.
701 North 5th Street, Suite 100 Richmond,
Virginia 23219, USA

(111) M 1998 9189 R
(151) 04 05 1998
(181) 2018 11 04

(732) ITF S.p.A.
Via Tortona, 15, 20144 Milano, USA

(111) M 1998 9095 R
(151) 30 04 1998
(181) 2018 10 30

(732) PROCTER & GAMBLE HOLDING GmbH
Sulzbacher Strasse 40, 65824 Schwalbach
am Taunus, Germany

(111) M 1998 9096 R
(151) 30 04 1998
(181) 2018 10 30

(732) PROCTER & GAMBLE HOLDING GmbH
Sulzbacher Strasse 40, 65824 Schwalbach
am Taunus, Germany

(111) M 1998 9364P R
(151) 19 05 1998
(181) 2018 11 19

(732) VAN MELLE TABAK NEDERLAND B.V.
Leeuwarderweg 1, 8501 ZD Joure, Netherlands

(111) M 1998 9555 R
(151) 03 06 1998
(181) 2018 12 03

(732) NOVARTIS AG
4002 Basel, Switzerland

(111) M 1998 9101 R
(151) 30 04 1998
(181) 2018 10 30

(732) BRITISH AMERICAN TOBACCO THE
NETHERLANDS B.V.
Handelsweg 53A, Amstelveen 1181
ZA, Netherlands

(111) M 1998 9102 R
(151) 30 04 1998
(181) 2018 10 30

(732) TURMAC TOBACCO COMPANY B.V.
21, Drentestraat, NL-1083 HK
AMSTERDAM, Netherlands

(111) M 1998 9104 R
(151) 30 04 1998
(181) 2018 10 30

(732) SCHIMMELPENNINCK
SIGARENFABRIEKEN V/H GEURTS EN
VAN SCHUPPEN B.V.
Nude 28, Wageningen, Netherlands

(111) M 2008 18382 R
(151) 29 04 2008
(181) 2018 10 29

(732) LTD "SMARTHOUSE"
Takaishvilis q. 10, b.1, 0179, Tbilisi,
Georgia

(111) M 2008 18383 R
(151) 29 04 2008
(181) 2018 10 29

(732) JSC "TBILCHEMPHARM"
Tsuladzis q., 34, 0113, Tbilisi, Georgia

(111) M 2008 18411 R
(151) 01 05 2008
(181) 2018 11 01

(732) KISS NAIL PRODUCTS, INC.
57 Seaview Blvd. Port Washington,
New York, USA

(111) M 2008 18412 R
(151) 01 05 2008
(181) 2018 11 01

(732) KISS NAIL PRODUCTS, INC.
57 Seaview Blvd. Port Washington,
New York, USA

(111) M 2008 18438 R
(151) 16 05 2008
(181) 2018 11 16

(732) AMIRAN KAPATADZE
Arakishvilis q.6, 4600, Kutaisi, Georgia

(111) M 2008 18444 R
(151) 16 05 2008
(181) 2018 11 16

(732) LABORATORIOS CASASCO S.A.I.C.
Lavalle 310, Ciudad Aut. De Buenos
Aires, Argentina

(111) M 2008 18445 R
(151) 16 05 2008
(181) 2018 11 16

(732) LABORATORIOS CASASCO S.A.I.C.
Lavalle 310, Ciudad Aut. De Buenos
Aires, Argentina

(111) M 2008 18446 R
(151) 16 05 2008
(181) 2018 11 16

(732) LABORATORIOS CASASCO S.A.I.C.
Lavalle 310, Ciudad Aut. De Buenos
Aires, Argentina

(111) M 2008 18447 R
(151) 16 05 2008
(181) 2018 11 16

(732) LABORATORIOS CASASCO S.A.I.C.
Lavalle 310, Ciudad Aut. De Buenos
Aires, Argentina

(111) M 2008 18448 R
(151) 16 05 2008
(181) 2018 11 16

(732) LABORATORIOS CASASCO S.A.I.C.
Lavalle 310, Ciudad Aut. De Buenos
Aires, Argentina

(111) M 2008 18384 R
(151) 29 04 2008
(181) 2018 10 29

(732) Ind. metsarme "MIKAVA NATALIA"
Avtomsheneblis q. 38/15, 4600, Kutaisi,
Georgia

(111) M 2008 18414 R
(151) 01 05 2008
(181) 2018 11 01

(732) FADI ASLI
Nutsbidzis q. 1, 0177, Tbilisi, Georgia

(111) M 2008 18415 R
(151) 01 05 2008
(181) 2018 11 01

(732) FADI ASLI
Nutsbidzis q. 1, 0177, Tbilisi, Georgia

(111) M 2008 18449 R
(151) 16 05 2008
(181) 2018 11 16

(732) LTD "IDEA"
Digmis masivi, 4 kvart., 24 korp, b. 56, 0159,
Tbilisi, Georgia

(111) M 2008 18450 R
(151) 16 05 2008
(181) 2018 11 16

(732) LTD "IDEA"
Digmis masivi, 4 kvart., 24 korp, b.56, 0159,
Tbilisi, Georgia

(111) M 2008 18452 R
(151) 16 05 2008
(181) 2018 11 16

(732) APOLLO TYRES LTD.

Apollo House, 7, Institutional Area,
Sector-32, Gurgaon, Haryana-122001, India

(111) M 2008 18386 R
(151) 29 04 2008
(181) 2018 10 29
(732) VLADIMER ANTADZE
Al. Kazbegis q. 19, 0179, Tbilisi, Georgia

(111) M 2008 18417 R
(151) 01 05 2008
(181) 2018 11 01
(732) IRINA NASKIDASHVILI
Al. Kazbegis q. 19, 0179, Tbilisi, Georgia

(111) M 2008 18480 R
(151) 27 05 2008
(181) 2018 11 27
(732) LTD "LINA GROUP"
Eristavis q. 2, 0192, Tbilisi, Georgia

(111) M 2008 18481 R
(151) 27 05 2008
(181) 2018 11 27
(732) LTD "LINA GROUP"
Eristavis q. 2, 0192, Tbilisi, Georgia

(111) M 2008 18482 R
(151) 27 05 2008
(181) 2018 11 27
(732) LTD "LINA GROUP"
Eristavis q. 2, 0192, Tbilisi, Georgia

(111) M 2008 18455 R
(151) 16 05 2008
(181) 2018 11 16
(732) Tovarystva z obmezhenouju vidprovydal`nistju
"VYROBNYCHNO-KOMERCIJNA FIRMA
"ELTA"
vul. Muzychna, 2, Zaporizhzhia 69083,
Ukraine

(111) M 2008 18456 R
(151) 16 05 2008
(181) 2018 11 16
(732) Obschestvo s ogranichennoi
otvetstvennostiu "koordiniruiushchi
raspredelitelni tsentr "EFKO-KASKAD"
Ul. Frunze, d.4, g. Aleqseevka, RU-309850,
Belgorodskaa oblast, Russian Federation

(111) M 2008 18457 R
(151) 16 05 2008
(181) 2018 11 16
(732) UNICHARM GULF HYGIENIC
INDUSTRIES LTD
P.O. Box 99883, Riyadh 11625, Saudi Arabia

(111) M 2008 18458 R
(151) 16 05 2008
(181) 2018 11 16
(732) UNICHARM GULF HYGIENIC
INDUSTRIES LTD
P.O. Box 99883, Riyadh 11625, Saudi Arabia

(111) M 2008 18459 R
(151) 16 05 2008
(181) 2018 11 16
(732) UNICHARM GULF HYGIENIC
INDUSTRIES LTD
P.O. Box 99883, Riyadh 11625, Saudi Arabia

(111) M 2008 18460 R (151) 16 05 2008
(181) 2018 11 16
(732) AL-BIL LTD STI
VII mkr., 3097 kvart., Baku, Azerbaijan

(111) M 2008 18487 R
(151) 27 05 2008
(181) 2018 11 27
(732) EMZAR BALADZE
Fanaskertelis q.me-11 korp., b.4, 0194,
Tbilisi, Georgia

(111) M 2008 18488 R
(151) 27 05 2008
(181) 2018 11 27
(732) EMZAR BALADZE
Panaskertelis q., korp. 11, b. 4, 0194,
Tbilisi, Georgia

(111) M 2008 18463 R
(151) 16 05 2008
(181) 2018 11 16
(732) YILDIZ HOLDING A.Ş.
Kişikli mah. Ferah. cad Çeşme sok.
No:2/4 B. Camlica, Uskudar, Istanbul, Turkey

(111) M 2008 18466 R
(151) 16 05 2008
(181) 2018 11 16
(732) LTD "G-T-C & COMPANYI"

Akaki Tseretlis q. 186, 4600, Kutaisi,
Georgia

(732) VAKHTANG RCHEULISHVILI
L. Botsvazdis q. 14, 0179, Tbilisi, Georgia

(111) M 2008 18467 R
(151) 16 05 2008
(181) 2018 11 16
(732) LTD "G-T-C & COMPANYI"
Akaki Tseretlis q. 186, 4600, Kutaisi,
Georgia

(111) M 2008 18395 R
(151) 29 04 2008
(181) 2018 10 29
(732) VAKHTANG RCHEULISHVILI
L. Botsvazdis q. 14, 0179, Tbilisi, Georgia

(111) M 2008 18387 R
(151) 29 04 2008
(181) 2018 10 29
(732) NOVARTIS AG
4002 Basel, Switzerland

(111) M 2008 18396 R
(151) 29 04 2008
(181) 2018 10 29
(732) P.T. KALBE FARMA, TBK.
Kawasan Industri Delta Silicon, JI.M.H
Thamrin Blok A3-1, Lippo Cikarang, Bekasi
17550, Indonesia

(111) M 2008 18388 R
(151) 29 04 2008
(181) 2018 10 29
(732) ELDAR IUKURIDZE
Zhukovskis q.19, b.9, odesa, Ukraine

(111) M 2008 18419 R
(151) 01 05 2008
(181) 2018 11 01
(732) LTD "VISOL TRADE HOUSE"
Ilia Chavchavadzis gamz. 74 b, 0162, Tbilisi,
Georgia

(111) M 2008 18390 R
(151) 29 04 2008
(181) 2018 10 29
(732) NOVARTIS AG
4002 Basel, Switzerland

(111) M 2008 18398 R
(151) 29 04 2008
(181) 2018 10 29
(732) NOVARTIS AG
4002 Basel, Switzerland

(111) M 2008 18468 R
(151) 16 05 2008
(181) 2018 11 16
(732) NUNU BUKHRASHVILI
Nutsbidzis Perdobi II mkr., III kvart.,
korp. 9, b. 1, 0183, Tbilisi, Georgia

(111) M 2008 18492 R
(151) 27 05 2008
(181) 2018 11 27
(732) GIORGI NIKURADZE
Abastumnis q. 1, korp, b. 3, 0112, Tbilisi,
Georgia

(111) M 2008 18469 R
(151) 16 05 2008
(181) 2018 11 16
(732) SODALCO S.R.L.
Via Manzoni No 45, Milan 20121, Italy

(111) M 2008 18493 R
(151) 27 05 2008
(181) 2018 11 27
(732) LTD Holding "Georgian Industrial Group"
Delisis me-3 shesak., korp. 22, sart. 4,
0177, Tbilisi, Georgia

(111) M 2008 18393 R
(151) 29 04 2008
(181) 2018 10 29
(732) VAKHTANG RCHEULISHVILI
L. Botsvazdis q. 14, 0179, Tbilisi, Georgia

(111) M 2008 18399 R
(151) 29 04 2008
(181) 2018 10 29
(732) JV ROYAL ARMENIA LTD
38 app/26, Davidashen 2, Yerevan,
Armenia

(111) M 2008 18394 R
(151) 29 04 2008
(181) 2018 10 29

(111) M 2008 18470 R
(151) 16 05 2008
(181) 2018 11 16
(732) CJSC Comercial Bank "PRIVATBANK"
Ul. Naberezhnaya Pobedi 50,
Dnepropetrovsk, 49094, Ukraine

(111) M 2008 18422 R
(151) 01 05 2008
(181) 2018 11 01
(732) WYETH LLC
Five Giralda Farms, Madison, New Jersey,
07940, USA

(111) M 2008 18423 R
(151) 01 05 2008
(181) 2018 11 01
(732) WYETH LLC
Five Giralda Farms, Madison, New Jersey,
07940, USA

(111) M 2008 18424 R
(151) 01 05 2008
(181) 2018 11 01
(732) WYETH LLC
Five Giralda Farms, Madison, New Jersey,
07940, USA

(111) M 2008 18425 R
(151) 01 05 2008
(181) 2018 11 01
(732) WYETH LLC
Five Giralda Farms, Madison, New Jersey,
07940, USA

(111) M 2008 18426 R
(151) 01 05 2008
(181) 2018 11 01
(732) ABDI IBRAHIM İLAÇ SANAYİ VE
TİCARET ANONİM ŞİRKETİ
Eski Büyükdere Cad. Ayazağa Yolu 34398
No:5 Maslak, İstanbul, Turkey

(111) M 2008 18427 R
(151) 01 05 2008
(181) 2018 11 01
(732) ABDI IBRAHIM İLAÇ SANAYİ VE
TİCARET ANONİM ŞİRKETİ
Eski Büyükdere Cad. Ayazağa Yolu 34398
No:5 Maslak, İstanbul, Turkey

(111) M 2008 18471 R
(151) 16 05 2008
(181) 2018 11 16
(732) LTD "LINCS"
Gamsakhurdias q. 2, 0105, Tbilisi, Georgia

(111) M 2008 18494 R
(151) 27 05 2008
(181) 2018 11 27
(732) IOSEB MIKADZE
Erekle II-is q. 8/10, 0105, Tbilisi, Georgia

(111) M 2008 18495 R
(151) 27 05 2008
(181) 2018 11 27
(732) IOSEB MIQADZE
Erekle II-is q. 8/10, 0105, Tbilisi, Georgia

(111) M 2008 18428 R
(151) 01 05 2008
(181) 2018 11 01
(732) LTD "ACHARINVEST"
Cholokashvilis q. 1/2, b. 35, 0113, Tbilisi,
Georgia

(111) M 2008 18429 R
(151) 01 05 2008
(181) 2018 11 01
(732) "TIFLIS CITY" (G-I-G Group)
Ilia Chavchavadzis gamz. 62, 0126, Tbilisi,
Georgia

(111) M 2008 18404 R
(151) 29 04 2008
(181) 2018 10 29
(732) GALLAHER LIMITED
Members Hill, Brooklands Road, Weybridge,
Surrey KT13 0QU, United Kingdom

(111) M 2008 18405 R
(151) 29 04 2008
(181) 2018 10 29
(732) JSC "Gefa"
Sanapiros q. 6, 0108, Tbilisi, Georgia

(111) M 2008 18406 R
(151) 29 04 2008
(181) 2018 10 29
(732) NOVARTIS AG
4002 Basel, Switzerland

-
- (111) M 2008 18407 R
(151) 29 04 2008
(181) 2018 10 29
(732) NOVARTIS AG
4002 Basel, Switzerland
-
- (111) M 2008 18497 R
(151) 27 05 2008
(181) 2018 11 27
(732) SPIRITS INTERNATIONAL B.V.
1A, Rue Thomas Edison, L-1445 Strassen,
Luxemburg, Luxembourg
-
- (111) M 2008 18498 R
(151) 27 05 2008
(181) 2018 11 27
(732) SPIRITS INTERNATIONAL B.V.
1A, Rue Thomas Edison, L-1445, Strassen,
Luxembourg
-
- (111) M 2008 18499 R
(151) 27 05 2008
(181) 2018 11 27
(732) SPIRITS INTERNATIONAL B.V.
1A, Rue Thomas Edison, L-1445, Strassen,
Luxembourg
-
- (111) M 2008 18500 R
(151) 27 05 2008
(181) 2018 11 27
(732) SPIRITS INTERNATIONAL B.V.
1A, Rue Thomas Edison, L-1445, Strassen,
Luxembourg
-
- (111) M 2008 18501 R
(151) 27 05 2008
(181) 2018 11 27
(732) SPIRITS INTERNATIONAL B.V.
1A, Rue Thomas Edison, L-1445, Strassen,
Luxembourg
-
- (111) M 2008 18502 R
(151) 27 05 2008
(181) 2018 11 27
(732) SPIRITS INTERNATIONAL B.V.
1A, Rue Thomas Edison, L-1445, Strassen,
Luxembourg
-
- (111) M 2008 18504 R
(151) 27 05 2008
(181) 2018 11 27
- (732) LTD G-P-C
Marjanishvilis q. 26, 0102, Tbilisi, Georgia
-
- (111) M 2008 18505 R
(151) 27 05 2008
(181) 2018 11 27
(732) LTD "GBC"
Aleksidzis q. 1, Akademqalaqi, kvart. I,
korp. 3, 0193, Tbilisi, Georgia
-
- (111) M 2008 18506 R
(151) 27 05 2008
(181) 2018 11 27
(732) LTD "GBC"
Aleksidzis q. 1, Akademqalaqi, kvart. I,
korp. 3, 0193, Tbilisi, Georgia
-
- (111) M 2008 18507 R
(151) 27 05 2008
(181) 2018 11 27
(732) LTD "GBC"
Aleksidzis q. 1, Akademqalaqi, kvart. I,
korp. 3, 0193, Tbilisi, Georgia
-
- (111) M 2008 18508 R
(151) 27 05 2008
(181) 2018 11 27
(732) GLAXO GROUP LIMITED
980 Great West Road, Brentford, Middlesex
TW8 9GS, United Kingdom
-
- (111) M 2008 18509 R
(151) 27 05 2008
(181) 2018 11 27
(732) LTD "CAUCASUS TRAVEL"
Leselidzis q. 44/2, 0105, Tbilisi, Georgia
-
- (111) M 2008 18510 R
(151) 27 05 2008
(181) 2018 11 27
(732) PHILIP MORRIS PRODUCTS S. A.
Quai Jeanrenaud 3, CH-2000 Neuchatel,
Switzerland
-
- (111) M 2008 18511 R
(151) 27 05 2008
(181) 2018 11 27
(732) PHILIP MORRIS PRODUCTS S. A.
Quai Jeanrenaud 3, CH-2000 Neuchatel,
Switzerland
-

(111) M 2008 18512 R
 (151) 27 05 2008
 (181) 2018 11 27
 (732) PHILIP MORRIS PRODUCTS S. A.
 Quai Jeanrenaud 3, CH-2000 Neuchatel,
 Switzerland

(111) M 1998 9281 R
 (151) 11 05 1998
 (181) 2018 11 11
 (732) DIAGEO BRANDS B.V.
 Molenwerf 10-12, 1014 BG Amsterdam,
 Netherlands

(111) M 1998 9296 R
 (151) 13 05 1998
 (181) 2018 11 13
 (732) BRISTOL-MYERS SQUIBB COMPANY
 345 Park Avenue, New York, New York
 10154, USA

(111) M 1998 9098 R
 (151) 30 04 1998
 (181) 2018 10 30
 (732) ANHEUSER-BUSCH, LLC
 One Busch Place, St.Louis, Missouri, USA

(111) M 1998 9476 R
 (151) 29 05 1998
 (181) 2018 11 29
 (732) BEIERSDORF AG
 Unnastrasse 48, D-20253 Hamburg, Germany

(111) M 1998 9477 R
 (151) 29 05 1998
 (181) 2018 11 29
 (732) BEIERSDORF AG
 Unnastrasse 48, D-20253 Hamburg, Germany

(111) M 1998 9114 R
 (151) 30 04 1998
 (181) 2018 10 30
 (732) KYOCERA MITA CORPORATION
 No.2-28, 1-chome, Tamatsukuri, Chuo-ku,
 Osaka, Japan

(111) M 1998 9301 R
 (151) 13 05 1998
 (181) 2018 11 13
 (732) BIOTHERM S.A.

"Le Neptune", 11 Avenue Albert II, MC
 98000, Monaco

(111) M 1998 9435 R
 (151) 27 05 1998
 (181) 2018 11 27
 (732) CHOICE HOTELS INTERNATIONAL, INC.
 10750 Columbia Pike, Silver Spring, MD
 20901, USA

(111) M 1998 9304 R
 (151) 13 05 1998
 (181) 2018 11 13
 (732) BLOCKBUSTER L.L.C.
 9601 S. Meridian Blvd., Englewood,
 Colorado 80112, USA

(111) M 1998 9311 R
 (151) 13 05 1998
 (181) 2018 11 13
 (732) MEAD JOHNSON & COMPANY,
 a Delaware Corporation
 2400 West Lloyd Expressway, Evansville,
 Indiana 47721, USA

(111) M 1998 9314 R
 (151) 13 05 1998
 (732) EMANUEL UNGARO ITALIA s.r.l.
 12/a, Via Vittor Pisani, Milano, Italy

(111) M 1998 9324 R
 (151) 14 05 1998
 (181) 2018 11 14
 (732) CONOPCO INC.
 700 Sylvan Avenue, Englewood Cliffs,
 NJ 07632, USA

(111) M 1998 9325 R
 (151) 14 05 1998
 (181) 2018 11 14
 (732) HOUSE OF PRINCE A/S
 Tobaksvejen 4, 2860 Seborg, Denmark

(111) M 2015 25585 R
 (151) 12 01 2015
 (181) 2025 07 12
 (732) LTD "IDILIA"
 Tsatskhvebis q. 1, Isianis q. 25, 4600,
 Kutaisi, Georgia

(111) M 1998 9332 R
(151) 14 05 1998
(181) 2018 11 14
(732) PUIG FRANCE, Societe par Actions
Simplifíee
6, Boulevard du Parc, 92200 Neuilly-
Sur-Seine, France

(111) M 1998 9334 R
(151) 14 05 1998
(181) 2018 11 14
(732) PUIG FRANCE, Societe par Actions
Simplifíee
6, Boulevard du Parc, 92200 Neuilly-
Sur-Seine, France

(111) M 1998 9508 R
(151) 01 06 1998
(181) 2018 12 01
(732) PROCTER & GAMBLE HOLDING GmbH
Sulzbacher Strasse 40, 65824 Schwalbach
am Taunus, Germany

(111) M 1998 9509 R
(151) 02 06 1998
(181) 2018 12 02
(732) PROCTER & GAMBLE HOLDING GmbH
Sulzbacher Strasse 40, 65824 Schwalbach
am Taunus, Germany

(111) M 1998 9192 R
(151) 04 05 1998
(181) 2018 11 04
(732) ITF S.p.A.
Via Tortona, 15, 20144 Milano, USA

(111) M 1998 9513 R
(151) 02 06 1998
(181) 2018 12 02
(732) BRITISH AMERICAN TOBACCO
(BRANDS) LIMITED
Globe House, 4 Temple Place, London
WC2R 2PG, United Kingdom

(111) M 1998 9356 R
(151) 19 05 1998
(181) 2018 11 19
(732) VAN NELLE TABAK NEDERLAND B.V.
Slachtedyk 28 A, 8501 ZA Joure,
Netherlands

(111) M 1998 9362 R
(151) 19 05 1998
(181) 2018 11 19
(732) THE PROCTER & GAMBLE COMPANY
One Procter & Gamble Plaza, Cincinnati,
Ohio 45202, USA

(111) M 1998 9523 R
(151) 03 06 1998
(181) 2018 12 03
(732) BRITISH AMERICAN TOBACCO
(BRANDS) INC.
2711 Centerville Road, Suite 3000,
Wilmington, Delaware 19808, USA

(111) M 1998 9380 R
(151) 20 05 1998
(181) 2018 11 20
(732) CASTROL LIMITED
Technology Centre, Whitchurch Hill,
Pangbourne, Reading RG8 7QR, United
Kingdom

(111) M 1998 9379 R
(151) 20 05 1998
(181) 2018 11 20
(732) CASTROL LIMITED
Technology Centre, Whitchurch Hill,
Pangbourne, Reading RG8 7QR, United
Kingdom

(111) M 1998 9374 R
(151) 20 05 1998
(181) 2018 11 20
(732) CASTROL LIMITED
Technology Centre, Whitchurch Hill,
Pangbourne, Reading RG8 7QR, United
Kingdom

(111) M 1998 9527 R
(151) 03 06 1998
(181) 2018 12 03
(732) PFIZER INC.
235, East 42nd Street, New York 10017,
USA

(111) M 1998 9529 R
(151) 03 06 1998
(181) 2018 12 03
(732) ZOETIS LLC
100 Campus Drive, Florham Park, NJ 07932,
USA

(111) M 1998 9532 R
(151) 03 06 1998
(181) 2018 12 03
(732) ZOETIS LLC
100 Campus Drive, Florham Park, NJ 07932,
USA

Lawrenceville-Princeton Road, Princeton,
New Jersey 08540, USA

(111) M 1998 9536 R
(151) 03 06 1998
(181) 2018 12 03
(732) ZOETIS LLC
100 Campus Drive, Florham Park, NJ 07932,
USA

(111) M 1998 9564 R
(151) 04 06 1998
(181) 2018 12 04
(732) NINE WEST DEVELOPMENT LLC
1411 Broadway, New York, NY 10018, USA

(111) M 1998 9383 R
(151) 20 05 1998
(181) 2018 11 20
(732) HENKEL AG & Co. KgaA
Henkelstrasse 67, 40589 Dusseldorf,
Germany

(111) M 1998 9404 R
(151) 25 05 1998
(181) 2018 11 25
(732) XEROX LIMITED
Bridge House, Oxford Road, Uxbridge,
Middlesex UB8 1HS, United Kingdom,
United Kingdom

(111) M 1998 9389 R
(151) 22 05 1998
(181) 2018 11 22
(732) GALLAHER LIMITED
Members Hill, Brooklands Road, Weybridge,
Surrey, KT13 0QU, United Kingdom

(111) M 1998 9265 R
(151) 07 05 1998
(181) 2018 11 07
(732) THORFA HOLDING B.V.
Koningin Wilhelminaplein 2-4, 1062 HK
Amsterdam, Netherlands

(111) M 2016 27707 R
(151) 12 10 2016
(181) 2027 04 12
(732) LTD "PRIMARK G"
Temqa, 11 mkr., kvart. I, korp. 9, b. 54,
0197, Tbilisi, Georgia

(111) M 2016 27882 R
(151) 02 12 2016
(181) 2027 06 02
(732) LTD "PRIMARK G"
Temqa, 11 mkr., kvart. I, korp. 9, b. 54,
0197, Tbilisi, Georgia

(111) M 1998 9399 R
(151) 22 05 1998
(181) 2018 11 22
(732) E.R. SQUIBB & SONS, L.L.C.

CANCELLATION OF LICENSE AGREEMENT

(111) M 1999 12849 R
(732) EcoPharm Patent Management AG
Haldenstraße 5, Baar, CH-6342,
Switzerland
(791) LLC "Scientific-Technological Firm
"Polisan"
Ul. Salova, d. 72, korp. 2, lit. A,
192102 Sankt Peterburg, Russian Federation
License Agreement (License No. 735) is
cancelled

(800) 838965
(732) EcoPharm Patent Management AG
Haldenstraße 5, Baar, CH-6342,
Switzerland
(791) LLC "Scientific-Technological Firm
"Polisan"
Ul. Salova, d. 72, korp. 2, lit. A,
192102 Sankt Peterburg, Russian Federation
License Agreement (License No. 737) is
cancelled

(800) 819768
(732) EcoPharm Patent Management AG
Haldenstraße 5, Baar, CH-6342,
Switzerland
(791) LLC "Scientific-Technological Firm
"Polisan"
Ul. Salova, d. 72, korp. 2, lit. A,
192102 Sankt Peterburg, Russian Federation
License Agreement (License No. 738) is
cancelled

(800) 826545
(732) EcoPharm Patent Management AG
Haldenstraße 5, Baar, CH-6342,
Switzerland
(791) LLC "Scientific-Technological Firm
"Polisan"
Ul. Salova, d. 72, korp. 2, lit. A,
192102 Sankt Peterburg, Russian Federation
License Agreement (License No. 739) is
cancelled

(800) 831026
(732) EcoPharm Patent Management AG
Haldenstraße 5, Baar, CH-6342,
Switzerland
(791) LLC "Scientific-Technological Firm
"Polisan"
Ul. Salova, d. 72, korp. 2, lit. A,
192102 Sankt Peterburg, Russian Federation
License Agreement (License No. 736) is
cancelled

CLASSIFICATION INDEXES

INVENTIONS

CONCORDANCE TABLE OF INTERNATIONAL CLASSIFICATION INDEX AND PUBLICATION NUMBERS

INTERNATIONAL CLASSIFICATION INDEXES (51)	NUMBER OF PUBLISHED APPLICATION (10)
A 01 N 43/40; C 07 D 401/06; C 07 D 213/46; A 01 P 7/00; A 01 N 51/00; A 01 N 43/42; A 01 N 43/56; A 01 N 43/80; A 01 N 47/02; A 01 N 43/76; A 01 N 43/22; A 01 N 47/40; A 01 N 43/707; A 01 N 43/82; A 01 N 37/50	AP 2018 13585 A
A 47 K 10/38; A 47 K 10/32	AP 2018 14167 A
A 61 K 9/10; A 61 K 9/107; A 61 K 9/08; A 61 K 9/00; A 61 K 31/473; A 61 P 25/16	AP 2018 13377 A
A 61 K 38/17; C 07 K 14/81	AP 2018 14277 A
E 02 B 3/16; E 02 B 3/10; E 00 B 3/12	AP 2018 14325 A

CONCORDANCE TABLE OF PUBLICATION NUMBERS AND INTERNATIONAL CLASSIFICATION INDEX

NUMBER OF PUBLISHED APPLICATION (10)	INTERNATIONAL CLASSIFICATION INDEXES (51)
AP 2018 13377 A	A 61 K 9/10; A 61 K 9/107; A 61 K 9/08; A 61 K 9/00; A 61 K 31/473; A 61 P 25/16
AP 2018 13585 A	A 01 N 43/40; C 07 D 401/06; C 07 D 213/46; A 01 P 7/00; A 01 N 51/00; A 01 N 43/42; A 01 N 43/56; A 01 N 43/80; A 01 N 47/02; A 01 N 43/76; A 01 N 43/22; A 01 N 47/40; A 01 N 43/707; A 01 N 43/82; A 01 N 37/50
AP 2018 14167 A	A 47 K 10/38; A 47 K 10/32
AP 2018 14277 A	A 61 K 38/17; C 07 K 14/81
AP 2018 14325 A	E 02 B 3/16; E 02 B 3/10; E 00 B 3/12

CONCORDANCE TABLE OF INTERNATIONAL CLASSIFICATION INDEX, PATENT NUMBERS AND PUBLICATION NUMBERS

INTERNATIONAL CLASSIFICATION INDEX (51)	NUMBER OF PATENT (11)	NUMBER OF PUBLISHED APPLICATION (10)
A 01 N 43/40	P 2018 6939 B	AP 2018 14459 A
A 61 C 8/00	P 2018 6936 B	AP 2018 14140 A
C 07 D 471/04; C 07 D 473/02; C 07 D 487/04; A 61 K 31/52; A 61 K 31/519; A 61 P 11/00; A 61 P 37/00; A 61 P 29/00	P 2018 6938 B	AP 2018 14349 A
G 01 B 5/004	P 2018 6935 B	AP 2018 14457 A
G 09 B 5/00; B 42 D 3/12	P 2018 6937 B	AP 2018 14344 A

**CONCORDANCE TABLE OF PATENT NUMBERS,
PUBLICATION NUMBERS AND INTERNATIONAL CLASSIFICATION INDEX**

NUMBER OF PATENT (11)	NUMBER OF PUBLISHED APPLICATION (10)	INTERNATIONAL CLASSIFICATION INDEX (51)
P 2018 6935 B	AP 2018 14457 A	G 01 B 5/004
P 2018 6936 B	AP 2018 14140 A	A 61 C 8/00
P 2018 6937 B	AP 2018 14344 A	G 09 B 5/00; B 42 D 3/12
P 2018 6938 B	AP 2018 14349 A	C 07 D 471/04; C 07 D 473/02; C 07 D 487/04; A 61 K 31/52; A 61 K 31/519; A 61 P 11/00; A 61 P 37/00; A 61 P 29/00
P 2018 6939 B	AP 2018 14459 A	A 01 N 43/40

**CONCORDANCE TABLE OF APPLICATION NUMBERS, PUBLICATION NUMBERS
AND PATENTS**

NUMBER OF APPLICATION (21)	NUMBER OF PUBLISHED APPLICATION (10)	NUMBER OF PATENT (11)
AP 2016 14140	AP 2018 14140 A	P 2018 6936 B
AP 2016 14344	AP 2018 14344 A	P 2018 6937 B
AP 2015 14349	AP 2018 14349 A	P 2018 6938 B
AP 2015 14459	AP 2018 14459 A	P 2018 6939 B
AP 2017 14457	AP 2018 14457 A	P 2018 6935 B

UTILITY MODEL

**CONCORDANCE TABLE OF INTERNATIONAL CLASSIFICATION INDEX,
PATENT NUMBERS AND PUBLICATION NUMBERS**

INTERNATIONAL CLASSIFICATION INDEX (51)	NUMBER OF PATENT (11)	NUMBER OF PUBLISHED APPLICATION (10)
E 05 F 13/04	U 2018 1997 Y	AU 2018 14614

**CONCORDANCE TABLE OF PATENT NUMBERS,
PUBLICATION NUMBERS AND INTERNATIONAL CLASSIFICATION INDEX**

NUMBER OF PATENT (11)	NUMBER OF PUBLISHED APPLICATION (10)	INTERNATIONAL CLASSIFICATION INDEX (51)
U 2018 1997 Y	AU 2018 14614	E 05 F 13/04

**CONCORDANCE TABLE OF APPLICATION NUMBERS, PUBLICATION NUMBERS
AND PATENTS**

NUMBER OF APPLICATION (21)	NUMBER OF PUBLISHED APPLICATION (10)	NUMBER OF PATENT (11)
AU 2017 14614	AU 2018 14614	U 2018 1997 Y

DESIGNS

**CONCORDANCE TABLE OF INTERNATIONAL CLASSIFICATION INDEX
AND PUBLICATION NUMBERS**

INTERNATIONAL CLASSIFICATION INDEXES (51)	NUMBER OF PUBLISHED APPLICATION (10)
09-01	AD 2018 1050 S

**CONCORDANCE TABLE OF PUBLICATION NUMBERS
AND INTERNATIONAL CLASSIFICATION INDEX**

NUMBER OF PUBLISHED APPLICATION (10)	INTERNATIONAL CLASSIFICATION INDEXES (51)
AD 2018 1050 S	09-01

**CONCORDANCE TABLE OF INTERNATIONAL CLASSIFICATION INDEX,
PATENT NUMBERS AND PUBLICATION NUMBERS**

INTERNATIONAL CLASSIFICATION INDEX (51)	NUMBER OF PATENT (11)	NUMBER OF PUBLISHED APPLICATION (10)
31-00	D 2018 795 S	AD 2018 1020 S

**CONCORDANCE TABLE OF PATENT NUMBERS,
PUBLICATION NUMBERS AND INTERNATIONAL CLASSIFICATION INDEX**

NUMBER OF PATENT (11)	NUMBER OF PUBLISHED APPLICATION (10)	INTERNATIONAL CLASSIFICATION INDEX (51)
D 2018 795 S	AD 2018 1020 S	31-00

CONCORDANCE TABLE OF APPLICATION NUMBERS, PUBLICATION NUMBERS
AND PATENTS

NUMBER OF APPLICATION (21)	NUMBER OF PUBLISHED APPLICATION (10)	NUMBER OF PATENT (11)
AD 2018 1020	AD 2018 1020 S	D 2018 795 S

TRADEMARKS

CONCORDANCE TABLE OF REGISTRATION NUMBERS, APPLICATION NUMBERS,
PUBLICATION NUMBERS AND BULLETIN NUMBERS

NUMBER OF REGISTRATION (111)	NUMBER OF APPLICATIONS (210)	NUMBER OF PUBLISHED APPLICATIONS (260)	NUMBER OF BULLETIN
M 2018 30562 R	AM 100590	-	24(508)2018
M 2018 30563 R	AM 100611	-	24(508)2018
M 2018 30564 R	AM 100609	-	24(508)2018
M 2018 30565 R	AM 100454	-	24(508)2018
M 2018 30566 R	AM 100662	-	24(508)2018
M 2018 30567 R	AM 100466	-	24(508)2018
M 2018 30568 R	AM 100608	-	24(508)2018
M 2018 30569 R	AM 100663	-	24(508)2018
M 2018 30570 R	AM 97806	-	24(508)2018
M 2018 30571 R	AM 90932	AM 2018 90932 A	1(485) 2018
M 2018 30572 R	AM 90933	AM 2018 90933 A	1(485)2018
M 2018 30573 R	AM 91537	AM 2018 91537 A	16(500)2018
M 2018 30574 R	AM 91539	AM 2018 91539 A	4(488)2018
M 2018 30575 R	AM 93483	AM 2018 93483 A	10(494)2018
M 2018 30576 R	AM 93533	AM 2018 93533 A	11(495)2018
M 2018 30577 R	AM 93618	AM 2018 93618 A	10(494)2018
M 2018 30578 R	AM 93720	AM 2018 93720 A	16(500)2018
M 2018 30579 R	AM 94056	AM 2018 94056 A	10(494)2018
M 2018 30580 R	AM 94057	AM 2018 94057 A	10(494)2018
M 2018 30581 R	AM 94079	AM 2018 94079 A	10(494)2018
M 2018 30582 R	AM 94371	AM 2018 94371 A	10(494)2018
M 2018 30583 R	AM 94439	AM 2018 94439 A	11(495)2018
M 2018 30584 R	AM 94440	AM 2018 94440 A	11(495)2018
M 2018 30585 R	AM 94543	AM 2018 94543 A	11(495)2018
M 2018 30586 R	AM 94559	AM 2018 94559 A	14(498)2018
M 2018 30587 R	AM 100610	-	24(508)2018
M 2018 30588 R	AM 100612	-	24(508)2018
M 2018 30589 R	AM 94601	AM 2018 94601 A	12(496)2018
M 2018 30590 R	AM 94604	AM 2018 94604 A	12(496)2018
M 2018 30591 R	AM 94671	AM 2018 94671 A	13(497)2018
M 2018 30592 R	AM 94691	AM 2018 94691 A	11(495)2018
M 2018 30593 R	AM 94694	AM 2018 94694 A	11(495)2018
M 2018 30594 R	AM 94701	AM 2018 94701 A	11(495)2018
M 2018 30595 R	AM 94776	AM 2018 94776 A	12(496)2018
M 2018 30596 R	AM 94777	AM 2018 94777 A	12(496)2018
M 2018 30597 R	AM 94877	AM 2018 94877 A	16(500)2018
M 2018 30598 R	AM 95007	AM 2018 95007 A	14(498)2018
M 2018 30599 R	AM 95008	AM 2018 95008 A	14(498)2018
M 2018 30600 R	AM 95010	AM 2018 95010 A	14(498)2018
M 2018 30601 R	AM 95011	AM 2018 95011 A	13(497)2018
M 2018 30602 R	AM 95039	AM 2018 95039 A	13(497)2018
M 2018 30603 R	AM 95208	AM 2018 95208 A	16(500)2018
M 2018 30604 R	AM 95259	AM 2018 95259 A	13(497)2018
M 2018 30605 R	AM 95415	AM 2018 95415 A	14(498)2018
M 2018 30606 R	AM 95458	AM 2018 95458 A	14(498)2018
M 2018 30607 R	AM 95518	AM 2018 95518 A	14(498)2018
M 2018 30608 R	AM 95551	AM 2018 95551 A	15(499)2018
M 2018 30609 R	AM 95559	AM 2018 95559 A	16(500)2018
M 2018 30610 R	AM 95568	AM 2018 95568 A	16(500)2018

1	2	3	4
M 2018 30611 R	AM 95657	AM 2018 95657 A	14(498)2018
M 2018 30612 R	AM 95695	AM 2018 95695 A	13(497)2018
M 2018 30613 R	AM 95709	AM 2018 95709 A	16(500)2018
M 2018 30614 R	AM 95920	AM 2018 95920 A	15(499)2018
M 2018 30615 R	AM 95927	AM 2018 95927 A	14(498)2018
M 2018 30616 R	AM 95932	AM 2018 95932 A	16(500)2018
M 2018 30617 R	AM 95933	AM 2018 95933 A	16(500)2018
M 2018 30618 R	AM 95942	AM 2018 95942 A	16(500)2018
M 2018 30619 R	AM 96005	AM 2018 96005 A	15(499)2018
M 2018 30620 R	AM 96069	AM 2018 96069 A	16(500)2018
M 2018 30621 R	AM 96071	AM 2018 96071 A	16(500)2018
M 2018 30622 R	AM 96098	AM 2018 96098 A	16(500)2018
M 2018 30623 R	AM 96117	AM 2018 96117 A	15(499)2018
M 2018 30624 R	AM 100420	-	24(508)2018
M 2018 30625 R	AM 100704	-	24(508)2018
M 2018 30626 R	AM 100759	-	24(508)2018

**CONCORDANCE TABLE OF PUBLICATION NUMBERS
AND APPLICATION NUMBERS**

NUMBER OF PUBLISHED APPLICATION (260)	NUMBER OF APPLICATION (210)	1	2
		1	2
AM 2018 91645 A	AM 91645	AM 2018 97462 A	AM 97462
AM 2018 92339 A	AM 92339	AM 2018 97463 A	AM 97463
AM 2018 96489 A	AM 96489	AM 2018 97464 A	AM 97464
AM 2018 96553 A	AM 96553	AM 2018 97466 A	AM 97466
AM 2018 96554 A	AM 96554	AM 2018 97467 A	AM 97467
AM 2018 96555 A	AM 96555	AM 2018 97481 A	AM 97481
AM 2018 97000 A	AM 97000	AM 2018 97484 A	AM 97484
AM 2018 97380 A	AM 97380	AM 2018 97678 A	AM 97678
AM 2018 97387 A	AM 97387	AM 2018 97683 A	AM 97683
AM 2018 97391 A	AM 97391	AM 2018 97689 A	AM 97689
AM 2018 97394 A	AM 97394	AM 2018 97691 A	AM 97691
AM 2018 97407 A	AM 97407	AM 2018 97692 A	AM 97692
AM 2018 97422 A	AM 97422	AM 2018 97694 A	AM 97694
AM 2018 97425 A	AM 97425	AM 2018 97695 A	AM 97695
AM 2018 97426 A	AM 97426	AM 2018 97696 A	AM 97696
AM 2018 97428 A	AM 97428	AM 2018 97697 A	AM 97697
AM 2018 97429 A	AM 97429	AM 2018 97700 A	AM 97700
AM 2018 97432 A	AM 97432	AM 2018 97701 A	AM 97701
AM 2018 97434 A	AM 97434	AM 2018 97707 A	AM 97707
AM 2018 97441 A	AM 97441	AM 2018 97709 A	AM 97709
AM 2018 97442 A	AM 97442	AM 2018 97710 A	AM 97710
AM 2018 97448 A	AM 97448	AM 2018 97763 A	AM 97763
AM 2018 97451 A	AM 97451	AM 2018 97768 A	AM 97768
AM 2018 97453 A	AM 97453	AM 2018 97770 A	AM 97770
AM 2018 97460 A	AM 97460	AM 2018 97778 A	AM 97778
		AM 2018 97783 A	AM 97783
		AM 2018 97789 A	AM 97789
		AM 2018 97790 A	AM 97790
		AM 2018 97792 A	AM 97792
		AM 2018 97795 A	AM 97795
		AM 2018 97888 A	AM 97888

1	2
AM 2018 97894 A	AM 97894
AM 2018 97896 A	AM 97896

1	2
AM 2018 97899 A	AM 97899
AM 2018 97979 A	AM 97979

CONCORDANCE TABLE OF INDEX OF GOODS AND/OR SERVICES
AND APPLICATION NUMBERS

INDEX OF GOODS AND/OR SERVICES (511)	NUMBER OF PUBLISHED APPLICATIONS (26)	1	2
1	2		
1	AM 2018 97694 A	20	AM 2018 97899 A
1	AM 2018 97695 A	25	AM 2018 97678 A
1	AM 2018 97696 A	25	AM 2018 97700 A
1	AM 2018 97697 A	25	AM 2018 97701 A
3	AM 2018 97481 A	25	AM 2018 97896 A
4	AM 2018 97451 A	25	AM 2018 97899 A
5	AM 2018 91645 A	28	AM 2018 97783 A
5	AM 2018 97422 A	28	AM 2018 97896 A
5	AM 2018 97425 A	28	AM 2018 97899 A
5	AM 2018 97426 A	28	AM 2018 97896 A
5	AM 2018 97428 A	28	AM 2018 97899 A
5	AM 2018 97429 A	28	AM 2018 97896 A
5	AM 2018 97442 A	29	AM 2018 97387 A
5	AM 2018 97453 A	29	AM 2018 97394 A
5	AM 2018 97464 A	29	AM 2018 97442 A
5	AM 2018 97467 A	29	AM 2018 97453 A
5	AM 2018 97481 A	29	AM 2018 97463 A
5	AM 2018 97694 A	29	AM 2018 97789 A
5	AM 2018 97695 A	29	AM 2018 97790 A
5	AM 2018 97696 A	29	AM 2018 97790 A
5	AM 2018 97697 A	29	AM 2018 97790 A
5	AM 2018 97710 A	29	AM 2018 97790 A
5	AM 2018 97888 A	30	AM 2018 97387 A
5	AM 2018 97888 A	30	AM 2018 97391 A
7	AM 2018 97380 A	30	AM 2018 97442 A
9	AM 2018 96489 A	30	AM 2018 97453 A
9	AM 2018 97000 A	30	AM 2018 97463 A
9	AM 2018 97466 A	30	AM 2018 97463 A
9	AM 2018 97894 A	30	AM 2018 97790 A
9	AM 2018 97894 A	30	AM 2018 97790 A
11	AM 2018 97380 A	31	AM 2018 97463 A
12	AM 2018 97460 A	31	AM 2018 97768 A
14	AM 2018 97763 A	31	AM 2018 97768 A
16	AM 2018 97000 A	32	AM 2018 97463 A
16	AM 2018 97896 A	32	AM 2018 97484 A
16	AM 2018 97899 A	32	AM 2018 97484 A
18	AM 2018 97691 A	32	AM 2018 97979 A
18	AM 2018 97692 A	32	AM 2018 97407 A
19	AM 2018 97441 A	33	AM 2018 97463 A
20	AM 2018 97442 A	33	AM 2018 97484 A
20	AM 2018 97453 A	33	AM 2018 97689 A
20	AM 2018 97896 A	33	AM 2018 97795 A
		33	AM 2018 97795 A
		33	AM 2018 97979 A
		34	AM 2018 97707 A
		34	AM 2018 97709 A
		35	AM 2018 97000 A
		35	AM 2018 97387 A
		35	AM 2018 97442 A
		35	AM 2018 97453 A
		35	AM 2018 97464 A
		35	AM 2018 97481 A
		35	AM 2018 97683 A
		35	AM 2018 97763 A
		35	AM 2018 97768 A
		35	AM 2018 97979 A
		36	AM 2018 92339 A

1	2
36	AM 2018 97442 A
36	AM 2018 97453 A
37	AM 2018 92339 A
37	AM 2018 97442 A
37	AM 2018 97453 A
38	AM 2018 96489 A
38	AM 2018 97000 A
39	AM 2018 96553 A
39	AM 2018 96554 A
39	AM 2018 96555 A
39	AM 2018 97432 A
39	AM 2018 97442 A
39	AM 2018 97453 A

1	2
39	AM 2018 97792 A
39	AM 2018 97792 A
41	AM 2018 96489 A
41	AM 2018 97000 A
41	AM 2018 97434 A
41	AM 2018 97896 A
41	AM 2018 97899 A
42	AM 2018 97448 A
43	AM 2018 97442 A
43	AM 2018 97453 A
43	AM 2018 97462 A
43	AM 2018 97770 A

**CONCORDANCE TABLE OF INDEX OF GOODS AND/OR SERVICES
AND NUMBERS OF TRADEMARKS REGISTERED ACCORDING
TO THE ACCELERATED PROCEDURE**

INDEX OF GOODS AND/OR SERVICES (511)	NUMBERS OF REGISTERED ACCORDING TO THE ACCELERATED PROCEDURE (111)
3	M 2018 30624 R
9	M 2018 30562 R
14	M 2018 30568 R
24	M 2018 30569 R
29	M 2018 30565 R
30	M 2018 30567 R
32	M 2018 30564 R
32	M 2018 30566 R
33	M 2018 30570 R
33	M 2018 30587 R
33	M 2018 30588 R
35	M 2018 30625 R
36	M 2018 30625 R
37	M 2018 30626 R
42	M 2018 30563 R

OFFICIAL BULLETIN OF THE INDUSTRIAL PROPERTY

INVENTIONS
UTILITY MODELS
DESIGNS
TRADEMARKS
APPELLATIONS OF ORIGIN OF GOODS

24(508)

EDITOR-IN-CHIEF: N. Bebrishvili

EDITOR-TRANSLATOR: E. Gabunia

PROOFREADER: A. Shikhashvili

COMPUTER LAYOUT: M. Ordenidze
K. Svanidze

www.sakpatenti.gov.ge
E-mail: info@sakpatenti.org.ge