

Official Bulletin of the Industrial Property

Inventions

Utility Models

Designs

Trademarks



საქართველოს ინტელექტუალური
საკუთრების ეროვნული ცენტრი

საქპატენტი

SAKPATENTI

NATIONAL INTELLECTUAL PROPERTY
CENTER OF GEORGIA

www.sakpatenti.gov.ge

Date of Publication – 2020 12 31

24(556)

INID CODES FOR IDENTIFICATION OF BIBLIOGRAPHIC DATA

INVENTIONS, UTILITY MODELS

- (10) Number of publication for application, which has been examined
- (11) Number of patent and kind of document
- (21) Serial number of application
- (22) Date of filing of the application
- (23) Date of exhibition or the date of the earlier filing and the number of application, if any
- (24) Date from which patent may have effect
- (31) Number of priority application
- (32) Date of filing of priority application
- (33) Code of the country or regional organization allotting priority application number
- (44) Date of publication of application not granted, but examined and number of bulletin
- (45) Date of publication of registered document
- (51) International Patent Classification Index

- (54) Title of the invention
- (57) Abstract
- (60) Number of examined patent document granted by foreign patent office, date from which patent has effect and country code
- (62) Number of the earlier application and in case of divided application, date of filing an application
- (71) Name, surname and address of applicant (country code)
- (72) Name, surname of inventor (country code)
- (73) Name, surname and address of patent owner (country code)
- (74) Name, surname of representative or patent attorney
- (85) Date of commencement of the national phase of International Application
- (86) Number and date of filing of international application
- (87) Number and date of publication of international application
- (94) Calculated date of expiry of the SPC or the duration of the SPC

DESIGNS

- (10) Number of publication for application
- (11) Number of patent and kind of document or number of registration
- (15) Date of registration/Date of patent renewal
- (18) Expected expiration date of patent or registration
- (21) Serial number of application
- (22) Date of filing of the application
- (23) Date of exhibition or the date of the earlier filing and the number of application, if any
- (24) Date from which patent may have effect
- (28) Number of designs included in the application
- (30) Data relating to priority (number of application, date of filing of application, two-letter code identifying the authority with whom the priority application was made)
- (31) Number of priority application
- (32) Date of filing of priority application
- (33) Code of the country or regional organization allotting priority application number
- (34) Two-letter code according to WIPO St.3 identifying the authority with which the priority application was made
- (44) Date of publication of design and number of bulletin (the first publication)
- (45) Date of publication of design registered by WIPO and number of bulletin

- (51) International Classification for designs (class and subclass of the Locarno Classification)
- (54) Title of the invention
- (55) Reproduction of the design
- (57) Description of characteristic features of the design including indication of colors
- (58) Date of recording of any kind of amendment in the Register
- (62) Number of the earlier application, registration and document number and if available the date of filing an application in case of divided application
- (71) Name, surname and address of applicant (country code)
- (72) Name, surname of creator (country code)
- (73) Name, surname and address of patent owner (country code)
- (74) Name, surname of representative or patent attorney
- (81) Contracting states concerned
 - II designated contracting states according to the 1960 Act
 - III designated contracting states according to the 1999 Act
- (85) Owner's permanent address
- (86) Owner's nationality
- (87) Owner's residence
- (88) State in which the owner has a real and effective industrial or commercial establishment

TRADEMARKS

- (111) - Number of registration
- (151) - Date of registration
- (156) - Date of the renewal
- (181) - Expected expiration date of registration
- (186) - Renewal expiration date of registration
- (141) - Date of cancel of duration of the mark
- (210) - Serial number of application
- (220) - Date of filing of the application
- (230) - Data concerning exhibition
- (260) - Number of application, for which favorable decision of examination about registration has been taken (publication number)
- (310) - Number of the first application
- (320) - Date of filing of the first application
- (330) - Code, identifying national or regional Office where the first application was made
- (511) - International Classification of Goods and Services for the purposes of registration of trade marks and/or list of goods and/or services classified according thereto
- (526) - Disclaimer
- (531) - Description of figurative elements of Trade Marks according to the International Classification of the Figurative Elements of Marks

- (540) - Reproduction of Trade Mark
- (550) - Nature and kind of Trade Mark
- (551) - Indication to the effect that the mark is a collective mark, a certification mark or a guarantee mark
- (554) - Three-dimensional mark
- (580) - Date of recording of any kind changes in respect of applications or registrations
- (591) - Information concerning colors claimed
- (731) - Name and address of the applicant
- (732) - Name and address of the holder of the registration
- (740) - Name and address of the representative
- (750) - Addreses for correspondence
- (770) - Name and address of the previous applicant or holder in case of change in ownership
- (771) - Previous name and address of the applicant or holder in case of change in ownership
- (791) - Name and address of the licensee
- (793) - Indication of conditions and/or restrictions under the license (Type of license, number of license agreement, data of license, data of validity of license)
- (800) - Certain data relating to the international registration of Trade Marks under the Protocol Relating to Madrid Agreement (International registration number
- (852) - Partial cancellation of the list of goods and services
- (891) - Date of subsequent designation

CODES FOR PUBLICATION IN BULLETIN

- (21) AP 0000 000000 - serial number of application for invention
- (10) AP 0000 0000 A - number of published application for invention (first publication)
- (11) P 0000 0000 B - number of patent for invention (second publication)
- (21) API 0000 000000 - number of application for imported patent
- (11) PI 0000 0000 A - number of imported patent (first publication)
- (21) AU 0000 000000 - serial number of application for utility model
- (10) AU 0000 000 U - number of published application for utility model (first publication)
- (11) U 0000 000 Y - number of patent for utility model (second publication)
- (21) AD 0000 000000 - serial number of application for design
- (10) AD 0000 000 S - number of published application for design (first publication)
- (11) D 0000 000 S - registered design

INTERNATIONAL PATENT CLASSIFICATION FOR INVENTIONS AND UTILITY MODELS

- SECTION A - HUMAN NECESSITIES
- SECTION B - PERFORMING OPERATIONS; TRANSPORTING
- SECTION C - CHEMISTRY; METALLURGY
- SECTION D - TEXTILES; PAPER
- SECTION E - FIXED CONSTRUCTIONS
- SECTION F - MECHANICAL ENGINEERING; LIGHTING; HEATING; WEAPONS; BLASTING
- SECTION G - PHYSICS
- SECTION H - ELECTRICITY

-
- M - Trade Mark
 - (210) AM 0000 000000 - Serial number of application;
 - (260) AAM 0000 00000 A - Publication number of application;
 - (111) M 0000 00000 R - Number of registration;
 - (111) MMM0000 00000 Rn - Number of renewals, in which n=1,2,3;
 - (111) M 0000 00000 R(P) - Number of registration under partial assignment of rights
-

Official Bulletin of the Industrial Property

Inventions

Utility Models

Designs

Trademarks

CONTENTS

PUBLISHED TITLES OF PROTECTION	3
INVENTIONS	
▪ APPLICATIONS APPROVED FOR GRANTING PATENTS	4
▪ PATENTED INVENTIONS	7
UTILITY MODELS	
▪ APPLICATIONS APPROVED FOR GRANTING PATENTS	12
▪ PATENTED UTILITY MODELS	14
DESIGNS	
▪ APPLICATIONS APPROVED FOR REGISTRATION	15
▪ DESIGN REGISTERED ACCORDING TO THE ACCELERATED PROCEDURE	31
▪ DESIGNS, WHICH HAVE BEEN REGISTERED WITH THE INTERNATIONAL BUREAU CLAIMING PRIORITY ON THE TERRITORY OF GEORGIA	32
TRADEMARKS	
▪ APPLICATIONS FILED UNDER THE NATIONAL PROCEDURE APPROVED FOR REGISTRATION	43
▪ REGISTERED TRADEMARKS	51
▪ TRADEMARKS REGISTERED ACCORDING TO THE ACCELERATED PROCEDURE	54
▪ INTERNATIONAL TRADEMARKS FOR WHICH A DECISION ON GRANTING PROTECTION IS TAKEN	57
▪ INTERNATIONAL TRADEMARKS PROTECTED IN GEORGIA	88
OFFICIAL NOTIFICATIONS	
INVENTIONS	
▪ EXPIRATION OF PATENT RESTORATION	93
▪ ABOLITION OF PATENTS WITH THE RIGHT TO RESTORE	93
▪ EXPIRATION OF TERM OF RESTORATION OF PATENTS	95
▪ EXPIRATION OF PATENT	96
UTILITY MODELS	
▪ EXPIRATION OF PATENT RESTORATION	97
▪ ABOLITION OF PATENT WITH THE RIGHT TO RESTORE	97
▪ EXPIRATION OF TERM OF RESTORATION OF PATENT	98
▪ TRANSFER OF RIGHT	99
DESIGN	
▪ EXTENSION OF REGISTRATION OF DESIGN	99
TRADEMARKS	
▪ RENEWAL OF REGISTRATIONS	100
▪ COMPLETE TRANSFER OF RIGHTS	103
▪ CHANGES OF NAMES AND/OR ADDRESSES OF OWNER	104
▪ TERMINATION OF TRADEMARKS REGISTRATION	107
▪ REGISTRATION OF LICENSE AGREEMENTS	109
CLASSIFICATION INDEXES	
INVENTIONS	110
UTILITY MODELS	113
DESIGNS	114
TRADEMARKS	116

PUBLISHED TITLES OF PROTECTION

INVENTIONS

- **APPLICATIONS APPROVED FOR GRANTING PATENT:**
15102; 14966; 15047; 14864; 15125
- **PATENTED INVENTIONS:**
7192-7208

UTILITY MODELS

- **APPLICATIONS APPROVED FOR GRANTING PATENTS:**
15270; 15290; 15358
- **PATENTED UTILITY MODEL:**
2063

DESIGNS

- **APPLICATIONS APPROVED FOR REGISTRATION:**
1173, 1174; 1176; 1165-1171
- **DESIGN REGISTERED ACCORDING TO THE ACCELERATED PROCEDURE:**
873
- **DESIGNS, WHICH HAVE BEEN REGISTERED WITH THE INTERNATIONAL BUREAU CLAIMING PRIORITY ON THE TERRITORY OF GEORGIA:**
210562; 210633; 208347; 210755; 210819; 208576, 208577; 208887

TRADEMARKS

- **APPLICATIONS FILED UNDER THE NATIONAL PROCEDURE APPROVED FOR REGISTRATION:**
103570; 105214; 105558; 106822; 108060; 108119; 108121; 108130; 108208; 108215; 108230; 108292; 108299; 108301; 108319; 108384-108388; 108411; 108414-108418; 108420, 108421; 108423-108426; 108432-108435; 108478-108481; 108483; 108485, 108486; 108488; 108511, 108512; 108515; 108595; 108612, 108613
- **REGISTERED TRADEMARKS:**
33429-33463
- **TRADEMARKS REGISTERED ACCORDING TO THE ACCELERATED PROCEDURE:**
33420-33428; 33464-33467
- **INTERNATIONAL TRADEMARKS FOR WHICH A DECISION ON GRANTING PROTECTIONS IS TAKEN:**
105575; 107192; 107229; 107328; 107330-107335; 107337-107343; 107424, 107425; 107430; 107432, 107433; 107436-107438; 107446; 107448-107450; 107452, 107453; 107501; 107503, 107504; 107611, 107612; 107641; 107697; 107704; 107730, 107731; 107745-107753; 107794, 107795; 107796; 107864; 107881; 107968, 107969; 107971; 107973-107977
- **INTERNATIONAL TRADEMARKS PROTECTED IN GEORGIA:**
105694; 105705; 105826; 105831, 105832; 105836; 105850; 105863; 105866-105868; 105906-105909; 105911; 105916; 105927; 105935; 105954; 106006; 106009; 106022, 106023; 106031; 106131, 106132; 106134, 106135; 106149; 106199; 106201; 106220; 106225, 106226; 106291; 106295, 106296; 106307-106311; 106316; 106324; 106329; 106331, 106332; 106416; 106422, 106423; 106549, 106550; 106713; 106715; 106717; 106719-106722; 106741; 106852; 106910-106912; 106917-106919

INVENTIONS

APPLICATIONS APPROVED FOR GRANTING PATENTS

The decision can be appealed at the Chamber of Appeal of Sakpatenti within 3 months from the publication or at the Mtskheta District Court Administrative Cases Board (Address: №17, Samkhedro str., Mtskheta), within 1 month following the publication.

PART A

A 61

(10) AP 2020 15102 A (51) Int. Cl. (2006)
A 61 F 9/007

(21) AP 2019 15102 (22) 2019 06 05

(71) Nikoloz Labauri (GE)

P. Kavtaradze St. 14a, app. 13, 0171, Tbilisi,
Georgia (GE)

(72) Nikoloz Labauri (GE)

(74) Dito Khvichia

(54) LABAURI GLAUCOMA VALVE

(57) Labauri glaucoma valve includes locked case 1, connected thereto from above the fluid inflow silicone pipe 2, whereto is connected placed in the case the opening/locking shovel 7 also connected to an axle 6 rotatable; the axle in its turn is connected to fixed in the case the movable spring 5 providing shovel opening and locking. Case lower spatial part creates a tank 8, which front, lower and side parts are the grids 4 outflowing intraocular fluid falt in the tank. At that, at the case of aggressive forms of glaucoma the valve can be equipped with the blades 9 fixed onto valve case by means of belts 10.

Claims: 1 independent

1 dependent

Fig.: 5

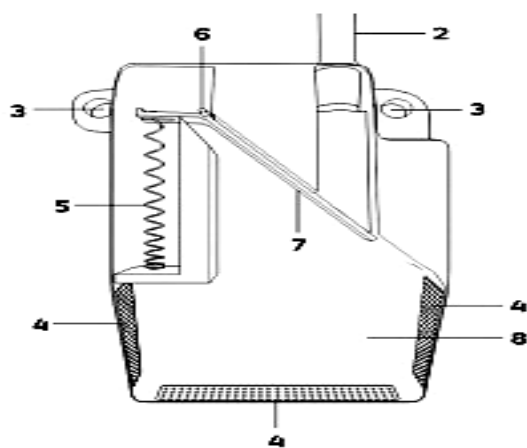

Fig. 2

(10) AP 2020 14966 A (51) Int. Cl. (2006)

A 61 K 9/08

A 61 K 47/26

A 61 K 47/10

A 61 K 47/14

A 61 K 9/00

A 61 K 39/395

A 61 K 39/00

(21) AP 2017 14966 (22) 2017 06 28

(31) 10 2016 0083039

(32) 2016 06 30

(33) KR

(71) Celltrion Inc. (KR)

23, Academy-ro, Yeonsu-gu Incheon 22014,
Republic of Korea (KR)

(72) KIM, Su Jung (KR);

LEE, Joon Won (KR);

HAN, Won Yong (KR);

OH, Jun Seok (KR);

SHIN, Yeon Kyeong (KR);

HONG, Su Hyeon (KR);

KIM, So Young (KR)

(74) Larisa Amirkhanyan

(85) 2018 12 18

(86) PCT/KR2017/006855, 2017 06 28

(54) STABLE LIQUID PHARMACEU-
TICAL PREPARATION

(57) Present invention relates to stable liquid pharmaceutical preparation containing infliximab or antigen-binding fragment thereof, surfactant, sugar or derivative thereof, and a buffer, and intended to be administered subcutaneously.

Claims: 4 independents

17 dependents

(10) AP 2020 15047 A (51) Int. Cl. (2006)

A 61 K 9/127

A 61 K 31/519

A 61 P 35/00

(21) AP 2017 15047 (22) 2017 10 27

(31) 16306415.7

(32) 2016 10 28

(33) EP

(71) Les Laboratoires Servier (FR)

35, Rue de Verdun, 92284 Suresnes Cedex,
France (FR);

Novartis AG (CH)
Lichtstraße 35, 4056, Basel, Switzerland (CH)

- (72) WESSELS, Peter (CH);
TIEMESSEN, Henricus (CH);
DE MARCO, Paolo (CH);
LARABI, Malika (CH);
SCHIEDEL, Christiane (CH);
GURINA, Marina (CH)

(74) Tamaz Shilakadze

(85) 2019 04 15

(86) PCT/EP2017/077538, 2017 10 27

(54) LIPOSOMAL FORMULATION FOR
USE IN THE TREATMENT OF CANCER

(54) Composition comprises 2-[[5-{3-chloro-2-methyl-4-[2-(4-methylpiperazin-1-yl)ethoxy]phenyl}-6-(4-fluorophenyl)thieno [2,3-*d*]pyrimidin-4-yl]oxy]-3-(2-{[2-(2-methoxyphenyl)pyrimidin-4-yl]methoxy}phenyl) propanoic acid, negatively charged or polar phospholipid, and antigen stabilizers.

Claims: 7 independents

21 dependents

Fig.: 4

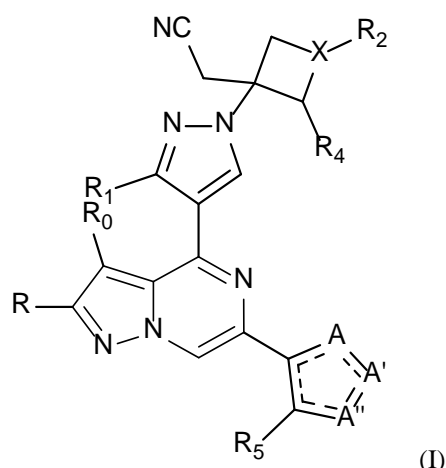

concrete compounds, pharmaceutically acceptable salts and solvates thereof. The invention also relates to usage of said compound, and pharmaceutical compositions containing them at autoimmune or inflammatory diseases treatment.

Claims: 14 independents

1 dependent

- (10) AP 2020 14864 A (51) Int. Cl. (2006)
A 61 K 31/4985
A 61 P 25/28
A 61 P 29/00
A 61 P 37/02
C 07 D 487/04

(21) AP 2017 14864 (22) 2017 02 10

(31) 62/299,130

(32) 2016 02 24

(33) US

(71) Pfizer Inc. (US)
235 East 42nd St., New York, NY 10017,
USA (US)

(72) BROWN, Matthew Frank (US);
DERMENCI, Alpay (US);
FENSOME, Andrew (US);
GERSTENBERGER, Brian Stephen (US);
HAYWARD, Matthew Merrill (US);
OWEN, Dafydd Rhys (US);
WRIGHT, Stephen Wayne (US);
XING, Li Huang (US);
YANG, Xiaojing (US)

(74) Shalva Gvaramadze

(85) 2018 08 24

(86) PCT/IB2017/050748, 2017 02 10

(54) PYRAZOLO[1,5-*A*]PYRAZIN-4-*YL*
DERIVATIVES AS JAK-INHIBITORS

(57) An invention relates to compound of structural formula (I)

PART C

C 04

(10) AP 2020 15125 A (51) Int. Cl. (2006)
C 04 B 21/00

(21) AP 2019 15125 (22) 2019 07 03

(71) Razhden Skhvitaridze (GE);
Ninoshvili St. 3, 0102, Tbilisi, Georgia (GE);
Elene Shapakidze (GE)
I. Chavchavadze Av., Lane I, corp. 6, app. 7,
0179, Tbilisi, Georgia (GE);
Merab Abazadze (GE)
Tsinamdzhvishvili St. 60, Tbilisi,
Georgia (GE);
Ioseb Gejadze (GE)
I. Chavchavadze Av., Lane I, corp. 6, app. 7,
0179, Tbilisi, Georgia (GE);
Malkhaz Turdzeladze (GE)
Ghambashidze St. Lane II, 3, 2000, Zestaponi,
Georgia (GE);
Shalva Verulava (GE)
M. Kostava St. 75, 0160, Tbilisi, Georgia (GE);
LEPL Levan Samkharauli National Forensics
Bureau (GE)
I. Chavchavadze Av. 84, 0162, Tbilisi,
Georgia (GE);
Georgian Technical University (GE)
M. Kostava St. 77, 0171, Tbilisi, Georgia (GE);
Iv. Javakhishvili Tbilisi State University (GE)
I. Chavchavadze Av. 1, 0179, Tbilisi,
Georgia (GE);

LEPL Shota Rustaveli National Science
Foundation of Georgia (GE)
M. Aleksidze St. 1, 0193, Tbilisi, Georgia (GE)

(72) Razhden Skhvitardze (GE);

Elene Shapakidze (GE);

Merab Abazadze (GE);

Ioseb Gejadze (GE);

Malkhaz Turdzeladze (GE);

Shalva Verulava (GE)

(54) PREPARATION METHOD FOR
EXPANDED CLAY WITH SHALE
BROUGHT BY THE RIVER DURUJI
AND ACCUMULATED IN THE
RIVER-BED NEARBY CITY KVARELI

(57) Preparation method for expanded clay provides output, crumbling, sorting by passing through a mesh, baking till expanding, and creating granules with baked surface of shale brought by the River Duruji; at that, initially, shale mass sorting is executed by its passing through the mesh of 1 and 10 mm size; then, the fraction of size no more than 10mm is delivered to be heated and expanded, and the fraction of more size is crumbled, and passed again and again through the mesh till whole mass passing; at that, the fraction of size less than 1mm is granulated to be increased with diameter up to 10 mm, and then, they are delivered to be heated and expanded, as well.

Claims: 1 independent

PATENTED INVENTIONS

PART A

A 01

- (11) P 2020 7203 B (51) Int. Cl. (2006)
A 01 N 53/00
A 01 N 35/04
A 01 P 7/02
A 01 P 7/04
- (10) AP 2020 15137 A (44) 14(546)/2020
(21) AP 2019 15137
(22) 2019 07 15
(24) 2019 07 15
(73) Ramaz Gakhokidze (GE)
Barnov St. 82, app. 7, 0179, Tbilisi,
Georgia (GE);
Lia Kvaratskhelia (GE)
Tbilisi Sea St., IV Lane, House 9, Tbilisi,
Georgia (GE)
- (72) Ramaz Gakhokidze (GE);
Lia Kvaratskhelia (GE)
- (54) BIOINSECTICIDE REPELLENT
(SYNONYMS: BIOPHAR, ANTIPHAR,
BIORAL)

A 61

- (11) P 2020 7194 B (51) Int. Cl. (2006)
A 61 K 9/08
A 61 K 31/194
A 61 K 31/455
A 61 K 31/675
A 61 K 31/708
A 61 K 47/02
A 61 K 47/18
- (10) AP 2020 15060 A (44) 16(548)/2020
(21) AP 2017 15060
(22) 2017 09 07
(24) 2017 09 07
(31) 2016138632
(32) 2016 09 29
(33) RU
(86) PCT/RU2017/000658, 2017 09 07
(73) LTD "NTFF "POLYSAN" (RU)
Ul. Salova 72, corp. 2 Litera "A",
St.Peterburg, 192102, Russian Federation (RU)
- (72) KOVALENKO, Alexey Leonidovich (RU);
PETROV, Andrey Yurievich (RU)
- (74) Tamar Kochlamazashvili
- (54) METHOD FOR PRODUCING
STABILIZED PHARMACEUTICAL
COMPOSITION IN FORM OF
AQUEOUS SOLUTION

- (11) P 2020 7208 B (51) Int. Cl. (2006)
A 61 K 9/20
A 61 K 9/28
A 61 K 9/24
A 61 K 9/48
- (10) AP 2020 14156 A (44) 16(548)/2020
(21) AP 2013 14156
(22) 2013 10 29
(24) 2013 10 29
(86) PCT/EP2013/072648, 2013 10 29
(73) TILLOTTS PHARMA AG (CH)
Baslerstrasse 15, CH-4310 Rheinfelden,
Switzerland (CH)
- (72) VARUM, Felipe José Oliveira (CH);
BRAVO GONZÁLEZ, Roberto Carlos (CH);
BUSER, Thomas (CH);
BASIT, Abdul Waseh (GB);
FREIRE, Ana Cristina (GB)
- (74) Tamaz Shilakadze
- (54) DELAYED RELEASE DRUG
FORMULATION

- (11) P 2020 7204 B (51) Int. Cl. (2006)
A 61 K 31/436
A 61 P 27/02
- (10) AP 2020 14989 A (44) 14(546)/2020
(21) AP 2017 14989
(22) 2017 06 29
(24) 2017 06 29
(31) 62/440,658; 62/356,613
(32) 2016 12 30; 2016 06 30
(33) US; US
(86) PCT/US2017/039968, 2017 06 29
(73) Durect Corporation (US)
10260 Bubb Road, Cupertino,
CA 95014-4166, USA (US);
Santen Pharmaceutical CO., LTD. (JP)
9-19 Shimoshinjo 3-tome, Higashi
Yodogawa-ku. Osaka-si, Osaka 533-8651,
Japan (JP)
- (72) MATSUMOTO, Naoki (JP);
LIN, Weiqi (US);
SU, Huey-Ching Lin (US);
OKABE, Komei (JP);
MUDUMBA, Sreenivasu (US);
YAMADA, Kazuhito (JP);
TAMRAZ, Wilma (US)
- (74) Shalva Gvaramadze
- (85) 2019 01 25
(86) PCT/US2017/039968, 2017 06 29
(54) DEPOT FORMULATIONS

- (11) P 2020 7202 B (51) Int. Cl. (2006)
A 61 K 31/437
A 61 K 31/519
A 61 P 11/06
C 07 D 471/04
C 07 D 487/04
C 07 D 519/00
- (10) AP 2020 15169 A (44) 16(548)/2020
(21) AP 2018 15169
(22) 2018 01 26
(24) 2018 01 26
(31) 17153785.5
(32) 2017 01 30
(33) EP
(86) PCT/EP2018/052009, 2018 01 26
(73) CHIESI FARMACEUTICI S.P.A. (IT)
Via Palermo, 26/A, 43122 Parma, Italy (IT)
(72) CAPELLI, Anna Maria (IT);
BHALAY, Gurdip (IT);
TISSELLI, Patrizia (IT);
CLARK, David Edward (IT);
CHEGUILLAUME, Arnaud Jean Francois
Auguste (IT);
EDWARDS, Christine (IT);
RANCATI, Fabio (IT);
ACCETTA, Alessandro (IT)
(74) Shalva Gvaramadze
(54) TYROSINE AMIDE DERIVATIVES
AS RHO-KINASE INHIBITORS

- (11) P 2020 7205 B (51) Int. Cl. (2006)
A 61 K 31/519
A 61 P 9/00
A 61 P 9/10
A 61 P 9/12
A 61 P 9/04
C 07 D 487/04
- (10) AP 2020 14831 A (44) 15(547)/2020
(21) AP 2016 14831
(22) 2016 12 20
(24) 2016 12 20
(31) PCT/CN2015/098251
(32) 2015 12 22
(33) CN
(86) PCT/US2016/067654, 2016 12 20
(73) MERCK SHARP & DOHME CORP. (US)
126 East Lincoln Ave., Rahway,
NJ 07065-0907, USA (US)
(72) BERGER, Raphelle (US);
CHEN, Yi-Heng (US);
LI, Guoqing (US);
GARFUNKLE, Joie (US);
LI, Hong (US);
MIAO, Shouwu (US);
RAGHAVAN, Subharekha (US)
SMITH, Cameron, J. (US);
STELMACH, John (US);
WHITEHEAD, Alan (US);

- ZHANG, Rui (US);
ZHANG, Yong (US);
FU, Jianmin (CN);
JI, Gang (CN);
JIANG, Falong (CN)
(74) Shalva Gvaramdze
(54) 4-AMINO-2-(1H-PYRAZOLO[3,4-B]PYRI-
DIN-3-YL)-6-OXO-6,7-DIHYDRO-5H-PYR-
ROLO[2,3-D]PYRIMIDINE DERIVATI-
VES AND RESPECTIVE (1H-INDAZOL-
3-YL) DERIVATIVES AS CGMP MODU-
LATORS FOR TREATING CARDIOVAS-
CULAR DISEASES

PART C

C 08

- (11) P 2020 7199 B (51) Int. Cl. (2006)
C 08 K 5/098
C 09 D 167/08
- (10) AP 2020 14587 A (44) 14(546)/2020
(21) AP 2017 14587
(22) 2017 09 18
(24) 2017 09 18
(31) 16189511.5
(32) 2016 09 19
(33) EP
(73) DAW SE (DE)
Roßdörfer Straße 50,64372 Ober-Ramstadt,
Germany (DE)
(72) BEATRIX, Herrmann (DE);
MENZEL, Stefan (DE);
DANIEL, Andre (DE)
(74) Liliana Darakhvelidze
(54) SOLVENT-COATING COMPOSITION
FOR PAINT COATINGS
-

PART D**D 06**

- (11) P 2020 7192 B (51) Int. Cl. (2006)
D 06 P 1/52
D 06 P 5/30
D 06 P 5/00
- (10) AP 2020 14825 A (44) 13(545)/2020
(21) AP 2016 14825
(22) 2016 12 22
(24) 2016 12 22
(31) 102015000089200
(32) 2015 12 30
(33) IT
(86) PCT/EP2016/082328, 2016 12 22
(73) MANIFATTURA DEL SEVESO S.P.A. (IT)
Via Monte Grappa, 7, Bergamo, 24121,
Italy (IT)
(72) BOLOGNA, Franco (IT)
(74) Tamar Kochlamazashvili
(54) PROCESS FOR OBTAINING A CLOTH
WITH HIGH PERFORMANCES FOR
DIGITAL PRINTING AND RELATIVE
CLOTH

- (11) P 2020 7207 B (51) Int. Cl. (2006)
E 01 F 7/04
- (10) AP 2020 14926 A (44) 14(546)/2020
(21) AP 2018 14926
(22) 2018 11 16
(24) 2018 11 16
(73) Goga Chakhaia (GE)
Nutsubidze Plateau, I mcr., corp. 1, app. 4,
0183, Tbilisi, Georgia (GE);
Levan Tsulukidze (GE)
Nutsubidze Plateau, I mcr., corp. 1, app. 40,
0183, Tbilisi, Georgia (GE);
Zurab Lobzhanidze (GE)
Nutsubidze Plateau, I mcr., corp. 1, app. 4,
0183, Tbilisi, Georgia (GE);
Sopio Gogilava (GE)
Nutsubidze Plateau, I mcr., corp. 1, app. 4,
0183, Tbilisi, Georgia (GE);
LTD "High School Education Academy" (GE)
Ksani St. 35, 0141, Tbilisi, Georgia (GE)
- (72) Goga Chakhaia (GE);
Levan Tsulukidze (GE);
Zurab Lobzhanidze (GE);
Sopio Gogilava (GE)
- (54) CONSTRUCTION FOR SNOWSLIDE
CONTROL

PART E**E 01**

- (11) P 2020 7193 B (51) Int. Cl. (2006)
E 01 B 9/30
E 01 B 9/10
E 01 B 9/02
F 16 B 35/04
F 16 B 5/02
- (10) AP 2020 15022 A (44) 14(546)/2020
(21) AP 2017 15022
(22) 2017 07 25
(24) 2017 07 25
(31) 1613802.6
(32) 2016 08 11
(33) GB
(86) PCT/GB2017/052164, 2017 07 25
(73) PANDROL LIMITED (GB)
63 Station Road Addlestone Surrey KT15
2AR, United Kingdom (GB)
(72) COX, Stephen John (GB);
JOHN DAVID, Spencer (GB)
(74) Liliana Darakhvelidze
(54) SCREWED FASTENING SYSTEM
FOR RAILWAY RAILS

E 02

- (11) P 2020 7201 B (51) Int. Cl. (2006)
E 02 D 5/02
- (10) AP 2020 14645 A (44) 14(546)/2020
(21) AP 2016 14645
(22) 2016 04 22
(24) 2016 04 22
(31) P.412127
(32) 2015 04 27
(33) PL
(86) PCT/PL2016/050015, 2016 04 22
(73) PPH S. I A. Pietrucha Andrzej Pietrucha (PL)
Ul. Przemysłowa 10, 98-235 Błaszki,
Polska (PL)
(72) PIETRUCHA, Jerzy (PL);
KOLASIŃSKI, Daniel (PL);
EJCHMAN, Dariusz (PL);
PIETRUCHA, Andrzej (PL)
(74) Khatuna Imnadze
(54) METHOD OF REINFORCED GEOTE-
CHNICAL PROFILES MANUFACTURE
AND PROFILES MANUFACTURED
WITH SAID METHOD

PART G**G 01**

- (11) P 2020 7206 B (51) Int. Cl. (2006)
G 01 T 1/00
- (10) AP 2020 15190 A (44) 17(549)/2020
- (21) AP 2019 15190
- (22) 2019 10 09
- (24) 2019 10 09
- (73) LEPL IV. BERITASHVILI CENTER
OF EXPERIMENTAL BIOMEDICINE (GE)
L. Gotua St. 14, 0160, Tbilisi, Georgia (GE)
- (72) Gari Grebenchuk (GE);
Nazi Ivanishvili (GE);
Davit Nadareishvili (GE);
Mikheil Gogebashvili (GE)
- (74) Gari Grebenchuk
- (54) METHOD FOR DETERMINATION OF
RADIATION DOSAGE ABSORBED BY
BIOLOGICAL OBJECT UNDER
INFLUENCE OF RA LEVEL

G 06

- (11) P 2020 7195 B (51) Int. Cl. (2006)
G 06 F 1/16
- (10) AP 2020 15012 A (44) 13(545)/2020
- (21) AP 2019 15012
- (22) 2019 02 22
- (24) 2019 02 22
- (73) Vasil Petriashvili (GE)
Nutsbidze Plateau, III mcr., quarter 3,
corp. 8, app. 1, 0183, Tbilisi, Georgia (GE);
Irakli Petriashvili (GE)
Nutsbidze Plateau, III mcr., quarter 3,
corp. 8, app. 1, 0183, Tbilisi, Georgia (GE)
- (72) Vasil Petriashvili (GE);
Irakli Petriashvili (GE)
- (74) Aleksandre Gegechkori
- (54) FOLDABLE PC (PERSONAL COMPUTER)

- (11) P 2020 7198 B (51) Int. Cl. (2006)
G 06 F 3/02
G 06 K 9/00
- (10) AP 2020 14953 A (44) 15(547)/2020
- (21) AP 2017 14953
- (22) 2017 05 16
- (24) 2017 05 16
- (31) 16173961.0
- (32) 2016 06 10
- (33) EP
- (86) PCT/EP2017/061684, 2017 05 16
- (73) SICPA HOLDING SA (CH)
Av. De Florissant 41, 1008 Prilly,
Switzerland (CH)

- (72) DECOUX, Eric (CH)
- (74) Liliana Darakhvelidze
- (54) METHOD, IMAGING DEVICE AND
SYSTEM FOR GENERATING MEASURE
OF AUTHENTICITY OF OBJECT

G 07

- (11) P 2020 7196 B (51) Int. Cl. (2006)
G 07 D 7/202
G 07 D 7/1205
- (10) AP 2020 14962 A (44) 15(547)/2020
- (21) AP 2017 14962
- (22) 2017 06 26
- (24) 2017 06 26
- (31) 16177270.2
- (32) 2016 06 30
- (33) EP
- (86) PCT/EP2017/065666, 2017 06 26
- (73) SICPA HOLDING SA (CH)
Av. De Florissant 41, 1008 Prilly,
Switzerland (CH)
- (72) RAEMY, Xavier-Cédric (CH);
DORIER, Jean-Luc (CH);
HALASZ, Edmund (CH);
DINOEV, Todor (CH)
- (74) Liliana Darakhvelidze
- (54) SYSTEMS, METHODS AND COMPUTER
PROGRAMS FOR GENERATING
MEASURE OF AUTHENTICITY
OF OBJECT

- (11) P 2020 7197 B (51) Int. Cl. (2006)
G 07 D 7/1205
G 07 D 7/202
- (10) AP 2020 14961 A (44) 15(547)/2020
- (21) AP 2017 14961
- (22) 2017 06 26
- (24) 2017 06 26
- (31) 16177272.8
- (32) 2016 06 30
- (33) EP
- (86) PCT/EP2017/065668, 2017 06 26
- (73) SICPA HOLDING SA (CH)
Av. De Florissant 41, 1008 Prilly,
Switzerland (CH)
- (72) RAEMY, Xavier-Cédric (CH);
DORIER, Jean-Luc (CH);
HALASZ, Edmund (CH);
DINOEV, Todor (CH)
- (74) Liliana Darakhvelidze
- (54) SYSTEMS, METHODS AND COMPUTER
PROGRAMS FOR GENERATING
MEASURE OF AUTHENTICITY
OF OBJECT

PART F**F 22**

- (11) P 2020 7200 B (51) Int. Cl. (2006)
F 22 B 1/28
H 05 B 6/10
- (10) AP 2020 15260 A (44) 17(549)/2020
(21) AP 2018 15260
(22) 2018 06 19
(24) 2018 06 19
(31) 2017121852
(32) 2017 06 21
(33) RU
(86) PCT/RU2018/000406, 2018 06 19
(73) ASLANOV, Georgiy Sevastiyevich (RU)
Ul. 3-ya Koltsevaya, 58A, qu. 33,
Rostov-on-Don, 344004, Russian
Federation (RU)
(72) ASLANOV, Georgiy Sevastiyevich (RU)
(74) Shalva Gvaramadze
(54) ELECTRIC STEAM GENERATOR
-

UTILITY MODELS

APPLICATIONS APPROVED FOR GRANTING PATENTS

The decision can be appealed at the Chamber of Appeal of Sakpatenti within 3 months from the publication or at the Mtskheta District Court Administrative Cases Board (Address: №17, Samkhedro str., Mtskheta), within 1 month following the publication.

PART A

A 61

- (10) AU 2020 15270 U (51) Int. Cl. (2006)
A 61 F 13/15
(21) AU 2020 15270 (22) 2020 02 04
(71) Nino Mchedlishvili (GE)
Dighomi Array 3/5, app. 45, 0159, Tbilisi,
Georgia (GE)
(72) Nino Mchedlishvili (GE)
(54) MULTIPLE USAGE PAD FOR LADY
(57) Multiple usage pad includes at least two layers,
the upper therefrom is liquid absorbing layer, and
contains at least one cotton fabric layer, and lower
one is liquid restraining, waterproof layer made with
at least one silk fabric layer. Upper and lower layers
are connected to each other and from right and left
edges have fixing buttons to be tied on underwear
back side to fix the pad immobile.
Claims: 1 independent
-

PART E

E 02

- (10) AU 2020 15290 U (51) Int. Cl. (2006)
E 02 B 8/06
(21) AU 2020 15290 (22) 2020 02 21
(71) Goga Chakhaia (GE)
Sh. Nutsbidze Plateau, I mcr., corp. 1, app. 4,
0183, Tbilisi, Georgia (GE);
Levan Tsulukidze (GE)
Sh. Nutsbidze Plateau, I mcr., corp. 1, app. 40,
0183, Tbilisi, Georgia (GE)
(72) Goga Chakhaia (GE);
Levan Tsulukidze (GE);
Temuraz Gugushvili (RU);
Shalva Bosikashvili (GE);
Ekaterine Topuria (GE);
Nugzar Kvashilava (GE);
Irine Khubulava (GE);
Irakli Kvirkvelia (GE);
Sopio Gogilava (GE)

(54) ANTILANDSLIDE CONSTRUCTION

(57) Antilandslide construction includes inserted in
landslide bed, impaled onto metal axles (5), filled
with inert material (2), and made with automobile
amortized tyres (3) the componentry (1) disposed in
parallel to each other on bed (4) bottom horizontally,
mirror-like, and rectangularly – relative to the slopes
(6). Disposed on slope sides the metal axle ends are
inserted on bed slopes on bottom level thereof, and
other free ends are anchored therein. Disposed on
slope side the diameters of componentry tyres are
more than of others, and their sizes decrease towards
bed center. Each next component tyres amount and
diameter sizes are increasing gradually towards
landslide (7) motion.

Claims: 1 independent

Fig.: 4

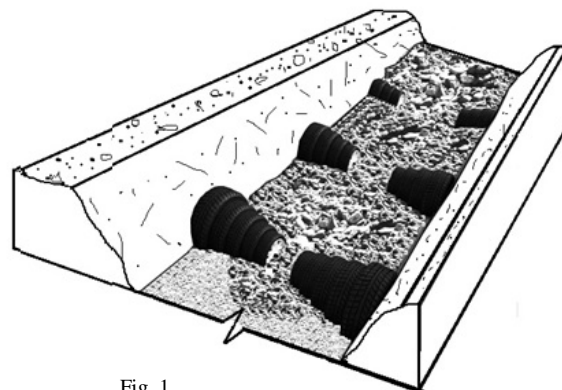

Fig. 1

PART F**F 03**

(10) AU 2020 15358 U (51) Int. Cl. (2006)
F 03 B 13/00

(21) AU 2020 15358 (22) 2020 06 06

(71) Savle Chkhitunidze (GE)

K. Timiryazev St. 20, Sokhumi, Georgia (GE)

(72) Savle Chkhitunidze (GE)

(54) HYDROPOWER ON COMMUNICATING
VESSELS PRINCIPLE

(57) The hydropower on communicating vessels principle includes small reservoir 1, vertical pipe 4, a turbine 5, and a tank 3 connected to small reservoir tank 3 by means of pipe 2; at that, small reservoir and the tank with pipe create communicating vessels. The reservoir and the tank are disposed on equal level. A buoy 7 is fixed onto pipe end connected to small reservoir. Vertical pipe one end is connected to the turbine, and a buoy 8 is attached to another, and is connected to the tank. An equipment 6 purifying water from sediments is installed onto communicating vessels pipe.

Claims: 1 independent

Fig.: 1

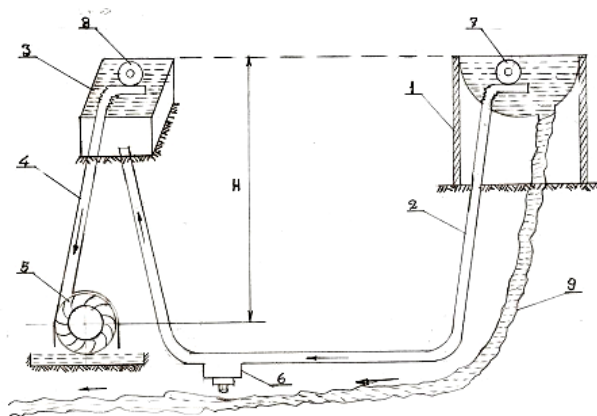

Fig. 1

PATENTED UTILITY MODEL

PART A

A 41

- (11) U 2020 2063 Y (51) Int. Cl. (2006)
A 41 D 13/11
(10) AU 2020 15312 U (44) 14(546)/2020
(21) AU 2020 15312
(22) 2020 04 14
(24) 2020 04 14
(73) Davit Mizandari (GE)
Barakoni St. 4, 0101, Tbilisi, Georgia (GE)
(72) Davit Mizandari (GE)
(74) Nugzar Ksovreli
(54) PROTECTING BREATHING DEVICE
-

DESIGNS

APPLICATIONS APPROVED FOR REGISTRATION

The decision can be appealed at the Chamber of Appeal of Sakpatenti within 3 months from the publication or at the Mtskheta District Court Administrative Cases Board (Address: №17, Samkhedro str., Mtskheta), within 1 month following the publication.

- (10) AD 2020 1173 S (51) 06-01
(21) AD 2020 1173 (22) 2020 08 11
(28) 3
(71) Aleksandre Lominashvili (GE)
M. Kostava St. 12, 0108, Tbilisi, Georgia (GE)
(72) Aleksandre Lominashvili (GE)
(74) Tamaz Shilakadze (GE)
(54) 1.-3. CHAIRS
(55)



1.1



1.2



1.3

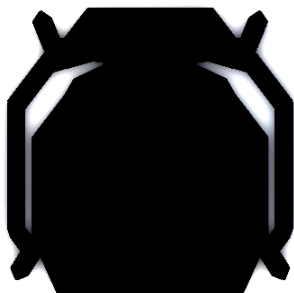

1.4

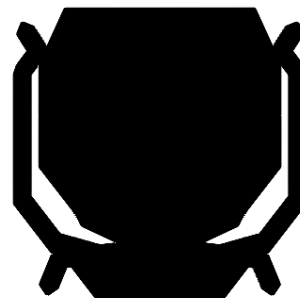

1.5



2.1



2.2



2.3



2.4



2.5

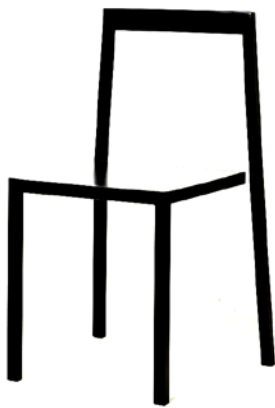

3.1

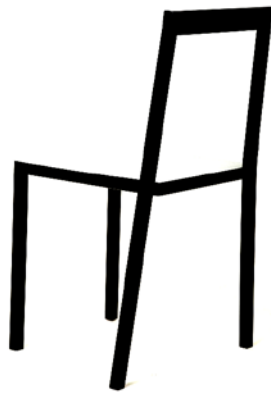

3.2



3.3



3.4

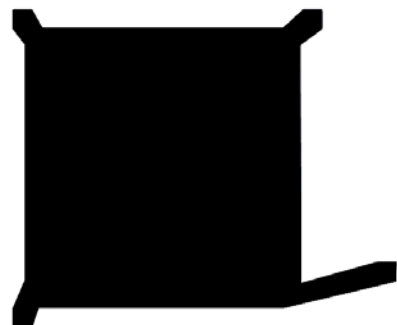

3.5

- (10) AD 2020 1174 S (51) 07-02
(21) AD 2020 1174 (22) 2020 08 13
(28) 1
(71) Giorgi Tandilashvili (GE)
Gurgenidze St. 4, 0101, Tbilisi, Georgia (GE)
(72) Giorgi Tandilashvili (GE)
(54) MINI ROASTER
(55)

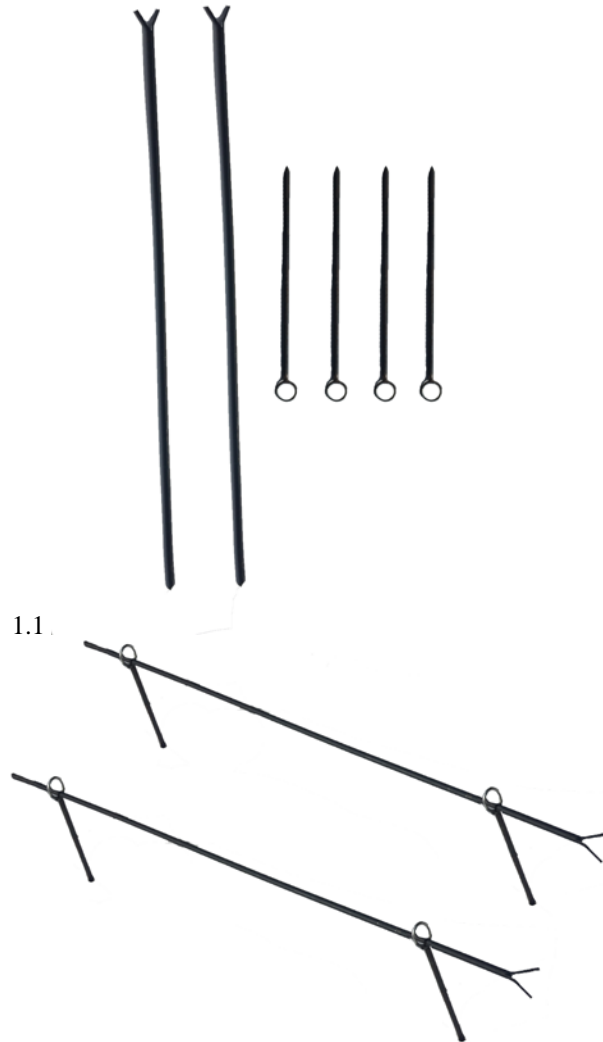

1.2

(10) AD 2020 1176 S (51) 19-08
(21) AD 2020 1176 (22) 2020 08 26
(28) 38
(71) LLC "KVARELI CELLAR" (GE)
Vill. Chikaani, Kvareli, Georgia (GE)
(72) Vazha Ghvaladze (GE)
(74) Khatuna Imnadze (GE)
(54) 1.-38. BOTTLE LABEL
(55)



1.1



2.1



3.4



4.1



5.1



6.1



7.1



8.1



9.1



10.1

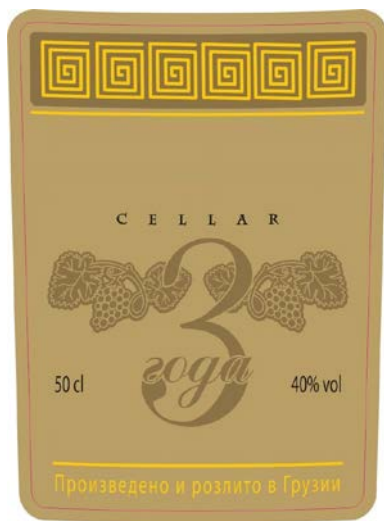

11.1



12.1

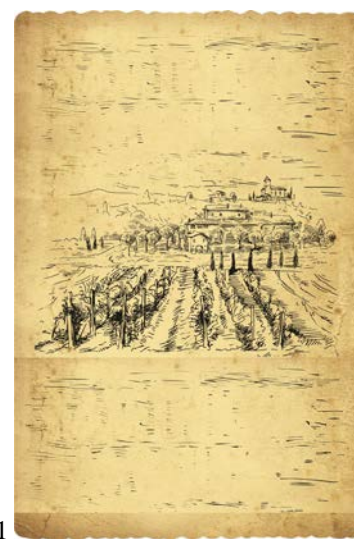

13.1



14.1



15.1



16.1

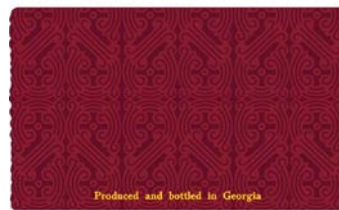

17.1

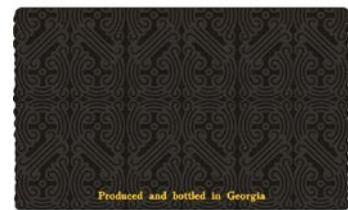

18.1

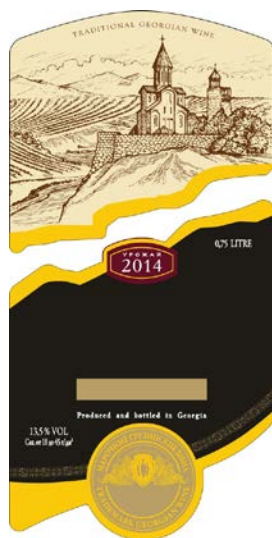

19.1

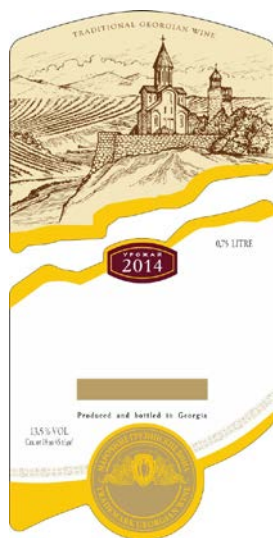

20.1



21.1



22.1



23.1



24.1



25.1



26.1



27.1



28.1



29.1

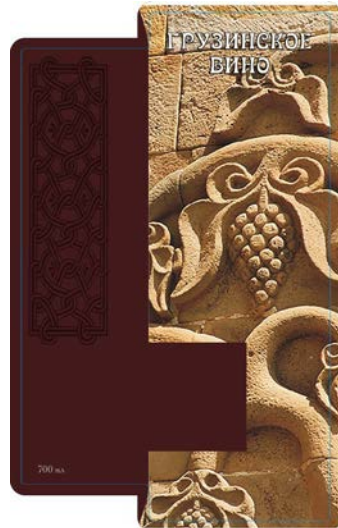

30.1

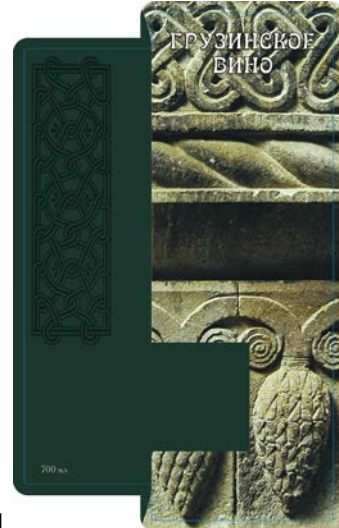

31.1

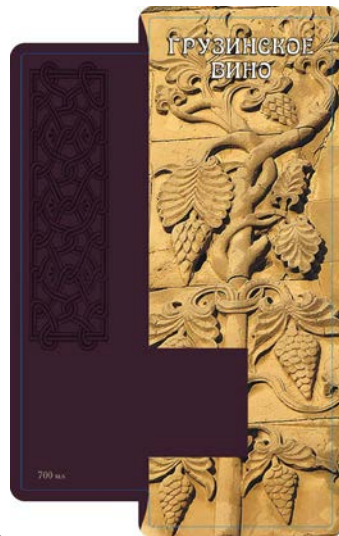

32.1

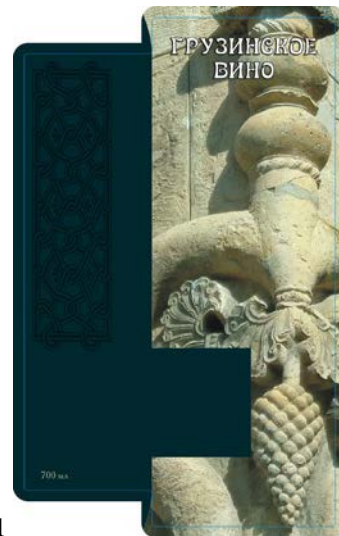

33.1



34.1



35.1

36.1



37.1



38.1

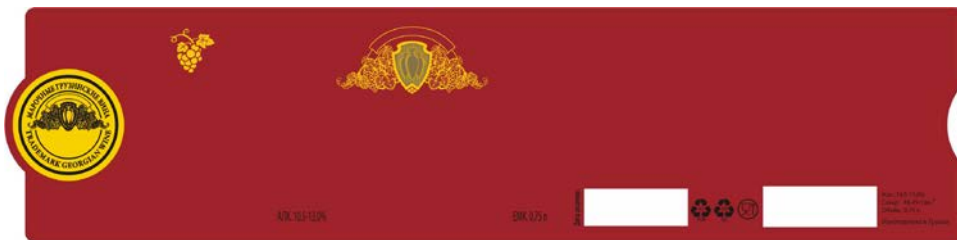

- (10) AD 2020 1165 S (51) 32-00
(21) AD 2020 1165 (22) 2020 07 28
(28) 1
(71) ZHURAVLEV, Gennadiy Vasilyevich (RU)
Federal Av., Building 28, app. 47, 111399, Moscow, Russian Federation (RU)
(72) EROFEEV, Valeriy Valeryevich (RU)
(74) Shalva Gvaramadze (GE)
(54) GRAPHICAL COMPOSITION
(55)

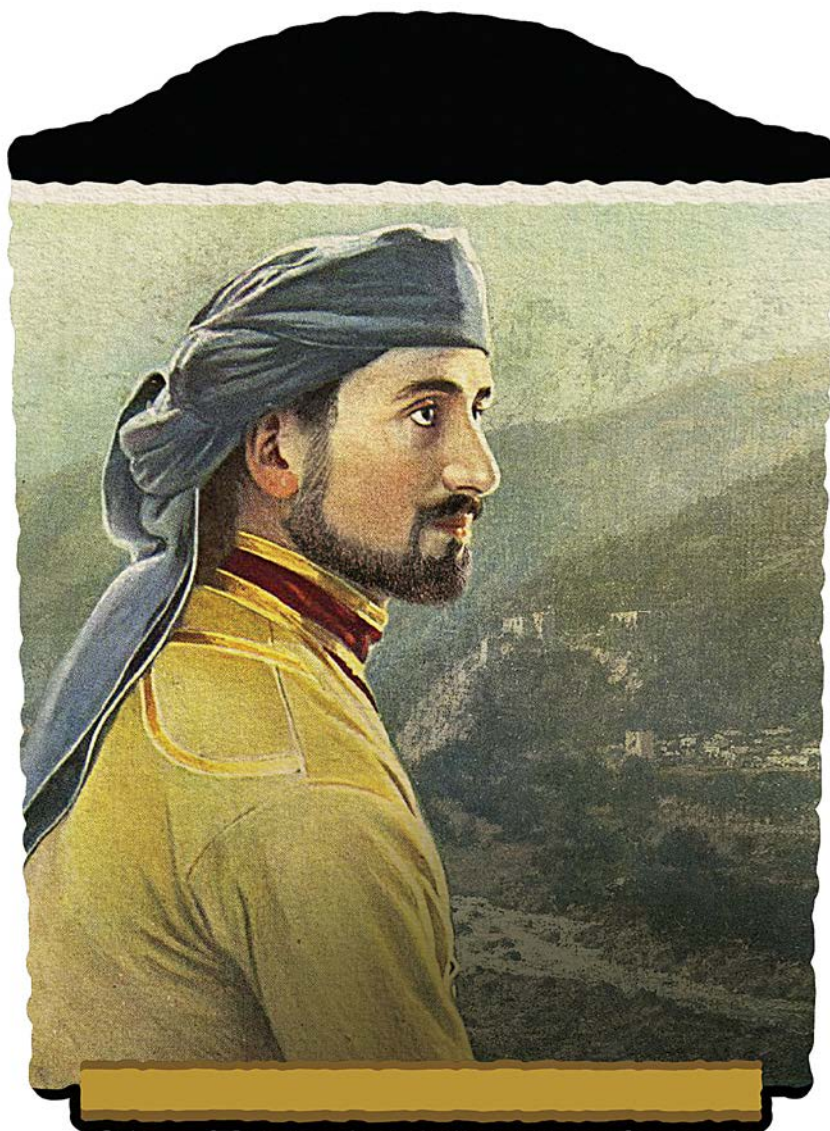

1.1

- (10) AD 2020 1166 S (51) 32-00
(21) AD 2020 1166 (22) 2020 07 28
(28) 1
(71) ZHURAVLEV, Gennadiy Vasilyevich (RU)
Federal Av., Building 28, app. 47, 111399, Moscow, Russian Federation (RU)
(72) EROFEEV, Valeriy Valeryevich (RU)
(74) Shalva Gvaramadze (GE)
(54) GRAPHICAL COMPOSITION
(55)

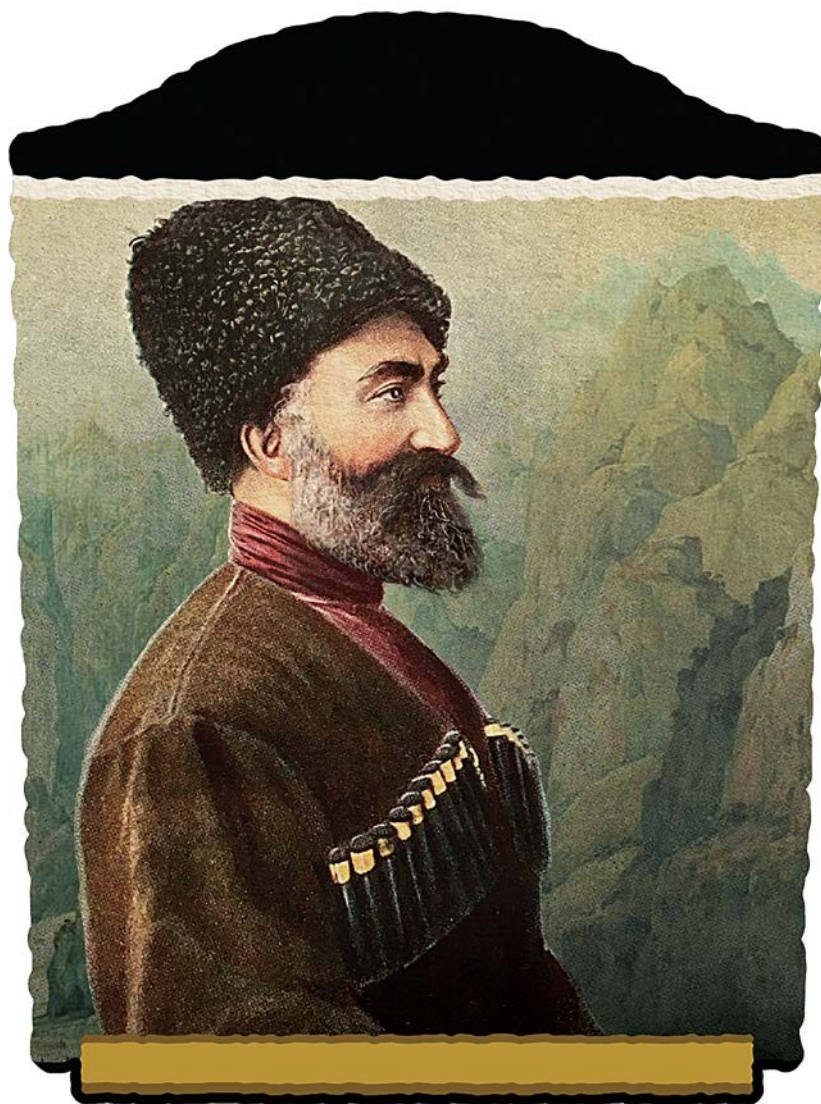

1.1

- (10) AD 2020 1167 S (51) 32-00
(21) AD 2020 1167 (22) 2020 07 28
(28) 1
(71) ZHURAVLEV, Gennadiy Vasilyevich (RU)
Federal Av., Building 28, app. 47, 111399, Moscow, Russian Federation (RU)
(72) EROFEEV, Valeriy Valeryevich (RU)
(74) Shalva Gvaramadze (GE)
(54) GRAPHICAL COMPOSITION
(55)

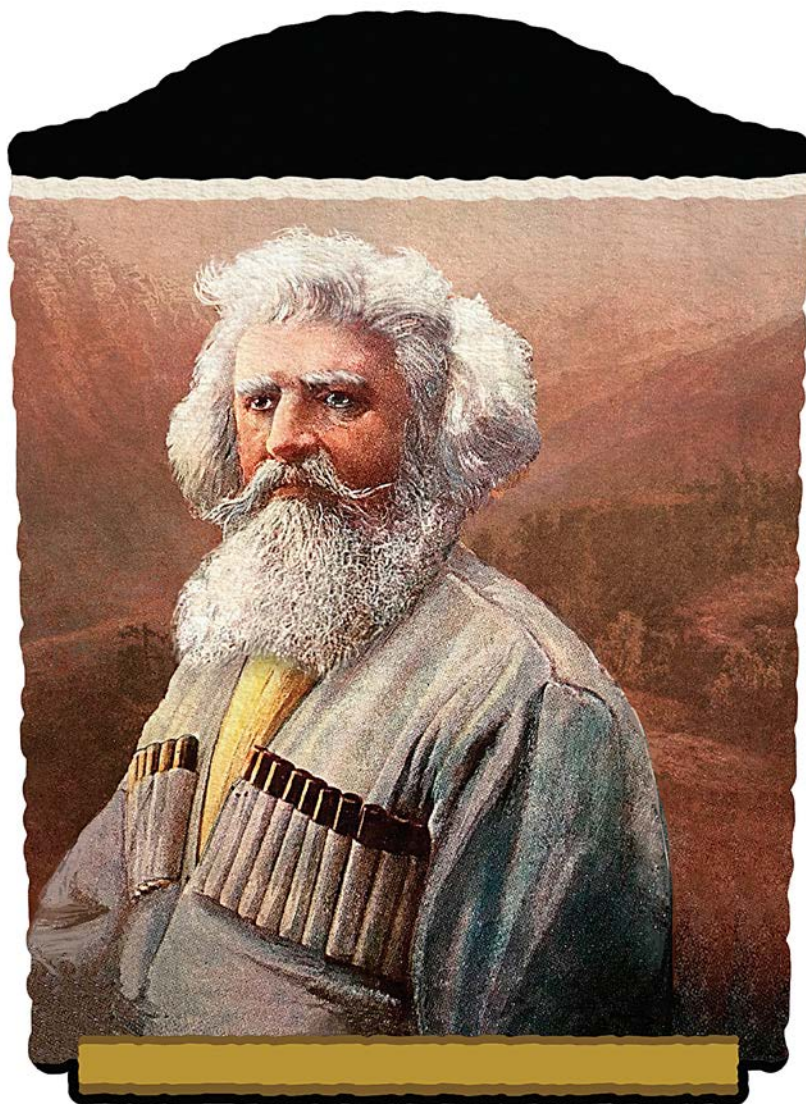

1.1

- (10) AD 2020 1168 S (51) 32-00
(21) AD 2020 1168 (22) 2020 07 28
(28) 1
(71) ZHURAVLEV, Gennadiy Vasilyevich (RU)
Federal Av., Building 28, app. 47, 111399, Moscow, Russian Federation (RU)
(72) EROFEEV, Valeriy Valeryevich (RU)
(74) Shalva Gvaramadze (GE)
(54) GRAPHICAL COMPOSITION
(55)



1.1

- (10) AD 2020 1169 S (51) 32-00
(21) AD 2020 1169 (22) 2020 07 28
(28) 1
(71) ZHURAVLEV, Gennadiy Vasilyevich (RU)
Federal Av., Building 28, app. 47, 111399, Moscow, Russian Federation (RU)
(72) EROFEEV, Valeriy Valeryevich (RU)
(74) Shalva Gvaramadze (GE)
(54) GRAPHICAL COMPOSITION
(55)



1.1

- (10) AD 2020 1170 S (51) 32-00
(21) AD 2020 1170 (22) 2020 07 28
(28) 1
(71) ZHURAVLEV, Gennadiy Vasilyevich (RU)
Federal Av., Building 28, app. 47, 111399, Moscow, Russian Federation (RU)
(72) EROFEEV, Valeriy Valeryevich (RU)
(74) Shalva Gvaramadze (GE)
(54) GRAPHICAL COMPOSITION
(55)

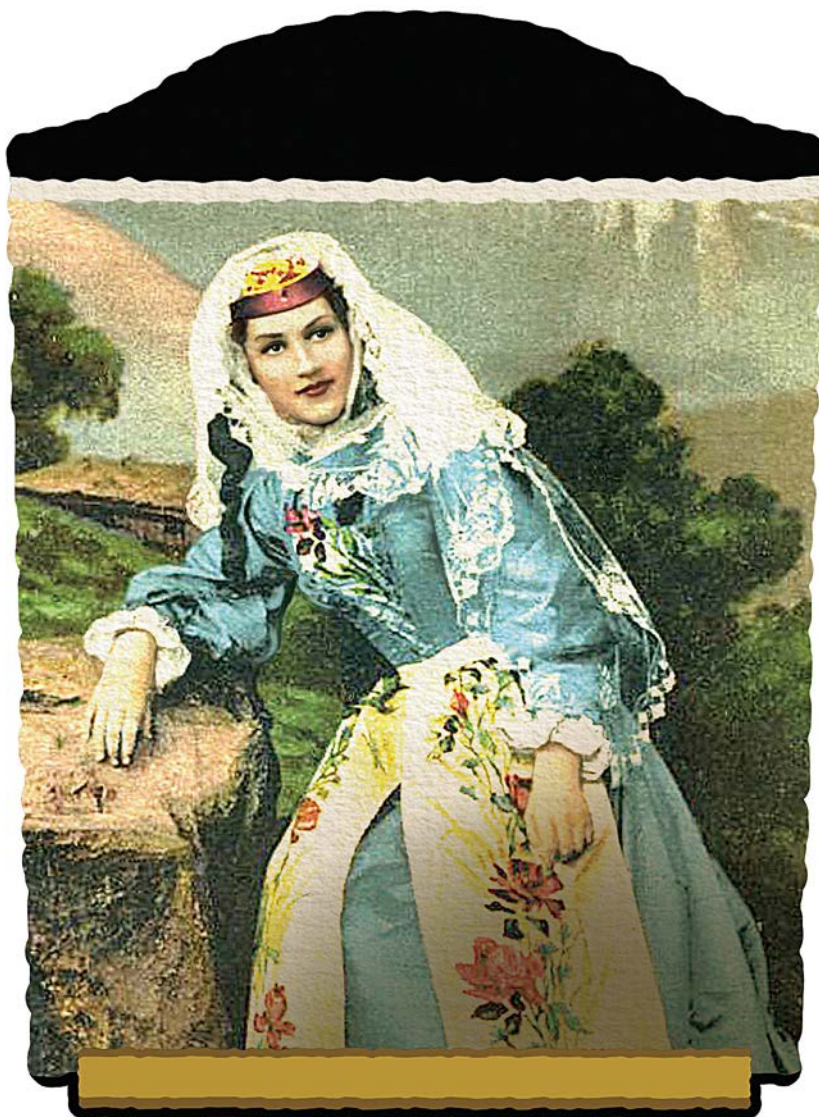

1.1

- (10) AD 2020 1171 S (51) 32-00
(21) AD 2020 1171 (22) 2020 07 28
(28) 1
(71) ZHURAVLEV, Gennadiy Vasilyevich (RU)
Federal Av., Building 28, app. 47, 111399, Moscow, Russian Federation (RU)
(72) EROFEEV, Valeriy Valeryevich (RU)
(74) Shalva Gvaramadze (GE)
(54) GRAPHICAL COMPOSITION
(55)



1.1

DESIGN REGISTERED ACCORDING TO THE ACCELERATED PROCEDURE

The decision can be appealed at the Chamber of Appeal of Sakpatenti within 3 months from the publication.

(11) D 2020 873 S (51) 09-01
(21) AD 2020 1193 (22) 2020 11 20
(24) 2020 11 20
(28) 1
(18) 2025 11 20
(73) LTD "KAKHETIAN TRADITIONAL WINEMAKING" (GE)
 Tsintsadze St. 12, 0160, Tbilisi, Georgia (GE)
(72) Lasha Imnadze (GE)
(54) BOTTLE
(55)



1.1

DESIGNS, WHICH HAVE BEEN REGISTERED WITH THE INTERNATIONAL BUREAU CLAIMING PRIORITY ON THE TERRITORY OF GEORGIA

The decision can be appealed at the Chamber of Appeal of Sakpatenti within 3 months from the publication or at the Mtskheta District Court Administrative Cases Board (Address: №17, Samkhedro Str., Mtskheta), within 1 month following the publication.

- (11) DM/210 562 (51) 24-99
- (15) 2020 09 25 (44) 41/2020 (2020 10 09)
- (22) 2020 09 25
- (28) 1
- (73) Pranamat Holding SIA
 Karla Ulmana Gatve 2A, 1004 Riga (LV)
- (85) LV
- (86) –
- (87) –
- (88) LV
- (89) LV
- (81) III. GE, US, KG, MX, VN, KR, JP, SG
- (72) Olga Vahatova
 P.O. Box 17, 1069 Riga (LV);
 Deniss Grigorenko
 Dzintaru Prospekts 32-6, 2015, Jurmala (LV)
- (54) 1. Acupressure pillow
- (55)

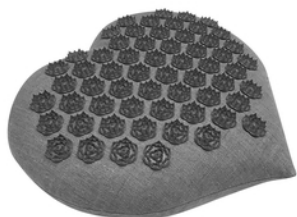

1.1



1.2



1.3



1.4



1.5

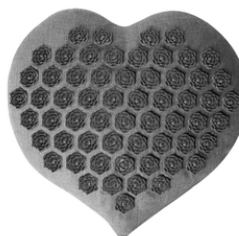

1.6



1.7

- (11) DM/210 633 (51) 26-06
 (15) 2019 12 19 (44) 42/2020 (2020 10 16)
 (22) 2019 12 19
 (28) 3
 (73) Strands Group AB
 Hagalundsvägen, 51172 Fritsla (SE)
 (85) –
 (86) EM
 (87) –
 (88) –
 (89) EM
 (81) III. ES, HU, IS, MN, PL, GB, LT, BN, FR, AL, LV, HR, TM, BZ, MC, SG, NA, DE, BA, MK, LI, KG,
 FI, RU, EG, AM, MD, TJ, BW, GH, ST, TR, KH, TN, CH, KP, UA, AZ, ME, BX, SI, OA, RS, NO, EE, OM,
 GE, RO, SM, EM, DK, SY, BG, RW
 (72) Strands Fordonskomponenter AB
 Hagalundsvägen, 51172, Fritsla (SE)
 (54) 1.-3. LED work light for vehicles with infinity lens
 (55)



1.1



1.2



1.3



2.1



2.2



2.3



3.1



3.2



3.3

- (11) DM/208 347
- (15) 2020 04 17
- (22) 2020 04 17
- (28) 1
- (73) The Swatch Group Management Services AG (The Swatch Group Management Services SA)
(The Swatch Group Management Services Ltd.)
Seevorstadt 6, 2502 Biel/Bienne (CH)
- (85) CH
- (86) CH
- (87) CH
- (88) CH
- (89) CH
- (81) II. MA III. AM, UA, AL, AZ, BZ, ME, MD, MC, SG, MN, NO, BA, OM, MK, GE, TR, LI, KG, GB,
TN, EM, CH
- (72) Fabrice DUPORT
Avenue De La Gare 4, 2000, Neuchâtel (CH)
- (74) The Swatch Group AG (The Swatch Group SA) (The Swatch Group Ltd.)
Faubourg Du Lac 6, 2501 Biel/Bienne (CH)
- (54) 1. Wristwatch
- (55)



1.1

1.2



1.3

- (11) DM/210 755 (51) 12-08
 (15) 2020 10 05 (44) 43/2020 (2020 10 23)
 (22) 2020 10 05
 (28) 2
 (30) No1: 07.04.2020; 3-2020-00769; VN; No2: 07.04.2020; 3-2020-00773; VN
 (73) VINFAST TRADING AND PRODUCTION LIMITED LIABILITY COMPANY
 Dinh Vu – Cat Hai Economic Zone, Cat Hai Island, Cat Hai Town, Cat Hai District, 180000 Hai Phong (VN)
 (85) –
 (86) VN
 (87) –
 (88) –
 (89) VN
 (81) III. GE, KH, AM, UA, KG, BN, TM, AZ, TJ, SG, RU
 (72) NAZZARENO EPIFANI
 Viale Generale Armando Diaz, 10, Chieri, 10023, Torino (IT);
 GIOVANNI GUGLIELMO CARTIA
 Strada Bricale, 4, Marentino, 10020, Torino (IT);
 DIMITRI VICEDOMINI
 Via Passo Buole, 162, 10135, Torino (IT)
 (74) AMBYS HANOI LAW FIRM
 No. 3 Lane 123, Au Co Road, Tay Ho Dist., 100000 Hano (VN)
 (54) 1. Electric car, 2. Motor car
 (55)



1.1



1.2



1.3



1.4



1.5



1.6



2.1



2.2



2.3



2.4



2.5



2.6

- (11) DM/210 819 (51) 09-03
 (15) 2020 10 12 (44) 44/2020 (2020 10 30)
 (22) 2020 10 12
 (28) 4
 (30) No1: 25.08.2020; 20200021; AM; No2: 25.08.2020; 20200021; AM; No3: 25.08.2020; 20200021; AM;
 No4: 25.08.2020; 20200021; AM
 (73) ROYAL ARMENIA JV LTD
 Davtashen 2nd Block 26/38, 0054 Yerevan (AM)
 (85) –
 (86) AM
 (87) AM
 (88) AM
 (89) AM
 (81) III. GE, US, UA, EM, RU
 (72) Stepan Azaryan
 Budaghyan Str. 1, 0014, Yerevan (AM);
 David Akopian Alujas
 Sevastopolyan Str. 51, 0021, Yerevan (AM)
 (74) Areg Petrosyan & Partner LLC
 Tumanyan Str. 30/36a, 0001 Yerevan (AM)
 (54) 1.-4. Cans
 (55)

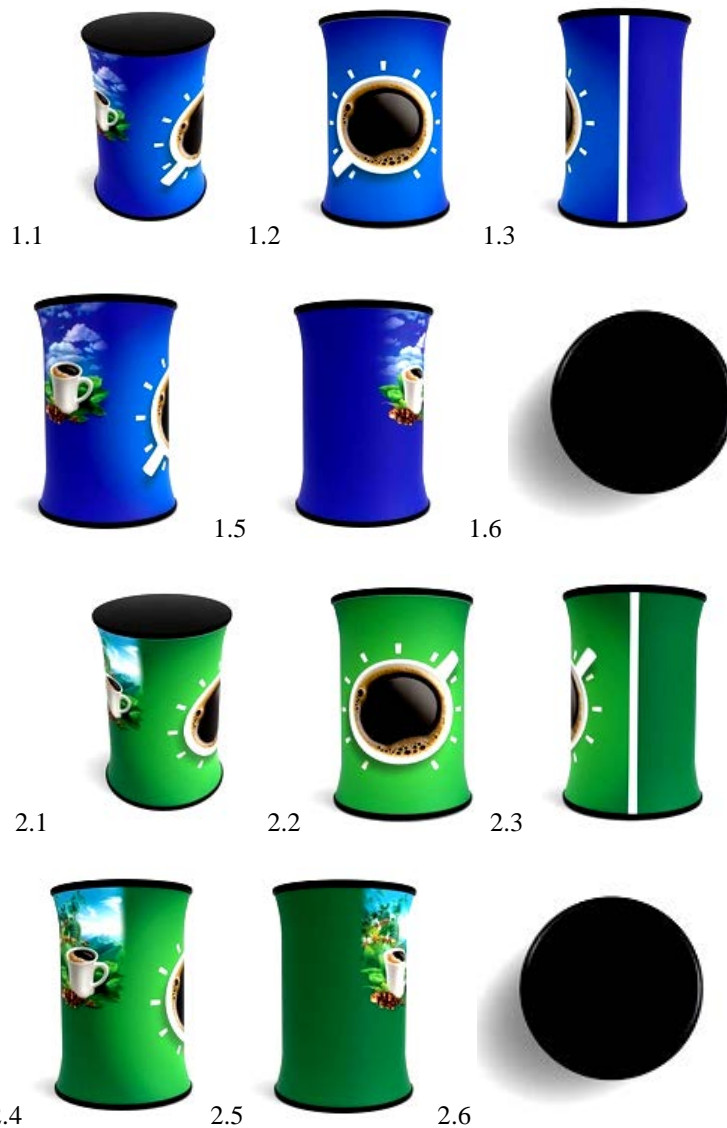



- (11) DM/208 576 (51) 09-01
- (15) 2020 05 04 (44) 45/2020 (2020 11 06)
- (22) 2020 05 04
- (28) 2
- (30) No1: 17.12.2019; 29/717,407; US
- (73) Sire Spirits LLC
264 West 40th Street, 15th Floor, 10018 New York, NY (US)
- (85) US
- (86) US
- (87) US
- (88) US
- (89) US
- (81) III. ES, HU, IS, MN, PL, GB, LT, FR, BN, AL, HR, LV, TM, BZ, MC, SG, NA, DE, BA, MK, LI, KG,
WS, FI, RU, EG, AM, VN, MD, TJ, BW, ST, GH, TR, KH, TN, CH, KP, IL, UA, AZ, ME, SI, BX, OA, RS,
NO, EE, OM, GE, RO, SM, EM, DK, SY, BG, RW
- (72) 1 Curtis J. Jackson III
264 West 40th Street, 15th Floor, 10018, New York (US)
- (74) Stephen J. Lieb, Wissing Miller LLP
The Lofts At Manhattan West, 434 West 33rd Street, 10001 New York, NY (US)
- (54) 2. Beverage bottle
- (55)

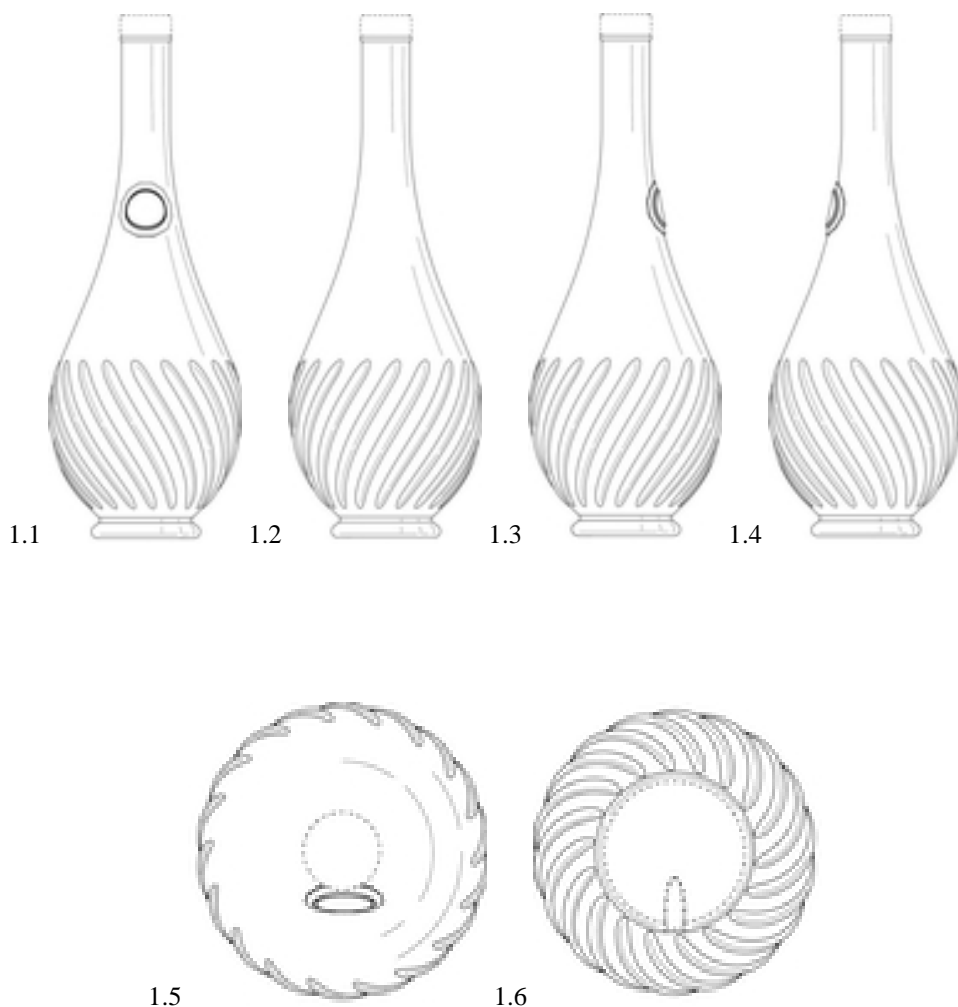

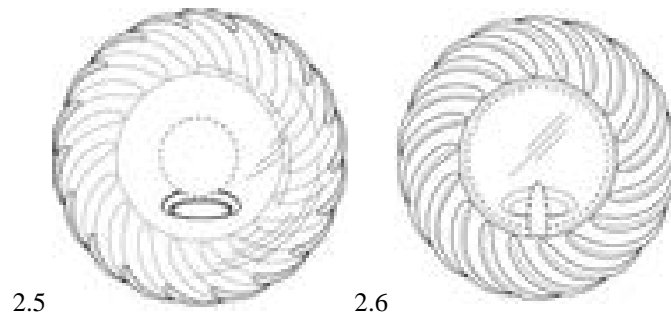

- (11) DM/208 577 (51) 09-01
- (15) 2020 05 04 (44) 45/2020 (2020 11 06)
- (22) 2020 05 04
- (28) 2
- (30) No1: 17.12.2019; 29/717,437; US
- (73) Sire Spirits LLC
264 West 40th Street, 15th Floor, 10018 New York, NY (US)
- (85) US
- (86) US
- (87) US
- (88) US
- (89) US
- (81) III. ES, HU, IS, MN, PL, GB, LT, BN, FR, AL, HR, LV, TM, BZ, MC, SG, NA, DE, BA, MK, LI, KG,
WS, FI, RU, EG, AM, VN, MD, TJ, BW, GH, ST, TR, KH, TN, KP, CH, IL, UA, AZ, ME, BX, SI, OA, NO,
RS, EE, OM, GE, RO, SM, EM, DK, SY, RW, BG
- (72) 1 Curtis J. Jackson, III
264 West 40th Street, 15th Floor, 10018, New York, NY (US)
- (74) Stephen Lieb, The Lofts At Manhattan West
434 West 33rd Street, 12th Floor, 10001 New York, NY (US)
- (54) 1. Beverage bottle, 2. Beverage bottle
- (55)

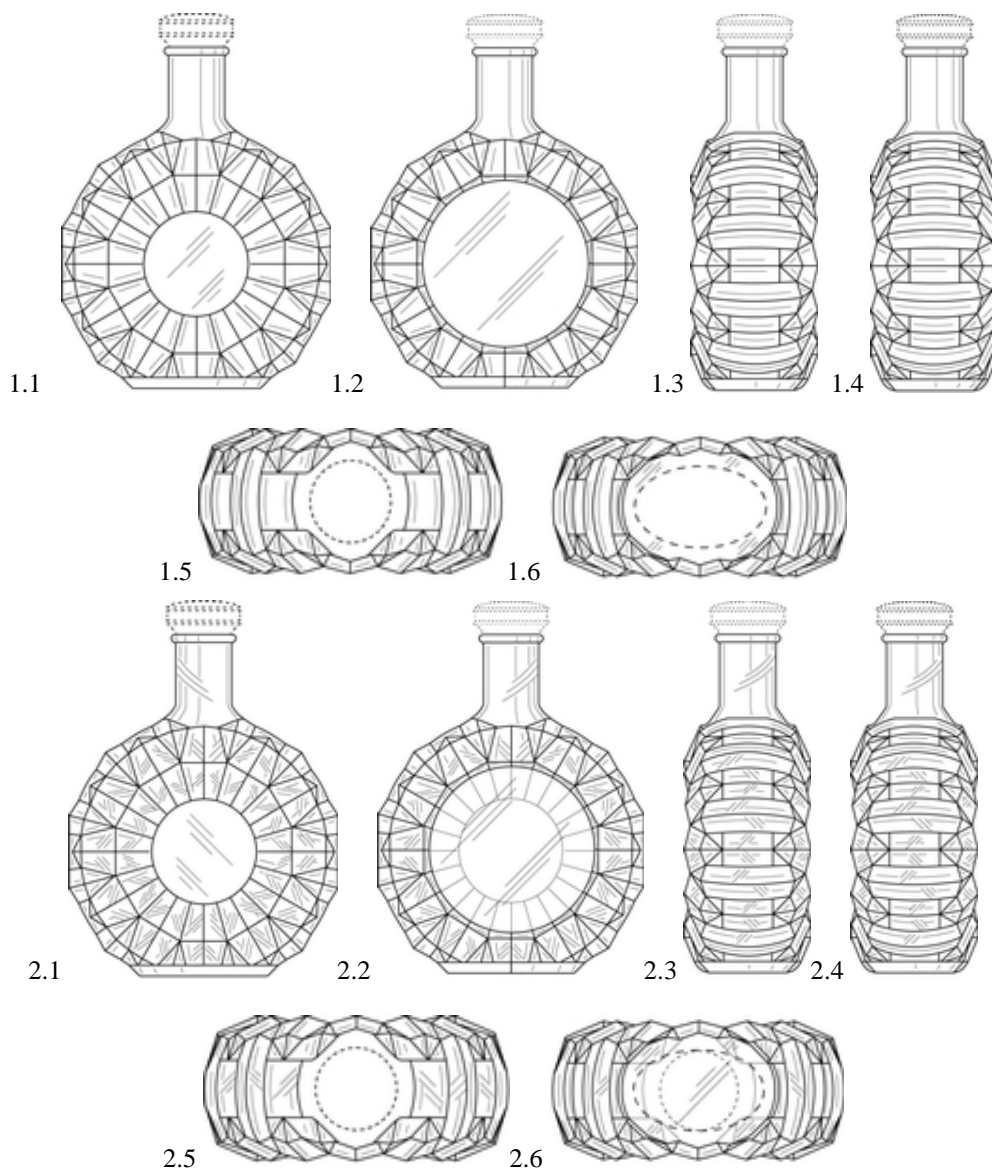

(11) DM/208 887

(51) 24-04

(15) 2020 05 04

(44) 45/2020 (2020 11 06)

(22) 2020 05 04

(28) 2

(30) No1: 07.11.2019; 2019/07092; TR; No2: 07.11.2019; 2019/07092; TR

(73) Neutec Ilac San Tic AŞ

Yıldız Teknik Üniversitesi Davutpaşa Kampüsü Teknoloji Geliştirme Bölgesi D1 Blok Kat 3 Esenler, 34220
İstanbul (TR)

(85) TR

(86) TR

(87) TR

(88) TR

(89) TR

(81) III. AM, IS, VN, MD, TJ, BW, GH, ST, MN, KH, GB, TN, KR, JP, KP, CH, IL, BN, UA, AL, AZ, TM,
BZ, ME, MC, SG, NA, OA, NO, RS, BA, GE, OM, US, MK, CA, LI, KG, WS, SM, EM, SY, RW, RU, EG

(72) Mahmut Bilgiç

General Ali Rıza Gürcan Cad. Merter İş Merkezi Bağımsız Bölüm No:2/13 Merter-Güngören, İstanbul (TR)

(74) Burcu Gokdemir

Yıldız Teknik Üniversitesi Davutpaşa Kampüsü Teknoloji Geliştirme Bölgesi D1 Blok Kat 3 Esenler, 34220
İstanbul (TR)

(54) 1. Inhalation device, 2. Inhalation device

(55)

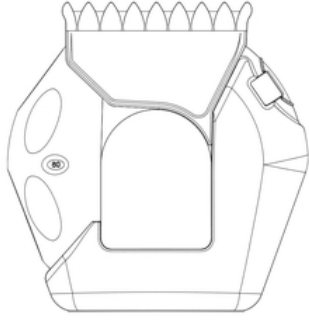

1.1

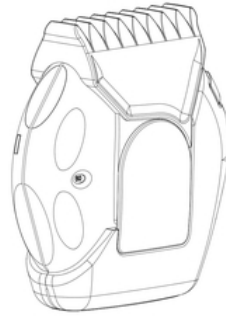

1.2

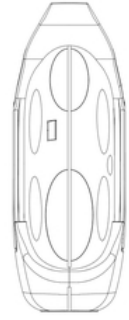

1.3

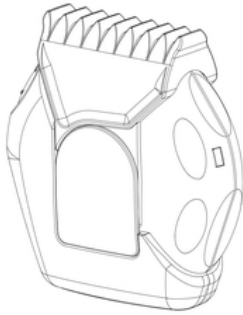

1.4

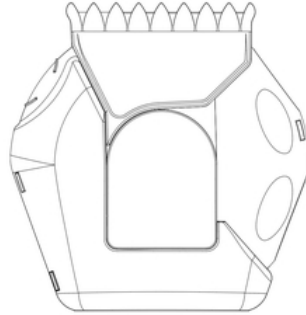

1.5

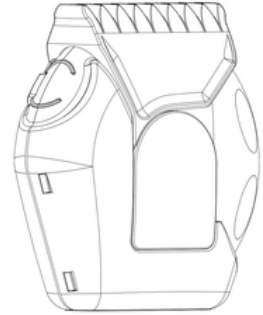

1.6



1.7



1.8

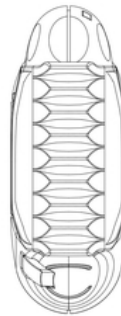

1.9



1.10



TRADEMARKS

APPLICATIONS FILED UNDER THE NATIONAL PROCEDURE APPROVED FOR REGISTRATION

The decision can be appealed at the Chamber of Appeal of Sakpatenti within 3 months from the publication or at the Mtskheta District Court Administrative Cases Board (Address: №17, Samkhedro St., Mtskheta), within 1 month following the publication.

(260) AM 2020 103570 A
(210) AM 103570
(220) 2020 05 13
(731) LLC "Georgian Agroproduct"
Chirnakhuli St. 2, Tbilisi, Georgia
(540)

კეთილი და პატიოსანი
kind & noble

(591) Black-white
(511) 29, 30, 32

(260) AM 2020 105214 A
(210) AM 105214
(220) 2020 06 05
(731) LTD "VILLA ERALDO"
Al. Kazbegi Av. 1, app. 12, Tbilisi, Georgia
(540)

AMARI

(591) Black-white
(511) 33, 43

(260) AM 2020 105558 A
(210) AM 105558
(220) 2019 10 29
(731) LTD "DAKO TRADE"
Saburtalo St. 41, app. 34, Tbilisi, Georgia
(740) Giorgi Batlidze
(540)



(591) C20E1A red, 427C3E green, white
(531) 02.09.01; 26.11.12; 27.05.01; 28.19; 29.01.13
(511) 29, 30, 31, 32

(260) AM 2020 106822 A
(210) AM 106822
(220) 2020 01 31
(731) Betek Boya ve Kimya Sanayi Anonim Şirketi
Kaynarca, Kavakpınar Mah. Tandoğan Cad.
Kocamezarlık Karşısı Pendik-Istanbul,
Turkey
(740) Tamaz Shilakadze
(540)



(591) White, black, yellow, orange, red, lilac, blue,
light blue, green
(531) 25.07.01; 26.04.09; 27.05.24; 29.01.15
(511) 1, 2, 16, 17, 21

(260) AM 2020 108060 A
(210) AM 108060
(220) 2020 04 27
(731) LTD "Georgian Wine House"
Vill. Zegaani, 1500, Gurjaani, Georgia
(740) Sopio Vacheishvili
(540)

CARANTINA
КАРАНТИНА
კარანტინა

(591) Black-white
(511) 33, 43

(260) AM 2020 108119 A
(210) AM 108119
(220) 2020 05 04
(731) İPEKYOL GİYİM SANAYİ PAZARLAMA
VE TİCARET ANONİM ŞİRKETİ
Merkez Mah. Kazim Orbay Caddesi N35,
Istanbul, 34381, Turkey
(740) Giorgi Sarajishvili

(540)

TWIST

(591) Black-white
(531) 27.05.01
(511) 3, 9, 14, 18, 35

(260) AM 2020 108121 A
(210) AM 108121
(220) 2020 05 05
(731) LTD "CAPITALCLUB"
Kakheti Highway 110a, 0198, Tbilisi, Georgia
(740) Davit Dzamukashvili
(540)

კობი
Koshi
КoШи

(591) Black-white
(511) 33

(260) AM 2020 108130 A
(210) AM 108130
(220) 2020 05 06
(731) Streamax Technology Co., Ltd
21-23/F B1 Building, Zhiyuan, No.1001
Xueyuan Avenue, Nanshan District, Shenzhen
City, Guangdong Province, China
(740) Giorgi Kartvelishvili
(540)

Streamax

(591) Black-white
(511) 9, 35, 42

(260) AM 2020 108208 A
(210) AM 108208
(220) 2020 05 08
(731) N(N)LE "Nino Museridze Foundation "For You"
Shio Mghvimeli St. 5, app. 13, Tbilisi, Georgia
(540)



(591) Black-white
(531) 02.07.12; 02.09.01; 02.09.15; 28.19
(511) 36, 44

(260) AM 2020 108215 A
(210) AM 108215
(220) 2020 05 12
(731) Paata Sulaberidze
Iakob Nikoladze St. 5a, app. 3, Tbilisi, Georgia
(740) Vakhtang Torotadze
(540)

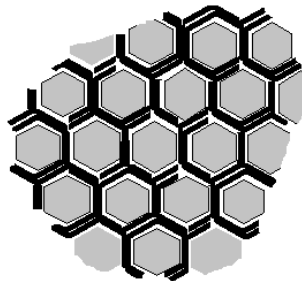

(591) Grey, black, white
(531) 03.13.05; 26.05.04; 29.01.13
(511) 20, 21, 32

(260) AM 2020 108230 A
(210) AM 108230
(220) 2020 05 14
(731) LTD "GEMOVANI"
Krtsanisi St. 22-24, app, 44, Krtsanisi District,
Tbilisi, Georgia
(540)

გემოვანი
gemovani
ГЕМОВАНИ

(591) Black-white
(511) 5, 29, 33

(260) AM 2020 108292 A
(210) AM 108292
(220) 2020 05 15
(731) Kelp Products International (PTY) LTD
Blue Waters Close, Cnr. Main and Red Hill
Roads, Simons Town 7995, Cape Town,
South Africa
(740) Merab Kvimsadze
(540)



(591) Black-white
(531) 24.15.13; 27.05.01
(511) 1

(260) AM 2020 108299 A
 (210) AM 108299
 (220) 2020 05 18
 (731) LTD "ASKANELI GROUP"
 Kakheti Highway 110a (plot 01/016),
 0101, Samgori District, Tbilisi, Georgia
 (740) Davit Dzamukashvili
 (540)



(591) Black-white
 (531) 03.07.01; 27.05.01; 27.07.01; 27.07.21
 (526) 1880
 (511) 29, 32, 33, 43

(260) AM 2020 108301 A
 (210) AM 108301
 (220) 2020 05 18
 (731) Aleksandre Buadze
 Kavsadze St. 7a, 0179, Tbilisi, Georgia
 (540)

მისღო

(591) Black-white
 (511) 30

(260) AM 2020 108319 A
 (210) AM 108319
 (220) 2020 05 21
 (731) Avtandil Shermadini
 Saakadze St. 77a, 0180, Nadzaladevi
 District, Tbilisi, Georgia
 (540)

ODZISELI

(591) Black-white
 (511) 33

(260) AM 2020 108384 A
 (210) AM 108384
 (220) 2020 05 22
 (731) LTD "KVARELI PALACE"
 I. Chavchavadze St. 52, Kvareli, Georgia
 (540)



KVARELI LAKE
 RESORT

(591) Black, white, morengo
 (531) 26.01.18; 27.05.01; 27.05.21
 (526) KVARELI
 (511) 43

(260) AM 2020 108385 A
 (210) AM 108385
 (220) 2020 05 22
 (731) Bayer Consumer Care AG
 Peter Merian-Str. 84, 4052 Basel, Switzerland
 (740) Shalva Gvaramadze
 (540)

RELIEFIPIN

(591) Black-white
 (511) 5

(260) AM 2020 108386 A
 (210) AM 108386
 (220) 2020 05 22
 (731) Bayer Consumer Care AG
 Peter Merian-Str. 84, 4052 Basel, Switzerland
 (740) Shalva Gvaramadze
 (540)

Релифипин

(591) Black-white
 (531) 28.05
 (511) 5

(260) AM 2020 108387 A
 (210) AM 108387
 (220) 2020 05 22
 (731) Bayer Consumer Care AG
 Peter Merian-Str. 84, 4052 Basel, Switzerland
 (740) Shalva Gvaramadze
 (540)

Релидипин

(591) Black-white
 (531) 28.05
 (511) 5

(260) AM 2020 108388 A
 (210) AM 108388
 (220) 2020 05 22
 (731) Bayer Consumer Care AG
 Peter Merian-Str. 84, 4052 Basel, Switzerland
 (740) Shalva Gvaramadze
 (540)

RELIEDIPIN

(591) Black-white
 (511) 5

(260) AM 2020 108411 A
 (210) AM 108411
 (220) 2020 05 27
 (731) LTD "SAM Support & Management"
 Iasamani St. 6, app. 112, Saburtalo District,
 Tbilisi, Georgia
 (740) Nato Lashkhi
 (540)



(591) Black, yellow
 (531) 27.05.01; 27.05.22; 29.01.12
 (511) 3, 35

(260) AM 2020 108414 A
 (210) AM 108414
 (220) 2020 05 28
 (310) 40 2019 0189934
 (320) 2019 12 06
 (330) KR
 (731) Hyundai Motor Company
 12, Heolleung-ro, Seocho-gu, Seoul, Republic
 of Korea
 (740) Tamar Kotchlamazashvili
 (540)



(591) Black-white
 (531) 03.07.17; 24.01.15; 24.01.18; 24.11.25
 (511) 8

(260) AM 2020 108415 A
 (210) AM 108415
 (220) 2020 05 28
 (310) 40 2019 0189938
 (320) 2019 12 06
 (330) KR
 (731) Hyundai Motor Company
 12, Heolleung-ro, Seocho-gu, Seoul, Republic
 of Korea
 (740) Tamar Kotchlamazashvili
 (540)



(591) Black-white
 (531) 03.07.17; 24.01.15; 24.01.18; 24.11.25
 (511) 14

(260) AM 2020 108416 A
 (210) AM 108416
 (220) 2020 07 09
 (310) 40 2019 0189939
 (320) 2019 12 06
 (330) KR
 (731) Hyundai Motor Company
 12, Heolleung-ro, Seocho-gu, Seoul, Republic
 of Korea
 (740) Tamar Kotchlamazashvili
 (540)



(591) Black-white
 (531) 03.07.17; 24.01.15; 24.01.18; 24.11.25
 (511) 16

(260) AM 2020 108417 A
 (210) AM 108417
 (220) 2020 05 28
 (310) 40 2019 0189940
 (320) 2019 12 06
 (330) KR
 (731) Hyundai Motor Company
 12, Heolleung-ro, Seocho-gu, Seoul, Republic
 of Korea
 (740) Tamar Kotchlamazashvili
 (540)



(591) Black-white
 (531) 03.07.17; 24.01.15; 24.01.18; 24.11.25
 (511) 17

(260) AM 2020 108418 A
 (210) AM 108418
 (220) 2020 07 09
 (310) 40 2019 0189941
 (320) 2019 12 06
 (330) KR
 (731) Hyundai Motor Company
 12, Heolleung-ro, Seocho-gu, Seoul, Republic
 of Korea
 (740) Tamar Kotchlamazashvili

(540)



(591) Black-white

(531) 03.07.17; 24.01.09; 24.01.15; 24.01.18;
24.11.25

(511) 18

(260) AM 2020 108420 A

(210) AM 108420

(220) 2020 05 28

(310) 40 2019 0189942

(320) 2019 12 06

(330) KR

(731) Hyundai Motor Company
12, Heolleung-ro, Seocho-gu, Seoul, Republic
of Korea

(740) Tamar Kotchlamazashvili

(540)



(591) Black-white

(531) 03.07.17; 24.01.15; 24.01.18; 24.11.25

(511) 20

(260) AM 2020 108421 A

(210) AM 108421

(220) 2020 05 28

(310) 40 2019 0189943

(320) 2019 12 06

(330) KR

(731) Hyundai Motor Company
12, Heolleung-ro, Seocho-gu, Seoul, Republic
of Korea

(740) Tamar Kotchlamazashvili

(540)



(591) Black-white

(531) 03.07.17; 24.01.15; 24.01.18; 24.11.25

(511) 21

(260) AM 2020 108423 A

(210) AM 108423

(220) 2020 05 28

(310) 40 2019 0189944

(320) 2019 12 06

(330) KR

(731) Hyundai Motor Company

12, Heolleung-ro, Seocho-gu, Seoul, Republic
of Korea

(740) Tamar Kotchlamazashvili

(540)



(591) Black-white

(531) 03.07.17; 03.07.19; 24.01.15; 24.01.18;
27.05.02

(511) 24

(260) AM 2020 108424 A

(210) AM 108424

(220) 2020 05 28

(310) 40 2019 0189945

(320) 2019 12 06

(330) KR

(731) Hyundai Motor Company
12, Heolleung-ro, Seocho-gu, Seoul, Republic
of Korea

(740) Tamar Kotchlamazashvili

(540)



(591) Black-white

(531) 03.07.17; 24.01.15; 24.01.18; 27.05.02

(511) 25

(260) AM 2020 108425 A

(210) AM 108425

(220) 2020 05 28

(310) 40 2019 0189950

(320) 2019 12 06

(330) KR

(731) Hyundai Motor Company
12, Heolleung-ro, Seocho-gu, Seoul, Republic
of Korea

(740) Tamar Kotchlamazashvili

(540)



(591) Black-white

(531) 03.07.17; 24.01.15; 24.01.18; 27.05.02

(511) 39

(260) AM 2020 108426 A
 (210) AM 108426
 (220) 2020 05 28
 (731) BASF Agricultural Solutions Seed US LLC
 100 Park Avenue, Florham Park, NJ, USA
 (740) Giorgi Taktakishvili
 (540)

INVIGOR

(591) Black-white
 (511) 1, 31

(260) AM 2020 108432 A
 (210) AM 108432
 (220) 2020 05 29
 (731) LTD "IMPEXPHARM"
 On the right bank of the River Mtkvari, nearby
 descent way going
 to the Bacteriophage, 0160, Tbilisi, Georgia
 (740) Nugzar Ksovreli
 (540)

ValuBroncho

(591) Black-white
 (511) 5

(260) AM 2020 108433 A
 (210) AM 108433
 (220) 2020 05 29
 (731) LTD "IMPEXPHARM"
 On the right bank of the River Mtkvari,
 nearby descent way going to the Bacteriophage,
 0160, Tbilisi, Georgia
 (740) Nugzar Ksovreli
 (540)

ValuVit

(591) Black-white
 (511) 5

(260) AM 2020 108434 A
 (210) AM 108434
 (220) 2020 05 29
 (731) LTD "IMPEXPHARM"
 On the right bank of the River Mtkvari,
 nearby descent way going to the Bacteriophage,
 0160, Tbilisi, Georgia
 (740) Nugzar Ksovreli
 (540)

ValuPropol

(591) Black-white
 (511) 5

(260) AM 2020 108435 A
 (210) AM 108435
 (220) 2020 05 29
 (731) LTD "IMPEXPHARM"
 On the right bank of the River Mtkvari,
 nearby descent way going to the Bacteriophage,
 0160, Tbilisi, Georgia
 (740) Nugzar Ksovreli
 (540)

ValuRest

(591) Black-white
 (511) 5

(260) AM 2020 108478 A
 (210) AM 108478
 (220) 2020 05 29
 (731) LTD "IMPEXPHARM"
 On the right bank of the River Mtkvari,
 nearby descent way going to the Bacteriophage,
 0160, Tbilisi, Georgia
 (740) Nugzar Ksovreli
 (540)

ValuDorm

(591) Black-white
 (511) 5

(260) AM 2020 108479 A
 (210) AM 108479
 (220) 2020 05 29
 (731) LTD "IMPEXPHARM"
 On the right bank of the River Mtkvari,
 nearby descent way going to the Bacteriophage,
 0160, Tbilisi, Georgia
 (740) Nugzar Ksovreli
 (540)

Nutrikum

(591) Black-white
 (511) 5

(260) AM 2020 108480 A
 (210) AM 108480
 (220) 2020 05 29
 (731) LTD "IMPEXPHARM"
 On the right bank of the River Mtkvari,
 nearby descent way going to the Bacteriophage,
 0160, Tbilisi, Georgia
 (740) Nugzar Ksovreli
 (540)

PAVASED

(591) Black-white
 (511) 5

(260) AM 2020 108481 A
 (210) AM 108481
 (220) 2020 05 29
 (731) LTD "IMPEXPHARM"
 On the right bank of the River Mtkvari,
 nearby descent way going to the Bacteriophage,
 0160, Tbilisi, Georgia
 (740) Nugzar Ksovreli
 (540)

PRO-GOLA

(591) Black-white
 (511) 5

(260) AM 2020 108483 A
 (210) AM 108483
 (220) 2020 05 29
 (731) LTD "IMPEXPHARM"
 On the right bank of the River Mtkvari,
 nearby descent way going to the Bacteriophage,
 0160, Tbilisi, Georgia
 (740) Nugzar Ksovreli
 (540)

Dropskol junior

(591) Black-white
 (511) 5

(260) AM 2020 108485 A
 (210) AM 108485
 (220) 2020 05 29
 (731) LTD "IMPEXPHARM"
 On the right bank of the River Mtkvari,
 nearby descent way going to the Bacteriophage,
 0160, Tbilisi, Georgia
 (740) Nugzar Ksovreli
 (540)

Normo Flu

(591) Black-white
 (511) 5

(260) AM 2020 108486 A
 (210) AM 108486
 (220) 2020 05 29
 (731) LTD "IMPEXPHARM"
 On the right bank of the River Mtkvari,
 nearby descent way going to the Bacteriophage,
 0160, Tbilisi, Georgia
 (740) Nugzar Ksovreli
 (540)

Blikol

(591) Black-white
 (511) 5

(260) AM 2020 108488 A
 (210) AM 108488
 (220) 2020 05 29
 (731) Zoetis Services LLC
 10 Sylvan Way, Parsippany, NJ, 07054, USA
 (740) Natela Otavidze
 (540)

VANGUARD

(591) Black-white
 (511) 5

(260) AM 2020 108511 A
 (210) AM 108511
 (220) 2020 06 03
 (731) KWANG YANG MOTOR CO., LTD
 No.35, Wan Hsing Street, Sanmin District,
 Kaohsiung, Taivani (TW), China
 (740) Shalva Gvaramadze
 (540)



(591) Black-white
 (531) 26.01.02; 26.01.18; 27.05.21
 (511) 12

(260) AM 2020 108512 A
 (210) AM 108512
 (220) 2020 06 03
 (731) KWANG YANG MOTOR CO., LTD
 No.35, Wan Hsing Street, Sanmin District,
 Kaohsiung, Taivani (TW), China
 (740) Shalva Gvaramadze
 (540)

KYMCO

(591) Black-white
 (531) 27.05.17
 (511) 12

(260) AM 2020 108515 A
 (210) AM 108515
 (220) 2020 06 03
 (731) M/S TEJ RAM DHARAM PAUL
 93, Chanderlok, Pitampura, Delhi, 110034,
 India
 (740) Liliana Darakhvelidze
 (540)

Myth

(591) Black-white
 (511) 34

(260) AM 2020 108595 A
(210) AM 108595
(220) 2020 06 10
(731) Irakli Lomidze
Kachreti St. 44/21, Tbilisi, Georgia
(540)



(591) White, black, orange
(531) 07.01.09; 27.05.09; 29.01.12
(511) 37

(260) AM 2020 108612 A
(210) AM 108612
(220) 2020 06 12
(731) Netflix Inc.
100 Winchester Circle, Los Gatos, CA
95032, USA
(740) Tamaz Shilakadze
(540)



(591) Red
(531) 27.05.01; 27.05.10; 27.05.14; 27.05.17;
29.01.01
(511) 9, 38, 41

(260) AM 2020 108613 A
(210) AM 108613
(220) 2020 06 12
(731) Netflix Inc.
100 Winchester Circle, Los Gatos, CA
95032, USA
(740) Tamaz Shilakadze
(540)



(591) Black-white
(511) 9, 38, 41

REGISTERED TRADEMARKS

(111) M 2020 33429 R
 (151) 2020 12 11
 (181) 2030 12 11
 (260) AM 2020 104178 A
 (220) 2020 01 13
 (732) Enriko Beridze
 T. Tabidze St. 10, Lane 1, Tbilisi, Georgia

(111) M 2020 33430 R
 (151) 2020 12 11
 (181) 2030 12 11
 (260) AM 2020 104179 A
 (220) 2020 01 13
 (732) Enriko Beridze
 T. Tabidze St. 10, Lane 1, Tbilisi, Georgia

(111) M 2020 33431 R
 (151) 2020 12 11
 (181) 2030 12 11
 (260) AM 2020 104180 A
 (220) 2020 01 13
 (732) Enriko Beridze
 T. Tabidze St. 10, Lane 1, Tbilisi, Georgia

(111) M 2020 33432 R
 (151) 2020 12 11
 (181) 2030 12 11
 (260) AM 2020 104181 A
 (220) 2020 01 13
 (732) Enriko Beridze
 T. Tabidze St. 10, Lane 1, Tbilisi,
 Georgia

(111) M 2020 33433 R
 (151) 2020 12 11
 (181) 2030 12 11
 (260) AM 2020 104182 A
 (220) 2020 01 13
 (732) Enriko Beridze
 T. Tabidze St. 10, Lane 1, Tbilisi,
 Georgia

(111) M 2020 33434 R
 (151) 2020 12 11
 (181) 2030 12 11
 (260) AM 2020 104184 A
 (220) 2020 01 13
 (732) Enriko Beridze
 T. Tabidze St. 10, Lane 1, Tbilisi,
 Georgia

(111) M 2020 33435 R
 (151) 2020 12 11
 (181) 2030 12 11
 (260) AM 2020 104323 A
 (220) 2020 01 13
 (732) JSC "Georgian Beer Company"
 Vill. Saguramo, 3311, Mtskheta,
 Georgia

(111) M 2020 33436 R
 (151) 2020 12 11
 (181) 2030 12 11
 (260) AM 2019 104434 A
 (220) 2019 08 06
 (732) "Modern Business Solutions" LLC
 Gorgasali St. 8, Krtsanisi district,
 Tbilisi, Georgia

(111) M 2020 33437 R
 (151) 2020 12 11
 (181) 2030 12 11
 (260) AM 2019 104435 A
 (220) 2019 08 06
 (732) "Modern Business Solutions" LLC
 Gorgasali St. 8, Krtsanisi district,
 Tbilisi, Georgia

(111) M 2020 33438 R
 (151) 2020 12 11
 (181) 2030 12 11
 (260) AM 2019 104939 A
 (220) 2019 09 19
 (732) LTD "British Georgian Academy"
 Leo Kvachadze St. 17, Saburtalo district,
 Tbilisi, Georgia

(111) M 2020 33439 R
 (151) 2020 12 11
 (181) 2030 12 11
 (260) AM 2019 105230 A
 (220) 2019 10 08
 (732) Zaza Rusadze
 Batu Kraveishvili St. 7, 0108, Tbilisi,
 Georgia

(111) M 2020 33440 R
 (151) 2020 12 11
 (181) 2030 12 11
 (260) AM 2019 105636 A
 (220) 2019 11 04

(732) LTD "CAVEA SABURTALO"
Ingorokva St. 21, Mtatsminda district,
0114, Tbilisi, Georgia

(111) M 2020 33441 R
(151) 2020 12 11
(181) 2030 12 11
(260) AM 2019 105659 A
(220) 2019 11 06

(732) ASHLEY FURNITURE INDUSTRIES INC.
One Ashley Way, Arcadia, Wisconsin
54612, USA

(111) M 2020 33442 R
(151) 2020 12 11
(181) 2030 12 11
(260) AM 2019 105874 A
(220) 2019 11 25

(732) LTD "Nice +"
B. Khmelnitsky St. 24, Isani District, Tbilisi,
Georgia

(111) M 2020 33443 R
(151) 2020 12 11
(181) 2030 12 11
(260) AM 2019 105882 A
(220) 2019 11 26

(732) Guangzhou Xibin Trading Co., Ltd
1802-1803, Guanchjou Interneshnl
Fainans-senter, №5 Chjuczian Vest Roud,
Tianhe Distriqt, Guanchjou Siti, Guandun
Provins, China

(111) M 2020 33444 R
(151) 2020 12 11
(181) 2030 12 11
(260) AM 2019 105994 A
(220) 2019 12 05

(732) Dentafill Plyus LLC
Sergeli District, St. Margib, 1, Tashkent,
100102, Uzbekistan

(111) M 2020 33445 R
(151) 2020 12 11
(181) 2030 12 11
(260) AM 2019 106064 A
(220) 2019 12 10

(732) LTD "SALO"
Ivane Javakhishvili St. 59, Tetriskaro,
Georgia

(111) M 2020 33446 R
(151) 2020 12 11
(181) 2030 12 11
(260) AM 2019 106072 A
(220) 2019 12 11

(732) Levan Chikvaidze
S. Janashia St. 19, 0179, Tbilisi, Georgia;
Levan Turzeladze
Il. Chavchavadze Av. 62, 0162, Tbilisi, Georgia

(111) M 2020 33447 R
(151) 2020 12 11
(181) 2030 12 11
(260) AM 2019 106179 A
(220) 2019 12 17

(732) Enriko Beridze
Giorgi Tsitsishvili St. 18, Tbilisi, Georgia

(111) M 2020 33448 R
(151) 2020 12 11
(181) 2030 12 11
(260) AM 2019 106180 A
(220) 2019 12 17

(732) Enriko Beridze
Giorgi Tsitsishvili St. 18, Tbilisi, Georgia

(111) M 2020 33449 R
(151) 2020 12 11
(181) 2030 12 11
(260) AM 2020 106590 A
(220) 2020 01 10

(732) World Trade Center Association Inc.
115 Broadway, Suite 1202, New York,
NY 10006, USA

(111) M 2020 33450 R
(151) 2020 12 11
(181) 2030 12 11
(260) AM 2020 106591 A
(220) 2020 01 10

(732) World Trade Center Association Inc.
115 Broadway, Suite 1202, New York,
NY 10006, USA

(111) M 2020 33451 R
(151) 2020 12 11
(181) 2030 12 11
(260) AM 2020 106608 A
(220) 2020 01 16

(732) LTD "Tbilisi Free University"
David Aghmashenebeli Alley 240, 0131,
Tbilisi, Georgia

(111) M 2020 33452 R
(151) 2020 12 11
(181) 2030 12 11
(260) AM 2020 106615 A
(220) 2020 01 16
(732) LTD "TBILI SIO"
Mtskheta St., I Lane 3, 0179, Tbilisi,
Georgia

(111) M 2020 33453 R
(151) 2020 12 11
(181) 2030 12 11
(260) AM 2020 106662 A
(220) 2020 01 22
(732) LTD "CONFIDENCE GROUP"
300 Aragveli St. 24, 0144, Tbilisi, Georgia

(111) M 2020 33454 R
(151) 2020 12 11
(181) 2030 12 11
(260) AM 2020 106672 A
(220) 2020 01 23
(732) COMPAGNIE GERVAIS DANONE
(a French corporation)
17, boulevard Haussmann, 75009 Paris,
France

(111) M 2020 33455 R
(151) 2020 12 11
(181) 2030 12 11
(260) AM 2020 106766 A
(220) 2020 01 27
(732) Alvogen Pharma Trading Europe EOOD
Bulgaria Bulvar 86, 1680 Sofia, Bulgaria

(111) M 2020 33456 R
(151) 2020 12 11
(181) 2030 12 11
(260) AM 2020 106784 A
(220) 2020 01 29
(732) LTD "JULY"
Beliashvili St. 104, Tbilisi, Georgia

(111) M 2020 33457 R
(151) 2020 12 11
(181) 2030 12 11
(260) AM 2020 106788 A
(220) 2020 01 30
(732) Giorgi Gobechia
Bakhtioni St. 16, app. 134, 0194, Tbilisi,
Georgia

(111) M 2020 33458 R
(151) 2020 12 11
(181) 2030 12 11
(260) AM 2020 106816 A
(220) 2020 01 30
(732) LTD "Brokers I O"
Sulkhan Tsintsadze St. 12, non-residential
area 3-9 (Davit Gamrekeli 2), Tbilisi,
Georgia

(111) M 2020 33459 R
(151) 2020 12 11
(181) 2030 12 11
(260) AM 2019 103435 A
(220) 2019 06 03
(732) MIRAGE GRANITO CERAMICO S.P.A.
Via Jardini Nordi, 225, 41026 Pavulo-nelfriniano
(modena), Italy

(111) M 2020 33460 R
(151) 2020 12 11
(181) 2030 12 11
(260) AM 2019 102922 A
(220) 2019 10 04
(732) LTD "AGRONOM"
L. Gotua St. 12a, 0160, Tbilisi, Georgia

(111) M 2020 33461 R
(151) 2020 12 11
(181) 2030 12 11
(260) AM 2019 102923 A
(220) 2019 10 04
(732) LTD "AGRONOM"
L. Gotua St. 12a, 0160, Tbilisi, Georgia

(111) M 2020 33462 R
(151) 2020 12 11
(181) 2030 12 11
(260) AM 2019 102925 A
(220) 2019 10 04
(732) LTD "AGRONOM"
L. Gotua St. 12a, 0160, Tbilisi, Georgia

(111) M 2020 33463 R
(151) 2020 12 11
(181) 2030 12 11
(260) AM 2019 102926 A
(220) 2019 10 04
(732) LTD "AGRONOM"
L. Gotua St. 12a, 0160, Tbilisi, Georgia

TRADEMARKS REGISTERED ACCORDING TO THE ACCELERATED PROCEDURE

The decision can be appealed at the Chamber of Appeal of Sakpatenti within 3 months from the publication.

(111) M 2020 33420 R

(151) 2020 12 07

(181) 2030 12 07

(210) AM 110613

(220) 2020 11 26

(732) Giorgi Gochitashvili

Aleksandre Kazbegi Av. 51, app. 25b, Tbilisi,
Georgia;

Gela Gochitashvili

Aleksandre Kazbegi Av. 51, app. 25b, Tbilisi,
Georgia

LTD "5 GE"

Aleksandre Kazbegi Av. 51, app. 25b,
Saburtalo District, Tbilisi, Georgia

(540)



(591) Black, white, yellow, red

(531) 08.01.06; 08.01.07; 08.01.09; 08.01.10;
26.13.25; 28.19; 29.01.14

(511) 43

(111) M 2020 33421 R

(151) 2020 12 08

(181) 2030 12 08

(210) AM 110676

(220) 2020 11 30

(732) JSC "ASIA SOFTWARE"

Lekh and Maria Kaczynskiy St. 1a, 5th floor,
entrance D, app. D405, 6010, Batumi, Georgia

(540)



(591) Black, yellow

(531) 21.01.11; 26.04.01; 26.04.09; 26.04.24;
27.05.01; 27.05.17; 27.05.22; 29.01.12

(511) 9, 38, 39

(111) M 2020 33422 R

(151) 2020 12 09

(181) 2030 12 09

(210) AM 110677

(220) 2020 11 30

(732) LTD "STANLEY INTERNATIONAL"

Shartava St. 6, app. 30, 0160, Tbilisi, Georgia

(540)



(591) Blue, red, white, black, brown

(531) 15.07.01; 15.07.03; 26.01.01; 26.01.18;
26.01.21; 26.04.10; 27.01.12; 27.05.22

(511) 4

(111) M 2020 33423 R

(151) 2020 12 09

(181) 2030 12 09

(210) AM 110678

(220) 2020 11 30

(732) Otani Tire Co., Ltd

55 Mu 7 Petchkasem K.M. 37 Road, Klongmai,
Sampran, Nakhonpathom, 73110, Thailand

(740) Sopio Panjikidze

(540)



(591) Black-white

(531) 26.01.01; 26.01.03; 26.04.03; 26.04.10;
27.05.01; 27.05.03

(511) 12

(111) M 2020 33424 R
 (151) 2020 12 10
 (181) 2030 12 10
 (210) AM 110742
 (220) 2020 12 04
 (732) LTD "HILTON APARTMENTS"
 Pirosmeni St. 18, app. 196, Block "A", 6010,
 Batumi, Georgia
 (540)

HILTON.APARTMENTS

(591) Black-white
 (531) 26.04.02; 26.04.22; 27.05.05; 27.05.11
 (511) 35

(111) M 2020 33425 R
 (151) 2020 12 10
 (181) 2030 12 10
 (210) AM 110537
 (220) 2020 11 18
 (732) LTD "H & Z"
 Mukhiani, I mcr., corp. 5, app. 40, 0100,
 Gldani District, Tbilisi, Georgia
 (540)



H&Z

(591) Brown, black, white
 (531) 03.13.05; 03.13.24; 19.11.09; 26.05.01;
 26.05.15; 29.01.13
 (511) 5

(111) M 2020 33426 R
 (151) 2020 12 10
 (181) 2030 12 10
 (210) AM 110549
 (220) 2020 11 19
 (732) JSC "TSKALI MAREBELI"
 Vill. Nabeghlavi, Chokhatauri Region,
 Georgia;
 RAUCH Fruchtsäfte GmbH
 Langgasse 1, 6830 Rankweil, Austria
 (740) Giorgi Meipariani
 (540)

WHITE POWDER

(591) Black-white
 (511) 32, 33

(111) M 2020 33427 R
 (151) 2020 12 11
 (181) 2030 12 11
 (210) AM 110683

(220) 2020 12 01
 (732) LTD "JAKARTA"
 Davit Aghmashenebeli Av. 179, app. 39,
 Tbilisi, Georgia
 (540)



(591) Golden, dark lilac, light lilac, black, grey
 (531) 02.09.04; 02.09.08; 03.01.16; 04.05.05;
 04.05.15; 05.03.08; 25.01.09; 25.01.10;
 25.03.05; 25.07.25; 27.05.01; 27.05.24;
 29.01.13
 (511) 33

(111) M 2020 33428 R
 (151) 2020 12 11
 (181) 2030 12 11
 (210) AM 110771
 (220) 2020 12 08
 (732) Foundation "ATINATI"
 Irakli Abashidze St. 28, app. 6, Vake District
 0109, Tbilisi, Georgia
 (740) Tamaz Urtmelidze
 (540)



A T I N A T I

(591) Black-white
 (531) 27.05.01; 27.05.21; 28.19
 (511) 9, 42

(111) M 2020 33464 R
(151) 2020 12 16
(181) 2030 12 16
(210) AM 110783
(220) 2020 12 10
(732) LTD "ABG"

Ivane Javakhishvili St. 80, app. 58, Batumi,
Georgia

(540)



(591) Blue, sky-blue, white, red
(531) 01.15.15; 26.01.02; 26.01.22; 26.01.24;
27.05.02; 29.01.14
(511) 3, 5

(111) M 2020 33465 R
(151) 2020 12 16
(181) 2030 12 16
(210) AM 110775
(220) 2020 12 08
(732) Luka Gulaghashvili

Gldani, VIII mcr., corp. 7, entrance 5, app. 87,
0107, Tbilisi, Georgia

(540)

DECOLLETE

(591) Black-white
(511) 35

(111) M 2020 33466 R
(151) 2020 12 16
(181) 2030 12 16
(210) AM 110862
(220) 2020 12 12
(732) Lia Kapanadze

Giramishvili St. 39b, Tbilisi, Georgia

(540)



(591) Yellow, green, grey
(531) 07.01.09; 07.03.11; 26.01.01; 26.01.04;
26.01.16; 26.01.20; 27.05.01; 27.05.23; 28.19;
29.01.14
(511) 41

(111) M 2020 33467 R
(151) 2020 12 17
(181) 2030 12 17
(210) AM 110788
(220) 2020 12 10
(732) LLC "YAMUNA GEORGIA"
Giorgi Brtskinvale St. 1, corp. 1, 0131,
Vake-Saburtalo District, Tbilisi, Georgia
(540)



(591) Red, white
(531) 26.04.02; 26.04.04; 26.04.07; 26.04.22; 28.05;
29.01.12
(511) 30

INTERNATIONAL TRADEMARKS FOR WHICH A DECISION ON GRANTING PROTECTIONS IS TAKEN

The decision can be appealed at the Chamber of Appeal of Sakpatenti within 3 months from the publication or at the Mtskheta District Court Administrative Cases Board (Address: №17, Samkhedro str., Mtskheta), within 1 month following the publication.

- (260) AM 2020 105575 A
(800) 1495106
(151) 2019 06 03
(891) 2019 06 03
(731) Limited Liability Company "IMPULS M"
Warsawskoe shosse, 1, stroenie 1-2, pom. 25,
RU-117105 Moscow, Russian Federation
(540)



- (591) Black, white
(531) 26.04.05; 27.05.08; 27.05.09; 27.05.10;
27.05.24
(526) ENERGY DRINK
(511)
32 – Aperitifs, non-alcoholic; barley wine [beer]; aerated water; lithia water; seltzer water; soda water; waters [beverages]; mineral water [beverages]; table waters; kvass [non-alcoholic beverage]; cocktails, non-alcoholic; beer-based cocktails; lemonades; non-alcoholic beverages; isotonic beverages; non-alcoholic honey-based beverages; rice-based beverages, other than milk substitutes; soya-based beverages, other than milk substitutes; aloe vera drinks, non-alcoholic; whey beverages; protein-enriched sports beverages; soft drinks; non-alcoholic beverages flavored with coffee; non-alcoholic beverages flavored with tea; non-alcoholic fruit juice beverages; energy drinks; fruit nectars, non-alcoholic; orgeat; beer; ginger beer; malt beer; powders for effervescing beverages; sarsaparilla [non-alcoholic beverage]; syrups for lemonade; syrups for beverages; smoothies; tomato juice [beverage]; cider, non-alcoholic; vegetable juices [beverages]; fruit juices; preparations for making aerated water; must; grape must, unfermented; beer wort; malt wort; pastilles for effervescing beverages; non-alcoholic fruit extracts; extracts of hops for making beer; essences for making beverages; non-alcoholic preparations for making beverages; sherbets [beverages].
35 – Demonstration of goods; opinion polling; market studies; business information; commercial information and advice for consumers in the choice of products

and services; business investigations; marketing research; targeted marketing; updating of advertising material; organization of exhibitions for commercial or advertising purposes; organization of trade fairs for commercial or advertising purposes; shop window dressing; design of advertising materials; commercial intermediation services; providing business information via a web site; web indexing for commercial or advertising purposes; sales promotion for others; promotion of goods and services through sponsorship of sports events; rental of vending machines; rental of sales stands; publication of publicity texts; distribution of samples; dissemination of advertising matter; direct mail advertising; advertising; online advertising on a computer network; bill-posting; advertising by mail order; television advertising; telemarketing services; commercial administration of the licensing of the goods and services of others; public relations; search engine optimization for sales promotion; procurement services for others [purchasing goods and services for other businesses]; business efficiency expert services; provision of an online marketplace for buyers and sellers of goods and services; presentation of goods on communication media, for retail purposes.

- (260) AM 2020 107192 A
(800) 1514864
(151) 2019 07 29
(891) 2019 07 29
(731) Dr. Theiss Naturwaren GmbH
Michelinstr. 10, 66424 Homburg, Germany
(540)

Lashes Up

- (591) Black, white
(511)
3 – Bleaching preparations and other substances for laundry use; cleaning, polishing, scouring and abrasive preparations; soaps; perfumery, essential oils, cosmetics, including non-medical skin cleaning and care preparations, and hair care preparations; eyelashes (false -); hair lotion; dentifrices.
5 – Pharmaceutical and veterinary preparations; medicines for human or veterinary purposes; sanitary preparations for medical purposes; dietetic foodstuffs and substances adapted for medical use; nutritional supp-

lements; vitamin preparations, including beauty capsules.

(260) AM 2020 107229 A

(800) 1515531

(151) 2019 11 19

(891) 2019 11 19

(731) HANGZHOU DE&E APPLIANCES CO., LTD.

No.98 Hongxing Road, Qiaonan Block
Xiaoshan Economic and Technological
Development Zone, Xiaoshan District,
Hangzhou, Zhejiang, China

(540)



(591) Black, white

(531) 24.17.09; 27.05.01

(511)

7 – Bean sprouting machine; beverage preparation machines, electromechanical; dishwashers; kitchen machines, electric; fruit presses, electric, for household purposes; kitchen grinders, electric; soybean milk machine, for household purposes; washing machines [laundry]; waste disposers [machines]; vacuum cleaners.

(260) AM 2020 107328 A

(800) 1516559

(151) 2019 12 18

(891) 2019 12 18

(731) URSA Salgótarján Glass Wool Close Co., Ltd.
Szépvölgyi út 41, 2/2, H-1037 BUDAPEST,
Hungary

(540)



(591) Blue, red, white

(531) 03.01.14; 03.01.24; 26.04.05; 26.04.15;
26.04.18; 26.04.24; 27.05.01; 29.01.13

(511)

17 – Insulating, soundproofing and stopping materials; fabrics, felts, webs, plates, panels and sheets for use as insulation material; rubber or plastics for padding and stuffing; mineral wool, glass wool, stone wool, rock wool, slag wool and fiber glass for thermal or acoustic insulation; glass fibers for insulation; slag wool, glass wool blankets and panels for insulation;

wood fiber, plastic insulation materials, especially foamed plastic materials; insulation boards, made from polystyrene, especially made from extruded polystyrene; XPS (extruded polystyrene) material for packing and stuffing; XPS (extruded polystyrene) panels for insulation; plastic film, other than for packaging purposes; substances for insulating buildings against moisture; sealant compounds for joints; insulating paper, insulating tape and band, rubber, gutta-percha, gum, asbestos, mica; plastics in extruded form for use in manufacture; packing materials, joint packaging for flexible pipes; membranes and other materials for air tightness and vapor barriers (membrane for moisture protection); vapor barriers; insulating adhesives for sealing and/or attaching or linking membranes of air tightness and/or vapor barriers (for moisture protection) to anything that has to pass through like carpentry, timber studs, tubes, chimney, parts used for ventilation, ducts; insulating adhesives, especially in the form of tapes to be used in combination with insulating material, like mineral wool and XPS (extruded polystyrene); adhesive tapes for industrial purposes; insulating material for buildings and/or to glass; mineral wool for insulation purposes together with respective fixing for fastening the insulation material and/or mineral wool to the construction of a building, namely warm frame construction, cold frame construction, wall/floor junction timber floor, cavity batts made of mineral fibers, pitched roof insulation, roof junctions for separating wall / attic space, roof junctions for separating wall / room in the roof.

19 – Building materials (non-metallic), including panels and sheets of mineral fibers (especially fiber glass) for buildings; ducts for air conditioning, self-bearing duct designs made from mineral wool especially glass fiber panels used for HVAC (heating, ventilation and air conditioning); mineral wool panels with woven or non-woven facings or coverings; non-metallic rigid pipes for building; asphalt, pitch and bitumen; non-metallic transportable buildings; monuments, not of metal, waterproofing claddings.

(260) AM 2020 107330 A

(800) 1516629

(151) 2019 09 09

(891) 2019 09 09

(731) 40 Days For Life

4112 E. 29th St., Bryan TX 77802, USA

(540)



(591) Black, white

(531) 04.01.03; 05.03.13; 05.03.15; 27.03.02;
27.07.01

(511)

35 – Promoting public awareness of the interests of the preborn (terms considered too vague by the International Bureau – Rule 13(2)(b) of the Common Regulations); promoting public awareness of the need for ending abortion (terms considered too vague by the International Bureau – Rule 13(2)(b) of the Common Regulations); promoting the interests of people concerned with abortion issues (terms considered too vague by the International Bureau – Rule 13(2)(b) of the Common Regulations); charitable services, namely, organizing and conducting volunteer programs and community service projects.

41 – Charitable services, namely, providing educational materials in the nature of books, magazines, newsletters and pamphlets featuring information regarding the support pro-life efforts in local communities; education services, namely, providing training programs in the field of organizing pro-life events that center on the issues of the sanctity of life and the rights of the preborn; educational and entertainment services, namely, providing motivational and educational speakers; organizing exhibitions for educational purposes in the field defending the lives of the preborn and ending abortion; providing educational demonstrations in the field of pro-life activities, namely, defending and supporting the life of the preborn; providing educational mentoring services and programs in the field of pro-life support to expecting mothers.

(260) AM 2020 107331 A

(800) 1516640

(151) 2019 12 13

(891) 2019 12 13

(731) Apple Inc.

One Apple Park Way, Cupertino CA 95014,
USA

(540)



(591) White, gray, blue, light green and medium green

(531) 16.03.01; 26.01.05; 26.04.04; 26.04.10; 29.01.14

(511)

42 – Providing online non-downloadable software for use in geographically locating and tracking electronic devices; providing online non-downloadable software for providing alerts and notifications concerning the location of electronic devices; providing online non-downloadable software for providing alerts and notifications concerning the location of people; providing

online non-downloadable software for use in social networking, namely, software for displaying and sharing a user's location and finding, locating, and interacting with other users; providing online non-downloadable software for recovering electronic devices by using global position systems (GPS) and cellular telecommunications; providing online non-downloadable software for remotely accessing, locking and deleting data stored on an electronic device; providing online non-downloadable software for controlling access privileges of users of electronic devices and restricting unauthorized access to electronic devices.

(260) AM 2020 107332 A

(800) 1516679

(151) 2018 10 15

(891) 2018 10 15

(731) Tungsram Operations Kft.

Váci út 77, H-1044 Budapest, Hungary

(540)



(591) Blue (C: 100 M: 80 Y: 0 K: 15; R: 20 G: 58 B: 132, #143a84).

(531) 26.04.22; 26.04.24; 27.05.01; 27.05.24; 29.01.12

(511)

9 – Scientific, nautical, surveying, photographic, cinematographic, optical, weighing, measuring, signalling, checking (supervision), life-saving and teaching apparatus and instruments; apparatus and instruments for conducting, switching, transforming, accumulating, regulating, or controlling electricity; apparatus for recording, transmission or reproduction of sound or images; magnetic data carriers, recording discs; compact discs, DVDs and other digital recording media; mechanisms for coin-operated apparatus; cash registers, calculating machines, data processing equipment, computers; computer software; fire-extinguishing apparatus; 3D spectacles; abacuses; accelerometers; accumulator boxes; accumulator jars; accumulators, electric; accumulators, electric, for vehicles; acid hydrometers; acidimeters for batteries; acoustic alarms; acoustic conduits; acoustic couplers; actinometers; adding machines; aerials; aerometers; air analysis apparatus; alarm bells, electric; alarms; alcoholmeters; alidades; altimeters; ammeters; amplifiers; amplifying tubes; amplifying valves; anemometers; animated cartoons; anode batteries; anodes; answering machines; antennas; anticathodes; anti-glare glasses; anti-interference devices [electricity]; anti-theft warning apparatus; apertometers [optics]; apparatus and installations for the production of X-rays, not for medical purposes; apparatus and instruments for astronomy; apparatus and instruments for physics; apparatus for changing record player needles; apparatus for edi-

ting cinematographic film; apparatus for fermentation [laboratory apparatus]; apparatus for measuring the thickness of skins; apparatus for recording distance; apparatus to check franking; apparatus to check stamping mail; appliances for measuring the thickness of leather; armatures [electricity]; asbestos clothing for protection against fire; asbestos gloves for protection against accidents; asbestos screens for firemen; audio- and video-receivers; audio interfaces; audio mixers; audiovisual teaching apparatus; automated teller machines [ATM]; automatic indicators of low pressure in vehicle tires; automatic indicators of low pressure in vehicle tyres; azimuth instruments; baby monitors; baby scales; bags adapted for laptops; balances [steelyards]; balancing apparatus; barcode readers; barometers; bathroom scales; batteries, electric; batteries, electric, for vehicles; batteries for electronic cigarettes; batteries for lighting; battery boxes; battery chargers; battery jars; beacons, luminous; bells [warning devices]; betatrons; binoculars; biochips; black boxes [data recorders]; blinkers [signalling lights]; blueprint apparatus; boiler control instruments; branch boxes [electricity]; breathing apparatus, except for artificial respiration; breathing apparatus for underwater swimming; bullet-proof clothing; bullet-proof vests; bullet-proof waistcoats; buzzers; cabinets for loudspeakers; cables, electric; calculating machines; calibrating rings; calipers; calorimeters; camcorders; cameras [photography]; capacitors; capillary tubes; carpenters' rules; carriers for dark plates [photography]; cases especially made for photographic apparatus and instruments; cases for smartphones; cash registers; cassette players; cathodes; cathodic anti-corrosion apparatus; cell phones; cell phone straps; cell switches [electricity]; cellular phones; centering apparatus for photographic transparencies; central processing units [processors]; chargers for electric batteries; chargers for electronic cigarettes; charging stations for electric vehicles; chemistry apparatus and instruments; chips [integrated circuits]; choking coils [impedance]; chromatography apparatus for laboratory use; chronographs [time recording apparatus]; cinematographic cameras; cinematographic film, exposed; circuit breakers; circuit closers; circular slide rules; cleaning apparatus for phonograph records; cleaning apparatus for sound recording discs; clinometers; close-up lenses; clothing especially made for laboratories; clothing for protection against accidents, irradiation and fire; clothing for protection against fire; coaxial cables; coils, electric; coin-operated mechanisms for television sets; coin-operated musical automata [juke boxes]; collectors, electric; commutators; compact disc players; compact discs [audio-video]; compact discs [read-only memory]; comparators; compasses for measuring; computer game software; computer hardware; computer keyboards; computer memory devices; computer operating programs, recorded; computer peripheral devices; computer programs [downloadable software]; computer programs, recorded; co-

mputers; computer screen saver software, recorded or downloadable; computer software applications, downloadable; computer software platforms, recorded or downloadable; computer software, recorded; condensers [capacitors]; conductors, electric; connected bracelets [measuring instruments]; connections, electric; connections for electric lines; connectors [electricity]; contact lenses; contacts, electric; containers for contact lenses; containers for microscope slides; control panels [electricity]; converters, electric; copper wire, insulated; cordless telephones; correcting lenses [optics]; cosmographic instruments; counterfeit coin detectors; counters; couplers [data processing equipment]; couplings, electric; covers for electric outlets; covers for personal digital assistants [PDAs]; covers for smartphones; covers for tablet computers; crash test dummies; crucibles [laboratory]; cupels [laboratory]; current rectifiers; cyclotrons; darkroom lamps [photography]; darkrooms [photography]; data processing apparatus; decompression chambers; decorative magnets; demagnetizing apparatus for magnetic tapes; densimeters; densitometers; detectors; diagnostic apparatus, not for medical purposes; diaphragms [acoustics]; diaphragms for scientific apparatus; diaphragms [photography]; dictating machines; diffraction apparatus [microscopy]; digital photo frames; digital signs; digital weather stations; directional compasses; discharge tubes, electric, other than for lighting; disk drives for computers; disks, magnetic; distance measuring apparatus; distance recording apparatus; distillation apparatus for scientific purposes; distribution boards [electricity]; distribution boxes [electricity]; distribution consoles [electricity]; divers' masks; diving suits; DNA chips; dog whistles; dosage dispensers; dosimeters; downloadable graphics for mobile phones; downloadable image files; downloadable music files; downloadable ring tones for mobile phones; drainers for use in photography; dressmakers' measures; drying apparatus for photographic prints; drying racks [photography]; ducts [electricity]; DVD players; dynamometers; ear plugs for divers; egg-candlers; egg timers [sandglasses]; electrical adapters; electric and electronic effects units for musical instruments; electric apparatus for commutation; electric apparatus for remote ignition; electric discharge tubes, other than for lighting; electric door bells; electric installations for the remote control of industrial operations; electricity conduits; electric loss indicators; electric wire harnesses for automobiles; electrified fences; electrified rails for mounting spot lights; electro-dynamic apparatus for the remote control of railway points; electro-dynamic apparatus for the remote control of signals; electrolyzers; electromagnetic coils; electronic access control systems for interlocking doors; electronic agendas; electronic book readers; electronic collars to train animals; electronic interactive whiteboards; electronic key fobs being remote control apparatus; electronic notice boards; electronic numeric displays; electronic pens [visual display

units]; electronic pocket translators; electronic publications, downloadable; electronic sheet music, downloadable; electronic tags for goods; encoded identification bracelets, magnetic; encoded key cards; encoded magnetic cards; enlarging apparatus [photography]; epidiascopes; equalisers [audio apparatus]; equalizers [audio apparatus]; ergometers; exposure [light meters]; eyeglass cases; eyeglass chains; eyeglass cords; eyeglasses; eyeglass frames; eyeglass lenses; eyepieces; eyewear; facsimile machines; fiber optic cables; fibre optic cables; film cutting apparatus; films, exposed; filters for respiratory masks; filters for ultraviolet rays, for photography; filters [photography]; finger sizers; fire alarms; fire beaters; fire blankets; fire boats; fire engines; fire escapes; fire extinguishers; fire extinguishing apparatus; fire hose; fire hose nozzles; fire pumps; flash-bulbs [photography]; flashing lights [luminous signals]; flashlights [photography]; floppy disks; flowmeters; fluorescent screens; fog signals, non-explosive; food analysis apparatus; frames for photographic transparencies; frequency meters; furnaces for laboratory use; furniture especially made for laboratories; fuses; fuse wire; galena crystals [detectors]; galvanic batteries; galvanic cells; galvanometers; garments for protection against fire; gasoline gauges; gasometers [measuring instruments]; gas testing instruments; gauges; glazing apparatus for photographic prints; global positioning system [GPS] apparatus; gloves for divers; gloves for protection against accidents; gloves for protection against X-rays for industrial purposes; goggles for sports; gradient indicators; graduated glassware; grids for batteries; hand-held electronic dictionaries; hands-free kits for telephones; head cleaning tapes [recording]; head guards for sports; headphones; heat regulating apparatus; heliographic apparatus; hemline markers; high-frequency apparatus; high tension batteries; holders for electric coils; holograms; horns for loudspeakers; hour-glasses; humanoid robots with artificial intelligence; hydrometers; hygrometers; identification sheaths for electric wires; identification threads for electric wires; identity cards, magnetic; igniting apparatus, electric, for igniting at a distance; inclinometers; incubators for bacteria culture; inductors [electricity]; infrared detectors; instruments containing eyepieces; integrated circuit cards [smart cards]; integrated circuits; interactive touch screen terminals; intercommunication apparatus; interfaces for computers; inverters [electricity]; invoicing machines; ionization apparatus not for the treatment of air or water; jigs [measuring instruments]; joysticks for use with computers, other than for video games; juke boxes for computers; juke boxes, musical, junction boxes [electricity]; junction sleeves for electric cables; kilometer recorders for vehicles; knee-pads for workers; laboratory centrifuges; laboratory robots; laboratory trays; lactodensimeters; lactometers; laptop computers; lasers, not for medical purposes; lenses for astrophotography; lens hoods; letter scales; levelling instruments; levelling staffs [sur-

veying instruments]; levels [instruments for determining the horizontal]; lever scales [steelyards]; life belts; life buoys; life jackets; life nets; life saving apparatus and equipment; life-saving capsules for natural disasters; life-saving rafts; light dimmers [regulators], electric; light-emitting diodes [LED]; light-emitting electronic pointers; lighting ballasts; lightning arresters; lightning conductors; lightning rods; light regulators [dimmers], electric; limiters [electricity]; locks, electric; logs [measuring instruments]; loudspeakers; magic lanterns; magnetic data media; magnetic encoders; magnetic resonance imaging [MRI] apparatus, not for medical purposes; magnetic tapes; magnetic tape units for computers; magnetic wires; magnets; magnifying glasses [optics]; manometers; marine compasses; marine depth finders; marking buoys; marking gauges [joinery]; masts for wireless aerials; materials for electricity mains [wires, cables]; material testing instruments and machines; mathematical instruments; measures; measuring apparatus; measuring devices, electric; measuring glassware; measuring instruments; measuring spoons; mechanical signs; mechanisms for coin-operated apparatus; mechanisms for counter-operated apparatus; megaphones; memory cards for video game machines; mercury levels; metal detectors for industrial or military purposes; meteorological balloons; meteorological instruments; meters; metronomes; micrometer gauges; micrometers; micrometer screws for optical instruments; microphones; microprocessors; microscopes; microtomes; mileage recorders for vehicles; mirrors for inspecting work; mirrors [optics]; mobile telephones; modems; money counting and sorting machines; monitoring apparatus, other than for medical purposes; monitors [computer hardware]; monitors [computer programs]; mouse [computer peripheral]; mouse pads; mouth guards for sports; nautical apparatus and instruments; naval signalling apparatus; navigational instruments; navigation apparatus for vehicles [on-board computers]; needles for record players; needles for surveying compasses; neon signs; nets for protection against accidents; nose clips for divers and swimmers; notebook computers; objectives [lenses] [optics]; observation instruments; octants; ohmmeters; optical apparatus and instruments; optical character readers; optical condensers; optical data media; optical discs; optical fibers [light conducting filaments]; optical fibres [light conducting filaments]; optical glass; optical lamps; optical lanterns; optical lenses; oscillographs; ovens for laboratory use; oxygen transvasing apparatus; ozonisers [ozonators]; parking meters; particle accelerators; pedometers; peepholes [magnifying lenses] for doors; periscopes; personal digital assistants [PDAs]; personal stereos; Petri dishes; petrol gauges; phonograph records; photocopiers [photographic, electrostatic, thermic]; photographic racks; photometers; phototelegraphy apparatus; photovoltaic cells; pince-nez; pipettes; Pitot tubes; plane tables [surveying instruments]; planimeters; plates for batte-

ries; plotters; plugs, sockets and other contacts [electric connections]; plumb bobs; plumb lines; pocket calculators; polarimeters; portable media players; precision balances; precision measuring apparatus; pressure gauges; pressure indicator plugs for valves; pressure indicators; pressure measuring apparatus; printed circuit boards; printed circuits; printers for use with computers', prisms [optics]; probes for scientific purposes; processors [central processing units]; projection apparatus; projection screens; protection devices against X-rays, not for medical purposes; protection devices for personal use against accidents; protective films adapted for computer screens; protective films adapted for smartphones; protective helmets; protective helmets for sports; protective masks; protective suits for aviators; protractors [measuring instruments]; punched card machines for offices; push buttons for bells; pyrometers; quantity indicators; radar apparatus; radiological apparatus for industrial purposes; radiology screens for industrial purposes; radio pagers; radios; radiotelegraphy sets; radiotelephony sets; railway traffic safety appliances; range finders; readers [data processing equipment]; rearview cameras for vehicles; record players; reducers [electricity]; reflective articles for wear, for the prevention of accidents; reflective safety vests; refractometers; refractors; regulating apparatus, electric; relays, electric; remote control apparatus; rescue laser signalling flares; resistances, electric; respirators for filtering air; respiratory masks, other than for artificial respiration; resuscitation mannequins [teaching apparatus]; resuscitation training simulators; retorts; retorts' stands; revolution counters; rheostats; riding helmets; ring sizers; road signs, luminous or mechanical; rods for water diviners; rods [surveying instruments]; rulers [measuring instruments]; rules [measuring instruments]; saccharometers; safety nets; safety restraints, other than for vehicle seats and sports equipment; safety tarpaulins; salinometers; satellite finder meters; satellite navigational apparatus; satellites for scientific purposes; scales; scales with body mass analysers; scales with body mass analyzers; scanners [data processing equipment]; screens for photoengraving; screens [photography]; screw-tapping gauges; security surveillance robots; security tokens [encryption devices]; selfie lenses; selfie sticks [hand-held monopods]; semi-conductors; sextants; sheaths for electric cables; shoes for protection against accidents, irradiation and fire; shutter releases [photography]; shutters [photography]; sighting telescopes for firearms; signal bells; signal lanterns; signalling buoys; signalling panels, luminous or mechanical; signalling whistles; signals, luminous or mechanical; signs, luminous; simulators for the steering and control of vehicles; sirens; sleeves for laptops; slide calipers; slide projectors; slide-rules; slides [photography]; slope indicators; smart cards [integrated circuit cards]; smartglasses; smartphones; smart rings; smartwatches; smoke detectors; snorkels; solar batteries; solar panels for the production of elec-

tricity; solderers' helmets; solenoid valves [electromagnetic switches]; sonars; sound alarms; sounding apparatus and machines; sounding leads; sounding lines; sound locating instruments; sound recording apparatus; sound recording carriers; sound recording discs; sound recording strips; sound reproduction apparatus; sound transmitting apparatus; spark-guards; speaking tubes; spectacle cases; spectacle chains; spectacle cords; spectacle frames; spectacle lenses; spectacles; spectrograph apparatus; spectrosopes; speed checking apparatus for vehicles; speed indicators; speed measuring apparatus [photography]; speed regulators for record players; spherometers; spirit levels; spools [photography]; sports whistles; sprinkler systems for fire protection; square rulers for measuring; squares for measuring; stage lighting regulators; stands for photographic apparatus; starter cables for motors; steelyards [lever scales]; steering apparatus, automatic, for vehicles; step-up transformers; stereoscopes; stereoscopic apparatus; stills for laboratory experiments; stroboscopes; styli for record players; subwoofers; sulfimeters; sunglasses; surveying apparatus and instruments; surveying chains; surveying instruments; surveyors' levels; switchboards; switchboxes [electricity]; switches, electric; tablet computers; tachometers; tape recorders; taximeters; teaching apparatus; teaching robots; teeth protectors, telecommunication apparatus in the form of jewellery; telecommunication apparatus in the form of jewelry; telegraphs [apparatus]; telegraph wires; telemeters; telephone apparatus; telephone receivers; telephone transmitters; telephone wires; teleprinters; teleprompters; telerupters; telescopes; telescopic sights for artillery; telescopic sights for firearms; teletypewriters; television apparatus; temperature indicator labels, not for medical purposes; temperature indicators; terminals [electricity]; testing apparatus not for medical purposes; test tubes; theft prevention installations, electric; theodolites; thermal imaging cameras; thermionic tubes; thermionic valves; thermo-hygrometers; thermometers, not for medical purposes; thermostats; thermostats for vehicles; thin client computers; thread counters; ticket dispensers; time clocks [time recording devices]; time recording apparatus; time switches, automatic; tone arms for record players; toner cartridges, unfilled, for printers and photocopiers; totalizers; traffic cones; traffic-light apparatus [signalling devices]; transformers [electricity]; transistors [electronic]; transmitters of electronic signals; transmitters [telecommunication]; transmitting sets [telecommunication]; transparencies [photography]; transparency projection apparatus; transponders; triodes; tripods for cameras; T-squares for measuring; urinometers; USB flash drives; vacuum gauges; vacuum tubes [radio]; variometers; vehicle breakdown warning triangles; vehicle radios; verniers; video baby monitors; video cassettes; video game cartridges; video recorders; video screens; videotapes; video telephones; viewfinders, photographic; virtual reality headsets; viscosi-

meters; visors for helmets; voltage regulators for vehicles; voltage surge protectors; voltmeters; voting machines; wafers for integrated circuits; walkie-talkies; washing trays [photography]; water level indicators; wavemeters; wearable activity trackers; wearable computers; wearable video display monitors; weighing bridges; weighing apparatus and instruments; weighing machines; weights; whistle alarms; wind socks for indicating wind direction; wire connectors [electricity]; wires, electric; workmen's protective face-shields; wrist rests for use with computers; X-ray apparatus not for medical purposes; X-ray films, exposed; X-ray photographs, other than for medical purposes; X-ray tubes not for medical purposes; apparatus and instruments for storing or checking electricity; magnetic media for storing data and sound; LED drivers; starters for discharge lamps and replacement starters for LED applications; electrical circuit boards; solar cells for electricity generation; electronic transformers; halogen transformers; halogen transformers and power sources; external electronic power supplies for LED modules, for LED fixtures and for the current and voltage regulation that is necessary for LED lamps; external electronic transformers for operating low-voltage halogen lamps; ignition current regulators, current regulators and voltage regulator equipment and apparatus for LED lamps, linear fluorescent lamps and other lighting apparatus; electronic or magnetic ballasts for gas discharge lamps (including high intensity discharge lamps); external electronic or magnetic ballasts for ignition current and voltage regulation required for the operation of linear fluorescent lamps (LFL); external electronic or magnetic ballasts for ignition current and voltage regulation required for the operation of high intensity discharge lamps; flashlights, flashbulbs; electrical control apparatus; LED parts included in this class; traffic lights and signal lights (including those used in water, air, railway, road and other ground traffic) and components and accessories for the installation, fixing, connection and operation thereof; LED controlling apparatus; products for controlling LED modules, LED lights and LED lamps; other units, apparatus and instruments for controlling lighting, including products for controlling lights and lighting apparatus of any kind; instruments for controlling light intensity, motion detection, or light detection and instruments for controlling lighting in accordance with other lighting-related aspects; electrical apparatus and instruments capable of destroying or repelling bacteria and other organisms; electrical apparatus and instruments for cleaning or disinfecting; LED drivers.

10 – Surgical, medical, dental and veterinary apparatus and instruments; lighting and light-emitting equipment of any kind for surgical, medical, dental and veterinary purposes; therapeutic and assistive devices for the disabled; lamps and light-emitting devices for healthcare research, and for therapy and research; apparatus, devices and products for nursing infants; se-

xual activity apparatus, devices and products; apparatus and devices for destroying or repelling other organisms; lamps, quartz lamps, infrared lamps, UV lamps and other light-, heat- and radiation emitting and detecting apparatus for surgical, medical, dental and veterinary purposes; UV lamps for therapeutic purposes; mirrors for physicians, surgeons and dentists; thermo-electric compresses; apparatus and installations for the production of X-rays, for medical purposes; X-ray tubes and radium tubes for medical purposes; radiological apparatus; lasers for medical purposes; magnetic resonance imaging apparatus for medical purposes and accessories thereof; incubators and accessories thereof; electric dental apparatus and other electric medical apparatus; electric heating cushions, electric heating pads, for medical purposes; electric acupuncture instruments; electrocardiographs; electrodes for medical use; analysers for bacterial identification.

11 – Apparatus for lighting, heating, steam generating, cooking, refrigerating, drying, ventilating, water supply and sanitary purposes; acetylene burners; acetylene flares; acetylene generators; air conditioners for vehicles; air-conditioning apparatus; air-conditioning installations; air cooling apparatus; air deodorising apparatus; air deodorizing apparatus; air driers; air dryers; air filtering installations; air fryers; air purifying apparatus and machines; air reheaters; air sterilisers; air sterilizers; air valves for steam heating installations; alcohol burners; anti-dazzle devices for vehicles [lamp fittings]; anti-glare devices for vehicles [lamp fittings]; anti-splash tap nozzles; apparatus for dehydrating food waste; aquarium filtration apparatus; aquarium heaters; aquarium lights; arc lamps; ash conveyor installations, automatic; ash pits for furnaces; atomic piles; autoclaves, electric, for cooking; automobile lights; bakers' ovens; barbecues; bath fittings; bath installations; bath plumbing fixtures; bath tubs; bath tubs for sitz baths; bed warmers; beverage cooling apparatus; bicycle lights; bidets; blankets, electric, not for medical purposes; boiler pipes [tubes] for heating installations; boilers, other than parts of machines; book sterilisation apparatus; book sterilization apparatus; brackets for gas burners; bread baking machines; bread-making machines; bread toasters; burners; burners for lamps; candle lanterns; carbon for arc lamps; ceiling lights; central heating radiators; chandeliers; chimney blowers; chimney flues; Chinese lanterns; chocolate fountains, electric; chromatography apparatus for industrial purposes; clean chambers [sanitary installations]; cocks for pipes and pipelines; coffee machines, electric; coffee percolators, electric; coffee roasters; coils [parts of distilling, heating or cooling installations]; cookers; cooking apparatus and installations; cooking rings; cooking stoves; cooking utensils, electric; cool boxes, electric; coolers, electric; coolers for furnaces; cooling appliances and installations; cooling installations and machines; cooling installations for liquids; cooling installations for tobacco; cooling installations for water; cooling

vats for furnaces; curling lamps; dampers [heating]; deep fryers, electric; defrosters for vehicles; dental ovens; deodorising apparatus, not for personal use; deodorizing apparatus, not for personal use; desalination plants; desiccating apparatus; directional lights for bicycles; discharge tubes, electric, for lighting; disinfectant apparatus; disinfectant apparatus for medical purposes; disinfectant dispensers for toilets; disinfectant distributors for toilets; distillation apparatus; distillation columns; diving lights; drip irrigation emitters [irrigation fittings]; drying apparatus; drying apparatus and installations; drying apparatus for fodder and forage; electrically heated carpets; electrically heated clothing; electric appliances for making yogurt; electric cooktops; electric fans for personal use; electric flashlights; electric lamps; electric lights for Christmas trees; electric torches; evaporators; expansion tanks for central heating installations; extractor hoods for kitchens; fabric steamers; fairy lights for festive decoration; fans [air-conditioning]; fans [parts of air-conditioning installations]; faucets; faucets for pipes and pipelines; feeding apparatus for heating boilers; filaments for electric lamps; filters for air conditioning; filters for drinking water; fire bars; fireplaces, domestic; fittings, shaped, for furnaces; fittings, shaped, for ovens; flaming torches; flare stacks for use in the oil industry; flues for heating boilers; flushing apparatus; flushing tanks; food steamers, electric; footmuffs, electrically heated; footwarmers, electric or non-electric; forage drying apparatus; forges, portable; fountains; framework of metal for ovens; freezers; friction lighters for igniting gas; fruit roasters; fumigation apparatus, not for medical purposes; furnace ash boxes; furnace grates; furnaces, other than for laboratory use; gas boilers; gas burners; gas condensers, other than parts of machines; gas lamps; gas lighters; gas scrubbers [parts of gas installations]; gas scrubbing apparatus; germicidal burners; germicidal lamps for purifying air; globes for lamps; glue-heating appliances; griddles [cooking appliances]; grills [cooking appliances]; hair driers; hair dryers; hand drying apparatus for washrooms; headlights for automobiles; head torches; hearths; heat accumulators; heated display cabinets; heaters, electric, for feeding bottles; heaters for baths; heaters for heating irons; heaters for vehicles; heat exchangers, other than parts of machines; heat guns; heating and cooling apparatus for dispensing hot and cold beverages; heating apparatus; heating apparatus, electric; heating apparatus for defrosting vehicle windows; heating apparatus for solid, liquid or gaseous fuels; heating boilers; heating cushions, electric, not for medical purposes; heating elements; heating filaments, electric; heating installations; heating installations [water]; heating pads, electric, not for medical purposes; heating plates; heat pumps; heat regenerators; hot air apparatus; hot air bath fittings; hot air ovens; hot plates; hot water bottles; hot water heating installations; humidifiers for central heating radiators; hydrants; hydromassage

bath apparatus; ice-cream making machines; ice machines and apparatus; immersion heaters; incandescent burners; incinerators; installations for processing nuclear fuel and nuclear moderating material; ionization apparatus for the treatment of air or water; kettles, electric; kiln furniture [supports]; kilns; kitchen ranges [ovens]; laboratory burners; laboratory lamps; lamp casings; lamp chimneys; lamp glasses; lamp globes; lamp mantles; lamp reflectors; lamps; lampshade holders; lamp shades; lanterns for lighting; laundry driers, electric; laundry dryers, electric; laundry room boilers; lava rocks for use in barbecue grills; level controlling valves in tanks; light bulbs; light bulbs, electric; light bulbs for directional signals for vehicles; light diffusers; light-emitting diodes [LED] lighting apparatus; lighters; lighting apparatus and installations; lighting apparatus for vehicles; lighting installations for air vehicles; lights, electric, for Christmas trees; lights for automobiles; lights for vehicles; loading apparatus for furnaces luminous house numbers; luminous tubes for lighting; magnesium filaments for lighting; malt roasters; microbubble generators for baths; microwave ovens [cooking apparatus]; microwave ovens for industrial purposes; milk cooling installations; miners' lamps; mixer faucets for water pipes; mixer taps for water pipes; motorcycle lights; multicookers; nail lamps; nuclear reactors; oil burners; oil lamps; oil-scrubbing apparatus; ornamental fountains; oven fittings made of fireclay; ovens, other than for laboratory use; oxyhydrogen burners; pasteurisers; petrol burners; pipes [parts of sanitary installations]; plate warmers; pocket warmers; polymerisation installations; portable headlamps; pounded rice cake making machines, electric, for household purposes; pressure cookers, electric; pressure water tanks; processing installations for fuel and nuclear moderating material; purification installations for sewage; radiator caps; radiators, electric; radiators [heating]; refining towers for distillation; refrigerating apparatus and machines; refrigerating appliances and installations; refrigerating cabinets; refrigerating chambers; refrigerating containers; refrigerating display cabinets; refrigerators; regulating accessories for water or gas apparatus and pipes; regulating and safety accessories for gas apparatus; regulating and safety accessories for gas pipes; regulating and safety accessories for water apparatus; roasters; roasting apparatus; roasting jacks; roasting spits; rotisseries; safety accessories for water or gas apparatus and pipes; safety lamps; sanitary apparatus and installations; sauna bath installations; scrubbers [parts of gas installations]; searchlights; shaped fittings for furnaces; shaped fittings for ovens; shower cubicles; shower enclosures; showers; sinks; sockets for electric lights; socks, electrically heated; solar furnaces; solar thermal collectors [heating]; sous-vide cookers, electric; spa baths [vessels]; spigots for pipes and pipelines; standard lamps; steam accumulators; steam boilers, other than parts of machines; steam facial apparatus [sau-

nas]; steam generating installations; sterilisers; sterilizers; stills, stoves [heating apparatus]; street lamps; string lights for festive decoration; structural plates for ovens; swimming pool chlorinating apparatus; tanning apparatus [sun beds]; taps-; taps for pipes and pipelines; thermostatic valves [parts of heating installations]; toasters; tobacco roasters; toilet bowls; toilet seats; toilets, portable; toilets [water-closets]; tortilla presses, electric; Turkish bath cabinets, portable; ultraviolet ray lamps, not for medical purposes; urinals [sanitary fixtures]; vehicle headlights; vehicle reflectors; ventilation [air-conditioning] installations and apparatus; ventilation [air-conditioning] installations for vehicles; ventilation hoods; ventilation hoods for laboratories; waffle irons, electric; walk-in refrigerators; warming pans; washers for water faucets; washers for water taps; wash-hand basins [parts of sanitary installations]; wash-hand bowls [parts of sanitary installations]; washing coppers; water closets; water conduits installations; water distribution installations; water filtering apparatus; water flushing installations; water heaters; water heaters [apparatus]; watering installations, automatic; watering machines for agricultural purposes; water intake apparatus; water-pipes for sanitary installations; water purification installations; water purifying apparatus and machines; water softening apparatus and installations; water sterilisers; water sterilizers; water supply installations; whirlpool-jet apparatus; wicks adapted for oil stoves; wine cellars, electric; incandescent lamp bulbs; incandescent lamp kits; lamps and lamp kits for vehicles; automotive lamp kits; lamps and sets of lamps of any kind; lamp accessories; suspendable lights, wall lamps, floor lamps; lamps, indicators and light-emitting apparatus, and accessories thereof for vehicles; automotive lights (including headlights, break-lights, stop-lights, indicator lights and taillights); automotive wall-display light sets, dashboard lamps; lamps, indicators and light-emitting apparatus and accessories thereof for transportation (including transportation by rail, air, water, road and other land-based modes of transportation); lighting apparatus of any kind; automotive gas discharge lamps; other gas discharge lamps; neon tubes; halogen light bulbs; halogen lamps; halogen light bulbs for vehicles; incandescent lamp fixtures; electrical light bulbs; LED miniature lamps, LED lights; miniature lamps; lamp fixtures, including open, partially closed and closed lamp fixtures; incandescent lamps; general incandescent lamps; illuminators, including lamp fixtures; indoor non-LED illuminators and outdoor non-LED illuminators, and their parts, accessories and components; parts for the installation, fixing, connection and operation of indoor and outdoor non-LED illuminators; indoor LED illuminators and outdoor LED illuminators, and their parts, accessories and components; parts for the installation, fixing, connection and operation of indoor LED illuminators and outdoor LED illuminators, as well as of their parts, accessories and components; LED lamps,

LED light sources, LED signal lights, LED lighting fixtures, including LED lamp fixtures and accessories and parts thereof; fluorescent tubes and starters; compact fluorescent tubes and compact fluorescent lamps; halogen lamps; headlights; high intensity discharge lamps; lights for transportation (including transportation by water, air, railway, road and other land-based modes of transportation); lamps and indicator lights for transportation (including transportation by water, air, railway, road and other land-based modes of transportation), and the parts, accessories and components necessary for their installation, fixing, connection and operation; lights for general lighting and light effects; lights for general lighting and light effects in the entertainment and hospitality industries; high-performance lights for photography and projection; special lamps and lighting fixtures for destroying bacteria and other organisms, and for cleaning or disinfecting; lamps and lighting fixtures emitting infrared radiation, for industrial purposes; lights and lighting fixtures facilitating the growth of plants, vegetables, fruits and other agricultural products and produce; LED lights and lighting fixtures for indoor and outdoor accentuating and decorative lighting of buildings, structures, statues and other industrial design works; UV lamps; fluorescent lamps; floodlights; special lamps and lighting fixtures for destroying bacteria, and for cleaning or disinfecting; apparatus and devices for disinfecting and cleaning; disinfectant apparatus and devices and accessories thereof for medical, sanitary and biological purposes.

(260) AM 2020 107333 A

(800) 1516685

(151) 2019 08 20

(891) 2019 08 20

(731) SoftBank Group Corp.

1-9-1, Higashi-shimbashi, Minato-ku, Tokyo

105-7303, Japan

(540)



(591) Black, white

(531) 26.04.02; 26.04.09; 26.11.08

(511)

35 – Advertising and publicity services; information services relating to advertising; organization of trade fairs and exhibitions; publicity video production; providing advertising space on the Internet; business management analysis or business consultancy; marketing research; providing information on product sales and sales ranking; providing information related to product prices and retail sales outlet; providing information related to product sales; organization and management of call center services; mediation of sales agreement of products through Internet; consultancy or advice on purchase agreement of products; marketing

agency services, mediation, inter-mediation, or providing information regarding sales agreement of products; consultancy or advice on business management of product distribution and providing information related thereto; analysis of economic trend; business management of hotels; business consultancy including the provision of information relating to business size and company profiles; providing information related to company management; employment recruitment services; providing employment agency services and employment information via the Internet or mobile phones; providing employment information; planning and organizing Internet auction; auctioneering; import-export agencies; office functions, namely filing, in particular documents or magnetic tapes; clerical services; computer clerical services; accounting; clerical services for welfare benefit plans; clerical services for mail-orders; clerical services related to sales agreement; clerical services related to data entry; providing business assistance to others in the operation of data processing apparatus namely, computers, typewriters, telex machines and other similar office machines; publicity material rental; arranging subscriptions to satellite broadcast services for others; arranging subscriptions to computer telecommunication services [including computer telecommunications via the Internet or other communication networks] for others; providing advice or information on arranging subscriptions to computer telecommunication services [including computer telecommunications via the Internet or other communication networks] for others; arranging subscription to services for small mobile wireless devices, telephones, car phones and mobile phones for others; compilation of information into computer databases; systemization of information into computer databases; administration of consumer loyalty programs; marketing in the framework of software publishing; promotion of goods and services through sponsorship of sports events; targeted marketing; telemarketing services; sales promotion for others; marketing; administration of frequent flyer programs; web site traffic optimization; web indexing for commercial or advertising purposes; search engine optimization for sales promotion; presentation of goods on communication media, for retail purposes; rental of advertising space; business auditing; administrative assistance in responding to requests for proposals [RFPs]; gift registry services; book-keeping; arranging subscriptions to telecommunication services for others; writing of resumes for others; interim business management; outsourced administrative management for companies; cost price analysis; professional business consultancy; business organization consultancy; business inquiries; business appraisals; business intermediary services relating to the matching of potential private investors with entrepreneurs needing funding; financial auditing; providing business marketing information; business marketing consultancy; arranging subscriptions to information

packages for others; mailing list preparation; compilation of mailing lists; secretarial services; telephone answering for unavailable subscribers; office machines and equipment rental; commercial information and advice for consumers in the choice of products and services; news clipping services; rental of vending machines; book-keeping for electronic funds transfer.

36 – Acceptance of deposits [including substitute bond issuance] and acceptance of fixed interval installment deposits; loans [financing] and discount of bills; domestic exchange settlement; liability guarantee and acceptance of bills; securities lending; acquisition and transfer of monetary claims; safekeeping of valuables including securities and precious metals [safe-deposit services]; money exchange [exchanging money]; trusteeship of financial futures contracts; trusteeship of money, securities, monetary claims, personal property, land, rights on land fixtures, surface rights or lease on land; agencies for bond subscriptions; foreign exchange transactions; Letter-of-Credit related services; brokerage for hire-purchase; brokerage of credit card issuance; issuance of credit cards; issuance of debit cards; issuance of IC cards being stored value cards for use as electronic travel tickets; electronic payment settlement services for payment by electronic money; account balance inquiry services via mobile telephones and computer devices; providing information on savings account; money transfer by telecommunications; issue of tokens of value; agencies for collecting gas or electric power utility payments; consigned collection of payment for goods and services; buying and selling of securities; trading of securities index futures; trading of securities options; trading of overseas market securities futures; agencies for brokerage of securities, securities index futures, securities options, and overseas market securities futures; agencies for brokerage of entrusting agents without-commission trading in domestic markets of securities, securities index futures and securities options; agencies for brokerage of entrusting agents with on-commission trading in overseas markets of securities and securities index futures; agencies for brokerage of forward agreement of securities, for forward agreement of securities index futures, for forward agreement of securities options, spot and forward transaction of securities index futures; brokerage for securities liquidation; securities underwriting; securities offering; brokerage services relating to securities subscription or offering; providing stockmarket information; providing information relating to securities lending and securities underwriting; financial and investment services, namely, management on investment partnership property by founding an investment partnership; financial investment services, namely, management and operation of assets based on investment advisory contracts for financial assets, and advisory services relating thereto; financial and investment services, namely advice on investment in the field of

stocks; financial and investment services, namely, management, brokerage, transfer, transaction and offering of investment trust fund; providing information relating to money trust and other investment trust; financial research, analysis and projection; providing information in the field of finance; life insurance brokerage; life insurance underwriting; agencies for non-life insurance; claim adjustment for non-life insurance; non-life insurance underwriting; insurance premium rate computing; providing information relating to insurance; management of buildings; agency services for the leasing or rental of buildings; leasing or renting of buildings; purchase and sale of buildings; agency services for the purchase or sale of buildings; real estate appraisal; land management; agency services for the leasing or rental of land; leasing of land; purchase and sale of land; agency services for the purchase or sales of land; used automobiles appraisal; banking; mutual funds; brokerage; financial evaluation [insurance, banking, real estate]; financial appraisals in responding to requests for proposals [RFPs]; providing financial information via a web site; financial information; financial consultancy; financial research; debt advisory services; financial evaluation of development costs relating to the oil, gas and mining industries; brokerage of carbon credits; capital investment; investment of funds; financing services; real estate brokerage; insurance underwriting; financial analysis; financial management; financial assessment of company credit; provident fund services; providing information on options markets via a web site; financial management services provided via the Internet; financial consultancy services relating to infrastructure investment; financial consultancy in the field of mergers and acquisitions; financial management of investment capital; financial advice relating to tax planning; fund raising services; rental of cash dispensers; electronic transfer of a virtual currency for use by members of an on-line community via a global computer network; management of private equity funds; establishing mutual funds for others; intellectual property venture capital fund management services; electronic funds transfer.

(260) AM 2020 107334 A
 (800) 1516777
 (151) 2019 12 26
 (891) 2019 12 26
 (731) International Fruit Genetics, LLC
 8224 Espresso Drive, Suite 200, Bakersfield
 CA 93312, USA

(540)

CHEERY GLOW

(591) Black, white
 (511)
 31 – Fresh fruits and fresh vegetables; cherry trees; propagating material of cherry trees.

(260) AM 2020 107335 A
 (800) 1516798
 (151) 2020 01 22
 (891) 2020 01 22
 (731) SOREMARTEC S.A.
 16 Route de Trèves, L-2633 Senningerberg,
 Luxembourg

(540)

GOLDEN TICKET

(591) Black, white
 (511)
 30 – Pastries and confectionery; chocolate; ice creams, sorbets and other edible ices; cocoa based beverages; sugar confectionery; chocolate confectionery; chewing gum.

(260) AM 2020 107337 A
 (800) 1516808
 (151) 2019 12 26
 (891) 2019 12 26
 (731) International Fruit Genetics, LLC
 8224 Espresso Drive, Suite 200, Bakersfield
 CA 93312, USA

(540)

CHEERY BURST

(591) Black, white
 (511)
 31 – Fresh fruits and fresh vegetables; cherry trees; propagating material of cherry trees.

(260) AM 2020 107338 A
 (800) 1516811
 (151) 2019 12 26
 (891) 2019 12 26
 (731) International Fruit Genetics, LLC
 8224 Espresso Drive, Suite 200, Bakersfield
 CA 93312, USA

(540)

SWEET SECRETS

(591) Black, white
 (511)
 31 – Fresh fruits and vegetables; grape vines, plants and plant propagating material.

(260) AM 2020 107339 A
 (800) 1516821
 (151) 2019 12 26
 (891) 2019 12 26
 (731) International Fruit Genetics, LLC
 8224 Espresso Drive, Suite 200, Bakersfield
 CA 93312, USA

(540)

JACK'S SALUTE

(591) Black, white
 (511)
 31 – Fresh fruits and vegetables; grape vines, plants and plant propagating material.

(260) AM 2020 107340 A
 (800) 1516826
 (151) 2019 12 12
 (891) 2019 12 12
 (731) "Unipharm-Ukraine", LLC
 Moskovskiyi prospect 9-V, Kyiv 04073,
 Ukraine
 (540)

ADEMIN

(591) Black, white
 (511)
 3 – Non-medicated cosmetics and toiletry preparations; non-medicated dentifrices; perfumery, essential oils; bleaching preparations and other substances for laundry use; cleaning, polishing, scouring and abrasive preparations.

5 – Pharmaceuticals, medical and veterinary preparations; sanitary preparations for medical purposes; dietetic food and substances adapted for medical or veterinary use, food for babies; dietary supplements for human being and animals; plasters, materials for dressings; material for stopping teeth, dental wax; disinfectants; preparations for destroying vermin; fungicides, herbicides.

10 – Surgical, medical, dental and veterinary apparatus and instruments; artificial limbs, eyes and teeth; orthopaedic articles; suture materials; therapeutic and assistive devices adapted for the disabled; massage apparatus; apparatus, devices and articles for nursing infants; sexual activity apparatus, devices and articles.

32 – Beers; non-alcoholic beverages; mineral and aerated waters; fruit beverages and fruit juices; syrups and other non-alcoholic preparations for making beverages.

(260) AM 2020 107341 A
 (800) 1516855
 (151) 2019 08 09
 (891) 2019 08 09
 (731) Skyscanner Limited
 Floor 6, The Avenue, 1 Bedford Avenue,
 LONDON WC1B 3AU, United Kingdom
 (540)

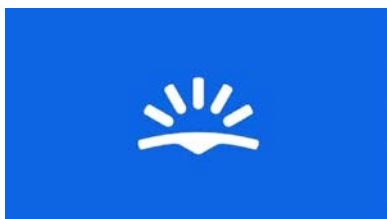

(591) Blue and white
 (531) 01.03.01; 01.03.02; 26.04.05; 26.04.13;
 26.04.24; 26.11.07; 26.11.09; 26.11.12;
 29.01.12

(511)
 35 – Advertising services provided via the Internet, opinion polling, data processing, provision of business information, business information services, namely data feeds, auctioneering, all relating to the travel and hospitality sectors.

39 – Travel information and arrangement services provided from an Internet website; providing travel information via means of a global computer network; travel information provided online from a computer database; travel information accessible via a mobile phone utilising wireless application protocol technology; travel agency services; travel booking agencies; booking of airport parking.

42 – Providing search engines for the Internet relating to the travel and hospitality sectors.

43 – Booking of temporary accommodation; agency services for booking temporary accommodation; information and booking services in relation to temporary accommodation provided from an Internet website; providing information relating to temporary accommodation via means of a global computer network; information relating to temporary accommodation provided online from a computer database; information relating to temporary accommodation accessible via a mobile phone utilising wireless application protocol technology; restaurant booking services; provision of information relating to restaurants and bars.

(260) AM 2020 107342 A
 (800) 1516856
 (151) 2019 12 26
 (891) 2019 12 26
 (731) International Fruit Genetics, LLC
 8224 Espresso Drive, Suite 200, Bakersfield
 CA 93312, USA
 (540)

RAINDANCE

(591) Black, white
 (511)
 31 – Fresh fruits and vegetables; grape vines, plants and plant propagating material.

(260) AM 2020 107343 A
 (800) 1516859
 (151) 2019 12 26
 (891) 2019 12 26
 (731) International Fruit Genetics, LLC
 8224 Espresso Drive, Suite 200, Bakersfield
 CA 93312, USA

(540)

QUIP

(591) Black, white

(511)

31 – Fresh fruits and vegetables; grape vines, plants and plant propagating material.

(260) AM 2020 107424 A

(800) 1518089

(151) 2020 01 28

(891) 2020 01 28

(731) TCHIBO C.I.S. LLC

Horoshevskoe shosse, d. 32A, RU-123007
Moscow, Russian Federation

(540)

Давать самое лучшее

(591) Dark blue and white

(531) 26.04.22; 26.04.24; 28.05

(511)

21 – Household or kitchen utensils and containers; cookware and tableware, except forks, knives and spoons; containers for household or kitchen use; kitchen containers; glass jars [carboys]; heat-insulated containers; heat-insulated containers for beverages; thermally insulated containers for food; coffee percolators, non-electric; coffeepots, non-electric; coffee grinders, hand-operated; coffee filters, non-electric.

24 – Textiles and substitutes for textiles; household linen; curtains of textile or plastic; handkerchiefs of textile; picnic blankets; travelling rugs [lap robes]; tablecloths, not of paper; oilcloth for use as tablecloths.

29 – Milk; almond milk; almond milk for culinary purposes; albumin milk; cream [dairy products]; vegetable-based cream.

30 – Coffee flavorings; artificial coffee; vegetal preparations for use as coffee substitutes; coffee; unroasted coffee; coffee beverages with milk; coffee-based beverages; chicory [coffee substitute].

35 – Advertising; business management; business administration; office functions; demonstration of goods; commercial information and advice for consumers in the choice of products and services; sales promotion for others; distribution of samples; procurement services for others [purchasing goods and services for other businesses].

(260) AM 2020 107425 A

(800) 1518095

(151) 2019 12 10

(891) 2019 12 10

(731) AVAKYAN Vanik Horenovich

ul. Borisovskiye Prudy, d. 10, korp. 1, kv. 392,
RU-115211 Moscow, Russian Federation

(540)



(591) Black, white

(531) 26.11.12; 27.05.01; 27.05.07

(511)

19 – Building panels, not of metal; ceilings, not of metal; cement; floors, not of metal; mortar for building; non-metallic rigid pipes for building; pantiles, not of metal; rigid pipes, not of metal, for building; vinyl siding.

(260) AM 2020 107430 A

(800) 1518242

(151) 2019 12 09

(891) 2019 12 09

(731) Private Joint Stock Company "Dnipropetrovsk combine of food concentrates"

1, Molodogvardiyska str., Dnipro 49800, Ukraine

(540)



(591) Gold, green, white and black

(531) 05.03.14; 26.01.03; 28.05; 29.01.14

(511)

29 – Broth concentrates; vegetables, dried; preparations for making bouillon; preparations for making soup; soups.

30 – Vanillin [vanilla substitute], waffles; oat flakes; custard; artificial coffee; cereal preparations; coffee; ketchup [sauce]; groats for human food; corn, milled/maize, milled; corn flakes/maize flakes; muesli; stick liquorice [confectionery]; chips [cereal products]; powders for making ice cream; condiments; seasonings; spices; puddings, cake powder; soya flour; rusks; fruit jellies [confectionery]; chicory [coffee substitute]; chocolate.

35 – Auctioneering; market studies; organization of exhibitions for commercial or advertising purposes; import-export agency services; distribution of samples; sales promotion for others.

(260) AM 2020 107432 A

(800) 1518323

(151) 2019 12 26

(891) 2019 12 26

(731) Aktsionernoe obshchestvo "Nizhegorodsky maslo-zhirovoy kombinat"
sh. Zhirkombinata, 11, RU-603028 g. Nizhny Novgorod, Russian Federation

(540)

Astoria

(591) Black, white

(511)

29 – Ajvar [preserved peppers]; aloe vera prepared for human consumption; alginates for culinary purposes; anchovy, not live; peanuts, prepared; artichokes, preserved; albumen for culinary purposes; white of eggs; beans, preserved; soya beans, preserved, for food; bouillon; ginger jam; ham; fatty substances for the manufacture of edible fats; laver, preserved; edible birds' nests; peas, preserved; mushrooms, preserved; guacamole [mashed avocado]; game, not live; gelatine; meat jellies; jellies for food; fruit jellies; yolk of eggs; coconut fat; bone oil for food; lard; suet for food; edible fats; fruit-based snack food; milk substitutes; soya patties; charcuterie; raisins; caviar; eggplant paste; vegetable marrow paste; fish roe, processed; yogurt; galbi [grilled meat dish]; sauerkraut; kefir [milk beverage]; kimchi [fermented vegetable dish]; isinglass for food; clams, not live; potato-based dumplings; klipfish [salted and dried cod]; milk shakes; black pudding; onion rings; arrangements of processed fruit; compotes; meat, tinned; vegetables, tinned; fish, tinned; fruits, tinned; bouillon concentrates; corn dogs; gherkins; tofu patties; shrimps, not live; prawns, not live; buttercream; croquettes; silkworm chrysalis for human consumption; sweet corn, processed; kumys [milk beverage]; spiny lobsters, not live; lecithin for culinary purposes; salmon, not live; onions, preserved; margarine; marmalade; oils for food; peanut butter; cocoa butter for food; coconut oil for food; coconut butter; corn oil for food; sesame oil for food; linseed oil for food; extra virgin olive oil for food; olive oil for food; palm oil for food; palm kernel oil for food; sunflower oil for food; colza oil for food; butter; soya bean oil for food; shellfish, not live; almonds, ground; animal marrow for food; mussels, not live; milk; peanut milk; peanut milk for culinary purposes; coconut milk; coconut milk for culinary purposes; almond milk; almond milk for culinary purposes; oat milk; rice milk; rice milk for culinary purposes; albumin milk; condensed milk; soya milk; powdered milk; fish meal for human consumption; vegetable mousses; fish mousses; fruit pulp; meat; meat, preserved; freeze-dried meat; milk beverages, milk predominating; peanut milk-based beverages; coconut milk-based beverages; almond milk-based beverages; edible insects, not live; sausage casings, natural or artificial; vegetables, preserved; freeze-dried vegetables; vegetables, dried; vegetables, cooked; potato fritters; olives, preserved; lobsters, not live; flavored nuts; candied nuts;

coconut, desiccated; nuts, prepared; tomato purée; pressed fruit paste; liver pâté; pectin for culinary purposes; liver; pickles; jams; powdered eggs; milk products; fish-based foodstuffs; prostokvasha [soured milk]; poultry, not live; bulgogi [Korean beef dish]; pollen prepared as foodstuff; cranberry compote; apple purée; crayfish, not live; crustaceans, not live; fish, preserved; fish, not live; salted fish; ryazhenka [fermented baked milk]; vegetable salads; fruit salads; bacon; sardines, not live; pork; herrings, not live; seeds, prepared; sunflower seeds, prepared; cream [dairy products]; whipped cream; vegetable-based cream; fat-containing mixtures for bread slices; smetana [sour cream]; lemon juice for culinary purposes; tomato juice for cooking; vegetable juices for cooking; salted meats; sausages; sausages in batter; hot dog sausages; preparations for making bouillon; preparations for making soup; nut-based spreads; tripe; soups; vegetable soup preparations; whey; cheese; tajine [prepared meat, fish or vegetable dish]; tahini [sesame seed paste]; tofu; sea-cucumbers, not live; truffles, preserved; tuna, not live; oysters, not live; falafel; milk ferments for culinary purposes; rennet; fish fillets; dates; crystallized fruits; frozen fruits; fruit, preserved; fruit preserved in alcohol; fruit, stewed; hazelnuts, prepared; potato flakes; hummus [chickpea paste]; fruit peel; preserved garlic; lentils, preserved; potato chips; low-fat potato chips; fruit chips; non-alcoholic eggnog; seaweed extracts for food; meat extracts; escamoles [edible ant larvae, prepared]; yuba [tofu skin]; berries, preserved; eggs; snail eggs for consumption; yakitori.

30 – Vanilla flavorings for culinary purposes; flavorings, other than essential oils, for cakes; flavorings, other than essential oils, for beverages; coffee flavorings; food flavorings, other than essential oils; star aniseed; baozi [stuffed buns]; cereal bars; high-protein cereal bars; pancakes; noodle-based prepared meals; freeze-dried dishes with the main ingredient being pasta; freeze-dried dishes with the main ingredient being rice; buns; bulgur; bread rolls; edible rice paper; edible paper; burritos; vanillin [vanilla substitute]; varenik [stuffed dumplings]; waffles; vermicelli [noodles]; natural sweeteners; sausage binding materials; binding agents for ice cream; sea water for cooking; seaweed [condiment]; malt biscuits; cloves [spice]; mirror icing [mirror glaze]; cake frosting [icing]; glucose for culinary purposes; mustard; croûtons; buckwheat, processed; gluten additives for culinary purposes; yeast; thickening agents for cooking foodstuffs; leaven; rice-based snack food; cereal-based snack food; artificial coffee; vegetal preparations for use as coffee substitutes; dressings for salad; zephyr [confectionery]; fruit jellies [confectionery]; candy decorations for cakes; confectionery for decorating Christmas trees; cakes; pastries; peanut confectionery; almond confectionery; pasta; ginger [spice]; frozen yogurt [confectionery ices]; cocoa; cream of tartar for culinary purposes; capers; caramels [candy]; curry [spice]; ketchup [sauce]; gimbap [Korean rice dish]; kimchijeon

[fermented vegetable pancakes]; quinoa, processed; quiches; gluten prepared as foodstuff; flour-based dumplings; sweetmeats [candy]; liquorice [confectionery]; peppermint sweets; mints for breath freshening; dulce de leche; cinnamon [spice]; coffee; unroasted coffee; starch for food; crackers; custard; hominy grits; semolina; oatmeal; crushed barley; groats for human food; ice cubes; corn, milled; corn, roasted; meat pies; turmeric; couscous [semolina]; noodles; soba noodles; udon noodles; ice for refreshment; ice, natural or artificial; edible ices; candies; rice cakes; lomper [potato-based flatbread]; mayonnaise; macaroons [pastry]; macaroni; maltose; hominy; piccalilli; marinades; marzipan; honey; royal jelly; ice cream; bean meal; buckwheat flour; tapioca flour; potato flour; corn flour; nut flours; flour; wheat flour; soya flour; barley meal; dessert mousses [confectionery]; chocolate mousses; muesli; mint for confectionery; cocoa beverages with milk; coffee beverages with milk; coffee-based beverages; cocoa-based beverages; chamomile-based beverages; tea-based beverages; chocolate beverages with milk; chocolate-based beverages; infusions, not medicinal; crushed oats; husked oats; okonomiyaki [Japanese savory pancakes]; onigiri [rice balls]; nutmegs; chocolate-coated nuts; stick liquorice [confectionery]; soya bean paste [condiment]; pastila [confectionery]; pastilles [confectionery]; molasses for food; pâtés en croûte; pelmeni [dumplings stuffed with meat]; pepper; allspice; peppers [seasonings]; pesto [sauce]; cookies; petit-beurre biscuits; bibimbap [rice mixed with vegetables and beef]; pies; pizzas; meat gravies; fondants [confectionery]; popcorn; powders for making ice cream; baking powder; mustard meal; pralines; condiments; meat tenderizers for household purposes; cereal preparations; oat-based food; propolis; gingerbread; spices; petits fours [cakes]; rice pudding; puddings; cake powder; fruit coulis [sauces]; ravioli; ramen [Japanese noodle-based dish]; chewing gum; chewing gum for breath freshening; relish [condiment]; rice; instant rice; wheat germ for human consumption; spring rolls; sago; sugar; palm sugar; sesame seeds [seasonings]; linseed for culinary purposes [seasoning]; processed seeds for use as a seasoning; aniseed; agave syrup [natural sweetener]; golden syrup; confectionery; batter mixes for okonomiyaki [Japanese savory pancakes]; baking soda [bicarbonate of soda for cooking purposes]; malt for human consumption; salt for preserving foodstuffs; cooking salt; celery salt; sherbets [ices]; ham glaze; cranberry sauce [condiment]; soya sauce; tomato sauce; apple sauce [condiment]; sauces [condiments]; pasta sauce; spaghetti; seasonings; chocolate-based spreads; chocolate spreads containing nuts; preparations for stiffening whipped cream; shaved ice with sweetened red beans; rusks; breadcrumbs; sushi; senbei [rice crackers]; sandwiches; tabbouleh; tacos; tapioca; tarts; dough; pastry dough; almond paste; rice pulp for culinary purposes; cake dough; tortillas; garden herbs, preserved [seasonings]; chocolate decorations for cakes; vine-

gar; beer vinegar; ferments for pastes; halvah; bread; unleavened bread; chips [cereal products]; corn flakes; oat flakes; hot dog sandwiches; flowers or leaves for use as tea substitutes; jiaozi [stuffed dumplings]; chicory [coffee substitute]; tea; iced tea; chutneys [condiments]; minced garlic [condiment]; cheeseburgers [sandwiches]; chow-chow [condiment]; saffron [seasoning]; chocolate; malt extract for food; essences for foodstuffs, except etheric essences and essential oils; husked barley.

(260) AM 2020 107433 A

(800) 1518354

(151) 2020 01 24

(891) 2020 01 24

(731) Ginzburg Mariya Vadimovna

ul. Spiridonovka, dom 10, str. 3, kv. 3-4,

RU-123001 Moscow, Russian Federation

(540)

W&g
wax & go

(591) Black, white

(511)

3 – Toilet water; perfumery; cosmetic creams; nail polish; essential oils; soap; cosmetic kits; nail care preparations; eyebrow cosmetics; make-up preparations; sun-tanning preparations [cosmetics]; hair dyes; cosmetic preparations for eyelashes; cosmetic preparations for skin care; cosmetics; mascara; antiperspirants [toiletries]; toiletry preparations; bath preparations, not for medical purposes; collagen preparations for cosmetic purposes; aloe vera preparations for cosmetic purposes; lotions for cosmetic purposes; almond milk for cosmetic purposes; massage candles for cosmetic purposes; astringents for cosmetic purposes; herbal extracts for cosmetic purposes; decorative transfers for cosmetic purposes; massage gels, other than for medical purposes; bath salts, not for medical purposes; detergents, other than for use in manufacturing operations and for medical purposes; degreasers, other than for use in manufacturing processes; cosmetic preparations for baths; hair straightening preparations; hair waving preparations; cosmetic preparations for slimming purposes; make-up removing preparations; depilatory preparations; depilatory wax.

44 – Manicuring; hairdressing; beauty salon services; visagists' services; solarium services; tattooing; plastic surgery; massage; medical clinic services; aromatherapy services; alternative medicine services; chiropractic; body piercing; medical assistance; therapy services.

(260) AM 2020 107436 A
 (800) 1518433
 (151) 2020 01 28
 (891) 2020 01 28
 (731) Joint Stock Company United Chemical
 Company Uralchem
 Presnenskaya nab., 6, bld. 2, Moscow,
 RU-123112, Russian Federation

(540)

AQUADROP

(591) Black, white
 (531) 01.15.15; 27.05.01; 27.05.04
 (511)
 1 – Fertilizing preparations.

(260) AM 2020 107437 A
 (800) 1518487
 (151) 2019 12 23
 (891) 2019 12 23
 (731) Joint Stock Company United Chemical
 Company Uralchem
 Presnenskaya nab., 6, bld. 2, Moscow,
 RU-123112, Russian Federation

(540)



(591) Blue, gray, green
 (531) 01.13.01; 26.01.01; 26.01.06; 26.01.24;
 26.13.25; 28.05; 29.01.13
 (526) URALKHIM in Cyrillic
 (511)
 1 – Chemicals used in industry, science and photography, as well as in agriculture, horticulture and forestry.

(260) AM 2020 107438 A
 (800) 1518500
 (151) 2020 01 31
 (891) 2020 01 31
 (731) UNITED INDUSTRIES CO., LTD.
 96-82, Sinhang-ro, Gangseo-gu, Busan
 46767, Republic of Korea

(540)

JETT

(591) Black, white
 (531) 26.03.04; 26.05.12; 27.05.17

(511)
 12 – Coil springs for vehicle suspensions; leaf-springs for vehicle suspensions; air suspension systems for vehicles; vehicle suspension springs; suspension shock absorbers for vehicles; vehicle suspension springs; suspension systems for vehicles; suspension struts for vehicles; shock absorbers for motorcycles; sway bars for land vehicle suspensions; coil springs for land vehicle suspensions; torsion bars for land vehicle suspensions; leaf springs for land vehicle suspensions; shock absorbers for automobiles; suspension systems for land vehicles; shock absorbers for automobiles; suspension systems for automobiles; shock absorbers for bicycles; suspension systems for bicycles; wheel suspensions; connecting rods for land vehicles, other than parts of motors and engines; axles for air suspension systems in vehicles; axles for leaf spring suspensions systems in vehicles; bushes for vehicles; axles for leaf spring suspensions in vehicles.

(260) AM 2020 107446 A
 (800) 1156166
 (151) 2013 02 04
 (891) 2020 02 18
 (731) LANIKAI S.r.l.
 Via Francesco Nullo, 1, I-24128 Bergamo,
 Italy

(540)



(591) Blue, red and white
 (531) 21.01.11; 25.07.03; 26.04.09; 27.05.01;
 27.07.17; 29.01.13
 (511)
 25 – Clothing, footwear, headgear.

(260) AM 2020 107448 A
 (800) 1252299
 (151) 2015 05 07
 (891) 2020 02 18
 (731) LABORATOIRES FILL-MED
 MANUFACTURING
 Boulevard Paepsem 18, B-1070
 ANDERLECHT, Belgium

(540)

ART-FILLER

(591) Black, white
 (511)
 10 – Hypodermic syringes for medical use for injecting a product with a view to filling in wrinkles.

(260) AM 2020 107449 A
 (800) 1334021
 (151) 2016 01 27
 (891) 2019 12 12
 (731) KERATILE, S.L.
 C/ Ferrocarril, 4, E-12593 Moncofar
 (Castellón), Spain

(540)

KERATILE

(591) Silver

(531) 27.05.25; 29.01.04

(511)

19 – Non-metallic building materials, in particular asphalt, alabaster, tiles not of metal for building, earthenware (terra-cotta), materials for making and coating roads, plywood, quartz, floor tiles, not of metal, granite, sandstone for building (sandstone), bricks, luminous paving, non-metallic paving blocks of stoneware, ceramic, marble, mosaics for building, wall linings not of metal for the construction of stoneware, ceramic, stone, artificial stone, limestone, fire burrs, slate, refractory materials, wainscoting, not of metal, floors, not of metal, ceramic tiles.

(260) AM 2020 107450 A
 (800) 1344132
 (151) 2016 12 27
 (891) 2020 02 18
 (731) LABORATOIRES FILL-MED
 2-4 rue de Lisbonne, F-75008 PARIS, France

(540)

NCTF

(591) Black, white

(531) 27.05.01

(511)

3 – Cosmetics; cosmetic preparations, cosmetic creams, cosmetic lotions and gels for skin, face, neck and lip care and appearance improvement.

5 – Pharmaceutical products for skin care.

10 – Hypodermic syringes for medical use for injecting a product with a view to filling in wrinkles.

(260) AM 2020 107452 A
 (800) 1351215
 (151) 2017 03 04
 (891) 2020 01 31
 (731) Welton Auto Pte. Ltd.
 80, Anson Road, # 24-02 Fuji Xerox
 Tower, Singapore 079907, Singapore

(540)

G BRAKE

(591) Black, white

(531) 26.01.18; 26.01.24; 27.05.01

(511)

12 – Brake shoes for vehicles; brake pads for automobiles; brake linings for vehicles; bands for wheel hubs; vehicle wheel rims; anti-theft devices for vehicles; anti-theft alarms for vehicles; brakes for vehicles.

(260) AM 2020 107453 A

(800) 1392324

(151) 2018 01 12

(891) 2020 02 18

(731) LABORATOIRES FILL-MED

MANUFACTURING

Boulevard Paepsem 18, B-1070

ANDERLECHT, Belgium

(540)

ART-FILLER

(591) Black, white

(511)

5 – Dermatological preparations for medical use; products for medical use designed to be injected under the skin.

(260) AM 2020 107501 A

(800) 1518821

(151) 2020 02 04

(891) 2020 02 04

(731) Brodetskiy Oleg Vladimirovich

shosse Entuziastov, d. 11a, korp. 4, kv. 173,

RU-111024 Moscow, Russian Federation

(540)

 **BRAYER**

(591) Black and red

(531) 15.09.10; 26.01.18; 26.11.12; 27.05.01;
 29.01.12

(511)

7 – Crushers for kitchen use, electric; kitchen grinders, electric; can openers, electric; coffee grinders, other than hand-operated; churns; hair clipping machines for animals; knitting machines; ironing machines; crushing machines; blade sharpening [stropping] machines; lace making machines; butter machines; grinding machines; dishwashers; dairy machines; peeling machines; pasta making machines, electric; bread cutting machines; kitchen machines, electric; rinsing machines; hemming machines; grating machines for vegetables; stitching machines; washing machines [laundry]; kneading machines; mills [machines]; mills for household purposes, other than hand-operated; pepper mills, other than hand-operated; centrifugal mills; mixers [machines]; blenders, electric, for household purposes; vacuum cleaner bags; meat choppers [machines]; suction nozzles for vacuum cleaners; vacuum cleaner attachments for disseminating perfumes

and disinfectants; knives, electric; scissors, electric; wine presses; basket presses; fruit presses, electric, for household purposes; pedal drives for sewing machines; cleaning appliances utilizing steam; food processors, electric; spinning wheels; vacuum cleaners; tambours for embroidery machines; whisks, electric, for household purposes; cream/milk separators; juice extractors, electric; sharpening machines; beverage preparation machines, electromechanical; food preparation machines, electromechanical; shoe polishers, electric; machines and apparatus for wax-polishing, electric; vacuum cleaner hoses; brushes for vacuum cleaners.

8 – Razors, electric or non-electric; sharpening steels; cutlery; edge tools [hand tools]; depilation appliances, electric and non-electric; sharpening instruments; nail clippers, electric or non-electric; razor blades; table knives, forks and spoons for babies; beard clippers; hair clippers for personal use, electric and non-electric; hair clippers for animals [hand instruments]; mincing knives [hand tools]; manicure sets; manicure sets, electric; pedicure sets; shaving cases; cheese slicers, non-electric; egg slicers, non-electric; pizza cutters, non-electric; scaling knives; ceramic knives; can openers, non-electric; vegetable slicers; nail files; nail files, electric; table cutlery [knives, forks and spoons]; hand implements for hair curling; vegetable choppers; fingernail polishers, electric or non-electric; flat irons; irons [non-electric hand tools]; razor cases; curling tongs.

9 – Antennas; barometers; DVD players; balances [steelyards]; scales; baby scales; bathroom scales; precision balances; scales with body mass analysers; video baby monitors; pressure measuring apparatus; pressure indicators; temperature indicators; ionization apparatus not for the treatment of air or water; measuring spoons; microphones; weighing machines; egg-candlers; measuring glassware; food analysis apparatus; diagnostic apparatus, not for medical purposes; weighing apparatus and instruments; audio- and video-receivers; baby monitors; radios; vehicle radios; subwoofers; alcoholmeters; egg timers [sandglasses]; sound reproduction apparatus; digital photo frames.

11 – Pressure cookers, electric; distillation apparatus; desiccating apparatus; hydromassage bath apparatus; tanning apparatus [sun beds]; ionization apparatus for the treatment of air or water; coffee roasters; beverage cooling apparatus; hand drying apparatus for washrooms; fruit roasters; refrigerating apparatus and machines; drying apparatus and installations; freezers; drying apparatus; refining towers for distillation; boilers, other than parts of machines; spa baths [vessels]; waffle irons, electric; fans [air-conditioning]; electric fans for personal use; roasting spits; water heaters; water heaters [apparatus]; air reheaters; extractor hoods for kitchens; footwarmers, electric or non-electric; bed warmers; pocket warmers; warming pans; grills [cooking appliances]; stills; refrigerating containers;

heating apparatus; cool boxes, electric; refrigerating chambers; fireplaces, domestic; pressure cooking saucepans, electric; distillation columns; coffee machines, electric; germicidal lamps for purifying air; bread-making machines; multicookers; footmuffs, electrically heated; socks, electrically heated; refrigerating appliances and installations; blankets, electric, not for medical purposes; fabric steamers; hearths; food steamers, electric; steam boilers, other than parts of machines; pasteurisers; coffee percolators, electric; stoves [heating apparatus]; bakers' ovens; hot air ovens; kitchen ranges [ovens]; microwave ovens [cooking apparatus]; hot plates; wine cellars, electric; heaters, electric, for feeding bottles; heating cushions, electric, not for medical purposes; tortilla presses, electric; air purifying apparatus and machines; ice machines and apparatus; cooling appliances and installations; cooking apparatus and installations; cooking rings; heating apparatus for solid, liquid or gaseous fuels; heating apparatus, electric; steam facial apparatus [saunas]; plate warmers; electric appliances for making yogurt; rotisseries; heat guns; radiators [heating]; radiators, electric; roasters; sterilizers; water sterilizers; air sterilizers; air dryers; laundry dryers, electric; hair dryers; bread toasters; air-conditioning installations; cooling installations for water; steam generating installations; air cooling apparatus; cooking utensils, electric; filters for air conditioning; filters for drinking water; chocolate fountains, electric; deep fryers, electric; refrigerators; kettles, electric; refrigerating cabinets.

21 – Pressure cookers, non-electric; wine aerators; cookie jars; dishes; vegetable dishes; saucers; mugs; bottles; demijohns; vases; epergnes; fruit cups; waffle irons, non-electric; coolers [ice pails]; whisks, non-electric, for household purposes; cooking skewers of metal; heads for electric toothbrushes; cruets; decanters; toothpick holders; table napkin holders; soap dispensers; plug-in diffusers for mosquito repellents; ironing boards; cutting boards for the kitchen; bread boards; crushers for kitchen use, non-electric; strainers for household purposes; containers for household or kitchen use; kitchen containers; heat-insulated containers; heat-insulated containers for beverages; thermally insulated containers for food; closures for pot lids; ceramics for household purposes; majolica; works of art of porcelain, ceramic, earthenware or glass; kitchen grinders, non-electric; stew-pans; basting brushes; baking mats; ladles for serving wine; hot pots, not electrically heated; glass bulbs [receptacles]; napkin rings; bread baskets for household purposes; baskets for household purposes; lunch boxes; tea caddies; earthenware saucepans; mess-tins; coffee percolators, non-electric; coffeepots, non-electric; coffee grinders, hand-operated; beer mugs; tankards; butter-dish covers; dish covers; cheese-dish covers; pitchers; ice cream scoops; mixing spoons [kitchen utensils]; basting spoons [cooking utensils]; pie servers; spatulas for kitchen use; butter dishes; noodle machines,

hand-operated; lint removers, electric or non-electric; pepper mills, hand-operated; mills for household purposes, hand-operated; bowls [basins]; cooking pot sets; fitted picnic baskets, including dishes; cookie [biscuit] cutters; pastry cutters; food steamers, non-electric; pepper pots; pestles for kitchen use; plates to prevent milk boiling over; trays for household purposes; lazy susans; heaters for feeding bottles, non-electric; trivets [table utensils]; coasters, not of paper or textile; knife rests for the table; flat-iron stands; egg cups; serving ladles; pots; cooking pots; painted glassware; tableware, other than knives, forks and spoons; porcelain ware; earthenware; crystal [glassware]; trouser presses; tortilla presses, non-electric [kitchen utensils]; cruet sets for oil and vinegar; spice sets; bottle openers, electric and non-electric; electric combs; combs; sifters [household utensils]; salad bowls; sugar bowls; beaters, non-electric; egg separators, non-electric, for household purposes; services [dishes]; coffee services [tableware]; liqueur sets; tea services [tableware]; sieves [household utensils]; tea strainers; siphon bottles for carbonated water; rolling pins, domestic; frying pans; fruit presses, non-electric, for household purposes; salt cellars; drinking vessels; vessels of metal for making ices and iced drinks; refrigerating bottles; glasses [receptacles]; drinking glasses; mortars for kitchen use; portable cool boxes, non-electric; soup bowls; drying racks for laundry; basins [receptacles]; table plates; graters for kitchen use; insulating flasks; water apparatus for cleaning teeth and gums; utensils for household purposes; kitchen utensils; cooking utensils, non-electric; coffee filters, non-electric; hip flasks; drinking bottles for sports; molds [kitchen utensils]; cake moulds; ice cube molds; cookery moulds; deep fryers, non-electric; bread bins; teapots; kettles, non-electric; cups; garlic presses [kitchen utensils]; ironing board covers, shaped; corkscrews, electric and non-electric; toothbrushes; toothbrushes, electric; carpet sweepers; tar-brushes, long handled; electric brushes, except parts of machines; nutcrackers; ice tongs; salad tongs; sugar tongs.

(260) AM 2020 107503 A

(800) 1518893

(151) 2019 11 25

(891) 2019 11 25

(731) KORCHEVSKYI Dmytro

Rupniecibas St. 44, apt. 17, Riga,
Latvia

(540)

IT STEP SCHOOL

(591) Black, white

(511)

41 – Arranging and conducting of conferences in the fields of computer science, computer and information technologies; arranging and conducting of educational courses, classes and lectures in the fields of computer

programming, software and game development, computer graphics and design, network technologies, robotics and system administration; arranging and conducting of in-person educational forums in the fields of computer science, computer and information technologies; arranging and conducting of seminars in the fields of computer programming, software and game development, computer graphics and design, network technologies, robotics and system administration; arranging and conducting of symposiums in the fields of computer science, computer and information technologies; arranging and conducting of workshops [training] in the fields of computer programming, software and game development, computer graphics and design, network technologies, robotics and system administration; computer graphics and design training courses; computer programming training courses; consultancy relating to training, further training and education in the fields of computer science, computer and information technologies; correspondence courses in the fields of computer programming, software and game development, computer graphics and design, network technologies, robotics and system administration; education information relating to computer science, computer and information technologies; educational examination in the fields of computer science, computer and information technologies; providing educational services at children's summer camps in the fields of computer science, computer and information technologies; educational services provided by computer schools in the fields of computer science, computer and information technologies; educational services provided by schools in the fields of computer science, computer and information technologies; educational services, namely, providing computer classes and lessons for children in the fields of computer science, computer and information technologies; providing entertainment services at children's summer camps in the fields of computer science, computer and information technologies; holiday camp services [entertainment] in the fields of computer science, computer and information technologies; online publication of electronic books and journals in the fields of computer science, computer and information technologies; organization of educational competitions in the fields of computer science, computer and information technologies; organization of exhibitions for educational purposes in the fields of computer science, computer and information technologies; practical training [demonstration] in the fields of computer programming, software and game development, computer graphics and design, network technologies, robotics and system administration; providing online electronic publications, not downloadable, in the fields of computer science, computer and information technologies; providing online videos, not downloadable, in the fields of computer science, computer and information technologies; publication of books in the fields of computer science, computer and information technologies; pub-

lication of texts, other than publicity texts, in the fields of computer science, computer and information technologies; publication of training guides, manuals, educational materials in the fields of computer science, computer and information technologies; providing educational and entertainment services at children's computer camps; teaching in the fields of computer science, computer and information technologies; training in computer and network technologies; training in computer programming; training in computer software testing; training in computer-aided montage; training in development and promotion of web sites and other web projects; training in system administration; training in the use of computer programs; training in the use of computers; training using gamification technologies with the use of computer programs and the Internet in the fields of computer science, computer and information technologies; tutoring in the fields of computer programming, software and game development, computer graphics and design, network technologies, robotics and system administration; vocational guidance [education or training advice] in the fields of computer science, computer and information technologies; web design training courses.

(260) AM 2020 107504 A

(800) 1518917

(151) 2019 12 13

(891) 2019 12 13

(731) Apple Inc.

One Apple Park Way, Cupertino CA 95014,
USA

(540)



(591) White, gray, blue, light green and medium green

(531) 16.03.01; 26.01.05; 26.04.04; 26.04.10;
29.01.14

(511)

9 – Downloadable computer software for use in finding, tracking, displaying, and sharing the geographic location of individuals and consumer electronics goods, sending notifications on the geographic location of individuals, locating lost or missing consumer electronics goods, and preventing unauthorized access to consumer electronics goods.

(260) AM 2020 107611 A

(800) 1520576

(151) 2019 12 30

(891) 2019 12 30

(731) Individual entrepreneur Dudukin Maksim
Anatolievich

Ladozhskaya street, 150-354, RU-440071

Penza, Russian Federation

(540)



(591) Green, yellow-green, white, grey-green, apple-green and grey

(531) 05.03.14; 24.17.04; 27.05.08; 27.05.09;

27.05.10; 27.05.12; 29.01.13

(511)

3 – Balms, other than for medical purposes; toilet water; massage gels, other than for medical purposes; deodorants for human beings or for animals; toiletry preparations; perfumery; oils for perfumes and scents; oils for cosmetic purposes; soap; shampoos.

35 – Retail and wholesale services for toiletry preparations, perfumery, cosmetics.

(260) AM 2020 107612 A

(800) 1520630

(151) 2019 12 23

(891) 2019 12 23

(731) August Storck KG

Waldstraße 27, 13403 Berlin, Germany

(540)

Мамба Кислая

(591) Black, white

(531) 28.05

(511)

30 – Confectionery; chocolate; chocolate products; pastries; ice-cream; preparations for making the aforementioned products, included in this class.

(260) AM 2020 107641 A

(800) 1122888

(151) 2012 04 12

(891) 2020 02 06

(731) "Delta Medical Promotions AG"

Oetenbachgasse 26, CH-8001 Zurich,
Switzerland

(540)

FLUVIR

(591) Black, white

(531) 27.05.01; 27.05.17

(511)

3 – Almond milk for cosmetic purposes; almond oil; almond soap; amber (perfume); antiperspirant soap; antiperspirants (toiletries); aromatics (essential oils); astringents for cosmetic purposes; bath salts, not for medical purposes; cosmetic preparations for baths; beauty masks; bergamot oil; bleaching preparations (laundry); bleaching salts; breath freshening sprays; color- [colour-] brightening chemicals for household purposes (laundry); cakes of toilet soap; essential oils of cedarwood; essential oils of citron; cleaning preparations; cleansing milk for toilet purposes; cloths impregnated with a detergent for cleaning; color-removing preparations; colorants for toilet purposes; cosmetic kits; cosmetics; cosmetics for animals; cotton sticks for cosmetic purposes; cotton wool for cosmetic purposes; cosmetic creams; skin whitening creams; deodorant soap; detergents other than for use in manufacturing operations and for medical purposes; disinfectant soap; dry-cleaning preparations; eau de cologne; ethereal essences; essential oils; extracts of flowers (perfumes); bases for flower perfumes; soap for foot perspiration; fumigation preparations (perfumes); laundry glaze; greases for cosmetic purposes; jasmine oil; petroleum jelly for cosmetic purposes; joss sticks; lacquer-removing preparations; laundry bleach; laundry soaking preparations; lavender oil; lavender water; sachets for perfuming linen; tissues impregnated with cosmetic lotions; lotions for cosmetic purposes; make-up powder; medicated soap; mint essence (essential oil); mint for perfumery; mouth washes, not for medical purposes; musk (perfumery); oil of turpentine for degreasing; oils for cleaning purposes; oils for cosmetic purposes; oils for perfumes and scents; oils for toilet purposes; perfumery; perfumes; shampoos for pets; potpourris (fragrances); rose oil; scented water; scented wood; scouring solutions; shampoos; shining preparations (polish); cosmetic preparations for skin care; soap; stain removers; talcum powder, for toilet use; terpenes (essential oils); toilet water; toiletries; deodorants for human beings or for animals.

5 – Dental abrasives; absorbent cotton; acaricides; aconitine; adhesive plaster; fly catching adhesives; adhesives for dentures; air deodorising preparations; air purifying preparations; alloys of precious metals for dental purposes; bouillons for bacteriological cultures; dental amalgams; animal washes; antiparasitic collars for animals; antiparasitic preparations; antiseptic cotton; antiseptics; aseptic cotton; asthmatic tea; bacterial poisons; hygienic bandages; menstruation bandages; bandages for dressings; ; therapeutic preparations for the bath; bath preparations, medicated; bath salts for medical purposes; oxygen baths; salts for mineral water baths; belts for sanitary napkins (towels); biocides; biological preparations for veterinary purposes; bone cement for surgical and orthopaedic purposes; breast-nursing pads; bunion pads; cattle washes; cedar wood for use as an insect repellent; cement for animal

hooves; tobacco-free cigarettes for medical purposes; deodorants for clothing and textiles; compresses; solutions for use with contact lenses; corn remedies; corn rings for the feet; cotton for medical purposes; dental cements; dental impression materials; dental lacquer; dental mastics; deodorants, other than for human beings or for animals; disinfectants for chemical toilets; disinfectants for hygiene purposes; dog lotions; dog washes; repellents for dogs; preparations for destroying dry rot fungus; evacuants; eye-washes; fly catching paper; fly destroying preparations; food for babies; remedies for foot perspiration; fly catching paper; fly destroying preparations; food for babies; remedies for foot perspiration; fly catching paper; fly destroying preparations; food for babies; remedies for foot perspiration; fumigating pastilles; fungicides; gauze for dressings; germicides; dental amalgams of gold; goulard water; surgical implants (living tissues); insect repellent incense; napkins for incontinents; pants, absorbent, for incontinents; insect repellents; herbicides; insecticides; semen for artificial insemination; menstruation knickers; lacteal flour for babies; larvae exterminating preparations; laxatives; liniments; tissues impregnated with pharmaceutical lotions; surgical dressings; dressings, medical; menstruation tampons; menthol; mercurial ointments; preparations for destroying mice; nutritive substances for microorganisms; chemical preparations to treat mildew; milking grease; mineral food supplements; mineral water salts; molding wax for dentists; mothproofing paper; mothproofing preparations; mud for baths; mustard plasters; preparations for destroying noxious animals; nutritional supplements; paper for mustard plasters; parasiticides; chemical preparations for treating phylloxera; porcelain for dental prostheses; poultices; pyrethrum powder; rat poison; remedies for perspiration; royal jelly dietary supplements; rubber for dental purposes; sanitary napkins; solvents for removing adhesive plasters; sterilising preparations; surgical cloth (tissues); teeth filling material; preparations to facilitate teething; thermal water; teeth filling material; preparations to facilitate teething; thermal water; tobacco extracts (insecticides); vaginal washes; vermin destroying preparations; vesicants; vine disease treating chemicals; vitamin preparations; chemical preparations to treat wheat blight (smut); yeast dietary supplements; jalap.

(260) AM 2020 107697 A

(800) 1521628

(151) 2020 01 13

(891) 2020 01 13

(731) SPORT & FASHION MANAGEMENT PTE. LTD.

6 Shenton Way, # 18-11 OUE Downtown 2,
Singapore 068809, Singapore

(540)

FORSIO

(591) Black, white

(511)

29 – Jellies for food; jams; compotes; marmalade; milk beverages, milk predominating.

30 – Cereal bars; muesli bars; high-protein cereal bars; flapjacks [oat bars]; cookies; bread, pastries and confectionery; pastries; cakes; sweetmeats [candy]; caramels [candy]; sugarfree candies; gum sweets; chips [cereal products]; chewing gum, not for medical purposes; chewing gum for breath freshening; tea-based beverages; muesli.

32 – Waters [beverages]; drinking water; bottled drinking water; vitamin enriched water [beverages]; mineral water [beverages]; mineral enriched water [beverages]; isotonic beverages; sports drinks; protein-enriched sports beverages; energy drinks; smoothies; non-alcoholic beverages; soya-based beverages, other than milk substitutes; whey beverages; soft drinks; non-alcoholic beverages flavored with coffee; non-alcoholic beverages flavored with tea; non-alcoholic preparations for making beverages; pastilles for effervescing beverages; essences for making beverages.

33 – Alcoholic energy drinks; prepared alcoholic cocktails; pre-mixed alcoholic beverages, other than beer-based; alcoholic beverages, except beer; spirits [beverages]; mead [hydromel].

35 – Advertising; business management; business administration; office functions; import-export agency services; rental of advertising space; demonstration of goods; market studies; business information; commercial information and advice for consumers in the choice of products and services; layout services for advertising purposes; scriptwriting for advertising purposes; updating of advertising material; organization of exhibitions for commercial or advertising purposes; organization of fashion shows for promotional purposes; organization of trade fairs; shop window dressing; development of advertising concepts; commercial intermediation services; providing business information via a web site; provision of an online marketplace for buyers and sellers of goods and services; web indexing for commercial or advertising purposes; presentation of goods on communication media, for retail or wholesale purposes; auctioneering; sales promotion for others; retail or wholesale services for goods, including services provided by stores, on-line ordering services; promotion of goods and services through sponsorship of sports events; production of advertising films; publicity material rental; rental of billboards [advertising boards]; rental of vending machines; rental of sales stands; publication of publicity texts; radio advertising; bill-posting; distribution of samples; dissemination of advertising matter; direct mail advertising; writing of publicity texts; online ad-

vertising on a computer network; outdoor advertising; advertising by mail order; television advertising; negotiation and conclusion of commercial transactions for third parties; telemarketing services; commercial administration of the licensing of the goods and services of others; business management of reimbursement programs for others; administration of consumer loyalty programs; administrative processing of purchase orders; modelling for advertising or sales promotion; gift registry services; price comparison services; procurement services for others [purchasing goods and services for other businesses]; outsourcing services [business assistance].

39 – Water supplying.

(260) AM 2020 107704 A

(800) 1521924

(151) 2020 01 31

(891) 2020 01 31

(731) N.V. Organon

Kloosterstraat 6, NL-5349 AB Oss,

Netherlands

(540)

VREE

(591) Black, white

(511)

5 – Pharmaceutical preparations and over the counter pharmaceutical preparations and products.

9 – Downloadable software in the nature of a mobile application for providing information on pharmaceuticals, medicines, medical devices, health and wellness.

10 – Surgical and medical apparatus, devices and instruments.

42 – Providing online, non-downloadable software for providing and managing health and healthcare information; scientific research for medical purposes.

44 – Providing information in the fields of pharmaceuticals, medicines, medical devices, health, and wellness.

(260) AM 2020 107730 A

(800) 1522499

(151) 2019 09 11

(891) 2019 09 11

(731) Internationaler Bund (IB) Freier Träger der

Jugend-, Sozial- und Bildungsarbeit e.V.

Valentin-Senger-Straße 5, 60389 Frankfurt,

Germany

(540)

ib

(591) Black, white
(531) 27.05.19; 27.05.22
(511)

35 – Advertising; business management; business administration; office functions; services of a provider of youth, social, and educational work, namely, business organization, economic and administrative support in respect to voluntary, organizational support of voluntary, social years, voluntary ecological years, youth community works, guarantee fund measures, extra-curricular educational institutions, youth hostels, international youth work, youth and communication centers, job-related youth social work, institutions for asylum seekers and foreign refugees, hostels providing temporary accommodation for resettlers, workers' residences, facilities for the disabled, educational assistance institutions, therapeutic workshops, youth residences, external residential groups, resocialization measures, student residences, facilities for girls and women, counseling centers for foreign adolescents, socio-educational counseling centers for young people, social group work, child care, work with the elderly, special training courses for promoting existing knowledge, basic training courses, measures for obtaining the hauptschule leaving certificate, the "hauptschule" being a secondary school in Germany and Austria, starting after 4 years of elementary schooling and offering lower secondary education (level 2) according to the international standard classification of education, German language courses for foreigners, integration courses for women and girls, assistance during training, retraining measures, adaptation training measures, career development measures, job creation projects and national and international vocational training projects.

41 – Education; training; entertainment; sporting activities; cultural activities; educational and training services in the nature of seminars, courses, workshops; providing services of a provider of youth, social and educational work, namely providing advanced courses, basic training courses, educational examination for obtaining the German Hauptschule leaving certificate, German language courses for foreigners, integration courses for women and girls, assistance during training, retraining measures, adaptation training measures, career development measures, career training for jobs and national and international vocational training projects.

43 – Services for providing food and drink; services for temporary accommodation.

45 – Services of a provider of youth, social and educational work, namely planning and arranging social services with respect to voluntary social years, voluntary ecological years, youth community work, guarantee fund measures, extra-curricular educational institutions, youth hostels, international youth work, youth and communication centers, job-related youth social work, institutions for asylum seekers and foreign re-

fugees, hostels providing temporary accommodation for resettlers, workers' residences, facilities for the disabled, institutions for educational assistance, therapeutic workshops, youth residences, external residential groups, resocialization measures, student dormitories, facilities for girls and women, counseling centers for foreign adolescents, socio-educational counseling centers for adolescents, social group work, child care, work for the elderly, special training courses for promoting existing knowledge, basic training courses, measures for obtaining the German Hauptschule leaving certificate, German language courses for foreigners, integration courses for women and girls, assistance during training, retraining measures, adaptation training measures, career development measures, job creation projects and national and international vocational training projects.

(260) AM 2020 107731 A

(800) 1522508

(151) 2019 12 16

(891) 2019 12 16

(731) HUAWEI TECHNOLOGIES CO., LTD.

Administration Building, Huawei Technologies Co., Ltd., Bantian, Longgang District, Shenzhen, China

(540)

HUAWEI HiQ

(591) Black, white

(531) 27.05.01

(511)

9 – Earphones; virtual reality headsets; digital video recorder for vehicles; set-top boxes; loudspeakers; portable media players; sound transmitting apparatus; camcorders; cameras (photography); computer keyboards; mouse (computer peripheral); pedometers; monitoring apparatus, other than for medical purposes; video monitors; connected bracelets (measuring instruments); computer programs, recorded; computer software applications, downloadable; optical lenses; switchboards; transmitters of electronic signals; transmitting sets (telecommunication); gas testing instruments; scales; black boxes (data recorders); interactive touch screen terminals; humanoid robots with artificial intelligence; electronic sheet music, downloadable; electric sockets; intercoms; digital door locks; alarm central units; sensors; downloadable emoticons for mobile phones; computer operating programs, recorded; liquid crystal displays (LCD) with large screens; electronic diaries; liquid crystal displays (LCD); electronic pens; video image printers; portable digital electronic scales; holders for mobile phones; wrist-mounted smartphones; television apparatus for vehicles; computer styluses; computer programs, downloadable; computer software, recorded; touch screen pens; 3D spectacles; computer programs (dow-

nloadable software); audio interfaces; electric and electronic effects units for musical instruments; equalizers (audio apparatus); digital weather stations; biochips; infrared detectors; electronic key fobs being remote control apparatus; smart rings; smartglasses; smartwatches; smartphones; wearable activity trackers; digital photo frames; microphones; computer hardware; computer memories; integrated circuit cards (smart cards); transponders; human face recognition devices; stored program controlled telephone switching apparatus; radios; air analysis apparatus; materials for electricity mains (wires, cables); video screens; integrated circuits; security tokens (encryption devices); fingerprint identifier; electronic chips; cabinets for loudspeakers; network communication apparatus; modems; electric batteries; chargers for electric batteries; mobile power source (rechargeable batteries); tablet computers; flat panel displays; flexible flat panel displays for computers; laptop computers; notebook computers; bags adapted for laptops; headphones; thermal imaging cameras; bathroom scales; scales with body mass analyzers; personal digital assistants (PDAs); computer software platforms, recorded or downloadable; thin client computers; handheld electronic dictionaries; computer screen saver software, recorded or downloadable; downloadable graphics for mobile phones; wearable computers; telecommunication apparatus in the form of jewellery; selfie sticks for mobile phones; security surveillance robots; wearable video display monitors; selfie lenses; television apparatus; laboratory robots; teaching robots; USB data lines or data cables; USB data lines or data cables for mobile phones; downloadable mobile phone software applications; touch screens; electric plugs.

42 – Computer systems integration services; design and development of computer software; installation and maintenance of computer software; providing computer software design for others; rental of web servers; advisory services in the field of development and quality improvement of software; writing and updating of computer software; testing services of website usability; electronic storage services for archiving electronic data; development of software for securities of network operating system; computer programming consultancy; programming of multimedia devices; installation, maintenance and repair of computer software; computer hardware design; telecommunications technology consultancy; product safety testing services; scientific research and development; design of telecommunications apparatus and parts; design and development of multimedia products; computer programming; computer software design; computer system design; conversion of data or documents from physical to electronic media; creating and maintaining web sites for others; data conversion of computer programs and data (not physical conversion); computer software consultancy; information technology (IT) consultancy; electronic data storage; providing information

on computer technology and programming via a web site; consultancy in the design and development of computer hardware; software as a service [SaaS]; cloud computing; computer technology consultancy; software development in the framework of software publishing; platform as a service [PaaS]; database design and development; writing of data processing programs; updating and maintenance of computer software; computer aided graphic design; creating, designing and maintaining web sites; design and development of wireless computer networks; data conversion of electronic information; design and development of virtual reality software; developing of driver and operating system software; research and development of computer software; database development services; maintenance and updating of computer software.

(260) AM 2020 107745 A
 (800) 1148878
 (151) 2012 12 24
 (891) 2020 02 06
 (731) "Delta Medical Promotions AG"
 Oetenbachgasse 26, CH-8001 Zurich,
 Switzerland
 (540)

ДермаПРО

(591) Black, white
 (531) 28.05
 (511)
 5 – Dental abrasives; absorbent cotton; acaricides; acetates for pharmaceutical purposes; acids for pharmaceutical purposes; aconitine; adhesive bands for medical purposes; adhesive plaster; fly catching adhesives; adhesives for dentures; adjuvants for medical purposes; air deodorising preparations; air purifying preparations; albuminous foodstuffs for medical purposes; albuminous preparations for medical purposes; alcohol for pharmaceutical purposes; aldehydes for pharmaceutical purposes; algicides; alkaline iodides for pharmaceutical purposes; alkaloids for medical purposes; alloys of precious metals for dental purposes; milk of almonds for pharmaceutical purposes; aluminium acetate for pharmaceutical purposes; dental amalgams; amino acids for medical purposes; amino acids for veterinary purposes; anaesthetics; analgesics; angostura bark for medical purposes; animal washes; anthelmintics; anti-rheumatism bracelets; anti-rheumatism rings; anti-uric preparations; antibiotics; anticryptogamic preparations; antiparasitic collars for animals; antiparasitic preparations; antiseptic cotton; antiseptics; appetite suppressants for medical purposes; aseptic cotton; asthmatic tea; bacterial poisons; bacterial preparations for medical and veterinary use; bouillons for bacteriological cultures; bacteriological preparations for medical and veterinary use; balms for medical purposes; balsamic preparations for

medical purposes; hygienic bandages; menstruation bandages; bandages for dressings; barks for pharmaceutical purposes; therapeutic preparations for the bath; bath preparations, medicated; bath salts for medical purposes; oxygen baths; salts for mineral water baths; belts for sanitary napkins [towels]; bicarbonate of soda for pharmaceutical purposes; biocides; biological preparations for medical purposes; biological preparations for veterinary purposes; bismuth preparations for pharmaceutical purposes; bismuth subnitrate for pharmaceutical purposes; blood for medical purposes; blood plasma; bone cement for surgical and orthopaedic purposes; bracelets for medical purposes; diabetic bread adapted for medical use; breast-nursing pads; bromine for pharmaceutical purposes; bronchodilating preparations; bunion pads; preparations for the treatment of burns; by-products of the processing of cereals for dietetic or medical purposes; cachets for pharmaceutical purposes; cachou for pharmaceutical purposes; preparations for callouses; calomel; camphor for medical purposes; camphor oil for medical purposes; candy for medical purposes; candy, medicated; powder of cantharides; capsules for medicines; carbolineum [parasiticide]; castor oil for medical purposes; cattle washes; caustic pencils; caustics for pharmaceutical purposes; cedar wood for use as an insect repellent; cellulose esters for pharmaceutical purposes; cellulose ethers for pharmaceutical purposes; cement for animal hooves; charcoal for pharmaceutical purposes; chemical conductors for electrocardiograph electrodes; chemical preparations for medical purposes; chemical preparations for pharmaceutical purposes; chemical preparations for veterinary purposes; chemical reagents for medical or veterinary purposes; chemico-pharmaceutical preparations; chewing gum for medical purposes; chilblain preparations; chinoline for medical purposes; chloroform; tobacco-free cigarettes for medical purposes; cinchona for medical purposes; contact lens cleaning preparations; deodorants for clothing and textiles; cocaine; cod liver oil; collodion for pharmaceutical purposes; collyrium; compresses; condurango bark for medical purposes; medicines for alleviating constipation; solutions for use with contact lenses; chemical contraceptives; corn remedies; corn rings for the feet; cotton for medical purposes; cream of tartar for pharmaceutical purposes; creosote for pharmaceutical purposes; croton bark; cultures of microorganisms for medical and veterinary use; curare; pharmaceutical preparations for treating dandruff; decoctions for pharmaceutical purposes; dental cements; dental impression materials; dental lacquer; dental mastics; deodorants, other than for human beings or for animals; depuratives; detergents for medical purposes; chemical preparations for the diagnosis of pregnancy; diagnostic preparations for medical purposes; diastase for medical purposes; dietetic beverages adapted for medical purposes; dietetic foods adapted for medical purposes; dietetic substances adapted for medical use; digestives for pharma-

ceutical purposes; digitalin; dill oil for medical purposes; disinfectants for chemical toilets; disinfectants for hygiene purposes; dog lotions; dog washes; repellents for dogs; surgical dressings; dressings, medical; medicinal drinks; drugs for medical purposes; preparations for destroying dry rot fungus; elixirs [pharmaceutical preparations]; enzyme preparations for medical purposes; enzyme preparations for veterinary purposes; enzymes for medical purposes; enzymes for veterinary purposes; ergot for pharmaceutical purposes; esters for pharmaceutical purposes; ethers for pharmaceutical purposes; eucalyptol for pharmaceutical purposes; eucalyptus for pharmaceutical purposes; evacuants; eye-washes; eyepatches for medical purposes; febrifuges; fennel for medical purposes; milk ferments for pharmaceutical purposes; ferments for pharmaceutical purposes; first-aid boxes, filled; fish meal for pharmaceutical purposes; flaxseed for pharmaceutical purposes; flour for pharmaceutical purposes; flowers of sulphur for pharmaceutical purposes; fly catching paper; fly destroying preparations; food for babies; remedies for foot perspiration; formic aldehyde for pharmaceutical purposes; frostbite salve for pharmaceutical purposes; fumigating pastilles; fumigation preparations for medical purposes; fungicides; gallic acid for pharmaceutical purposes; gamboge for medical purposes; gases for medical purposes; gauze for dressings; gelatine for medical purposes; gentian for pharmaceutical purposes; germicides; glucose for medical purposes; glycerine for medical purposes; glycerophosphates; dental amalgams of gold; goulard water; greases for medical purposes; greases for veterinary purposes; guaiacol for pharmaceutical purposes; gum for medical purposes; gurjun [gurjon, gurjan] balsam for medical purposes; haematogen; haemoglobin; haemorrhoid preparations; haemostatic pencils; medicinal hair growth preparations; articles for headache; headache pencils; herbal teas for medicinal purposes; herbicides; medicinal herbs; smoking herbs for medical purposes; extracts of hops for pharmaceutical purposes; hormones for medical purposes; hydrastine; hydrastinine; hydrated chloral for pharmaceutical purposes; hydrogen peroxide for medical purposes; surgical implants [living tissues]; insect repellent incense; napkins for incontinents; pants, absorbent, for incontinents; medicinal infusions; insect repellents; insecticides; semen for artificial insemination; iodides for pharmaceutical purposes; iodine for pharmaceutical purposes; iodoform; Irish moss for medical purposes; isotopes for medical purposes; jalap; petroleum jelly for medical purposes; jujube, medicated; menstruation knickers; lacteal flour for babies; lactose for pharmaceutical purposes; larvae exterminating preparations; laxatives; lecithin for medical purposes; leeches for medical purposes; preparations of lime for pharmaceutical purposes; liniments; lint for medical purposes; liquorice for pharmaceutical purposes; tissues impregnated with pharmaceutical lotions; lotions for pharmaceutical purposes; lotions for

veterinary purposes; lozenges for pharmaceutical purposes; lupulin for pharmaceutical purposes; magnesia for pharmaceutical purposes; malt for pharmaceutical purposes; malted milk beverages for medical purposes; mangrove bark for pharmaceutical purposes; medicinal oils; medicinal roots; medicinal tea; medicine cases, portable, filled; medicines for dental purposes; medicines for human purposes; medicines for veterinary purposes; melissa water for pharmaceutical purposes; menthol; mercurial ointments; preparations for destroying mice; nutritive substances for microorganisms; chemical preparations to treat mildew; milking grease; mineral food supplements; mineral water salts; mineral waters for medical purposes; mint for pharmaceutical purposes; molding wax for dentists; moleskin for medical purposes; mothproofing paper; mothproofing preparations; mouthwashes for medical purposes; medicinal mud; mud for baths; mustard for pharmaceutical purposes; mustard oil for medical purposes; mustard plasters; myrobalan bark for pharmaceutical purposes; narcotics; nervines; preparations for destroying noxious animals; nutritional supplements; oil of turpentine for pharmaceutical purposes; ointments for pharmaceutical purposes; opiates; opium; opodeldoc; opotherapy preparations; oxygen for medical purposes; panty liners [sanitary]; paper for mustard plasters; parasiticides; pectin for pharmaceutical purposes; pepsins for pharmaceutical purposes; peptones for pharmaceutical purposes; pharmaceutical preparations; phenol for pharmaceutical purposes; phosphates for pharmaceutical purposes; chemical preparations for treating phylloxera; plasters for medical purposes; poisons; pomades for medical purposes; porcelain for dental prostheses; potassium salts for medical purposes; poultices; pyrethrum powder; quassia for medical purposes; quebracho for medical purposes; quinine for medical purposes; radioactive substances for medical purposes; radiological contrast substances for medical purposes; radium for medical purposes; rat poison; remedies for perspiration; rhubarb roots for pharmaceutical purposes; rubber for dental purposes; salts for medical purposes; sanitary napkins; sarsaparilla for medical purposes; scapulars for surgical purposes; sea water for medicinal bathing; sedatives; serotherapeutic medicines; serums; siccatives [drying agents] for medical purposes; pharmaceutical preparations for skin care; medical preparations for slimming purposes; slug exterminating preparations; smelling salts; sodium salts for medical purposes; soil-sterilising preparations; solvents for removing adhesive plasters; soporifics; starch for dietetic or pharmaceutical purposes; sterilising preparations; steroids; stick liquorice for pharmaceutical purposes; sulphur sticks [disinfectants]; strychnine; styptic preparations; sugar for medical purposes; sulphonamides [medicines]; sunburn ointments; sunburn preparations for pharmaceutical purposes; suppositories; surgical cloth [tissues]; syrups for pharmaceutical purposes; tartar for pharma-

ceutical purposes; teeth filling material; preparations to facilitate teething; thermal water; thymol for pharmaceutical purposes; tincture of iodine; tinctures for medical purposes; tobacco extracts [insecticides]; tonics [medicines]; preparations of trace elements for human and animal use; turpentine for pharmaceutical purposes; vaccines; vaginal washes; vermin destroying preparations; vesicants; veterinary preparations; vine disease treating chemicals; vitamin preparations; wadding for medical purposes; wart pencils; chemical preparations to treat wheat blight [smut]; yeast for pharmaceutical purposes.

(260) AM 2020 107746 A

(800) 1149464

(151) 2012 12 24

(891) 2020 02 06

(731) "Delta Medical Promotions AG"

Oetenbachgasse 26, CH-8001 Zurich,
Switzerland

(540)

ФЛУВИР

591) Black, white

(531) 28.05; 28.05

(511)

3 – Almond milk for cosmetic purposes; almond oil; almond soap; amber [perfume]; antiperspirant soap; antiperspirants [toiletries]; aromatics [essential oils]; astringents for cosmetic purposes; bath salts, not for medical purposes; cosmetic preparations for baths; beauty masks; bergamot oil; bleaching preparations [laundry]; bleaching salts; breath freshening sprays; color- [colour-] brightening chemicals for household purposes [laundry]; cakes of toilet soap; essential oils of cedarwood; essential oils of citron; cleaning preparations; cleansing milk for toilet purposes; cloths impregnated with a detergent for cleaning; color-removing preparations; colorants for toilet purposes; cosmetic kits; cosmetics; cosmetics for animals; cotton sticks for cosmetic purposes; cotton wool for cosmetic purposes; cosmetic creams; skin whitening creams; deodorant soap; detergents other than for use in manufacturing operations and for medical purposes; disinfectant soap; dry-cleaning preparations; eau de Cologne; ethereal essences; essential oils; extracts of flowers [perfumes]; bases for flower perfumes; soap for foot perspiration; fumigation preparations [perfumes]; laundry glaze; greases for cosmetic purposes; jasmine oil; petroleum jelly for cosmetic purposes; joss sticks; lacquer-removing preparations; laundry bleach; laundry soaking preparations; lavender oil; lavender water; sachets for perfuming linen; tissues impregnated with cosmetic lotions; lotions for cosmetic purposes; make-up powder; medicated soap; mint essence [essential oil]; mint for perfumery; mouth washes, not for medical purposes; musk [perfumery]; oil of turpentine for degreasing; oils for clea-

ning purposes; oils for cosmetic purposes; oils for perfumes and scents; oils for toilet purposes; perfumery; perfumes; shampoos for pets; potpourris [fragrances]; rose oil; scented water; scented wood; scouring solutions; shampoos; shining preparations [polish]; cosmetic preparations for skin care; soap; stain removers; talcum powder, for toilet use; terpenes [essential oils]; toilet water; toiletries; deodorants for human beings or for animals.

5 – Dental abrasives; absorbent cotton; acaricides; aconitine; adhesive plaster; fly catching adhesives; adhesives for dentures; air deodorising preparations; air purifying preparations; alloys of precious metals for dental purposes; bouillons for bacteriological cultures; dental amalgams; animal washes; antiparasitic collars for animals; antiparasitic preparations; antiseptic cotton; antiseptics; aseptic cotton; asthmatic tea; bacterial poisons; hygienic bandages; menstruation bandages; bandages for dressings; ; therapeutic preparations for the bath; bath preparations, medicated; bath salts for medical purposes; oxygen baths; salts for mineral water baths; belts for sanitary napkins (towels); biocides; biological preparations for veterinary purposes; bone cement for surgical and orthopaedic purposes; breast-nursing pads; bunion pads; cattle washes; cedar wood for use as an insect repellent; cement for animal hooves; tobacco-free cigarettes for medical purposes; deodorants for clothing and textiles; compresses; solutions for use with contact lenses; corn remedies; corn rings for the feet; cotton for medical purposes; dental cements; dental impression materials; dental lacquer; dental mastics; deodorants, other than for human beings or for animals; disinfectants for chemical toilets; disinfectants for hygiene purposes; dog lotions; dog washes; repellents for dogs; preparations for destroying dry rot fungus; evacuants; eye-washes; fly catching paper; fly destroying preparations; food for babies; remedies for foot perspiration; fly catching paper; fly destroying preparations; food for babies; remedies for foot perspiration; fly catching paper; fly destroying preparations; food for babies; remedies for foot perspiration; fumigating pastilles; fungicides; gauze for dressings; germicides; dental amalgams of gold; goulard water; surgical implants (living tissues); insect repellent incense; napkins for incontinents; pants, absorbent, for incontinents; insect repellents; herbicides; insecticides; semen for artificial insemination; menstruation knickers; lacteal flour for babies; larvae exterminating preparations; laxatives; liniments; tissues impregnated with pharmaceutical lotions; surgical dressings; dressings, medical; menstruation tampons; menthol; mercurial ointments; preparations for destroying mice; nutritive substances for microorganisms; chemical preparations to treat mildew; milking grease; mineral food supplements; mineral water salts; molding wax for dentists; mothproofing paper; mothproofing preparations; mud for baths; mustard plasters; preparations for destroying noxious animals; nutritional supplements; paper for

mustard plasters; parasiticides; chemical preparations for treating phylloxera; porcelain for dental prostheses; poultices; pyrethrum powder; rat poison; remedies for perspiration; royal jelly dietary supplements; rubber for dental purposes; sanitary napkins; solvents for removing adhesive plasters; sterilising preparations; surgical cloth (tissues); teeth filling material; preparations to facilitate teething; thermal water; teeth filling material; preparations to facilitate teething; thermal water; tobacco extracts (insecticides); vaginal washes; vermin destroying preparations; vesicants; vine disease treating chemicals; vitamin preparations; chemical preparations to treat wheat blight (smut); yeast dietary supplements; jalap.

(260) AM 2020 107747 A
 (800) 1205861
 (151) 2014 01 28
 (891) 2019 12 09
 (731) Bund der Freien Waldorfschulen e.V.
 Wagenburgstraße 6, 70184 Stuttgart, Germany
 (540)

Waldorf

(591) Black, white
 (511)
 41 – Running schools, boarding schools and nursery schools, namely education, providing of training and instruction for children and young people; providing of training for teachers and nursery school teachers; providing of further training for adults, instruction and further training for apprentices; day-nurseries [crèches].

(260) AM 2020 107748 A
 (800) 1236621
 (151) 2015 01 06
 (891) 2020 03 09
 (731) GILEAD SCIENCES IRELAND UC
 IDA Business and Technology Park,
 Carrigtohill, Co. Cork, Ireland
 (540)

VEKLURY

(591) Black, white
 (511)
 5 – Pharmaceutical preparations.

(260) AM 2020 107749 A
 (800) 1304608
 (151) 2016 04 01
 (891) 2020 02 11
 (731) Public Joint-Stock Company, "Krasnyj
 Ocyabr"
 ul. Malaya Krasnoselskaya, d. 7, str. 24
 RU-107140 Moscow, Russian Federation

(540)

РУСЬ-ТРОЙКА

(591) Black, white

(531) 28.05

(511)

30 – Sweetmeats [candy]; caramels [candy]; pralines; fondants [confectionery]; chocolate; confectionery, namely biscuits, petit-beurre biscuits, malt biscuits, crackers, waffles.

(260) AM 2020 107750 A

(800) 1454411

(151) 2018 12 06

(891) 2020 03 10

(731) COMPAGNIE GERVAIS DANONE

17 boulevard Haussmann, F-75009 PARIS,
France

(540)

ACTIVIA

(591) Black, white

(511)

29 – Milk, milk products and substitutes therefor; powdered milk; flavored jellied milks and buttermilk; milk desserts; yogurts; drinking yogurts; white cheese; petit suisse; beverages mainly consisting of milk or dairy products; milk beverages, milk predominating; milk beverages containing fruit; unflavored or flavored fermented dairy products; milk substitutes of vegetable origin; substitutes of dairy products based on plants or nuts; fruit or vegetable beverages consisting mainly of milk products.

30 – Cocoa, chocolate, cocoa-based beverages, chocolate-based beverages, coffee-based beverages, tea-based beverages; custard; chocolate mousses, dessert mousses [confectionery], confectionery, sugar confectionery, sugar, puffed rice, preparations made from cereals, breakfast cereals; biscuits (sweet or savory); cakes; pastries; waffles; cereal-based desserts; rice cakes; semolina cakes; rice pudding, rice-based snack food, cereal-based snack food; edible ices, edible ices consisting primarily of yogurt, ice-cream, sherbet (edible ices), frozen yogurts (edible ices), edible ice-cream made with flavored frozen water; fruit coulis [sauces]; beverages of vegetable origin, excluding dairy substitutes, included in this class.

32 – Still or sparkling waters (mineral or other), fruit or vegetable juices, beverages with fruits or vegetables, lemonades, soda water, sherbets (beverages), preparations for making beverages, syrups for beverages, vegetable or fruit extract without alcohol, non-alcoholic beverages; plant-based beverages.

(260) AM 2020 107751 A

(800) 1497572

(151) 2019 09 12

(891) 2020 03 12

(731) British American Tobacco (Brands) Limited
Globe House, 4 Temple Place, London
WC2R 2PG, United Kingdom

(540)

VELO

(591) Black, white

(511)

34 – Cigarettes; tobacco, raw or manufactured; tobacco free oral nicotine pouches (not for medical use); snuff with tobacco; snus with tobacco; snuff without tobacco; snus without tobacco; roll your own tobacco; pipe tobacco; tobacco products; tobacco substitutes (not for medical purposes); cigars; cigarillos; lighters for smokers; matches; smokers' articles; cigarette paper, cigarette tubes, cigarette filters; pocket apparatus for rolling cigarettes; hand held machines for injecting tobacco into paper tubes; electronic cigarettes; liquids for electronic cigarettes; tobacco products for the purpose of being heated.

(260) AM 2020 107752 A

(800) 1502550

(151) 2019 10 28

(891) 2020 03 12

(731) Alcon Inc.

Rue Louis-d'Affry 6, CH-1701 Fribourg,
Switzerland

(540)



(591) Blue, light blue, white

(531) 01.15.15; 16.03.19; 24.17.02; 26.01.16;
26.01.21; 26.03.23

(511)

9 – Contact lenses.

(260) AM 2020 107753 A

(800) 1502553

(151) 2019 10 28

(891) 2020 03 12

(731) Alcon Inc.

Rue Louis-d'Affry 6, CH-1701 Fribourg,
Switzerland

(540)

ACTIV-FLO

(591) Black, white

(511)

9 – Contact lenses.

(260) AM 2020 107794 A
 (800) 1034190
 (151) 2010 02 25
 (891) 2020 02 26
 (731) KOWA COMPANY, LTD.
 6-29, Nishiki 3 chome, Naka-ku, Nagoya-shi,
 Aichi 460-8625, Japan

(540)

KALIMATE

(591) Black, white
 (511)
 5 – Pharmaceutical preparations; veterinary preparations; sanitary preparations; pharmaceutical preparations for hyperkalemia resulting from acute or chronic renal failure.

(260) AM 2020 107795 A
 (800) 1053378
 (151) 2010 08 06
 (891) 2020 01 30
 (731) Trenkwalder Group AG
 Lugeck 1-2, A-1010 Wien, Austria

(540)

TRENKWALDER

(591) Black, white
 (511)
 35 – Employment agencies, especially hiring manpower; personnel selection using aptitude test.
 42 – Computer and software development and construction; software maintenance; Web page design; scientific and technological services as well as research and design services relating thereto in the field of information technology.
 45 – Personal and social services concerning individual needs.

(260) AM 2020 107796 A
 (800) 1294662
 (151) 2016 01 16
 (891) 2020 03 13
 (731) Simpsons Malt Limited
 Tweed Valley Maltings, Tweedside Trading
 Estate, Ord Road, Berwick-upon-Tweed
 TD15 2UZ, United Kingdom

(540)



(591) Gold, brown, white
 (531) 05.07.01; 05.07.02; 29.01.02
 (511)
 30 – Malt for use in the preparation of food.
 31 – Malt for brewing and distilling.

(260) AM 2020 107864 A
 (800) 1524512
 (151) 2019 12 30
 (891) 2019 12 30
 (731) Red Moon Srl
 Via della Mendola 21, I-39100 Bolzano, Italy

(540)

SWING

(591) Black, white
 (531) 27.05.01
 (511)
 29 – Processed apples; preserved, dried and cooked fruit and vegetables; fruit jams; fruit jellies.
 31 – Fresh fruit; fresh apples; fruit plants; fruit trees; rootstocks for fruit tree grafting; scions for fruit tree grafting.
 32 – Fruit-based drinks; apple juice; fruit juice; syrups and other preparations for making beverages.

(260) AM 2020 107881 A
 (800) 1225332
 (151) 2014 08 05
 (891) 2019 11 27
 (731) IZHEVSK PLASTICS PLANT JSC.
 Avtozavodskaya St., 7, Izhevsk, RU-426065
 UDMURT REPUBLIC, Russian Federation

(540)



(591) Blue, red and white
 (531) 27.05.10; 27.05.17; 27.05.22; 29.01.13
 (511)
 10 – Arch supports for footwear; knee bandages, orthopedic.
 17 – Caulking materials; compositions to prevent the radiation of heat; expansion joint fillers; floating anti-pollution barriers; gaskets; insulating materials; insulating tape and band; non-conducting materials for retaining heat; packing [cushioning, stuffing] materials of rubber or plastics; padding materials of rubber or plastics; pipe gaskets; sealant compounds for joints; soundproofing materials; waterproof packings; weatherstripping compositions.

19 – Building panels, not of metal; ceilings, not of metal; cladding, not of metal, for building; construction materials, not of metal; duckboards, not of metal; flashing, not of metal, for building; floor tiles, not of

metal; materials for making and coating roads; partitions, not of metal; roof coverings, not of metal; roof flashing, not of metal; roofing, not of metal; tiles, not of metal, for building; wall claddings, not of metal, for building; wainscotting, not of metal; wall linings, not of metal, for building.

27 – Bath mats; carpet underlay; gymnastic mats; floor coverings; mats; wall hangings, not of textile.

28 – Archery implements; climbers' harness; jigsaw puzzles; knee guards [sports articles]; protective padding [parts of sports suits]; swimming belts; swimming kick boards; swimming jackets; water wings.

(260) AM 2020 107968 A

(800) 1526036

(151) 2020 03 19

(891) 2020 03 19

(731) SEAT, S.A.

Autovia A-2 km.585, E-08760 Martorell
(Barcelona), Spain

(540)



(591) Gray and matte gray

(531) 27.05.01; 27.05.17; 27.05.23

(511)

12 – Vehicles; apparatus for locomotion by land; cars; vehicle parts and accessories.

25 – Ready-to-wear clothing for men, women and children, footwear (except orthopedic footwear) and headgear; clothing for motorists and cyclists; T-shirts; scarves; belts (clothing); neckties; gloves (clothing); Ascots; caps; sun visors.

27 – Carpets for automobiles; mats for automobiles; rugs for automobiles.

(260) AM 2020 107969 A

(800) 327579

(151) 1966 11 23

(891) 2020 03 20

(731) Bayer Intellectual Property GmbH

Alfred-Nobel-Straße 10, 40789 Monheim
am Rhein, Germany

(540)

Resochin

(591) Black, white

(531) 27.05.01; 27.05.17

(511)

5 – Medicines for humans and animals.

(260) AM 2020 107971 A

(800) 1007202

(151) 2009 06 01

(891) 2020 03 10

(731) ASAHI INTECC CO., LTD.

3-100 Akatsuki-cho, Seto-shi, Aichi 489-0071,
Japan

(540)

ASAHI INTECC

(591) Black, white

(531) 27.05.01

(511)

10 – Medical catheters and their parts and accessories; medical guide wires and their parts and accessories; medical stent and their parts and accessories; medical cables of metal, rubber or plastic; medical wires of metal, rubber or plastic; medical tubes of metal, rubber or plastic; medical coils of metal, rubber or plastic; medical cables of metal, rubber or plastic coated with polymeric materials; medical wires of metal, rubber or plastic coated with polymeric materials; medical tubes of metal, rubber or plastic coated with polymeric materials; medical coils of metal, rubber or plastic coated with polymeric materials; threads, coils, tubing and ropes (metal or non-metal) as part of medical apparatus, instruments and/or devices; polypectomy snares; medical devices having wire cages or slitted tube cages for capturing an object in a human body; endoscopic cleaning brushes; medical machines, instruments and apparatus and their parts and accessories; devices and apparatus for minimally invasive procedures.

(260) AM 2020 107973 A

(800) 1223240

(151) 2014 06 11

(891) 2020 03 10

(731) ASAHI INTECC CO., LTD.

3-100 Akatsuki-cho, Seto-shi, Aichi 489-0071,
Japan

(540)



(591) Black, white

(531) 26.03; 26.03.06; 26.13.25

(511)

10 – Surgical, medical and dental apparatus and instruments, and their parts and accessories; medical guidewires, and their parts and accessories; IVR (interventional radiology) guidewires; PTCA (percutaneous transluminal coronary angioplasty) guidewires; spring guidewires; plastic clad guidewires; medical catheters

and their parts and accessories; PTCA (percutaneous transluminal coronary angioplasty) guiding catheters; PTCA balloon catheters; angiographic catheters; micro catheters; occlusion catheters; ablation catheters; atherectomy catheters; stents and their parts and accessories.

(260) AM 2020 107974 A

(800) 1477266

(151) 2019 05 15

(891) 2020 03 12

(731) Novartis AG

CH-4002 Basel, Switzerland

(540)

APGRADA

(591) Black, white

(511)

10 – Drug delivery devices.

(260) AM 2020 107975 A

(800) 1477308

(151) 2019 05 15

(891) 2020 03 12

(731) Novartis AG

CH-4002 Basel, Switzerland

(540)

UNOREADY

(591) Black, white

(511)

10 – Drug delivery devices.

(260) AM 2020 107976 A

(800) 1477401

(151) 2019 05 15

(891) 2020 03 12

(731) Novartis AG

CH-4002 Basel, Switzerland

(540)

UPLYFTA

(591) Black, white

(511)

10 – Drug delivery devices.

(260) AM 2020 107977 A

(800) 1495887

(151) 2019 09 20

(891) 2020 04 01

(731) BASF SE

Carl-Bosch-Str. 38, 67056 Ludwigshafen
am Rhein, Germany

(540)



(591) Black, white

(531) 26.01.05; 26.01.19

(511)

1 – Chemicals used in industry, in particular antifreeze agents and preparations for protection against frost, corrosion and overheating.

2 – Preservatives against rust.

INTERNATIONAL TRADEMARKS PROTECTED IN GEORGIA

(260) AM 2020 105694 A
(800) 1496295
(151) 2019 05 17
(181) 2029 05 17
(891) 2019 05 17
(511) 09, 28

(260) AM 2020 105863 A
(800) 961857
(151) 2008 03 11
(181) 2028 03 11
(891) 2019 11 07
(511) 05

(260) AM 2020 105705 A
(800) 1496464
(151) 2019 10 03
(181) 2029 10 03
(891) 2019 10 03
(511) 34

(260) AM 2020 105866 A
(800) 1436022
(151) 2018 08 09
(181) 2028 08 09
(891) 2019 10 14
(511) 09

(260) AM 2020 105826 A
(800) 1498862
(151) 2019 09 03
(181) 2029 09 03
(891) 2019 09 03
(511) 03, 05, 10

(260) AM 2020 105867 A
(800) 1463252
(151) 2019 03 04
(181) 2029 03 04
(891) 2019 07 12
(511) 09, 35

(260) AM 2020 105831 A
(800) 1498933
(151) 2019 10 17
(181) 2029 10 17
(891) 2019 10 17
(511) 08

(260) AM 2020 105868 A
(800) 1493260
(151) 2019 07 16
(181) 2029 07 16
(891) 2019 10 25
(511) 09

(260) AM 2020 105832 A
(800) 1498934
(151) 2019 04 16
(181) 2029 04 16
(891) 2019 04 16
(511) 33

(260) AM 2020 105906 A
(800) 1499897
(151) 2019 09 24
(181) 2029 09 24
(891) 2019 09 24
(511) 12

(260) AM 2020 105836 A
(800) 1499010
(151) 2019 09 23
(181) 2029 09 23
(891) 2019 09 23
(511) 29

(260) AM 2020 105907 A
(800) 1499905
(151) 2019 10 11
(181) 2029 10 11
(891) 2019 10 11
(511) 09, 34

(260) AM 2020 105850 A
(800) 1499411
(151) 2019 10 17
(181) 2029 10 17
(891) 2019 10 17
(511) 07

(260) AM 2020 105908 A
(800) 1499914
(151) 2019 10 11
(181) 2029 10 11
(891) 2019 10 11
(511) 09, 34

(260) AM 2020 105909 A
(800) 1499917
(151) 2019 10 11
(181) 2029 10 11
(891) 2019 10 11
(511) 09, 34

(260) AM 2020 105911 A
(800) 1499932
(151) 2019 05 22
(181) 2029 05 22
(891) 2019 05 22
(511) 18

(260) AM 2020 105916 A
(800) 1499960
(151) 2019 08 19
(181) 2029 08 19
(891) 2019 08 19
(511) 07, 12, 37

(260) AM 2020 105927 A
(800) 1500092
(151) 2019 09 11
(181) 2029 09 11
(891) 2019 09 11
(511) 32, 33

(260) AM 2020 105935 A
(800) 1500444
(151) 2019 08 05
(181) 2029 08 05
(891) 2019 08 05
(511) 42

(260) AM 2020 105954 A
(800) 1500932
(151) 2019 09 05
(181) 2029 09 05
(891) 2019 09 05
(511) 30

(260) AM 2020 106006 A
(800) 1501375
(151) 2019 09 25
(181) 2029 09 25
(891) 2019 09 25
(511) 03

(260) AM 2020 106009 A
(800) 1501399
(151) 2019 07 10
(181) 2029 07 10

(891) 2019 07 10
(511) 37

(260) AM 2020 106022 A
(800) 1501807
(151) 2019 08 28
(181) 2029 08 28
(891) 2019 08 28
(511) 43

(260) AM 2020 106023 A
(800) 1501847
(151) 2019 10 25
(181) 2029 10 25
(891) 2019 10 25
(511) 09

(260) AM 2020 106031 A
(800) 1502226
(151) 2019 08 16
(181) 2029 08 16
(891) 2019 08 16
(511) 07, 12, 37

(260) AM 2020 106131 A
(800) 1503271
(151) 2019 10 24
(181) 2029 10 24
(891) 2019 10 24
(511) 05

(260) AM 2020 106132 A
(800) 1503273
(151) 2019 10 24
(181) 2029 10 24
(891) 2019 10 24
(511) 05

(260) AM 2020 106134 A
(800) 1503279
(151) 2019 10 24
(181) 2029 10 24
(891) 2019 10 24
(511) 05

(260) AM 2020 106135 A
(800) 1503280
(151) 2019 10 24
(181) 2029 10 24
(891) 2019 10 24
(511) 05

(260) AM 2020 106149 A
(800) 1120963
(151) 2012 05 23
(181) 2022 05 23
(891) 2019 11 20
(511) 39

(260) AM 2020 106199 A
(800) 1503702
(151) 2019 10 24
(181) 2029 10 24
(891) 2019 10 24
(511) 05

(260) AM 2020 106201 A
(800) 1503713
(151) 2019 10 24
(181) 2029 10 24
(891) 2019 10 24
(511) 05

(260) AM 2020 106220 A
(800) 1504161
(151) 2019 10 15
(181) 2029 10 15
(891) 2019 10 15
(511) 32

(260) AM 2020 106225 A
(800) 1504228
(151) 2019 11 20
(181) 2029 11 20
(891) 2019 11 20
(511) 03

(260) AM 2020 106226 A
(800) 1504229
(151) 2019 10 29
(181) 2029 10 29
(891) 2019 10 29
(511) 29, 30, 35

(260) AM 2020 106291 A
(800) 1497338
(151) 2019 01 24
(181) 2029 01 24
(891) 2019 01 24
(511) 35, 36

(260) AM 2020 106295 A
(800) 1497359
(151) 2019 08 09
(181) 2029 08 09

(891) 2019 08 09
(511) 29

(260) AM 2020 106296 A
(800) 1497370
(151) 2019 03 28
(181) 2029 03 28
(891) 2019 03 28
(511) 03, 16, 18, 25, 35, 40, 42

(260) AM 2020 106307 A
(800) 1497527
(151) 2019 08 28
(181) 2029 08 28
(891) 2019 08 28
(511) 03, 05, 10

(260) AM 2020 106308 A
(800) 1497538
(151) 2019 07 02
(181) 2029 07 02
(891) 2019 07 02
(511) 29, 30, 32

(260) AM 2020 106309 A
(800) 1497548
(151) 2019 10 17
(181) 2029 10 17
(891) 2019 10 17
(511) 09

(260) AM 2020 106310 A
(800) 1497588
(151) 2019 08 09
(181) 2029 08 09
(891) 2019 08 09
(511) 03

(260) AM 2020 106311 A
(800) 1497595
(151) 2019 08 14
(181) 2029 08 14
(891) 2019 08 14
(511) 09, 28, 41

(260) AM 2020 106316 A
(800) 1497692
(151) 2019 10 16
(181) 2029 10 16
(891) 2019 10 16
(511) 08

(260) AM 2020 106324 A
(800) 1497956
(151) 2019 07 16
(181) 2029 07 16
(891) 2019 07 16
(511) 18, 25

(260) AM 2020 106329 A
(800) 1498005
(151) 2019 07 23
(181) 2029 07 23
(891) 2019 07 23
(511) 35

(260) AM 2020 106331 A
(800) 1498045
(151) 2019 06 24
(181) 2029 06 24
(891) 2019 06 24
(511) 06, 09, 35

(260) AM 2020 106332 A
(800) 1498064
(151) 2018 11 01
(181) 2028 11 01
(891) 2018 11 01
(511) 06, 19

(260) AM 2020 106416 A
(800) 1498435
(151) 2019 05 16
(181) 2029 05 16
(891) 2019 05 16
(511) 01, 17, 19, 20

(260) AM 2020 106422 A
(800) 1498455
(151) 2019 08 20
(181) 2029 08 20
(891) 2019 08 20
(511) 30

(260) AM 2020 106423 A
(800) 1498489
(151) 2019 08 14
(181) 2029 08 14
(891) 2019 08 14
(511) 01, 17, 20, 21

(260) AM 2020 106549 A
(800) 1508168
(151) 2019 12 09
(181) 2029 12 09

(891) 2019 12 09
(511) 31

(260) AM 2020 106550 A
(800) 1508193
(151) 2019 10 23
(181) 2029 10 23
(891) 2019 10 23
(511) 34

(260) AM 2020 106713 A
(800) 1509887
(151) 2019 11 26
(181) 2029 11 26
(891) 2019 11 26
(511) 03, 05, 10, 31, 32

(260) AM 2020 106715 A
(800) 1509901
(151) 2019 12 04
(181) 2029 12 04
(891) 2019 12 04
(511) 09, 42

(260) AM 2020 106717 A
(800) 1509961
(151) 2019 11 28
(181) 2029 11 28
(891) 2019 11 28
(511) 03

(260) AM 2020 106719 A
(800) 1509976
(151) 2019 11 19
(181) 2029 11 19
(891) 2019 11 19
(511) 12

(260) AM 2020 106720 A
(800) 1509987
(151) 2019 10 24
(181) 2029 10 24
(891) 2019 10 24
(511) 05

(260) AM 2020 106721 A
(800) 1509999
(151) 2019 12 11
(181) 2029 12 11
(891) 2019 12 11
(511) 03

(260) AM 2020 106722 A
(800) 1510021
(151) 2019 11 19
(181) 2029 11 19
(891) 2019 11 19
(511) 12

(891) 2020 01 09
(511) 35, 36, 41, 42

(260) AM 2020 106741 A
(800) 775729
(151) 2002 02 06
(181) 2022 02 06
(891) 2019 12 06
(511) 29

(260) AM 2020 106919 A
(800) 865125
(151) 2005 08 10
(181) 2025 08 10
(891) 2019 12 12
(511) 06

(260) AM 2020 106852 A
(800) 1510639
(151) 2019 11 26
(181) 2029 11 26
(891) 2019 11 26
(511) 05

(260) AM 2020 106910 A
(800) 1511782
(151) 2019 11 07
(181) 2029 11 07
(891) 2019 11 07
(511) 09, 42

(260) AM 2020 106911 A
(800) 1511805
(151) 2019 12 06
(181) 2029 12 06
(891) 2019 12 06
(511) 05

(260) AM 2020 106912 A
(800) 1511819
(151) 2019 11 05
(181) 2029 11 05
(891) 2019 11 05
(511) 10

(260) AM 2020 106917 A
(800) 706192
(151) 1998 11 23
(181) 2028 11 23
(891) 2020 01 16
(511) 06, 09, 11

(260) AM 2020 106918 A
(800) 856324
(151) 2004 03 17
(181) 2024 03 17

OFFICIAL NOTIFICATIONS

INVENTIONS

EXPIRATION OF PATENT RESTORATION

(21) AP 2012 13496
(11) P 2018 6928 B
(73) Amgen Research (Munich) GMBH;
Amgen Inc.
(54) BINDING MOLECULES FOR BCMA AND CD3
DATE OF CANCELLATION OF PATENT: 2020 11 15
THE TERM OF RESTORATION OF PATENT: 2020 12 25

ABOLITION OF PATENTS WITH THE RIGHT TO RESTORE

(21) AP 2009 12278
(11) P 2014 6003 B
(73) TAKEDA PHARMACEUTICAL COMPANY LIMITED
(54) BENZOTHIAZOLE DERIVATIVES AS ANTICANCER AGENTS
DATE OF CANCELLATION OF PATENT: 2020 12 01
THE TERM OF RESTORATION OF PATENT: 2021 12 01

(21) AP 2013 13312
(11) P 2016 6494 B
(73) Zhora Gabrichidze;
Nani Mikava;
Nata Gogokhia
(54) METHOD FOR SMOKED VODKA PRODUCTION
DATE OF CANCELLATION OF PATENT: 2020 12 05
THE TERM OF RESTORATION OF PATENT: 2021 12 05

(21) AP 2013 13876
(11) P 2017 6740 B
(73) LABORATOIRE HRA-PHARMA
(54) SOLID DISPERSION OF A SELECTIVE MODULATOR OF THE PROGESTERONE RECEPTOR
DATE OF CANCELLATION OF PATENT: 2020 12 05
THE TERM OF RESTORATION OF PATENT: 2021 12 05

(21) AP 2016 14336
(11) P 2018 6815 B
(73) Jimsher Chkhaidze
(54) METHOD FOR WHISKY PREPARATION
DATE OF CANCELLATION OF PATENT: 2020 12 02
THE TERM OF RESTORATION OF PATENT: 2021 12 02

(21) AP 2017 14646
(11) P 2020 7152 B
(73) DAW SE
(54) AQUEOUS COMPOSITION FOR A TINTING SYSTEM, KIT-OF-PARTS TINTING SYSTEM, TINTED PAINT AND PLASTER SYSTEMS AND PAINTS AND PLASTERS OBTAINABLE BY APPLYING THE TINTED PAINT OR PLASTER SYSTEMS
DATE OF CANCELLATION OF PATENT: 2020 12 07
THE TERM OF RESTORATION OF PATENT: 2021 12 07

(21) AP 2016 14719
(11) P 2020 7062 B
(73) Dong-hiun Seo;
Min-kiu Seo;
HYUN ENGINEERING AND CONSTRUCTION CO., LTD
(54) TUNNEL CONSTRUCTION METHOD USING PRE-SUPPORT AND POST-SUPPORT
DATE OF CANCELLATION OF PATENT: 2020 11 23
THE TERM OF RESTORATION OF PATENT: 2021 11 23

(21) AP 2016 14824
(11) P 2020 7104 B
(73) BAYER PHARMA AKTIENGESELLSCHAFT
(54) 2-PHENYL-3-(PIPERAZINOMETHYL)IMIDAZO[1,2-A]PYRIDINE DERIVATIVES AS BLOCKERS OF TASK-1 AND TASK-2 CHANNELS, FOR THE TREATMENT OF SLEEP-RELATED BREATHING DISORDERS
DATE OF CANCELLATION OF PATENT: 2020 12 07
THE TERM OF RESTORATION OF PATENT: 2021 12 07

(21) AP 2018 14938
(11) P 2020 7121 B
(73) Zviad Khmaladze
(54) EQUIPMENT FOR TRANSMISSION NUMBER MULTISTAGE CHANGE
DATE OF CANCELLATION OF PATENT: 2020 11 26
THE TERM OF RESTORATION OF PATENT: 2021 11 26

(21) AP 2002 8281
(11) P 2006 3984 B
(73) GTX Inc.
(54) USE OF SELECTIVE ANDROGEN RECEPTOR MODULATORS FOR TREATING MUSCLE WASTING
DATE OF CANCELLATION OF PATENT: 2020 12 05
THE TERM OF RESTORATION OF PATENT: 2021 12 05

(21) AP 2003 8861
(11) P 2008 4303 B
(73) INTERDIGITAL TECHNOLOGY CORPORATION
(54) OUTER LOOP POWER CONTROL FOR WIRELESS COMMUNICATION SYSTEMS
DATE OF CANCELLATION OF PATENT: 2020 11 25
THE TERM OF RESTORATION OF PATENT: 2021 11 25

EXPIRATION OF TERM OF RESTORATION OF PATENTS

(21) AP 2005 10172

(11) P 2009 4589 B

(73) Aziende Chimiche Riunite Angelini Francesco A.C.R.A.F. S.p.A.

(54) ORALLY DISPERSIBLE PHARMACEUTICAL COMPOSITION AND PROCESS FOR THE PREPARATION THEREOF

DATE OF CANCELLATION OF PATENT: 2019 11 25

THE TERM OF RESTORATION OF PATENT VALIDITY HAS EXPIRED: 2020 11 25

(21) AP 2007 10392

(11) P 2009 4747 B

(73) Les Laboratoires Servier

(54) USE OF AGOMELATINE TO OBTAIN MEDICATION AIMED AT TREATING PERIVENTRICULAR LEUKOMALACIA

DATE OF CANCELLATION OF PATENT: 2019 11 22

THE TERM OF RESTORATION OF PATENT VALIDITY HAS EXPIRED: 2020 11 22

(21) AP 2008 10990

(11) P 2011 5232 B

(73) Kokhta Japaridze;

Tsisana Zurabishvili;

Gia Petriashvili

(54) METHOD FOR RECEPTION OF PHOTSENSITIVE LIQUID-CRYSTAL POLYMERIC FILM AND THE FILM OBTAINED BY THIS METHOD

DATE OF CANCELLATION OF PATENT: 2019 11 27

THE TERM OF RESTORATION OF PATENT VALIDITY HAS EXPIRED: 2020 11 27

(21) AP 2009 12270

(11) P 2014 6072 B

(73) BOEHRINGER INGELHEIM INTERNATIONAL GMBH

(54) NEW COMPOUNDS

DATE OF CANCELLATION OF PATENT: 2019 11 24

THE TERM OF RESTORATION OF PATENT VALIDITY HAS EXPIRED: 2020 11 24

(21) AP 2013 13309

(11) P 2015 6413 B

(73) Les Laboratoires Servier

(54) NEW PROCESS FOR SYNTHESIS OF 3-(2-BROMO-4,5-DIMETHOXYBENZYL) PROPANENITRILE, AND APPLICATION IN SYNTHESIS OF IVABRADINE AND ADDITION SALTS THEREWITH PHARMACEUTICALLY ACCEPTABLE ACID

DATE OF CANCELLATION OF PATENT: 2019 12 04

THE TERM OF RESTORATION OF PATENT VALIDITY HAS EXPIRED: 2020 12 04

(21) AP 2013 13849

(11) P 2017 6710 B

(73) PFIZER LIMITED

(54) IMIDAZOPYRIDAZINE DERIVATIVES AS GABAA RECEPTOR MODULATORS

DATE OF CANCELLATION OF PATENT: 2019 12 04

THE TERM OF RESTORATION OF PATENT VALIDITY HAS EXPIRED: 2020 12 04

(21) AP 2015 14011
(11) P 2017 6654 B
(73) LEPL Rapiel Dvali Institute of Mechanical Engineering
(54) RADIAL-PRESSING MACHINE FOR AXISYMMETRIC ARTICLES PRODUCTION
DATE OF CANCELLATION OF PATENT: 2019 12 07
THE TERM OF RESTORATION OF PATENT VALIDITY HAS EXPIRED: 2020 12 07

(21) AP 2014 14198
(11) P 2018 6847 B
(73) Les Laboratoires Servier
(54) NOVEL METHOD FOR SYNTHESIS OF 7-METHOXY-NAPHTHALENE-1- CARBALDEHYDE AND
USAGE THEREIN SYNTHESIS OF AGOMELATINE
DATE OF CANCELLATION OF PATENT: 2019 12 04
THE TERM OF RESTORATION OF PATENT VALIDITY HAS EXPIRED: 2020 12 04

(21) AP 2016 14333
(11) P 2018 6844 B
(73) Guram Dgebuadze;
Tamaz Batsikadze;
Zurab Razmadze;
Aleksandre Mikaberidze
(54) FACILITY/MODULE FOR CONTROLLED LOWTEMPERATURE NUCLEAR REACTION EXECUTION
DATE OF CANCELLATION OF PATENT: 2019 11 30
THE TERM OF RESTORATION OF PATENT VALIDITY HAS EXPIRED: 2020 11 30

EXPIRATION OF PATENT

(21) AP 2000 6885
(11) P 2006 3808 B
(73) Council of Scientific and Industrial Research
(54) METHOD FOR CHROMATOGRAPHIC FINGER PRINTING AND STANDARDIZATION
OF SINGLE MEDICINES AND FORMULATIONS
EXPIRATION DATE OF THE PATENT: 08 12 2020

UTILITY MODELS

EXPIRATION OF PATENT RESTORATION

(21) AU 2018 14944
(11) U 2019 2023 Y
(73) Revaz Sikharulidze
(54) DEVICE FOR FLEXIBLE ROD
DATE OF CANCELLATION OF PATENT: 2020 11 30
THE TERM OF RESTORATION OF PATENT: 2020 12 25

ABOLITION OF PATENTS WITH THE RIGHT TO RESTORE

(21) AU 2012 12912
(11) U 2015 1855 Y
(73) N(N)LE Tbilisi State Medical University
(54) METHOD OF TRITERPENIC SAPONINS PRODUCTION HAVING ANTIINFLAMMATORY ACTIVITY
AT INFLAMMATIONS OF NOSE APPENDAGES AND AURICLE SINUS
DATE OF CANCELLATION OF PATENT: 2020 12 06
THE TERM OF RESTORATION OF PATENT: 2021 12 06

(21) AU 2013 13297
(11) U 2014 1839 Y
(73) Merab Baghaturia
(54) DEVICE FOR MEAT FOODS HEATING
DATE OF CANCELLATION OF PATENT: 2020 11 25
THE TERM OF RESTORATION OF PATENT: 2021 11 25

(21) AU 2017 14635
(11) U 2019 2012 Y
(73) Omar Mukbanian;
Jimsher Aneli;
Eliza Markarashvili;
Tamar Tatrishvili
(54) POLYMERIC COMPOSIT
DATE OF CANCELLATION OF PATENT: 2020 11 29
THE TERM OF RESTORATION OF PATENT: 2021 11 29

(21) AU 2018 14942
(11) U 2019 2025 Y
(73) Akaki Gigineishvili;
David Dadiani;
Teimuraz Dadiani;
David Gzirishvili;
Tengiz Kukava;
Yuri Sichinava
(54) APPARATUS FOR DESTRUCTION OF MARBLE BUGS WITH ELECTRICITY
DATE OF CANCELLATION OF PATENT: 2020 11 27
THE TERM OF RESTORATION OF PATENT: 2021 11 27

(21) AU 2018 14944
(11) U 2019 2023 Y
(73) Revaz Sikharulidze
(54) DEVICE FOR FLEXIBLE ROD
DATE OF CANCELLATION OF PATENT: 2020 11 30
THE TERM OF RESTORATION OF PATENT: 2022 11 30

EXPIRATION OF TERM OF RESTORATION OF PATENTS

(21) AU 2011 12492
(11) U 2013 1761 Y
(73) LTD "AVERSI-RATIONAL"
(54) ADRENO- AND DOPAMINOMIMETIC DRUG SHAPED AS STERILE CONCENTRATE
DATE OF CANCELLATION OF PATENT: 2019 12 06
THE TERM OF RESTORATION OF PATENT VALIDITY HAS EXPIRED: 2020 12 06

(21) AU 2011 12493
(11) U 2013 1762 Y
(73) LTD "AVERSI-RATIONAL"
(54) COMBINED HEPATOPROTECTIVE VEGETABLE PREPARATION SHAPED AS CAPSULE
DATE OF CANCELLATION OF PATENT: 2019 12 06
THE TERM OF RESTORATION OF PATENT VALIDITY HAS EXPIRED: 2020 12 06

(21) AU 2012 12914
(11) U 2014 1801 Y
(73) LTD "AVERSI-RATIONAL"
(54) COMBINED PLANT PARATHERAPEUTIC AGENT FOR MEMORY STIMULATION IN AS SYRUP
DATE OF CANCELLATION OF PATENT: 2019 12 07
THE TERM OF RESTORATION OF PATENT VALIDITY HAS EXPIRED: 2020 12 07

(21) AU 2012 12915
(11) U 2014 1802 Y
(73) LTD "AVERSI-RATIONAL"
(54) COMBINED PLANT PARATHERAPEUTIC AGENT FOR MEMORY STIMULATION AS CAPSULE
DATE OF CANCELLATION OF PATENT: 2019 12 07
THE TERM OF RESTORATION OF PATENT VALIDITY HAS EXPIRED: 2020 12 07

(21) AU 2012 12916
(11) U 2013 1795 Y
(73) LTD "AVERSI-RATIONAL"
(54) ANTIHYPERTENSIVE THERAPEUTIC AGENT – NONBLON H
DATE OF CANCELLATION OF PATENT: 2019 12 07
THE TERM OF RESTORATION OF PATENT VALIDITY HAS EXPIRED: 2020 12 07

(21) AU 2012 12918
(11) U 2013 1779 Y
(73) LTD "AVERSI-RATIONAL"
(54) COMBINED VEGETABLE PREPARATION OF HEPATOPROTECTIVE ACTIVITY AS SYRUP
DATE OF CANCELLATION OF PATENT: 2019 12 07
THE TERM OF RESTORATION OF PATENT VALIDITY HAS EXPIRED: 2020 12 07

TRANSFER OF RIGHT

(21) AU 2012 12659

(11) U 2013 1772 Y

(54) DEVICE FOR SYRINGE

New patentowner and address: Otar Chichinadze (GE)
Pekin St. 7, app. 61, 0171, Tbilisi, Georgia (GE)

Former patentowner and address: Gocha Chichinadze (GE)
Pekin St. 7, app. 62, 0171, Tbilisi, Georgia (GE)

Date of registered: 04 12 2020

DESIGN

EXTENSION OF REGISTRATION OF DESIGN

(11) D 2016 676 S

(73) Leonid Ezik (GE)

Vil. Khutsubani, 6200, Kobuleti, Georgia (GE)

(54) FACING CONCRETE SLAB

(28) 1

(24) 2015 08 18

(18) 2025 08 18

(58) 2020 12 05

TRADEMARKS

RENEWAL OF REGISTRATIONS

(111) M 2001 14004 R2
(156) 2001 09 12
(186) 2031 09 12
(732) EXXON MOBIL CORPORATION
5959 Las Colinas Boulevard, Irving, Texas
75039-2298, USA

(111) M 2000 13354 R2
(156) 2000 06 09
(186) 2030 06 09
(732) Berloni Group S.R.L.
Via Bartolucci 3, Pesaro, Italy

(111) M 2000 13355 R2
(156) 2000 06 09
(186) 2030 06 09
(732) Berloni Group S.R.L.
Via Bartolucci 3, Pesaro, Italy

(111) M 2001 14126 R2
(156) 2001 10 31
(186) 2031 10 31
(732) EXXON MOBIL CORPORATION
5959 Las Colinas Boulevard, Irving, Texas
75039-2298, USA

(111) M 2000 13458 R2
(156) 2000 09 11
(186) 2030 09 11
(732) ViiV Healthcare UK Limited
980 Great West Road, Brentford, Middlesex
9GS, United Kingdom

(111) M 2001 13756 R2
(156) 2001 02 20
(186) 2031 02 20
(732) MASTERCARD INTERNATIONAL
INCORPORATED
2000 Purchase Street, Purchase, New York
10577-2405, USA

(111) M 2001 14125 R2
(156) 2001 10 31
(186) 2031 10 31
(732) EXXON MOBIL CORPORATION
5959 Las Colinas Boulevard, Irving, Texas
75039-2298, USA

(111) M 2000 13642 R2
(156) 2000 12 21
(186) 2030 12 21
(732) FORD MOTOR COMPANY (a Delaware
corporation)
One American Road, Dearborn, Michigan
48126, USA

(111) M 2000 13643 R2
(156) 2000 12 21
(186) 2030 12 21
(732) FORD MOTOR COMPANY (a Delaware
corporation)
One American Road, Dearborn, Michigan
48126, USA

(111) M 2000 13644 R2
(156) 2000 12 21
(186) 2030 12 21
(732) FORD MOTOR COMPANY (a Delaware
corporation)
One American Road, Dearborn, Michigan
48126, USA

(111) M 2000 13645 R2
(156) 2000 12 21
(186) 2030 12 21
(732) FORD MOTOR COMPANY (a Delaware
corporation)
One American Road, Dearborn, Michigan
48126, USA

(111) M 2000 13646 R2
(156) 2000 12 21
(186) 2030 12 21
(732) FORD MOTOR COMPANY (a
corporation)
One American Road, Dearborn, Michigan
48126, USA

(111) M 2000 13647 R2
(156) 2000 12 21
(186) 2030 12 21
(732) FORD MOTOR COMPANY (a Delaware
corporation)
One American Road, Dearborn, Michigan
48126, USA

(111) M 2001 13684 R2
(156) 2001 01 22
(186) 2031 01 22
(732) The Coca-Cola Company
One Coca-Cola Plaza, Atlanta, Georgia
30313, USA

(111) M 2001 13685 R2
(156) 2001 01 22
(186) 2031 01 22
(732) The Coca-Cola Company
One Coca-Cola Plaza, Atlanta, Georgia
30313, USA

(111) M 2001 13703 R2
(156) 2001 01 30
(186) 2031 01 30
(732) CTBAT International Co. Limited
29 th Floor Oxford House, Taikoo Place, 979
King's Road, Island East, Hong Kong

(111) M 2001 13761 R2
(156) 2001 02 22
(186) 2031 02 22
(732) MOSCHINO S.P.A.
San Giovanni in Marignano, via delle Querce
No. 51, Italy

(111) M 2001 13779 R2
(156) 2001 02 22
(186) 2031 02 22
(732) Bayer Intellectual Property GmbH
Alfred-Nobel-Strasse 10, 40789 Monheim
am Rhein, Germany

(111) M 2001 13808 R2
(156) 2001 03 02
(186) 2031 03 02
(732) Alcon Inc.
Rue Louis-d'Affry 6, CH-1701 Fribourg,
Switzerland

(111) M 2001 14112 R2
(156) 2001 10 30
(186) 2031 10 30
(732) 3M COMPANY
3M Center, 2501 Hudson Road, St. Paul,
Minnesota 55144, USA

(111) M 2010 20627 R1
(156) 2010 07 28
(186) 2030 07 28
(732) JSC "BADAGONI"
Vill. Khodasheni, 0910, Akhmeta District,
Georgia

(111) M 2010 20628 R1
(156) 2010 07 28
(186) 2030 07 28
(732) JSC "BADAGONI"
Vill. Khodasheni, 0910, Akhmeta District,
Georgia

(111) M 2010 20629 R1
(156) 2010 07 28
(186) 2030 07 28
(732) JSC "BADAGONI"
Vill. Khodasheni, 0910, Akhmeta District,
Georgia

(111) M 2011 21304 R1
(156) 2011 03 24
(186) 2031 03 24
(732) Diversey Inc.
8310 16th Street, Sturtevant, WI 53177
-1964, USA

(111) M 2010 20958 R1
(156) 2010 11 30
(186) 2030 11 30
(732) BASF Agro Trademarks GmbH
Carl-Bosch-Strasse 38, Ludwigshafen,
Germany

(111) M 2010 20862 R1
(156) 2010 10 20
(186) 2030 10 20
(732) ViiV Healthcare UK Limited
980 Great West Road, Brentford, Middlesex
TW8 9GS, United Kingdom

(111) M 2011 21089 R1
(156) 2011 01 25
(186) 2031 01 25
(732) LTD MISO "SMART FINANCE"
Rustavelis gamz. da Tseretli St. 1/2, Qutaisi,
4600, Georgia

(111) M 2011 21121 R1
(156) 2011 02 10
(186) 2031 02 10
(732) Herbalife International Inc.
800 W. Olympic Blvd., suite 406,
Los Angeles, CA 90015, USA

(111) M 2011 22050 R1
(156) 2011 12 08
(186) 2031 12 08
(732) LTD "WONDERLAND"
K. Gamsakhurdia St. 36, 6000, Batumi,
Georgia

(111) M 2011 21122 R1
(156) 2011 02 10
(186) 2031 02 10
(732) Herbalife International Inc.
800 W. Olympic Blvd., suite 406,
Los Angeles, CA 90015, USA

(111) M 2011 21123 R1
(156) 2011 02 10
(186) 2031 02 10
(732) Herbalife International Inc.
800 W. Olympic Blvd., suite 406,
Los Angeles, CA 90015, USA

(111) M 2011 21124 R1
(156) 2011 02 10
(186) 2031 02 10
(732) Herbalife International Inc.
800 W. Olympic Blvd., suite 406,
Los Angeles, CA 90015, USA

(111) M 2011 21126 R1
(156) 2011 02 10
(186) 2031 02 10
(732) Herbalife International Inc.
800 W. Olympic Blvd., suite 406,
Los Angeles, CA 90015, USA

(111) M 2011 21127 R1
(156) 2011 02 10
(186) 2031 02 10
(732) Herbalife International Inc.
800 W. Olympic Blvd., suite 406,
Los Angeles, CA 90015, USA

(111) M 2011 21953 R1
(156) 2011 10 28
(186) 2031 10 28
(732) Future Enterprises Pte Ltd
31 Harrison Road, №08-01 Food Empire
Business Suites, Singapore 369649,
Singapore

COMPLETE TRANSFER OF RIGHTS

(111) M 2016 27861 R
(732) Yanmar Holdings Co., Ltd.
1-32, Chayamachi, Kita-ku, Osaka, Japan
(770) YANMAR POWER TECHNOLOGY CO.,
LTD
1-32, Chayamachi, Kita-ku, Osaka, Japan
(580) 2020 12 01

(111) M 2019 31413 R
(732) Giorgi Arazashvili
Dolidze St. 5, app. 7, Tbilisi, Georgia
(770) Oleksandr Ishchuk
Nutsbidze St. 26a, app. 83, 0186, Tbilisi,
Georgia
(580) 2020 11 20

(111) M 2016 27184 R
(732) LTD International Tobacco Corporation
Davit Agmashenebeli Av. 4-6, app. 12,
Kutaisi, Georgia
(770) Gocha Giorkhelidze
J. Shartava St. 36, app. 1, 0160, Tbilisi,
Georgia
(580) 2020 12 08

(111) M 2018 29545 R
(732) LTD "ZOOHAB"
Giorgi Tch kondideli St. 109, Floor 6, app. 45,
Nadzaladevi Distric, Tbilisi, Georgia
(770) LTD "ZOO HAB"
Akhaldaba St. 61, Nadzaladevi Distric,
Tbilisi, Georgia
(580) 2020 12 08

(111) M 2019 31400 R
(732) Travco Group International Holding S.A.E.
26th of July corri9dor, Sheikh Zayed, Giza,
(770) Steigenberger Hotels AG
Lyoner Str. 25, Frankfurt 60528, Germany
(580) 2020 11 30

(111) M 2019 31401 R
(732) Travco Group International Holding S.A.E.
26th of July corri9dor, Sheikh Zayed, Giza,
Egypt
(770) Steigenberger Hotels AG
Lyoner Str. 25, Frankfurt 60528, Germany
(580) 2020 11 30

(111) M 2019 31402 R
(732) Travco Group International Holding S.A.E.
26th of July corri9dor, Sheikh Zayed, Giza,
Egypt
(770) Steigenberger Hotels AG
Lyoner Str. 25, Frankfurt 60528, Germany
(580) 2020 11 30

CHANGES OF NAMES AND/OR ADDRESS OF OWNERS

(111) M 2020 32301 R
(732) ADP Inc.
Uan ADp Boulevard, Roseland, New Jersey,
07068, USA
(770) ADP, LLC
Uan ADp Boulevard, Roseland, New Jersey
07068, USA
(580) 2020 12 10

(111) M 2020 32307 R
(732) ADP Inc.
One ADP Boulevard, Roseland, New Jersey
07068, USA
(770) ADP, Llc
One ADP Boulevard, Roseland, New Jersey
07068, USA
(580) 2020 12 10

(111) M 2000 13642 R
(732) FORD MOTOR COMPANY (a Delaware
corporation)
One American Road, Dearborn, Michigan
48126, USA
(770) FORD MOTOR COMPANY (a Delaware
corporation)
The American Road, Dearborn, Michigan
48121, USA
(580) 2020 10 27

(111) M 2000 13643 R
(732) FORD MOTOR COMPANY (a Delaware
corporation)
One American Road, Dearborn, Michigan
48126, USA
(770) FORD MOTOR COMPANY (a Delaware
corporation)
The American Road, Dearborn, Michigan
48121, USA
(580) 2020 10 27

(111) M 2000 13644 R
(732) FORD MOTOR COMPANY (a Delaware
corporation)
One American Road, Dearborn, Michigan
48126, USA
(770) FORD MOTOR COMPANY (a Delaware
corporation)
The American Road, Dearborn, Michigan
48121, USA
(580) 2020 10 27

(111) M 2000 13645 R
(732) FORD MOTOR COMPANY (a Delaware
corporation)
One American Road, Dearborn, Michigan
48126, USA
(770) FORD MOTOR COMPANY (a Delaware
corporation)
The American Road, Dearborn, Michigan
48121, USA
(580) 2020 10 27

(111) M 2000 13646 R
(732) FORD MOTOR COMPANY (a Delaware
corporation)
One American Road, Dearborn, Michigan
48126, USA
(770) FORD MOTOR COMPANY (a Delaware
corporation)
The American Road, Dearborn, Michigan
48121, USA
(580) 2020 10 27

(111) M 2000 13647 R
(732) FORD MOTOR COMPANY (a Delaware
corporation)
One American Road, Dearborn, Michigan
48126, USA
(770) FORD MOTOR COMPANY (a Delaware
corporation)
The American Road, Dearborn, Michigan
48121, USA
(580) 2020 10 27

(111) M 2016 27861 R
(732) YANMAR POWER TECHNOLOGY CO.,
LTD.
1-32, Chayamachi, Kita-ku, Osaka, Japan
(770) YANMAR CO., LTD
1-32, Chayamachi, Kita-ku, Osaka, Japan
(580) 2020 12 01

(111) M 2017 28169 R
(732) Victoria's Secret Stores Brand Management
LLC
4 Limited Parkway, Reynoldsburg
Ohio 43068, USA
(770) Victoria's Secret Stores Brand Management
Inc.
4 Limited Parkway, Reynoldsburg
Ohio 43068, USA
(580) 2020 12 01

(111) M 2017 28172 R
(732) Victoria's Secret Stores Brand Management
LLC
4 Limited Parkway, Reynoldsburg
Ohio 43068, USA
(770) Victoria's Secret Stores Brand Management
Inc.
4 Limited Parkway, Reynoldsburg
43068, USA
(580) 2020 12 01

(111) M 2017 28165 R
(732) Victoria's Secret Stores Brand Management
LLC
4 Limited Parkway, Reynoldsburg
Ohio 43068, USA
(770) Victoria's Secret Stores Brand Management
Inc.
4 Limited Parkway, Reynoldsburg
Ohio 43068, USA
(580) 2020 12 01

(111) M 2017 28166 R
(732) Victoria's Secret Stores Brand Management
LLC
4 Limited Parkway, Reynoldsburg
Ohio 43068, USA
(770) Victoria's Secret Stores Brand Management
Inc.
4 Limited Parkway, Reynoldsburg
Ohio 43068, USA
(580) 2020 12 01

(111) M 2017 28167 R
(732) Victoria's Secret Stores Brand Management
LLC
4 Limited Parkway, Reynoldsburg
Ohio 43068, USA
(770) Victoria's Secret Stores Brand Management,
Inc.
4 Limited Parkway, Reynoldsburg
Ohio 43068, USA
(580) 2020 12 01

(111) M 2017 28168 R
(732) Victoria's Secret Stores Brand Management
LLC
4 Limited Parkway, Reynoldsburg
43068, USA
(770) Victoria's Secret Stores Brand Management
Inc.
4 Limited Parkway, Reynoldsburg
Ohio 43068, USA
(580) 2020 12 01

(111) M 2017 28170 R
(732) Victoria's Secret Stores Brand Management,
LLC
4 Limited Parkway, Reynoldsburg
Ohio 43068, USA
(770) Victoria's Secret Stores Brand Management
Inc.
4 Limited Parkway, Reynoldsburg
Ohio 43068, USA
(580) 2020 12 01

(111) M 2017 28171 R
(732) Victoria's Secret Stores Brand Management
LLC
4 Limited Parkway, Reynoldsburg
Ohio 43068, USA
(770) Victoria's Secret Stores Brand Management
Inc.
4 Limited Parkway, Reynoldsburg
Ohio 43068, USA
(580) 2020 12 01

(111) M 2017 28173 R
(732) Victoria's Secret Stores Brand Management
LLC
4 Limited Parkway, Reynoldsburg
Ohio 43068, USA
(770) Victoria's Secret Stores Brand Management
Inc.
4 Limited Parkway, Reynoldsburg
Ohio 43068, USA
(580) 2020 12 01

(111) M 2018 29410 R
(732) ALLERGAN HOLDINGS France SAS
Tour CBX, 1 Passerelle des Reflets,
92400 Courbevoie, France
(770) ALLERGAN HOLDINGS France SAS
12 Place de la Defense, 4eme etage,
92400, Courbevoie, France
(580) 2020 12 02

(111) M 2019 31216 R
(732) Waterwipes Unlimited Company
Donor Industrial ESTATE, Co Louth, Ireland
(770) Irish Breeze Unlimited Company
Donor Industrial ESTATE, Drogheda,
Co Louth, Ireland
(580) 2020 11 06

(111) M 2019 31728 R

(732) ALLERGAN HOLDINGS France SAS

Tour CBX, 1 Passerelle des Reflets,

92400 Courbevoie, France

(770) ALLERGAN HOLDINGS France SAS

12 Place de la Defense, 4eme etage,

92400, Courbevoie, France

(580) 2020 12 02

TERMINATION OF TRADEMARKS REGISTRATION

(111) M 2000 13314 R
(151) 2000 05 30
(732) American-Cigarette Company (Overseas)
Limited
Zählerweg 4, CH-6300 Zug, Switzerland
(141) 2020 12 16

(111) M 2000 13315 R
(151) 2000 05 30
(732) American-Cigarette Company (Overseas)
Limited
Zählerweg 4, CH-6300 Zug, Switzerland
(141) 2020 12 16

(111) M 2000 13316 R
(151) 2000 05 30
(732) American-Cigarette Company (Overseas)
Limited
Zählerweg 4, CH-6300 Zug, Switzerland
(141) 2020 12 16

(111) M 2000 13311 R
(151) 2000 05 30
(732) Harrington Development Inc.
Arango-Orillac Bldg. East 54 th street,
Republic of Panama
(141) 2020 12 16

(111) M 2000 13312 R
(151) 2000 05 30
(732) Harrington Development Inc.
Arango-Orillac Bldg. East 54 th street,
Republic of Panama
(141) 2020 12 16

(111) M 2000 13313 R
(151) 2000 05 30
(732) Harrington Development Inc.
Arango-Orillac Bldg. East 54 th street,
Panama, Republic of Panama
(141) 2020 12 16

(111) M 2010 20491 R
(151) 2010 05 27
(732) Intersun Holding FZCO
P.O. box: 61051, Jebel Ali Free Zone, Dubai,
United Arab Emirates
(141) 2020 12 14

(111) M 2010 20492 R
(151) 2010 05 27
(732) ENISELI WINES
Mtskheta St. 28, 0179, Tbilisi, Georgia
(141) 2020 12 14

(111) M 2010 20493 R
(151) 2010 05 27
(732) Wm. Wrigley Jr. Company
410 North Michigan Avenue, Chicago,
Illinois 60611, USA
(141) 2020 12 14

(111) M 2010 20494 R
(151) 2010 05 27
(732) Wm. Wrigley Jr. Company
410 North Michigan Avenue, Chicago,
Illinois 60611, USA
(141) 2020 12 14

(111) M 2010 20497 R
(151) 2010 05 27
(732) LTD "TOPIVERTA"
Sanapiro St. 10, 0112 Tbilisi, Georgia
(141) 2020 12 14

(111) M 2010 20498 R
(151) 2010 05 27
(732) JSC "Nobel Ilac Sanayii Ve Ticaret Anonim
Sirketi" Representation in Georgia
Tavisuplebis Moedani 4, 0105, Tbilisi,
Georgia
(141) 2020 12 14

(111) M 2010 20500 R
(151) 2010 05 27
(732) Alcon Inc.
Rue Louis-d'Affry 6, CH-1701 Fribourg,
Switzerland
(141) 2020 12 14

(111) M 2010 20506 R
(151) 2010 05 27
(732) Philip Morris Brands SARL
Quai Jeanrenaud 3, 2000 Neuchâtel,
Switzerland
(141) 2020 12 14

(111) M 2010 20507 R
(151) 2010 05 27
(732) Philip Morris Brands SARL
 Quai Jeanrenaud 3, 2000 Neuchâtel,
 Switzerland
(141) 2020 12 14

(111) M 2010 20508 R
(151) 2010 05 27
(732) Philip Morris Brands SARL
 Quai Jeanrenaud 3, 2000 Neuchâtel,
 Switzerland
(141) 2020 12 14

(111) M 2010 20509 R
(151) 2010 05 27
(732) Al Jaber Aviation LLC
 P.O, Box 2175, Al Musaffah Industrial Sity,
 Abu Dhabi, United Arab Emirates
(141) 2020 12 14

(111) M 2010 20513 R
(151) 2010 05 27
(732) Sun Pharmaceuticals Industries Limited
 SPARC, Tandalja, Vadodara - 390 020,
 Gujarat, India
(141) 2020 12 14

(111) M 2010 20514 R
(151) 2010 05 27
(732) Ranbaxy Laboratories Limited
 Plot N 90, Sector-32, Gurgaon-122001,
 Haryana, India
(141) 2020 12 14

(111) M 2010 20517 R
(151) 2010 05 27
(732) Phaik Kopchiev
 Tsinanauri St. 77, 0114, Tbilisi, Georgia
(141) 2020 12 14

REGISTRATION OF LICENSE AGREEMENTS

(800) 1459532
(732) Pierre Cardin
59, rue du Faubourg Saint-Honoré, F-75008
PARIS, France
(791) Societe de Gestion Pierre Cardin
59, Rue du Foubourg Saint-Honore, 75008
Paris, France
(793) №1616
Exclusive
Validity period: from 03 04 2001
to 31 12 2061
Class: 18, 25

(800) 332384
(732) Pierre Cardin
59,rue du Faubourg Saint-Honore, F-75008
PARIS, France
(791) Societe de Gestion Pierre Cardin
59, Rue du Foubourg Saint-Honore, 75008
Paris, France
(793) №1617
Exclusive
Validity period: from 03 04 2001
to 31 12 2061
Class: 3

(800) 803664
(732) Pierre Cardin
59, rue du Faubourg Saint Honore, F-75008
PARIS, France
(791) Societe de Gestion Pierre Cardin
59, Rue du Foubourg Saint-Honore, 75008
Paris, France
(793) №1618
Exclusive
Validity period: from 03 04 2001
to 31 12 2061
Class:25

(800) 1116533
(732) Pierre Cardin
59, rue du Faubourg Saint Honore, F-75008
PARIS, France
(791) Societe de Gestion Pierre Cardin
59, Rue du Foubourg Saint-Honore, 75008
Paris, France
(793) №1619
Exclusive
Validity period: from 03 04 2001
to 31 12 2061
Class:10, 12, 18, 20

CLASSIFICATION INDEXES

INVENTIONS

CONCORDANCE TABLE OF INTERNATIONAL CLASSIFICATION INDEX AND PUBLICATION NUMBERS

INTERNATIONAL CLASSIFICATION INDEXES (51)	NUMBER OF PUBLISHED APPLICATION (10)
A 61 F 9/007	AP 2020 15102 A
A 61 K 9/08; A 61 K 47/26; A 61 K 47/10; A 61 K 47/14; A 61 K 9/00; A 61 K 39/395; A 61 K 39/00	AP 2020 14966 A
A 61 K 9/127; A 61 K 31/519; A 61 P 35/00	AP 2020 15047 A
A 61 K 31/4985; A 61 P 25/28; A 61 P 29/00; A 61 P 37/02; C 07 D 487/04	AP 2020 14864 A
C 04 B 21/00	AP 2020 15125 A

CONCORDANCE TABLE OF PUBLICATION NUMBERS AND INTERNATIONAL CLASSIFICATION INDEX

NUMBER OF PUBLISHED APPLICATION (10)	INTERNATIONAL CLASSIFICATION INDEXES (51)
AP 2020 14864 A	A 61 K 31/4985; A 61 P 25/28; A 61 P 29/00; A 61 P 37/02; C 07 D 487/04
AP 2020 14966 A	A 61 K 9/08; A 61 K 47/26; A 61 K 47/10; A 61 K 47/14; A 61 K 9/00; A 61 K 39/395; A 61 K 39/00
AP 2020 15047 A	A 61 K 9/127; A 61 K 31/519; A 61 P 35/00
AP 2020 15102 A	A 61 F 9/007
AP 2020 15125 A	C 04 B 21/00

**CONCORDANCE TABLE OF INTERNATIONAL CLASSIFICATION INDEX,
PATENT NUMBERS AND PUBLICATION NUMBERS**

INTERNATIONAL CLASSIFICATION INDEX (51)	NUMBER OF PATENT (11)	NUMBER OF PUBLISHED APPLICATION (10)
A 01 N 53/00; A 01 N 35/04; A 01 P 7/02; A 01 P 7/04	P 2020 7203 B	AP 2020 15137 A
A 61 K 9/08; A 61 K 31/194; A 61 K 31/455; A 61 K 31/675; A 61 K 31/708; A 61 K 47/02; A 61 K 47/18	P 2020 7194 B	AP 2020 15060 A
A 61 K 9/20; A 61 K 9/28; A 61 K 9/24; A 61 K 9/48	P 2020 7208 B	AP 2020 14156 A
A 61 K 31/436; A 61 P 27/02	P 2020 7204 B	AP 2020 14989 A
A 61 K 31/437; A 61 K 31/519; A 61 P 11/06; C 07 D 471/04; C 07 D 487/04; C 07 D 519/00	P 2020 7202 B	AP 2020 15169 A
A 61 K 31/519; A 61 P 9/00; A 61 P 9/10; A 61 P 9/12; A 61 P 9/04; C 07 D 487/04	P 2020 7205 B	AP 2020 14831 A
C 08 K 5/098; C 09 D 167/08	P 2020 7199 B	AP 2020 14587 A
D 06 P 1/52; D 06 P 5/30; D 06 P 5/00	P 2020 7192 B	AP 2020 14825 A
E 01 B 9/30; E 01 B 9/10; E 01 B 9/02; F 16 B 35/04; F 16 B 5/02	P 2020 7193 B	AP 2020 15022 A
E 01 F 7/04	P 2020 7207 B	AP 2020 14926 A
E 02 D 5/02	P 2020 7201 B	AP 2020 14645 A
G 01 T 1/00	P 2020 7206 B	AP 2020 15190 A
G 06 F 1/16	P 2020 7195 B	AP 2020 15012 A
G 06 F 3/02; G 06 K 9/00	P 2020 7198 B	AP 2020 14953 A
G 07 D 7/202; G 07 D 7/1205	P 2020 7196 B	AP 2020 14962 A
G 07 D 7/1205; G 07 D 7/202	P 2020 7197 B	AP 2020 14961 A
F 22 B 1/28; H 05 B 6/10	P 2020 7200 B	AP 2020 15260 A

**CONCORDANCE TABLE OF PATENT NUMBERS,
PUBLICATION NUMBERS AND INTERNATIONAL CLASSIFICATION INDEX**

NUMBER OF PATENT (11)	NUMBER OF PUBLISHED APPLICATION (10)	INTERNATIONAL CLASSIFICATION INDEX (51)
P 2020 7192 B	AP 2020 14825 A	D 06 P 1/52; D 06 P 5/30; D 06 P 5/00
P 2020 7193 B	AP 2020 15022 A	E 01 B 9/30; E 01 B 9/10; E 01 B 9/02; F 16 B 35/04; F 16 B 5/02
P 2020 7194 B	AP 2020 15060 A	A 61 K 9/08; A 61 K 31/194; A 61 K 31/455; A 61 K 31/675; A 61 K 31/708; A 61 K 47/02; A 61 K 47/18
P 2020 7195 B	AP 2020 15012 A	G 06 F 1/16
P 2020 7196 B	AP 2020 14962 A	G 07 D 7/202; G 07 D 7/1205
P 2020 7197 B	AP 2020 14961 A	G 07 D 7/1205; G 07 D 7/202
P 2020 7198 B	AP 2020 14953 A	G 06 F 3/02; G 06 K 9/00
P 2020 7199 B	AP 2020 14587 A	C 08 K 5/098; C 09 D 167/08
P 2020 7200 B	AP 2020 15260 A	F 22 B 1/28; H 05 B 6/10
P 2020 7201 B	AP 2020 14645 A	E 02 D 5/02
P 2020 7202 B	AP 2020 15169 A	A 61 K 31/437; A 61 K 31/519; A 61 P 11/06; C 07 D 471/04; C 07 D 487/04; C 07 D 519/00
P 2020 7203 B	AP 2020 15137 A	A 01 N 53/00; A 01 N 35/04; A 01 P 7/02; A 01 P 7/04
P 2020 7204 B	AP 2020 14989 A	A 61 K 31/436; A 61 P 27/02
P 2020 7205 B	AP 2020 14831 A	A 61 K 31/519; A 61 P 9/00; A 61 P 9/10; A 61 P 9/12; A 61 P 9/04; C 07 D 487/04
P 2020 7206 B	AP 2020 15190 A	G 01 T 1/00
P 2020 7207 B	AP 2020 14926 A	E 01 F 7/04
P 2020 7208 B	AP 2020 14156 A	A 61 K 9/20; A 61 K 9/28; A 61 K 9/24; A 61 K 9/48

**CONCORDANCE TABLE OF APPLICATION NUMBERS, PUBLICATION NUMBERS
AND PATENTS**

NUMBER OF APPLICATION (21)	NUMBER OF PUBLISHED APPLICATION (10)	NUMBER OF PATENT (11)
AP 2013 14156	AP 2020 14156 A	P 2020 7208 B
AP 2017 14587	AP 2020 14587 A	P 2020 7199 B
AP 2016 14645	AP 2020 14645 A	P 2020 7201 B
AP 2016 14825	AP 2020 14825 A	P 2020 7192 B
AP 2016 14831	AP 2020 14831 A	P 2020 7205 B
AP 2018 14926	AP 2020 14926 A	P 2020 7207 B
AP 2017 14953	AP 2020 14953 A	P 2020 7198 B
AP 2017 14962	AP 2020 14962 A	P 2020 7196 B
AP 2017 14961	AP 2020 14961 A	P 2020 7197 B
AP 2017 14989	AP 2020 14989 A	P 2020 7204 B
AP 2019 15012	AP 2020 15012 A	P 2020 7195 B
AP 2017 15022	AP 2020 15022 A	P 2020 7193 B
AP 2017 15060	AP 2020 15060 A	P 2020 7194 B
AP 2019 15137	AP 2020 15137 A	P 2020 7203 B
AP 2018 15169	AP 2020 15169 A	P 2020 7202 B
AP 2019 15190	AP 2020 15190 A	P 2020 7206 B
AP 2018 15260	AP 2020 15260 A	P 2020 7200 B

UTILITY MODELS

CONCORDANCE TABLE OF INTERNATIONAL CLASSIFICATION INDEX AND PUBLICATION NUMBERS

INTERNATIONAL CLASSIFICATION INDEXES (51)	NUMBER OF PUBLISHED APPLICATION (10)
A 61 F 13/15	AU 2020 15270 U
E 02 B 8/06	AU 2020 15290 U
F 03 B 13/00	AU 2020 15358 U

CONCORDANCE TABLE OF PUBLICATION NUMBERS AND INTERNATIONAL CLASSIFICATION INDEX

NUMBER OF PUBLISHED APPLICATION (10)	INTERNATIONAL CLASSIFICATION INDEXES (51)
AU 2020 15270 U	A 61 F 13/15
AU 2020 15290 U	E 02 B 8/06
AU 2020 15358 U	F 03 B 13/00

CONCORDANCE TABLE OF INTERNATIONAL CLASSIFICATION INDEX, PATENT NUMBERS AND PUBLICATION NUMBERS

INTERNATIONAL CLASSIFICATION INDEX (51)	NUMBER OF PATENT (11)	NUMBER OF PUBLISHED APPLICATION (10)
A 41 D 13/11	U 2020 2063 Y	AU 2020 15312 U

CONCORDANCE TABLE OF PATENT NUMBERS, PUBLICATION NUMBERS AND INTERNATIONAL CLASSIFICATION INDEX

NUMBER OF PATENT (11)	NUMBER OF PUBLISHED APPLICATION (10)	INTERNATIONAL CLASSIFICATION INDEX (51)
U 2020 2063 Y	AU 2020 15312 U	A 41 D 13/11

CONCORDANCE TABLE OF APPLICATION NUMBERS, PUBLICATION NUMBERS AND PATENTS

NUMBER OF APPLICATION (21)	NUMBER OF PUBLISHED APPLICATION (10)	NUMBER OF PATENT (11)
AU 2020 15312	AU 2020 15312 U	U 2020 2063 Y

DESIGNS

CONCORDANCE TABLE OF INTERNATIONAL CLASSIFICATION INDEX AND PUBLICATION NUMBERS

INTERNATIONAL CLASSIFICATION INDEXES (51)	NUMBER OF PUBLISHED APPLICATION (10)
06-01	AD 2020 1173 S
07-02	AD 2020 1174 S
19-08	AD 2020 1176 S
32-00	AD 2020 1165 S
32-00	AD 2020 1166 S
32-00	AD 2020 1167 S
32-00	AD 2020 1168 S
32-00	AD 2020 1169 S
32-00	AD 2020 1170 S
32-00	AD 2020 1171 S

CONCORDANCE TABLE OF PUBLICATION NUMBERS AND INTERNATIONAL CLASSIFICATION INDEX

NUMBER OF PUBLISHED APPLICATION (10)	INTERNATIONAL CLASSIFICATION INDEXES (51)
AD 2020 1165 S	32-00
AD 2020 1166 S	32-00
AD 2020 1167 S	32-00
AD 2020 1168 S	32-00
AD 2020 1169 S	32-00
AD 2020 1170 S	32-00
AD 2020 1171 S	32-00
AD 2020 1173 S	06-01
AD 2020 1174 S	07-02
AD 2020 1176 S	19-08

DESIGN REGISTERED ACCORDING TO THE ACCELERATED PROCEDURE

CONCORDANCE TABLE OF INTERNATIONAL CLASSIFICATION INDEX AND PUBLICATION NUMBERS

INTERNATIONAL CLASSIFICATION INDEXES (51)	NUMBER OF PUBLISHED APPLICATION (11)
09-01	D 2020 873 S

CONCORDANCE TABLE OF PUBLICATION NUMBERS AND INTERNATIONAL CLASSIFICATION INDEX

NUMBER OF PUBLISHED APPLICATION (11)	INTERNATIONAL CLASSIFICATION INDEXES (51)
D 2020 873 S	09-01

CONCORDANCE TABLE OF APPLICATION NUMBERS, PUBLICATION NUMBERS AND PATENTS

NUMBER OF APPLICATION (21)	NUMBER OF PATENT (11)
AD 2020 1193	D 2020 873 S

TRADEMARKS

CONCORDANCE TABLE OF REGISTRATION NUMBERS, APPLICATION NUMBERS, PUBLICATION NUMBERS AND BULLETIN NUMBERS

NUMBER OF REGISTRATION (111)	NUMBER OF APPLICATIONS (210)	NUMBER OF PUBLISHED APPLICATIONS (260)	NUMBER OF BULLETIN
M 2020 33420 R	AM 110613	-	24(556)2020
M 2020 33421 R	AM 110676	-	24(556)2020
M 2020 33422 R	AM 110677	-	24(556)2020
M 2020 33423 R	AM 110678	-	24(556)2020
M 2020 33424 R	AM 110742	-	24(556)2020
M 2020 33425 R	AM 110537	-	24(556)2020
M 2020 33426 R	AM 110549	-	24(556)2020
M 2020 33427 R	AM 110683	-	24(556)2020
M 2020 33428 R	AM 110771	-	24(556)2020
M 2020 33429 R	AM 104178	AM 2020 104178 A	15(547)2020
M 2020 33430 R	AM 104179	AM 2020 104179 A	15(547)2020
M 2020 33431 R	AM 104180	AM 2020 104180 A	15(547)2020
M 2020 33432 R	AM 104181	AM 2020 104181 A	15(547)2020
M 2020 33433 R	AM 104182	AM 2020 104182 A	15(547)2020
M 2020 33434 R	AM 104184	AM 2020 104184 A	15(547)2020
M 2020 33435 R	AM 104323	AM 2020 104323 A	16(548)2020
M 2020 33436 R	AM 104434	AM 2020 104434 A	10(542)2020
M 2020 33437 R	AM 104435	AM 2020 104435 A	10(542)2020
M 2020 33438 R	AM 104939	AM 2020 104939 A	12(544)2020
M 2020 33439 R	AM 105230	AM 2020 105230 A	11(543)2020
M 2020 33440 R	AM 105636	AM 2020 105636 A	12(544)2020
M 2020 33441 R	AM 105659	AM 2020 105659 A	11(543)2020
M 2020 33442 R	AM 105874	AM 2020 105874 A	16(548)2020
M 2020 33443 R	AM 105882	AM 2020 105882 A	13(545)2020
M 2020 33444 R	AM 105994	AM 2020 105994 A	14(546)2020
M 2020 33445 R	AM 106064	AM 2020 106064 A	14(546)2020
M 2020 33446 R	AM 106072	AM 2020 106072 A	15(547)2020
M 2020 33447 R	AM 106179	AM 2020 106179 A	15(547)2020
M 2020 33448 R	AM 106180	AM 2020 106180 A	15(547)2020
M 2020 33449 R	AM 106590	AM 2020 106590 A	16(548)2020
M 2020 33450 R	AM 106591	AM 2020 106591 A	16(548)2020
M 2020 33451 R	AM 106608	AM 2020 106608 A	16(548)2020
M 2020 33452 R	AM 106615	AM 2020 106615 A	15(547)2020
M 2020 33453 R	AM 106662	AM 2020 106662 A	16(548)2020
M 2020 33454 R	AM 106672	AM 2020 106672 A	16(548)2020
M 2020 33455 R	AM 106766	AM 2020 106766 A	16(548)2020
M 2020 33456 R	AM 106784	AM 2020 106784 A	15(547)2020
M 2020 33457 R	AM 106788	AM 2020 106788 A	16(548)2020
M 2020 33458 R	AM 106816	AM 2020 106816 A	16(548)2020
M 2020 33459 R	AM 103435	AM 2019 103435 A	24(532)2019
M 2020 33460 R	AM 102922	AM 2020 102922 A	9(541) 020
M 2020 33461 R	AM 102923	AM 2020 102923 A	9(541)2020

1	2	3	4
M 2020 33462 R	AM 102925	AM 2020 102925 A	9(541)2020
M 2020 33463 R	AM 102926	AM 2020 102926 A	9(541)2020
M 2020 33464 R	AM 110783	–	24(556)2020
M 2020 33465 R	AM 110775	–	24(556)2020
M 2020 33466 R	AM 110862	–	24(556)2020
M 2020 33467 R	AM 110788	–	24(556)2020

**CONCORDANCE TABLE OF PUBLICATION NUMBERS
AND APPLICATION NUMBERS**

NUMBER OF PUBLISHED APPLICATION (260)	NUMBER OF APPLICATION (210)	1	2
		1	2
AM 2020 103570 A	AM 103570	AM 2020 108416 A	AM 108416
AM 2020 105214 A	AM 105214	AM 2020 108417 A	AM 108417
AM 2020 105558 A	AM 105558	AM 2020 108418 A	AM 108418
AM 2020 106822 A	AM 106822	AM 2020 108420 A	AM 108420
AM 2020 108060 A	AM 108060	AM 2020 108421 A	AM 108421
AM 2020 108119 A	AM 108119	AM 2020 108423 A	AM 108423
AM 2020 108121 A	AM 108121	AM 2020 108424 A	AM 108424
AM 2020 108130 A	AM 108130	AM 2020 108425 A	AM 108425
AM 2020 108208 A	AM 108208	AM 2020 108426 A	AM 108426
AM 2020 108215 A	AM 108215	AM 2020 108432 A	AM 108432
AM 2020 108230 A	AM 108230	AM 2020 108433 A	AM 108433
AM 2020 108292 A	AM 108292	AM 2020 108434 A	AM 108434
AM 2020 108299 A	AM 108299	AM 2020 108435 A	AM 108435
AM 2020 108301 A	AM 108301	AM 2020 108478 A	AM 108478
AM 2020 108319 A	AM 108319	AM 2020 108479 A	AM 108479
AM 2020 108384 A	AM 108384	AM 2020 108480 A	AM 108480
AM 2020 108385 A	AM 108385	AM 2020 108481 A	AM 108481
AM 2020 108386 A	AM 108386	AM 2020 108483 A	AM 108483
AM 2020 108387 A	AM 108387	AM 2020 108485 A	AM 108485
AM 2020 108388 A	AM 108388	AM 2020 108486 A	AM 108486
AM 2020 108411 A	AM 108411	AM 2020 108488 A	AM 108488
AM 2020 108414 A	AM 108414	AM 2020 108511 A	AM 108511
AM 2020 108415 A	AM 108415	AM 2020 108512 A	AM 108512
		AM 2020 108515 A	AM 108515
		AM 2020 108595 A	AM 108595
		AM 2020 108612 A	AM 108612
		AM 2020 108613 A	AM 108613

CONCORDANCE TABLE OF INDEX OF GOODS AND/OR SERVICES
AND APPLICATION NUMBERS

INDEX OF GOODS AND/OR SERVICES (511)	NUMBER OF PUBLISHED APPLICATIONS (260)	1	2
1	2		
1	AM 2020 106822 A	20	AM 2020 108215 A
1	AM 2020 108292 A	20	AM 2020 108420 A
1	AM 2020 108426 A	21	AM 2020 106822 A
2	AM 2020 106822 A	21	AM 2020 108215 A
3	AM 2020 108119 A	21	AM 2020 108421 A
3	AM 2020 108411 A	24	AM 2020 108423 A
5	AM 2020 108230 A	25	AM 2020 108424 A
5	AM 2020 108385 A	29	AM 2020 103570 A
5	AM 2020 108386 A	29	AM 2020 105558 A
5	AM 2020 108387 A	29	AM 2020 108230 A
5	AM 2020 108388 A	29	AM 2020 108299 A
5	AM 2020 108432 A	30	AM 2020 103570 A
5	AM 2020 108433 A	30	AM 2020 105558 A
5	AM 2020 108434 A	30	AM 2020 108301 A
5	AM 2020 108435 A	30	AM 2020 105558 A
5	AM 2020 108478 A	31	AM 2020 105558 A
5	AM 2020 108479 A	31	AM 2020 108426 A
5	AM 2020 108480 A	32	AM 2020 103570 A
5	AM 2020 108481 A	32	AM 2020 105558 A
5	AM 2020 108483 A	32	AM 2020 108215 A
5	AM 2020 108485 A	32	AM 2020 108299 A
5	AM 2020 108486 A	32	AM 2020 105214 A
5	AM 2020 108488 A	33	AM 2020 105214 A
8	AM 2020 108414 A	33	AM 2020 108060 A
9	AM 2020 108119 A	33	AM 2020 108121 A
9	AM 2020 108130 A	33	AM 2020 108230 A
9	AM 2020 108612 A	33	AM 2020 108299 A
9	AM 2020 108613 A	33	AM 2020 108319 A
12	AM 2020 108511 A	33	AM 2020 108515 A
12	AM 2020 108512 A	34	AM 2020 108515 A
14	AM 2020 108119 A	35	AM 2020 108119 A
14	AM 2020 108415 A	35	AM 2020 108130 A
16	AM 2020 106822 A	35	AM 2020 108411 A
16	AM 2020 108416 A	36	AM 2020 108208 A
17	AM 2020 106822 A	37	AM 2020 108595 A
17	AM 2020 108417 A	38	AM 2020 108612 A
18	AM 2020 108119 A	38	AM 2020 108613 A
18	AM 2020 108418 A	39	AM 2020 108425 A
		41	AM 2020 108612 A
		41	AM 2020 108613 A
		42	AM 2020 108130 A
		43	AM 2020 105214 A
		43	AM 2020 108060 A
		43	AM 2020 108299 A
		43	AM 2020 108384 A
		44	AM 2020 108208 A

CONCORDANCE TABLE OF INDEX OF GOODS AND/OR SERVICES
AND NUMBERS OF TRADEMARKS REGISTERED ACCORDING
TO THE ACCELERATED PROCEDURE

INDEX OF GOODS AND/OR SERVICES (511)	NUMBERS OF REGISTERED ACCORDING TO THE ACCELERATED PROCEDURE (111)
3	M 2020 33464 R
4	M 2020 33422 R
5	M 2020 33425 R
5	M 2020 33464 R
9	M 2020 33421 R
9	M 2020 33428 R
12	M 2020 33423 R
30	M 2020 33467 R
32	M 2020 33426 R
33	M 2020 33426 R
33	M 2020 33427 R
35	M 2020 33424 R
35	M 2020 33465 R
38	M 2020 33421 R
39	M 2020 33421 R
41	M 2020 33466 R
42	M 2020 33428 R
43	M 2020 33420 R

OFFICIAL BULLETIN OF THE INDUSTRIAL PROPERTY

INVENTIONS
UTILITY MODELS
DESIGNS
TRADEMARKS

24(556)

EDITOR-IN-CHIEF: N. Bebrishvili

EDITOR-TRANSLATOR: E. Gabunia

PROOFREADER: A. Shikhashvili

COMPUTER LAYOUT: M. Ordenidze
K. Svanidze

www.sakpatenti.gov.ge

E-mail: info@sakpatenti.org.ge