



Official Bulletin of the Industrial Property

- Inventions
- Utility Models
- Designs
- Trademarks



საქართველოს ინტელექტუალური
საკუთრების ეროვნული ცენტრი
საქპატენტი
SAKPATENTI
NATIONAL INTELLECTUAL PROPERTY
CENTER OF GEORGIA
www.sakpatenti.gov.ge

3(606)

INID CODES FOR IDENTIFICATION OF BIBLIOGRAPHIC DATA

INVENTIONS, UTILITY MODELS

- (10) Number of publication for application, which has been examined
- (11) Number of patent and kind of document
- (21) Serial number of application
- (22) Date of filing of the application
- (23) Date of exhibition or the date of the earlier filing and the number of application, if any
- (24) Date from which patent may have effect
- (31) Number of priority application
- (32) Date of filing of priority application
- (33) Code of the country or regional organization allotting priority application number
- (44) Date of publication of application not granted, but examined and number of bulletin
- (45) Date of publication of registered document
- (51) International Patent Classification Index

- (54) Title of the invention
- (57) Abstract
- (60) Number of examined patent document granted by foreign patent office, date from which patent has effect and country code
- (62) Number of the earlier application and in case of divided application, date of filing an application
- (71) Name, surname and address of applicant (country code)
- (72) Name, surname of inventor (country code)
- (73) Name, surname and address of patent owner (country code)
- (74) Name, surname of representative or patent attorney
- (85) Date of commencement of the national phase of International Application
- (86) Number and date of filing of international application
- (87) Number and date of publication of international application
- (94) Calculated date of expiry of the SPC or the duration of the SPC

DESIGNS

- (10) Number of publication for application
- (11) Number of patent and kind of document or number of registration
- (15) Date of registration/Date of patent renewal
- (18) Expected expiration date of patent or registration
- (21) Serial number of application
- (22) Date of filing of the application
- (23) Date of exhibition or the date of the earlier filing and the number of application, if any
- (24) Date from which patent may have effect
- (28) Number of designs included in the application
- (30) Data relating to priority (number of application, date of filing of application, two-letter code identifying the authority with whom the priority application was made)
- (31) Number of priority application
- (32) Date of filing of priority application
- (33) Code of the country or regional organization allotting priority application number
- (34) Two-letter code according to WIPO St.3 identifying the authority with which the priority application was made
- (44) Date of publication of design and number of bulletin (the first publication)
- (45) Date of publication of design registered by WIPO and number of bulletin

- (51) International Classification for designs (class and subclass of the Locarno Classification)
- (54) Title of the invention
- (55) Reproduction of the design
- (57) Description of characteristic features of the design including indication of colors
- (58) Date of recording of any kind of amendment in the Register
- (62) Number of the earlier application, registration and document number and if available the date of filing an application in case of divided application
- (71) Name, surname and address of applicant (country code)
- (72) Name, surname of creator (country code)
- (73) Name, surname and address of patent owner (country code)
- (74) Name, surname of representative or patent attorney
- (81) Contracting states concerned
 - II designated contracting states according to the 1960 Act
 - III designated contracting states according to the 1999 Act
- (85) Owner's permanent address
- (86) Owner's nationality
- (87) Owner's residence
- (88) State in which the owner has a real and effective industrial or commercial establishment

TRADEMARKS

- (111) - Number of registration
- (151) - Date of registration
- (156) - Date of the renewal
- (181) - Expected expiration date of registration
- (186) - Renewal expiration date of registration
- (141) - Date of cancel of duration of the mark
- (210) - Serial number of application
- (220) - Date of filing of the application
- (230) - Data concerning exhibition
- (260) - Number of application, for which favorable decision of examination about registration has been taken (publication number)
- (310) - Number of the first application
- (320) - Date of filing of the first application
- (330) - Code, identifying national or regional Office where the first application was made
- (511) - International Classification of Goods and Services for the purposes of registration of trade marks and/or list of goods and/or services classified according thereto
- (526) - Disclaimer
- (531) - Description of figurative elements of Trade Marks according to the International Classification of the Figurative Elements of Marks

- (540) - Reproduction of Trade Mark
- (550) - Nature and kind of Trade Mark
- (551) - Indication to the effect that the mark is a collective mark, a certification mark or a guarantee mark
- (554) - Three-dimensional mark
- (580) - Date of recording of any kind changes in respect of applications or registrations
- (591) - Information concerning colors claimed
- (731) - Name and address of the applicant
- (732) - Name and address of the holder of the registration
- (740) - Name and address of the representative
- (750) - Addreses for correspondence
- (770) - Name and address of the previous applicant or holder in case of change in ownership
- (771) - Previous name and address of the applicant or holder in case of change in ownership
- (791) - Name and address of the licensee
- (793) - Indication of conditions and/or restrictions under the license (Type of license, number of license agreement, data of license, data of validity of license)
- (800) - Certain data relating to the international registration of Trade Marks under the Protocol Relating to Madrid Agreement (International registration number
- (852) - Partial cancellation of the list of goods and services
- (891) - Date of subsequent designation

CODES FOR PUBLICATION IN BULLETIN

- (21) AP 0000 000000 - serial number of application for invention
- (10) AP 0000 0000 A - number of published application for invention (first publication)
- (11) P 0000 0000 B - number of patent for invention (second publication)
- (21) API 0000 000000 - number of application for imported patent
- (11) PI 0000 0000 A - number of imported patent (first publication)
- (21) AU 0000 000000 - serial number of application for utility model
- (10) AU 0000 000 U - number of published application for utility model (first publication)
- (11) U 0000 000 Y - number of patent for utility model (second publication)
- (21) AD 0000 000000 - serial number of application for design
- (10) AD 0000 000 S - number of published application for design (first publication)
- (11) D 0000 000 S - registered design

INTERNATIONAL PATENT CLASSIFICATION FOR INVENTIONS AND UTILITY MODELS

- SECTION A - HUMAN NECESSITIES
- SECTION B - PERFORMING OPERATIONS; TRANSPORTING
- SECTION C - CHEMISTRY; METALLURGY
- SECTION D - TEXTILES; PAPER
- SECTION E - FIXED CONSTRUCTIONS
- SECTION F - MECHANICAL ENGINEERING; LIGHTING; HEATING; WEAPONS; BLASTING
- SECTION G - PHYSICS
- SECTION H - ELECTRICITY

-
- M - Trade Mark
 - (210) AM 0000 000000 - Serial number of application;
 - (260) AAM 0000 00000 A - Publication number of application;
 - (111) M 0000 00000 R - Number of registration;
 - (111) MMM0000 00000 Rn - Number of renewals, in which n=1,2,3;
 - (111) M 0000 00000 R(P) - Number of registration under partial assignment of rights
-

Official Bulletin of the Industrial Property

Inventions

Utility Models

Designs

Trademarks

CONTENT

PUBLISHED TITLES OF PROTECTION	3
INVENTIONS	
▪ APPLICATIONS APPROVED FOR GRANTING PATENT	4
▪ PATENTED INVENTIONS	7
UTILITY MODELS	
▪ APPLICATION APPROVED FOR GRANTING PATENT	8
▪ PATENTED UTILITY MODEL	9
DESIGNS	
▪ APPLICATIONS APPROVED FOR REGISTRATION	10
▪ REGISTERED DESIGNS	14
▪ DESIGN REGISTERED ACCORDING TO THE ACCELERATED PROCEDURE	15
▪ DESIGNS, WHICH HAVE BEEN REGISTERED WITH THE INTERNATIONAL BUREAU CLAIMING PRIORITY ON THE TERRITORY OF GEORGIA	16
TRADEMARKS	
▪ APPLICATIONS FILED UNDER THE NATIONAL PROCEDURE APPROVED FOR REGISTRATION	34
▪ REGISTERED TRADEMARKS	38
▪ TRADEMARKS REGISTERED ACCORDING TO THE ACCELERATED PROCEDURE	40
▪ INTERNATIONAL TRADEMARKS FOR WHICH A DECISION ON GRANTING PROTECTION IS TAKEN	42
▪ INTERNATIONAL TRADEMARKS PROTECTED IN GEORGIA	119
OFFICIAL NOTIFICATIONS	
INVENTIONS	
▪ RESTORATION OF PATENTS	129
▪ ABOLITION OF PATENTS WITH THE RIGHT TO RESTORE	129
▪ DATE OF PATENTS RESTORATION EXPIRATION	130
▪ EXPIRATION OF TERMS OF PATENT	131
▪ COMPLETE CANCELLATION OF PATENT BASED ON RE-EXAMINATION	131
UTILITY MODELS	
▪ RESTORATION OF PATENTS	132
▪ ABOLITION OF PATENTS WITH THE RIGHT TO RESTORE	132
▪ DATE OF PATENTS RESTORATION EXPIRATION	133
DESIGNS	
▪ EXTENSION OF TERMS OF DESIGNS REGISTRATION	134
▪ CANCELLATION OF DESIGNS REGISTRATION	134
▪ CHANGE OF OWNER DATA	134
▪ EXTENSION OF TERMS OF INTERNATIONAL DESIGNS REGISTRATION	135
▪ CANCELLATION OF INTERNATIONAL DESIGNS REGISTRATION	141
TRADEMARKS	
▪ EXTENSION OF TERMS OF TRADEMARKS REGISTRATION	144
▪ COMPLETE TRANSFER OF RIGHTS	148
▪ CHANGES OF NAMES AND/OR ADDRESSES OF TRADEMARKS OWNERS	150
▪ CANCELLATION OF TRADEMARKS REGISTRATION	151
▪ INTERNATIONAL LICENSE AGREEMENTS	153
▪ PUBLICATION OF DATA IN CASE OF CLASSES ARE ADDED	153
CLASSIFICATION INDEXES	
INVENTIONS	154
UTILITY MODELS	155
DESIGNS	157
TRADEMARKS	159

PUBLISHED TITLES OF PROTECTION

INVENTIONS

- **APPLICATIONS APPROVED FOR GRANTING PATENT:**
15682; 15128; 15886; 15965
- **PATENTED INVENTIONS:**
7467-7474

UTILITY MODELS

- **APPLICATION APPROVED FOR GRANTING PATENT:**
15837
- **PATENTED UTILITY MODEL:**
2144

DESIGNS

- **APPLICATIONS APPROVED FOR REGISTRATION:**
1278; 1275
- **REGISTERED DESIGNS:**
956-958
- **DESIGN REGISTERED ACCORDING TO THE ACCELERATED PROCEDURE:**
959
- **DESIGNS, WHICH HAVE BEEN REGISTERED WITH THE INTERNATIONAL BUREAU CLAIMING PRIORITY ON THE TERRITORY OF GEORGIA:**
221377; 225482; 221697; 221993

TRADEMARKS

- **APPLICATIONS FILED UNDER THE NATIONAL PROCEDURE APPROVED FOR REGISTRATION:**
99509*; 10005*8, 100059*; 115851; 117717; 117806; 118158; 118161, 118162; 118403; 118547; 118551; 118559; 118562, 118563; 118566; 118728; 118737; 118754
- **REGISTERED TRADEMARKS:**
36358-36371; 36377-36385
- **TRADEMARKS REGISTERED ACCORDING TO THE ACCELERATED PROCEDURE:**
36356, 36357; 36372-36376; 36386-36388
- **INTERNATIONAL TRADEMARKS FOR WHICH A DECISION ON GRANTING PROTECTIONS IS TAKEN:**
116712; 117580; 117582; 117585, 117586; 117678, 117679; 117707, 117708; 117710; 117751-117761; 117767-117773; 117775, 117776; 117782-117786; 117790, 117791; 117854-117856; 117865-117867; 117869-117873; 117885, 117886; 117888-117893; 117956; 118023, 118024; 118035, 118036; 118038, 118039; 118043, 118044; 118186; 118207-118210; 118212; 118343-118345; 118347; 118349-118356; 118602-118610; 118612-118621; 118797-118799; 118807-118814; 118816
- **INTERNATIONAL TRADEMARKS PROTECTED IN GEORGIA:**
114080; 114208; 114578; 115080; 115824, 115825; 115915; 115949; 116013; 116028; 116030; 116036, 116037; 116039-116041; 116044, 116045; 116052; 116057-116059; 116061-116064; 116087; 116089-116093; 116104-116111; 116113-116123; 116125; 116135; 116137-116140; 116142, 116143; 116172-116178; 116180-116185; 116188-116204; 116206-116212; 116275; 116348-116350; 116352-116356; 116364; 116368-116370; 116372-116377; 116469-116471; 116598-116601; 116603, 116604; 116871, 116872; 116913, 116914; 116916; 116918; 116920

INVENTIONS

APPLICATIONS APPROVED FOR GRANTING PATENT

The decision can be appealed at the Chamber of Appeal of Sakpatenti within 3 months from the publication or at the Mtskheta District Court Administrative Cases Board (Address: №17, Samkhedro St., Mtskheta), within 1 month following the publication.

PART A

A 61

- (10) AP 2023 15682 A (51) Int. Cl. (2006)
A 61 K 9/28
(21) AP 2019 15682 (22) 2019 12 05
(31) 18211154.2
(32) 2018 12 07
(33) EP
(71) Tillots Pharma AG (CH)
Baslerstrasse 15. CH-4310 Rheinfelden,
Switzerland (CH)
(72) VARUM, Filipe (CH);
BRAVO GONZALEZ, Roberto Carlos (CH)
(74) Shalva Gvaramadze
(85) 2021 07 05
(86) PCT/EP2019/083909, 2019 12 05
(54) COLON DRUG DELIVERY FORMULATIONS
(57) The formulation comprises a core comprising a
drug and a coating. The coating includes outer and
inner layers. Wherein said outer layer comprises the
film-forming enteric polymer, having pH threshold of
at least about pH 6, said inner layer comprises film-
forming nonionic polymer soluble in intestinal or
gastrointestinal fluids, and buffering agent in an
amount 20-60 wt%.
Claims: 2 independents
28 dependents
Fig.: 6
-

- (10) AP 2023 15128 A (51) Int. Cl. (2006)
A 61 K 39/395
C 07 K 16/00
C 07 K 16/10
(21) AP 2017 15128 (22) 2017 12 20
(31) 201621044139
(32) 2016 12 23
(33) IN
(71) Serum Institute Of India Private Limited (IN)
212/2, Off Soli Poonawalla Road, Hadapsar
Pune, Maharashtra 411028, India (IN)
(72) MHALASAKANT, Dhere Rajeev (IN);
SHANKAR, Pisal Sambhaji (IN);
REDDY, Peddi Reddy Srinivas (IN);
CHAHAR, Singh Digamber (IN);
RAVINDRA, Yeolekar Leena (IN);
SINGH, Chouhan Pankaj (IN);
DATTATRAY, Avalaskar Nikhil (IN)

- (74) Tamaz Shilakadze
(85) 2019 07 04
(86) PCT/IB2017/058194, 2017 12 20
(54) IMPROVED METHODS FOR ENHANCING
ANTIBODY PRODUCTIVITY IN MAMMA-
LIAN CELL CULTURE AND MINIMIZING
AGGREGATION DURING DOWNSTREAM,
FORMULATION PROCESSES AND STABLE
ANTIBODY FORMULATIONS OBTAINED
THEREOF
(57) The invention describes a method for antigen
binding protein manufacturing, with improved feeding
and minimum aggregation, wherein antigen binding
protein is monoclonal antibody specific to the Dengue
virus. The invention describes pharmaceutical
content, and usage thereof the Dengue or rabies virus
treatment, as well.
Claims: 4 independents
28 dependents
Fig.: 2
-

PART F

F 03

- (10) AP 2023 15886 A (51) Int. Cl. (2006)
F 03 B 17/02
(21) AP 2020 15886 (22) 2020 08 13
(31) 2019126771
(32) 2019 08 26
(33) RU
(71) TIAGLIN, Denis Valentinovich (RU)
Gorsky Microrayon, bld. 8, Litera A, ap. 300,
30073, Novosibirsk, Russian Federation (RU)
(72) TIAGLIN, Denis Valentinovich (RU)
(74) Shalva Gvaramadze
(85) 2022 02 28
(86) PCT/RU2020/050186, 2020 08 13
(54) ENERGY GENERATOR
(57) Power generator comprises a body 1 having the
shape of vertical vessel filled with liquid 6, wherein a
platform 3 with an opening in the upper part, the inner
part whereof has the shape of bell, is placed, as well
as a means 5 for imparting positive buoyancy to the
platform by accumulating air, located on lower side of
platform, a channel 4 connected to the opening in
upper part of platform, the windows connected to the

channel, the valves 9 installed between the channel and the means for imparting positive buoyancy to the platform; a turbine installed on the platform rotatable under the action of liquid flowing through the channel, and equipped with the means for transmitting generated electric power; the means for preventing the platform from rotating, the turbine is also rotatable under the action of air released through the valves from the means for imparting positive buoyancy to the platform.

Claims: 1 independent
3 dependent

Fig.: 1

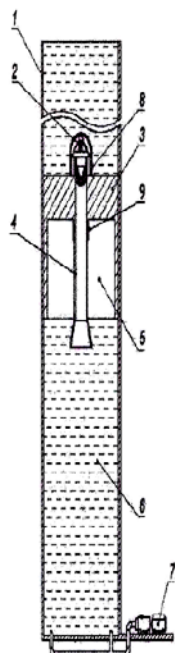

Fig. 1

(57) A plant includes energy block 5 equipped with a multiplier and electric generator, and wheels 7 with shovels to be dropped in water stream. The wheels are set onto energy block actuating valve jugged from both sides part, clamping support, a winch 10 and the burtons 8 and 9; at that, clamping support includes executed as a plate the frame 1 and a rigel 2 connected hingedly to front and back abutment struts 3 connected hingedly to the frame, energy block, together with wheels with shovels, are hanged on one end of rigel; at that, hingedly arranged rigel, abutment struts and the frame are executed as flat hinged parallelogram, installed together with the frame on the ground, the winch is executed as to be bilateral, and one end of cable thereof is connected to back abutment strut by passing throughout the burton, and another end – to the frame by passing throughout the burton, as well; at that, one 9 of burtons is connected to the frame, and another one 8 – to front abutment strut, providing folding-unfolding of hinged parallelogram, accordingly, wheels with shovels are capable of drop-off in the river.

Claims: 1 independent

Fig.: 3

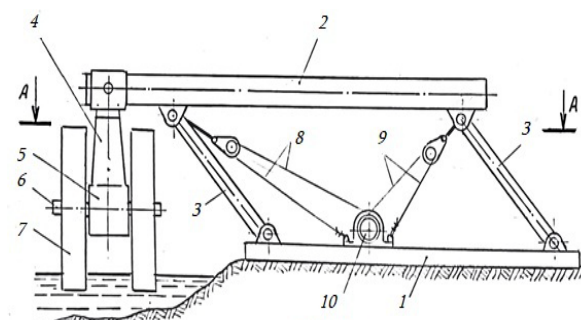

Fig. 1

(10) AP 2023 15965 A (51) Int. Cl. (2006)
F 03 B 13/00

(21) AP 2022 15965 (22) 2022 06 01

(71) Vladimer Chkhaidze (GE)

Akhmeteli St. 5, ap. 41, 6010, Batumi,
Georgia (GE);

Gela Kipiani (GE)

Dzmebi Zubalashvilebi St., II Dead End 13,
0160, Tbilisi, Georgia (GE);

Makvala Bekirishvili (GE)

G. Chokheli St. 12, 6400, Batumi, Georgia (GE);

Tsiuri Kurshubadze (GE)

Rustaveli St. 57, ap. 27, 6010, Batumi,
Georgia (GE);

Ana Beridze (GE)

G. Chokheli St. 12, 6400, Batumi, Georgia (GE)

(72) Vladimer Chkhaidze (GE);

Gela Kipiani (GE);

Makvala Bekirishvili (GE);

Tsiuri Kurshubadze (GE);

Ana Beridze (GE)

(54) RIVER HYDROPOWER PLANT

PATENTED IVENTIONS

PART A

A 01

- (11) P 2023 7468 B (51) Int. Cl. (2006)
A 01 G 9/12
- (10) AP 2022 15958 A (44) 19(598)/2022
- (21) AP 2022 15958
- (22) 2022 05 25
- (24) 2022 05 25
- (73) Tornike Mzhavanadze (GE)
Iiko Kurkhuli St. 4, 0301, Tbilisi, Georgia (GE)
- (72) Tornike Mzhavanadze (GE)
- (54) ROTOR-PLANETARY DEVICE INTENDED
FOR PLANT CULTIVATION

A 24

- (11) P 2023 7469 B (51) Int. Cl. (2006)
A 24 D 3/14
A 61 K 7/00
A 61 K 38/44
A 61 L 2/00
- (10) AP 2022 15488 A (44) 16(595)/2022
- (21) AP 2020 15488
- (22) 2020 11 10
- (24) 2020 11 10
- (73) LTD "DZALA" (GE)
Rustaveli Av. 40/40a, Tbilisi, Georgia (GE)
- (72) Teimuraz Kurtskhalia (DE);
Veronica Diez (DE);
Vakhtang Pavlenishvili (GE);
Jan Prochazka (CZ)
- (74) Nikoloz Gogilidze
- (54) NOVEL COMPOSITIONS FOR NEUTRALI-
ZING TOXIC EFFECTS OF HYDROGEN
PEROXIDE IN LIVING CELLS OR
TISSUES

A 47

- (11) P 2023 7474 B (51) Int. Cl. (2006)
A 47 J 31/18
A 47 J 31/42
- (10) AP 2022 15490 A (44) 20(599)/2022
- (21) AP 2019 15490
- (22) 2019 05 15
- (24) 2019 05 15
- (31) 2018 028
- (32) 2018 09 10
- (33) LT
- (86) PCT/IB2019/054020, 2019 05 15

- (73) WAB "Aparata" (LT)
155-19 Šiauliai, Vilnius, LT-76352,
Lithuania (LT)
- (72) KLEISMANTAS, Giedrius (LT)
- (74) Irakli Gvilia
- (54) AUTOMATIC COFFEE AND TEA
MAKER

A 61

- (11) P 2023 7472 B (51) Int. Cl. (2006)
A 61 K 8/60
A 61 K 8/43
A 61 K 8/04
A 61 Q 11/00
- (10) AP 2022 15745 A (44) 20(599)/2022
- (21) AP 2020 15745
- (22) 2020 02 27
- (24) 2020 02 27
- (31) 102019000003009
- (32) 2019 03 01
- (33) IT
- (86) PCT/EP2020/055199, 2020 02 27
- (73) Curasept A.D.S. S.R.L. (IT)
Via Giuseppe Parini 19A, 21047, Saronno,
Italy (IT)
- (72) BOIOCCHI, Lorenzo Emiliano (IT)
- (74) Shalva Gvaramadze
- (54) ORAL CARE PRODUCT

- (11) P 2023 7467 B (51) Int. Cl. (2006)
A 61 K 31/573
A 61 K 31/56
A 61 K 31/454
A 61 P 37/08
A 61 P 43/00
A 61 P 37/00
A 61 P 11/06
- (10) AP 2022 15712 A (44) 19(598)/2022
- (21) AP 2019 15712
- (22) 2019 11 22
- (24) 2019 11 22
- (62) AP 2019 15619 2021 04 29
- (31) 2018141291
- (32) 2018 11 23
- (33) RU
- (86) PCT/RU2019/050225, 2019 11 22
- (73) Obchestvo s Ogranichennoy Otvetstvennoctiu
"Pharmenterprises" (RU)
Skolkovo Innovation Centre, Bolshoy Blvd. 42,
bld. 1, 2nd fl., Offices 771, 772, Moscow 12105,
Russian Federation (RU)
- (72) NEBOLSIN, Vladimir Evgenievich (RU)

(74) Shalva Gvaramadze
 (54) GLUTARIMIDE DERIVATIVE FOR OVERCOMING RESISTANCE TO STEROIDS AND TREATMENT OF DISEASES ASSOCIATED WITH ABERRANT SIGNALING OF INTERFERON PI3K-GAMMA

SHAGHAFI, Michael B. (US)
 (74) Tamaz Shilakadze
 (54) MAGL INHIBITORS

PART B

B 29

(11) P 2023 7473 B (51) Int. Cl. (2006)
 B 29 C 43/02
 B 29 C 53/20
 (10) AP 2022 15867 A (44) 20(599)/2022
 (21) AP 2022 15867
 (22) 2022 01 28
 (24) 2022 01 28
 (73) Irakli Chantadze (GE)
 Davit Aghmashenebeli Ave., bld. 179, ap. 5,
 0112, Tbilisi, Georgia (GE);
 Vakhtang Chantadze (GE)
 Davit Aghmashenebeli Ave., bld. 179, ap. 5,
 0112, Tbilisi, Georgia (GE)
 (72) Irakli Chantadze (GE);
 Vakhtang Chantadze (GE)
 (54) METHOD AND EQUIPMENT FOR
 MAKING RECTANGULAR GROOVES
 FROM POLYMER MATERIAL PIPES

PART E

E 01

(11) P 2023 7471 B (51) Int. Cl. (2006)
 E 01 F 15/04
 (10) AP 2022 15547 A (44) 20(599)/2022
 (21) AP 2019 15547
 (22) 2019 07 22
 (24) 2019 07 22
 (31) A 50645/2018
 (32) 2018 07 24
 (33) AT
 (86) PCT/EP2019/069695, 2019 07 22
 (73) Deltabloc International GMBH (AT)
 Kirchdorfer Platz 1, 2752 Wöllersdorf-
 Steinabrückl, Austria (AT)
 (72) EDL, Thomas (AT);
 LEHMANN, Stefan (AT)
 (74) Shalva Gvaramadze
 (54) VEHICLE RESTRAINT SYSTEM

PART C

C 07

(11) P 2023 7470 B (51) Int. Cl. (2006)
 C 07 D 498/08
 C 07 D 471/10
 C 07 D 295/205
 C 07 D 403/04
 C 07 D 295/26
 (10) AP 2022 15088 A (44) 16(595)/2022
 (21) AP 2017 15088
 (22) 2017 11 15
 (24) 2017 11 15
 (31) 62/423,099
 (32) 2016 11 16
 (33) US
 (86) PCT/US2017/061868, 2017 11 15
 (73) H. Lundbeck A/S (DK)
 Ottiliavej 9, DK-2500, Valby, Denmark (DK)
 (72) GRICE, Cheryl A. (US);
 BUZARD, Daniel J. (US);

UTILITY MODELS

APPLICATION APPROVED FOR GRANTING PATENT

The decision can be appealed at the Chamber of Appeal of Sakpatenti within 3 months from the publication or at the Mtskheta District Court Administrative Cases Board (Address: №17, Samkhedro St., Mtskheta), within 1 month following the publication.

PART G

G 10

(10) AU 2023 15837 U (51) Int. Cl. (2006)

G 10 D 1/00

(21) AU 2021 15837 (22) 2021 12 24

(71) Mikheil Ramishvili (GE)

Vazha-Pshavela Ave. 12, ap. 46, 0160, Tbilisi,
Georgia (GE)

(72) Mikheil Ramishvili (GE)

(54) FINGER TRAINING DEVICE

"KVATCHITCHO" ON STRING INSTRUMENT

(57) Finger training device includes a frame (1) having the sides (2), and a bottom (3) connecting the sides (2). Draught perforation (4) is executed on the sides. Nylon or metal strings (5), the ends whereof are fixed into frame from back side, and keeping standard distance relative to each other, are passing throughout the perforation (4) between frame sides, in parallel of bottom (3).

Claims: 1 independent

Fig.: 1

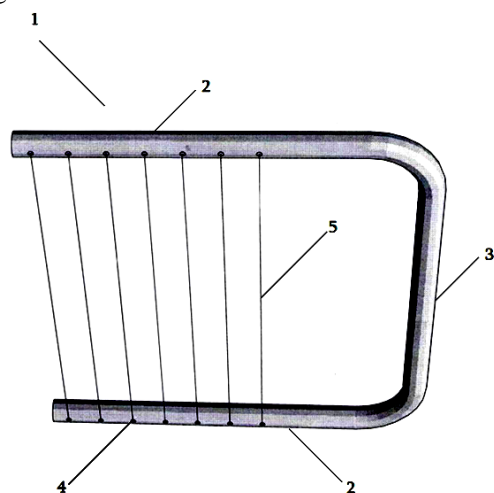

Fig 1

PATENTED UTILITY MODEL

PART A

A 61

- (11) U 2023 2144 Y (51) Int. Cl. (2006)
A 61 P 43/00
- (10) AU 2022 15537 U (44) 19(598)/2022
- (21) AU 2021 15537
- (22) 2021 01 17
- (24) 2021 01 17
- (73) Guram Kupatadze (GE)
Varketili III Array, VIII qu., bld. 4, ap. 36,
Tbilisi, Georgia (GE);
Shakro Kvirkvia (GE)
Nino Zhvania St. 10, ap. 12, Tbilisi,
Georgia (GE);
Anzor Japaridze (GE)
Zhiuli Shartava St. 44a, Tbilisi, Georgia (GE)
- (72) Guram Kupatadze (GE);
Shakro Kvirkvia (GE);
Anzor Japaridze (GE)
- (74) Shalva Gvaramadze
- (54) BIOLOGICALLY ACTIVE FOOD ADDITIVE
-

DESIGNS

APPLICATIONS APPROVED FOR REGISTRATION

The decision can be appealed at the Chamber of Appeal of Sakpatenti within 3 months from the publication or at the Mtskheta District Court Administrative Cases Board (Address: №17, Samkhedro str., Mtskheta), within 1 month following the publication.

(10) AD 2023 1278 S (51) 11-01

(21) AD 2022 1278 (22) 2022 10 18

(28) 14

(71) LTD "Eshvi" (GE)

Gergeti St. 3, 0105, Mtatsminda District, Tbilisi, Georgia (GE)

(72) Natia Chkhartishvili (GE)

(54) 10-11. RING; 12. NECKLACE; 1.-3. EARRINGS; 13. EARRINGS; 14. BRASLET; 15. NECKLACE;

4. NECKLACE; 5. EARRINGS; 6.-7. HAIR CLIP; 9. EARRINGS

(55)





9.1



10.1



11.1



12.1



13.1

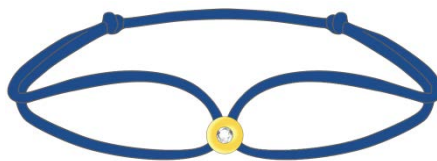

14.1



15.1

- (10) AD 2023 1275 S (51) 25-03
- (21) AD 2022 1275 (22) 2022 09 30
- (28) 9
- (71) LTD "Petro+" (GE)
Krtsanisi Str. 3, bld. 3, ap. 17, 0114, Tbilisi, Georgia (GE)
- (72) Aleksey Shishko (BY)
- (74) Nikoloz Gogilidze (GE)
- (54) GAS STATION OF VERTICAL PLANNING
- (55)

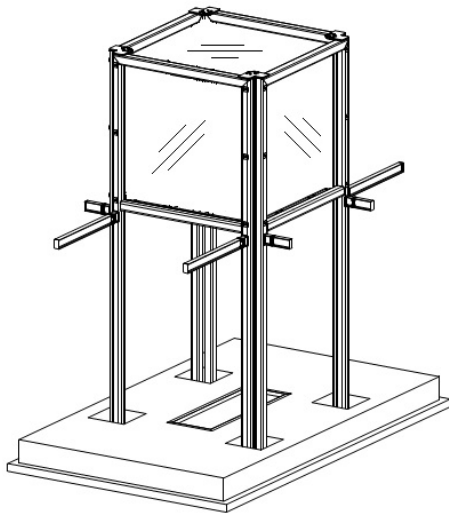

1.1

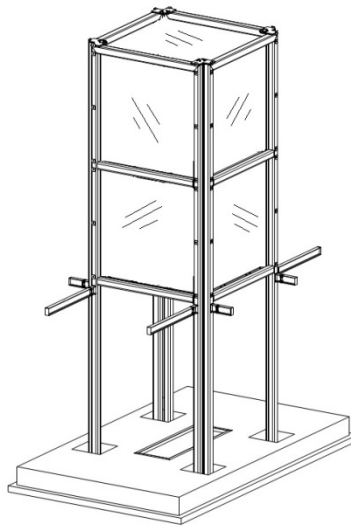

2.1

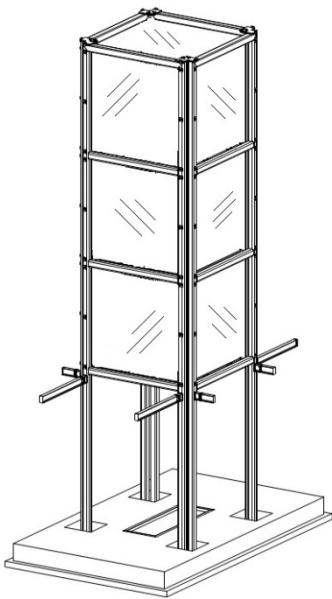

3.1

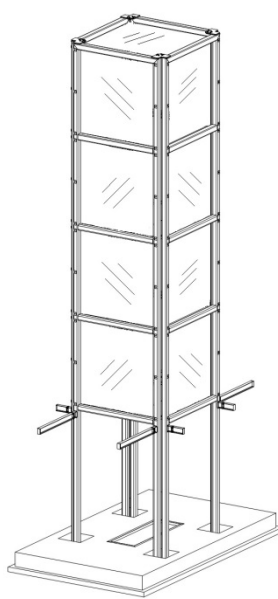

4.1

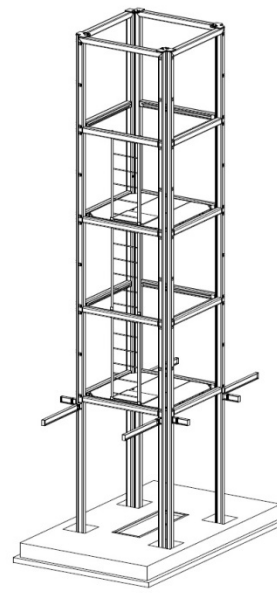

5.1

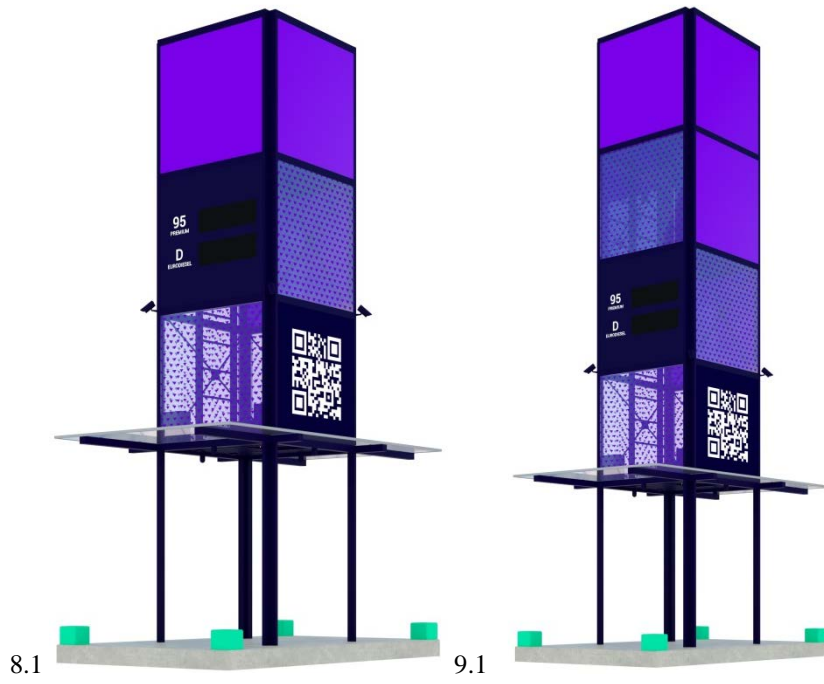
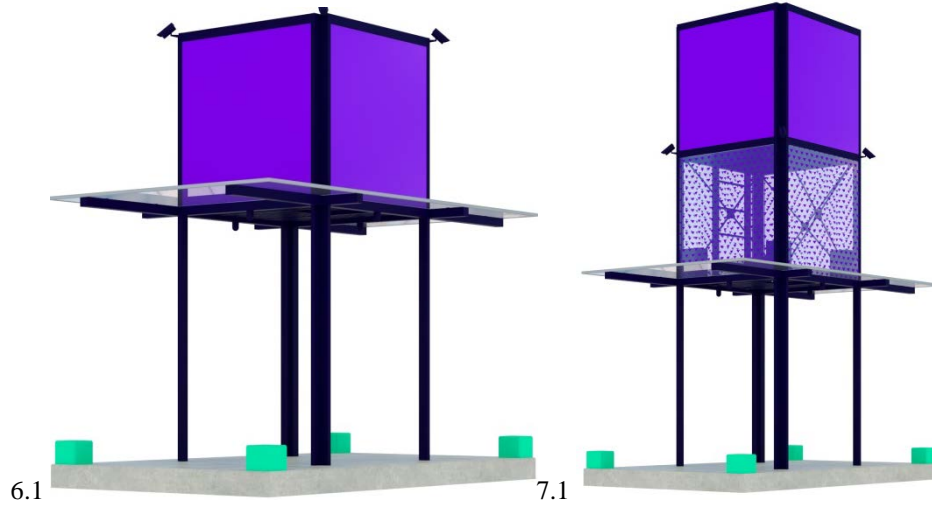

REGISTERED DESIGNS

(11) D 2023 958 S (51) 01-01
(10) AD 2022 1267 S (44) 2022 10 25 №20
(21) AD 2022 1267
(22) 2022 05 16
(24) 2022 05 16
(28) 3
(18) 2027 05 16
(73) Marina Akhaladze (GE)
Chechelashvili St. 37, 4600, Kutaisi,
Georgia (GE)
(72) Marina Akhaladze (GE)
(74) Mariam Gogitidze (GE)
(54) 1.-3. KHINKALI-SHAPED CONFECTION-
ERY HAVING CONTENT OF CHUR-
CHKHELA OR SOMETHING ELSE

(11) D 2023 957 S (51) 02-04
(10) AD 2022 1269 S (44) 2022 10 25 №20
(21) AD 2022 1269
(22) 2022 06 17
(24) 2022 06 17
(28) 2
(18) 2027 06 17
(73) LLC "Crosty Global" (GE)
N. Zhvania Str. 2, fl. 10, ap. 39 (Block II),
0101, Old Tbilisi District, Tbilisi, Georgia (GE)
(72) Giorgi Mikaia (GE)
(74) Giorgi Zhorzholiani (GE)
(54) SHOE

(11) D 2023 956 S (51) 06-01; 06-03
(10) AD 2022 1268 S (44) 2022 10 10 №19
(21) AD 2022 1268
(22) 2022 05 25
(24) 2022 05 25
(28) 7
(18) 2027 05 25
(73) Davit Donadze (GE)
Nutsbidze Plateau, III mcr., II qu., bld. 6, Floor
4, app. 19, 0183, Tbilisi, Georgia (GE)
(72) Davit Donadze (GE)
(54) 1.-7. TRANSFORMABLE FURNITURE

DESIGN REGISTERED ACCORDING TO THE ACCELERATED PROCEDURE

The decision can be appealed at the Chamber of Appeal of Sakpatenti within 3 months from the publication.

- (11) D 2023 959 S
- (21) AD 2023 1291
- (24) 2023 01 25
- (28) 1
- (18) 2028 01 25
- (73) Nino Dzidzadze (GE)
Vazha-Pshavela Ave., IV qu., bld. 7, ap. 33, 0186, Tbilisi, Georgia (GE)
- (72) Nino Dzidzadze (GE)
- (54) SINK
- (55)



DESIGNS, WHICH HAVE BEEN REGISTERED WITH THE INTERNATIONAL BUREAU CLAIMING PRIORITY ON THE TERRITORY OF GEORGIA

The decision can be appealed at the Chamber of Appeal of Sakpatenti within 3 months from the publication or at the Mtskheta District Court Administrative Cases Board (Address: №17, Samkhedro St., Mtskheta), within 1 month following the publication.

- (11) DM/221 377 (51) 10-07
 (15) 2022 06 03 (44) 49/2022 (2022 12 09)
 (22) 2022 06 03
 (28) 6
 (73) HARRY WINSTON SA
 Chemin Du Tourbillon 8, 1228 Plan-les-Ouates (CH)
 (85) CH
 (86) CH
 (87) CH
 (88) CH
 (89) CH
 (81) II. MA III. AL, AM, AZ, BA, BZ, CA, CH, EM, GB, GE, KG, LI, MC, MD, ME, MK, MN, NO, OM, SG, TN, TR, UA
 (72) 1-2: Christophe LASSERRE
 c/o Harry Winston SA, Chemin du Tourbillon 8, 1228, Plan-les-Ouates (CH);
 3-5: Steve KAMILINDI
 c/o Harry Winston SA, Chemin du Tourbillon 8, 1228, Plan-les-Ouates (CH);
 6: Christophe LASSERRE
 c/o Harry Winston SA, Chemin du Tourbillon 8, 1228, Plan-les-Ouates (CH)
 (74) The Swatch Group AG (The Swatch Group SA) (The Swatch Group Ltd.)
 Faubourg du Lac 6, 2501 Biel/Bienne (CH)
 (46) 2022 12 09
 (54) 1. WATCH CASE, 2.-4. WATCH DIAL, 5. WATCH BRACELET, 6. WATCH DIAL
 (55)

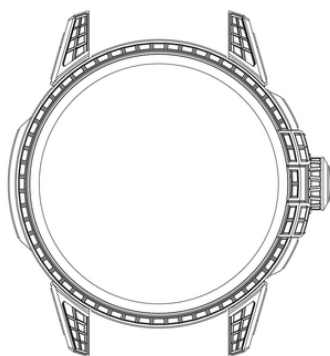

1.1

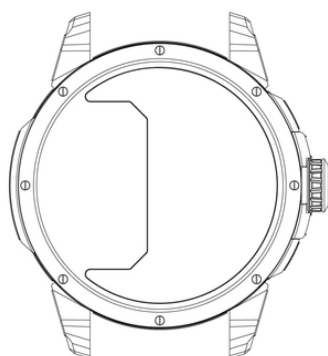

1.2

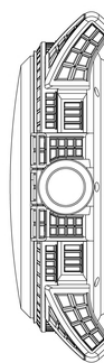

1.3

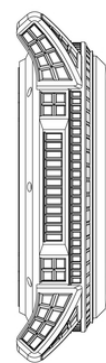

1.4

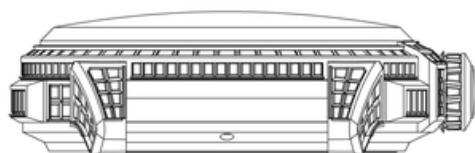

1.5

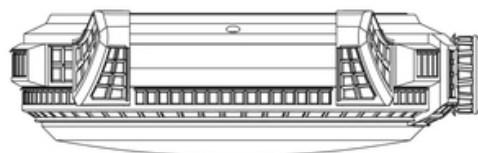

1.6



1.7

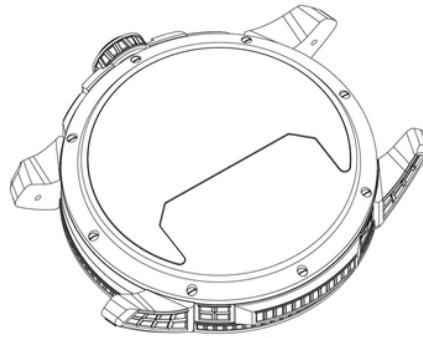

1.8

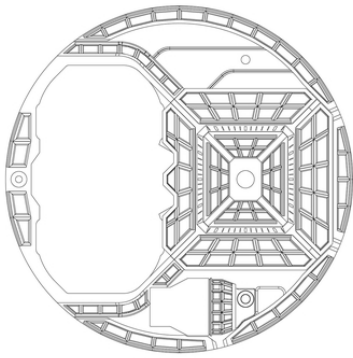

2.1

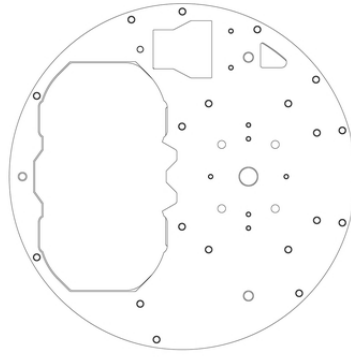

2.2



2.3



2.4



2.5



2.6

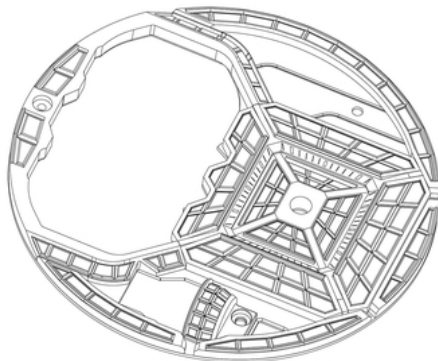

2.7

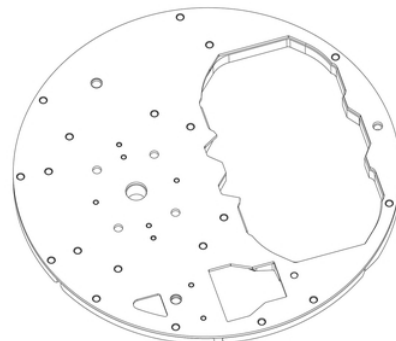

2.8

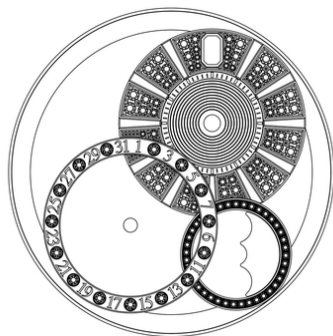

3.1

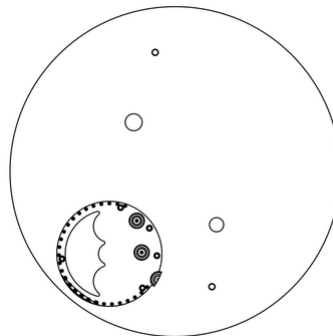

3.2



3.3



3.4



3.5

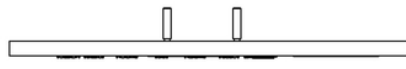

3.6

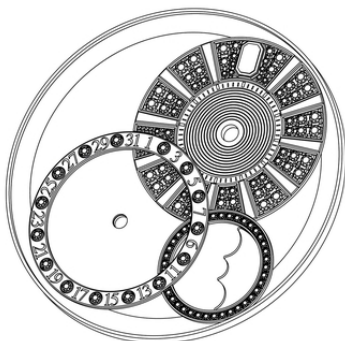

3.7

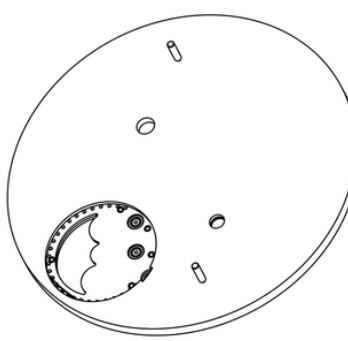

3.8

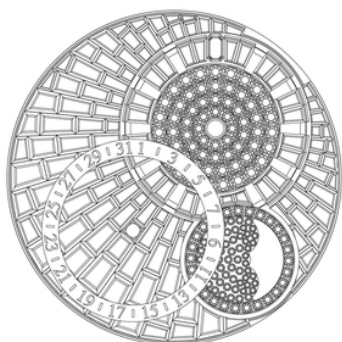

4.1

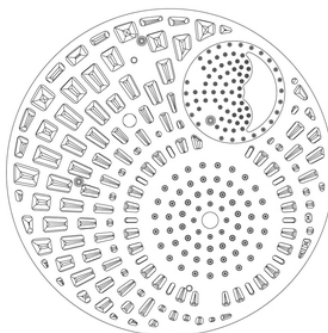

4.2



4.3



4.4



4.5



4.6



4.7

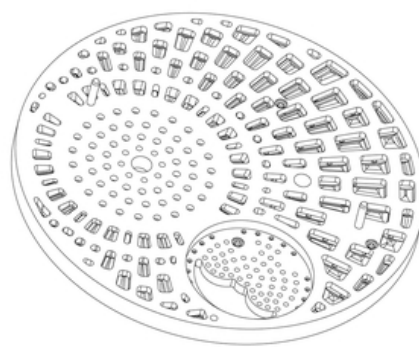

4.8

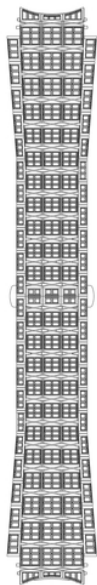

5.1

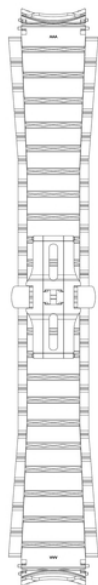

5.2



5.3



5.4

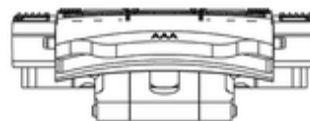

5.5

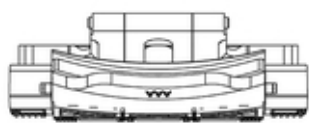

5.6

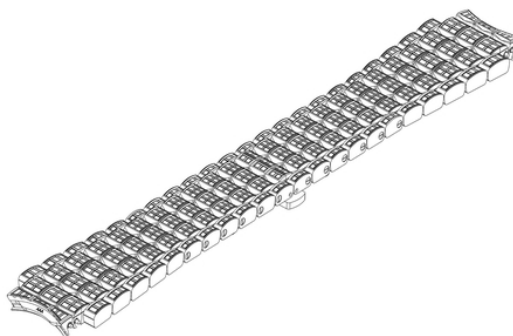

5.7

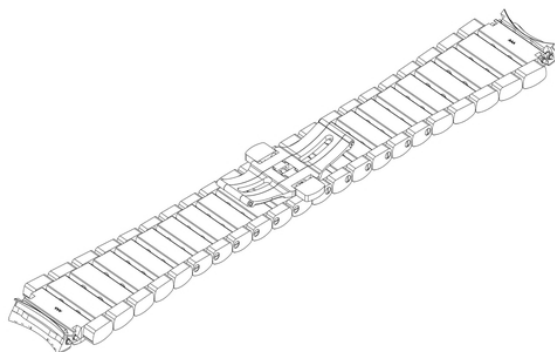

5.8

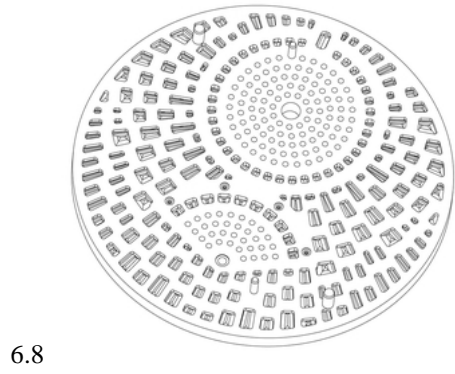
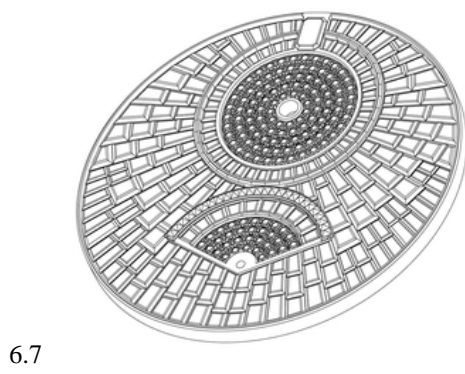
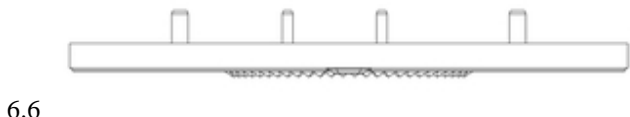
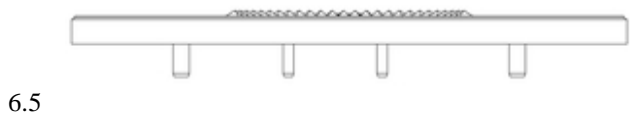
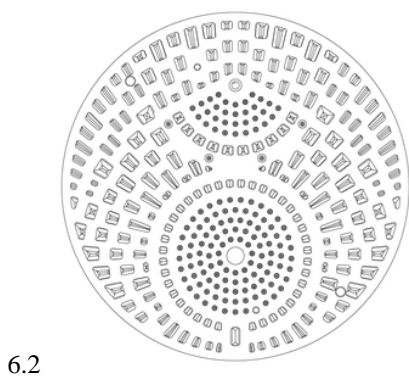
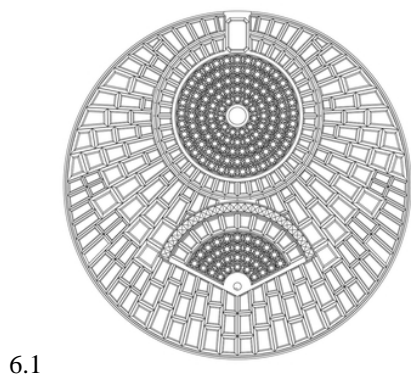

(11) DM/225 482

(51) 03-01

(15) 2022 12 05

(44) 51/2022 (2022 12 23)

(22) 2022 12 05

(28) 1

(73) Chanel SARL

Quai Du Général-Guisan 24, 1204 Genève (CH)

(85) CH

(86) CH

(87) CH

(88) CH

(89) CH

(81) II. GR III. BG, DK, EG, FI, GE, JP, MA, MX, NO, OA, PL, RU, TN, TR, UA

(72) Marianna Nitsch

135 Avenue Charles De Gaulle, 92521, Neuilly Sur Seine (FR)

(46) 2022 12 23

(54) 1. HANDBAG STRAP

(55)



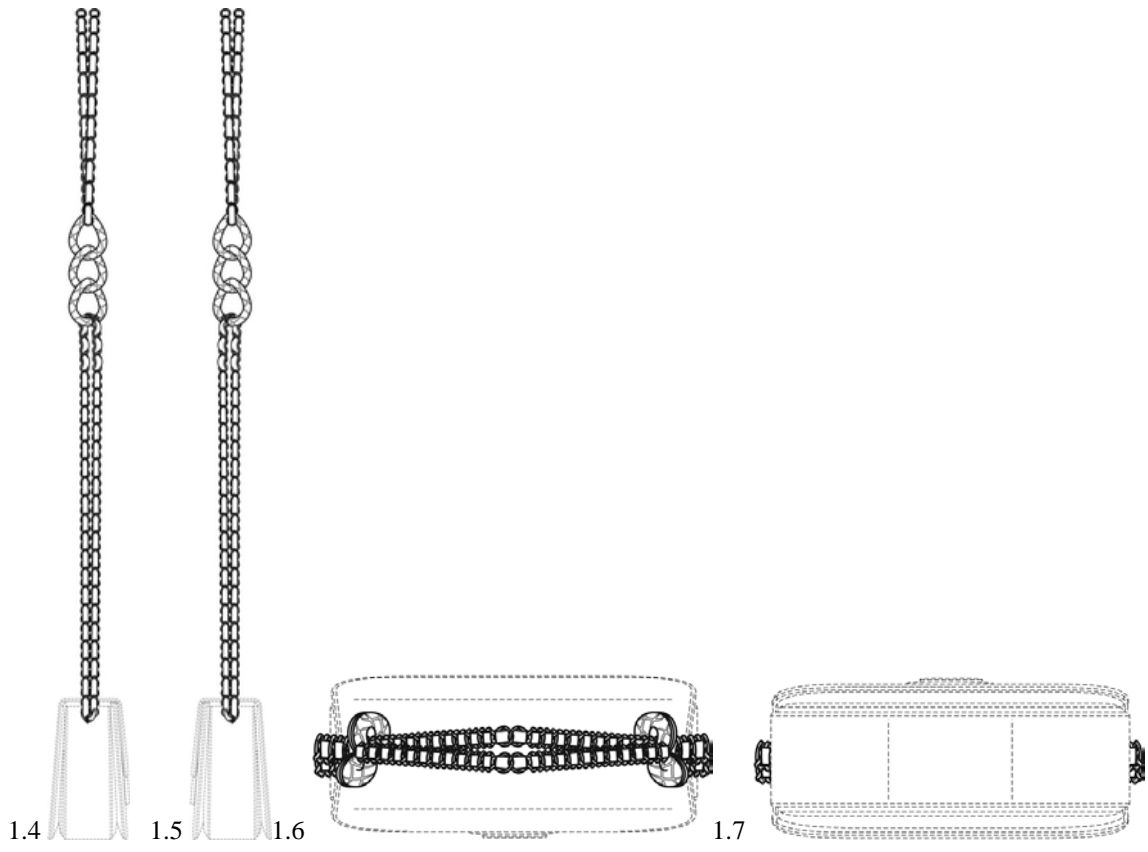



1.9

- (11) DM/221 697 (51) 11-01
(15) 2022 06 20 (44) 51/2022 (2022 12 23)
(22) 2022 06 20
(28) 8
(73) HARRY WINSTON SA
Chemin Du Tourbillon 8, 1228 Plan-les-Ouates (CH)
(85) CH
(86) CH
(87) CH
(88) CH
(89) CH
(81) II. MA III. AL, AM, AZ, BA, BZ, CA, CH, EM, GB, GE, KG, LI, MC, MD, ME, MK, MN, NO, OM, SG,
TN, TR, UA
(72) 1-2 Dominique RIVIERE
C/o Harry Winston Inc. 718 Fifth Avenue, 10019, New York, NY (US);
3-4 Rie YATSUGI-KANG
C/o Harry Winston Inc. 718 Fifth Avenue, 10019, New York, NY (US);
5-8 Tobias WUEST
C/o Harry Winston Inc. 718 Fifth Avenue, 10019, New York (US)
(74) The Swatch Group AG (The Swatch Group SA) (The Swatch Group Ltd.)
Faubourg Du Lac 6, 2501 Biel/Bienne (CH)
(46) 2022 12 23
(54) 1.-2. NECKLACE, 3. FINGER RING, 4. PAIR OF EARRINGS, 5.-6. NECKLACE, 7. FINGER RING,
8. PAIR OF EARRINGS
(55)



1.1



1.2



1.3



1.4



1.5



1.6



1.7



1.8



2.1



2.2



2.3



2.4



2.5



2.6



2.7



2.8



3.1



3.2



3.3



3.4



3.5



3.6



3.7



3.8



4.1



4.2



4.3







5.4



5.5



5.6



5.7



5.8



6.1



6.2



6.3



6.4



6.5



6.6



6.7



6.8



6.9



7.1



7.2



7.3



7.4

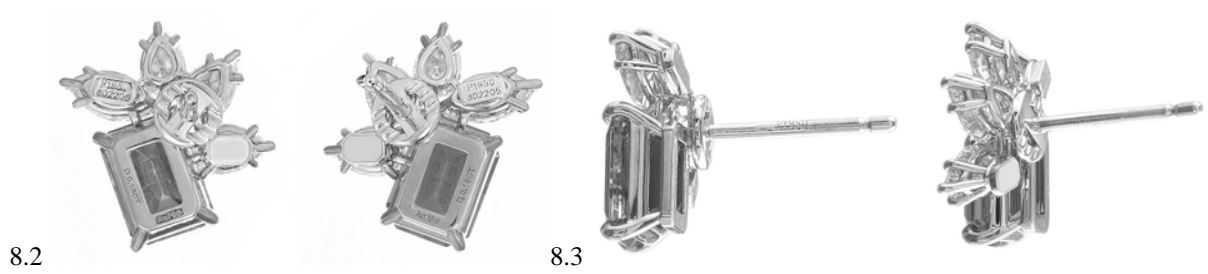

(11) DM/221 993

(51) 11-01

(15) 2022 06 30

(44) 52/2022 (2022 12 30)

(22) 2022 06 30

(28) 1

(73) HARRY WINSTON SA

Chemin Du Tourbillon 8, 1228 Plan-les-Ouates (CH)

(85) CH

(86) CH

(87) CH

(88) CH

(89) CH

(81) II. MA III. AL, AM, AZ, BA, BZ, CA, CH, EM, GB, GE, KG, LI, MC, MD, ME, MK, MN, NO, OM, RU, SG, TN, TR, UA

(72) Rie YATSUGI-KANG

C/o Harry Winston Inc., 718 Fifth Avenue, 10019, New York (US)

(74) The Swatch Group AG (The Swatch Group SA) (The Swatch Group Ltd.)

Faubourg Du Lac 6, 2501 Biel/Bienne (CH)

(46) 2022 12 30

(54) 1. NECKLACE

(55)

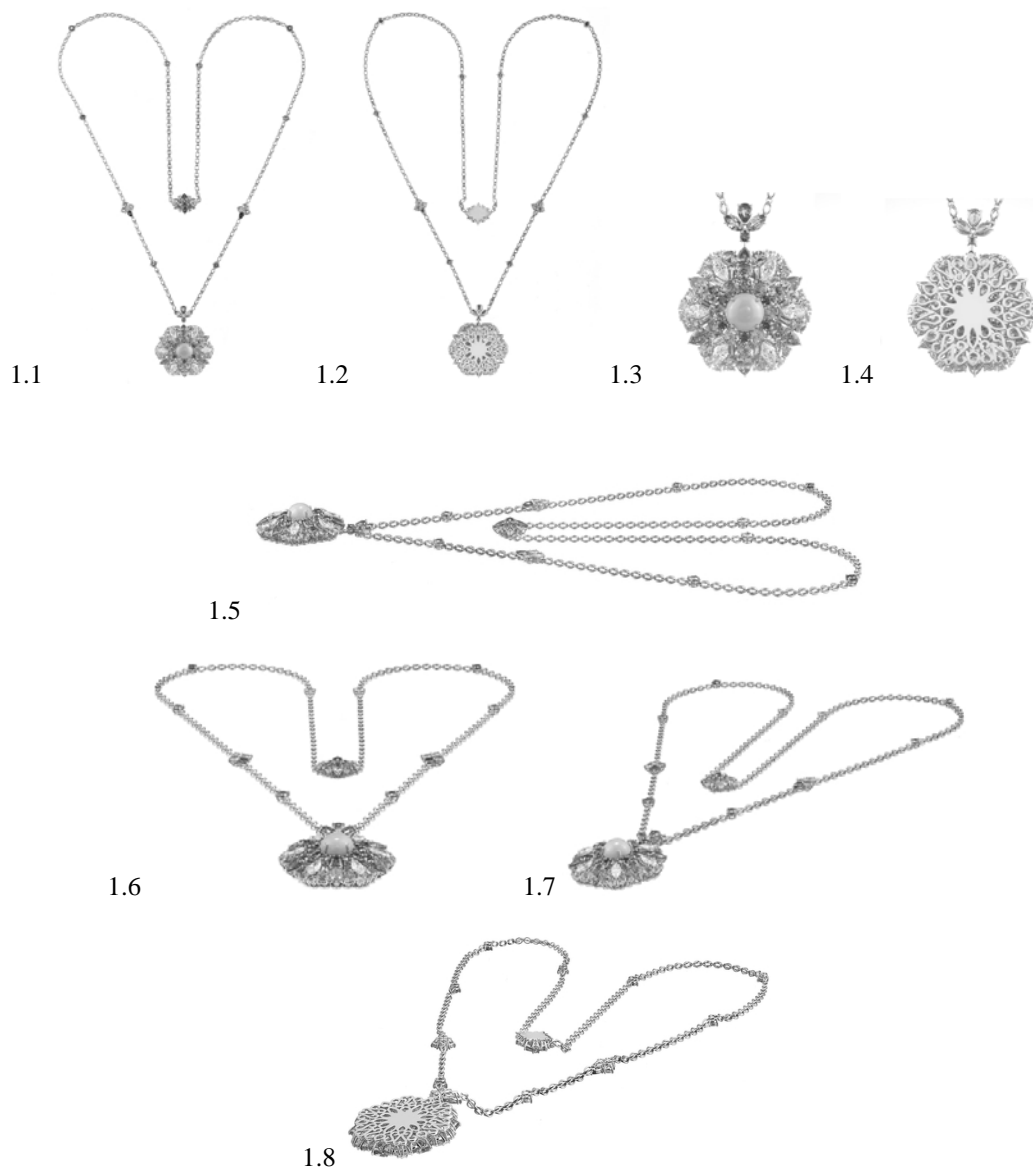

TRADEMARKS

APPLICATIONS FILED UNDER THE NATIONAL PROCEDURE APPROVED FOR REGISTRATION

The decision can be appealed at the Chamber of Appeal of Sakpatenti within 3 months from the publication or at the Mtskheta District Court Administrative Cases Board (Address: №17, Samkhedro St., Mtskheta), within 1 month following the publication.

(260) AM 2023 99509 A*
(210) AM 99509
(220) 2018 09 25
(731) LLC "Zhorzholiani Trading"
Nutsbidze Plateau, II mcr., I qu., bld. 6, ap. 6,
0183, Tbilisi, Georgia
(740) Davit Zhorzholiani
(540)



(591) White, red, golden
(531) 03.01.01; 03.01.02; 03.01.22; 05.05.20;
05.07.10; 19.09.02; 24.01.10; 24.01.15;
24.09.01; 25.01.05; 28.19; 29.01.15
(511) 33, 35

(260) AM 2023 100058 A*
(210) AM 100058
(220) 2019 04 03
(731) GSH Trademarks Limited
Afroditis, 25, 2nd Floor, Flet/Office 204,
Nicosia, Cyprus
(740) Giorgi Taktakishvili
(540)

ШУСТОБ

(591) Black-white
(511) 33

(260) AM 2023 100059 A*
(210) AM 100059
(220) 2019 04 03
(731) GSH Trademarks Limited
Afroditis, 25, 2nd Floor, Flet/Office 204,
Nicosia, Cyprus
(740) Giorgi Taktakishvili

(540)

SHUSTOFF

(591) Black-white
(511) 33

(260) AM 2023 115851 A
(210) AM 115851
(220) 2021 12 20
(731) LLC "Winery Khareba"
Davit Aghmashenebeli Alley 170a, 0131,
Tbilisi, Georgia
(540)



(591) Grey, dark blue, white, golden, green, light golden,
carnelian
(531) 03.13.04; 03.13.05; 26.05.03; 26.05.15;
26.05.22; 29.01.13
(526) მუხურის თაფლი MUKHURI'S HONEY
(511) 30, 35

(260) AM 2023 117717 A
(210) AM 117717
(220) 2022 05 06
(731) LLC Wine Company "Shumi"
Lionidze Str. 33, Telavi, Georgia
(740) Shalva Gvaramadze

(540)

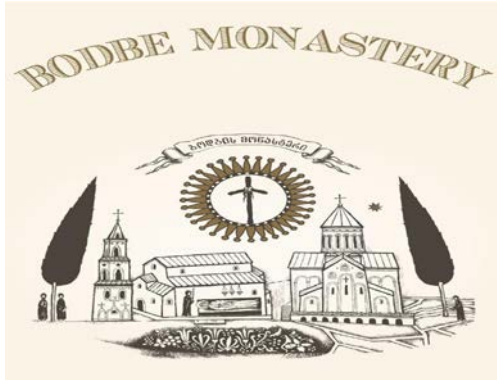

- (591) Light brown, black, white
 (531) 02.01.03; 02.03.04; 02.03.16; 02.03.23;
 05.01.01; 05.01.02; 07.01.03; 24.13.09;
 24.13.22
 (526) ბოდბის მონასტერი, BODBE MONASTERY
 (511) 33

- (260) AM 2023 117806 A
 (210) AM 117806
 (220) 2022 05 13
 (731) LLC "Geb Group"
 Simon Chikovani Str. 24a, ap. 24, 0108, Vake
 District, Tbilisi, Georgia
 (740) Ioane Iarajuli;
 Lia Shikhiashvili;
 Zurab Bezhashvili

(540)

ნიკალა
Nikala
 Никала

- (591) Black-white
 (511) 2

- (260) AM 2023 118158 A
 (210) AM 118158
 (220) 2022 06 15
 (731) LLC "Alta Technologies"
 Akaki Beliashvili Str. 104, Place 12, Bld. 1,
 0159, Tbilisi, Georgia
 (540)



- (591) FFFFFFF white, 5B6670 grey, FFB71B yellow
 (531) 26.03.01; 26.03.04; 27.05.01; 28.19; 29.01.13
 (511) 9, 35, 37

- (260) AM 2023 118161 A
 (210) AM 118161
 (220) 2022 06 16
 (731) Reckitt & Colman (Overseas)
 Hygiene Home Limited
 103-105 Bath Road, Slough, Berkshire,
 SL1 3UH, United Kingdom
 (740) Liliana Darakhvelidze
 (540)

WOOLITE

- (591) Black-white
 (511) 3

- (260) AM 2023 118162 A
 (210) AM 118162
 (220) 2022 06 16
 (731) Reckitt & Colman (Overseas)
 Hygiene Home Limited
 103-105 Bath Road, Slough, Berkshire,
 SL1 3UH, United Kingdom
 (740) Liliana Darakhvelidze
 (540)

STREPSILS

- (591) Black-white
 (511) 30

- (260) AM 2023 118403 A
 (210) AM 118403
 (220) 2022 07 06
 (731) LTD "Tiflisi Marani"
 Zakaria Paliashvili Str. 33, ap. 6, Tbilisi, 0179,
 Georgia
 (540)

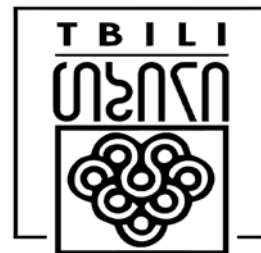

- (591) 000000 black, white
 (531) 05.07.10; 25.01.15; 25.01.19; 26.04.01;
 26.04.02; 26.04.07; 26.04.09; 27.05.01;
 27.05.11
 (511) 32

- (260) AM 2023 118547 A
 (210) AM 118547
 (220) 2022 07 13
 (731) Vakhtang Botsvadze
 Al. Kazbegi Ave. 24, ap. 13, 0160, Tbilisi,
 Georgia
 (740) Giorgi Taktakishvili

(540)

Layers

(591) Black-white
(511) 29

(260) AM 2023 118551 A
(210) AM 118551
(220) 2022 07 13
(731) LTD "Loris Parfum Georgia"
Shota Rustaveli Ave. 26, Tbilisi, Georgia

(540)

LORIS
P A R F U M

(591) Black-white
(531) 27.05.01; 27.05.09; 27.05.10
(511) 35

(260) AM 2023 118559 A
(210) AM 118559
(220) 2022 07 13
(731) LTD "Inosan Bioscience and Research"
Isani Str. 1, 0103, Isani District, Tbilisi, Georgia

(540)



(591) Sky-blue, dark blue, white
(531) 26.04.03; 26.04.22; 27.05.01; 28.05; 28.19;
29.01.12
(511) 3, 5

(260) AM 2023 118562 A
(210) AM 118562
(220) 2022 07 14
(731) LTD "Nik-2007"
Akhvlediani Str., Lane 6, 0103, Chughureti
District, Tbilisi, Georgia

(540)



(591) Blue, sky-blue, white
(531) 06.01.01; 06.01.04; 29.01.04
(511) 6, 8, 18, 22, 25, 28

(260) AM 2023 118563 A
(210) AM 118563
(220) 2022 07 14
(731) LTD "Iani "
Ilia Chavchavadze Ave. 50b, ap. 72, Tbilisi,
Georgia



(591) Green, black
(531) 26.04.09; 26.04.22; 26.04.24; 29.01.12
(511) 43

(260) AM 2023 118566 A
(210) AM 118566
(220) 2022 07 14
(310) 085943
(320) 2022 03 10
(330) JM
(731) Worldwide Franchise Systems Inc.
One StarPoint, Stamford, Connecticut 06902,
USA

(740) Tamaz Shilakadze
(540)

FOUR POINTS EXPRESS

(591) Black-white
(511) 35, 43

(260) AM 2023 118728 A
(210) AM 118728
(220) 2022 07 23
(731) LTD "Archil Mchedlidze's Law Company"
Kote Marjanishvili Str. 6, 0102, Tbilisi, Georgia

(540)



Archil Mchedlidze's
LAW PRACTICE

(591) 58595B dark grey, F37A36 orange, white
(531) 26.04.03; 26.13.25; 27.05.01; 27.05.10;
29.01.12
(511) 45

(260) AM 2023 118737 A
(210) AM 118737
(220) 2022 07 26
(731) LTD "Andronikashvili's Gamma"
Udabnos Monasteri Str. 28, Tbilisi, Georgia
(740) Giorgi Taktakishvili
(540)



Andronikashvili's
GAMMA

since 1826

(591) Black-white
(531) 02.03.01; 02.03.02; 05.07.10; 26.01.14;
27.05.01; 27.05.09; 27.05.10; 27.05.19
(511) 33

(260) AM 2023 118754 A
(210) AM 118754
(220) 2022 07 28
(731) JSC "Insurance Company Imedi L"
Anna Politkovskaya Str. 9, Tbilisi, Georgia
(740) Giorgi Taktakishvili
(540)

იმედი
IMEDI

(591) Black-white
(511) 36

REGISTERED TRADEMARKS

(111) M 2023 36358 R
(151) 2023 01 20
(181) 2033 01 20
(260) AM 2022 116333 A
(220) 2022 01 27
(732) LTD "Medical World"
Nearby Krtsanisi Str. 16, 0114, Tbilisi, Georgia

(111) M 2023 36359 R
(151) 2023 01 20
(181) 2033 01 20
(260) AM 2022 116526 A
(220) 2022 02 08
(732) LTD "Nikora"
A. Mrevlishvili Str. 2, 0180, Tbilisi, Georgia

(111) M 2023 36360 R
(151) 2023 01 23
(181) 2033 01 23
(260) AM 2022 116624 A
(220) 2022 02 13
(732) LTD "Pharmhub"
Akaki Tsereteli Ave. 116, 0186, Tbilisi, Georgia

(111) M 2023 36361 R
(151) 2023 01 23
(181) 2033 01 23
(260) AM 2022 116169 A
(220) 2022 01 13
(732) LTD "Biopolus"
Noneshvili Str. 65, 6000, Batumi, Georgia

(111) M 2023 36362 R
(151) 2023 01 23
(181) 2033 01 23
(260) AM 2021 115884 A
(220) 2021 12 22
(732) Decathlon
4, boulevard de Mons, 59650 Villeneuve
d'Ascq, France

(111) M 2023 36363 R
(151) 2023 01 23
(181) 2033 01 23
(260) AM 2022 116626 A
(220) 2022 02 13
(732) LTD "Pharmhub"
Akaki Tsereteli Ave. 116, 0186, Tbilisi, Georgia

(111) M 2023 36364 R
(151) 2023 01 23
(181) 2033 01 23
(260) AM 2022 116623 A
(220) 2022 02 13
(732) LTD "Pharmhub"
Akaki Tsereteli Ave. 116, 0186, Tbilisi, Georgia

(111) M 2023 36365 R
(151) 2023 01 23
(181) 2033 01 23
(260) AM 2022 116642 A
(220) 2022 02 14
(732) LTD "Pharmhub"
Akaki Tsereteli Ave. 116, 0186, Tbilisi, Georgia

(111) M 2023 36366 R
(151) 2023 01 23
(181) 2033 01 23
(260) AM 2022 116625 A
(220) 2022 02 13
(732) LTD "Pharmhub"
Akaki Tsereteli Ave. 116, 0186, Tbilisi, Georgia

(111) M 2023 36367 R
(151) 2023 01 23
(181) 2033 01 23
(260) AM 2022 116622 A
(220) 2022 02 13
(732) LTD "Pharmhub"
Akaki Tsereteli Ave. 116, 0186, Tbilisi, Georgia

(111) M 2023 36368 R
(151) 2023 01 23
(181) 2033 01 23
(260) AM 2022 116246 A
(220) 2022 01 20
(732) LTD "Biopolus"
Noneshvili Str. 65, 6000, Batumi, Georgia

(111) M 2023 36369 R
(151) 2023 01 23
(181) 2033 01 23
(260) AM 2022 116435 A
(220) 2022 02 03
(732) LTD "Biopolus"
Noneshvili Str. 65, Batumi, Georgia

(111) M 2023 36370 R
(151) 2023 01 23
(181) 2033 01 23
(260) AM 2022 116545 A
(220) 2022 02 09
(732) LTD "Biopolus"
Noneshvili Str. 65, Batumi, Georgia

(111) M 2023 36371 R
(151) 2023 01 23
(181) 2033 01 23
(260) AM 2022 116330 A
(220) 2022 01 26
(732) LTD "Biopolus"
Noneshvili Str. 65, Batumi, Georgia

(111) M 2023 36377 R
(151) 2023 01 31
(181) 2033 01 31
(260) AM 2022 116315 A
(220) 2022 01 24
(732) Alkaloid AD Skopje
Blvd. Aleksandar Makedonski 12, 1000 Skopje,
The Republic of North Macedonia

(111) M 2023 36378 R
(151) 2023 01 31
(181) 2033 01 31
(260) AM 2021 115687 A
(220) 2021 12 08
(732) LTD "LJ Group"
Merab Kostava Str. 72, app. 8, Tbilisi, Georgia

(111) M 2023 36379 R
(151) 2023 01 31
(181) 2033 01 31
(260) AM 2021 115686 A
(220) 2021 12 08
(732) LTD "LJ Group"
Merab Kostava Str. 72, app. 8, Tbilisi, Georgia

(111) M 2023 36380 R
(151) 2023 01 31
(181) 2033 01 31
(260) AM 2021 115594 A
(220) 2021 11 29
(732) LTD "City Development"
Vazha-Pshavela Ave. 70, 0186, Tbilisi, Georgia

(111) M 2023 36381 R
(151) 2023 01 31
(181) 2033 01 31
(260) AM 2021 115126 A

(220) 2021 10 28
(732) Giorgi Chikhladze
N. Kipshidze Str. 2, 0162, Tbilisi, Georgia

(111) M 2023 36382 R
(151) 2023 01 31
(181) 2033 01 31
(260) AM 2022 116537 A
(220) 2022 02 08
(732) Alma Lasers LTD
18 Haharash St., Caesarea Business & Industrla
Park PO BOX 3021, Israel

(111) M 2023 36383 R
(151) 2023 01 31
(181) 2033 01 31
(260) AM 2022 116531 A
(220) 2022 02 08
(732) Alma Lasers LTD
18 Haharash St., Caesarea Business & Industrla
Park PO BOX 3021, Israel

(111) M 2023 36384 R
(151) 2023 01 31
(181) 2033 01 31
(260) AM 2022 116765 A
(220) 2022 02 25
(732) Hangzhou Shishi Technology Co., Ltd.
Room 403, 4th Floor, Building 4, No. 735
Jianghong Road, Changhe Street, Binjiang
District, Hangzhou City, Zhejiang Province,
People Republic of China

(111) M 2023 36385 R
(151) 2023 01 31
(181) 2033 01 31
(260) AM 2022 116527 A
(220) 2022 02 08
(732) LTD "Nikora"
A. Mrevlishvili Str. 2, 0180, Tbilisi, Georgia

TRADEMARKS REGISTERED ACCORDING TO THE ACCELERATED PROCEDURE

The decision can be appealed at the Chamber of Appeal of Sakpatenti within 3 months from the publication.

(111) M 2023 36356 R
 (151) 2023 01 20
 (181) 2033 01 20
 (210) AM 121045
 (220) 2022 12 30
 (732) Gela Gamtkitsulashvili
 Vazha-Pshavela Ave. 71, bld. "C", ap. 7, 0186,
 Tbilisi, Georgia;
 Gia Gamtkitsulashvili
 Vazha-Pshavela Ave. 71, bld. "C", ap. 7, 0186,
 Tbilisi, Georgia;
 (740) Giorgi Taktakishvili
 (540)

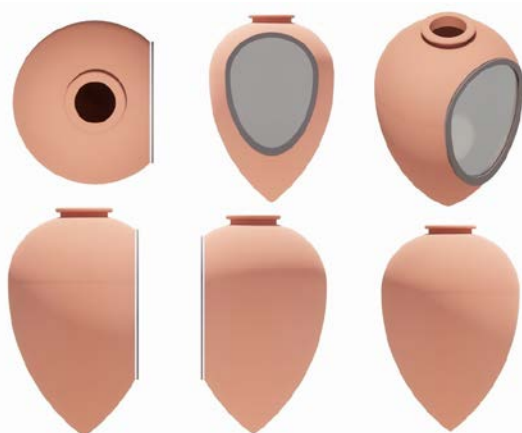

(591) Terracotta, grey, black
 (531) 19.09.02; 29.01.13
 (554) Three Dimensional
 (511) 33, 35, 41, 43

(111) M 2023 36357 R
 (151) 2023 01 20
 (181) 2033 01 20
 (210) AM 121130
 (220) 2023 01 10
 (732) Badri Bagatelia
 Irakli Abashidze Str. 70, ap. 76, 0179,
 Tbilisi, Georgia
 (740) Zurab Bezhashvili;
 Ioane Iarajuli
 (540)



(591) White, yellow, red
 (531) 25.01.25; 26.04.02; 26.04.05; 26.04.16;
 26.04.22; 26.04.24; 26.13.25; 27.05.24; 28.19
 (511) 43

(111) M 2023 36372 R
 (151) 2023 01 24
 (181) 2033 01 24
 (210) AM 120936
 (220) 2022 12 23
 (732) Iago Kartsivadze
 Ketevan Tsamebuli Str., II Lane 47, ap. 7,
 Batumi, Georgia
 (740) Khatuna Imnadze
 (540)



(591) Black-white
 (531) 28.19
 (511) 29, 31

(111) M 2023 36373 R
 (151) 2023 01 25
 (181) 2033 01 25
 (210) AM 121054
 (220) 2023 01 05
 (732) Elguja Keburia
 Orkhevi, first Exit, 7, 0103, Tbilisi,
 Georgia
 (540)

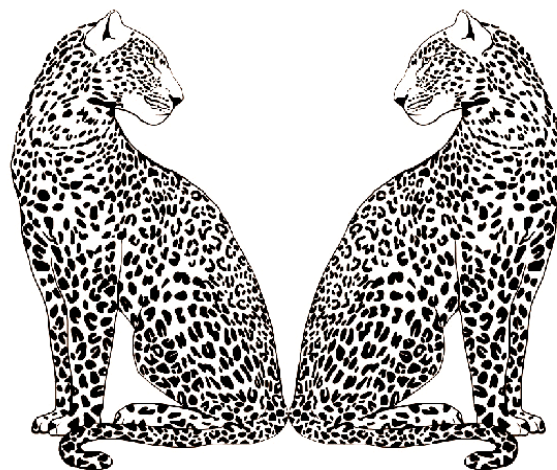

(591) Silver, white
 (531) 03.01.04; 03.01.17; 03.01.23; 03.01.28
 (511) 9, 41, 43

(111) M 2023 36374 R
 (151) 2023 01 31
 (181) 2033 01 31
 (210) AM 121131
 (220) 2023 01 10
 (732) LTD "Gagra +"
 Davit Aghmashenebeli Ave. 172, 0112, Tbilisi,
 Georgia
 (540)



(591) Orange
 (531) 24.17.05; 24.17.07; 26.11.08; 27.05.01;
 27.05.10; 27.05.11; 29.01.01
 (526) GAGRA გაგრა
 (511) 29, 30

(111) M 2023 36375 R
 (151) 2023 01 31
 (181) 2033 01 31
 (210) AM 121219
 (220) 2023 01 16
 (732) LTD "Chirina"
 Lado Gudiashvili Str. 9, 0105, Tbilisi, Georgia
 (540)



(591) White, green
 (531) 26.13.25; 27.05.01; 29.01.12
 (511) 29

(111) M 2023 36376 R
 (151) 2023 01 31
 (181) 2033 01 31
 (210) AM 121224
 (220) 2023 01 17
 (732) LTD "4+1"
 Kaloubani Str. 36, ap. 58, Tbilisi, Georgia
 (540)

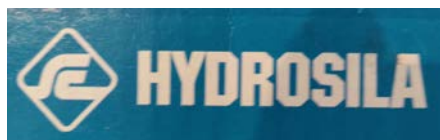

(591) Blue, white
 (531) 26.04.02; 26.04.03; 26.04.12; 26.04.18;
 26.04.22; 26.04.24; 27.05.01; 27.05.17;
 27.05.24; 29.01.12
 (511) 7

(111) M 2023 36386 R
 (151) 2023 02 01
 (181) 2033 02 01
 (210) AM 121225
 (220) 2023 01 17
 (732) LTD "Khilari"
 Ikalto Str. 26, ap. 21, 2206, Saburtalo District,
 Tbilisi, Georgia
 (540)



(591) Black-white
 (531) 01.15.21; 27.05.07; 28.05; 28.19
 (511) 32

(111) M 2023 36387 R
 (151) 2023 02 01
 (181) 2033 02 01
 (210) AM 120967
 (220) 2022 12 29
 (732) Philip Morris Products S.A.
 Quai Jeanrenaud 3, 2000 Neuchâtel,
 Switzerland
 (740) Pavle Meipariani
 (540)

VEEV NOW MELON
 COCONUT

(591) Black-white
 (511) 34

(111) M 2023 36388 R
 (151) 2023 02 01
 (181) 2033 02 01
 (210) AM 121243
 (220) 2023 01 18
 (732) LTD "Tineti"
 Kote Marjanishvili Str. 7, 0161, Tbilisi, Georgia
 (740) Mariam Usenashvili
 (540)



(591) Blue, white, azure
 (531) 26.01.01; 26.01.05; 26.11.12; 27.05.01;
 29.01.04; 29.01.12
 (511) 35, 36, 39, 41, 41

INTERNATIONAL TRADEMARKS FOR WHICH A DECISION ON GRANTING PROTECTIONS IS TAKEN

The decision can be appealed at the Chamber of Appeal of Sakpatenti within 3 months from the publication or at the Mtskheta District Court Administrative Cases Board (Address: №17, Samkhedro St., Mtskheta), within 1 month following the publication.

(260) AM 2023 116712 A

(800) 1645527

(151) 2021 06 10

(891) 2021 06 10

(731) KASTAMONU ENTEGRE AĞAÇ SANAYİ
VE TİC.ANONİM ŞİRKETİ

ALTUNİZADE MAH.KISIKLI CAD.,

ALLIANZ13, Üsküdar, İstanbul, Türkiye

(540)



(591) Blue, green

(531) 26.15.01; 29.01.12

(511)

19 – Sand, gravel, crushed stone, asphalt, bitumen, cement, gypsum, plaster, concrete, marble blocks for construction, included in this class, building materials (as finished products) made of concrete, gypsum, clay, potters' clay, stone, marble, wood, plastics and synthetic materials for building, construction, road construction purposes, included in this class; non-metallic buildings, non-metallic building materials, poles not of metal for power lines, barriers not of metal; natural and synthetic coatings in the form of panels and sheets, being building materials, bitumen cardboard coatings for roofing; bitumen coating for roofing; doors and windows of wood and synthetic materials, traffic signs not of metal, non-luminous and non-mechanical, for roads, monuments and statuettes of stone, concrete and marble, building glass, prefabricated swimming pools not of metal (structures), aquarium sand.

20 – Furniture, made of any kind of material, mattresses, pillows, air mattresses and cushions, not for medical purposes, water beds, mirrors, beehives, artificial honeycombs and sections of wood for honeycombs, bouncing chairs for babies, playpens for babies, cradles, infant walkers, display boards, frames for pictures and paintings, identification plates, identification tags, nameplates, identification labels made of wood or synthetic materials, packaging containers of wood or plastics, casks for use in transportation or storage, barrels, storage drums, tanks, boxes, storage containers, transportation containers, chests, loading pallets and closures for the aforementioned goods, of wood or plastics, small hardware goods of wood or synthetic materials included in this class, furniture fittings, of

wood or synthetic materials, opening and closing mechanisms of wood or synthetic materials, ornaments and decorative goods of wood, cork, reed, cane, wicker, horn, bone, ivory, whalebone, shell, amber, mother-of-pearl, meerschaum, beeswax, plastic or plaster namely figurines, holiday ornaments for walls, sculptures, trophies, baskets, not of metal, fishing baskets, kennels, nesting boxes and beds for household pets, portable ladders and mobile boarding stairs of wood or synthetic materials, bamboo curtains, roller indoor blinds [for interiors], slatted indoor blinds, trip curtains, bead curtains for decoration, curtain hooks, curtain rings, curtain tie-backs, curtain rods, non-metal wheel chocks.

35 – Advertising, marketing and public relations, organization of exhibitions and trade fairs for commercial or advertising purposes, development of advertising concepts, provision of an online marketplace for buyers and sellers of goods and services, office functions, secretarial services, arranging newspaper subscriptions for others, compilation of statistics, rental of office machines, systemization of information into computer databases, telephone answering for unavailable subscribers, business management, business administration and business consultancy, accounting, commercial consultancy services, personnel recruitment, personnel placement, employment agencies, import-export agencies, temporary personnel placement services, auctioneering, the bringing together, for the benefit of others, of a variety of goods, namely, sand, gravel, crushed stone, asphalt, bitumen, cement, gypsum, plaster, concrete, marble blocks for construction, building materials (as finished products) made of concrete, gypsum, clay, potters' clay, stone, marble, wood, plastics and synthetic materials for building, construction, road construction purposes, non-metallic buildings, non-metallic building materials, poles not of metal for power lines, barriers not of metal, natural and synthetic coatings in the form of panels and sheets, being building materials, bitumen cardboard coatings for roofing, bitumen coating for roofing, doors and windows of wood and synthetic materials, traffic signs not of metal, non-luminous and non-mechanical, for roads, monuments and statuettes of stone, concrete and marble, building glass, prefabricated swimming pools not of metal (structures), aquarium sand, furniture, made of any kind of material, mattresses, pillows, air mattresses and cushions, not for medical purposes, water beds, mirrors, beehives, artificial honeycombs and sections of wood for honeycombs, boun-

cing chairs for babies, playpens for babies, cradles, infant walkers, display boards, frames for pictures and paintings, identification plates, identification tags, nameplates, identification labels made of wood or synthetic materials, packaging containers of wood or plastics, casks for use in transportation or storage, barrels, storage drums, tanks, boxes, storage containers, transportation containers, chests, loading pallets and closures for the aforementioned goods, of wood or plastics, small hardware goods of wood or synthetic materials included in this class, furniture fittings, of wood or synthetic materials, opening and closing mechanisms of wood or synthetic materials, ornaments and decorative goods of wood, cork, reed, cane, wicker, horn, bone, ivory, whalebone, shell, amber, mother-of-pearl, meerschaum, beeswax, plastic or plaster namely figurines, holiday ornaments for walls, sculptures, trophies, baskets, fishing baskets, kennels, nesting boxes and beds for household pets, portable ladders and mobile boarding stairs of wood or synthetic materials, bamboo curtains, roller indoor blinds [for interiors], slatted indoor blinds, trip curtains, bead curtains for decoration, curtain hooks, curtain rings, curtain tie-backs, curtain rods, non-metal wheel chocks, enabling customers to conveniently view and purchase those goods, such services may be provided by retail stores, wholesale outlets, by means of electronic media or through mail order catalogues.

(260) AM 2023 117580 A
 (800) 1657121
 (151) 2022 02 25
 (891) 2022 02 25
 (731) Limited Liability Company "AZKOMTRADE"
 Mazhorov lane, 10, p. 1, floor 5, room 15504,
 RU-107023 Moscow, Russian Federation

(540)

HEBA
NEVA

(591) Black, white
 (531) 28.05
 (511)
 33 – Aperitifs; arrack [arak]; brandy; wine; piquette; whisky; vodka; anisette [liqueur]; kirsch; gin; digestifs [liqueurs and spirits]; cocktails; curacao; anise [liqueur]; liqueurs; grain-based distilled alcoholic beverages; alcoholic beverages, except beer; sugarcane-based alcoholic beverages; pre-mixed alcoholic beverages, other than beer-based; alcoholic beverages containing fruit; distilled beverages; spirits [beverages]; hydromel [mead]; peppermint liqueurs; bitters; rum; sake; perry; cider; rice alcohol; alcoholic extracts; fruit extracts, alcoholic; alcoholic essences.

(260) AM 2023 117582 A
 (800) 1657146
 (151) 2022 03 18
 (891) 2022 03 18
 (731) ISHA FOUNDATION, INC
 951 Isha Lane, McMinnville TN 37110, USA

(540)

SHAMBHAVI
MAHAMUDRA

(591) Black, white
 (511)
 41 – Providing yoga instruction, namely, to impart Yoga to Meditators, the general public, corporate executives, hospitals or any other individual or organization that may be interested in learning yoga for their personal welfare.

(260) AM 2023 117585 A
 (800) 1657236
 (151) 2021 05 04
 (891) 2021 05 04
 (731) MWWMWWVM Limited
 80 Broad Street, Monrovia, Liberia

(540)

VELOQX MOTORSPORT

(591) Black, white
 (511)
 12 – Vehicles; apparatus for locomotion by land.
 36 – Real estate affairs.

(260) AM 2023 117586 A
 (800) 1657238
 (151) 2021 05 04
 (891) 2021 05 04
 (731) MWWMWWVM Limited
 80 Broad Street, Monrovia, Liberia

(540)

VELOQX

(591) Black, white
 (511)
 12 – Vehicles; apparatus for locomotion by land.
 36 – Real estate affairs.

(260) AM 2023 117678 A
 (800) 1659136
 (151) 2022 02 23
 (891) 2022 02 23
 (731) SHENZHEN AIRSMART TECHNOLOGY
 CO., LTD
 616, Ant's Union Start-Up Accelerator, No. 9
 Keji Road, Science And Technology Park,
 Nanshan District, 518000 Shenzhen City, China

(540)

MUZEN

(591) Black, white

(531) 27.05.01; 27.05.03; 27.05.10

(511)

9 – Diaphragms [acoustics]; horns for loudspeakers; juke boxes for computers; compact disc players; personal stereos; headphones; smartphones; portable media players; cabinets for loudspeakers; sound recording carriers.

(260) AM 2023 117679 A

(800) 1659138

(151) 2022 02 24

(891) 2022 02 24

(731) Hangzhou Shishi Technology Co., Ltd.

Room 403, 4th Floor, Building 4, No. 735
Jianghong Road, Changhe Street, Binjiang
District, Hangzhou City, Zhejiang Province,
China

(540)

Jmoon

(591) Black, white

(531) 27.05.01

(511)

5 – Vitamin preparations; contact lens cleaning preparations; disinfectants; traditional Chinese medicines; medicinal hair growth preparations; medicated hair lotions; massage gels for medical purposes; sanitary napkins; dietetic substances adapted for medical use; dietetic beverages adapted for medical purposes.

8 – Manicure sets; hand implements for hair curling; electric irons for styling hair; laser hair removal apparatus, other than for medical purposes; crimping irons; electric hair clippers; electric hair trimmers; electric nose hair trimmers; depilation appliances, electric and non-electric; hair braiders, electric; electric hair straightening irons.

10 – Eye massage apparatus; fumigation apparatus for medical purposes; massage apparatus; electric massage apparatus for household use; lasers for beauty therapy; lasers for medical purposes; medical apparatus and instruments; abdominal belts; body fat monitors; electric scalp massagers for household use.

(260) AM 2023 117707 A

(800) 1130445

(151) 2012 04 19

(891) 2022 04 20

(731) BORCO-MARKEN-IMPORT Matthiesen
GmbH & Co. KG
Winsbergring 12-22, 22525 HAMBURG,
Germany

(540)



(591) Red, green, white, blue, gold, yellow, brown and black

(531) 02.01.09; 02.01.17; 05.11.19; 06.06.01; 09.01.10; 09.07.17; 25.01.15; 29.01.15

(511)

33 – Spirits of Mexican origin, namely tequila.

(260) AM 2023 117708 A

(800) 1353521

(151) 2017 04 28

(891) 2022 04 19

(731) LABORATOIRES PARIS DOME

Z.I de Droué sur Drouette, Lieu-dit la
Queue d'Hirondelle, F-28230 EPERNON,
France

(540)

Body Respect

(591) Black, white

(511)

3 – Bleaching preparations and other substances for laundry use; cleaning, polishing, degreasing and abrasive preparations; soaps; perfumes, essential oils, cosmetics, hair lotions; dentifrices; Depilatories; make-up removing products; lipstick; beauty masks; shaving products; preservatives for leather (polishes); creams for leather.

5 – Pharmaceutical and veterinary products; sanitary products for medical purposes; dietetic substances for medical use; food for babies; plasters, materials for dressings; material for dental fillings and dental impressions; disinfectants; products for destroying vermin; fungicides, herbicides; Medicated baths; sanitary pads, panties or towels; chemical preparations for medical or pharmaceutical use; medicinal herbs; herbal teas; parasiticides; sugar for medical use; alloys of precious metals for dental use.

44 – Agricultural, horticultural and forestry services; Medical services; Veterinary services; hygienic and beauty care for human beings or animals; Medical assistance; Plastic surgery; Hospital services; Nursing homes; Convalescence or rest homes; Opticians' services; Beauty salons; Hairdressing salons; Pet grooming; Gardening; Landscape gardening services.

(260) AM 2023 117710 A
 (800) 1618788
 (151) 2021 07 15
 (891) 2022 04 21
 (731) Aerie Pharmaceuticals, Inc.
 550 Hills Drive, 3rd Floor, Bedminster 07921,
 USA
 (540)

ROCLANDA

(591) Black, white
 (511)
 5 – Pharmaceutical preparations, in particular for the
 treatment of glaucoma and ocular hypertension.

(260) AM 2023 117751 A
 (800) 1660060
 (151) 2022 04 11
 (891) 2022 04 11
 (731) Rigo Trading S.A.
 Route de Trèves 6, EBBC, Building E, L-2633
 Senningerberg, Luxembourg
 (540)



(591) Yellow, white, orange, pink and red
 (531) 01.15.03; 01.15.07; 24.17.01; 24.17.25;
 27.05.02; 27.05.04; 27.05.08; 27.05.09;
 27.05.17; 29.01.15
 (511)
 30 – Confectionery.

(260) AM 2023 117752 A
 (800) 1660067
 (151) 2021 12 09
 (891) 2021 12 09
 (731) PRIVATE JOINT-STOCK COMPANY
 "VENTILATION SYSTEMS"
 Vul. M. Kotsiubynskoho, 1, m. Kyiv 01030,
 Ukraine
 (540)

VENTS

(591) Black, white
 (531) 27.05.01; 27.05.19
 (511)
 6 – Reinforcing materials of metal for pipes; hardware
 of metal, small; water-pipes of metal; gutter pipes of
 metal; sleeves [metal hardware]; street gutters of me-

tal; accordion doors of metal; folding doors of metal;
 swing doors of metal; chimney cowls of metal; chim-
 neys of metal; chimney shafts of metal; drain pipes of
 metal; shutters of metal; plugs of metal; hoop iron;
 outdoor blinds of metal; clips of metal for cables and
 pipes; junctions of metal for pipes; water-pipe valves
 of metal; drain traps [valves] of metal; valves of metal,
 other than parts of machines; chimney pots of metal;
 manifolds of metal for pipelines; elbows of metal
 for pipes; pipe muffs of metal; penstock pipes of metal;
 casings of metal for oilwells; branching pipes of
 metal; fireplace grates of metal; grilles of metal; furnace
 fireguards of metal; ducts of metal for ventilating
 and air-conditioning installations; ducts of metal, for
 central heating installations / ducts and pipes of metal
 for central heating installations; pipes of metal; steel
 pipes; pipework of metal; fittings of metal for compressed
 air lines.

7 – Vacuum pumps [machines]; fans for motors and
 engines; centrifugal pumps; suction machines for industrial
 purposes; motors, other than for land vehicles; flues for
 engine boilers; feeders [parts of machines]; feeding
 apparatus for engine boilers; valves [parts of machines];
 compressors [machines]; compressors for refrigerators;
 steam condensers [parts of machines]; condensing
 installations; pumps [machines]; pumps [parts of machines,
 engines or motors]; pumps for heating installations;
 fittings for engine boilers; steam engines; fan belts for
 motors and engines; air suction machines; blowing
 machines; fans for the compression, sucking and carrying
 of grain; blowing machines for the compression, exhaust-
 ion and transport of gases; air condensers; air pumps
 [garage installations]; boiler tubes [parts of machines];
 filters for cleaning cooling air, for engines; filters being
 parts of machines or engines; filter presses; filtering
 machines.

11 – Steam accumulators; heat accumulators; hot air
 apparatus; air deodorizing apparatus; ionization appa-
 ratus for the treatment of air or water; air cooling appa-
 ratus; desiccating apparatus; drying apparatus for
 fodder and forage; hand drying apparatus for washrooms;
 air purifying apparatus and machines; fans [air-
 conditioning]; fans [parts of air-conditioning installa-
 tions]; electric fans for personal use; ventilation [air-
 conditioning] installations for vehicles; ventilation
 [air-conditioning] installations and apparatus; extrac-
 tor hoods for kitchens; ventilation hoods; ventilation
 hoods for laboratories; pipes [parts of sanitary installa-
 tions]; disinfectant apparatus; disinfectant apparatus
 for medical purposes; deodorizing apparatus, not for
 personal use; chimney flues; flues for heating boilers;
 safety accessories for water or gas apparatus and pipes;
 humidifiers; coils [parts of distilling, heating or
 cooling installations]; air valves for steam heating installa-
 tions; furnace grates; air conditioners for vehicles;
 taps for pipes and pipelines; mixer taps for water pipes;
 boilers, other than parts of machines; steam boilers,
 other than parts of machines; cooling appliances

and installations; air-conditioning apparatus; air sterilizers; thermostatic valves [parts of heating installations]; pipes [parts of sanitary installations]; boiler pipes [tubes] for heating installations; air-conditioning installations; filters for air conditioning.

19 – Water-pipes, not of metal; roof gutters, not of metal; gutter pipes, not of metal; street gutters, not of metal; accordion doors, not of metal; folding doors, not of metal; swing doors, not of metal; chimney shafts, not of metal; lengthening pieces, not of metal, for chimneys; drain pipes, not of metal; jalousies, not of metal; water-pipe valves, not of metal or plastic; drain traps [valves], not of metal or plastic; chimney pots, not of metal; penstock pipes, not of metal; branching pipes, not of metal; ducts, not of metal, for ventilating and air-conditioning installations; rigid pipes, not of metal, for building.

(260) AM 2023 117753 A

(800) 1660093

(151) 2022 03 10

(891) 2022 03 10

(731) Japan Tobacco Inc.

1-1, Toranomon 4-chome, Minato-ku, Tokyo,
Japan

(540)

PACKCARE

(591) Black, white

(511)

34 – Tobacco, raw or manufactured; smoking tobacco, pipe tobacco, rolling tobacco, chewing tobacco, snus; cigarettes, electronic cigarettes, liquid for electronic cigarettes, tobacco vaporizer, cigars, cigarillos; snuff; smokers' articles included in class 34; cigarette paper, cigarette tubes and matches.

(260) AM 2023 117754 A

(800) 1660098

(151) 2021 10 01

(891) 2021 10 01

(731) TEQBALL HOLDING S.A.R.L.

44, avenue John F. Kennedy, L-1855
Luxembourg, Luxembourg

(540)

TEQBALL

(591) Black, white

(511)

25 – Clothing, footwear, headgear; pants; underpants; underwear; petticoats; sleep masks; ready-made linings [parts of clothing]; boas [necklets]; teddies [undergarments]; clothing of leather; studs for football boots; top hats; boot uppers; shoes; heels; inner soles; fittings of metal for footwear; layettes [clothing]; babies' pants [clothing]; hoods [clothing]; non-slipping devices for footwear; pocket squares; heelpieces for

stockings; heelpieces for footwear; jackets [clothing]; jumper dresses; jerseys [clothing]; uniforms; leggings [trousers]; wooden shoes; veils [clothing]; headgear for wear; headbands [clothing]; topcoats; outerclothing; wimples; ear muffs [clothing]; bath robes; bathing trunks; bath slippers; swimsuits; bathing caps; bath sandals; football boots; corsets [underclothing]; corselets; lace boots; camisoles; gabardines [clothing]; shoulder wraps; stockings; tights; stocking suspenders; girdles; hosiery; shirt yokes; shirts; short-sleeve shirts; bodices [lingerie]; anti-sweat underwear; sweat-absorbent stockings; dress shields; masquerade costumes; coats; hats; hat frames [skeletons]; spats; tips for footwear; maniples; shirt fronts; skull caps; cyclists' clothing; ready-made clothing; gloves [clothing]; cuffs; combinations [clothing]; slippers [undergarments]; dressing gowns; suits; aprons [clothing]; knitwear [clothing]; footwear uppers; footwear; leg warmers; detachable collars; liveries; half-boots; boots; mantillas; stuff jackets [clothing]; sweaters; vests; fishing vests; brassieres; chasubles; miters [hats]; clothing of imitations of leather; muffs [clothing]; smocks; ascots; trousers; footmuffs, not electrically heated; dresses; neckties; neck gaiters; wet suits for water-skiing; belts [clothing]; paper hats [clothing]; paper clothing; slippers; parkas; bibs, not of paper; pelerines; money belts [clothing]; pyjamas; tee-shirts; ponchos; fur stoles; pullovers; welts for footwear; motorists' clothing; clothing; pockets for clothing; scarfs; cap peaks; caps [headwear]; galoshes; ski boots; ski gloves; skorts; esparto shoes or sandals; sports shoes; boots for sports; singlets; beach shoes; beach clothes; berets; sandals; saris; sarongs; visors [headwear]; skirts; pelisses; furs [clothing]; soles for footwear; gaiter straps; bandanas [neckerchiefs]; suspenders; breeches for wear; garters; togas; gymnastic shoes; clothing for gymnastics; turbans; mittens; shawls; sashes for wear; waterproof clothing; socks; sock suspenders; shower caps.

28 – Games and playthings; gymnastic and sporting articles not included in other classes; decorations for christmas trees; clay pigeon traps; clay pigeons [targets]; camouflage screens [sports articles]; hunting game calls; stationary exercise bicycles; masts for sailboards; tables for table tennis; tables for indoor football; dolls' beds; dolls' houses; dolls' clothes; dolls' rooms; puppets; backgammon games; baseball gloves; batting gloves [accessories for games]; gut for rackets; billiard table cushions; billiard tables; billiard cues; billiard balls; billiard markers; bingo cards; bobsleighs; body boards; billiard cue tips; spinning tops [toys]; conjuring apparatus; targets; lures for hunting or fishing; rattles [playthings]; slides [playthings]; dolls' feeding bottles; checkers [games]; checkerboards; discuses for sports; flying discs [toys]; dice; dominoes; electronic targets; arcade video game machines; building games; building blocks [toys]; amusement machines, automatic and coin-operated; coin-operated billiard tables; machines for physical exerci-

ses; exercisers [expanders]; harness for sailboards; seal skins [coverings for skis]; bowling apparatus and machinery; golf gloves; golf bags, with or without wheels; golf clubs; playing balls; skateboards; rollers for stationary exercise bicycles; roller skates; in-line roller skates; rosin used by athletes; divot repair tools [golf accessories]; candle holders for christmas trees; detonating caps [toys]; fish hooks; nets for sports; bells for christmas trees; climbers' harness; gut for fishing; swings; rocking horses; snowshoes; snow globes; hockey sticks; punching bags; portable games with liquid crystal displays; rods for fishing; fishing tackle; reels for fishing; lines for fishing; strings for rackets; bows for archery; archery implements; scent lures for hunting or fishing; toy vehicles; dolls; play balloons; toy pistols; kites; apparatus for games; marbles for games; playing cards; games; toys; toys for domestic pets; kaleidoscopes; scratch cards for playing lottery games; bite sensors [fishing tackle]; bite indicators [fishing tackle]; ornaments for christmas trees, except illumination articles and confectionery; christmas trees of synthetic material; christmas tree stands; ring games; toy masks; gloves for games; swimming kick boards; jigsaw puzzles; stuffed toys; confetti; elbow guards [sports articles]; skating boots with skates attached; ice skates; chalk for billiard cues; cricket bags; balls for games; air pistols [toys]; bladders of balls for games; butterfly nets; mah-jong; ascenders [mountaineering equipment]; scale model vehicles; landing nets for anglers; artificial fishing bait; artificial snow for christmas trees; mobiles [toys]; gaming machines for gambling; darts; boxing gloves; kite reels; scale model kits [toys]; weight lifting belts [sports articles]; pachinkos; paintballs [ammunition for paintball guns] [sports apparatus]; paintball guns [sports apparatus]; paper party hats; sling shots [sports articles]; horseshoe games; slot machines [gaming machines]; piñatas; caps for pistols [toys]; plush toys; teddy bears; cups for dice; starting blocks for sports; coxaques [toy fireworks]; scooters [toys]; poles for pole vaulting; roulette wheels; chess games; chessboards; hang gliders; bags especially designed for skis and surfboards; paragliders; ski bindings; sole coverings for skis; skis; edges of skis; surf skis; shin guards [sports articles]; snowboards; bar-bells; sleighs [sports articles]; soap bubbles [toys]; harpoon guns [sports articles]; theatrical masks; surf boards; surfboard leashes; board games; novelties for parties, dances [party favors, favours]; parlor games; radio-controlled toy vehicles; ninepins; skittles; quoits; tennis nets; tennis ball throwing apparatus; rackets; knee guards [sports articles]; body-building apparatus; shuttlecocks; appliances for gymnastics; trampolines; practical jokes [novelties]; spring boards [sports articles]; floats for fishing; swimming pools [play articles]; swimming jackets; flippers for swimming; swimming belts; water wings; men's athletic supporters [sports articles]; protective paddings [parts of sports suits]; creels [fishing traps]; twirling batons; controllers for

game consoles; fairground ride apparatus; video game machines; sailboards; fencing weapons; fencing gloves; fencing masks; waterskis; counters [discs] for games; chips for gambling.

(260) AM 2023 117755 A

(800) 1660101

(151) 2021 12 16

(891) 2021 12 16

(731) Euro Games Technology Ltd.

4, "Maritsa" Str., "Vranya-Lozen-Triugulnika",
BG-1151 Sofia, Bulgaria

(540)

Fruit Ways

(591) Black, white

(511)

9 – Software; computer gaming software; computer software packages; computer operating system software; computer software, recorded; software drivers; virtual reality software; games software; entertainment software for computer games; computer programs for network management; operating computer software for main frame computers; monitors (computer hardware); computer hardware; apparatus for recording images; monitors (computer programs); computer game programs; computer programs for recorded games; apparatus for recording, transmission or reproduction of sound or images; communications servers [computer hardware]; electronic components for gambling machines; computer application software featuring games and gaming; computer software for the administration of on-line games and gaming; computer hardware for games and gaming; hardware and software for gambling, gambling machines, gambling games on the Internet and via telecommunication network.

28 – Gaming machines for gambling; chips for gambling; mah-jong; arcade games; gambling machines operating with coins, notes and cards; games; electronic games; parlor games; gaming chips; gaming tables; slot machines [gaming machines]; LCD game machines; slot machines and gaming devices; coin-operated amusement machines; roulette chips; poker chips; chips and dice [gaming equipment]; gaming equipment for casinos; roulette tables; gaming roulette wheels; casino games; gambling machines and amusement machines, automatic and coin-operated; coin-operated amusement machines and/or electronic coin-operated amusement machines with or without the possibility of gain; boxes for coin-operated machines, slot machines and gaming machines; electronic or electrotechnical amusement machines and apparatus, gaming machines, coin-operated entertainment machines; housings for coin-operated machines, gaming equipment, gaming machines, machines for gambling; electropneumatic and electrical gambling machines (slot machines).

41 – Gambling; entertainment services related to gambling; gaming services for entertainment purposes; casino, gaming and gambling services; training in the development of software systems; provision of gaming equipment for gambling halls; providing casino equipment [gambling]; gaming machine entertainment services; providing casino facilities [gambling]; gaming hall services; amusement arcade services; games equipment rental; rental of gaming machines; providing amusement arcade services; rental of gaming machines with images of fruits; editing or recording of sounds and images; sound recording and video entertainment services; hire of sound reproducing apparatus; provision of gaming equipment for casinos; providing of casino facilities; online gambling services; casino, gaming and gambling services; provision of gaming facilities, gaming hall facilities, Internet casinos and online gambling services.

(260) AM 2023 117756 A

(800) 1660107

(151) 2021 12 14

(891) 2021 12 14

(731) ZHEJIANG YIDUN MECHANICAL & ELECTRICAL CO., LTD

Changhong Industrial District, Zeguo Town, Wenling City, Taizhou City, 317523 Zhejiang Province, China

(540)



(591) Black, white

(531) 27.05.01; 27.05.17

(511)

7 – Welding apparatus, gas-operated; electric welding apparatus; electric arc welding apparatus; electric arc cutting apparatus; washing apparatus; blowing machines; harvesting machines; aerating pumps for aquaria; saws [machines]; agitators; electric hammers; cutting machines; chain saws; hand-held tools, other than hand-operated; electric hand drills; dynamos; generators of electricity; motors, electric, other than for land vehicles; pumps [machines]; compressed air pumps; blowing machines for the compression, exhaustion and transport of gases; compressed air machines; welding machines, electric.

(260) AM 2023 117757 A

(800) 1660151

(151) 2022 03 25

(891) 2022 03 25

(731) Kia Corporation

12, Heolleung-ro, Seocho-gu, Seoul 06797, Republic of Korea

(540)



(591) Black, white

(531) 27.05.01; 27.05.17

(511)

35 – Business intermediary services for the sale and purchase of goods and services; mediation of contracts for purchase and sale of products; mediations for the purchase and sale of goods; business management of car parking facilities; negotiation and conclusion of commercial transactions for third parties via telecommunication systems; administration of incentive award programs to promote the sale of the goods and services of others; publicity, promotional and marketing services relating to vehicles; advertising; publicity; marketing services; arranging of contractual (trade) services with third parties; research services relating to advertising and marketing; advertising and commercial information services; information, advisory and consultancy services relating to business and management or business administration, including such services provided on line or via the internet; business administration in the field of transport and delivery; business administration services in the field of transportation; arranging of buying and selling contracts for third parties; procurement of contracts for the purchase and sale of goods.

(260) AM 2023 117758 A

(800) 1660168

(151) 2022 03 02

(891) 2022 03 02

(731) SWISS GEMO TECHNOLOGY GmbH

C/O FDS Consulting GmbH, Reitergasse 6, CH-8004 Zurich, Switzerland

(540)



(591) Black, white

(531) 27.05.01

(511)

5 – Dietetic substances adapted for medical use; dietetic beverages adapted for medical purposes; traditional Chinese medicines; medicinal hair growth preparations; vitamin preparations; massage gels for medical purposes; medicated hair lotions; contact lens cleaning preparations; disinfectants; sanitary napkins.

9 – Earphones; computer software applications, downloadable; machine learning software; testing apparatus not for medical purposes; battery chargers; diagnostic apparatus, not for medical purpose; batteries, electric; portable digital electronic scales; electrical adapters; eyeglasses.

10 – Electric scalp massagers for household use; body fat monitors; medical apparatus and instruments; abdominal belts; lasers for medical purposes; eye massage apparatus; fumigation apparatus for medical purposes; electric massage apparatus for household use; lasers for beauty therapy; massage apparatus.

(260) AM 2023 117759 A

(800) 1660216

(151) 2021 12 16

(891) 2021 12 16

(731) Euro Games Technology Ltd.

4, "Maritsa" Str., "Vranya-Lozen-Triugulnika",
BG-1151 Sofia, Bulgaria

(540)



(591) Red, orange, yellow and brown

(531) 27.05.01; 27.05.02; 27.07.01; 27.07.02;
29.01.14

(511)

9 – Software; computer gaming software; computer software packages; computer operating system software; computer software, recorded; software drivers; virtual reality software; games software; entertainment software for computer games; computer programs for network management; operating computer software for main frame computers; monitors (computer hardware); computer hardware; apparatus for recording images; monitors (computer programs); computer game programs; computer programs for recorded games; apparatus for recording, transmission or reproduction of sound or images; communications servers [computer hardware]; electronic components for gambling machines; computer application software featuring games and gaming; computer software for the administration of on-line games and gaming; computer hardware for games and gaming; hardware and software for gambling, gambling machines, gambling games on the Internet and via telecommunication network.

28 – Gaming machines for gambling; chips for gambling; mah-jong; arcade games; gambling machines operating with coins, notes and cards; games; electronic games; parlor games; gaming chips; gaming tables; slot machines [gaming machines]; LCD game machines; slot machines and gaming devices; coin-operated amusement machines; roulette chips; poker chips; chips and dice [gaming equipment]; gaming equipment for casinos; roulette tables; gaming roulette wheels; casino games; gambling machines and amusement machines, automatic and coin-operated; coin-operated amusement machines and/or electronic coin-operated amusement machines with or without the possibility of gain; boxes for coin-operated machines,

slot machines and gaming machines; electronic or electrotechnical amusement machines and apparatus, gaming machines, coin-operated entertainment machines; housings for coin-operated machines, gaming equipment, gaming machines, machines for gambling; electropneumatic and electrical gambling machines (slot machines).

41 – Gambling; entertainment services related to gambling; gaming services for entertainment purposes; casino, gaming and gambling services; training in the development of software systems; provision of gaming equipment for gambling halls; providing casino equipment [gambling]; gaming machine entertainment services; providing casino facilities [gambling]; gaming hall services; amusement arcade services; games equipment rental; rental of gaming machines; providing amusement arcade services; rental of gaming machines with images of fruits; editing or recording of sounds and images; sound recording and video entertainment services; hire of sound reproducing apparatus; provision of gaming equipment for casinos; providing of casino facilities; online gambling services; casino, gaming and gambling services; provision of gaming facilities, gaming hall facilities, Internet casinos and online gambling services.

(260) AM 2023 117760 A

(800) 1660253

(151) 2022 02 04

(891) 2022 02 04

(731) Obshchestvo s ogranichennoi otvetstvennostyu
"Torgovyi dom "Vash Gold"

Municipalnyi okrug Mozhaiskii vn.ter.g.,
ul. Gorbunova, 2, str. 3, et./pom.2/II, kom. 4,
RU-121596 Moscow, Russian Federation

(540)

VASH GOLD

(591) Black, white

(511)

3 – Abrasives; amber [perfume]; descaling preparations for household purposes; antistatic preparations for household purposes; aromatics [essential oils]; air fragrancing preparations; cake flavourings [essential oils]; flavourings for beverages [essential oils]; food flavourings [essential oils]; breath freshening sprays; canned pressurized air for cleaning and dusting purposes; balms, other than for medical purposes; basma [cosmetic dye]; lip glosses; nail glitter; body glitter; polishing stones; abrasive paper; emery paper; polishing paper; petroleum jelly for cosmetic purposes; shoe polish; cobblers' wax; cotton wool for cosmetic purposes; cotton wool impregnated with make-up removing preparations; sachets for perfuming linen; drying agents for dishwashing machines; adhesives for cosmetic purposes; scented water; Javelle water; lavender water; micellar water; toilet water; wax for parquet floors; floor wax; non-slipping wax for floors;

depilatory wax; moustache wax; tailors' wax; waxes for leather; polish for furniture and flooring; shoemakers' wax; polishing wax; massage gels, other than for medical purposes; heliotropine; dental bleaching gels; geraniol; make-up; deodorants for pets; deodorants for human beings or for animals; depilatory preparations; air fragrance reed diffusers; scented wood; perfumes; non-slipping liquids for floors; windscreen cleaning liquids; greases for cosmetic purposes; volcanic ash for cleaning; perfumery; decorative transfers for cosmetic purposes; ionone [perfumery]; shaving stones [astringents]; smoothing stones; eyebrow pencils; cosmetic pencils; silicon carbide [abrasive]; carbides of metal [abrasives]; alum stones [astringents]; tripoli stone for polishing; adhesives for affixing false eyelashes; adhesives for affixing false hair; hair conditioners; quillaia bark for washing; corundum [abrasive]; beard dyes; colorants for toilet purposes; cosmetic dyes; body paint for cosmetic purposes; laundry starch; laundry glaze; shoe cream; polishing creams; cosmetic creams; skin whitening creams; polishing rouge; incense; hair spray; nail varnish; liquid latex body paint for cosmetic purposes; hair lotions; lotions for cosmetic purposes; after-shave lotions; beauty masks; oils for perfumes and scents; oils for cosmetic purposes; oils for toilet purposes; essential oils; essential oils of cedarwood; essential oils of lemon; essential oils of citron; oils for cleaning purposes; bergamot oil; gaultheria oil; jasmine oil; lavender oil; almond oil; rose oil; oil of turpentine for degreasing; whitening; cleaning chalk; almond milk for cosmetic purposes; cleansing milk for toilet purposes; musk [perfumery]; deodorant soap; shaving soap; soap for brightening textile; cakes of toilet soap; antiperspirant soap; soap for foot perspiration; soap; almond soap; mint for perfumery; cosmetic kits; emery; gel eye patches for cosmetic purposes; nail art stickers; double eyelid tapes; false nails; eau de Cologne; joss sticks; pastes for razor strops; toothpaste; pumice stone; lipstick cases; hydrogen peroxide for cosmetic purposes; breath freshening strips; teeth whitening strips; sandcloth; glass cloth [abrasive cloth]; lipsticks; pomades for cosmetic purposes; shaving preparations; cosmetic preparations for baths; bath preparations, not for medical purposes; hair straightening preparations; hair waving preparations; laundry soaking preparations; grinding preparations; smoothing preparations [starching]; colour-removing preparations; leather bleaching preparations; polishing preparations; denture polishes; mouthwashes, not for medical purposes; cosmetic preparations for slimming purposes; starch glaze for laundry purposes; preparations to make the leaves of plants shiny; eye-washes, not for medical purposes; fabric softeners for laundry use; laundry preparations; dry-cleaning preparations; paint stripping preparations; lacquer removing preparations; make-up removing preparations; floor wax removers [scouring preparations]; varnish-removing preparations; rust removing preparations; nail care preparati-

ons; cleaning preparations; preparations for cleaning dentures; wallpaper cleaning preparations; preparations for unblocking drain pipes; chemical cleaning preparations for household purposes; collagen preparations for cosmetic purposes; bleaching preparations [decolorants] for household purposes; laundry bleach; aloe vera preparations for cosmetic purposes; sunscreen preparations; colour-brightening chemicals for household purposes [laundry]; breath freshening preparations for personal hygiene; shining preparations [polish]; make-up powder; diamantine [abrasive]; stain removers; nail varnish removers; vaginal washes for personal sanitary or deodorant purposes; scouring solutions; false eyelashes; antistatic dryer sheets; baby wipes impregnated with cleaning preparations; colour run prevention laundry sheets; tissues impregnated with cosmetic lotions; tissues impregnated with make-up removing preparations; saffrol; massage candles for cosmetic purposes; laundry blueing; turpentine for degreasing; potpourris [fragrances]; bleaching soda; washing soda, for cleaning; bath salts, not for medical purposes; bleaching salts; fumigation preparations [perfumes]; leather preservatives [polishes]; ammonia [volatile alkali] [detergent]; astringents for cosmetic purposes; eyebrow cosmetics; make-up preparations; sun-tanning preparations [cosmetics]; hair dyes; neutralizers for permanent waving; cosmetic preparations for eyelashes; cosmetic preparations for skin care; shoe wax; dentifrices; cosmetics; cosmetics for children; cosmetics for animals; mascara; cleansers for intimate personal hygiene purposes, non medicated; douching preparations for personal sanitary or deodorant purposes [toiletries]; detergents, other than for use in manufacturing operations and for medical purposes; degreasers, other than for use in manufacturing processes; bleaching preparations [decolorants] for cosmetic purposes; antiperspirants [toiletries]; toiletry preparations; phytocosmetic preparations; talcum powder, for toilet use; cotton swabs for cosmetic purposes; terpenes [essential oils]; emery cloth; cloths impregnated with a detergent for cleaning; henna [cosmetic dye]; shampoos for animals [non-medicated grooming preparations]; shampoos for pets [non-medicated grooming preparations]; dry shampoos; shampoos; sandpaper; soda lye; herbal extracts for cosmetic purposes; extracts of flowers [perfumes]; ethereal essences; badian essence; mint essence [essential oil].

(260) AM 2023 117761 A
(800) 1660310
(151) 2022 03 09
(891) 2022 03 09
(731) Bahlsen GmbH & Co. KG
Podbielskistraße 11, 30163 Hannover,
Germany

(540)



(591) Yellow and Brown

(531) 08.01.11; 08.01.19; 26.04.16; 26.04.18;
27.05.08; 29.01.12

(511)

29 – Milk; milk products; yoghurt; meat; poultry, not live; game, not live; fish, not live; meat extracts; jellies for food; jams; compotes; frozen fruits; fruit, preserved; dried fruit; frozen vegetables; vegetables, preserved; vegetables, dried; vegetables, cooked; potato snacks; raisins; dried nuts; roasted nuts; salted nuts; spiced nuts; dried fruit products; cooked fruits; eggs; oils for food; edible fats; fat-containing mixtures for bread slices; dairy products and dairy substitutes.

30 – Coffee; tea; cocoa; chocolate; chocolates; coffee substitutes; aperitif biscuits; pastries; flour confectionery; rolled wafers [biscuits]; cakes; biscuits; chocolate candies; candy bars; bonbons made of sugar; popcorn; candy coated confections; marzipan; chocolate confectionery containing pralines; snack foods consisting principally of confectionery; chocolate for confectionery and bread; non-medicated confectionery in jelly form; prepared desserts [confectionery]; chocolate based products; candy; waffles; confectionery items coated with chocolate; truffles [confectionery]; bread; sugar; honey; golden syrup; sauces [condiments]; mustard; salt; vinegar; spices; extruded food products made of rice; flour; sago; extruded food products made of wheat; extruded food products made of maize; rice; cereal preparations; yeast; baking powder; tapioca; edible ices; ice for refreshment.

41 – Sporting activities; entertainment services; cultural activities.

(260) AM 2023 117767 A

(800) 1660672

(151) 2022 02 10

(891) 2022 02 10

(731) TADIM GIDA MADDELERİ SANAYİ VE
TİCARET ANONİM ŞİRKETİ
GEBZE OSB2 MAH. 1100. SK. 1105 /2 1,
Çayırova Kocaeli, Türkiye

(540)

TADIMCA

(591) Black, white

(531) 27.05.01

(511)

30 – Cereal-based snack food, popcorn, crushed oats, corn chips, breakfast cereals, processed wheat for human consumption, crushed barley for human consumption, processed oats for human consumption, processed rye for human consumption, rice, honey, puffed rice and oat-based bars with addition of peanuts, hazelnut, pistachio, groundnut, grape, almond, walnut, roasted sesame, dried nuts and dried fruits.

(260) AM 2023 117768 A

(800) 1660674

(151) 2022 03 01

(891) 2022 03 01

(731) LABORATORIOS NORMON, S.A.

Ronda de Valdecarrizo, 6 E-28760 Tres Cantos,
Madrid, Spain

(540)

LUBRILAX

(591) Black, white

(511)

5 – Pharmaceutical and veterinary products; hygienic and sanitary products for medical use; dietetic substances for medical use, food for babies; plasters, material for dressings; teeth filling and dental impression materials; disinfectants; products for destroying vermin; fungicides, herbicides.

(260) AM 2023 117769 A

(800) 1660675

(151) 2022 03 01

(891) 2022 03 01

(731) LABORATORIOS NORMON, S.A.

Ronda de Valdecarrizo, 6, E-28760 Tres
Cantos, Madrid, Spain

(540)

NORMOBUCAL

(591) Black, white

(511)

5 – Pharmaceutical and veterinary products; hygienic and sanitary products for medical use; dietetic food and substances for medical or veterinary use, food for babies; food supplements for humans or animals; plasters, material for dressings; teeth filling and dental impression materials; disinfectants.

(260) AM 2023 117770 A

(800) 1660722

(151) 2022 01 12

(891) 2022 01 12

(731) Euro Games Technology Ltd.

4, "Maritsa" Str., "Vranya-Lozen-Triugulnika",
BG-1151 Sofia, Bulgaria

(540)

BURNING HOT
Extreme(591) Green, yellow, red, brown and white
(531) 27.05.01; 27.05.02; 27.05.03; 27.05.08;
27.05.09; 27.05.10; 29.01.15

(511)

9 – Software; computer gaming software; computer software packages; computer operating system software; computer software, recorded; software drivers; virtual reality software; games software; entertainment software for computer games; computer programs for network management; operating computer software for main frame computers; monitors (computer hardware); computer hardware; apparatus for recording images; monitors (computer programs); computer game programs; computer programs for recorded games; apparatus for recording, transmission or reproduction of sound or images; communications servers [computer hardware]; electronic components for gambling machines; computer application software featuring games and gaming; computer software for the administration of on-line games and gaming; computer hardware for games and gaming; electronic components and computer software for gambling, gambling machines, gambling games on the Internet and via telecommunication network.

28 – Gaming machines for gambling; chips for gambling; mah-jong; arcade games; gambling machines operating with coins, notes and cards; games; electronic games; parlor games; gaming chips; gaming tables; slot machines [gaming machines]; LCD game machines; slot machines and gaming devices; coin-operated amusement machines; roulette chips; poker chips; chips and dice [gaming equipment]; gaming equipment for casinos; roulette tables; gaming roulette wheels; casino games; gambling machines and amusement machines, automatic and coin-operated; coin-operated amusement machines and/or electronic coin-operated amusement machines with or without the possibility of gain; boxes for coin-operated amusement machines, slot machines and gaming machines; electronic or electrotechnical amusement machines and apparatus, gaming machines, coin-operated entertainment machines; housings for coin-operated amusement machines, gaming equipment, gaming machines, machines for gambling; electropneumatic and electrical gambling machines (slot machines).

41 – Gambling; entertainment services related to gambling; gaming services for entertainment purposes; casino, gaming and gambling services; training in the development of software systems; provision of gaming equipment for gambling halls; providing casino equipment [gambling]; gaming machine entertainment services; providing casino facilities [gambling]; gaming hall services; amusement arcade services; games equipment rental; rental of gaming machines; provi-

ding amusement arcade services; rental of gaming machines with images of fruits; editing or recording of sounds and images; sound recording and video entertainment services; hire of sound reproducing apparatus; provision of gaming equipment for casinos; providing of casino facilities; online gambling services; casino services; provision of gaming facilities and gaming hall facilities, Internet casinos and online gambling services.

(260) AM 2023 117771 A

(800) 1660760

(151) 2022 01 27

(891) 2022 01 27

(731) THINKCAR TECH CO., LTD.

2606, Building 4, Phase II, TiananYungu,
Gangtou Community, Bantian, Longgang
District, Shenzhen, Guangdong, China

(540)

THINKCAR

(591) Black, white

(531) 27.05.17

(511)

9 – Speed checking apparatus for vehicles; automobile fault diagnosis instrument; automobile test equipment; engine analyzer; automatic indicators of low pressure in vehicle tyres; diagnostic apparatus, not for medical purposes; testing apparatus; remotely controlled telemetry equipment and instrument.

37 – Vehicle repair services; motor vehicle maintenance and repair; vehicle maintenance; vehicle breakdown repair services; vehicle service stations [refueling and maintenance]; providing information relating to repairs; rebuilding engines that have been worn or partially destroyed; retreading of tyres; installation, maintenance and repair of computer hardware; vehicle cleaning; office machines and equipment installation, maintenance and repair; interference suppression in electrical apparatus; machinery installation, maintenance and repair; rebuilding machines that have been worn or partially destroyed; tyre balancing; vehicle battery charging; burglar alarm installation and repair.

(260) AM 2023 117772 A

(800) 1660771

(151) 2022 03 17

(891) 2022 03 17

(731) Ricosta Schuhfabriken GmbH

Dürrheimer Strasse 43, 78166 Donaueschingen,
Germany

(540)



(591) Olive green

(531) 02.09.19; 24.03.07; 24.03.12; 24.03.18;
29.01.03

(511)

25 – Footwear, in particular baby walking shoes, shoes for children, teens, men and women, boots.

(260) AM 2023 117773 A

(800) 1660819

(151) 2021 06 23

(891) 2021 06 23

(731) voestalpine AG

voestalpine-Straße 1, A-4020 Linz, Austria

(540)



(591) Black, white

(531) 01.13.01; 27.03.12; 27.05.10; 27.05.21

(511)

6 – Building materials and building elements of metal; construction materials of metal; steel sheets for building purposes; plates of metal for building purposes; shaped metal components; shaped metal components for building purpose; castings of metal for building purposes; steel forgings; track construction material of metal; rails of metal; tracks [rails] of metal; railway construction material of metal; railway switches of metal and steel; building elements of metal in the form of panels; building materials of metal for reinforcement purpose; structures and transportable buildings of metal; ladders and scaffolding, of metal; metal scaffolding for facades; facade building components of metal; facade elements of metal for buildings; goods of common metals and their alloys for construction purposes; pipes, tubes and hoses, and fittings therefor, including valves, of metal and steel; couplings of metal for tubes; steel constructions; framework of metal for building and constructions; steel frames for construction purposes; frames of metal; structural platforms [supporting structure] of metal; doors, gates, windows and window coverings of metal; roofing sheets; metal containers for storage or transport; wrapping or binding bands of metal; unwrought or semi-wrought common metals; ores; iron ores; iron ore in brick shape; metal in powdered form;

metal in powdered form for use in manufacturing; steel; steel alloys; stainless steel; common metals and their alloys; common metals and their alloys including profiled metal sections [semi-finished]; metal sheets, metal bands; metal strips; slit strips of metal and coiled metal bands (coils); metal sheets, blanks of metal sheet as components for automobile construction; steel and stainless steel in the form of strips; steel and stainless steel in the form of bands; steel and stainless steel in the form of coiled bands (coils); steel sheets; steel sheets for automobile construction; panels of metal; panels of metal as components for automobile construction; steel fabrications; steel fabrications coated or uncoated; metal alloy forgings (rough or semi-finished); open-die forgings and die-forged parts (pre-fabricated or semi-finished); bar steels; bright steel; ironmongery of metal for building purposes; metal goods for building purposes; metal hardware; molds of metal; cables, wires and chains, of metal; cables and wires, of common metal (non-electric); wire for ropes; nuts, bolts and fasteners, of metal; metal hinges, metal strap hinges and metal hinge clamps; fittings of metal for furniture; shelving frames of metal for storage racks [other than furniture]; welding and soldering materials of metal; soldering material in the form of soldering wires; welding wire; welding wires as welding auxiliaries; filled welding wires, namely cored wires; welding wires with flux core; welding rods; welding rods of metal with flux coating; welding sheets; welding steel; strips of metal as welding material; metal powder for welding; welding material in the form of weld studs of metal; soldering material in the form of alloys and bars of metal as soldering auxiliaries; soldering material in the form of solder pre-forms; parts and fittings of all aforesaid goods, included in this class.

37 – Building services, construction services and demolition services; construction; building construction supervision; construction consultancy; construction of railways and related consultancy services; installation of building scaffolds, working platforms and building platforms; road construction and related consultancy services; structural and civil engineering construction in respect of agricultural land; construction project management services [building supervision]; plant refurbishment; installation of industrial plants; assembling [installation] of shelving; building maintenance and building repair; installation, maintenance and repair of computer hardware and telecommunication devices; construction, installation, maintenance and repair of industrial plants and metallurgical plants; construction, installation, maintenance and repair of facilities for decarbonization of industrial plants and metallurgical plants as well as related consultancy service, not included in other classes; installation, maintenance and repair of machine tools for processing and treatment of metal; installation, maintenance and repair of welding machines and welding devices.

(260) AM 2023 117775 A
 (800) 1660956
 (151) 2022 04 04
 (891) 2022 04 04
 (731) Apple Inc.

One Apple Park Way, Cupertino CA 95014,
 USA

(540)

MAGSAFE CHARGING CASE

(591) Black, white
 (526) CHARGING CASE
 (511)

9 – Battery chargers; battery charge devices; wireless chargers; wireless battery chargers; charging appliances, namely, charging cases for earphones, headphones, earbuds, and headsets; wireless charging cases for mobile digital electronic devices, wearable electronic devices, earphones, headphones, earbuds, and headsets; carrying cases featuring power supply connectors and battery charging devices specially adapted for use with handheld digital electronic devices, namely, mobile digital electronic devices, wearable electronic devices, earphones, headphones, earbuds, headsets; carrying cases specially adapted for mobile digital electronic devices, wearable electronic devices, earphones, headphones, earbuds, headsets; cases for earphones, headphones, earbuds and headsets.

(260) AM 2023 117776 A
 (800) 1660969
 (151) 2021 10 07
 (891) 2021 10 07

(731) UNION DES ASSOCIATIONS
 EUROPEENNES DE FOOTBALL (UEFA)
 Route de Genève 46, CH-1260 Nyon,
 Switzerland

(540)

EURO 2024

(591) Black, white
 (511)

4 – Lubricants; engine oils and fuels, including gasoline, diesel oil, gases and bio-fuels; candles; waxes; industrial greases; natural gas; liquid gases; industrial oils; lubricating oils and greases; carburants; liquefied petroleum gas; non-chemical additives for fuel, lubricants and greases; dust absorbing, wetting and binding compositions; lighting fuel; lubricants, oils and greases, and lubricating preparations for industrial use; cutting oils for industrial use; milling oils; all the aforesaid goods are from Europe.

9 – Video game disks; software (recorded programs), including game software; computer programs; videotapes, magnetic tapes, magnetic disks, DVDs, mini-disks, diskettes, optical disks, compact disks, CD-

ROMs, video disks, memory cards, USB flash drives, blank or pre-recorded with music, eyeglasses, sunglasses, diving and swimming goggles; cases, cords and chains for sunglasses and spectacles; binoculars; magnets and decorative magnets; directional compasses; sound and image recording, transmitting and reproducing apparatus; satellite dishes; decoders, namely, electronic hardware and software which can convert, supply and transmit audio and video data; television sets; flat screens, liquid crystal display screens, high-definition screens and plasma screens; radios; home cinema systems; video recorders; CD players; DVD players; MP3 players; cassette players; mini-disk players; digital music players; loudspeakers; headphones, earphones; computers, including laptop computers and electronic tablets; karaoke apparatus; sound editing and sound mixing apparatus; apparatus for editing and mixing video images; apparatus for computer data processing; computer keyboards; computer screens; modems; computer mice, mouse pads; navigation apparatus, personal digital assistants (PDAs); electronic pocket translators; dictating machines; electronic agendas; scanners; printers; photocopiers; facsimile machines; telephones; answering machines; video telephones; cellular telephones; accessories for cellular telephones included in this class, namely, cases for cellular telephones, apparatus for using hands-free cellular telephones, earphones and headsets for cellular telephones, keypads for cellular telephones, straps for cellular telephones, special cases for carrying cellular telephones, cameras and video cameras integrated in cellular telephones, and portable telephone covers; remote controls for television sets and video systems; software intended for enabling teleconferencing services; calculating machines; credit card readers; currency converting machines; automated teller machines; video cameras, portable video cameras with built-in videocassette recorders (camcorders); photographic equipment, photographic apparatus, cameras (cinematographic apparatus), projectors, flash lamps, special cases and cords for photographic apparatus and instruments, electric cells and batteries; screen saver programs for computers; magnetic, digital or analog recording media, recorded or not, for sounds or images; magnetic cards (encoded); integrated circuit cards (smart cards); microchip or magnetic credit cards, microchip or magnetic telephone cards, microchip or magnetic cards for cash dispensers, microchip or magnetic cards for automated teller machines and money exchange machines, prepaid microchip or magnetic cards for cellular telephones, microchip or magnetic travel and show admission cards, microchip or magnetic check guarantee cards and microchip or magnetic debit cards; alarms; wind socks (for indicating wind direction); distance-measuring apparatus; apparatus for measuring and displaying speed; protective gloves; audio receivers, sound amplifiers; television tubes; cathode ray tubes; decoders, namely computer hardware and software which can convert, supply and

transmit audio and video data; disk drives for computers; protected semi-conductors; integrated circuits containing programs for processing audio, visual or computer data; rechargeable batteries; audio and video data processors and converters; data transmission cables; payment apparatus for electronic commerce; protective helmets for sports; magnetic identification bracelets; components of electronic instruments; fuel/air coefficient analyzers; remote control devices for locking cars; photovoltaic cells; video game cassettes; all the aforesaid goods are from Europe.

12 – Bicycles, motorcycles, motor cars, trucks, vans, utility vehicles, buses, camper vans, refrigerated vehicles; airplanes and boats; air balloons, dirigible balloons [airships]; vehicle accessories, namely sun visors, pneumatic tires, tire covers, luggage racks, ski racks, rims and hub caps for wheels; seat linings, vehicle covers, baby carriages, strollers, safety seats for infants and children (for vehicles); engines and motors for land vehicles; bull bars; headlamp covers; steering wheels for vehicles; trailers; all the aforesaid goods are from Europe.

16 – Bookmarks; score sheets; autograph books; printed timetables; collectible photographs of players; bumper stickers; tablecloths of paper; towels of paper; bags of paper; invitation cards; greeting cards; gift wrapping paper; coasters and place mats of paper; garbage bags of paper or of plastics; food wrapping paper; small bags for preserving foodstuffs; coffee filters of paper; labels (not of textile); hand towels of paper; wet hand-wipes of paper; toilet paper; napkins for removing make-up; handkerchief boxes of paper and cardboard; handkerchiefs of paper; stationery; typewriter paper; copying paper; envelopes; notepads; folders for papers; tissue paper; writing books; paper sheets for note-taking; writing paper; binder paper; files; covering paper; luminous paper; adhesive paper for notes; paperweights; crêpe paper; tissue paper; badges or insignia of paper; flags of paper; pennants (flags) of paper; writing instruments; fountain pens; pencils; ballpoint pens; ballpoint pen and pencil sets; felt-tip pens (marking pens); fiber-tip pens and felt-tip pens; marking pens; ink, inking pads, rubber stamps; typewriters (electric or non-electric); paint cans, paint crayons and colored pencils; writing chalk; pencil ornaments [stationery]; printing blocks; address books; advertising boards, banners and material included in this class; sticking labels; office requisites (except furniture); correction fluids; rubber erasers; pencil sharpeners; holders and containers for office requisites; paper clips; thumbtacks; drafting rulers; adhesive tapes for stationery purposes, adhesive tape dispensers; staples; stencils; document holders (stationery); paper clips; holders for notepads; bookends; credit cards, telephone cards, cards for cash dispensers, check guarantee cards and debit cards, non-magnetic and of paper or cardboard; baggage tags of paper; passport cases; travelers' checks; holders for checkbooks; money

clips of metal; letter trays; all the aforesaid goods are from Europe.

18 – Leather and imitations of leather; leather straps; umbrellas, parasols; sports bags (other than those adapted for products they are designed to contain); leisure bags; travel bags, backpacks; school bags; bags for hanging on belts; handbags, leather bags; beach bags; garment bags; suitcases; document cases; belts for suitcases; briefcases (leather goods); cases for toiletry articles known as vanity cases (not fitted); toiletry bags; key cases (leather goods); business card cases; wallets; purses; whips; collars for animals; luggage tags of leather; identity card holders; credit card holders (wallets); all the aforesaid goods are from Europe.

25 – Clothing; shoes and footwear; headwear; shirts; knitwear (clothing); pullovers; slipovers; tee-shirts; vests; jerseys; sleeveless jerseys, dresses; skirts; underwear, functional underwear, brassieres; swimsuits; bathrobes; shorts; trousers; sweaters; stocking caps; caps; hats; long scarves; scarves, shawls; peaked caps; tracksuits; sweatshirts; jackets, sports jackets, stadium jackets (jumpers); blazers; waterproof clothing; coats; uniforms; neckties; wrist bands (clothing); headbands; gloves; aprons; bibs (not of paper); pajamas; play suits for infants and children; socks and stockings; tights and leggings, garters; belts; suspenders; sandals; sports shoes, namely, shoes for outdoor sports, basketball shoes, multi-sport shoes, cycling shoes, indoor sports shoes, track and field shoes, football shoes (indoor and outdoor), canvas shoes, tennis shoes, sneakers, sailing shoes, shoes for aerobics; hiking boots; flip-flops; sportswear, namely, fleece tops, jogging suits, knitted sportswear, casual sports pants, polo shirts, sweat shirts, sweat pants football shirts, rugby shirts, bathing suits, sports jerseys, leotards, ski suits, ski jackets, ski trousers; wrist bands [clothing]; all the aforesaid goods are from Europe.

28 – Games and toys; sports balls; play balloons; board games; tables for indoor football; dolls and plush toys; vehicles (toys); jigsaw puzzles; balloons; inflatable toys; play disks (pogs); playing cards; confetti; gymnastic and sporting articles; football equipment, namely balls for football, gloves, knee guards, elbow guards, shoulder guards, shin guards; football goals; sports bags and containers (adapted to objects) for carrying sports articles; party hats (toys); small electronic games designed for use with a television set; video game apparatus; game consoles, electronic games other than those adapted for use with television receivers only; steering wheels for video games and mats for video games (for dancing upon); hands made of rubber or foam (toys); entertainment robots; appliances for gymnastics; kites; roller skates; scooters; skateboards; coin-operated video games for game halls (arcade games); electronic games with liquid crystal display; joysticks for video games, manually or voice-activated joysticks for video games; lottery

cards, scratch tickets for lottery games; toys for household pets; computer game joysticks; voice-activated or manually operated computer game joysticks; wrist straps for sports; all the aforesaid goods are from Europe.

32 – Non-alcoholic beverages; syrups and powders for making non-alcoholic beverages; mineral and aerated waters; energy drinks, isotonic drinks, hypertonic and hypotonic drinks; fruit and vegetable beverages; fruit and vegetable juices; sports beverages; frozen fruit drinks, frozen flavored drinks, non-carbonated and non-alcoholic; drinks enriched with added vitamins, not for medical use; beers; strong dark beers; lagers and ales; non-alcoholic or low-alcohol beers; all the aforesaid goods are from Europe.

35 – Employment agencies; personnel recruitment; dissemination of advertisements; rental of advertising space; rental of advertising time in film credits; television advertising; market study services; market research services; public opinion polling services; retail sale services for and bringing together of various goods for the benefit of others (excluding the transport thereof), namely clothing, footwear, headgear, sports articles, stationery, apparatus for recording, transmission and reproduction of sound and images, books, newspapers, magazines, publications, video games, toys, dolls, badges of all kinds, key rings, tickets, watches and jewelry, souvenir items in connection with football, bags, luggage, briefcases, umbrellas, flags and pennants, alcoholic and non-alcoholic beverages, confectionery, medical apparatus and instruments, vehicles and accessories for motor cars; auctioneering on a global computer network (the Internet) or via wireless electronic communication devices; collection of directories for publication on the Internet and on wireless electronic communication networks; business administration services for processing commercial services on a global computer network (Internet) or via wireless electronic communication devices; compilation, creation and management of databases, namely collection of domain names in a register; sales promotion, namely creation of preferential programs for customers; implementation of bonus programs for customers in stadiums by distributing encoded loyalty and membership cards which can contain the personal data of the user; development, launch and administration of loyalty programs, namely issuing loyalty cards to fans, containing personal information on the identity of the card holder; electronic commerce (e-commerce) services, namely provision of information on goods via telecommunication networks for advertising or sales purposes; compilation of data into a computer database, especially still or animated images; e-commerce services, namely online services for providing contracts for the purchase and sale of goods on behalf of others; promotion of the goods and services of others, through contractual agreements, particularly partnership (sponsoring) and

licensing agreements, providing them with increased notoriety and enhanced image derived from cultural and sporting events, particularly international events; compilation and recording of data and information on sporting performances; provision of personnel, particularly for selling beverages and foods; retail sale of interactive educational and entertainment products, interactive compact disks, CD-ROMs and computer games; retail sale services, particularly on a global computer network, for interactive educational and entertainment products, interactive compact disks, CD-ROMs and computer games; presentation of computer programs for retail sale purposes; procurement services for others [purchasing goods and services for other businesses]; procurement services for others [purchasing goods and services for other businesses] for sports events or entertainment; promotion of the goods and services of others, through contractual agreements, particularly partnership (sponsoring) and licensing agreements, providing them with increased notoriety and/or enhanced image and/or affinity derived from cultural and sporting events, particularly international events; all the aforesaid goods are from Europe.

38 – Telecommunication services; communication by mobile telephones; communication by telex; communication via electronic computer terminals linked to telecommunication networks, data banks and the Internet or via wireless electronic communication devices; communication by telegraphs; communication by telephones; communications by facsimile; paging services; telephone or video conferencing services; television program broadcasting; broadcasting of cable television programs; radio program broadcasting; transmission of radio and television programs of sports and sports events; news and press agency services; other message transmission services; rental of telephones, facsimile machines and other telecommunication apparatus; transmission of commercial Internet pages online or via wireless electronic communication devices; services for transmitting and broadcasting television and radio programs provided via the Internet or via any wireless electronic communication network; electronic transmission of messages, simultaneous broadcasting of film recordings and sound and video recordings; provision of access to telematic servers and real-time chat forums; computer-aided transmission of messages and images; telecommunication via fiber-optic networks; provision of access to a global computer network or interactive communication technologies for access to private and commercial purchasing and ordering services; transmission of information and other data via websites and computers; transmission of information (including sites by telematic means) via telecommunication, computer programs and other data; transmission of information, computer programs and other data by telematic means; electronic mail services; provision of access via the Internet or on any wireless electronic communication network (telecommunication services); providing

connections for telecommunications with a global computer network (the Internet) or data banks; provision of access to websites offering digital music on the Internet by means of a global computer network or via wireless electronic communication devices; rental of access time to MP3 websites on the Internet, via a global computer network or via wireless electronic communication devices; rental of access time to a database server center (telecommunication services); rental of access time to a computer database (telecommunication services); transmission of digital music by telecommunications; online transmission of electronic publications; digital music transmission via the Internet or on any wireless electronic communication network; digital music transmission via MP3 Internet sites; simultaneous broadcasting and/or netcasting of film recordings and sound and video recordings (telecommunications); simultaneous broadcasting and/or netcasting of interactive educational and entertainment products, interactive compact disks, CD-ROMs, computer programs and computer games (telecommunications); providing access to blackboards (display and advertisement notice boards), discussion forums (chat rooms) in real time via a global computer network; rental and provision of access time to blackboards (boards for displaying information and advertisements) and to chat rooms in real time by means of a global computer network (communication services); telecommunication services dedicated to retail sale by means of interactive communications with customers; multimedia telecommunication; videotext and teletext transmission services; information transmission via communication satellite, microwave or by electronic, digital or analog means; transmission of digital information by cable, wire or fiber; transmission of information by mobile telephones, telephones, facsimile and telex; telecommunication services for receiving and exchanging information, messages, images and data; telecommunication services for setting up discussion groups on the Internet and on any wireless electronic communication network; providing access to Internet search engines; all the aforesaid goods are from Europe.

39 – Ticket reservation and information services for travel; transport by airplane, railway, bus and truck; boat transport; boat travel services; tourist travel services; rental of vehicles and automobiles; rental of parking spaces; taxi services; boat transport services for goods; distribution of water, heat, gas or electricity; distribution of newspapers, magazines and books; postal services, third-party mail services and courier services; storage of merchandise; delivery of solvents, paraffins, waxes, bitumens and oil products, excluding liquid gas; distribution (delivery) of films and sound and image recordings; distribution (delivery) of interactive educational and entertainment products, interactive compact disks, CD-ROMs, computer programs and computer games; ticket distribution (transport); navigation services by global positioning sys-

tem; advice relating to power and electricity distribution; all the aforesaid services are from Europe.

41 – Organization of lotteries, raffles and competitions; betting and gaming services in connection with sports; provision of entry tickets and information brochures on sports for VIPs, as well as guiding and gathering VIPs for sports or entertainment events, provision of online information in the field of sports or sports events from a computer database or the Internet; customer reception services (entertainment services) including provision of access tickets during sports or entertainment events; entertainment services relating to sporting events; entertainment services in the form of public gatherings during the retransmission of sports events; sporting and cultural activities; organization of sporting and cultural events and activities; amusement park services; sports club services [health and fitness training]; organization of sports competitions; organization of events in the field of football; sports camp services; providing sports facilities; rental of video and audiovisual installations; production, presentation, distribution and/or rental of film recordings and sound and video recordings; presentation, distribution and/or rental of interactive educational and entertainment products, interactive compact disks, CD-ROMs, and computer games; radio and television coverage of sporting events; production services for radio, television programs and video films; ticket reservation services and information services for sports or entertainment events; timing services relating to sports events; interactive entertainment; online betting and gaming services on the Internet or on any wireless electronic communication network; information in the field of entertainment (including in the field of sports), provided on-line from a computer database or via the Internet or via any wireless electronic communication network; electronic game services transmitted via the Internet or on mobile telephones; editing of books; publication of books and electronic journals on-line; audio and video recording services; production of animated cartoons for the cinema, production of animated cartoons for television; rental of sound and image recordings for entertainment purposes; information in the field of education provided on-line from a computer database or via the Internet or any wireless electronic communication network; translation services; photography services; provision of entertainment infrastructure; ticket agencies in connection with sports events; all the aforesaid services are from Europe.

(260) AM 2023 117782 A

(800) 1661047

(151) 2022 01 19

(891) 2022 01 19

(731) Kia Corporation

12, Heolleung-ro, Seocho-gu, Seoul 06797,
Republic of Korea

(540)



Movement that inspires

(591) Black, white

(531) 27.05.01; 27.05.19; 27.05.22

(511)

7 – Taps (machine tools); sorting machines for industry; dairy machines; motors and engines (except for land vehicles); machine coupling and transmission components except for land vehicles; aerating pumps for aquaria; gas pumps (gas station equipment); vending machines; electric door opening and closing apparatus; cranes; snow ploughs; metalworking machines; civil engineering machinery; machines for use in chemical industry; printing machines; sewing machines; glass-working machines; painting machines; packing machines; electronic ignitions for vehicles; mechanical engine parts for land vehicles; filters for automobile engines; automotive engine blocks; ignition coils for automotive engines; pumps for land vehicle engines; speed change gears being parts of machines; hydraulic accumulators being parts of machines; brakes for machines; vehicle washing machines; automatic parking installations; plastic processing machines; 3D printers; ignition devices for motors of land vehicles; current generators for automobiles; industrial robots; robots for helping with daily chores for household purposes; machines for manufacturing dry cells; robots for machine tools; driving devices for robots; control mechanisms for robotic machines; electrodes for welding machines.

(260) AM 2023 117783 A

(800) 1661075

(151) 2021 09 14

(891) 2021 09 14

(731) Exeger Operations AB

Box 55597, SE-102 04 Stockholm, Sweden

(540)

EXEGER

(591) Black, white

(531) 27.05.01; 27.05.09

(511)

6 – Metal roofing; windows of metal; building panels of metal; metal cladding for walls.

7 – Domestic robots; robots in the field of agriculture; marine robotics; space robots; robots in the field of automobile; robots for construction, robots for industrial use, robots for household and commercial cleaning, robots used in manufacture; solar power generators and peripheral apparatus therefor; electric generators using solar cells and parts and fittings therefor.

9 – Scientific, nautical, surveying, photographic, cinematographic, optical, weighing, measuring, signalling, checking (supervision), life-saving and teaching apparatus and instruments; apparatus and instruments for conducting, switching, transforming, accumulating, regulating or controlling electricity; measuring instruments and measuring and control instruments; apparatus and instruments for storing power; apparatus and instruments for recording, transmission or reproduction of sound or images; solar panels for use in energy generation and recycling; data processing equipment; computers; calculating machines; computer software; photovoltaic apparatus for generating electricity; photovoltaic apparatus for converting solar radiation and light energy into electricity; solar cells for electricity generation, parts for solar cells, included in this class; solar panels; photovoltaic solar modules; solar batteries; solar battery chargers; solar batteries for domestic use; solar-powered rechargeable batteries; solar-powered electronic apparatus and instruments and fittings thereto included in this class; solar-powered portable electronic apparatus and instruments; solar-powered computers; solar-powered computer tablets; solar-powered ear phones; solar-powered electronic sports simulators; portable electronic sports and fitness apparatus, being portable computers; electronic reading and electronic reading apparatus having writing function; wireless communication apparatus; cell phones; cases adapted for mobile phones; tablets; cases for tablet computers; portable computers; sleeves for laptops; wireless headphones; loudspeakers; speakers for wireless use; wireless keyboards; mouse pads; electric signs; light (traffic- -) apparatus [signalling devices]; safety helmets; sports glasses; helmets for use in sports; games software; head protection; goggles; remote control; digital and electronic computer tablets; telecommunication apparatus; video devices; calibrating apparatus and instruments; electronic tracking devices; fitness monitoring devices; remote controls, remote control, controllers for machine tools, management software, control apparatus for software, checking (supervision) apparatus; bags and fittings for the aforesaid goods included in this class; smartwatches; headwear for sporting activities for protection against injury; military and emergency response robots; security robots; humanoid robots; robots for experiments; teaching apparatus in the nature of robots; robots with artificial intelligence; electric power supply units using solar cells.

11 – Solar cell lighting apparatus; solar powered torches; solar energy powered heating installations; solar powered lamps; roof lights [lamps]; solar panels for use in heating; fittings for the aforesaid goods included in this class.

12 – Vehicles; robot vehicles; apparatus for locomotion by land, air or water, and structural parts and fittings therefor, included in this class; transportation robots.

14 – Time instruments; solar clocks and watches; parts and fittings for chronometric instruments; sports watches.

18 – Leather and imitation leather; leatherboard (imitation of leather); imitation leather cases; bags made of imitation leather; imitation leather purses; imitations of leather for furniture; imitations of leather for shoes; shoulder belts, bands and straps of leather or imitation leather; casual bags; fashion handbags; travelling trunks and all-purpose carrying bags; umbrellas and parasols; walking sticks; whips, harness and saddlery; collars, clothing and leashes for animals.

19 – Ceilings, not of metal; windows, not of metal; building panels, not of metal; wall cladding, not of metal.

20 – Furniture; mirrors (silvered glass); picture frames; indoor window blinds [furniture] containing photovoltaic cells.

25 – Clothing; footwear; hats; sportswear; athletics shoes; clothing accessories, namely belts [clothing].

28 – Toys; games [intelligence games]; electronic games; sports playthings; robotic toys; handheld video game apparatus; video game controllers; video games accessories; sporting goods, sporting articles, sports equipment and accessories; protectors (sporting articles); bags for sporting goods; protective equipment (sporting articles); gymnastic articles; remote control toys.

37 – Installation, repair and maintenance of light and solar systems; light and solar system installation services; installation of utility solar installations; installation of utility solar installations for buildings; installation of residential solar panel power systems; construction services.

40 – Generation of electricity from solar energy; custom assembly of materials for others.

42 – Scientific and technological services and research and design relating thereto; industrial analysis and research; design and development of computer hardware and software; design and development of software for control, regulation and monitoring of solar energy systems; research and design in the field of solar cell development; consultancy relating to solar cell technology.

(260) AM 2023 117784 A

(800) 1661088

(151) 2022 03 30

(891) 2022 03 30

(731) Ningbo Senrog Tools Co., Ltd.

Room 1104, No. 158 Taian Middle Road,
Shounan Sub-District, Yinzhou District,
Ningbo City, 315000 Zhejiang, China

(540)

SENROG

(591) Black, white

(531) 27.05.17

(511)

8 – Hand tools, hand-operated; whetstones; trowels [gardening]; livestock marking tools; harpoons; hammers [hand tools]; punches [hand tools]; levers; nail extractors, hand-operated; chisels; awls; borers; ditchers [hand tools]; graving tools [hand tools]; tweezers; scissors; paring knives; knife handles.

(260) AM 2023 117785 A

(800) 1661105

(151) 2020 07 07

(891) 2020 07 07

(731) Kraft Foods Schweiz Holding GmbH

Chollerstrasse 4, CH-6300 Zug, Switzerland

(540)



(591) Brownish yellow (yellow ocher), red, gold and blue

(531) 27.05.03; 29.01.13

(511)

9 – Electric apparatus, instruments and cables; battery chargers, including for electronic cigarettes; USB chargers, including for electronic cigarettes; chargers for automobiles, including for electronic cigarettes; electrical adapters; telephone adapters; information technology apparatus and equipment; audiovisual, multimedia, optical, cinematographic and photographic apparatus; communication equipment; reproduction apparatus; data processing equipment and accessories (electrical and mechanical); sound, image or data recording, transmitting, reproducing or processing apparatus and instruments; calculating devices; computer peripheral devices; mouse pads; protective covers and cases for mobile phones, tablets and other electronic telecommunication and computer hardware; headsets; headphone cases; magnets, magnetizers, demagnetizers; measuring, weighing, detecting and controlling instruments, indicators and controllers; navigation, guidance, tracking, targeting and mapping devices; optical devices, enhancers and correctors; 3D spectacles; spectacles, sunglasses and contact lenses; sports goggles; lasers not for medical purposes; devices for safety, security, protection and signaling; protective and safety equipment; scientific and laboratory apparatus for treatment using electricity; scientific research and laboratory apparatus, educational apparatus

tus and simulators; recorded content; cartridges for video games; video game programs on CD-ROM and computer game discs; vending machines for hot and cold food products and beverages and related refill components; odour detection apparatus.

14 – Precious metals and their alloys; jewelry articles; body jewelry; precious stones and their imitations; key rings and key chains and their charms; timepieces and chronometric instruments; movements for timepieces; pin badges of precious metals; lapel badges of precious metals; lapel pins; tie pins; pins [jewelry]; ornaments made of or coated with precious or semi-precious metals or precious stones or imitations thereof; jewelry boxes and watch boxes; cuff links.

16 – Paper, cardboard; printing products (printed matter); bookbinding material; photographs; stationery; adhesives for stationery or household purposes; drawing materials and materials for artists; paintbrushes; instructional or teaching material (except apparatus); printing blocks; printed matter; bags, pouches and sheets for packaging made of paper or plastic; paper sheets (stationery); works of art and figurines made of paper or cardboard and architect's models; and paint boxes (articles for use in school); school supplies; stamping and writing instruments; staples for offices; thumbtacks; pencil sharpeners; correcting fluids; paper cutters; pens, pencils, mechanical pencils, erasers; envelopes; desk files; photo albums and collectors' albums; albums, books, periodicals; almanacs, brochures, writing or drawing books, catalogs; calendars; lithographs, engravings; framed or unframed paintings (pictures); posters; stickers; postage stamps; adhesive tape dispensers (office requisites); cases, covers and devices for holding or fixing paper; passport cases; holders for checkbooks; paper clips; paper cutters and paper trimmers (office requisites); specialty paper, namely, parchment paper used for packaging; greeting cards; postcards; patterns for making clothes; paper products for household and hygiene use included in this class, especially toilet paper, kitchen towels, handkerchiefs, table napkins, hand towels, cosmetic tissues, diapers for babies; photograph stands.

18 – Leather and imitations of leather; animal leathers and skins; luggage and transport bags; baby carriers with pockets; boxes and cases made of leather or cardboard; document cases and small suitcases; bags, sports bags, handbags, school bags, cosmetic bags, backpacks; traveling sets (leatherware); saddlery articles of leather; handbags, wallets, coin purses, key bags; business card cases; hip and belt bags; net bags for shopping; raw skins; umbrellas and parasols; walking sticks; whips, harness and saddlery; collars, leashes and clothing for animals; toiletry bags for carrying toiletries; cosmetic bags; cash holders in the form of wallets.

21 – Household or kitchen utensils and containers; lunch boxes; fitted picnic baskets including dishes;

cooking pot sets; baking dishes; tableware; corkscrews; thermally insulated bags; non-electric portable coldboxes; glassware, porcelain and earthenware (not included in other classes); unworked or semi-worked glass (except building glass); statues, figurines, plaques and art objects of porcelain, terracotta or glass (not included in other classes); gardening articles, other than gardening tools; cleaning material; household utensils for cleaning purposes; brushes and brush-making materials; clothes pegs; trash cans; cosmetic and toilet utensils; electric and non-electronic combs; non-medicated dental cleaning products, in particular dental finger cots, dental flossers, dental tape, battery operated dental floss, dental finger cots, dental floss dispensers, dental floss forks, dental floss holders, dental flossers, dental picks for personal use, dental sticks for personal use, finger guards for dental or oral care, dental floss, dental care kits comprising toothbrushes and floss; cages for pets; cleaning material for clothing and footwear care; baskets for domestic use, not of precious metal; paper cups and trays.

24 – Textiles and substitutes thereof; furniture coverings of textile or plastic materials; household linen; curtains of textile or plastic materials; bed linen of paper; filtering materials (textiles); sleeping bags; mosquito nets.

25 – Clothing; footwear; headwear; sports clothing; socks, stockings and tights; underwear; hosiery; belts; gloves; neckties; bathing suits for men and women; heels and tips; paper clothing; paper hats; headgear (niqab); aprons; ski boots; ear muffs (clothing); bath-
robes.

(260) AM 2023 117786 A
(800) 811649
(151) 2003 08 27
(891) 2022 01 14
(731) C A Casyso GmbH
St. Jakobs-Str. 17, CH-4052 Basel, Switzerland
(540)

ROTEM

(591) Black, white
(511)
5 – Diagnostic products for medical use.

10 – Medical apparatus and instruments; apparatus for measuring and diagnosis for medical use.

(260) AM 2023 117790 A
(800) 1342186
(151) 2017 01 31
(891) 2022 04 27
(731) Breville USA, Inc.
19400 S WESTERN AVE, TORRANCE CA
90501, USA

(540)

BARATZA

(591) Black, white

(511)

7 – Electrical coffee grinders.

(260) AM 2023 117791 A

(800) 1342285

(151) 2016 03 11

(891) 2021 11 30

(731) PXG Pharma GmbH

Pfingstweidstraße 10-12, 68199 Mannheim,
Germany

(540)

LIVSANE

(591) Black, white

(511)

3 – Cosmetics and hair lotions (namely skin-care creams, lotions, deodorants, antiperspirants, hair shampoos, hair conditioners, hair lotions, baby oils, baby lotion, baby creams, make-up removing preparations); cotton for cosmetic purposes; dentifrices; essential oils; lipsticks, lip balms; mouthwashes; perfumery; soaps; sunscreen preparations; tissues (namely impregnated with cosmetic lotions or make-up removing preparations); toiletries.

5 – Pharmaceutical preparations (namely anti-fungals, anti-infectives, anti-itch lotions and creams, asthma medication, analgesics, cough and cold medication, antidiarrheals, laxatives, sleep aids, antiallergics, antihistamines, dermatologics, diaper rash ointments, preparations for allergy prevention and treatment, antacids and acid reducers, hemorrhoid treatments, smoking cessation preparations, pediculicides, wart removal medications, contraceptives, pregnancy testing preparations); dietetic substances adapted for medical use, food for babies; disinfectants (namely antiseptic handwash, antiseptic handcream, antiseptic mouthwash); fungicides; meal replacements, dietetic food and beverages, adapted for medical use; medicine cases, filled; nutritional supplements, vitamin preparations, mineral food supplements; plasters, materials for dressings; sanitary preparations for medical purposes (namely incontinence pads and diapers, nursing pads, bathing preparations and bath salts for medical purposes, lubricants for medical purposes); teas for medicinal purposes; wadding for medical purposes.

8 – Files; nail scissors, cuticle scissors; scissors for children; nail nippers, cuticle nippers; tweezers; nail files; nail clippers; nail polishers; manicure sets; pedicure sets.

10 – Surgical, medical and dental apparatus and instruments (namely surgical scissors, blood pressure measuring apparatus, apparatus for blood analysis (for medical use), clinical thermometers, diagnostic appa-

ratus for pregnancy testing, inhalers for medical use, contraceptive devices, oral irrigators for use in dentistry); compression socks; orthopedic articles; suture materials.

16 – Tissues of paper and cellulose for babies; tissues of paper or cellulose for removing make-up; babies' bibs of paper or cellulose; paper tissues for cosmetic purposes; toilet paper; paper towels; paper handkerchiefs; bags, envelopes and pouches of paper or plastics, for packaging.

21 – Floss for dental purposes; toothbrushes, electric and non-electric; toothpicks.

(260) AM 2023 117854 A

(800) 1661465

(151) 2022 01 04

(891) 2022 01 04

(731) University of Miami

1320 S. Dixie Highway, Suite 1250, Coral
Gables FL 33146, USA

(540)



(591) Orange and green

(531) 27.05.01; 27.05.04; 27.05.09; 27.05.17;
29.01.12

(511)

41 – Educational services, namely, conducting courses of instruction at the university level and presenting various athletic events.

(260) AM 2023 117855 A

(800) 1661479

(151) 2022 03 29

(891) 2022 03 29

(731) Robert Bosch Power Tools GmbH

Max-Lang-Strasse 40-46, 70771 Leinfelden-
Echterdingen, Germany

(540)



(591) Blue and white

(531) 24.01.03; 26.11.03; 26.11.07; 26.11.09;
27.05.01; 27.05.10; 29.01.12

(511)

9 – Measuring, detection, monitoring and control devices and apparatus, in particular laser range finders, [cross] line lasers, rotating lasers, detectors, thermal imaging cameras, 2D and 3D scanners.

(260) AM 2023 117856 A
 (800) 1661556
 (151) 2021 12 16
 (891) 2021 12 16
 (731) Euro Games Technology Ltd.
 4, "Maritsa" Str., "Vranya-Lozen-Triugulnika",
 BG-1151 Sofia, Bulgaria
 (540)



(591) Red, orange, yellow, pink, purple, blue, white,
 black and brown
 (531) 01.01.04; 01.15.07; 01.15.09; 24.17.25;
 27.05.01; 27.05.02; 27.05.03; 27.05.08;
 27.05.09; 27.05.10; 29.01.15

(511)
 9 – Software; computer gaming software; computer software packages; computer operating system software; computer software, recorded; software drivers; virtual reality software; games software; entertainment software for computer games; computer programs for network management; operating computer software for main frame computers; monitors (computer hardware); computer hardware; apparatus for recording images; monitors (computer programs); computer game programs; computer programs for recorded games; apparatus for recording, transmission or reproduction of sound or images; communications servers [computer hardware]; electronic components for gambling machines; computer application software featuring games and gaming; computer software for the administration of on-line games and gaming; computer hardware for games and gaming; hardware and software for gambling, gambling machines, gambling games on the Internet and via telecommunication network.

28 – Gaming machines for gambling; chips for gambling; mah-jong; arcade games; gambling machines operating with coins, notes and cards; games; electronic games; parlor games; gaming chips; gaming tables; slot machines [gaming machines]; LCD game machines; slot machines and gaming devices; coin-operated amusement machines; roulette chips; poker chips; chips and dice [gaming equipment]; gaming equipment for casinos; roulette tables; gaming roulette wheels; casino games; gambling machines and amusement machines, automatic and coin-operated; coin-operated amusement machines and/or electronic coin-operated amusement machines with or without the possibility of gain; boxes for coin-operated machines, slot machines and gaming machines; electronic or electrotechnical amusement machines and apparatus, gaming machines, coin-operated entertainment machi-

nes; housings for coin-operated machines, gaming equipment, gaming machines, machines for gambling; electropneumatic and electrical gambling machines (slot machines).

41 – Gambling; entertainment services related to gambling; gaming services for entertainment purposes; casino, gaming and gambling services; training in the development of software systems; provision of gaming equipment for gambling halls; providing casino equipment [gambling]; gaming machine entertainment services; providing casino facilities [gambling]; gaming hall services; amusement arcade services; games equipment rental; rental of gaming machines; providing amusement arcade services; rental of gaming machines with images of fruits; editing or recording of sounds and images; sound recording and video entertainment services; hire of sound reproducing apparatus; provision of gaming equipment for casinos; providing of casino facilities; online gambling services; casino, gaming and gambling services; provision of gaming facilities, gaming hall facilities, Internet casinos and online gambling services.

(260) AM 2023 117865 A
 (800) 1661811
 (151) 2021 10 07
 (891) 2021 10 07
 (731) Apple Inc.
 One Apple Park Way, Cupertino CA 95014,
 USA
 (540)

SHAREPLAY

(591) Black, white
 (511)
 38 – Broadcasting and transmission of television, movies, music, electronic publications, software applications, and other audio, video, and multimedia content by means of telecommunications networks, computer networks, the Internet, and wireless communications networks; broadcast and transmission of streamed television, movies, music, electronic publications, software applications, and other audio, video, and multimedia by means of telecommunications networks, computer networks, the Internet, and wireless communications networks; subscription and pay-per-view broadcasting and transmission services by means of telecommunications networks, computer networks, the Internet, wireless communications networks, and television; broadcast and transmission of television, movies, music, electronic publications, software applications, and other audio, video, and multimedia content between matched users by means of telecommunications networks, computer networks, the Internet, wireless communications networks, and television; electronic messaging, electronic data transmission, videoconferencing, and real-time video and audio communication services.

41 – Providing ongoing television, radio, audio, video, podcast, and webcast programs; providing entertainment, sports, animation, music, informational, news, reality, documentary, current events, and arts and culture programming by means of telecommunications networks, computer networks, the Internet, wireless communications networks, and television; providing non-downloadable entertainment, sports, animation, music, informational, news, reality, documentary, current events, and arts and culture programming; providing interactive guides for searching, selecting, recording, and archiving television programs, motion pictures, multimedia entertainment content, podcasts, and sound recordings; providing entertainment, sports, animation, music, informational, news, reality, documentary, current events, and arts and culture programming via websites and computer applications; providing information in the field of entertainment, sports, music, news, documentaries, current events, and arts and culture via websites and computer applications; entertainment information; publication and presentation of reviews, surveys, and ratings; providing online non-downloadable pre-recorded audio, video, and multimedia files featuring television, movies, music, electronic publications and other audio, video, and multimedia content.

42 – Providing online non-downloadable software; providing online non-downloadable computer software for use in transmitting, receiving, browsing, searching, selecting, playing, streaming, and viewing television, movies, music, electronic publications, software applications, and other audio, video, and multimedia content; providing online non-downloadable computer software allowing multiple users to simultaneously view, interact with, and comment on television, movies, music, electronic publications, software applications, and other audio, video, and multimedia content; providing online non-downloadable computer software for controlling the operation of media players, digital audio and video players, streaming devices, set top boxes, and computers; providing online non-downloadable computer software for electronic data transmission, video conferencing, real-time video and audio communication, and sending and receiving electronic messages, images, audio, video, and multimedia content; providing online non-downloadable computer software for use in developing other software applications; providing online non-downloadable computer application development software; providing online non-downloadable computer software for the posting and sharing of reviews, surveys, and ratings relating to entertainment, motion pictures via a website; providing online non-downloadable computer software for the uploading, storing, sharing, viewing and posting of audio, videos, podcasts, and multimedia content via a website.

(260) AM 2023 117866 A

(800) 1661829

(151) 2021 12 07

(891) 2021 12 07

(731) Düker GmbH

Würzburger Strasse 10, 97753 Karlstadt,
Germany

(540)



(591) Red and blue

(531) 01.15.24; 26.01.03; 27.05.01; 29.01.12

(511)

6 – Pressure valves of cast metal for steam and hot water circulation; pipes; pipework; bends for pipes (term considered too vague by the International Bureau – Rule 13 (2) (b) of the Regulations); pipe sockets; pipe collars or brackets; pipe connectors and parts thereof; fittings (term considered too vague by the International Bureau – Rule 13 (2) (b) of the Regulations); valves of metal, for controlling the flow of fluids in pipes; valves of metal for shut off the flow of fluids in pipes; valves of metal for preventing back flow in pipes; valves; coverings of metal for roads (term considered too vague by the International Bureau – Rule 13 (2) (b) of the Regulations); fire resistant couplings for structural engineering and/or civil engineering, in particular for pipelines for gas, water and waste water; valves of metal for outlets of pipes; fitting and dismantling joints (term considered too vague by the International Bureau – Rule 13 (2) (b) of the Regulations); exhaust chimneys; all the aforesaid goods of metal, preferably of cast iron or steel, with or without protective covers and linings in the form of enamelling or a synthetic or resin material coating and or lining.

11 – Hydrants.

37 – Maintenance and servicing in relation to the following goods: installations for water supply.

40 – Custom manufacture of customised castings; contract enamelling, in particular of cast parts or steel parts.

42 – Technical measuring in relation to the following goods: pipeline systems and components of pipeline systems; engineering design and consultancy in relation to the following goods: pipeline systems.

(260) AM 2023 117867 A

(800) 1661946

(151) 2022 01 31

(891) 2022 01 31

(731) New Tech Solution

Harju maakond, Tallin, EE-10117 Kesklinna
linnaosa, Narva mnt 7-636, Estonia

(540)



(591) Black, white

(531) 24.15.02; 24.17.08; 27.05.01

(511)

36 – Actuarial services; financial analysis; banking; stock brokerage services; stocks and bonds brokerage; brokerage of carbon credits; real estate brokerage; insurance brokerage; securities brokerage; brokerage; repair costs evaluation [financial appraisal]; issuance of travellers' cheques; issuance of credit cards; issuance of tokens of value; investment of funds; arranging finance for construction projects; preparation of quotes for cost estimation purposes; online banking; trusteeship; debt advisory services; electronic transfer of virtual currencies; electronic funds transfer; providing insurance information; providing financial information; providing financial information via a website; safe deposit services; deposits of valuables; charitable fund raising; rent collection; capital investment; mortgage banking; apartment house management; real estate management; clearing, financial; insurance consultancy; stock exchange quotations; crowdfunding; pawn brokerage; marine insurance underwriting; providing rebates at participating establishments of others through use of a membership card; loans [financing]; instalment loans; bail-bonding; exchanging money; processing of debit card payments; processing of credit card payments; real estate affairs; organization of monetary collections; rental of apartments; rental of real estate; rental of offices [real estate]; rental of offices for co-working; rental of farms; antique appraisal; stamp appraisal; real estate appraisal; numismatic appraisal; art appraisal; fiscal valuation; jewellery appraisal; cheque verification; lending against security; accommodation bureau services [apartments]; real estate agency services; credit bureau services; mutual funds; surety services; financing services; debt collection agency services; e-wallet payment services; savings bank services; provident fund services; insurance underwriting; accident insurance underwriting; fire insurance underwriting; life insurance underwriting; health insurance underwriting; factoring; financial management; financial management of reimbursement payments for others; financial consultancy; financial evaluation of development costs relating to the oil, gas and mining industries; financial evaluation of wool; financial evaluation of standing timber; financial valuation of intellectual property assets; financial appraisals in responding to calls for tenders; financial evaluation [insurance, banking, real estate]; financial sponsorship; financial research; financial exchange of virtual currency; financial customs brokerage services; hire-purchase financing; business liquidation services, financial; retirement payment services.

(260) AM 2023 117869 A

(800) 1662142

(151) 2021 11 23

(891) 2021 11 23

(731) Obshchestvo s ogranichennoy otvetstvennostyu "Lazerny Centr"

Piskarevsky pr-kt, 25, pom. 132, RU-195176

St. Petersburg, Russian Federation

(540)



(591) Red and white

(531) 20.05.07; 26.01.01; 26.01.03; 26.01.12;

26.01.16; 26.11.11; 28.05; 29.01.12

(511)

6 – Aluminium; fittings of metal for compressed air lines; fittings of metal for building; white metal; beacons of metal, non-luminous; vats of metal; beams of metal; joists of metal; bottles [containers] of metal for compressed gas or liquid air; balustrades of metal; preserve tins; reels of metal, non-mechanical, for flexible hoses; swimming pools [structures] of metal; beryllium [glucinium]; arbours [structures] of metal; blooms [metallurgy]; ingots of common metal; anchors; bolts of metal; eye bolts; casks of metal; mooring buoys of metal; barrels of metal; identification bracelets of metal; bronze; bells; bells for animals; letters and numerals of common metal, except type; silos of metal; busts of common metal; vanadium; bird baths [structures] of metal; valves of metal, other than parts of machines; screws of metal; aviaries [structures] of metal; tungsten; hoppers of metal, non-mechanical; gates of metal; sleeves [metal hardware]; ferrules of metal for handles; signboards of metal; diving boards of metal; loading gauge rods of metal for railway wagons; nuts of metal; galena [ore]; celtium [hafnium]; nails; tacks [nails]; horseshoe nails; shoe pegs of metal; germanium; vice claws of metal; armoured doors of metal; doors of metal; folding doors of metal; metal automatic swing doors; swing doors of metal; chimney pots of metal; towel dispensers, fixed, of metal; door closers of metal, non-electric; prefabricated houses [kits] of metal; memorial plates of metal; chimney shafts of metal; wall plugs of metal; troughs of metal for mixing mortar; packaging containers of metal; containers of metal for storing acids; jalousies of metal; outdoor blinds of metal; iron, unwrought or semi-wrought; iron strip; roof gutters of metal; street gutters of metal; tinsplate; plugs [metal hardware]; iron slabs; door bolts of metal; window fasteners of metal; bolts, flat; clips of metal for sealing bags; binding screws of metal for cables; cramps of metal [crampons]; wheel clamps [boots]; rivets of metal; box fasteners of metal; locks of metal for bags; locks of metal for vehicles; locks of metal, other than electric; padlocks of metal, other than electronic; spring locks; closures of metal for containers; plugs of metal; latches of metal; tension links; couplings of metal for chains; road signs, non-luminous and non-

mechanical, of metal; registration plates of metal; signs, non-luminous and non-mechanical, of metal; fences of metal; buckles of common metal [hardware]; bronzes [works of art]; works of art of common metal; ironmongery; indium; cabanas of metal; sound-proof booths of metal, transportable; telephone booths of metal; cadmium; paint spraying booths of metal; telpher cables; ropes of metal; jerrycans of metal; horticultural frames of metal; greenhouse frames of metal; framework of metal for building; cornices of metal; skating rinks [structures] of metal; cermets; water-pipe valves of metal; drain traps [valves] of metal; metal cages for wild animals; keys of metal; mooring bollards of metal; cobalt, raw; chill-moulds [foundry]; elbows of metal for pipes; bed casters of metal; furniture casters of metal; manifolds of metal for pipelines; door bells of metal, non-electric; casings of metal for oilwells; pillars of metal for building; chimney cowls of metal; bottle caps of metal; sealing caps of metal; tent pegs of metal; pegs of metal; copper rings; split rings of common metal for keys; rings of metal; door fittings of metal; fittings of metal for windows; brackets of metal for building; buildings of metal; buildings, transportable, of metal; steel buildings; oil drainage containers of metal; containers of metal [storage, transport]; check rails of metal for railways; baskets of metal; door frames of metal; tool boxes of metal, empty; stringers [parts of staircases] of metal; crampons [climbing irons]; taps of metal for casks; tubing of metal; brackets of metal for furniture; roofing of metal; roofing of metal, incorporating photovoltaic cells; turntables [railways]; screw tops of metal for bottles; manhole covers of metal; hooks [metal hardware]; pitons of metal; pot hooks of metal; hooks of metal for roofing slates; sash fasteners of metal for windows; hooks of metal for clothes rails; bag hangers of metal; clothes hooks of metal; chicken-houses of metal; chests of metal; brass, unwrought or semi-wrought; bands of metal for tying-up purposes; scaffolding of metal; staircases of metal; ladders of metal; limonite; steel sheets; cast steel; traps for wild animals; magnesium; manganese; reinforcing materials, of metal, for concrete; reinforcing materials of metal for machine belts; reinforcing materials of metal for pipes; reinforcing materials of metal for building; railway material of metal; materials of metal for funicular railway permanent ways; building materials of metal; refractory construction materials of metal; masts of metal; steel masts; copper, unwrought or semi-wrought; sheets and plates of metal; common metals, unwrought or semi-wrought; pyrophoric metals; metals in powder form; mouldings of metal for building; molybdenum; metal knockers; pipe muffs of metal; shoe dowels of metal; porches [structures] of metal; bronzes for tombstones; tombs of metal; flashing of metal for building; roof flashing of metal; fish plates [rails]; anvils; anvils [portable]; beak-irons; rope thimbles of metal; ferrules of metal for walking sticks; handcuffs; jets of metal; duckboards of metal; belt stretchers of

metal; stretchers for metal bands [tension links]; wire stretchers [tension links]; stretchers for iron bands [tension links]; nickel silver; nickel; niobium; grease nipples; binding thread of metal for agricultural purposes; thread of metal for tying-up purposes; house numbers of metal, non-luminous; braces of metal for handling loads; wall claddings of metal for building; mouldings of metal for cornices; enclosures of metal for tombs; laths of metal; barrel hoops of metal; wall linings of metal for building; palings of metal; crash barriers of metal for roads; furnace fire screens; tree protectors of metal; latticework of metal; door stops of metal; stops of metal; window stops of metal; windows of metal; ironwork for doors; ironwork for windows; tin; shuttering of metal for concrete; filings of metal; posts of metal for power lines; props of metal; branching pipes of metal; monuments of metal; monuments of metal for tombs; metal ramps for use with vehicles; acoustic panels of metal; metal door panels; wainscotting of metal; signalling panels, non-luminous and non-mechanical, of metal; building panels of metal; partitions of metal; lintels of metal; casement windows of metal; strap-hinges of metal; shims; rocket launching platforms of metal; platforms, prefabricated, of metal; wall tiles of metal; floor tiles of metal; tiles of metal for building; anchor plates; paving slabs of metal; grave slabs of metal; tile floorings of metal; slabs of metal for building; lead seals; loading pallets of metal; handling pallets of metal; transport pallets of metal; trays of metal; stakes of metal for plants or trees; firedogs [andirons]; armour-plating of metal; paving blocks of metal; roof coverings of metal; cladding of metal for building; linings of metal for building; fireplace mantles of metal; steel strip; floors of metal; sills of metal; bathtub grab bars of metal; ceilings of metal; brazing alloys; gold solder; silver solder; collars of metal for fastening pipes; winding spools of metal, non-mechanical, for flexible hoses; floating docks of metal, for mooring boats; aluminium wire; iron wire; wire of common metal; wire of common metal alloys, except fuse wire; barbed wire; copper wire, not insulated; soldering wire of metal; steel wire; springs [metal hardware]; rods of metal for welding; rods of metal for brazing and welding; rods of metal for brazing; peeled metal bars; drawn and polished metal bars; bright steel bars; hot-rolled steel bars; dispensers for dog waste bags, fixed, of metal; window frames of metal; frames of metal for building; crucifixes of common metal, other than jewellery; containers of metal for liquid fuel; containers of metal for compressed gas or liquid air; tanks of metal; floating containers of metal; rails of metal; straps of metal for handling loads; furnace fireguards of metal; gratings of metal; runners of metal for sliding doors; iron ores; ores of metal; chrome ores; door handles of metal; knobs of metal; sheet piles of metal; pigsties of metal; lead, unwrought or semi-wrought; safes [metal or non-metal]; safes, electronic; insect screens of metal; burial vaults of metal; door scrapers; cable joints

of metal, non-electric; junctions of metal for pipes; nozzles of metal; anti-friction metal; silver-plated tin alloys; alloys of common metal; sheaf binders of metal; bindings of metal; bottle closures of metal; shutters of metal; steel alloys; steel, unwrought or semi-wrought; tinfoil; statues of common metal; figurines of common metal; cask stands of metal; tombstone stelae of metal; bars for metal railings; stables of metal; advertisement columns of metal; posts of metal; telegraph posts of metal; railway points; steps [ladders] of metal; slings of metal for handling loads; stair treads [steps] of metal; machine belt fasteners of metal; tombstone plaques of metal; nameplates of metal; step stools of metal; tantalum [metal]; greenhouses of metal, transportable; titanium; wire cloth; tombac; mobile boarding stairs of metal for passengers; cables of metal, non-electric; wire rope; pipework of metal; penstock pipes of metal; water-pipes of metal; gutter pipes of metal; ducts of metal for ventilating and air-conditioning installations; drain pipes of metal; chimneys of metal; pipes of metal; ducts of metal, for central heating installations; steel pipes; automatic turnstiles of metal; angle irons of metal; tinplate packings; door fasteners of metal; bicycle parking installations of metal; window closers of metal, non-electric; door openers of metal, non-electric; window openers of metal, non-electric; wind-driven bird-repelling devices made of metal; tungsten iron; molybdenum iron; silicon iron; titanium iron; chrome iron; figures of common metal; flagpoles [structures] of metal; hand-held flagpoles of metal; flanges of metal [collars]; weather- or wind-vanes of metal; aluminium foil; metals in foil or powder form for 3D printers; foils of metal for wrapping and packaging; ice moulds of metal; foundry moulds of metal; fittings of metal for coffins; fittings of metal for beds; fittings of metal for furniture; clips of metal for cables and pipes; chromium; cattle chains; chains of metal; safety chains of metal; zinc; zirconium; pantiles of metal; roofing tiles of metal; cast iron, unwrought or semi-wrought; washers of metal; balls of steel; hinges of metal; poles of metal; safety cashboxes; pulleys of metal, other than for machines; window pulleys of metal; railway sleepers of metal; window casement bolts; cotter pins of metal; spurs; pins [hardware]; roller blinds of steel; latch bars of metal; badges of metal for vehicles; labels of metal; lock bolts; cashboxes [metal or non-metal]; tool chests of metal, empty; boxes of common metal; letter boxes of metal.

7 – Vending machines; 3D printers; welding machines, electric; soldering apparatus, gas-operated; vulcanization apparatus; acetylene cleaning apparatus; high pressure washers; apparatus for drawing up beer under pressure; apparatus for aerating water; apparatus for aerating beverages; electrical apparatus for sealing plastics [packaging]; electric arc cutting apparatus; electric arc welding apparatus; electric welding apparatus; inking apparatus for printing machines; electric soldering apparatus; fittings for engine boilers; expan-

sion tanks [parts of machines]; drums [parts of machines]; reels, mechanical, for flexible hoses; brake shoes, other than for vehicles; concrete mixers [machines]; reels [parts of machines]; bobbins for weaving looms; harrows; journal boxes [parts of machines]; bulldozers; hoppers [mechanical discharging]; mine borers; railway wagon lifts; rolling mill cylinders; crank shafts; printing rollers for machines; camshafts for vehicle engines; transmission shafts, other than for land vehicles; valves [parts of machines]; fans for motors and engines; saw benches [parts of machines]; winnowers; vibrators [machines] for industrial use; bearings [parts of machines]; water heaters being parts of machines; bellows [parts of machines]; agitators; drilling rigs, floating or non-floating; lawnmowers [machines]; card clothing [parts of carding machines]; nail extractors, electric; emergency power generators; alternators; dynamos; bicycle dynamos; current generators; generators of electricity; hydraulic controls for machines, motors and engines; mufflers for motors and engines; drilling heads [parts of machines]; drilling bits [parts of machines]; cylinder heads for engines; soldering blow pipes, gas-operated; gas-operated blow torches; raking machines; stalk separators [machines]; sieves [machines or parts of machines]; mud catchers and collectors [machines]; tarring machines; rubber tracks being parts of crawlers on mining machines; rubber tracks being parts of crawlers on snow ploughs; rubber tracks being parts of crawlers on loading-unloading machines and apparatus; rubber tracks being parts of crawlers on agricultural machines; rubber tracks being parts of crawlers on construction machines; hydraulic engines and motors; aeronautical engines; aeroplane engines; engines for air cushion vehicles; compressed air engines; jet engines, other than for land vehicles; engines for boats; driving motors, other than for land vehicles; motors, other than for land vehicles; propulsion mechanisms, other than for land vehicles; de-aerators for feedwater; disintegrators; tympan [parts of printing presses]; holding devices for machine tools; turf removing ploughs; pump diaphragms; hydraulic door closers; pneumatic door closers; electric door closers; chisels for machines; jacks [machines]; rack and pinion jacks; moving walkways; electric hand drills; crushers for kitchen use, electric; flues for engine boilers; reapers; reapers and binders; millstones; rakes for raking machines; shredders [machines] for industrial use; kitchen grinders, electric; injectors for engines; incubators for eggs; tools [parts of machines]; ski edge sharpening tools, electric; hand-held tools, other than hand-operated; agricultural implements, other than hand-operated; air condensers; control cables for machines, engines or motors; capstans; calenders; rotary steam presses, portable, for fabrics; ditchers [ploughs]; carburettors; sliders for knitting machines; crankcases for machines, motors and engines; steamrollers; pressure valves [parts of machines]; clack valves [parts of machines]; pressure reducers [parts of

machines]; cowlings [parts of machines]; machine wheels; freewheels, other than for land vehicles; scale collectors for machine boilers; lasts for shoes [parts of machines]; brake pads, other than for vehicles; piston segments; grease rings [parts of machines]; reapers and threshers; coal-cutting machines; compressors [machines]; air pumps [garage installations]; compressors for refrigerators; conveyors [machines]; belt conveyors; converters for steelworks; steam condensers [parts of machines]; aerocondensers; diggers [machines]; rams [machines]; thermic lances [machines]; mechanized livestock feeders; boxes for matrices [printing]; gear boxes, other than for land vehicles; grease boxes [parts of machines]; housings [parts of machines]; harvesting machines; steam engine boilers; coffee grinders, other than hand-operated; taps [parts of machines, engines or motors]; cranes [lifting and hoisting apparatus]; roller bridges; mobile cranes; water separators; spray guns for paint; cranks [parts of machines]; potters' wheels; grindstones [parts of machines]; cultivators [machines]; soldering lamps; winches; ploughshares; belts for conveyors; lubricators [parts of machines]; igniting magnetos; handling machines, automatic [manipulators]; churns; matrices for use in printing; machine fly-wheels; shearing machines for animals; blowing machines; knitting machines; galvanizing machines; bending machines; ironing machines; mineworking machines; blowing machines for the compression, exhaustion and transport of gases; blowing machines for the compression, sucking and carrying of grain; net hauling machines [fishing]; electroplating machines; bottle sealing machines; sealing machines for industrial purposes; embossing machines; engraving machines; finishing machines; crushing machines; waste disposal units; blade sharpening [stropping] machines; earth moving machines; cord making machines; lace making machines; butter machines; cigarette machines for industrial purposes; sausage making machines; stereotype machines; hosiery looms; dyeing machines; bottle washing machines; dishwashers; bottle filling machines; cheese slicers, electric; racket stringing machines; leather-working machines; dairy machines; glass-working machines; tobacco processing machines; grain husking machines; painting machines; oil refining machines; peeling machines; machines for processing plastics; ore treating machines; printing machines for use on sheet metal; brewing machines; whitewashing machines; road sweeping machines, self-propelled; leather paring machines; bitumen making machines; papermaking machines; pasta making machines, electric; machines for the production of sugar; weeding machines; sifting machines; cinder sifters [machines]; puddling machines; notchers [machine tools]; bread cutting machines; road making machines; railroad constructing machines; machines for the textile industry; rammers [machines]; rail-laying machines; bottle capping machines; bottle stoppering machines; waste compacting machines; vegetable peelers, electric; die-stamping m-

chines; stamping machines; darning machines; milking machines; drainage machines; wrapping machines; grain separators; bookbinding apparatus and machines for industrial purposes; machines and apparatus for cleaning, electric; machines and apparatus for carpet shampooing, electric; machines and apparatus for polishing [electric]; sizing machines; punching machines; riveting machines; kitchen machines, electric; foundry machines; smoothing presses; fleshing machines; flour mill machines; type-setting machines [printing]; hemming machines; grating machines for vegetables; braiding machines; rinsing machines; wringing machines for laundry; cutting machines; steam engines; printing machines; rotary printing presses; industrial inkjet printing machines; compressed air machines; tilling machines for agricultural purposes; trimming machines; spinning machines; filling machines; friezing machines; cutters [machines]; satinizing machines; agricultural machines; mixing machines; sorting machines for industry; stitching machines; washing machines [laundry]; coin-operated washing machines; clippers [machines]; spinning frames; looms; kneading machines; typographic machines; type-setting machines [photocomposition]; beating machines; beaters, electric; packing machines; packaging machines; filtering machines; moulding machines; carding machines; sewing machines; typecasting machines; electromechanical machines for chemical industry; labellers [machines]; mills [machines]; mills for household purposes, other than hand-operated; pepper mills, other than hand-operated; centrifugal mills; machine wheelwork; feeders [parts of machines]; forge blowers; mixers [machines]; blenders, electric, for household purposes; vacuum cleaner bags; threshing machines; pneumatic hammers; hammers [parts of machines]; tilt hammers; power hammers; reeling apparatus, mechanical; motorized cultivators; motors for boats; clutches, other than for land vehicles; meat choppers [machines]; superchargers; brake linings, other than for vehicles; guides for machines; suction nozzles for vacuum cleaners; vacuum cleaner attachments for disseminating perfumes and disinfectants; pumps [machines]; pumps [parts of machines, engines or motors]; aerating pumps for aquaria; vacuum pumps [machines]; compressed air pumps; pumps for heating installations; beer pumps; pumps for counter-current swimming; lubricating pumps; self-regulating fuel pumps; fuel dispensing pumps for service stations; centrifugal pumps; hydrogen dispensing pumps for service stations; blades [parts of machines]; tin openers, electric; knives for mowing machines; chaff cutter blades; knives, electric; shears, electric; scissors, electric; vegetable spiralizers, electric; engine mounts, other than for land vehicles; bearing brackets for machines; pulverisers [machines]; axles for machines; steam traps; chucks [parts of machines]; drill chucks [parts of machines]; exhaust manifold for engines; soldering irons, gas-operated; soldering irons, electric; superheaters; gears, other than for land vehic-

les; reduction gears, other than for land vehicles; drilling machines; saws [machines]; chain saws; guns [tools using explosives]; glue guns, electric; compressed air guns for the extrusion of mastics; carburetter feeders; feeding apparatus for engine boilers; loading ramps; ploughs; pneumatic transporters; pneumatic controls for machines, motors and engines; hangers [parts of machines]; anti-friction bearings for machines; roller bearings; self-oiling bearings; bearings for transmission shafts; ball-bearings; elevators [lifts]; hoists; lifts, other than ski-lifts; pulleys; saw blades [parts of machines]; pistons [parts of machines or engines]; shock absorber plungers [parts of machines]; pistons for engines; pistons for cylinders; catalytic converters; torque converters, other than for land vehicles; fuel conversion apparatus for internal combustion engines; presses [machines for industrial purposes]; wine presses; fruit presses, electric, for household purposes; fodder presses; basket presses; printing presses; typographic presses; swaging machines; pedal drives for sewing machines; cleaning appliances utilizing steam; food processors, electric; springs [parts of machines]; spinning wheels; punches for punching machines; vacuum cleaners; tambours for embroidery machines; radiators [cooling] for motors and engines; sewage pulverizers; air brushes for applying colour; regulators [parts of machines]; pressure regulators [parts of machines]; speed governors for machines, engines and motors; knives [parts of machines]; cutting blow pipes, gas-operated; blade holders [parts of machines]; loom shafts; gears for weaving looms; belts for machines; elevator belts; fan belts for motors and engines; dynamo belts; belts for motors and engines; adhesive bands for pulleys; industrial robots; 3D printing pens; kick starters for motorcycles; joysticks being parts of machines, other than for game machines; stuffing boxes [parts of machines]; paper feeders [printing]; whisks, electric, for household purposes; sparking plugs for internal combustion engines; glow plugs for Diesel engines; brake segments, other than for vehicles; tedding machines; steam/oil separators; cream/milk separators; ball rings for bearings; sowers [machines]; exhausts for motors and engines; pigs for cleaning pipes; snow ploughs; sheaf-binding machines; shaft couplings [machines]; joints [parts of engines]; juice extractors, electric; straw [chaff] cutters; suction cups for milking machines; stands for machines; machine tools; die-cutting and tapping machines; woodworking machines; sharpening machines; bicycle assembling machines; mortising machines; stone-working machines; metalworking machines; threading machines; straightening machines; planing machines; lathes [machine tools]; milling machines; trueing machines; metal drawing machines; rolling mills; starters for motors and engines; stators [parts of machines]; glaziers' diamonds [parts of machines]; tables for machines; derricks; slide rests [parts of machines]; spin dryers [not heated]; couplings, other than for land vehicles; heat exchangers

[parts of machines]; transmissions for machines; transmissions, other than for land vehicles; boiler tubes [parts of machines]; wind turbines; hydraulic turbines; turbines, other than for land vehicles; turbocompressors; central vacuum cleaning installations; suction machines for industrial purposes; machines for the mineralization of drinking water; washing installations for vehicles; degreasers [machines]; dust exhausting installations for cleaning purposes; sifting installations; pneumatic tube conveyors; dust removing installations for cleaning purposes; condensing installations; floating production storage and offloading [FPSO] units; pneumatic waste oil drainers; lifting apparatus; air suction machines; dividing machines; igniting devices for internal combustion engines; window closers, hydraulic; window closers, pneumatic; window closers, electric; washing apparatus; binding apparatus for hay; haulage apparatus [mining]; door openers, hydraulic; door openers, pneumatic; door openers, electric; window openers, hydraulic; window openers, pneumatic; window openers, electric; curtain drawing devices, electrically operated; adhesive tape dispensers [machines]; anti-pollution devices for motors and engines; beverage preparation machines, electromechanical; food preparation machines, electromechanical; elevator operating apparatus; control mechanisms for machines, engines or motors; shoe polishers, electric; machines and apparatus for wax-polishing, electric; air cushion devices for moving loads; handling apparatus for loading and unloading; elevating apparatus; aprons [parts of machines]; filter presses; filters for cleaning cooling air, for engines; filters being parts of machines or engines; moulds [parts of machines]; printing plates; journals [parts of machines]; centrifugal machines; elevator chains [parts of machines]; driving chains, other than for land vehicles; transmission chains, other than for land vehicles; cylinders for motors and engines; cylinders for machines; printing cylinders; pneumatic jacks; shuttles [parts of machines]; universal joints [Cardan joints]; engine rods; connecting rods for machines; steam mops; pulleys [parts of machines]; vacuum cleaner hoses; screwdrivers, electric; brushes [parts of machines]; dynamo brushes; brushes for vacuum cleaners; brushes, electrically operated [parts of machines]; carbon brushes [electricity]; ejectors; robotic exoskeleton suits, other than for medical purposes; fuel economisers for motors and engines; excavators; shovels, mechanical; agricultural elevators; motors, electric, other than for land vehicles; electrodes for welding machines; electric hammers; parquet wax-polishers, electric; cartridges for filtering machines; moving staircases [escalators]; automatic grapnels for marine purposes; metal cutting machines; machines using laser radiation.

8 – Glaziers' diamonds [parts of hand tools]; apparatus for tattooing; laser hair removal apparatus, other than for medical purposes; razors, electric or non-electric; sharpening steels; scythe stones; gimlets [hand

tools]; borers; augers [hand tools]; carpenters' augers; pickhammers; carving forks; table forks; weeding forks [hand tools]; agricultural forks [hand tools]; lawn clippers [hand instruments]; harpoons; harpoons for fishing; nail extractors, hand-operated; rakes [hand tools]; sand trap rakes; cutter bars [hand tools]; whetstone holders; priming irons [hand tools]; sculptors' chisels; lifting jacks, hand-operated; hand drills, hand-operated; truncheons; clamps for carpenters or coopers; spades [hand tools]; rabbeting planes; chisels; engraving needles; tattoo needles; cutlery; edge tools [hand tools]; garden tools, hand-operated; abrading instruments [hand instruments]; numbering punches; goffering irons; implements for decanting liquids [hand tools]; depilation appliances, electric and non-electric; sharpening instruments; blade sharpening instruments; livestock marking tools; nail clippers, electric or non-electric; oyster openers; polishing irons [glazing tools]; ear-piercing apparatus; tube cutting instruments; wire strippers [hand tools]; riveters [hand tools]; expanders [hand tools]; cutting tools; cutting tools [hand tools]; ski edge sharpening tools, hand-operated; hand tools, hand-operated; sterile body piercing instruments; stamping-out tools [hand tools]; picks [hand tools]; sharpening stones; punch rings [knuckle dusters]; trowels; centre punches [hand tools]; daggers; pickaxes; mallets [hand instruments]; pliers; punch pliers [hand tools]; blades [weapons]; annular screw plates; spanners [hand tools]; tap wrenches; ladles [hand tools]; foundry ladles [hand tools]; meat claws; breast drills; lasts [shoemakers' hand tools]; scythe rings; instruments for punching tickets; diggers [hand tools]; rams [hand tools]; scythes; hainault scythes; fire irons; emery grinding wheels; grindstones [hand tools]; sledgehammers; thistle extractors [hand tools]; nail nippers; tree pruners; nail drawers [hand tools]; ice picks; blades [hand tools]; razor blades; blades for planes; plane irons; jig-saws; spoons; table knives, forks and spoons for babies; table knives, forks and spoons of plastic; crow bars; trowels [gardening]; shovels [hand tools]; palette knives; machetes; beard clippers; hair clippers for personal use, electric and non-electric; hair clippers for animals [hand instruments]; taps [hand tools]; fireplace bellows [hand tools]; swords; hammers [hand tools]; emergency hammers; fullers [hand tools]; stone hammers; masons' hammers; riveting hammers [hand tools]; mattocks; ditchers [hand tools]; mincing knives [hand tools]; manicure sets; manicure sets, electric; pedicure sets; needle files; bits [hand tools]; files [tools]; emery files; air pumps, hand-operated; hand pumps; shaving cases; knives; cheese slicers, non-electric; fruit segmenters; egg slicers, non-electric; vegetable knives; pizza slicers; scaling knives; hobby knives [scalpels]; fruit corers; moulding irons; ceramic knives; tin openers, non-electric; farriers' knives; budding knives; hunting knives; penknives; grafting tools [hand tools]; carving knives; braiders [hand tools]; box cutters; bill-hooks; paring knives; cleavers;

scissors; wick trimmers [scissors]; shears; cattle shears; border shears; pruning shears; shearers [hand instruments]; sword scabbards; kitchen mandolines; vegetable slicers, hand-operated; vegetable spiralizers, hand-operated; vegetable peelers, hand-operated; agricultural implements, hand-operated; side arms, other than firearms; stropping instruments; screwdrivers, non-electric; sabres; stirring sticks for mixing paint; reamer sockets; drill holders [hand tools]; perforating tools [hand tools]; rammers [hand tools]; emery boards; nail files; nail files, electric; saws [hand tools]; bow saws; tweezers; hair-removing tweezers; guns [hand tools]; non-electric caulking guns; guns, hand-operated, for the extrusion of mastics; dies [hand tools]; fruit pickers [hand tools]; saw blades [parts of hand tools]; shear blades; tool belts [holders]; hair braiders, electric; table cutlery [knives, forks and spoons]; crimping irons; hand implements for hair curling; vegetable choppers; money scoops; instruments and tools for skinning animals; fingernail polishers, electric or non-electric; hackles [hand tools]; pin punches; nail punches; fish tapes [hand tools]; punches [hand tools]; insecticide vaporizers [hand tools]; syringes for spraying insecticides; reamers; frames for handsaws; saw holders; rasps [hand tools]; paring irons [hand tools]; graving tools [hand tools]; milling cutters [hand tools]; razor strops; leather strops; planes; scythe handles; knife handles; handles for hand-operated hand tools; levers; marline spikes; bits [parts of hand tools]; hollowing bits [parts of hand tools]; pruning scissors; silver plate [knives, forks and spoons]; pruning knives; sickles; drawing knives; scrapers [hand tools]; scrapers for skis; mortise chisels; caulking irons; gouges [hand tools]; mortars for pounding [hand tools]; mitre boxes [hand tools]; branding irons; hatchets; adzes [tools]; vices; bench vices [hand implements]; hoop cutters [hand tools]; axes; holing axes; fulling tools [hand tools]; earth rammers [hand tools]; tube cutters [hand tools]; hoes [hand tools]; squares [hand tools]; extension pieces for braces for screw taps; embossers [hand tools]; apparatus for destroying plant parasites, hand-operated; metal wire stretchers [hand tools]; metal band stretchers [hand tools]; flat irons; irons [non-electric hand tools]; razor cases; ratchets [hand tools]; scraping tools [hand tools]; awls; choppers [knives]; spatulas [hand tools]; spatulas for use by artists; wine bottle foil cutters, hand-operated; bayonets; curling tongs; cuticle tweezers; eyelash curlers; metal-cutting saws; metal-cutting scissors [tin shears].

9 – 3D spectacles; DVD players; ticket dispensers; juke boxes, musical; fire engines; answering machines; electrical adapters; batteries for electronic cigarettes; accumulators, electric; batteries, electric, for vehicles; accelerometers; actinometers; alidades; altimeters; ear pads for earphones; ammeters; nanoparticle size analysers; anemometers; anodes; aerials; anticathodes; apertometers [optics]; high-frequency apparatus; testing apparatus not for medical purposes; remote con-

trol apparatus; electro-dynamic apparatus for the remote control of railway points; electro-dynamic apparatus for the remote control of signals; monitoring apparatus, other than for medical purposes; sound recording apparatus; Global Positioning System [GPS] apparatus; distillation apparatus for scientific purposes; diffraction apparatus [microscopy]; air analysis apparatus; apparatus to check franking; sound transmitting apparatus; apparatus for fermentation [laboratory apparatus]; breathing apparatus for underwater swimming; breathing apparatus, except for artificial respiration; apparatus and installations for the production of X-rays, not for medical purposes; cash registers; electric apparatus for commutation; magnetic resonance imaging [MRI] apparatus, not for medical purposes; intercommunication apparatus; stills for laboratory experiments; projection apparatus; fire extinguishing apparatus; radiological apparatus for industrial purposes; X-ray apparatus not for medical purposes; blueprint apparatus; flashing lights [luminous signals]; stereoscopic apparatus; telephone apparatus; facsimile machines; phototelegraphy apparatus; igniting apparatus, electric, for igniting at a distance; acid hydrometers; salinometers; acidimeters for batteries; aerometers; beacons, luminous; battery jars; automated teller machines [ATM]; barometers; anode batteries; galvanic batteries; ignition batteries; solar batteries; solar panels for the production of electricity; batteries, electric; balances [steelyards]; betatrons; binoculars; biochips; electronic tags for goods; lens hoods; magnetic tape units for computers; computer memory devices; fire hose nozzles; encoded identification bracelets, magnetic; connected bracelets [measuring instruments]; safety tarpaulins; electronic key fobs being remote control apparatus; bullet-proof clothing; signalling buoys; life buoys; marking buoys; directional compasses; vacuum gauges; electrolyzers; variometers; verniers; scales; baby scales; bathroom scales; letter scales; weighbridges; precision balances; scales with body mass analysers; levelling staffs [surveying instruments]; camcorders; video baby monitors; video cassettes; video projectors; video telephones; video screens; viewfinders, photographic; electric plugs; micrometer screws for optical instruments; viscosimeters; circuit closers; wavemeters; voltmeters; mechanical signs; signs, luminous; switchboxes [electricity]; current rectifiers; gas testing instruments; gasometers [measuring instruments]; galvanometers; hands-free kits for telephones; heliographic apparatus; hygrometers; hydrometers; weights; peepholes [magnifying lenses] for doors; hairdressing training heads [teaching apparatus]; holograms; plotters; loudspeakers; sounding leads; plumb bobs; range finders; parking sensors for vehicles; piezoelectric sensors; densimeters; densitometers; detectors; smoke detectors; infrared detectors; counterfeit coin detectors; joysticks for use with computers, other than for video games; transparencies [photography]; slide projectors; diaphragms [photography]; dictating machines; dynamome-

ters; light-emitting diodes [LED]; quantum dot light-emitting diodes [QLED]; organic light-emitting diodes [OLED]; floppy disks; phonograph records; disks, magnetic; optical discs; circular slide rules; disk drives for computers; juke boxes for computers; wearable video display monitors; electronic numeric displays; DNA chips; electronic interactive whiteboards; electronic notice boards; electric wire harnesses for automobiles; bullet-proof vests; life jackets; reflective safety vests; identification threads for electric wires; nose clips for divers and swimmers; padlocks, electronic; locks, electric; bells [warning devices]; alarm bells, electric; electric door bells; signal bells; acoustic conduits; mirrors for inspecting work; road signs, luminous or mechanical; downloadable emoticons for mobile phones; marine depth finders; probes for scientific purposes; buzzers; needles for surveying compasses; needles for record players; eyewear; reflective articles for wear, for the prevention of accidents; measures; pressure measuring apparatus; simulators for the steering and control of vehicles; inverters [electricity]; pressure indicators; automatic indicators of low pressure in vehicle tyres; temperature indicators; incubators for bacteria culture; measuring instruments; cosmographic instruments; mathematical instruments; levelling instruments; instruments containing eyepieces; surveying instruments; azimuth instruments; interfaces for computers; audio interfaces; ionization apparatus not for the treatment of air or water; satellite finder meters; spark-guards; coaxial cables; fibre optic cables; cables, electric; calipers; slide calipers; screw-tapping gauges; calorimeters; calculating machines; pocket calculators; decompression chambers; rearview cameras for vehicles; cinematographic cameras; thermal imaging cameras; mouth guards for sports; life-saving capsules for natural disasters; electronic pens [visual display units]; holders for electric coils; biometric identity cards; identity cards, magnetic; video game cartridges; toner cartridges, unfilled, for printers and photocopiers; ink cartridges, unfilled, for printers and photocopiers; memory cards for video game machines; encoded magnetic cards; riding helmets; protective helmets; carriers for dark plates [photography]; cathodes; spools [photography]; choking coils [impedance]; coils, electric; electromagnetic coils; cinematographic film, exposed; computer keyboards; solenoid valves [electromagnetic switches]; wire connectors [electricity]; thin client computers; downloadable cryptographic keys for receiving and spending cryptocurrency; encoded key cards; electronic book readers; electronic agendas; push buttons for bells; mouse pads; magnetic encoders; visors for helmets; collectors, electric; calibrating rings; smart rings; ring sizers; protective suits for aviators; compact discs [audio-video]; compact discs [read-only memory]; comparators; marine compasses; computers; laptop computers; tablet computers; notebook computers; wearable computers; condensers [capacitors]; contacts, electric; wind socks for indicating

wind direction; traffic cones; branch boxes [electricity]; distribution boxes [electricity]; junction boxes [electricity]; connectors [electricity]; battery boxes; cabinets for loudspeakers; diving suits; downloadable e-wallets; galena crystals [detectors]; covers for electric outlets; logs [measuring instruments]; lasers, not for medical purposes; lactodensimeters; lactometers; vacuum tubes [radio]; darkroom lamps [photography]; thermionic valves; amplifying tubes; flashlights [photography]; head cleaning tapes [recording]; magnetic tapes; videotapes; surveying chains; fire escapes; rulers [measuring instruments]; square rulers for measuring; slide-rulers; contact lenses; correcting lenses [optics]; optical lenses; optical condensers; sounding lines; electricity conduits; measuring spoons; magnifying glasses [optics]; thread counters; magnets; decorative magnets; close-up lenses; crash test dummies; resuscitation mannequins [teaching apparatus]; mouse [computer peripheral]; trackballs [computer peripherals]; pressure gauges; security tokens [encryption devices]; divers' masks; solderers' helmets; protective masks; respiratory masks, other than for artificial respiration; materials for electricity mains [wires, cables]; voting machines; money counting and sorting machines; material testing instruments and machines; furniture especially made for laboratories; megaphones; portable media players; diaphragms [acoustics]; diaphragms for scientific apparatus; metal detectors for industrial or military purposes; digital weather stations; metronomes; rules [measuring instruments]; carpenters' rules; dressmakers' measures; mechanisms for coin-operated apparatus; mechanisms for counter-operated apparatus; coin-operated mechanisms for television sets; shutter releases [photography]; micrometers; microprocessors; microscopes; microtomes; microphones; audio mixers; modems; lightning conductors; monitors [computer hardware]; monitors [computer programs]; selfie sticks [hand-held monopods]; terminals [electricity]; junction sleeves for electric cables; teeth protectors; temperature indicator labels, not for medical purposes; knee-pads for workers; ear pads for headphones; headphones; earpieces for remote communication; surveyors' levels; sound recording carriers; magnetic data media; optical data media; electronic sheet music, downloadable; laptops; recorded computer gaming software for gambling; computer software, recorded; sheaths for electric cables; identification sheaths for electric wires; weighing machines; computer hardware; punched card machines for offices; life saving equipment; shoes for protection against accidents, irradiation and fire; objectives [lenses] [optics]; lenses for astrophotography; selfie lenses; egg-candlers; fire extinguishers; rescue laser signalling flares; electrified fences; limiters [electricity]; clothing for protection against accidents, irradiation and fire; clothing for protection against fire; asbestos clothing for protection against fire; clothing especially made for laboratories; survival blankets; ozonisers [ozonators]; octants; eyepieces; ohmmeters; wrist

rests for use with computers; spectacle frames; oscillographs; plumb lines; mirrors [optics]; spectacles; sunglasses; goggles for sports; electronic collars to train animals; finger sizers; signalling panels, luminous or mechanical; biometric passports; wah-wah pedals; radio pagers; pince-nez; electronic pocket translators; transmitters [telecommunication]; telephone transmitters; transmitters of electronic signals; switches, electric; periscopes; data gloves; gloves for divers; gloves for protection against accidents; gloves for protection against X-rays for industrial purposes; asbestos gloves for protection against accidents; furnaces for laboratory use; droppers for measuring, other than for medical or household purposes; laboratory pipettes; pyrometers; planimeters; plane tables [surveying instruments]; plates for batteries; computer software platforms, recorded or downloadable; wafers for integrated circuits; printed circuit boards; compact disc players; cassette players; protective films adapted for computer screens; protective films adapted for smartphones; sound recording strips; X-ray films, exposed; films, exposed; life-saving rafts; animal signalling rattles for directing livestock; laboratory trays; digital signs; stands adapted for laptops; semi-conductors; polarimeters; personal digital assistants [PDAs]; fire pumps; measuring glassware; weight belts for divers; life belts; fuses; circuit breakers; converters, electric; telerupters; food analysis apparatus; diagnostic apparatus, not for medical purposes; distance recording apparatus; distance measuring apparatus; speed measuring apparatus [photography]; appliances for measuring the thickness of leather; apparatus for measuring the thickness of skins; speed checking apparatus for vehicles; teaching apparatus; time recording apparatus; apparatus and instruments for astronomy; surveying apparatus and instruments; weighing apparatus and instruments; nautical apparatus and instruments; navigational instruments; optical apparatus and instruments; apparatus and instruments for physics; chemistry apparatus and instruments; measuring apparatus; measuring devices, electric; boiler control instruments; meteorological instruments; naval signalling apparatus; observation instruments; navigation apparatus for vehicles [on-board computers]; satellite navigational apparatus; regulating apparatus, electric; telecommunication apparatus in the form of jewellery; precision measuring apparatus; audio- and video-receivers; prisms [optics]; computer software applications, downloadable; ticket printers; printers for use with computers; hemline markers; retorts' stands; apparatus for changing record player needles; drainers for use in photography; cleaning apparatus for phonograph records; fire beaters; sighting telescopes for firearms; telescopic sights for artillery; test tubes; pressure indicator plugs for valves; magnetic wires; telegraph wires; telephone wires; wires, electric; conductors, electric; copper wire, insulated; fuse wire; computer programs, recorded; computer game software, downloadable; computer programs, downloadable;

computer operating programs, recorded; computer screen saver software, recorded or downloadable; record players; processors [central processing units]; rods for water diviners; electronic publications, downloadable; distribution consoles [electricity]; control panels [electricity]; radar apparatus; masts for wireless aerials; transmitting sets [telecommunication]; radios; vehicle radios; sprinkler systems for fire protection; frames for photographic transparencies; screens for photoengraving; flowmeters; walkie-talkies; voltage surge protectors; voltage regulators for vehicles; stage lighting regulators; light dimmers [regulators], electric; speed regulators for record players; cell switches [electricity]; washing trays [photography]; marking gauges [joinery]; T-squares for measuring; time switches, automatic; relays, electric; safety restraints, other than for vehicle seats and sports equipment; body harnesses for support when lifting loads; X-ray photographs, other than for medical purposes; rheostats; respirators for filtering air; retorts; refractometers; refractors; grids for batteries; security surveillance robots; laboratory robots; teaching robots; telepresence robots; humanoid robots with artificial intelligence; electric sockets; height measuring instruments; speaking tubes; horns for loudspeakers; subwoofers; saccharometers; optical fibres [light conducting filaments]; traffic-light apparatus [signalling devices]; dog whistles; signalling whistles; sports whistles; sextants; inductors [electricity]; safety nets; nets for protection against accidents; fire alarms; signals, luminous or mechanical; rescue flares, non-explosive and non-pyrotechnic; sirens; electronic access control systems for interlocking doors; scanners [data processing equipment]; hand-held electronic dictionaries; integrated circuit cards [smart cards]; smartglasses; smartphones; smartwatches; connections for electric lines; couplings, electric; sonars; sound locating instruments; lighting ballasts; resistances, electric; spectrograph apparatus; spectroscopes; speed indicators; alcoholmeters; satellites for scientific purposes; protection devices for personal use against accidents; audiovisual teaching apparatus; charging stations for electric vehicles; radiotelegraphy sets; radiotelephony sets; spectacle lenses; anti-glare glasses; optical glass; personal stereos; stereoscopes; stands for photographic apparatus; stroboscopes; fire boats; sulfitemeters; bags adapted for laptops; drying racks [photography]; spherometers; integrated circuits; printed circuits; counters; parking meters; mileage recorders for vehicles; revolution counters; abacuses; egg timers [sandglasses]; taximeters; ear plugs for divers; tachometers; television apparatus; telegraphs [apparatus]; telescopes; teleprompters; teleprinters; cordless telephones; mobile telephones; theodolites; credit card terminals; interactive touch screen terminals; thermo-hygrometers; thermometers, not for medical purposes; thermostats; thermostats for vehicles; climate control digital thermostats; crucibles [laboratory]; tone arms for record players; totalizers; transistors [electronic]; transpon-

ders; protractors [measuring instruments]; transformers [electricity]; step-up transformers; resuscitation training simulators; vehicle breakdown warning triangles; triodes; starter cables for motors; discharge tubes, electric, other than for lighting; capillary tubes; neon signs; Pitot tubes; X-ray tubes not for medical purposes; telephone receivers; headgear being protective helmets; squares for measuring; gauges; quantity indicators; petrol gauges; water level indicators; electric loss indicators; light-emitting electronic pointers; slope indicators; levels [instruments for determining the horizontal]; mercury levels; spirit levels; urinometers; amplifiers; particle accelerators; electric installations for the remote control of industrial operations; baby monitors; steering apparatus, automatic, for vehicles; balancing apparatus; video recorders; sound reproduction apparatus; invoicing machines; tape recorders; protection devices against X-rays, not for medical purposes; railway traffic safety appliances; data processing apparatus; oxygen transvasing apparatus; theft prevention installations, electric; devices for the projection of virtual keyboards; film cutting apparatus; drying apparatus for photographic prints; optical character readers; centering apparatus for photographic transparencies; dosage dispensers; battery chargers; chargers for electric accumulators; chargers for electronic cigarettes; acoustic alarms; sounding apparatus and machines; apparatus for editing cinematographic film; cathodic anti-corrosion apparatus; couplers [data processing equipment]; wearable activity trackers; anti-theft warning apparatus; computer peripheral devices; anti-interference devices [electricity]; demagnetizing apparatus for magnetic tapes; acoustic couplers; alarms; fog signals, non-explosive; whistle alarms; adding machines; readers [data processing equipment]; heat regulating apparatus; photocopiers [photographic, electrostatic, thermic]; electric and electronic effects units for musical instruments; bar code readers; downloadable ring tones for mobile phones; downloadable image files; downloadable music files; animated cartoons; filters for respiratory masks; filters for ultraviolet rays, for photography; filters for use in photography; USB flash drives; magic lanterns; optical lanterns; signal lanterns; cameras [photography]; glazing apparatus for photographic prints; shutters [photography]; darkrooms [photography]; photometers; flash-bulbs [photography]; digital photo frames; enlarging apparatus [photography]; photovoltaic cells; containers for contact lenses; spectacle cases; containers for microscope slides; cases for smartphones; cases especially made for photographic apparatus and instruments; chromatography apparatus for laboratory use; chronographs [time recording apparatus]; laboratory centrifuges; spectacle chains; cyclotrons; compasses for measuring; frequency meters; time clocks [time recording devices]; Petri dishes; sleeves for laptops; covers for personal digital assistants [PDAs]; covers for tablet computers; covers for smartphones; fire blankets; chips [integrated circuits];

jigs [measuring instruments]; pedometers; meteorological balloons; electrified rails for mounting spot lights; asbestos screens for firemen; fire hose; virtual reality headsets; protective helmets for sports; head guards for sports; lifeboats; snorkels; cell phone straps; spectacle cords; tripods for cameras; switchboards; distribution boards [electricity]; equalizers [audio apparatus]; screens [photography]; workmen's protective face-shields; projection screens; radiology screens for industrial purposes; fluorescent screens; exposure meters [light meters]; ducts [electricity]; galvanic cells; downloadable graphics for mobile phones; epidiascopes; ergometers; armatures [electricity]; black boxes [data recorders].

10 – Analysers for bacterial identification for medical purposes; cholesterol meters; blood testing apparatus; testing apparatus for medical purposes; anaesthetic apparatus; galvanic therapeutic appliances; apparatus for artificial respiration; apparatus for the treatment of deafness; physical exercise apparatus for medical purposes; body rehabilitation apparatus for medical purposes; dental apparatus and instruments; surgical apparatus and instruments; resuscitation apparatus; dental apparatus, electric; physiotherapy apparatus; bed vibrators; hot air therapeutic apparatus; diagnostic apparatus for medical purposes; traction apparatus for medical purposes; radiotherapy apparatus; microdermabrasion apparatus; fumigation apparatus for medical purposes; apparatus for the regeneration of stem cells for medical purposes; apparatus for DNA and RNA testing for medical purposes; apparatus and installations for the production of X-rays, for medical purposes; magnetic resonance imaging [MRI] apparatus for medical purposes; orthodontic apparatus; medical cooling apparatus for treating heatstroke; medical cooling apparatus for use in therapeutic hypothermia; radiological apparatus for medical purposes; X-ray apparatus for medical purposes; hearing aids; nasal aspirators; trusses; maternity belts; support bandages; bandages, elastic; cupping glasses; dental burs; acupressure bands; bracelets for medical purposes; anti-nausea wristbands; anti-rheumatism bracelets; feeding bottles; air cushions for medical purposes; vaporizers for medical purposes; hot air vibrators for medical purposes; vibromassage apparatus; gastroscopes; hemocytometers; glucometers; lice combs; surgical sponges; pill cutters; defibrillators; dialyzers; containers especially made for medical waste; clips, surgical; mirrors for dentists; mirrors for surgeons; probes for medical purposes; urethral probes; artificial teeth; acupuncture needles; suture needles; needles for medical purposes; orthopedic articles; pill crushers; biodegradable bone fixation implants; surgical implants comprised of artificial materials; inhalers; hydrogen inhalers; injectors for medical purposes; incubators for medical purposes; incubators for babies; obstetric apparatus; obstetric apparatus for cattle; electric acupuncture instruments; surgical cutlery; insufflators; chambers for inhalers; endoscopy cameras for medical

purposes; cannulae; droppers for medical purposes; dropper bottles for medical purposes; heart monitors; heart pacemakers; catheters; catgut; draw-sheets for sick beds; enema apparatus for medical purposes; clips for dummies; artificial skin for surgical purposes; menstrual cups; biomagnetic rings for therapeutic or medical purposes; teething rings; anti-rheumatism rings; compressors [surgical]; thermo-electric compresses [surgery]; oxygen concentrators for medical purposes; abdominal corsets; corsets for medical purposes; crutches; dentists' armchairs; armchairs for medical or dental purposes; waterbeds for medical purposes; air mattresses [air beds] for medical purposes; beds specially made for medical purposes; feeding bottle valves; love dolls [sex dolls]; lasers for medical purposes; lamps for medical purposes; curing lamps for medical purposes; quartz lamps for medical purposes; ultraviolet ray lamps for medical purposes; lancets; kinesiology tapes; lenses [intraocular prostheses] for surgical implantation; spoons for administering medicine; sanitary masks for medical purposes; masks for use by medical personnel; respiratory masks for artificial respiration; anaesthetic masks; LED masks for therapeutic purposes; therapeutic facial masks; gum massagers for babies; suture materials; childbirth mattresses; air mattresses for medical purposes; furniture especially made for medical purposes; water bags for medical purposes; douche bags; breast pumps; body fat monitors; body composition monitors; urinals being vessels; portable hand-held urinals; teeth protectors for dental purposes; temperature indicator labels for medical purposes; knee bandages, orthopaedic; tips for crutches; nanorobots for medical purposes; finger guards for medical purposes; bone void fillers comprised of artificial materials; medical guide-wires; pumps for medical purposes; thread, surgical; knives for surgical purposes; scissors for surgery; ambulance stretchers; stretchers, wheeled; boots for medical purposes; orthopaedic footwear; clothing especially for operating rooms; compression garments; blankets, electric, for medical purposes; supports for flat feet; ophthalmometers; ophthalmoscopes; cooling pads for first aid purposes; slings [supporting bandages]; gloves for massage; gloves for medical purposes; pessaries; saws for surgical purposes; ear picks; cooling patches for medical purposes; spittoons for medical purposes; plaster bandages for orthopaedic purposes; orthopaedic bandages for joints; abdominal pads; cushions for medical purposes; pads for preventing pressure sores on patient bodies; air pillows for medical purposes; soporific pillows for insomnia; heating cushions, electric, for medical purposes; patient hoists; abdominal belts; galvanic belts for medical purposes; hypogastric belts; belts for medical purposes; orthopaedic belts; umbilical belts; belts, electric, for medical purposes; condoms; aerosol dispensers for medical purposes; sphygmotensimeters; pulse meters; esthetic massage apparatus; massage apparatus; veterinary apparatus and instruments; medi-

cal apparatus and instruments; urological apparatus and instruments; brushes for cleaning body cavities; appliances for washing body cavities; corn knives; incontinence sheets; sterile sheets, surgical; surgical drapes; hair prostheses; artificial eyes; artificial breasts; dentures; artificial limbs; artificial jaws; ice bags for medical purposes; toe separators for orthopaedic purposes; surgical bougies; orthodontic rubber bands; X-ray photographs for medical purposes; respirators for artificial respiration; surgical robots; ear trumpets; strait jackets; sex toys; scalpels; tongue scrapers; dummies for babies; feeding bottle teats; baby feeding dummies; receptacles for applying medicines; spirometers [medical apparatus]; vaginal syringes; implantable subcutaneous drug delivery devices; hearing protectors; contraceptives, non-chemical; orthopaedic soles; stents; stethoscopes; medical examination tables; operating tables; commode chairs; basins for medical purposes; bed pans; instrument cases for use by doctors; arch supports for footwear; suspensory bandages; ear plugs [ear protection devices]; thermal packs for first aid purposes; thermometers for medical purposes; tomographs for medical purposes; trocars; walking sticks for medical purposes; drainage tubes for medical purposes; X-ray tubes for medical purposes; radium tubes for medical purposes; balling guns; protection devices against X-rays, for medical purposes; apparatus for acne treatment; filters for ultraviolet rays, for medical purposes; patient examination gowns; quad canes for medical purposes; wheeled walkers to aid mobility; walking frames for disabled persons; cases fitted for medical instruments; elastic stockings for surgical purposes; stockings for varices; splints, surgical; laser therapy helmets for treating alopecia; tongue depressors for medical purposes; syringes for injections; syringes for medical purposes; hypodermic syringes; uterine syringes; urethral syringes; pins for artificial teeth; castrating pincers; forceps for medical purposes; robotic exoskeleton suits for medical purposes; radiology screens for medical purposes; electrodes for medical use; electrocardiographs; brain pacemakers; laser machines for medical purposes.

14 – Agates; diamonds; amulets [jewellery]; anchors [clock- and watchmaking]; barrels [clock- and watchmaking]; bracelets [jewellery]; bracelets made of embroidered textile [jewellery]; watch bands; charms for key rings; jewellery charms; brooches [jewellery]; alarm clocks; pins [jewellery]; ornamental pins; tie pins; jewellery hat pins; beads for making jewellery; pearls made of ambroid [pressed amber]; busts of precious metal; jewellery rolls; jet, unwrought or semi-wrought; jewellery findings; key rings [split rings with trinket or decorative fob]; retractable key rings; pearls [jewellery]; copper tokens; tie clips; cuff links; clasps for jewellery; badges of precious metal; gold, unwrought or beaten; cloisonne jewellery; works of art of precious metal; jewellery; ivory jewellery; jewellery of yellow amber; iridium; cabochons; preci-

ous stones; semi-precious stones; spun silver [silver wire]; necklaces [jewellery]; split rings of precious metal for keys; rings [jewellery]; boxes of precious metal; presentation boxes for jewellery; watch cases [parts of watches]; clock cases; pendulums [clock- and watchmaking]; medals; locket [jewellery]; precious metals, unwrought or semi-wrought; movements for clocks and watches; clockworks; misbaha [prayer beads]; coins; gold thread [jewellery]; threads of precious metal [jewellery]; silver thread [jewellery]; olivine [gems]; osmium; palladium; platinum [metal]; chronometric instruments; watch springs; crucifixes of precious metal, other than jewellery; crucifixes as jewellery; rhodium; ruthenium; stopwatches; silver, unwrought or beaten; earrings; ingots of precious metals; alloys of precious metal; statues of precious metal; figurines of precious metal; watch glasses; paste jewellery; watch hands; clock hands; ornaments of jet; shoe jewellery; hat jewellery; presentation boxes for watches; chronographs [watches]; chronometers; chronoscopes; chains [jewellery]; watch chains; dials [clock- and watchmaking]; atomic clocks; watches; sundials; clocks and watches, electric; control clocks [master clocks]; clocks; wristwatches; rosaries; jewellery boxes; spinel [precious stones].

16 – Fountain pens; aquarelles; albums; almanacs; document laminators for office use; mimeograph apparatus and machines; atlases; posters; banknotes; banners of paper; paper bows, other than haberdashery or hair decorations; name badges [office requisites]; table linen of paper; tickets; baggage claim check tags of paper; forms, printed; announcement cards [stationery]; glitter for stationery purposes; note books; pads [stationery]; drawing pads; wristbands for the retention of writing instruments; pamphlets; booklets; paper; paper sheets [stationery]; waxed paper; paper for medical examination tables; paper for recording machines; paper for radiograms; papers for painting and calligraphy; electrocardiograph paper; drawer liners of paper, perfumed or not; wood pulp paper; carbon paper; copying paper [stationery]; parchment paper; writing paper; rice paper; luminous paper; toilet paper; wrapping paper; filter paper; japanese paper; blotters; newsletters; rollers for typewriters; house painters' rollers; composing sticks; modelling wax, not for dental purposes; signboards of paper or cardboard; sewing patterns; bunting of paper; newspapers; electrotypes; hectographs; modelling clay; polymer modelling clay; terrestrial globes; drawing sets; engravings; slate pencils; pencil leads; document holders [stationery]; pencil holders; chalk holders; holders for cheque books; holders for stamps [seals]; page holders; name badge holders [office requisites]; diagrams; table runners of paper; engraving plates; writing slates; blackboards; galley racks [printing]; drawing boards; advertisement boards of paper or cardboard; duplicators; punches [office requisites]; cream containers of paper; magazines [periodicals]; money clips; clips for

name badge holders [office requisites]; tags for index cards; pen clips; bookmarks; etching needles; tracing needles for drawing purposes; periodicals; printed publications; paper shredders for office use; graphic representations; credit card imprinters, non-electric; paper creasers [office requisites]; graining combs; drawing instruments; calendars; tracing paper; tracing cloth; tracing patterns; gums [adhesives] for stationery or household purposes; lithographic stones; ink stones [ink reservoirs]; pencils; pencil lead holders; charcoal pencils; pictures; transfers [decalcomanias]; paintings [pictures], framed or unframed; cardboard; wood pulp board [stationery]; hat boxes of cardboard; cards; index cards [stationery]; geographical maps; paper tapes and cards for the recordal of computer programmes; trading cards, other than for games; perforated cards for Jacquard looms; catalogues; spools for inking ribbons; flower-pot covers of paper; paintbrushes; painters' brushes; writing brushes; typewriter keys; glue for stationery or household purposes; isinglass for stationery or household purposes; gluten [glue] for stationery or household purposes; starch paste [adhesive] for stationery or household purposes; printing blocks; books; colouring books; manifolds [stationery]; comic books; drawing pins; cigar bands; envelopes [stationery]; boxes of paper or cardboard; cases for stamps [seals]; paint boxes for use in schools; correcting fluids [office requisites]; printed coupons; stencils [stationery]; French curves; paper ribbons, other than haberdashery or hair decorations; gummed tape [stationery]; typewriter ribbons; barcode ribbons; adhesive bands for stationery or household purposes; correcting tapes [office requisites]; inking ribbons; self-adhesive tapes for stationery or household purposes; square rulers for drawing; drawing rulers; flyers; absorbent sheets of paper or plastic for foodstuff packaging; humidity control sheets of paper or plastic for foodstuff packaging; viscose sheets for wrapping; sheets of reclaimed cellulose for wrapping; plastic bubble packs for wrapping or packaging; steel letters; type [numerals and letters]; lithographs; letter trays; paint trays; architects' models; postage stamps; plastics for modelling; graphic prints; modelling materials; teaching materials [except apparatus]; sealing compounds for stationery purposes; adhesives [glues] for stationery or household purposes; padding materials of paper or cardboard; bookbinding material; packing [cushioning, stuffing] materials of paper or cardboard; packaging material made of starches; filtering materials of paper; table mats of paper; addressing machines; pencil sharpening machines, electric or non-electric; bookbinding apparatus and machines [office equipment]; typewriters, electric or non-electric; franking machines for office use; chalk for lithography; writing chalk; tailors' chalk; marking chalk; spray chalk; bags [envelopes, pouches] of paper or plastics, for packaging; garbage bags of paper or of plastics; plastic bags for pet waste disposal; painters' easels; hand-rests for painters; printing sets, portable [office requisites];

bibs of paper; bibs, sleeved, of paper; stickers [stationery]; fingerstalls for office use; writing cases [stationery]; cords for bookbinding; paper knives [letter openers]; printed sheet music; numbering apparatus; bottle envelopes of paper or cardboard; sealing wafers; covers [stationery]; passport holders; protective covers for books; plastic cling film, extensible, for palletization; embroidery designs [patterns]; handwriting specimens for copying; oleographs; musical greeting cards; greeting cards; postcards; etchings; conical paper bags; paper bags for use in the sterilization of medical instruments; bags for microwave cooking; palettes for painters; ink sticks; pantographs [drawing instruments]; loose-leaf binders; files [office requisites]; folders for papers; papier mâché; pastels [crayons]; modelling paste; pen cases; pen wipers; office perforators; pens [office requisites]; nibs of gold; nibs; steel pens; drawing pens; song books; seals [stamps]; sealing stamps; clipboards; address plates for addressing machines; handkerchiefs of paper; plastic film for wrapping; transparencies [stationery]; desk mats; trays for sorting and counting money; coasters of paper; bookends; stamp stands; mats for beer glasses; stands for pens and pencils; photograph stands; obliterating stamps; inking pads; stamp pads; adhesive tapes for stationery or household purposes; binding strips [bookbinding]; towels of paper; inking sheets for document reproducing machines; inking sheets for duplicators; cloth for bookbinding; gummed cloth for stationery purposes; printers' blankets, not of textile; portraits; paperweights; writing cases [sets]; inkstands; office requisites, except furniture; writing materials; writing instruments; drawing materials; school supplies [stationery]; adhesive tape dispensers [office requisites]; hand labelling appliances; printed matter; lithographic works of art; prospectuses; printed timetables; ledgers [books]; printers' galleys; indexes; paper cutters [office requisites]; rubber erasers; elastic bands for offices; T-squares for drawing; graphic reproductions; retractable reels for name badge holders [office requisites]; penholders; marking pens [stationery]; tissues of paper for removing make-up; paper wipes for cleaning; dental tray covers of paper; place mats of paper; tablemats of paper; tablecloths of paper; paper clasps; document files [stationery]; scrapers [erasers] for offices; paper-clips; clips for offices; erasing products; biological samples for use in microscopy [teaching materials]; histological sections for teaching purposes; figurines of papier mâché; steatite [tailor's chalk]; writing board erasers; composing frames [printing]; sealing wax; arithmetical tables; placards of paper or cardboard; writing or drawing books; fabrics for bookbinding; stationery; pencil sharpeners, electric or non-electric; stencil plates; stencils for decorating food and beverages; cardboard tubes; Indian inks; moisteners [office requisites]; moisteners for gummed surfaces [office requisites]; squares for drawing; chart pointers, non-electronic; bottle wrappers of paper or cardboard; envelope sealing machines

for offices; sealing machines for offices; vignetting apparatus; apparatus for mounting photographs; stapling presses [office requisites]; manuals [handbooks]; paper coffee filters; flags of paper; silver paper; moulds for modelling clays [artists' materials]; photo-engravings; photographs [printed]; stencil cases; canvas for painting; chromolithographs [chromos]; animation cels; compasses for drawing; numbers [type]; artists' watercolour saucers; ink; correcting ink [heliography]; inkwells; blueprints; stencils; erasing shields; balls for ball-point pens; desktop cabinets for stationery [office requisites]; printing type; address stamps; stamps [seals]; shields [paper seals]; prints [engravings]; labels of paper or cardboard; advertising pamphlets; printed advertising boards of paper or cardboard.

40 – Paper finishing; applying finishes to textiles; beer brewing for others; upcycling [waste recycling]; vulcanization [material treatment]; skin dressing; fruit crushing; embroidering; galvanization; electroplating; engraving; decontamination of hazardous materials; air deodorizing; stripping finishes; tanning; metal tempering; freezing of foods; gilding; gold plating; cadmium plating; permanent-press treatment of fabrics; food and drink preservation; consultancy in the field of wine making; food smoking; leather staining; fur dyeing; shoe staining; textile dyeing; cloth dyeing; laminating; lithographic printing; metal casting; fur glossing; tin plating; boilermaking; taxidermy; magnetization; nickel plating; abrasion; paper treating; water treating; woodworking; processing of cinematographic films; leather working; cloth edging; metal treating; fur conditioning; fur mothproofing; waste treatment [transformation]; textile mothproofing; cloth waterproofing; crease-resistant treatment for clothing; cloth fireproofing; textile treating; wool treating; framing of works of art; air freshening; fabric bleaching; air purification; soldering; pasteurizing of food and beverages; clothing alteration; recycling of waste and trash; processing of oil; pattern printing; photographic printing; offset printing; metal plating; printing; burnishing by abrasion; flour milling; dressmaking; providing information relating to material treatment; wine making for others; custom manufacturing of bread; rental of boilers; knitting machine rental; rental of generators; rental of air-conditioning apparatus; rental of space heating apparatus; photographic film development; pottery firing; blacksmithing; custom assembling of materials for others; bookbinding; welding services; glass-blowing; saddlery working; grinding; cloth cutting; sawing of materials; refining services; timber felling and processing; fur satining; silver plating; incineration of waste and trash; laser scribing; warping [looms]; sorting of waste and recyclable material [transformation]; photocomposing services; quilting; planing of materials; fulling of cloth; tinting of car windows; window tinting treatment being surface coating; slaughtering of animals; destruction of waste and trash; cloth pre-shrinking;

custom 3D printing for others; services of a dental technician; cryopreservation services; key cutting; dyeing services; sandblasting services; production of energy; custom tailoring; custom fashioning of fur; photogravure; millworking; chromium plating; colour separation services; silkscreen printing; optical glass grinding; treatment of materials by laser beam; die steel treating; custom manufacturing of stamps, matrices and seals.

42 – Water analysis; computer system analysis; handwriting analysis [graphology]; chemical analysis; rental of meters for the recording of energy consumption; energy auditing; recovery of computer data; business card design; graphic design of promotional materials; interior design; industrial design; graphic arts design; computer virus protection services; oil-field surveys; geological surveys; engineering; installation of computer software; meteorological information; clinical trials; material testing; textile testing; bacteriological research; biological research; geological research; research in the field of environmental protection; cosmetic research; mechanical research; research in the field of welding; research in the field of building construction; research in the field of telecommunications technology; research in the field of physics; chemical research; research and development of new products for others; medical research; scientific and technological research relating to patent mapping; scientific and technological research in the field of natural disasters; scientific research; analysis for oil-field exploitation; underwater exploration; technological research; calibration [measuring]; website design consultancy; computer security consultancy; information technology [IT] consultancy; computer technology consultancy; consultancy in the design and development of computer hardware; architectural consultancy; internet security consultancy; computer software consultancy; data security consultancy; technological consultancy; oil-well testing; quality control; vehicle roadworthiness testing; land surveying; dress designing; updating of computer software; monitoring of computer systems to detect breakdowns; monitoring of computer systems for detecting unauthorized access or data breach; monitoring of computer systems by remote access; electronic monitoring of credit card activity to detect fraud via the internet; electronic monitoring of personally identifying information to detect identity theft via the internet; software as a service [SaaS]; maintenance of computer software; authenticating works of art; design of interior decor; quality evaluation of standing timber; quality evaluation of wool; digitization of documents [scanning]; conversion of data or documents from physical to electronic media; urban planning; providing information relating to computer technology and programming via a website; providing scientific information, advice and consultancy relating to carbon offsetting; providing search engines for the internet; platform as a service [PaaS]; conversion of computer programs and data,

other than physical conversion; conducting technical project studies; computer system design; rental of web servers; computer rental; rental of computer software; unlocking of mobile phones; geological prospecting; oil prospecting; hosting computer sites [web sites]; server hosting; development of computer platforms; construction drafting; computer software design; software development in the framework of software publishing; cloud seeding; consultancy in the field of energy-saving; creating and designing website-based indexes of information for others [information technology services]; creating and maintaining websites for others; computer programming; technical writing; copying of computer programs; cloud computing; architectural services; information technology services provided on an outsourcing basis; chemistry services; packaging design; off-site data backup; telecommunications technology consultancy; scientific laboratory services; user authentication services using single sign-on technology for online software applications; user authentication services using technology for e-commerce transactions; weather forecasting; styling [industrial design]; cartography services; exploration services in the field of the oil, gas and mining industries; data encryption services; electronic data storage; surveying.

(260) AM 2023 117870 A

(800) 1662143

(151) 2021 11 23

(891) 2021 11 23

(731) Obschestvo s ogranichennoy otvetstvennostyu
"Lazerny Centr"

Piskarevsky pr-kt, 25, pom. 132, RU-195176
St. Petersburg, Russian Federation

(540)

TURBOFORMA
ТУРБОФОРМА

(591) Black, white

(531) 28.05

(511)

6 – Aluminium; fittings of metal for compressed air lines; fittings of metal for building; white metal; beacons of metal, non-luminous; vats of metal; beams of metal; joists of metal; bottles [containers] of metal for compressed gas or liquid air; balustrades of metal; preserve tins; reels of metal, non-mechanical, for flexible hoses; swimming pools [structures] of metal; beryllium [glucinium]; arbours [structures] of metal; blooms [metallurgy]; ingots of common metal; anchors; bolts of metal; eye bolts; casks of metal; mooring buoys of metal; barrels of metal; identification bracelets of metal; bronze; bells; bells for animals; letters and numerals of common metal, except type; silos of metal; busts of common metal; vanadium; bird baths [structures] of metal; valves of metal, other than

parts of machines; screws of metal; aviaries [structures] of metal; tungsten; hoppers of metal, non-mechanical; gates of metal; sleeves [metal hardware]; ferrules of metal for handles; signboards of metal; diving boards of metal; loading gauge rods of metal for railway wagons; nuts of metal; galena [ore]; celtium [hafnium]; nails; tacks [nails]; horseshoe nails; shoe pegs of metal; germanium; vice claws of metal; armoured doors of metal; doors of metal; folding doors of metal; metal automatic swing doors; swing doors of metal; chimney pots of metal; towel dispensers, fixed, of metal; door closers of metal, non-electric; prefabricated houses [kits] of metal; memorial plates of metal; chimney shafts of metal; wall plugs of metal; troughs of metal for mixing mortar; packaging containers of metal; containers of metal for storing acids; jalousies of metal; outdoor blinds of metal; iron, unwrought or semi-wrought; iron strip; roof gutters of metal; street gutters of metal; tinsplate; plugs [metal hardware]; iron slabs; door bolts of metal; window fasteners of metal; bolts, flat; clips of metal for sealing bags; binding screws of metal for cables; cramps of metal [crampons]; wheel clamps [boots]; rivets of metal; box fasteners of metal; locks of metal for bags; locks of metal for vehicles; locks of metal, other than electric; padlocks of metal, other than electronic; spring locks; closures of metal for containers; plugs of metal; latches of metal; tension links; couplings of metal for chains; road signs, non-luminous and non-mechanical, of metal; registration plates of metal; signs, non-luminous and non-mechanical, of metal; fences of metal; buckles of common metal [hardware]; bronzes [works of art]; works of art of common metal; ironmongery; indium; cabanas of metal; soundproof booths of metal, transportable; telephone booths of metal; cadmium; paint spraying booths of metal; telfer cables; ropes of metal; jerrycans of metal; horticultural frames of metal; greenhouse frames of metal; framework of metal for building; cornices of metal; skating rinks [structures] of metal; cermets; water-pipe valves of metal; drain traps [valves] of metal; metal cages for wild animals; keys of metal; mooring bollards of metal; cobalt, raw; chill-moulds [foundry]; elbows of metal for pipes; bed casters of metal; furniture casters of metal; manifolds of metal for pipelines; door bells of metal, non-electric; casings of metal for oilwells; pillars of metal for building; chimney cowls of metal; bottle caps of metal; sealing caps of metal; tent pegs of metal; pegs of metal; copper rings; split rings of common metal for keys; rings of metal; door fittings of metal; fittings of metal for windows; brackets of metal for building; buildings of metal; buildings, transportable, of metal; steel buildings; oil drainage containers of metal; containers of metal [storage, transport]; check rails of metal for railways; baskets of metal; door frames of metal; tool boxes of metal, empty; stringers [parts of staircases] of metal; crampions [climbing irons]; taps of metal for casks; tubing of metal; brackets of metal for furniture; roofing of

metal; roofing of metal, incorporating photovoltaic cells; turntables [railways]; screw tops of metal for bottles; manhole covers of metal; hooks [metal hardware]; pitons of metal; pot hooks of metal; hooks of metal for roofing slates; sash fasteners of metal for windows; hooks of metal for clothes rails; bag hangers of metal; clothes hooks of metal; chicken-houses of metal; chests of metal; brass, unwrought or semi-wrought; bands of metal for tying-up purposes; scaffolding of metal; staircases of metal; ladders of metal; limonite; steel sheets; cast steel; traps for wild animals; magnesium; manganese; reinforcing materials, of metal, for concrete; reinforcing materials of metal for machine belts; reinforcing materials of metal for pipes; reinforcing materials of metal for building; railway material of metal; materials of metal for funicular railway permanent ways; building materials of metal; refractory construction materials of metal; masts of metal; steel masts; copper, unwrought or semi-wrought; sheets and plates of metal; common metals, unwrought or semi-wrought; pyrophoric metals; metals in powder form; mouldings of metal for building; molybdenum; metal knockers; pipe muffers of metal; shoe dowels of metal; porches [structures] of metal; bronzes for tombstones; tombs of metal; flashing of metal for building; roof flashing of metal; fish plates [rails]; anvils; anvils [portable]; beak-irons; rope thimbles of metal; ferrules of metal for walking sticks; handcuffs; jets of metal; duckboards of metal; belt stretchers of metal; stretchers for metal bands [tension links]; wire stretchers [tension links]; stretchers for iron bands [tension links]; nickel silver; nickel; niobium; grease nipples; binding thread of metal for agricultural purposes; thread of metal for tying-up purposes; house numbers of metal, non-luminous; braces of metal for handling loads; wall claddings of metal for building; mouldings of metal for cornices; enclosures of metal for tombs; laths of metal; barrel hoops of metal; wall linings of metal for building; palings of metal; crash barriers of metal for roads; furnace fire screens; tree protectors of metal; latticework of metal; door stops of metal; stops of metal; window stops of metal; windows of metal; ironwork for doors; ironwork for windows; tin; shuttering of metal for concrete; filings of metal; posts of metal for power lines; props of metal; branching pipes of metal; monuments of metal; monuments of metal for tombs; metal ramps for use with vehicles; acoustic panels of metal; metal door panels; wainscotting of metal; signalling panels, non-luminous and non-mechanical, of metal; building panels of metal; partitions of metal; lintels of metal; casement windows of metal; strap-hinges of metal; shims; rocket launching platforms of metal; platforms, prefabricated, of metal; wall tiles of metal; floor tiles of metal; tiles of metal for building; anchor plates; paving slabs of metal; grave slabs of metal; tile floorings of metal; slabs of metal for building; lead seals; loading pallets of metal; handling pallets of metal; transport pallets of metal; trays of metal; stakes of metal for

plants or trees; firedogs [andirons]; armour-plating of metal; paving blocks of metal; roof coverings of metal; cladding of metal for building; linings of metal for building; fireplace mantles of metal; steel strip; floors of metal; sills of metal; bathtub grab bars of metal; ceilings of metal; brazing alloys; gold solder; silver solder; collars of metal for fastening pipes; winding spools of metal, non-mechanical, for flexible hoses; floating docks of metal, for mooring boats; aluminium wire; iron wire; wire of common metal; wire of common metal alloys, except fuse wire; barbed wire; copper wire, not insulated; soldering wire of metal; steel wire; springs [metal hardware]; rods of metal for welding; rods of metal for brazing and welding; rods of metal for brazing; peeled metal bars; drawn and polished metal bars; bright steel bars; hot-rolled steel bars; dispensers for dog waste bags, fixed, of metal; window frames of metal; frames of metal for building; crucifixes of common metal, other than jewellery; containers of metal for liquid fuel; containers of metal for compressed gas or liquid air; tanks of metal; floating containers of metal; rails of metal; straps of metal for handling loads; furnace fireguards of metal; gratings of metal; runners of metal for sliding doors; iron ores; ores of metal; chrome ores; door handles of metal; knobs of metal; sheet piles of metal; pigsties of metal; lead, unwrought or semi-wrought; safes [metal or non-metal]; safes, electronic; insect screens of metal; burial vaults of metal; door scrapers; cable joints of metal, non-electric; junctions of metal for pipes; nozzles of metal; anti-friction metal; silver-plated tin alloys; alloys of common metal; sheaf binders of metal; bindings of metal; bottle closures of metal; shutters of metal; steel alloys; steel, unwrought or semi-wrought; tinfoil; statues of common metal; figurines of common metal; cask stands of metal; tombstone stelae of metal; bars for metal railings; stables of metal; advertisement columns of metal; posts of metal; telegraph posts of metal; railway points; steps [ladders] of metal; slings of metal for handling loads; stair treads [steps] of metal; machine belt fasteners of metal; tombstone plaques of metal; nameplates of metal; step stools of metal; tantalum [metal]; greenhouses of metal, transportable; titanium; wire cloth; tombac; mobile boarding stairs of metal for passengers; cables of metal, non-electric; wire rope; pipework of metal; penstock pipes of metal; water-pipes of metal; gutter pipes of metal; ducts of metal for ventilating and air-conditioning installations; drain pipes of metal; chimneys of metal; pipes of metal; ducts of metal, for central heating installations; steel pipes; automatic turnstiles of metal; angle irons of metal; tinsplate packings; door fasteners of metal; bicycle parking installations of metal; window closers of metal, non-electric; door openers of metal, non-electric; window openers of metal, non-electric; wind-driven bird-repelling devices made of metal; tungsten iron; molybdenum iron; silicon iron; titanium iron; chrome iron; figures of common metal; flagpoles [structures] of metal; hand-

held flagpoles of metal; flanges of metal [collars]; weather- or wind-vanes of metal; aluminium foil; metals in foil or powder form for 3D printers; foils of metal for wrapping and packaging; ice moulds of metal; foundry moulds of metal; fittings of metal for coffins; fittings of metal for beds; fittings of metal for furniture; clips of metal for cables and pipes; chromium; cattle chains; chains of metal; safety chains of metal; zinc; zirconium; pantiles of metal; roofing tiles of metal; cast iron, unwrought or semi-wrought; washers of metal; balls of steel; hinges of metal; poles of metal; safety cashboxes; pulleys of metal, other than for machines; window pulleys of metal; railway sleepers of metal; window casement bolts; cotter pins of metal; spurs; pins [hardware]; roller blinds of steel; latch bars of metal; badges of metal for vehicles; labels of metal; lock bolts; cashboxes [metal or non-metal]; tool chests of metal, empty; boxes of common metal; letter boxes of metal.

7 – Vending machines; 3D printers; welding machines, electric; soldering apparatus, gas-operated; vulcanization apparatus; acetylene cleaning apparatus; high pressure washers; apparatus for drawing up beer under pressure; apparatus for aerating water; apparatus for aerating beverages; electrical apparatus for sealing plastics [packaging]; electric arc cutting apparatus; electric arc welding apparatus; electric welding apparatus; inking apparatus for printing machines; electric soldering apparatus; fittings for engine boilers; expansion tanks [parts of machines]; drums [parts of machines]; reels, mechanical, for flexible hoses; brake shoes, other than for vehicles; concrete mixers [machines]; reels [parts of machines]; bobbins for weaving looms; harrows; journal boxes [parts of machines]; bulldozers; hoppers [mechanical discharging]; mine borers; railway wagon lifts; rolling mill cylinders; crank shafts; printing rollers for machines; camshafts for vehicle engines; transmission shafts, other than for land vehicles; valves [parts of machines]; fans for motors and engines; saw benches [parts of machines]; winnowers; vibrators [machines] for industrial use; bearings [parts of machines]; water heaters being parts of machines; bellows [parts of machines]; agitators; drilling rigs, floating or non-floating; lawnmowers [machines]; card clothing [parts of carding machines]; nail extractors, electric; emergency power generators; alternators; dynamos; bicycle dynamos; current generators; generators of electricity; hydraulic controls for machines, motors and engines; mufflers for motors and engines; drilling heads [parts of machines]; drilling bits [parts of machines]; cylinder heads for engines; soldering blow pipes, gas-operated; gas-operated blow torches; raking machines; stalk separators [machines]; sieves [machines or parts of machines]; mud catchers and collectors [machines]; tarring machines; rubber tracks being parts of crawlers on mining machines; rubber tracks being parts of crawlers on snow ploughs; rubber tracks being parts of crawlers on loading-unloading machines and appara-

tus; rubber tracks being parts of crawlers on agricultural machines; rubber tracks being parts of crawlers on construction machines; hydraulic engines and motors; aeronautical engines; aeroplane engines; engines for air cushion vehicles; compressed air engines; jet engines, other than for land vehicles; engines for boats; driving motors, other than for land vehicles; motors, other than for land vehicles; propulsion mechanisms, other than for land vehicles; de-aerators for feedwater; disintegrators; tympan [parts of printing presses]; holding devices for machine tools; turf removing ploughs; pump diaphragms; hydraulic door closers; pneumatic door closers; electric door closers; chisels for machines; jacks [machines]; rack and pinion jacks; moving walkways; electric hand drills; crushers for kitchen use, electric; flues for engine boilers; reapers; reapers and binders; millstones; rakes for raking machines; shredders [machines] for industrial use; kitchen grinders, electric; injectors for engines; incubators for eggs; tools [parts of machines]; ski edge sharpening tools, electric; hand-held tools, other than hand-operated; agricultural implements, other than hand-operated; air condensers; control cables for machines, engines or motors; capstans; calenders; rotary steam presses, portable, for fabrics; ditchers [ploughs]; carburettors; sliders for knitting machines; crankcases for machines, motors and engines; steam-rollers; pressure valves [parts of machines]; clack valves [parts of machines]; pressure reducers [parts of machines]; cowlings [parts of machines]; machine wheels; freewheels, other than for land vehicles; scale collectors for machine boilers; lasts for shoes [parts of machines]; brake pads, other than for vehicles; piston segments; grease rings [parts of machines]; reapers and threshers; coal-cutting machines; compressors [machines]; air pumps [garage installations]; compressors for refrigerators; conveyors [machines]; belt conveyors; converters for steelworks; steam condensers [parts of machines]; aerocondensers; diggers [machines]; rams [machines]; thermic lances [machines]; mechanized livestock feeders; boxes for matrices [printing]; gear boxes, other than for land vehicles; grease boxes [parts of machines]; housings [parts of machines]; harvesting machines; steam engine boilers; coffee grinders, other than hand-operated; taps [parts of machines, engines or motors]; cranes [lifting and hoisting apparatus]; roller bridges; mobile cranes; water separators; spray guns for paint; cranks [parts of machines]; potters' wheels; grindstones [parts of machines]; cultivators [machines]; soldering lamps; winches; ploughshares; belts for conveyors; lubricators [parts of machines]; igniting magnetos; handling machines, automatic [manipulators]; churns; matrices for use in printing; machine fly-wheels; shearing machines for animals; blowing machines; knitting machines; galvanizing machines; bending machines; ironing machines; mineworking machines; blowing machines for the compression, exhaustion and transport of gases; blowing machines for the compression, sucking

and carrying of grain; net hauling machines [fishing]; electroplating machines; bottle sealing machines; sealing machines for industrial purposes; embossing machines; engraving machines; finishing machines; crushing machines; waste disposal units; blade sharpening [stropping] machines; earth moving machines; cord making machines; lace making machines; butter machines; cigarette machines for industrial purposes; sausage making machines; stereotype machines; hosiery looms; dyeing machines; bottle washing machines; dishwashers; bottle filling machines; cheese slicers, electric; racket stringing machines; leather-working machines; dairy machines; glass-working machines; tobacco processing machines; grain husking machines; painting machines; oil refining machines; peeling machines; machines for processing plastics; ore treating machines; printing machines for use on sheet metal; brewing machines; whitewashing machines; road sweeping machines, self-propelled; leather paring machines; bitumen making machines; papermaking machines; pasta making machines, electric; machines for the production of sugar; weeding machines; sifting machines; cinder sifters [machines]; puddling machines; notchers [machine tools]; bread cutting machines; road making machines; railroad constructing machines; machines for the textile industry; rammers [machines]; rail-laying machines; bottle capping machines; bottle stoppering machines; waste compacting machines; vegetable peelers, electric; die-stamping machines; stamping machines; darning machines; milking machines; drainage machines; wrapping machines; grain separators; bookbinding apparatus and machines for industrial purposes; machines and apparatus for cleaning, electric; machines and apparatus for carpet shampooing, electric; machines and apparatus for polishing [electric]; sizing machines; punching machines; riveting machines; kitchen machines, electric; foundry machines; smoothing presses; fleshing machines; flour mill machines; type-setting machines [printing]; hemming machines; grating machines for vegetables; braiding machines; rinsing machines; wringing machines for laundry; cutting machines; steam engines; printing machines; rotary printing presses; industrial inkjet printing machines; compressed air machines; tilling machines for agricultural purposes; trimming machines; spinning machines; filling machines; friezing machines; cutters [machines]; satinizing machines; agricultural machines; mixing machines; sorting machines for industry; stitching machines; washing machines [laundry]; coin-operated washing machines; clippers [machines]; spinning frames; looms; kneading machines; typographic machines; type-setting machines [photocomposition]; beating machines; beaters, electric; packing machines; packaging machines; filtering machines; moulding machines; carding machines; sewing machines; typecasting machines; electromechanical machines for chemical industry; labellers [machines]; mills [machines]; mills for household purposes, other than hand-operated; pe-

pper mills, other than hand-operated; centrifugal mills; machine wheelwork; feeders [parts of machines]; forge blowers; mixers [machines]; blenders, electric, for household purposes; vacuum cleaner bags; threshing machines; pneumatic hammers; hammers [parts of machines]; tilt hammers; power hammers; reeling apparatus, mechanical; motorized cultivators; motors for boats; clutches, other than for land vehicles; meat choppers [machines]; superchargers; brake linings, other than for vehicles; guides for machines; suction nozzles for vacuum cleaners; vacuum cleaner attachments for disseminating perfumes and disinfectants; pumps [machines]; pumps [parts of machines, engines or motors]; aerating pumps for aquaria; vacuum pumps [machines]; compressed air pumps; pumps for heating installations; beer pumps; pumps for counter-current swimming; lubricating pumps; self-regulating fuel pumps; fuel dispensing pumps for service stations; centrifugal pumps; hydrogen dispensing pumps for service stations; blades [parts of machines]; tin openers, electric; knives for mowing machines; chaff cutter blades; knives, electric; shears, electric; scissors, electric; vegetable spiralizers, electric; engine mounts, other than for land vehicles; bearing brackets for machines; pulverisers [machines]; axles for machines; steam traps; chucks [parts of machines]; drill chucks [parts of machines]; exhaust manifold for engines; soldering irons, gas-operated; soldering irons, electric; superheaters; gears, other than for land vehicles; reduction gears, other than for land vehicles; drilling machines; saws [machines]; chain saws; guns [tools using explosives]; glue guns, electric; compressed air guns for the extrusion of mastics; carburetter feeders; feeding apparatus for engine boilers; loading ramps; ploughs; pneumatic transporters; pneumatic controls for machines, motors and engines; hangers [parts of machines]; anti-friction bearings for machines; roller bearings; self-oiling bearings; bearings for transmission shafts; ball-bearings; elevators [lifts]; hoists; lifts, other than ski-lifts; pulleys; saw blades [parts of machines]; pistons [parts of machines or engines]; shock absorber plungers [parts of machines]; pistons for engines; pistons for cylinders; catalytic converters; torque converters, other than for land vehicles; fuel conversion apparatus for internal combustion engines; presses [machines for industrial purposes]; wine presses; fruit presses, electric, for household purposes; fodder presses; basket presses; printing presses; typographic presses; swaging machines; pedal drives for sewing machines; cleaning appliances utilizing steam; food processors, electric; springs [parts of machines]; spinning wheels; punches for punching machines; vacuum cleaners; tambours for embroidery machines; radiators [cooling] for motors and engines; sewage pulverizers; air brushes for applying colour; regulators [parts of machines]; pressure regulators [parts of machines]; speed governors for machines, engines and motors; knives [parts of machines]; cutting blow pipes, gas-operated; blade holders

[parts of machines]; loom shafts; gears for weaving looms; belts for machines; elevator belts; fan belts for motors and engines; dynamo belts; belts for motors and engines; adhesive bands for pulleys; industrial robots; 3D printing pens; kick starters for motorcycles; joysticks being parts of machines, other than for game machines; stuffing boxes [parts of machines]; paper feeders [printing]; whisks, electric, for household purposes; sparking plugs for internal combustion engines; glow plugs for Diesel engines; brake segments, other than for vehicles; tedding machines; steam/oil separators; cream/milk separators; ball rings for bearings; sowers [machines]; exhausts for motors and engines; pigs for cleaning pipes; snow ploughs; sheaf-binding machines; shaft couplings [machines]; joints [parts of engines]; juice extractors, electric; straw [chaff] cutters; suction cups for milking machines; stands for machines; machine tools; die-cutting and tapping machines; woodworking machines; sharpening machines; bicycle assembling machines; mortising machines; stone-working machines; metalworking machines; threading machines; straightening machines; planing machines; lathes [machine tools]; milling machines; trueing machines; metal drawing machines; rolling mills; starters for motors and engines; stators [parts of machines]; glaziers' diamonds [parts of machines]; tables for machines; derricks; slide rests [parts of machines]; spin dryers [not heated]; couplings, other than for land vehicles; heat exchangers [parts of machines]; transmissions for machines; transmissions, other than for land vehicles; boiler tubes [parts of machines]; wind turbines; hydraulic turbines; turbines, other than for land vehicles; turbocompressors; central vacuum cleaning installations; suction machines for industrial purposes; machines for the mineralization of drinking water; washing installations for vehicles; degreasers [machines]; dust exhausting installations for cleaning purposes; sifting installations; pneumatic tube conveyors; dust removing installations for cleaning purposes; condensing installations; floating production storage and offloading [FPSO] units; pneumatic waste oil drainers; lifting apparatus; air suction machines; dividing machines; igniting devices for internal combustion engines; window closers, hydraulic; window closers, pneumatic; window closers, electric; washing apparatus; binding apparatus for hay; haulage apparatus [mining]; door openers, hydraulic; door openers, pneumatic; door openers, electric; window openers, hydraulic; window openers, pneumatic; window openers, electric; curtain drawing devices, electrically operated; adhesive tape dispensers [machines]; anti-pollution devices for motors and engines; beverage preparation machines, electromechanical; food preparation machines, electromechanical; elevator operating apparatus; control mechanisms for machines, engines or motors; shoe polishers, electric; machines and apparatus for wax-polishing, electric; air cushion devices for moving loads; handling apparatus for loading and unloading; eleva-

ting apparatus; aprons [parts of machines]; filter presses; filters for cleaning cooling air, for engines; filters being parts of machines or engines; moulds [parts of machines]; printing plates; journals [parts of machines]; centrifugal machines; elevator chains [parts of machines]; driving chains, other than for land vehicles; transmission chains, other than for land vehicles; cylinders for motors and engines; cylinders for machines; printing cylinders; pneumatic jacks; shuttles [parts of machines]; universal joints [Cardan joints]; engine rods; connecting rods for machines; steam mops; pulleys [parts of machines]; vacuum cleaner hoses; screwdrivers, electric; brushes [parts of machines]; dynamo brushes; brushes for vacuum cleaners; brushes, electrically operated [parts of machines]; carbon brushes [electricity]; ejectors; robotic exoskeleton suits, other than for medical purposes; fuel economisers for motors and engines; excavators; shovels, mechanical; agricultural elevators; motors, electric, other than for land vehicles; electrodes for welding machines; electric hammers; parquet wax-polishers, electric; cartridges for filtering machines; moving staircases [escalators]; automatic grapnels for marine purposes; metal cutting machines; machines using laser radiation.

8 – Glaziers' diamonds [parts of hand tools]; apparatus for tattooing; laser hair removal apparatus, other than for medical purposes; razors, electric or non-electric; sharpening steels; scythe stones; gimlets [hand tools]; borers; augers [hand tools]; carpenters' augers; pickhammers; carving forks; table forks; weeding forks [hand tools]; agricultural forks [hand tools]; lawn clippers [hand instruments]; harpoons; harpoons for fishing; nail extractors, hand-operated; rakes [hand tools]; sand trap rakes; cutter bars [hand tools]; whetstone holders; priming irons [hand tools]; sculptors' chisels; lifting jacks, hand-operated; hand drills, hand-operated; truncheons; clamps for carpenters or coopers; spades [hand tools]; rabbeting planes; chisels; engraving needles; tattoo needles; cutlery; edge tools [hand tools]; garden tools, hand-operated; abrading instruments [hand instruments]; numbering punches; goffering irons; implements for decanting liquids [hand tools]; depilation appliances, electric and non-electric; sharpening instruments; blade sharpening instruments; livestock marking tools; nail clippers, electric or non-electric; oyster openers; polishing irons [glazing tools]; ear-piercing apparatus; tube cutting instruments; wire strippers [hand tools]; riveters [hand tools]; expanders [hand tools]; cutting tools; cutting tools [hand tools]; ski edge sharpening tools, hand-operated; hand tools, hand-operated; sterile body piercing instruments; stamping-out tools [hand tools]; picks [hand tools]; sharpening stones; punch rings [knuckle dusters]; trowels; centre punches [hand tools]; daggers; pickaxes; mallets [hand instruments]; pliers; punch pliers [hand tools]; blades [weapons]; annular screw plates; spanners [hand tools]; tap wrenches; ladles [hand tools]; foundry ladles [hand tools];

meat claws; breast drills; lasts [shoemakers' hand tools]; scythe rings; instruments for punching tickets; diggers [hand tools]; rams [hand tools]; scythes; hainault scythes; fire irons; emery grinding wheels; grindstones [hand tools]; sledgehammers; thistle extractors [hand tools]; nail nippers; tree pruners; nail drawers [hand tools]; ice picks; blades [hand tools]; razor blades; blades for planes; plane irons; jig-saws; spoons; table knives, forks and spoons for babies; table knives, forks and spoons of plastic; crow bars; trowels [gardening]; shovels [hand tools]; palette knives; machetes; beard clippers; hair clippers for personal use, electric and non-electric; hair clippers for animals [hand instruments]; taps [hand tools]; fireplace bellows [hand tools]; swords; hammers [hand tools]; emergency hammers; fullers [hand tools]; stone hammers; masons' hammers; riveting hammers [hand tools]; mattocks; ditchers [hand tools]; mincing knives [hand tools]; manicure sets; manicure sets, electric; pedicure sets; needle files; bits [hand tools]; files [tools]; emery files; air pumps, hand-operated; hand pumps; shaving cases; knives; cheese slicers, non-electric; fruit segmenters; egg slicers, non-electric; vegetable knives; pizza slicers; scaling knives; hobby knives [scalpels]; fruit corers; moulding irons; ceramic knives; tin openers, non-electric; farriers' knives; budding knives; hunting knives; penknives; grafting tools [hand tools]; carving knives; braiders [hand tools]; box cutters; bill-hooks; paring knives; cleavers; scissors; wick trimmers [scissors]; shears; cattle shearers; border shears; pruning shears; shearers [hand instruments]; sword scabbards; kitchen mandolines; vegetable slicers, hand-operated; vegetable spiralizers, hand-operated; vegetable peelers, hand-operated; agricultural implements, hand-operated; side arms, other than firearms; stropping instruments; screwdrivers, non-electric; sabres; stirring sticks for mixing paint; reamer sockets; drill holders [hand tools]; perforating tools [hand tools]; rammers [hand tools]; emery boards; nail files; nail files, electric; saws [hand tools]; bow saws; tweezers; hair-removing tweezers; guns [hand tools]; non-electric caulking guns; guns, hand-operated, for the extrusion of mastics; dies [hand tools]; fruit pickers [hand tools]; saw blades [parts of hand tools]; shear blades; tool belts [holders]; hair braiders, electric; table cutlery [knives, forks and spoons]; crimping irons; hand implements for hair curling; vegetable choppers; money scoops; instruments and tools for skinning animals; fingernail polishers, electric or non-electric; hackles [hand tools]; pin punches; nail punches; fish tapes [hand tools]; punches [hand tools]; insecticide vaporizers [hand tools]; syringes for spraying insecticides; reamers; frames for handsaws; saw holders; rasps [hand tools]; paring irons [hand tools]; graving tools [hand tools]; milling cutters [hand tools]; razor strops; leather strops; planes; scythe handles; knife handles; handles for hand-operated hand tools; levers; marline spikes; bits [parts of hand tools]; hollowing bits [parts of hand tools];

pruning scissors; silver plate [knives, forks and spoons]; pruning knives; sickles; drawing knives; scrapers [hand tools]; scrapers for skis; mortise chisels; caulking irons; gouges [hand tools]; mortars for pounding [hand tools]; mitre boxes [hand tools]; branding irons; hatchets; adzes [tools]; vices; bench vices [hand implements]; hoop cutters [hand tools]; axes; holing axes; fulling tools [hand tools]; earth rammers [hand tools]; tube cutters [hand tools]; hoes [hand tools]; squares [hand tools]; extension pieces for braces for screw taps; embossers [hand tools]; apparatus for destroying plant parasites, hand-operated; metal wire stretchers [hand tools]; metal band stretchers [hand tools]; flat irons; irons [non-electric hand tools]; razor cases; ratchets [hand tools]; scraping tools [hand tools]; awls; choppers [knives]; spatulas [hand tools]; spatulas for use by artists; wine bottle foil cutters, hand-operated; bayonets; curling tongs; cuticle tweezers; eyelash curlers; metal-cutting saws; metal-cutting scissors [tin shears].

9 – 3D spectacles; DVD players; ticket dispensers; juke boxes, musical; fire engines; answering machines; electrical adapters; batteries for electronic cigarettes; accumulators, electric; batteries, electric, for vehicles; accelerometers; actinometers; alidades; altimeters; ear pads for earphones; ammeters; nanoparticle size analysers; anemometers; anodes; aerials; anticathodes; apertometers [optics]; high-frequency apparatus; testing apparatus not for medical purposes; remote control apparatus; electro-dynamic apparatus for the remote control of railway points; electro-dynamic apparatus for the remote control of signals; monitoring apparatus, other than for medical purposes; sound recording apparatus; Global Positioning System [GPS] apparatus; distillation apparatus for scientific purposes; diffraction apparatus [microscopy]; air analysis apparatus; apparatus to check franking; sound transmitting apparatus; apparatus for fermentation [laboratory apparatus]; breathing apparatus for underwater swimming; breathing apparatus, except for artificial respiration; apparatus and installations for the production of X-rays, not for medical purposes; cash registers; electric apparatus for commutation; magnetic resonance imaging [MRI] apparatus, not for medical purposes; intercommunication apparatus; stills for laboratory experiments; projection apparatus; fire extinguishing apparatus; radiological apparatus for industrial purposes; X-ray apparatus not for medical purposes; blueprint apparatus; flashing lights [luminous signals]; stereoscopic apparatus; telephone apparatus; facsimile machines; phototelegraphy apparatus; igniting apparatus, electric, for igniting at a distance; acid hydrometers; salinometers; acidimeters for batteries; aerometers; beacons, luminous; battery jars; automated teller machines [ATM]; barometers; anode batteries; galvanic batteries; ignition batteries; solar batteries; solar panels for the production of electricity; batteries, electric; balances [steelyards]; betatrons; binoculars; biochips; electronic tags for goods; lens

hoods; magnetic tape units for computers; computer memory devices; fire hose nozzles; encoded identification bracelets, magnetic; connected bracelets [measuring instruments]; safety tarpaulins; electronic key fobs being remote control apparatus; bullet-proof clothing; signalling buoys; life buoys; marking buoys; directional compasses; vacuum gauges; electrolyzers; variometers; verniers; scales; baby scales; bathroom scales; letter scales; weighbridges; precision balances; scales with body mass analysers; levelling staffs [surveying instruments]; camcorders; video baby monitors; video cassettes; video projectors; video telephones; video screens; viewfinders, photographic; electric plugs; micrometer screws for optical instruments; viscosimeters; circuit closers; wavemeters; voltmeters; mechanical signs; signs, luminous; switchboxes [electricity]; current rectifiers; gas testing instruments; gasometers [measuring instruments]; galvanometers; hands-free kits for telephones; heliographic apparatus; hygrometers; hydrometers; weights; peepholes [magnifying lenses] for doors; hairdressing training heads [teaching apparatus]; holograms; plotters; loudspeakers; sounding leads; plumb bobs; range finders; parking sensors for vehicles; piezoelectric sensors; densimeters; densitometers; detectors; smoke detectors; infrared detectors; counterfeit coin detectors; joysticks for use with computers, other than for video games; transparencies [photography]; slide projectors; diaphragms [photography]; dictating machines; dynamometers; light-emitting diodes [LED]; quantum dot light-emitting diodes [QLED]; organic light-emitting diodes [OLED]; floppy disks; phonograph records; disks, magnetic; optical discs; circular slide rules; disk drives for computers; juke boxes for computers; wearable video display monitors; electronic numeric displays; DNA chips; electronic interactive whiteboards; electronic notice boards; electric wire harnesses for automobiles; bullet-proof vests; life jackets; reflective safety vests; identification threads for electric wires; nose clips for divers and swimmers; padlocks, electronic; locks, electric; bells [warning devices]; alarm bells, electric; electric door bells; signal bells; acoustic conduits; mirrors for inspecting work; road signs, luminous or mechanical; downloadable emoticons for mobile phones; marine depth finders; probes for scientific purposes; buzzers; needles for surveying compasses; needles for record players; eyewear; reflective articles for wear, for the prevention of accidents; measures; pressure measuring apparatus; simulators for the steering and control of vehicles; inverters [electricity]; pressure indicators; automatic indicators of low pressure in vehicle tyres; temperature indicators; incubators for bacteria culture; measuring instruments; cosmographic instruments; mathematical instruments; levelling instruments; instruments containing eyepieces; surveying instruments; azimuth instruments; interfaces for computers; audio interfaces; ionization apparatus not for the treatment of air or water; satellite finder meters; spark-guards; coaxial

cables; fibre optic cables; cables, electric; calipers; slide calipers; screw-tapping gauges; calorimeters; calculating machines; pocket calculators; decompression chambers; rearview cameras for vehicles; cinematographic cameras; thermal imaging cameras; mouth guards for sports; life-saving capsules for natural disasters; electronic pens [visual display units]; holders for electric coils; biometric identity cards; identity cards, magnetic; video game cartridges; toner cartridges, unfilled, for printers and photocopiers; ink cartridges, unfilled, for printers and photocopiers; memory cards for video game machines; encoded magnetic cards; riding helmets; protective helmets; carriers for dark plates [photography]; cathodes; spools [photography]; choking coils [impedance]; coils, electric; electromagnetic coils; cinematographic film, exposed; computer keyboards; solenoid valves [electromagnetic switches]; wire connectors [electricity]; thin client computers; downloadable cryptographic keys for receiving and spending cryptocurrency; encoded key cards; electronic book readers; electronic agendas; push buttons for bells; mouse pads; magnetic encoders; visors for helmets; collectors, electric; calibrating rings; smart rings; ring sizers; protective suits for aviators; commutators; compact discs [audio-video]; compact discs [read-only memory]; comparators; marine compasses; computers; laptop computers; tablet computers; notebook computers; wearable computers; condensers [capacitors]; contacts, electric; wind socks for indicating wind direction; traffic cones; branch boxes [electricity]; distribution boxes [electricity]; junction boxes [electricity]; connectors [electricity]; battery boxes; cabinets for loudspeakers; diving suits; downloadable e-wallets; galena crystals [detectors]; covers for electric outlets; logs [measuring instruments]; lasers, not for medical purposes; lactodensimeters; lactometers; vacuum tubes [radio]; darkroom lamps [photography]; thermionic valves; amplifying tubes; flashlights [photography]; head cleaning tapes [recording]; magnetic tapes; videotapes; surveying chains; fire escapes; rulers [measuring instruments]; square rulers for measuring; slide-rules; contact lenses; correcting lenses [optics]; optical lenses; optical condensers; sounding lines; electricity conduits; measuring spoons; magnifying glasses [optics]; thread counters; magnets; decorative magnets; close-up lenses; crash test dummies; resuscitation mannequins [teaching apparatus]; mouse [computer peripheral]; trackballs [computer peripherals]; pressure gauges; security tokens [encryption devices]; divers' masks; solderers' helmets; protective masks; respiratory masks, other than for artificial respiration; materials for electricity mains [wires, cables]; voting machines; money counting and sorting machines; material testing instruments and machines; furniture especially made for laboratories; megaphones; portable media players; diaphragms [acoustics]; diaphragms for scientific apparatus; metal detectors for industrial or military purposes; digital weather stations; metronomes; rules [measuring ins-

truments]; carpenters' rules; dressmakers' measures; mechanisms for coin-operated apparatus; mechanisms for counter-operated apparatus; coin-operated mechanisms for television sets; shutter releases [photography]; micrometers; microprocessors; microscopes; microtomes; microphones; audio mixers; modems; lightning conductors; monitors [computer hardware]; monitors [computer programs]; selfie sticks [hand-held monopods]; terminals [electricity]; junction sleeves for electric cables; teeth protectors; temperature indicator labels, not for medical purposes; knee-pads for workers; ear pads for headphones; headphones; earpieces for remote communication; surveyors' levels; sound recording carriers; magnetic data media; optical data media; electronic sheet music, downloadable; laptops; recorded computer gaming software for gambling; computer software, recorded; sheaths for electric cables; identification sheaths for electric wires; weighing machines; computer hardware; punched card machines for offices; life saving equipment; shoes for protection against accidents, irradiation and fire; objectives [lenses] [optics]; lenses for astrophotography; selfie lenses; egg-candlers; fire extinguishers; rescue laser signalling flares; electrified fences; limiters [electricity]; clothing for protection against accidents, irradiation and fire; clothing for protection against fire; asbestos clothing for protection against fire; clothing especially made for laboratories; survival blankets; ozonisers [ozonators]; octants; eyepieces; ohmmeters; wrist rests for use with computers; spectacle frames; oscillographs; plumb lines; mirrors [optics]; spectacles; sunglasses; goggles for sports; electronic collars to train animals; finger sizers; signalling panels, luminous or mechanical; biometric passports; wah-wah pedals; radio pagers; pince-nez; electronic pocket translators; transmitters [telecommunication]; telephone transmitters; transmitters of electronic signals; switches, electric; periscopes; data gloves; gloves for divers; gloves for protection against accidents; gloves for protection against X-rays for industrial purposes; asbestos gloves for protection against accidents; furnaces for laboratory use; droppers for measuring, other than for medical or household purposes; laboratory pipettes; pyrometers; planimeters; plane tables [surveying instruments]; plates for batteries; computer software platforms, recorded or downloadable; wafers for integrated circuits; printed circuit boards; compact disc players; cassette players; protective films adapted for computer screens; protective films adapted for smartphones; sound recording strips; X-ray films, exposed; films, exposed; life-saving rafts; animal signalling rattles for directing livestock; laboratory trays; digital signs; stands adapted for laptops; semi-conductors; polarimeters; personal digital assistants [PDAs]; fire pumps; measuring glassware; weight belts for divers; life belts; fuses; circuit breakers; converters, electric; telerupters; food analysis apparatus; diagnostic apparatus, not for medical purposes; distance recording apparatus; distance measu-

ring apparatus; speed measuring apparatus [photography]; appliances for measuring the thickness of leather; apparatus for measuring the thickness of skins; speed checking apparatus for vehicles; teaching apparatus; time recording apparatus; apparatus and instruments for astronomy; surveying apparatus and instruments; weighing apparatus and instruments; nautical apparatus and instruments; navigational instruments; optical apparatus and instruments; apparatus and instruments for physics; chemistry apparatus and instruments; measuring apparatus; measuring devices, electric; boiler control instruments; meteorological instruments; naval signalling apparatus; observation instruments; navigation apparatus for vehicles [on-board computers]; satellite navigational apparatus; regulating apparatus, electric; telecommunication apparatus in the form of jewellery; precision measuring apparatus; audio- and video-receivers; prisms [optics]; computer software applications, downloadable; ticket printers; printers for use with computers; hemline markers; retorts' stands; apparatus for changing record player needles; drainers for use in photography; cleaning apparatus for phonograph records; fire beaters; sighting telescopes for firearms; telescopic sights for artillery; test tubes; pressure indicator plugs for valves; magnetic wires; telegraph wires; telephone wires; wires, electric; conductors, electric; copper wire, insulated; fuse wire; computer programs, recorded; computer game software, downloadable; computer programs, downloadable; computer operating programs, recorded; computer screen saver software, recorded or downloadable; record players; processors [central processing units]; rods for water diviners; electronic publications, downloadable; distribution consoles [electricity]; control panels [electricity]; radar apparatus; masts for wireless aerials; transmitting sets [telecommunication]; radios; vehicle radios; sprinkler systems for fire protection; frames for photographic transparencies; screens for photoengraving; flowmeters; walkie-talkies; voltage surge protectors; voltage regulators for vehicles; stage lighting regulators; light dimmers [regulators], electric; speed regulators for record players; cell switches [electricity]; washing trays [photography]; marking gauges [joinery]; T-squares for measuring; time switches, automatic; relays, electric; safety restraints, other than for vehicle seats and sports equipment; body harnesses for support when lifting loads; X-ray photographs, other than for medical purposes; rheostats; respirators for filtering air; retorts; refractometers; refractors; grids for batteries; security surveillance robots; laboratory robots; teaching robots; telepresence robots; humanoid robots with artificial intelligence; electric sockets; height measuring instruments; speaking tubes; horns for loudspeakers; subwoofers; saccharometers; optical fibres [light conducting filaments]; traffic-light apparatus [signalling devices]; dog whistles; signalling whistles; sports whistles; sextants; inductors [electricity]; safety nets; nets for protection against accidents;

fire alarms; signals, luminous or mechanical; rescue flares, non-explosive and non-pyrotechnic; sirens; electronic access control systems for interlocking doors; scanners [data processing equipment]; hand-held electronic dictionaries; integrated circuit cards [smart cards]; smartglasses; smartphones; smartwatches; connections for electric lines; couplings, electric; sonars; sound locating instruments; lighting ballasts; resistances, electric; spectrograph apparatus; spectroscopes; speed indicators; alcoholmeters; satellites for scientific purposes; protection devices for personal use against accidents; audiovisual teaching apparatus; charging stations for electric vehicles; radiotelegraphy sets; radiotelephony sets; spectacle lenses; anti-glare glasses; optical glass; personal stereos; stereoscopes; stands for photographic apparatus; stroboscopes; fire boats; sulfimeters; bags adapted for laptops; drying racks [photography]; spherometers; integrated circuits; printed circuits; counters; parking meters; mileage recorders for vehicles; revolution counters; abacuses; egg timers [sandglasses]; taximeters; ear plugs for divers; tachometers; television apparatus; telegraphs [apparatus]; telescopes; teleprompters; teleprinters; cordless telephones; mobile telephones; theodolites; credit card terminals; interactive touch screen terminals; thermo-hygrometers; thermometers, not for medical purposes; thermostats; thermostats for vehicles; climate control digital thermostats; crucibles [laboratory]; tone arms for record players; totalizers; transistors [electronic]; transponders; protractors [measuring instruments]; transformers [electricity]; step-up transformers; resuscitation training simulators; vehicle breakdown warning triangles; triodes; starter cables for motors; discharge tubes, electric, other than for lighting; capillary tubes; neon signs; Pitot tubes; X-ray tubes not for medical purposes; telephone receivers; headgear being protective helmets; squares for measuring; gauges; quantity indicators; petrol gauges; water level indicators; electric loss indicators; light-emitting electronic pointers; slope indicators; levels [instruments for determining the horizontal]; mercury levels; spirit levels; urinometers; amplifiers; particle accelerators; electric installations for the remote control of industrial operations; baby monitors; steering apparatus, automatic, for vehicles; balancing apparatus; video recorders; sound reproduction apparatus; invoicing machines; tape recorders; protection devices against X-rays, not for medical purposes; railway traffic safety appliances; data processing apparatus; oxygen transvasing apparatus; theft prevention installations, electric; devices for the projection of virtual keyboards; film cutting apparatus; drying apparatus for photographic prints; optical character readers; centering apparatus for photographic transparencies; dosage dispensers; battery chargers; chargers for electric accumulators; chargers for electronic cigarettes; acoustic alarms; sounding apparatus and machines; apparatus for editing cinematographic film; cathodic anti-corrosion apparatus; coup-

lers [data processing equipment]; wearable activity trackers; anti-theft warning apparatus; computer peripheral devices; anti-interference devices [electricity]; demagnetizing apparatus for magnetic tapes; acoustic couplers; alarms; fog signals, non-explosive; whistle alarms; adding machines; readers [data processing equipment]; heat regulating apparatus; photocopiers [photographic, electrostatic, thermic]; electric and electronic effects units for musical instruments; bar code readers; downloadable ring tones for mobile phones; downloadable image files; downloadable music files; animated cartoons; filters for respiratory masks; filters for ultraviolet rays, for photography; filters for use in photography; USB flash drives; magic lanterns; optical lanterns; signal lanterns; cameras [photography]; glazing apparatus for photographic prints; shutters [photography]; darkrooms [photography]; photometers; flash-bulbs [photography]; digital photo frames; enlarging apparatus [photography]; photovoltaic cells; containers for contact lenses; spectacle cases; containers for microscope slides; cases for smartphones; cases especially made for photographic apparatus and instruments; chromatography apparatus for laboratory use; chronographs [time recording apparatus]; laboratory centrifuges; spectacle chains; cyclotrons; compasses for measuring; frequency meters; time clocks [time recording devices]; Petri dishes; sleeves for laptops; covers for personal digital assistants [PDAs]; covers for tablet computers; covers for smartphones; fire blankets; chips [integrated circuits]; jigs [measuring instruments]; pedometers; meteorological balloons; electrified rails for mounting spot lights; asbestos screens for firemen; fire hose; virtual reality headsets; protective helmets for sports; head guards for sports; lifeboats; snorkels; cell phone straps; spectacle cords; tripods for cameras; switchboards; distribution boards [electricity]; equalizers [audio apparatus]; screens [photography]; workmen's protective face-shields; projection screens; radiology screens for industrial purposes; fluorescent screens; exposure meters [light meters]; ducts [electricity]; galvanic cells; downloadable graphics for mobile phones; epidiascopes; ergometers; armatures [electricity]; black boxes [data recorders].

10 – Analysers for bacterial identification for medical purposes; cholesterol meters; blood testing apparatus; testing apparatus for medical purposes; anaesthetic apparatus; galvanic therapeutic appliances; apparatus for artificial respiration; apparatus for the treatment of deafness; physical exercise apparatus for medical purposes; body rehabilitation apparatus for medical purposes; dental apparatus and instruments; surgical apparatus and instruments; resuscitation apparatus; dental apparatus, electric; physiotherapy apparatus; bed vibrators; hot air therapeutic apparatus; diagnostic apparatus for medical purposes; traction apparatus for medical purposes; radiotherapy apparatus; microdermabrasion apparatus; fumigation apparatus for medical purposes; apparatus for the regeneration of stem

cells for medical purposes; apparatus for DNA and RNA testing for medical purposes; apparatus and installations for the production of X-rays, for medical purposes; magnetic resonance imaging [MRI] apparatus for medical purposes; orthodontic apparatus; medical cooling apparatus for treating heatstroke; medical cooling apparatus for use in therapeutic hypothermia; radiological apparatus for medical purposes; X-ray apparatus for medical purposes; hearing aids; nasal aspirators; trusses; maternity belts; support bandages; bandages, elastic; cupping glasses; dental burs; acupressure bands; bracelets for medical purposes; anti-nausea wristbands; anti-rheumatism bracelets; feeding bottles; air cushions for medical purposes; vaporizers for medical purposes; hot air vibrators for medical purposes; vibromassage apparatus; gastroscopes; hemocytometers; glucometers; lice combs; surgical sponges; pill cutters; defibrillators; dialyzers; containers especially made for medical waste; clips, surgical; mirrors for dentists; mirrors for surgeons; probes for medical purposes; urethral probes; artificial teeth; acupuncture needles; suture needles; needles for medical purposes; orthopedic articles; pill crushers; biodegradable bone fixation implants; surgical implants comprised of artificial materials; inhalers; hydrogen inhalers; injectors for medical purposes; incubators for medical purposes; incubators for babies; obstetric apparatus; obstetric apparatus for cattle; electric acupuncture instruments; surgical cutlery; insufflators; chambers for inhalers; endoscopy cameras for medical purposes; cannulae; droppers for medical purposes; dropper bottles for medical purposes; heart monitors; heart pacemakers; catheters; catgut; draw-sheets for sick beds; enema apparatus for medical purposes; clips for dummies; artificial skin for surgical purposes; menstrual cups; biomagnetic rings for therapeutic or medical purposes; teething rings; anti-rheumatism rings; compressors [surgical]; thermo-electric compresses [surgery]; oxygen concentrators for medical purposes; abdominal corsets; corsets for medical purposes; crutches; dentists' armchairs; armchairs for medical or dental purposes; waterbeds for medical purposes; air mattresses [air beds] for medical purposes; beds specially made for medical purposes; feeding bottle valves; love dolls [sex dolls]; lasers for medical purposes; lamps for medical purposes; curing lamps for medical purposes; quartz lamps for medical purposes; ultraviolet ray lamps for medical purposes; lancets; kinesiology tapes; lenses [intraocular prostheses] for surgical implantation; spoons for administering medicine; sanitary masks for medical purposes; masks for use by medical personnel; respiratory masks for artificial respiration; anaesthetic masks; LED masks for therapeutic purposes; therapeutic facial masks; gum massagers for babies; suture materials; childbirth mattresses; air mattresses for medical purposes; furniture especially made for medical purposes; water bags for medical purposes; douche bags; breast pumps; body fat monitors; body composition

monitors; urinals being vessels; portable hand-held urinals; teeth protectors for dental purposes; temperature indicator labels for medical purposes; knee bandages, orthopaedic; tips for crutches; nanorobots for medical purposes; finger guards for medical purposes; bone void fillers comprised of artificial materials; medical guidewires; pumps for medical purposes; thread, surgical; knives for surgical purposes; scissors for surgery; ambulance stretchers; stretchers, wheeled; boots for medical purposes; orthopaedic footwear; clothing especially for operating rooms; compression garments; blankets, electric, for medical purposes; supports for flat feet; ophthalmometers; ophthalmoscopes; cooling pads for first aid purposes; slings [supporting bandages]; gloves for massage; gloves for medical purposes; pessaries; saws for surgical purposes; ear picks; cooling patches for medical purposes; spittoons for medical purposes; plaster bandages for orthopaedic purposes; orthopaedic bandages for joints; abdominal pads; cushions for medical purposes; pads for preventing pressure sores on patient bodies; air pillows for medical purposes; soporific pillows for insomnia; heating cushions, electric, for medical purposes; patient hoists; abdominal belts; galvanic belts for medical purposes; hypogastric belts; belts for medical purposes; orthopaedic belts; umbilical belts; belts, electric, for medical purposes; condoms; aerosol dispensers for medical purposes; sphygmotensimeters; pulse meters; esthetic massage apparatus; massage apparatus; veterinary apparatus and instruments; medical apparatus and instruments; urological apparatus and instruments; brushes for cleaning body cavities; appliances for washing body cavities; corn knives; incontinence sheets; sterile sheets, surgical; surgical drapes; hair prostheses; artificial eyes; artificial breasts; dentures; artificial limbs; artificial jaws; ice bags for medical purposes; toe separators for orthopaedic purposes; surgical bougies; orthodontic rubber bands; X-ray photographs for medical purposes; respirators for artificial respiration; surgical robots; ear trumpets; strait jackets; sex toys; scalpels; tongue scrapers; dummies for babies; feeding bottle teats; baby feeding dummies; receptacles for applying medicines; spirometers [medical apparatus]; vaginal syringes; implantable subcutaneous drug delivery devices; hearing protectors; contraceptives, non-chemical; orthopaedic soles; stents; stethoscopes; medical examination tables; operating tables; commode chairs; basins for medical purposes; bed pans; instrument cases for use by doctors; arch supports for footwear; suspensory bandages; ear plugs [ear protection devices]; thermal packs for first aid purposes; thermometers for medical purposes; tomographs for medical purposes; trocars; walking sticks for medical purposes; drainage tubes for medical purposes; X-ray tubes for medical purposes; radium tubes for medical purposes; balling guns; protection devices against X-rays, for medical purposes; apparatus for acne treatment; filters for ultraviolet rays, for medical purposes; patient examination

gowns; quad canes for medical purposes; wheeled walkers to aid mobility; walking frames for disabled persons; cases fitted for medical instruments; elastic stockings for surgical purposes; stockings for varices; splints, surgical; laser therapy helmets for treating alopecia; tongue depressors for medical purposes; syringes for injections; syringes for medical purposes; hypodermic syringes; uterine syringes; urethral syringes; pins for artificial teeth; castrating pincers; forceps for medical purposes; robotic exoskeleton suits for medical purposes; radiology screens for medical purposes; electrodes for medical use; electrocardiographs; brain pacemakers; laser machines for medical purposes.

14 – Agates; diamonds; amulets [jewellery]; anchors [clock- and watchmaking]; barrels [clock- and watchmaking]; bracelets [jewellery]; bracelets made of embroidered textile [jewellery]; watch bands; charms for key rings; jewellery charms; brooches [jewellery]; alarm clocks; pins [jewellery]; ornamental pins; tie pins; jewellery hat pins; beads for making jewellery; pearls made of ambroid [pressed amber]; busts of precious metal; jewellery rolls; jet, unwrought or semi-wrought; jewellery findings; key rings [split rings with trinket or decorative fob]; retractable key rings; pearls [jewellery]; copper tokens; tie clips; cuff links; clasps for jewellery; badges of precious metal; gold, unwrought or beaten; cloisonné jewellery; works of art of precious metal; jewellery; ivory jewellery; jewellery of yellow amber; iridium; cabochons; precious stones; semi-precious stones; spun silver [silver wire]; necklaces [jewellery]; split rings of precious metal for keys; rings [jewellery]; boxes of precious metal; presentation boxes for jewellery; watch cases [parts of watches]; clock cases; pendulums [clock- and watchmaking]; medals; lockets [jewellery]; precious metals, unwrought or semi-wrought; movements for clocks and watches; clockworks; misbaha [prayer beads]; coins; gold thread [jewellery]; threads of precious metal [jewellery]; silver thread [jewellery]; olivine [gems]; osmium; palladium; platinum [metal]; chronometric instruments; watch springs; crucifixes of precious metal, other than jewellery; crucifixes as jewellery; rhodium; ruthenium; stopwatches; silver, unwrought or beaten; earrings; ingots of precious metals; alloys of precious metal; statues of precious metal; figurines of precious metal; watch glasses; paste jewellery; watch hands; clock hands; ornaments of jet; shoe jewellery; hat jewellery; presentation boxes for watches; chronographs [watches]; chronometers; chronoscopes; chains [jewellery]; watch chains; dials [clock- and watchmaking]; atomic clocks; watches; sundials; clocks and watches, electric; control clocks [master clocks]; clocks; wristwatches; rosaries; jewellery boxes; spinel [precious stones].

16 – Fountain pens; aquarelles; albums; almanacs; document laminators for office use; mimeograph apparatus and machines; atlases; posters; banknotes; banners of paper; paper bows, other than haberdashery or hair

decorations; name badges [office requisites]; table linen of paper; tickets; baggage claim check tags of paper; forms, printed; announcement cards [stationery]; glitter for stationery purposes; note books; pads [stationery]; drawing pads; wristbands for the retention of writing instruments; pamphlets; booklets; paper; paper sheets [stationery]; waxed paper; paper for medical examination tables; paper for recording machines; paper for radiograms; papers for painting and calligraphy; electrocardiograph paper; drawer liners of paper, perfumed or not; wood pulp paper; carbon paper; copying paper [stationery]; parchment paper; writing paper; rice paper; luminous paper; toilet paper; wrapping paper; filter paper; japanese paper; blotters; newsletters; rollers for typewriters; house painters' rollers; composing sticks; modelling wax, not for dental purposes; signboards of paper or cardboard; sewing patterns; bunting of paper; newspapers; electrotypes; hectographs; modelling clay; polymer modelling clay; terrestrial globes; drawing sets; engravings; slate pencils; pencil leads; document holders [stationery]; pencil holders; chalk holders; holders for cheque books; holders for stamps [seals]; page holders; name badge holders [office requisites]; diagrams; table runners of paper; engraving plates; writing slates; blackboards; galley racks [printing]; drawing boards; advertisement boards of paper or cardboard; duplicators; punches [office requisites]; cream containers of paper; magazines [periodicals]; money clips; clips for name badge holders [office requisites]; tags for index cards; pen clips; bookmarks; etching needles; tracing needles for drawing purposes; periodicals; printed publications; paper shredders for office use; graphic representations; credit card imprinters, non-electric; paper creators [office requisites]; graining combs; drawing instruments; calendars; tracing paper; tracing cloth; tracing patterns; gums [adhesives] for stationery or household purposes; lithographic stones; ink stones [ink reservoirs]; pencils; pencil lead holders; charcoal pencils; pictures; transfers [decalcomanias]; paintings [pictures], framed or unframed; cardboard; wood pulp board [stationery]; hat boxes of cardboard; cards; index cards [stationery]; geographical maps; paper tapes and cards for the recordal of computer programmes; trading cards, other than for games; perforated cards for Jacquard looms; catalogues; spools for inking ribbons; flower-pot covers of paper; paintbrushes; painters' brushes; writing brushes; typewriter keys; glue for stationery or household purposes; isinglass for stationery or household purposes; gluten [glue] for stationery or household purposes; starch paste [adhesive] for stationery or household purposes; printing blocks; books; colouring books; manifolds [stationery]; comic books; drawing pins; cigar bands; envelopes [stationery]; boxes of paper or cardboard; cases for stamps [seals]; paint boxes for use in schools; correcting fluids [office requisites]; printed coupons; stencils [stationery]; French curves; paper ribbons, other than haberdashery or hair decorations; gu-

mmed tape [stationery]; typewriter ribbons; barcode ribbons; adhesive bands for stationery or household purposes; correcting tapes [office requisites]; inking ribbons; self-adhesive tapes for stationery or household purposes; square rulers for drawing; drawing rulers; flyers; absorbent sheets of paper or plastic for foodstuff packaging; humidity control sheets of paper or plastic for foodstuff packaging; viscose sheets for wrapping; sheets of reclaimed cellulose for wrapping; plastic bubble packs for wrapping or packaging; steel letters; type [numerals and letters]; lithographs; letter trays; paint trays; architects' models; postage stamps; plastics for modelling; graphic prints; modelling materials; teaching materials [except apparatus]; sealing compounds for stationery purposes; adhesives [glues] for stationery or household purposes; padding materials of paper or cardboard; bookbinding material; packing [cushioning, stuffing] materials of paper or cardboard; packaging material made of starches; filtering materials of paper; table mats of paper; addressing machines; pencil sharpening machines, electric or non-electric; bookbinding apparatus and machines [office equipment]; typewriters, electric or non-electric; franking machines for office use; chalk for lithography; writing chalk; tailors' chalk; marking chalk; spray chalk; bags [envelopes, pouches] of paper or plastics, for packaging; garbage bags of paper or of plastics; plastic bags for pet waste disposal; painters' easels; hand-rests for painters; printing sets, portable [office requisites]; bibs of paper; bibs, sleeved, of paper; stickers [stationery]; fingerstalls for office use; writing cases [stationery]; cords for bookbinding; paper knives [letter openers]; printed sheet music; numbering apparatus; bottle envelopes of paper or cardboard; sealing wafers; covers [stationery]; passport holders; protective covers for books; plastic cling film, extensible, for palletization; embroidery designs [patterns]; handwriting specimens for copying; oleographs; musical greeting cards; greeting cards; postcards; etchings; conical paper bags; paper bags for use in the sterilization of medical instruments; bags for microwave cooking; palettes for painters; ink sticks; pantographs [drawing instruments]; loose-leaf binders; files [office requisites]; folders for papers; papier mâché; pastels [crayons]; modelling paste; pen cases; pen wipers; office perforators; pens [office requisites]; nibs of gold; nibs; steel pens; drawing pens; song books; seals [stamps]; sealing stamps; clipboards; address plates for addressing machines; handkerchiefs of paper; plastic film for wrapping; transparencies [stationery]; desk mats; trays for sorting and counting money; coasters of paper; bookends; stamp stands; mats for beer glasses; stands for pens and pencils; photograph stands; obliterating stamps; inking pads; stamp pads; adhesive tapes for stationery or household purposes; binding strips [bookbinding]; towels of paper; inking sheets for document reproducing machines; inking sheets for duplicators; cloth for bookbinding; gummed cloth for stationery purposes;

printers' blankets, not of textile; portraits; paperweights; writing cases [sets]; inkstands; office requisites, except furniture; writing materials; writing instruments; drawing materials; school supplies [stationery]; adhesive tape dispensers [office requisites]; hand labelling appliances; printed matter; lithographic works of art; prospectuses; printed timetables; ledgers [books]; printers' galleys; indexes; paper cutters [office requisites]; rubber erasers; elastic bands for offices; T-squares for drawing; graphic reproductions; retractable reels for name badge holders [office requisites]; penholders; marking pens [stationery]; tissues of paper for removing make-up; paper wipes for cleaning; dental tray covers of paper; place mats of paper; tablemats of paper; tablecloths of paper; paper clasps; document files [stationery]; scrapers [erasers] for offices; paper-clips; clips for offices; erasing products; biological samples for use in microscopy [teaching materials]; histological sections for teaching purposes; figurines of papier mâché; steatite [tailor's chalk]; writing board erasers; composing frames [printing]; sealing wax; arithmetical tables; placards of paper or cardboard; writing or drawing books; fabrics for bookbinding; stationery; pencil sharpeners, electric or non-electric; stencil plates; stencils for decorating food and beverages; cardboard tubes; Indian inks; moisteners [office requisites]; moisteners for gummed surfaces [office requisites]; squares for drawing; chart pointers, non-electronic; bottle wrappers of paper or cardboard; envelope sealing machines for offices; sealing machines for offices; vignetting apparatus; apparatus for mounting photographs; stapling presses [office requisites]; manuals [handbooks]; paper coffee filters; flags of paper; silver paper; moulds for modelling clays [artists' materials]; photo-engravings; photographs [printed]; stencil cases; canvas for painting; chromolithographs [chromos]; animation cels; compasses for drawing; numbers [type]; artists' watercolour saucers; ink; correcting ink [heliography]; inkwells; blueprints; stencils; erasing shields; balls for ball-point pens; desktop cabinets for stationery [office requisites]; printing type; address stamps; stamps [seals]; shields [paper seals]; prints [engravings]; labels of paper or cardboard; advertising pamphlets; printed advertising boards of paper or cardboard.

40 – Paper finishing; applying finishes to textiles; beer brewing for others; upcycling [waste recycling]; vulcanization [material treatment]; skin dressing; fruit crushing; embroidering; galvanization; electroplating; engraving; decontamination of hazardous materials; air deodorizing; stripping finishes; tanning; metal tempering; freezing of foods; gilding; gold plating; cadmium plating; permanent-press treatment of fabrics; food and drink preservation; consultancy in the field of wine making; food smoking; leather staining; fur dyeing; shoe staining; textile dyeing; cloth dyeing; laminating; lithographic printing; metal casting; fur glossing; tin plating; boilermaking; taxidermy; magnetization; nickel plating; abrasion; paper treating;

water treating; woodworking; processing of cinematographic films; leather working; cloth edging; metal treating; fur conditioning; fur mothproofing; waste treatment [transformation]; textile mothproofing; cloth waterproofing; crease-resistant treatment for clothing; cloth fireproofing; textile treating; wool treating; framing of works of art; air freshening; fabric bleaching; air purification; soldering; pasteurizing of food and beverages; clothing alteration; recycling of waste and trash; processing of oil; pattern printing; photographic printing; offset printing; metal plating; printing; burnishing by abrasion; flour milling; dress-making; providing information relating to material treatment; wine making for others; custom manufacturing of bread; rental of boilers; knitting machine rental; rental of generators; rental of air-conditioning apparatus; rental of space heating apparatus; photographic film development; pottery firing; blacksmithing; custom assembling of materials for others; bookbinding; welding services; glass-blowing; saddlery working; grinding; cloth cutting; sawing of materials; refining services; timber felling and processing; fur satining; silver plating; incineration of waste and trash; laser scribing; warping [looms]; sorting of waste and recyclable material [transformation]; photocopying services; quilting; planing of materials; fulling of cloth; tinting of car windows; window tinting treatment being surface coating; slaughtering of animals; destruction of waste and trash; cloth pre-shrinking; custom 3D printing for others; services of a dental technician; cryopreservation services; key cutting; dyeing services; sandblasting services; production of energy; custom tailoring; custom fashioning of fur; photogravure; millworking; chromium plating; colour separation services; silkscreen printing; optical glass grinding; treatment of materials by laser beam; die steel treating; custom manufacturing of stamps, matrices and seals.

42 – Water analysis; computer system analysis; handwriting analysis [graphology]; chemical analysis; rental of meters for the recording of energy consumption; energy auditing; recovery of computer data; business card design; graphic design of promotional materials; interior design; industrial design; graphic arts design; computer virus protection services; oil-field surveys; geological surveys; engineering; installation of computer software; meteorological information; clinical trials; material testing; textile testing; bacteriological research; biological research; geological research; research in the field of environmental protection; cosmetic research; mechanical research; research in the field of welding; research in the field of building construction; research in the field of telecommunications technology; research in the field of physics; chemical research; research and development of new products for others; medical research; scientific and technological research relating to patent mapping; scientific and technological research in the field of natural disasters; scientific research; analysis for oil-field ex-

ploitation; underwater exploration; technological research; calibration [measuring]; website design consultancy; computer security consultancy; information technology [IT] consultancy; computer technology consultancy; consultancy in the design and development of computer hardware; architectural consultancy; internet security consultancy; computer software consultancy; data security consultancy; technological consultancy; oil-well testing; quality control; vehicle roadworthiness testing; land surveying; dress designing; updating of computer software; monitoring of computer systems to detect breakdowns; monitoring of computer systems for detecting unauthorized access or data breach; monitoring of computer systems by remote access; electronic monitoring of credit card activity to detect fraud via the internet; electronic monitoring of personally identifying information to detect identity theft via the internet; software as a service [SaaS]; maintenance of computer software; authenticating works of art; design of interior decor; quality evaluation of standing timber; quality evaluation of wool; digitization of documents [scanning]; conversion of data or documents from physical to electronic media; urban planning; providing information relating to computer technology and programming via a website; providing scientific information, advice and consultancy relating to carbon offsetting; providing search engines for the internet; platform as a service [PaaS]; conversion of computer programs and data, other than physical conversion; conducting technical project studies; computer system design; rental of web servers; computer rental; rental of computer software; unlocking of mobile phones; geological prospecting; oil prospecting; hosting computer sites [web sites]; server hosting; development of computer platforms; construction drafting; computer software design; software development in the framework of software publishing; cloud seeding; consultancy in the field of energy-saving; creating and designing website-based indexes of information for others [information technology services]; creating and maintaining websites for others; computer programming; technical writing; copying of computer programs; cloud computing; architectural services; information technology services provided on an outsourcing basis; chemistry services; packaging design; off-site data backup; telecommunications technology consultancy; scientific laboratory services; user authentication services using single sign-on technology for online software applications; user authentication services using technology for e-commerce transactions; weather forecasting; styling [industrial design]; cartography services; exploration services in the field of the oil, gas and mining industries; data encryption services; electronic data storage; surveying.

(260) AM 2023 117871 A
 (800) 1662156
 (151) 2022 03 04
 (891) 2022 03 04
 (731) ALCO LLC

Yasamal district, IsmayilBey Outqashinli
 str. 30, apt. 45, AZ-1073 Baku, Azerbaijan

(540)



(591) Blue, dark blue, red and dark red
 (531) 01.15.05; 01.15.15; 27.05.01; 29.01.12
 (511)

35 – Advertising; wholesale and retail services for goods.

(260) AM 2023 117872 A
 (800) 1662231
 (151) 2021 07 09
 (891) 2021 07 09
 (731) H. Lundbeck A/S

Ottiliavej 9, DK-2500 Valby, Denmark

(540)



(591) Golden, pantone 8382 C
 (531) 27.05.11; 27.05.13; 29.01.02
 (511)

5 – Pharmaceuticals and medical preparations and substances; vaccines; pharmaceutical preparations and substances for the prevention and treatment of disorders and diseases in, generated by or acting on the central nervous system; pharmaceutical preparations and substances acting on the central nervous system; central nervous system stimulants; pharmaceutical preparations and substances for the prevention and treatment of psychiatric and neurological disorders and diseases; preparations, substances, reagents and agents for diagnostic and medical purposes.

(260) AM 2023 117873 A
 (800) 1662245
 (151) 2021 11 30
 (891) 2021 11 30
 (731) Fischerwerke GmbH & Co. KG

Klaus-Fischer-Straße 1, 72178 Waldachtal,
 Germany

(540)



(591) Black, white
 (531) 03.09.01; 03.09.24; 26.04.15; 26.04.24;
 27.05.01

(511)

19 – Building materials (non-metallic), including fire-proof building materials, in particular for construction of fire protection bulkheads and plates; self-hardening mortar, in particular for the anchoring of fastening elements; expanding foam; mounting foams for building, including in the form of fireproof substances; mortar, artificial resin mortar; mineral mortar; cements; fire cushions, fire protection bricks and fire protection collars of non-flammable material, in the form of construction materials (non-metallic) for sealing off pipes, tubes or cables.

(260) AM 2023 117885 A
 (800) 1239257
 (151) 2014 08 22
 (891) 2022 04 12
 (731) RAUCH Fruchtsäfte GmbH

Langgasse 1, A-6830 Rankweil, Austria

(540)

HAPPY DAY

(591) Black, white
 (511)

30 – Coffee, tea, cocoa and artificial coffee; coffee based drinks; drinking chocolate; cocoa-based beverages; coffee beverages with milk; coffee-based beverages with milk; cappuccino; macchiato; latte-macchiato; iced coffee; rice; tapioca and sago; chocolate and chocolate goods; edible ices; ices and ice creams; sugar, honey, treacle; salt; mustard; vinegar, sauces (condiments); marinades; fruit sauces; tomato sauces; spices; ice; tea-based beverages; ice tea; tea-based beverages with fruit flavoring or fruit taste; fruit teas; fruit teas with lemon and/or elderflower flavour; fruit tea with peach and/or honey flavour; flavoured tea-based beverages.

32 – Beers; mineral and aerated waters; non-alcoholic beverages; fruit beverages and fruit juices; nectars; fruit nectars; fruit nectar beverages; vegetable drinks and vegetable juices; syrups and other preparations for making beverages; energy drinks; lemonades; non-alcoholic beverages, in particular with fruit flavouring; smoothies; flavoured water-based beverages; coconut juice; coconut water; tomato juice; non-alcoholic beverages made with fruits; non-alcoholic extracts; fruit juice concentrate; cocktails, non-alco-

holic; isotonic drinks; non-alcoholic beverages with coffee components or a coffee flavour, non-alcoholic energy drinks with coffee components or a coffee flavour; must (unfermented); non-alcoholic aperitifs; non-alcoholic beverages consisting of coconut juice or with coconut juice flavouring or with coconut flavouring; whey beverages; non-alcoholic beverages with tea flavor; coffee-flavoured soft drinks; non-alcoholic beverages containing fruits or fruit extracts; water-based beverages; non-alcoholic beverages with tea flavor or tea taste; soft drinks with coffee taste; non-alcoholic beverages containing tea or tea extracts; non-alcoholic beverages containing coffee or coffee extracts.

33 – Alcoholic beverages (except beers); alcoholic beverages containing fruit; pre-mixed alcoholic beverages, other than beer-based; alcoholic cocktails.

(260) AM 2023 117886 A
 (800) 1343199
 (151) 2017 01 27
 (891) 2022 01 07
 (731) Arctiko A/S
 Oddesundvej 39, DK-6715 Esbjerg N, Denmark
 (540)

ARCTIKO

(591) Black, white
 (511)
 37 – Scientific and technological services and research and design relating thereto; industrial analysis and research services; design and development of computer hardware and software; design and development of refrigerating and freezing equipment and apparatus and control units therefore; engineering services; technical project planning; engineering project management services; technical planning and technical project management for the development of refrigerating and freezing equipment and apparatus; mechanical engineering; preparation of engineering drawings, including in 3d; certification [quality control]; quality testing of products for certification purposes; advise and consultancy in relation to the aforementioned services.

(260) AM 2023 117888 A
 (800) 1562251
 (151) 2020 10 26
 (891) 2022 04 01
 (731) Bausch + Lomb Ireland Limited
 3013 Lake Drive, Citywest Business Campus,
 Dublin 24, Ireland
 (540)

LUXLIFE

(591) Black, white

(511)
 10 – Intraocular lenses; preloaded intraocular lens inserters.

(260) AM 2023 117889 A
 (800) 1621868
 (151) 2021 09 21
 (891) 2022 01 07
 (731) F. Hoffmann-La Roche AG
 Grenzacherstrasse 124, CH-4070 Basel,
 Switzerland
 (540)

RYGANVI

(591) Black, white
 (511)
 5 – Pharmaceutical preparations.

(260) AM 2023 117890 A
 (800) 1631535
 (151) 2021 11 10
 (891) 2022 04 29
 (731) FibroGen, Inc.
 409 Illinois Street, San Francisco CA 94158,
 USA
 (540)

CETGOFY

(591) Black, white
 (511)
 5 – Pharmaceutical preparations for the treatment of chronic fibrotic and proliferative disorders; pharmaceutical preparations for the treatment of cancer, muscular dystrophy and idiopathic pulmonary fibrosis.

(260) AM 2023 117891 A
 (800) 1631725
 (151) 2021 11 10
 (891) 2022 04 29
 (731) FibroGen, Inc.
 409 Illinois Street, San Francisco CA 94158,
 USA
 (540)

EFREVIC

(591) Black, white
 (511)
 5 – Pharmaceutical preparations for the treatment of chronic fibrotic and proliferative disorders; pharmaceutical preparations for the treatment of cancer, muscular dystrophy and idiopathic pulmonary fibrosis.

(260) AM 2023 117892 A

(800) 1634323

(151) 2021 09 22

(891) 2022 05 03

(731) Brunchco 21 S.A.

Rue de la Victoire 1, B-1060 Saint-Gilles,
Belgium

(540)



(591) Green, white

(531) 01.15.23; 05.03.11; 05.03.13; 05.03.15;
26.01.03; 26.01.15; 29.01.12

(511)

29 – Jams; preserves in the form of fruit-based spreads; olive oil; olive paste; packaged olives; processed olives; vegetable-based spreads; packaged sun-dried tomatoes; processed artichokes; marmalade; salads consisting primarily of vegetables, fruit, meat, fish, and/or seafood; soups; meat, fish, poultry and game; meat extracts; preserved, dried and cooked fruits and vegetables; salads; fruit salads; potato chips; chips (french fries); edible nuts; food products made from nuts; nut-based snack bars; fruit-based snack foods; cheese; chilli beans; preserved beans; bean curd; eggs; preparations made wholly or principally of eggs; omelettes; prepared meals made from meat (meat predominating); prepared meals, predominantly of meat or vegetables; prepared meals consisting principally of mushrooms; prepared meals made principally of cheese; prepared foods consisting principally of fish; prepared meals consisting principally of poultry; prepared snacks made from vegetables, meat, fruit or nuts; burgers, meat-based, nut-based or dairy-based snack foods; edible oils and fats; jellies, yoghurt; yoghurt for drinking; yoghurt preparations; dairy desserts (except ice cream or frozen yoghurt); soya dessert; fruit desserts; compotes; yoghurt desserts (except frozen yoghurt); desserts in the form of puddings with a milk base; milk based beverages; pickles.

30 – Bread, pasty and confectionery; flour and preparations made from cereals; yeast and baking-powder; packaged herbs [seasonings]; bread; sandwiches; croissants; baguettes; brioche; muffins; pastries; tarts; cakes; biscuits; brownies; cookies; nougat; waffles; scones; pancakes; toast; muesli; quiche; coffee; coffee-based beverages; tea; sugar; honey; chocolate; chocolate spread; packaged seasoning primarily consisting of herbs; capers; salt; table salt; pepper; cereals mainly consisting of processed grains with added nuts and dried fruits; salads consisting primarily of pasta; food

products consisting primarily of cereals; cereal breakfast foods; muesli consisting predominantly of cereals; cereal products in bar form; cereal based snack food; snack bars consisting of chocolate; chips (cereal products); quiches; porridge oats; meals made predominantly from rice, pasta or noodles; prepared rice rolled in seaweed; prepared meals in the form of pizzas; noodle-based prepared meals; meat pies; pasties; pasta salads; rice salads; salad dressings; condiments; seasonings, spices, preserved herbs; mustard; relishes; puddings; prepared desserts (chocolate based); prepared desserts (confectionery); prepared desserts (pastries); frozen yoghurt; frozen desserts; ice cream desserts; sorbets and other edible ices; confectionery; confectionery bars; beverages consisting principally of chocolate.

35 – Retail services connected with the sale of specialty food and drink products and ingredients; retail bakery store services; business management services; business management assistance, business management consultancy, in particular for bakers and pastry-cooks; business and commercial advice in the running of establishments as franchises; assistance in business management and product and service commercialisation, within the framework of franchise contracts; sales promotion, including retail store promotion services featuring specialty food and drink products and ingredients; franchise services, namely, offering business management assistance in the establishment and operation of restaurants combined with retail bakery shops and retail stores featuring food and drink products; promotion services for the sale of products in the framework of setting up and operating restaurants; providing an online business directory, namely, a restaurant, bakery, and retail store locator; online retail services with a range of specialty food and drink products and ingredients; order procurement services for restaurants and take away restaurants; ordering of takeaway restaurant and restaurant meals, arranged via a website; sales and product promotion services relating to the establishment and/or operation of restaurants, bakery shops and retail stores featuring food and drink products; sales promotions by means of cookery displays and demonstrations (for others); organisation and management of customer loyalty programmes; advertising and promotional services; business management assistance, business management consultancy.

39 – Food delivery services; delivery of food by restaurants and bakeries.

40 – Providing information about recycling, treatment of waste materials in the field of environmental pollution control and improving the environment through recycling.

43 – Services for providing food and drink; restaurant services; coffee-house services; catering; carry-out restaurant services; providing food and drinks on co-

mmunal seating in restaurants to foster interaction among other people who might not know each other to eat, drink, and meet; restaurant services featuring communal seating options in restaurants to foster interaction among others by providing extra-large tables for people who might not know each other to eat, drink, and meet; restaurants providing delivery to homes and businesses; takeaway food and drink services; snack-bars; salad bar restaurant services; provision of meals; services for the provision of meals; bakery services; cooking services; reservation of meals; restaurant reservation services; cooking services for restaurants and takeaway restaurants; advice concerning food and drink and cooking recipes; providing information, including online, about services for providing food and drink; provision of information relating to the preparation of food and drink; providing information relating to the location of restaurants, bakeries and retail stores featuring food and drink products.

(260) AM 2023 117893 A

(800) 1637120

(151) 2021 11 10

(891) 2022 04 19

(731) GT Licensing Lux S.à.r.l.

15, Bd F.W. Raiffeisen, L-2411

LUXEMBOURG, Luxembourg

(540)

ROYAL TULIP

(591) Black, white

(531) 05.05.03; 05.05.20; 05.05.21; 27.03.11;

27.05.01; 29.01; 29.01.02

(511)

35 – Commercial management, including management of hotels, apartments and condominiums, beauty salons, bars, café-restaurants, cafeterias, coffee shops, food supply services, restaurants, clubs, wine bars, reception lounges and snack bars for others; commercial advice in the field of franchising, commercial assistance in the establishment of franchises; administrative services relating to the commercial business of franchises; services rendered by a franchisor, namely, commercial assistance in the operation or management of industrial or business enterprises and providing commercial information; promotional and advertising services; demonstration of goods, dissemination of advertising matter, distribution of samples, shop window dressing; organization of exhibitions for commercial or advertising purposes; organization of trade fairs for commercial or advertising purposes; professional business consultancy; business organization consultancy; commercial research; economic forecasting; assistance with respect to business management for the sale of goods, consultancy with respect to business management for the sale of goods, assistance with respect to commercial management for the sale

of goods; sales promotion; retail services for meals, direct sale of meals at home parties, wholesale services for meals; delicatessen retailing services; information services, advice and support services relating to all the aforementioned services.

41 – Education services, namely, organizing and conducting of seminars, workshops, courses, conferences and symposiums in the field of leadership development, human resources, customer service, customer and employee satisfaction and loyalty, employee recruitment, guidance, training and development of employees, cooking, art, foreign languages, protocol, arts and crafts, nature and conservation; Provision of recreational, sporting and cultural activities; health club services [health and fitness training], namely, provision of services, installations, instructions and equipment in the fields of fitness and exercise; providing recreation facilities, classes and equipment for swimming pools, cycling, golf, water sports, horse riding, skiing and beach access; providing golf clubs, golf courses and instruction in golf; providing tennis facilities, rental of tennis courts and instruction in tennis; operation of amusement arcades; organizing entertainment for weddings; event planning and management services, namely, preparing, organizing, planning, and designing special events for social entertainment; organization of conferences and organization of exhibitions for cultural and educational purposes; casino services; gambling; cabaret services; night club services [entertainment]; providing educational and entertainment information to guests in hotels on local attractions and the points of interest near the hotels and distributing course material in connection therewith; art exhibitions; cultural, educational and entertainment services provided by art galleries.

43 – Hotel services; restaurant, catering, bar and cocktail lounge services; provision of general-purpose infrastructure for meetings, conferences and exhibitions; providing meeting and conference facilities for business meetings; organizing wedding receptions [venues]; organization of wedding receptions [food and beverages]; and hotel room reservation services for others.

(260) AM 2023 117956 A

(800) 1663188

(151) 2022 01 26

(891) 2022 01 26

(731) ZHEJIANG RED DRAGONFLY FOOTWEAR CO., LTD.

No. 2357, Shuangta Road, Oubei Subdistrict, Yongjia, Wenzhou, 325100 Zhejiang, China

(540)

红蜻蜓 

(591) Black, white
 (531) 03.13.06; 03.13.24; 28.03
 (511)

18 – Imitation leather; trunks [luggage]; rucksacks; briefcases; school bags; trimmings of leather for furniture; reins for guiding children; umbrellas; mountaineering sticks; clothing for pets.

25 – Clothing; layettes [clothing]; swimsuits; waterproof clothing; dance clothing; shoes; hats; gloves [clothing]; scarfs; leather belt [clothing]; albs; wedding clothing; sleep masks.

(260) AM 2023 118023 A
 (800) 1663601
 (151) 2021 11 30
 (891) 2021 11 30
 (731) Victron Energy B.V.
 De Paal 35, NL-1351 JG Almere, Netherlands
 (540)

Victron

(591) Black, white
 (511)

9 – Apparatus and instruments for the conduction, distribution, conversion, storage, regulation and management of electricity; apparatus and instruments for accumulating and storing electricity; apparatus and instruments for controlling electricity; photovoltaic apparatus for generating electricity; electric cables and wires; electrical adapter cords, splitter cords, power inlets and wireboxes; measuring, detecting, monitoring and controlling devices; electricity measuring instruments; controllers and regulators; sensors, detectors and monitoring instruments; solar charge controllers; dongles; autotransformers; galvanic isolators; solar home systems for electricity generation; inverters; photovoltaic inverters; electrical inverters; dc/ac inverters; ac/dc inverters; inverters for power supply; inverters used in solar power generation; isolation transformers; chargers; current collectors; current transformers; current meters; current limiters; current converters; current shunts; current breakers; current rectifiers; current testers; fault current breakers; alternating current adaptors; electric current adaptors; current overload protectors; direct current converters; dc-dc converters; electric current sensors; ac current sensors; energy meters; electric current transformers; voltage transformers; voltage stabilizers; voltage regulators; voltage dividers; voltage meters; voltage limiters; voltage detectors; voltage testers; high voltage transformers; voltage monitor modules; induction voltage regulators; voltage surge suppressors; static voltage regulators; maximum power point trackers; electric current switches; electric current rectifiers; fuses for electric current; electric current control devices; instruments for distributing electric current; voltage converters; voltage multipliers; voltage-to-current conver-

ters; voltage stabilizing power supply; voltage regulators for vehicles; high voltage power supplies; low voltage power supplies; distribution amplifiers; distribution transformers; distribution boards; electricity distribution boards; distribution consoles (electricity); electric power distribution apparatus; panels for the distribution of electricity; power conditioners; power modules; power connectors; power adaptors; power distribution systems; power adaptors; power amplifiers; power controllers; power capacitors; power switches; power analyzers; power testers; power stabilizers; power meters; power cables; power banks; power wires; electric power units; power units [transformers]; power conditioning apparatus; power packs [batteries]; electrical power adaptors; power units [batteries]; power line protectors; power line conditioners; static power convertors; power packs [transformers]; electric power analyzers; power distributing boxes; electronic power controllers; outdoor power relays; electronic power transformers; underwater power cables; power regulating apparatus; low power microcontrollers; electric power converters; power distributors [electrical]; electrical distributing busbars; high current distributors; switching power supply apparatus; uninterruptable power supply apparatus; electrical power distribution blocks; electric power supply sockets; electrical power outlet boxes; electric power supply units; mains power units (electric -); power-line transmission apparatus; electrical power extension cords; power transformers for amplification; ac/dc power supplies; dc input power supplies; high-voltage power supplies; low voltage power supplies; accumulators for photovoltaic power; solar-powered battery chargers; solar powered rechargeable batteries; distribution boxes for electrical power; voltage regulators for electric power; high-frequency switching power supplies; uninterruptible power supply apparatus [battery]; modules for photovoltaic power generation; apparatus for improving power efficiency; crystalline silicon solar power cells; portable power supplies (rechargeable batteries); apparatus for diagnosing electrical power installations; electric batteries for powering electric vehicles; photovoltaic installations for generating electricity [photovoltaic power plants]; apparatus and instruments for regulating the distribution of electricity; apparatus and instruments for conducting the distribution of electricity; apparatus and instruments for controlling the distribution of electricity; apparatus and instruments for switching the distribution of electricity; apparatus and instruments for transforming the distribution of electricity; apparatus and instruments for accumulating the distribution of electricity; measurement apparatus; data loggers and recorders; computer networking and data communications equipment; controller area network (can bus); computer networks; data processing equipment and accessories (electrical and mechanical); sensors; sensor controllers; electronic sensors; infrared sensors; detectors; electric monitoring apparatus; electric mo-

monitoring units; voltage monitoring units; electronic measurement sensors; monitoring control apparatus [electric]; panels for the control of electricity; electric control devices for energy management; electronic apparatus for the remote control of signals; computer software for controlling and managing electricity; apparatus and instruments for controlling the use of electricity; wireless controllers to remotely monitor and control the function and status of other electrical, electronic, and mechanical devices or systems; remote controls; programmable controls; microprocessor controls; electrical controls; remote controllers; multipoint controllers; inverter controllers; programmable controllers; electrical controllers; energy control devices; electronic control systems; dual terminal studs and terminal studs (electric connectors); automatic control apparatus; electric control panels; electric control apparatus; process controlling software; electric power controllers; software for operating and managing integrated circuit components; auxiliary battery packs; transfer switches; dc distribution systems; battery adapters; battery booster cables; battery boxes; battery cables; battery cases; battery charge devices; battery chargers; battery charging devices for motor vehicles; battery charging equipment; battery compensation chargers; battery jars; battery jump starters; battery leads; battery packs; battery preheaters; battery separators; battery starters; battery terminals; battery management systems; battery protectors; battery isolators; battery connectors; battery switches; software for apparatus and instruments for the conduction, distribution, conversion, storage, regulation and management of electricity; software for monitoring, analysing, controlling and running physical world operations; electrical engineering software; networking software; computer network hardware; computer bus network; network management apparatus; network management software; network communication apparatus; software for remote diagnostics; diagnostic apparatus, not for medical purposes; testing apparatus for diagnostic purposes [other than medical]; cellular modem; cellular network modem; gps receivers; automatic solar tracking sensors; electronic sensors for measuring solar radiation; solar energy collectors for electricity generation; photovoltaic apparatus and installations for generating solar electricity; photovoltaic apparatus for converting solar radiation to electrical energy; monitors; monitor screens; tablet monitors; touchscreen monitors; monitoring instruments; monitoring apparatus and instruments; mains monitoring apparatus (electric -); temperature monitors for industrial use; temperature monitors for household use; non intrusive load monitoring [nilm] apparatus; apparatus for monitoring electrical energy consumption; monitoring apparatus, other than for medical purposes; software for apparatus for measuring, monitoring and analyzing electricity consumption; power relays; midi fuses; mega fuses; field effect transistors (fet); buck-boost converters; solar cells; photovoltaic solar mo-

dules; load break isolators; electric transformers; electric voltage transformers; electronic power supplies; power dividers [electric]; regulated power supply apparatus; battery balancers; battery combiners; software for battery monitors; software for power inverters; software for electric inverters.

(260) AM 2023 118024 A

(800) 1663656

(151) 2022 03 02

(891) 2022 03 02

(731) Stiftung Ethereum (Foundation Ethereum)

Zeughausgasse 7a, CH-6300 Zug, Switzerland

(540)

REMIX

(591) Black, white

(511)

9 – Downloadable computer software development tools; downloadable computer programs, namely, compilers, assemblers, visual development software and applications development environments; downloadable computer software development tools intended for use in creating applications and smart contracts, developing graphical user interfaces and providing data exchanges and communications between programs and computers in a distributed or networked environment; downloadable computer programs for use in the design, development, writing and implementation of applications, general programs and smart contracts; downloadable computer software frameworks, namely, reusable software platforms to assist in the development of applications, products and software solutions; downloadable computer software for data and application modeling.

38 – Providing online forums for the transmission of messages and information among users concerning data, information, publications and digital content in the field of computer software development; sending messages via electronic transmission; communication services, namely, electronic transmission of data, information, publications and digital content among users; providing an online forum for accessing, sharing and transmitting messages, text, information, documents, publications and digital content among users; providing access to computer networks, namely, providing multiple-user access to a computer network of applications built on a blockchain software platform; providing access to a discussion website on the Internet concerning technical information with respect to computers and concerning a computer project management method (known as model-based design).

42 – Providing software, namely utility programs, language and interpretation processors, on computer networks (in particular the Internet), telecommunication networks and on mobile data services (provision of hosted applications); technical support services with respect to software; customer support services in rela-

tion to computer software; computer software maintenance services; computer programming; computer system analysis; software research, design and development services; providing online technical information with respect to computers; providing online information with respect to the design and development of computer hardware and software, including for a computer project management method (known as model-based design); technical support services with respect to software in the form of online journals or blogs; consultation, advisory and information services relating to the aforesaid services; providing software on computer networks (in particular the Internet), telecommunication networks and on mobile data services (provision of hosted applications) in the field of technical information with respect to computers; temporary provision of non-downloadable software applications accessible via a website; information technology (IT) consultancy; software development services.

(260) AM 2023 118035 A

(800) 1664074

(151) 2021 11 03

(891) 2021 11 03

(731) Arity International Limited

10 Mays Meadow, Belfast BT1 3PH,
United Kingdom

(540)

ARITY IQ

(591) Black, white

(511)

9 – Computer application software for monitoring telematics, for collecting, analyzing, managing, and storing business and data related to driving conditions, weather, motorists, vehicles, and vehicle insurance consumers, for collecting, analyzing, managing, and storing business and data from third-party applications in order to assess driver behavior and risk; computer application software for monitoring speed, driving time, driving hour, brake activity, and other driving habits, for providing driver scores and feedback, for providing parking reminders, for providing information related to driving to users; computer application software for providing information related to car maintenance and mechanical repair services and providers, for providing roadside assistance information, and for sending and receiving electronic messages; downloadable software for monitoring telematics, for collecting, analyzing, managing, and storing business and data related to driving conditions, weather, motorists, vehicles, and vehicle insurance consumers, for collecting, analyzing, managing, and storing business and data from third-party applications in order to assess driver behavior and risk; downloadable software for monitoring speed, driving time, driving hour, brake activity, and other driving habits, for providing driver scores and feedback, for providing parking reminders, for providing information related to driving to users,

for providing information related to car maintenance and mechanical repair services and providers, for providing roadside assistance information, and for sending and receiving electronic messages; kits composed of software development tools.

36 – Consulting and information concerning insurance; providing information on insurance matters; providing information on financial risks.

42 – Providing temporary use of non-downloadable, cloud-based software for monitoring telematics, for collecting, analyzing, managing, storing, and reporting business and data related to driving conditions, weather, motorists, vehicles, and vehicle insurance consumers, for monitoring speed, driving time, driving hour, brake activity, and other driving habits, for providing driver scores and feedback; providing temporary use of non-downloadable, cloud-based software for providing parking reminders, for providing information related to driving to users, for providing information related to car maintenance and mechanical repair services and providers, for providing roadside assistance information, and for sending and receiving electronic messages, for collecting, analyzing, managing, and storing business and data from third-party applications in order to assess driver behavior and risk; platform as a service (PaaS) featuring computer software platforms for collecting, analyzing, managing, storing, and reporting data; technical support services, namely, troubleshooting of computer software platform problems; technical consulting services in the field of designing and engineering electronic sensors; software as a service (SaaS) services featuring software for compiling and analyzing a motorist's driving data all for providing information regarding driver risk; providing non-downloadable computer software for the collection of motorist telematics data; providing non-downloadable computer software for data acquisition and collection for driver risk assessment and analysis.

45 – Providing information concerning safety risks on driver behavior through vehicle and driver telematics services; providing information on personal and commercial business safety risks.

(260) AM 2023 118036 A

(800) 1664078

(151) 2021 10 26

(891) 2021 10 26

(731) Nowodworski spolka jawna

Bojemskiego, PL-42-202 Czestochowa, Poland

(540)



Nowodvorski

(591) Black, white

(531) 26.01.01; 26.01.12; 26.01.18; 27.05.01

(511)

9 – Electrical adapters; batteries, electric; batteries for lighting; alarms; burglar alarms; acoustic alarms; fire alarms; aerials; computer software applications, downloadable; barometers; solar batteries; fuses; smart bracelets; magnets; coils, electric; chips [integrated circuits]; digital weather stations; climate control digital thermostats; frequency meters; piezoelectric sensors; LED position sensors; quantum dot light-emitting diodes [QLED]; light-emitting diodes [LED]; bells [warning devices]; alarm bells, electric; joysticks for use with computers, other than for video games; fluorescent screens; video screens; electronic key fobs being remote control apparatus; electronic tags for goods; electronic control gears [ECGs] for LED lamps and light fixtures; electronic access control systems for interlocking doors; electronic notice boards; theft prevention installations, electric; light dimmers [regulators], electric; regulating apparatus, electric; measuring devices, electric, photometers; fire extinguishing apparatus; gasometers [measuring instruments]; loudspeaker units; smart speakers; electric sockets; holograms; ducts [electricity]; electric installations for the remote control of industrial operations; sprinkler systems for fire protection; intelligent gateways for communication; connected bracelets [measuring instruments]; smart padlocks; smart rings; smart locks; smart door locks; electronic interactive whiteboards; interactive touch screen terminals; audio interfaces; interfaces for computers; cables, electric; coaxial cables; fibre optic cables; calorimeters; thermal imaging cameras; camcorders; integrated circuit cards [smart cards]; selfie sticks [hand-held monopods]; computer keypads; downloadable cryptographic keys for receiving and spending cryptocurrency; padlocks, electronic; magnetic encoders; encoded identification bracelets, magnetic; encoded magnetic cards; encoded key cards; collectors, electric; photovoltaic cells; computers; wearable computers; personal digital assistants [PDAs]; laptop computers; condensers [capacitors]; optical condensers; terminals [electricity]; galena crystals [detectors]; flashlights [photography]; darkroom lamps [photography]; electron tubes; vacuum tubes [radio]; optical lanterns; X-ray tubes not for medical purposes; lasers, not for medical purposes; counters; thread counters; revolution counters; magnifying glasses [optics]; mirrors [optics]; mirrors for inspecting work; chargers for electric batteries; circuit closers;

masts for wireless aerials; sounding apparatus and machines; materials for electricity mains [wires, cables]; gauges; smart meters; microphones; microprocessors; monitors [computer programs]; LED monitors; wearable video display monitors; transmitters [telecommunication]; transmitters of electronic signals; neon signs; electronic numeric displays; objectives [lenses] [optics]; lens caps; cabinets for loudspeakers; lighting conductors; audio- and video-receivers; voltage surge protectors; smart manufacturing software; smart house software; software for evaluating customer behaviour in online shops; software for the planning, integration and optimization of smart city applications; software for operating an online shop; electromechanical software; firmware; software; multimedia software; industrial software; sensory software; simulation software; telecommunications software; utility software; assistive software; security software; organic light-emitting diodes [OLED]; covers for electric outlets; visors for helmets; solar panels for the production of electricity; pyrometers; computer software platforms, recorded or downloadable; downloadable image files; downloadable music files; wafers for integrated circuits; sheaths for electric cables; identification sheaths for electric wires; semi-conductors; processors [central processing units]; computer programs, downloadable; computer software, recorded; computer operating programs, recorded; current rectifiers; prisms [optics]; relays, electric; time switches, automatic; switches, electric; inverters [electricity]; electrical transducers; conductors, electric; acoustic conduits; electricity conduits; push buttons for bells; temperature indicators; azimuth instruments; meteorological instruments; navigational instruments; measuring apparatus; accelerometers; electronic publications, downloadable, distribution consoles [electricity]; branch boxes [electricity]; junction boxes [electricity]; spherometers; scanners [data processing equipment]; battery boxes; distribution boxes [electricity]; optical lens blanks; salinometers; computer hardware; computer peripheral devices; connectors [electricity]; charging stations for electric vehicles; lighting ballasts; tripods for cameras; smart manufacturing system controls; LED drivers; stroboscopes; contacts, electric; subwoofers; signals, luminous or mechanical; switchboxes [electricity]; petri dishes; battery jars; optical glass; flashing lights [luminous signals]; optical fibres [light conducting filaments]; tablet computers; LED display panels; distribution boards [electricity]; control panels [electricity]; reflective articles for wear, for the prevention of accidents; LED televisions; thermo-hygrometers; thermometers, not for medical purposes; transformers [electricity]; step-up transformers; transistors [electronic]; junction sleeves for electric cables; armatures [electricity]; gas testing instruments; infrared detectors; heat regulating apparatus; sound locating instruments; baby monitors; sound reproduction apparatus; precision measuring apparatus; pressure gauges; devices for the projection of vir-

tual keyboards; data processing apparatus; sound recording apparatus; sound transmitting apparatus; optical apparatus and instruments; monitoring apparatus, other than for medical purposes; anti-interference devices [electricity]; telecommunication apparatus in the form of jewellery; television apparatus; video baby monitors; remote control apparatus; hygrometers; voltmeters; electric plugs; detectors; discharge tubes, electric, other than for lighting; telerupters; LED screen displays; light emitting diode displays; inductors [electricity]; amplifiers; locks, electric; electrified rails for mounting spot lights; LED light engines; connections for electric lines; signs, luminous; lighting transformers.

11 – Lamp shades; table lamp (lampshades for -); shades for light sources; hid [high-intensity discharge] architectural lighting fixtures; architectural lighting fixtures; architectural up lights for installation in the ground; germicidal lamps for purifying air; flameless light-emitting diode candles; head torches; diffusers being parts of lighting installations; screens for directing light; screens for controlling light; light sources of electro luminescence; electric fairy lights; electric lamps; electric indoor lighting installations; discharge tubes, electric, for lighting; electric incandescent lamps; ceiling lights; luminaires; LED lighting fixtures; outdoor electrical lighting fixtures; electric fiber lighting apparatus; electric track lighting units; electric holiday lights; electric night lights; decorative electric lighting apparatus; electrical discharge lighting fixtures; fluorescent electric light bulbs; electric bulbs; electric light fittings; electrical lighting fixtures for use in hazardous locations; infrared lamps; counterweight fittings for pendant lamps; lighting fittings; filters for use with torches; filters for stage lighting; filters for use with lighting apparatus; filters for use with lamps; color filters for lighting apparatus; indoor fluorescent electrical lighting fittings; indoor fluorescent lighting fixtures; fluorescent lamps with low ultra-violet light output; battery powered fluorescent emergency lighting units; halogen architectural lighting fixtures; halogen stage lighting fixtures; halogen luminaires; fiber optic illuminators; installations for street lighting; installations for lighting christmas trees; emergency lighting installations; HID [high-intensity discharge] stage lighting fixtures; incandescent lighting fixtures; lighting installations; fixed underwater lighting installations for swimming pools; film stage lighting apparatus; LED lighting installations; Japanese paper lanterns; electric candelabras; sconces [electric light fixtures]; lamp chimneys; lamp chimneys made of glass; fairy lights for festive decoration; flange light fittings; chimneys for oil lamps; xenon arc lamps; mirror balls being lighting fittings; lamp globes; candle lanterns; electric Chinese lanterns; portable paper lanterns (chochin); desk lamps; reading lights; lights, electric, for christmas trees; lamps for christmas trees; bedside lamps; night lights [other than candles]; map lights for vehicles; book lights;

lamp mantles; lamp glasses; lamps; aquarium lamps; emergency lighting; safety lamps; safety lamps for underground use; LED safety lamps; projector lamps; lamps for festive decoration; lamps for electrical installations; helmet lights; lamps for tents; aquarium lights; nail lamps; infrared lamps for drying the hair; curling lamps; washstand lamps; lamps for outdoor use; electrical lamps for indoor lighting; electrical lamps for outdoor lighting; fluorescent lamps; fluorescent luminaires for architectural lighting; fluorescent luminaires for stage lighting; fluorescent lamp tubes; fluorescent lighting tubes; gas lamps; halogen lamps; UV halogen metal vapour lamps; inspection lamps; uplighters; solar lamps; sun lamps for tanning purposes; ultra-violet sun ray lamps for cosmetic purposes; ultraviolet sun ray lamps, other than for medical use; laboratory lamps; curing lamps, not for medical purposes; LED lamps; arc lamps; arc lamps [lighting fixtures]; solar powered lamps; infrared lamps, not for medical purposes; diving lights; oil lamps; floor lamps; vacuum lamps; spot lights for household illumination; mercury lamps; street lamps; table lamps; stroboscopic lamps [light effects]; stroboscopic lamps [decorative]; strobe lights for discos; studio lamps; wall lights; ultraviolet ray lamps, not for medical purposes; candle lamps; lamp fixtures; discharge lamps; high intensity discharge luminaires; lamps fitted with extendible supports; flexible lamps; fresnel lanterns; searchlights; rechargeable torches; penlights; electric torches; LED flashlights; solar powered torches; flashlights utilising electric rechargeable devices; lanterns; lanterns made of ceramics; camping lanterns; lanterns for lighting; light bars; LED light machines; miniature light bulbs; mobile light towers; neon lamps for illumination; opaque casings for lights; lamp holders; sockets for electric lights; indoor electrical lighting fixtures; lighting fixtures for commercial use; lighting fixtures for household use; glass covers being fittings for lamps for sun lamps; wall lights (fittings for -) [other than switches]; fiber optic lighting fixtures; fixtures for incandescent light bulbs; security lighting; photocells (security lighting operated by -); security lighting incorporating a heat activated sensor; security lighting incorporating an infra-red activated sensor; security lighting incorporating a movement activated sensor; roof lights [lamps]; decorative lights; decorative lighting for christmas trees; lighting for display purposes; lighting for ponds; lighting being for use with security systems; vehicle lighting and lighting reflectors; dome lights for furniture; mood lights; LED mood lights; garden lighting; plasma lighting system [PLS] lighting; lights for music stands; strobe lights [light effects]; strobe lights [decorative]; downlights; LED landscape lights; interior lights for refrigerators; display lighting; light discharge tubes; illuminant lamps for projectors; luminous discharge lamps; decorative gas lighting; decorative lighting sets; decorative gas lighting sets; lighting ornaments [fittings]; christmas tree ornaments for illumination

[electric lights]; burners for lamps; incandescent burners; lighting panels; strip lights; flat panel lighting apparatus; candle torches; bases for non-electric lamps; lamp bases; bases adapted for the mounting of lamps; lighted disco balls; illuminated push-buttons; LED underwater lights; industrial lighting fixtures; portable paper lanterns; portable lamps [for illumination]; portable hand lamps [for illumination], portable search lamps; luminous cables for lighting purposes; reflector lamps; lamp reflectors; reflectors for light control; reflectors for light deflection; reflectors for wide area lighting fixtures; klieg lights; search lights; high intensity search lights; spotlights; electric hand lamps [other than for photographic use]; handheld spotlights; bicycle reflectors; light diffusers; luminous tubes for lighting; light tubes being parts of insect killing apparatus; light projectors; laser light projectors; self-luminous light sources; lamp posts; lampshade holders; pedestal lamps; standing paper lanterns [andon]; hanging ceiling lamps; glass covers for lamps; strings of coloured lights; strings of coloured lights for decorative purposes; strings of lights; lighting tracks [lighting apparatus]; suspension rails [not electrified] for electrical lighting fixtures; electric lights for festive decorations; christmas lights [other than candles]; accent lights for indoor use; lights for external installation; lights for gas-discharge lamps; lights for track mounting; lighting apparatus for vehicles; roadlights; inspection lights; fish-luring lights; plant grow lights; fiber optic lighting installations; luminous house numbers; flameless candles; electric candles; battery-operated electric candles; LED candles; compact fluorescent light bulbs; ultra-violet apparatus for tanning the whole body; ultra-violet apparatus for tanning the face; tanning apparatus [sun lamps]; light-emitting diodes [LED] lighting apparatus; stage lighting apparatus; lighting apparatus and installations; LED nail drying apparatus; lighting apparatus; lighting devices for showcases; LED luminaires; computer controlled lighting apparatus; solar cell lighting apparatus; organic light emitting diodes (OLED) lighting devices; lighting apparatus incorporating optical fibers; ceiling fans with integrated lights; pendant fluorescent lighting fixtures; magnesium filaments for lighting; freestanding paper lanterns; flashlight pointers; scented electric candles; light assemblies; LED lighting assemblies for illuminated signs; lamp finials; light sources [other than for photographic or medical use]; full spectrum light sources; louvres for light deflection; louvres for light control; filaments for electric lamps; light bulbs for gas-discharge lamps; flashlight bulbs; incandescent lamps for optical instruments; headlamp bulbs; fluorescent light bulbs; basking lights for turtles; halogen light bulbs; incandescent lamps and their fittings; incandescent light bulbs; LED light bulbs; battery powered incandescent emergency lighting units; chandeliers; LED light strips; LED underwater lights.

35 – Administrative processing and organising of mail order services; sales administration; market prospecting; advertising, marketing and promotional consultancy, advisory and assistance services; providing consumer information relating to goods and services; distribution of advertising, marketing and promotional material; electronic order processing; commercial information and advice for consumers in the choice of products and services; foreign trade information and consultation; market campaigns; compilation of advertisements; affiliate marketing; direct marketing; digital marketing; targeted marketing; dissemination of advertisements via the internet; dissemination of advertising matter online; compilation of business directories for publishing on the internet; provision of commercial information; providing marketing information via websites; advertising via electronic media and specifically the internet; commercial information services, via the internet; providing consumer product information via the internet; providing an on-line commercial information directory on the internet; compilation of directories for publication on the internet; provision of business and commercial contact information via the internet; presentation of companies and their goods and services on the internet; providing business information via a web site; compilation of directories for publishing on global computer networks or the internet; business information services provided on-line from a computer database or the internet; business administration services for processing sales made on the internet; business information services provided online from a global computer network or the internet; providing business information, also via internet, the cable network or other forms of data transfer; mediation of advertising; arranging of trading transactions and commercial contracts; production of sound recordings for advertising purposes; production of video recordings for advertising purposes; production of visual advertising matter; sales promotions at point of purchase or sale, for others; business promotion; promoting the benefits of energy efficient lighting technologies to professionals in the lighting field; preparation of advertising material; preparation of advertisements; publication of printed matter for advertising purposes; publication of printed matter for advertising purposes in electronic form; publication of advertising literature; publication of publicity materials and texts; publication of publicity materials; publication of publicity texts; writing of publicity texts; advertising of business web sites; advertising; electronic billboard advertising; online advertising on a computer network; advertising through all public communication means; advertising the goods and services of online vendors via a searchable online guide; advertising in periodicals, brochures and newspapers; advertising in the popular and professional press; advertisement via mobile phone networks; promotional services provided by telephone; outdoor advertising; advertising relating to transport and delivery; radio and

television advertising; computerised business promotion; computerized on-line ordering services; provision of online price comparison services; providing consumer product information; providing a searchable online advertising guide featuring the goods and services of other on-line vendors on the internet; provision of advertising space, time and media; providing consumer product advice; advertisements (placing of -); administrative services relating to warranty claims processing; import-export agency services; auctioneering services; loyalty, incentive and bonus program services; advertising services to promote public awareness of environmental matters; business advertising services relating to franchising; advertising services relating to the sale of goods; advertising, including on-line advertising on a computer network; online retail store services relating to clothing; services rendered by a franchisor, namely, assistance in the running or management of industrial or commercial enterprises; trade show and commercial exhibition services; business management of wholesale and retail outlets; advertising and marketing services provided by means of blogging; supply chain management services; stock management services; services with regard to product presentation to the public; providing assistance in the field of product commercialization; providing user rankings for commercial or advertising purposes; arranging advertising and promotional contracts for others; administrative processing of purchase orders; internet marketing; promotion, advertising and marketing of on-line websites; promoting the designs of others by means of providing online portfolios via a website; provision of an online marketplace for buyers and sellers of goods and services; outsourcing services in the nature of arranging procurement of goods for others; retail services in relation to domestic electrical equipment; presentation of goods on communication media, for retail purposes; retail services in relation to lighting; wholesale services in relation to lighting.

42 – Computer analysis; analytical laboratory services; computer aided scientific analysis services; energy auditing; chemical technological research; electrical safety research; research relating to construction machinery; research relating to industrial machinery; research relating to data processing; technical research projects and studies; research in the field of materials science; research in instrumentation; industrial process research; scientific and industrial research; scientific and technological research relating to patent mapping; scientific research conducted using databases; technical research; research in the field of energy; mechanical research; research in the field of welding; research in the field of artificial intelligence; research in the field of information technology; research in measurement technology; research in the field of data processing technology; research in the area of semiconductor processing technology; research on building construction or city planning; research in the field of

manufacturing machinery; research relating to metals; research to develop new products; research relating to the computerised automation of technical processes; research relating to the computerised automation of industrial processes; certification of data via blockchain; technical consultancy relating to the use of materials for the preparation of electronic circuitry; technical consultancy in relation to the production of semiconductors; technical consultancy in the field of light engineering; engineering consultancy relating to computer programming; technological consultancy; technological consultancy in the fields of energy production and use; internet security consultancy; consultancy in the field of scientific research; consultancy in the field of industrial research; consultancy in the field of energy-saving; consultancy relating to technological services in the field of power and energy supply; preparation of reports relating to technological research; integration of computer systems and networks; engineering services relating to computers; technical consultancy relating to product development; quality checking and testing; quality control of goods and services; quality control relating to computer systems; inspection of plant and machinery; research laboratories; scientific laboratory services; optical research laboratory services; monitoring of computer systems by remote access; technological studies relating to machine tools; technical project studies in the field of construction; preparation of technical studies; development and testing of computing methods, algorithms and software; development of computers; development of industrial machinery; development of measuring and testing methods; development of new products; development of new technology for others; preparation of technical manuals; development of coatings for metals; development of coatings for non-metals; development of industrial processes; development of consumer products; development of industrial products; development of computer based networks; computer hardware development; development of systems for the transmission of data; development of energy and power management systems; development of computer systems; development of systems for the storage of data; development of systems for the processing of data; development of machining techniques; development of data processing apparatus; development of testing apparatus for electrical wires; development of power assemblies; technical planning and technical project management for the development of lighting equipment; technical advice in connection with energy-saving measures; research and development of new products for others; research and development of new products; product research and development; research and development of new products for third parties in the field of plastic materials; professional consultancy relating to technology; professional consultancy relating to the science of ergonomics; professional consultancy relating to energy efficiency in buildings; professional consultancy relating

to the conservation of energy; programming of software for evaluating customer behaviour in online shops; construction drafting; interior design; design of interior decor for shops; design and development of wireless data transmission apparatus, instruments and equipment; design and development of computer peripherals; design and development of electronic database software; design and development of electronic data security systems; design and development of data storage systems, design and development of data entry systems; design and development of systems for data input, output, processing, display and storage; design and development of data display systems; computer system design and development; design and development of data processing systems; technical design and planning of water purification plants; design and development of computer hardware; design of computer machine and computer software for commercial analysis and reporting, design of industrial machinery; design of specialist machinery; design of specialist machinery for use in making equipment for lighting; design of computer microchips; design of models; design of mathematical models; design of electric circuit boards; designing of electronic systems; designing of electrical systems; computer system design; design of communication systems; design of lighting systems; design services for furniture; design of diagnostic apparatus; design of mechanical, electromechanical and optoelectronic apparatus and instruments; architectural design for exterior decoration; conducting research and technical project studies relating to the use of natural energy; industrial analysis and research services; conducting industrial tests; preparation of computer programs for data processing; preparation of technological research reports; recording data relating to energy consumption in buildings; rendering of computer graphics (digital imaging services); software development, programming and implementation; drafting of construction plans for recreation premises; drafting and development of photovoltaic systems; preparation of reports relating to technical research; preparation of technological reports; computer system analysis; testing of machinery; testing of raw materials; creating and maintaining websites; creating, designing and maintaining web sites; creation of control programs for automated measurement, assembly, adjustment, and related visualisation; provision of information relating to industrial design; providing information about industrial analysis and research services; providing information in the field of product development; providing technical advice relating to energy-saving measures; analysis and testing services relating to electrical engineering apparatus; architectural services for the design of commercial buildings; architectural services for the design of industrial buildings; electromagnetic compatibility testing services; product research and development services; computer diagnostic services; advisory services relating to the use of energy; consultancy services for designing information

systems; advisory services relating to material testing; advisory services relating to energy efficiency; technical consultancy services relating to computer programming; technological consulting services in the field of alternative energy generation; engineering services related to integrated circuit diagnostics; control technology consulting services; optical research laboratory services; technical measuring; design services relating to architecture; design services relating to metalworking tools; services for the design of business premises; industrial packaging design services; retail design services; design services for display systems for promotional purposes; design services relating to residential property; testing services for alarm and monitoring systems; industrial design; services for the industrial design of computers; interior and exterior design services; research services in the field of computer hardware and software; computer graphics services; IT security, protection and restoration services in the field data applications; computer design and programming services; shop interior design; design services relating to interior decorating for offices; design services relating to interior decorating for homes; computer network services; troubleshooting in the nature of diagnosing computer hardware and software problems; rental of science and technology equipment; rental of computer hardware and facilities; provision of data centre facilities; computer project management in the field of EDP; computer project management services; IT project management; technical management of household appliances and computer equipment; IT service management [ITSM]; remote server administration; creating and maintaining websites.

(260) AM 2023 118038 A

(800) 1664090

(151) 2021 11 04

(891) 2021 11 04

(731) MARGIELA

12 Place des Etats Unis, F-75116 Paris,
France

(540)

MAISON MARGIELA

(591) Black, white

(511)

4 – Candles; Christmas tree candles; aromatherapy fragrance candles; scented candles.

35 – Retail and wholesale services in connection with: bleaching preparations and other substances for laundry use, cleaning, polishing, degreasing and abrasive preparations, perfumery products, perfumes, eau de toilet, cosmetic products, soaps, toiletry soaps, lotions, salts, oils and gels (not for medical use) for the bath, shaving and toiletry purposes, essential oils, make-up powder, make-up, nail polish, lipstick, talcum powder for toiletry use, hair lotions (not for medical

use), hair spray, shampoos, toothpastes; retail and wholesale services in connection with: ethereal essences and oils, incense sticks, scented sachet, scented linen water, scented room sprays, fragrances for automobiles, household fragrances, air fragrance reed diffusers, fragrance refills for non-electric room fragrance dispensers, potpourris (fragrances), room fragrances, room fresheners (fragrance preparations), body deodorants; retail and wholesale services in connection with: retail, Christmas tree candles, aromatherapy fragrance candles, scented candles; retail and wholesale services in connection with: spectacles, spectacles cases, spectacle chains, optical frames, contact lenses, protective helmets, headphone-microphone combinations, smart watches, earbuds, wearable activity trackers, mobile phones, cases and carrying cases, sacks, and bags, all for use with computers and portable and handheld digital electric and electronic devices, covers for use with computers and portable and handheld digital electric and electronic devices; retail and wholesale services in connection with: docking stations for computers and mobile phones, loudspeakers, computers, computer mice, battery pack, power adapters for computers, earphones, downloadable mobile applications and software for computers and mobile devices, headphones and earphones; retail and wholesale services in connection with: lighting apparatus, linear air diffusers, electric dispensers for air fresheners, air freshener plug-ins, supply air diffusers, electric candles; retail and wholesale services in connection with: jewelry and costume jewelry, namely rings, bracelets, necklaces, tie-bars, scarf rings, pendants, ear clips, tie clips cufflinks, earrings, key holders made of precious metals, brooches, pins being jewelry, clocks, watches, chronographs for use as watches, chronometers; retail and wholesale services in connection with: bags, handbags, purses, clutches, bumbags, travel baggage, valises, pocket wallets, leather purses, umbrellas, key cases, grocery tote bags, net-bags for shopping, vanity cases, not fitted, duffel bags, haversacks, attaché cases, credit-card holders, business card cases, school book bags, rucksacks, small bags for men, suitcases, shopping bags, satchels; retail and wholesale services in connection with: furniture, mirrors, picture frames, plaster, mattresses; retail and wholesale services in connection with: household utensils and containers, kitchen utensils and containers, combs and sponges, glassware for household purposes, knife holders for the table, dishes, plates, carafes, drinking glasses, candle holders, incense burners, flowerpots not made of paper, trays for domestic purposes, vases, glasses (containers), perfume sprays, pomanders [containers], aromatic oil diffusers, other than reed diffusers, scent sprays [atomizers]; retail and wholesale services in connection with: fabrics, bed and table covers, bath linen (except clothing), household linen, curtains of textile; retail and wholesale services in connection with: clothing, coats, mantles, raincoats, dusters, furs, dresses, suits,

skirts, jackets, knitwear, trousers, shorts sets, bermuda jeans, waistcoats, shirts, t-shirts, tops, blouses, jerseys, sweaters, blazers, cardigans, stockings, socks, underwear, corsets, brassiere, underpants, dressing gowns, night-gowns, nightwear, shifts, pajamas, bathrobes, bathing suits, beach-wraps, sun suits, sport jackets, waterproof clothing, wind-resistant jackets, anoraks, sweat suits; retail and wholesale services in connection with: ties, neckties, scarves, shawls, mufflers, foulards being clothing articles, gloves being clothing, headgear, caps, hats, hoods, sashes, belts, footwear, boots, shoes, slippers, hoodies, leggings, parkas, sweatpants, sneakers, ankle boots, mittens, headbands, headwear, face mask [clothing]; retail and wholesale services in connection with: carpets, cutlery, printed matter, stationery.

(260) AM 2023 118039 A

(800) 1664134

(151) 2021 12 10

(891) 2021 12 10

(731) WENZHOU QIQIANG AUTO PARTS
CO., LTD
NO.27 FENGZHUANG ROAD, SHUANGAO
VILLAGE, YONGZHONG SUB-DISTRICT,
LONGWAN DISTRICT, WENZHOU,
ZHEJIANG, China

(540)



(591) Black, white

(531) 26.03.01; 26.03.19; 27.05.01; 27.05.08;
27.05.17

(511)

12 – Automobile chassis; clutches for land vehicles; connecting rods for land vehicles, other than parts of motors and engines; transmission shafts for land vehicles; brakes for vehicles; shock absorbers for automobiles; steering wheels for vehicles; torque converters for land vehicles; axles for vehicles; brake cables for vehicles.

(260) AM 2023 118043 A

(800) 1664269

(151) 2022 03 03

(891) 2022 03 03

(731) Mondelez Europe GmbH
Lindbergh-Allee 1, CH-8152 Glattpark,
Switzerland

(540)



(591) Green and white

(531) 05.05.20; 05.05.21; 26.01.03; 26.01.15;
27.05.24; 29.01.12

(511)

30 – Cocoa, chocolate; bakery, pastry and confectionery products, any of these goods containing chocolate or cocoa flavoring.

35 – Business consulting for companies, business management assistance for companies.

39 – Providing tourist information with respect to travel on environmental protection, responsible and sustainable use of natural resources and biodiversity; providing tourist information with respect to travel on economic, social and employment issues related to environmental standards in the tourism sector.

41 – Educational services; organization of seminars and conferences; publication of research reports and educational information related to the sustainability of environmental protection.

42 – Testing, analysis, evaluation and certification of products of others, of technology and practices for compliance with standards for environmental protection, responsible natural resource management, sustainable protection, biodiversity; assessment of compliance with standards of third-party volunteers in the field of environmental protection, responsible natural resource management, sustainable protection, questions relating to social issues and connected with work in agriculture, forestry and tourism.

44 – Agriculture, horticulture and forestry services, advice and consultations relating to forest and land use (advice in the fields of agriculture and forestry); providing information relating to forestry.

(260) AM 2023 118044 A

(800) 1664291

(151) 2022 02 23

(891) 2022 02 23

(731) D ET VE ET ÜRÜNLERİ GIDA
PAZARLAMA TİCARET ANONİM ŞİRKETİ
Dikilitaş Mahallesi, Üzengi Sokak, 8, 139,
Beşiktaş, İstanbul, Türkiye

(540)

NO SALT NO LIFE

(591) Black, white

(511)

43 – Services for providing food and drink; rental of banquet and social function facilities for special occasions, namely, wedding receptions, conferences and meetings; day-nurseries (crèches); boarding for animals.

(260) AM 2023 118186 A

(800) 1666427

(151) 2022 01 11

(891) 2022 01 11

(731) Windex Technologies OÜ

Kohtu 3a-2, EE-10130 Tallinn, Estonia

(540)



(591) Red, blue, brown, white, green, grey, yellow

(531) 01.13.01; 01.13.02; 26.04.02; 26.04.18;
27.05.01; 27.05.03; 27.05.09; 27.05.10;
27.05.24; 29.01.15

(511)

38 – Transmission and reception [transmission] of database information via the telecommunication network; transmission of database information via telecommunications networks; data transmission; data transmission and reception services via telecommunication means; data transmission for others; transmission of data by laser beam; transmission of data by microwave; transfer of information by radio; transmission of data via satellite; transmission of data by teletypewriter; data transmission services over telecommunications networks; data transmission services over telematic networks; provision of telecommunication connections for data centres; data communication by electronic means; communication of data by means of telecommunications; consultancy services relating to data communications; transmission of data by communications satellite; transfer of data by telecommunications; communication services for the electronic transmission of data; transmission of data, sound and images via satellites; secured data, sound and image transmission services; packet transmission of data and images.

41 – Publication of year books; publication of magazines; multimedia publishing of magazines, journals and newspapers; publishing of journals; consultation services relating to the publication of magazines; multimedia publishing of magazines; journalism services; publication of periodicals and books in electronic form; publication of newspapers, periodicals, catalogs

and brochures; newspaper publication; multimedia publishing of newspapers; publication of work manuals for business management; publishing services for books and magazines; publishing of reviews; providing newsletters in the field of computer games via e-mail; provision of an online magazine featuring information in the field of computer games; publishing services carried out by computerised means; publication of audio books; writing services for blogs; publication of leaflets; publication of booklets; digital video, audio and multimedia entertainment publishing services; publication of documents in the field of training, science, public law and social affairs; publishing of documents; publishing of magazines in electronic form on the internet; online publication of electronic books and journals; providing online electronic publications, not downloadable.

42 – Research relating to the computerised automation of administrative processes; providing temporary use of on-line non-downloadable software development tools; computer system analysis; electronic monitoring services for computer security threat analysis for protecting data; development of systems for the transmission of data; data mining; provision of data centre facilities; design and development of data display systems; development of systems for the storage of data; design of data storage systems; design and development of systems for data input, output, processing, display and storage; design and development of data entry systems; design and development of data storage systems; certification of data via blockchain; data duplication and conversion services; data migration services; research relating to data processing; development and testing of computing methods, algorithms and software; development of data processing apparatus; design and development of data processing apparatus; design of data processing apparatus; development of systems for the processing of data; design and development of data processing systems; maintenance of data processing software; research in the field of data processing technology; data security consultancy; design of computer machine and computer software for commercial analysis and reporting; research services in the field of computer hardware and software; technical research relating to computers; technological services relating to computers; technological research relating to computers; research relating to computers; computer analysis; computer diagnostic services; engineering services relating to computers; computer design and programming services; creation of computing platforms for third parties; computer project management services; development of computer based networks; preparation of computer programs for data processing; computer hardware development; rental of computer hardware and facilities; troubleshooting of computer hardware and software problems; diagnosing computer hardware problems using software; computer hardware development; development of computer systems; computer system

analysis services; integration of computer systems and networks; technological consultancy relating to the performance of computer systems; updating of memory banks of computer systems; computer system design and development; monitoring of computer systems by remote access; providing information about the design and development of computer software, systems and networks; software development, programming and implementation; analytical services relating to computers; development of computers; computer performance testing; design and development of computer peripherals; computer network configuration services; computer network services; digital watermarking; design and development of electronic database software; computer project management in the field of edp; hosting services, software as a service, and rental of software; outsource service providers in the field of information technology; research in the field of information technology; internet security consultancy; it consultancy, advisory and information services; it project management; it service management [itsm]; design and development of wireless data transmission apparatus.

(260) AM 2023 118207 A
 (800) 444060
 (151) 1979 02 19
 (891) 2022 05 31
 (731) Dr. Wild & Co. AG
 Hofackerstrasse 8, CH-4132 Muttenz,
 Switzerland
 (540)

EMOFORM

(591) Black, white
 (531) 27.05.01; 27.05.17
 (511)
 3 – Products for dental and oral hygiene, such as mouthwashes, toothpastes.
 5 – Pharmaceutical and dental preparations.
 10 – Dental floss.
 21 – Toothbrushes.

(260) AM 2023 118208 A
 (800) 1106572
 (151) 2011 12 08
 (891) 2022 05 30
 (731) "MEXON" LTD
 266, "Vasil Levski" Str., BG-4003 PLOVDIV,
 Bulgaria
 (540)

WAIX

(591) Black, white

(511)

3 – Bleaching preparations and other substances for laundry use; cleaning, polishing and scouring preparations; soaps; shampoos.

5 – Biocides.

(260) AM 2023 118209 A

(800) 1271512

(151) 2015 09 11

(891) 2022 05 27

(731) Société des Produits Nestlé S.A.
CH-1800 Vevey, Switzerland

(540)

XPYTKA

(591) Black, white

(531) 28.05

(511)

30 – Coffee, coffee extracts, coffee-based beverages and preparations; iced coffee; artificial coffee, artificial coffee extracts, artificial coffee-based beverages and preparations; chicory (coffee substitute); tea, tea extracts, tea-based beverages and preparations; iced tea; malt-based preparations for human consumption; cocoa and cocoa-based beverages and preparations; chocolate, chocolate products, chocolate-based beverages and preparations; confectionery, sugar confectionery, candy; sugar; chewing gum not for medical use; natural sweeteners; bakery products, bread, yeast, pastries; biscuits, cookies, cakes, wafers, caramels, puddings; edible ices, water ices, sherbets, frozen confectionery, frozen cakes, ice creams, frozen yogurts, powders and binding agents (included in this class) for making edible ices and/or water ices and/or sherbets and/or frozen confectionery and/or frozen cakes and/or ice creams and/or frozen yogurts; breakfast cereals, muesli, corn flakes, cereal bars, ready-to-eat cereals; cereal preparations.

(260) AM 2023 118210 A

(800) 1416528

(151) 2018 04 27

(891) 2022 05 16

(731) SAB OTOMOTİV YEDEK PARÇA METAL
MAKİNA SANAYİ VE TİCARET ANONİM
ŞİRKETİ

Konya Organize Sanayi Bölgesi, T. Ziyaettin
Caddesi, 8 Nolu Sokak, No:3, Selçuklu,
Konya, Türkiye

(540)

BAGEN

(591) Orange, blue and white

(531) 26.04.18; 27.05.01; 29.01.13

(511)

12 – Motor land vehicles, motorcycles, mopeds; engines and motors for land vehicles; clutches for land

vehicles; transmissions, transmission belts and transmission chains for land vehicles; gearing for land vehicles; brakes, brake discs and brake linings for land vehicles; vehicle chassis, automobile bonnets, vehicle suspension springs, shock absorbers for automobiles, gearboxes for land vehicles, steering wheels for vehicles, rims for vehicle wheels.

(260) AM 2023 118212 A

(800) 1470608

(151) 2019 04 11

(891) 2022 06 01

(731) Helsinn Healthcare SA
Via Pian Scairolo 9, CH-6912 Lugano,
Switzerland

(540)

LEDAGA

(591) Black, white

(511)

5 – Pharmaceutical preparations for the treatment of lymphoma, non-Hodgkin's lymphoma, cutaneous T-cell lymphoma, fungoid mycosis, vitiligo, psoriasis, alopecia areata, histiocytosis, melanoma and auto-immune skin diseases.

(260) AM 2023 118343 A

(800) 1669705

(151) 2022 04 15

(891) 2022 04 15

(731) Honor Device Co., Ltd.
Suite 3401, Unit A, Building 6, Shum Yip Sky
Park, No. 8089, Hongli West Road, Xiangmihu
Street, Futian District, Shenzhen, 518040
Guangdong, China

(540)

MagicBook X 14

(591) Black, white

(531) 27.05.01; 27.07.01

(511)

9 – Notebook computers; laptop computers; computers; tablet computers; wearable computers; computer keyboards; mouse [computer peripheral]; smartwatches; computer software applications, downloadable; computer programs, recorded; computer hardware; stands adapted for laptops; data sets, recorded or downloadable; 3d scanners; haptic suits, other than for medical purposes; quantum computers; head-mounted displays; wireless portable printers for use with laptops and mobile devices; neural helmets, not for medical purposes; cooling pads for laptop computers; pedometers; face identification apparatus; bathroom scales; smartphones; routers; home automation hubs; foldable smartphones; mobile phone screen protectors; mobile phone ring holders; mobile phone ring stands; holders adapted for mobile telephones and smartpho-

nes; in-car telephone handset cradles; dashboard mats adapted for holding mobile telephones and smartphones; cabinets for loudspeakers; television apparatus; head-up display apparatus for vehicles; smart speakers; wearable speakers; wireless speaker microphones; headsets; headsets for playing video games; portable speakers; cameras; flash lamps for smartphones; measuring instruments; teaching robots; optical lenses; usb cables; chips [integrated circuits]; electrical adapters; video screens; computer screens; electronic key fobs being remote control apparatus; biometric locks; contact lens cases incorporating ultrasonic cleaning functions; mobile power supply (rechargeable batteries); portable power chargers; battery chargers for laptop computers; animated cartoons.

(260) AM 2023 118344 A

(800) 1669706

(151) 2022 04 15

(891) 2022 04 15

(731) Honor Device Co., Ltd.

Suite 3401, Unit A, Building 6, Shum Yip Sky Park, No. 8089, Hongli West Road, Xiangmihu Street, Futian District, Shenzhen, 518040 Guangdong, China

(540)

MagicBook X 16

(591) Black, white

(531) 27.05.01; 27.07.01

(511)

9 – Notebook computers; laptop computers; computers; tablet computers; wearable computers; computer keyboards; mouse [computer peripheral]; smartwatches; computer software applications, downloadable; computer programs, recorded; computer hardware; stands adapted for laptops; data sets, recorded or downloadable; 3d scanners; haptic suits, other than for medical purposes; quantum computers; head-mounted displays; wireless portable printers for use with laptops and mobile devices; neural helmets, not for medical purposes; cooling pads for laptop computers; pedometers; face identification apparatus; bathroom scales; smartphones; routers; home automation hubs; foldable smartphones; mobile phone screen protectors; mobile phone ring holders; mobile phone ring stands; holders adapted for mobile telephones and smartphones; in-car telephone handset cradles; dashboard mats adapted for holding mobile telephones and smartphones; cabinets for loudspeakers; television apparatus; head-up display apparatus for vehicles; smart speakers; wearable speakers; wireless speaker microphones; headsets; headsets for playing video games; portable speakers; cameras; flash lamps for smartphones; measuring instruments; teaching robots; optical lenses; usb cables; chips [integrated circuits]; electrical adapters; video screens; computer screens; electronic key fobs being remote control apparatus;

biometric locks; contact lens cases incorporating ultrasonic cleaning functions; mobile power supply (rechargeable batteries); portable power chargers; battery chargers for laptop computers; animated cartoons.

(260) AM 2023 118345 A

(800) 1669729

(151) 2022 06 03

(891) 2022 06 03

(731) SIMONELLI GROUP S.P.A.

Via Emilio Betti 1, I-62020 BELFORTE DEL CHIANTI (MC), Italy

(540)

PUREBREW

(591) Black, white

(531) 27.05.01

(511)

11 – Coffee machines, electric; espresso machines, electric; coffee percolators, electric; electric wireless coffee pots; automatic installations for making coffee; coffee roasters; coffee roasting ovens; electric coffee filters; coffee roasting machines; electric chocolate makers; heating and cooling apparatus for dispensing hot and cold beverages; apparatus for keeping hot drinks warm; thermoelectric apparatus for heating beverages; refrigerated units for dispensing beverages; beverage cooling apparatus; refrigerating apparatus and machines; refrigerators; apparatus for heating, steam generating, cooking, drying and water supply.

21 – Coffee machines, non-electric; coffee percolators, non-electric; plunger-style coffee makers, non-electric; vacuum coffee makers; coffee grinders, hand-operated; spice grinders (non-electric -); coffee stirrers; non-electric coffee frothers; tea infusers of precious metal; tea infusers, not of precious metal; coffee filters, non-electric; coffee services [tableware]; coffee cups; cups; tea cups; coffee scoops; sugar bowls; drinking glasses; coffee mugs; refillable coffee capsules; refillable tea capsules; coffee filters, non-electric; household utensils and containers; tableware; dishes; household or kitchen utensils; household containers.

(260) AM 2023 118347 A

(800) 1669781

(151) 2022 01 21

(891) 2022 01 21

(731) Onmobile Global Limited

tower 194/1c and 94/2, veerasandra village, attibele hobli, anekal taluk, electronic city phase 1, banglore, karnataka 560100, India

(540)

JUST BEAT IT

(591) Black, white

(531) 27.05.10

(511)

9 – Computer gaming software; gaming software; computer application software featuring games and gaming; computer software for the administration of online games and gaming; software for online traffic management and software for managing social interactions in the field of online games on websites and game apps on mobile.

41 – Education services; providing of training services; entertainment services; sporting and cultural activities; online game services.

42 – Platforms for gaming as software as a service [saas]; software as a service [saas] featuring software platforms for electronic gaming; development of computer system for providing multimodal platform that offers an integrated mobile applications environment, system for providing an environment for integrating sms, wap and voice interactivity, system for providing live audio streaming, interactive media programming, karaoke and m-commerce.

(260) AM 2023 118349 A

(800) 1669836

(151) 2022 05 02

(891) 2022 05 02

(731) ARKEMA FRANCE

420 rue d'Estienne d'Orves, F-92700 Colombes,
France

(540)



(591) Black, green

(531) 27.05.02; 29.01.12

(511)

1 – Chemical products for use in industry, science, photography, as well as in agriculture, horticulture and forestry; unprocessed artificial resins; unprocessed plastic materials; soil fertilizers; fire-extinguishing compositions; tempering and soldering preparations; chemical substances for preserving foodstuffs; tanning materials; adhesives for use in industry; chemical products for the manufacture of adhesives; adhesives (adhesive materials) for industry; adhesives for ceiling coverings, for floor coverings, for wall coverings; glues for repair and assembly of objects; glues for wallpaper; separating and unsticking [ungluing] products; size for finishing and priming; solvents (chemical products for use in industry) for glues; unprocessed epoxy, acrylic and synthetic resins.

16 – Adhesives (glues) for stationery or household purposes; paintbrushes; artists' materials; glues for wood for household use; glues for fabrics for household use.

17 – Rubber, gutta-percha, gum, asbestos, mica; products made of semi-finished plastic materials; pac-

king, stopping and insulating materials; flexible pipes not of metal; Epoxy, acrylic and synthetic resins (semi-finished products); sealant compounds for joints; insulating coatings; insulating varnish; adhesive tapes and strips other than for medical, stationery or household purposes; waterproof packings.

42 – Industrial research and analysis, technological and scientific services, namely research and development of new products, chemical research, mechanical research, biological research, chemical analysis; technical project studies in the field of chemistry.

(260) AM 2023 118350 A

(800) 1669839

(151) 2022 05 03

(891) 2022 05 03

(731) Novartis AG

CH-4002 Basel, Switzerland

(540)

AAKINBEV

(591) Black, white

(511)

5 – Pharmaceutical preparations for human use.

(260) AM 2023 118351 A

(800) 1669925

(151) 2022 04 06

(891) 2022 04 06

(731) Navasard Limited

Agias Irinis 16, Office 101, Aglantzia,
CY-2102 Nicosia, Cyprus

(540)



(591) Dark blue, light blue and white

(531) 27.05.17; 27.05.19; 27.07.01; 29.01.04

(511)

41 – Provision of information relating to racing; provision of information relating to jockeys; provision of information relating to racehorses; provision of information relating to sports; provision of information relating to motor sports; entertainment in the nature of golf tournaments; entertainment in the nature of wrestling contests; entertainment in the nature of basketball games; entertainment in the nature of yacht races; entertainment in the nature of boxing contests; entertainment in the nature of tennis tournaments; entertainment in the nature of football games; entertainment in the nature of soccer games; entertainment in the nature of automobile races; entertainment in the nature of gymnastic performances; entertainment in the nature of baseball games; entertainment in the nature of hockey games; entertainment in the nature of weight lifting competitions; entertainment in the natu-

re of track and field competitions; provision of information relating to motor racing; racing information services; handicapping for sporting events; entertainment services in the nature of skating events; providing wrestling news and information via a global computer network; sporting results services; betting services; horses (betting on -); casino, gaming and gambling services; providing of casino and gaming facilities; dog races; football pools services; wagering services; online gaming services; gaming services for entertainment purposes; gaming services; gambling; gambling services; online gambling services; game services provided on-line from a computer network; electronic game services and competitions provided by means of the internet; games equipment rental; providing online electronic publications, not downloadable; operating lotteries; recreation information.

42 – Computer programming; computer software design; rental of computer software; rental of computer software and programs; rental and maintenance of computer software; creating and maintaining websites; creating and maintaining web sites for others; providing information on computer technology and programming via a web site; maintenance of computer software; updating and maintenance of computer software and programs.

(260) AM 2023 118352 A
(800) 785069
(151) 2002 06 10
(891) 2022 06 13
(731) Mühlbauer Technology GmbH
Elbgaustraße 248, 22547 Hamburg, Germany
(540)

Luxatemp

(591) Black, white
(511)
5 – Material (dental) for stopping teeth and dental wax.

(260) AM 2023 118353 A
(800) 785094
(151) 2002 06 10
(891) 2022 06 13
(731) Mühlbauer Technology GmbH
Elbgaustraße 248, 22547 Hamburg, Germany
(540)

Tempocem

(591) Black, white
(511)
5 – Dental cement.

(260) AM 2023 118354 A
(800) 785095
(151) 2002 06 10
(891) 2022 06 13
(731) Mühlbauer Technology GmbH
Elbgaustraße 248, 22547 Hamburg, Germany
(540)

PERMACEM

(591) Black, white
(526)
(511)
5 – Dental cement.

(260) AM 2023 118355 A
(800) 785096
(151) 2002 06 11
(891) 2022 06 12
(731) Mühlbauer Technology GmbH
Elbgaustraße 248, 22547 Hamburg, Germany
(540)

LUXACORE

(591) Black, white
(511)
5 – Material (dental) for stopping teeth, and dental wax.

(260) AM 2023 118356 A
(800) 841847
(151) 2004 06 14
(891) 2022 05 30
(731) GALLERIA S.r.l.
Viale Vittorio Veneto 6, I-20124 MILANO, Italy
(540)

Love Therapy

(591) Black, white
(531) 27.05.01
(511)
18 – Bags; handbags; valises; rucksacks; wallets; purses; briefcases; briefcases leather and leather substitutes; pouches for men; trunks; hide; articles of hide; leather and leather goods; parasols; beach parasols; umbrellas; walking sticks.

25 – Clothing for men, women and children in general, including clothing made of skin or hide; shirts; short-sleeved shirts, skirts; suits; jackets; trousers; short trousers; jumpers; woollen clothing; pyjamas; stockings; tank tops; corsets; sock suspenders; undershorts; brassieres; underclothing; hats; scarves; neckties; waterproof clothing; overcoats; coats; bathing suits; sports suits; windbreaker jackets; ski trousers; belts; pelisses; sashes for wear; gloves; dressing gowns; shoes in general, including slippers, shoes, sports shoes, boots and sandals.

(260) AM 2023 118602 A
 (800) 1672532
 (151) 2022 02 23
 (891) 2022 02 23
 (731) ACADIA Pharmaceuticals, Inc.
 12830 El Camino Real, Suite 400, San Diego
 CA 92130, USA

(540)

JUBRYTON

(591) Black, white

(511)

5 – Pharmaceuticals for use in the prevention and treatment of neurologic, genetic, psychologic, and psychiatric diseases and disorders.

35 – Promoting awareness of patient support offerings for neurologic, genetic, psychologic, and psychiatric diseases and disorders; medical referrals.

42 – Scientific and industrial biotechnological and biomedical research; chemical, biochemical and molecular biological analyses; providing medical and scientific research information in the field of pharmaceuticals and clinical trials.

44 – Medical consulting with respect to neurologic, genetic, psychologic, and psychiatric diseases and disorders, including Rett syndrome and its identification and treatment; providing online information for health care providers, caregivers, and patients in the field of neurologic, genetic, psychologic, and psychiatric diseases and disorders; medical informational support services, namely, providing information about the benefits of diagnostic tools, medical information regarding disease diagnosis, identification, treatment, and management, and healthcare-related information to patients, caregivers, and healthcare professionals all related to neurologic, genetic, psychologic, and psychiatric diseases and disorders; medical testing, namely, in vitro and in vivo preclinical testing of potential drugs; consultation related thereto.

(260) AM 2023 118603 A
 (800) 1672533
 (151) 2022 02 23
 (891) 2022 02 23
 (731) ACADIA Pharmaceuticals, Inc.
 12830 El Camino Real, Suite 400, San Diego
 CA 92130, USA

(540)

DAYBUE

(591) Black, white

(511)

5 – Pharmaceuticals for use in the prevention and treatment of neurologic, genetic, psychologic, and psychiatric diseases and disorders.

35 – Promoting awareness of patient support offerings for neurologic, genetic, psychologic, and psychiatric

diseases and disorders; medical referrals.

42 – Scientific and industrial biotechnological and biomedical research; chemical, biochemical and molecular biological analyses; providing medical and scientific research information in the field of pharmaceuticals and clinical trials.

44 – Medical consulting with respect to neurologic, genetic, psychologic, and psychiatric diseases and disorders, including Rett syndrome and its identification and treatment; providing online information for health care providers, caregivers, and patients in the field of neurologic, genetic, psychologic, and psychiatric diseases and disorders; medical informational support services, namely, providing information about the benefits of diagnostic tools, medical information regarding disease diagnosis, identification, treatment, and management, and healthcare-related information to patients, caregivers, and healthcare professionals all related to neurologic, genetic, psychologic, and psychiatric diseases and disorders; medical testing, namely, in vitro and in vivo preclinical testing of potential drugs; consultation related thereto.

(260) AM 2023 118604 A
 (800) 1672534
 (151) 2022 02 23
 (891) 2022 02 23
 (731) ACADIA Pharmaceuticals, Inc.
 12830 El Camino Real, Suite 400, San Diego
 CA 92130, USA

(540)

YULINXUS

(591) Black, white

(511)

5 – Pharmaceuticals for use in the prevention and treatment of neurologic, genetic, psychologic, and psychiatric diseases and disorders.

35 – Promoting awareness of patient support offerings for neurologic, genetic, psychologic, and psychiatric diseases and disorders; medical referrals.

42 – Scientific and industrial biotechnological and biomedical research; chemical, biochemical and molecular biological analyses; providing medical and scientific research information in the field of pharmaceuticals and clinical trials.

44 – Medical consulting with respect to neurologic, genetic, psychologic, and psychiatric diseases and disorders, including Rett syndrome and its identification and treatment; providing online information for health care providers, caregivers, and patients in the field of neurologic, genetic, psychologic, and psychiatric diseases and disorders; medical informational support services, namely, providing information about the benefits of diagnostic tools, medical information regarding disease diagnosis, identification, treatment, and

management, and healthcare-related information to patients, caregivers, and healthcare professionals all related to neurologic, genetic, psychologic, and psychiatric diseases and disorders; medical testing, namely, in vitro and in vivo preclinical testing of potential drugs; consultation related thereto.

(260) AM 2023 118605 A

(800) 1672538

(151) 2021 12 30

(891) 2021 12 30

(731) WORLD VET İLAÇ SANAYİ VE TİCARET LİMİTED ŞİRKETİ

15 Temmuz Mah., Camiyolu Cad. No.50

K.2, Güneşli Bağcılar, İstanbul, Türkiye

(540)

AZITROSTAR - АЗИТРОСТАР

(591) Black, white

(531) 28.05

(511)

5 – Pharmaceutical and veterinary preparations for medical purposes, chemical preparations for medical and veterinary purposes, chemical reagents for pharmaceutical and veterinary purposes, medicated cosmetics, dietary supplements for pharmaceutical and veterinary purposes, dietary supplements, nutritional supplements, medical preparations for slimming purposes, food for babies, herbs and herbal beverages adapted for medicinal purposes, dental preparations and articles: teeth filling material, dental impression material, dental adhesives and material for repairing teeth, sanitary preparations for medical use, hygienic pads, hygienic tampons, plasters, materials for dressings, diapers made of paper and textiles for babies, adults and pets, preparations for destroying vermin, herbicides, fungicides, preparations for destroying rodents, deodorants, other than for human beings or for animals, air purifying preparations, air deodorising preparations, disinfectants, antiseptics, detergents for medical purposes, medicated soaps, disinfectant soaps, antibacterial hand lotions.

(260) AM 2023 118606 A

(800) 1672539

(151) 2022 02 18

(891) 2022 02 18

(731) Gulbahar Tobacco International FZE

P.O. Box 61401, Jebel Ali Free Zone,

Dubai, United Arab Emirates

(540)

CAVALLO

(591) Black, white

(511)

34 – Cigarettes; cigarillos; cigars; tobacco; tobacco pipes; matches; ashtrays for smokers; lighters for smokers; cigar holders; cigarette holders.

(260) AM 2023 118607 A

(800) 1672554

(151) 2022 03 24

(891) 2022 03 24

(731) Henan Shuanghui Investment & Development Co., Ltd.

No. 1, Shuanghui Road, Luohe City, 462000

Henan Province, China

(540)

双汇

(591) Black, white

(531) 28.03

(511)

29 – Quick-frozen instant dishes consisting primarily of fish, meat, fruits, vegetables or dairy products; fish-based foodstuffs; cooked meat products; oils for food; meat; tofu products; charcuterie; meat, canned; sausages; ham.

30 – Coffee-based beverages; pastries; relish for use as a condiment; rice-based prepackaged lunch with meat, fish or vegetables; instant rice; boxed lunches consisting primarily of noodles or rice and also containing fish, meat, fruits, vegetables or dairy products; cereal preparations; noodle-based prepared meals; seasonings; condiments.

(260) AM 2023 118608 A

(800) 1672566

(151) 2022 04 05

(891) 2022 04 05

(731) HELL ENERGY Magyarország Kft.

Andrássy út 126., H-1062 Budapest, Hungary

(540)

FOCUS

(591) Black, white

(511)

32 – Beer; mineral and aerated waters and other non-alcoholic beverages; waters [beverages]; fruit juice beverages; syrups and other preparations for making beverages; isotonic beverages; vegetable juices [beverages]; energy drinks.

(260) AM 2023 118609 A

(800) 1672605

(151) 2022 05 10

(891) 2022 05 10

(731) Richter Gedeon Nyrt.

Gyömrői út 19-21., H-1103 Budapest, Hungary

(540)

PAFENORM

(591) Black, white
(511)
5 – Pharmaceutical preparations.

(260) AM 2023 118610 A
(800) 1672658
(151) 2022 01 12
(891) 2022 01 12
(731) Arrow Home Group Co., Ltd.
1 Tower, No. 1 Kangyu Three Road, Nanshan
Town, Sanshui District, Foshan City,
Guangdong Province, China

(540)

ARROW

(591) Black, white
(511)
6 – Poles of metal; common metals, unwrought or semi-wrought; props of metal; sheets and plates of metal; nozzles of metal; jets of metal; water-pipes of metal; sleeves [metal hardware]; junctions of metal for pipes; reinforcing materials of metal for pipes; collars of metal for fastening pipes; water-pipe valves of metal; branching pipes of metal; pipes of metal; valves of metal, other than parts of machines; hose clamps of metal; metal pipe supports; metal connectors for pipes; clips of metal for cables and pipes; elbows of metal for pipes, including those made from alloy steel and titanium; window rails of metal; floor tiles of metal; doors of metal; jalousies of metal; outdoor blinds of metal; porches [structures] of metal; shutters of metal; ceilings of metal; floors of metal; door panels of metal; window frames of metal; door frames of metal; windows of metal; wall tiles of metal; handrails of metal; metal stepladders and ladders; washers of metal; rings of metal; shims; pegs of metal; cramps of metal [crampons]; buckles of common metal [hardware]; pins [hardware]; cabinet stops of metal; hat hooks of metal; towel dispensers, fixed, of metal; window stops of metal; window pulleys of metal; window fasteners of metal; fittings of metal for windows; door closers of metal, non-electric; non-electric door closers made of metal; latches of metal; door knockers of metal; furniture casters of metal; clothes hooks of metal; door handles of metal; door openers of metal, non-electric; hooks of metal for clothes rails; fixed towel dispensers of metal; fittings of metal for furniture; door fittings of metal; bathtub grab bars of metal; brackets of metal for furniture; door bells of metal, non-electric; bells; bag hangers of metal; safes [metal or non-metal]; safes, electronic; pot hooks of metal; hooks [metal hardware]; vice claws of metal; pulleys of metal, other than for machines; baskets of metal; casks of metal; boxes of common metal; chests of metal; household water tanks of metal.

20 – Washstands [furniture]; casks, not of metal; mirrors [looking glasses]; bamboo curtains; coathooks, not of metal; indoor window blinds [furniture]; shoe

cabinets; bathroom vanities [furniture]; furniture; wardrobes; beds; towel stands [furniture]; tables; bathroom mirrors; curtain rails of metal; chests for toys; boxes of wood or plastic; brush mountings; statues of wood, wax, plaster or plastic; towel dispensers, fixed, not of metal.

21 – Boxes of glass; works of art made of crystal; tangsancai [tri-coloured glazed pottery]; works of art of porcelain, ceramic, earthenware, terra-cotta and glass; figurines of porcelain, ceramic, earthenware, terra-cotta and glass; statuettes of porcelain, ceramic, earthenware, terra-cotta and glass; china ornaments; chopstick cases; soap holders; boxes for dispensing paper towels; soap dispensers; drying racks for laundry; rails and rings for towels; toilet paper holders; laundry drying racks; toothpick holders; perfume sprayers.

(260) AM 2023 118612 A
(800) 1672757
(151) 2022 04 04
(891) 2022 04 04
(731) LKW WALTER Internationale
Transportorganisation AG
IZ NÖ-Süd, Straße 14/Objekt 15, A-2355
Wiener Neudorf, Austria

(540)



(591) Black, white
(531) 01.05.02; 18.01.08; 18.01.12; 18.03.14;
18.03.15; 26.11.08; 27.05.01; 27.05.08;
27.05.24

(511)
36 – Underwriting relating to transport insurance; transport insurance brokerage; financial services relating to the transportation of goods.

39 – Transport; transport by road; transport by rail; transport by sea; hauling; storage; transportation logistics; arrangement of transportation; consultancy services relating to transportation: providing transport information; tracking of freight vehicles by computer or via GPS.

(260) AM 2023 118613 A
(800) 1672786
(151) 2022 06 08
(891) 2022 06 08
(731) AMB SARL
1 Rue Jean Jaurès, F-74000 Annecy, France

(540)

Mont Blanc

(591) Blue and red.
 (531) 27.05.01; 27.05.11; 29.01.12
 (511)
 33 – Vodka; anisette; kirsch; vodka-based alcoholic carbonated beverages with fruit flavoring.

(260) AM 2023 118614 A
 (800) 983484
 (151) 2008 08 19
 (891) 2022 06 10
 (731) Mühlbauer Technology GmbH
 Elbgaustraße 248, 22547 Hamburg, Germany
 (540)

ICON

(591) Black, white
 (511)
 5 – Dental material for stopping teeth, fastening and moulding material; pharmaceutical preparations as well as preparations for dental purposes, in particular for dental minimal invasive therapies, in particular for infiltrations of caries lesions of the dental enamel.
 10 – Surgical, medical and dental apparatus and instruments, in particular apparatus and applications of dental materials.

(260) AM 2023 118615 A
 (800) 1089612
 (151) 2011 06 10
 (891) 2022 06 14
 (731) SAKALAK TARIM MAKINALARI SAN. VE TIC. A.S.
 3. Organize San. Böl. Evrenköy, Cd. 1. Nolu Sk. No:4, KONYA, Türkiye
 (540)



(591) Metallic grey, yellow, black and red
 (531) 05.07.02; 15.07.15; 15.07.20; 27.05.17; 29.01.13
 (511)
 7 – Agricultural machines used in animal husbandry and other agricultural sectors; machines for processing grain, fruit and vegetables; food processing machines and robotic mechanisms namely agricultural elevators, agricultural implements other than hand-operated, agricultural machines.

(260) AM 2023 118616 A
 (800) 1314183
 (151) 2016 06 09
 (891) 2022 06 24
 (731) IZIPIZI
 19 rue de Calais, F-75009 Paris, France



(591) Black, white
 (531) 26.01.01; 26.01.05; 27.05.17
 (526) PARIS.
 (511)
 9 – Spectacles (optics); sunglasses; spectacle cases; spectacle cords, all the aforesaid goods designed and/or made in France.
 35 – Advertising; online retail sale services featuring optical goods; demonstration of goods; organization of exhibitions for commercial or advertising purposes; retail store services for optical goods and wholesale distribution of optical goods.

(260) AM 2023 118617 A
 (800) 1398953
 (151) 2018 02 22
 (891) 2022 06 07
 (731) BTL Industries
 8 Tzar Kaloyan str, BG-1000 Sofia, Bulgaria
 (540)

HIFEM

(591) Black, white
 (511)
 10 – Medical and aesthetic apparatus and instruments, in particular apparatus and instruments generating electrical, magnetic, electromagnetic, mechanical or thermal therapeutic energy; medical and aesthetic apparatus and instruments, in particular apparatus and instruments for body shaping, fat removal, circumference reduction, skin tightening, cellulite reduction, skin rejuvenation, wrinkle reduction, scar reduction, stretch mark reduction; aesthetic massage apparatus, in particular apparatus for lymphatic drainage and increasing the circulation of bodily fluids; physical therapy apparatus, in particular apparatus for treating pain and preventing muscle cramps; aesthetic massage apparatus; gynaecological and urological apparatus and instruments; dental equipment; rehabilitation apparatus (body -) for medical purposes; physical therapy equipment; physiotherapy and rehabilitation equipment; beds specially made for medical purposes; contraceptive devices; artificial limbs; orthopedic articles; suture materials.

(260) AM 2023 118618 A
 (800) 1401107
 (151) 2018 02 27
 (891) 2022 06 07
 (731) BTL Industries
 8 Tzar Kaloyan str, BG-1000 Sofia, Bulgaria
 (540)

EMSELLA

(591) Black, white
 (511)
 10 – Medical and aesthetic apparatus and instruments, in particular apparatus and instruments generating electrical, magnetic, electromagnetic, mechanical or thermal therapeutic energy; medical and aesthetic apparatus and instruments, in particular apparatus and instruments for body shaping, fat removal, circumference reduction, skin tightening, cellulite reduction, skin rejuvenation, wrinkle reduction, scar reduction, stretch mark reduction; above medical apparatuses with exception for the treatment of the nasopharynx including inhalers and nasal irrigators; aesthetic massage apparatus, in particular apparatus for lymphatic drainage and increasing the circulation of bodily fluids; physical therapy apparatus, in particular apparatus for treating pain and preventing muscle cramps; aesthetic massage apparatus; gynaecological and urological apparatus and instruments; dental equipment; rehabilitation apparatus (body -) for medical purposes; physical therapy equipment; physiotherapy and rehabilitation equipment; beds specially made for medical purposes; contraceptive devices; artificial limbs; orthopedic articles; suture materials; all the aforementioned goods not in connection with cardiologic and cardiovascular treatment apparatus, including body fluid movement pumps, enablers or enhancers of any kind.

(260) AM 2023 118619 A
 (800) 1401812
 (151) 2018 03 13
 (891) 2022 06 24
 (731) DONNAFUGATA S.r.l.
 Via S. Lipari, 18, I-91025 MARSALA (TP),
 Italy
 (540)

DONNAFUGATA

(591) Black, white
 (511)
 33 – Alcoholic beverages [except beers], wines.

(260) AM 2023 118620 A
 (800) 1476464
 (151) 2019 04 18
 (891) 2022 06 24
 (731) IZIPIZI
 19 rue de Calais, F-75009 Paris, France

(540)

IZIPIZI

(591) Black, white
 (511)
 9 – Spectacles (optics); sunglasses; ski goggles; ski masks; spectacle cases; spectacle cords.
 35 – Advertising; online retail sale services featuring optical goods; demonstration of goods; organization of exhibitions for commercial or advertising purposes; retail store services for optical goods and wholesale distribution services for optical goods.

(260) AM 2023 118621 A
 (800) 1497557
 (151) 2019 07 16
 (891) 2022 05 17
 (731) Obshchestvo s ogranichennoy otvetstvennostyu
 "Khaiper PK"
 ul. Timiryazevskaya, 17, k. 1, kv. 42,
 RU-127442 Moscow, Russian Federation
 (540)

HYPERPC

(591) Black, white
 (531) 27.05.01
 (511)
 9 – Apparatus for recording, transmission or reproduction of sound or images; data processing equipment; computers; computer software; magnetic tape units for computers; computer memory devices; joysticks for use with computers, other than for video games; floppy disks; disks, magnetic; optical discs; circular slide rules; disk drives for computers; juke boxes for computers; wearable video display monitors; electronic numeric displays; electronic interactive whiteboards; electronic notice boards; interfaces for computers; electronic pens [visual display units]; video game cartridges; toner cartridges, unfilled, for printers and photocopiers; memory cards for video game machines; encoded magnetic cards; computer keyboards; thin client computers; electronic book readers; electronic agendas; compact discs [audio-video]; compact discs [read-only memory]; laptop computers; tablet computers; notebook computers; wearable computers; microprocessors; modems; monitors [computer hardware]; monitors [computer programs]; headphones; sound recording carriers; optical data media; computer software, recorded; computer hardware; wrist rests for use with computers; electronic pocket translators; computer software platforms, recorded or downloadable; wafers for integrated circuits; printed circuit boards; protective films adapted for computer screens; personal digital assistants [PDAs]; navigation apparatus for vehicles [on-board computers]; computer software applications, downloadable; printers for use with computers; computer programs, recorded; computer game software; computer programs [downloadable software]; computer operating programs, re-

corded; computer screen saver software, recorded or downloadable; processors [central processing units]; electronic publications, downloadable; scanners [data processing equipment]; hand-held electronic dictionaries; smart cards [integrated circuit cards]; smartglasses; smartphones; smartwatches; bags adapted for laptops; interactive touch screen terminals; data processing apparatus; couplers [data processing equipment]; computer peripheral devices; readers [data processing equipment]; USB flash drives; sleeves for laptops; covers for personal digital assistants [PDAs]; covers for tablet computers; covers for smartphones; chips [integrated circuits].

35 – Demonstration of goods; commercial information and advice for consumers in the choice of products and services; marketing in the framework of software publishing; online retail services for downloadable digital music; organization of exhibitions for commercial or advertising purposes; arranging newspaper subscriptions for others; design of advertising materials; data search in computer files for others; providing business information via a web site; presentation of goods on communication media, for retail purposes; distribution of samples; dissemination of advertising matter; direct mail advertising; advertising; on-line advertising on a computer network; compilation of information into computer databases; systemization of information into computer databases; web site traffic optimization; search engine optimization for sales promotion; procurement services for others [purchasing goods and services for other businesses]; retail and wholesale store services; retail and wholesale services; retail services provided by means of mail order catalogs; retail services via TV shops or Internet.

37 – Repair information; installation, maintenance and repair of computer hardware.

42 – Design and development of computer hardware and software; computer system analysis; recovery of computer data; computer virus protection services; installation of computer software; web site design consultancy; computer security consultancy; information technology [IT] consultancy; consultancy in the design and development of computer hardware; internet security consultancy; computer software consultancy; data security consultancy; technological consultancy; updating of computer software; monitoring of computer systems to detect breakdowns; monitoring of computer systems for detecting unauthorized access or data breach; monitoring of computer systems by remote access; software as a service [SaaS]; maintenance of computer software; digitization of documents [scanning]; conversion of data or documents from physical to electronic media; providing information on computer technology and programming via a web site; providing information on computer technology and programming via a website; providing search engines for the internet; platform as a service [PaaS]; conversion of computer programs and data, other than physical con-

version; conducting technical project studies; computer system design; rental of web servers; computer rental; rental of computer software; hosting computer sites [web sites]; server hosting; computer software design; software development in the framework of software publishing; creating and designing website-based indexes of information for others [information technology services]; creating and maintaining web sites for others; computer programming; technical writing; duplication of computer programs; cloud computing; outsource service providers in the field of information technology; off-site data backup; computer technology consultancy; data encryption services; electronic data storage.

(260) AM 2023 118797 A

(800) 1675001

(151) 2022 05 11

(891) 2022 05 11

(731) ASSOCIATION OF HEMATOLOGISTS

ul. Argunovskaya, d. 12, kv. 278, RU-129075
Moscow, Russian Federation

(540)



(591) Red and white

(531) 01.13.15; 01.15.15; 02.09.14; 03.11.01;

11.03.07; 24.01.08; 24.01.09; 24.17.05; 28.05;
29.01.12

(511)

9 – Electronic publications, downloadable; audiovisual teaching apparatus.

16 – Pamphlets; booklets; newsletters; newspapers; magazines [periodicals]; periodicals; printed publications; books; printed matter; prospectuses; manuals [handbooks]; instructional and teaching materials.

41 – Providing of training; organization of cultural or educational events; educational services; providing online electronic publications, not downloadable; correspondence courses; practical training [demonstration]; arranging and conducting of conferences; arranging and conducting of workshops [training]; arranging and conducting of seminars; online publication of electronic books and journals; publication of texts, other than publicity texts; providing online videos, not downloadable.

42 – Scientific and technological services and research and design relating thereto; industrial analysis and industrial research services; medical research; scientific research.

(260) AM 2023 118798 A
 (800) 1675050
 (151) 2022 05 11
 (891) 2022 05 11
 (731) FRESH FOOD ARTS GIDA SANAYİ VE
 TİCARET ANONİM ŞİRKETİ
 ALTAYÇEŞME MAH. ÖZ SK., GOLD
 PLAZA MALTEPE 19 25, Maltepe, İstanbul,
 Türkiye
 (540)



(591) Black, white, red, light orange and light blue
 (531) 03.07.03; 03.07.19; 03.07.24; 24.17.04;
 26.04.05; 26.04.16; 26.04.22; 26.04.24;
 26.07.25; 26.13.25; 27.05.01; 27.05.09;
 27.05.10; 27.05.24; 29.01.15
 (511)
 43 – Services for providing food and drink; temporary
 accommodation.

(260) AM 2023 118799 A
 (800) 1675056
 (151) 2022 06 01
 (891) 2022 06 01
 (731) Obshchestvo s ogranichennoy otvetstvennostiyu
 "SINDIKAOIL"
 ul. Dovatorcev, dom 47 korpus B,
 pomeshchenie 57, RU-355042 Stavropol,
 Russian Federation
 (540)



SINDIKA OIL

(591) Black, white, yellow, turquoise and dark
 turquoise
 (531) 01.15.15; 27.05.01; 29.01.14
 (526) OIL
 (511)
 4 – Industrial oils and greases; lubricants; dust absor-
 bing, wetting and binding compositions; fuels (includ-
 ing motor spirit) and illuminants; candles and wicks
 for lighting.
 12 – Vehicles; apparatus for locomotion by land, air
 or water.

(260) AM 2023 118807 A
 (800) 1675161
 (151) 2021 11 30
 (891) 2021 11 30
 (731) PAVO CAPITAL JOINT STOCK COMPANY
 No. 14-16-18 Chu Manh Trinh Street, Ben
 Nghe Ward, District 1, Ho Chi Minh City,
 Viet Nam
 (540)

MOVINAVIR

(591) Black, white
 (511)
 5 – Pharmaceuticals; pharmaceutical preparations; di-
 sinfectedants for medical purposes; functional foods for
 medical purposes; nutritional supplements.

(260) AM 2023 118808 A
 (800) 1675170
 (151) 2022 05 17
 (891) 2022 05 17
 (731) CGP (WUHU) SEALING CO., LTD.
 #1000 FIRST NANJI ROAD, XINWU
 DEVELOPMENT AREA, WUHU COUNTY,
 ANHUI PROVINCE, China
 (540)



(591) Black, white
 (531) 26.01.01; 26.01.03; 26.01.12; 26.01.24;
 26.11.12; 27.05.24
 (511)
 7 – Joints [parts of engines]; pistons for cylinders; fan
 belts for motors and engines; injectors for engines; oil
 pumps for automobiles; water pumps for automobiles;
 universal joints [cardan joints]; shock absorbers for
 machines; mechanical seals [machine parts]; bushings
 [parts of machines].

12 – Cars; automobile chassis; motors, electric, for
 land vehicles; clutches for land vehicles; engines for
 land vehicles; motors for land vehicles; propulsion
 mechanisms for land vehicles; shock absorbers for au-
 tomobiles; transmission shafts for land vehicles; brake
 pads for automobiles.

(260) AM 2023 118809 A
 (800) 1675191
 (151) 2022 06 27
 (891) 2022 06 27
 (731) JOINT STOCK COMPANY "FATS AND OIL"

INTEGRATED WORKS"
UL. TITOVA 27, EKATERINBURG,
RU-620085 SVERDLOVSKAYA OBLAST,
Russian Federation

(540)



(591) White, black, yellow, dark-yellow, brown, light-brown, dark-brown, beige, dark-beige, red, pink, and light-pink

(531) 02.03.01; 02.03.11; 02.03.23; 08.01.08; 25.01.15; 25.03.01; 28.05; 29.01.15

(511)

29 – Oils and fats for food; butter; margarine; cream-vegetable oils for food; spreads, namely dairy-based spreads, spreads made from vegetable oils and fats; buttercream; fat-containing mixtures for bread slices.

(260) AM 2023 118810 A

(800) 1675203

(151) 2022 01 13

(891) 2022 01 13

(731) Becreo Technologies Spółka z ograniczoną odpowiedzialnością
Plac Andersa 7, PL-61-894 Poznań, Poland

(540)

BECREO

(591) Black, white

(511)

9 – Recorded content; software; games software; educational computer programs; downloadable educational course materials; e-books; electronic publications, downloadable; teaching apparatus and instruments; instructional and teaching apparatus and instruments; science sets being teaching apparatus; science sets being instructional apparatus; teaching robots.

28 – Toys, games, playthings and novelties; video game apparatus.

35 – Retail or wholesale services for the following goods: games, playthings and curiosities, video games apparatus, information and data recorded on storage media, software programs, gambling software, education software, downloadable educational course materials, e-books, e-publications, teaching apparatus and instruments, instructional and teaching apparatus and instruments, science sets being teaching apparatus, science sets being instructional apparatus, teaching robots; business management of retail, wholesale and internet shops; business intermediary services relating

to matching business partners; import-export agency services; business and advertising consultancy, for others, in the field of selection of goods; business consultancy relating to franchising; business management services relating to franchising; business management and organisation consultancy; arranging and conducting of exhibitions and trade fairs for commercial or advertising purposes; demonstration of goods; shop window dressing; sales promotion for others; organisation of customer loyalty programs for commercial, promotional or advertising purposes.

41 – Training; education relating to the development of mental faculties; training in computer programming; educational services relating to the writing of computer programs; conducting of congresses for commercial and advertising purposes.

(260) AM 2023 118811 A

(800) 1675242

(151) 2022 05 26

(891) 2022 05 26

(731) MAX EUROPE EOOD

str. "Golyamokonarsko shose" 1, BG-4204
Tsaratsovo, area of Plovdiv, Bulgaria

(540)



(591) Black, white

(531) 26.11.02; 26.11.12; 26.13.25; 27.05.01; 27.05.09; 27.05.10; 27.05.24

(511)

9 – Cyclists' glasses; protective helmets for cyclists; bicycle helmets; satellite navigational system for bicycles; bicycle speedometers; locks (electric) for bicycles; protective visors; goggles; head protection; protective helmets; protective helmets for motorcyclists.

11 – Headlights for bicycles; bicycle lights; bicycle dynamo lights; headlamps for use on cycles; bicycle reflectors for attachment to spokes.

12 – Bicycles; mountain bikes; racing bicycles; folding bikes; sports bicycles; electric bicycles, bicycle saddles, racing bicycles, handlebars; bicycle handlebar grips; bicycle kickstands; bicycle carriers; spindles of bicycles, electric unicycles; motorised bicycles; motorised unicycles; bicycle pedals, self-balancing electric unicycles; saddlebags adapted for bicycles; hubs for bicycle wheels; brake levers for cycles; drive chains [bicycle parts]; brakes [bicycle parts]; gears for bicycles; bicycle trailers, gears for bicycles; hydraulic rim brakes for bicycles; saddle covers for bicycles; luggage carriers for cycles; covers for foot pedals on cycles, bicycle wheels, handlebar ends for bicycles; rack trunk bags for bicycles, bags for bicycles; direction indicators for bicycles; fittings for bicycles for

carrying luggage; fittings for bicycles for carrying beverages; windproof covers adapted for electric bicycles, bicycle racks for vehicles, pumps for bicycle tyres; bicycle mudguards, dress guards for bicycles; structural parts of bicycles; metal bells for bicycles; drivetrains for bicycles, charge-speed gears [bicycle parts]; mopeds.

25 – Cycling gloves; cyclists' clothing; cycling shorts; sports caps.

35 – Retail services in relation to bicycles; retail services in relation to bicycle accessories; providing online commercial directory information services; advertising, marketing and promotional services; business assistance, management and administrative services; wholesale services in relation to vehicles; wholesale ordering services; wholesale services in relation to sporting articles; wholesale services in relation to sporting equipment.

37 – Repair of bicycles; maintenance and repair of bicycles; providing information relating to the repair of bicycles repair or maintenance of bicycle parking apparatus.

(260) AM 2023 118812 A

(800) 1675283

(151) 2022 04 04

(891) 2022 04 04

(731) Euro Games Technology Ltd.

4, "Maritsa" Str., "Vranya-Lozen-Triugulnika",
BG-1151 Sofia, Bulgaria

(540)

BURNING

(591) Black, white

(511)

9 – Software; computer gaming software; computer software packages; computer operating system software; computer software, recorded; software drivers; virtual reality software; games software; entertainment software for computer games; computer programs for network management; operating computer software for main frame computers; monitors (computer hardware); computer hardware; apparatus for recording images; monitors (computer programs); computer game programs; computer programs for recorded games; apparatus for recording, transmission or reproduction of sound or images; communications servers [computer hardware]; electronic components for gambling machines; computer application software featuring games and gaming; computer software for the administration of on-line games and gaming; computer hardware for games and gaming; electronic components and computer software for gambling, gambling machines, gambling games on the Internet and via telecommunication network.

28 – Gaming machines for gambling; chips for gambling; mah-jong; arcade games; gambling machines

operating with coins, notes and cards; games; electronic games; parlor games; gaming chips; gaming tables; slot machines [gaming machines]; LCD game machines; slot machines and gaming devices; coin-operated amusement machines; roulette chips; poker chips; chips and dice [gaming equipment]; gaming equipment for casinos; roulette tables; gaming roulette wheels; casino games; gambling machines and amusement machines, automatic and coin-operated; coin-operated amusement machines and / or electronic coin-operated amusement machines with or without the possibility of gain; boxes for coin-operated amusement machines, slot machines and gaming machines; electronic or electrotechnical amusement machines and apparatus, gaming machines, coin-operated entertainment machines; housings for coin-operated amusement machines, gaming equipment, gaming machines, machines for gambling; electropneumatic and electrical gambling machines (slot machines).

41 – Gambling; entertainment services related to gambling; gaming services for entertainment purposes; casino, gaming and gambling services; training in the development of software systems; provision of gaming equipment for gambling halls; providing casino equipment [gambling]; gaming machine entertainment services; providing casino facilities [gambling]; gaming hall services; amusement arcade services; games equipment rental; rental of gaming machines; providing amusement arcade services; rental of gaming machines with images of fruits; editing or recording of sounds and images; sound recording and video entertainment services; hire of sound reproducing apparatus; provision of gaming equipment for casinos; providing of casino facilities; online gambling services; casino services; provision of gaming facilities and gaming hall facilities, internet casinos and online gambling services.

(260) AM 2023 118813 A

(800) 1675305

(151) 2022 06 28

(891) 2022 06 28

(731) Caisley International GmbH

Harderhook 31, 46395 Bocholt, Germany

(540)

Caisley

(591) Black, white

(511)

6 – Identification tags of metal for animals.

8 – Agricultural hand tools.

9 – Measuring, detecting, monitoring and controlling devices.

20 – Identification tags of plastic for animals; identification tags for animals, not of metal.

(260) AM 2023 118814 A

(800) 1675308

(151) 2022 07 04

(891) 2022 07 04

(731) "Froneri Rus" Limited Liability Company
Kosmodamianskaya naberezhnaya, 52, bld. 1,
4 floor, ap. 2, office 4, RU-115054 Moscow,
Russian Federation

(540)

Monterra

(591) Black, white

(511)

30 – Binding agents for ice cream; frozen yogurt [confectionery ices]; ice for refreshment; ice, natural or artificial; edible ices; ice pops; ice cream; powders for making ice cream; sorbets [ices].

(260) AM 2023 118816 A

(800) 1675384

(151) 2022 04 12

(891) 2022 04 12

(731) Kia Corporation
12, Heolleung-ro, Seocho-gu, Seoul 06797,
Republic of Korea

(540)

wible

(591) Black, white

(531) 27.05.01

(511)

39 – Providing information relating to traffic and traffic congestion; providing traffic information; providing road and traffic information; providing mobile traffic information; transportation of merchandise and passengers; providing information relating to the transportation of goods and passengers; vehicle rental services; rental of parking places and garages for vehicles; transport of persons and goods; reservation of transport for passengers, goods and animals; transport of persons; transport; booking of transport; providing transportation information; arranging of transport; transport brokerage; providing information to travellers regarding fares, timetables and public transport; providing transportation information via a web site; providing information relating to travel via a web site; providing traffic information by car navigation; rental of automobiles and bicycles; providing traffic information for bicycles; bicycle parking place rental; providing information relating to vehicle parking services; reservation of parking spaces; rental of vehicle parking spaces; provision of parking spaces; provision of car parking facilities; car parking; parking lot services; parking space rental; car pool transport brokerage; car pool brokerage; providing traffic information via computer communication networks; providing taxi transport information by telephone call centers and

hotlines; providing taxi booking services via mobile applications; taxi booking services; taxi transport; freight and transport brokerage; car sharing services; vehicle rental; rental car reservation; leasing of rental car; carpooling services; tracking of automobile fleets using electronic navigation and locating devices [transport information]; tracking of freight vehicles by computer or via global positioning systems [transport information]; providing taxi transport; storage, distribution and supply of energy and fuel; distribution of electricity; storage and distribution of electricity; electricity supply services; energy supplying; distribution of energy.

INTERNATIONAL TRADEMARKS PROTECTED IN GEORGIA

(260) AM 2023 114080 A
(800) 1604196
(151) 2021 02 01
(181) 2031 02 01
(891) 2021 02 01
(511) 33, 35

(260) AM 2023 115949 A
(800) 1635143
(151) 2021 11 19
(181) 2031 11 19
(891) 2021 11 19
(511) 03

(260) AM 2023 114208 A
(800) 867712
(151) 2005 07 21
(181) 2025 07 21
(891) 2021 07 06
(511) 35

(260) AM 2023 116013 A
(800) 1635649
(151) 2021 06 25
(181) 2031 06 25
(891) 2021 06 25
(511) 25

(260) AM 2023 114578 A
(800) 1612420
(151) 2021 02 22
(181) 2031 02 22
(891) 2021 02 22
(511) 33

(260) AM 2023 116028 A
(800) 1636195
(151) 2021 08 26
(181) 2031 08 26
(891) 2021 08 26
(511) 05, 30, 35

(260) AM 2023 115080 A
(800) 1621635
(151) 2021 08 19
(181) 2031 08 19
(891) 2021 08 19
(511) 09

(260) AM 2023 116030 A
(800) 1636258
(151) 2021 09 27
(181) 2031 09 27
(891) 2021 09 27
(511) 09, 41

(260) AM 2023 115824 A
(800) 1270144
(151) 2015 01 21
(181) 2025 01 21
(891) 2021 11 24
(511) 09, 28

(260) AM 2023 116036 A
(800) 1636404
(151) 2021 11 15
(181) 2031 11 15
(891) 2021 11 15
(511) 11

(260) AM 2023 115825 A
(800) 1270145
(151) 2015 01 21
(181) 2025 01 21
(891) 2021 11 24
(511) 09, 28

(260) AM 2023 116037 A
(800) 1636414
(151) 2021 11 23
(181) 2031 11 23
(891) 2021 11 23
(511) 32, 33

(260) AM 2023 115915 A
(800) 1634210
(151) 2021 10 28
(181) 2031 10 28
(891) 2021 10 28
(511) 09

(260) AM 2023 116039 A
(800) 1636442
(151) 2021 11 25
(181) 2031 11 25
(891) 2021 11 25
(511) 44

(260) AM 2023 116040 A
(800) 1636450
(151) 2021 10 26
(181) 2031 10 26
(891) 2021 10 26
(511) 03

(260) AM 2023 116059 A
(800) 1207547
(151) 2014 02 13
(181) 2024 02 13
(891) 2021 12 06
(511) 05

(260) AM 2023 116041 A
(800) 1636451
(151) 2021 10 26
(181) 2031 10 26
(891) 2021 10 26
(511) 03

(260) AM 2023 116061 A
(800) 1337132
(151) 2016 10 05
(181) 2026 10 05
(891) 2021 12 03
(511) 07, 34, 35

(260) AM 2023 116044 A
(800) 1636522
(151) 2021 11 23
(181) 2031 11 23
(891) 2021 11 23
(511) 30

(260) AM 2023 116062 A
(800) 1341165
(151) 2016 10 05
(181) 2026 10 05
(891) 2021 12 03
(511) 07, 34, 35

(260) AM 2023 116045 A
(800) 1636551
(151) 2021 11 10
(181) 2031 11 10
(891) 2021 11 10
(511) 14

(260) AM 2023 116063 A
(800) 1420476
(151) 2018 07 11
(181) 2028 07 11
(891) 2021 12 14
(511) 03

(260) AM 2023 116052 A
(800) 1636748
(151) 2020 02 04
(181) 2030 02 04
(891) 2020 02 04
(511) 09, 38, 41

(260) AM 2023 116064 A
(800) 1422244
(151) 2018 06 19
(181) 2028 06 19
(891) 2021 12 03
(511) 03, 20

(260) AM 2023 116057 A
(800) 1148026
(151) 2012 09 27
(181) 2022 09 27
(891) 2021 10 04
(511) 09, 28

(260) AM 2023 116087 A
(800) 1636988
(151) 2021 12 06
(181) 2031 12 06
(891) 2021 12 06
(511) 05

(260) AM 2023 116058 A
(800) 1180685
(151) 2013 06 19
(181) 2023 06 19
(891) 2021 12 02
(511) 05

(260) AM 2023 116089 A
(800) 1637054
(151) 2021 10 19
(181) 2031 10 19
(891) 2021 10 19
(511) 09, 38, 42, 45

(260) AM 2023 116090 A
(800) 1637080
(151) 2021 11 22
(181) 2031 11 22
(891) 2021 11 22
(511) 32

(260) AM 2023 116107 A
(800) 1637583
(151) 2021 11 17
(181) 2031 11 17
(891) 2021 11 17
(511) 05

(260) AM 2023 116091 A
(800) 1637098
(151) 2021 11 03
(181) 2031 11 03
(891) 2021 11 03
(511) 12

(260) AM 2023 116108 A
(800) 1637623
(151) 2021 11 18
(181) 2031 11 18
(891) 2021 11 18
(511) 09

(260) AM 2023 116092 A
(800) 1637107
(151) 2021 11 26
(181) 2031 11 26
(891) 2021 11 26
(511) 05

(260) AM 2023 116109 A
(800) 1637706
(151) 2021 07 16
(181) 2031 07 16
(891) 2021 07 16
(511) 06, 09, 11, 17, 20, 21

(260) AM 2023 116093 A
(800) 1637160
(151) 2021 09 28
(181) 2031 09 28
(891) 2021 09 28
(511) 38, 41

(260) AM 2023 116110 A
(800) 1637793
(151) 2021 10 14
(181) 2031 10 14
(891) 2021 10 14
(511) 09, 38, 42, 45

(260) AM 2023 116104 A
(800) 1637461
(151) 2021 11 30
(181) 2031 11 30
(891) 2021 11 30
(511) 12

(260) AM 2023 116111 A
(800) 1637810
(151) 2021 09 28
(181) 2031 09 28
(891) 2021 09 28
(511) 09, 11

(260) AM 2023 116105 A
(800) 1637520
(151) 2021 10 20
(181) 2031 10 20
(891) 2021 10 20
(511) 29

(260) AM 2023 116113 A
(800) 1637947
(151) 2021 11 24
(181) 2031 11 24
(891) 2021 11 24
(511) 05

(260) AM 2023 116106 A
(800) 1637559
(151) 2021 10 29
(181) 2031 10 29
(891) 2021 10 29
(511) 34

(260) AM 2023 116114 A
(800) 1638049
(151) 2021 12 13
(181) 2031 12 13
(891) 2021 12 13
(511) 05

(260) AM 2023 116115 A
(800) 1638050
(151) 2021 12 13
(181) 2031 12 13
(891) 2021 12 13
(511) 05

(260) AM 2023 116122 A
(800) 1638200
(151) 2021 11 15
(181) 2031 11 15
(891) 2021 11 15
(511) 25

(260) AM 2023 116116 A
(800) 1638057
(151) 2021 12 07
(181) 2031 12 07
(891) 2021 12 07
(511) 05

(260) AM 2023 116123 A
(800) 1638247
(151) 2021 07 12
(181) 2031 07 12
(891) 2021 07 12
(511) 09

(260) AM 2023 116117 A
(800) 1638059
(151) 2021 12 07
(181) 2031 12 07
(891) 2021 12 07
(511) 05

(260) AM 2023 116125 A
(800) 1638272
(151) 2021 07 23
(181) 2031 07 23
(891) 2021 07 23
(511) 09, 28, 41

(260) AM 2023 116118 A
(800) 1638060
(151) 2021 12 07
(181) 2031 12 07
(891) 2021 12 07
(511) 05

(260) AM 2023 116135 A
(800) 1412931
(151) 2018 06 14
(181) 2028 06 14
(891) 2021 12 20
(511) 05

(260) AM 2023 116119 A
(800) 1638095
(151) 2021 11 22
(181) 2031 11 22
(891) 2021 11 22
(511) 04

(260) AM 2023 116137 A
(800) 1460119
(151) 2019 01 24
(181) 2029 01 24
(891) 2021 06 16
(511) 03

(260) AM 2023 116120 A
(800) 1638140
(151) 2021 06 14
(181) 2031 06 14
(891) 2021 06 14
(511) 35, 36, 39, 41, 42, 43, 44

(260) AM 2023 116138 A
(800) 1535066
(151) 2020 03 11
(181) 2030 03 11
(891) 2021 12 15
(511) 18, 25

(260) AM 2023 116121 A
(800) 1638149
(151) 2021 07 09
(181) 2031 07 09
(891) 2021 07 09
(511) 09, 35, 39, 43

(260) AM 2023 116139 A
(800) 1535175
(151) 2020 03 11
(181) 2030 03 11
(891) 2021 12 15
(511) 18, 25

(260) AM 2023 116140 A
(800) 1536152
(151) 2020 03 10
(181) 2030 03 10
(891) 2021 12 15
(511) 18

(260) AM 2023 116176 A
(800) 1638439
(151) 2021 09 13
(181) 2031 09 13
(891) 2021 09 13
(511) 28, 35

(260) AM 2023 116142 A
(800) 1584069
(151) 2020 12 17
(181) 2030 12 17
(891) 2021 06 29
(511) 31

(260) AM 2023 116177 A
(800) 1638451
(151) 2021 09 22
(181) 2031 09 22
(891) 2021 09 22
(511) 07, 11

(260) AM 2023 116143 A
(800) 1584304
(151) 2021 01 26
(181) 2031 01 26
(891) 2021 12 03
(511) 17, 19

(260) AM 2023 116178 A
(800) 1638462
(151) 2021 11 25
(181) 2031 11 25
(891) 2021 11 25
(511) 12

(260) AM 2023 116172 A
(800) 1638324
(151) 2021 04 16
(181) 2031 04 16
(891) 2021 04 16
(511) 33

(260) AM 2023 116180 A
(800) 1638475
(151) 2021 09 30
(181) 2031 09 30
(891) 2021 09 30
(511) 29

(260) AM 2023 116173 A
(800) 1638361
(151) 2021 10 25
(181) 2031 10 25
(891) 2021 10 25
(511) 09, 10, 18, 25, 28, 35, 41

(260) AM 2023 116181 A
(800) 1638531
(151) 2021 05 10
(181) 2031 05 10
(891) 2021 05 10
(511) 06, 07, 09, 11, 12, 14, 18, 19, 20, 25, 28, 37, 40, 42

(260) AM 2023 116174 A
(800) 1638402
(151) 2020 10 27
(181) 2030 10 27
(891) 2020 10 27
(511) 03, 05

(260) AM 2023 116182 A
(800) 1638607
(151) 2021 08 25
(181) 2031 08 25
(891) 2021 08 25
(511) 29, 30, 31, 40

(260) AM 2023 116175 A
(800) 1638435
(151) 2021 07 22
(181) 2031 07 22
(891) 2021 07 22
(511) 09, 28, 41, 42

(260) AM 2023 116183 A
(800) 1638639
(151) 2021 10 29
(181) 2031 10 29
(891) 2021 10 29
(511) 33

(260) AM 2023 116184 A
(800) 1638643
(151) 2021 10 22
(181) 2031 10 22
(891) 2021 10 22
(511) 35, 36, 39

(260) AM 2023 116193 A
(800) 1638757
(151) 2021 12 07
(181) 2031 12 07
(891) 2021 12 07
(511) 05

(260) AM 2023 116185 A
(800) 1638665
(151) 2021 11 19
(181) 2031 11 19
(891) 2021 11 19
(511) 09, 36, 42

(260) AM 2023 116194 A
(800) 1638758
(151) 2021 12 07
(181) 2031 12 07
(891) 2021 12 07
(511) 05

(260) AM 2023 116188 A
(800) 1638752
(151) 2021 12 06
(181) 2031 12 06
(891) 2021 12 06
(511) 05

(260) AM 2023 116195 A
(800) 1638759
(151) 2021 12 07
(181) 2031 12 07
(891) 2021 12 07
(511) 05

(260) AM 2023 116189 A
(800) 1638753
(151) 2021 12 06
(181) 2031 12 06
(891) 2021 12 06
(511) 05

(260) AM 2023 116196 A
(800) 1638760
(151) 2021 12 07
(181) 2031 12 07
(891) 2021 12 07
(511) 05

(260) AM 2023 116190 A
(800) 1638754
(151) 2021 12 06
(181) 2031 12 06
(891) 2021 12 06
(511) 05

(260) AM 2023 116197 A
(800) 1638761
(151) 2021 11 03
(181) 2031 11 03
(891) 2021 11 03
(511) 35, 43

(260) AM 2023 116191 A
(800) 1638755
(151) 2021 12 06
(181) 2031 12 06
(891) 2021 12 06
(511) 05

(260) AM 2023 116198 A
(800) 1638776
(151) 2021 01 11
(181) 2031 01 11
(891) 2021 01 11
(511) 03, 05, 09, 10, 16, 21, 24

(260) AM 2023 116192 A
(800) 1638756
(151) 2021 12 07
(181) 2031 12 07
(891) 2021 12 07
(511) 05

(260) AM 2023 116199 A
(800) 1638807
(151) 2021 06 09
(181) 2031 06 09
(891) 2021 06 09
(511) 16

(260) AM 2023 116200 A
(800) 1638825
(151) 2021 07 02
(181) 2031 07 02
(891) 2021 07 02
(511) 03, 16, 18, 25

(260) AM 2023 116208 A
(800) 1639191
(151) 2021 11 29
(181) 2031 11 29
(891) 2021 11 29
(511) 10

(260) AM 2023 116201 A
(800) 1638850
(151) 2021 11 01
(181) 2031 11 01
(891) 2021 11 01
(511) 09

(260) AM 2023 116209 A
(800) 1639211
(151) 2021 08 10
(181) 2031 08 10
(891) 2021 08 10
(511) 29, 30, 43

(260) AM 2023 116202 A
(800) 1638906
(151) 2021 11 29
(181) 2031 11 29
(891) 2021 11 29
(511) 34

(260) AM 2023 116210 A
(800) 1639218
(151) 2021 09 16
(181) 2031 09 16
(891) 2021 09 16
(511) 03

(260) AM 2023 116203 A
(800) 1638949
(151) 2021 08 02
(181) 2031 08 02
(891) 2021 08 02
(511) 09, 35, 37, 39, 42

(260) AM 2023 116211 A
(800) 1639237
(151) 2021 12 15
(181) 2031 12 15
(891) 2021 12 15
(511) 33

(260) AM 2023 116204 A
(800) 1638951
(151) 2021 09 08
(181) 2031 09 08
(891) 2021 09 08
(511) 39

(260) AM 2023 116212 A
(800) 1237519
(151) 2014 10 01
(181) 2024 10 01
(891) 2021 11 22
(511) 09, 11, 35

(260) AM 2023 116206 A
(800) 1639044
(151) 2021 05 25
(181) 2031 05 25
(891) 2021 05 25
(511) 11

(260) AM 2023 116275 A
(800) 1639616
(151) 2021 12 06
(181) 2031 12 06
(891) 2021 12 06
(511) 05

(260) AM 2023 116207 A
(800) 1639148
(151) 2021 09 22
(181) 2031 09 22
(891) 2021 09 22
(511) 09

(260) AM 2023 116348 A
(800) 1640322
(151) 2021 12 17
(181) 2031 12 17
(891) 2021 12 17
(511) 05

(260) AM 2023 116349 A
 (800) 1640339
 (151) 2021 04 07
 (181) 2031 04 07
 (891) 2021 04 07
 (511) 12, 35

(260) AM 2023 116364 A
 (800) 1640653
 (151) 2021 12 15
 (181) 2031 12 15
 (891) 2021 12 15
 (511) 09, 28, 41

(260) AM 2023 116350 A
 (800) 1640406
 (151) 2021 11 19
 (181) 2031 11 19
 (891) 2021 11 19
 (511) 43

(260) AM 2023 116368 A
 (800) 1641006
 (151) 2021 12 16
 (181) 2031 12 16
 (891) 2021 12 16
 (511) 43

(260) AM 2023 116352 A
 (800) 1640419
 (151) 2021 12 13
 (181) 2031 12 13
 (891) 2021 12 13
 (511) 40

(260) AM 2023 116369 A
 (800) 1641007
 (151) 2021 12 16
 (181) 2031 12 16
 (891) 2021 12 16
 (511) 43

(260) AM 2023 116353 A
 (800) 1640503
 (151) 2021 08 11
 (181) 2031 08 11
 (891) 2021 08 11
 (511) 03, 05

(260) AM 2023 116370 A
 (800) 1641008
 (151) 2021 12 06
 (181) 2031 12 06
 (891) 2021 12 06
 (511) 05

(260) AM 2023 116354 A
 (800) 1640504
 (151) 2021 08 11
 (181) 2031 08 11
 (891) 2021 08 11
 (511) 03, 05

(260) AM 2023 116372 A
 (800) 1641011
 (151) 2021 12 06
 (181) 2031 12 06
 (891) 2021 12 06
 (511) 05

(260) AM 2023 116355 A
 (800) 1640505
 (151) 2021 08 19
 (181) 2031 08 19
 (891) 2021 08 19
 (511) 03, 05

(260) AM 2023 116373 A
 (800) 1641012
 (151) 2021 12 06
 (181) 2031 12 06
 (891) 2021 12 06
 (511) 05

(260) AM 2023 116356 A
 (800) 1640518
 (151) 2021 11 25
 (181) 2031 11 25
 (891) 2021 11 25
 (511) 33

(260) AM 2023 116374 A
 (800) 1641013
 (151) 2021 12 06
 (181) 2031 12 06
 (891) 2021 12 06
 (511) 05

(260) AM 2023 116375 A
(800) 1641038
(151) 2021 11 24
(181) 2031 11 24
(891) 2021 11 24
(511) 25

(260) AM 2023 116599 A
(800) 1643817
(151) 2021 12 14
(181) 2031 12 14
(891) 2021 12 14
(511) 10

(260) AM 2023 116376 A
(800) 1045371
(151) 2010 06 10
(181) 2030 06 10
(891) 2021 12 23
(511) 05

(260) AM 2023 116600 A
(800) 1643858
(151) 2021 10 01
(181) 2031 10 01
(891) 2021 10 01
(511) 02

(260) AM 2023 116377 A
(800) 1103549
(151) 2011 09 22
(181) 2031 09 22
(891) 2021 11 12
(511) 05

(260) AM 2023 116601 A
(800) 1644008
(151) 2021 11 18
(181) 2031 11 18
(891) 2021 11 18
(511) 18, 25

(260) AM 2023 116469 A
(800) 1641621
(151) 2021 05 31
(181) 2031 05 31
(891) 2021 05 31
(511) 09, 12, 14, 16, 18, 25, 28, 30, 32, 35, 36, 38, 39,
41, 43

(260) AM 2023 116603 A
(800) 1644083
(151) 2021 07 07
(181) 2031 07 07
(891) 2021 07 07
(511) 07, 09, 11, 21

(260) AM 2023 116470 A
(800) 1641633
(151) 2021 10 14
(181) 2031 10 14
(891) 2021 10 14
(511) 09, 42

(260) AM 2023 116604 A
(800) 1644100
(151) 2021 09 22
(181) 2031 09 22
(891) 2021 09 22
(511) 01, 35

(260) AM 2023 116471 A
(800) 1641737
(151) 2021 09 09
(181) 2031 09 09
(891) 2021 09 09
(511) 35, 41

(260) AM 2023 116871 A
(800) 1647184
(151) 2021 10 07
(181) 2031 10 07
(891) 2021 10 07
(511) 09, 28, 41

(260) AM 2023 116598 A
(800) 1643798
(151) 2021 12 17
(181) 2031 12 17
(891) 2021 12 17
(511) 09, 41

(260) AM 2023 116872 A
(800) 1647215
(151) 2021 09 24
(181) 2031 09 24
(891) 2021 09 24
(511) 03, 05, 10

(260) AM 2023 116913 A
(800) 1648239
(151) 2022 01 19
(181) 2032 01 19
(891) 2022 01 19
(511) 28

(260) AM 2023 116914 A
(800) 1648303
(151) 2022 01 12
(181) 2032 01 12
(891) 2022 01 12
(511) 18

(260) AM 2023 116916 A
(800) 1648335
(151) 2021 08 10
(181) 2031 08 10
(891) 2021 08 10
(511) 05, 29, 30, 32, 35, 43

(260) AM 2023 116918 A
(800) 1648366
(151) 2021 09 24
(181) 2031 09 24
(891) 2021 09 24
(511) 08, 09, 13, 18, 20, 22, 24, 28

(260) AM 2023 116920 A
(800) 1648395
(151) 2021 10 20
(181) 2031 10 20
(891) 2021 10 20
(511) 41, 43, 44, 45

OFFICIAL NOTIFICATIONS

INVENTIONS

RESTORATION OF PATENTS

(21) AP 2010 11644
(11) P 2012 5618 B
(73) Phagelux Inc.
(54) BIODEGRADED COPOLYMERS POLY (ESTER UREA) AND METHOD OF THEIR RECEPTION
DATE OF PATENT CANCELLATION: 2023 01 15
DATE OF PATENT RESTORATION: 2023 02 10

(21) AP 2014 13909
(11) P 2018 6817 B
(73) Greenrail S.R.L.
(54) COMPOSITE RAILWAY SLEEPER
DATE OF PATENT CANCELLATION: 2023 01 13
DATE OF PATENT RESTORATION: 2023 02 10

(21) AP 2019 15240
(11) P 2021 7323 B
(73) LLC "Aquix"
(54) METHOD OF PREPARING OF BEVERAGE
DATE OF PATENT CANCELLATION: 2022 12 19
DATE OF PATENT RESTORATION: 2023 02 10

ABOLITION OF PATENTS WITH THE RIGHT TO RESTORE

(21) AP 2010 11644
(11) P 2012 5618 B
(73) Phagelux Inc.
(54) BIODEGRADED COPOLYMERS POLY (ESTER UREA) AND METHOD OF THEIR RECEPTION
DATE OF PATENT CANCELLATION: 2023 01 15
LIMITED DATE OF PATENT RESTORATION: 2025 01 15

(21) AP 2014 13909
(11) P 2018 6817 B
(73) Greenrail S.R.L.
(54) COMPOSITE RAILWAY SLEEPER
DATE OF PATENT CANCELLATION: 2023 01 13
LIMITED DATE OF PATENT RESTORATION: 2025 01 13

(21) AP 2019 15413
(11) P 2022 7412 B
(73) Assa Abloi Ziherrhaitstekhnik Gmbh
(54) FLAT KEY PROFILE FOR LOCK-KEY SYSTEM
DATE OF PATENT CANCELLATION: 2023 01 18
LIMITED DATE OF PATENT RESTORATION: 2024 01 18

(21) AP 2005 9505
(11) P 2011 5256 B
(73) Geox S.P.A.
(54) SHOE WITH BREATHABLE AND WATERPROOF SOLE AND UPPER
DATE OF PATENT CANCELLATION: 2023 01 20
LIMITED DATE OF PATENT RESTORATION: 2024 01 20

DATE OF PATENTS RESTORATION EXPIRATION

(21) AP 2007 10866
(11) P 2013 5876 B
(73) Honeywell International Inc.
(54) STABILIZED COMPOSITIONS CONTAINING AMMONIUM NITRATE
DATE OF PATENT CANCELLATION: 2022 01 13
DATE OF PATENT RESTORATION EXPIRATION: 2023 01 13

(21) AP 2009 11882
(11) P 2013 5790 B
(73) Sunrise R&D Holdings LLC
(54) METHOD OF TRACKING INDIVIDUALS REAL TIME LOCATION THROUGH
MULTINETWORK WITHIN STORE
DATE OF PATENT CANCELLATION: 2022 01 15
DATE OF PATENT RESTORATION EXPIRATION: 2023 01 15

(21) AP 2009 11883
(11) P 2013 5764 B
(73) Sunrise R&D Holdings LLC
(54) SYSTEM OF TRACKING CUSTOM REAL TIME LOCATION THROUGH MULTINETWORK
WITHIN STORE
DATE OF PATENT CANCELLATION: 2022 01 15
DATE OF PATENT RESTORATION EXPIRATION: 2023 01 15

(21) AP 2011 12837
(11) P 2016 6544 B
(73) Corteva Agriscience LLC
(54) EXCISION OF TRANSGENES IN GENETICALLY MODIFIED ORGANISMS
DATE OF PATENT CANCELLATION: 2022 01 21
DATE OF PATENT RESTORATION EXPIRATION: 2023 01 21

(21) AP 2013 13555
(11) P 2016 6540 B
(73) Les Laboratoires Servier;
Vernalis (R & D) LTD.
(54) NEW INDOLIZINE DERIVATIVES, METHOD FOR THEIR PREPARATION AND
PHARMACEUTICAL COMPOSITIONS CONTAINING THEREOF
DATE OF PATENT CANCELLATION: 2022 01 23
DATE OF PATENT RESTORATION EXPIRATION: 2023 01 23

(21) AP 2015 14215
(11) P 2019 6982 B
(73) Santen Pharmaceutical Co., LTD.
(54) PHARMACEUTICAL COMPOSITION CONTAINING PYRIDYLAMINO ACETIC ACID
COMPOUND
DATE OF PATENT CANCELLATION: 2022 01 08
DATE OF PATENT RESTORATION EXPIRATION: 2023 01 08

(21) AP 2015 14216
(11) P 2018 6916 B
(73) Santen Pharmaceutical Co., LTD.
(54) PYRIDYLAMINOACETIC ACID COMPOUND AND POLYOXYETHYLENE CASTOR
OIL-CONTAINING PHARMACEUTICAL COMPOSITION
DATE OF PATENT CANCELLATION: 2022 01 08
DATE OF PATENT RESTORATION EXPIRATION: 2023 01 08

(21) AP 2015 14239
(11) P 2018 6917 B
(73) Santen Pharmaceutical Co., LTD.
(54) PHARMACEUTICAL PREPARATION INCLUDING PYRIDYLAMINO ACETIC ACID COMPOUND
DATE OF PATENT CANCELLATION: 2022 01 08
DATE OF PATENT RESTORATION EXPIRATION: 2023 01 08

EXPIRATION OF TERMS OF PATENT

(21) AP 2003 8365
(11) P 2007 4024 B
(73) Biogen MA Inc.
(54) POLYALKYLENE GLYCOL COMPRISING A RADICAL FOR CONJUGATION OF BIOLOGICALLY
ACTIVE COMPOUND
DATE OF PATENT EXPIRATION: 2023 01 17

COMPLETE CANCELLATION OF PATENT BASED ON RE-EXAMINATION

(11) U 2021 2069 Y (51) Int. Cl. (2006)
G 06 Q 20/36
(21) AU 2019 015243 (22) 2019 12 20
(24) 2019 12 20
(73) LTD "Community Soft Solution" (GE)
Otar Lortkipanidze Str. 6, ap. 10 (attic), 0114, Tbilisi, Georgia (GE)
(72) Levan Sharangia (GE)
Davit Pirvelashvili (GE)
(54) E-WALLET SERVICE COLLECTIVE USAGE SYSTEM

Ground: Re-examination decision № R 14915-2/2022, 2022 12 12

UTILITY MODELS RESTORATION OF PATENTS

(21) AU 2014 13669
(11) U 2015 1878 Y
(73) Raul Turmanidze;
Giorgi Pofkhadze
(54) EQUIPMENT FOR VINE PLANTS PROTECTION
DATE OF PATENT CANCELLATION: 2022 12 22
DATE OF PATENT RESTORATION: 2023 02 10

(21) AU 2017 14654
(11) U 2018 1989 Y
(73) Vladimer Saanishvili
(54) DEVICE FOR HOLDING IN HAND THE DOUGH PRODUCT WITH FILLING - KHINKALI
DATE OF PATENT CANCELLATION: 2022 12 20
DATE OF PATENT RESTORATION: 2023 02 10

(21) AU 2021 15539
(11) U 2022 2123 Y
(73) Archil Prangishvili;
Levani Imnaishvili;
Maguli Bedineishvili;
Gocha Zedginidze
(54) REMOTE LABORATORY SYSTEM
DATE OF PATENT CANCELLATION: 2023 01 18
DATE OF PATENT RESTORATION: 2023 02 10

ABOLITION OF PATENTS WITH THE RIGHT TO RESTORE

(21) AU 2017 14383
(11) U 2019 2003 Y
(73) Mamuchar Kifiani;
Nikoloz Batselashvili;
Ruslan Geladze
(54) METHOD FOR HELMINTOX DRUG PREPARATION
DATE OF PATENT CANCELLATION: 2023 01 17
LIMITED DATE OF PATENT RESTORATION: 2024 01 17

(21) AU 2019 14990
(11) U 2020 2045 Y
(73) Paata Gogoladze
(54) METHOD FOR RETICULAR TISSUE PRODUCTION FOR ARMORING ASPHALT CONCRETE
DATE OF PATENT CANCELLATION: 2023 01 25
LIMITED DATE OF PATENT RESTORATION: 2024 01 25

(21) AU 2020 15253
(11) U 2021 2075 Y
(73) Koba Kvatchantiradze;
 Vakhtang Khechikashvili
(54) GAS STOVE
DATE OF PATENT CANCELLATION: 2023 01 09
LIMITED DATE OF PATENT RESTORATION: 2024 01 09

(21) AU 2021 15539
(11) U 2022 2123 Y
(73) Archil Prangishvili;
 Levani Imnaishvili;
 Maguli Bedineishvili;
 Gocha Zedginidze
(54) REMOTE LABORATORY SYSTEM
DATE OF PATENT CANCELLATION: 2023 01 18
LIMITED DATE OF PATENT RESTORATION: 2025 01 18

DATE OF PATENTS RESTORATION EXPIRATION

(21) AU 2013 12969
(11) U 2014 1812 Y
(73) Eter Kemertelidze
 Meri Alania
(54) METHOD FOR OBTAINING ROBININ
DATE OF PATENT CANCELLATION: 2022 01 17
DATE OF PATENT RESTORATION EXPIRATION: 2023 01 17

(21) AU 2014 13353
(11) U 2014 1840 Y
(73) Nadezhda Margishvili
(54) DEPILATING MEANS
DATE OF PATENT CANCELLATION: 2022 01 21
DATE OF PATENT RESTORATION EXPIRATION: 2023 01 21

DESIGNS

EXTENSION OF TERMS OF DESIGNS REGISTRATION

(11) D 2018 795 S
(73) Capbran Holdings LLC (US)
11601 Wilshire Blvd., Suite 2300, Los Angeles, California, 90025, USA (US)
(54) 1. BLENDER, 2. BLENDER CASE, 3. BLENDER CUTTERS HOLDER, 4. BLENDER CONTAINER
(28) 4
(24) 2018 02 08
(18) 2028 02 08
(58) 2023 01 24

(11) D 2013 539 S
(73) Viko Elektrik Ve Elektronik Endüstrisi Sanayi Ve Ticaret Anonim Şirketi (TR)
Abdurahmangazi Mah. Ebubekir Kad. No: 44, Samandira Sanjanktepe/Istambul, Türkiye (TR)
(54) FRAME OF SWITCH (VIKO) (MERIDIAN)
(28) 1
(24) 2012 07 27
(18) 2027 07 27
(58) 2023 01 31

CANCELLATION OF DESIGN REGISTRATION

(11) D 2013 527 S
(73) Teimuraz Giorgadze (GE)
Shota Rustaveli Str., IX Lane 4a, 4600, Kutaisi, Georgia (GE)
(54) TABLE GAME "SPECTRUM" BOARD
(18) 2022 07 10
(58) 2023 01 20

CHANGE OF OWNER DATA

(11) D 2013 539 S
NAME AND ADDRESS OF NEW OWNER: Panasonic Eleqtriq Vorqs Eleqtriq Sanayi Ve Ticaret Anonim Şirketi (TR)
Abdurahmangazi Mah. Ebubekir Kad. No: 44, Samandira Sanjanktepe/Istambul, Türkiye (TR)
NAME AND ADDRESS OF FORMER OWNER: Panasonic Eco Solutions Elektrik Sanayi Ve Ticaret Anonim Şirketi (TR)
Abdurahmangazi Mah. Ebubekir Kad. No: 44, Sanjanktepe/Istambul, Türkiye (TR)
(58) 2023 01 25

EXTENTION OF TERMS OF INTERNATIONAL DESIGNS REGISTRATION

(11) DM/100332
(73) ARC MANAGEMENT & SERVICES
104 AVENUE DU GENERAL DE GAULLE 62510 ARQUES (FR)
(15) 2017 12 18
(24) 2017 12 18
(18) 2027 12 18
(28) 8
(28') 8
(54) CARDBOARD BOXES FOR PACKAGING

(11) DM/100458
(73) VALENTINO S.P.A.
Via Turati, 16/18, I-20121 Milano (EM)
(15) 2018 03 29
(24) 2018 03 29
(18) 2028 03 29
(28) 3
(28') 3
(54) BAGS

(11) DM/100617
(73) VALENTINO S.P.A.
Via Turati, 16/18, I-20121 Milano (EM)
(15) 2018 03 29
(24) 2018 03 29
(18) 2028 03 29
(28) 1
(28') 1
(54) SHOE

(11) DM/101030
(73) ARC MANAGEMENT & SERVICES
104 AVENUE DU GENERAL DE GAULLE 62510 ARQUES (FR)
(15) 2017 12 15
(24) 2017 12 15
(18) 2027 12 15
(28) 79
(28') 68
(54) CHAMPAGNE GLASS, CHAMPAGNE GLASSES, CHEESE DISH COVER ON ITS TRAY, DISH,
DISHES, FORKS, ICE CREAM BOWL, PLATE, RAMEQUIN DISH, SALAD BOWL, SALAD BOWLS,
SMALL BOWL, SPOONS, STEMMED GLASS, STEMMED GLASSES, TABLE KNIVES, TUMBLERS,
WATER JUG

(11) DM/69597
(73) ETA SA MANUFACTURE HORLOGERE SUISSE
CH-2540 GRENCHEN (CH)
(15) 2008 01 09
(24) 2008 01 09
(18) 2028 01 09
(28) 2
(28') 2
(54) WATCH CASES

(11) DM/69633
(73) OMEGA SA (OMEGA AG) (OMEGA LTD.)
 Jakob-Stämpfli-Strasse 96, CH-2502 Biel/Bienne (CH)
(15) 2008 01 28
(24) 2008 01 28
(18) 2028 01 28
(28) 1
(28') 1
(54) WRISTWATCH

(11) DM/69637
(73) SWATCH AG (SWATCH SA) (SWATCH LTD.)
 Jakob-Stämpfli-Strasse 94, CH-2502 Biel/Bienne (CH)
(15) 2008 01 08
(24) 2008 01 08
(18) 2028 01 08
(28) 1
(28') 1
(54) WRISTWATCH

(11) DM/69732
(73) SWATCH AG (SWATCH SA) (SWATCH LTD.)
 Jakob-Stämpfli-Strasse 94, CH-2502 Biel/Bienne (CH)
(15) 2008 01 31
(24) 2008 01 31
(18) 2028 01 31
(28) 1
(28') 1
(54) WRISTWATCH

(11) DM/69734
(73) OMEGA SA (OMEGA AG) (OMEGA LTD.)
 Jakob-Stämpfli-Strasse 96, CH-2502 Biel/Bienne (CH)
(15) 2008 01 31
(24) 2008 01 31
(18) 2028 01 31
(28) 1
(28') 1
(54) PERFUME BOTTLE

(11) DM/69735
(73) SWATCH AG (SWATCH SA) (SWATCH LTD.)
 Jakob-Stämpfli-Strasse 94, CH-2502 Biel/Bienne (CH)
(15) 2008 01 31
(24) 2008 01 31
(18) 2028 01 31
(28) 2
(28') 2
(54) WRISTWATCHES

(11) DM/69955
(73) KRÜGER GMBH & CO. KG
 Senefelderstraße 44, 51469 Bergisch Gladbach (DE)
(15) 2008 03 13

(24) 2008 03 13
(18) 2028 03 13
(28) 2
(28') 2
(54) PACKAGING FOR FOODSTUFFS

(11) DM/70034
(73) ELECTROLUX HOME PRODUCTS CORPORATION N.V.
Belgicastraat 17, B-1930 Zaventem (BX)
(15) 2007 12 21
(24) 2007 12 21
(18) 2027 12 21
(28) 2
(28') 2
(54) HANDLES FOR ELECTRIC HOUSEHOLD APPLIANCES

(11) DM/70441
(73) ELECTROLUX HOME PRODUCTS CORPORATION N.V.
Belgicastraat 17, B-1930 Zaventem (BX)
(15) 2007 12 21
(24) 2007 12 21
(18) 2027 12 21
(28) 1
(28') 1
(54) COOKER

(11) DM/79660
(73) SAVERGLASS (SOCIÉTÉ PAR ACTIONS SIMPLIFIÉE)
3 rue de La Gare, F-60960 FEUQUIERES (FR)
(15) 2012 12 03
(24) 2012 12 03
(18) 2027 12 03
(28) 1
(28') 1
(54) BOTTLES

(11) DM/79661
(73) SAVERGLASS
3 rue de la Gare, F-60960 FEUQUIERES (FR)
(15) 2012 12 03
(24) 2012 12 03
(18) 2027 12 03
(28) 1
(28') 1
(54) BOTTLES

(11) DM/79848
(73) SWATCH AG (SWATCH SA)(SWATCH LTD.)
Jakob-Stämpfli-Strasse 94, CH-2502 Biel/Bienne (CH)
(15) 2013 01 07
(24) 2013 01 07
(18) 2028 01 07
(28) 1
(28') 1

(54) WRISTWATCH

(11) DM/79920

(73) TISSOT SA (TISSOT AG) (TISSOT LTD)

Chemin des Tourelles 17, CH-2400 Le Locle (CH)

(15) 2013 01 08

(24) 2013 01 08

(18) 2028 01 08

(28) 1

(28') 1

(54) WATCH CASE WITH BRACELET

(11) DM/79922

(73) TISSOT SA (TISSOT AG) (TISSOT LTD)

Chemin des Tourelles 17, CH-2400 Le Locle (CH)

(15) 2013 01 09

(24) 2013 01 09

(18) 2028 01 09

(28) 3

(28') 2

(54) DIAL, WATCH CASE, WATCH STRAP

(11) DM/79923

(73) TISSOT SA (TISSOT AG) (TISSOT LTD)

Chemin des Tourelles 17, CH-2400 Le Locle (CH)

(15) 2013 01 09

(24) 2013 01 09

(18) 2028 01 09

(28) 2

(28') 2

(54) WATCH CASE, WATCH MOVEMENT

(11) DM/79925

(73) DERNEK GRUP ELEKTRİK ELEKTRONİK DIŞ TİCARET VE SANAYİ LİMİTED ŞİRKETİ

Kartaltepe Mahallesi, Teyyareci Nurettin Sokak, Funda Apt. No:2, Daire:9, Bakırköy - İstanbul (TR)

(15) 2012 11 26

(24) 2012 11 26

(18) 2027 11 26

(28) 5

(28') 5

(54) 1. PLUG; 2. SWITCH; 3. PLUG; 4. SWITCH; 5. PLUG / 1. PRISE; 2. INTERRUPTEUR; 3. PRISE;
4. INTERRUPTEUR; 5. PRISE

(11) DM/79982

(73) HAMILTON INTERNATIONAL AG (HAMILTON INTERNATIONAL SA) (HAMILTON INTERNATIONAL LTD)

Längfeldweg 119, CH-2504 Biel/Bienne (CH)

(15) 2013 01 14

(24) 2013 01 14

(18) 2028 01 14

(28) 11

(28') 5

(54) DIAL, WATCH, WATCH CASES, WATCHES, WATCH STRAP

(11) DM/79997
(73) BLANCPAIN SA
Le Rocher 12, CH-1348 LE BRASSUS (CH)
(15) 2013 01 23
(24) 2013 01 23
(18) 2028 01 23
(28) 1
(28') 1
(54) DIAL

(11) DM/80030
(73) GLASHÜTTER UHRENBETRIEB GMBH
Altenberger Str. 1, 01768 Glashütte (DE)
(15) 2013 01 29
(24) 2013 01 29
(18) 2028 01 29
(28) 6
(28') 2
(54) DIAL, WATCH BAND, WATCH CASES

(11) DM/80139
(73) MAY-AGRO TOHUMCULUK SANAYİ VE TİCARET ANONİM ŞİRKETİ
Samanlı Mahallesi, Yiğitler Caddesi, No: 28, YILDIRIM-BURSA (TR)
(15) 2013 01 09
(24) 2013 01 09
(18) 2028 01 09
(28) 1
(28') 1
(54) LOGO

(11) DM/80164
(73) OMEGA SA (OMEGA AG) (OMEGA LTD.)
Jakob-Stämpfli-Strasse 96, CH-2502 Biel/Bienne (CH)
(15) 2013 01 29
(24) 2013 01 29
(18) 2028 01 29
(28) 1
(28') 1
(54) WATCH

(11) DM/80373
(73) HERMANN STAIB GMBH
Grimmigweg 27, 75179 Pforzheim (DE)
(15) 2013 03 04
(24) 2013 03 04
(18) 2028 03 04
(28) 1
(28') 1
(54) WATCH BRACELET

(11) DM/80374
(73) HERMANN STAIB GMBH
Grimmigweg 27, 75179 Pforzheim (DE)
(15) 2013 03 04

(24) 2013 03 04
(18) 2028 03 04
(28) 1
(28') 1
(54) WATCH BRACELET PART

(11) DM/80375
(73) HERMANN STAIB GMBH
Grimmigweg 27, 75179 Pforzheim (DE)
(15) 2013 03 04
(24) 2013 03 04
(18) 2028 03 04
(28) 1
(28') 1
(54) WATCH BRACELET PART

(11) DM/80376
(73) HERMANN STAIB GMBH
Grimmigweg 27, 75179 Pforzheim (DE)
(15) 2013 03 04
(24) 2013 03 04
(18) 2028 03 04
(28) 1
(28') 1
(54) WATCH BRACELET

(11) DM/80385
(73) HERMANN STAIB GMBH
Grimmigweg 27, 75179 Pforzheim (DE)
(15) 2013 03 04
(24) 2013 03 04
(18) 2028 03 04
(28) 1
(28') 1
(54) WATCH BRACELET

(11) DM/99238
(73) RADO UHREN AG (RADO WATCH CO. LTD.) (MONTRES RADO SA)
Bielstrasse 43, CH-2543 LENGNAU (CH)
(15) 2018 01 15
(24) 2018 01 15
(18) 2028 01 15
(28) 1
(28') 1
(54) WATCH DIAL WITH RELATED HANDS

(11) DM/99471
(73) HARRY WINSTON SA
Chemin du Tourbillon 8, CH-1228 Plan-les-Ouates (CH)
(15) 2018 01 05
(24) 2018 01 05
(18) 2028 01 05

(28) 5
(28') 5
(54) 1.-4. DIALS, 5. OSCILLATING WEIGHT

(11) DM/99903
(73) HAMILTON INTERNATIONAL AG (HAMILTON INTERNATIONAL SA)
(HAMILTON INTERNATIONAL LTD)
Mattenstrasse 149, CH-2503 Biel/Bienne (CH)
(15) 2018 01 29
(24) 2018 01 29
(18) 2028 01 29
(28) 7
(28') 4
(54) DIALS, WATCH-BRACELET BUCKLE, WATCH CASE

CANCELLATION OF INTERNATIONAL DESIGNS REGISTRATION

(11) DM/68914
(73) MILONAS GEORGIOS
1, Plateia Dimokratias, GR-54629 Thessaloniki (GR)
DATE OF REGISTRATION CANCELLATION: 2022 04 23
(58) 2023 01 31

(11) DM/68937
(73) SWATCH AG (SWATCH SA) (SWATCH LTD.)
Jakob-Stämpfli-Strasse 94, CH-2502 Biel/Bienne (CH)
DATE OF REGISTRATION CANCELLATION: 2022 05 04
(58) 2023 01 31

(11) DM/68980
(73) SWATCH AG (SWATCH SA) (SWATCH LTD.)
Jakob-Stämpfli-Strasse 94, CH-2502 Biel/Bienne (CH)
DATE OF REGISTRATION CANCELLATION: 2022 06 07
(58) 2023 01 31

(11) DM/68983
(73) CHINOIN GYÓGYSZER ÉS VEGYÉSZETI TERMÉKEK GYÁRA ZRT.,
Tó utca 1-5, H-1045 Budapest (HU)
DATE OF REGISTRATION CANCELLATION: 2022 05 21
(58) 2023 01 31

(11) DM/68986
(73) ELBI ELEKTRIK ULUSLARARASI TICARET VE SANAYI ANONIM SIRKETI
Tasoluk Mehmet Akif Ersoy Mah. Maltepe Cad. No: 15 Arnavutkoy G.O.P., ISTANBUL (TR)
DATE OF REGISTRATION CANCELLATION: 2022 05 29
(58) 2023 01 31

(11) DM/94643
(73) TORUŃSKIE ZAKŁADY MATERIAŁÓW OPATRUNKOWYCH SPÓŁKA AKCYJNA
ul. Żółkiewskiego 20/26, PL-87-100 Toruń (PL)
DATE OF REGISTRATION CANCELLATION: 2022 01 03
(58) 2023 01 31

(11) DM/95096
(73) MIDO AG (MIDO SA) (MIDO LTD.)
Chemin des Tourelles 17, CH-2400 Le Locle (CH)
DATE OF REGISTRATION CANCELLATION: 2022 03 02
(58) 2023 01 31

(11) DM/95311
(73) ONTEX TÜKETİM ÜRÜNLERİ SANAYİ VE TİCARET ANONİM ŞİRKETİ
Oruç Reis Mah. Tekstil Kent Cad. Koza Plaza A Blok Kat:2 Esenler, İstanbul (TR)
DATE OF REGISTRATION CANCELLATION: 2022 03 07
(58) 2023 01 31

(11) DM/95556
(73) VALENTINO S.P.A.
Via Turati, 16/18, I-20121 Milano (EM)
DATE OF REGISTRATION CANCELLATION: 2022 03 30
(58) 2023 01 31

(11) DM/95557
(73) SOREMARTEC SA
Rue de Trèves (FBC)-Complexe B, L-2632 Findel (BX)
DATE OF REGISTRATION CANCELLATION: 2022 03 30
(58) 2023 01 31

(11) DM/96015
(73) PEUGEOT CITROËN AUTOMOBILES SA
Route de Gisy, F-78140 VELIZY-VILLACOUBLAY (FR)
DATE OF REGISTRATION CANCELLATION: 2022 05 04
(58) 2023 01 31

(11) DM/96016
(73) PEUGEOT CITROËN AUTOMOBILES SA
Route de Gisy, F-78140 VELIZY-VILLACOUBLAY (FR)
DATE OF REGISTRATION CANCELLATION: 2022 05 04
(58) 2023 01 31

(11) DM/96081
(73) PEUGEOT CITROËN AUTOMOBILES SA
F-78140 VELIZY-VILLACOUBLAY (FR)
DATE OF REGISTRATION CANCELLATION: 2022 04 14
(58) 2023 01 31

(11) DM/96158
(73) VALENTINO S.P.A.
Via Turati, 16/18, I-20121 MILANO (EM)
DATE OF REGISTRATION CANCELLATION: 2022 05 17
(58) 2023 01 31

(11) DM/96163
(73) ANY PTE. LTD.
30 Cecil Street, #19-08 Prudential Tower, Singapore 049712 (SG)
DATE OF REGISTRATION CANCELLATION: 2022 04 21
(58) 2023 01 31

(11) DM/96230
(73) PEUGEOT CITROËN AUTOMOBILES SA
Route de Gisy, F-78140 VELIZY-VILLACOUBLAY (FR)
DATE OF REGISTRATION CANCELLATION: 2022 02 24
(58) 2023 01 31

TRADEMARKS**EXTENSION OF TERMS OF TRADEMARKS REGISTRATION**

(111) M 2003 14959 R2

(151) 2003 01 30

(186) 2033 01 30

(732) Tenneco Automotive Operating

Company Inc.

500 North Field Drive, Lake Forest,

IL 60045, USA

(111) M 2013 23230 R1

(151) 2013 01 09

(186) 2033 01 09

(732) PepsiCo Inc.

a North Carolina Corporation

700 Anderson Hill Road, Purchase, New York

10577, USA

(111) M 2003 14861 R2

(151) 2003 01 14

(186) 2033 01 14

(732) Shell Brands International AG

Baarermatte, 6340 Baar, Switzerland

(111) M 2013 23231 R1

(151) 2013 01 09

(186) 2033 01 09

(732) PepsiCo Inc.

a North Carolina Corporation

700 Anderson Hill Road, Purchase, New York

10577, USA

(111) M 2003 14942 R2

(151) 2003 01 30

(186) 2033 01 30

(732) Amgen Inc.

One Amgen Center Drive, Thousand Oaks,

California 91320-1799, USA

(111) M 2013 23232 R1

(151) 2013 01 09

(186) 2033 01 09

(732) PepsiCo Inc.

a North Carolina Corporation

700 Anderson Hill Road, Purchase, New York

10577, USA

(111) M 2003 15207 R2

(151) 2003 07 16

(186) 2033 07 16

(732) PepsiCo Inc.

a North Carolina Corporation

700 Anderson Hill Road, Purchase, New York

10577, USA

(111) M 2013 23233 R1

(151) 2013 01 09

(186) 2033 01 09

(732) PepsiCo Inc.

a North Carolina Corporation

700 Anderson Hill Road, Purchase, New York

10577, USA

(111) M 2003 15270 R2

(151) 2003 10 15

(186) 2033 10 15

(732) Mars Incorporated

(a Delaware Corporation)

6885 Elm Street, McLean, Virginia

22101-3883, USA

(111) M 2013 23234 R1

(151) 2013 01 09

(186) 2033 01 09

(732) PepsiCo Inc.

a North Carolina Corporation

700 Anderson Hill Road, Purchase, New York

10577, USA

(111) M 2010 20986 R1

(151) 2010 12 13

(186) 2030 12 13

(732) LTD "Georgian Bakers"

Beliashvili Str. 2, 0159, Tbilisi, Georgia

(111) M 2013 23235 R1

(151) 2013 01 09

(186) 2033 01 09

(732) PepsiCo Inc.

a North Carolina Corporation

700 Anderson Hill Road, Purchase, New York

10577, USA

(111) M 2013 23236 R1
(151) 2013 01 09
(186) 2033 01 09
(732) PepsiCo Inc.
a North Carolina Corporation
700 Anderson Hill Road, Purchase, New York
10577, USA

(111) M 2013 23237 R1
(151) 2013 01 09
(186) 2033 01 09
(732) Portfolio Concentrate Solutions Unlimited
Company
5 Eastgate Road, Eastgate Business Park,
Little Island, Co.Cork, Ireland

(111) M 2013 23269 R1
(151) 2013 01 25
(186) 2033 01 25
(732) PepsiCo Inc.
a North Carolina Corporation
700 Anderson Hill Road, Purchase, New York
10577, USA

(111) M 2013 23270 R1
(151) 2013 01 25
(186) 2033 01 25
(732) PepsiCo Inc.
a North Carolina Corporation
700 Anderson Hill Road, Purchase, New York
10577, USA

(111) M 2013 23240 R1
(151) 2013 01 09
(186) 2033 01 09
(732) PepsiCo Inc.
a North Carolina Corporation
700 Anderson Hill Road, Purchase, New York
10577, USA

(111) M 2013 23241 R1
(151) 2013 01 09
(186) 2033 01 09
(732) PepsiCo Inc.
a North Carolina Corporation
700 Anderson Hill Road, Purchase, New York
10577, USA

(111) M 2013 23278 R1
(151) 2013 01 25
(186) 2033 01 25
(732) JSC "NizhegorodskiyKhimiko-Pharmacev-
ticheskiy Zavod"

Salganskaya Str. 7, Nizhny Novgorod,
RU-603950, Russian Federation

(111) M 2013 23279 R1
(151) 2013 01 25
(186) 2033 01 25
(732) JSC "NizhegorodskiyKhimiko-Pharmacev-
ticheskiy Zavod"
Salganskaya Str. 7, Nizhny Novgorod,
RU-603950, Russian Federation

(111) M 2013 23280 R1
(151) 2013 01 25
(186) 2033 01 25
(732) JSC "NizhegorodskiyKhimiko-Pharmacev-
ticheskiy Zavod"
Salganskaya Str. 7, Nizhny Novgorod,
RU-603950, Russian Federation

(111) M 2013 23281 R1
(151) 2013 01 25
(186) 2033 01 25
(732) JSC "NizhegorodskiyKhimiko-Pharmacev-
ticheskiy Zavod"
Salganskaya Str. 7, Nizhny Novgorod,
RU-603950, Russian Federation

(111) M 2013 23282 R1
(151) 2013 01 25
(186) 2033 01 25
(732) JSC "NizhegorodskiyKhimiko-Pharmacev-
ticheskiy Zavod"
Salganskaya Str. 7, Nizhny Novgorod,
RU-603950, Russian Federation

(111) M 2013 23283 R1
(151) 2013 01 25
(186) 2033 01 25
(732) JSC "NizhegorodskiyKhimiko-Pharmacev-
ticheskiy Zavod"
Salganskaya Str. 7, Nizhny Novgorod,
RU-603950, Russian Federation

(111) M 2013 23242 R1
(151) 2013 01 09
(186) 2033 01 09
(732) Otis Elevator Company
10 Farm Springs, Farmington, Connecticut
06032, USA

(111) M 2013 23558 R1 (151) 2013 04 12 (186) 2033 04 12 (732) Collective Licensing International LLC 800 Englewood Parkway, Suite C-200, Englewood, Colorado 80110, USA	17, Boulevard Haussmann, 75009 Paris, France
(111) M 2013 23559 R1 (151) 2013 04 12 (186) 2033 04 12 (732) Collective Licensing International LLC 800 Englewood Parkway, Suite C-200, Englewood, Colorado 80110, USA	(111) M 2013 23628 R1 (151) 2013 04 26 (186) 2033 04 26 (732) Hock Seng Food Pte LTD 267 Pandan Loop 128439, Singapore
(111) M 2013 23295 R1 (151) 2013 01 25 (186) 2033 01 25 (732) Cargill Incorporated 15407 McGinty Road West, Wayzata, Minnesota 55391-5624, USA	(111) M 2013 23407 R1 (151) 2013 02 27 (186) 2033 02 27 (732) Lafarge 14-16 Boulevard Garibaldi, 92130 Issy Les Moulineaux, France
(111) M 2013 23439 R1 (151) 2013 03 13 (186) 2033 03 13 (732) Samsung Electronics Co., LTD 129, Samsung-ro, Yeongtong-gu, Suwon-si, Gyeonggi-do, Republic of Korea	(111) M 2013 23640 R1 (151) 2013 04 26 (186) 2033 04 26 (732) Mars Incorporated 6885 Elm Street, McLean, Virginia 22101-388, USA
(111) M 2013 23394 R1 (151) 2013 02 27 (186) 2033 02 27 (732) Sun Pharmaceutical Industries Limited [Sun Pharmaceutical Industries Ltd] Spark, Tandalja, Vadodara – 390 020, Gujarat; Sun House, 201 B/1, Western Express Highway, Goregaon (E), Mumbai – 400 063, India	(111) M 2013 24255 R1 (151) 2013 11 18 (186) 2033 11 18 (732) Mars Incorporated 6885 Elm Street, McLean, Virginia 22101-388, USA
(111) M 2013 23399 R1 (151) 2013 02 27 (186) 2033 02 27 (732) Sun Pharmaceutical Industries Limited [Sun Pharmaceutical Industries Ltd] Spark, Tandalja, Vadodara – 390 020, Gujarat; Sun House, 201 B/1, Western Express Highway, Goregaon (E), Mumbai – 400 063, India	(111) M 2013 23819 R1 (151) 2013 06 25 (186) 2033 06 25 (732) Shalva Gvaramadze Bakhrioni Str., bld. 1, ap. 10, 0160, Tbilisi, Georgia
(111) M 2013 23732 R1 (151) 2013 06 07 (186) 2033 06 07 (732) Compagnie Gervais Danone (a Franch Corporation)	(111) M 2013 23770 R1 (151) 2013 06 07 (186) 2033 06 07 (732) PepsiCo, Inc., a North Carolina Corporation 700 Anderson Hill Road, Purchase, New York 10577, USA
	(111) M 2013 23862 R1 (151) 2013 07 19 (186) 2033 07 19 (732) Mars Incorporated 6885 Elm Street, McLean, Virginia 22101-388, USA

(111) M 2013 24163 R1
(151) 2013 10 17
(186) 2033 10 17
(732) LLC "Publishing Lelo"
Iosebidge Str. 49, 0160, Tbilisi,
Georgia

(111) M 2013 24335 R1
(151) 2013 12 13
(186) 2033 12 13
(732) LTD "Newsroom"
Iosebidge Str. 49, 0160, Tbilisi, Georgia

(111) M 2013 24183 R1
(151) 2013 10 17
(186) 2033 10 17
(732) Wm. Wrigley Jr. Company
1132 West Blackhawk Street, Chicago, Illinois
60642, USA

(111) M 2013 24346 R1
(151) 2013 12 13
(186) 2033 12 13
(732) Shalva Gvaramadze
Bakhtrioni Str., bld. 1, ap. 10, 0160,
Tbilisi, Georgia

COMPLETE TRANSFER OF RIGHTS

-
- (111) M 2019 31367 R
(732) LLC "Formula"
Mitskevich Str. 29 (Plot 15/39), attic, 0194,
Tbilisi, Georgia
(770) LLC "Formula Proesco Production"
Mitskevich Str. 29 (Plot 15/39), attic, 0194,
Tbilisi, Georgia
(580) 2022 12 28
-
- (111) M 2021 34135 R
(732) Cytokinetics Incorporated
280 East I Grand Avenue South, San Francisco,
California, USA
(770) Amgen Inc.
One Amgen Center Drive, Thousand Oaks,
California 91320-1799, USA
(580) 2022 11 18
-
- (111) M 2022 35829 R
(732) April International Enterprise Pte. Ltd.
80 Rafflz Pleis, №50-01 Iuob Plaza 1,
Singapuri 048624, Singapore
(770) Asia Symbol China Holdings Limited
21/F, China Building, No. 29 Queen's
Road Central, Hong Kong
(580) 2022 11 11
-
- (111) M 2022 35842 R
(732) Karo Pharma Aktiebolag
Box 16184, 103 24 Stockholm, Sweden
(770) Reckitt & Colman (Overseas)
Health Limited
103-105 Bath Road, Slough, Berkshire,
SL1 3UH, United Kingdom
(580) 2022 11 07
-
- (111) M 1998 8136 R
(732) Ekaterra Group IP Holdings B.V.
Weena 455, NL-3013 AL Rotterdam,
Netherlands
(770) Unilever IP Holdings B.V.
Weena 455, 3013 AL Rotterdam,
Netherlands
(580) 2022 06 07
-
- (111) M 1998 8143 R
(732) Ekaterra Group IP Holdings B.V.
Weena 455, NL-3013 AL Rotterdam,
Netherlands
-
- (111) M 2019 31367 R
(732) LLC "Formula"
Mitskevich Str. 29 (Plot 15/39), attic, 0194,
Tbilisi, Georgia
(770) LLC "Formula Proesco Production"
Mitskevich Str. 29 (Plot 15/39), attic, 0194,
Tbilisi, Georgia
(580) 2022 06 07
-
- (111) M 1998 8149 R
(732) Ekaterra Group IP Holdings B.V.
Weena 455, NL-3013 AL Rotterdam,
Netherlands
(770) Unilever IP Holdings B.V.
Weena 455, 3013 AL Rotterdam, Netherlands
(580) 2022 06 07
-
- (111) M 1998 8150 R
(732) Ekaterra Group IP Holdings B.V.
Weena 455, NL-3013 AL Rotterdam,
Netherlands
(770) Unilever IP Holdings B.V.
Weena 455, 3013 AL Rotterdam, Netherlands
(580) 2022 06 07
-
- (111) M 2000 13584 R
(732) Talisman Brands Inc.
1013 Centre Road, Suite 403-B, City of
Wilmington, County of New Castle, State of
Delaware 19805, USA
(770) Technicolor
8-10 rue du Renard, 75004 Paris, France
(580) 2022 11 30
-
- (111) M 1999 12871 R
(732) Ekaterra Group IP Holdings B.V.
Weena 455, NL-3013 AL Rotterdam,
Netherlands
(770) Unilever IP Holdings B.V.
Weena 455, 3013 AL Rotterdam, Netherlands
(580) 2022 06 07
-
- (111) M 2005 16379 R
(732) Pfizer Pfe Us Holdings 4 llc
235 East 42nd Street, New York,
N.Y. 10017, USA
(770) Pfizer Health AB
Vetenskapsvägen 10, 191 90, Sollentuna,
Sweden
(580) 2022 11 10
-
- (111) M 1997 6847 R
(732) Merck Sharp & Dohme LLC
126 East Lincoln Av., P.O. Box 2000,
Rahway New Jersey 07065, USA
-

(770) Merck Sharp & Dohme Corp.
One Merck Drive, Whitehouse Station,
New Jersey 08889, USA

(580) 2022 11 14

(111) M 2008 18907 R

(732) Ekaterra Group IP Holdings B.V.
Weena 455, NL-3013 AL Rotterdam,
Netherlands

(770) Unilever IP Holdings B.V.
Weena 455, 3013 AL Rotterdam, Netherlands

(580) 2022 06 07

(111) M 1998 8730 R

(732) Ekaterra Group IP Holdings B.V.
Weena 455, NL-3013 AL Rotterdam,
Netherlands

(770) Unilever IP Holdings B.V.
Weena 455, 3013 AL Rotterdam, Netherlands

(580) 2022 06 07

(111) M 2013 23352 R

(732) Sun Pharmaceutical Industries Limited
[Sun Pharmaceutical Industries Ltd]
Spark, Tandajja, Vadodara – 390 020, Gujarat;
Sun House, 201 B/1, Western Express
Highway, Goregaon (E), Mumbai - 400 063,
India

(770) Ranbaxy Laboratories Limited
Plot N 90, Sector-32, Gurgaon-122001,
Haryana, India

(580) 2022 11 21

(111) M 2017 28187 R

(732) LLC "Formula"
Mitskevich Str. 29 (Plot 15/39), attic, 0194,
Tbilisi, Georgia

(770) LLC "Formula Proesco Production"
Mitskevich Str. 29 (Plot 15/39), attic, 0194,
Tbilisi, Georgia

(580) 2022 12 28

(111) M 1997 5555 R

(732) Axalta Coating Systems GmbH
Uferstr. 90, 4057 Basel, Switzerland

(770) Coatings Foreign IP Co. LLC
c/o The Corporation Trust Company,
Corporation Trust Center, 1209 Orange
Street, Wilmington, Delaware 19801, USA

(580) 2022 07 21

CHANGES OF NAMES AND/OR ADDRESSES OF TRADEMARKS OWNERS

(111) M 1996 3437 R
(732) Gabrielle Studio Inc.
512 Seventh Avenue, New York, New York
10018, USA
(770) Gabrielle Studio Inc.
240 West 40th Street, New York, New York
10018, USA
(580) 2022 11 15

(111) M 1997 7335 R
(732) Azzaro Beaute
14, Rue Royale, F-75008 PARIS, France
(770) Azzaro Beaute
49 avenue de l'Opera, 75002, Paris, France
(580) 2022 12 20

(111) M 2002 14734 R
(732) Gabrielle Studio Inc.
512 Seventh Avenue, New York, New York
10018, USA
(770) Gabrielle Studio Inc.
240 West 40th Street, New York, New York
10018, USA
(580) 2022 11 15

(111) M 2013 23316 R
(732) Corporacion Habanos S.A.
Avenida Tercera entre 78 y 80, Centro
de Negocios Miramar, Edificio Habana,
3er. Piso, Playa, La Habana, Cuba
(770) Corporacion Habanos S.A.
Carretera Vieja de Guanabacoa y Linea
del Ferrocarril Final, Guanabacoa,
La Habana, Cuba
(580) 2022 12 29

(111) M 2014 25135 R
(732) Sanofi Healthcare India Private Limited
Sanofi House, C.T.S.-117B, L & T Business
Park, Saki Vihar Road, Powai, Mumbai,
Mumbai City, Maharashtra, 400072, India
(770) Shantha Biotechnics Private Limited
3rd & 4th Floors, H.No.5-10-173, Fateh
Maidan Road, Basheerbagh, Hyderabad –
500004, Telangana, India
(580) 2022 12 29

(111) M 1996 3345 R
(732) Azzaro Beaute
14, Rue Royale, F-75008 Paris, France
(770) Azzaro Beaute
49 avenue de l'Opera, 75002, Paris, France
(580) 2022 12 20

CANCELLATION OF TRADEMARKS REGISTRATION

(111) M 2002 14546 R
(151) 2002 07 11
(732) Dunhill Tobacco of London Limited
Globe House, 4 Temple Place, London
WC2R 2PG, United Kingdom
(141) 2023 01 20

(111) M 2012 22769 R
(151) 2012 07 13
(732) Kakhaber Berishvili
Akaki Tseretli Str. 49, ap. 22, 6700, Gagra,
Georgia
(141) 2023 01 23

(111) M 2002 14551 R
(151) 2002 07 11
(732) Zoetis P LLC
100 Campus Drive, Florham Park, NJ 07932,
USA
(141) 2023 01 20

(111) M 2012 22771 R
(151) 2012 07 13
(732) Nissan Jidosha Kabushiki Kaisha
(also trading as Nissan Motor Co., Ltd.)
No.2 Takaracho, Kanagawa-ku, Yokohama-
shi, Kanagawa-ken, Japan
(141) 2023 01 23

(111) M 2002 14556 R
(151) 2002 07 11
(732) Pfizer Products Inc.
a Connecticut Corporation
Eastern Point Road, Groton, Connecticut
06340, USA
(141) 2023 01 20

(111) M 2012 22772 R
(151) 2012 07 13
(732) Nissan Jidosha Kabushiki Kaisha
(also trading as Nissan Motor Co., Ltd.)
No.2 Takaracho, Kanagawa-ku, Yokohama-
shi, Kanagawa-ken, Japan
(141) 2023 01 23

(111) M 2012 22758 R
(151) 2012 07 13
(732) Genzyme Corporation
(a Massachusetts Corporation)
50 Binney Street, Cambridge, Massachusetts
02142, USA
(141) 2023 01 23

(111) M 2012 22776 R
(151) 2012 07 13
(732) LTD "GoodFood Georgia"
H. Abashidze Str. 17, 0160, Tbilisi, Georgia
(141) 2023 01 23

(111) M 2012 22761 R
(151) 2012 07 13
(732) JSC "Smartex"
Ilia Chavchavadze Ave. 74, 0162, Tbilisi,
Georgia
(141) 2023 01 23

(111) M 2012 22777 R
(151) 2012 07 13
(732) LTD "GoodFood Georgia"
H. Abashidze Str. 17, 0160, Tbilisi, Georgia
(141) 2023 01 23

(111) M 2012 22765 R
(151) 2012 07 13
(732) JSC "Hotels and Restaurants Management
Group - EM/Group"
Marshall Gelovani Ave. 2, 5th fl., 0159,
Tbilisi, Georgia
(141) 2023 01 23

(111) M 2012 22778 R
(151) 2012 07 13
(732) Creative Nail Design Inc.
1125 Joshua Way, Vista, California 92083,
USA
(141) 2023 01 23

(111) M 2012 22767 R
(151) 2012 07 13
(732) General Motors LLC
300 Renaissance Center, City of Detroit,
State of Michigan 48265-3000, USA
(141) 2023 01 23

(111) M 2012 22782 R
(151) 2012 07 13
(732) LTD "G R C"
Bakhrioni Str. 16, 0194, Tbilisi, Georgia
(141) 2023 01 23

(111) M 2012 22785 R
(151) 2012 07 13
(732) LTD "T.B.T. Group"
Gamsakhurdia Ave. 24a, ap. 18, 0194,
Tbilisi, Georgia
(141) 2023 01 23

(111) M 2012 22804 R
(151) 2012 07 26
(732) LTD "Engadi"
Vill. Dighomi, Land Plot 034/546, 0131,
Tbilisi, Georgia
(141) 2023 02 03

(111) M 2012 22788 R
(151) 2012 07 13
(732) LTD "Levanto"
Akaki Tseretli Str. 165, 4600, Kutaisi, Georgia
(141) 2023 01 23

(111) M 2012 22790 R
(151) 2012 07 13
(732) სს „მეზღვაურთა სამედიცინო ცენტრი-
2010“
გ. ტაბიძის ქ. 2ა, 6020, ბათუმი,
საქართველო
(732) JSC "Sailor's Medical Center-2010"
Galaktion Tabidze Str. 2a, 6020, Batumi,
Georgia
(141) 2023 01 23

(111) M 2012 22798 R
(151) 2012 07 13
(732) LLC "Gorbi" – Georgia International Center
for Public Opinion and Business Research
Vazha-Pshavela Ave. 45, 0177, Tbilisi,
Georgia
(141) 2023 01 23

(111) M 2012 22803 R
(151) 2012 07 20
(732) Jarji Akimidze
Tsgareli Str. 12, 0194, Tbilisi, Georgia
(141) 2023 01 30

(111) M 2012 22801 R
(151) 2012 07 13
(732) LTD "EPIC Development"
Uritskiy Str. 26, 0103, Tbilisi, Georgia
(141) 2023 01 23

(111) M 2012 22802 R
(151) 2012 07 19
(732) Harrington Development Inc.
Arango-Orillac Bldg. East 54 th street,
Republic of Panama
(141) 2023 01 27

INTERNATIONAL LICENSE AGREEMENTS

(800) 820785

(732) Yandex LLC

Leo Tolstoy Str. 16, RU-119021 Moscow, Russian Federation

(791) Yandex Deliveri Holding LLC

1 st Krasnogvardeisky passage, 22, building 1, room 12-40, floor 12, 123112 Moscow,
Russian Federation

(793) №1724

Simple

From 2022 01 01 - for the period of validity of the trademark

Class: 9, 16, 18, 35, 36, 38, 39, 41, 42

(800) 1334648

(732) Yandex LLC

Leo Tolstoy Str. 16, RU-119021 Moscow, Russian Federation

(791) Yandex Deliveri Holding LLC

1 st Krasnogvardeisky passage, 22, building 1, room 12-40, floor 12, 123112 Moscow,
Russian Federation

(793) №1723

Simple

From 2022 01 01 - for the period of validity of the trademark

Class: 9, 16, 35, 38, 39, 41, 42

PUBLICATION OF DATA IN CASE OF CLASSES ARE ADDED

(800) 1650144

(731) Adventist Development and Relief Agency International

12501 Old Columbia Pike, Silver Spring MD 20904, USA

(540)



(511)

41 – Educational services, namely, conferences, workshops, seminars and college and university courses and programs involving international community development.

45 – Missionary services; disaster preparedness and disaster relief services, namely, providing of clothing, all for charity purposes.

CLASSIFICATION INDEXES

INVENTIONS

CONCORDANCE TABLE OF INTERNATIONAL CLASSIFICATION INDEX AND PUBLICATION NUMBERS

INTERNATIONAL CLASSIFICATION INDEXES (51)	NUMBER OF PUBLISHED APPLICATION (10)
A 61 K 9/28	AP 2023 15682 A
A 61 K 39/395; C 07 K 16/00; C 07 K 16/10	AP 2023 15128 A
F 03 B 17/02	AP 2023 15886 A
F 03 B 13/00	AP 2023 15965 A

CONCORDANCE TABLE OF PUBLICATION NUMBERS AND INTERNATIONAL CLASSIFICATION INDEX

NUMBER OF PUBLISHED APPLICATION (10)	INTERNATIONAL CLASSIFICATION INDEXES (51)
AP 2023 15128 A	A 61 K 39/395; C 07 K 16/00; C 07 K 16/10
AP 2023 15682 A	A 61 K 9/28
AP 2023 15886 A	F 03 B 17/02
AP 2023 15965 A	F 03 B 13/00

CONCORDANCE TABLE OF INTERNATIONAL CLASSIFICATION INDEX, PATENT NUMBERS AND PUBLICATION NUMBERS

INTERNATIONAL CLASSIFICATION INDEX (51)	NUMBER OF PATENT (11)	NUMBER OF PUBLISHED APPLICATION (10)
A 01 G 9/12	P 2023 7468 B	AP 2022 15958 A
A 24 D 3/14; A 61 K 7/00; A 61 K 38/44; A 61 L 2/00	P 2023 7469 B	AP 2022 15488 A
A 47 J 31/18; A 47 J 31/42	P 2023 7474 B	AP 2022 15490 A
A 61 K 8/60; A 61 K 8/43; A 61 K 8/04; A 61 Q 11/00	P 2023 7472 B	AP 2022 15745 A
A 61 K 31/573; A 61 K 31/56; A 61 K 31/454; A 61 P 37/08; A 61 P 43/00; A 61 P 37/00; A 61 P 11/06	P 2023 7467 B	AP 2022 15712 A
B 29 C 43/02; B 29 C 53/20	P 2023 7473 B	AP 2022 15867 A
C 07 D 498/08; C 07 D 471/10; C 07 D 295/205; C 07 D 403/04; C 07 D 295/26	P 2023 7470 B	AP 2022 15088 A
E 01 F 15/04	P 2023 7471 B	AP 2022 15547 A

**CONCORDANCE TABLE OF PATENT NUMBERS,
PUBLICATION NUMBERS AND INTERNATIONAL CLASSIFICATION INDEX**

NUMBER OF PATENT (11)	NUMBER OF PUBLISHED APPLICATION (10)	INTERNATIONAL CLASSIFICATION INDEX (51)
P 2023 7467 B	AP 2022 15712 A	A 61 K 31/573; A 61 K 31/56; A 61 K 31/454; A 61 P 37/08; A 61 P 43/00; A 61 P 37/00; A 61 P 11/06
P 2023 7468 B	AP 2022 15958 A	A 01 G 9/12
P 2023 7469 B	AP 2022 15488 A	A 24 D 3/14; A 61 K 7/00; A 61 K 38/44; A 61 L 2/00
P 2023 7470 B	AP 2022 15088 A	C 07 D 498/08; C 07 D 471/10; C 07 D 295/205; C 07 D 403/04; C 07 D 295/26
P 2023 7471 B	AP 2022 15547 A	E 01 F 15/04
P 2023 7472 B	AP 2022 15745 A	A 61 K 8/60; A 61 K 8/43; A 61 K 8/04; A 61 Q 11/00
P 2023 7473 B	AP 2022 15867 A	B 29 C 43/02; B 29 C 53/20
P 2023 7474 B	AP 2022 15490 A	A 47 J 31/18; A 47 J 31/42

**CONCORDANCE TABLE OF APPLICATION NUMBERS,
PUBLICATION NUMBERS AND PATENTS**

NUMBER OF APPLICATION (21)	NUMBER OF PUBLISHED APPLICATION (10)	NUMBER OF PATENT (11)
AP 2017 15088	AP 2022 15088 A	P 2023 7470 B
AP 2020 15488	AP 2022 15488 A	P 2023 7469 B
AP 2019 15490	AP 2022 15490 A	P 2023 7474 B
AP 2019 15547	AP 2022 15547 A	P 2023 7471 B
AP 2019 15712	AP 2022 15712 A	P 2023 7467 B
AP 2020 15745	AP 2022 15745 A	P 2023 7472 B
AP 2022 15867	AP 2022 15867 A	P 2023 7473 B
AP 2022 15958	AP 2022 15958 A	P 2023 7468 B

UTILITY MODELS

**CONCORDANCE TABLE OF INTERNATIONAL CLASSIFICATION INDEX
AND PUBLICATION NUMBERS**

INTERNATIONAL CLASSIFICATION INDEXES (51)	NUMBER OF PUBLISHED APPLICATION (10)
G 10 D 1/00	AU 2023 15837 U

CONCORDANCE TABLE OF PUBLICATION NUMBERS
AND INTERNATIONAL CLASSIFICATION INDEX

NUMBER OF PUBLISHED APPLICATION (10)	INTERNATIONAL CLASSIFICATION INDEXES (51)
AU 2023 15837 U	G 10 D 1/00

CONCORDANCE TABLE OF INTERNATIONAL CLASSIFICATION INDEX,
PATENT NUMBERS AND PUBLICATION NUMBERS

INTERNATIONAL CLASSIFICATION INDEX (51)	NUMBER OF PATENT (11)	NUMBER OF PUBLISHED APPLICATION (10)
A 61 P 43/00	U 2023 2144 Y	AU 2022 15537 U

CONCORDANCE TABLE OF PATENT NUMBERS,
PUBLICATION NUMBERS AND INTERNATIONAL CLASSIFICATION INDEX

NUMBER OF PATENT (11)	NUMBER OF PUBLISHED APPLICATION (10)	INTERNATIONAL CLASSIFICATION INDEX (51)
U 2023 2144 Y	AU 2022 15537 U	A 61 P 43/00

CONCORDANCE TABLE OF APPLICATION NUMBERS,
PUBLICATION NUMBERS AND PATENTS

NUMBER OF APPLICATION (21)	NUMBER OF PUBLISHED APPLICATION (10)	NUMBER OF PATENT (11)
AU 2021 15537	AU 2022 15537 U	U 2023 2144 Y

DESIGNS**CONCORDANCE TABLE OF INTERNATIONAL CLASSIFICATION INDEX
AND PUBLICATION NUMBERS**

INTERNATIONAL CLASSIFICATION INDEXES (51)	NUMBER OF PUBLISHED APPLICATION (10)
11-01	AD 2023 1278 S
25-03	AD 2023 1275 S

**CONCORDANCE TABLE OF PUBLICATION NUMBERS
AND INTERNATIONAL CLASSIFICATION INDEX**

NUMBER OF PUBLISHED APPLICATION (10)	INTERNATIONAL CLASSIFICATION INDEXES (51)
AD 2023 1275 S	25-03
AD 2023 1278 S	11-01

**CONCORDANCE TABLE OF INTERNATIONAL CLASSIFICATION INDEX,
NUMBERS OF REGISTRATION AND PUBLICATION NUMBERS**

INTERNATIONAL CLASSIFICATION INDEX (51)	NUMBER OF REGISTRATION (11)	NUMBER OF PUBLISHED APPLICATION (10)
01-01	D 2023 958 S	AD 2022 1267 S
02-04	D 2023 957 S	AD 2022 1269 S
06-01; 06-03	D 2023 956 S	AD 2022 1268 S

**CONCORDANCE TABLE OF NUMBERS OF REGISTRATION,
PUBLICATION NUMBERS AND INTERNATIONAL CLASSIFICATION INDEX**

NUMBER OF REGISTRATION (11)	NUMBER OF PUBLISHED APPLICATION (10)	INTERNATIONAL CLASSIFICATION INDEX (51)
D 2023 956 S	AD 2022 1268 S	06-01; 06-03
D 2023 957 S	AD 2022 1269 S	02-04
D 2023 958 S	AD 2022 1267 S	01-01

**CONCORDANCE TABLE OF APPLICATION NUMBERS,
PUBLICATION NUMBERS AND NUMBERS OF REGISTRATION**

NUMBER OF APPLICATION (21)	NUMBER OF PUBLISHED APPLICATION (10)	NUMBER OF REGISTRATION (11)
AD 2022 1267	AD 2022 1267 S	D 2023 958 S
AD 2022 1268	AD 2022 1268 S	D 2023 956 S
AD 2022 1269	AD 2022 1269 S	D 2023 957 S

DESIGNS REGISTERED ACCORDING TO THE ACCELERATED PROCEDURE

CONCORDANCE TABLE OF INTERNATIONAL CLASSIFICATION INDEX AND PUBLICATION NUMBERS

INTERNATIONAL CLASSIFICATION INDEXES (51)	NUMBER OF REGISTRATION (11)
23-06	D 2023 959 S

CONCORDANCE TABLE OF PUBLICATION NUMBERS AND INTERNATIONAL CLASSIFICATION INDEX

NUMBER OF REGISTRATION (11)	INTERNATIONAL CLASSIFICATION INDEXES (51)
D 2023 959 S	23-06

CONCORDANCE TABLE OF APPLICATION NUMBERS, PUBLICATION NUMBERS AND PATENTS

NUMBER OF APPLICATION (21)	NUMBER OF REGISTRATION (11)
AD 2023 1291	D 2023 959 S

TRADEMARKS

CONCORDANCE TABLE OF REGISTRATION NUMBERS, APPLICATION NUMBERS, PUBLICATION NUMBERS AND BULLETIN NUMBERS

NUMBER OF REGISTRATION (111)	NUMBER OF APPLICATIONS (210)	NUMBER OF PUBLISHED APPLICATIONS (260)	NUMBER OF BULLETIN
M 2023 36356 R	AM 121045	–	3(606)2023
M 2023 36357 R	AM 121130	–	3(606)2023
M 2023 36358 R	AM 116333	AM 2022 116333 A	17(596)2022
M 2023 36359 R	AM 116526	AM 2022 116526 A	17(596)2022
M 2023 36360 R	AM 116624	AM 2022 116624 A	17(596)2022
M 2023 36361 R	AM 116169	AM 2022 116169 A	14(593)2022
M 2023 36362 R	AM 115884	AM 2022 115884 A	13(592)2022
M 2023 36363 R	AM 116626	AM 2022 116626 A	17(596)2022
M 2023 36364 R	AM 116623	AM 2022 116623 A	17(596)2022
M 2023 36365 R	AM 116642	AM 2022 116642 A	17(596)2022
M 2023 36366 R	AM 116625	AM 2022 116625 A	17(596)2022
M 2023 36367 R	AM 116622	AM 2022 116622 A	17(596)2022
M 2023 36368 R	AM 116246	AM 2022 116246 A	17(596)2022
M 2023 36369 R	AM 116435	AM 2022 116435 A	16(595)2022
M 2023 36370 R	AM 116545	AM 2022 116545 A	17(596)2022
M 2023 36371 R	AM 116330	AM 2022 116330 A	16(595)2022
M 2023 36372 R	AM 120936	–	3(606)2023
M 2023 36373 R	AM 121054	–	3(606)2023
M 2023 36374 R	AM 121131	–	3(606)2023
M 2023 36375 R	AM 121219	–	3(606)2023
M 2023 36376 R	AM 121224	–	3(606)2023
M 2023 36377 R	AM 116315	AM 2022 116315 A	17(596)2022
M 2023 36378 R	AM 115687	AM 2022 115687 A	12(591)2022
M 2023 36379 R	AM 115686	AM 2022 115686 A	12(591)2022
M 2023 36380 R	AM 115594	AM 2022 115594 A	14(593)2022
M 2023 36381 R	AM 115126	AM 2022 115126 A	13(592)2022
M 2023 36382 R	AM 116537	AM 2022 116537 A	18(597)2022
M 2023 36383 R	AM 116531	AM 2022 116531 A	18(597)2022
M 2023 36384 R	AM 116765	AM 2022 116765 A	18(597)2022
M 2023 36385 R	AM 116527	AM 2022 116527 A	18(597)2022
M 2023 36386 R	AM 121225	–	3(606)2023
M 2023 36387 R	AM 120967	–	3(606)2023
M 2023 36388 R	AM 121243	–	3(606)2023

**CONCORDANCE TABLE OF PUBLICATION NUMBERS
AND APPLICATION NUMBERS**

NUMBER OF PUBLISHED APPLICATION (260)	NUMBER OF APPLICATION (210)
AM 2023 99509 A*	AM 99509
AM 2023 100058 A*	AM 100058
AM 2023 100059 A*	AM 100059
AM 2023 115851 A	AM 115851
AM 2023 117717 A	AM 117717
AM 2023 117806 A	AM 117806
AM 2023 118158 A	AM 118158
AM 2023 118161 A	AM 118161
AM 2023 118162 A	AM 118162
AM 2023 118403 A	AM 118403
AM 2023 118547 A	AM 118547
AM 2023 118551 A	AM 118551
AM 2023 118559 A	AM 118559
AM 2023 118562 A	AM 118562
AM 2023 118563 A	AM 118563
AM 2023 118566 A	AM 118566
AM 2023 118728 A	AM 118728
AM 2023 118737 A	AM 118737
AM 2023 118754 A	AM 118754

**CONCORDANCE TABLE OF INDEX OF GOODS AND/OR SERVICES
AND APPLICATION NUMBERS**

INDEX OF GOODS AND/OR SERVICES (511)	NUMBER OF PUBLISHED APPLICATIONS (260)	1	2
1	2		
2	AM 2023 117806 A	30	AM 2023 118162 A
3	AM 2023 118161 A	32	AM 2023 118403 A
3	AM 2023 118559 A	33	AM 2023 99509 A*
5	AM 2023 118559 A	33	AM 2023 100058 A*
6	AM 2023 118562 A	33	AM 2023 100059 A*
8	AM 2023 118562 A	33	AM 2023 117717 A
9	AM 2023 118158 A	33	AM 2023 118737 A
18	AM 2023 118562 A	35	AM 2023 99509 A*
22	AM 2023 118562 A	35	AM 2023 115851 A
25	AM 2023 118562 A	35	AM 2023 118158 A
28	AM 2023 118562 A	35	AM 2023 118551 A
29	AM 2023 118547 A	35	AM 2023 118566 A
30	AM 2023 115851 A	36	AM 2023 118754 A
		37	AM 2023 118158 A
		43	AM 2023 118563 A
		43	AM 2023 118566 A
		45	AM 2023 118728 A

CONCORDANCE TABLE OF INDEX OF GOODS AND/OR SERVICES
AND NUMBERS OF TRADEMARKS REGISTERED ACCORDING
TO THE ACCELERATED PROCEDURE

INDEX OF GOODS AND/OR SERVICES (511)	NUMBERS OF REGISTERED ACCORDING TO THE ACCELERATED PROCEDURE (111)
7	M 2023 36376 R
9	M 2023 36373 R
29	M 2023 36372 R
29	M 2023 36374 R
29	M 2023 36375 R
30	M 2023 36374 R
31	M 2023 36372 R
32	M 2023 36386 R
33	M 2023 36356 R
34	M 2023 36387 R
35	M 2023 36356 R
35	M 2023 36388 R
36	M 2023 36388 R
39	M 2023 36388 R
41	M 2023 36356 R
41	M 2023 36373 R
41	M 2023 36388 R
42	M 2023 36388 R
43	M 2023 36356 R
43	M 2023 36357 R
43	M 2023 36373 R

OFFICIAL BULLETIN OF THE INDUSTRIAL PROPERTY

INVENTIONS
UTILITY MODELS
DESIGNS
TRADEMARKS

3(606)

EDITOR-IN-CHIEF: N. Bebrishvili

EDITOR-TRANSLATOR: E. Gabunia

PROOFREADER: A. Shixashvili

COMPUTER LAYOUT: M. Ordenidze
K. Svanidze

ISSN 2720-8486

info@sakpatenti.gov.ge
www.sakpatenti.gov.ge