



Official Bulletin of the Industrial Property

Inventions
Utility Models
Designs
Trademarks



საქართველოს ინტელექტუალური
საკუთრების ეროვნული ცენტრი
საქპატენტი
SAKPATENTI
NATIONAL INTELLECTUAL PROPERTY
CENTER OF GEORGIA

3(630)

INID CODES FOR IDENTIFICATION OF BIBLIOGRAPHIC DATA

INVENTIONS, UTILITY MODELS

- (10) Number of publication of examined application/
Application publication number***
- (11) Patent number/ Patent number***
Registered utility model number***
- (21) Application number
- (22) Date of filing of the application
- (23) Date of exhibition priority
- (24) Date from which patent may have effect
- (31) Number of priority application
- (32) Date of filing of priority application
- (33) Code of the country or regional organization allotting application number
- (43) Date of publication of application, number of bulletin***
- (44) Date of publication of examined application, on which no grant has taken place and number of bulletin
- (45) Date of publication of patent/ Date of publication of patent***
Date of publication of registered utility model***
- (51) International Patent Classification Index
- (54) Title of the invention/title of the utility model
- (57) Abstract
- (60) Number of examined patent document granted by foreign patent office, date from which patent has effect and country code
- (62) Number and filing date of the earlier application in case of a divisional application
- (71) Name and address of applicant (country code)
- (72) Name of inventor (country code)
- (73) Name and address of patent owner/patent owner***/ registered utility model owner*** (country code)
- (74) Name of representative or patent attorney
- (85) Date of commencement of the national phase of international application (PCT)
- (86) Number and date of filing of international application (PCT)
- (87) Number and date of publication of international application (PCT)
- (94) Calculated date of expiry of the SPC or the duration of the SPC

DESIGNS

- (10) Number of publication for application
- (11) Number of patent and kind of document or number of registration
- (15) Date of registration/Date of patent renewal
- (18) Expected expiration date of patent or registration
- (21) Serial number of application
- (22) Date of filing of the application
- (23) Date of exhibition or the date of the earlier filing and the number of application, if any
- (24) Date from which patent may have effect
- (28) Number of designs included in the application
- (30) Data relating to priority (number of application, date of filing of application, two-letter code identifying the authority with whom the priority application was made)
- (31) Number of priority application
- (32) Date of filing of priority application
- (33) Code of the country or regional organization allotting priority application number
- (34) Two-letter code according to WIPO St.3 identifying the authority with which the priority application was made
- (44) Date of publication of design and number of bulletin (the first publication)
- (45) Date of publication of design registered by WIPO and number of bulletin
- (51) International Classification for designs (class and subclass of the Locarno Classification)
- (54) Title of the invention
- (55) Reproduction of the design
- (57) Description of characteristic features of the design including indication of colors
- (58) Date of recording of any kind of amendment in the Register
- (62) Number of the earlier application, registration and document number and if available the date of filing an application in case of divided application
- (71) Name, surname and address of applicant (country code)
- (72) Name, surname of creator (country code)
- (73) Name, surname and address of patent owner (country code)
- (74) Name, surname of representative or patent attorney
- (81) Contracting states concerned
II designated contracting states according to the 1960 Act
III designated contracting states according to the 1999 Act
- (85) Owner's permanent address
- (86) Owner's nationality
- (87) Owner's residence
- (88) State in which the owner has a real and effective industrial or commercial establishment

TRADEMARKS

- (111) - Number of registration
- (151) - Date of registration
- (156) - Date of the renewal
- (181) - Expected expiration date of registration
- (186) - Renewal expiration date of registration
- (141) - Date of cancel of duration of the mark
- (210) - Serial number of application
- (220) - Date of filing of the application
- (230) - Data concerning exhibition
- (260) - Number of application, for which favorable decision of examination about registration has been taken (publication number)
- (310) - Number of the first application
- (320) - Date of filing of the first application
- (330) - Code, identifying national or regional Office where the first application was made
- (511) - International Classification of Goods and Services for the purposes of registration of trade marks and/or list of goods and/or services classified according thereto
- (526) - Disclaimer
- (531) - Description of figurative elements of Trade Marks according to the International Classification of the Figurative Elements of Marks
- (540) - Reproduction of Trade Mark
- (550) - Nature and kind of Trade Mark
- (551) - Indication to the effect that the mark is a collective mark, a certification mark or a guarantee mark
- (554) - Three-dimensional mark
- (580) - Date of recording of any kind changes in respect of applications or registrations
- (591) - Information concerning colors claimed
- (731) - Name and address of the applicant
- (732) - Name and address of the holder of the registration
- (740) - Name and address of the representative
- (750) - Addreses for correspondence
- (770) - Name and address of the previous applicant or holder in case of change in ownership
- (771) - Previous name and address of the applicant or holder in case of change in ownership
- (791) - Name and address of the licensee
- (793) - Indication of conditions and/or restrictions under the license (Type of license, number of license agreement, data of license, data of validity of license)
- (800) - Certain data relating to the international registration of Trade Marks under the Protocol Relating to Madrid Agreement (International registration number
- (852) - Partial cancellation of the list of goods and services
- (891) - Date of subsequent designation

CODES FOR PUBLICATION IN BULLETIN

- (21) AP 0000 000000 - number of application for invention
- (10) AP 0000 0000 A - number of publication of application for invention
- (11) P 0000 0000 B - number of patent for invention/ patent number***
- (21) API 0000 000000 - number of application for imported patent
- (11) PI 0000 0000 A - number of imported patent
- (21) AU 0000 000000 - number of application for utility model
- (10) AU 0000 000 U - number of publication of application for utility model
- (11) U 0000 000 Y - number of patent for utility model/ registered utility model number***
- (21) AD 0000 000000 - serial number of application for design
- (10) AD 0000 000 S - number of published application for design (first publication)
- (11) D 0000 000 S - registered design

INTERNATIONAL PATENT CLASSIFICATION FOR INVENTIONS AND UTILITY MODELS

- SECTION A - HUMAN NECESSITIES
- SECTION B - PERFORMING OPERATIONS; TRANSPORTING
- SECTION C - CHEMISTRY; METALLURGY
- SECTION D - TEXTILES; PAPER
- SECTION E - FIXED CONSTRUCTIONS
- SECTION F - MECHANICAL ENGINEERING; LIGHTING; HEATING; WEAPONS; BLASTING
- SECTION G - PHYSICS
- SECTION H - ELECTRICITY

* Number of application published after the decision of Appellation Chamber of SAKPATENTI

** Number of application published after Court decision

*** Materials published according to the amendments of May 16, 2023 (No. 2883-XI0b-X03) to the Patent Law of Georgia

- M - Trade Mark
- (210) AM 0000 000000 - Serial number of application;
- (260) AAM 0000 00000 A - Publication number of application;
- (111) M 0000 00000 R - Number of registration;
- (111) MMM0000 00000 Rn - Number of renewals, in which n=1,2,3;
- (111) M 0000 00000 R(P) - Number of registration under partial assignment of rights

Official Bulletin of the Industrial Property

Inventions

Utility Models

Designs

Trademarks

CONTENT

PUBLISHED TITLES OF PROTECTION	2
INVENTIONS	
▪ APPLICATIONS APPROVED FOR GRANTING PATENT	4
▪ PATENTED INVENTIONS	8
▪ APPLICATIONS***	10
UTILITY MODELS	
▪ PATENTED UTILITY MODELS	13
▪ APPLICATION***	15
▪ REGISTERED UTILITY MODEL***	16
DESIGNS	
▪ APPLICATIONS APPROVED FOR REGISTRATION	17
▪ REGISTERED DESIGNS	21
▪ DESIGNS, WICH HAVE BEEN REGISTERED WITH THE INTERNATIONAL BUREAU CLAIMING PRIORITY ON THE TERRITORY OF GEORGIA	22
TRADEMARKS	
▪ APPLICATIONS FILED UNDER THE NATIONAL PROCEDURE APPROVED FOR REGISTRATION	27
▪ REGISTERED TRADEMARKS	48
▪ TRADEMARKS REGISTERED ACCORDING TO THE ACCELERATED PROCEDURE	51
▪ INTERNATIONAL TRADEMARKS FOR WHICH A DECISION ON GRANTING PROTECTION IS TAKEN	54
▪ INTERNATIONAL TRADEMARKS PROTECTED IN GEORGIA	130
OFFICIAL NOTIFICATION	
INVENTIONS	
▪ RESTORATION OF PATENTS	140
▪ LAPSE OF PATENTS WITH THE RIGHT TO RESTORE	140
▪ EXPIRATION OF PATENTS RESTORATION TERM	141
UTILITY MODELS	
▪ LAPSE OF PATENTS WITH THE RIGHT TO RESTORE	142
▪ EXPIRATION OF PATENT RESTORATION TERM	142
DESIGNS	
EXTENSION OF TERM OF INTERNATIONAL DESIGNS REGISTRATION	143
TRADEMARKS	
▪ EXTENSION OF TERM OF TRADEMARKS REGISTRATION	144
▪ COMPLETE TRANSFER OF RIGHTS	145
▪ CHANGES OF NAME AND/OR ADDRESS OF TRADEMARKS OWNERS	146
▪ CANCELLATION OF TRADEMARKS REGISTRATION	147
CLASSIFICATION INDEXES	
INVENTIONS	149
UTILITY MODELS	151
DESIGNS	153
TRADEMARKS	155

PUBLISHED TITLES OF PROTECTION

INVENTIONS

- **APPLICATIONS APPROVED FOR GRANTING PATENT:**
15883; 15986; 15804; 15966; 15748; 15522; 15941
- **PATENTED INVENTIONS:**
7590-7595
- **APPLICATIONS:*****
16349; 16395; 16425; 16351; 16383

UTILITY MODELS

- **PATENTED UTILITY MODELS:**
2162-2166
- **APPLICATION:*****
16304
- **REGISTERED UTILIYU MODEL:*****
2161

DESIGNS

- **APPLICATIONS APPROVED FOR REGISTRATION:**
1329; 1328
- **REGISTERED DESIGNS:**
992, 993
- **DESIGNS, WHICH HAVE BEEN REGISTERED WITH THE INTERNATIONAL BUREAU CLAIMING PRIORITY ON THE TERRITORY OF GEORGIA:**
233000; 232927; 232998; 224981; 233184

TRADEMARKS

- **APPLICATIONS FILED UNDER THE NATIONAL PROCEDURE APPROVED FOR REGISTRATION:**
122028; 122429; 122569; 122577; 122580; 122586; 122651; 122672; 122738-122740; 122747; 122827; 122839; 122841; 122852; 122857; 122858; 122860-122862; 122939-122942; 122944; 122967; 122974; 122975; 123066; 123068; 123074; 123078-123081; 123083; 123084; 123086; 123088; 123089; 123092; 123094; 123096; 123098; 123099; 123101-123103; 123105; 123180-123185; 123187; 123188; 123192-123199; 123201; 123212; 123216; 123305; 123318-123320; 123323; 123324; 123333; 123341; 123344; 123351; 123353-123355; 123360; 123409; 123413; 123414; 123416; 123418; 123419; 123478; 123480; 123481; 123486; 123488; 123493; 123498; 123499; 123503; 123504; 123511; 123573-123575; 123585-123587; 123592; 123594; 123596; 123597; 123602; 123603; 123606; 123610; 123612; 123617; 123618; 123620-123622; 123651; 123653; 123676; 123870; 123871; 123881-123884; 123904; 123912; 123920-123923; 123931; 124008; 124067; 124069; 124071
- **REGISTERED TRADEMARKS:**
37804-37833
- **TRADEMARKS REGISTERED ACCORDING TO THE ACCELERATED PROCEDURE:**
37798-37803; 37834-37844
- **INTERNATIONAL TRADEMARKS FOR WHICH A DECISION ON GRANTING PROTECTIONS IS TAKEN:**
121009; 121943; 121948; 121956; 121979; 122085; 122163; 122382; 122456; 122471; 122472; 122475; 122513; 122514; 122516-122518; 122593; 122603-122605; 122641-122645; 122681; 122682; 122691; 122692; 122694; 122695; 122697-122699; 122714; 122717; 122757; 122759; 122769; 122772; 122773; 122775; 122776; 122781-122783; 122791; 122792; 122795; 122796; 122807; 122808; 122810; 122812; 122818; 122871; 122872; 122874; 122891; 122899-122902; 122922; 122934-122937; 122988-122991; 122996; 122997; 123004; 123023-123026; 123031; 123032; 123055; 123056; 123062-123064; 123120-123123; 123125; 123232; 123233; 123235; 123236; 123274-123277
- **INTERNATIONAL TRADEMARKS PROTECTED IN GEORGIA:**
120372; 121182-121184; 121199; 121205; 121252-121263; 121276-121281; 121283; 121291; 121294; 121353-121355; 121367-121372; 121379; 121383; 121385-121390; 121403-121408; 121463-121487; 121492-121497; 121567-121571; 121577-121582; 121585; 121586; 121606; 121617-121621; 121627; 121628; 121674-121676; 121678; 121689; 121710-121714; 121782-121785; 121817-121821; 121841; 121947; 121957; 121963; 121971; 121975; 121989; 121992; 121999; 122148; 122164; 122165

INVENTIONS

APPLICATIONS APPROVED FOR GRANTING PATENT

The decision can be appealed at the Chamber of Appeal of Sakpatenti within 3 months from the publication or at the Mtskheta District Court Administrative Cases Board (Address: №17, Samkhedro St., Mtskheta), within 1 month following the publication.

PART A

A 61

- (10) AP 2024 15883 A (51) Int. Cl. (2006)
A 61 K 31/4188
A 61 P 35/02
A 61 P 35/00
A 61 P 31/00
C 07 D 519/00
C 07 D 498/16
- (21) AP 2020 15883 (22) 2020 07 22
- (31) 201921029556; 201921051086;
202021003961
- (32) 2019 07 22; 2019 12 10;
2020 01 29
- (33) IN; IN; IN
- (71) Lupin, LTD (IN)
Kalpataru Inspire, 3rd fl. Off Western Express
Highway,
Santacruz (East) Maharashtra Mumbai 400 055,
India (IN)
- (72) BANERJEE, Moloy (IN);
KARCHE, Navnath Popat (IN);
JADHAV, Ganesh Rajaram (IN);
VYAVAHARE, Vinod Popatrao (IN);
PALLE, Venkata P. (IN);
KAMBOJ, Rajender Kumar (IN);
GUPTA, Nishant Ramnivasji (IN);
DAS, Amit Kumar (IN);
WALKE, Deepak Sahebrao (IN);
KALHAPURE, Vaibhav Madhukar (IN);
BHOSKAR, Smita Aditya (IN);
RAMDAS, Vidya (IN)
- (74) Larisa Amirkhanyan
- (85) 2022 02 21
- (86) PCT/IB2020/056875, 2020 07 22
- (54) MACROCYCLIC COMPOUNDS AS STING
AGONISTS AND METHODS AND USES
THEREOF
- (57) Disclosed are macrocyclic compounds having the
general formula (I) or (II),

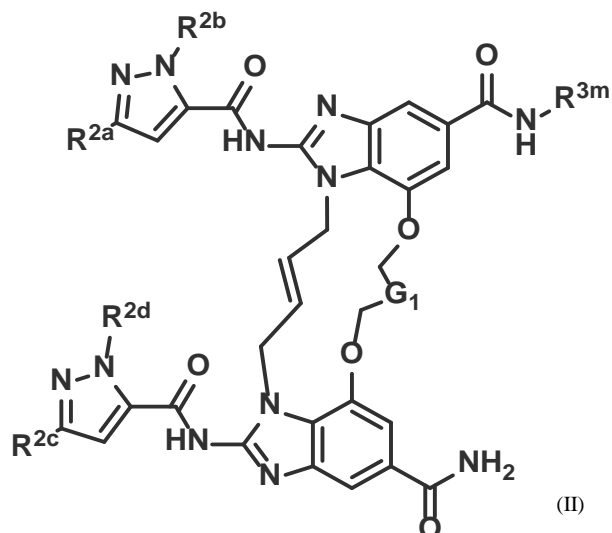
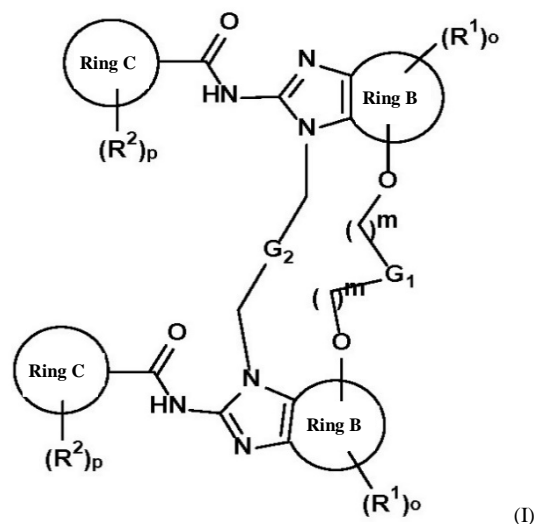

and their tautomeric forms, stereoisomers, pharmaceutically acceptable salts, hydrates, solvates, and their combination with suitable medicament, corresponding processes for the synthesis and pharmaceutical compositions used as STING agonists, particularly, various kind of cancer treatment.

Claims: 7 independents

17 dependents

Fig.: 7

- (10) AP 2024 15986 A (51) Int. Cl. (2006)
A 61 K 31/4353
A 61 P 35/00
C 07 D 403/04
- (21) AP 2020 15986 (22) 2020 11 24
(31) 19 212 252.1; 20 181 065.2
(32) 2019 11 28; 2020 06 19
(33) EP; EP
- (71) Bayer Aktiengesellschaft (DE)
Kaiser-Wilhelm-Allee 1, Leverkusen, 51373,
Germany (DE);
Bayer Pharma Aktiengesellschaft (DE)
Müllerstraße 178, Berlin, 13353, Germany (DE)
- (72) MEIER, Robin, Michael (DE);
OFFRINGA, Rienk (DE);
NGUYEN, Thi, Thanh, Uyen (DE);
KIRCHHOFF, Dennis (DE);
SCHMEES, Norbert (DE);
KOSEMUND, Dirk (DE);
WORTMANN, Lars (DE);
GREES, Mareike (DE);
KERSCHGENS, Isabel, Patrizia (DE);
HERBERT, Simon, Anthony (DE);
LECHNER, Christian (DE);
STÖCKIGT, Detlef (DE);
KOBBER, Christina (DE);
PETERSEN, Kirstin (DE);
BÖMER, Ulf (DE);
WERBECK, Nicolas (DE)
- (74) Tamar Kochlamazashvili
(85) 2022 06 24
(86) PCT/EP2020/083198, 2020 11 24
(54) SUBSTITUTED AMINOQUINOLONES AS
DGKALPHA INHIBITORS FOR IMMUNE
ACTIVATION
- (57) Compound of formula (I):

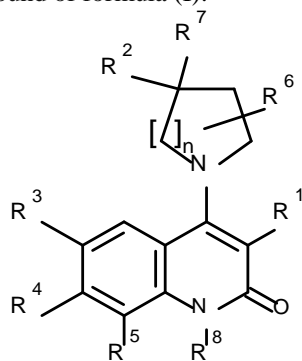

(I)

wherein R^1 , R^2 , R^3 , R^4 , R^5 , R^6 , R^7 , R^8 substituents and n variable are provided in the claims or their pharmaceutically acceptable salt, pharmaceutical composition on the basis thereof, and usage thereof the treatment of cancer or condition with violation of immune response regulation.

Claims: 7 independents

14 dependents

Table: 26

Fig.: 6

- (10) AP 2024 15804 A (51) Int. Cl. (2006)
A 61 K 31/4545
A 61 P 35/00
C 07 D 471/04
- (21) AP 2020 15804 (22) 2020 04 22
(31) 62/838,051; 62/940,036
(32) 2019 04 24; 2019 11 25
(33) US; US
- (71) The Broad Institute, Inc. (US)
415 Main Street, Cambridge, MA 02142,
USA (US);
Dana-Farber Cancer Institute, INC. (US)
450 Brookline Ave, Boston, MA 02215,
USA (US);
Bayer Aktiengesellschaft (DE)
Kaiser-Wilhelm-Allee 1, Leverkusen, 51373,
Germany (DE)
- (72) MÖNNING, Ursula (DE);
NIEHUES, Michael (DE);
SIEGEL, Franziska (DE);
GRAHAM, Keith (DE);
SIEGEL, Stephan (DE);
MEYERSON, Matthew (US);
GREULICH, Heidi (US);
SCHRÖDER, Jens (DE);
SCHULZE, Volker (DE);
KORR, Daniel (DE);
KAPLAN, Bethany (US);
BÖMER, Ulf (DE);
BERGER, Markus (DE);
SÜLZLE, Detlev (DE)
- (74) Tamar Kochlamazashvili
(85) 2021 11 22
(86) PCT/EP2020/061176, 2020 04 22
(54) 4H-PYRROLO[3,2-C]PYRIDIN-4-ONE
COMPOUNDS
- (57) Compounds of formula (I),

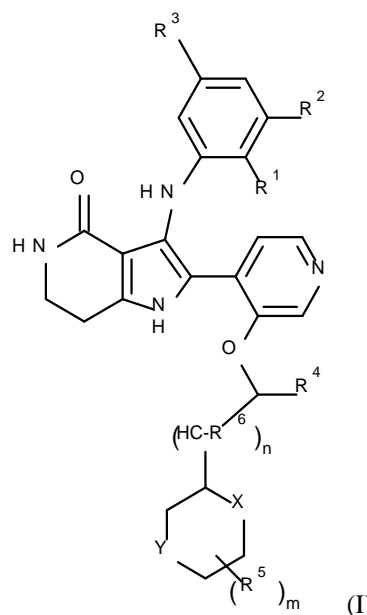

(I)

pharmaceutical compositions on the basis thereof, and usage thereat the treatment of hyperproliferative diseases.

Claims: 12 independents
29 dependents

- (10) AP 2024 15966 A (51) Int. Cl. (2006)
A 61 K 31/454
A 61 P 9/00
A 61 P 25/00
A 61 P 11/00
C 07 D 417/14
C 07 D 413/14
- (21) AP 2020 15966 (22) 2020 11 05
(31) 19207536.4
(32) 2019 11 06
(33) EP
(71) Bayer Aktiengesellschaft (DE)
Kaiser-Wilhelm-Allee 1, Leverkusen, 51373,
Germany (DE)
(72) BECKER-PELSTER, Eva Maria (DE);
MÜLLER, Thomas (DE);
DIETZ, Lisa (DE);
PLATZK, Magdalena (US);
MEIBOM, Daniel (DE);
SCHMECK, Carsten (DE);
DELBECK, Martina (DE);
HAHN, Michael (DE);
BUCHGRABER, Philipp (DE);
LINDNER, Niels (DE)
(74) Giorgi Kartvelishvili
(85) 2022 06 02
(86) PCT/EP2020/081097, 2020 11 05
(54) INHIBITORS OF ADRENORECEPTOR
ADRAC2
(57) Compounds of common formula (I),

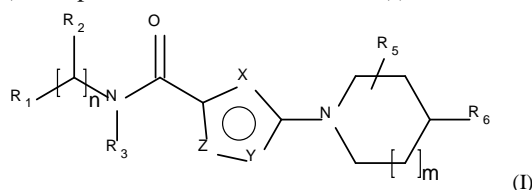

preparation methods thereof, and their usage for the treatment and/or prevention of breathing difficulties including sleep-induced breathing difficulties such as central and obstructive sleep apnoea, snoring (primary and obstructive snoring), dysphagia, peripheral and cardiac vascular disorders including diabetic microangiopathies and disorders of the peripheral and central nervous system including neurodegenerative and neuroinflammatory disorders.

Claims: 13 independents
9 dependents

PART B

B 01

- (10) AP 2024 15748 A (51) Int. Cl. (2006)
B 01 F 17/00
C 10 L 10/02
C 10 L 1/32
- (21) AP 2020 15748 (22) 2020 03 05
(31) 1903169.9
(32) 2019 03 08
(33) GB
(71) SulNOx Group PLC (GB)
10 Orange Street, Haymarket London
WC2H7DQ, UK (GB)
(72) REDMAN, James (GB)
(74) Shalva Gvaramadze
(85) 2021 10 06
(86) PCT/EP2020/055901, 2020 03 05
(54) EMULSIFIER AND EMULSIONS
(57) There is provided an emulsifier comprising at least one C₈ to C₁₈ fatty acid diethanolamide, at least one C₁₂ to C₂₄ fatty acid, at least one C₆ to C₁₈ alcohol ethoxylate. There is additionally provided cleaning additive solution containing this emulsifier, diesel fuel emulsion and diesel fuel nanoemulsion.
Claims: 9 independents
6 dependents
Fig.: 4

PART E

E 04

- (10) AP 2024 15522 A (51) Int. Cl. (2006)
E 04 B 1/24
E 04 B 2/76
E 04 B 2/74
E 04 B 1/38
E 04 B 2/58
E 04 F 11/18
- (21) AP 2019 15522 (22) 2019 05 24
(31) 202018003027.9
(32) 2018 06 28
(33) DE
(71) Knauf Gips KG (DE)
Am Bahnhof 7, 97346 Iphofen, Germany (DE)
(72) ESIN, Yener (DE);
GLOCK, Dietmar (DE)
(74) Shalva Gvaramadze
(85) 2020 12 21
(86) PCT/EP2019/000166, 2019 05 24
(54) CONNECTION PIECE FOR THE ANGULAR
CONNECTION OF TWO COMPONENTS

(57) Connection piece (1) for the angular connection of two components to one another, in particular for a drywall or metal lightweight construction, wherein two studs, preferably U-stud-shaped studs, to be arranged essentially at right angles to one another, are to be connected to one another, characterised in that the connection piece comprises a bottom plate (2) and a stud-shaped, preferably U-stud-shaped, sidewall (3), which is fitted essentially vertically on the bottom plate, and wherein at least one cutout (7), in particular for the feed-through in each case of a fastening element, preferably a concrete anchor, is present on each side of the bottom plate divided by the sidewall.

Claims: 4 independents
12 dependents

Fig.: 2

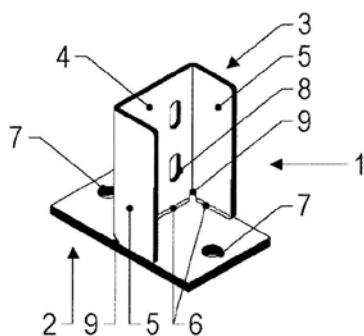

Fig. 1

"pipe-in-pipe" (17, 18) having telescopic action for the purpose to move the scaffold on building facade. The hydrocylinders are equipped with horizontal and vertical two-way extendable stocks (3, 5). The scaffold also has nodes to attach hydrocylinders and pipes ends to the facade (6, 7, 8). Hydraulic drive (29) having an engine, pump and hydraulic distributor is attached to working platform from below, and engine control panel (30) is placed onto scaffold handrail.

Claims: 1 independents

2 dependents

Fig.: 28

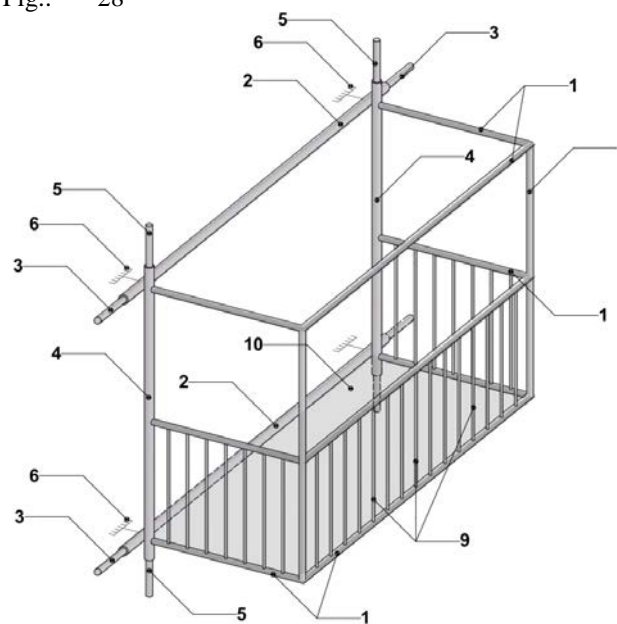

Fig. 1

(10) AP 2024 15941 A (51) Int. Cl. (2006)
E 04 G 3/10

(21) AP 2022 15941 (22) 2022 05 06

(71) Nikalay Sharashenidze (GE)
Temka, II m/r, I qu., bld. "a", ap. 7, 0192, Tbilisi, Georgia (GE);
Shakhi Bakanidze (GE)
Tevdore Zhordania St. 12, Tbilisi, Georgia (GE);
Beka Surguladze (GE)
Gldani Array I m/r, bld. 3, ap. 41, 0167, Tbilisi, Georgia (GE);
Giorgi Nadirashvili (GE)
Zaza Panaskerteli St., bld. 6, ap. 28, Tbilisi, Georgia (GE);
Tornike Piranishvili (GE)
E. Bedia St., bld. 3, ap. 1, 0183, Tbilisi, Georgia (GE)

(72) Nikalay Sharashenidze (GE);

Shakhi Bakanidze (GE);

Beka Surguladze (GE);

Giorgi Nadirashvili (GE);

Tornike Piranishvili (GE)

(54) MOVABLE SCAFFOLD FOR PAVING WORKS ON BUILDING FACADE

(57) A scaffold for paving works on building includes spatial frame (1) having a handrail (9) disposed therewith working platform (10), and horizontal and vertical componentry executed for the purpose to move hydrocylinders (2, 4) or system executed as

PATENTED INVENTIONS

PART A

A 61

- (11) P 2024 7594 B (51) Int. Cl. (2006)
 A 61 K 31/58
 A 61 K 31/137
 A 61 K 31/167
 A 61 K 31/573
 A 61 K 47/02
 A 61 K 47/10
 A 61 K 9/00
 A 61 P 11/00
- (10) AP 2023 16025 A (44) 20(623)/2023
 (21) AP 2021 16025
 (22) 2021 01 26
 (24) 2021 01 26
 (31) 20153973.1; 20214091.9
 (32) 2020 01 28; 2020 12 15
 (33) EP; EP
 (86) PCT/EP2021/051669, 2021 01 26
 (73) Chiesi Farmaceutici S.P.A. (IT)
 Via Palermo 26/A, 43122 Parma, Italy (IT)
 (72) ZAMBELLI, Enrico (IT)
 (74) Shalva Gvaramadze
 (54) PRESSURISED METERED DOSE INHALERS
 COMPRISING A BUFFERED PHARMA-
 CEUTICAL FORMULATION
-
- (11) P 2023 7590 B (51) Int. Cl. (2006)
 A 61 K 31/4709
 A 61 K 31/506
 A 61 P 31/06
 C 07 D 401/04
 C 07 D 409/14
 C 07 D 401/14
 C 07 D 405/14
- (10) AP 2023 16014 A (44) 19(622)/2023
 (21) AP 2020 16014
 (22) 2020 12 28
 (24) 2020 12 28
 (31) 116028; 116168; 20163200.7
 (32) 2019 12 27; 2020 03 13; 2020 03 13
 (33) PT; PT; EP
 (86) PCT/IB2020/062483, 2020 12 28
 (73) Tecnimede-Sociedade Técnico-Medicinal SA (PT)
 Rua Da Tapada Grande, Nº2 Abrunheira,
 2710-089 Sintra, Portugal (PT)
 (72) PARDAL FILIPE, Augusto Eugénio (PT);
 RAMOS DAMIL, João Carlos (PT);
 CORDEIRO SIMÕES, Ana Vanessa (PT);
 DA COSTA PEREIRA ROSA, Carla
 Patrícia (PT);

- ALMEIDA FERREIRA, Ana Lúcia (PT);
 SILVA SERRA, João Pedro (PT);
 MARQUES HOMEM E SOUSA DOS
 SANTOS, Sara Alexandra (PT);
 GOMES NEVES, Rita Isabel (PT)
- (74) Larisa Amirkhanyan
 (54) ANTIBACTERIAL QUINOLINES

-
- (11) P 2024 7593 B (51) Int. Cl. (2006)
 A 61 K 39/395
 A 61 K 45/06
 C 07 K 16/40
- (10) AP 2023 15019 A (44) 17(620)/2023
 (21) AP 2017 15019
 (22) 2017 07 31
 (24) 2017 07 31
 (31) 62/369,674; 62/419,420; 62/478,336
 (32) 2016 08 01; 2016 11 08; 2017 03 29
 (33) US; US; US
 (86) PCT/US2017/044714, 2017 07 31
 (73) University of Leicester (GB)
 University Road of Leicester, Leicestershire,
 LE1 7RH, UK (GB);
 Omeros Corporation (US)
 201 Elliott Avenue, West Seattle, WA 98119,
 USA (US)
- (72) WOOD, Christi, L. (US);
 DEMOPULOS, Gregory, A. (US);
 SCHWAEBLE, Hans-Wilhelm (GB);
 CUMMINGS, W., Jason (US);
 YABUKI, Munehisa (US);
 DUDLER, Thomas (US);
 TJOELKER, Larry, W. (US)
- (74) Tamar Kotchlamazashvili
 (54) COMPOSITIONS AND METHODS OF
 INHIBITING MASP-3 FOR THE TREA-
 TMENT OF VARIOUS DISEASES AND
 DISORDERS

PART C

(54) ANGULAR OSCILLATION EIGHT-POLE
ELECTROMAGNETIC VIBRATION
MACHINE

C 03

- (11) P 2024 7592 B (51) Int. Cl. (2006)
C 03 B 37/00
(10) AP 2023 15931 A (44) 18(621)/2023
(21) AP 2022 15931
(22) 2022 04 15
(24) 2022 04 15
(73) Paata Gogoladze (GE)
Iliа Chavchavadze St., bld. 6, ap. 43-44, 3700,
Rustavi, Georgia (GE)
(72) Paata Gogoladze (GE);
Vazha Chagelishvili (GE)
(74) Davit Dzamukashvili
(54) METHOD FOR RECEIVING TEXTILE FIBER
FROM BASALT STONE
-

PART E**E 04**

- (11) P 2024 7591 B (51) Int. Cl. (2006)
E 04 H 6/06
(10) AP 2023 16038 A (44) 19(622)/2023
(21) AP 2022 16038
(22) 2022 09 07
(24) 2022 09 07
(73) Sergo Jorbenadze (GE)
Didi Dighomi, III m/r, bld.. 19, ap. 80, Tbilisi,
Georgia (GE)
(72) Sergo Jorbenadze (GE)
(54) PARKING LIFT SAFETY BRAKE (ALUM)
-

PART H**H 02**

- (11) P 2024 7595 B (51) Int. Cl. (2006)
H 02 K 33/04
(10) AP 2023 16203 A (44) 20(623)/2023
(21) AP 2023 16203
(22) 2023 04 03
(24) 2023 04 03
(73) Gela Javakhishvili (GE)
Bukhaidze St. 18, Tbilisi, 0102, Georgia (GE);
Aleksandre Didebulidze (GE)
Merab Kostava St. 44, Entrance 1, ap. 5, 0179,
Tbilisi, Georgia (GE)
(72) Gela Javakhishvili (GE);
Aleksandre Didebulidze (GE)
-

APPLICATIONS***

PART A

A 61

(10) AP 2024 16349 A (51) A 61 K 31/4166
 A 61 K 9/00
 A 61 K 31/165
 A 61 K 31/19
 A 61 K 31/4015
 A 61 K 31/41
 A 61 K 31/435
 A 61 P 25/00
 A 61 P 25/08

(43) 2024 02 12 №3

(21) AP 2022 16349

(22) 2022 02 09

(31) 63/147,736

(32) 2021 02 09

(33) US

(71) Xenon Pharmaceuticals Inc. (CA)
 200-3650 Gilmore Way, Burnaby, British
 Columbia V5G 4W8, Canada (CA)

(72) JOHNSON, JR, James Philip (CA)

(74) Nikoloz Gogilidze

(85) 2023 09 08

(86) PCT/US2022/015851, 2022 02 09

(54) CONJOINT THERAPY FOR TREATING
 SEIZURE DISORDERS

(57) In certain embodiments, the present disclosure is directed to methods and uses for treating seizure disorders in a human in need thereof, wherein the methods and uses comprise conjointly administering N-[4-(6-fluoro-3,4-dihydro-1H-isoquinolin-2-yl)-2,6-dimethylphenyl]-3,3-dimethylbutanamide (Compound A) and an antiseizure medication (ASM) to the human in amounts that are therapeutically effective when conjointly administered. The present disclosure is further directed to various improved methods of therapy and administration of Compound A.

(10) AP 2024 16395 A (51) A 61 K 31/506
 A 61 P 43/00
 C 07 D 207/14
 C 07 D 417/12
 C 07 D 491/04
 C 07 D 403/12
 C 07 D 405/14

(43) 2024 02 12 №3

(21) AP 2021 16395

(22) 2021 08 16

(62) AP 2021 16190 2023 03 16

(31) 63/226,798; 63/066,908

(32) 2021 07 29; 2020 08 18

(33) US; US

(71) Merck Sharp & Dohme LLC (US)
 126 East Lincoln Avenue, Rahway, NJ 07065,
 USA (US)

(72) RUDD, Michael, T. (US);
 YANG, Dexi (US);
 XIAO, Li (US);
 WEI, Lan (US);
 LIN, Shishi (US);
 HAO, Jinsong (US);
 GUIADEEN, Deodial Guy (US);
 CLAUSEN, Dane James (US);
 BOGEN, Stephane, L. (US)

(74) Shalva Gvaramadze

(85) 2023 11 15

(86) PCT/US2021/046098, 2021 08 16

(54) BICYCLOHEPTANE PYRROLIDINE OREXIN
 RECEPTOR AGONISTS

(57) Present invention is directed to bicyclo[4.1.0]heptane pyrrolidine compounds of formula (I),

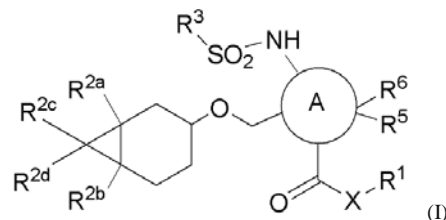

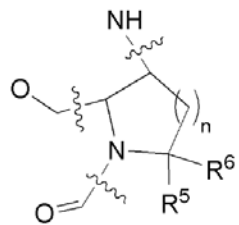
wherein:  is  or

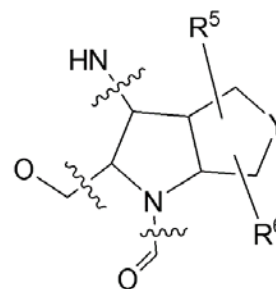

wherein n is 0 or 1, and they are agonists of orexin receptors. Present invention is also directed to uses of the compounds described herein in the potential treatment or prevention of neurological and psychiatric disorders and diseases in which orexin receptors are involved. Present invention is also directed to compositions comprising these compounds. Present invention is also directed to uses of these compositions in the potential prevention or treatment of such diseases in which orexin receptors are involved.

(10) AP 2024 16425 A (51) A 61 K 31/517
A 61 K 31/4184
A 61 K 31/417

(43) 2024 02 12 №3

(21) AP 2021 16425

(22) 2021 05 24

(31) 63/192,822

(32) 2021 05 25

(33) US

(71) BioCryst Pharmaceuticals Inc. (US)
4505 Emperor Blvd. Suite 200, Durham,
NC 2773, USA (US)

(72) KOTIAN, Pravin L. (US);
BABU, Yarlagadda S. (US);
ZHANG, Weihe (US);
LV, Wei (US);
LU, Peng-Cheng (US);
SPAULDING, Andrew E. (US);
RAMAN, Krishnan (US)

(74) Nikoloz Gogilidze

(85) 2023 12 17

(86) PCT/US2022/030690, 2022 05 24

(54) IMIDAZOLE-CONTAINING INHIBITORS OF
ALK2 KINASE

(57) Disclosed are compounds of formula I, II, III, and IV, and pharmaceutically acceptable salts thereof. The compounds are inhibitors of ALK2 kinase. Also provided are pharmaceutical compositions comprising a compound, of formula. I, II, III, or IV,

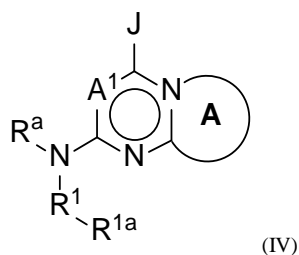
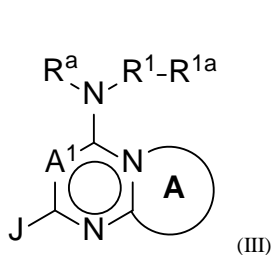
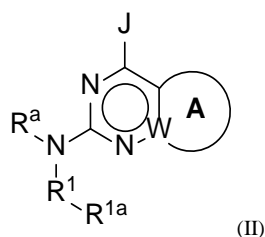
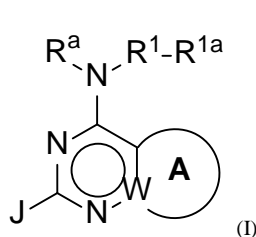

or pharmaceutically acceptable salt thereof, and methods involving use of the compounds or pharmaceutically acceptable salts thereof and compositions in the treatment and prevention of various diseases and conditions, such as fibrodysplasia ossificans progressiva.

(10) AP 2024 16351 A (51) A 61 K 39/395
A 61 P 29/00
A 61 P 1/00
C 07 K 16/28
C 07 K 16/24

(43) 2024 02 12 №3

(21) AP 2022 16351

(22) 2022 02 16

(31) 63/150,373

(32) 2021 02 17

(33) US

(71) Prometheus Biosciences, Inc. (US)
3050 Science park, Road San Diego, CA 92121,
USA (US);
Dr. Falk Pharma GmbH (DE)
Leinenweberstraße 5, 79108 Freiburg im
Breisgau, Germany (DE)

(72) FECTEAU, Jessie-Farah (US);
RENSHAW, Mark (US);
FRANSSON, Johan (US);
LAURENT, Olivier (US);
BARNETT, Burton (US)

(74) Shalva Gvaramadze

(85) 2023 09 14

(86) PCT/US2022/016565, 2022 02 16

(54) ANTI-CD30L ANTIBODIES AND USES
THEREOF

(57) Described herein are anti-CD30L antibodies and pharmaceutical compositions for the treatment of autoimmune diseases and disorders such inflammatory bowel disease (IBD), including Crohn's Disease (CD) and ulcerative colitis (UC).

(10) AP 2024 16383 A (51) A 61 K 47/68
A 61 K 45/06
A 61 K 39/395
A 61 P 35/00

(43) 2024 02 12 №3

(21) AP 2022 16383

(22) 2022 04 28

(31) 202110482012.2

(32) 2021 04 30

(33) CN

(71) Sichuan Kelun-Biotech Biopharmaceutical Co.,
LTD (CN)
№666, Xinhua Avenue (Section 2), Hai Xia
Industrial Park, Wenjiang
District Chengdu, Sichuan 611138, People's
Republic of China (CN)

(72) GE, Junyou (CN);
OUYANG, Xuenong (CN);
JIN, Xiaoping (CN);
DIAO, Yina (CN);
LIU, Gesha (CN);
CHENG, Yezhe (CN);
WANG, Jingyi (CN);
XU, Ying (CN);
RAO, Chun (CN)

(74) Tamaz Shilakadze

(85) 2023 10 27

(86) PCT/CN2022/089737, 2022 04 28

(54) USE OF MEDICAMENT IN TREATMENT OF
TUMOR DISEASE

(57) Present invention relates to the use of a medicament in treatment of a tumor disease. In particular, the present invention provides the use of a biologically active conjugate represented by formula (I) in treatment of a tumor disease. The tumor disease particularly and preferably refers to an unresectable locally advanced or metastatic solid tumor that is refractory according to existing treatment standards, including but not limited to breast cancer, gastric cancer, lung cancer, ovarian cancer, urinary tract epithelial cancer, esophageal cancer, liver cancer, colorectal cancer, cervical cancer, endometrial cancer, pancreatic cancer, and brain tumor.

UTILITY MODELS

PATENTED UTILITY MODELS

PART A

A 23

- (11) U 2024 2163 Y (51) Int. Cl. (2006)
A 23 F 3/00
- (10) AU 2023 16196 U (44) 19(622)/2023
- (21) AU 2023 16196
- (22) 2023 03 22
- (24) 2023 03 22
- (73) Bakhva Dolidze (GE)
I. Shemokmedeli St. 32, 3500, Ozurgeti,
Georgia (GE);
Temur Revishvili (GE)
University St. 9/13, 3500, Ozurgeti, Georgia
(GE);
Zurab Andghuladze (GE)
II. Chavchavadze St. 10, ap. 2, 3500, Ozurgeti,
Georgia (GE);
Ekaterine Gobronidze (GE)
II. Chavchavadze St. 11, 3500, Ozurgeti,
Georgia (GE);
Luka Zhvania (GE)
Merab Aleksidze St., bld. 1, ap. 42, Tbilisi,
Georgia (GE)
- (72) Bakhva Dolidze (GE);
Temur Revishvili (GE);
Zurab Andghuladze (GE);
Ekaterine Gobronidze (GE);
Luka Zhvania (GE)
- (54) TWISTED TEA-LEAF SHAPING-DRYING
DEVICE
-

PART B

B 24

- (11) U 2024 2162 Y (51) Int. Cl. (2006)
B 24 D 3/10
- (10) AU 2023 16092 U (44) 19(622)/2023
- (21) AU 2022 16092
- (22) 2022 11 16
- (24) 2022 11 16
- (73) Nikoloz Loladze (GE)
Merab Kostava St. 75, bld. 11, ap. 12, Tbilisi,
Georgia (GE);
Medea Tserodze (GE)
Tskneti Highway 20, ap. 64, Tbilisi,
Georgia (GE);

- Zurab Avalishvili (GE)
Tskaltubo St. 24a, ap. 43, Tbilisi, Georgia (GE);
Iuri Dzidzishvili (GE)
Vazisubani, IV m/r, I qu., bld. 13, ap. 60,
Tbilisi, Georgia (GE);
Georgian Technical University (GE)
Merab Kostava St. 77, 0175, Tbilisi,
Georgia (GE);
LEPL "Shota Rustaveli National Science
Foundation of Georgia" (GE)
M. Aleksidze St. 1, Tbilisi, Georgia (GE)
- (72) Nikoloz Loladze (GE);
Medea Tserodze (GE);
Zurab Avalishvili (GE);
Iuri Dzidzishvili (GE)
- (54) Metal binder for diamond tools
-

PART E

E 21

- (11) U 2024 2165 Y (51) Int. Cl. (2006)
E 21 B 43/01
- (10) AU 2023 16069 U (44) 20(623)/2023
- (21) AU 2022 16069
- (22) 2022 10 25
- (24) 2022 10 25
- (73) Georgian Technical University (GE)
Merab Kostava St. 77, Tbilisi, Georgia (GE)
- (72) Koba Kikabidze (GE);
Giorgi Abramishvili (GE);
Nugzar Iashvili (GE);
Nodari Dzidzikashvili (GE);
Shota Mestvirishvili (GE)
- (54) METHOD FOR EXTRACTION OF GASES
FLOWING INTO THE HYDROSPHERE
-

APPLICATION*****PART D****D 04**

(10) AU 2024 16304 U (51) Int. Cl. (2006)
D 04 H 1/16

(43) 2024 02 12 №3

(21) AU 2023 16304 (22) 2023 07 21

(71) Olga Rukhadze (GE)

Aleksandre Diuma St. 12, Tbilisi, Georgia (GE)

(72) Olga Rukhadze (GE)

(54) FELTMAKING METHOD

(57) Feltmaking method provides layering of yarn, fabric or combination thereon stand or template in accordance with previously selected composition, packing outer edges therewith woolen net rectilinear, and their disposition between at least woolen net two layers, wetting and felting of obtained layer providing first felting on a pipe, and next – on diagonals of layers from all four sides, only once.

DESIGNS

APPLICATIONS APPROVED FOR REGISTRATION

The decision can be appealed at the Chamber of Appeal of Sakpatenti within 3 months from the publication or at the Mtskheta District Court Administrative Cases Board (Address: №17, Samkhedro str., Mtskheta), within 1 month following the publication.

- (10) AD 2024 1329 S (51) 09-01
- (21) AD 2023 1329 (22) 2023 08 31
- (28) 2
- (71) JSC "Lomisi" (GE)
Vill. Natakhtari, 3308, Mtskheta Region, Georgia (GE)
- (72) Sorin-Marian Paun (RO)
- (74) Shalva Gvaramadze (GE)
- (54) CAN
- (55)



1.1



1.2



1.3



1.4



1.5



1.6



2.1



2.2



2.3



2.4



2.5



2.6

(10) AD 2024 1328 S (51) 15-09
(21) AD 2023 1328 (22) 2023 08 24
(28) 1

(71) Levan Kitiashvili (GE)
Moscow Av., V qu., bld. 9, ap. 15, 0145, Tbilisi, Samgori District, Georgia (GE)

(72) Levan Kitiashvili (GE)

(54) STEPWISE PRESSING MULTIFUNCTIONAL ENERGY INDEPENDENT MECHANICAL
HYDRAULIC /ENERGY DEPENDENT ELECTRO-HYDRAULIC PRESSURE

(55)





1.5



1.6

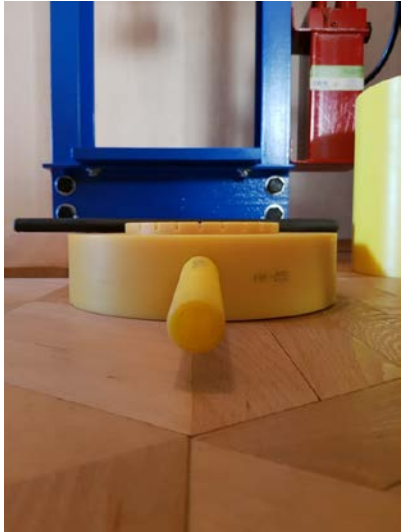

1.7

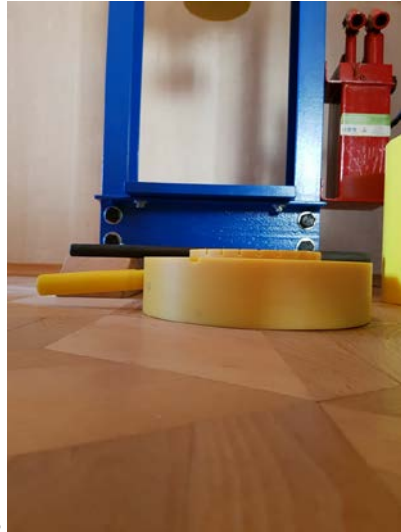

1.8



1.9

REGISTERED DESIGNS

(11) D 2024 992 S (51) 11-01
(10) AD 2023 1313 S (44) 2023 10 25 №20
(21) AD 2023 1313
(22) 2023 06 09
(24) 2023 06 09
(28) 5
(18) 2028 06 09
(73) Donara Berdzenishvili (GE)
 Vill. Kvemo Erketi, 4900, Chokhatauri,
 Georgia (GE)
(72) Donara Berdzenishvili (GE)
(54) METAL AND THREAD COMBINED
 BRACELET

(11) D 2024 993 S (51) 21-01
(10) AD 2023 1315 S (44) 2023 10 25 №20
(21) AD 2023 1315
(22) 2023 06 17
(24) 2023 06 17
(28) 1
(18) 2028 06 17
(73) Konrad Adenauer Foundation Representa-
 tive in Georgia (GE)
 Tamar Chovelidze St. 4, Fl. 7, 0108, Old Tbilisi
 District, Tbilisi, Georgia (GE)
(72) Sopio Kuridze (GE)
(74) Gela Chighoshvili (GE);
 Tamta Muradashvili (GE)
(54) BOARD GAME

DESIGNS, WHICH HAVE BEEN REGISTERED WITH THE INTERNATIONAL BUREAU CLAIMING PRIORITY ON THE TERRITORY OF GEORGIA

The decision can be appealed at the Chamber of Appeal of Sakpatenti within 3 months from the publication or at the Mtskheta District Court Administrative Cases Board (Address: №17, Samkhedro St., Mtskheta), within 1 month following the publication.

- (11) DM/233 000 (51) 08-07
- (15) 2023 10 11 (44) 46/2023 (2023 11 17)
- (22) 2023 10 11
- (28) 1
- (30) No1: 01.06.2023; 202330333864.5; CN
- (73) Zhejiang Hiland Technology Co.
Ltd, NO.68, Beizhuang Road, Dipu Street, Anji County, 313300 Huzhou City, Zhejiang Province (CN)
- (85) CN
- (86) CN
- (87) CN
- (88) CN
- (89) CN
- (81) III. US, GE, TR, EM
- (72) Bosheng Yin
NO.68, Beizhuang Road, Dipu Street, Anji County, 313300, Huzhou City, Zhejiang Province (CN)
- (74) Jinghua Liu
Floor 4, Building 18, No. 8 Borun Center, Anping North Street, Shunyi District, 101300 Beijing (CN)
- (46) 2023 11 17
- (54) 1. DOOR OPENER [ELECTRIC]
- (55)

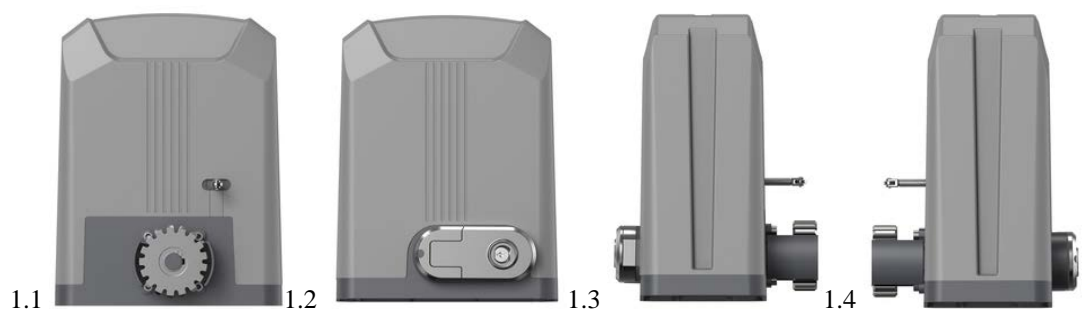

(11) DM/232 927 (51) 10-04
 (15) 2023 10 26 (44) 46/2023 (2023 11 17)

(22) 2023 10 26

(28) 1

(30) No1: 18.07.2023; 2023-00404; CH

(73) Rolex SA
 rue François-Dussaud 3-5-7, 1211 Genève 26 (CH)

(85) CH

(86) CH

(87) CH

(88) CH

(89) CH

(81) III. CA, GE, OM, RS, NO, RW, MU, EM, AM, BW, TJ, MD, VN, TN, SR, MN, JP, KR, UA, OA, MA, ME, AZ, SM, WS, KG, LI, MK, BA, EG, JM, RU, IS, BY, GB, KH, TR, ST, GH, IL, KP, AL, MX, BN, BR, NA, SG, MC, BZ, TM

(72) Christophe BOURBAN
 Chemin de la Barillette 17, 1260, Nyon (CH)

(74) BUGNION S.A.
 10, Route de Florissant, Case postale 375, 1211 Genève 12 (CH)

(54) 1. MEASURING APPARATUS

(55)

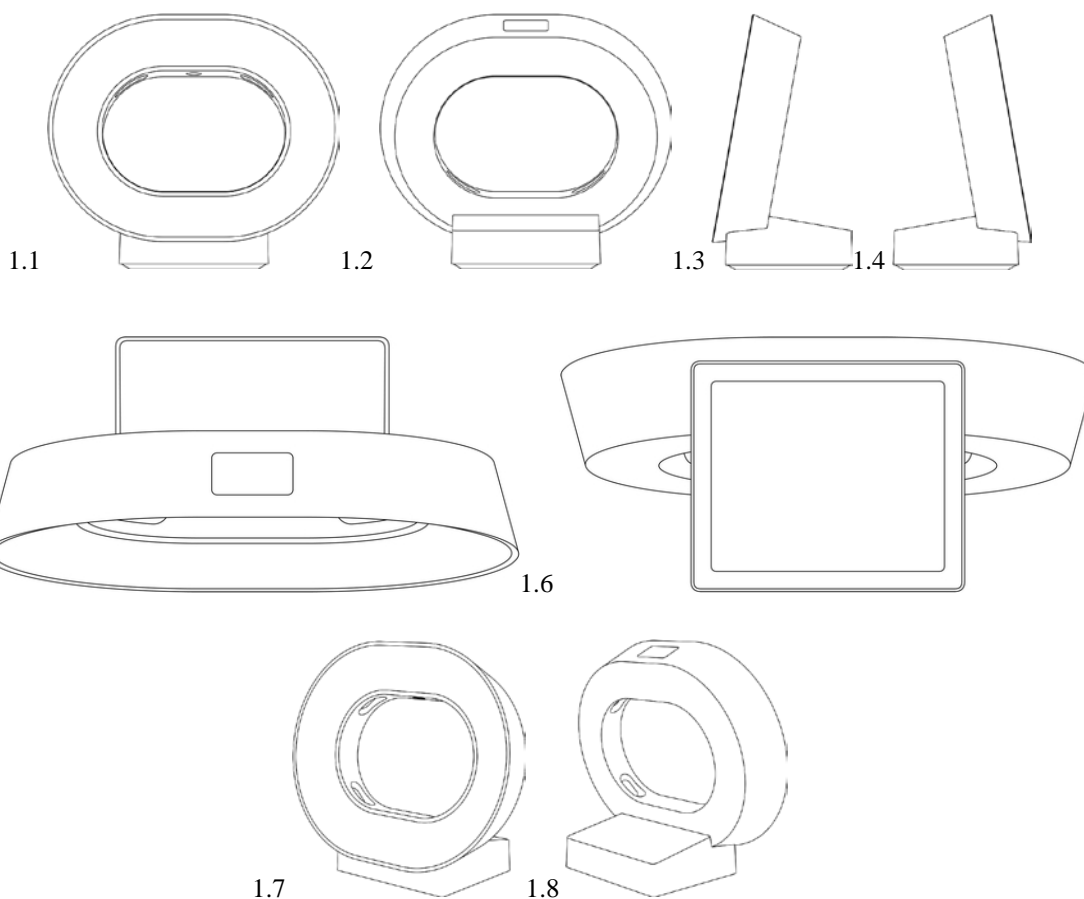

- (11) DM/232 998
- (15) 2023 10 11
- (22) 2023 10 11
- (28) 1
- (30) No1: 19.05.2023; 202330298712.6; CN
- (73) Zhejiang Hiland Technology Co., Ltd
NO.68, Beizhuang Road, Dipu Street, Anji County, 313300 Huzhou City, Zhejiang Province (CN)
- (85) CN
- (86) CN
- (87) CN
- (88) CN
- (89) CN
- (81) III. GE, TR, US, EM
- (72) Bosheng Yin
NO.68, Beizhuang Road, Dipu Street, Anji County, 313300, Huzhou City, Zhejiang Province (CN)
- (74) Jinghua Liu
Floor 4, Building 18, No. 8 Borun Center, Anping North Street, Shunyi District, 101300 Beijing (CN)
- (46) 2023 11 17
- (54) 1. TELL-TALE LIGHT
- (55)



- (11) DM/224 981 (51) 10-07
 (15) 2022 11 15 (44) 46/2023 (2023 11 17)
 (22) 2022 11 15
 (28) 1
 (73) Rado Uhren AG (Rado Watch Co. LTD.) (Montres Rado SA)
 Bielstrasse 45, 2543 Lengnau (CH)
 (85) –
 (86) CH
 (87) CH
 (88) –
 (89) CH
 (81) III. UA, GE, OM, TR, BA, NO, MA, SG, CH, EM, TN, GB
 (72) Mélanie Armenti
 c/o Rado Uhren AG (Rado Watch Co. Ltd.) (Montres Rado SA), Bielstrasse 45, 2543, Lengnau (CH);
 Sovyra Srou
 c/o Rado Uhren AG (Rado Watch Co. Ltd.) (Montres Rado SA), Bielstrasse 45, 2543, Lengnau (CH)
 (74) The Swatch Group AG
 Faubourg du Lac 6, 2501 Biel (CH)
 (46) 2023 11 17
 (54) 1. WATCH CASE
 (55)

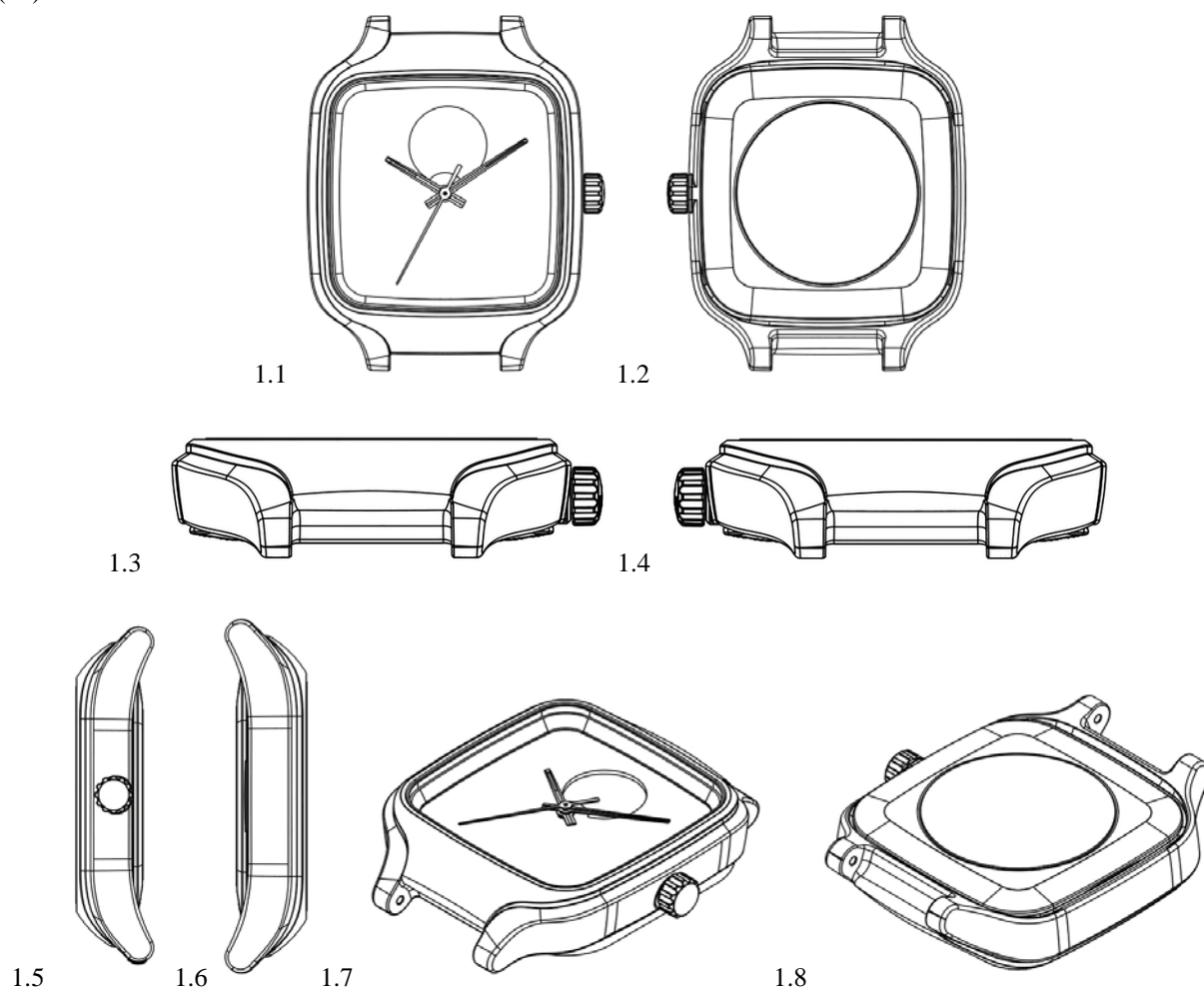

(11) DM/233 184

(51) 15-99

(15) 2023 09 12

(44) 47/2023 (2023 11 24)

(22) 2023 09 12

(28) 1

(73) Saha Robotik Ve Teslimat Teknolojileri Anonim Şirketi

Muallimköy Mahallesi, Bilişim Vadisi Kongre Merkezi Binası, Deniz Caddesi, No: 143, Gebze,
41400 KOCAELİ (TR)

(85) TR

(86) TR

(87) TR

(88) TR

(89) TR

(81) III. KG, OM, GE, EM, AZ

(72) MURAT AYRANCI

Muallimköy Mahallesi, Bilişim Vadisi Kongre Merkezi Binası, Deniz Caddesi, No: 143, Gebze, 41400,
Kocaeli (TR)

(74) Destek Patent Anonim Şirketi

Odunluk Mahallesi, Akademi Caddesi, Zeno İş Merkezi, D Blok Kat: 4, Nilüfer, 16110 Bursa (TR)

(46) 2023 11 24

(54) 1. SERVICE ROBOT

(55)

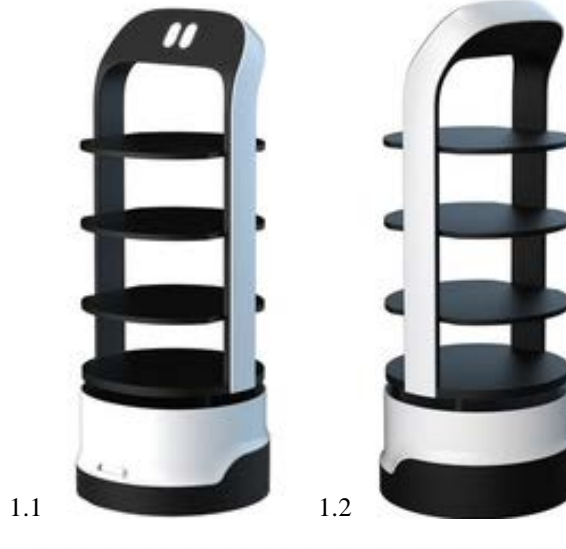

TRADEMARKS

APPLICATIONS FILED UNDER THE NATIONAL PROCEDURE APPROVED FOR REGISTRATION

The decision can be appealed at the Chamber of Appeal of Sakpatenti within 3 months from the publication or at the Mtskheta District Court Administrative Cases Board (Address: №17, Samkhedro St., Mtskheta), within 1 month following the publication.

(260) AM 2024 122028 A
(210) AM 122028
(220) 2023 03 15
(731) LLC "Silk Road Group Holding"
Republic Square, 0108, Mtatsminda District,
Tbilisi, Georgia

(540)

სილქ ჰოსპიტალიტი
Silk Hospitality

(591) Black-white
(511) 35, 41, 43

(260) AM 2024 122429 A
(210) AM 122429
(220) 2023 04 13
(731) SolaX Power Network Technology
(Zhejiang) Co., Ltd.
No.288, Shizhu Road, Tonglu Economic
Development Zone, Tonglu County, Hangzhou
City, Zhejiang Province, People's Republic of
China

(740) Giorgi Kartvelishvili
(540)



(591) Morengo, pale (mushroom) grey, white
(531) 27.05.01; 27.05.09; 27.05.10; 27.05.17;
27.05.21
(511) 9

(260) AM 2024 122569 A
(210) AM 122569
(220) 2023 04 24
(731) LLC "Kakhetian Traditional Winemaking"
Sulkhan Tsintsadze St. 12, 0160, Tbilisi,
Georgia

(540)

ზიარი კრიკო
Ziari creek
Зиари крик

(591) Black-white
(526) ზიარი, Ziari, Зиари
(511) 33

(260) AM 2024 122577 A
(210) AM 122577
(220) 2023 04 25
(731) LTD "BurgerLions"
Petre Kavtaradze St. 27, ap. 50, 0160, Vake-
Saburtalo District, Tbilisi, Georgia
(540)

ბურგერ ლომები/ burger lions



(591) Black-white
(531) 03.01.01; 08.01.01; 08.01.07; 08.05.03;
08.05.04; 08.05.25; 24.09.02; 24.09.09
(511) 43

(260) AM 2024 122580 A
(210) AM 122580
(220) 2023 04 25
(731) LTD "Impexpharm"
Giorgi Saakadze II exit 17, 0160, Tbilisi,
Georgia
(740) Nugzar Ksovreli
(540)

Marinos

(591) Black-white
(511) 5

(260) AM 2024 122586 A
 (210) AM 122586
 (220) 2023 04 27
 (731) LLC "Rustavi International Motorpark"
 Surrounding area of Red Bridge Highway,
 21 km from Tbilisi, 3700, Rustavi, Georgia
 (540)



(591) 000000 black, FF0000 red, white
 (531) 26.04.09; 27.05.01; 27.05.21; 28.19; 29.01.12
 (526) რუსთავი
 (511) 35, 41

(260) AM 2024 122651 A
 (210) AM 122651
 (220) 2023 05 01
 (731) LLC "Business and Technology University"
 Iia Chavchavadze Av. 82, 0162, Tbilisi,
 Georgia
 (540)



(591) 070000 black-white
 (531) 27.05.11; 28.19
 (526) საქართველოს, GEORGIA
 (511) 16, 35

(260) AM 2024 122672 A
 (210) AM 122672
 (220) 2023 05 03
 (731) Nike Innovate C.V.
 One Bowerman Drive, Beaverton, Oregon
 97005-6453, USA
 (740) Tamaz Shilakadze
 (540)



(591) Black-white
 (531) 21.03.07; 26.11.12
 (511) 3, 7, 10, 12, 21, 26, 27, 35, 41, 42

(260) AM 2024 122738 A
 (210) AM 122738
 (220) 2023 05 10
 (731) Businessmedia Georgia
 Gamrekeli St. 19, Fl. 3, Office 6, Tbilisi,
 Georgia
 (740) Giorgi Taktakishvili

(540)
Leader.one
 (591) Black-white
 (511) 9, 16, 35, 38, 41

(260) AM 2024 122739 A
 (210) AM 122739
 (220) 2023 05 10
 (731) LLC "Dolo Georgia"
 Kazbegi II exit 6, Rustavi, Georgia;
 Jae-Hyun Seo
 Mapo daero 195, 202-702, Seoul, Republic of
 Korea
 (740) Giorgi Taktakishvili
 (540)



(591) Black-white
 (531) 01.01.03; 01.01.09; 02.09.01; 05.05.20;
 27.05.01; 28.03
 (511) 5

(260) AM 2024 122740 A
 (210) AM 122740
 (220) 2023 05 10
 (731) Negin Shahd Shahran
 Second floor, No. 101, Amirkabir Blvd,
 District 22, Tehran, Islamic Republic of Iran
 (740) Tamaz Shilakadze
 (540)



(591) Black-white, green
 (531) 01.15.15; 05.03.14; 27.05.07; 28.01; 29.01.13
 (511) 32

(260) AM 2024 122747 A
 (210) AM 122747
 (220) 2023 05 11
 (731) LTD "Palavani"
 Shindisi Highway 19, Gori, Georgia
 (740) Giorgi Taktakishvili

(540)

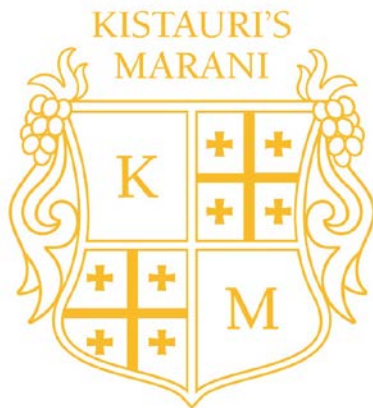

(591) Golden, white
 (531) 24.01.03; 24.01.05; 24.01.13; 24.01.15;
 24.01.17; 24.01.18; 24.07.03; 25.01.25;
 27.05.01; 29.01.12
 (526) Imitation of the State Flag of Georgia
 (511) 33

(260) AM 2024 122827 A
 (210) AM 122827
 (220) 2023 05 15
 (731) The Goodyear Tire & Rubber Company
 200 Innovation Way, Akron, Ohio 44316, USA
 (740) Tamaz Shilakadze
 (540)

WINTERCOMMAND CARGO

(591) Black-white
 (511) 12

(260) AM 2024 122839 A
 (210) AM 122839
 (220) 2023 05 16
 (731) Enriko Beridze
 G. Tsitsishvili St. 18, Tbilisi, Georgia
 (740) Salome Jeladze
 (540)

მარანი ზესოფელი Marani Zesopheli

(591) Black-white
 (526) ზესოფელი, Zesopheli
 (511) 35

(260) AM 2024 122841 A
 (210) AM 122841
 (220) 2023 05 16
 (731) LTD "Re:Invent"
 Pavle Aslanidi St. 14, ap. 15, Tbilisi, Georgia
 (740) Mariam Gogitidze

(540)

re:invent

(591) Black-white
 (531) 24.17.01; 27.05.01
 (511) 7, 9, 28, 35, 36, 41, 42

(260) AM 2024 122852 A
 (210) AM 122852
 (220) 2023 05 18
 (731) LLC "B and R of Georgia"
 Besarion Keburia Settlement II St. 12, Samgori
 District, Tbilisi, Georgia
 (540)



ROYAL KEBURIA

(591) Black-white, grey
 (531) 05.13.08; 18.04.01; 18.04.02; 23.01.01;
 23.01.25; 24.13.01; 24.13.22; 24.13.24;
 24.15.13; 27.05.01
 (511) 33

(260) AM 2024 122857 A
 (210) AM 122857
 (220) 2023 05 18
 (731) Philip Morris Brands Sàrl
 Quai Jeanrenaud 3, 2000 Neuchâtel,
 Switzerland
 (740) Pavle Meipariani
 (540)

GARDEN BREEZE

(591) Black-white
 (511) 34

(260) AM 2024 122858 A
 (210) AM 122858
 (220) 2023 05 18
 (731) Philip Morris Brands Sàrl
 Quai Jeanrenaud 3, 2000 Neuchâtel,
 Switzerland
 (740) Pavle Meipariani
 (540)

MARLBORO TROPICAL FUSION

(591) Black-white
(511) 34

(260) AM 2024 122860 A
(210) AM 122860
(220) 2023 05 18
(731) Philip Morris Brands Sàrl
Quai Jeanrenaud 3, 2000 Neuchâtel,
Switzerland
(740) Pavle Meipariani
(540)

EXOTIC MIST

(591) Black-white
(511) 34

(260) AM 2024 122861 A
(210) AM 122861
(220) 2023 05 18
(731) Philip Morris Brands Sàrl
Quai Jeanrenaud 3, 2000 Neuchâtel,
Switzerland
(740) Pavle Meipariani

(540)

MIDDAY BREEZE

(591) Black-white
(511) 34

(260) AM 2024 122862 A
(210) AM 122862
(220) 2023 05 18
(731) Philip Morris Brands Sàrl
Quai Jeanrenaud 3, 2000 Neuchâtel,
Switzerland
(740) Pavle Meipariani
(540)

TROPICAL MIST

(591) Black-white
(511) 34

(260) AM 2024 122939 A
(210) AM 122939
(220) 2023 05 19
(310) 89185
(320) 2023 03 31
(330) JM
(731) Philip Morris Brands Sàrl
Quai Jeanrenaud 3, 2000 Neuchâtel,
Switzerland
(740) Pavle Meipariani

(540)



(591) Black-white
(531) 26.03.23; 27.05.21
(511) 34

(260) AM 2024 122940 A
(210) AM 122940
(220) 2023 05 19
(310) 88724
(320) 2023 02 20
(330) JM
(731) Philip Morris Brands Sàrl
Quai Jeanrenaud 3, 2000 Neuchâtel,
Switzerland
(740) Pavle Meipariani
(540)



(591) Black-white
(531) 26.03.23; 27.05.21
(511) 34

(260) AM 2024 122941 A
(210) AM 122941
(220) 2023 05 19
(310) 88867
(320) 2023 03 03
(330) JM
(731) Philip Morris Brands Sàrl
Quai Jeanrenaud 3, 2000 Neuchâtel,
Switzerland
(740) Pavle Meipariani
(540)

VEEV
now



(591) Black-white
(531) 26.03.23; 27.05.01; 27.05.21
(511) 34

(260) AM 2024 122942 A
 (210) AM 122942
 (220) 2023 05 19
 (310) 88859
 (320) 2023 03 03
 (330) JM
 (731) Philip Morris Brands Sàrl
 Quai Jeanrenaud 3, 2000 Neuchâtel,
 Switzerland
 (740) Pavle Meipariani
 (540)



(591) Black-white
 (531) 26.03.23; 27.05.01; 27.05.21
 (511) 34

(260) AM 2024 122944 A
 (210) AM 122944
 (220) 2023 05 19
 (310) 88819
 (320) 2023 02 28
 (330) JM
 (731) Philip Morris Brands Sàrl
 Quai Jeanrenaud 3, 2000 Neuchâtel,
 Switzerland
 (740) Pavle Meipariani
 (540)



(591) Various shades of grey, white
 (531) 26.03.23; 27.05.01; 27.05.21
 (511) 34

(260) AM 2024 122967 A
 (210) AM 122967
 (220) 2023 05 23
 (731) Nike Innovate C.V.
 One Bowerman Drive, Beaverton, Oregon
 97005-6453, USA
 (740) Tamaz Shilakadze
 (540)

JUST DO IT

(591) Black-white
 (511) 9, 14, 18, 21, 25, 26, 27, 28, 35, 41, 42

(260) AM 2024 122974 A
 (210) AM 122974
 (220) 2023 05 24
 (731) LLC "Unity Amusement"
 Ilia Chavchavadze Ave. 60b, fl. 14, ap. 55,
 0162, Vake District, Tbilisi, Georgia
 (540)



(591) 79866A green, F6C680 yellow, EBB9AB
 pink, CFBCAA beige, AC7366
 brown
 (531) 26.07.01; 26.07.03; 26.07.04; 26.07.09;
 26.07.25; 27.01.01; 27.01.25; 29.01.15
 (511) 41

(260) AM 2024 122975 A
 (210) AM 122975
 (220) 2023 05 24
 (731) Oleg Tyshkevych
 Sosnitskaya St. 21, ap. 219, Kyiv, 02090, Ukraine;
 LTD "LB Capital"
 Ilia Chavchavadze Av. 34, shop 12A, 0179, Vake
 District, Tbilisi, Georgia
 (740) Lia Shikhiashvili;
 Zurab Bezhhashvili;
 Ioane Iarajuli
 (540)

Dr. Sauber

(591) Black-white
 (511) 3

(260) AM 2024 123066 A
 (210) AM 123066
 (220) 2023 05 26
 (731) Mitsubishi Jidosha Kogyo Kabushiki Kaisha
 1-21, Shibaura 3-chome, Minato-ku, Tokyo
 108-8410, Japan
 (740) Pavle Meipariani
 (540)

SPORTERO

(591) Black-white
 (511) 12

(260) AM 2024 123068 A
 (210) AM 123068
 (220) 2023 05 27
 (731) Vladislav Golubev

Kintrishi Second Bank 1, Kobuleti, 6104,
Georgia;
Anna Golubeva
Kintrishi Second Bank 1, Kobuleti, Georgia

(540)



(591) Black-white

(531) 03.07.01

(511) 33

(260) AM 2024 123074 A

(210) AM 123074

(220) 2023 05 29

(731) JSC "TBC Insurance"

Aleksandre Kazbegi Av. 24b, Fl. 3, 0177,
Tbilisi, Georgia

(540)



(591) Lilac, white

(531) 19.11.04; 19.11.05; 26.02.01; 26.04.07;
26.04.16; 26.04.22; 26.04.24; 27.05.01;
27.05.24; 28.19; 29.01.12

(511) 35, 36

(260) AM 2024 123078 A

(210) AM 123078

(220) 2023 05 30

(731) LLC "Creadamo"

Tornike Eristavi St. 19, Tbilisi, Georgia

(740) Giorgi Taktakishvili

(540)



(591) Golden, white

(531) 27.05.03; 27.05.21; 29.01.02

(511) 20, 37, 41, 42

(260) AM 2024 123079 A

(210) AM 123079

(220) 2023 05 30

(731) LLC "Creadamo"

Tornike Eristavi St. 19, Tbilisi, Georgia

(740) Giorgi Taktakishvili

(540)



კრეადამო

(591) Bordeaux, white

(531) 27.05.21; 28.19; 29.01.01

(511) 20, 37, 41, 42

(260) AM 2024 123080 A

(210) AM 123080

(220) 2023 05 30

(731) LLC "Creadamo"

Tornike Eristavi St. 19, Tbilisi, Georgia

(740) Giorgi Taktakishvili

(540)

CREADAMO

(591) Bordeaux, white

(531) 27.05.01; 29.01.01

(511) 20, 37, 41, 42

(260) AM 2024 123081 A

(210) AM 123081

(220) 2023 05 30

(731) The News Hub Limited

Office at 10th Floor, Building 7, Chiswick Park,
566 Chiswick High Rd., London, W4 5YG, UK

(540)



(591) Blue, grey, white

(531) 26.11.02; 26.11.05; 26.11.08; 27.05.01;
27.05.11; 29.01.12

(511) 38, 41

(260) AM 2024 123083 A

(210) AM 123083

(220) 2023 05 30

(731) LTD "Bambu Ge"

Mukhiani Settlement, II m/r, bld. 22, fl. 9,
ap. 111, Tbilisi, Georgia

(540)

ბამბუკ
bamboo

(591) Green, white
(531) 05.03.11; 05.03.15; 27.05.08; 28.19; 29.01.12
(511) 25, 35

(260) AM 2024 123084 A
(210) AM 123084
(220) 2023 05 30
(731) LTD "Premium Web Solutions"
D. Toradze St. 9, 0179, Tbilisi, Georgia
(540)

 MYVIDEO

(591) Red, white
(531) 04.05.21; 27.05.01; 29.01.01
(511) 9, 35, 38, 41

(260) AM 2024 123086 A
(210) AM 123086
(220) 2023 05 30
(731) JSC "Kebuli Klimati"
Eter Botsvadze St. 4, 0159, Tbilisi, Georgia
(540)

KARIZZMA

(591) 070707 black, white
(531) 27.05.01
(511) 11

(260) AM 2024 123088 A
(210) AM 123088
(220) 2023 05 31
(731) JSC "Kotekhi-Winery of Gurjaani"
K. Koroghlishvili St. 38, 1500, Gurjaani,
Georgia
(540)

კავკასიური არწივი
Caucasian Eagle
Кавказский Орёл

(591) Black-white
(511) 33

(260) AM 2024 123089 A
(210) AM 123089
(220) 2023 05 31
(731) Toho Co., Ltd.
1-2-2, Yurakucho, Chiyoda-Ku, Tokyo, Japan
(740) Shalva Gvaramadze
(540)

GODZILLA

(591) Black-white
(511) 9, 16, 25, 28, 41

(260) AM 2024 123092 A
(210) AM 123092
(220) 2023 05 31
(731) Jafar Guseynov
G. Onashvili St., bld. 2, ap. 43, Isani District,
Tbilisi, Georgia
(740) Nino Bakhtadze
(540)

 BORN

(591) Black, red, golden
(531) 26.04.03; 26.04.22; 26.04.24; 26.11.08;
27.05.01; 27.05.11; 27.05.17; 27.05.24;
29.01.13
(511) 25

(260) AM 2024 123094 A
(210) AM 123094
(220) 2023 06 01
(731) LTD "Neues Leben"
Perdinand Tavadze St. 3, bld. 5, Non-residential
area, Vake District, Tbilisi, Georgia
(740) Liliana Darakhvelidze

(540)

Ivan  Cain

(591) Black, red, white
(531) 24.13.01; 24.13.14; 27.05.01; 29.01.12
(511) 33

(260) AM 2024 123096 A
(210) AM 123096
(220) 2023 06 01
(731) Guangdong Macro Gas Appliance Co., LTD.
Shunyuan South Road #9, Wusha Community,

Daliang Street, Foshan City, Guangdong
Province, People's Republic of China
(740) Khatuna Imnadze
(540)

macro

(591) Black-white
(531) 27.05.01
(511) 11

(260) AM 2024 123098 A
(210) AM 123098
(220) 2023 06 01
(731) LLC "Gvirila Retail"
Painters lane 19, Vake district, Tbilisi, Georgia
(540)

უფრო იაფი, უფრო ახლოს

(591) Black-white
(511) 35

(260) AM 2024 123099 A
(210) AM 123099
(220) 2023 06 01
(731) LLC "Industrial City"
Kostava St. 14, 0108, Tbilisi, Georgia
(740) Giorgi Taktakishvili
(540)

რადიო ქალაქი

RADIO CITY

(591) Black-white
(531) 27.05.01; 28.19
(511) 36, 41, 43

(260) AM 2024 123101 A
(210) AM 123101
(220) 2023 06 01
(731) VGP IPCO LLC
100 Valvoline Way, Suite 200, Lexington,
Kentucky 40509, USA
(740) Tamaz Shilakadze
(540)

VALVOLINE

(591) Black-white
(511) 1, 4

(260) AM 2024 123102 A
(210) AM 123102
(220) 2023 06 01
(731) VGP IPCO LLC

100 Valvoline Way, Suite 200, Lexington,
Kentucky 40509, USA

(740) Tamaz Shilakadze
(540)



(591) Silver, red, sky-blue, blue
(531) 26.03.23; 27.05.21; 29.01.13
(511) 1, 4

(260) AM 2024 123103 A
(210) AM 123103
(220) 2023 06 01
(731) VGP IPCO LLC
100 Valvoline Way, Suite 200, Lexington,
Kentucky 40509, USA
(740) Tamaz Shilakadze
(540)



(591) Black-white
(531) 26.03.23; 27.05.21
(511) 1, 4

(260) AM 2024 123105 A
(210) AM 123105
(220) 2023 06 02
(731) LTD "Nika Travel"
Chekhov St. 37, 0103, Isani District, Tbilisi,
Georgia
(540)

Chronograph

ქრონოგრაფი

(591) Black-white
(511) 43

(260) AM 2024 123180 A
(210) AM 123180
(220) 2023 06 05
(731) Toyota Jidosha Kabushiki Kaisha
(also trading as Toyota Motor Corporation)
1, Toyota-cho, Toyota-shi, Aichi-ken, Japan
(740) Tamar Kochlamazashvili
(540)

NX450h+

(591) Black-white
(511) 12

(260) AM 2024 123181 A
 (210) AM 123181
 (220) 2023 06 05
 (731) Nicoventures Holdings Limited
 Globe House, 1 Water Street, London, WC2R
 3LA, United Kingdom
 (740) Tamar Kochlamazashvili
 (540)

VUSE GO 700 MANGO ICE

(591) Black-white
 (511) 34

(260) AM 2024 123182 A
 (210) AM 123182
 (220) 2023 06 05
 (731) Nicoventures Holdings Limited
 Globe House, 1 Water Street, London, WC2R
 3LA, United Kingdom
 (740) Tamar Kochlamazashvili
 (540)

VUSE GO 700 PASSIONFRUIT ICE

(591) Black-white
 (511) 34

(260) AM 2024 123183 A
 (210) AM 123183
 (220) 2023 06 05
 (731) Nicoventures Holdings Limited
 Globe House, 1 Water Street, London, WC2R
 3LA, United Kingdom
 (740) Tamar Kochlamazashvili
 (540)

VUSE GO 700 CREAMY BLEND

(591) Black-white
 (511) 34

(260) AM 2024 123184 A
 (210) AM 123184
 (220) 2023 06 05
 (731) Nicoventures Holdings Limited
 Globe House, 1 Water Street, London, WC2R
 3LA, United Kingdom
 (740) Tamar Kochlamazashvili
 (540)

VUSE GO 700 STRAWBERRY ICE

(591) Black-white
 (511) 34

(260) AM 2024 123185 A
 (210) AM 123185
 (220) 2023 06 05
 (731) Nicoventures Holdings Limited
 Globe House, 1 Water Street, London, WC2R
 3LA, United Kingdom
 (740) Tamar Kochlamazashvili
 (540)

VUSE GO 700 LEMON BERRY

(591) Black-white
 (511) 34

(260) AM 2024 123187 A
 (210) AM 123187
 (220) 2023 06 05
 (731) Nicoventures Holdings Limited
 Globe House, 1 Water Street, London, WC2R
 3LA, United Kingdom
 (740) Tamar Kochlamazashvili
 (540)

VUSE GO 700 GRAPE ICE

(591) Black-white
 (511) 34

(260) AM 2024 123188 A
 (210) AM 123188
 (220) 2023 06 05
 (731) LTD "Tatal Group"
 Guramishvili St., Ozurgeti, Georgia
 (540)



DELNENTO

(591) Black-white
 (531) 26.01.18; 27.05.01
 (511) 7, 9, 11, 35

(260) AM 2024 123192 A
 (210) AM 123192
 (220) 2023 06 05
 (731) Nicoventures Holdings Limited
 Globe House, 1 Water Street, London, WC2R
 3LA, United Kingdom
 (740) Tamar Kochlamazashvili
 (540)

VUSE GO 700 DARK CHERRY

(591) Black-white
 (511) 34

(260) AM 2024 123193 A
 (210) AM 123193
 (220) 2023 06 05
 (731) Nicoventures Holdings Limited
 Globe House, 1 Water Street, London, WC2R
 3LA, United Kingdom
 (740) Tamar Kochlamazashvili
 (540)

**VUSE GO 700 STRAWBERRY
 KIWI**

(591) Black-white
 (511) 34

(260) AM 2024 123194 A
 (210) AM 123194
 (220) 2023 06 05
 (731) Nicoventures Holdings Limited
 Globe House, 1 Water Street, London, WC2R
 3LA, United Kingdom
 (740) Tamar Kochlamazashvili
 (540)

**VUSE GO 700 BERRY
 WATERMELON**

(591) Black-white
 (511) 34

(260) AM 2024 123195 A
 (210) AM 123195
 (220) 2023 06 05
 (731) Nicoventures Holdings Limited
 Globe House, 1 Water Street, London, WC2R
 3LA, United Kingdom
 (740) Tamar Kochlamazashvili
 (540)

VUSE GO 700 CRYSTAL ICE

(591) Black-white
 (511) 34

(260) AM 2024 123196 A
 (210) AM 123196
 (220) 2023 06 05
 (731) Nicoventures Holdings Limited
 Globe House, 1 Water Street, London, WC2R
 3LA, United Kingdom
 (740) Tamar Kochlamazashvili
 (540)

**VUSE GO 700 BERRY
 BLEND**

(591) Black-white
 (511) 34

(260) AM 2024 123197 A
 (210) AM 123197
 (220) 2023 06 06
 (731) Nicoventures Holdings Limited
 Globe House, 1 Water Street, London, WC2R
 3LA, United Kingdom
 (740) Tamar Kochlamazashvili
 (540)



(591) Purple
 (531) 26.05.11; 29.01.05
 (511) 34

(260) AM 2024 123198 A
 (210) AM 123198
 (220) 2023 06 06
 (731) Nicoventures Holdings Limited
 Globe House, 1 Water Street, London, WC2R
 3LA, United Kingdom
 (740) Tamar Kochlamazashvili
 (540)



(591) Bordeaux, pale red
 (531) 26.04.09; 26.05.01; 26.07.25; 29.01.01
 (511) 34

(260) AM 2024 123199 A
 (210) AM 123199
 (220) 2023 06 06
 (731) Nicoventures Holdings Limited
 Globe House, 1 Water Street, London, WC2R
 3LA, United Kingdom
 (740) Tamar Kochlamazashvili
 (540)



(591) Yellow
 (531) 01.15.23; 05.07.22; 26.02.07; 29.01.02
 (511) 34

(260) AM 2024 123201 A
 (210) AM 123201
 (220) 2023 06 06
 (731) Gravity Co., Ltd.
 (Sangam-dong) 15F. Nuritkum Square R&D
 Tower, 396, World Cup Buk-Ro, Mapo-Gu,
 Seoul, Republic of Korea
 (740) Giorgi Taktakishvili
 (540)



(591) Black-white
 (531) 01.05.05; 01.15.09; 01.17.07; 01.17.11;
 01.17.13; 01.17.25; 26.01.13; 26.01.16;
 27.05.02
 (511) 9, 41

(260) AM 2024 123212 A
 (210) AM 123212
 (220) 2023 06 06
 (731) Nicoventures Holdings Limited
 Globe House, 1 Water Street, London, WC2R
 3LA, United Kingdom
 (740) Tamar Kochlamazashvili
 (540)



(591) Yellow
 (531) 15.01.13; 29.01.02
 (511) 34

(260) AM 2024 123216 A
 (210) AM 123216
 (220) 2023 06 07
 (731) LTD "Lermont"
 Mikheil Lermontov St. 10, 0105, Tbilisi,
 Georgia
 (540)



(591) Black-white
 (531) 26.01.01; 26.01.03; 28.07; 28.19
 (511) 37

(260) AM 2024 123305 A
 (210) AM 123305
 (220) 2023 06 09
 (731) "IDS Borjomi Beverages Co.N.V."
 Pareravegis №45, Curaçao
 (740) Giorgi Jokharidze
 (540)



(591) F90000 Red
 (531) 03.04.07; 03.04.24; 29.01.01
 (511) 32, 35

(260) AM 2024 123318 A
 (210) AM 123318
 (220) 2023 06 10
 (731) LTD "PharmaHUB"
 Akaki Tsereteli Av. 116, 0119, Didube District,
 Tbilisi, Georgia
 (740) Davit Chikhladze
 (540)

მეგალაქს
MEGALAX
МЕГАЛІАКС

(591) Black-white
 (511) 5

(260) AM 2024 123319 A
 (210) AM 123319
 (220) 2023 06 10
 (731) LTD "PharmaHUB"
 Akaki Tsereteli Av. 116, 0119, Didube District,
 Tbilisi, Georgia
 (740) Davit Chikhladze
 (540)

ზავერს
ZAVERS
ЗАВЕРС

(591) Black-white
 (511) 5

(260) AM 2024 123320 A
 (210) AM 123320
 (220) 2023 06 10
 (731) LTD "PharmaHUB"
 Akaki Tsereteli Av. 116, 0119, Didube District,
 Tbilisi, Georgia
 (740) Davit Chikhladze
 (540)

ესცირო
ESCYRO
ЭСЦИРО

(591) Black-white
 (511) 5

(260) AM 2024 123323 A
 (210) AM 123323
 (220) 2023 06 10
 (731) LTD "PharmaHUB"
 Akaki Tsereteli Av. 116, 0119, Didube District,
 Tbilisi, Georgia
 (740) Davit Chikhladze
 (540)

აკსანტინო
AKSANTINE
АКСАНТИН

(591) Black-white
 (511) 5

(260) AM 2024 123324 A
 (210) AM 123324
 (220) 2023 06 10
 (731) LTD "PharmaHUB"
 Akaki Tsereteli Av. 116, 0119, Didube District,
 Tbilisi, Georgia
 (740) Davit Chikhladze
 (540)

ფორსეტა
FORSETTA
ФОРСЕТТА

(591) Black-white
 (511) 5

(260) AM 2024 123333 A
 (210) AM 123333
 (220) 2023 06 12
 (731) Aspen Global Incorporated
 GBS Plaza, Cnr. La Salette & Royal Roads,
 Grand Bay, Mauritius
 (740) Tamaz Shilakadze
 (540)

ALDOMET

(591) Black-white
 (511) 5

(260) AM 2024 123341 A
 (210) AM 123341
 (220) 2023 06 13
 (731) Celanese Sales Germany GmbH
 Am Unisys-Park 1, 65843 Sulzbach, Germany
 (740) Shalva Gvaramadze
 (540)

MOWILITH

(591) Black-white
 (511) 1, 2, 19

(260) AM 2024 123344 A
 (210) AM 123344
 (220) 2023 06 13
 (731) LTD "Kartveli"
 Kakheti Highway 110a, 0198, Samgori District,
 Tbilisi, Georgia
 (740) Davit Dzamukashvili
 (540)



(591) Golden, black, red
 (531) 26.04.02; 26.04.22; 26.04.24; 28.19; 29.01.12
 (511) 33

(260) AM 2024 123351 A
 (210) AM 123351
 (220) 2023 06 14
 (731) LTD "Nail Club"
 Nutsbidze St. Adjacent to 77
 (plot 01/216)/Nutsbidze St. 77, fl. 1,
 Commercial Space, Tbilisi, Georgia
 (740) Nino Bakhtadze
 (540)



Pattern

(591) White, golden
 (531) 26.13.25; 27.05.01; 29.01.02
 (511) 35, 44

(260) AM 2024 123353 A
 (210) AM 123353
 (220) 2023 06 15
 (731) Evyap Evcil Hayvan Ürünleri Sanayi ve Ticaret Anonim Şirketi
 Deri OSB Mahallesi, Güderi Caddesi, No: 1
 Tuzla İstanbul, Türkiye
 (740) Tamaz Shilakadze
 (540)



(591) Turquoise, white
 (531) 02.09.01; 03.06.03; 27.03.01; 27.03.02;
 29.01.12
 (511) 3, 5, 31

(260) AM 2024 123354 A
 (210) AM 123354
 (220) 2023 06 15
 (731) LLC "m² Group"
 Givi Kartoziya St. 10, Entrance 6, fl. 0,
 Commercial Space 13, 0177, Saburtalo
 District, Tbilisi, Georgia
 (540)



(591) Black-white, orange
 (531) 24.17.05; 24.17.07; 26.04.02; 26.04.22;
 26.04.24; 27.05.01; 27.05.12; 27.05.24;
 29.01.13
 (511) 36, 37

(260) AM 2024 123355 A
 (210) AM 123355
 (220) 2023 06 15
 (731) LLC "m² Group"
 Givi Kartoziya St. 10, Entrance 6, fl. 0,
 Commercial Space 13, 0177, Saburtalo
 District, Tbilisi, Georgia
 (540)



(591) Black-white, orange
 (531) 24.17.05; 24.17.07; 26.04.02; 26.04.22;
 26.04.24; 27.05.01; 27.05.12; 27.05.24; 28.19;
 29.01.13
 (511) 36, 37

(260) AM 2024 123360 A
 (210) AM 123360
 (220) 2023 06 15
 (731) Zhejiang Ucclife Electric Appliance Co., Ltd
 No.11, Hehua Road, Baihuashan Industrial
 Area, Wuyi, Zhejiang 321300, People's
 Republic of China
 (740) Giorgi Kartvelishvili
 (540)



(591) Black-white
 (531) 26.04.03; 26.04.22; 26.04.24; 27.05.24
 (511) 21

(260) AM 2024 123409 A
 (210) AM 123409
 (220) 2023 06 19
 (731) Ramaz Kharebava
 Vill. Zhebota, Tianeti, Georgia
 (740) Zurab Bezhashvili;
 Lia Shikhiashvili;
 Ioane Iarajuli
 (540)

Makes your day

(591) Black-white
 (511) 9, 16, 25, 28, 29, 30, 31, 32, 35, 41, 43

(260) AM 2024 123413 A
 (210) AM 123413
 (220) 2023 06 20
 (731) LLC "Space Resorts Group"
 Giorgi Leonidze St. 2a, area 7, 0108,
 Mtatsminda District, Tbilisi, Georgia

(740) Giorgi Batlidze
 (540)

COOPERS STATION SPACE RESORT

(591) Black-white
 (511) 35, 39, 41, 43

(260) AM 2024 123414 A
 (210) AM 123414
 (220) 2023 06 20
 (731) Hehe Family Growth Limited
 5/F Manulife Place 348 Kwun Tong RD KLN,
 Hong Kong
 (740) Giorgi Kartvelishvili

(540)

Lapanda

(591) Black-white
(531) 27.05.01
(511) 29, 30

(260) AM 2024 123416 A
(210) AM 123416
(220) 2023 06 21
(731) JSC "Kindzmarauli Corporation"
Iia Chavchavadze St. 55, 4800, Kvareli,
Georgia

(540)



(591) Golden, black
(531) 03.04.11; 29.01.12
(511) 33

(260) AM 2024 123418 A
(210) AM 123418
(220) 2023 06 21
(310) 1444030159; 1444030161; 1444030163
(320) 2023 03 12; 2023 03 12; 2023 03 12
(330) SA
(731) Aviation Services Company Single Person
Closed Joint Stock Company
Building No. 3026, Al Sahafah District, P.O.
Box 6133, Riyadh 13315, Saudi Arabia

(740) Tamaz Shilakadze
(540)



(591) Black-white
(531) 26.01.18; 26.01.19; 27.05.21
(511) 35, 39, 43

(260) AM 2024 123419 A
(210) AM 123419
(220) 2023 06 21
(731) RK "Akhali Megvineoba"
S. Dodashvili St. 38, Kvareli, Georgia
(540)



(591) C4932B golden, 08366B intensive blue
(531) 04.03.01; 05.03.04; 19.09.01; 19.09.02;
24.01.03; 24.01.05; 24.01.09; 24.01.17;
24.01.18; 26.11.09; 29.01.12
(511) 33

(260) AM 2024 123478 A
(210) AM 123478
(220) 2023 06 23
(731) LTD "Smotors"
Gakhokidze St. 4, 0171, Tbilisi, Georgia
(540)



(591) 111111 black, F20909 red
(531) 18.01.09; 26.11.02; 26.11.05; 26.11.07;
26.11.13; 27.05.01; 29.01.12
(511) 35, 37

(260) AM 2024 123480 A
(210) AM 123480
(220) 2023 06 23
(731) LTD "GM Pharmaceuticals"
Rustavi Highway 52, 0114, Tbilisi, Georgia
(740) Nugzar Ksovreli
(540)

ჰაიდოტერინი
Пайдотерин
Paidoterin

(591) Black-white
(511) 5

(260) AM 2024 123481 A
 (210) AM 123481
 (220) 2023 06 23
 (731) Cintana Education LLC
 1130 E. University Dr., Suite 101, Building B,
 Tempe, Arizona 85281, USA
 (740) Giorgi Taktakishvili
 (540)

CINTANA

(591) Black-white
 (511) 9, 35, 41, 42

(260) AM 2024 123486 A
 (210) AM 123486
 (220) 2023 06 23
 (731) Teleperformance SE
 21/25 Rue Balzac, 75008 PARIS, France
 (740) Tamaz Shilakadze
 (540)



(591) Black, white, intensive lilac, pale lilac, lilac,
 pink
 (531) 27.05.01; 27.05.03; 27.05.21; 29.01.13
 (511) 9, 16, 35, 38, 41, 42

(260) AM 2024 123488 A
 (210) AM 123488
 (220) 2023 06 23
 (731) Philip Morris Products S.A.
 Quai Jeanrenaud 3, 2000 Neuchâtel,
 Switzerland
 (740) Pavle Meipariani
 (540)



(591) Black, white, various shades of grey
 (531) 01.15.23; 24.15.13; 25.03.05; 26.01.01;
 26.01.05; 27.05.01
 (511) 40

(260) AM 2024 123493 A
 (210) AM 123493
 (220) 2023 06 26
 (731) Nino Kandelakishvili
 Nino Chkheidze St. 48, ap. 17 0163,
 (Chughureti District), Tbilisi, Georgia
 (540)



(591) 000000 black, FFFFFFF white
 (531) 14.11.01; 26.04.02; 26.04.05; 26.04.16;
 26.04.22; 26.04.24; 26.11.11; 27.05.24
 (511) 25

(260) AM 2024 123498 A
 (210) AM 123498
 (220) 2023 06 27
 (731) Denso Products and Services Americas Inc.
 3900 Via Oro Avenue, Long Beach,
 CA 90810, USA
 (740) Tamaz Shilakadze
 (540)

POWEREDGE

(591) Black-white
 (511) 7

(260) AM 2024 123499 A
 (210) AM 123499
 (220) 2023 06 27
 (731) Carrefour
 93 Avenue de Paris, 91300 MASSY, France
 (740) Giorgi Taktakishvili
 (540)



(591) Green, white
 (531) 03.09.01; 03.09.24; 26.04.03; 26.04.18;
 27.05.01; 27.05.09; 27.05.10; 27.05.21;
 29.01.12
 (511) 35

(260) AM 2024 123503 A
 (210) AM 123503
 (220) 2023 06 27
 (731) CJ Corporation
 12, Sowol-Ro 2-Gil, Jung-Gu, Seoul, Republic
 of Korea

(540)



(591) Black, blue, yellow, red
 (531) 26.03.04; 26.03.06; 26.03.07; 26.13.25;
 27.05.23; 29.01.14
 (511) 39

(260) AM 2024 123504 A
 (210) AM 123504
 (220) 2023 06 28
 (731) Hilton Worldwide Manage Limited
 Maple Court Central Park, Reeds Crescent,
 Watford WD24 4QQ, United Kingdom
 (740) Giorgi Taktakishvili
 (540)

TOGETHER & CO.

(591) Black-white
 (511) 43

(260) AM 2024 123511 A
 (210) AM 123511
 (220) 2023 06 28
 (731) LTD "EVG"
 Iliа Chavchavadze St. 66, 6000, Batumi,
 Georgia
 (540)



(591) Blue, white, grey
 (531) 25.05.03; 26.04.02; 26.04.22; 26.04.24;
 27.05.01; 27.05.23; 28.19; 29.01.13
 (511) 9, 16, 35, 37, 39, 42

(260) AM 2024 123573 A
 (210) AM 123573
 (220) 2023 06 30
 (731) Valvoline Licensing and Intellectual
 Property LLC
 100 Valvoline Way, Suite 100, Lexington,
 Kentucky 40509, USA
 (740) Tamaz Shilakadze
 (540)

VALVOLINE

(591) Black-white
 (511) 37

(260) AM 2024 123574 A
 (210) AM 123574
 (220) 2023 06 30

(731) Valvoline Licensing and Intellectual
 Property LLC
 100 Valvoline Way, Suite 100, Lexington,
 Kentucky 40509, USA

(740) Tamaz Shilakadze
 (540)



(591) Silver, red, sky-blue, blue
 (531) 26.03.23; 27.05.21; 29.01.13
 (511) 37

(260) AM 2024 123575 A
 (210) AM 123575
 (220) 2023 06 30
 (731) Valvoline Licensing and Intellectual
 Property LLC
 100 Valvoline Way, Suite 100, Lexington,
 Kentucky 40509, USA
 (740) Tamaz Shilakadze
 (540)



(591) Black-white
 (531) 26.03.23; 27.05.21
 (511) 37

(260) AM 2024 123585 A
 (210) AM 123585
 (220) 2023 07 04
 (731) LLC "Nutrimax"
 Levan Ghoghoberidze St. 67b, 0165, Krtsanisi
 District, Tbilisi, Georgia
 (740) Giorgi Kartvelishvili
 (540)



(591) Black-white
 (531) 01.01.01; 01.01.02; 01.01.10; 27.05.02;
 27.05.07
 (511) 31

(260) AM 2024 123586 A
 (210) AM 123586
 (220) 2023 07 04
 (731) LLC "Nutrimax"
 Levan Ghoghoberidze St. 67b, 0165, Krtsanisi
 District, Tbilisi, Georgia
 (740) Giorgi Kartvelishvili

(540)

Simp

(591) Black-white

(531) 26.04.03; 27.01.01; 27.01.02; 27.05.17

(511) 31

(260) AM 2024 123587 A

(210) AM 123587

(220) 2023 07 04

(731) LLC "Nutrimax"

Levan Ghogoberidze St. 67b, 0165, Krtsanisi
District, Tbilisi, Georgia

(740) Giorgi Kartvelishvili

(540)

Skippy

(591) Black-white

(531) 27.05.01

(511) 31

(260) AM 2024 123592 A

(210) AM 123592

(220) 2023 07 05

(731) Giorgi Kikabidze

Iia Chavchavadze Av. 54a, 0179, Tbilisi,
Georgia

(740) Giorgi Taktakishvili

(540)

Congress Tea

(591) Black-white

(511) 30, 32, 35

(260) AM 2024 123594 A

(210) AM 123594

(220) 2023 07 05

(731) LLC "LB Capital"

Iia Chavchavadze Av. 34, shop 12A, 0107,
Tbilisi, Georgia

(740) Ioane Iarajuli;

Lia Shikhiashvili;

Zurab Bezhashvili

(540)

Welt

(591) Black-white

(511) 36, 37, 39

(260) AM 2024 123596 A

(210) AM 123596

(220) 2023 07 05

(731) Irakli Nadiradze

Khizabavra St. 5, entr. 1, fl. 1, ap. 4,
Gldani District, Tbilisi, Georgia

(540)

HOPA TAPROOM

(591) Black-white

(511) 43

(260) AM 2024 123597 A

(210) AM 123597

(220) 2023 07 06

(731) LTD "Villa Godoly"

Al. Kazbegi Av. 11a, ap. 42, 0160, Tbilisi,
Georgia

(540)



(591) F2EC3E golden, white

(531) 05.03.04; 28.19; 29.01.02

(511) 33, 43

(260) AM 2024 123602 A

(210) AM 123602

(220) 2023 07 06

(731) Al Esaia Holding LLC

8125, Al Amir Sultan, Ar Rawdah District,
Jeddah, 23435, Saudi Arabia

(740) Irakli Gvilia

(540)



(591) Black, white, red, grey, yellow, orange

(531) 24.01.15; 27.05.23; 29.01.15

(511) 32

(260) AM 2024 123603 A

(210) AM 123603

(220) 2023 07 06

(731) LTD "Krik Events"

Angisa St. 8, ap. 1, 6000, Batumi, Georgia

(540)

რეგისტრირებული ბარის ტერასა

(591) White, sky-blue
 (531) 27.05.01; 27.05.09; 27.05.10; 28.19; 29.01.12
 (511) 43

(260) AM 2024 123606 A
 (210) AM 123606
 (220) 2023 07 09
 (731) LTD "Park Gida"
 Vill. Khutsubani, 5nd District, St. 46a, 6200,
 Kobuleti, Georgia
 (740) Dato Jaiani
 (540)

AMOUR UP

(591) Black-white
 (511) 32

(260) AM 2024 123610 A
 (210) AM 123610
 (220) 2023 07 10
 (731) LTD "Qaravan Trans Express"
 Lanchkhuti St. 4, 0101, Chugureti District,
 Tbilisi, Georgia
 (540)



(591) F7910C orange
 (531) 02.01.21; 03.02.13; 27.05.01; 29.01.01
 (511) 39

(260) AM 2024 123612 A
 (210) AM 123612
 (220) 2023 07 11
 (731) Tornike Mchedlishvili
 Panaskerteli St. 18a, ap. 13, Tbilisi, Georgia
 (540)



(591) Green, brown
 (531) 05.07.06; 27.05.01; 28.19; 29.01.12
 (511) 29, 31

(260) AM 2024 123617 A
 (210) AM 123617
 (220) 2023 07 11
 (731) LTD "Re:School"
 N. Tskvedadze St. 58g, ap. 17, Tbilisi,
 Georgia

(540)

re:sch+

(591) Black, yellow, red, green, blue
 (531) 24.17.01; 24.17.02; 24.17.05; 24.17.25
 (511) 9, 41, 42

(260) AM 2024 123618 A
 (210) AM 123618
 (220) 2023 07 11
 (731) LTD "Re:School"
 N. Tskvedadze St. 58g, ap. 17, Tbilisi,
 Georgia

(540)

re:გონცაჲ

(591) Black-white
 (531) 24.17.01; 27.05.01
 (511) 9, 41, 42

(260) AM 2024 123620 A
 (210) AM 123620
 (220) 2023 07 12
 (731) XCMG Construction Machinery Co., Ltd
 No. 26 Tuolanshan Road, Xuzhou Economic
 and Technological Development Zone, Jiangsu
 Province, People's Republic of China
 (740) Giorgi Kartvelishvili
 (540)



(591) Black-white
 (531) 27.05.01; 27.05.17; 27.05.19
 (511) 7, 12

(260) AM 2024 123621 A
 (210) AM 123621
 (220) 2023 07 12
 (731) XCMG Construction Machinery Co., Ltd
 No. 26 Tuolanshan Road, Xuzhou Economic
 and Technological Development Zone, Jiangsu
 Province, People's Republic of China
 (740) Giorgi Kartvelishvili
 (540)



(591) Black-white
 (531) 26.03.05; 26.03.24; 26.04.01; 26.04.04;
 26.04.10; 26.05.10
 (511) 7, 12

(260) AM 2024 123622 A
 (210) AM 123622
 (220) 2023 07 12
 (731) JSC "Platforma"
 Ilia Chavchavadze Av. 15, ap. 20a, 0179,
 Vake District, Tbilisi, Georgia
 (540)



(591) Black, blue, white
 (531) 24.17.02; 27.05.01; 27.05.21; 29.01.12
 (511) 41

(260) AM 2024 123651 A
 (210) AM 123651
 (220) 2023 07 13
 (731) Diageo Scotland Limited
 11 Lochside Place, Edinburgh, Scotland, EH12
 9HA, United Kingdom
 (740) Tamaz Shilakadze
 (540)

Oban

(591) Black-white
 (511) 33

(260) AM 2024 123653 A
 (210) AM 123653
 (220) 2023 07 13
 (731) Diageo Scotland Limited
 11 Lochside Place, Edinburgh, Scotland, EH12
 9HA, United Kingdom
 (740) Tamaz Shilakadze
 (540)

Mortlach

(591) Black-white
 (511) 33

(260) AM 2024 123676 A
 (210) AM 123676
 (220) 2023 07 14
 (731) LTD "Lily Vanilli"
 Gergeti St. 3, Tbilisi, Georgia
 (540)



(591) ED4040 Red, yellow, sky-blue, pink, brown,
 beige
 (531) 02.03.11; 08.01.17; 29.01.15
 (511) 30

(260) AM 2024 123870 A
 (210) AM 123870
 (220) 2023 07 14
 (731) LLC "Welfar Geo"
 Al. Kazbegi Av. 34-34b, 0177, Vake-Saburtalo
 District, Tbilisi, Georgia
 (540)

სტამიკო

(591) Black-white
 (511) 5

(260) AM 2024 123871 A
 (210) AM 123871
 (220) 2023 07 14
 (731) LLC "Welfar Geo"
 Al. Kazbegi Av. 34-34b, 0177, Vake-Saburtalo
 District, Tbilisi, Georgia
 (540)

სუროლი

(591) Black-white
 (511) 5

(260) AM 2024 123881 A
 (210) AM 123881
 (220) 2023 07 14
 (731) Alkaloid AD Skopje
 Blvd. Aleksandar Makedonski 12, 1000,
 Skopje, The Republic of North Macedonia
 (740) Shalva Gvaramadze
 (540)

МАЗЕНИД

(591) Black-white
 (511) 5

(260) AM 2024 123882 A
 (210) AM 123882
 (220) 2023 07 14
 (731) LTD "BWC"
 Tabukashvili St. 31, 6000, Batumi,
 Georgia
 (540)



(591) Green, golden

(531) 26.05.01; 26.11.08; 27.05.01; 27.05.10;
27.05.11; 28.19; 29.01.12
(511) 43

(260) AM 2024 123883 A
(210) AM 123883
(220) 2023 07 15
(731) Rational Intellectual Holdings Limited
Douglas Bay Complex, King Edward Road,
Onchan, IM3 1DZ, Isle of Man, United
Kingdom
(740) Giorgi Kartvelishvili
(540)

FLUTTER STUDIOS

(591) Black-white
(511) 9, 28, 35, 38, 41, 42

(260) AM 2024 123884 A
(210) AM 123884
(220) 2023 07 15
(731) Aleksii Morchiladze
Sergi Chilaia St. 8, 0180, Tbilisi, Georgia
(540)

სტუდიო

(591) 000000 black-white
(511) 20, 24

(260) AM 2024 123904 A
(210) AM 123904
(220) 2023 07 17
(731) LLC "Incoway"
Akaki Tsereteli Av. 39, 0154, Tbilisi,
Georgia
(540)



(591) 2C4556 blue, FFFEF1 pale ivory
(531) 11.01.10; 11.01.15; 11.01.25
(511) 30

(260) AM 2024 123912 A
(210) AM 123912
(220) 2023 07 19
(731) LLC "Wings"
Ilia Chavchavadze Av. 37m, fl. 19, ap. 56,
Tbilisi, Georgia
(740) Giorgi Taktakishvili

(540)

HERIO

(591) Black-white
(531) 26.04.02; 27.05.01
(511) 9, 15

(260) AM 2024 123920 A
(210) AM 123920
(220) 2023 07 20
(731) LTD "Aliud Unitas Georgia"
Ilia Chavchavadze St. 78/88, ap. 1, 2, 6010,
Batumi Georgia
(540)



(591) FFFFFFF white, EFDE21 golden
(531) 01.01.03; 01.01.09; 01.07.06; 27.05.01;
29.01.12
(511) 41, 43

(260) AM 2024 123921 A
(210) AM 123921
(220) 2023 07 20
(731) LLC "ExGeo Group"
Pankisi St. 7-9, ap. 40, 0171, Saburtalo
District, Tbilisi, Georgia
(540)



CRYPTOHUB

(591) Orange to yellowish, black, white
(531) 27.05.01; 27.05.22; 28.05; 28.19; 29.01.12
(511) 36

(260) AM 2024 123922 A
(210) AM 123922
(220) 2023 07 20
(731) Giorgi Tavadze
Giorgi Shatberashvili St. 15, 0179, Tbilisi,
Georgia
(740) Gocha Gogishvili
(540)

InnHerit Collection

(591) Black-white
(511) 35, 43

(260) AM 2024 123923 A
 (210) AM 123923
 (220) 2023 07 20
 (731) Giorgi Tavadze
 Giorgi Shatberashvili St. 15, 0179, Tbilisi,
 Georgia
 (740) Gocha Gogishvili
 (540)

Heritage Collection

(591) Black-white
 (511) 35, 43

(260) AM 2024 123931 A
 (210) AM 123931
 (220) 2023 07 20
 (731) Toyota Jidosha Kabushiki Kaisha
 (also trading as Toyota Motor Corporation)
 1, Toyota-cho, Toyota-shi, Aichi-ken, Japan
 (740) Tamar Kochlamazashvili
 (540)

TZ550e

(591) Black-white
 (511) 12

(260) AM 2024 124008 A
 (210) AM 124008
 (220) 2023 07 24
 (731) LTD "Aversi-Pharma"
 David Aghmashenebeli Av. 148, 0112, Tbilisi,
 Georgia

(540)

ორციფლოქსი Орцифлоркс Orciflox

(591) Black-white
 (511) 5

(260) AM 2024 124067 A
 (210) AM 124067
 (220) 2023 07 27
 (731) Toyota Jidosha Kabushiki Kaisha
 (also trading as Toyota Motor Corporation)
 1, Toyota-cho, Toyota-shi, Aichi-ken, Japan
 (740) Tamar Kochlamazashvili
 (540)

LFA

(591) Black-white
 (511) 12

(260) AM 2024 124069 A
 (210) AM 124069
 (220) 2023 07 28
 (310) 018897106
 (320) 2023 07 04
 (330) EUIPO
 (731) David Gómez Sánchez
 Calle Jose Lazaro Galdiano 6, Madrid, 28036,
 Spain
 (540)



(591) Blue, white
 (531) 27.05.01; 29.01.04
 (511) 4

(260) AM 2024 124071 A
 (210) AM 124071
 (220) 2023 07 28
 (731) LTD "BG Palace"
 Shalva Nutsubidze St. 77z, 0167, Tbilisi,
 Georgia

(540)



(591) Black, golden
 (531) 03.01.01; 03.01.02; 03.01.16; 26.01.15;
 26.04.02; 26.04.22; 26.04.24; 27.05.01;
 27.05.24; 29.01.12
 (511) 43

REGISTERED TRADEMARKS

(111) M 2024 37804 R

(151) 2024 01 25

(181) 2034 01 25

(260) AM 2023 122006 A

(220) 2023 03 10

(732) British American Tobacco (Brands) Limited

Globe House, 4 Temple Place, London,

WC2R 2PG, United Kingdom

(111) M 2024 37810 R

(151) 2024 01 25

(181) 2034 01 25

(260) AM 2022 120704 A

(220) 2022 12 12

(732) LTD "Tfilisis Marani"

Zakaria Paliashvili St. 33, ap. 6, 0179, Tbilisi,

Georgia

(111) M 2024 37805 R

(151) 2024 01 25

(181) 2034 01 25

(260) AM 2023 121660 A

(220) 2023 02 16

(732) LTD "Franco"

Kakheti Highway 20th km. 0190, Samgori

District, Tbilisi, Georgia

(111) M 2024 37811 R

(151) 2024 01 25

(181) 2034 01 25

(260) AM 2023 121214 A

(220) 2023 01 13

(732) Mamuka Todua

Irakli Abashidze St. 26a, ap. 23, 0179, Tbilisi,

Georgia

(111) M 2024 37806 R

(151) 2024 01 25

(181) 2034 01 25

(260) AM 2023 122204 A

(220) 2023 03 27

(732) Frito-Lay Trading Company (Europe) GmbH

2 Spitalgasse, Bern, CH 3011, Switzerland

(111) M 2024 37812 R

(151) 2024 01 25

(181) 2034 01 25

(260) AM 2022 120825 A

(220) 2022 12 19

(732) LLC "Meotkhe Sartuli"

Krtsanisi St., Salami St. 6, Floor 3, bld. 1,

Tbilisi, Georgia

(111) M 2024 37807 R

(151) 2024 01 25

(181) 2034 01 25

(260) AM 2023 121659 A

(220) 2023 02 16

(732) LTD "Franco"

Kakheti Highway 20th km. 0190, Samgori

District, Tbilisi, Georgia

(111) M 2024 37813 R

(151) 2024 01 25

(181) 2034 01 25

(260) AM 2023 121307 A

(220) 2023 01 20

(732) LTD "KTW Development"

Sulkhan Tsintsadze St. 12, Area 3-6, 0160,

Tbilisi Georgia

(111) M 2024 37808 R

(151) 2024 01 25

(181) 2034 01 25

(260) AM 2023 121763 A

(220) 2023 02 22

(732) Mariam Giorgobiani

Tskneti St. 14, 0162, Tbilisi, Georgia

(111) M 2024 37814 R

(151) 2024 01 25

(181) 2034 01 25

(260) AM 2023 121215 A

(220) 2023 01 13

(732) Mamuka Todua

Irakli Abashidze St. 26a, ap. 23, 0179, Tbilisi,

Georgia

(111) M 2024 37809 R

(151) 2024 01 25

(181) 2034 01 25

(260) AM 2023 121661 A

(220) 2023 02 16

(732) LTD "Franco"

Kakheti Highway 20th km. 0190, Samgori

District, Tbilisi, Georgia

(111) M 2024 37815 R

(151) 2024 01 25

(181) 2034 01 25

(260) AM 2022 120614 A

(220) 2022 12 05

(732) Hill's Pet Nutrition Inc.

A Delaware Corporation 400 SW Eighth Avenue, Topeka, Kansas, 66603, USA	(220) 2023 01 30 (732) Lego Juris A/S 7190 Billund, Denmark
(111) M 2024 37816 R (151) 2024 01 25 (181) 2034 01 25 (260) AM 2023 121051 A (220) 2023 01 05 (732) ITV Studios Netherlands Content B.V. Koos Postemalaan 8, 1217 ZC Hilversum, Netherlands	(111) M 2024 37822 R (151) 2024 01 25 (181) 2034 01 25 (260) AM 2022 120702 A (220) 2022 12 10 (732) LTD Arkoz Qazax Sement Factory Vill. Das Salahli, Gazahi Region, Azerbaijan
(111) M 2024 37817 R (151) 2024 01 25 (181) 2034 01 25 (260) AM 2023 121132 A (220) 2023 01 10 (732) BorgWarner Inc. a Delaware Corporation 3850 Hamlin Road Auburn Hills, Michigan 48326, USA	(111) M 2024 37823 R (151) 2024 01 25 (181) 2034 01 25 (260) AM 2022 120833 A (220) 2022 12 20 (732) Nobel Food Industry LLC Nizami District, Haydar Aliyev avenue, House 92a, Block 2023, Baku, AZ1029, Azerbaijan
(111) M 2024 37818 R (151) 2024 01 25 (181) 2034 01 25 (260) AM 2023 121352 A (220) 2023 01 26 (732) NTTM LLC 2120 Smithtown Avenue, Ronkonkoma, New York 11779, USA	(111) M 2024 37824 R (151) 2024 01 25 (181) 2034 01 25 (260) AM 2023 121340 A (220) 2023 01 25 (732) LTD "Sprabi" Kesklina District, Tartu Road 83-701, Tallinn, 10115, Estonia
(111) M 2024 37819 R (151) 2024 01 25 (181) 2034 01 25 (260) AM 2022 121040 A (220) 2022 12 30 (732) Seara Alimentos LTDA. Av. Marginal Direita do Tietê, 500 – Bloco II – Subsolo – Sala 13, Vila Jaguará 05118-100 São Paulo – SP, Brazil	(111) M 2024 37825 R (151) 2024 01 25 (181) 2034 01 25 (260) AM 2022 120613 A (220) 2022 12 05 (732) JSC "Aldagi Insurance Company" Davit Aghmashenebeli Alley 66a, 0171, Saburtalo District, Tbilisi, Georgia
(111) M 2024 37820 R (151) 2024 01 25 (181) 2034 01 25 (260) AM 2023 121321 A (220) 2023 01 24 (732) Société des Produits Nestlé S.A. 1800 Vevey, Switzerland	(111) M 2024 37826 R (151) 2024 01 25 (181) 2034 01 25 (260) AM 2022 120610 A (220) 2022 12 04 (732) JSC "Aldagi Insurance Company" Davit Aghmashenebeli Alley 66a, 0171, Saburtalo District, Tbilisi, Georgia
(111) M 2024 37821 R (151) 2024 01 25 (181) 2034 01 25 (260) AM 2023 121418 A	(111) M 2024 37827 R (151) 2024 01 25 (181) 2034 01 25 (260) AM 2023 121427 A (220) 2023 02 01

(732) LTD "Khaninvest"
Demetre Tavdadebuli St. 50, Ent. 2, fl. 11,
ap. 91, Batumi, Georgia

(111) M 2024 37828 R
(151) 2024 01 25
(181) 2034 01 25
(260) AM 2023 122027 A
(220) 2023 03 15

(732) Giorgi Ezugbaya
Oniashvili St. 61, ap. 4, Tbilisi, Georgia

(111) M 2024 37829 R
(151) 2024 01 25
(181) 2034 01 25
(260) AM 2023 121416 A
(220) 2023 01 30

(732) LTD "West Invest"
Grigol Lortkipanidze St. 13a, 0137, Tbilisi,
Georgia

(111) M 2024 37830 R
(151) 2024 01 25
(181) 2034 01 25
(260) AM 2023 121415 A
(220) 2023 01 30

(732) LTD "West Invest"
Grigol Lortkipanidze St. 13a, 0137, Tbilisi,
Georgia

(111) M 2024 37831 R
(151) 2024 01 25
(181) 2034 01 25
(260) AM 2023 121516 A
(220) 2023 02 06

(732) LLC "Online Clinic"
Tskaltubo St. Corp. 3, ap. 58, 0119, Tbilisi,
Georgia

(111) M 2024 37832 R
(151) 2024 01 25
(181) 2034 01 25
(260) AM 2023 121527 A
(220) 2023 02 08

(732) LTD "Macro Tourism"
Vakhtang Gorgasali St. 9, 0105, Tbilisi,
Georgia

(111) M 2024 37833 R
(151) 2024 01 25
(181) 2034 01 25
(260) AM 2023 121528 A
(220) 2023 02 08

(732) LTD "Macro Tourism"
Vakhtang Gorgasali St. 9, 0105, Tbilisi,
Georgia

TRADEMARKS REGISTERED ACCORDING TO THE ACCELERATED PROCEDURE

The decision can be appealed at the Chamber of Appeal of Sakpatenti within 3 months from the publication.

(111) M 2024 37798 R

(151) 2024 01 22

(181) 2034 01 22

(210) AM 126452

(220) 2024 01 12

(732) LTD "King Group"

Vakhtang Gorgasali St. 108, Batumi, Georgia

(540)



(591) FFFFFFFF pale (scarlet) red, pale (Champagne) golden

(531) 03.07.21; 04.01.03; 27.05.01; 27.05.10; 29.01.12

(511) 34

(111) M 2024 37799 R

(151) 2024 01 22

(181) 2034 01 22

(210) AM 126190

(220) 2023 12 28

(732) Ramaz Kharebava

Vill. Zhebota, 0107, Tianeti, Georgia

(740) Zurab Bezhashvili;

Ioane Iarajuli

(540)



(591) Black-white

(531) 01.01.01; 01.01.02; 01.01.10; 27.05.06; 27.05.21

(511) 25, 29, 43

(111) M 2024 37800 R

(151) 2024 01 22

(181) 2034 01 22

(210) AM 126362

(220) 2024 01 09

(732) LTD "New Pharm Group"

Irodion Evdoshvili St. 18, Office Space 2, 0154, Tbilisi, Georgia

(540)

ნიუპროსტი

Newprost

Ньюпрост

(591) 000000 black-white

(511) 5

(111) M 2024 37801 R

(151) 2024 01 22

(181) 2034 01 22

(210) AM 126392

(220) 2024 01 11

(732) LTD "Dani 2012"

Tsabadze St. 2, 0112, Didube District, Tbilisi, Georgia

(540)



(591) Black-white

(531) 26.01.02; 26.01.18; 28.19

(511) 43

(111) M 2024 37802 R

(151) 2024 01 22

(181) 2034 01 22

(210) AM 126004

(220) 2023 12 11

(732) Ultraquimia Agricola SA De Cv

Indiana #260, Cd. de los Deportes, Benito Juárez, 03710 Ciudad de México, CDMX

(740) Vakhtang Torotadze

(540)

MOLUS DIE

(591) 000000 black-white

(511) 1, 5

(111) M 2024 37803 R
 (151) 2024 01 24
 (181) 2034 01 24
 (210) AM 126346
 (220) 2024 01 08
 (732) LTD "ქერვან ტურიზმი-LTD Kervan Turizm"
 Zhordania/Z. Gamsakhurdia St. 8/15, 6010,
 Batumi, Adjara, Georgia
 (740) Lela Memiadze
 (540)



(591) Grey, intensive turquoise, white
 (531) 07.01.01; 07.01.08; 07.01.12; 27.05.01;
 27.07.01; 29.01.12
 (511) 43

(111) M 2024 37834 R
 (151) 2024 01 29
 (181) 2034 01 29
 (210) AM 126260
 (220) 2023 12 30
 (732) LTD "Tako Mek"
 Konstantine Gamsakhurdia St. 1, ap. 2,
 6000, Batumi, Georgia
 (540)

TAKO MEKVABIDZE

(591) Black-white
 (531) 27.05.01; 27.05.17
 (511) 25

(111) M 2024 37835 R
 (151) 2024 01 29
 (181) 2034 01 29
 (210) AM 126469
 (220) 2024 01 15
 (732) Davit Kvrivishvili
 Chkondideli St. 103, ap. 25, Tbilisi, Georgia
 (540)



CHEMI KAVA
 COFFEE

(591) Black-white
 (531) 01.15.11; 11.03.04; 27.05.01; 27.05.10
 (511) 30

(111) M 2024 37836 R
 (151) 2024 01 29
 (181) 2034 01 29
 (210) AM 126477
 (220) 2024 01 16
 (732) LTD "Danianti"
 Pekini (Beijing) Av. 2, ap. 21, Tbilisi, Georgia
 (540)



(591) White, intensive green, pale (lettuce) green, grey
 (531) 26.04.04; 26.04.22; 28.19; 29.01.13
 (511) 43

(111) M 2024 37837 R
 (151) 2024 01 29
 (181) 2034 01 29
 (210) AM 126191
 (220) 2023 12 28
 (732) Ramaz Kharebava
 Vill. Zhebota, 0107, Tianeti, Georgia
 (740) Zurab Bezhashvili;
 Ioane Iarajuli
 (540)



(591) Black-white
 (531) 01.01.01; 01.01.02; 01.01.09; 01.01.10;
 27.05.01
 (511) 29, 43

(111) M 2024 37838 R
 (151) 2024 01 29
 (181) 2034 01 29
 (210) AM 126451
 (220) 2024 01 12
 (732) LTD "Tako Mek"
 Konstantine Gamsakhurdia St. 1, ap. 2,
 6000, Batumi, Georgia
 (540)

TAKO MEK

(591) 070707 black, white
 (531) 27.05.01; 27.05.17
 (511) 25

(111) M 2024 37839 R
 (151) 2024 01 29
 (181) 2034 01 29
 (210) AM 126480
 (220) 2024 01 16

(732) LTD "K2 Service"
Z. Botsvadze St. 14, Tbilisi, Georgia
(740) Giorgi Taktakishvili
(540)

BET25

(591) Black-white
(511) 9, 28, 35, 36, 41

(111) M 2024 37840 R
(151) 2024 01 30
(181) 2034 01 30
(210) AM 126464
(220) 2024 01 12
(732) Shishu Pal Burdak
Dolabauri I Sq. 54, 0144, Tbilisi, Georgia
(540)



(591) Golden, green, white
(531) 05.01.19; 05.03.19; 05.07.10; 25.01.09;
25.01.10; 26.01.02; 26.01.18; 27.01.12;
27.05.22; 29.01.13
(511) 33

(111) M 2024 37841 R
(151) 2024 01 30
(181) 2034 01 30
(210) AM 126481
(220) 2024 01 16
(732) LLC "Beth Hotel Batumi"
Vill. Tabakhmela, Tbilisi-Kojori Highway 28,
Tbilisi, Georgia
(740) Giorgi Taktakishvili
(540)

BET25

(591) Black-white
(511) 43

(111) M 2024 37842 R
(151) 2024 01 30
(181) 2034 01 30
(210) AM 126497
(220) 2024 01 18
(732) Private Joint-Stock Company "Zaporizhzhnia"
44 Oleksia Poradi St. 44, Zaporizhzhia,
Zaporizhzhia Region, 69000, Ukraine

(740) Nugzar Ksovreli
(540)



(591) White, intensive (night) blue
(531) 26.01.18; 26.07.05; 27.05.01; 29.01.12
(511) 8

(111) M 2024 37843 R
(151) 2024 01 30
(181) 2034 01 30
(210) AM 126570
(220) 2024 01 24
(732) LLC "Airzena"
Airport Settlement 79, 0158, Tbilisi, Georgia
(540)



(591) EA0E0E red, pale (mushroom) grey
(531) 18.05.01; 18.05.03; 26.13.25; 27.05.01;
29.01.12
(511) 37, 39

(111) M 2024 37844 R
(151) 2024 01 30
(181) 2034 01 30
(210) AM 126571
(220) 2024 01 24
(732) LLC "Airzena"
Airport Settlement 79, 0158, Tbilisi, Georgia
(540)



(591) Red, pale (mushroom) grey
(531) 18.05.01; 18.05.03; 26.13.25; 28.19; 29.01.12
(511) 37, 39

INTERNATIONAL TRADEMARKS FOR WHICH A DECISION ON GRANTING PROTECTIONS IS TAKEN

The decision can be appealed at the Chamber of Appeal of Sakpatenti within 3 months from the publication or at the Mtskheta District Court Administrative Cases Board (Address: №17, Samkhedro St., Mtskheta), within 1 month following the publication.

(260) AM 2024 121009 A

(800) 1705041

(151) 2022 11 09

(891) 2022 11 09

(731) HYUNDAI MOTOR COMPANY

12, Heolleung-ro, Seocho-gu, Seoul 06797,

Republic of Korea

(540)



(591) Blue

(531) 24.11.18; 24.11.25; 26.01.02; 26.01.03;
26.01.18; 27.05.01; 27.05.09; 29.01.04

(511)

39 – Emergency automobile towing; leasing of rental car; providing transportation information; providing information relating to car transport; car rental; tracking of automobile fleets using electronic navigation and locating devices [transport information]; towing and transportation of cars as part of vehicle breakdown services; car sharing services; transport; carpooling services; providing information via the internet relating to the leasing of automobiles; rental of GPS equipment for navigation purposes; rental of safety seats for children, for vehicles; rental of airplanes; renting of vehicles; providing information relating to air transport; providing information relating to vehicle driving services; reservation services for vehicle rental; car rental, garage and parking space rental; providing information relating to vehicle parking services; reservation of parking spaces; transportation of passengers and passengers' luggage; providing information about transport services; logistics services consisting of the storage, transportation and delivery of goods; transport, delivery, packaging, and storage of goods; providing road and traffic information; inspection of vehicles before transport; storage of energy and fuels; depot services for the storage of vehicles; rental of wheelchairs; travel consultancy; travel organization; providing information relating to travel and sightseeing travel tours; booking agency services for travel; travel reservation; travel reservation and travel information services; conducting of sightseeing travel tours by automobiles; physical storage of electronically stored data, documents, digital photographs, music, images, video, and computer games; storage, distribution and supply of energy and fuel; providing information relating to the distribution of electricity; storage and distribution of electricity; GPS navigation

services; technical advice relating to transportation logistics; vehicle transport; vehicle leasing services; supply chain logistics and reverse logistics services consisting of the storage, transportation and delivery of goods for others by air, rail, ship or truck.

(260) AM 2024 121943 A

(800) 1716918

(151) 2023 01 06

(891) 2023 01 06

(731) WILMAX LIMITED

49 Bromley Street, LONDON E1 0NB,
United Kingdom

(540)

WILMAX

(591) Black, white

(511)

20 – Furniture, mirrors, picture frames; containers, not of metal, for storage or transport; unworked or semi-worked bone, horn, whalebone or mother-of pearl; shells; meerschaum; yellow amber.

24 – Textiles and substitutes for textiles; household linen; curtains of textile or plastic.

35 – Advertising; business management; business administration; office functions.

(260) AM 2024 121948 A

(800) 1717273

(151) 2022 11 17

(891) 2022 11 17

(731) ZF FRIEDRICHSHAFEN AG

Löwentaler Str. 20, 88046 Friedrichshafen,
Germany

(540)



(591) Black, white

(531) 27.05.01

(511)

9 – Computer software for providing transportation services of passengers and goods; computer software for communicating with robotic transport vehicles; mobile apps related to transportation services of passengers and goods; data, documents, information, video, sound, text and other media or multi-media, all being electronically recorded or downloadable from

the internet or other communications networks related to transportation services of passengers and goods; computer software for tracking, monitoring and remotely controlling vehicles; mobile application for scheduling, tracking, monitoring, and retrieving deliveries; computer operating systems in the field of automobiles, namely, an operating system for use in autonomous vehicles and vehicles with intelligent driver assistance system, for turning standard vehicles into autonomous vehicles and vehicles with intelligent driver assistance system, and for the operation of autonomous and vehicles with intelligent driver assistance system; computer software in the field of automobiles, namely, software for use in vehicles to facilitate the transmission of data between vehicles and between vehicles and another application; open platforms, computer software systems and application programming interface (api) software for use in the development of computer operating systems for driving, navigating, parking and monitoring autonomous cars and driverless cars with intelligent driver assistance systems; downloadable computer software platforms and recorded computer software platforms for use in computer operating systems for driving, navigating, parking and monitoring autonomous cars and driverless cars; artificial intelligence software, virtual assistant software and computer systems for driverless cars with intelligent driver assistance system; artificial intelligence and machine learning software in the field of autonomous driving and intelligent driver assistance; computer software for voice, speech, facial, image, motion and gesture recognition and for data collection, processing, conversion and output for use in automated and autonomous driving assistance systems.

12 – Robotic transport vehicles; apparatus for locomotion by land, air or water; autonomous, remotely-controlled and self-driving vehicles; robotic vehicles; parts and fittings for the aforesaid goods.

39 – Transport and delivery of passengers and goods; collection, storage, transportation, arranging of transportation and delivery of packets, packages, parcels, letters, messages, newspapers, periodical publications, freight and transportation of passengers and goods; courier services; advice and proof of delivery services related to transportation services of passengers and goods; rental of vehicles; freight forwarding; warehousing; rental of warehouses.

42 – Platform as a service (PAAS) providing access to source codes and software in the fields of autonomous vehicles, smart vehicles, Internet of vehicles and intelligent transportation; platform as a service (PAAS) providing a platform for the development of source codes and software in the fields of autonomous vehicles, smart vehicles, Internet of vehicles and intelligent transportation; research, design, development, engineering, installation, updating, maintenance and consulting of open platforms, computer software systems,

application programming interface (API) and operating systems in the field of autonomous driving, of artificial intelligence software and computer systems for driverless cars and of computer operating systems for driving, navigating, parking and monitoring driverless cars; development of computer software application solutions in the field of autonomous driving and driving assistance.

(260) AM 2024 121956 A
 (800) 1717492
 (151) 2023 02 07
 (891) 2023 02 07
 (731) TOYOTA MOTOR EUROPE, en abrégé TME, société anonyme
 Avenue du Bourget, 60, B-1140 Brussel, Belgium
 (540)

eZone

(591) Black, white
 (511)
 9 – Cruise controls for vehicles; vehicle automatic driving control devices; vehicle navigation systems featuring interactive displays; multimedia navigation system for vehicles; GPS navigation systems; vehicle control software; software allowing geofencing functionality; electrical measuring, recording, monitoring, switching devices; computer hardware, peripherals and software for control, monitoring and recording; navigation, guidance, tracking, targeting and map making devices; measuring, detecting and monitoring instruments, indicators and controllers; all of the aforesaid goods being exclusively for use in the fields of car powertrain and driving mode surveillance and control.

12 – Vehicles; plug-in hybrid cars; parts and fittings for vehicles.

(260) AM 2024 121979 A
 (800) 1717952
 (151) 2022 11 17
 (891) 2022 11 17
 (731) Evonik Operations GmbH
 Rellinghauser Str. 1-11, 45128 Essen, Germany
 (540)

Spherilex

(591) Black, white
 (511)
 1 – Silicon dioxide and silicates.

(260) AM 2024 122085 A
 (800) 1719545
 (151) 2023 02 10
 (891) 2023 02 10
 (731) Jinhua Vikiyi Arts & Crafts Co., Ltd.

Floor 1, Unit 3, Building 30, District 2,
Dasanlitang, Beiyuan Street, Yiwu City,
Zhejiang Province, China

(540)

Vikiyi

(591) Black, white

(531) 01.01.04; 01.01.09; 27.05.01; 27.05.07

(511)

3 – Facial cleansing milk; shoe cream; essential oils; false eyelashes; cosmetic preparations for eyelashes; cosmetics; toothpaste; incense; air fragrancing preparations; lipsticks; liquid foundation.

(260) AM 2024 122163 A

(800) 1720271

(151) 2023 02 21

(891) 2023 02 21

(731) Sovereign Brands, L.L.C.

1300 Old Skokie Valley Road, Highland Park
US-DE 60035, USA

(540)

BARDOT

(591) Black, white

(511)

33 – Alcoholic beverages (except beer); preparations for making alcoholic beverages.

(260) AM 2024 122382 A

(800) 1577402

(151) 2020 12 22

(891) 2023 03 09

(731) VENUS MANAGEMENT PTE. LTD.

111 NORTH BRIDGE ROAD, #21-03
PENINSULA PLAZA, SINGAPORE 179098,
Singapore

(540)

Pragon

(591) Black, white

(511)

34 – Cigarette cases; cigarette filters; cigarette holders; cigarette paper; cigarettes; cigars; electronic cigarettes; flavourings, other than essential oils, for use in electronic cigarettes; lighters for smokers; tobacco.

(260) AM 2024 122456 A

(800) 1724345

(151) 2022 11 02

(891) 2022 11 02

(731) Euro Games Technology Ltd.

4, "Maritsa" Str., "Vranya-Lozen-Triugulnika",
BG-1151 Sofia, Bulgaria

(540)



(591) Yellow, orange, green, black and white

(531) 02.09.01; 05.03.06; 27.05.03; 27.05.17;
29.01.15

(511)

9 – Operating computer software for main frame computers; monitors (computer hardware); computer hardware; apparatus for recording images; monitors (computer programs); computer game programs; recorded computer game programs; apparatus for recording, transmission or reproduction of sound or images; communications servers (computer hardware); electronic components for gambling machines; computer application software featuring games and gaming; computer software for the administration of on-line games and gaming; computer hardware for games and gaming; electronic components and computer software for gambling, gambling machines, gambling games on the internet and via telecommunication network; computer systems; computer operating system software; computer terminals; interactive terminals; multimedia terminals; electronic terminals for generating lottery tickets; interactive touch screen terminals; computer touchscreens; electronic display panels; liquid crystal display screens; digital signage display panels; multimedia software; multimedia apparatus and instruments; interactive multimedia software for playing games; computer screens; led large-screen displays; liquid crystal displays [lcds] for home theatres; media streaming software; computer application software for streaming audio-visual media content via the internet; software; computer gaming software; computer software packages; computer operating system software; computer software, recorded; software drivers; virtual reality software; games software; entertainment software for computer games; computer programs for network management; electronic lottery tickets; computer software platforms; operating systems; interactive computer systems; operating system programs; computer game software for use with on-line interactive games; interactive casino games provided through a computer or mobile platform; software for slot machines, betting software, software for video slot games, for casino games, for gambling and bingo games, provided online or through computer networks and that can be played on any type of computer device, including arcade games, personal computers, portable devices and mobile phones; automated ticket printing apparatus; automatic ticket dispensing machines; lottery ticket dispensing apparatus; electronic ticket examination machines.

28 – Gaming machines for gambling; chips for gambling; mah-jong; arcade games; gambling machines

operating with coins, notes and cards; games; electronic games; parlor games; gaming chips; gaming tables; slot machines [gaming machines]; LCD game machines; slot machines and gaming devices; coin-operated amusement machines; roulette chips; poker chips; chips and dice [gaming equipment]; gaming equipment for casinos; roulette tables; gaming roulette wheels; casino games; gambling machines and amusement machines, automatic and coin-operated; coin-operated amusement machines and / or electronic coin-operated amusement machines with or without the possibility of gain; boxes for coin-operated amusement machines, slot machines and gaming machines; electronic or electrotechnical amusement machines and apparatus, gaming machines, coin-operated entertainment machines; housings for coin-operated amusement machines, gaming equipment, gaming machines, machines for gambling; electropneumatic and electrical gambling machines (slot machines); lottery games; electronic targets for games and sports; parlor game equipment and accessories not included in other classes, in particular tokens, chips, marbles; parlor games, apparatus equipment and accessories therefor, not included in other classes, in particular electronic targets, backgammon, scratch cards, playing cards, lottery cards, dice; lottery tickets; printed lottery tickets; lottery scratch cards; scratch cards for playing lottery games.

41 – Gambling; entertainment services related to gambling; gaming services for entertainment purposes; casino, gaming and gambling services; training in the development of software systems; provision of gaming equipment for gambling halls; providing casino equipment [gambling]; gaming machine entertainment services; providing casino facilities [gambling]; providing halls with gaming machines; amusement arcade services; games equipment rental; rental of gaming machines; providing amusement arcade services; rental of gaming machines with images of fruits; editing or recording of sounds and images; sound recording and video entertainment services; hire of sound reproducing apparatus; provision of gaming equipment for casinos; providing of casino facilities; online gambling services; casino, gaming and gambling services; providing amusement arcade services, on-line casino services and on-line betting services via websites; on-line interactive entertainment; on-line casino services; online game services through mobile devices; providing online entertainment in the nature of game tournaments; providing on-line information in the field of computer gaming entertainment; sports betting services; online sports betting services; providing on-line computer games and games of chance; lottery services; organization of lotteries; conducting lotteries; prize draws [lotteries]; conducting lotteries for others; providing slot machine parlors; rental of slot machines [gaming machines].

42 – Computer software technical support services; troubleshooting of computer software problems; provision of technical support in the supervision of computing networks; provision of technical support in the operation of computing networks; technical support services relating to computer software and applications; technical supervision and inspection; monitoring of computer systems by remote access; machine condition monitoring; installation, repair and maintenance of computer software; design, maintenance and updating of computer software; installation, setting up and maintenance of computer software; design, maintenance, development and updating of computer software; installation and customisation of computer applications software; technical consultancy relating to the installation and maintenance of computer software; computer system monitoring services; design of graphic software systems; development of interactive multimedia software; design and development of computer hardware; advice relating to the design of computer hardware; advisory and information services relating to the design and development of computer hardware; design, development and testing of computer software and hardware, in particular for gambling, casino games and betting.

(260) AM 2024 122471 A

(800) 1724853

(151) 2022 12 29

(891) 2022 12 29

(731) Sanovel İlaç Sanayi ve Ticaret Anonim Şirketi
İstinye Mah. Balabandere Cad., 14-1 Sarıyer,
İstanbul, Türkiye

(540)

ROPSAL

(591) Black, white

(531) 27.05.01

(511)

5 – Pharmaceutical and veterinary preparations for medical purposes; chemical preparations for medical and veterinary purposes, chemical reagents for pharmaceutical and veterinary purposes; medicated cosmetics; dietary supplements for pharmaceutical and veterinary purposes; dietary supplements; nutritional supplements; medical preparations for slimming purposes; herbs and herbal beverages adapted for medicinal purposes; disinfectants; antiseptics; detergents for medical purposes; medicated soaps; disinfectant soaps; antibacterial hand lotions.

(260) AM 2024 122472 A

(800) 1724855

(151) 2023 01 26

(891) 2023 01 26

(731) MEDIOLANUM FARMACEUTICI S.p.A.
Via San Giuseppe Cottolengo 15, I-20143
Milano, Italy

(540)

MEDIOLANUM

(591) Black, white

(511)

5 – Pharmaceuticals; medicines.

(260) AM 2024 122475 A

(800) 563161

(151) 1990 11 06

(891) 2022 12 20

(731) CARREFOUR

93 avenue de Paris, F-91300 MASSY, France

(540)



(591) Black, white

(531) 24.15.15; 24.15.21; 26.04.18; 27.05.08;
27.05.21

(511)

3 – Bleaching preparations and other substances for laundry use; cleaning, polishing, scouring and abrasive preparations; soaps; perfumery, essential oils, cosmetics, hair lotions; dentifrices.

4 – Industrial oils and greases; lubricants; dust-absorbing, wetting and binding products; fuels (including motor spirit) and illuminants; candles, wicks.

5 – Pharmaceutical, veterinary and sanitary products; dietetic substances adapted for medical use, food for babies; plasters, materials for dressings; material for stopping teeth and dental wax; disinfectants; products for destroying vermin; fungicides, herbicides.

16 – Paper, cardboard and goods made of these materials, not included in other classes; printed matter; bookbinding material; photographs; stationery; adhesives for stationery or household purposes; materials for artists; paintbrushes; typewriters and office requisites (except furniture); instructional or teaching material (except apparatus); plastic materials for packaging (not included in other classes); playing cards; printing type; printing blocks.

18 – Leather and imitation leather, goods made of these materials not included in other classes; animal skins and hides; trunks and suitcases; umbrellas, parasols and walking sticks; whips and saddlery.

21 – Household or kitchen utensils and containers (not of precious metal or coated therewith); combs and sponges; brushes (except paintbrushes); brush-making materials; articles for cleaning purposes; steel wool; unworked or semi-worked glass (except building glass); glassware, porcelain and earthenware not included in other classes.

24 – Fabrics and textile goods not included in other classes; bed and table covers.

29 – Meat, fish, poultry and game; meat extracts; preserved, dried and cooked fruit and vegetables; jellies, jams; eggs, milk and dairy products; edible oils and fats; salad dressings; canned foods.

30 – Coffee, tea, cocoa, sugar, rice, tapioca, sago, artificial coffee; flours and preparations made from cereals, bread, pastry and confectionery, edible ices; honey, treacle syrup; yeast, baking-powder; salt, mustard; vinegar, sauces (except dressings for salads); spices; ice for refreshment.

31 – Agricultural, horticultural and forestry products and grains, not included in other classes; live animals; fresh fruit and vegetables; natural seeds, plants and flowers; foodstuffs for animals, malt.

32 – Beers; mineral and aerated waters and other non-alcoholic drinks; fruit drinks and fruit juices; syrups and other preparations for making beverages.

33 – Alcoholic beverages (except beers).

(260) AM 2024 122513 A

(800) 1725112

(151) 2023 02 28

(891) 2023 02 28

(731) avandeo GmbH

Lindenstrasse 16, CH-6340 Baar, Switzerland

(540)

(591) Orange (HEX # FF2F00)

(531) 02.09.01; 27.05.01; 29.01.01

(511)

11 – Apparatus and installations for lighting, heating, cooling, steam generating, cooking, drying, ventilating, water distribution and sanitary installations.

20 – Furniture, mirrors, picture frames; transport or storage containers not of metal; bone, horn, whalebone or mother-of-pearl, unprocessed or semi-processed; shells; meerschaum; yellow amber.

24 – Textiles and substitutes thereof; household linen; curtains of textile or plastic materials.

27 – Carpets, rugs, mats and matting, linoleum and other materials for covering existing floors; wall hangings, not of textile materials.

35 – Advertising; commercial business administration, organization and management; office functions.

(260) AM 2024 122514 A

(800) 1725135

(151) 2022 12 26

(891) 2022 12 26

(731) Fujian Huanong Food Co., Ltd.
Lot A, JinGu East Industrial Park, ShaXian
County, SanMing, 365500 FuJian, China

(540)



(591) Black, white
(531) 01.15.15; 03.09.01; 03.09.10; 03.09.24;
27.05.01; 28.03

(511)
29 – Fish, not live; fish-based foodstuffs; fish meat,
dried.

30 – Fish sandwiches; pastries; hamburger sandwich-
es; taiyaki [Japanese fish-shaped cakes with various
fillings]; sushi; boxed lunches consisting of rice, with
added meat, fish or vegetables; pre-packaged lunches
consisting primarily of rice, and also including meat,
fish or vegetables; starch for food; cereal-based snack
food.

(260) AM 2024 122516 A
(800) 1725211
(151) 2022 11 16
(891) 2022 11 16
(731) Egis Gyógyszergyár Zrt.
Keresztúri út 30-38, H-1106 Budapest,
Hungary

(540)

EXVAL

(591) Black, white
(511)
5 – Pharmaceutical preparations for human use; die-
tetic substances adapted for medical use; dietary sup-
plements.

(260) AM 2024 122517 A
(800) 1725212
(151) 2022 11 16
(891) 2022 11 16
(731) Egis Gyógyszergyár Zrt.
Keresztúri út 30-38, H-1106 Budapest,
Hungary

(540)

ENTAXOR

(591) Black, white
(511)
5 – Pharmaceutical preparations for human use; die-
tetic substances adapted for medical use; dietary sup-
plements.

(260) AM 2024 122518 A
(800) 1725239
(151) 2023 03 17
(891) 2023 03 17
(731) IVE S.r.l.
Via Toscanini 53, I-20831 Seregno (MB), Italy

(540)



(591) Black, white
(531) 26.04.02; 26.04.09; 26.04.18; 26.04.24;
26.11.02; 26.11.08; 27.05.15

(511)
2 – Colours; varnishes; lacquers; finishing preparati-
ons in the nature of varnishes; paint primers; primer;
preparations for protecting wood against deteriorati-
on; mordants; resins for use in pigmentation; synthetic
resins for protection against corrosion; raw natural
resins for use in the manufacture of varnishes; raw
natural resins for use in the manufacture of lacquers.

(260) AM 2024 122593 A
(800) 1726003
(151) 2022 12 06
(891) 2022 12 06
(731) Zakrytoe aktsionernoe obshchestvo
"Starodvorskie kolbasy"
ul. Poliny Osipenko, d. 41, of. 210, RU-600009
g. Vladimir, Russian Federation

(540)

Молокуши

(591) Black, white
(531) 28.05
(511)
29 – Preserved peppers; aloe vera prepared for human
consumption; alginates for culinary purposes; ancho-
vy, not live; peanuts, prepared; artichokes, preserved;
albumen for culinary purposes; white of eggs; beans,
preserved; soya beans, preserved, for food; broth; gin-
ger jam; ham; fatty substances for the manufacture of
edible fats; toasted laver; edible birds' nests; sea-cucu-
mbers, not live; peas, preserved; mushrooms, preser-
ved; guacamole; game, not live; gelatine; meat jellies;
jellies for food; fruit jellies; yolk of eggs; coconut fat;
bone oil for food; lard; suet for food; edible fats; curd;
fruit-based snack food; milk substitutes; charcuterie;
raisins; caviar; eggplant paste; vegetable marrow
paste; fish roe, prepared; yogurt; galbi [grilled meat
dish]; sauerkraut; kefir; kimchi; isinglass for food;
clams, not live; potato-based dumplings; milk shakes;
black pudding; onion rings; arrangements of proces-

sed fruit; compotes; meat, canned; vegetables, canned; fish, canned; fruits, canned; broth concentrates; corn dogs; gherkins; shrimps, not live; prawns, not live; buttercream; croquettes; silkworm chrysalis for human consumption; sweet corn, processed; kumys; spiny lobsters, not live; lecithin for culinary purposes; salmon, not live; onions, preserved; margarine; marmalade; oils for food; peanut butter; cocoa butter for food; coconut oil for food; coconut butter; corn oil for food; sesame oil for food; linseed oil for food; extra virgin olive oil for food; olive oil for food; palm oil for food; palm kernel oil for food; sunflower oil for food; rape oil for food; butter; soya bean oil for food; mussels, not live; almonds, ground; animal marrow for food; mollusks, not live; milk; peanut milk; peanut milk for culinary purposes; coconut milk; coconut milk for culinary purposes; almond milk; almond milk for culinary purposes; oat milk; rice milk; rice milk for culinary purposes; protein milk; condensed milk; soya milk; powdered milk; fish meal for human consumption; vegetable mousses; fish mousses; fruit pulp; meat; meat, preserved; freeze-dried meat; chicken nuggets; milk beverages, milk predominating; peanut milk-based beverages; coconut milk-based beverages; almond milk-based beverages; edible insects, not live; sausage casings, natural or artificial; pieces of chicken fried in batter; vegetables, preserved; freeze-dried vegetables; vegetables, dried; vegetables, cooked; potato fritters; olives, preserved; lobsters, not live; flavored nuts; candied nuts; coconut, desiccated; nuts, prepared; tomato paste; liver pâté; pectin for culinary purposes; liver; pickles; jams; powdered eggs; milk products; fish-based foodstuffs; soured milk; poultry, not live; breaded chicken pieces; bulgogi; pollen prepared as foodstuff; cranberry compote; tomato purée; apple purée; crayfish, not live; crustaceans, not live; fish, preserved; fish, not live; salted fish; fermented baked milk; vegetable salads; fruit salads; bacon; sardelki [sausages]; sardines, not live; pork; herrings, not live; seeds, prepared; sunflower seeds, prepared; cream [dairy products]; whipped cream; vegetable-based cream; fat-containing mixtures for bread slices; smetana; lemon juice for culinary purposes; tomato juice for cooking; vegetable juices for cooking; salted meats; sausages; sausages in batter; hot dog sausages; preparations for making bouillon; preparations for making soup; nut-based spreads; tripe; soups; vegetable soup preparations; whey; cheese; tahini; tofu; truffles, preserved; tuna, not live; oysters, not live; falafel; milk ferments for culinary purposes; rennet; fish fillets; dates; frosted fruits; frozen fruits; fruit, preserved; fruit preserved in alcohol; fruit, stewed; hazelnuts, prepared; potato flakes; hummus; fruit peel; preserved garlic; lentils, preserved; potato chips; low-fat potato chips; fruit chips; shpikachki [sausages]; non-alcoholic eggnog; seaweed extracts for food; meat extracts; edible ant larvae, prepared; berries, preserved; snail eggs for consumption; eggs; yakitori.

30 – Vanilla flavorings for culinary purposes; flavorings, other than essential oils, for cakes; flavorings, other than essential oils, for beverages; coffee flavorings; food flavorings, other than essential oils; star aniseed; baozi; cereal bars; high-protein cereal bars; pancakes; noodle-based prepared meals; freeze-dried dishes with the main ingredient being pasta; freeze-dried dishes with the main ingredient being rice; buns; bread rolls; edible rice paper; edible paper; burritos; vanillin [vanilla substitute]; vareniki [stuffed dumplings]; waffles; vermicelli; natural sweeteners; sausage binding materials; binding agents for ice cream; sea water for cooking; seaweed [condiment]; malt biscuits; cloves [spice]; mirror icing [mirror glaze]; cake frosting [icing]; glucose for culinary purposes; mustard; gluten additives for culinary purposes; yeast; thickening agents for cooking foodstuffs; leaven; rice-based snack food; cereal-based snack food; coffee substitutes; vegetal preparations for use as coffee substitutes; dressings for salad; fruit jellies [confectionery]; candy decorations for cakes; confectionery for decorating Christmas trees; cakes; pastries; peanut confectionery; almond confectionery; pasta; ginger [spice]; frozen yogurt [confectionery ices]; cocoa; cream of tartar for culinary purposes; capers; caramels [sweets]; curry [spice]; ketchup [sauce]; prepared rice rolled in seaweed; quiches; gluten prepared as foodstuff; flour-based dumplings; sweets; liquorice [confectionery]; peppermint sweets; dulce de leche; cinnamon [spice]; coffee; unroasted coffee; starch for food; crackers; custard; hominy grits; semolina; oatmeal; crushed barley; groats for human food; ice cubes; corn, milled; corn, roasted; meat pies; turmeric; couscous; noodles; ice for refreshment; ice, natural or artificial; edible ices; candies; rice cakes; mayonnaise; macarons; macaroni; maltose; hominy; piccalilli; marinades; marzipan; honey; miso [seasoning]; royal jelly; ice cream; bean meal; tapioca flour; potato flour; corn flour; nut flours; flour; wheat flour; soya flour; barley meal; confectionery in the form of mousses; chocolate mousses; muesli; mint for confectionery; cocoa beverages with milk; coffee beverages with milk; coffee-based beverages; cocoa-based beverages; chamomile-based beverages; tea-based beverages; chocolate beverages with milk; chocolate-based beverages; infusions, not medicinal; crushed oats; husked oats; savory pancakes; onigiri; nutmegs; chocolate-coated nuts; stick liquorice [confectionery]; pastilles [confectionery]; molasses for food; pâtés en croûte; pelmeni [dumplings stuffed with meat]; khinkali [stuffed dumplings]; manti [stuffed dumplings]; allspice; peppers [seasonings]; pesto; cookies; petit-beurre biscuits; bibimbap [rice mixed with vegetables and beef]; pies; pizzas; meat gravies; fondants [confectionery]; popcorn; powders for making ice cream; baking powder; mustard meal; pralines; aromatic preparations for food; condiments; meat tenderizers for household purposes; cereal preparations; oat-based food; bee glue; gingerbread; spices; petits fours [cakes]; rice pudding;

puddings; cake powder; fruit coulis [sauces]; ravioli; ramen; chewing gum; relish [condiment]; rice; instant rice; wheat germ for human consumption; spring rolls; sago; palm sugar; sugar; sesame seeds [seasonings]; linseed for culinary purposes [seasoning]; processed seeds for use as a seasoning; aniseed; agave syrup [natural sweetener]; golden syrup; confectionery; savory pancake mixes; baking soda [bicarbonate of soda for cooking purposes]; malt for human consumption; salt for preserving foodstuffs; cooking salt; celery salt; sherbets [ices]; ham glaze; soya sauce; tomato sauce; sauces [condiments]; pasta sauce; spaghetti; seasonings; chocolate-based spreads; chocolate spreads containing nuts; preparations for stiffening whipped cream; rusks; breadcrumbs; sushi; senbei [rice crackers]; sandwiches; tabbouleh; tacos; tapioca; tarts; dough; pastry dough; almond paste; rice pulp for culinary purposes; cake dough; tortillas; garden herbs, preserved [seasonings]; chocolate decorations for cakes; vinegar; beer vinegar; ferments for pastes; halvah; bread; unleavened bread; chips [cereal products]; corn flakes; oat flakes; hot dog sandwiches; flowers or leaves for use as tea substitutes; jiaozi; chicory [coffee substitute]; tea; iced tea; chutneys [condiments]; chebureki [deep-fried pies]; minced garlic [condiment]; cheeseburgers [sandwiches]; chow-chow [condiment]; saffron [seasoning]; chocolate; malt extract for food; essences for foodstuffs, except etheric essences and essential oils; husked barley.

(260) AM 2024 122603 A

(800) 1726177

(151) 2022 10 06

(891) 2022 10 06

(731) SU-ÇI TEKSTİL İNŞAAT GIDA
MADENCİLİK VE TURİZM DIŞ TİCARET
LİMİTED ŞİRKETİ
Mehmet Nesih Özmen Mahallesi, Fidan Sokak,
16 16, Güngören, İstanbul, Türkiye

(540)

Levure

(591) Black, white

(531) 27.05.01

(511)

25 – Clothing, including underwear and outer clothing, other than special purpose protective clothing; socks, mufflers [clothing], shawls, bandanas, scarves, belts [clothing]; footwear, shoes, slippers, sandals; headgear, hats, caps with visors, berets, caps [headwear], skull caps.

35 – The bringing together, for the benefit of others, of a variety of goods, namely, clothing, including underwear and outer clothing, other than special purpose protective clothing, socks, mufflers [clothing], shawls, bandanas, scarves, belts [clothing], footwear, shoes, slippers, sandals, headgear, hats, caps with visors, berets, caps [headwear], skull caps, enabling custo-

mers to conveniently view and purchase those goods, such services may be provided by retail stores, wholesale outlets, by means of electronic media or through mail order catalogues.

(260) AM 2024 122604 A

(800) 1726187

(151) 2022 12 05

(891) 2022 12 05

(731) Euro Games Technology Ltd.

4, "Maritsa" Str., "Vranya-Lozen-Triugulnika",
BG-1151 Sofia, Bulgaria

(540)



The logo features the word "RED" in a small, bold, red font above the word "COLLECTION" in a large, bold, red font with a metallic, 3D effect. To the right of "COLLECTION" is the word "SALOON" in a smaller, bold, red font.

(591) Red, white, silver and black

(531) 27.05.01; 27.05.02; 27.05.03; 27.05.09;
27.05.10; 29.01.14

(511)

9 – Software; computer gaming software; computer software packages; computer operating system software; computer software, recorded; software drivers; virtual reality software; games software; entertainment software for computer games; computer programs for network management; operating computer software for main frame computers; monitors (computer hardware); computer hardware; apparatus for recording images; monitors (computer programs); computer game programs; computer programs for recorded games; apparatus for recording, transmission or reproduction of sound or images; communications servers [computer hardware]; electronic components for gambling machines; computer application software featuring games and gaming; computer software for the administration of on-line games and gaming; computer hardware for games and gaming; hardware and software for gambling, gambling machines, gambling games on the Internet and via telecommunication network.

28 – Gaming machines for gambling; chips for gambling; mah-jong; arcade games; gambling machines operating with coins, notes and cards; games; electronic games; parlor games; gaming chips; gaming tables; slot machines [gaming machines]; LCD game machines; slot machines and gaming devices; coin-operated amusement machines; roulette chips; poker chips; chips and dice [gaming equipment]; gaming equipment for casinos; roulette tables; gaming roulette wheels; casino games; gambling machines and amusement machines, automatic and coin-operated; coin-operated amusement machines and/or electronic coin-operated amusement machines with or without the possibility of gain; boxes for coin-operated machines, slot machines and gaming machines; electronic or electrotechnical amusement machines and apparatus, gaming machines, coin-operated entertainment machines; housings for coin-operated machines, gaming

equipment, gaming machines, machines for gambling; electropneumatic and electrical gambling machines (slot machines).

41 – Gambling; entertainment services related to gambling; gaming services for entertainment purposes; casino, gaming and gambling services; training in the development of software systems; provision of gaming equipment for gambling halls; providing casino equipment [gambling]; gaming machine entertainment services; providing casino facilities [gambling]; gaming hall services; amusement arcade services; games equipment rental; rental of gaming machines; providing amusement arcade services; rental of gaming machines with images of fruits; editing or recording of sounds and images; sound recording and video entertainment services; hire of sound reproducing apparatus; provision of gaming equipment for casinos; providing of casino facilities; online gambling services; casino services; provision of gaming facilities, gaming hall facilities, Internet casinos and online gambling services.

(260) AM 2024 122605 A

(800) 1726201

(151) 2022 12 14

(891) 2022 12 14

(731) TOYOBO CO., LTD.

13-1, Umeda 1-chome, Kita-ku, Osaka-shi,

Osaka 530-0001, Japan

(540)

TOYOBO MC

(591) Black, white

(511)

1 – Chemical preparations for scientific purposes, other than for medical or veterinary use; ferments for chemical purposes; chemical reagents, other than for medical or veterinary purposes; stem cells other than for medical or veterinary purposes; industrial chemicals; chemical additives for use in manufacture; enzymes for industrial purposes; enzyme preparations for industrial purposes; chemical substances for analyses in laboratories, other than for medical or veterinary purposes; catalysts; biological tissue cultures other than for medical or veterinary purposes; glues and adhesives for industrial purposes; plant growth regulating preparations; agricultural chemicals, except fungicides, herbicides, insecticides and parasiticides; fertilizers; ceramic glazings; priming putty; higher fatty acids; alkaline metals; rare earths; fissionable material for nuclear energy; non-metallic minerals; chemical preparations for use in photography; sensitized paper; photosensitive plates; chemical preparations for use in photography; sensitized films, unexposed; reagent paper, other than for medical or veterinary purposes; artificial sweeteners; flour and starch for industrial purposes; plastics [raw materials]; synthetic resins, unprocessed; artificial resins, unprocessed; plastics, un-

processed; wood pulp; biological preparations, other than for medical or veterinary purposes; fatty acids; astatine; alkaline-earth metals; radioactive elements for scientific purposes; silicon; fuel for nuclear reactors; metalloids; sulfur; borax; by-products of the processing of cereals for industrial purposes; bacteriological preparations for acetification; bacteriological preparations, other than for medical and veterinary use; preparations of microorganisms, other than for medical and veterinary use; dendrimer-based polymers for use in the manufacture of capsules for pharmaceuticals; preparations of trace elements for plants; soil for growing; potting soil; topsoil; glaziers' putty; chimney cleaners, chemical; detergents for use in manufacturing processes; transmission fluid; transmission oil; power steering fluid; brake fluid; fluids for hydraulic circuits; milk ferments for chemical purposes; milk ferments for the food industry; cultures of microorganisms, other than for medical and veterinary use; ceramic compositions for sintering [granules and powders]; photosensitive resin film; photosensitive resin plate for printing; electrically conductive adhesives, other than for household or stationery purposes; vegetable aggregate for plaster [susa].

(260) AM 2024 122641 A

(800) 1609264

(151) 2021 06 17

(891) 2023 02 22

(731) SHENZHEN CHUANG XIN WEI BICYCLE CO., LTD

Floor 1, 2 and 3, Building B, No. 10, Xingye Second Road, Fenghuang Community, Fuyong Street, Baoan District, Shenzhen, 518103 Guangdong, China

(540)



(591) Black, white

(531) 24.01.25; 26.05.01; 26.05.12

(511)

12 – Cars; bicycle wheel rims; mopeds; electric bicycles; bicycles; bicycle frames; bicycle wheels; bicycle tyres; anti-theft devices for vehicles; motorcycles.

(260) AM 2024 122642 A

(800) 1650088

(151) 2021 12 30

(891) 2023 04 06

(731) ZHEJIANG GEELY HOLDING GROUP CO., LTD.

1760 Jiangling Road, Binjiang District,
Hangzhou, Zhejiang, China

(540)

ZEEKR

(591) Black, white

(511)

39 – Vehicle breakdown towing services; car transport; boat rental; delivery of goods; vehicle rental; piloting; chauffeur services; courier services [messages or merchandise]; escorting of travelers; physical storage of electronically stored data or documents.

(260) AM 2024 122643 A

(800) 1650702

(151) 2022 02 04

(891) 2023 03 22

(731) Limited Liability Company "NTS "Gradient"
ul. Borisa Galushkina, 14, korp. 1, RU-129301
Moscow, Russian Federation

(540)

Influence Beauty

(591) Black, white

(511)

3 – Aromatics [essential oils]; balms, other than for medical purposes; basma [cosmetic dye]; lip glosses; nail glitter; petroleum jelly for cosmetic purposes; cotton wool impregnated with make-up removing preparations; adhesives for cosmetic purposes; scented water; lavender water; micellar water; toilet water; massage gels, other than for medical purposes; make-up; perfumes; greases for cosmetic purposes; perfumery; decorative transfers for cosmetic purposes; eyebrow pencils; cosmetic pencils; adhesives for affixing false eyelashes; cosmetic dyes; body paint for cosmetic purposes; cosmetic creams; skin whitening creams; nail varnish; liquid latex body paint for cosmetic purposes; lotions for cosmetic purposes; beauty masks; oils for perfumes and scents; oils for cosmetic purposes; oils for toilet purposes; essential oils; essential oils of cedarwood; essential oils of lemon; essential oils of citron; bergamot oil; gaultheria oil; jasmine oil; lavender oil; almond oil; rose oil; almond milk for cosmetic purposes; cleansing milk for toilet purposes; cakes of toilet soap; almond soap; cosmetic kits; gel eye patches for cosmetic purposes; nail art stickers; false nails; eau de Cologne; hydrogen peroxide for cosmetic purposes; lipsticks; pomades for cosmetic purposes; cosmetic preparations for baths; bath preparations, not for medical purposes; eye-washes, not for medical purposes; make-up removing preparations; nail care preparations; collagen preparations for cosmetic purposes; aloe vera preparations for cosmetic purposes; sunscreen preparations; make-up powder; nail varnish removers; false eyelashes; tissues impregnated with cosmetic lotions; tissues impregnated

with make-up removing preparations; potpourris [fragrances]; bath salts, not for medical purposes; astringents for cosmetic purposes; eyebrow cosmetics; make-up preparations; sun-tanning preparations [cosmetics]; cosmetic preparations for eyelashes; cosmetic preparations for skin care; cosmetics; mascara; phytocosmetic preparations; terpenes [essential oils]; henna [cosmetic dye]; herbal extracts for cosmetic purposes.

(260) AM 2024 122644 A

(800) 1687661

(151) 2022 09 09

(891) 2023 03 29

(731) Seaboard Corporation

9000 W 67th St, Merriam KS 66202, USA

(540)

PRAIRIE FRESH

(591) Black, white

(526) FRESH

(511)

29 – Meat.

(260) AM 2024 122645 A

(800) 1717848

(151) 2022 11 16

(891) 2023 03 07

(731) ÇELİKLER GROUP DIŞ TİCARET
ANONİM ŞİRKETİ

GÖKEVLER MAH. 563. SK. 9 F, Esenyurt,
İstanbul, Türkiye

(540)

GO UP

(591) Black, white

(531) 27.05.01

(511)

32 – Beers; extracts of hops for making beer; mineral water, spring water, table water, soda water; fruit and vegetable juices, fruit and vegetable concentrates and extracts for making beverages, non-alcoholic soft drinks; energy drinks; protein-enriched sports beverages.

(260) AM 2024 122681 A

(800) 1727044

(151) 2023 04 04

(891) 2023 04 04

(731) COMPAGNIE FINANCIERE ET DE
PARTICIPATIONS ROULLIER (Société
Anonyme)

27 avenue Franklin Roosevelt, F-35400
Saint-Malo, France

(540)

MPPA DUO

(591) Black, white

(511)

1 – Chemical products for use in agriculture, horticulture, forestry; manures, soil fertilizers and soil conditioners.

5 – Disinfectants; fungicides, herbicides; products for destroying vermin.

(260) AM 2024 122682 A

(800) 1727089

(151) 2023 01 24

(891) 2023 01 24

(731) Limited Liability Company "Consortium-PIQ"

Oruzheyniy pereulok, d. 25, str. 1, pomesch.

I/etazh 1/komnata 21, RU-125047 Moscow,

Russian Federation

(540)

ДИБУФЕЛОН

(591) Black, white

(531) 28.05

(511)

5 – Pharmaceutical preparations; veterinary preparations.

(260) AM 2024 122691 A

(800) 1727438

(151) 2023 01 26

(891) 2023 01 26

(731) MOPAL AKSESUAR SANAYİ DIŞ TİCARET

LİMİTED ŞİRKET

Tahtakale Mh. Hasırcılar Cd., No:23/1 Fatih,

Istanbul, Türkiye

(540)

x-level

(591) Black, white

(531) 27.05.01

(511)

9 – Apparatus for recording, transmission or reproduction of sound or images, cameras, photographic cameras, television apparatus, video recorders, CD and DVD players and recorders, MP3 players, computers, desktop computers, tablet computers, microphones, loudspeakers, earphones, telecommunications apparatus, apparatus for the reproduction of sound or images, computer peripheral devices, cell phones, mobile phones, smart phones, covers for cell phones, mobile phones, smart phones, cases for smartphones; protective films adapted for smartphones, protective films, protective cases, protective covers adapted for cell phones, mobile phones, smart phones, accessories for mobile phones, smart phones, cell phones, telephone apparatus, computer printers, scanners [data processing equipment], photocopiers, battery chargers, smartphone chargers, battery chargers for cell phones, portable charger for smart phones; magnetic and opti-

cal data carriers and computer software and programmes recorded thereto, downloadable and recordable electronic publications, encoded magnetic and optical cards; antennas, satellite antennas, amplifiers for antennas, parts of the aforementioned goods; electronic components used in the electronic parts of machines and apparatus, semi-conductors, electronic circuits, integrated circuits, chips [integrated circuits], diodes, transistors [electronic], magnetic heads for electronic apparatus, electronic locks, photocells, remote control apparatus for opening and closing doors, optical sensors; eyeglasses, sunglasses, optical lenses and cases, containers, parts and components thereof; apparatus and instruments for conducting, transforming, accumulating or controlling electricity, electric plugs, junction boxes [electricity], electric switches, circuit breakers, fuses, lighting ballasts, battery starter cables, electrical circuit boards, electric resistances, electric sockets, transformers [electricity], electrical adapters, battery chargers, electric door bells, electric and electronic cables, batteries, electric accumulators.

(260) AM 2024 122692 A

(800) 1727471

(151) 2023 03 14

(891) 2023 03 14

(731) Mikro Kapital Group S.A.

10, Rue C.M. Spoo, L-2546 Luxembourg,

Luxembourg

(540)

Mikro Kapital

(591) Black, white

(531) 26.04.04; 26.04.09; 26.04.24; 27.05.01

(511)

36 – Financial, monetary and banking services; insurance services; real estate affairs; financing and credit services in the nature of loans, credits, financial and operational leasing; crowdfunding and peer-to-peer financing; financial transaction and payment services; financial management and research; safe deposit services; financial sponsorship; insurance underwriting; actuarial services; brokerage services; financial appraisals; cheque verification.

(260) AM 2024 122694 A

(800) 1727509

(151) 2023 03 28

(891) 2023 03 28

(731) Loskutov Dmitriy Gennadyevich

Rybatskiy pr., 43, 1, 183, RU-192076

Saint-Petersburg, Russian Federation

(540)

TARKOV

(591) Black, white
 (531) 02.01.02; 02.01.16; 27.05.01; 27.05.08;
 27.05.17

(511)
 9 – Compact discs, DVDs and other digital recording media; electronic publications, downloadable; downloadable image files; downloadable music files; animated cartoons; downloadable video recordings; computer software, recorded; computer programs, recorded; computer game software, downloadable; computer software [programs]; computer operating programs, recorded; pre-recorded video films; phonograph records; magnetic data media.

25 – Bandanas [neckerchiefs]; berets; trousers; jerseys [clothing]; waistcoats; sports jerseys; hosiery; hoods [clothing]; caps being headwear; combinations [clothing]; suits; masquerade costumes; jackets [clothing]; fishing vests; sports singlets; footwear; clothing; paper clothing; outerclothing; ready-made clothing; uniforms; overcoats; parkas; gloves [clothing]; fingerless gloves; headbands [clothing]; belts [clothing]; shirts; sweaters; knitwear [clothing]; headwear; tee-shirts; paper hats [clothing]; scarves; leisure suits; casual wear; ready-made linings [parts of clothing].

41 – Electronic desktop publishing; film directing, other than advertising films; rental of films and videos; providing films, not downloadable, via video-on-demand services; recording, production and distribution of films, video and audio recordings, radio and television programs; recording studio and film studio services for the production of multimedia presentations; providing online electronic publications, not downloadable; film production, other than advertising films; game services provided online from a computer network.

(260) AM 2024 122695 A

(800) 1727536

(151) 2022 10 05

(891) 2022 10 05

(731) Euro Games Technology Ltd.

4, "Maritsa" Str., "Vranya-Lozen-Triugulnika",
 BG-1151 Sofia, Bulgaria

(540)

2G SUPER 7 FLAME

(591) Yellow, orange, red, blue, light blue, black and white

(531) 26.11.13; 27.05.02; 27.07.02; 29.01.14

(511)

9 – Operating computer software for main frame computers; monitors (computer hardware); computer hardware; apparatus for recording images; monitors (computer programs); computer game programs; recorded computer game programs; apparatus for recording, transmission or reproduction of sound or images; communications servers (computer hardware); el-

ectronic components for gambling machines; computer application software featuring games and gaming; computer software for the administration of on-line games and gaming; computer hardware for games and gaming; hardware and software for gambling, gambling machines, gambling games on the Internet and via telecommunication network; computer systems; computer operating system software; computer terminals; interactive terminals; multimedia terminals; electronic terminals for generating lottery tickets; interactive touch screen terminals; computer touchscreens; electronic display panels; liquid crystal display screens; digital signage display panels; multimedia software; multimedia apparatus and instruments; interactive multimedia software for playing games; computer screens; LCD large-screen displays; liquid crystal displays [LCDs] for home theatres; media streaming software; computer application software for streaming audio-visual media content via the Internet; software; computer gaming software; computer software packages; computer operating system software; computer software, recorded; software drivers; virtual reality software; games software; entertainment software for computer games; computer programs for network management; electronic lottery tickets; computer software platforms; operating systems; interactive computer systems; operating system programs; computer game software for use with on-line interactive games; interactive casino games provided through a computer or mobile platform; software for slot machines, betting software, software for video slot games, for casino games, for gambling and bingo games, provided online or through computer networks and that can be played on any type of computer device, including arcade games, personal computers, portable devices and mobile phones.

28 – Gaming machines for gambling; chips for gambling; mah-jong; arcade games; gambling machines operating with coins, notes and cards; games; electronic games; parlor games; gaming chips; gaming tables; slot machines [gaming machines]; LCD game machines; slot machines and gaming devices; coin-operated amusement machines; roulette chips; poker chips; chips and dice [gaming equipment]; gaming equipment for casinos; roulette tables; gaming roulette wheels; casino games; gambling machines and amusement machines, automatic and coin-operated; coin-operated amusement machines and/or electronic coin-operated amusement machines with or without the possibility of gain; boxes for coin-operated amusement machines, slot machines and gaming machines; electronic or electrotechnical amusement machines and apparatus, gaming machines, coin-operated entertainment machines; housings for coin-operated amusement machines, gaming equipment, gaming machines, machines for gambling; electropneumatic and electrical gambling machines (slot machines); lottery games; electronic targets for games and sports.

41 – Gambling services; gaming services for entertainment purposes; casino, gaming and gambling services; training in the development of software systems; provision of gaming equipment for gambling halls; providing casino equipment [gambling]; gaming machine entertainment services; providing casino facilities [gambling]; gaming hall services; games equipment rental; rental of gaming machines; providing amusement arcade services; rental of gaming machines with images of fruits; editing or recording of sounds and images; sound recording and video entertainment services; hire of sound reproducing apparatus; provision of gaming equipment for casinos; providing of gambling facilities; online gambling services; casino services; provision of gaming facilities and gaming hall facilities, internet casinos and online gambling services; lottery services; organization of lotteries; provision of games by means of a computer based system; online interactive entertainment; online casino services; online game services through mobile devices; providing online entertainment in the nature of game tournaments; providing on-line information in the field of computer gaming entertainment; sports betting services; online sports betting services; providing online games and games of chance; entertainment services related to gambling.

(260) AM 2024 122697 A

(800) 1727579

(151) 2023 03 08

(891) 2023 03 08

(731) Bayer Aktiengesellschaft

Kaiser-Wilhelm-Allee, 51373 Leverkusen,
Germany

(540)

ЛИНКВИТ

(591) Black, white

(531) 28.05

(511)

5 – Pharmaceutical preparations for humans including treatment of gynecological related diseases, disorders and deficiencies; pharmaceutical preparations for humans including treatment of hormone related diseases, disorders and deficiencies; pharmaceutical preparations for humans including treatment of cardiological related diseases, disorders and deficiencies; pharmaceutical preparations for humans including treatment of oncological related diseases, disorders and deficiencies; pharmaceutical preparations for humans including treatment of genetic related diseases, disorders and deficiencies.

(260) AM 2024 122698 A

(800) 1727663

(151) 2022 11 17

(891) 2022 11 17

(731) LIMITED LIABILITY COMPANY "BY
WORLD"

st. Prechistenka, 40/2, building 1, floor 2, room.
XXIV, municipal district Khamovniki ext.ter.,
RU-119034 g., Moscow, Russian Federation

(540)



(591) Black, white

(531) 24.09.03; 24.09.05; 26.13.25

(511)

3 – Abrasives; amber [perfume]; descaling preparations for household purposes; antistatic preparations for household purposes; aromatics [essential oils]; air fragrancing preparations; cake flavourings [essential oils]; flavourings for beverages [essential oils]; food flavourings [essential oils]; breath freshening sprays; canned pressurized air for cleaning and dusting purposes; balms, other than for medical purposes; lip glosses; polishing stones; abrasive paper; emery paper; polishing paper; petroleum jelly for cosmetic purposes; shoe polish; cobblers' wax; cotton wool for cosmetic purposes; sachets for perfuming linen; drying agents for dishwashing machines; adhesives for cosmetic purposes; scented water; Javelle water; lavender water; toilet water; wax for parquet floors; floor wax; non-slipping wax for floors; depilatory wax; moustache wax; tailors' wax; polish for furniture and flooring; shoemakers' wax; polishing wax; massage gels, other than for medical purposes; heliotropine; dental bleaching gels; geraniol; make-up; deodorants for pets; depilatory preparations; air fragrance reed diffusers; scented wood; perfumes; non-slipping liquids for floors; windscreen cleaning liquids; greases for cosmetic purposes; volcanic ash for cleaning; perfumery; decorative transfers for cosmetic purposes; ionone [perfumery]; shaving stones [astringents]; smoothing stones; eyebrow pencils; cosmetic pencils; silicon carbide [abrasive]; carbides of metal [abrasives]; alum stones [astringents]; tripoli stone for polishing; adhesives for affixing false eyelashes; adhesives for affixing false hair; hair conditioners; quillaia bark for washing; corundum [abrasive]; beard dyes; colorants for toilet purposes; cosmetic dyes; shoe cream; polishing creams; cosmetic creams; skin whitening creams; polishing rouge; incense; hair spray; nail varnish; hair lotions; lotions for cosmetic purposes; after-shave lotions; beauty masks; oils for perfumes and scents; oils for cosmetic purposes; oils for toilet purposes; essential oils; essential oils of cedarwood; essential oils of lemon; essential oils of citron; oils for cleaning purposes; bergamot oil; gaultheria oil; jasmine oil; lavender

oil; almond oil; rose oil; oil of turpentine for degreasing; whitening; cleaning chalk; almond milk for cosmetic purposes; cleansing milk for toilet purposes; musk [perfumery]; deodorant soap; shaving soap; soap for brightening textile; cakes of toilet soap; antiperspirant soap; soap for foot perspiration; soap; almond soap; mint for perfumery; cosmetic kits; emery; nail art stickers; false nails; eau de Cologne; joss sticks; pastes for razor strops; pumice stone; lipstick cases; hydrogen peroxide for cosmetic purposes; breath freshening strips; teeth whitening strips; sandcloth; glass cloth [abrasive cloth]; lipsticks; pomades for cosmetic purposes; shaving preparations; cosmetic preparations for baths; bath preparations, not for medical purposes; hair straightening preparations; hair waving preparations; laundry soaking preparations; grinding preparations; smoothing preparations [starching]; colour-removing preparations; leather bleaching preparations; polishing preparations; denture polishes; mouthwashes, not for medical purposes; cosmetic preparations for slimming purposes; eye-washes, not for medical purposes; fabric softeners for laundry use; preparations for washing; dry-cleaning preparations; paint stripping preparations; lacquer-removing preparations; make-up removing preparations; floor wax removers [scouring preparations]; varnish-removing preparations; rust removing preparations; nail care preparations; cleaning preparations; preparations for cleaning dentures; wallpaper cleaning preparations; preparations for unblocking drain pipes; chemical cleaning preparations for household purposes; collagen preparations for cosmetic purposes; bleaching preparations [decolorants] for household purposes; aloe vera preparations for cosmetic purposes; sunscreen preparations; colour-brightening chemicals for household purposes [laundry]; breath freshening preparations for personal hygiene; shining preparations [polish]; make-up powder; diamantine [abrasive]; stain removers; nail varnish removers; vaginal washes for personal sanitary or deodorant purposes; scouring solutions; false eyelashes; tissues impregnated with cosmetic lotions; tissues impregnated with make-up removing preparations; saffrol; massage candles for cosmetic purposes; laundry blueing; turpentine for degreasing; potpourris [fragrances]; bleaching soda; washing soda, for cleaning; bath salts, not for medical purposes; bleaching salts; fumigation preparations [perfumes]; leather preservatives [polishes]; ammonia [volatile alkali] [detergent]; astringents for cosmetic purposes; eyebrow cosmetics; make-up preparations; sun-tanning preparations [cosmetics]; hair dyes; neutralizers for permanent waving; cosmetic preparations for eyelashes; cosmetic preparations for skin care; shoe wax; cosmetics; cosmetics for children; cosmetics for animals; mascara; cleansers for intimate personal hygiene purposes, non medicated; douching preparations for personal sanitary or deodorant purposes [toiletries]; detergents, other than for use in manufacturing operations and for medical purposes; degreasers, other than for use in manufactu-

ring processes; bleaching preparations [decolorants] for cosmetic purposes; antiperspirants [toiletries]; toiletry preparations; phytocosmetic preparations; talcum powder, for toilet use; cotton swabs for cosmetic purposes; terpenes [essential oils]; emery cloth; cloths impregnated with a detergent for cleaning; henna [cosmetic dye]; shampoos for animals [non-medicated grooming preparations]; shampoos for pets [non-medicated grooming preparations]; dry shampoos; shampoos; sandpaper; soda lye; herbal extracts for cosmetic purposes; extracts of flowers [perfumes]; ethereal essences; badian essence; mint essence [essential oil]; creams for leather; deodorants for human beings or for animals; dentifrices; toothpaste; laundry glaze; laundry bleach; preparations to make the leaves of plants shiny; starch for laundry purposes; starch glaze for laundry purposes.

4 – Anthracite; benzine; biomass fuel; wood briquettes; combustible briquettes; petroleum jelly for industrial purposes; wax [raw material]; ozokerite; wax for lighting; industrial wax; belting wax; carnauba wax; beeswax; beeswax for use in the manufacture of cosmetics; gas for lighting; oil-gas; fuel gas; producer gas; solidified gases [fuel]; fuel; lubricating graphite; additives, non-chemical, to motor fuel; firewood; paper spills for lighting fires; cutting fluids; fish oil, not edible; greases for the preservation of leather; oils for lighting; grease for leather; grease for footwear; tallow; industrial grease; kerosene; coke; lanolin for use in the manufacture of cosmetics; ligroin; wood spills for lighting fires; wax for skis; mazut; fuel oil; oils for the preservation of leather; oils for paints; oils for releasing form work [building]; oils for the preservation of masonry; textile oil; lubricating oil; industrial oil; moistening oil; coal tar oil; coal naphtha; castor oil for industrial purposes; bone oil for industrial purposes; motor oil; sunflower oil for industrial purposes; rape oil for industrial purposes; lubricants; naphtha; petroleum, raw or refined; nightlights [candles]; oleine; paraffin; dust removing preparations; soya bean oil preparations for non-stick treatment of cooking utensils; non-slipping preparations for belts; coal dust [fuel]; firelighters; perfumed candles; Christmas tree candles; candles; grease for arms [weapons]; lubricating grease; grease for belts; vaporized fuel mixtures; dust absorbing compositions; dust binding compositions for sweeping; dust laying compositions; alcohol [fuel]; stearine; benzene fuel; diesel oil; lighting fuel; xylene fuel; mineral fuel; carburants; fuel with an alcohol base; petrol; peat [fuel]; peat briquettes [fuel]; tinder; lignite; charcoal [fuel]; coal; coal briquettes; lamp wicks; wicks for candles; ceresine; electrical energy; ethanol [fuel]; petroleum ether; wool grease; methylated spirit.

5 – Acaricides; aconitine; alkaloids for medical purposes; alginates for pharmaceutical purposes; algicides; aldehydes for pharmaceutical purposes; dental amalgams of gold; dental amalgams; amino acids for

veterinary purposes; amino acids for medical purposes; analgesics; anaesthetics; antibiotics; antiseptics; medicine cases, portable, filled; first-aid boxes, filled; aluminium acetate for pharmaceutical purposes; acetates for pharmaceutical purposes; germicides; balms for medical purposes; bandages for dressings; diagnostic biomarker reagents for medical purposes; biocides; bromine for pharmaceutical purposes; paper for mustard plasters; fly catching paper; reagent paper for veterinary purposes; reagent paper for medical purposes; mothproofing paper; petroleum jelly for medical purposes; vaccines; oxygen baths; antiseptic cotton; aseptic cotton; absorbent cotton; wadding for medical purposes; cotton for medical purposes; dietetic substances adapted for medical use; radiological contrast substances for medical purposes; nutritive substances for microorganisms; radioactive substances for medical purposes; bismuth subnitrate for pharmaceutical purposes; melissa water for pharmaceutical purposes; seawater for medicinal bathing; mineral waters for medical purposes; thermal water; dietary fibre; moulding wax for dentists; gases for medical purposes; guaiacol for pharmaceutical purposes; sexual stimulant gels; haematogen; haemoglobin; hydrastine; hydrastinine; glycerine for medical purposes; glycerophosphates; glucose for medical purposes; gentian for pharmaceutical purposes; hormones for medical purposes; mustard for pharmaceutical purposes; mustard plasters; mud for baths; medicinal mud; gamboge for medical purposes; gurjun balsam for medical purposes; air deodorizing preparations; deodorants, other than for human beings or for animals; diastase for medical purposes; digitalin; vitamin supplement patches; mineral dietary supplements; dietary supplements; albumin dietary supplements; dietary supplements for animals; yeast dietary supplements; alginate dietary supplements; glucose dietary supplements; casein dietary supplements; lecithin dietary supplements; linseed oil dietary supplements; propolis dietary supplements; protein dietary supplements; protein supplements for animals; royal jelly dietary supplements; pollen dietary supplements; wheat germ dietary supplements; linseed dietary supplements; dietary supplements with a cosmetic effect; enzyme dietary supplements; yeast for pharmaceutical purposes; gelatine for medical purposes; cod liver oil; isotopes for medical purposes; immunostimulants; insecticides; iodine for pharmaceutical purposes; iodides for pharmaceutical purposes; alkaline iodides for pharmaceutical purposes; iodoform; calomel [fungicide]; cream of tartar for pharmaceutical purposes; tartar for pharmaceutical purposes; camphor for medical purposes; capsules for medicines; cachets for pharmaceutical purposes; haemostatic pencils; wart pencils; caustic pencils; carbolineum [parasiticide]; caustics for pharmaceutical purposes; cachou for pharmaceutical purposes; quassia for medical purposes; quebracho for medical purposes; oxygen for medical purposes; gallic acid for pharmaceutical purposes; acids for pharmaceutical

purposes; adhesives for dentures; surgical glues; stem cells for veterinary purposes; stem cells for medical purposes; cocaine for medical purposes; collagen for medical purposes; collodion for pharmaceutical purposes; corn rings for the feet; medicated sweets; angostura bark for medical purposes; barks for pharmaceutical purposes; cedar wood for use as an insect repellent; condurango bark for medical purposes; croton bark; mangrove bark for pharmaceutical purposes; myrobalan bark for pharmaceutical purposes; quinquina for medical purposes; medicated animal feed; medicinal roots; rhubarb roots for pharmaceutical purposes; lint for medical purposes; starch for dietetic or pharmaceutical purposes; creosote for pharmaceutical purposes; blood for medical purposes; cultures of microorganisms for medical or veterinary use; curare; dental lacquer; liquorice for pharmaceutical purposes; milk sugar for pharmaceutical purposes; candy for medical purposes; adhesive plasters; medicines for alleviating constipation; adhesive tapes for medical purposes; lecithin for medical purposes; lotions for veterinary purposes; medicated hair lotions; lotions for pharmaceutical purposes; medicated after-shave lotions; personal sexual lubricants; lupulin for pharmaceutical purposes; magnesia for pharmaceutical purposes; liniments; ointments for pharmaceutical purposes; sunburn ointments; mercurial ointments; frostbite salve for pharmaceutical purposes; gauze for dressings; medicinal oils; mustard oil for medical purposes; camphor oil for medical purposes; castor oil for medical purposes; oil of turpentine for pharmaceutical purposes; dill oil for medical purposes; dental mastics; dental abrasives; dental impression materials; teeth filling material; dressings, medical; surgical dressings; drugs for medical purposes; medicines for veterinary purposes; serotherapeutic medicines; medicines for human purposes; medicines for dental purposes; menthol; medicinal drinks; moleskin for medical purposes; almond milk for pharmaceutical purposes; powdered milk for babies; royal jelly for pharmaceutical purposes; milk ferments for pharmaceutical purposes; Irish moss for medical purposes; flour for pharmaceutical purposes; linseed meal for pharmaceutical purposes; fish meal for pharmaceutical purposes; fly glue; antibacterial soap; disinfectant soap; medicated soap; freeze-dried meat adapted for medical purposes; mint for pharmaceutical purposes; dietetic beverages adapted for medical purposes; malted milk beverages for medical purposes; narcotics; medicinal infusions; tincture of iodine; eucalyptol for pharmaceutical purposes; tinctures for medical purposes; opium; opodeldoc; decoctions for pharmaceutical purposes; antiparasitic collars for animals; stick liquorice for pharmaceutical purposes; sulfur sticks [disinfectants]; pastilles for pharmaceutical purposes; medicated toothpaste; pectin for pharmaceutical purposes; pepsins for pharmaceutical purposes; peptones for pharmaceutical purposes; hydrogen peroxide for medical purposes; pesticides; food for babies; leeches for medical purpo-

ses; blood plasma; nicotine patches for use as aids to stop smoking; eyepatches for medical purposes; poultices; compresses; scapulars for surgical purposes; babies' diapers; diapers for pets; diapers for incontinence; bunion pads; breast-nursing pads; pomades for medical purposes; powder of cantharides; pyrethrum powder; anti-uric preparations; bacterial preparations for medical and veterinary use; bacteriological preparations for medical and veterinary use; balsamic preparations for medical purposes; albuminous preparations for medical purposes; biological preparations for veterinary purposes; biological preparations for medical purposes; veterinary preparations; bismuth preparations for pharmaceutical purposes; vitamin preparations; diagnostic preparations for veterinary purposes; diagnostic preparations for medical purposes; bath preparations for medical purposes; therapeutic preparations for the bath; haemorrhoid preparations; preparations for callouses; lice treatment preparations [pediculicides]; acne treatment preparations; preparations to facilitate teething; preparations for the treatment of burns; fumigation preparations for medical purposes; opotherapy preparations; air purifying preparations; bronchodilating preparations; preparations for reducing sexual activity; sterilizing preparations; soil-sterilizing preparations; corn remedies; pharmaceutical preparations for treating dandruff; preparations for destroying noxious animals; herbicides; preparations for destroying dry rot fungus; larvae exterminating preparations; fly destroying preparations; preparations for destroying mice; slug exterminating preparations; preparations for destroying parasites; pharmaceutical preparations for skin care; contact lens cleaning preparations; preparations of microorganisms for medical or veterinary use; lime-based pharmaceutical preparations; styptic preparations; medicated eye-washes; medicinal hair growth preparations; nutraceutical preparations for therapeutic or medical purposes; opiates; anticryptogamic preparations; aloe vera preparations for pharmaceutical purposes; preparations of trace elements for human and animal use; sulfonamides [medicines]; pharmaceutical preparations; pharmaceutical preparations for treating sunburn; enzyme preparations for veterinary purposes; enzyme preparations for medical purposes; phytotherapy preparations for medical purposes; chemico-pharmaceutical preparations; chemical preparations for veterinary purposes; chemical preparations for the diagnosis of pregnancy; chemical preparations for medical purposes; chemical preparations for treating wheat blight; chemical preparations for treating diseases affecting vine plants; chemical preparations for treating mildew; chemical preparations for treating phylloxera; chemical preparations for pharmaceutical purposes; chill-lain preparations; mothproofing preparations; collyrium; lead water; chemical conductors for electrocardiograph electrodes; albuminous foodstuffs for medical purposes; dietetic foods adapted for medical purposes; by-products of the processing of cereals for

dietetic or medical purposes; homogenized food adapted for medical purposes; freeze-dried food adapted for medical purposes; pharmaceuticals; sanitary towels; panty liners [sanitary]; propolis for pharmaceutical purposes; pearl powder for medical purposes; radium for medical purposes; hydrated chloral for pharmaceutical purposes; solvents for removing adhesive plasters; vaginal washes for medical purposes; solutions for contact lenses; chemical reagents for medical or veterinary purposes; gum for medical purposes; rubber for dental purposes; chewing gum for medical purposes; nicotine gum for use as an aid to stop smoking; insect repellents; insect repellent incense; repellents for dogs; tissues impregnated with pharmaceutical lotions; sarsaparilla for medical purposes; sugar for medical purposes; asthmatic tea; fumigating sticks; massage candles for therapeutic purposes; suppositories; linseed for pharmaceutical purposes; tobacco-free cigarettes for medical purposes; siccatives [drying agents] for medical purposes; syrups for pharmaceutical purposes; turpentine for pharmaceutical purposes; greases for veterinary purposes; greases for medical purposes; lacteal flour for babies; infant formula; soporifics; bicarbonate of soda for pharmaceutical purposes; bath salts for medical purposes; salts for mineral water baths; salts for medical purposes; potassium salts for medical purposes; sodium salts for medical purposes; smelling salts; mineral water salts; malt for pharmaceutical purposes; semen for artificial insemination; alcohol for pharmaceutical purposes; medicinal alcohol; alloys of precious metals for dental purposes; ergot for pharmaceutical purposes; cooling sprays for medical purposes; antibacterial handwashes; adjuvants for medical purposes; astringents for medical purposes; vermifuges; disinfectants for hygiene purposes; disinfectants for chemical toilets; appetite suppressants for medical purposes; medical preparations for slimming purposes; parasiticides; mouthwashes for medical purposes; febrifuges; depuratives; animal washes [insecticides]; detergents for medical purposes; cattle washes [insecticides]; dog washes [insecticides]; insecticidal veterinary washes; vesicants; purgatives; remedies for perspiration; remedies for foot perspiration; chemical contraceptives; antiparasitic preparations; laxatives; tonics [medicines]; medicated toiletry preparations; digestives for pharmaceutical purposes; nervines; bouillons for bacteriological cultures; steroids; strychnine; serums; tanning pills; appetite suppressant pills; slimming pills; antioxidant pills; sanitary tampons; vulnerary sponges; thymol for pharmaceutical purposes; smoking herbs for medical purposes; medicinal herbs; transplants [living tissues]; surgical implants comprised of living tissues; pants, absorbent, for incontinence; sanitary panties; babies' diaper-pants; charcoal for pharmaceutical purposes; porcelain for dental prostheses; phenol for pharmaceutical purposes; enzymes for veterinary purposes; enzymes for medical purposes; ferments for pharmaceutical purposes; formic aldehyde for pharmaceutical

purposes; phosphates for pharmaceutical purposes; fungicides; quinine for medical purposes; chinoline for medical purposes; diabetic bread adapted for medical use; chloroform; flowers of sulfur for pharmaceutical purposes; cement for animal hooves; bone cement for surgical and orthopaedic purposes; dental cements; medicinal tea; herbal teas for medicinal purposes; insecticidal animal shampoos; medicated shampoos; medicated shampoos for pets; pediculicidal shampoos; medicated dry shampoos; pre-filled syringes for medical purposes; eucalyptus for pharmaceutical purposes; herbal extracts for medical purposes; plant extracts for pharmaceutical purposes; tobacco extracts [insecticides]; extracts of hops for pharmaceutical purposes; elixirs [pharmaceutical preparations]; ethers for pharmaceutical purposes; esters for pharmaceutical purposes; cellulose esters for pharmaceutical purposes; rat poison; poisons; bacterial poisons; jalap; disinfectants; all-purpose disinfectants; deodorants for clothing and textiles; acai powder dietetic supplements; cotton swabs for medical purposes; cotton wool swabs for medical purposes; milking grease; douching preparations for medical purposes; sedatives; jujube, medicated; biological tissue cultures for veterinary purposes; biological tissue cultures for medical purposes; fennel for medical purposes; cellulose ethers for pharmaceutical purposes.

7 – 3D printers; vending machines; welding machines, electric; soldering apparatus, gas-operated; vulcanization apparatus; acetylene cleaning apparatus; high pressure washers; apparatus for drawing up beer under pressure; apparatus for aerating water; apparatus for aerating beverages; electrical apparatus for sealing plastics [packaging]; electric arc cutting apparatus; electric arc welding apparatus; electric welding apparatus; inking apparatus for printing machines; electric welding machines; fittings for engine boilers; expansion tanks [parts of machines]; drums [parts of machines]; reels, mechanical, for flexible hoses; brake shoes, other than for vehicles; concrete mixers [machines]; bobbins for weaving looms; harrows; journal boxes [parts of machines]; bulldozers; hoppers [mechanical discharging]; mine borers; railway wagon lifts; rolling mill cylinders; crank shafts; printing rollers for machines; camshafts for vehicle engines; transmission shafts, other than for land vehicles; fans for motors and engines; saw benches [parts of machines]; winnowers; vibrators [machines] for industrial use; bearings [parts of machines]; bellows [parts of machines]; agitators; drilling rigs, floating or non-floating; lawnmowers [machines]; card clothing [parts of carding machines]; nail extractors, electric; emergency power generators; alternators; dynamos; bicycle dynamos; current generators; electricity generators; hydraulic controls for machines, motors and engines; mufflers for motors and engines; drilling heads [parts of machines]; drilling bits [parts of machines]; cylinder heads for engines; soldering blow pipes, gas-operated; gas-operated blow torches; raking machines; stalk separa-

tors [machines]; sieves [machines or parts of machines]; mud catchers and collectors [machines]; tarring machines; rubber tracks being parts of crawlers on mining machines; rubber tracks being parts of crawlers on snow ploughs; rubber tracks being parts of crawlers on loading-unloading machines and apparatus; rubber tracks being parts of crawlers on agricultural machines; rubber tracks being parts of crawlers on construction machines; hydraulic engines and motors; aeronautical engines; aeroplane engines; engines for air cushion vehicles; compressed air engines; jet engines, other than for land vehicles; engines for boats; driving motors, other than for land vehicles; motors, other than for land vehicles; propulsion mechanisms, other than for land vehicles; disintegrators; tympan [parts of printing presses]; holding devices for machine tools; turf removing ploughs; chisels for machines; jacks [machines]; rack and pinion jacks; moving walkways; electric hand drills; crushers for kitchen use, electric; flues for engine boilers; reapers; reapers and binders; millstones; rakes for raking machines; shredders [machines] for industrial use; kitchen grinders, electric; injectors for engines; incubators for eggs; cutting tools being parts of machines; hand-held tools, other than hand-operated; agricultural implements, other than hand-operated; air condensers; control cables for machines, engines or motors; capstans; calenders; rotary steam presses, portable, for fabrics; ditchers [ploughs]; carburetters; sliders for knitting machines; crankcases for machines, motors and engines; steam-rollers; pressure valves [parts of machines]; clack valves [parts of machines]; pressure reducers [parts of machines]; tin openers, electric; cowlings [parts of machines]; machine wheels; freewheels, other than for land vehicles; scale collectors for machine boilers; lasts for shoes [parts of machines]; brake pads, other than for vehicles; piston segments; grease rings [parts of machines]; reapers and threshers; coal-cutting machines; compressors [machines]; air pumps [garage installations]; compressors for refrigerators; conveyors [machines]; belt conveyors; converters for steelworks; steam condensers [parts of machines]; aero-condensers; diggers [machines]; rams [machines]; thermic lances [machines]; boxes for matrices [printing]; gear boxes, other than for land vehicles; grease boxes [parts of machines]; housings [parts of machines]; harvesting machines; steam engine boilers; coffee grinders, other than hand-operated; taps [parts of machines, engines or motors]; cranes [lifting and hoisting apparatus]; roller bridges; water separators; spray guns for paint; cranks [parts of machines]; potters' wheels; cultivators [machines]; soldering lamps; winches; ploughshares; belts for conveyors; igniting magnetos; handling machines, automatic [manipulators]; churns; matrices for use in printing; machine fly-wheels; shearing machines for animals; paper mill machines; blowing machines; knitting machines; galvanizing machines; bending machines; ironing machines; mineworking machines; blowing machines for

the compression, exhaustion and transport of gases; blowing machines for the compression, sucking and carrying of grain; net hauling machines [fishing]; electroplating machines; bottle sealing machines; sealing machines for industrial purposes; engraving machines; crushing machines; waste disposal units; earth moving machines; cord making machines; lace making machines; butter machines; cigarette machines for industrial purposes; sausage making machines; stereotype machines; hosiery looms; grinding machines; dyeing machines; bottle washing machines; dishwashers; bottle filling machines; racket stringing machines; leather-working machines; dairy machines; glass-working machines; tobacco processing machines; grain husking machines; painting machines; oil refining machines; peeling machines; machines for processing plastics; printing machines for use on sheet metal; brewing machines; whitewashing machines; road sweeping machines, self-propelled; bitumen making machines; papermaking machines; pasta making machines; machines for the production of sugar; weeding machines; sifting machines; puddling machines; notchers [machine tools]; bread cutting machines; road making machines; railroad constructing machines; rammers [machines]; rail-laying machines; bottle capping machines; bottle stoppering machines; packaging machines; waste compacting machines; die-stamping machines; stamping machines; darning machines; drainage machines; wrapping machines; grain separators; bookbinding apparatus and machines for industrial purposes; machines and apparatus for cleaning, electric; machines and apparatus for carpet shampooing, electric; machines and apparatus for polishing [electric]; size adjustment cutting machines for industrial purposes; punching machines; riveting machines; kitchen machines, electric; foundry machines; smoothing presses; fleshing machines; washing machines; flour mill machines; type-setting machines [printing]; hemming machines; grating machines for vegetables; braiding machines; wringing machines for laundry; cutting machines; steam engines; printing machines; rotary printing presses; compressed air machines; tilling machines for agricultural purposes; trimming machines; spinning machines; filling machines; friezing machines; cutters [machines]; satinizing machines; agricultural machines; mixing machines; sorting machines for industry; stitching machines; washing machines [laundry]; coin-operated washing machines; clippers [machines]; spinning frames; spin dryers [not heated]; looms; kneading machines; typographic machines; type-setting machines [photocomposition]; beating machines; beaters, electric; packing machines; filtering machines; moulding machines; carding machines; sewing machines; typecasting machines; electromechanical machines for chemical industry; labelers [machines]; mills [machines]; mills for household purposes, other than hand-operated; pepper mills, other than hand-operated; centrifugal mills; machine wheelwork; feeders [parts of machines]; forge blo-

wers; mixers [machines]; blenders, electric, for household purposes; vacuum cleaner bags; threshing machines; pneumatic hammers; hammers [parts of machines]; tilt hammers; power hammers; reeling apparatus, mechanical; motorized cultivators; motors for boats; clutches, other than for land vehicles; meat cutters [machines]; superchargers; brake linings, other than for vehicles; guides for machines; suction nozzles for vacuum cleaners; vacuum cleaner attachments for disseminating perfumes and disinfectants; pumps [machines]; pumps [parts of machines, engines or motors]; aerating pumps for aquaria; vacuum pumps [machines]; compressed air pumps; pumps for heating installations; beer pumps; pumps for counter-current swimming; lubricating pumps; self-regulating fuel pumps; fuel dispensing pumps for service stations; centrifugal pumps; knives [parts of machines]; knives for mowing machines; chaff cutter blades; knives, electric; shears, electric; scissors, electric; vegetable spiralizers, electric; engine mounts, other than for land vehicles; bearing brackets for machines; pulverizers [machines]; axles for machines; steam traps; chucks [parts of machines]; drill chucks [parts of machines]; exhaust manifold for engines; soldering irons, gas-operated; soldering irons, electric; superheaters; gears, other than for land vehicles; reduction gears, other than for land vehicles; drilling machines; saws [machines]; chain saws; guns [tools using explosive cartridges]; glue guns, electric; compressed air guns for the extrusion of mastics; carburetter feeders; feeding apparatus for engine boilers; loading ramps; ploughs; pneumatic transporters; pneumatic controls for machines, motors and engines; hangers [parts of machines]; anti-friction bearings for machines; roller bearings; self-oiling bearings; bearings for transmission shafts; ball-bearings; elevators [lifts]; hoists; lifts, other than ski-lifts; pulleys; saw blades [parts of machines]; pistons [parts of machines or engines]; shock absorber plungers [parts of machines]; pistons for engines; pistons for cylinders; catalytic converters; torque converters, other than for land vehicles; fuel conversion apparatus for internal combustion engines; presses [machines for industrial purposes]; wine presses; basket presses; fruit presses, electric, for household purposes; fodder presses; printing presses; typographic presses; swaging machines; pedal drives for sewing machines; cleaning appliances utilizing steam; food processors, electric; springs [parts of machines]; spinning wheels; punches for punching machines; vacuum cleaners; tambours for embroidery machines; radiators [cooling] for motors and engines; sewage pulverizers; air brushes for applying colour; regulators [parts of machines]; pressure regulators [parts of machines]; speed governors for machines, engines and motors; knives being parts of machines; cutting blow pipes, gas-operated; blade holders [parts of machines]; loom shafts; gears for weaving looms; belts for machines; elevator belts; fan belts for motors and engines; dynamo belts; belts for motors and engines; ad-

hesive bands for pulleys; industrial robots; 3D printing pens; kick starters for motorcycles; joysticks being parts of machines, other than for game machines; stuffing boxes [parts of machines]; paper feeders [printing]; whisks, electric, for household purposes; sparking plugs for internal combustion engines; glow plugs for Diesel engines; brake segments, other than for vehicles; tedding machines; steam/oil separators; cream/milk separators; ball rings for bearings; sowers [machines]; pigs for cleaning pipes; snow ploughs; sheaf-binding machines; shaft couplings [machines]; juice extractors, electric; straw [chaff] cutters; suction cups for milking machines; stands for machines; machine tools; die-cutting and tapping machines; wood-working machines; sharpening machines; bicycle assembling machines; mortising machines; stone-working machines; metalworking machines; threading machines; planing machines; lathes [machine tools]; milling machines; metal drawing machines; rolling mills; starters for motors and engines; stators [parts of machines]; glaziers' diamonds [parts of machines]; tables for machines; derricks; slide rests [parts of machines]; couplings, other than for land vehicles; heat exchangers [parts of machines]; transmissions for machines; transmission mechanisms, other than for land vehicles; boiler tubes [parts of machines]; wind turbines; hydraulic turbines; turbines, other than for land vehicles; turbocompressors; connecting rods for engines; central vacuum cleaning installations; suction machines for industrial purposes; washing installations for vehicles; degreasers [machines]; dust exhausting installations for cleaning purposes; machines for the mineralization of drinking water; sifting installations; pneumatic tube conveyors; dust removing installations for cleaning purposes; condensing installations; pneumatic waste oil drainers; lifting apparatus; air suction machines; dividing machines; igniting devices for internal combustion engines; door closers, hydraulic; door closers, pneumatic; door closers, electric; window closers, pneumatic; washing apparatus; binding apparatus for hay; haulage apparatus [mining]; door openers, hydraulic; door openers, pneumatic; door openers, electric; curtain drawing devices, electrically operated; adhesive tape dispensers [machines]; anti-pollution devices for motors and engines; beverage preparation machines, electromechanical; food preparation machines, electromechanical; elevator operating apparatus; control mechanisms for machines, engines or motors; shoe polishers, electric; machines and apparatus for wax-polishing, electric; air cushion devices for moving loads; handling apparatus for loading and unloading; elevating apparatus; aprons [parts of machines]; filter presses; filters [parts of machines or engines]; filters for cleaning cooling air, for engines; moulds [parts of machines]; printing plates; journals [parts of machines]; centrifugal machines; elevator chains [parts of machines]; drive chains, other than for land vehicles; transmission chains, other than for land vehicles; cylinders for motors and

engines; cylinders for machines; printing cylinders; pneumatic jacks; shuttles [parts of machines]; universal joints [Cardan joints]; pulleys [parts of machines]; vacuum cleaner hoses; screwdrivers, electric; brushes [parts of machines]; dynamo brushes; brushes, electrically operated [parts of machines]; carbon brushes [electricity]; ejectors; fuel economisers for motors and engines; excavators; shovels, mechanical; agricultural elevators; motors, electric, other than for land vehicles; electrodes for welding machines; electric hammers; parquet wax-polishers, electric; cartridges for filtering machines; moving staircases [escalators]; automatic grapnels for marine purposes; reels [parts of machines]; valves [parts of machines]; water heaters being parts of machines; exhausts for motors and engines; de-aerators for feedwater; pump diaphragms; ski edge sharpening tools, electric; mechanized feeders for animals; grindstones [parts of machines]; lubricators [parts of machines]; embossing machines; finishing machines; blade sharpening [stropping] machines; ore treating machines; leather paring machines; cinder sifters [machines]; machines for the textile industry; milking machines; joints [parts of engines]; window closers, hydraulic; window closers, electric; window openers, hydraulic; window openers, pneumatic; window openers, electric; brushes for vacuum cleaners.

8 – Glaziers' diamonds [parts of hand tools]; apparatus for tattooing; razors, electric or non-electric; sharpening steels; scythe stones; gimlets [hand tools]; borers; augers [hand tools]; carpenters' augers; dibbers, hand-operated; levers; table forks; agricultural forks [hand tools]; lawn clippers [hand instruments]; harpoons; harpoons for fishing; nail extractors, hand-operated; rakes [hand tools]; sand trap rakes; cutter bars [hand tools]; whetstone holders; priming irons [hand tools]; sculptors' chisels; lifting jacks, hand-operated; truncheons; clamps for carpenters or coopers; spades [hand tools]; rabbeting planes; chisels; engraving needles; tattoo needles; cutlery; edge tools [hand tools]; garden tools, hand-operated; abrading instruments [hand instruments]; numbering punches; goffering irons; implements for decanting liquids [hand tools]; depilation appliances, electric and non-electric; sharpening instruments; blade sharpening instruments; livestock marking tools; oyster openers; polishing irons [glazing tools]; ear-piercing apparatus; tube cutting instruments; wire strippers [hand tools]; riveters [hand tools]; expanders [hand tools]; cutting tools [hand tools]; ski edge sharpening tools, hand-operated; hand tools, hand-operated; stamping-out tools [hand tools]; picks [hand tools]; sharpening stones; punch rings [knuckle dusters]; trowels; centre punches [hand tools]; daggers; pickaxes; mallets [hand instruments]; pliers; punch pliers [hand tools]; blades [weapons]; annular screw plates; spanners [hand tools]; tap wrenches; ladles [hand tools]; foundry ladles [hand tools]; breast drills; lasts [shoemakers' hand tools]; scythe rings; instruments for punching

tickets; diggers [hand tools]; rams [hand tools]; scythes; hainault scythes; fire irons; emery grinding wheels; grindstones [hand tools]; sledgehammers; thistle extractors [hand tools]; tree pruners; nail drawers [hand tools]; ice picks; blades [hand tools]; razor blades; blades for planes; plane irons; jig-saws; spoons; table knives, forks and spoons for babies; table knives, forks and spoons of plastic; crow bars; shovels [hand tools]; palette knives; machetes; beard clippers; hair clippers for personal use, electric and non-electric; hair clippers for animals [hand instruments]; taps [hand tools]; fireplace bellows [hand tools]; swords; hammers [hand tools]; fullers [hand tools]; stone hammers; masons' hammers; riveting hammers [hand tools]; mattocks; hoes [hand tools]; ditchers [hand tools]; mincing knives; manicure sets; manicure sets, electric; pedicure sets; needle files; bits [hand tools]; files [tools]; emery files; air pumps, hand-operated; hand pumps; shaving cases; cheese slicers, non-electric; fruit segmenters; egg slicers, non-electric; non-electric pizza cutters; scaling knives; hobby knives [scalpels]; fruit corers; moulding irons; ceramic knives; tin openers, non-electric; farriers' knives; budding knives; hunting knives; penknives; grafting tools [hand tools]; braiders [hand tools]; box cutters; bill-hooks; paring knives; knives; cleavers; wick trimmers [scissors]; cattle shearers; border shears; pruning shears; shearers [hand instruments]; scissors; sword scabbards; kitchen mandolines; vegetable spiralizers, hand-operated; vegetable peelers [hand tools]; agricultural implements, hand-operated; side arms, other than firearms; stropping instruments; screwdrivers, non-electric; stirring sticks for mixing paint; reamer sockets; drill holders [hand tools]; perforating tools [hand tools]; rammers [hand tools]; emery boards; nail files; nail files, electric; saws [hand tools]; bow saws; tweezers; hair-removing tweezers; guns [hand tools]; non-electric caulking guns; guns, hand-operated, for the extrusion of mastics; dies [hand tools]; fruit pickers [hand tools]; saw blades [parts of hand tools]; shear blades; tool belts [holders]; hair braiders, electric; table cutlery [knives, forks and spoons]; crimping irons; hand implements for hair curling; vegetable choppers; money scoops; instruments and tools for skinning animals; hackles [hand tools]; pin punches; nail punches; fish tapes [hand tools]; punches [hand tools]; insecticide vaporizers [hand tools]; syringes for spraying insecticides; reamers; frames for handsaws; saw holders; rasps [hand tools]; paring irons [hand tools]; graving tools [hand tools]; milling cutters [hand tools]; razor strops; leather strops; planes; scythe handles; knife handles; handles for hand-operated hand tools; marline spikes; bits [parts of hand tools]; hollowing bits [parts of hand tools]; pruning scissors; silver plate [knives, forks and spoons]; pruning knives; sickles; drawing knives; scrapers [hand tools]; scrapers for skis; mortise chisels; caulking irons; gouges [hand tools]; mortars for pounding [hand tools]; mitre boxes [hand tools]; branding irons;

hatchets; adzes [tools]; vices; bench vices [hand implements]; hoop cutters [hand tools]; axes; holing axes; fulling tools [hand tools]; earth rammers [hand tools]; tube cutters [hand tools]; squares [hand tools]; extension pieces for braces for screw taps; embossers [hand tools]; apparatus for destroying plant parasites, hand-operated; metal wire stretchers [hand tools]; metal band stretchers [hand tools]; flat irons; irons [non-electric hand tools]; razor cases; ratchets [hand tools]; scraping tools [hand tools]; awls; choppers being knives; spatulas [hand tools]; spatulas for use by artists; wine bottle foil cutters, hand-operated; bayonets; pincers; curling tongs; cuticle tweezers; eyelash curlers; pickhammers; nail clippers, electric or non-electric; nail nippers; trowels [gardening]; putty knives; shears; sabres; fingernail polishers, electric or non-electric; cutters.

9 – 3D spectacles; DVD players; ticket dispensers; juke boxes, musical; fire engines; answering machines; electrical adapters; batteries for electronic cigarettes; accumulators, electric; batteries, electric, for vehicles; accelerometers; actinometers; alidades; altimeters; ammeters; anemometers; anodes; aerials; anticathodes; apertometers [optics]; high-frequency apparatus; testing apparatus not for medical purposes; electrodynamic apparatus for the remote control of railway points; electro-dynamic apparatus for the remote control of signals; remote control apparatus; monitoring apparatus, other than for medical purposes; sound recording apparatus; Global Positioning System [GPS] apparatus; distillation apparatus for scientific purposes; diffraction apparatus [microscopy]; air analysis apparatus; apparatus to check franking; sound transmitting apparatus; fermentation apparatus for laboratory use; breathing apparatus for underwater swimming; breathing apparatus, except for artificial respiration; apparatus and installations for the production of X-rays, not for medical purposes; cash registers; electric apparatus for commutation; intercommunication apparatus; stills for laboratory experiments; projection apparatus; fire extinguishing apparatus; radiological apparatus for industrial purposes; X-ray apparatus not for medical purposes; blueprint apparatus; flashing lights [luminous signals]; stereoscopic apparatus; telephone apparatus; facsimile machines; phototelegraphy apparatus; igniting apparatus, electric, for igniting at a distance; salinometers; acidimeters for batteries; aerometers; battery jars; barometers; anode batteries; galvanic batteries; ignition batteries; solar batteries; solar panels for the production of electricity; batteries, electric; balances [steelyards]; betatrons; binoculars; biochips; electronic tags for goods; lens hoods; magnetic tape units for computers; computer memory devices; fire hose nozzles; encoded identification bracelets, magnetic; connected bracelets [measuring instruments]; safety tarpaulins; electronic key fobs being remote control apparatus; bullet-proof clothing; signalling buoys; life buoys; marking buoys; vacuum gauges; electrolysis apparatus for laboratory

use; variometers; scales; baby scales; bathroom scales; letter scales; weighbridges; precision balances; scales with body mass analysers; camcorders; video cassettes; video telephones; video screens; viewfinders, photographic; micrometer screws for optical instruments; viscosimeters; circuit closers; wavemeters; voltmeters; luminous signs; switchboxes [electricity]; current rectifiers; gas testing instruments; gasometers [measuring instruments]; galvanometers; hands-free kits for telephones; heliographic apparatus; hygrometers; hydrometers; weights; peepholes [magnifying lenses] for doors; holograms; plotters; loudspeakers; plumb bobs; range finders; densimeters; densitometers; detectors; smoke detectors; infrared detectors; counterfeit coin detectors; joysticks for use with computers, other than for video games; transparencies [photography]; slide projectors; diaphragms [photography]; dictating machines; dynamometers; light-emitting diodes [LED]; floppy disks; phonograph records; disks, magnetic; optical discs; disk drives for computers; juke boxes for computers; wearable video display monitors; electronic numeric displays; DNA chips; electronic interactive whiteboards; electronic notice boards; electric wire harnesses for automobiles; bullet-proof vests; life jackets; reflective safety vests; identification threads for electric wires; nose clips for divers and swimmers; locks, electric; bells [warning devices]; alarm bells, electric; electric door bells; signal bells; acoustic conduits; mirrors for inspecting work; road signs, luminous or mechanical; marine depth finders; probes for scientific purposes; buzzers; needles for surveying compasses; needles for record players; eyewear; reflective articles for wear, for the prevention of accidents; measures; pressure measuring apparatus; simulators for the steering and control of vehicles; inverters [electricity]; pressure indicators; temperature indicators; incubators for bacteria culture; measuring instruments; cosmographic instruments; mathematical instruments; levelling instruments; instruments containing eyepieces; surveying instruments; azimuth instruments; interfaces for computers; ionization apparatus not for the treatment of air or water; satellite finder meters; spark-guards; coaxial cables; fibre optic cables; cables, electric; calipers; slide calipers; screw-tapping gauges; calorimeters; calculating machines; pocket calculators; decompression chambers; rearview cameras for vehicles; cinematographic cameras; thermal imaging cameras; mouth guards for sports; life-saving capsules for natural disasters; electronic pens [visual display units]; holders for electric coils; identity cards, magnetic; video game cartridges; toner cartridges, unfilled, for printers and photocopiers; memory cards for video game machines; encoded magnetic cards; riding helmets; carriers for dark plates [photography]; automated teller machines [ATM]; cathodes; spools [photography]; choking coils [impedance]; coils, electric; electromagnetic coils; cinematographic film, exposed; computer keyboards; solenoid valves [electromagnetic switches];

wire connectors [electricity]; thin client computers; encoded key cards; electronic book readers; electronic agendas; push buttons for bells; magnetic encoders; visors for helmets; collectors, electric; calibrating rings; smart rings; ring sizers; protective suits for aviators; commutators; compact discs [audio-video]; compact discs [read-only memory]; comparators; marine compasses; computers; laptop computers; tablet computers; notebook computers; wearable computers; condensers [capacitors]; contacts, electric; wind socks for indicating wind direction; traffic cones; branch boxes [electricity]; distribution boxes [electricity]; junction boxes [electricity]; battery boxes; cabinets for loudspeakers; diving suits; galena crystals [detectors]; covers for electric outlets; logs [measuring instruments]; lasers, not for medical purposes; lactodensimeters; lactometers; vacuum tubes [radio]; darkroom lamps [photography]; thermionic valves; amplifying tubes; flashlights [photography]; head cleaning tapes [recording]; magnetic tapes; videotapes; surveying chains; fire escapes; rulers [measuring instruments]; square rulers for measuring; slide-rules; contact lenses; correcting lenses [optics]; optical lenses; optical condensers; sounding lines; electricity conduits; measuring spoons; magnifying glasses [optics]; thread counters; magnets; decorative magnets; crash test dummies; resuscitation mannequins [teaching apparatus]; pressure gauges; security tokens [encryption devices]; divers' masks; solderers' helmets; protective masks, not for medical purposes; respiratory masks, other than for artificial respiration; materials for electricity mains [wires, cables]; voting machines; money counting and sorting machines; material testing instruments and machines; furniture especially made for laboratories; megaphones; portable media players; diaphragms [acoustics]; diaphragms for scientific apparatus; metal detectors for industrial or military purposes; digital weather stations; metronomes; rules [measuring instruments]; carpenters' rules; dressmakers' measures; mechanisms for coin-operated apparatus; mechanisms for counter-operated apparatus; coin-operated mechanisms for television sets; shutter releases [photography]; micrometers; microprocessors; microscopes; microtomes; microphones; audio mixers; modems; lightning conductors; monitors [computer hardware]; monitors [computer programs]; selfie sticks [handheld monopods]; terminals [electricity]; junction sleeves for electric cables; teeth protectors; temperature indicator labels, not for medical purposes; knee-pads for workers; headphones; surveyors' levels; sound recording carriers; magnetic data media; optical data media; electronic sheet music, downloadable; computer software; sheaths for electric cables; identification sheaths for electric wires; weighing machines; computer hardware; punched card machines for offices; life saving equipment; objectives [lenses] [optics]; lenses for astrophotography; selfie lenses; egg-candlers; fire extinguishers; rescue laser signalling flares; electrified fences; limiters [electricity];

clothing for protection against accidents, irradiation and fire; clothing for protection against fire; asbestos clothing for protection against fire; clothing especially made for laboratories; ozonisers [ozonators]; octants; eyepieces; ohmmeters; wrist rests for use with computers; spectacle frames; oscillographs; plumb lines; mirrors [optics]; spectacles; sunglasses; goggles for sports; finger sizers; signalling panels, luminous or mechanical; radio pagers; pince-nez; electronic pocket translators; transmitters [telecommunication]; telephone transmitters; transmitters of electronic signals; switches, electric; periscopes; gloves for divers; gloves for protection against accidents; gloves for protection against X-rays for industrial purposes; asbestos gloves for protection against accidents; furnaces for laboratory use; pipettes; pyrometers; planimeters; plane tables [surveying instruments]; plates for batteries; computer software platforms, recorded or downloadable; wafers for integrated circuits; printed circuit boards; compact disc players; cassette players; sound recording strips; X-ray films, exposed; films, exposed; life-saving rafts; laboratory trays; digital signs; semiconductors; polarimeters; personal digital assistants [PDAs]; fire pumps; measuring glassware; life belts; fuses; circuit breakers; converters, electric; telerupters; food analysis apparatus; diagnostic apparatus, not for medical purposes; distance recording apparatus; distance measuring apparatus; speed measuring apparatus [photography]; appliances for measuring the thickness of leather; apparatus for measuring the thickness of skins; speed checking apparatus for vehicles; teaching apparatus; time recording apparatus; apparatus and instruments for astronomy; surveying apparatus and instruments; weighing apparatus and instruments; nautical apparatus and instruments; navigational instruments; optical apparatus and instruments; apparatus and instruments for physics; chemistry apparatus and instruments; measuring apparatus; measuring devices, electric; boiler control instruments; meteorological instruments; naval signalling apparatus; observation instruments; navigation apparatus for vehicles [on-board computers]; satellite navigational apparatus; regulating apparatus, electric; telecommunication apparatus in the form of jewellery; precision measuring apparatus; audio- and video-receivers; prisms [optics]; computer software applications, downloadable; printers for use with computers; hemline markers; retorts' stands; apparatus for changing record player needles; drainers for use in photography; cleaning apparatus for phonograph records; fire beaters; sighting telescopes for firearms; telescopic sights for artillery; test tubes; pressure indicator plugs for valves; magnetic wires; telegraph wires; telephone wires; wires, electric; conductors, electric; copper wire, insulated; fuse wire; computer programs, recorded; game programs for computers; computer programs [downloadable software]; computer operating programs, recorded; computer screen saver software, recorded or downloadable; record players; pro-

cessors [central processing units]; rods for water diviners; electronic publications, downloadable; distribution consoles [electricity]; control panels [electricity]; radar apparatus; baby monitors; masts for wireless aeri-als; transmitting sets [telecommunication]; radios; vehicle radios; sprinkler systems for fire protection; frames for photographic transparencies; screens for photoengraving; flowmeters; walkie-talkies; voltage surge protectors; voltage regulators for vehicles; stage lighting regulators; speed regulators for record players; cell switches [electricity]; washing trays [photography]; marking gauges [joinery]; T-squares for measuring; time switches, automatic; relays, electric; X-ray photographs, other than for medical purposes; rheostats; respirators for filtering air; retorts; refractometers; refractors; grids for batteries; security surveillance robots; laboratory robots; teaching robots; humanoid robots with artificial intelligence for use in scientific research; speaking tubes; horns for loudspeakers; subwoofers; saccharometers; optical fibres [light conducting filaments]; traffic-light apparatus [signalling devices]; dog whistles; signalling whistles; sports whistles; sextants; inductors [electricity]; safety nets; nets for protection against accidents; fire alarms; signals, luminous or mechanical; sirens; electronic access control systems for interlocking doors; scanners [data processing equipment]; hand-held electronic dictionaries; integrated circuit cards [smart cards]; smartglasses; smartphones; smartwatches; connections for electric lines; couplings, electric; sonars; sound locating instruments; lighting ballasts; resistances, electric; spectrograph apparatus; spectroscopes; speed indicators; alcoholmeters; satellites for scientific purposes; protection devices for personal use against accidents; audiovisual teaching apparatus; charging stations for electric vehicles; radiotelegraphy sets; radiotelephony sets; spectacle lenses; anti-glare glasses; optical glass; personal stereos; stereoscopes; stands for photographic apparatus; stroboscopes; fire boats; sulfimeters; bags adapted for laptops; drying racks [photography]; spherometers; integrated circuits; printed circuits; counters; parking meters; mileage recorders for vehicles; revolution counters; abacuses; egg timers [sandglasses]; taximeters; ear plugs for divers; tachometers; television apparatus; telegraphs [apparatus]; telescopes; teleprompters; teleprinters; cordless telephones; theodolites; interactive touch screen terminals; thermo-hygrometers; thermometers, not for medical purposes; thermostats; thermostats for vehicles; crucibles [laboratory]; tone arms for record players; totalizers; transistors [electronic]; transponders; protractors [measuring instruments]; transformers [electricity]; step-up transformers; resuscitation training simulators; vehicle breakdown warning triangles; triodes; starter cables for motors; discharge tubes, electric, other than for lighting; capillary tubes for laboratory use; neon signs; Pitot tubes; X-ray tubes not for medical purposes; telephone receivers; squares for measuring; gauges; quantity

indicators; automatic indicators of low pressure in vehicle tyres; petrol gauges; water level indicators; electric loss indicators; light-emitting electronic pointers; slope indicators; levels [instruments for determining the horizontal]; mercury levels; spirit levels; urinometers; amplifiers; particle accelerators; electric installations for the remote control of industrial operations; steering apparatus, automatic, for vehicles; balancing apparatus; video recorders; sound reproduction apparatus; invoicing machines; tape recorders; protection devices against X-rays, not for medical purposes; railway traffic safety appliances; data processing apparatus; oxygen transvasing apparatus; theft prevention installations, electric; film cutting apparatus; drying apparatus for photographic prints; optical character readers; centering apparatus for photographic transparencies; dosage dispensers; battery chargers; chargers for electric accumulators; chargers for electronic cigarettes; acoustic alarms; sounding apparatus and machines; apparatus for editing cinematographic film; cathodic anti-corrosion apparatus; couplers [data processing equipment]; anti-theft warning apparatus; computer peripheral devices; anti-interference devices [electricity]; demagnetizing apparatus for magnetic tapes; acoustic couplers; alarms; fog signals, non-explosive; whistle alarms; adding machines; readers [data processing equipment]; heat regulating apparatus; photocopiers [photographic, electrostatic, thermic]; electric and electronic effects units for musical instruments; bar code readers; downloadable image files; downloadable music files; animated cartoons; filters for respiratory masks; filters for ultraviolet rays, for photography; USB flash drives; magic lanterns; optical lanterns; signal lanterns; cameras [photography]; glazing apparatus for photographic prints; shutters [photography]; darkrooms [photography]; photometers; flash-bulbs [photography]; digital photo frames; enlarging apparatus [photography]; photovoltaic cells; containers for contact lenses; spectacle cases; containers for microscope slides; cases for smartphones; cases especially made for photographic apparatus and instruments; chromatography apparatus for laboratory use; chronographs [time recording apparatus]; laboratory centrifuges; spectacle chains; cyclotrons; compasses for measuring; frequency meters; time clocks [time recording devices]; Petri dishes; sleeves for laptops; covers for personal digital assistants [PDAs]; covers for tablet computers; fire blankets; chips [integrated circuits]; jigs [measuring instruments]; pedometers; meteorological balloons; electrified rails for mounting spot lights; asbestos screens for firemen; fire hose; virtual reality headsets; protective helmets for sports; head guards for sports; snorkels; cell phone straps; spectacle cords; tripods for cameras; switchboards; distribution boards [electricity]; equalizers [audio apparatus]; screens [photography]; workmen's protective face-shields; projection screens; radiology screens for industrial purposes; fluorescent screens; exposure meters [light meters]; ducts [electricity];

galvanic cells; downloadable graphics for mobile phones; epidiascopes; ergometers; armatures [electricity]; black boxes [data recorders]; magnetic resonance imaging [MRI] apparatus, not for medical purposes; acid hydrometers; beacons, luminous; directional compasses; verniers; levelling staffs [surveying instruments]; video baby monitors; electric plugs; electric sockets; plug connectors; electrical plugs and sockets; current plugs; mechanical signs; sounding leads; circular slide rules; audio interfaces; protective helmets; mouse pads; close-up lenses; mouse [computer peripheral]; shoes for protection against accidents, irradiation and fire; electronic collars to train animals; protective films adapted for computer screens; protective films adapted for smartphone screens; light dimmers [regulators], electric; safety restraints, other than for vehicle seats and sports equipment; mobile telephones; wearable activity trackers; downloadable ring tones for mobile phones; filters for use in photography; protective cases for smartphones.

10 – Analysers for bacterial identification for medical purposes; blood testing apparatus; testing apparatus for medical purposes; anaesthetic apparatus; galvanic therapeutic appliances; apparatus for artificial respiration; apparatus for the treatment of deafness; physical exercise apparatus for medical purposes; body rehabilitation apparatus for medical purposes; dental apparatus and instruments; surgical apparatus and instruments; resuscitation apparatus; dental apparatus, electric; physiotherapy apparatus; bed vibrators; hot air therapeutic apparatus; diagnostic apparatus for medical purposes; traction apparatus for medical purposes; radiotherapy apparatus; microdermabrasion apparatus; fumigation apparatus for medical purposes; apparatus for the regeneration of stem cells for medical purposes; apparatus for DNA and RNA testing for medical purposes; apparatus and installations for the production of X-rays, for medical purposes; magnetic resonance imaging [MRI] apparatus for medical purposes; radiological apparatus for medical purposes; X-ray apparatus for medical purposes; hearing aids; nasal aspirators; trusses; maternity belts; bandages, elastic; cupping glasses; dental burs; bracelets for medical purposes; anti-nausea wristbands; anti-rheumatism bracelets; feeding bottles; vaporizers for medical purposes; hot air vibrators for medical purposes; vibromassage apparatus; gastroscopes; haemocytometers; lice combs; surgical sponges; defibrillators; dialyzers; containers especially made for medical waste; clips, surgical; mirrors for dentists; mirrors for surgeons; probes for medical purposes; urethral probes; artificial teeth; acupuncture needles; suture needles; needles for medical purposes; orthopedic articles; biodegradable bone fixation implants; surgical implants comprised of artificial materials; inhalers; hydrogen inhalers; injectors for medical purposes; incubators for medical purposes; incubators for babies; obstetric apparatus; obstetric apparatus for cattle; electric acupuncture instruments; surgical cutlery; insufflators; endoscopy

cameras for medical purposes; cannulae; droppers for medical purposes; dropper bottles for medical purposes; heart pacemakers; tonometers; catheters; catgut; draw-sheets for sick beds; enema apparatus for medical purposes; artificial skin for surgical purposes; menstrual cups; teething rings; anti-rheumatism rings; compressors [surgical]; thermo-electric compresses [surgery]; abdominal corsets; corsets for medical purposes; crutches; dentists' armchairs; armchairs for medical or dental purposes; beds specially made for medical purposes; feeding bottle valves; love dolls [sex dolls]; lasers for medical purposes; lamps for medical purposes; quartz lamps for medical purposes; ultraviolet ray lamps for medical purposes; lancets; lenses [intraocular prostheses] for surgical implantation; spoons for administering medicine; masks for use by medical personnel; respiratory masks for artificial respiration; anaesthetic masks; suture materials; childbirth mattresses; air mattresses for medical purposes; air beds for medical purposes; waterbeds for medical purposes; furniture especially made for medical purposes; water bags for medical purposes; douche bags; breast pumps; body fat monitors; body composition monitors; urinals being vessels; portable hand-held urinals; teeth protectors for dental purposes; temperature indicator labels for medical purposes; knee bandages, orthopaedic; tips for crutches; fingerstalls for medical purposes; medical guidewires; pumps for medical purposes; thread, surgical; knives for surgical purposes; scissors for surgery; ambulance stretchers; stretchers, wheeled; boots for medical purposes; orthopaedic footwear; clothing especially for operating rooms; compression garments; blankets, electric, for medical purposes; supports for flat feet; keratometers; ophthalmoscopes; cooling pads for first aid purposes; slings [support bandages]; gloves for massage; gloves for medical purposes; pessaries; saws for surgical purposes; ear picks; cooling patches for medical purposes; spittoons for medical purposes; plaster bandages for orthopaedic purposes; orthopaedic bandages for joints; support bandages; abdominal pads; cushions for medical purposes; pads for preventing pressure sores on patient bodies; air pillows for medical purposes; soporific pillows for insomnia; heating cushions, electric, for medical purposes; abdominal belts; galvanic belts for medical purposes; hypogastric belts; belts for medical purposes; orthopaedic belts; umbilical belts; belts, electric, for medical purposes; condoms; aerosol dispensers for medical purposes; sphygmotensimeters; pulse meters; esthetic massage apparatus; massage apparatus; veterinary apparatus and instruments; medical apparatus and instruments; urological apparatus and instruments; orthodontic appliances; brushes for cleaning body cavities; patient hoists; appliances for washing body cavities; corn knives; incontinence sheets; sterile sheets, surgical; surgical drapes; artificial eyes; artificial breasts; dentures; artificial limbs; artificial jaws; ice bags for medical purposes; toe separators for orthopaedic purposes; surgical bougies;

orthodontic rubber bands; X-ray photographs for medical purposes; respirators for artificial respiration; surgical robots; strait jackets; sex toys; scalpels; tongue scrapers; dummies for babies; feeding bottle teats; baby feeding dummies; receptacles for applying medicines; spirometers [medical apparatus]; vaginal syringes; implantable subcutaneous drug delivery devices; hearing protectors; contraceptives, non-chemical; orthopaedic soles; stents; stethoscopes; operating tables; commode chairs; basins for medical purposes; bed pans; instrument cases for use by doctors; arch supports for footwear; ear plugs [hearing protection devices]; thermal packs for first aid purposes; thermometers for medical purposes; tomographs for medical purposes; trocars; walking sticks for medical purposes; drainage tubes for medical purposes; X-ray tubes for medical purposes; radium tubes for medical purposes; balling guns; protection devices against X-rays, for medical purposes; apparatus for acne treatment; filters for ultraviolet rays, for medical purposes; wheeled walkers to aid mobility; walking frames for disabled persons; cases fitted for medical instruments; elastic stockings for surgical purposes; stockings for varices; splints, surgical; tongue depressors for medical purposes; syringes for injections; syringes for medical purposes; hypodermic syringes; uterine syringes; urethral syringes; pins for artificial teeth; obstetrical forceps; castrating pincers; radiology screens for medical purposes; electrodes for medical use; electrocardiographs; brain pacemakers; air cushions for medical purposes; hair prostheses; ear trumpets; quad canes for medical purposes; walking aids for medical purposes.

11 – Lampshades; steam accumulators; heat accumulators; defrosters for vehicles; disinfectant apparatus for medical purposes; distillation apparatus; desiccating apparatus; hydromassage bath apparatus; disinfectant apparatus; air deodorizing apparatus; tanning beds; ionization apparatus for the treatment of air or water; coffee roasters; beverage cooling apparatus; hand drying apparatus for washrooms; fruit roasters; water purifying apparatus and machines; refrigerating apparatus and machines; drying apparatus and installations; freezers; heating and cooling apparatus for dispensing hot and cold beverages; drying apparatus; structural framework for ovens; coolers for furnaces; expansion tanks for central heating installations; flushing tanks; refining towers for distillation; bidets; boilers, other than parts of machines; bath tubs; spa baths [vessels]; bath tubs for sitz baths; waffle irons, electric; fans [air-conditioning]; fans [parts of air-conditioning installations]; electric fans for personal use; roasting spits; refrigerating display cabinets; heated display cabinets; water heaters; water flushing installations; air reheaters; extractor hoods for kitchens; gas condensers, other than parts of machines; acetylene generators; microbubble generators for baths; hydrants; fairy lights for festive decoration; burners; acetylene burners; gas burners; burners for lamps;

germicidal burners; incandescent burners; oxyhydrogen burners; laboratory burners; oil burners; alcohol burners; hot water bottles; footwarmers, electric or non-electric; bed warmers; pocket warmers; warming pans; roasting apparatus; lampshade holders; stills; showers; refrigerating containers; gas lighters; grill lighters; candle lighters; friction lighters for igniting gas; chimney blowers; coils [parts of distilling, heating or cooling installations]; furnace ash boxes; evaporators; shower cubicles; Turkish bath cabinets, portable; heating apparatus; cool boxes, electric; refrigerating chambers; fireplaces, domestic; chimney flues; air valves for steam heating installations; level controlling valves in tanks; thermostatic valves [parts of heating installations]; electrically heated carpets; light bulbs; light bulbs, electric; solar thermal collectors [heating]; distillation columns; furnace grates; ventilation hoods; ventilation hoods for laboratories; lamp globes; air-conditioning apparatus; air conditioners for vehicles; gas boilers; laundry room boilers; heating boilers; coffee machines, electric; taps for pipes and pipelines; taps; mixer taps for water pipes; forges, portable; lava rocks for use in barbecue grills; lights, electric, for Christmas trees; acetylene flares; safety lamps; gas lamps; curling lamps; nail lamps; germicidal lamps for purifying air; light bulbs for directional signals for vehicles; arc lamps; laboratory lamps; oil lamps; ultraviolet ray lamps, not for medical purposes; miners' lamps; electric lamps; chandeliers; barbecues; bread baking machines; watering machines for agricultural purposes; ice-cream making machines; pounded rice cake making machines, electric, for household purposes; multicookers; footmuffs, electrically heated; heaters for baths; heaters for heating irons; immersion heaters; brackets for gas burners; anti-splash tap nozzles; heat pumps; filaments for electric lamps; magnesium filaments for lighting; heating filaments, electric; luminous house numbers; socks, electrically heated; heating apparatus for defrosting vehicle windows; hot air bath fittings; bath fittings; loading apparatus for furnaces; kiln furniture [supports]; sauna bath installations; refrigerating appliances and installations; directional lights for bicycles; electrically heated clothing; blankets, electric, not for medical purposes; fabric steamers; lamp reflectors; vehicle reflectors; hearths; electric cooktops; food steamers, electric; steam boilers, other than parts of machines; pasteurisers; lamp mantles; sockets for electric lights; coffee percolators, electric; stoves [heating apparatus]; bakers' ovens; hot air ovens; kitchen ranges [ovens]; microwave ovens [cooking apparatus]; microwave ovens for industrial purposes; incinerators; kilns; solar furnaces; dental ovens; furnaces, other than for laboratory use; urinals being sanitary fixtures; feeding apparatus for heating boilers; heating plates; cooking stoves; hot plates; wine cellars, electric; heaters, electric, for feeding bottles; aquarium heaters; aquarium lights; heating cushions, electric, not for medical purposes; clean chambers [sanitary installati-

ons]; tortilla presses, electric; water intake apparatus; deodorizing apparatus, not for personal use; apparatus for dehydrating food waste; fumigation apparatus, not for medical purposes; gas scrubbing apparatus; oil-scrubbing apparatus; glue-heating appliances; drying apparatus for fodder and forage; water filtering apparatus; air purifying apparatus and machines; ice machines and apparatus; cooling appliances and installations; cooking apparatus and installations; lighting apparatus and installations; sanitary apparatus and installations; cooking rings; lighting apparatus for vehicles; light-emitting diodes [LED] lighting apparatus; heating apparatus for solid, liquid or gaseous fuels; heating apparatus, electric; hot air apparatus; steam facial apparatus [saunas]; safety accessories for water or gas apparatus and pipes; regulating and safety accessories for gas apparatus; regulating accessories for water or gas apparatus and pipes; regulating and safety accessories for water apparatus; regulating and safety accessories for gas pipes; anti-glare devices for vehicles [lamp fittings]; roasting jacks; plate warmers; electric appliances for making yogurt; rotisseries; radiator caps; searchlights; diving lights; washers for water taps; heat guns; radiators [heating]; central heating radiators; radiators, electric; sinks; disinfectant apparatus for dispensing solutions into water-pipes for sanitary installations; drip irrigation emitters [irrigation fittings]; light diffusers; nuclear reactors; heat regenerators; pressure water tanks; roasters; lamps; standard lamps; ceiling lights; toilet seats; lighting installations for air vehicles; autoclaves, electric, for cooking; pressure cookers, electric; gas scrubbers [parts of gas installations]; lamp glasses; sterilizers; water sterilizers; air sterilizers; air dryers; laundry dryers, electric; hair dryers; malt roasters; tobacco roasters; heat exchangers, other than parts of machines; bread toasters; discharge tubes, electric, for lighting; lamp chimneys; luminous tubes for lighting; pipes [parts of sanitary installations]; flues for heating boilers; boiler pipes [tubes] for heating installations; toilets [water-closets]; toilets, portable; humidifiers for central heating radiators; wash-hand basins [parts of sanitary installations]; toilet bowls; water conduits installations; bath installations; air-conditioning installations; desalination plants; installations for processing nuclear fuel and nuclear moderating material; watering installations, automatic; cooling installations for water; cooling installations for liquids; milk cooling installations; cooling installations for tobacco; water purification installations; purification installations for sewage; steam generating installations; water distribution installations; air filtering installations; swimming pool chlorinating apparatus; ventilation [air-conditioning] installations and apparatus; ventilation [air-conditioning] installations for vehicles; water softening apparatus and installations; cooling installations and machines; heating installations; heaters for vehicles; heating installations [water]; polymerisation installations; water supply installations; flare stacks

for use in the oil industry; ash conveyor installations, automatic; whirlpool-jet apparatus; air cooling apparatus; aquarium filtration apparatus; cooking utensils, electric; flaming torches; headlights for automobiles; vehicle headlights; filters for air conditioning; filters for drinking water; wicks for oil stoves; lights for automobiles; bicycle lights; motorcycle lights; lights for vehicles; electric torches; head torches; lanterns for lighting; candle lanterns; Chinese lanterns; fountains; ornamental fountains; chocolate fountains, electric; air fryers; deep fryers, electric; fittings, shaped, for furnaces; oven fittings made of fireclay; bread-making machines; refrigerators; chromatography apparatus for industrial purposes; kettles, electric; dampers [heating]; book sterilization apparatus; refrigerating cabinets; carbon for arc lamps; heating elements.

12 – Motor buses; motor coaches; camping cars; driverless cars [autonomous cars]; motor racing cars; cars for transportation; robotic cars; sports cars; concrete mixing vehicles; refrigerated vehicles; caravans; shock absorbers for automobiles; suspension shock absorbers for vehicles; space vehicles; aircraft; aeronautical apparatus, machines and appliances; air cushion vehicles; hot air balloons; ski carriers for cars; luggage carriers for vehicles; bumpers for automobiles; vehicle bumpers; tyres for vehicle wheels; barges; brake shoes for vehicles; tailboard lifts [parts of land vehicles]; armored vehicles; buffers for railway rolling stock; mine cars; tilt trucks; railway carriages; sleeping cars; dining carriages; refrigerated railway wagons; transmission shafts for land vehicles; bicycles; electric bicycles; valves for vehicle tyres; automobile hoods; pushchair hoods; hoods for vehicles; oars; paddles for canoes; sculls; screws [propellers] for ships; lug nuts for vehicle wheels; seaplanes; flanges for railway wheel tyres; goods vehicles; horns for vehicles; treads for vehicles [tractor type]; doors for vehicles; bicycle motors; motorcycle engines; engines for land vehicles; jet engines for land vehicles; driving motors for land vehicles; screw-propellers; screw-propellers for boats; airships; brake discs for vehicles; telfer railways [cable cars]; dredgers [boats]; hand-cars; military drones; civilian drones; camera drones; clips adapted for fastening automobile parts to automobile bodies; adhesive rubber patches for repairing inner tubes; bicycle bells; rearview mirrors; side view mirrors for vehicles; portholes; cars for cable transport installations; inner tubes for pneumatic tyres; inner tubes for bicycle tyres; canoes; hoods for vehicle engines; crankcases for land vehicle components, other than for engines; boats; caissons [vehicles]; bicycle wheels; vehicle wheels; mine cart wheels; steering wheels for vehicles; casters for trolleys [vehicles]; brake pads for automobiles; hub caps; prams; side cars; brake linings for vehicles; ships; baskets adapted for bicycles; gear boxes for land vehicles; ship hulls; panniers adapted for bicycles; panniers adapted for motorcycles; fenders for ships; bands for

wheel hubs; ejector seats for aircraft; wheelchairs; caps for vehicle fuel tanks; boat hooks; automobile bodies; tipping bodies for lorries; bodies for vehicles; treads for retreading tyres; locomotives; masts for boats; golf carts [vehicles]; sprinkling trucks; propulsion mechanisms for land vehicles; mopeds; motor scooters; motorcycles; rubbish trucks; tyre mousse inserts; fitted footmuffs for pushchairs; fitted footmuffs for prams; freewheels for land vehicles; clutches for land vehicles; repair outfits for inner tubes; air pumps [vehicle accessories]; pumps for bicycle tyres; upholstery for vehicles; rims for bicycle wheels; vehicle wheel rims; windows for vehicles; omnibuses; engine mounts for land vehicles; axles for vehicles; headlight wipers; parachutes; ferry boats; bicycle pedals; ashtrays for automobiles; gearing for land vehicles; carts; head-rests for vehicle seats; bicycle kickstands; vehicle running boards; air bags [safety devices for automobiles]; ski lifts; chairlifts; casings for pneumatic tires; sleeping berths for vehicles; pontoons; torque converters for land vehicles; cigar lighters for automobiles; non-skid devices for vehicle tyres; anti-glare devices for vehicles; anti-theft devices for vehicles; sun-blinds adapted for automobiles; trailers for transporting bicycles; bicycle trailers; balance weights for vehicle wheels; shock absorbing springs for vehicles; bicycle frames; motorcycle frames; spars for ships; reduction gears for land vehicles; safety belts for vehicle seats; security harness for vehicle seats; vehicle suspension springs; rudders; bicycle handlebars; motorcycle handlebars; vehicle joysticks; bicycle cranks; aeroplanes; amphibious airplanes; sleighs [vehicles]; rescue sleds; kick sledges; brake segments for vehicles; bicycle saddles; motorcycle saddles; luggage nets for vehicles; dress guards for bicycles; fitted pushchair mosquito nets; anti-theft alarms for vehicles; reversing alarms for vehicles; safety seats for children, for vehicles; vehicle seats; bellows for articulated buses; hydraulic circuits for vehicles; mobility scooters; snowmobiles; rolling stock for railways; rolling stock for funicular railways; spokes for bicycle wheels; vehicle wheel spokes; spoilers for vehicles; air vehicles; vehicles for locomotion by land, air, water or rail; ambulances; autonomous underwater vehicles for seabed inspections; water vehicles; remotely operated vehicles for underwater inspections; remote control vehicles, other than toys; electric vehicles; tricycles; delivery tricycles; inclined ways for boats; windscreens; windshield wipers; motorcycle kickstands; hubs for bicycle wheels; hubs for vehicle wheels; bags adapted for strollers; saddlebags adapted for bicycles; railway couplings; trailer hitches for vehicles; couplings for land vehicles; wheelbarrows; handling carts; two-wheeled trolleys; shopping trolleys; fishing trolleys; hose carts; bogies for railway cars; casting carriages; tilting-carts; roll cage trolleys; forklift trucks; cleaning trolleys; bicycle brakes; brakes for vehicles; torsion bars for vehicles; tractors; tramcars; transmission mechanisms for land vehicles; military vehicles for trans-

port; aerial conveyors; trailers [vehicles]; funnels for ships; funnels for locomotives; cleats [nautical]; turbines for land vehicles; direction indicators for vehicles; rowlocks; disengaging gear for boats; steering gears for ships; cable transport apparatus and installations; spoke clips for wheels; tipping apparatus [parts of railway wagons]; funiculars; vans [vehicles]; drive chains for land vehicles; bicycle chains; motorcycle chains; anti-skid chains; transmission chains for land vehicles; undercarriages for vehicles; pram covers; spare wheel covers; covers for vehicle steering wheels; saddle covers for bicycles; saddle covers for motorcycles; seat covers for vehicles; vehicle covers [shaped]; automobile chassis; vehicle chassis; connecting rods for land vehicles, other than parts of motors and engines; axle journals; gears for bicycles; tubeless tyres for bicycles; bicycle tyres; automobile tyres; pneumatic tyres; solid tires for vehicle wheels; spikes for tyres; davits for boats; launches; timbers [frames] for ships; mudguards; bicycle mudguards; tow trucks; motors, electric, for land vehicles; yachts.

13 – Acetyl-nitrocellulose; ammunition; ammunition for firearms; explosives; ammonium nitrate explosives; pyrophoric substances; primings [fuses]; fuses for explosives, for use in mines; cartridge cases; noise-suppressors for guns; hand grenades; detonators; dynamite; lead shot for hunting; sighting mirrors for guns and rifles; breeches of firearms; detonating caps, other than toys; rifles; hammers for guns and rifles; gun carriages [artillery]; automatic firearm ammunition belts; gunstocks; mortars [firearms]; mines [explosives]; Bengal lights; firing platforms; artillery guns [cannons]; motorized weapons; firearms; hunting firearms; side arms [firearms]; tear-gas weapons; cartridge pouches; cartridges; explosive cartridges; firecrackers; guncotton; pistols [arms]; air pistols [weapons]; flare pistols; explosive powders; gunpowder; powder horns; shoulder straps for weapons; sights, other than telescopic sights, for artillery; sights, other than telescopic sights, for firearms; machine guns; cannons; rocket launchers; signal rocket flares; revolvers; belts adapted for ammunition; guns [weapons]; harpoon guns [weapons]; detonating plugs; fog signals, explosive; rescue flares, explosive or pyrotechnic; trigger guards for guns and rifles; projectiles [weapons]; shells [projectiles]; ballistic weapons; rockets [projectiles]; sprays for personal defence purposes; pyrotechnic products; rifle barrels; tanks [weapons]; torpedoes; cartridge loading apparatus; apparatus for filling cartridge belts; fireworks; fuses for explosives; trunnions for heavy weapons; rifle cases; detonating fuses for explosives; cleaning brushes for firearms.

14 – Agates; diamonds; amulets [jewellery]; anchors [clock- and watchmaking]; barrels [clock- and watchmaking]; bracelets [jewellery]; bracelets made of embroidered textile [jewellery]; watch bands; charms for key rings; jewellery charms; brooches [jewellery]; al-

arm clocks; pins [jewellery]; ornamental pins; tie pins; beads for making jewellery; pearls made of ambroid [pressed amber]; busts of precious metal; jewellery rolls; jet, unwrought or semi-wrought; jewellery findings; key rings [split rings with trinket or decorative fob]; pearls [jewellery]; copper tokens; tie clips; cuff links; clasps for jewellery; badges of precious metal; gold, unwrought or beaten; cloisonné jewellery; works of art of precious metal; jewellery; ivory jewellery; jewellery of yellow amber; iridium; cabochons; precious stones; semi-precious stones; spun silver [silver wire]; necklaces [jewellery]; split rings of precious metal for keys; rings [jewellery]; boxes of precious metal; presentation boxes for jewellery; watch cases [parts of watches]; clock cases; pendulums [clock- and watchmaking]; medals; lockets [jewellery]; precious metals, unwrought or semi-wrought; movements for clocks and watches; clockworks; misbaha [prayer beads]; coins; gold thread [jewellery]; threads of precious metal [jewellery]; silver thread [jewellery]; olivine [gems]; osmium; palladium; platinum [metal]; chronometric instruments; watch springs; crucifixes of precious metal, other than jewellery; crucifixes as jewellery; rhodium; ruthenium; stopwatches; silver, unwrought or beaten; earrings; ingots of precious metals; alloys of precious metal; statues of precious metal; figurines of precious metal; watch glasses; paste jewellery; watch hands; clock hands; ornaments of jet; shoe jewellery; hat jewellery; presentation boxes for watches; chronographs [watches]; chronometers; chronoscopes; chains [jewellery]; watch chains; dials [clock- and watchmaking]; atomic clocks; watches; sundials; clocks and watches, electric; control clocks [master clocks]; clocks; wristwatches; rosaries; jewellery boxes; spinel [precious stones].

16 – Fountain pens; aquarelles; albums; almanacs; document laminators for office use; mimeograph apparatus and machines; atlases; posters; banknotes; banners of paper; paper bows, other than haberdashery or hair decorations; table linen of paper; tickets; forms, printed; announcement cards [stationery]; note books; pads [stationery]; drawing pads; spiral notebooks; wristbands for the retention of writing instruments; pamphlets; booklets; paper sheets [stationery]; waxed paper; paper for medical examination tables; paper for recording machines; paper for radiograms; papers for painting and calligraphy; electrocardiograph paper; drawer liners of paper, perfumed or not; wood pulp paper; carbon paper; copying paper [stationery]; parchment paper; writing paper; rice paper; luminous paper; toilet paper; wrapping paper; filter paper; wash; paper; blotters; newsletters; rollers for typewriters; house painters' rollers; composing sticks; modelling wax, not for dental purposes; signboards of paper or cardboard; sewing patterns; bunting of paper; newspapers; electrotypes; hectographs; modelling clay; polymer modelling clay; terrestrial globes; drawing sets; engravings; slate pencils; pencil leads; document

holders [stationery]; pencil holders; chalk holders; holders for cheque books; holders for stamps [seals]; page holders; name badge holders [office requisites]; diagrams; table runners of paper; engraving plates; writing slates; blackboards; galley racks [printing]; drawing boards; advertisement boards of paper or cardboard; duplicators; punches [office requisites]; cream containers of paper; magazines [periodicals]; money clips; clips for name badge holders [office requisites]; tags for index cards; pen clips; bookmarks; etching needles; tracing needles for drawing purposes; periodicals; printed publications; paper shredders for office use; graphic representations; credit card imprints, non-electric; graining combs; drawing instruments; calendars; tracing paper; tracing cloth; tracing patterns; gums [adhesives] for stationery or household purposes; lithographic stones; ink stones [ink reservoirs]; pencils; pencil lead holders; charcoal pencils; pictures; transfers [decalcomanias]; paintings [pictures], framed or unframed; wood pulp board [stationery]; cardboard; hat boxes of cardboard; cards; index cards [stationery]; geographical maps; paper tapes and cards for the recordal of computer programmes; trading cards, other than for games; perforated cards for Jacquard looms; catalogues; spools for inking ribbons; flower-pot covers of paper; paintbrushes; painters' brushes; writing brushes; typewriter keys; glue for stationery or household purposes; isinglass for stationery or household purposes; gluten [glue] for stationery or household purposes; starch paste [adhesive] for stationery or household purposes; printing blocks; books; manifolds [stationery]; comic books; drawing pins; cigar bands; envelopes [stationery]; boxes of paper or cardboard; cases for stamps [seals]; paint boxes for use in schools; correcting fluids [office requisites]; printed coupons; stencils [stationery]; French curves; paper ribbons, other than haberdashery or hair decorations; typewriter ribbons; adhesive tapes for stationery or household purposes; correcting tapes [office requisites]; inking ribbons; self-adhesive tapes for stationery or household purposes; square rulers for drawing; drawing rulers; flyers; absorbent sheets of paper or plastic for foodstuff packaging; humidity control sheets of paper or plastic for foodstuff packaging; viscose sheets for wrapping; sheets of reclaimed cellulose for wrapping; plastic bubble packs for wrapping or packaging; steel letters; type [numerals and letters]; lithographs; letter trays; paint trays; architects' models; postage stamps; plastics for modelling; graphic prints; modelling materials; teaching materials [except apparatus]; sealing compounds for stationery purposes; adhesives [glues] for stationery or household purposes; padding materials of paper or cardboard; bookbinding material; packing [cushioning, stuffing] materials of paper or cardboard; packaging material made of starches; filtering materials of paper; tablemats of paper; addressing machines; pencil sharpening machines, electric or non-electric; bookbinding apparatus and machines [office equipment]; ty-

pewriters, electric or non-electric; paper creasers [office requisites]; franking machines for office use; chalk for lithography; writing chalk; tailors' chalk; marking chalk; spray chalk; bags [envelopes, pouches] of paper or plastics, for packaging; garbage bags of paper or of plastics; plastic bags for pet waste disposal; painters' easels; hand-rests for painters; printing sets, portable [office requisites]; bibs of paper; bibs, sleeved, of paper; stickers [stationery]; fingerstalls being office requisites; writing cases [stationery]; cords for bookbinding; paper knives [letter openers]; printed sheet music; numbering apparatus; bottle envelopes of paper or cardboard; sealing wafers; covers [stationery]; passport holders; plastic cling film, extensible, for palletization; embroidery designs [patterns]; handwriting specimens for copying; oleographs; musical greeting cards; greeting cards; postcards; etchings; conical paper bags; paper bags for use in the sterilization of medical instruments; bags for microwave cooking; palettes for painters; ink sticks; pantographs [drawing instruments]; files [office requisites]; folders for papers; papier mâché; pastels [crayons]; modelling paste; pen cases; pen wipers; office perforators; pens [office requisites]; nibs of gold; nibs; steel pens; drawing pens; song books; seals [stamps]; sealing stamps; clipboards; address plates for addressing machines; handkerchiefs of paper; plastic film for wrapping; desk mats; trays for sorting and counting money; coasters of paper; bookends; stamp stands; mats of paper for beer glasses; stands for pens and pencils; photograph stands; obliterating stamps; inking pads; stamp pads; binding strips [bookbinding]; towels of paper; inking sheets for document reproducing machines; inking sheets for duplicators; cloth for bookbinding; gummed cloth for stationery purposes; printers' blankets, not of textile; portraits; paperweights; writing cases [sets]; inkstands; office requisites, except furniture; writing materials; writing instruments; drawing materials; school supplies [stationery]; adhesive tape dispensers [office requisites]; hand labelling appliances; printed matter; lithographic works of art; prospectuses; printed timetables; ledgers [books]; printers' galleys; indexes; paper cutters [office requisites]; rubber erasers; elastic bands for offices; T-squares for drawing; graphic reproductions; retractable reels for name badge holders [office requisites]; penholders; marking pens [stationery]; tissues of paper for removing make-up; dental tray covers of paper; place mats of paper; tablecloths of paper; paper clasps; document files [stationery]; scrapers [erasers] for offices; paper-clips; clips for offices; erasing products; biological samples for use in microscopy [teaching materials]; histological sections for teaching purposes; steatite [tailor's chalk]; writing board erasers; composing frames [printing]; sealing wax; arithmetical tables; placards of paper or cardboard; writing or drawing books; fabrics for bookbinding; stationery; pencil sharpeners, electric or non-electric; transparencies [stationery]; stencil pla-

tes; cardboard tubes; Indian inks; moisteners [office requisites]; moisteners for gummed surfaces [office requisites]; squares for drawing; chart pointers, non-electronic; bottle wrappers of paper or cardboard; envelope sealing machines for offices; sealing machines for offices; vignetting apparatus; apparatus for mounting photographs; stapling presses [office requisites]; manuals [handbooks]; figurines of papier mâché; paper coffee filters; flags of paper; silver paper; moulds for modelling clays [artists' materials]; photo-engravings; photographs [printed]; stencil cases; canvas for painting; chromolithographs [chromos]; animation cels; compasses for drawing; numbers [type]; artists' watercolour saucers; correcting ink [heliography]; ink; inkwells; blueprints; stencils; erasing shields; balls for ball-point pens; desktop cabinets for stationery [office requisites]; printing type; address stamps; stamps [seals]; shields [paper seals]; prints [engravings]; labels of paper or cardboard.

18 – Mountaineering sticks; slings for carrying infants; luggage tags; pocket wallets; saddlecloths for horses; business card cases; reins; reins for guiding children; sling bags for carrying infants; harness fittings; credit card cases [wallets]; parts of rubber for stirrups; chamois leather, other than for cleaning purposes; umbrellas; parasols; saddlery; frames for umbrellas or parasols; frames for bags [structural parts of bags]; card cases [notecases]; cases of leather or leatherboard; valves of leather; whips; imitation leather; leather, unworked or semi-worked; leatherboard; casings, of leather, for springs; umbrella rings; hat boxes of leather; boxes of leather or leatherboard; boxes of vulcanized fibre; purses; chain mesh purses; fastenings for saddles; butts [parts of hides]; saddle trees; bags [envelopes, pouches] of leather, for packaging; moleskin [imitation of leather]; travelling sets [leatherware]; knee-pads for horses; muzzles; halters; vanity cases, not fitted; leather threads; furniture coverings of leather; clothing for pets; covers for animals; trimmings of leather for furniture; collars for animals; hiking sticks; conference folders; music cases; goldbeaters' skin; cat o' nine tails; leather leashes; pads for horse saddles; horseshoes; girths of leather; horse blankets; garment bags for travel; shoulder belts [straps] of leather; briefcases; traces [harness]; fur; randsels [Japanese school satchels]; haversacks; leather straps; straps for soldiers' equipment; harness straps; straps for skates; straps of leather [saddlery]; chin straps, of leather; stirrup leathers; umbrella handles; walking stick handles; suitcase handles; grips for holding shopping bags; rucksacks; travelling bags; riding saddles; net bags for shopping; umbrella or parasol ribs; stirrups; bags for climbers; tool bags, empty; handbags; beach bags; saddlebags; compression cubes adapted for luggage; bags for sports; bags for campers; reusable shopping bags; wheeled shopping bags; school bags; bags; pouch baby carriers; travelling trunks; trunks [luggage]; nose bags [feed bags]; bridoons; umbrella sticks; walking stick seats; wal-

king sticks; tefillin [phylacteries]; bits for animals [harness]; bridles [harness]; harness for animals; key cases; horse collars; suitcases; motorized suitcases; suitcases with wheels; valises; attaché cases; covers for horse saddles; umbrella covers; kid; curried skins; animal skins; cattle skins; leather cord; blinkers [harness]; labels of leather; game bags [hunting accessories].

20 – Picture frame brackets; bumper guards for cots, other than bed linen; reels, not of metal, non-mechanical, for flexible hoses; pulleys of plastics for blinds; bolts, not of metal; casks of wood for decanting wine; mooring buoys, not of metal; casks, not of metal; barrels, not of metal; identification bracelets, not of metal; sideboards; busts of wood, wax, plaster or plastic; costume stands; bolsters; fans for personal use, non-electric; work benches; vice benches [furniture]; valet stands; coatstands; coat hangers; shoulder poles [yokes]; screws, not of metal; display stands; showcases [furniture]; newspaper display stands; jewellery organizer displays; collars, not of metal, for fastening pipes; comb foundations for beehives; signboards of wood or plastics; loading gauge rods, not of metal, for railway wagons; nuts, not of metal; covers for clothing [wardrobe]; shoe pegs, not of metal; nesting boxes; coffins; doors for furniture; curtain holders, not of textile material; dowels, not of metal; divans; kennels for household pets; birdhouses; keyboards for hanging keys; display boards; plugs [dowels], not of metal; containers, not of metal, for liquid fuel; troughs, not of metal, for mixing mortar; oil drainage containers, not of metal; packaging containers of plastic; flower-stands [furniture]; curtain tie-backs; clips, not of metal, for cables and pipes; binding screws, not of metal, for cables; clips of plastic for sealing bags; rivets, not of metal; imitation tortoiseshell; locks, not of metal, for vehicles; locks, other than electric, not of metal; bead curtains for decoration; door bolts, not of metal; bottle closures, not of metal; closures, not of metal, for containers; latches, not of metal; mirrors [looking glasses]; hand-held mirrors [toilet mirrors]; bamboo, unworked or semi-worked; scratching posts for cats; animal claws; animal hooves; coral; meersch-chaum; whalebone, unworked or semi-worked; stag antlers; tortoiseshell; shells; horn, unworked or semi-worked; animal horns; rattan; ivory, unworked or semi-worked; corozo; plaited straw, except matting; wickerwork; hampers [baskets] for the transport of items; works of art of wood, wax, plaster or plastic; cabinet work; reeds [plaiting materials]; settees; jerry-cans, not of metal; curtain rods; index cabinets [furniture]; reels of wood for yarn, silk, cord; drain traps [valves] of plastic; water-pipe valves of plastic; valves, not of metal, other than parts of machines; staves of wood; plastic keys; plastic key cards, not encoded and not magnetic; mats for infant playpens; sleeping pads [mats or cushions]; saw horses; bed casters, not of metal; furniture casters, not of metal; brush mountings; chopping blocks [tables]; wind chimes [decora-

tion]; door bells, not of metal, non-electric; bottle caps, not of metal; bassinets; tent pegs, not of metal; curtain rings; split rings, not of metal, for keys; chests of drawers; console tables; containers, not of metal [storage, transport]; floating containers, not of metal; lecterns; dog kennels; bakers' bread baskets; baskets, not of metal; Moses baskets; bottle casings of wood; tool boxes, not of metal, empty; taps, not of metal, for casks; armchairs; hairdressers' chairs; deck chairs; hospital beds; bedsteads of wood; air beds, not for medical purposes; beds; cots for babies; edgings of plastic for furniture; brackets, not of metal, for furniture; screw tops, not of metal, for bottles; table tops; sash fasteners, not of metal, for windows; coathooks, not of metal; curtain hooks; clothes hooks, not of metal; bag hangers, not of metal; beds for household pets; nesting boxes for household pets; ladders of wood or plastics; playpens for babies; tailors' dummies; air mattresses, not for medical purposes; camping mattresses; mattresses; hydrostatic beds, not for medical purposes; furniture; furniture of metal; inflatable furniture; office furniture; school furniture; mobiles [decoration]; door knockers, not of metal; curtain rails; legs for furniture; feet for furniture; house numbers, not of metal, non-luminous; cask hoops, not of metal; door stops, not of metal or rubber; window stops, not of metal or rubber; mouldings for picture frames; bed bases; furniture partitions of wood; freestanding partitions [furniture]; mother-of-pearl, unworked or semi-worked; mirror tiles; ambroid plates; novelty license plates of plastic; identity plates, not of metal; loading pallets, not of metal; handling pallets, not of metal; transport pallets, not of metal; head-rests [furniture]; trays, not of metal; stakes, not of metal, for plants or trees; trestles [furniture]; magazine racks; book rests [furniture]; stands for calculating machines; flower pot supports; plastic ramps for use with vehicles; reusable baby changing mats; pet cushions; pillows; cushions; head support cushions for babies; anti-roll cushions for babies; air cushions, not for medical purposes; air pillows, not for medical purposes; head positioning pillows for babies; removable covers for sinks; racks [furniture]; library shelves; shelves for file cabinets; furniture shelves; shelves for storage; wood ribbon; straw edgings; towel stands [furniture]; hat stands; bathtub grab bars, not of metal; cask stands, not of metal; inflatable publicity objects; counters [tables]; bedding, except linen; corks for bottles; corks; stoppers, not of glass, metal or rubber; sealing caps, not of metal; stair rods; standing desks; embroidery frames; dispensers for dog waste bags, fixed, not of metal; tissue dispensers, fixed, not of metal; picture frames; sections of wood for beehives; crucifixes of wood, wax, plaster or plastic, other than jewellery; reservoirs, not of metal nor of masonry; fodder racks; curtain rollers; door handles, not of metal; knobs, not of metal; fishing baskets; writing desks; seats of metal; benches [furniture]; vats, not of metal; honeycombs; sofas; plugs, not of metal; statues of wood,

wax, plaster or plastic; figurines of wood, wax, plaster or plastic; oyster shells; silvered glass [mirrors]; shelving units; ambroid bars; umbrella stands; gun racks; trolleys for computers [furniture]; dressing tables; washstands [furniture]; typing desks; drafting tables; massage tables; tables of metal; wall-mounted baby changing platforms; saw benches [furniture]; desks; tea trolleys; dinner wagons [furniture]; tables; steps [ladders], not of metal; chairs [seats]; high chairs for babies; shower chairs; chests, not of metal; placards of wood or plastics; stools; footstools; crates; trolleys [furniture]; straw plaits; mobile boarding stairs, not of metal, for passengers; straw mattresses; decorations of plastic for foodstuffs; beehives; door fasteners, not of metal; window fasteners, not of metal; funerary urns; winding spools, not of metal, non-mechanical, for flexible hoses; hand-held flagpoles, not of metal; door fittings, not of metal; coffin fittings, not of metal; bed fittings, not of metal; furniture fittings, not of metal; window fittings, not of metal; infant walkers; garment covers [storage]; stuffed animals; stuffed birds; hinges, not of metal; chaise longues; poles, not of metal; screens [furniture]; filing cabinets; medicine cabinets; dish cabinets; meat safes; bookcases; wardrobes; cupboards; shoe dowels, not of metal; bamboo curtains; indoor window blinds of paper; slatted indoor blinds; indoor window blinds of woven wood; indoor window blinds [furniture]; indoor window blinds of textile; screens for fireplaces [furniture]; labels of plastic; yellow amber; lockers [furniture]; chests for toys; tool chests, not of metal, empty; boxes of wood or plastic; letter boxes, not of metal or masonry; bottle racks.

21 – Autoclaves, non-electric, for cooking; indoor aquaria; wine aerators; buckets; cookie jars; candle jars [holders]; china ornaments; dishes; paper plates; vegetable dishes; saucers; goblets; boxes for sweets; bottles; demijohns; busts of porcelain, ceramic, earthenware or glass; vases; epergnes; fruit bowls; inflatable bath tubs for babies; bird baths; baby baths, portable; plungers for clearing blocked drains; waffle irons, non-electric; ice buckets; mop wringer buckets; buckets made of woven fabrics; whisks, non-electric, for household purposes; cooking skewers of metal; towel rails and rings; clothing stretchers; hair for brushes; horsehair for brush-making; birdcages; funnels; carpet beaters [hand instruments]; signboards of porcelain or glass; candle extinguishers; heads for electric toothbrushes; flower pots; chamber pots; gluepots; cruets; decanters; large-toothed combs for the hair; combs for animals; tea cosies; abrasive sponges for scrubbing the skin; make-up sponges; sponges for household purposes; bath sponges; sponge holders; stands for portable baby baths; toothpick holders; soap holders; table napkin holders; holders for flowers and plants [flower arranging]; tea bag rests; shaving brush stands; toilet paper holders; soap dispensers; toilet paper dispensers; plug-in diffusers for mosquito repellents; ironing boards; cutting boards for the kitchen; bread boards; washing boards; crushers for kit-

chen use, non-electric; strainers for household purposes; smoke absorbers for household purposes; containers for household or kitchen use; kitchen containers; glass jars [carboys]; heat-insulated containers; heat-insulated containers for beverages; thermally insulated containers for food; glass flasks [containers]; closures for pot lids; chamois leather for cleaning; toothpicks; ceramics for household purposes; majolica; works of art of porcelain, ceramic, earthenware, terracotta or glass; brushes, except paint brushes; kitchen grinders, non-electric; cleaning instruments, hand-operated; cabarets [trays]; stew-pans; flower-pot covers, not of paper; shaving brushes; make-up brushes; basting brushes; cages for pets; baking mats; ladles for serving wine; polishing leather; hot pots, not electrically heated; glass bulbs [receptacles]; shoe trees; napkin rings; poultry rings; rings for birds; coin banks; piggy banks; bread baskets for household purposes; baskets for household purposes; waste paper baskets; feeding troughs; mangers for animals; lunch boxes; tea caddies; washtubs; earthenware saucepans; mess-tins; cauldrons; coffee percolators, non-electric; coffeepots, non-electric; coffee grinders, hand-operated; fused silica [semi-worked product], other than for building; beer mugs; tankards; rat traps; pot lids; aquarium hoods; butter-dish covers; dish covers; cheese-dish covers; buttonhooks; reusable ice cubes; jugs; perfume burners; watering cans; fly traps; insect traps; ice cream scoops; mixing spoons [kitchen utensils]; basting spoons [cooking utensils]; pie servers; cosmetic spatulas; spatulas for kitchen use; litter boxes for pets; butter dishes; material for brush-making; polishing materials for making shiny, except preparations, paper and stone; tablemats, not of paper or textile; noodle machines, hand-operated; lint removers, electric or non-electric; polishing apparatus and machines, for household purposes, non-electric; pepper mills, hand-operated; mills for household purposes, hand-operated; feather-dusters; brooms; isothermic bags; decorating bags for confectioners; bowls [basins]; mosaics of glass, not for building; saucepan scourers of metal; soap boxes; mouse traps; cooking pot sets; nozzles for watering cans; pouring spouts; cake decorating tips and tubes; nozzles for watering hose; fitted picnic baskets, including dishes; toilet cases; floss for dental purposes; fibreglass thread, other than for textile use; cookie [biscuit] cutters; pastry cutters; sprinklers; syringes for watering flowers and plants; cotton waste for cleaning; wool waste for cleaning; cleaning tow; cold packs for chilling food and beverages; chopsticks; cocktail stirrers; food steamers, non-electric; pepper pots; oven mitts; gloves for household purposes; car washing mitts; polishing gloves; gardening gloves; pestles for kitchen use; plates to prevent milk boiling over; dripping pans; trays for household purposes; trays of paper, for household purposes; lazy susans; heaters for feeding bottles, non-electric; candelabra [candlesticks]; trivets [table utensils]; coasters, not of paper or textile; grill sup-

ports; menu card holders; knife rests for the table; flat-iron stands; egg cups; abrasive pads for kitchen purposes; scouring pads; drinking troughs; serving ladles; powdered glass for decoration; pottery; pots; cooking pots, non-electric; painted glassware; tableware, other than knives, forks and spoons; porcelain ware; earthenware; crystal [glassware]; cosmetic utensils; cleaning utensils for toilets; trouser presses; tortilla presses, non-electric [kitchen utensils]; deodorizing apparatus for personal use; cruet sets for oil and vinegar; make-up removing appliances; spice sets; apparatus for wax-polishing, non-electric; bottle openers, electric and non-electric; glove stretchers; bootjacks; crumb trays; tie presses; potholders; clothespegs; glass stoppers; powder compacts; perfume vaporizers; powder puffs; dusting apparatus, non-electric; foam toe separators for use in pedicures; electric combs; combs; grills [cooking utensils]; sifters [household utensils]; drinking horns; shoe horns; candle drip rings; broom handles; salad bowls; place mats, not of paper or textile; sugar bowls; beaters, non-electric; egg separators, non-electric, for household purposes; services [dishes]; coffee services [tableware]; liqueur sets; tea services [tableware]; cooking mesh bags, other than for microwaves; sieves [household utensils]; cinder sifters [household utensils]; tea strainers; wine-tasting pipettes; siphon bottles for carbonated water; rolling pins, domestic; frying pans; steel wool for cleaning; currycombs; blenders, non-electric, for household purposes; scoops for household purposes; fruit presses, non-electric, for household purposes; straws for drinking; salt cellars; drinking vessels; vessels for making ices and ice cream, non electric; refrigerating bottles; bulb basters; cups of paper or plastic; glasses [receptacles]; drinking glasses; statues of porcelain, ceramic, earthenware, terracotta or glass; figurines of porcelain, ceramic, earthenware, terracotta or glass; glass for vehicle windows [semi-finished product]; plate glass [raw material]; opal glass; glass, unworked or semi-worked, except building glass; opaline glass; glass incorporating fine electrical conductors; enamelled glass, not for building; glass wool, other than for insulation; vitreous silica fibres, other than for textile use; fibreglass, other than for insulation or textile use; mortars for kitchen use; portable cool boxes, non-electric; soup tureens; drying racks for laundry; rotary washing lines; basins [receptacles]; table plates; disposable table plates; graters for kitchen use; insulating flasks; indoor terrariums [plant cultivation]; indoor terrariums [vivariums]; cloth for washing floors; polishing cloths; cloths for cleaning; dusting cloths [rags]; furniture dusters; urns being vases; urns being planter pots for flowers and plants; atomizers for household purposes; wax-polishing appliances, non-electric, for shoes; water apparatus for cleaning teeth and gums; electric devices for attracting and killing insects; watering devices; utensils for household purposes; kitchen utensils; cooking

utensils, non-electric; coffee filters, non-electric; flasks; hip flasks; drinking bottles for sports; moulds [kitchen utensils]; cake moulds; ice cube moulds; cookery moulds; deep fryers, non-electric; comb cases; bread bins; fly swatters; teapots; kettles, non-electric; cups; garlic presses [kitchen utensils]; ironing board covers, shaped; tea infusers; decorative glass spheres; mops; mop wringers; cocktail shakers; corkscrews, electric and non-electric; animal bristles [brushware]; pig bristles for brush-making; dishwashing brushes; ski wax brushes; brushes for cleaning tanks and containers; lamp-glass brushes; horse brushes; scrubbing brushes; toothbrushes; toothbrushes, electric; carpet sweepers; shoe brushes; tar-brushes, long handled; toilet brushes; electric brushes, except parts of machines; brushes; eyebrow brushes; nail brushes; eyelash brushes; nutcrackers; ice tongs; salad tongs; sugar tongs; decanter tags; nest eggs, artificial; boxes for dispensing paper towels; dustbins; window-boxes; boxes of glass.

22 – String; twine made of paper; packing string; tarpaulins; wadding for padding and stuffing upholstery; wadding for filtering; whipcord; packing rope; ropes; seaweed for stuffing; carbon fibres for textile use; esparto grass; coconut fibre; plastic fibres for textile use; ramie fibre; textile fibres; horsehair; hammocks; jute; wax ends; outdoor blinds of textile; ropes, not of metal; kapok; cocoons; raw linen [flax]; strips for tying-up vines; ladder tapes for Venetian blinds; wrapping or binding bands, not of metal; rope ladders; liners; liber; padding materials, not of rubber, plastics, paper or cardboard; packing [cushioning, stuffing] materials, not of rubber, plastics, paper or cardboard; bags [envelopes, pouches] of textile, for packaging; sacks for the transport and storage of materials in bulk; body bags; mail bags; mesh bags for washing laundry; purse seines; twine for nets; binding thread, not of metal, for agricultural purposes; thread, not of metal, for wrapping or binding; braces, not of metal, for handling loads; bindings, not of metal; sawdust; straw wrappers for bottles; tow; cotton tow; silk flock; tents; sails; sails for ski sailing; canvas for sails; hemp fibres; brattice cloth; feathers for stuffing upholstery; feathers for bedding; animal hair; fibrous gaskets for ships; down [feathers]; eiderdown; raffia; straps, not of metal, for handling loads; hemp bands; fleece wool; net pens for fish farming; snares [nets]; nets for camouflage; fishing nets; nets; animal feeding nets; sisal; straw for stuffing upholstery; sheaf-binding yarns; vitreous silica fibres for textile use; glass fibres for textile use; slings, not of metal, for handling loads; wood shavings; raw fibrous textile; awnings of synthetic materials; awnings of textile; network; grasses for upholstering; car towing ropes; cables, not of metal; cotton waste [flock] for padding and stuffing; schappe [raw silk waste]; wool flock; raw cotton; vehicle covers, not fitted; dust sheets; covers for camouflage; raw silk; carded wool; camel hair; flock [stuffing]; upholstery wool [stuffing]; wood wool;

combed wool; raw or treated wool; shorn wool; cords for hanging pictures; sash cords; pig bristles.

23 – Thread of metal for embroidery; embroidery thread and yarn; jute thread and yarn; coir thread and yarn; rayon thread and yarn; threads of plastic materials for textile use; fibreglass thread for textile use; linen thread and yarn; hemp thread and yarn; rubber thread for textile use; cotton thread and yarn; sewing thread and yarn; silk thread and yarn; woollen thread and yarn; darning thread and yarn; elastic thread and yarn for textile use; yarn; spun thread and yarn; spun cotton; spun silk; spun wool; chenille yarn.

24 – Frieze [cloth]; banners of textile or plastic; velvet; household linen; diapered linen; bath linen, except clothing; bed linen; table linen, not of paper; cot bumpers [bed linen]; buckram; fustian; sleeping bag liners; felt; bunting of textile or plastic; gauze [cloth]; damask; jersey [fabric]; table runners, not of paper; druggery; shower curtains of textile or plastic; curtains of textile or plastic; net curtains; zephyr [cloth]; canvas for tapestry or embroidery; bolting cloth; baby buntings; crepe [fabric]; crepon; marabouts [cloth]; furniture coverings of textile; fabrics for textile use; filtering materials of textile; wall hangings of textile; non-woven textile fabrics; plastic material [substitute for fabrics]; textile material; tablemats of textile; sleeping bags; sleeping bags for babies; moleskin [fabric]; muslin fabric; pillowcases; mattress covers; bed blankets; blankets for household pets; brocades; diaper changing cloths for babies; handkerchiefs of textile; travelling rugs [lap robes]; coasters of textile; bed valances; linings [textile]; hat linings, of textile, in the piece; curtain holders of textile material; bed covers; bed covers of paper; furniture coverings of plastic; towels of textile; hemp cloth; gummed cloth, other than for stationery purposes; printers' blankets of textile; cloth; door curtains; bedsheets; eiderdowns [down coverlets]; bath mitts; shrouds; glass cloths [towels]; cloths for removing make-up; face towels of textile; place mats of textile; table napkins of textile; mosquito nets; calico; oilcloth for use as tablecloths; tablecloths, not of paper; billiard cloth; taffeta [cloth]; ticks [mattress covers]; tick [linen]; lingerie fabric; fabric, impervious to gases, for aeronautical balloons; jute fabric; fabric for footwear; ramie fabric; esparto fabric; rayon fabric; fibreglass fabrics for textile use; adhesive fabric for application by heat; linen cloth; upholstery fabrics; hemp fabric; lining fabric for footwear; traced cloths for embroidery; chenille fabric; printed calico cloth; knitted fabric; cotton fabrics; silk fabrics for printing patterns; woollen cloth; elastic woven fabrics; fabric; fabric imitating animal skins; haircloth [sackcloth]; cheese cloth; tulle; flags of textile or plastic; flannel [fabric]; trellis [cloth]; covers for cushions; fitted toilet lid covers of fabric; covers [loose] for furniture; pillow shams; cheviots [cloth]; silk [cloth]; labels of textile.

25 – Wimples; bandanas [neckerchiefs]; underwear; sweat-absorbent underwear; berets; overalls; boas [necklets]; teddies [underclothing]; boxer shorts; ankle boots; ski boots; boots for sports; breeches for wear; trousers; football shoes; brassieres; valenki [felted boots]; collars [clothing]; detachable collars; shirt yokes; veils [clothing]; gabardines [clothing]; galoshes; neckties; ascots; gaiters; footless socks; boot uppers; corselets; jerseys [clothing]; waistcoats; sports jerseys; hosiery; heels; hoods [clothing]; hat frames [skeletons]; pockets for clothing; scarves; kimonos; sun visors [headwear]; cap peaks; tights; slippers [underclothing]; combinations [clothing]; wet suits for water-skiing; bodices [lingerie]; corsets [underclothing]; suits; bathing suits; masquerade costumes; beach clothes; leotards; jackets [clothing]; stuff jackets [clothing]; fishing vests; leggings [trousers]; liveries; camisoles; sports singlets; cuffs; short-sleeve shirts; mantillas; coats; sleep masks; furs [clothing]; fingerless gloves; mitres [hats]; muffs [clothing]; footmuffs, not electrically heated; top lifts for shoes; bibs, not of paper; bibs, sleeved, not of paper; fur stoles; hairdressing capes; ear muffs [clothing]; socks; sweat-absorbent socks; beach shoes; sports shoes; footwear; paper clothing; outerclothing; ready-made clothing; motorists' clothing; cyclists' clothing; clothing for gymnastics; clothing of imitations of leather; clothing of leather; waterproof clothing; uniforms; clothing; fittings of metal for footwear; maniples; overcoats; knickers; parkas; pelerines; gloves [clothing]; ski gloves; pyjamas; bathing trunks; shirt fronts; pocket squares; dresses; headbands [clothing]; garters; sock suspenders; stocking suspenders; ready-made linings [parts of clothing]; dress shields; soles for footwear; braces [suspenders] for clothing; half-boots; lace boots; sweaters; ponchos; girdles; belts [clothing]; money belts [clothing]; layettes [clothing]; non-slipping devices for footwear; heelpieces for stockings; welts for footwear; chasubles; shirts; wooden shoes; sandals; bath sandals; boots; jumper dresses; saris; sarongs; footwear uppers; inner soles; albs; bath slippers; togas; knitwear [clothing]; underpants; gymnastic shoes; slippers; shoes; skull caps; turbans; headwear; aprons [clothing]; judo uniforms; karate uniforms; tee-shirts; dressing gowns; bath robes; top hats; tips for footwear; stockings; sweat-absorbent stockings; shawls; caps [headwear]; paper hats [clothing]; shower caps; bathing caps; studs for football shoes; hats; babies' pants [underwear]; gaiter straps; pelisses; esparto shoes or sandals; skirts; petticoats; skorts.

26 – Appliqués [haberdashery]; haberdashery bows; fringes; mica spangles; shoe eyelets; false beards; charms, other than for jewellery, key rings or key chains; brooches [clothing accessories]; entomological pins; pins, other than jewellery; beads, other than for making jewellery; wreaths of artificial flowers; artificial Christmas wreaths; artificial Christmas wreaths incorporating lights; false hair; human hair; lace for edgings; artificial garlands; artificial Christmas

garlands; artificial Christmas garlands incorporating lights; darning lasts; expanding bands for holding sleeves; frills [lacework]; trouser clips for cyclists; hair grips; hair barrettes; heat adhesive patches for repairing textile articles; blouse fasteners; shoe fasteners; fastenings for clothing; fastenings for suspenders; belt clasps; hook and pile fastening tapes; zip fasteners; zippers for bags; badges for wear, not of precious metal; competitors' numbers; embroidery needles; needles for wool combing machines; binding needles; saddlers' needles; shoemakers' needles; sewing needles; darning needles; needles; boxes for needles; lace trimmings; embroidery; haberdashery [dressmakers' articles], except thread; decorative articles for the hair; heat adhesive patches for decoration of textile articles [haberdashery]; edgings for clothing; braids; gold embroidery; silver embroidery; bobbins for retaining embroidery floss or wool [not parts of machines]; tassels [haberdashery]; snap fasteners; sewing boxes; plaited hair; false hems; hooks [haberdashery]; crochet hooks; rug hooks; hooks for corsets; shoe hooks; haberdashery ribbons; ribbons for the hair; ribbons and bows, not of paper, for gift wrapping; prize ribbons; hatbands; elastic ribbons; letters for marking linen; numerals for marking linen; monogram tabs for marking linen; sewing kits; toupees; sewing thimbles; needle-threaders; skirt flounces; bows for the hair; spangles for clothing; hair curling papers; wigs; feathers [clothing accessories]; birds' feathers [clothing accessories]; ostrich feathers [clothing accessories]; eyelets for clothing; picot [lace]; corset busks; hair bands; brassards; tapes for curtain headings; shoulder pads for clothing; pin cushions; needle cushions; top-knots [pompoms]; hair curlers, electric and non-electric, other than hand implements; buckles [clothing accessories]; shoe buckles; buttons; ornamental novelty badges [buttons]; artificial plants, other than Christmas trees; rosettes [haberdashery]; frills for clothing; hair nets; chenille [passementerie]; knitting needles; cords for trimming; shoe trimmings; trimmings for clothing; hat trimmings; false moustaches; festoons [embroidery]; artificial fruit; needle cases; artificial flowers; shuttles for making fishing nets; hair colouring caps; bodkins; hair extensions; shoe laces; cords for clothing; woollen laces; hair pins; hair curling pins; collar supports.

27 – Artificial turf; yoga mats; floor mats, fire-resistant, for fireplaces and barbecues; carpets; decorative wall hangings, not of textile; carpets for automobiles; bath mats; non-slip mats; linoleum; mats of woven rope for ski slopes; wallpaper; textile wallpaper; carpet underlay; gymnastic mats; vinyl floor coverings; floor coverings; door mats; mats; reed mats.

28 – Arcade video game machines; video game machines; gaming machines for gambling; amusement machines, automatic and coin-operated; toy vehicles; swimming pools [play articles]; trampolines; novelty toys for parties; scratch cards for playing lottery

games; starting blocks for sports; bodyboards; skating boots with skates attached; dolls' feeding bottles; tri-cycles for infants [toys]; stationary exercise bicycles; creels [fishing traps]; shuttlecocks; spinning tops [toys]; dumb-bells; gyroscopes and flight stabilizers for model aircraft; jigsaw puzzles; clay pigeons [targets]; punching bags; bite sensors [fishing tackle]; hang gliders; joysticks for video games; flying discs [toys]; discs for sports; dolls' houses; dominoes; swimming kickboards; paddleboards; surfboards; spring boards [sports articles]; skateboards; sailboards; chessboards; draughtboards; drones [toys]; darts; Christmas trees of synthetic material; cups for dice; swimming jackets; ascenders [mountaineering equipment]; kites; needles for pumps for inflating balls for games; toys for pets; stuffed toys; plush toys; toy mobiles; novelty toys for playing jokes; toys; portable games and toys incorporating telecommunication functions; board games; table-top games; ring games; games; building games; toy imitation cosmetics; swimming pool air floats; kaleidoscopes; bladders of balls for games; rosin used by athletes; edges of skis; bingo cards; playing cards; fairground ride apparatus; reels for fishing; rocking horses; swings; skittles; skittles [games]; billiard cues; golf clubs; hockey sticks; baby gyms; seal skins [coverings for skis]; bells for Christmas trees; dolls' rooms; controllers for game consoles; controllers for toys; confetti; ice skates; roller skates; in-line roller skates; dice; paintball guns [sports apparatus]; ski bindings; dolls' beds; roulette wheels; fish hooks; building blocks [toys]; dolls; flippers for swimming; rhythmic gymnastics ribbons; fishing lines; gut for fishing; bows for archery; skis; water-skis; surf skis; mah-jong; toy models; hunting game calls; puppets; masks [playthings]; carnival masks; theatrical masks; fencing masks; toy putty; matryoshka dolls; masts for sailboards; ball pitching machines; teddy bears; chalk for billiard cues; targets; electronic targets; scale model kits [toys]; scale model vehicles; kite reels; balls for games; artificial fishing bait; billiard table cushions; knee guards [sports articles]; billiard cue tips; elbow guards [sports articles]; backgammon games; pumps specially adapted for use with balls for games; dolls' clothes; fencing weapons; twirling batons; paragliders; pachinkos; baseball gloves; boxing gloves; golf gloves; gloves for games; batting gloves [accessories for games]; fencing gauntlets; pinatas; toy pistols; toy air pistols; percussion caps [toys]; caps for pistols [toys]; toy dough; protective films adapted for screens for portable games; rattles [playthings]; horseshoe games; candle holders for Christmas trees; Christmas tree stands; sole coverings for skis; water wings; floats for fishing; portable games with liquid crystal displays; swimming belts; decoys for hunting or fishing; scent lures for hunting or fishing; archery implements; soap bubbles [toys]; divot repair tools [golf accessories]; billiard markers; protective paddings [parts of sports suits]; rackets; surfboard leashes; harness for sailboards; weight lifting

belts [sports articles]; toy robots; sling shots [sports articles]; rollers for stationary exercise bicycles; harpoon guns [sports articles]; plush toys with attached comfort blanket; scooters [toys]; sleds [sports articles]; bob-sleighs; butterfly nets; landing nets for anglers; nets for sports; tennis nets; bite indicators [fishing tackle]; slot machines [gaming machines]; appliances for gymnastics; quoits; bar-bells; climbers' harness; fishing tackle; artificial snow for Christmas trees; snowshoes; snowboards; remote-controlled toy vehicles; clay pigeon traps; billiard tables; coin-operated billiard tables; tables for table tennis; strings for rackets; gut for rackets; cricket bags; golf bags, with or without wheels; golf bag trolleys; slides [playthings]; body-building apparatus; machines for physical exercises; men's athletic supporters [sports articles]; rods for fishing; ornaments for Christmas trees, except illumination articles and confectionery; tennis ball throwing apparatus; conjuring apparatus; apparatus for games; bowling apparatus and machinery; toy figures; counters [discs] for games; chips for gambling; foosball tables; party poppers [party novelties]; Christmas crackers [party novelties]; bags especially designed for skis and surfboards; marbles for games; billiard balls; balls for playing bowls; play balloons; paintballs [ammunition for paintball guns] [sports apparatus]; snow globes; chess games; draughts [games]; poles for pole vaulting; paper party hats; shin guards [sports articles]; camouflage screens [sports articles]; chest expanders [exercisers].

29 – Ajvar being preserved peppers; aloe vera prepared for human consumption; alginates for culinary purposes; anchovy, not live; peanuts, prepared; artichokes, preserved; albumen for culinary purposes; white of eggs; beans, preserved; soya beans, preserved, for food; broth; ginger jam; ham; fatty substances for the manufacture of edible fats; laver, preserved; edible birds' nests; sea-cucumbers, not live; peas, preserved; mushrooms, preserved; guacamole; game, not live; gelatine; meat jellies; jellies for food; fruit jelly spreads; yolk of eggs; coconut fat; bone oil for food; lard; suet for food; edible fats; rennet; fruit-based snack food; milk substitutes; soya patties; tofu patties; charcuterie; cottage cheese fritters; raisins; caviar; aubergine paste; vegetable marrow paste; fish roe, prepared; yogurt; galbi being grilled meat dish; sauerkraut; kephir; kimchi [fermented vegetable dish]; isinglass for food; clams, not live; potato-based dumplings; klipfish [salted and dried cod]; milk shakes; black pudding; onion rings; arrangements of processed fruit; compotes; meat, tinned; vegetables, tinned; fish, tinned; fruits, tinned; broth concentrates; corn dogs; gherkins; shrimps, not live; prawns, not live; buttercream; croquettes; silkworm chrysalis for human consumption; sweet corn, processed; koumiss; spiny lobsters, not live; lecithin for culinary purposes; salmon, not live; onions, preserved; margarine; marmalade; oils for food; peanut butter; cocoa butter for food; coconut oil for food; coconut butter; maize oil for food;

sesame oil for food; linseed oil for food; extra virgin olive oil for food; olive oil for food; palm oil for food; palm kernel oil for food; sunflower oil for food; rape oil for food; butter; soya bean oil for food; mussels, not live; almonds, ground; animal marrow for food; molluscs, not live; milk; peanut milk; peanut milk for culinary purposes; coconut milk; coconut milk for culinary purposes; almond milk; almond milk for culinary purposes; oat milk; rice milk; rice milk for culinary purposes; albumin milk; condensed milk; soya milk; powdered milk; fish meal for human consumption; vegetable mousses; fish mousses; fruit pulp; meat; meat, preserved; freeze-dried meat; milk beverages, milk predominating; peanut milk-based beverages; coconut milk-based beverages; almond milk-based beverages; edible insects, not live; sausage casings, natural or artificial; vegetables, preserved; freeze-dried vegetables; vegetables, dried; vegetables, cooked; potato fritters; olives, preserved; lobsters, not live; flavoured nuts; candied nuts; coconut, desiccated; nuts, prepared; tomato paste; pressed fruit paste; liver pâté; pectin for culinary purposes; liver; pickles; jams; powdered eggs; milk products; fish-based foodstuffs; prostokvasha being soured milk; poultry, not live; bulgogi; pollen prepared as foodstuff; cranberry compote; tomato purée; apple purée; crayfish, not live; crustaceans, not live; fish, preserved; fish, not live; salted fish; ryazhenka being fermented baked milk; vegetable salads; fruit salads; bacon; sardines, not live; pork; herrings, not live; seeds, prepared; sunflower seeds, prepared; cream [dairy products]; whipped cream; vegetable-based cream; fat-containing mixtures for bread slices; smetana; lemon juice for culinary purposes; tomato juice for cooking; vegetable juices for cooking; salted meats; sausages; sausages in batter; hot dog sausages; preparations for making bouillon; preparations for making soup; nut-based spreads; tripe; soups; vegetable soup preparations; whey; cheese; tahini [sesame seed paste]; tofu; truffles, preserved; tuna, not live; oysters, not live; falafel; milk ferments for culinary purposes; fish fillets; dates; crystallized fruits; frozen fruits; fruit, preserved; fruit preserved in alcohol; fruit, stewed; hazelnuts, prepared; potato flakes; hummus [chickpea paste]; fruit peel; preserved garlic; lentils, preserved; potato crisps; low-fat potato crisps; fruit chips; non-alcoholic eggnog; seaweed extracts for food; meat extracts; escamoles being prepared edible ant larvae; yuba being tofu skin; berries, preserved; snail eggs for consumption; eggs; yakitori.

30 – Vanilla flavourings for culinary purposes; flavourings, other than essential oils, for cakes; flavourings, other than essential oils, for beverages; coffee flavourings; food flavourings, other than essential oils; star aniseed; baozi [steamed stuffed buns]; cereal bars; high-protein cereal bars; pancakes; noodle-based prepared meals; freeze-dried dishes with the main ingredient being pasta; freeze-dried dishes with the main ingredient being rice; buns; bulgur; bread rolls;

edible rice paper; edible paper; burritos; vanillin [vanilla substitute]; vareniki [stuffed dumplings]; waffles; vermicelli; natural sweeteners; sausage binding materials; binding agents for ice cream; seawater for cooking; seaweed [condiment]; malt biscuits; cloves [spice]; mirror icing [mirror glaze]; cake frosting [icing]; glucose for culinary purposes; mustard; croûtons; buckwheat, processed; gluten additives for culinary purposes; yeast; thickening agents for cooking foodstuffs; leaven; rice-based snack food; cereal-based snack food; coffee substitutes; vegetal preparations for use as coffee substitutes; dressings for salad; zephyr being confectionery; fruit jellies [confectionery]; candy decorations for cakes; confectionery for decorating Christmas trees; cakes; pastries; peanut confectionery; almond confectionery; pasta; ginger [spie]; frozen yogurt [confectionery ices]; cocoa; cream of tartar for culinary purposes; capers; caramels [sweets]; curry [spice]; ketchup [sauce]; gimbap [Korean rice dish]; kimchijeon [fermented vegetable pancakes]; quinoa, processed; quiches; gluten prepared as foodstuff; flour-based dumplings; sweets; liquorice [confectionery]; peppermint sweets; mints for breath freshening; dulce de leche; cinnamon [spice]; coffee; unroasted coffee; starch for food; crackers; custard; hominy grits; semolina; oatmeal; crushed barley; groats for human food; ice cubes; corn, milled; corn, roasted; meat pies; turmeric; couscous [semolina]; noodles; soba noodles; udon noodles; ice for refreshment; ice, natural or artificial; edible ices; lollipops [confectionery]; rice cakes; potato-based flatbreads; mayonnaise; macarons [pastries]; macaroni; maltose; hominy; piccalilli; marinades; marzipan; honey; miso; royal jelly; ice cream; bean meal; buckwheat flour; tapioca flour; potato flour; corn flour; nut flours; flour; wheat flour; soya flour; barley meal; confectionery in the form of mousses; chocolate mousses; muesli; mint for confectionery; cocoa beverages with milk; coffee beverages with milk; coffee-based beverages; cocoa-based beverages; chamomile-based beverages; tea-based beverages; chocolate beverages with milk; chocolate-based beverages; infusions, not medicinal; crushed oats; husked oats; okonomiyaki [Japanese savory pancakes]; onigiri; nutmegs; chocolate-coated nuts; stick liquorice [confectionery]; pastila [confectionery]; lozenges [confectionery]; molasses for food; pâtés en croûte; pelmeni [dumplings stuffed with meat]; pepper; allspice; peppers [seasonings]; pesto; biscuits; petit-beurre biscuits; bibimbap [rice mixed with vegetables and beef]; pies; pizzas; meat gravies; fondants [confectionery]; popcorn; powders for making ice cream; baking powder; mustard meal; pralines; aromatic preparations for food; condiments; meat tenderizers for household purposes; cereal preparations; oat-based food; propolis; gingerbread; spices; petits fours; rice pudding; puddings; cake powder; fruit colulis [sauces]; ravioli; ramen noodles; chewing gum for breath freshening; chewing gum; relish [condiment]; rice; instant rice; wheat germ for human con-

sumption; spring rolls; sago; palm sugar; sugar; sesame seeds [seasonings]; linseed for culinary purposes [seasoning]; processed seeds for use as a seasoning; aniseed; agave syrup [natural sweetener]; golden syrup; candy bars; batter mixes for okonomiyaki [Japanese savory pancakes]; baking soda [bicarbonate of soda for cooking purposes]; malt for human consumption; salt for preserving foodstuffs; cooking salt; celery salt; sorbets [ices]; ham glaze; cranberry sauce [condiment]; soya sauce; tomato sauce; apple sauce [condiment]; sauces [condiments]; pasta sauce; spaghetti; seasonings; chocolate-based spreads; chocolate spreads containing nuts; preparations for stiffening whipped cream; shaved ice with sweetened red beans; rusks; breadcrumbs; sushi; rice crackers; sandwiches; tabbouleh; tacos; tapioca; tarts; dough; pastry dough; almond paste; rice pulp for culinary purposes; cake batter; tortillas; garden herbs, preserved [seasonings]; chocolate decorations for cakes; vinegar; beer vinegar; ferments for pastes; halvah; unleavened bread; bread; chips [cereal products]; corn flakes; oat flakes; hot dog sandwiches; flowers or leaves for use as tea substitutes; jiaozi [stuffed dumplings]; chicory [coffee substitute]; tea; iced tea; chutneys [condiments]; minced garlic [condiment]; cheeseburgers [sandwiches]; chow-chow [condiment]; saffron [seasoning]; chocolate; malt extract for food; essences for foodstuffs, except etheric essences and essential oils; husked barley.

31 – Algarovilla for animal consumption; anchovy, live; oranges, fresh; peanuts, fresh; artichokes, fresh; draff; beans, fresh; Locust beans, raw; wreaths of natural flowers; grapes, fresh; algae, unprocessed, for human or animal consumption; fruit residue [marc]; dog biscuits; sea-cucumbers, live; peas, fresh; buckwheat, unprocessed; mushroom spawn for propagation; mushrooms, fresh; trees; palm trees; turf, natural; unsawn timber; undressed timber; yeast for animal consumption; Christmas trees; edible chews for animals; live animals; menagerie animals; peanut cake for animals; oil cake; maize cake for cattle; rape cake for cattle; bagasses of cane [raw material]; cereal seeds, unprocessed; grains [cereals]; grains for animal consumption; lime for animal forage; fish spawn; vegetable marrows, fresh; cocoa beans, raw; koi carp, live; Potatoes, fresh; chestnuts, fresh; quinoa, unprocessed; arrangements of fresh fruit; copra; raw barks; rough cork; animal foodstuffs; pet food; stall food for animals; bird food; strengthening animal forage; chicory roots; roots for animal consumption; nettles; groats for poultry; maize; edible sesame, unprocessed; shrubs; rose bushes; spiny lobsters, live; lemons, fresh; vine plants; salmon, live; onions, fresh; flower bulbs; leeks, fresh; olives, fresh; bran mash for animal consumption; mussels, live; almonds [fruits]; molluscs, live; peanut meal for animals; linseed meal for animal consumption; meal for animals; flax meal [fodder]; rice meal for forage; fish meal for animal consumption; straw mulch; beverages for pets; edible insects, live; oats; vegetables, fresh; cucumbers, fresh;

lobsters, live; fresh and unprocessed nuts; coconuts; kola nuts; bran; distillery waste for animal consumption; residue in a still after distillation; palms [leaves of the palm tree]; cuttle bone for birds; peppers [plants]; aromatic sand [litter] for pets; citrus fruit, fresh; litter for animals; mash for fattening livestock; unprocessed sweet corn ears [husked or unhusked]; animal fattening preparations; preparations for egg laying poultry; fishing bait, live; by-products of the processing of cereals, for animal consumption; seed germ for botanical purposes; poultry, live; wheat; pollen [raw material]; crayfish, live; crustaceans, live; seedlings; plants; aloe vera plants; plants, dried, for decoration; rhubarb, fresh; rice, unprocessed; rye; wheat germ for animal consumption; fish, live; lettuce, fresh; sardines, live; beet, fresh; herrings, live; seeds for planting; linseed for animal consumption; edible linseed, unprocessed; hay; coconut shell; bred stock; sanded paper [litter] for pets; malt for brewing and distilling; straw [forage]; straw litter; salt for cattle; trunks of trees; wood chips for the manufacture of wood pulp; litter peat; garden herbs, fresh; sugarcane; truffles, fresh; tuna, live; squashes, fresh; oysters, live; fruit, fresh; hazelnuts, fresh; fodder; hops; flowers, natural; flowers, dried, for decoration; chicory, fresh; silkworms; garlic, fresh; lentils, fresh; pine cones; hop cones; spinach, fresh; juniper berries; berries, fresh; eggs for hatching, fertilized; silkworm eggs; barley.

32 – Aperitifs, non-alcoholic; barley wine [beer]; lithia water; seltzer water; soda water; waters [beverages]; carbonated water; mineral water [beverages]; table waters; kvass; cocktails, non-alcoholic; beer-based cocktails; lemonades; non-alcoholic beverages; isotonic beverages; non-alcoholic honey-based beverages; rice-based beverages, other than milk substitutes; soya-based beverages, other than milk substitutes; aloe vera drinks, non-alcoholic; whey beverages; protein-enriched sports beverages; soft drinks; non-alcoholic beverages flavoured with coffee; non-alcoholic beverages flavoured with tea; non-alcoholic fruit juice beverages; energy drinks; fruit nectars, non-alcoholic; orgeat; beer; ginger beer; malt beer; powders for effervescing beverages; sarsaparilla [non-alcoholic beverage]; syrups for lemonade; syrups for beverages; smoothies; tomato juice [beverage]; cider, non-alcoholic; vegetable juices [beverages]; fruit juices; preparations for making non-alcoholic beverages; malt extracts for making liquors; preparations for making beverages; must; grape must, unfermented; beer wort; malt wort; pastilles for effervescing beverages; sherbets [beverages] infused with alcohol; non-alcoholic fruit extracts; extracts of hops for making beer.

33 – Aperitifs; arrack [arak]; baijiu [Chinese distilled alcoholic beverage]; brandy; wine; piquette; whisky; vodka; anisette [liqueur]; kirsch; gin; digestifs [liqueurs and spirits]; cocktails; curacao; anise [liqueur];

liqueurs; pre-mixed alcoholic beverages, other than beer-based; alcoholic beverages, except beer; alcoholic beverages containing fruit; spirits [beverages]; distilled beverages; hydromel [mead]; peppermint liqueurs; bitters; nira [sugarcane-based alcoholic beverage]; rum; sake; perry; cider; rice alcohol; alcoholic extracts; fruit extracts, alcoholic; alcoholic essences.

34 – Flavourings, other than essential oils, for use in electronic cigarettes; flavourings, other than essential oils, for tobacco; gas containers for cigar lighters; absorbent paper for tobacco pipes; cigarette paper; lighters for smokers; tobacco pouches; books of cigarette papers; humidors; matchboxes; firestones; cigar cutters; cigar holders; cigarette holders; mouthpieces for cigarette holders; tips of yellow amber for cigar and cigarette holders; ashtrays for smokers; spittoons for tobacco users; pipe racks for tobacco pipes; pipe cleaners for tobacco pipes; liquid solutions for use in electronic cigarettes; electronic cigarettes; cigarettes; cigarettes containing tobacco substitutes, not for medical purposes; cigarillos; cigars; tobacco jars; match holders; matches; oral vaporizers for smokers; tobacco; chewing tobacco; snuff; snuffboxes; herbs for smoking; tobacco pipes; pocket machines for rolling cigarettes; cigarette filters; cigarette tips; cigar cases; cigarette cases.

35 – Arranging subscriptions to telecommunication services for others; import-export agency services; commercial information agency services; advertising agency services; cost price analysis; rental of advertising space; business auditing; financial auditing; business intermediary services relating to the matching of potential private investors with entrepreneurs needing funding; employment agency services; computerized file management; book-keeping; invoicing; demonstration of goods; transcription of communications [office functions]; opinion polling; market studies; providing business information; providing commercial information and advice for consumers in the choice of products and services; business investigations; business research; marketing research; personnel recruitment; business management and organization consultancy; business organization consultancy; business management consultancy; personnel management consultancy; professional business consultancy; consultancy regarding public relations communication strategies; consultancy regarding advertising communication strategies; layout services for advertising purposes; marketing; marketing in the framework of software publishing; targeted marketing; business management of performing artists; business management of sports people; writing of curriculum vitae for others; scriptwriting for advertising purposes; news clipping services; updating and maintenance of information in registries; updating and maintenance of data in computer databases; updating of advertising material; word processing; online retail services for downloadable and pre-recorded music and movies; online retail

services for downloadable ring tones; online retail services for downloadable digital music; organization of exhibitions for commercial or advertising purposes; arranging newspaper subscriptions for others; organization of fashion shows for promotional purposes; organization of trade fairs for commercial or advertising purposes; shop window dressing; business appraisals; payroll preparation; data search in computer files for others; sponsorship search; administrative assistance in responding to calls for tenders; business management assistance; commercial or industrial management assistance; commercial intermediation services; providing business information via a website; providing commercial and business contact information; provision of an online marketplace for buyers and sellers of goods and services; web indexing for commercial or advertising purposes; presentation of goods on communication media, for retail purposes; economic forecasting; auctioneering; retail services for works of art provided by art galleries; sales promotion for others; promotion of goods and services through sponsorship of sports events; production of teleshopping programmes; production of advertising films; office machines and equipment rental; rental of advertising time on communication media; publicity material rental; rental of billboards [advertising boards]; rental of vending machines; rental of sales stands; rental of photocopying machines; publication of publicity texts; radio advertising; bill-posting; distribution of samples; dissemination of advertising matter; direct mail advertising; registration of written communications and data; editing of publicity texts; advertising; online advertising on a computer network; outdoor advertising; advertising by mail order; television advertising; document reproduction; compilation of statistics; compilation of information into computer databases; business inquiries; systemization of information into computer databases; advisory services for business management; negotiation of business contracts for others; negotiation and conclusion of commercial transactions for third parties; compiling indexes of information for commercial or advertising purposes; tax preparation; drawing up of statements of accounts; telemarketing services; psychological testing for the selection of personnel; wholesale services for pharmaceutical, veterinary and sanitary preparations and medical supplies; retail services for pharmaceutical, veterinary and sanitary preparations and medical supplies; interim business management; outsourced administrative management for companies; business management of hotels; business management for freelance service providers; business project management services for construction projects; commercial administration of the licensing of the goods and services of others; business management of reimbursement programmes for others; administration of consumer loyalty programs; administration of frequent flyer programs; administrative processing of purchase orders; public relations; competitive intelligence servi-

ces; modelling for advertising or sales promotion; typing; market intelligence services; appointment reminder services [office functions]; website traffic optimization; administrative services for the relocation of businesses; tax filing services; search engine optimization for sales promotion; appointment scheduling services [office functions]; gift registry services; price comparison services; pay per click advertising; secretarial services; procurement services for others [purchasing goods and services for other businesses]; shorthand; outsourcing services [business assistance]; telephone answering for unavailable subscribers; photocopying services; business efficiency expert services.

40 – Paper finishing; applying finishes to textiles; up-cycling [waste recycling]; vulcanization [material treatment]; skin dressing; fruit crushing; embroidering; galvanization; zinc plating; electroplating; engraving; decontamination of hazardous materials; air deodorizing; stripping finishes; tanning; metal tempering; freezing of foods; gilding; gold plating; providing information relating to material treatment; cadmium plating; permanent-press treatment of fabrics; food and drink preservation; food smoking; leather staining; fur dyeing; shoe staining; textile dyeing; cloth dyeing; laminating; lithographic printing; metal casting; fur glossing; tin plating; boilermaking; taxidermy; magnetization; nickel plating; abrasion; paper treating; water treating; woodworking; processing of cinematographic films; leather working; cloth edging; metal treating; fur conditioning; fur mothproofing; waste treatment [transformation]; textile mothproofing; cloth waterproofing; crease-resistant treatment for clothing; cloth fireproofing; textile treating; wool treating; framing of works of art; window tinting treatment being surface coating; air freshening; fabric bleaching; air purification; soldering; clothing alteration; recycling of waste and trash; processing of oil; pattern printing; photographic printing; offset printing; metal plating; printing; burnishing by abrasion; flour milling; dressmaking; rental of boilers; knitting machine rental; rental of electricity generators; rental of air-conditioning apparatus; rental of space heating apparatus; photographic film development; pottery firing; blacksmithing; custom assembly of products for others; bookbinding; welding services; glass-blowing; saddlery working; grinding; cloth cutting; sawing of materials; refining services; timber felling and processing; fur satining; silver plating; incineration of waste and trash; laser scribing; warping [looms]; sorting of waste and recyclable material [transformation]; photo-composing services; quilting; planing of materials; fulling of cloth; tinting of car windows; slaughtering of animals; destruction of waste and trash; cloth pre-shrinking; services of a dental technician; cryopreservation services; key cutting; dyeing services; sand-blasting services; production of energy; custom tailoring; custom fashioning of fur; photogravure; mill-

working; chromium plating; colour separation services; silkscreen printing; optical glass grinding.

41 – Modelling for artists; academies [education]; rental of indoor aquaria; rental of artwork; rental of sports grounds; rental of tennis courts; lending library services; booking of seats for shows; videotaping; physical education; production of music; discotheque services; animal training; dubbing; gambling services; publication of books; providing information in the field of education; providing information relating to recreational activities; providing information in the field of entertainment; movie studio services; health club services [health and fitness training]; nightclub services [entertainment]; layout services, other than for advertising purposes; microfilming; videotape editing; production of radio and television programmes; screenplay writing; game services provided online from a computer network; providing online electronic publications, not downloadable; religious education; aikido instruction; gymnastic instruction; correspondence courses; practical training [demonstration]; training services provided via simulators; organization of balls; organization of exhibitions for cultural and educational purposes; providing recreation facilities; arranging and conducting of colloquiums; arranging and conducting of congresses; arranging and conducting of conferences; arranging and conducting of concerts; arranging and conducting of workshops [training]; arranging and conducting of in-person educational forums; arranging and conducting of seminars; arranging and conducting of symposiums; organization of competitions [education or entertainment]; arranging of beauty contests; organization of cosplay entertainment events; organization of lotteries; organization of fashion shows for entertainment purposes; organization of shows [impresario services]; organization of sports competitions; vocational guidance [education or training advice]; amusement park services; sign language interpretation; television entertainment; mobile library services; vocational retraining; providing online videos, not downloadable; providing online music, not downloadable; providing television programmes, not downloadable, via video-on-demand services; providing films, not downloadable, via video-on-demand services; providing golf facilities; providing sports facilities; providing amusement arcade services; cinema presentations; presentation of circus performances; presentation of variety shows; presentation of live performances; theatre productions; conducting guided climbing tours; conducting fitness classes; educational examination; film production, other than advertising films; rental of audio equipment; rental of video cameras; rental of video cassette recorders; rental of videotapes; rental of show scenery; rental of sound recordings; toy rental; rental of cinematographic apparatus; rental of motion pictures; games equipment rental; rental of stadium facilities; rental of lighting apparatus for theatrical sets or television studios; rental of radio and television sets;

rental of skin diving equipment; rental of sports equipment, except vehicles; rental of stage scenery; electronic desktop publishing; online publication of electronic books and journals; publication of texts, other than publicity texts; radio entertainment; entertainer services; entertainment services; writing of texts; sado instruction [tea ceremony instruction]; zoological garden services; news reporters services; party planning [entertainment]; music composition services; subtitling; tutoring; holiday camp services [entertainment]; conducting guided tours; disc jockey services; personal trainer services [fitness training]; providing casino facilities [gambling]; calligraphy services; karaoke services; club services; songwriting; cultural, educational or entertainment services provided by art galleries; providing museum facilities; teaching; educational services provided by schools; orchestra services; translation; scriptwriting, other than for advertising purposes; ticket agency services [entertainment]; coaching [training]; sport camp services; recording studio services; language interpretation; nursery schools; photography; photographic reporting; timing of sports events; boarding school education; production of shows.

43 – Accommodation bureau services [hotels, boarding houses]; rental of temporary accommodation; rental of meeting rooms; tourist home services; hotel reservations; boarding house bookings; temporary accommodation reservations; hotel accommodation services; retirement home services; snack-bar services; café services; cafeteria services; motel services; boarding house services; boarding for animals; rental of cooking apparatus; rental of chairs, tables, table linen, glassware; rental of lighting apparatus; rental of tents; rental of transportable buildings; rental of drinking water dispensers; restaurant services; self-service restaurant services; reception services for temporary accommodation [management of arrivals and departures]; food sculpting; canteen services; holiday camp services [lodging]; bar services; providing campground facilities; food and drink catering; washoku restaurant services; udon and soba restaurant services; day-nursery [crèche] services.

(260) AM 2024 122699 A

(800) 1727670

(151) 2023 03 10

(891) 2023 03 10

(731) DURUKAN ŞEKERLEME SANAYİ VE
TİCARET ANONİM ŞİRKETİ
AHİ EVRAN OSB MAHALLESİ, DAĞISTAN
CADDESİ 11 1, SİNCAN, ANKARA, Türkiye

(540)



(591) Black, dark green, light green, brown, yellow, white

(531) 02.05.01; 02.05.03; 02.05.23; 26.01.01;
26.01.05; 26.01.14; 26.01.19; 27.01.12;
27.05.03; 27.05.17; 29.01.14

(511)

30 – Coffee, tea, cocoa and substitutes therefor; rice, pasta and noodles; tapioca and sago; flour and preparations made from cereals; bread, pastries and confectionery; chocolate; ice cream, sorbets and other edible ices; sugar, honey, treacle; yeast, baking-powder; salt, seasonings, spices, preserved herbs; vinegar, sauces and other condiments; ice (frozen water).

(260) AM 2024 122714 A

(800) 1728151

(151) 2023 03 22

(891) 2023 03 22

(731) Revolution Beauty Holdings Ltd
2-3 Sheet Glass Road, Cullet Drive,
Queenborough, Kent ME11 5JS, United
Kingdom

(540)

REVOLUTION SKIN

(591) Black, white

(531) 27.05.01; 27.05.10

(511)

3 – Body and beauty care cosmetics; beauty creams for body care; cosmetic preparations for skin care; cosmetic preparations for skin renewal; cosmetic skin fresheners; moisturizing preparations for the skin; non-medicated skin care creams and lotions; non-medicated skin care preparations, namely, creams, lotions, gels, toners, cleaners and peels; skin and body topical lotions, creams and oils for cosmetic use; moisturizing oil, anti-wrinkle oil, facial oil, hand oil, body oil, foot oil, perfumed oil, body shimmer oil; skin cleansers; toning lotions for the face, body and hands; skin moisturisers; skin conditioners; skin emollients; skin lighteners; moisturizing facial masks; anti-wrinkle facial masks, facial beauty masks; facial scrubs, foot scrubs, hand scrubs, body scrubs; soaps for body care; bath and shower preparations; cosmetic preparations for protecting the skin from the sun's rays; non-medicated sun care preparations; after-sun care lotions; cosmetic self-tanning preparations; topical skin sprays for cosmetic purposes, topical skin sprays for hydrating the skin, topical skin sprays for fixing body makeup; preparations and products for removing make-up; wipes impregnated with a skin cleanser; body sprays; face sprays, facial makeup fixing sprays, facial makeup setting sprays, face refreshing sprays, face cooling sprays for cosmetic purposes; wrinkle removing skin care preparations; eye compresses for cosmetic purposes.

(260) AM 2024 122717 A
 (800) 1173057
 (151) 2013 04 11
 (891) 2023 04 17
 (731) NUTRILAB GRAND FONTAINE, S.L.U.
 Valencia, 287, 2º 1ª, E-08009 Barcelona, Spain
 (540)

FONTACTIV

(591) Black, white
 (511)
 5 – Pharmaceutical and veterinary products; Sanitary products for medical use; Dietetic food and substances for medical or veterinary use, food for babies; Nutritional supplements for humans and animals; Plasters, materials for dressings; Teeth filling and dental impression materials; Disinfectants; Pest control products; Fungicides, herbicides.

(260) AM 2024 122757 A
 (800) 1728171
 (151) 2023 02 13
 (891) 2023 02 13
 (731) "ARGEMONA" EOOD
 bul."Zar Osvoboditel" 10, fl.3, BG-1000 Sofia,
 Bulgaria
 (540)



MEDITERRANEAN RESTAURANT

(591) Blue, white
 (531) 03.09.15; 03.09.24; 07.15.08; 07.15.25;
 26.01.05; 26.01.15; 27.05.01; 29.01.12
 (511)
 35 – Business management of restaurants; business advice relating to restaurant franchising; business management assistance in the operation of restaurants; business advisory services relating to the running of restaurants; marketing services in the field of restaurants; restaurant management for others; business management assistance in the establishment and operation of restaurants; business advisory services relating to the setting up of restaurants; business management of hotels; business management of resort hotels.

41 – Hospitality services (entertainment); provision of entertainment facilities in hotels.

43 – Delicatessens [restaurants]; restaurant services provided by hotels; restaurant services; spanish restaurant services; hotel restaurant services; provision of information relating to restaurants; providing reviews of restaurants; booking of restaurant seats; providing food and drink for guests in restaurants; serving food

and drink for guests in restaurants; serving food and drink in restaurants and bars; carvery restaurant services; providing reviews of restaurants and bars; restaurant reservation services; restaurant information services; bar and restaurant services; making reservations and bookings for restaurants and meals; tea rooms; providing food and drink in restaurants and bars; hotel services; hotel reservations; information relating to hotels; resort hotel services; hotel catering services; arranging of meals in hotels; provision of hotel accommodation; provision of information relating to hotels; electronic information services relating to hotels.

(260) AM 2024 122759 A
 (800) 1728196
 (151) 2023 02 28
 (891) 2023 02 28
 (731) Nan Wang
 No. 38, Group 5, Xintang Village, Dailou
 Town, Jinhu County, 211600 Jiangsu, China
 (540)

CONAN

(591) Black, white
 (531) 27.05.01
 (511)
 7 – Wrapping machines; electric hammers; circular saw blade (machine part); screwdrivers, electric; oil pumps for vehicles; grease boxes [parts of machines]; welding machines, electric.
 8 – Emery grinding wheels; hand tools, hand-operated; picks [hand tools]; garden tools, hand-operated; livestock marking tools; beard clippers; pliers; riveters [hand tools]; spatulas [hand tools]; tree pruners.

(260) AM 2024 122769 A
 (800) 1728345
 (151) 2023 03 02
 (891) 2023 03 02
 (731) SHENZHEN ITZR TECHNOLOGY CO.,
 LTD.
 Building 101, No. 1600003, Tangqian Industrial
 Zone, Zhangge community, Fucheng street,
 Longhua District, Shenzhen, Guangdong, China
 (540)

BENEWISEN

(591) Black, white
 (531) 27.05.01
 (511)
 9 – Computers; display screens; notebook computers; computer hardware; computer motherboards; tablet computers; computer peripheral devices; laptop computers; integrated circuits; smartphones.

(260) AM 2024 122772 A

(800) 1728365

(151) 2023 02 13

(891) 2023 02 13

(731) "ARGEMONA" EOOD

bul."Zar Osvoboditel" 10, fl.3, BG-1000 Sofia,
Bulgaria

(540)



MI-17

CONFERENCE CENTER

(591) Pantone 877 C.

(531) 02.01.01; 02.01.23; 02.01.24; 07.15.08;
07.15.25; 26.01.05; 26.01.14; 27.05.01;
27.07.01

(511)

35 – Business management of conference centers.

41 – Conference services; arranging of conferences; arrangement of conferences for educational purposes; conducting of business conferences; arranging and conducting of conferences; organisation of meetings and conferences; arranging of an annual educational conference; organisation of seminars and conferences; arranging and conducting educational conferences; arranging of conferences relating to business; arranging of conferences relating to trade; organisation of conferences, exhibitions and competitions; arranging of conferences relating to advertising; organisation of conferences related to entertainment; arrangement of conferences for recreational purposes; consultancy and information services relating to arranging, conducting and organisation of conferences; organisation of congresses and conferences for cultural and educational purposes; organisation of conferences and symposia in the field of medical science; arranging and conducting of commercial, trade and business conferences; arranging and conducting of conferences and congresses; arranging and conducting of conferences, congresses and symposiums; arranging of conferences relating to cultural activities; organisation of conferences relating to vocational training; arranging and conducting conferences and seminars; arranging of an annual conference relating to telecommunications; planning of conferences for educational purposes; arranging, conducting and organisation of conferences; seminars; educational seminars; organisation of seminars; workshops for cultural purposes; conducting of instructional seminars; organisation of seminars relating to training; organisation of seminars relating to education; arranging of workshops and seminars; conducting of seminars and congresses; organisation of continuing educational seminars; conducting works-

hops [training]; booking of entertainment halls; rental of entertainment halls.

43 – Catering services for conference centers; hiring of furniture for conferences; provision of conference, exhibition and meeting facilities; provision of conference facilities; providing conference rooms; rental of conference rooms; rental of meeting rooms; room rental for exhibitions; providing food and drink catering services for exhibition facilities; providing food and drink catering services for fair and exhibition facilities.

(260) AM 2024 122773 A

(800) 1728368

(151) 2023 02 13

(891) 2023 02 13

(731) "ARGEMONA" EOOD

bul."Zar Osvoboditel" 10, fl.3, BG-1000 Sofia,
Bulgaria

(540)



NIGHTFALL

NIGHT CLUB & LOUNGE

(591) Pantone 871 C.

(531) 07.15.08; 07.15.25; 11.03.02; 26.01.05;
26.01.16; 27.05.10; 29.01.11

(511)

35 – Business management of restaurants; business advice relating to restaurant franchising; business management assistance in the operation of restaurants; business advisory services relating to the running of restaurants; marketing services in the field of restaurants; restaurant management for others; business management assistance in the establishment and operation of restaurants; online ordering services in the field of restaurant take-out and delivery; business advisory services relating to the setting up of restaurants; business management of entertainment venues.

41 – Musical entertainment; entertainment services; provision of amusement facilities; providing recreation facilities.

43 – Salad bars; bar services; wine bar services; hookah lounge services; juice bars; snack-bar services; beer bar services; bar and restaurant services; provision of information relating to bars; providing reviews of restaurants and bars; providing information about bar services; serving beverages in brewpubs; serving food and drink in restaurants and bars; providing food and drink in restaurants and bars; restaurant services provided by hotels; delicatessens [restaurants]; restaurant services; hotel restaurant services; provision of information relating to restaurants; providing reviews

of restaurants; booking of restaurant seats; restaurant services incorporating licensed bar facilities; providing food and drink for guests in restaurants; serving food and drink for guests in restaurants; restaurant reservation services; restaurant information services; travel agency services for booking restaurants; making reservations and bookings for restaurants and meals; tea rooms.

(260) AM 2024 122775 A

(800) 1728424

(151) 2023 03 01

(891) 2023 03 01

(731) Chery Automobile Co., Ltd.

8 Changchun Road, Economy & Technology
Development Zone, Wuhu City, 241009
Anhui Province, China

(540)

JAECOO

(591) Black, white

(531) 27.05.01

(511)

37 – Heating equipment installation and repair; vehicle service stations [refuelling and maintenance]; vehicle battery charging; vehicle (automobile) maintenance; installation, maintenance and repair of computer hardware; rebuilding engines that have been worn or partially destroyed; motor vehicle maintenance and repair; leather care, cleaning and repair; tyre balancing; vehicle breakdown repair services.

(260) AM 2024 122776 A

(800) 1728436

(151) 2023 03 01

(891) 2023 03 01

(731) BERLIN-CHEMIE Aktiengesellschaft

Glienicker Weg 125, 12489 Berlin, Germany

(540)

ENDEBRO

(591) Black, white

(511)

3 – Balms, cosmetics, dentifrices, herbal extracts for cosmetic purposes, lavender oil, mouthwashes, shampoos, vaginal washes.

5 – Pharmaceuticals, dietetic substances adapted for medical use.

(260) AM 2024 122781 A

(800) 1728541

(151) 2022 11 21

(891) 2022 11 21

(731) Egis Gyógyszergyár Zrt.

Keresztúri út 30-38., H-1106 Budapest,
Hungary

(540)

XAVABAN

(591) Black, white

(511)

5 – Pharmaceutical preparations for human use; dietetic substances adapted for medical use; dietary supplements.

(260) AM 2024 122782 A

(800) 1728544

(151) 2022 11 21

(891) 2022 11 21

(731) Egis Gyógyszergyár Zrt.

Keresztúri út 30-38., H-1106 Budapest,
Hungary

(540)

EDOAC

(591) Black, white

(511)

5 – Pharmaceutical preparations for human use; dietetic substances adapted for medical use; dietary supplements.

(260) AM 2024 122783 A

(800) 1728555

(151) 2023 03 27

(891) 2023 03 27

(731) 1141931 ONTARIO LTD.

3605 Weston Rd, Toronto ON M9L 1V7,
Canada

(540)



(591) Black, white

(531) 24.01.05; 24.01.15; 27.05.01; 27.05.22

(511)

12 – Limousines and structural parts thereof; armored vehicles and structural parts thereof.

35 – Retail and wholesale store service featuring limousines and structural parts thereof; armored vehicles and structural parts thereof; on-line wholesale and retail store services featuring limousines and structural parts thereof, armored vehicles and structural parts thereof.

(260) AM 2024 122791 A

(800) 1728775

(151) 2023 03 06

(891) 2023 03 06

(731) Obshchestvo s ogranichennoi otvetstvennostyu
"Torgovyi dom "Vash Gold"
ul. Gorbunova, 2, str. 3, et./pom. 2/II, kom. 4,
Municipalnyi okrug Mozhaiskii vn.ter.g.,
RU-121596 Moscow, Russian Federation

(540)



(591) Black and green

(531) 03.01.06; 03.01.16; 03.01.24; 26.03.01;

26.03.05; 27.03.01; 27.03.03; 29.01.12

(511)

3 – Abrasives; amber [perfume]; descaling preparations for household purposes; antistatic preparations for household purposes; aromatics [essential oils]; air fragrancing preparations; cake flavourings [essential oils]; flavourings for beverages [essential oils]; food flavourings [essential oils]; breath freshening sprays; canned pressurized air for cleaning and dusting purposes; balms, other than for medical purposes; basma [cosmetic dye]; lip glosses; nail glitter; body glitter; polishing stones; abrasive paper; emery paper; polishing paper; petroleum jelly for cosmetic purposes; shoe polish; cobblers' wax; cotton wool for cosmetic purposes; cotton wool impregnated with make-up removing preparations; sachets for perfuming linen; drying agents for dishwashing machines; adhesives for cosmetic purposes; scented water; Javelle water; lavender water; micellar water; toilet water; wax for parquet floors; floor wax; non-slipping wax for floors; depilatory wax; moustache wax; tailors' wax; waxes for leather; polish for furniture and flooring; shoemakers' wax; polishing wax; massage gels, other than for medical purposes; heliotropine; dental bleaching gels; geraniol; make-up; deodorants for pets; deodorants for human beings or for animals; depilatory preparations; air fragrance reed diffusers; scented wood; perfumes; non-slipping liquids for floors; windscreen cleaning liquids; greases for cosmetic purposes; volcanic ash for cleaning; perfumery; decorative transfers for cosmetic purposes; ionone [perfumery]; shaving stones [astringents]; smoothing stones; eyebrow pencils; cosmetic pencils; silicon carbide [abrasive]; carbides of metal [abrasives]; alum stones [astringents]; tripoli stone for polishing; adhesives for affixing false eyelashes; adhesives for affixing false hair; hair conditioners; quillaia bark for washing; corundum [abrasive]; beard dyes; colorants for toilet purposes; cosmetic dyes; body paint for cosmetic purposes; laundry starch; laundry glaze; shoe cream; polishing creams; cosmetic creams; skin whitening creams; polishing rouge; incense; hair spray; nail varnish; liquid latex

body paint for cosmetic purposes; hair lotions; lotions for cosmetic purposes; after-shave lotions; beauty masks; oils for perfumes and scents; oils for cosmetic purposes; oils for toilet purposes; essential oils; essential oils of cedarwood; essential oils of lemon; essential oils of citron; oils for cleaning purposes; bergamot oil; gaultheria oil; jasmine oil; lavender oil; almond oil; rose oil; oil of turpentine for degreasing; whitening; cleaning chalk; almond milk for cosmetic purposes; cleansing milk for toilet purposes; musk [perfumery]; deodorant soap; shaving soap; soap for brightening textile; cakes of toilet soap; antiperspirant soap; soap for foot perspiration; soap; almond soap; mint for perfumery; cosmetic kits; emery; gel eye patches for cosmetic purposes; nail art stickers; double eyelid tapes; false nails; eau de Cologne; joss sticks; pastes for razor strops; toothpaste; pumice stone; lipstick cases; hydrogen peroxide for cosmetic purposes; breath freshening strips; teeth whitening strips; sandcloth; glass cloth [abrasive cloth]; lipsticks; pomades for cosmetic purposes; shaving preparations; cosmetic preparations for baths; bath preparations, not for medical purposes; hair straightening preparations; hair waving preparations; laundry soaking preparations; grinding preparations; smoothing preparations [starching]; colour-removing preparations; leather bleaching preparations; polishing preparations; denture polishes; mouthwashes, not for medical purposes; cosmetic preparations for slimming purposes; starch glaze for laundry purposes; preparations to make the leaves of plants shiny; eye-washes, not for medical purposes; fabric softeners for laundry use; laundry preparations; dry-cleaning preparations; paint stripping preparations; lacquer-removing preparations; make-up removing preparations; floor wax removers [scouring preparations]; varnish-removing preparations; rust removing preparations; nail care preparations; cleaning preparations; preparations for cleaning dentures; wall-paper cleaning preparations; preparations for unblocking drain pipes; chemical cleaning preparations for household purposes; collagen preparations for cosmetic purposes; bleaching preparations [decolorants] for household purposes; laundry bleach; aloe vera preparations for cosmetic purposes; sunscreen preparations; colour-brightening chemicals for household purposes [laundry]; breath freshening preparations for personal hygiene; shining preparations [polish]; make-up powder; diamantine [abrasive]; stain removers; nail varnish removers; vaginal washes for personal sanitary or deodorant purposes; scouring solutions; false eyelashes; antistatic dryer sheets; baby wipes impregnated with cleaning preparations; colour run prevention laundry sheets; tissues impregnated with cosmetic lotions; tissues impregnated with make-up removing preparations; safrol; massage candles for cosmetic purposes; laundry blueing; turpentine for degreasing; potpourris [fragrances]; bleaching soda; washing soda, for cleaning; bath salts, not for medical purposes; bleaching salts; fumigation preparations [perfumes];

leather preservatives [polishes]; ammonia [volatile alkali] [detergent]; astringents for cosmetic purposes; eyebrow cosmetics; make-up preparations; sun-tanning preparations [cosmetics]; hair dyes; neutralizers for permanent waving; cosmetic preparations for eyelashes; cosmetic preparations for skin care; shoe wax; dentifrices; cosmetics; cosmetics for children; cosmetics for animals; mascara; cleansers for intimate personal hygiene purposes, non medicated; douching preparations for personal sanitary or deodorant purposes [toiletries]; detergents, other than for use in manufacturing operations and for medical purposes; degreasers, other than for use in manufacturing processes; bleaching preparations [decolorants] for cosmetic purposes; antiperspirants [toiletries]; toiletry preparations; phytocosmetic preparations; talcum powder, for toilet use; cotton swabs for cosmetic purposes; terpenes [essential oils]; emery cloth; cloths impregnated with a detergent for cleaning; henna [cosmetic dye]; shampoos for animals [non-medicated grooming preparations]; shampoos for pets [non-medicated grooming preparations]; dry shampoos; shampoos; sandpaper; soda lye; herbal extracts for cosmetic purposes; extracts of flowers [perfumes]; ethereal essences; badian essence; mint essence [essential oil].

(260) AM 2024 122792 A

(800) 1728803

(151) 2022 11 30

(891) 2022 11 30

(731) LC WAİKİKİ MAĞAZACILIK HİZMETLERİ
TİCARET ANONİM ŞİRKETİ

15 Temmuz Mahallesi, Gülbahar Caddesi,

No. 41, Bağcılar, İstanbul, Türkiye

(540)

Staunch

(591) Black, white

(511)

3 – Bleaching and cleaning preparations, detergents other than for use in manufacturing operations and for medical purposes, laundry bleach, fabric softeners for laundry use, stain removers, dishwasher detergents; perfumery; non-medicated cosmetics; fragrances; deodorants for personal use and animals; soaps; dental care preparations: dentifrices, denture polishes, tooth whitening preparations, mouth washes, not for medical purposes; abrasive preparations; emery cloth; sandpaper; pumice stone; abrasive pastes; polishing preparations for leather, vinyl, metal and wood, polishes and creams for leather, vinyl, metal and wood, wax for polishing.

18 – Unworked or semi-worked leather and animal skins, imitations of leather, stout leather, leather used for linings; labels of leather, girths of leather, leather straps, leather leads, leather cord, bags, wallets, boxes and trunks made of leather or stout leather; keycases, trunks [luggage], suitcases; umbrellas; parasols; sun

umbrellas; walking sticks; whips; harness; saddlery; stirrups; straps of leather (saddlery).

25 – Clothing, including underwear and outerclothing, other than special purpose protective clothing; socks, mufflers [clothing], shawls, bandanas, scarves, belts [clothing]; footwear, shoes, slippers, sandals; headgear, hats, caps with visors, berets, caps [headwear], skull caps.

35 – Advertising, marketing and public relations; organization of exhibitions and trade fairs for commercial or advertising purposes; development of advertising concepts; provision of an online marketplace for buyers and sellers of goods and services; office functions; secretarial services; arranging newspaper subscriptions for others; compilation of statistics; rental of office machines; systemization of information into computer databases; telephone answering for unavailable subscribers; business management, business administration and business consultancy; accounting; commercial consultancy services; personnel recruitment, personnel placement, employment agencies, import-export agencies; temporary personnel placement services; auctioneering; the bringing together, for the benefit of others, of a variety of goods, namely, bleaching and cleaning preparations, detergents other than for use in manufacturing operations and for medical purposes, laundry bleach, fabric softeners for laundry use, stain removers, dishwasher detergents, perfumery, non-medicated cosmetics, fragrances, deodorants for personal use and animals, soaps, dental care preparations, dentifrices, denture polishes, tooth whitening preparations, mouth washes, not for medical purposes, abrasive preparations, emery cloth, sandpaper, pumice stone, abrasive pastes, polishing preparations for leather, vinyl, metal and wood, polishes and creams for leather, vinyl, metal and wood, wax for polishing, unworked or semi-worked leather and animal skins, imitations of leather, stout leather, leather used for linings, labels of leather, girths of leather, leather straps, leather leads, leather cord, bags, wallets, boxes and trunks made of leather or stout leather, keycases, trunks [luggage], suitcases, umbrellas, parasols, sun umbrellas, walking sticks, whips, harness, saddlery, stirrups, straps of leather (saddlery), clothing, underwear and outerclothing, other than special purpose protective clothing, socks, mufflers [clothing], shawls, bandanas, scarves, belts [clothing], footwear, shoes, slippers, sandals, headgear, hats, caps with visors, berets, caps [headwear], skull caps, hand-operated non-electric cleaning instruments and appliances, brushes, except paintbrushes, steel chips for cleaning, sponges for cleaning, steel wool for cleaning, cloths of textile for cleaning, gloves for dishwashing, non-electric polishing machines for household purposes, brooms for carpets, mops, toothbrushes, electric toothbrushes, dental floss, shaving brushes, hair brushes, combs, non-electric household or kitchen utensils [other than forks, knives, spoons], services [dishes], pots and

pans, bottle openers, flower pots, drinking straws, non-electric cooking utensils, ironing boards and shaped covers therefor, drying racks for washing, clothes drying hangers, cages for household pets, indoor aquariums, vivariums and indoor terrariums for animals and plant cultivation, ornaments and decorative goods of glass, porcelain, earthenware or clay namely statues, figurines, vases and trophies, mouse traps, insect traps, electric devices for attracting and killing flies and insects, fly catchers, fly swatters, perfume burners, perfume sprayers, perfume vaporizers, electric or non-electric make-up removing appliances, powder puffs, toilet cases, nozzles for sprinkler hose, nozzles for watering cans, watering devices, garden watering cans, unworked or semi-worked glass, except building glass, mosaics of glass and powdered glass for decoration, except for building, glass wool other than for insulation or textile use, carpets, rugs, mats, prayer rugs, linoleum, artificial turf, linoleum for covering floors, gymnasium mats, wallpaper, wall hangings not of textile, enabling customers to conveniently view and purchase those goods, such services may be provided by retail stores, wholesale outlets, by means of electronic media or through mail order catalogues.

(260) AM 2024 122795 A

(800) 1728824

(151) 2022 09 21

(891) 2022 09 21

(731) Pacific Pharmaceuticals Pte Ltd.

101 CECIL STREET, #17-07 TONG ENG

BUILDING, SINGAPORE 069533, Singapore

(540)

MOLNUPAC

(591) Black, white

(531) 27.05.01

(511)

5 – Mineral dietary supplements for humans; pharmaceutical drugs.

(260) AM 2024 122796 A

(800) 1728825

(151) 2022 09 21

(891) 2022 09 21

(731) Pacific Pharmaceuticals Pte Ltd.

101 CECIL STREET, #17-07 TONG ENG

BUILDING, SINGAPORE 069533, Singapore

(540)

BARICIPAC

(591) Black, white

(531) 27.05.01

(511)

5 – Mineral dietary supplements for humans; pharmaceutical drugs.

(260) AM 2024 122807 A

(800) 1729107

(151) 2023 03 13

(891) 2023 03 13

(731) KRKA, tovarna zdravil, d.d., Novo mesto
Šmarješka cesta 6, SI-8000 Novo mesto,
Slovenia

(540)

Дабиксом

(591) Black, white

(531) 28.05

(511)

5 – Pharmaceutical preparations.

(260) AM 2024 122808 A

(800) 1729206

(151) 2022 12 29

(891) 2022 12 29

(731) REHAU Industries SE & Co. KG

Helmut-Wagner-Strasse 1, 95111 Rehaus,
Germany

(540)

РЕХАУ

(591) Black, white

(531) 28.05

(511)

17 – Adhesive bands other than stationery and not for medical or household purposes; anti-glare films for windows [tinted films]; goods made of synthetic rubber for joints; goods made of rubber for pipe joint; artificial resins (semi-finished products); carbon fibers, other than for textile use; shells of rubber for pipes; shells of synthetic rubber for pipes; caulking materials; chemical compositions for repairing leaks; clack valves of rubber; clutch linings; collars of rubber for fastening pipes; compositions to prevent the radiation of heat; compressed air pipe fittings, not of metal; connecting hose for vehicle radiators; non-metallic connectors for pipes; cords of rubber; non-metallic couplings for flexible pipes; couplings of rubber for pipes; cylinder jointings; draught excluder strips; draught excluder strips of rubber; draught excluders for windows; elastic threads, not for use in textiles; non-metallic elbow joints for flexible pipes; expansion joint fillers; extruded plastic in the form of bars, blocks, pellets, rods, sheets and tubes for use in manufacturing; extruded plastics [semi-finished products]; fiberglass fabrics for insulation; fiberglass for insulation; filtering materials of semi-processed films of plastic; filtering materials of semi-processed foams of plastic; fittings, not of metal, for flexible pipes; fittings, not of metal, for rigid pipes; flanged elbow hoses; flexible hoses of plastic; flexible hose pipes of rubber; flexible pipes, not of metal; flexible pipes, tubes and hoses, not of metal; flexible pipes, tubes, hoses and fittings therefor (including valves), and fittings for rigid pipes, all non-metallic; non-metallic

flexible pipes, tubes, hoses, and fittings therefor, including valves, non-metallic; flexible plastic pipe insulators; flexible plumbing pipes of plastic; floating anti-pollution barriers; foils of metal for insulating; garden hoses; gaskets; gaskets for industrial use; seals, not of metal, for pipes; non-metallic hose connectors; couplings, not of metal, for hoses; hose pipes made of plastic; hose pipes made of rubber; hose pipes made of textile materials; hoses of textile material; hydraulic hoses of plastic; identification couplings of plastics for pipes; identification couplings of rubber for pipes; industrial hoses of plastic; injection moulding plastics; insulated pipe supports, not of metal; non-metallic insulated pipes; insulating fabrics; insulating materials; insulation for underground pipes and tanks; insulation jackets for industrial pipes; insulators; insulators for railway tracks; jackets [insulating] for pipes; joint packings; joint packings for pipes; joint sealants, other than for ships; junctions, not of metal, for flexible pipes; junctions, not of metal, for rigid pipes; laminated plastic films for use on windows; non-conducting materials for retaining heat; non-metal elbows for pipes; non-metal elbows for rigid pipes; non-metal fittings for pipes; non-metal gaskets; non-metal pipe couplings and joints; non-metal pipe muffers; non-metallic couplings for rigid pipes; non-metallic flexible hoses made of polyvinylchloride; flexible hoses, not of metal; hose pipes, not of metal; insulating pipe muffers, not of metal; insulating jackets for pipes, not of metal; non-metallic microporous hoses for use in agriculture; non-metallic microporous hoses for use in horticulture; non-metallic pipe sleeves; seals, not of metal; non-metallic window profiles; packing (cushioning, stuffing) materials of rubber or plastics; packing, stopping and insulating materials; padding materials of rubber or plastics; clips of plastic for pipes; junctions, not of metal, being parts of rigid water pipes; non-metallic pipe extensions; pipe couplings and joints, not of metal; pipe couplings and joints, not of metal being parts of rigid water pipes; pipe fittings comprised primarily of plastic; pipe gaskets; pipe insulation; pipe joint compound; pipe joint sealant; pipe joint tape; pipe jointing compounds for preventing leakage; pipe jointing compounds for sealing pipe threads; non-metallic pipe linings; non-metallic pipe linings for sealing pipes; pipe sealing compositions; non-metallic pipe spacers; pipe support sleeves of rubber; pipe thread tapes for sealing; pipe joints, not of metal; pipe wrappings for insulation purposes; pipes made of synthetic flexible material; plastic fibers, not for textile use; plastic film other than for wrapping; plastics in extruded form for use in manufacture; plastic plumbing hoses; plastic seals; plastic sheeting for agricultural purposes; plastic substances, semi-processed; plastics in the form of sheets, films, blocks, rods and tubes; plastics in the form of blocks [semi-finished products]; plastics in the form of plates [semi-finished products]; plastics in the form of rods [semi-finished products]; plastics in the form of secti-

ons [semi-finished products]; plastics in the form of strips [semi-finished products]; plastics substances, semi-processed, in the form of sheets, films, blocks, rods and tubes; porous irrigation hoses; reflective plastic films for use on windows; reinforcing materials, not of metal, for pipes; rings of rubber; rings of rubber for use as pipe connection seals; rubber sleeves for protecting parts of machines; rubber stoppers; tubes and pipes of rubber; sealant compounds for joints; sealing and insulating materials; non-metallic sealing assemblies; non-metallic sealing profiles; non-metallic sealing rings for pipe fittings; seals; non-metallic seals for pipes; seals for pipe connections; self-adhesive tapes, other than stationery and not for medical or household purposes; semi-processed plastics; shaped strips of foam rubber for use as draught seals in windows; shaped strips of rubber for use as draught seals in windows; shaped strips of rubber for use as seals in the manufacture of windows; shaped strips of rubber for use in the manufacture of windows; shock absorbing buffers of rubber; silicon rubber pipes; sleeves of rubber for protecting parts of machines; soundproofing materials; non-metallic sprinkling pipes; stops of rubber; stuffing of rubber or plastic; stuffing rings; substances for insulating buildings against moisture; synthetic resins in rod form for use in manufacture; synthetic rubber; thermally insulated pipes made of plastic; threads of plastic for soldering; threads of plastic materials, not for textile use; threads of rubber, not for use in textiles; tinted plastic films for use on windows; translucent flexible material for insulating windows; valves of india-rubber or vulcanized fiber; washers of rubber or vulcanized fiber; water-tight rings; watering hose; waterproof packings; watertight rings for plumbing pipes; weatherstripping compositions for windows; non-metallic weather strips for windows; weatherstripping; weatherstripping sealants in the nature of caulk; window masking films; non-metallic window seals; window stops of rubber; polymer underfloor insulations.

19 – Angle irons, not of metal; floor access covers, not of metal; armoured windows having non-metallic frames; balcony enclosures, not of metal; balusters, not of metal; balustrades, not of metal; beacons, not of metal, non-luminous; beams, not of metal; blinds (outdoor), not of metal and not of textile; branching pipes, not of metal; building glass; non-metallic building materials; building panels, not of metal; buildings, not of metal; buildings, transportable, not of metal; casement windows, not of metal; ceilings, not of metal; cladding, not of metal, for windows; cladding, not of metal, for building; coatings (building materials); coloured window glass for building; cornices, not of metal; non-metallic covering systems for commercial chest freezers; linings, not of metal, for building; waste pipes, not of metal, for building installations; dome shaped skylight windows, not of metal; door casings, not of metal; door frames, not of metal; door panels, not of metal; doors, not of metal; gates,

not of metal; windows, not of metal; window ventilators, not of metal; drain channels, not of metal; drain covers, not of metal; drain gullies, not of metal; drain pipes, not of metal; drain traps (valves), not of metal or plastic; drainage courses, not of metal; drain installations, not of metal; ducts, not of metal, for ventilating and air-conditioning installations; electronically controlled skylights, not of metal; outdoor blinds, not of metal; facings, not of metal, for building; fences, not of metal; fire resistant collars for pipes, not of metal; flashing, not of metal, for building; floor boards, not of metal; floor drainage channels made of non-metallic materials; floor drains of non-metallic materials; floor tiles, not of metal; floors, not of metal; folding doors, not of metal; non-metallic frames for glazed doors; non-metallic frames for glazed windows; framework for building, not of metal; French balcony, not metal; furrings of plastics; geotextiles; girders, not of metal; glass covering systems for chest freezers; glass covers for commercial freezing equipment; glass doors; glass doors for refrigerating and freezing equipment; glass elements for windows; window glass, other than vehicle window glass; sheet glass for windows; glass panels for building; glass for glazing buildings; glass panels for windows; greenhouse frames, not of metal; greenhouses, transportable, not of metal; grout; gutter pipes not of metal; gutters, not of metal; hips for roofing; horticultural frames, not of metal; insect screens, not of metal, for windows; insect screens not of metal; insulated water pipes, not of metal; insulating glass for building; interior non-metal window shutters; jalousies, not of metal; joists, not of metal; laths, not of metal; lattice-work, not of metal; lighting slabs; lintels, not of metal; sets of non-metal louvered windows and shutters; lumber; manhole covers, not of metal; mantlepieces; manufactured building elements, not of metal; manufactured timber; moldable wood; moldings, not of metal, for building; mortar for building; non-metal drains for use in construction of basement waterproofing system; non-metal railings for balconies; non-metal sewer pipes; non-metal window frames; non-metal window jambs; non-metal window sashes; non-metal window screens; non-metal window shutters; non-metal window sills; non-metal windows; air pipes, not of metal, for buildings; non-metallic pipes for roof drainage installations; non-metallic rigid pipes for construction purposes; palisades, not of metal; par-tiles, not of metal; parquet floor boards; parquet flooring; partitions, not of metal; penstock pipes, not of metal; pilings, not of metal; water pipes, not of metal; plaster; plastic conduits for drainage; plastic pipes for conveying natural gas; water-pipes of plastic; plastic window frames; rigid water-pipes of plastic; plate glass [windows], for building; platforms, prefabricated, not of metal; canopies [building structures], not of metal and not of textile; posts, not of metal; posts, not of metal, for electric power lines; pre-insulated non-metallic welded pipes for building; prefabricated build-

ing components, not of metal; prefabricated non-metallic building elements for on site assembly; prefabricated non-metal buildings; props, not of metal; railroad ties, not of metal; railway sleepers, not of metal; rainwater drainage systems; rainwater hoppers, not of metal; rainwater reservoirs, not of metal; rainwater tanks, not of metal; reinforcing materials, not of metal, for building; rigid pipes and valves therefor, not of metal; rigid pipes, not of metal; rigid pipes, not of metal, for building; rigid underdrainage pipes, not of metal; roof coverings, not of metal; window fanlights and ventlights, not of metal; roof flashing, not of metal; skylights, not of metal; skylights of plastic; roofing slates; roofing, not of metal; safety glass; sash windows, not of metal; scaffolding, not of metal; plastic liners for sewer pipes; non-metallic sewers; sheet piles, not of metal; flexible shingle; shutters, not of metal; signalling panels, non-luminous and non-mechanical, not of metal; sills, not of metal; non-metallic skylight frames for buildings; slabs, not of metal, for building; sliding doors for commercial chest freezers; sliding doors for refrigerating and freezing equipment; sliding doors, not of metal; stables, not of metal; stained glass windows; handrails, not of metal, for stairs; stair-treads (steps), not of metal; staircases, not of metal; rainwater manholes [concrete drain structures]; stringers (parts of staircases), not of metal; tile floorings, not of metal; tiles, not of metal, for building; trellises, not of metal; veneer wood; veneers; vinyl siding; vinyl windows; wainscoting, not of metal; wall claddings, not of metal, for building; wall linings, not of metal, for building; wall tiles, not of metal, for building; water-pipe valves, not of metal or plastic; window facades, not of metal; window glass for building; non-metallic window sashes; window sills, not of metal; stained-glass windows; wood window frames; dado rails, not of metal; laminate flooring, not of metal; duckboards, not of metal; interior window shutters, not of metal.

20 – Benches (furniture); indoor window blinds [shades] [furniture]; bolts, not of metal; cabinet work; cases of wood or plastic; chairs (seats); chests of drawers; chests, not of metal; clamps, not of metal, for fixing windows; clips made of plastics for pipes; clips, not of metal, for cables and pipes; closures, not of metal, for containers; collars of plastic for fastening pipes; construction kits (sold complete) consisting of parts to be fitted in commercial chest freezers; containers, not of metal (storage, transport); counters (tables); crates; cupboards; curtain holders, not of textile material; curtain hooks; curtain rails; curtain rings; curtain rods; curtain rollers; curtain tie-backs; deck chairs; decorative edging strips of plastic for use with window fittings; decorative wall plaques (furniture) not of textile; desks (furniture); dinner wagons (furniture); display boards; display stands; display stands for shop windows; divans; door fittings, not of metal; window fittings, not of metal; gate fittings, not of metal; doors for furniture; doors made of glass for furni-

ture; drain traps (valves) of plastic; padded armchairs; edgings of plastic for furniture; filing cabinets; furniture; furniture casters, not of metal; furniture fittings, not of metal; furniture of metal; furniture partitions of wood; furniture shelves; mirrors, picture frames; garment covers (storage); glass furniture; hand-operated non-metal garden hose reels; handling pallets, not of metal; non-metallic hinges for doors and windows; hinges, not of metal; hinges, not of metal, for fastening pipes; holders for fixing window coverings and sashings; hooks, not of metal, for clothes rails; horizontal slatted venetian indoor blinds for windows; hose clamps, not of metal; hose clips, not of metal; hose hangers, not of metal; index cabinets (furniture); indoor window blinds [furniture]; kits of parts [sold complete] for assembly into articles of furniture; kits of parts [sold complete] for assembly into display cases; latches, not of metal; lecterns; loading pallets, not of metal; lockers; magazine racks; mechanisms for lifting windows, not of metal, non-electric; mechanisms for locking windows, not of metal, non-electric; mechanisms for rolling windows, not of metal, non-electric; mechanisms for sliding windows, not of metal, non-electric; metal indoor window blinds; mirror tiles; mirrors (looking glasses); non-metal window trims; clips, not of metal, for pipes; nuts, not of metal; office furniture; packaging containers of plastic; partitions of wood for furniture; pins [pegs], not of metal; pipe fasteners, pipe connectors and pipe holders, non-metallic; clips of plastics, for cables and pipes; sleeves and couplings of plastic for fixing pipes; plastic window handles; plate racks; plugs [dowels], not of metal; plugs, not of metal; poles, not of metal; pulleys of plastics for blinds; racks (furniture); reeds [plaiting materials]; reels, not of metal, non-mechanical, for flexible hoses; reservoirs, not of metal nor of masonry; rivets, not of metal; rollers, not of metal, for windows; runners, not of metal, for sliding doors; sash fasteners, not of metal, for windows; window openers and closers being window cranks, not of metal, non-electric; saw horses; school furniture; screens (furniture); screws, not of metal; sealing caps, not of metal; seats; seats of metal; settees; shelves for file cabinets; shelves for storage; shelves for typewriters; shoulder poles (yokes); showcases (furniture); sideboards; signboards of wood or plastics; silvered glass (mirrors); slatted indoor blinds; slatted indoor blinds for windows; stag antlers; stair rods; stakes for plants or trees; staves of wood; steps (ladders), not of metal; stools; table tops; tables; tanks, not of metal nor of masonry; taps, not of metal, for casks; transparent doors for furniture, not of metal; transparent doors of glass for furniture; transport pallets, not of metal; trays, not of metal; trestles (furniture); trolleys (furniture); trolleys for computers (furniture); typing desks; valves, not of metal, other than parts of machines; vats, not of metal; vice benches [furniture]; non-metallic wall mounted hose supports; wall plugs, not of metal; water inlets [valves of plastic] for water pipes; water outlets

[valves of plastic] for water pipes; water regulating valves of plastic for water pipes; water-pipe valves of plastic; winding spools, not of metal, non-mechanical, for flexible hoses; window blinds; window closers, not of metal, nonelectric; window fasteners, not of metal; fittings for window glazing, not of metal; non-metallic window handles; non-metallic window hardware; window openers, not of metal, non-electric; window pulleys, not of metal; indoor window shades; window stops of plastic; wood window handles; writing desks; furniture panels; work surfaces; pipe collars, not of metal; window hardware being guards; pipe clamps of rubber.

(260) AM 2024 122810 A

(800) 1729306

(151) 2023 01 11

(891) 2023 01 11

(731) ETAS GmbH

Borsigstrasse 24, 70469 Stuttgart, Germany

(540)

(591) Ultramarine blue

(531) 27.05.01; 29.01.04

(511)

9 – Electronic data processing equipment and computers, in particular data input and output apparatus, add-on cards for data processing equipment, storages, input and output interface apparatus and programs, data carriers, programmes recorded on data carriers, data processing programs, programs being tools for facilitating software production and configuring hardware systems, modelling tools for modelling functions on computers.

42 – Hardware and software development services; technological consultancy services, in the following fields: software use, computer programming; cloud services (saas), relating to the following sectors: connection of vehicles to the cloud, management of cloud-based functional software and vehicle data; technological consultancy services, relating to the following sectors: realisation of integrated software development and IT operations solutions; technological consultancy services in the field of cybersecurity for the automobile industry, covering the whole software development and IT operations solutions cycle, embedded systems (including hardware security modules and automotive firewalls) up to the cloud (including key management solutions).

(260) AM 2024 122812 A

(800) 458808

(151) 1981 03 02

(891) 2023 04 24

(731) LEONOR GREYL

29 rue du Terrage, F-75010 PARIS, France

(540)

LEONOR GREYL

(591) Black, white

(531) 27.05.01

(511)

3 – Soaps; perfumery, essential oils, cosmetics, hair lotions.

42 – Hair-styling, scalp treatment, beauty care.

(260) AM 2024 122818 A

(800) 1591561

(151) 2020 10 26

(891) 2023 03 24

(731) Novotech (Australia) Pty Ltd
L3, 235 Pyrmont St, PYRMONT NSW 2009,
Australia

(540)

NOVOTECH HEALTH

(591) Black, white

(511)

42 – Clinical trials; conducting and managing clinical trials, including clinical trials for pharmaceuticals, biotechnology and other related industries; conducting clinical trials for others (scientific research); providing information about the results of clinical trials, including clinical trials for pharmaceuticals and biotechnology; scientific research; medical research (scientific research for medical purposes); preparation of statistics for scientific research; preparation of biostatistics for scientific research in the fields of pharmaceuticals, biotechnology and other related industries; provision of information and data relating to medical and scientific research for pharmaceuticals, biotechnology and other related industries; database design and development services to process data collected from clinical trials; medical research services, namely medical monitoring services for research in the fields of pharmaceuticals, biotechnology and other related industries; quality audits; preparation of reports and applications to regulators relating to aspects of clinical trials; provision and exchange of information and data exchange between scientists, manufacturers and health authorities relating to pharmaceutical and biotechnology quality standards; technical writing of clinical report forms which are required by clinical trial drug protocols.

(260) AM 2024 122871 A

(800) 1729808

(151) 2023 02 16

(891) 2023 02 16

(731) Limited liability company "PROMOMED RUS"
prospekt Mira, d. 13, str. 1, of. 13, RU-129090
Moscow, Russian Federation

(540)

SKYVIRA

(591) Black, white

(511)

5 – Pharmaceutical preparations, including pharmaceutical antiviral preparations.

(260) AM 2024 122872 A

(800) 1729812

(151) 2023 03 13

(891) 2023 03 13

(731) SILKIN PETR IGOREVICH

Sosnovaya Str., 22, Zhelyabino village, g/o
Krasnogorsk, Krasnogorsk district, RU-143340
Moscow region, Russian Federation

(540)

Super Jump

(591) Black, white

(511)

41 – Academies [education]; physical education; publication of books; health club services [health and fitness training]; practical training [demonstration]; arranging and conducting of colloquiums; arranging and conducting of congresses; arranging and conducting of conferences; arranging and conducting of workshops [training]; arranging and conducting of in-person educational forums; arranging and conducting of seminars; arranging and conducting of symposiums; organization of competitions [education or entertainment]; providing information in the field of education; providing information relating to recreational activities; electronic desktop publishing; online publication of electronic books and journals; publication of texts, other than publicity texts; tutoring; personal trainer services [fitness training]; educational services; physical fitness assessment services for training purposes; coaching [training].

(260) AM 2024 122874 A

(800) 1729822

(151) 2023 04 11

(891) 2023 04 11

(731) Raytheon Company

870 Winter Street, Waltham MA 02451, USA;
Lockheed Martin Corporation
6801 Rockledge Drive, Bethesda MD 20817,
USA

(540)

JAVELIN

(591) Black, white

(511)

13 – Guided missile systems comprised of missiles, missile launchers, and hardware and recorded software for targeting missiles.

(260) AM 2024 122891 A
 (800) 1730242
 (151) 2023 02 20
 (891) 2023 02 20
 (731) KAYHAN AV TUFEKLERI SANAYI VE DIS
 TICARET LIMITED SIRKETI
 BARBAROS MAH. MİLLET CAD., ISIS
 PLAZA 77 2 Ataşehir, İstanbul, Türkiye

(540)

Setter

(591) Black, white
 (531) 27.05.17
 (511)
 13 – Firearms, air pistols (weapons), spring-loaded fi-
 rearms, adapted cases and shoulder straps therefor.

(260) AM 2024 122899 A
 (800) 1730316
 (151) 2023 03 09
 (891) 2023 03 09
 (731) VENUS MANAGEMENT PTE. LTD.
 111 NORTH BRIDGE ROAD, #21-03
 PENINSULA PLAZA; SINGAPORE 179098,
 Singapore

(540)

Redwood

(591) Black, white
 (531) 27.05.01
 (511)
 34 – Cigarettes; cigars; tobacco; cigarette filters; ciga-
 rette holders; cigarette paper; cigarette cases; lighters
 for smokers.

(260) AM 2024 122900 A
 (800) 1730322
 (151) 2023 04 13
 (891) 2023 04 13
 (731) PepsiCo, Inc., (a North Carolina corporation)
 700 Anderson Hill Road; Purchase NY 10577,
 USA

(540)

ЖАЖДА БОЛЬШЕГО

(591) Black, white
 (531) 28.05
 (511)
 32 – Aperitifs, non-alcoholic; carbonated water; soda
 water; waters [beverages]; mineral water [beverages];
 table waters; cocktails, non-alcoholic; lemonades;
 non-alcoholic beverages; isotonic beverages; soft
 drinks; non-alcoholic beverages flavoured with tea;
 non-alcoholic fruit juice beverages; energy drinks;
 fruit nectars, non-alcoholic; powders for effervescing
 beverages; powders for making soft drinks; sarsa-

parilla [non-alcoholic beverage]; syrups for lemonade;
 syrups for beverages; vegetable juices [beverages];
 fruit juices; preparations for making non-alcoholic be-
 verages; preparations for making carbonated water;
 pastilles for effervescing beverages; sherbets [bevera-
 ges]; non-alcoholic fruit extracts; non-alcoholic essen-
 ces for making beverages.

(260) AM 2024 122901 A
 (800) 1730362
 (151) 2023 03 24
 (891) 2023 03 24
 (731) ZITRO LABORATORY S.L.U.
 Ronda Maiols, n° 23-27; E-08192 Sant Quirze
 del Vallès (BARCELONA), Spain

(540)



(591) Red and yellow
 (531) 25.01.25; 26.04.02; 26.04.24; 27.05.01;
 27.05.10; 29.01.12

(511)
 9 – Hardware and software for bingo halls, casinos,
 automatic game machines; game programs; data pro-
 cessing equipment; computers; gambling and betting
 hardware and software; games for gambling machines
 [software]; downloadable information relating to ga-
 mbling and betting; electronic publications, downloa-
 dable, relating to gambling and betting; gambling
 software that generates or displays the betting results
 of gambling machines.

28 – Games; stand-alone video game machines; gam-
 bling and betting machines; housings for gambling
 and betting machines.

(260) AM 2024 122902 A
 (800) 1730379
 (151) 2022 10 21
 (891) 2022 10 21
 (731) WORLD MEDICINE İLAÇ SAN.VE TİC.A.Ş.
 15 TEMMUZ MAH. CAMİ YOLU CAD. 50;
 Bağcılar, İstanbul, Türkiye

(540)

FOLENSA-ФОЛЕНСА

(591) Black, white
 (531) 28.05
 (511)
 5 – Pharmaceutical and veterinary preparations for
 medical purposes; chemical preparations for medical
 and veterinary purposes, chemical reagents for phar-
 maceutical and veterinary purposes; medicated cos-
 metics, dietary supplements for pharmaceutical and
 veterinary purposes; dietary supplements; nutritional

supplements; medical preparations for slimming purposes; food for babies; herbs and herbal beverages adapted for medicinal purposes, dental preparations and articles (term too vague in the opinion of the International Bureau (Rule 13 (2) (b) of the Common Regulations); teeth filling material, dental impression material, dental adhesives and material for repairing teeth, sanitary preparations for medical use; hygienic pads; hygienic tampons; plasters; materials for dressings; diapers made of paper and textiles for babies, adults and pets, preparations for destroying vermin; herbicides, fungicides, preparations for destroying rodents, deodorants, other than for human beings or for animals; air purifying preparations; air deodorising preparations, disinfectants; antiseptics; detergents for medical purposes; medicated soaps; disinfectant soaps; antibacterial hand lotions.

(260) AM 2024 122922 A

(800) 1013405

(151) 2009 07 14

(891) 2023 04 28

(731) IEMME S.R.L. più brevemente I.M. S.R.L.

Via Germania 2; I-20083 Gaggiano (MI), Italy

(540)

RAYWELL

(591) Black, white

(511)

3 – Products for care and beauty of the body, the face, the hands, the feet and the hair, namely, shampoos, after-shampoos, colour dying preparations, conditioners, hair creams.

(260) AM 2024 122934 A

(800) 1689487

(151) 2022 07 25

(891) 2023 04 03

(731) FONTAINE LIMITED

C/O TMF Group, 8th Floor, 20 Farringdon

Street, LONDON EC4A 4AB, United Kingdom

(540)

LOVE IN WHITE

(591) Black, white

(511)

3 – Perfumes; fragrances; eau de parfum; toilet water; colognes; shaving preparations; shaving gels; shaving soaps; shaving foams; aftershave preparations; shaving balms; lotions for beards; non-medicated toiletry preparations for personal use, namely, soaps, bath and shower preparations, body lotions and body oils; shampoos, conditioners and oils for the hair; oils for grooming; essential oils; scented oils; deodorants for personal use; room fragrances.

(260) AM 2024 122935 A

(800) 1700938

(151) 2022 10 24

(891) 2023 04 13

(731) UAB "OMG Bubble Tea"

Žalgirio g. 114, Vilnius, Lithuania

(540)



(591) Black, white

(531) 04.05.03; 04.05.21; 27.03.02; 27.05.01; 27.05.17; 27.05.23

(511)

30 – Coffee, tea, cocoa and coffee substitutes; tapioca; ice cream, sherbets and other edible ices.

32 – Non-alcoholic beverages; fruit beverages and fruit juices; syrups and other preparations for making non-alcoholic beverages.

(260) AM 2024 122936 A

(800) 1708133

(151) 2022 07 19

(891) 2023 03 16

(731) HERAY FİLTRE TEKNOLOJİLERİ

MÜHENDİSLİK İTHALAT İHRACAT

SANAYİ VE TİCARET LİMİTED ŞİRKETİ

Büyükkayacikosb Mahallesi, Lalehan Caddesi,

61, Selçuklu, Konya, Türkiye

(540)



(591) Purple and red

(531) 01.15.15; 26.11.01; 26.11.06; 26.11.12; 27.05.10; 27.05.17; 29.01.12

(526) Filtre sistemleri

(511)

11 – Water softening apparatus; water purification apparatus; water purification installations; wastewater purification installations; drip irrigation systems; drip irrigation systems, comprised of filters.

(260) AM 2024 122937 A

(800) 1720680

(151) 2023 01 19

(891) 2023 05 03

(731) Zakrytoe aktsionernoe obshchestvo "Myasnaya galereya"

ul. Poliny Osipenko, d. 65, of. 10, RU-600009

g. Vladimir, Russian Federation

(540)

Чебупай

(591) Black, white

(531) 28.05

(511)

29 – Ajvar being preserved peppers; aloe vera prepared for human consumption; alginates for culinary purposes; anchovy, not live; peanuts, prepared; artichokes, preserved; white of eggs; beans, preserved; soya beans, preserved, for food; broth; ginger jam; ham; fatty substances for the manufacture of edible fats; toasted laver; edible birds' nests; sea-cucumbers, not live; peas, preserved; mushrooms, preserved; guacamole [mashed avocado]; game, not live; gelatine; meat jellies; jellies for food, other than confectionery; fruit jellies; yolk of eggs; coconut fat; bone oil for food; lard; suet for food; edible fats; curd; fruit-based snack food; milk substitutes; charcuterie; raisins; caviar; aubergine paste; vegetable marrow paste; fish roe, prepared; yogurt; galbi being grilled meat dish; sauerkraut; kefir [milk beverage]; kimchi [fermented vegetable dish]; isinglass for food; clams, not live; potato-based dumplings; milk shakes; black pudding; onion rings; arrangements of processed fruit; compotes; meat, tinned; vegetables, tinned; fish, tinned; fruits, tinned; broth concentrates; corn dogs; gherkins; meat cutlets; frozen meat cutlets; shrimps, not live; prawns, not live; buttercream; croquettes; silkworm chrysalis for human consumption; sweet corn, processed; kumys [kumyss] [milk beverage]; chicken wings; spiny lobsters, not live; lecithin for culinary purposes; salmon, not live; onions, preserved; margarine; marmalade; oils for food; peanut butter; cocoa butter for food; coconut oil for food; coconut butter; maize oil for food; sesame oil for food; cottonseed oils for culinary purposes; extra virgin olive oil for food; olive oil for food; palm oil for food; palm kernel oil for food; sunflower oil for food; rape oil for food; butter; soya bean oil for food; mussels, not live; almonds, ground; animal marrow for food; molluscs, not live; milk; peanut milk; peanut milk for culinary purposes; coconut milk; coconut milk for culinary purposes; almond milk; almond milk for culinary purposes; oat milk; rice milk; rice milk for culinary purposes; albumin milk; condensed milk; soya milk; powdered milk; fish meal for human consumption; vegetable mousses; fish mousses; fruit pulp; meat; meat, preserved; freeze-dried meat; chicken nuggets; milk beverages, milk predominating; peanut milk-based beverages; coconut milk-based beverages; almond milk-based beverages; edible insects, not live; sausage casings, natural or artificial; vegetables, preserved; freeze-dried vegetables; vegetables, dried; vegetables, cooked; potato fritters; olives, preserved; lobsters, not live; flavoured nuts; candied nuts; coconut, desiccated; nuts, prepared; tomato paste; liver pâté; pectin for culinary purposes; liver; pickles; jams; powdered eggs; milk pro-

ducts; fish-based foodstuffs; prostokvasha [soured milk]; poultry, not live; battered chicken pieces; bulgogi; pollen prepared as foodstuff; cranberry compote; tomato purée; apple purée; crayfish, not live; crustaceans, not live; fish, preserved; fish, not live; salted fish; ryazhenka [fermented baked milk]; vegetable salads; fruit salads; bacon; sardelki [sausages]; sardines, not live; pork; herrings, not live; seeds, prepared; sunflower seeds, prepared; cream [dairy products]; whipped cream; vegetable-based cream; fat-based spreads for bread slices; smetana [sour cream]; lemon juice for culinary purposes; tomato juice for cooking; vegetable juices for cooking; salted meats; sausages; sausages in batter; hot dog sausages; preparations for making bouillon; preparations for making soup; nut-based spreads; tripe; soups; vegetable soup preparations; whey; cheese; tahini [sesame seed paste]; tofu; truffles, preserved; tuna, not live; oysters, not live; falafel; milk ferments for culinary purposes; rennet; fish fillets; dates; crystallized fruits; frozen fruits; fruit, preserved; fruit preserved in alcohol; fruit, stewed; hazelnuts, prepared; potato flakes; hummus [chickpea paste]; fruit peel; preserved garlic; lentils, preserved; potato crisps; low-fat potato crisps; fruit chips; shpikachki [sausages]; non-alcoholic eggnog; seaweed extracts for food; meat extracts; edible ant larvae, prepared; berries, preserved; snail eggs for consumption; eggs; yakitori.

30 – Vanilla flavourings for culinary purposes; flavourings, other than essential oils, for cakes; flavourings, other than essential oils, for beverages; coffee flavourings; food flavourings, other than essential oils; star aniseed; baozi [stuffed buns]; cereal bars; high-protein cereal bars; pancakes; noodle-based prepared meals; freeze-dried dishes with the main ingredient being pasta; freeze-dried dishes with the main ingredient being rice; buns; bread rolls; edible rice paper; edible paper; burritos; vanillin [vanilla substitute]; vareniki [stuffed dumplings]; waffles; vermicelli; natural sweeteners; sausage binding materials; binding agents for ice cream; seawater for cooking; seaweed [condiment]; malt biscuits; cloves [spice]; mirror icing [mirror glaze]; cake frosting [icing]; glucose for culinary purposes; mustard; gluten additives for culinary purposes; yeast; fried pelmeni; thickening agents for cooking foodstuffs; leaven; rice-based snack food; cereal-based snack food; coffee substitutes; vegetal preparations for use as coffee substitutes; dressings for salad; fruit jellies [confectionery]; candy decorations for cakes; confectionery for decorating Christmas trees; cakes; pastries; peanut confectionery; almond confectionery; pasta; ginger [spice]; frozen yogurt [confectionery ices]; cocoa; cream of tartar for culinary purposes; capers; caramels [sweets]; curry [spice]; ketchup [sauce]; kimbap; quiches; gluten prepared as foodstuff; flour-based dumplings; sweets; liquorice [confectionery]; peppermint sweets; dulce de leche; cinnamon [spice]; coffee; unroasted coffee; starch for food; crackers; custard; hominy

grits; semolina; oatmeal; crushed barley; groats for human food; ice cubes; corn, milled; corn, roasted; meat pies; turmeric; couscous [semolina]; noodles; ice for refreshment; ice, natural or artificial; edible ices; lollipops [confectionery]; rice cakes; mayonnaise; macaroons [pastry]; macaroni; maltose; hominy; piccalilli; marinades; marzipan; honey; miso [seasoning]; royal jelly; ice cream; bean meal; tapioca flour; potato flour; corn flour; nut flours; flour; wheat flour; soya flour; barley meal; dessert mousses [confectionery]; chocolate mousses; muesli; mint for confectionery; cocoa beverages with milk; coffee beverages with milk; coffee-based beverages; cocoa-based beverages; chamomile-based beverages; tea-based beverages; chocolate beverages with milk; chocolate-based beverages; infusions, not medicinal; crushed oats; husked oats; okonomiyaki [Japanese savory pancakes]; onigiri [rice balls]; nutmegs [spice]; chocolate-coated nuts; stick liquorice [confectionery]; lozenges [confectionery]; molasses for food; pâtés en croûte; pelmeni; khinkali [stuffed dumplings]; manti [stuffed dumplings]; pepper; allspice; peppers [seasonings]; pesto [sauce]; biscuits; petit-beurre biscuits; bibimbap [rice mixed with vegetables and beef]; pies; pizzas; meat gravies; fondants [confectionery]; popcorn; powders for making ice cream; baking powder; mustard meal; pralines; aromatic preparations for food; condiments; meat tenderizers for culinary purposes; cereal preparations; oat-based food; propolis; gingerbread; spices; petits fours [cakes]; rice pudding; puddings; cake powder; fruit coulis [sauces]; ravioli; ramen [Japanese noodle-based dish]; chewing gum; relish [condiment]; rice; instant rice; wheat germ for human consumption; spring rolls; sago; palm sugar; sugar; sesame seeds [seasonings]; linseed for culinary purposes [seasoning]; processed seeds for use as a seasoning; aniseed; agave syrup [natural sweetener]; golden syrup; candy bars; batter mixes for okonomiyaki [Japanese savory pancakes]; baking soda [bicarbonate of soda for cooking purposes]; malt for human consumption; salt for preserving foodstuffs; cooking salt; celery salt; sorbets [ices]; ham glaze; soya sauce; tomato sauce; sauces [condiments]; pasta sauce; spaghetti; seasonings; chocolate-based spreads; chocolate spreads containing nuts; preparations for stiffening whipped cream; rusks; breadcrumbs; sushi; senbei [rice crackers]; sandwiches; tabbouleh; tacos; tapioca; tarts; dough; pastry dough; almond paste; rice pulp for culinary purposes; cake batter; tortillas; garden herbs, preserved [seasonings]; chocolate decorations for cakes; vinegar; beer vinegar; ferments for dough; halvah; bread; unleavened bread; chips [cereal products]; corn flakes; oat flakes; hot dog sandwiches; jiaozi [stuffed dumplings]; chicory [coffee substitute]; tea; iced tea; chutneys [condiments]; chebureki [deep-fried pies]; minced garlic [condiment]; cheeseburgers [sandwiches]; chow-chow [condiment]; saffron [seasoning]; chocolate; malt extract for food; essences for

foodstuffs, except etheric essences and essential oils; husked barley.

(260) AM 2024 122988 A

(800) 1730867

(151) 2022 11 23

(891) 2022 11 23

(731) Highsun Holding Group Co., Ltd.

Longmen Village, Hangcheng Avenue, Changle District, Fuzhou (No A1-1, Changshanhu Mall), 350200 Fujian Province, China

(540)

HSCC 恒申

(591) Black, white

(531) 26.13.25; 27.05.01; 28.03

(511)

23 – Filament yarn; stretch yarn for textile use; darning thread and yarn; rayon; rayon thread and yarn; yarn; silk thread and yarn; spun thread and yarn; threads of plastic materials for textile use; nylon thread; artificial spun wool.

(260) AM 2024 122989 A

(800) 1730911

(151) 2023 04 28

(891) 2023 04 28

(731) Fall Creek Farm and Nursery, Inc.

39318 Jasper-Lowell Road, Lowell OR 97452, USA

(540)

SEKOYA FIESTA

(591) Black, white

(511)

31 – Fresh fruit; living plants.

(260) AM 2024 122990 A

(800) 1730928

(151) 2022 11 30

(891) 2022 11 30

(731) CİVİL MAĞAZACILIK ANONİM ŞİRKETİ

ABDURRAHMANGAZİ MAH. BOSNA BLV., CIVIL 1 A 1 SULTANBEYLİ, İSTANBUL, Türkiye

(540)

Civil

(591) Red

(531) 27.05.01; 27.05.17; 29.01.01

(511)

25 – Clothing, including underwear and outer clothing, other than special purpose protective clothing; socks,

mufflers [clothing], shawls, bandanas, scarves, belts [clothing]; footwear, shoes, slippers, sandals; headgear, hats, caps with visors, berets, caps [headwear], skull caps.

35 – Advertising, marketing and public relations; organization of exhibitions and trade fairs for commercial or advertising purposes; office functions; secretarial services; arranging newspaper subscriptions for others; compilation of statistics; rental of office machines; systemization of information into computer databases; telephone answering for unavailable subscribers; business management, business administration and business consultancy; accounting; commercial consultancy services; personnel recruitment, personnel placement, employment agencies, import-export agencies; temporary personnel placement services; auctioneering; the bringing together, for the benefit of others, of a variety of goods, namely, clothing, including underwear and outerclothing, other than special purpose protective clothing, socks, mufflers [clothing], shawls, bandanas, scarves, belts [clothing], footwear, shoes, slippers, sandals, headgear, hats, caps with visors, berets, caps [headwear], skull caps enabling customers to conveniently view and purchase those goods, such services may be provided by retail stores, wholesale outlets, by means of electronic media or through mail order catalogues.

(260) AM 2024 122991 A
(800) 1730933
(151) 2023 03 16
(891) 2023 03 16
(731) SUPROBION spolka z ograniczona
odpowiedzialnoscia spolka komandytowa
ul. Kielczowska 2, PL-55-095 Mirkow,
Poland

(540)

KROPIA

(591) Black, white
(511)
5 – Pharmaceuticals; pharmaceutical preparations for the treatment of eye diseases and conditions; eye lotions for medical use; pharmaceutical preparations for use in ophthalmology; pharmaceutical preparations for the prevention of ocular diseases; pharmaceutical preparations for ocular or intraocular surgery; solutions for contact lenses; medicated eye-washes; dietetic substances adapted for medical use; food supplements.

(260) AM 2024 122996 A
(800) 1731021
(151) 2023 05 01
(891) 2023 05 01
(731) Apple Inc.
One Apple Park Way, Cupertino CA 95014,
USA

(540)

SIDECAR

(591) Black, white
(511)
9 – Downloadable computer operating system software; recorded computer operating system software.

(260) AM 2024 122997 A
(800) 1731022
(151) 2023 04 27
(891) 2023 04 27
(731) Limited Liability Company "Consortium-PIQ"
Oruzheyniy pereulok, d. 25, str. 1, pomesch.
I/etazh 1/komnata 21, RU-125047 Moscow,
Russian Federation

(540)

VISMOSEPT

(591) Black, white
(511)
5 – Pharmaceutical and veterinary preparations; sanitary preparations for medical purposes; dietetic food and substances adapted for medical or veterinary use; food for babies; dietary supplements for human beings and animals; plasters, dressings; material for dental fillings and dental impressions; disinfectants; preparations for destroying vermin; fungicides, herbicides.

(260) AM 2024 123004 A
(800) 1731211
(151) 2023 05 02
(891) 2023 05 02
(731) Bradken Resources Pty Limited
20 McIntosh Drive, Mayfield West NSW 2304,
Australia

(540)

ZENITH

(591) Black, white
(511)
7 – Machines and machine tools being unitary sandwich pins, tooth systems, tooth points, adapters, components of tooth systems for heavy machinery for earth moving and excavation.

(260) AM 2024 123023 A
(800) 1731766
(151) 2023 03 31
(891) 2023 03 31
(731) DİDO KONFEKSİYON TEKSTİL TİCARET
VE SANAYİİ LİMİTED ŞİRKETİ
YENİBOSNA MERKEZ MAH., CEMAL
ULUSOY CAD. 49, BAHÇELİEVLER,
İSTANBUL, Türkiye

(540)



(591) Black, white

(531) 26.04.04; 26.04.09; 26.04.24; 27.05.01

(511)

25 – Clothing; footwear; headgear; underwear; socks.

35 – Import-export agencies, the bringing together for the benefit of others of a variety of goods, namely, perfumery, cosmetics, sun glasses, jewellery, imitation jewellery, gold, precious stones and jewellery made thereof, clocks, watches, bedspreads, pillow shams, towels of textile, clothing, including underwear and outer clothing, other than special purpose protective clothing, socks, mufflers, shawls, bandanas, scarves, belts, footwear, shoes, slippers, sandals, headgear, hats, berets, caps, enabling customers to conveniently view and purchase those goods, retail store services featuring the foregoing goods, wholesale store services featuring the foregoing goods, online retail store services featuring the foregoing goods, and mail order catalog services featuring the foregoing goods.

(260) AM 2024 123024 A

(800) 1731772

(151) 2023 03 20

(891) 2023 03 20

(731) Wytwórnia Surowic i Szczepionek BIOMED
Sp. z o.o.
ul. Chełmska 30/34, PL-00-725 Warszawa,
Poland

(540)

BIOSTREPTA

(591) Black, white

(511)

5 – Drugs for the treatment of chronic inflammatory processes of the uterine appendages, postoperative infiltrative lesions of the pelvic organs, endometritis, hemorrhoids in acute and chronic course, periodontal abscesses and fistulas with large inflammatory infiltrates and purulent cysts of various origin.

(260) AM 2024 123025 A

(800) 1731782

(151) 2022 12 29

(891) 2022 12 29

(731) ALTONA COSMETICS TECHNOLOGY
SANAYİ VE TİCARET ANONİM ŞİRKETİ
KARAMEHMET MAH/SEMT AVRUPA,
SERBEST BÖLGESİ 13. SK. 8 1 Ergene,
Tekirdağ, Türkiye

(540)

MEXES

(591) Black, white

(511)

3 – Non-medicated cosmetics and toiletry preparations; non-medicated dentifrices; perfumery, essential oils; soaps; hair lotions; bleaching preparations and other substances for laundry use; cleaning, polishing, scouring and abrasive preparations.

(260) AM 2024 123026 A

(800) 1731786

(151) 2023 04 25

(891) 2023 04 25

(731) MYTESTER LLC

2-ja Dubrovskaja street, 10/8, pom. 1, kom. 3,
RU-109044 Moscow, Russian Federation

(540)

MYTESTER

(591) Black, white

(531) 27.05.01

(511)

9 – Measures; measuring instruments; precision measuring apparatus; measuring apparatus; measuring devices, electric.

(260) AM 2024 123031 A

(800) 1731977

(151) 2023 04 25

(891) 2023 04 25

(731) Lineate LLC

178 Columbus Ave, PO Box #237190,
SMB#42386, New York NY 10023, USA

(540)

LINEATE

(591) Black, white

(511)

42 – Design, development and implementation of software; software design and development; technical support services, namely, remote and on-site infrastructure management services for monitoring, administration and management of public and private cloud computing IT and application systems.

(260) AM 2024 123032 A

(800) 1731997

(151) 2023 02 01

(891) 2023 02 01

(731) BIMBA & LOLA, S.L.

Parque Tecnológico y Logístico de Vigo,
Nave D13, E-36315 VIGO, Spain

(540)



(591) Black, white
 (531) 26.01.04; 26.01.21
 (511)

3 – Bleaching preparations and other substances for laundry use; cleaning, polishing, degreasing and abrasive preparations; soaps; perfumery products, essential oils, cosmetics, hair lotions; dentifrices; abrasives; almond oil; gaultheria oil; jasmine oil; lavender oil; rose oil; oil of turpentine [degreasing product]; oils for cleaning; oils for perfumes and scents; oils for toiletry purposes; essential oils of cedarwood; essential oils of citron; essential oils of lemon; ethereal oils; oils for cosmetic use; cosmetic preparations for slimming; adhesives for affixing false eyelashes; adhesives for affixing false hair; adhesives for cosmetic use; aerosol products for freshening breath; shaving products; sharpening products; drying agents for dishwashing machines; eau de Cologne; lavender water; eau de toilette; scented water; canned pressurized air for cleaning and dusting purposes; volatile alkali [ammonia] [detergent]; smoothing products (laundry); starch for laundry purposes; starch glaze for laundry purposes; musk [perfumery]; amber [perfumery]; bluing for laundry; antistatic products for household use; antiperspirants (toiletries); aromatics [essential oils]; flavorings for cakes [essential oils]; flavorings for beverages [essential oils]; air fragrancing products; astringents for cosmetic use; color-brightening chemicals for household use [laundry]; balms other than for medical use; cosmetic preparations for baths; varnish-removing products; shoe black (shoe polish); whitening; bleaching products for leather; sachets for perfuming linen; products for making the leaves of plants shiny; shining products; lip glosses; sun-tanning preparations; polishing preparations; hair waving preparations; silicon carbide [abrasive]; carbides of metal [abrasives]; eyebrow cosmetics; volcanic ash for cleaning; non-slipping wax for floors; laundry wax; tailors' wax; shoemakers' wax; depilatory wax; shoe wax; mustache wax; parquet floor wax; polishing wax; waxes for leather; shampoos; dry shampoos; shampoos for pets; preservatives for leather [polishes]; corundum [abrasive]; quillaia bark for washing; cosmetics; cosmetics for animals; skin whitening creams; cosmetic creams; boot polish; polishing creams; cosmetic products for skin care; floor wax removers [scouring preparations]; scouring solutions; bleaches for cosmetic use; depilatories; degreasing products other than for use in manufacturing processes; scale removing preparations for household use; make-up removing preparations; deodorants for pets; deodorants [perfumery products]; detergents other than for use in manufacturing operations and for medical use; diamantine [abrasive]; douching preparations for personal sanitary or deodorant purposes [toiletries]; polish for furniture and flooring; mouthwashes not for medical use; badian essence; bergamot oil; mint essence [essential oil]; ethereal essences; emery; extracts of flowers [perfumery products]; bases for flower perfumes; fu-

migation products (perfumes); whitening gels for dental use; massage gels other than for medical use; geraniol; laundry glaze; greases for cosmetic use; cotton wool for cosmetic use; heliotropine; henna [dyes for cosmetic use]; swabs [toiletries]; incense; ionone [perfumery]; shaving soap; almond soap; antiperspirant soaps; soap for foot perspiration; disinfectant soaps; deodorant soaps; medicinal soaps; soap for brightening textile; petroleum jelly for cosmetic use; nail polish; hair sprays; nail polish removing products; breath freshening strips; eyebrow pencils; pencils for cosmetic use; almond milk for cosmetic use; cleansing milk for toilet purposes; Javelle water; soda lye; windshield cleaning liquids; preparations for cleaning dentures; dry cleaning products; cleaning products; non-slipping liquids for floors; hair lotions; after-shave lotions; lotions for cosmetic use; scented wood; make-up; make-up products; mascara; beauty masks; mint for perfumery; decorative patterns for cosmetic use; cosmetic kits; neutralizers for permanent waving; cloths impregnated with a detergent for cleaning; emery paper; sandpaper; polishing paper; wallpaper cleaning products; abrasive papers; pastes for razor strops; bars of soap; nail art stickers; perfumery products; perfumes; hydrogen peroxide for cosmetic use; cosmetics for eyelashes; false eyelashes; cobblers' wax; pumice stone; shaving stones [astringents]; alum stones [astringents]; polishing stones; smoothing stones; lipsticks; preparations for removing paints; make-up powder; pomades for cosmetic use; potpourris [fragrances]; laundry preparations; sunscreen preparations; aloe vera preparations for cosmetic use; preparations for unblocking drain pipes; bleaching products for laundry use; rust removing products; preparations for polishing dental prostheses; polishing preparations; stain removers; products for soaking laundry; jewelers' rouge; safrol; bleaching salts; bath salts other than for medical use; washing soda for cleaning; bleaching soda; fabric softeners for laundry use; talcum powder, for toilet use; sandcloth; emery cloth; glass cloth; terpenes [essential oils]; cosmetic dyes; dyes for toilet purposes; hair dyes; beard dyes; products for removing dyes; cleaning chalk; tissues impregnated with cosmetic lotions; toiletry products; turpentine [degreasing product]; tripoli stone for polishing; false nails; nail care products; joss sticks.

9 – Scientific, nautical, surveying, photographic, cinematographic, optical, weighing, measuring, signaling, checking (supervision), life-saving and teaching apparatus and instruments; apparatus and instruments for conducting, switching, transforming, accumulating, regulating or controlling electricity; sound or image recording, transmission or reproduction apparatus; magnetic recording media, sound recording disks; compact disks, DVDs and other digital recording media; mechanisms for coin-operated apparatus; cash registers, calculating machines, data processing equipment, computers; software; fire extinguishers; abacuses; personal devices for protection against accidents;

particle accelerators; acid hydrometers; azimuth instruments; connections for electric lines; acoustic couplers; couplers [data processing equipment]; actinometers; electric accumulators; recording discs (cleaning devices therefor); aerometers; electronic agendas; surveying instruments; railway points (electrodynamic apparatus for the remote control thereof); needles for record players; air analysis apparatus; stills for laboratory experiments; alarms (instruments therefor); anti-theft alarms; fire alarms; sound alarms; alcoholmeters; metal alloy wires [fuses]; mouse pads; alidades; food analysis apparatus; loudspeakers; altimeters; asbestos (fireproof clothing made thereof); ammeters; enlarging apparatus [photography]; amplifiers; analysis apparatus not for medical purposes; anemometers; calibrating rings; anodes; antennas; telescope levels; anticathodes; anti-rust (cathodic devices for protection against rust); anti-interference devices [electricity]; anti-glare eyeglasses; electric theft prevention installations; GPS (global positioning system) apparatus; data processing apparatus; X-ray apparatus not for medical use; X-ray producing apparatus and installations, not for medical use; apertometers [optics]; downloadable image files; downloadable music files; distribution boxes [electricity]; safety restraints, other than for vehicle seats and sports equipment; asbestos (gloves made thereof) for protection against accidents; astronomy (apparatus and instruments for-); audiovisual teaching apparatus; earphones; telephone receivers; fire engines; rescue (apparatus and devices therefor); scales; precision balances; lighting ballasts; luminous beacons; luminous or mechanical road signs; life-saving rafts; laboratory trays; fire boats; barometers; weighbridges; fire beaters; batteries (battery acidimeters); anode batteries; batteries for lighting; electric batteries for vehicles; battery plates; betatrons; binoculars; electric coils; electric coil carriers; electromagnetic coils; speaking tubes; special bags for portable computers; fire engines; flashlights [photography]; wire connectors [electricity]; terminals [electricity]; push buttons for bells; reference buoys; signaling buoys; tone arms for record players; identification threads for electric wires; directional compasses; marine compasses; spirit levels; coaxial cables; starter cables for motors and engines; fiber-optic cables; electric cables; surveying chains; eyeglass chains; cabinets for loudspeakers; accumulator boxes; branch boxes [electricity]; switchboxes [electricity]; junction boxes [electricity]; petri dishes; containers for microscope slides; cash registers; automatic cash dispensing machines; electrically heated socks; calculators; pocket calculators; boilers (instruments for controlling boilers); gauges; calipers; footwear for protection against accidents, irradiation and fire; cinematographic cameras; decompression chambers; cameras [photography]; jukeboxes for computers; signal bells; protective masks for workers; solderers' helmets; battery chargers; chargers for electric batteries; spools [photography]; video game car-

tridges; riding helmets; protective helmets; protective helmets for sports; video cassettes; telescopes; cathodes; galvanic cells; photovoltaic cells; laboratory centrifuges; electric locks; bullet-proof vests; life jackets; chips [integrated circuits]; DNA chips; cyclotrons; film editing devices; magnetic tapes; demagnetizing apparatus for magnetic tapes; sound recording strips; head cleaning tapes; life belts; printed circuits; integrated circuits; gradient indicators; insulated copper wires; magnetic encoders; bar code readers; electric collectors; comparators; compasses [measuring instruments]; laptop computers; condensers [capacitors]; optical condensers; ducts [electricity]; electricity duct materials [wires, cables]; electric conductors; acoustic conduits; electricity conduits; connectors [electricity]; switching (electrical apparatus therefor); commutators (switches); converters; traffic cones; distribution consoles [electricity]; electric contacts; counters; answering machines; control (electrical apparatus therefor); speed control for vehicles (apparatus therefor); franking control (apparatus therefor); remote control (apparatus therefor); remote control of industrial operations (electrical installations therefor); remote control of signals (electrodynamic apparatus therefor); cupels [laboratory]; eyeglass cords; straps for mobile telephones; logs [measuring instruments]; cosmography instruments; dressmaking tape measures; circuit closers; galena crystals [detectors]; chromatography (apparatus therefor) for laboratories; chronographs [time recording apparatus]; darkrooms [photography]; washing trays [photography]; measuring spoons; thread counters; kilometer recorders for vehicles; revolution counters; leather (apparatus for measuring the thickness thereof); densimeters; densitometers; distillation apparatus for scientific purposes; detectors; counterfeit [false] coin detectors; smoke detectors; metal detectors for industrial or military use; diaphragms [acoustics]; diaphragms [photography]; diaphragms for scientific apparatus; diagnosis apparatus other than for medical purposes; transparencies; slide framing apparatus; animated cartoons; dictaphones; diffraction apparatus [microscopy]; dynamometers; money (machines for counting and sorting thereof); light-emitting diodes [LED]; sound recording disks; compact disks [audio-video]; calculating disks; magnetic disks; optical disks; optical compact disks; reflecting disks for wear, for the prevention of traffic accidents; shutter releases [photography]; floppy disks; distance measuring devices; ticket dispensers; circuit breakers; dosage dispensers; marine depth finders; electrolyzers; transmitters of electronic signals; transmitting sets [telecommunication]; electric couplings; remote ignition (electrical devices therefor); plugs, sockets and other contacts [electric connections]; testing of materials (instruments and machines therefor); epidiascopes; balancing (devices therefor); ergometers; diving suits; fire escapes; sounding leads; scanners [data processing equipment]; school apparatus; drainers for use in photography; spherometers; spectrograph apparatus;

mirrors for inspecting work; mirrors [optics]; thickness of skins (apparatus for the measurement thereof); drying racks [photography]; stereoscopic apparatus; stereoscopes; stroboscopes; cases fitted with dissecting instruments [microscopy]; cases especially made for photographic apparatus and instruments; spectacle cases; cases for contact lenses; pince-nez cases; electronic tags for goods; temperature indicator labels not for medical use; exposure meters [light meters]; billing machines; fax machines; fermentation apparatus [laboratory apparatus]; optical fibers [light conducting filaments]; tokens (mechanisms for apparatus operated thereby); filters for ultraviolet rays for photography; filters [photography]; filters for respiratory masks; physics (apparatus and instruments for-); flash-bulbs [photography]; photoprints (apparatus therefor); photocopiers; apparatus for glazing photographic prints; apparatus for drying photographic prints; photometers; high-frequency apparatus; frequency meters; identification sheaths for electric wires; sheaths for electric cables; covers for laptops; fuses; spectacles for sports; sunglasses; spectacles [optics]; jigs [measuring instruments]; galvanometers; gases (apparatus for the analysis thereof); gasometers [measuring instruments]; surveying (apparatus and instruments therefor); meteorological balloons; sound recording apparatus; sound recording media; video recorders; marking gauges [joinery]; gloves for divers; gloves for protection against accidents; gloves for protection against X-rays for industrial purposes; heliographic apparatus; hydrometers; hygrometers; electric wires; magnetic wires; telephone wires; telegraph wires; holograms; furnaces for laboratory use; magnets; decorative magnets; computer printers; incubators for bacteria culture; automatic indicators of low pressure in vehicle tires; quantity indicators; gasoline gauges; electric loss indicators; temperature indicators; speed indicators; water level indicators; armatures [electricity]; inductors [electricity]; intercommunication apparatus; interfaces [computers]; carriers for dark plates [photography]; electric switches; inverters [electricity]; ionization apparatus other than for the treatment of air or water; leveling staffs [surveying instruments]; hands free kits for telephones; lactodensimeters; optical lamps; darkroom lamps [photography]; fire hose nozzles; electronic pens [visual display units]; lasers, not for medical use; cassette players; compact disc players; DVD players; readers [data processing equipment]; optical character readers; correcting lenses [optics]; contact lenses; eyepieces (instruments containing eyepieces); optical lenses; lenses for spectacles; lens hoods; neon signs; luminous signs; mechanical signs; limiters [electricity]; signal lanterns; magic lanterns; safety tarpaulins; blinkers [signaling lights]; magnifying glasses [optics]; tape recorders; wind socks for indicating wind direction; fire hoses; junction sleeves for electric cables; crash test dummies; resuscitation mannequins [teaching apparatus]; pressure gauges; fire blankets; hemline mar-

kers; frames for photographic transparencies; digital photograph frames; divers' masks; protective masks; respiratory masks, other than for artificial respiration; mathematical instruments; measuring apparatus; electrical measuring apparatus; measuring instruments; precision measuring apparatus; measures; speed measuring apparatus [photography]; megaphones; computer memory devices; USB flash drives; mercury (levels thereof); meteorological instruments; metronomes; rules [measuring instruments]; microphones; microprocessors; microscopes; microtomes; sighting telescopes for firearms; peepholes [magnifying lenses] for doors; furniture especially made for laboratories; modems; monitors [computer hardware]; monitors [computer programs]; spectacle frames; eyeglass frames; underwater swimming (breathing apparatus therefor); nautical apparatus and instruments; naval signaling apparatus; navigation apparatus for vehicles [on-board computers]; navigation apparatus via satellite; navigation instruments; leveling instruments; levels [instruments for determining the horizontal]; verniers; lenses for astrophotography; objectives [lenses] [optics]; boards for integrated circuits; observation instruments; shutters [photography]; octants; eyepieces; office punched card machines; ohmmeters; wave-meters; optical items; optical apparatus and instruments; computers; notebook computers (laptops); oscillographs; egg-candlers; oxygen transfilling apparatus; ozonizers; horns for loudspeakers; micrometer gauges; luminous or mechanical signaling panels; asbestos screens for firemen; projection screens; video screens; fluorescent screens; screens [photography]; radiology screens for industrial use; spark-guards; lightning conductors [rods]; parking meters; film cutting apparatus; exposed cinematographic films; exposed X-ray films; exposed films; computer peripheral devices; periscopes; letter scales; weighing (apparatus and instruments therefor); weighing machines; lactometers; weights; slide calipers; stands for photographic apparatus; electric batteries; galvanic batteries; solar batteries; autopilots; nose clips for divers and swimmers; pipettes; pyrometers; plane tables [surveying instruments]; planimeters; plumb lines; plumb bobs; plotters; pedometers; polarimeters; masts for wireless aeri-als; pressure meters; prepayment apparatus mechanisms; prisms [optics]; test tubes; processors [central processing units]; recorded computer operating programs; recorded computer programs; computer programs [downloadable software]; voltage surge protectors; teeth protectors; projectors; slide projectors; styluses for record players (stylus replacement devices); downloadable electronic publications; magnetic encoded identification bracelets; light-emitting electronic pointers; pince-nez; chemistry (apparatus and instruments therefor); radar apparatus; radios; radios for vehicles; pagers; X-ray photographs, other than for medical use; radiology apparatus for industrial purposes; radiotelephone sets; walkie-talkies; radiotelegraph sets; electrified rails for mounting spot lights;

mice [data processing equipment]; x-ray apparatus other than for medical purposes; x-ray shielding devices other than for medical purposes; reactance coils [impedance coils]; receivers [audio and video]; measuring glassware; current rectifiers; nets for protection against accidents; life nets; cell switches [electricity]; refractometers; refractors; distance measurers; pressure indicators; time recording apparatus; slide-rules; carpenters' rules; rulers [measuring instruments]; stage lighting regulators; speed regulators for record players; voltage regulators for vehicles; grids for batteries; electric relays; egg timers [sandglasses]; time clocks [time recording devices]; rheostats; wrist rests for use with computers; reproduction of sound (apparatus therefor); personal stereos; portable media players; electric resistors; breathing apparatus other than for artificial respiration; respirators for filtering air; retorts; sprinkler systems for fire protection; musical jukeboxes; knee-pads for workers; balances [steelyards]; clothing especially made for laboratories; clothing for protection against fire; screw-tapping gages; saccharometers; salinometers; life buoys; satellites for scientific use; safety apparatus for railway traffic; traffic-light apparatus [signaling devices]; semi-conductors; non-explosive fog signals; luminous or mechanical signals; sextants; whistle alarms; signaling whistles; dog whistles; simulators for the steering and control of vehicles; sirens; computer game software; software [recorded programs]; sonars; sounding lines; probes for scientific use; drilling (apparatus and machines therefor); sound (apparatus for the transmission thereof); sound locating instruments; magnetic data media; optical data media; retorts' stands; sulphitometers; adding machines; switchboards; control panels [electricity]; distribution boards [electricity]; electronic notice boards; tachometers; covers for electric outlets; ear plugs for divers; pressure indicator plugs for valves; printed circuit boards; smart cards [integrated circuit cards]; encoded magnetic cards; magnetic identity cards; taximeters; computer keyboards; teleprompters; telephone (apparatus); telephone (transmitters); mobile telephones; picture transmission (apparatus for-); telegraphs [apparatus]; range finders; tele-rupters; teleprinters; television apparatus; television sets (prepayment mechanisms therefor); automatic time switches; theodolites; thermometers not for medical use; thermoregulators; thermostats; thermostats for vehicles; bells [warning devices]; electric alarm bells; electric door bells; record players; downloadable ringtones for mobile telephones; micrometer screws for optical instruments; totalizators; electronic pocket translators; clothing for protection against accidents, irradiation and fire; protective suits for aviators; suits for protection against fire; screens for photoengraving; transformers [electricity]; step-up transformers; transistors [electronic]; transmitters [telecommunication]; transponders; protractors [measuring instruments]; vehicle breakdown warning triangles; triodes; tripods for cameras; amplifying tubes; capillary tubes;

electric discharge tubes other than for lighting; Pitot tubes; X-ray tubes not for medical purposes; vacuum tubes [radio]; thermionic tubes; magnetic tape units for computers; disk drives for computers; urinometers; vacuum gauges; electrified fences; solenoid valves [electromagnetic switches]; electric light regulators [dimmers]; rods for water diviners; variometers; accumulator jars; camcorders; videotapes; video telephones; glass covered with an electrical conductor; optical glass; surveillance (electrical apparatus therefor); viscosimeters; anti-dazzle shades; photographic viewfinders; voltmeters; voting machines; buzzers.

14 – Precious metals and their alloys, as well as goods made of these materials or coated therewith not included in other classes; jewelry articles, jewelry, precious stones; timepieces and chronometric instruments; ornaments [jewelry]; ornaments of jet; footwear ornaments of precious metal; hat ornaments of precious metal; agates; clock hands; alloys of precious metal; pins [jewelry]; ornamental pins; amulets [jewelry]; anchors [clock and watch making]; rings [jewelry]; earrings; works of art of precious metal; unwrought or semi-wrought jet; brooches [jewelry]; busts of precious metal; chains [jewelry]; watch chains; boxes of precious metal; clock cases; necklaces [jewelry]; watch glasses; chronographs [watches]; chronometric instruments; chronometers; stopwatches; chronoscopes; beads for making jewelry; alarm clocks; diamonds; charms [jewelry]; dials [clock and watch making]; spinel [precious stones]; statues of precious metal; statuettes of precious metal; costume jewelry; cases for timepieces; cases for watches [presentation]; copper tokens; tie pins; cuff links; threads of precious metal [jewelry]; badges of precious metal; iridium; jewelry of yellow amber; cloisonné jewelry; jewelry articles; jewelry cases [caskets]; ingots of precious metals; key rings [trinkets or fobs]; clockworks; ivory decorations [jewelry articles]; movements for timepieces; medals; medallions [jewelry]; unwrought or semi-wrought precious metals; coins; watch springs; olivine [gems]; unwrought or beaten gold; gold threads (jewelry articles); osmium; palladium; pendulums [clock and watch making]; pearls [jewelry]; pearls made of ambroid [pressed amber]; precious stones; semi-precious stones; unwrought or beaten silver; spun silver [silver wire]; silver threads; platinum [metal]; bracelets [jewelry]; watch straps; watches; atomic clocks; watch casings; wall clocks; wristwatches; sundials; electric clocks and watches; master clocks; rhodium; ruthenium; tie clips; barrels [clock and watch making].

18 – Leather and imitation leather, goods made of these materials not included in other classes; animal skins; trunks and suitcases; umbrellas and parasols; walking sticks; whips, harness and saddlery; leather trimmings for furniture; umbrella rings; blinkers [harness]; handbag frames; frames for umbrellas or parasols; harness for animals; saddle trees; suitcase

handles; shoulder belts [straps] of leather; chin straps of leather; walking stick seats; mountaineering sticks; umbrella sticks; traveling trunks; trunks [luggage]; wallets; bags; bags for campers; empty tool bags of leather; sports bags; bags for climbers; beach bags; net bags for shopping; wheeled shopping bags; travel bags; shopping bags; envelopes, of leather, for packing; handbags; muzzles; bridles [harness]; bridoons; kid; boxes of leather or leather board; boxes of vulcanized fiber; pouch baby carriers; school satchels; leather board; bands of leather; fastenings for saddles; coverings of skins [furs]; collars for animals; horse collars; leather laces; straps for soldiers' equipment; harness straps; straps of leather [saddlery]; leather leashes for animals; stirrup leathers; straps for skates; artificial leather; unworked or semi-worked leather; butts [parts of hides]; walking stick handles; stirrups; parts of rubber for stirrups; cases of leather or leather board; traveling cases [leatherware]; vanity cases; key cases; bits for animals [harness]; slings for carrying infants; casings, of leather, for springs; umbrella covers; covers for horse-saddles; whips; chamois leather other than for cleaning purposes; saddlery; harness fittings; horseshoes; leather laces; cat o' nine tails; haversacks; suitcases; hand luggage [suitcases]; attaché cases; horse blankets; backpacks; leather backpacks for carrying infants; moleskin [imitation of leather]; purses; chain mesh purses; nose bags [feed bags]; game bags [hunting accessories]; umbrellas; parasols; curried skins; cattle skins; furs [animal skins]; document cases; music cases; garment bags for travel; umbrella handles; furniture coverings of leather; reins; knee-pads for horses; halters; clothing for animals; riding saddles; hat boxes of leather; pads for horse saddles; card cases [notecases]; leather straps; traces [harness]; gold beaters' skin; gut for making sausages; valves of leather; umbrella or parasol ribs.

25 – Clothing, footwear, headwear; coats; layettes [clothing]; bath robes; esparto shoes or sandals; non-slipping devices for footwear; sleep masks; hat frames [skeletons]; clothing for motorists; bibs not of paper; swimsuits; bandanas [neckerchiefs]; bands; headbands [clothing]; bath slippers; bath sandals; overalls; dressing gowns; boas [mufflers]; teddies [undergarments]; berets; footmuffs, not electrically heated; pockets for clothing; lace boots; boots; ski boots; football boots; half-boots; panties; babies' pants [clothing]; socks; leggings [leg warmers]; footwear; sports footwear; beach shoes; boxer shorts; shirts; short-sleeve shirts; sports jerseys; tee-shirts; bodices [lingerie]; boot uppers; shirt yokes; hoods [clothing]; chasubles; vests; shawls; galoshes; jackets; fishing vests; stuff jackets; rain slickers; clothing for cyclists; money belts [clothing]; belts [clothing]; caps; slippers [undergarments]; ready-made clothing; combinations [clothing]; heel-pieces for footwear; neckties; corselets; corsets [underclothing]; camisoles; collars [clothing]; detachable collars; aprons [clothing]; sneakers; masquerade costumes; petticoats; fur stoles; girdles [underwear];

skirts; skorts; ready-made linings [parts of clothing]; foulards; top coats; gabardines [clothing]; footwear for gymnastics; bathing caps; shower caps; ski gloves; gloves [clothing]; metal fittings for footwear; jerseys [clothing]; leggings [trousers]; body linen [garments]; liveries; sock suspenders; garters; stocking suspenders; muffs [clothing]; maniples; mantillas; stockings; sweat-absorbent stockings; hosiery; mittens; miters [hats]; ear muffs [clothing]; footwear uppers; long pants; tights; pocket squares; Ascots; parkas; bootees; shirt fronts; pelerines; pelisses; jumper dresses; furs [clothing]; pajamas; inner soles; beach clothes; spats; ponchos; knitwear [clothing]; collar protectors for clothing; pullovers; cuffs; toe caps for footwear; heel-pieces for stockings; clothing of leather; clothing of imitation leather; clothing for gymnastics; paper clothing; outerclothing; sweat-absorbent underclothing [underwear]; sandals; saris; sarongs; bathing drawers; underpants; dress shields; skull caps; hats; top hats; paper hats [clothing]; brassieres; soles for footwear; sweaters; heels; studs for football boots; suspenders; head coverings [headgear]; wimples; togas; trouser straps; suits; wet suits for water-skiing; turbans; uniforms; veils [clothing]; dresses; clothing (garments); welts for footwear; visors [headwear]; cap peaks; shoes; wooden shoes.

35 – Advertising; commercial business management; commercial administration; office functions; procurement services for others [purchasing goods and services for other businesses]; updating of advertising material; import-export agencies; commercial information agencies; advertising agencies; rental of vending machines; rental of advertising space; rental of photocopying machines; office machines and equipment rental; advertising material rental; rental of advertising time on communication media; cost price analysis; advisory services for business management; business management assistance; business auditing; data search in computer files for others; market research; sponsorship search; business research; commercial or industrial management assistance; price comparison services; compilation of information in computer databases; layout services for advertising purposes; news clipping services; business management consultancy; personnel management consultancy; business organization consultancy; business management and organization consultancy; professional business consultancy; accounting; telephone answering for unavailable subscribers; advertising mail; tax preparation; shop-window dressing; demonstration of goods; dissemination of advertisements; distribution of samples; relocation services for businesses; drawing up of statements of accounts; market study; outsourcing services [business assistance]; invoicing; organization of trade fairs for commercial or advertising purposes; administrative management of hotels; commercial management of the licensing of goods and services for third parties; computerized file management; business management of performing artists;

business inquiries; business information; commercial information and advice for consumers [consumer advice shop]; commercial investigation; marketing; typing services; modeling for advertising or sales promotion; payroll preparation; employment agencies; organization of fashion shows for promotional purposes; organization of exhibitions for commercial or advertising purposes; arranging newspaper subscriptions for others; psychological testing for the selection of personnel; presentation of goods on communication media for retail purposes; economic forecasting; production of advertising films; sales promotion for third parties; publication of advertising texts; on-line advertising on a computer network; bill-posting; direct mail advertising; advertising by mail order; radio advertising; television advertising; compilation of statistics; writing of advertising texts; public relations; document reproduction; secretarial services; personnel selection; business efficiency expert services; photocopying services; representation services for sports people; telemarketing services; systematization of information in computer databases; opinion polling; arranging subscriptions to telecommunication services for others; shorthand services; administrative processing of purchase orders; transcription of communications; word processing; commercial business appraisal; retail sale or wholesale of pharmaceutical, veterinary and sanitary preparations, as well as of medical supplies; auctioneering; retail and wholesale services in stores, via global computer networks, by catalog, by mail order, by telephone, via radio and television, and via other electronic means, for bleaching preparations and other substances for laundry use, preparations for cleaning, polishing, degreasing and abrading, soaps, perfumery products, essential oils, cosmetics, hair lotions, dentifrices, abrasives, almond oil, gaultheria oil, jasmine oil, lavender oil, rose oil, oil of turpentine [degreasing product], cleaning oils, perfumery oils, toiletry oils, essential oils of cedarwood, essential oils of citron, essential oils of lemon, ethereal oils, oils for cosmetic use, slimming preparations [cosmetic preparations], adhesives for affixing false eyelashes, adhesives for affixing false hair, adhesives for cosmetic use, aerosol products for freshening breath, shaving products, sharpening products, drying agents for dishwashing, eau de cologne, lavender water, toilet water, scented water, canned pressurized air for cleaning and dusting purposes, volatile alkali [ammonia] detergent, smoothing products [laundry], laundry starch, starch glaze for laundry purposes, musk [perfumery products], amber [perfumery products], bluing for laundry, antistatic products for household use, antiperspirants [toiletries], aromatics [essential oils], flavorings for cakes [essential oils], flavorings for beverages [essential oils], air fragrancing products, astringents for cosmetic use, color-brightening chemicals for household use [laundry], balms other than for medical use, cosmetic preparations for baths, products for removing varnishes, shoe black, bleaching pro-

ducts for leather, sachets for perfuming linen, products for making the leaves of plants shiny, lip gloss, bronzers, polishing preparations, hair waving preparations, silicon carbide [abrasive], carbides of metal [abrasives], cosmetics for eyebrows, volcanic ash for cleaning, non-slipping wax for floors, laundry wax, tailors' wax, shoemakers' wax, depilatory wax, shoe wax, mustache wax, parquet floor wax, polishing wax, waxes for leather, shampoos, dry shampoos, shampoos for pets, preservatives for leather [polishes], corundum [abrasive], quillaia bark for washing, cosmetics, cosmetics for animals, skin whitening creams, cosmetic creams, shoe creams, polishing creams, cosmetic products for skin care, floor wax removers, scouring solutions, bleaches for cosmetic use, dentifrices, depilatories, degreasing products other than for use in manufacturing processes, make-up removers, deodorants for pets, deodorants [perfumery products], detergents other than for use in manufacturing processes and for medical use, diamantine [abrasive], douching preparations for personal sanitary or deodorant purposes, polish for furniture and flooring, mouth washes, not for medical use, badian essence, bergamot essence, mint essence, ethereal essences, emery, extracts of flowers [perfumery products], bases for flowers, fumigation products, [perfumes], bleaching gels for dental use, massage gels other than for medical use, geraniol, laundry glaze, greases for cosmetic use, wadding for cosmetic use, heliotropine, henna [dyes for cosmetic use], swabs for cosmetic use, incense, ionone [perfumery products], shaving soap, almond soap, soaps, antiperspirant soaps, soaps for foot perspiration, disinfectant soaps, deodorant soaps, medicated soaps, soaps for brightening the colors of textile materials, petroleum jelly for cosmetic use, nail varnish, hair sprays, products for removing lacquers, breath freshening strips, eyebrow pencils, pencils for cosmetic use, almond milk for cosmetic use, cleansing milks for toilet purposes, javelle water, soda lye, windscreen wipers liquids, preparations for cleaning dentures, dry-cleaning products, cleaning products, non-slipping liquids for floors, hair lotions, after-shave lotions, lotions for cosmetic use, scented woods, make-up, make-up products, cosmetics, eyelash mascara, beauty masks, mint for perfumery, decorative transfers for cosmetic use, cosmetic kits, neutralizers for permanent waving, cleaning cloths impregnated with a detergent, emery paper, sandpaper, polishing paper, products for cleaning wallpaper, abrasive papers, pastes for razor strops, bars of soap, decorative stickers for nails, perfumery products, perfumes, hydrogen peroxide for cosmetic use, cosmetics for eyelashes, false eyelashes, cobblers' wax, pumice stones, astringent after-shaving stones, alum stones [astringents], polishing stones, smoothing stones, lipsticks, products for removing paints, make-up powders, pomades for cosmetic use, potpourris, bleaching preparations [laundry], sunscreen preparations, aloe vera preparations for cosmetic use, preparations for unblocking drain pipes,

bleaching bleach for laundry, rust removing preparations, preparations for polishing dental prostheses, preparations for polishing, stain removers, products for soaking laundry, jewelers' rouge, safrol, bleaching salts, bath salts, not for medical use, soda for cleaning, soda for bleaching, fabric softeners for laundry use, talcum powder for toilet use, abrasive cloth, emery cloth, glass cloth, terpenes, cosmetic dyes, dyes for toilet purposes, hair dyes, beard dyes, products for removing dyes, cleaning chalk, wipes impregnated with cosmetic lotions, toiletry products, turpentine [degreasing product], tripoli stone for polishing, false nails, preparations for nail care, scientific, nautical, surveying, photographic, cinematographic, optical, weighing, measuring, signaling, checking [supervision], life-saving and teaching apparatus and instruments, apparatus and instruments for conducting, distribution, transformation, accumulating, regulation or control of electricity, apparatus for recording, transmission or reproduction of sound or images, magnetic data carriers, recording discs, compact discs, DVDs and other digital recording media, mechanisms for coin-operated apparatus, cash registers, calculating machines, data processing equipment, computers, software, fire-extinguishers, abacuses, personal devices for protection against accidents, particle accelerators, acid hydrometers, azimuth instruments, connections for electric lines, acoustic couplers, couplers [data processing equipment], actinometers, electric accumulators, cleaning devices for acoustic discs, aerometers, electronic agendas, land surveying instruments, electro-dynamic apparatus for the remote control of railway tracks, sapphire needles for record players, apparatus for analyzing air, stills for laboratory use, alarms instruments, burglar alarms, fire alarms, sound alarms, alcoholmeters, wires of metal alloys [fuses], mouse pads, alidades, apparatus for analyzing food, speakers, altimeters, fireproof suits of asbestos, ammeters, enlarging apparatus [photography], amplifiers, analysis apparatus other than for medical use, anemometers, calibrating rings, anodes, antennas, surveyors' levels, anticathodes, cathodic devices for protection against rust, anti-interference devices [electricity], anti-glare eyeglasses, electric theft prevention installations, GPS apparatus, data processing apparatus, X-ray apparatus other than for medical use, apparatus and installations for generating X-rays other than for medical use, apertometers [optics], downloadable image files, downloadable music files, distribution cabinets [electricity], safety restraints, other than for vehicle seats and sports equipment, asbestos gloves for accident protection, apparatus and instruments for astronomy, audiovisual teaching apparatus, headphones, telephone headsets, fire engines, rescue apparatus and devices, scales, precision balances, ballasts for lighting apparatus, luminous beacons, luminous or mechanical beacons for roads, life-saving rafts, laboratory trays, fire boats, barometers, weighing scales [weighing apparatus], fire beaters, acid hydrometers for batteries, anode

batteries, starter batteries, electric batteries for vehicles, plates for batteries, betatrons, electric coils, electric coils holders, electromagnetic coils, horns, special bags for laptops, fire engines, flashlights, wire connectors [electricity], terminals [electricity], push buttons for bells, reference buoys, signaling buoys, tone arms for record players, identification threads for electric wires, directional compasses, marine compasses, spirit levels, coaxial cables, starter cables for motors, fiber optic cables, electric cables, land surveying chains, pince-nez chains, cabinets for loudspeakers, battery boxes, branch boxes [electricity], distribution boxes [electricity], junction boxes [electricity], petri dishes, containers for microscope slides, cash registers, automatic teller machines [ATM], electrically heated socks, calculators, pocket calculators, boilers monitoring instruments, gages, calipers, footwear for protection against accidents, irradiation and fire, film cameras, decompression chambers, photographic cameras, disc changers for computers, signal bells, protective masks for workers, solderers' helmets, battery chargers, chargers for electric batteries, spools [photography], video game cartridges, riding helmets, protective helmets, protective helmets for sports, video cassettes, spyglasses, cathodes, galvanic cells, photovoltaic cells, laboratory centrifuges, electric locks, bullet-proof vests, life jackets, chips [integrated circuits], DNA chips, cyclotrons, cinematographic editing apparatus, magnetic tapes, demagnetizing apparatus for magnetic tapes, strips for sound recordings, head cleaning tapes, life belts, printed circuits, integrated circuits, clinometers, insulated copper wires, magnetic encoders, bar codes readers, electric collectors, comparators, compasses [measuring instruments], laptop computers, electric condensers, optical condensers, electric conduits, material for electric conduits [wires, cables], electric conductors, acoustic conduits, electric conduits, connectors [electricity], electric apparatus for commutation, switches, converters, traffic cones, distribution consoles [electricity], electric contacts, counters, answering machines, electric apparatus for monitoring, apparatus for speed monitoring for vehicles, apparatus for franking control, remote control apparatus, electric installations for remote control of industrial operations, electro-dynamic apparatus for remote control of signals, cupels, pince-nez cords, straps for mobile telephones, slides, cosmographic instruments, dressmaking tape measures, circuit closers, galena crystals [detectors], chromatography apparatus for laboratories, chronographs [time recording apparatus], darkrooms [photography], washing trays [photography], measuring spoons, thread counters, kilometer recorders for vehicles, revolution counters, apparatus for measuring the thickness of leather, densimeters, densimeters, densitometers, distillation apparatus for scientific use, detectors, counterfeit [false] coin detectors, smoke detectors, metal detectors for industrial or military use, diaphragms [acoustics], diaphragms [photography], diaphragms for

scientific apparatus, diagnostic apparatus other than for medical use, slides, apparatus for centering slides, animated drawings, dictaphones, diffraction apparatus [microscopy], dynamometers, machines for counting and sorting money, light-emitting diodes [LED], acoustic discs, compact discs [audio-video], calculating discs, magnetic discs, optical discs, optical compact discs, personal reflective discs for the prevention of traffic accidents, shutter releases [photography], floppy discs, distance meters, ticket dispensers, circuit breakers, dosimeters, hydrographic echo sounders, electrolyzers, transmitters of electronic signals, transmitters [telecommunication], electric connections, electric devices for remote ignition, plugs, instruments and machines for materials testing, epidiascopes, balancing [devices, ergometers, escutcheons, fire escapes, escutcheons, scanners [computer peripherals], school apparatus, drainers for photographic use, spherometers, spectrographs, mirrors for inspecting work, mirrors [optics], apparatus for measuring thickness of skins, drying racks [photography], stereoscopic apparatus, stereoscopes, stroboscopes, dissection instruments cases [microscopy], special cases for photographic apparatus and instruments, spectacle cases, cases for contact lenses, pince-nez cases, electronic tags for goods, temperature indicating labels not for medical use, exposure meters, fire extinguishers, invoicing machines, fax apparatus, fermentation apparatus [laboratory apparatus], optical fibers [light conducting filaments], mechanisms for apparatus operated by tokens, ultraviolet ray filters for photography, photographic filters, filters for respiratory masks, apparatus and instruments for physics, flashes [photography], apparatus for photoprints, photocopiers, apparatus for glazing photographic prints, apparatus for drying photographic prints, photometers, high-frequency apparatus, frequency meters, identification sheaths for electric wires, sheaths for electric cables, covers for laptops, fuses, sports glasses, sunglasses, spectacles [optics], jigs [measuring instruments], galvanometers, apparatus for analyzing gases, gasometers [measuring instruments], apparatus and instruments for surveying, meteorological balloons, apparatus for sound recording, carriers for sound recordings, video recorders, marking gages, diving gloves, gloves for protection against accidents, gloves for protection against X-rays for industrial use, heliographic apparatus, hydrometers, humidity meters, electric wires, magnetic wires, telephone wires, telegraph wires, holograms, laboratory ovens, magnets, decorative magnets, computer printers, incubators for bacteria culture, automatic indicators of low pressure in vehicle tires, quantity indicators, petrol gages, electric loss indicators, temperature indicators, speed indicators, water level indicators, armatures [electricity], inductors [electricity], intercommunication apparatus, interfaces [computers], intermediaries [photography], switches, inverters [electricity], ionization apparatus other than for the treatment of air or water, leveling staffs [surve-

ying instruments], hands-free kits for telephones, lactodensimeters, optical lamps, darkroom lamps [photography], fire hose nozzles, electronic pens for visual display units, lasers other than for medical use, cassette players, compact disc players, DVD players, readers [hardware], optical readers, corrective lenses [optics], contact lenses, instruments containing eyepieces, optical lenses, lenses for glasses, supplementary lenses [optics], neon signs, luminous signs, mechanical signs, limiters [electricity], signal lanterns, magic lanterns, safety tarpaulins, blinkers [signaling lights], magnifying glasses [optics], tape recorders, wind socks for indicating wind direction, fire hose, junction sleeves for electric cables, crash test dummies, resuscitation mannequins [teaching apparatus], pressure gages, fire blankets, hemline markers, slide frames, digital photo frames, divers' masks, protective masks, respiratory masks other than for artificial respiration, mathematical instruments, measuring apparatus, electric measuring apparatus, measuring instruments, apparatus for precision measurements, meters, apparatus for measuring speed [photography], megaphones, computer memories, USB flash drives, levels of mercury, meteorological instruments, metronomes, rules [measuring instruments], microphones, microprocessors, microscopes, microtomes, telescopic sights for firearms, optical peepholes for doors, furniture especially for laboratories, modems, monitors [hardware], monitors [computer programs], spectacle frames, eyeglass frames, breathing apparatus for underwater swimming, nautical apparatus and instruments, naval signaling apparatus, navigation apparatus for vehicles [on-board computers], navigation apparatus via satellite, navigation instruments, leveling instruments, levels [instruments for determining the horizontal], verniers, astrophotography objectives, objectives [optics], boards for integrated circuits, observation instruments [photography], shutters [photography], octants, eyepieces, punched card machines for offices, ohmmeters, wavemeters, opticians' articles, optical apparatus and instruments, computers, notebook computers, oscillographs, egg-candlers, apparatus for transferring oxygen, ozonizers, horns for loudspeakers, micrometer gages, signaling panels, luminous or mechanical, asbestos screens for firemen, projection screens, video screens, fluorescent screens, screens [photography], radiology screens for industrial use, fire screens, lightning arresters, parking meters, apparatus for cutting film, exposed cinematographic films, exposed X-ray films, exposed films, computer peripherals, periscopes, letter scales, apparatus and instruments for weighing, weighing machines, lactometers, weights, slide calipers, stands for photographic apparatus, electric cells, galvanic cells, solar cells, automatic pilots, nose clips for divers and swimmers, pipettes, pyrometers, plane tables [surveying instruments], planimeters, plumb bobs, plumb bobs, plotters, pedometers, polarimeters, masts for wireless aerials, pressure meters, mechanisms for pre-payment apparatus,

prisms [optics], test tubes, processors [central processing units], recorded computer operating system programs, recorded computer programs, computer programs [downloadable software], voltage surge protectors, teeth protectors, projection apparatus, slide projectors, devices for changing record player picks, downloadable electronic publications, magnetic encoded identification bracelets, light-emitting electronic pointers, pince-nez, chemistry apparatus and instruments, radars, radio apparatus, radio apparatus for vehicles, paging apparatus, radiographs other than for medical use, radiology apparatus for industrial use, radiotelephony apparatus, radiotelephones [walkie-talkies], radiotelegraph apparatus, electrified rails for projectors, mouse [hardware], X-rays apparatus other than for medical use, devices for protection against X-rays other than for medical use, reactance coil [impedance coils], receivers [audio-video], measuring glassware, current rectifiers, nets for protection against accidents, safety nets, reducers [electricity], refractometers, refractors, distance recording apparatus, pressure recorders, apparatus for recording time, slide-rules, carpenters' rules [slide-rules], rulers [measuring instruments], stage lighting regulators, speed regulators for record players, voltage regulators for vehicles, grids for electric accumulators, electric relays, hour-glasses, time clocks, rheostats, wrist rests for use with computers, apparatus for sound reproduction, portable multimedia players, electric resistors, breathing apparatus other than for artificial respiration, respirators for filtering air, retorts, sprinkler systems for fire protection, musical juke boxes, knee-pads for workers, balances [steelyards], special laboratory clothing, fire-proof clothing, screw-tapping gages, saccharometers, salinometers, life preservers, satellites for scientific use, security apparatus for railway traffic, traffic lights [signaling devices], semi-conductors, fog signals, non-explosive, luminous or mechanical signals, sextants, alarm whistles, signaling whistles, dog whistles, simulators for driving and controlling vehicles, sirens, computer game software, software [recorded programs], sonars, sounding lines, probes for scientific use, sampling apparatus and machines, apparatus for transmission of sound, sound level meters, magnetic data carriers, optical data carriers, stands for retorts, sulfimeters, adding machines, switchboards, switchboards, control panels [electricity], distribution boards [electricity], electronic notice boards, tachometers, socket covers, ear plugs for divers, pressure indicator plugs for valves, printed circuit boards, smart cards, encoded magnetic cards, magnetic identification cards, taximeters, computer keyboards, teleprompters, telephonic apparatus, telephonic transmitters, mobile telephones, phototelegraphy apparatus, telegraphs apparatus, telemeters, telerupters, teleprinters, televisions, coin-operated mechanisms for televisions time switches other than timepieces, theodolites, thermometers other than for medical use, thermoregulators apparatus, thermostats, thermostats for vehicles,

bells [alarm apparatus], electric alarm bells, electric door bells, turntables, downloadable ring tones for mobile telephones, micrometer screws for optical instruments, totalizers, electronic pocket translators, suits for protection against accidents, irradiation and fire, special protective suits for aviators, fireproof suits, screens for photoengraving, electric transformers, step-up transformers, transistors [electronic], transmitters [telecommunication], transponders, projectors [measuring instruments], vehicle breakdown warning triangles, triodes, tripods for cameras, amplifying tubes, capillary tubes, discharge tubes, electric, other than for lighting, pitot tubes, X-ray tubes other than for medical use, vacuum tubes [radio], thermionic tubes, magnetic tape units [for computers], disk drives [hardware], rheometers, vacuum gages, electrified fences, solenoid valves [electromagnetic switches], electric light regulators, rods for water diviners, variometers, battery jars, camcorders, video tapes, video telephones, glass with electrical conductor covering, optical glass, electrical surveillance apparatus, viscometers, anti-glare shades, photographic viewfinders, voltmeters, voting machines, buzzers, precious metals and their alloys, as well as goods made of these materials or coated therewith, articles of jewelry, costume jewelry, precious stones, horological and chronometric instruments, ornaments [jewelry articles], ornaments of jet, shoe ornaments of precious metals, hat ornaments of precious metals, agates, clock hands, alloys of precious metals, pins [jewelry articles], ornamental pins, amulets [jewelry articles], anchors [clock-and watchmaking], rings [jewelry articles], earrings, works of art of precious metals, jet, unwrought or semi-wrought, brooches [jewelry articles], busts of precious metals, chains [jewelry articles], watch chains, boxes of precious metals, watch boxes, necklaces [jewelry articles], watch glasses, chronographs [watches], chronometric instruments, chronometers, stopwatches, chronoscopes, beads for making jewelry, alarm clocks, diamonds, charms [jewelry articles], dials [clock and watch making], spinel [precious stones], statues of precious metals, statuettes of precious metals, costume jewelry, cases for clock-and watchmaking, cases for watches [presentation], copper tokens, tie pins, cuff links, wires of precious metals [jewelry articles], badges of precious metals, iridium, jewelry of yellow amber, cloisonné jewelry, jewelry articles, jewelry boxes, ingots of precious metals, key rings [trinkets or fobs], clockworks, ornaments of ivory [jewelry articles], clock mechanisms, medals, medallions [jewelry articles], precious metals, unwrought or semi-wrought, coins, watch springs, olive, gold, unwrought or beaten, gold threads [jewelry articles], osmium, palladium, pendulums [clock-and watchmaking], pearls [jewelry articles], pearls of pressed amber, precious stones, semi-precious stones, silver, unwrought or beaten, spun silver, silver thread, platinum [metal], bracelets [jewelry articles], watch bands, clocks, atomic clocks, watch cases, wall

clocks, wristwatches, sundials, electric clocks, master clocks, rhodium, ruthenium, tie clips, barrels [clock and watch making], leather and imitations of leather, goods made from these materials, animal skins, trunks and traveling bags, umbrellas and parasols, walking sticks, whips, harness and saddlery, leather trimmings for furniture, umbrella rings, blinders [harness], handbag frames, frames for umbrellas or parasols, harnessing, saddle trees, suitcase handles, leather shoulder belts, chin straps of leather, walking sticks, walking stick seats, mountaineering sticks, umbrella sticks, traveling trunks, trunks [luggage], pocket wallets, bags, bags for camping, empty tool bags of leather, bags for sports, bags for climbers, beach bags, net bags for shopping, wheeled shopping bags, traveling bags, shopping bags, pouches of leather for packaging, handbags, muzzles, bridles for horses, bridoons, kid, boxes of leather or leather board, boxes of vulcanized fiber, pouch baby carriers, school satchels, leatherboard, girths of leather, fastenings for saddles, coverings of skins [furs], collars for animals, collars for horses, leather laces, military straps, harness straps, straps of leather [saddlery], leather leashes for animals, stirrup straps, straps for skates, artificial leather, unworked or semi-worked leather, butts [parts of hides], walking stick handles, stirrups, parts of rubber for stirrups, cases of leather or leatherboard, traveling sets [leatherware], vanity cases, key cases, bits for animals [harness], slings for carrying infants, cases of leather for springs, umbrella covers, covers for horse saddles, whips, chamois leather other than for cleaning, saddlery, harness fittings, horseshoes, leather thread, cat o'nine tails, knapsacks, suitcases, hand luggage, attaché cases, horse blankets, rucksacks, rucksacks for carrying infants, moleskin [imitation of leather], coin purses, chain mesh purses, feeding bags, game bags [hunting accessories], umbrellas, parasols, curried skins, animal skins, hides, cattle skins, fur skins [animal skins], document cases, music cases, garment bags, umbrella handles, furniture coverings of leather, lead reins, knee pads for horses, halters for horses, clothing for animals, riding saddles, hat boxes of leather, pads for horse saddles, card cases [notecases], leather straps, traces [harness], gold beaters' skin, gut for making sausages, valves of leather, rods for umbrellas or parasols, furniture, mirrors, picture frames, goods of wood, cork, reeds, cane, wicker, horn, bone, ivory, whalebone, shell, amber, mother-of-pearl, meerschaum, substitutes for all these materials, or of plastics, household or kitchen utensils and containers, combs and sponges, brushes, materials for making brushes, cleaning articles, steelwool, unworked or semi-worked glass [except construction glass], glassware, porcelain and earthenware, textiles and textile goods, bed linen, table linen, clothing, footwear, headwear, coats, layettes [clothing], bath robes, espadrilles, non-slip devices for footwear, sleep masks, hat frames, clothing for motorists, bibs, not of paper, swimsuits, bandanas [neckerchiefs], bands, headbands

[clothing], bath slippers, bath sandals, overalls, aprons, boas [necklets], teddies [underclothing], berets, footmuffs, not electrically heated, pockets for clothing, lace boots, boots, ski boots, football boots, half-boots, panties, babies' pants, socks, leg warmers, footwear, footwear for sports, beach shoes, drawers [clothing], shirts, short-sleeve shirts, sports jerseys, T-shirts, camisoles, boot uppers, shirt yokes, hoods, chasubles, vests, shawls, galoshes, jackets, fishermen's jackets, heavy jackets, rain jackets, clothing for cyclists, money belts [clothing], belts [clothing], bonnets, combinations [underwear], ready-made clothing, combinations, heelpieces for footwear, ties, corselets, corsets [underclothing], camisoles, collars, detachable collars, aprons [clothing], sports shoes, masquerade costumes, petticoats, fur stoles, sashes [underwear], skirts, short skirts, ready-made linings [parts of clothing], scarves, overcoats, gabardines [clothing], gymnastic shoes, bathing caps, shower caps, ski gloves, gloves [clothing], fittings of metal for footwear, jerseys [clothing], leggings [trousers], lingerie, liveries, sock suspenders, garters, stocking suspenders, muffs [clothing], maniples, mantillas, stockings, sweat-absorbent stockings, half-boots [clothing], fingerless gloves, miters [hats], ear muffs [clothing], footwear uppers, trousers, tights, pocket squares [clothing], ascots, parkas, booties, shirt fronts, pelerines, pelisses, jumper dresses, furs [clothing], pyjamas, inner soles, beach clothing, gaiters, ponchos, knitwear [clothing], collar protectors for clothing, jumpers [pullovers], cuffs [clothing], toe caps for footwear, heel pieces for stockings, clothing of leather, clothing of imitations of leather, clothing for gymnastics, paper clothing, outer-clothing, anti-sweat underwear, sandals, saris, sarongs, bathing shorts, underpants, dress shields, skull caps, hats, top hats, paper hats [clothing], brassiere, soles for footwear, sweaters, heels, studs for football boots, suspenders, head coverings [headwear], wimples [clothing], togas, trouser straps, suits [clothing], wet suits, turbans, uniforms, veils, dresses, apparel for wear, welts for footwear, sun visors [headwear], cap peaks, shoes, clogs [footwear], lace and embroidery, ribbons and braids, buttons, hooks and eyes, pins and needles, artificial flowers, carpets, rugs, mats and matting, linoleum and other floor coverings, wall hangings other than of textile materials, games and toys, gymnastic and sporting articles, decorations for Christmas trees, meat, fish [not live], poultry and game, meat extracts, preserved, frozen, dried and cooked fruits and green vegetables, vegetables and pulses, jelly, jams, compotes, eggs, milk and milk products, edible oils and fats, coffee, tea, cocoa and coffee substitutes, rice, tapioca and sago, flour and preparations based on cereals, bread, pastry and confectionery products, edible ices, sugar, honey, treacle, yeast, baking powder, salt, mustard, vinegar, sauces [condiments], spices, ice, beer, mineral and aerated waters and other non-alcoholic beverages, fruit beverages and fruit jui-

ces, syrups and other preparations for making beverages.

(260) AM 2024 123055 A

(800) 1345552

(151) 2016 10 20

(891) 2023 04 25

(731) Polycasa Slovakia s. r. o.

M. R. Štefánika 71, SK-010 39 Žilina, Slovakia

(540)

AKRYLON

(591) Black, white

(511)

17 – Plastics in extruded form for use in manufacture; planks, blocks, bands, tapes, panels, rods, bars, tubes and pellets of plastic (semi-finished products); planks, blocks, bands, tapes, panels, rods, bars, tubes and pellets of acrylic glass (semi-finished products); planks, blocks, bands, tapes, panels, rods, bars, tubes and pellets of extruded acrylic glass (semi-finished products); wall coverings for sound absorption, not of metal; soundproofing wall claddings, not of metal.

19 – Building materials, not of metal; building planks of plastic; building components of plastic; building planks of transparent plastic; building planks of translucent plastic; transparent plastics for building; planks of plastic for building; non-metallic wall claddings for building; non-metallic facade claddings; non-metallic shielding walls for building; wall panels of plastic for building; wall planks of plastic for building; partitions, not of metal; parts of wall coverings; three-sided transparent arches, not of metal, for building; two-sided transparent arches, not of metal, for building; non-metallic wall panels.

40 – Processing of plastics; treating of plastics to produce plastic molds; treatment of plastic materials.

(260) AM 2024 123056 A

(800) 1349732

(151) 2016 12 13

(891) 2023 05 05

(731) V-Label GmbH

Niederfeldstrasse 92, CH-8408 Winterthur,

Switzerland

(540)



(591) Black, white

(531) 05.03.14; 27.05.08; 27.05.21

(511)

2 – Paints, varnishes, lacquers; preservatives against rust and against deterioration of wood; dyestuffs; mordant; dyestuffs for dyeing clothing.

3 – Bleaching preparations and other substances for laundry use; cleaning, polishing, degreasing and abrasive preparations; soaps; perfumery, essential oils, cosmetics, hair lotions; dentifrices.

5 – Dietetic food and substances for medical or veterinary use, food for babies; food supplements for humans and animals.

16 – Paper, cardboard and goods made from these materials, not included in other classes; printing products; bookbinding material; photographs; stationery; adhesives for stationery or household purposes; artists' materials; paintbrushes; typewriters and office requisites (except furniture); instructional or teaching material (except apparatus); plastic materials for packaging not included in other classes; printing type; printing blocks.

17 – Products of plastic materials and rubber (semi-finished); padding and stuffing materials of rubber or plastics.

18 – Imitation leather and products made of these materials not included for other classes.

20 – Upholstered furniture; cushions; bedding except linen; futons (furniture); mattresses and mattress foundations; sleeping bags; goods not included in other classes, of wood, cork, reed, cane, wicker, substitutes for all these materials, or of plastics.

22 – Ropes, string, nets, tents, awnings, tarpaulins, sails, sacks and bags (not included in other classes); padding and stuffing materials (except of rubber or plastics); raw fibrous textile materials; kapok; raw cotton.

24 – Fabrics and textile goods not included in other classes; bed throws; table covers; nylon fabrics; hemp fabrics; mixed cotton-based fabrics.

25 – Clothing, footwear, headgear.

29 – Meat, fish, poultry and game; meat extracts; preserved, dried and cooked fruit and vegetables; jellies, jams; eggs, milk and dairy products; edible oils and fats; processed chickpeas; transformed soybeans; soy milk and rice milk; soy-based snacks; tofu; tempeh; meat and poultry substitutes; substitutes for cheese, butter and eggs; artificial cream (dairy product substitutes); stews; prepared and packaged dishes consisting primarily of meat, fish, poultry, vegetables, meat substitutes or substitutes of poultry, soy, tofu or tempeh; prepared salads; processed edible seeds; composites.

30 – Coffee, tea, cocoa, sugar, rice, tapioca, sago, artificial coffee; flours and preparations made from cereals, bread, pastry and confectionery, edible ices;

honey, treacle; yeast, baking powder; salt, mustard; vinegar, sauces (condiments); spices; ice for refreshment; processed corn; soya sauce; cereal bars, cereal-based snack food; semolina based on cereals; oat flakes; noodles; pizzas; ready-to-eat cereals; cakes; sandwiches; prepared and prepared-packed dishes made with rice and noodles; fruit coulis [sauces]; soya flour.

31 – Agricultural, horticultural and forestry products and grains (included in this class); live animals; fresh fruits and vegetables; seeds, natural plants and flowers; foodstuffs for animals, malt.

32 – Beers; mineral and aerated waters and other non-alcoholic beverages; fruit drinks and fruit juices; syrups and other preparations for making beverages.

33 – Alcoholic beverages (except beers).

41 – Education; education and training.

43 – Serving of food and drink.

44 – Medical services and veterinary services; hygienic and beauty care for human beings or animals; agriculture, horticulture and forestry services.

(260) AM 2024 123062 A

(800) 1659749

(151) 2021 11 22

(891) 2023 05 02

(731) ALTERCOSMETO DIFFUSION

Zone de Pen Lan, 1 allée des Embruns,
F-22610 PLEUBIAN, France

(540)

DOCTEUR RENAUD

(591) Black, white

(511)

3 – Cosmetics; collagen preparations for cosmetic use; lotions for cosmetic use; tissues impregnated with cosmetic lotions; cosmetic creams; balm other than for medical use; pomades for cosmetic use; beauty masks; phytocosmetic preparations; cleansing milk for toilet purposes; toiletries; oils for cosmetic use; greases for cosmetic use; hygiene, beauty and toiletry products and care products for the face and body; cleansing milk for cosmetic purposes; cosmetic products for skin care; cosmetic products for hands; cosmetic products for feet; cosmetics for body care; scrubs for skin, body and face care; make-up removing products; wipes impregnated with make-up removing preparations; massage oils; massage gels other than for medical use; eye creams (not for medical use); eye lotions; cosmetic preparations for slimming; cosmetic skin-tanning preparations; sunscreen preparations; bath preparations, not for medical use; cosmetic preparations for baths; bath salts not for medical use; perfumes; soaps; essential oils; perfumery product; fumigation products [perfumes]; deodorants [perfumery]; eau de cologne; lavender water; scented waters; eaux de toilette; oils for perfumes and scents;

oils for toilet purposes; extracts of flowers [perfumes]; make-up products; lip gloss; false eyelashes; cosmetics for eyelashes; adhesives for affixing false eyelashes; eyebrow cosmetics; pencils for cosmetic use; eyebrow pencils; roses, namely, rose oils; nail polish; nail polish removers; varnish-removing products; artificial nails; lipstick cases; make-up; eye shadows; mascara; cosmetic kits; false nails; make-up powder; lipstick; non-medicated hair lotions; hair lotions; hair care products; shampoos; hair conditioners; hair straightening preparations; hair-waving preparations; hair dyes; hair sprays; hair fixatives; non-medicated dentifrices; preparations for mouthwashes (not for medical use); douching preparations for intimate hygiene, deodorant preparations or for sanitary purposes [toiletries]; bleaching preparations [decolorants] for cosmetic use; plant extracts for cosmetic use; hair-removing products; decorative transfers for cosmetic use; astringents for cosmetic use; anti-ageing creams [for cosmetic use]; anti-ageing lotion; anti-ageing gel; anti-ageing moisturizers; anti-ageing serum; cosmetics for the treatment of wrinkles; concealers for wrinkles and fine lines.

5 – Food supplements for human beings; food supplements with cosmetic effects in all galenic forms, namely gelatin capsules, granules, powders, liquids, gels, jars and hygiene products; disinfectants; dietetic substances and foods for medical use; dietetic beverages for medical use; pharmaceutical preparations for skin care; sunscreen products [sunburn ointments]; bath preparation for medical use; mud for baths; mineral water for pharmaceutical use; thermal water; salts for medical use; bath salts for medical use; therapeutic preparations for the bath; medical preparations for slimming; pharmaceutical preparations; parpharmaceutical products; hygienic products for medicine; medicated hand-washing products; plant preparations for medical use; detoxifying agents for metabolism; medicinal infusions; antioxidants.

(260) AM 2024 123063 A

(800) 1685167

(151) 2022 07 27

(891) 2023 04 11

(731) LARA TEKSTİL SANAYİ TİCARET
ANONİM ŞİRKETİ

Mimar Kemalettin Mahallesi, Ağaçeşmesi
Sokak No:4-B, Fatih, İstanbul, Türkiye

(540)



(591) Red, white

(531) 05.03.13; 26.13.25; 27.05.01; 29.01.12

(511)

25 – Clothing, footwear, headwear.

(260) AM 2024 123064 A
 (800) 1723933
 (151) 2023 01 19
 (891) 2023 05 06
 (731) ZHEJIANG GEELY HOLDING GROUP CO.,
 LTD.
 1760 JIANGLING ROAD, BINJIANG
 DISTRICT, HANGZHOU, ZHEJIANG,
 China

(540)

STARRAY

(591) Black, white
 (531) 27.05.17
 (511)
 12 – Electric vehicles; vehicles for locomotion by
 land, air, water or rail; propulsion mechanisms for
 land vehicles; gear boxes for land vehicles; electric
 cars; cars; automobile chassis; tyres for vehicle whe-
 els; brakes for vehicles; self-balancing electric scoo-
 ters.

(260) AM 2024 123120 A
 (800) 1732356
 (151) 2023 04 06
 (891) 2023 04 06
 (731) Henkel AG & Co. KgaA
 Henkelstrasse 67, 40589 Düsseldorf, Germany

(540)

Шаума

(591) Black, white
 (531) 28.05
 (511)
 3 – Non-medicated cosmetics and toiletry preparati-
 ons; preparations for the conditioning, cleaning, tin-
 ting, dyeing, bleaching, fixing and waving of hair, ha-
 ir lotions and shampoos for cosmetic purposes.

(260) AM 2024 123121 A
 (800) 1732357
 (151) 2023 04 07
 (891) 2023 04 07
 (731) Henkel AG & Co. KgaA
 Henkelstrasse 67, 40589 Düsseldorf, Germany

(540)

ГОТ26

(591) Black, white
 (531) 28.05
 (511)
 3 – Non-medicated cosmetics and toiletry preparati-
 ons; preparations for the conditioning, cleaning, tin-
 ting, dyeing, bleaching, fixing and waving of hair, ha-
 ir lotions and shampoos for cosmetic purposes.

(260) AM 2024 123122 A
 (800) 1732358
 (151) 2023 04 07
 (891) 2023 04 07
 (731) Henkel AG & Co. KgaA
 Henkelstrasse 67, 40589 Düsseldorf, Germany

(540)

Палетт

(591) Black, white
 (531) 28.05
 (511)
 3 – Non-medicated cosmetics and toiletry preparati-
 ons; preparations for the conditioning, cleaning, tin-
 ting, dyeing, bleaching, fixing and waving of hair, ha-
 ir lotions and shampoos for cosmetic purposes.

(260) AM 2024 123123 A
 (800) 1732359
 (151) 2023 04 07
 (891) 2023 04 07
 (731) Henkel AG & Co. KgaA
 Henkelstrasse 67, 40589 Düsseldorf, Germany

(540)

СЙОСС

(591) Black, white
 (531) 28.05
 (511)
 3 – Non-medicated cosmetics and toiletry preparati-
 ons; preparations for the conditioning, cleaning, tin-
 ting, dyeing, bleaching, fixing and waving of hair, ha-
 ir lotions and shampoos for cosmetic purposes.

(260) AM 2024 123125 A
 (800) 1732361
 (151) 2023 04 07
 (891) 2023 04 07
 (731) Henkel AG & Co. KgaA
 Henkelstrasse 67, 40589 Düsseldorf, Germany

(540)

Шварцкопф

(591) Black, white
 (531) 28.05
 (511)
 3 – Non-medicated cosmetics and toiletry preparati-
 ons; preparations for the conditioning, cleaning, tin-
 ting, dyeing, bleaching, fixing and waving of hair, ha-
 ir lotions and shampoos for cosmetic purposes.

(260) AM 2024 123232 A
 (800) 1733146
 (151) 2023 04 19
 (891) 2023 04 19

(731) Zakrytoe aktsionernoe obshchestvo
"Starodvorskie kolbasy"
ul. Poliny Osipenko, d. 41, of. 210, RU-600009
g. Vladimir, Russian Federation

(540)

СЛИВУШКИ

(591) Black, white

(531) 28.05

(511)

9 – Charcuterie; croquettes; ham; liver pâté; sausages; sardelki [sausages]; sausages in batter; hot dog sausages; corn dogs; shpikachki [sausages]; chicken nuggets; fat-based spreads for bread slices.

30 – Vareniki [stuffed dumplings]; pelmeni; khinkali [stuffed dumplings]; manti [stuffed dumplings]; hot dog sandwiches.

(260) AM 2024 123233 A

(800) 1733156

(151) 2023 03 24

(891) 2023 03 24

(731) Siniakov Artem Sergeevich

ul. Kurskaia, 5, kvartira 12, RU-192007
Saint-Petersburg, Russian Federation

(540)

TING

TANGIERS LOUNGE

(591) Black, white

(531) 27.05.01; 27.05.09; 27.05.10

(511)

34 – Gas containers for cigar lighters; hookah saucers; absorbent paper for tobacco pipes; cigarette paper; lighters for smokers; hookahs; tobacco pouches; books of cigarette papers; bulbs for hookahs; humidors; matchboxes; firestones; cigar cutters; mouthpieces for hookahs; cigar holders; cigarette holders; mouthpieces for cigarette holders; tips of yellow amber for cigar and cigarette holders; ashtrays for smokers; spittoons for tobacco users; racks for hookahs; pipe racks for tobacco pipes; cleaners for hookahs; pipe cleaners for tobacco pipes; cigarettes; cigarettes containing tobacco substitutes, not for medical purposes; electronic cigarettes; cigarillos; cigars; tobacco jars; match holders; matches; tobacco; chewing tobacco; tobacco mixtures for hookahs; hookah tobacco; snuff; snuff boxes; herbs for smoking; hookah pipes; tobacco pipes; pocket machines for rolling cigarettes; cigarette filters; cigarette tips; hookah shafts; hookah hoses; cigar cases; cigarette cases.

43 – Accommodation bureau services [hotels, boarding houses]; rental of temporary accommodation; rental of meeting rooms; tourist home services; hotel reservations; boarding house bookings; temporary ac-

commodation reservations; boutique-hotel services; hotel services; snack-bar services; hookah lounge services; café services; cafeteria services; smoking room services; mini-hotel services; motel services; pubs; boarding house services; rental of cooking apparatus; rental of chairs, tables, table linen, glassware; rental of lighting apparatus; rental of tents; rental of transportable buildings; rental of drinking water dispensers; restaurant services; self-service restaurant services; canteen services; holiday camp services [lodging]; bar services; providing campground facilities; food and drink catering; food sculpting.

(260) AM 2024 123235 A

(800) 1733237

(151) 2023 03 21

(891) 2023 03 21

(731) LECHLER S.p.A.

VIA CECILIO 17, I-22100 COMO, Italy

(540)



(591) Black, white

(531) 03.07.01; 03.07.16; 26.11.02; 26.11.06;
26.11.13; 27.05.17

(511)

2 – Dyes; colorants; pigments; lacquers; varnishes; paints; fixatives [varnishes]; acrylic paints; mordants; exterior paint; interior paint; paint for wood; dyewood extracts; fixatives for dyestuffs; varnish for the protection of wood from deterioration; wood preservatives; metal in foil and powder form for use in painting, decorating, printing and art; raw natural resins; synthetic resins for protection against corrosion; raw natural resins for use in the manufacture of varnishes; raw natural resins for use in the manufacture of lacquers; synthetic resin paints; resins for use in pigmentation; resins for coating purposes; primers; finishing coatings [paints] for building interiors and exteriors; powder coatings; textured wall coatings [paints]; water-proof coatings [paints]; materials [paints] for damp proof treatment; floor sealing compounds [paints and oils]; protective coatings for repelling water [paint]; preparations for waterproofing [paints]; interior protective finish coatings [paints]; damp proofing preparations [paints] for masonry; coating compositions having waterproofing properties [paints or oils]; anti-rust preparations; paints for protection against corrosion; varnishes for protection against corrosion; thinners, thickeners, binders for varnishes, pigments and paints; thinners for lacquers; binding preparations for paints; siccatives [drying agents] for paints.

(260) AM 2024 123236 A
 (800) 1733238
 (151) 2023 04 18
 (891) 2023 04 18
 (731) Zakrytoe aktsionernoe obshchestvo "Myasnaya galereya"
 ul. Poliny Osipenko, d. 65, of. 10, RU-600009
 g. Vladimir, Russian Federation
 (540)

Chebupizza

(591) Black, white
 (511)

29 – Ajvar being preserved peppers; aloe vera prepared for human consumption; alginates for culinary purposes; anchovy, not live; peanuts, prepared; artichokes, preserved; white of eggs; beans, preserved; soya beans, preserved, for food; broth; ginger jam; ham; fatty substances for the manufacture of edible fats; toasted laver; edible birds' nests; sea-cucumbers, not live; peas, preserved; mushrooms, preserved; guacamole [mashed avocado]; game, not live; gelatine; meat jellies; jellies for food, other than confectionery; fruit jellies [jams]; yolk of eggs; coconut fat; bone oil for food; lard; suet for food; edible fats; julienne being baked poultry or mushroom dish with sour cream; curd; fruit-based snack food; milk substitutes; charcuterie; raisins; caviar; aubergine paste; vegetable marrow paste; fish roe, prepared; yogurt; galbi being grilled meat dish; sauerkraut; kefir [milk beverage]; kimchi [fermented vegetable dish]; isinglass for food; clams, not live; potato-based dumplings; milk shakes; black pudding; onion rings; arrangements of processed fruit; compotes; meat, tinned; vegetables, tinned; fish, tinned; fruits, tinned; broth concentrates; corn dogs; gherkins; meat cutlets; frozen meat cutlets; shrimps, not live; prawns, not live; buttercream; croquettes; silkworm chrysalis for human consumption; sweet corn, processed; kumys; chicken wings; spiny lobsters, not live; lecithin for culinary purposes; salmon, not live; onions, preserved; margarine; marmalade; oils for food; peanut butter; cocoa butter for food; coconut oil for food; coconut butter; maize oil for food; sesame oil for food; linseed oil for food; extra virgin olive oil for food; olive oil for food; palm oil for food; palm kernel oil for food; sunflower oil for food; rape oil for food; butter; soya bean oil for food; mussels, not live; almonds, ground; animal marrow for food; molluscs, not live; milk; peanut milk; peanut milk for culinary purposes; coconut milk; coconut milk for culinary purposes; almond milk; almond milk for culinary purposes; oat milk; rice milk; rice milk for culinary purposes; albumin milk; condensed milk; soya milk; powdered milk; fish meal for human consumption; vegetable mousses; fish mousses; fruit pulp; meat; meat, preserved; freeze-dried meat; chicken nuggets; milk beverages, milk predominating; peanut milk-based beverages; coconut milk-based beverages; almond milk-based beverages; edible insects, not live; sausage casings, natural or artifi-

cial; vegetables, preserved; freeze-dried vegetables; vegetables, dried; vegetables, cooked; potato fritters; olives, preserved; lobsters, not live; flavoured nuts; candied nuts; coconut, desiccated; nuts, prepared; tomato paste; liver pâté; pectin for culinary purposes; liver; pickles; jams; powdered eggs; milk products; fish-based foodstuffs; prostokvasha [soured milk]; poultry, not live; battered chicken pieces; bulgogi; pollen prepared as foodstuff; cranberry compote; tomato purée; apple purée; crayfish, not live; crustaceans, not live; fish, preserved; fish, not live; salted fish; ryazhenka [fermented baked milk]; vegetable salads; fruit salads; bacon; sardelki [sausages]; sardines, not live; pork; herrings, not live; seeds, prepared; sunflower seeds, prepared; cream [dairy products]; whipped cream; vegetable-based cream; fat-based spreads for bread slices; smetana [sour cream]; lemon juice for culinary purposes; tomato juice for cooking; vegetable juices for cooking; salted meats; sausages; sausages in batter; hot dog sausages; preparations for making bouillon; preparations for making soup; nut-based spreads; tripe; soups; vegetable soup preparations; whey; cheese; tahini [sesame seed paste]; tofu; truffles, preserved; tuna, not live; oysters, not live; falafel; milk ferments for culinary purposes; rennet; fish fillets; dates; crystallized fruits; frozen fruits; fruit, preserved; fruit preserved in alcohol; fruit, stewed; hazelnuts, prepared; potato flakes; hummus [chickpea paste]; fruit peel; preserved garlic; lentils, preserved; potato crisps; low-fat potato crisps; fruit chips; shpikachki [sausages]; non-alcoholic eggnog; seaweed extracts for food; meat extracts; edible ant larvae, prepared; berries, preserved; snail eggs for consumption; eggs; yakitori.

30 – Vanilla flavourings for culinary purposes; flavourings, other than essential oils, for cakes; flavourings, other than essential oils, for beverages; coffee flavourings; food flavourings, other than essential oils; star aniseed; baozi [stuffed buns]; cereal bars; high-protein cereal bars; pancakes; noodle-based prepared meals; freeze-dried dishes with the main ingredient being pasta; freeze-dried dishes with the main ingredient being rice; buns; bread rolls; edible rice paper; edible paper; burritos; vanillin [vanilla substitute]; vareniki [stuffed dumplings]; waffles; vermicelli; natural sweeteners; sausage binding materials; binding agents for ice cream; seawater for cooking; seaweed [condiment]; malt biscuits; cloves [spice]; mirror icing [mirror glaze]; cake frosting [icing]; glucose for culinary purposes; mustard; gluten additives for culinary purposes; yeast; fried pelmeni; thickening agents for cooking foodstuffs; leaven; rice-based snack food; cereal-based snack food; coffee substitutes; vegetal preparations for use as coffee substitutes; dressings for salad; fruit jellies [confectionery]; candy decorations for cakes; confectionery for decorating Christmas trees; cakes; pastries; peanut confectionery; almond confectionery; pasta; ginger [spice]; frozen yogurt [confectionery ices]; cocoa; cream of tartar for

culinary purposes; capers; caramels [sweets]; curry [spice]; ketchup [sauce]; kimbab; quiches; gluten prepared as foodstuff; flour-based dumplings; sweets; liquorice [confectionery]; peppermint sweets; dulce de leche; cinnamon [spice]; coffee; unroasted coffee; starch for food; crackers; custard; hominy grits; semolina; oatmeal; crushed barley; groats for human food; ice cubes; corn, milled; corn, roasted; meat pies; turmeric; couscous [semolina]; noodles; ice for refreshment; ice, natural or artificial; edible ices; lollipops [confectionery]; rice cakes; mayonnaise; macarons [pastry]; macaroni; maltose; hominy; piccalilli; marinades; marzipan; honey; miso [seasoning]; royal jelly; ice cream; bean meal; tapioca flour; potato flour; corn flour; nut flours; flour; wheat flour; soya flour; barley meal; dessert mousses [confectionery]; chocolate mousses; muesli; mint for confectionery; cocoa beverages with milk; coffee beverages with milk; coffee-based beverages; cocoa-based beverages; chamomile-based beverages; tea-based beverages; chocolate beverages with milk; chocolate-based beverages; infusions, not medicinal; crushed oats; husked oats; okonomiyaki [Japanese savory pancakes]; onigiri [rice balls]; nutmegs [spice]; chocolate-coated nuts; stick liquorice [confectionery]; lozenges [confectionery]; molasses for food; pâtés en croûte; pelmeni; khinkali [stuffed dumplings]; manti [stuffed dumplings]; pepper; allspice; peppers [seasonings]; pesto [sauce]; biscuits; petit-beurre biscuits; bibimbap [rice mixed with vegetables and beef]; pies; pizzas; meat gravies; fondants [confectionery]; popcorn; powders for making ice cream; baking powder; mustard meal; pralines; aromatic preparations for food; condiments; meat tenderizers for culinary purposes; cereal preparations; oat-based food; propolis; gingerbread; spices; petits fours [cakes]; rice pudding; puddings; cake powder; fruit coulis [sauces]; ravioli; ramen [Japanese noodle-based dish]; chewing gum; relish [condiment]; rice; instant rice; wheat germ for human consumption; spring rolls; sago; palm sugar; sugar; sesame seeds [seasonings]; linseed for culinary purposes [seasoning]; processed seeds for use as a seasoning; aniseed; agave syrup [natural sweetener]; golden syrup; candy bars; batter mixes for okonomiyaki [Japanese savory pancakes]; baking soda [bicarbonate of soda for cooking purposes]; malt for human consumption; salt for preserving foodstuffs; cooking salt; celery salt; sorbets [ices]; ham glaze; soya sauce; tomato sauce; sauces [condiments]; pasta sauce; spaghetti; seasonings; chocolate-based spreads; chocolate spreads containing nuts; preparations for stiffening whipped cream; rusks; breadcrumbs; sushi; senbei [rice crackers]; sandwiches; tabbouleh; tacos; tapioca; tarts; dough; pastry dough; almond paste; rice pulp for culinary purposes; cake batter; tortillas; garden herbs, preserved [seasonings]; chocolate decorations for cakes; vinegar; beer vinegar; ferments for dough; halvah; bread; unleavened bread; chips [cereal products]; corn flakes; oat flakes; hot dog sandwiches; flowers or

leaves for use as tea substitutes; jiaozi [stuffed dumplings]; chicory [coffee substitute]; tea; iced tea; chutneys [condiments]; chebureki [deep-fried pies]; minced garlic [condiment]; cheeseburgers [sandwiches]; chow-chow [condiment]; saffron [seasoning]; chocolate; malt extract for food; essences for foodstuffs, except etheric essences and essential oils; husked barley.

(260) AM 2024 123274 A

(800) 1734182

(151) 2023 03 29

(891) 2023 03 29

(731) HUAWEI TECHNOLOGIES CO., LTD.

Administration Building, Huawei Technologies Co., Ltd., Bantian, Longgang District, Shenzhen, China

(540)

HUAWEI

(591) Black, white

(511)

12 – Self-generating electric locomotives (diesel-electric locomotives); electric vehicles; remote control vehicles, other than toys; brake linings for land vehicles; brake segments for motor cars; brakes for motor cars; brake pads for automobiles; diesel engines for land vehicles; jet engines for land vehicles; window rain guards for cars; engine mounts for land vehicles; horns for automobiles; electric reversing alarms for vehicles; automobile spare wheel holders; windscreen wipers for automobiles; hydraulic circuits for automobiles; air springs for vehicle suspension components for cushioning driver's seats and cabs; head rests for automobiles seats; gear boxes for automobiles; sun visors for automobiles; caps for automobile fuel tanks; automobile dashboards; doors for automobiles; torsion bars for automobiles; mudguards for automobiles; upholstery for automobiles; cup holders for use in automobiles (automobile accessories); clutches for automobiles; steering wheels for automobiles; automobile seats for children; safety seats for children, for automobiles; windows for automobiles; air pumps for automobiles; ski carriers for cars; spokes for automobile wheel; windscreens for automobiles; automobile sunroofs; door handles for automobiles; hybrid cars; luggage carriers for automobiles; rims for automobile wheels; theft prevention installations for automobiles; vehicle seats; rearview mirrors for automobiles; doors for vehicles; shock absorbing springs for automobiles; electric cars; sun visors for automobile windscreens; plug-in hybrid cars; torque converter for automobiles; directional signals for vehicles; gasoline engines for land vehicles; bicycles; pushchairs; sleighs (vehicles); repair outfits for inner tubes; camera drones; steering gears for ships; brake pads for vehicles; brake cables for vehicles; brake discs for vehicles; brakes for vehicles; horns for vehicles; convertible tops for vehicles; air bags for vehicles; windscreens for vehicles; covers for vehicle steering wheels; safety seats for

children, for vehicles; fitted vehicle seat covers; axles for air suspension systems in vehicles; electrical anti-theft installations for vehicles; air pumps (vehicle accessories); non-skid devices for vehicle tires; vehicle chassis; hubs for vehicle wheels; upholstery for vehicles; seat covers for vehicles; anti-dazzle devices for vehicles; side view mirrors for vehicles; vehicle joysticks; cup holders for vehicles; anti-theft alarms for vehicles; windscreen wipers; headlight wipers; inner tubes for vehicle tires; tires for vehicle wheels.

(260) AM 2024 123275 A

(800) 1734193

(151) 2022 10 05

(891) 2022 10 05

(731) Euro Games Technology Ltd.

4, "Maritsa" Str., "Vranya-Lozen-Triugulnika",
BG-1151 Sofia, Bulgaria

(540)



(591) Green, dark green, light green, black, gray, white, gold and yellow.

(531) 01.15.09; 02.09.01; 05.03.06; 05.03.13;

26.04.04; 26.04.05; 26.04.06; 26.04.13;

26.04.15; 26.04.18; 27.05.01; 27.05.03;

27.05.08; 29.01.13

(511)

9 – Operating computer software for main frame computers; monitors (computer hardware); computer hardware; apparatus for recording images; monitors (computer programs); computer game programs; recorded computer game programs; apparatus for recording, transmission or reproduction of sound or images; communications servers (computer hardware); electronic components for gambling machines; computer application software featuring games and gaming; computer software for the administration of on-line games and gaming; computer hardware for games and gaming; hardware and software for gambling, gambling machines, gambling games on the internet and via telecommunication network; computer systems; computer operating system software; computer terminals; interactive terminals; multimedia terminals; electronic terminals for generating lottery tickets; interactive touch screen terminals; computer touchscreens; electronic display panels; liquid crystal display screens; digital signage display panels; multimedia software; multimedia apparatus and instruments; interactive multimedia software for playing games; computer screens; LCD large-screen displays; liquid crystal displays [LCDs] for home theatres; me-

dia streaming software; computer application software for streaming audio-visual media content via the internet; software; computer gaming software; computer software packages; computer operating system software; computer software, recorded; software drivers; virtual reality software; games software; entertainment software for computer games; computer programs for network management; electronic lottery tickets; computer software platforms; operating systems; interactive computer systems; operating system programs; computer game software for use with on-line interactive games; interactive casino games provided through a computer or mobile platform; software for slot machines, betting software, software for video slot games, for casino games, for gambling and bingo games, provided online or through computer networks and that can be played on any type of computer device, including arcade games, personal computers, portable devices and mobile phones.

28 – Gaming machines for gambling; chips for gambling; mah-jong; arcade games; gambling machines operating with coins, notes and cards; games; electronic games; parlor games; gaming chips; gaming tables; slot machines [gaming machines]; LCD game machines; slot machines and gaming devices; coin-operated amusement machines; roulette chips; poker chips; chips and dice [gaming equipment]; gaming equipment for casinos; roulette tables; gaming roulette wheels; casino games; gambling machines and amusement machines, automatic and coin-operated; coin-operated amusement machines and/or electronic coin-operated amusement machines with or without the possibility of gain; boxes for coin-operated amusement machines, slot machines and gaming machines; electronic or electrotechnical amusement machines and apparatus, gaming machines, coin-operated entertainment machines; housings for coin-operated amusement machines, gaming equipment, gaming machines, machines for gambling; electropneumatic and electrical gambling machines (slot machines); lottery games; electronic targets for games and sports.

41 – Gambling services; gaming services for entertainment purposes; casino, gaming and gambling services; training in the development of software systems; provision of gaming equipment for gambling halls; providing casino equipment [gambling]; gaming machine entertainment services; providing casino facilities [gambling]; gaming hall services; games equipment rental; rental of gaming machines; providing amusement arcade services; rental of gaming machines with images of fruits; editing or recording of sounds and images; sound recording and video entertainment services; hire of sound reproducing apparatus; provision of gaming equipment for casinos; providing of gambling facilities; online gambling services; casino services; provision of gaming facilities and gaming hall facilities, internet casinos and online gambling services; lottery services; organization of lo-

teries; provision of games by means of a computer based system; online interactive entertainment; on-line casino services; online game services through mobile devices; providing online entertainment in the nature of game tournaments; providing on-line information in the field of computer gaming entertainment; sports betting services; online sports betting services; providing online games and games of chance; entertainment services related to gambling.

(260) AM 2024 123276 A

(800) 1734233

(151) 2023 04 19

(891) 2023 04 19

(731) Zakrytoe aktsionernoe obshchestvo

"Starodvorskie kolbasy"

ul. Poliny Osipenko, d. 41, of. 210, RU-600009

g. Vladimir, Russian Federation

(540)

Slivushki

(591) Black, white

(511)

29 – Ajvar being preserved peppers; aloe vera prepared for human consumption; alginates for culinary purposes; anchovy, not live; peanuts, prepared; artichokes, preserved; white of eggs; beans, preserved; soya beans, preserved, for food; broth; ginger jam; ham; fatty substances for the manufacture of edible fats; toasted laver; edible birds' nests; sea-cucumbers, not live; peas, preserved; mushrooms, preserved; guacamole; game, not live; gelatine; meat jellies; jellies for food, other than confectionery; fruit jellies [jams]; yolk of eggs; coconut fat; bone oil for food; lard; suet for food; edible fats; julienne being baked poultry or mushroom dish with sour cream; curd; fruit-based snack food; milk substitutes; charcuterie; raisins; caviar; aubergine paste; vegetable marrow paste; fish roe, prepared; yogurt; galbi being grilled meat dish; sauerkraut; kephir; kimchi [fermented vegetable dish]; isinglass for food; clams, not live; potato-based dumplings; milk shakes; black pudding; onion rings; arrangements of processed fruit; compotes; meat, tinned; vegetables, tinned; fish, tinned; fruits, tinned; broth concentrates; corn dogs; gherkins; meat cutlets; frozen meat cutlets; shrimps, not live; prawns, not live; buttercream; croquettes; silkworm chrysalis for human consumption; sweet corn, processed; koumiss; chicken wings; spiny lobsters, not live; lecithin for culinary purposes; salmon, not live; onions, preserved; margarine; marmalade; oils for food; peanut butter; cocoa butter for food; coconut butter; maize oil for food; sesame oil for food; linseed oil for food; extra virgin olive oil for food; olive oil for food; palm oil for food; palm kernel oil for food; sunflower oil for food; rape oil for food; butter; soya bean oil for food; mussels, not live; almonds, ground; animal marrow for food; molluscs, not live; peanut milk; peanut milk for culinary purposes; coconut milk; milk; coconut milk for

culinary purposes; almond milk; almond milk for culinary purposes; oat milk; rice milk; rice milk for culinary purposes; albumin milk; condensed milk; soya milk; powdered milk; fish meal for human consumption; vegetable mousses; fish mousses; fruit pulp; meat; meat, preserved; freeze-dried meat; chicken nuggets; milk beverages, milk predominating; peanut milk-based beverages; coconut milk-based beverages; almond milk-based beverages; edible insects, not live; sausage casings, natural or artificial; vegetables, preserved; freeze-dried vegetables; vegetables, dried; vegetables, cooked; potato fritters; olives, preserved; lobsters, not live; flavoured nuts; candied nuts; coconut, desiccated; nuts, prepared; tomato paste; liver pâté; pectin for culinary purposes; liver; pickles; jams; powdered eggs; milk products; fish-based foodstuffs; prostokvasha being soured milk; poultry, not live; battered chicken pieces; bulgogi; pollen prepared as foodstuff; cranberry compote; tomato purée; apple purée; crayfish, not live; crustaceans, not live; fish, preserved; fish, not live; salted fish; ryazhenka being fermented baked milk; vegetable salads; fruit salads; bacon; sardelki [sausages]; sardines, not live; pork; herrings, not live; seeds, prepared; sunflower seeds, prepared; cream [dairy products]; whipped cream; vegetable-based cream; fat-based spreads for bread slices; smetana; lemon juice for culinary purposes; tomato juice for cooking; vegetable juices for cooking; salted meats; sausages; sausages in batter; hot dog sausages; preparations for making bouillon; preparations for making soup; nut-based spreads; tripe; soups; vegetable soup preparations; whey; cheese; tahini; tofu; truffles, preserved; tuna, not live; oysters, not live; falafel; milk ferments for culinary purposes; rennet; fish fillets; dates; crystallized fruits; frozen fruits; fruit, preserved; fruit preserved in alcohol; fruit, stewed; hazelnuts, prepared; potato flakes; hummus [chickpea paste]; fruit peel; preserved garlic; lentils, preserved; potato crisps; low-fat potato crisps; fruit chips; shpikachki [sausages]; non-alcoholic eggnog; seaweed extracts for food; meat extracts; berries, preserved; snail eggs for consumption; eggs; yakitori; edible ant larvae, prepared.

30 – Vanilla flavourings for culinary purposes; flavourings, other than essential oils, for cakes; flavourings, other than essential oils, for beverages; coffee flavourings; food flavourings, other than essential oils; star aniseed; baozi; cereal bars; high-protein cereal bars; pancakes; noodle-based prepared meals; freeze-dried dishes with the main ingredient being pasta; freeze-dried dishes with the main ingredient being rice; buns; bread rolls; edible rice paper; edible paper; burritos; vanillin [vanilla substitute]; vareniki [stuffed dumplings]; waffles; vermicelli; natural sweeteners; sausage binding materials; binding agents for ice cream; seawater for cooking; seaweed [condiment]; malt biscuits; cloves [spice]; mirror icing [mirror glaze]; cake frosting [icing]; glucose for culinary purposes; mustard; gluten additives for culinary pur-

poses; yeast; fried pelmeni; thickening agents for cooking foodstuffs; leaven; rice-based snack food; cereal-based snack food; coffee substitutes; vegetal preparations for use as coffee substitutes; dressings for salad; fruit jellies [confectionery]; candy decorations for cakes; confectionery for decorating Christmas trees; cakes; pastries; peanut confectionery; almond confectionery; pasta; ginger [spice]; frozen yogurt [confectionery ices]; cocoa; cream of tartar for culinary purposes; capers; caramels [sweets]; curry [spice]; ketchup [sauce]; kimbap; quiches; gluten prepared as foodstuff; flour-based dumplings; sweets; liquorice [confectionery]; peppermint sweets; dulce de leche; cinnamon [spice]; coffee; unroasted coffee; starch for food; crackers; custard; hominy grits; semolina; oatmeal; crushed barley; groats for human food; ice cubes; corn, milled; corn, roasted; meat pies; turmeric; couscous [semolina]; noodles; ice for refreshment; ice, natural or artificial; edible ices; lollipops [confectionery]; rice cakes; mayonnaise; macaroons [pastries]; macaroni; maltose; hominy; piccalilli; marinades; marzipan; honey; miso [seasoning]; royal jelly; ice cream; bean meal; tapioca flour; potato flour; corn flour; nut flours; flour; wheat flour; soya flour; barley meal; mousses [confectionery]; chocolate mousses; muesli; mint for confectionery; cocoa beverages with milk; coffee beverages with milk; coffee-based beverages; cocoa-based beverages; chamomile-based beverages; tea-based beverages; chocolate beverages with milk; chocolate-based beverages; infusions, not medicinal; onigiri; crushed oats; husked oats; okonomiyaki [Japanese savory pancakes]; nutmegs [spice]; chocolate-coated nuts; stick liquorice [confectionery]; lozenges [confectionery]; molasses for food; pâtés en croûte; pelmeni; khinkali [stuffed dumplings]; manti [stuffed dumplings]; pepper; allspice; peppers [seasonings]; pesto; biscuits; petit-beurre biscuits; bibimbap [rice mixed with vegetables and beef]; pies; pizzas; meat gravies; fondants [confectionery]; popcorn; powders for making ice cream; baking powder; mustard meal; pralines; aromatic preparations for food; condiments; meat tenderizers for culinary purposes; cereal preparations; oat-based food; propolis; gingerbread; spices; petits fours; rice pudding; puddings; cake powder; fruit coulis [sauces]; ravioli; ramen [Japanese noodle-based dish]; chewing gum; relish [condiment]; rice; instant rice; wheat germ for human consumption; spring rolls; sago; palm sugar; sugar; sesame seeds [seasonings]; linseed for culinary purposes [seasoning]; processed seeds for use as a seasoning; aniseed; agave syrup [natural sweetener]; golden syrup; candy bars; batter mixes for okonomiyaki [Japanese savory pancakes]; baking soda [bicarbonate of soda for cooking purposes]; malt for human consumption; salt for preserving foodstuffs; cooking salt; celery salt; sorbets [ices]; ham glaze; soya sauce; tomato sauce; sauces [condiments]; pasta sauce; spaghetti; seasonings; chocolate-based spreads; chocolate spreads containing nuts; preparations for

stiffening whipped cream; rusks; breadcrumbs; sushi; senbei [rice crackers]; sandwiches; tabbouleh; tacos; tapioca; tarts; dough; pastry dough; almond paste; rice pulp for culinary purposes; cake batter; tortillas; garden herbs, preserved [seasonings]; chocolate decorations for cakes; vinegar; beer vinegar; ferments for dough; halvah; bread; unleavened bread; chips [cereal products]; corn flakes; oat flakes; hot dog sandwiches; flowers or leaves for use as tea substitutes; jiaozi; chicory [coffee substitute]; tea; iced tea; chutneys [condiments]; chebureki [deep-fried pies]; minced garlic [condiment]; cheeseburgers [sandwiches]; chow-chow [condiment]; saffron [seasoning]; chocolate; malt extract for food; essences for foodstuffs, except etheric essences and essential oils; husked barley.

(260) AM 2024 123277 A

(800) 1734234

(151) 2023 04 19

(891) 2023 04 19

(731) Zakrytoe aktsionernoe obshchestvo

"Starodvorskie kolbasy"

ul. Poliny Osipenko, d. 41, of. 210, RU-600009
g. Vladimir, Russian Federation

(540)

Dugushka

(591) Black, white

(511)

29 – Ajvar being preserved peppers; aloe vera prepared for human consumption; alginates for culinary purposes; anchovy, not live; peanuts, prepared; artichokes, preserved; white of eggs; beans, preserved; soya beans, preserved, for food; broth; ginger jam; ham; fatty substances for the manufacture of edible fats; toasted laver; edible birds' nests; sea-cucumbers, not live; peas, preserved; mushrooms, preserved; guacamole; game, not live; gelatine; meat jellies; jellies for food, other than confectionery; fruit jellies [jams]; yolk of eggs; coconut fat; bone oil for food; lard; suet for food; edible fats; julienne being baked poultry or mushroom dish with sour cream; curd; fruit-based snack food; milk substitutes; charcuterie; raisins; caviar; aubergine paste; vegetable marrow paste; fish roe, prepared; yogurt; galbi being grilled meat dish; sauerkraut; kephir; kimchi [fermented vegetable dish]; isinglass for food; clams, not live; potato-based dumplings; milk shakes; black pudding; onion rings; arrangements of processed fruit; compotes; meat, tinned; vegetables, tinned; fish, tinned; fruits, tinned; broth concentrates; corn dogs; gherkins; meat cutlets; frozen meat cutlets; shrimps, not live; prawns, not live; buttercream; croquettes; silkworm chrysalis for human consumption; sweet corn, processed; koumiss; chicken wings; spiny lobsters, not live; lecithin for culinary purposes; salmon, not live; onions, preserved; margarine; marmalade; oils for food; peanut butter; cocoa butter for food; coconut butter; maize oil for food;

sesame oil for food; linseed oil for food; extra virgin olive oil for food; olive oil for food; palm oil for food; palm kernel oil for food; sunflower oil for food; rape oil for food; butter; soya bean oil for food; mussels, not live; almonds, ground; animal marrow for food; molluscs, not live; peanut milk; peanut milk for culinary purposes; coconut milk; milk; coconut milk for culinary purposes; almond milk; almond milk for culinary purposes; oat milk; rice milk; rice milk for culinary purposes; albumin milk; condensed milk; soya milk; powdered milk; fish meal for human consumption; vegetable mousses; fish mousses; fruit pulp; meat; meat, preserved; freeze-dried meat; chicken nuggets; milk beverages, milk predominating; peanut milk-based beverages; coconut milk-based beverages; almond milk-based beverages; edible insects, not live; sausage casings, natural or artificial; vegetables, preserved; freeze-dried vegetables; vegetables, dried; vegetables, cooked; potato fritters; olives, preserved; lobsters, not live; flavoured nuts; candied nuts; coconut, desiccated; nuts, prepared; tomato paste; liver pâté; pectin for culinary purposes; liver; pickles; jams; powdered eggs; milk products; fish-based foodstuffs; prostokvasha being soured milk; poultry, not live; battered chicken pieces; bulgogi; pollen prepared as foodstuff; cranberry compote; tomato purée; apple purée; crayfish, not live; crustaceans, not live; fish, preserved; fish, not live; salted fish; ryazhenka being fermented baked milk; vegetable salads; fruit salads; bacon; sardelki [sausages]; sardines, not live; pork; herrings, not live; seeds, prepared; sunflower seeds, prepared; cream [dairy products]; whipped cream; vegetable-based cream; fat-based spreads for bread slices; smetana; lemon juice for culinary purposes; tomato juice for cooking; vegetable juices for cooking; salted meats; sausages; sausages in batter; hot dog sausages; preparations for making bouillon; preparations for making soup; nut-based spreads; tripe; soups; vegetable soup preparations; whey; cheese; tahini; tofu; truffles, preserved; tuna, not live; oysters, not live; falafel; milk ferments for culinary purposes; rennet; fish fillets; dates; crystallized fruits; frozen fruits; fruit, preserved; fruit preserved in alcohol; fruit, stewed; hazelnuts, prepared; potato flakes; hummus [chickpea paste]; fruit peel; preserved garlic; lentils, preserved; potato crisps; low-fat potato crisps; fruit chips; shpikachki [sausages]; non-alcoholic eggnog; seaweed extracts for food; meat extracts; berries, preserved; snail eggs for consumption; eggs; yakitori; edible ant larvae, prepared.

30 – Vanilla flavourings for culinary purposes; flavourings, other than essential oils, for cakes; flavourings, other than essential oils, for beverages; coffee flavourings; food flavourings, other than essential oils; star aniseed; baozi; cereal bars; high-protein cereal bars; pancakes; noodle-based prepared meals; freeze-dried dishes with the main ingredient being pasta; freeze-dried dishes with the main ingredient being rice; buns; bread rolls; edible rice paper; edible paper;

burritos; vanillin [vanilla substitute]; vareniki [stuffed dumplings]; waffles; vermicelli; natural sweeteners; sausage binding materials; binding agents for ice cream; seawater for cooking; seaweed [condiment]; malt biscuits; cloves [spice]; mirror icing [mirror glaze]; cake frosting [icing]; glucose for culinary purposes; mustard; gluten additives for culinary purposes; yeast; fried pelmeni; thickening agents for cooking foodstuffs; leaven; rice-based snack food; cereal-based snack food; coffee substitutes; vegetal preparations for use as coffee substitutes; dressings for salad; fruit jellies [confectionery]; candy decorations for cakes; confectionery for decorating Christmas trees; cakes; pastries; peanut confectionery; almond confectionery; pasta; ginger [spice]; frozen yogurt [confectionery ices]; cocoa; cream of tartar for culinary purposes; capers; caramels [sweets]; curry [spice]; ketchup [sauce]; kimbap; quiches; gluten prepared as foodstuff; flour-based dumplings; sweets; liquorice [confectionery]; peppermint sweets; dulce de leche; cinnamon [spice]; coffee; unroasted coffee; starch for food; crackers; custard; hominy grits; semolina; oatmeal; crushed barley; groats for human food; ice cubes; corn, milled; corn, roasted; meat pies; turmeric; couscous [semolina]; noodles; ice for refreshment; ice, natural or artificial; edible ices; lollipops [confectionery]; rice cakes; mayonnaise; macarons [pastries]; macaroni; maltose; hominy; piccalilli; marinades; marzipan; honey; miso [seasoning]; royal jelly; ice cream; bean meal; tapioca flour; potato flour; corn flour; nut flours; flour; wheat flour; soya flour; barley meal; mousses [confectionery]; chocolate mousses; muesli; mint for confectionery; cocoa beverages with milk; coffee beverages with milk; coffee-based beverages; cocoa-based beverages; chamomile-based beverages; tea-based beverages; chocolate beverages with milk; chocolate-based beverages; infusions, not medicinal; onigiri; crushed oats; husked oats; okonomiyaki [Japanese savory pancakes]; nutmegs [spice]; chocolate-coated nuts; stick liquorice [confectionery]; lozenges [confectionery]; molasses for food; pâtés en croûte; pelmeni; khinkali [stuffed dumplings]; manti [stuffed dumplings]; pepper; allspice; peppers [seasonings]; pesto; biscuits; petit-beurre biscuits; bibimbap [rice mixed with vegetables and beef]; pies; pizzas; meat gravies; fondants [confectionery]; popcorn; powders for making ice cream; baking powder; mustard meal; pralines; aromatic preparations for food; condiments; meat tenderizers for culinary purposes; cereal preparations; oat-based food; propolis; gingerbread; spices; petits fours; rice pudding; puddings; cake powder; fruit coulis [sauces]; ravioli; ramen [Japanese noodle-based dish]; chewing gum; relish [condiment]; rice; instant rice; wheat germ for human consumption; spring rolls; sago; palm sugar; sugar; sesame seeds [seasonings]; linseed for culinary purposes [seasoning]; processed seeds for use as a seasoning; aniseed; agave syrup [natural sweetener]; golden syrup; candy bars; batter mixes for okonomiyaki [Japanese savory

pancakes]; baking soda [bicarbonate of soda for cooking purposes]; malt for human consumption; salt for preserving foodstuffs; cooking salt; celery salt; sorbets [ices]; ham glaze; soya sauce; tomato sauce; sauces [condiments]; pasta sauce; spaghetti; seasonings; chocolate-based spreads; chocolate spreads containing nuts; preparations for stiffening whipped cream; rusks; breadcrumbs; sushi; senbei [rice crackers]; sandwiches; tabbouleh; tacos; tapioca; tarts; dough; pastry dough; almond paste; rice pulp for culinary purposes; cake batter; tortillas; garden herbs, preserved [seasonings]; chocolate decorations for cakes; vinegar; beer vinegar; ferments for dough; halvah; bread; unleavened bread; chips [cereal products]; corn flakes; oat flakes; hot dog sandwiches; flowers or leaves for use as tea substitutes; jiaozi; chicory [coffee substitute]; tea; iced tea; chutneys [condiments]; chebureki [deep-fried pies]; minced garlic [condiment]; cheeseburgers [sandwiches]; chow-chow [condiment]; saffron [seasoning]; chocolate; malt extract for food; essences for foodstuffs, except etheric essences and essential oils; husked barley.

INTERNATIONAL TRADEMARKS PROTECTED IN GEORGIA

(260) AM 2024 120372 A
(800) 1695603
(151) 2022 09 15
(181) 2032 09 15
(891) 2022 09 15
(511) 03, 16, 35, 41, 44

(260) AM 2024 121182 A
(800) 1707335
(151) 2022 09 20
(181) 2032 09 20
(891) 2022 09 20
(511) 35, 41, 45

(260) AM 2024 121183 A
(800) 1707352
(151) 2022 09 16
(181) 2032 09 16
(891) 2022 09 16
(511) 17, 19, 20, 21, 22, 24, 25

(260) AM 2024 121184 A
(800) 1707353
(151) 2022 10 18
(181) 2032 10 18
(891) 2022 10 18
(511) 03, 06, 09, 11, 12, 14, 16, 18, 20, 21, 24, 25, 26,
27, 28, 42, 43

(260) AM 2024 121199 A
(800) 1707695
(151) 2022 08 11
(181) 2032 08 11
(891) 2022 08 11
(511) 03, 04, 05, 16, 18, 21, 24, 30, 33, 35

(260) AM 2024 121205 A
(800) 1218472
(151) 2014 07 21
(181) 2024 07 21
(891) 2022 12 22
(511) 29, 30

(260) AM 2024 121252 A
(800) 1707852
(151) 2022 11 15
(181) 2032 11 15
(891) 2022 11 15
(511) 05

(260) AM 2024 121253 A
(800) 1707883
(151) 2022 11 10
(181) 2032 11 10
(891) 2022 11 10
(511) 09

(260) AM 2024 121254 A
(800) 1707884
(151) 2022 11 10
(181) 2032 11 10
(891) 2022 11 10
(511) 09

(260) AM 2024 121255 A
(800) 1707888
(151) 2022 12 06
(181) 2032 12 06
(891) 2022 12 06
(511) 07, 09, 11

(260) AM 2024 121256 A
(800) 1707891
(151) 2022 12 05
(181) 2032 12 05
(891) 2022 12 05
(511) 29, 30

(260) AM 2024 121257 A
(800) 1707912
(151) 2022 11 11
(181) 2032 11 11
(891) 2022 11 11
(511) 33

(260) AM 2024 121258 A
(800) 1707914
(151) 2022 12 01
(181) 2032 12 01
(891) 2022 12 01
(511) 09

(260) AM 2024 121259 A
(800) 1707916
(151) 2022 12 02
(181) 2032 12 02
(891) 2022 12 02
(511) 03, 09, 18, 25

(260) AM 2024 121260 A
(800) 1707922
(151) 2022 11 11
(181) 2032 11 11
(891) 2022 11 11
(511) 30

(260) AM 2024 121279 A
(800) 1708415
(151) 2022 12 20
(181) 2032 12 20
(891) 2022 12 20
(511) 42

(260) AM 2024 121261 A
(800) 1707978
(151) 2022 11 09
(181) 2032 11 09
(891) 2022 11 09
(511) 36

(260) AM 2024 121280 A
(800) 1708461
(151) 2022 10 21
(181) 2032 10 21
(891) 2022 10 21
(511) 42, 44

(260) AM 2024 121262 A
(800) 1708063
(151) 2022 08 25
(181) 2032 08 25
(891) 2022 08 25
(511) 39

(260) AM 2024 121281 A
(800) 1708462
(151) 2022 11 15
(181) 2032 11 15
(891) 2022 11 15
(511) 02

(260) AM 2024 121263 A
(800) 1708083
(151) 2022 10 06
(181) 2032 10 06
(891) 2022 10 06
(511) 09, 28, 41

(260) AM 2024 121283 A
(800) 1708540
(151) 2022 07 14
(181) 2032 07 14
(891) 2022 07 14
(511) 01, 29, 30

(260) AM 2024 121276 A
(800) 1708357
(151) 2022 09 01
(181) 2032 09 01
(891) 2022 09 01
(511) 35

(260) AM 2024 121291 A
(800) 1477689
(151) 2019 05 07
(181) 2029 05 07
(891) 2022 12 30
(511) 19, 20

(260) AM 2024 121277 A
(800) 1708360
(151) 2022 10 27
(181) 2032 10 27
(891) 2022 10 27
(511) 29, 30, 32

(260) AM 2024 121294 A
(800) 1566943A
(151) 2020 07 29
(181) 2030 07 29
(891) 2022 10 26
(511) 09, 41, 42

(260) AM 2024 121278 A
(800) 1708406
(151) 2022 12 14
(181) 2032 12 14
(891) 2022 12 14
(511) 09

(260) AM 2024 121353 A
(800) 1708604
(151) 2022 11 28
(181) 2032 11 28
(891) 2022 11 28
(511) 05

(260) AM 2024 121354 A
(800) 1708610
(151) 2022 12 15
(181) 2032 12 15
(891) 2022 12 15
(511) 05, 44

(260) AM 2024 121355 A
(800) 1708622
(151) 2022 09 01
(181) 2032 09 01
(891) 2022 09 01
(511) 33

(260) AM 2024 121367 A
(800) 1709049
(151) 2022 12 19
(181) 2032 12 19
(891) 2022 12 19
(511) 09

(260) AM 2024 121368 A
(800) 1709062
(151) 2022 10 04
(181) 2032 10 04
(891) 2022 10 04
(511) 03

(260) AM 2024 121369 A
(800) 1709117
(151) 2022 08 26
(181) 2032 08 26
(891) 2022 08 26
(511) 07, 35

(260) AM 2024 121370 A
(800) 1709159
(151) 2022 12 12
(181) 2032 12 12
(891) 2022 12 12
(511) 17, 19

(260) AM 2024 121371 A
(800) 1709165
(151) 2022 12 13
(181) 2032 12 13
(891) 2022 12 13
(511) 25

(260) AM 2024 121372 A
(800) 1709207
(151) 2022 11 18
(181) 2032 11 18
(891) 2022 11 18
(511) 34

(260) AM 2024 121379 A
(800) 1709371
(151) 2022 12 02
(181) 2032 12 02
(891) 2022 12 02
(511) 31

(260) AM 2024 121383 A
(800) 1709451
(151) 2022 07 26
(181) 2032 07 26
(891) 2022 07 26
(511) 09, 28, 41

(260) AM 2024 121385 A
(800) 1709475
(151) 2022 12 10
(181) 2032 12 10
(891) 2022 12 10
(511) 09, 11, 34, 35

(260) AM 2024 121386 A
(800) 1709476
(151) 2022 12 10
(181) 2032 12 10
(891) 2022 12 10
(511) 34, 35

(260) AM 2024 121387 A
(800) 1709509
(151) 2022 03 23
(181) 2032 03 23
(891) 2022 03 23
(511) 01, 05, 16, 17, 31

(260) AM 2024 121388 A
(800) 1709535
(151) 2022 12 22
(181) 2032 12 22
(891) 2022 12 22
(511) 01

(260) AM 2024 121389 A
(800) 1709573
(151) 2022 11 17
(181) 2032 11 17
(891) 2022 11 17
(511) 03, 05

(260) AM 2024 121390 A
(800) 1709606
(151) 2022 08 01
(181) 2032 08 01
(891) 2022 08 01
(511) 09, 14, 16, 18, 20, 24, 25, 27, 30, 33, 35, 36,
41, 43

(260) AM 2024 121403 A
(800) 1442377
(151) 2018 05 03
(181) 2028 05 03
(891) 2022 12 19
(511) 25

(260) AM 2024 121404 A
(800) 1452467
(151) 2018 05 03
(181) 2028 05 03
(891) 2022 12 19
(511) 25

(260) AM 2024 121405 A
(800) 1503491
(151) 2019 07 22
(181) 2029 07 22
(891) 2022 12 07
(511) 03, 21

(260) AM 2024 121406 A
(800) 1505420
(151) 2019 09 03
(181) 2029 09 03
(891) 2023 01 10
(511) 09, 38

(260) AM 2024 121407 A
(800) 1583796
(151) 2021 02 16
(181) 2031 02 16
(891) 2023 01 10
(511) 32

(260) AM 2024 121408 A
(800) 1648753
(151) 2021 11 18
(181) 2031 11 18
(891) 2022 12 13
(511) 30

(260) AM 2024 121463 A
(800) 1710455
(151) 2022 10 24
(181) 2032 10 24
(891) 2022 10 24
(511) 09, 11, 35, 37, 42

(260) AM 2024 121464 A
(800) 1710483
(151) 2022 10 07
(181) 2032 10 07
(891) 2022 10 07
(511) 29, 31, 32, 33, 35

(260) AM 2024 121465 A
(800) 1710596
(151) 2022 09 19
(181) 2032 09 19
(891) 2022 09 19
(511) 09, 18, 25

(260) AM 2024 121466 A
(800) 1710624
(151) 2022 12 21
(181) 2032 12 21
(891) 2022 12 21
(511) 09, 35, 37

(260) AM 2024 121467 A
(800) 1710668
(151) 2022 12 16
(181) 2032 12 16
(891) 2022 12 16
(511) 03

(260) AM 2024 121468 A
(800) 1710669
(151) 2022 11 29
(181) 2032 11 29
(891) 2022 11 29
(511) 05, 40, 42

(260) AM 2024 121469 A
(800) 1710703
(151) 2022 12 02
(181) 2032 12 02
(891) 2022 12 02
(511) 09, 42

(260) AM 2024 121476 A
(800) 1710929
(151) 2022 11 16
(181) 2032 11 16
(891) 2022 11 16
(511) 07, 09, 11, 12, 37

(260) AM 2024 121470 A
(800) 1710761
(151) 2022 11 10
(181) 2032 11 10
(891) 2022 11 10
(511) 12, 35, 37

(260) AM 2024 121477 A
(800) 1710937
(151) 2022 07 27
(181) 2032 07 27
(891) 2022 07 27
(511) 32, 33

(260) AM 2024 121471 A
(800) 1710776
(151) 2022 08 26
(181) 2032 08 26
(891) 2022 08 26
(511) 09, 39, 42

(260) AM 2024 121478 A
(800) 1710977
(151) 2022 11 14
(181) 2032 11 14
(891) 2022 11 14
(511) 03

(260) AM 2024 121472 A
(800) 1710825
(151) 2022 12 21
(181) 2032 12 21
(891) 2022 12 21
(511) 05

(260) AM 2024 121479 A
(800) 1710983
(151) 2022 12 05
(181) 2032 12 05
(891) 2022 12 05
(511) 29

(260) AM 2024 121473 A
(800) 1710826
(151) 2022 12 21
(181) 2032 12 21
(891) 2022 12 21
(511) 05

(260) AM 2024 121480 A
(800) 1711040
(151) 2022 09 07
(181) 2032 09 07
(891) 2022 09 07
(511) 05, 30

(260) AM 2024 121474 A
(800) 1710872
(151) 2022 11 03
(181) 2032 11 03
(891) 2022 11 03
(511) 12

(260) AM 2024 121481 A
(800) 1711087
(151) 2022 11 04
(181) 2032 11 04
(891) 2022 11 04
(511) 12

(260) AM 2024 121475 A
(800) 1710918
(151) 2022 08 16
(181) 2032 08 16
(891) 2022 08 16
(511) 09, 14, 18, 20, 21, 24, 25, 28

(260) AM 2024 121482 A
(800) 1711088
(151) 2022 12 05
(181) 2032 12 05
(891) 2022 12 05
(511) 03, 05, 10, 16, 35, 39, 42

(260) AM 2024 121483 A
(800) 1711151
(151) 2023 01 05
(181) 2033 01 05
(891) 2023 01 05
(511) 09

(260) AM 2024 121494 A
(800) 1540035
(151) 2020 05 29
(181) 2030 05 29
(891) 2023 01 12
(511) 34

(260) AM 2024 121484 A
(800) 1711201
(151) 2022 07 15
(181) 2032 07 15
(891) 2022 07 15
(511) 31, 35

(260) AM 2024 121495 A
(800) 1540037
(151) 2020 05 29
(181) 2030 05 29
(891) 2023 01 12
(511) 34

(260) AM 2024 121485 A
(800) 1711218
(151) 2022 12 09
(181) 2032 12 09
(891) 2022 12 09
(511) 12

(260) AM 2024 121496 A
(800) 1651307
(151) 2021 11 02
(181) 2031 11 02
(891) 2022 12 20
(511) 32, 33

(260) AM 2024 121486 A
(800) 1711219
(151) 2022 12 09
(181) 2032 12 09
(891) 2022 12 09
(511) 12

(260) AM 2024 121497 A
(800) 1666510
(151) 2021 12 27
(181) 2031 12 27
(891) 2022 11 30
(511) 25, 35

(260) AM 2024 121487 A
(800) 1711239
(151) 2022 10 26
(181) 2032 10 26
(891) 2022 10 26
(511) 09

(260) AM 2024 121567 A
(800) 1711974
(151) 2023 01 09
(181) 2033 01 09
(891) 2023 01 09
(511) 31

(260) AM 2024 121492 A
(800) 1288763
(151) 2015 10 21
(181) 2025 10 21
(891) 2023 01 19
(511) 11

(260) AM 2024 121568 A
(800) 1711999
(151) 2022 09 15
(181) 2032 09 15
(891) 2022 09 15
(511) 07, 09, 12, 28, 38

(260) AM 2024 121493 A
(800) 1441499
(151) 2018 06 09
(181) 2028 06 09
(891) 2022 09 01
(511) 04, 34

(260) AM 2024 121569 A
(800) 1712003
(151) 2022 09 15
(181) 2032 09 15
(891) 2022 09 15
(511) 35, 42, 45

(260) AM 2024 121570 A
(800) 1712005
(151) 2022 09 15
(181) 2032 09 15
(891) 2022 09 15
(511) 35, 42, 45

(260) AM 2024 121582 A
(800) 1712320
(151) 2023 01 12
(181) 2033 01 12
(891) 2023 01 12
(511) 45

(260) AM 2024 121571 A
(800) 1712006
(151) 2022 09 15
(181) 2032 09 15
(891) 2022 09 15
(511) 35, 42, 45

(260) AM 2024 121585 A
(800) 1712333
(151) 2023 01 17
(181) 2033 01 17
(891) 2023 01 17
(511) 05, 10

(260) AM 2024 121577 A
(800) 1712253
(151) 2022 11 22
(181) 2032 11 22
(891) 2022 11 22
(511) 34

(260) AM 2024 121586 A
(800) 1712335
(151) 2023 01 17
(181) 2033 01 17
(891) 2023 01 17
(511) 05, 10

(260) AM 2024 121578 A
(800) 1712293
(151) 2022 12 01
(181) 2032 12 01
(891) 2022 12 01
(511) 12

(260) AM 2024 121606 A
(800) 1712829
(151) 2022 11 24
(181) 2032 11 24
(891) 2022 11 24
(511) 20, 39, 40, 42

(260) AM 2024 121579 A
(800) 1712305
(151) 2022 11 18
(181) 2032 11 18
(891) 2022 11 18
(511) 12

(260) AM 2024 121617 A
(800) 1454204
(151) 2018 12 11
(181) 2028 12 11
(891) 2023 01 10
(511) 09, 16, 42

(260) AM 2024 121580 A
(800) 1712308
(151) 2022 11 18
(181) 2032 11 18
(891) 2022 11 18
(511) 37

(260) AM 2024 121618 A
(800) 1527978
(151) 2020 01 13
(181) 2030 01 13
(891) 2022 12 30
(511) 29

(260) AM 2024 121581 A
(800) 1712309
(151) 2022 11 28
(181) 2032 11 28
(891) 2022 11 28
(511) 20

(260) AM 2024 121619 A
(800) 1577985
(151) 2020 12 07
(181) 2030 12 07
(891) 2022 12 29
(511) 05, 35, 39, 41

(260) AM 2024 121620 A
(800) 1581477
(151) 2021 01 22
(181) 2031 01 22
(891) 2023 01 23
(511) 29, 30

(260) AM 2024 121678 A
(800) 1713065
(151) 2022 12 13
(181) 2032 12 13
(891) 2022 12 13
(511) 05, 44

(260) AM 2024 121621 A
(800) 1647891
(151) 2021 12 27
(181) 2031 12 27
(891) 2023 01 06
(511) 09

(260) AM 2024 121689 A
(800) 1713540
(151) 2022 12 26
(181) 2032 12 26
(891) 2022 12 26
(511) 29, 30

(260) AM 2024 121627 A
(800) 1682300
(151) 2022 05 18
(181) 2032 05 18
(891) 2023 01 24
(511) 42

(260) AM 2024 121710 A
(800) 1408878
(151) 2017 12 27
(181) 2027 12 27
(891) 2023 01 31
(511) 02

(260) AM 2024 121628 A
(800) 1686560
(151) 2022 06 16
(181) 2032 06 16
(891) 2023 01 24
(511) 29, 30

(260) AM 2024 121711 A
(800) 1490398
(151) 2019 06 28
(181) 2029 06 28
(891) 2023 01 24
(511) 09, 42

(260) AM 2024 121674 A
(800) 1712939
(151) 2022 08 26
(181) 2032 08 26
(891) 2022 08 26
(511) 09

(260) AM 2024 121712 A
(800) 1494131
(151) 2019 09 10
(181) 2029 09 10
(891) 2023 02 02
(511) 33

(260) AM 2024 121675 A
(800) 1712952
(151) 2022 12 16
(181) 2032 12 16
(891) 2022 12 16
(511) 06, 19, 37, 42, 45

(260) AM 2024 121713 A
(800) 1565719
(151) 2020 11 17
(181) 2030 11 17
(891) 2023 01 30
(511) 07

(260) AM 2024 121676 A
(800) 1712953
(151) 2022 12 05
(181) 2032 12 05
(891) 2022 12 05
(511) 29

(260) AM 2024 121714 A
(800) 1565728
(151) 2020 11 17
(181) 2030 11 17
(891) 2023 01 30
(511) 07

(260) AM 2024 121782 A
(800) 1714353
(151) 2022 12 17
(181) 2032 12 17
(891) 2022 12 17
(511) 05

(260) AM 2024 121820 A
(800) 1715575
(151) 2022 11 07
(181) 2032 11 07
(891) 2022 11 07
(511) 30, 35, 43

(260) AM 2024 121783 A
(800) 1714435
(151) 2022 12 12
(181) 2032 12 12
(891) 2022 12 12
(511) 05, 44

(260) AM 2024 121821 A
(800) 1715585
(151) 2022 11 21
(181) 2032 11 21
(891) 2022 11 21
(511) 05

(260) AM 2024 121784 A
(800) 1714473
(151) 2023 01 25
(181) 2033 01 25
(891) 2023 01 25
(511) 21

(260) AM 2024 121841 A
(800) 1469662
(151) 2019 03 29
(181) 2029 03 29
(891) 2022 12 14
(511) 03

(260) AM 2024 121785 A
(800) 1714516
(151) 2022 11 16
(181) 2032 11 16
(891) 2022 11 16
(511) 09, 14, 35

(260) AM 2024 121947 A
(800) 1717252
(151) 2022 10 21
(181) 2032 10 21
(891) 2022 10 21
(511) 05

(260) AM 2024 121817 A
(800) 1715391
(151) 2022 10 24
(181) 2032 10 24
(891) 2022 10 24
(511) 03

(260) AM 2024 121957 A
(800) 1717515
(151) 2022 11 08
(181) 2032 11 08
(891) 2022 11 08
(511) 09, 28, 41

(260) AM 2024 121818 A
(800) 1715424
(151) 2022 12 14
(181) 2032 12 14
(891) 2022 12 14
(511) 33

(260) AM 2024 121963 A
(800) 1717646
(151) 2023 01 26
(181) 2033 01 26
(891) 2023 01 26
(511) 12

(260) AM 2024 121819 A
(800) 1715490
(151) 2022 12 06
(181) 2032 12 06
(891) 2022 12 06
(511) 09

(260) AM 2024 121971 A
(800) 1717763
(151) 2023 02 20
(181) 2033 02 20
(891) 2023 02 20
(511) 17

(260) AM 2024 121975 A
(800) 1717856
(151) 2023 02 08
(181) 2033 02 08
(891) 2023 02 08
(511) 05

(260) AM 2024 121989 A
(800) 1718080
(151) 2022 09 30
(181) 2032 09 30
(891) 2022 09 30
(511) 29, 30

(260) AM 2024 121992 A
(800) 962559
(151) 2008 04 02
(181) 2028 04 02
(891) 2023 02 16
(511) 03, 05, 21

(260) AM 2024 121999 A
(800) 1635615
(151) 2021 11 19
(181) 2031 11 19
(891) 2023 02 23
(511) 32

(260) AM 2024 122148 A
(800) 1719715
(151) 2023 01 25
(181) 2033 01 25
(891) 2023 01 25
(511) 30

(260) AM 2024 122164 A
(800) 1720307
(151) 2022 11 23
(181) 2032 11 23
(891) 2022 11 23
(511) 03, 05, 10, 25

(260) AM 2024 122165 A
(800) 1720323
(151) 2023 01 31
(181) 2033 01 31
(891) 2023 01 31
(511) 30

OFFICIAL NOTIFICATIONS

INVENTIONS RESTORATION OF PATENTS

(21) AP 2018 15132
(11) P 2021 7227 B
(73) Rivus Pharmaceuticals Inc.
(54) NOVEL PHENYL DERIVATIVES
DATE OF PATENT LAPSE: 2024 01 05
DATE OF PATENT RESTORATION: 2024 02 12

(21) AP 2020 15715
(11) P 2023 7550 B
(73) Marker Holdings AG
(54) PLASMA DETOXIFICATION METHODS AND SYSTEMS
DATE OF PATENT LAPSE: 2024 01 13
DATE OF PATENT RESTORATION: 2024 02 12

LAPSE OF PATENTS WITH THE RIGHT TO RESTORE

(21) AP 2010 11644
(11) P 2012 5618 B
(73) Phagelux Inc.
(54) BIODEGRADED COPOLYMERS POLY (ESTER UREA) AND METHOD OF THEIR RECEPTION
DATE OF PATENT LAPSE: 2024 01 15
PATENT RESTORATION TERM: 2025 01 15

(21) AP 2011 12838
(11) P 2017 6628 B
(73) Dow Agrosiences LLC;
Sangamo Biosciences Inc.
(54) მიზანმიმართული გენომური ჩანაცვლებები
DATE OF PATENT LAPSE: 2024 01 24
PATENT RESTORATION TERM: 2025 01 24

(21) AP 2013 12974
(11) P 2016 6446 B
(73) Zurab Aslamazashvili;
Giorgi Oniashvili;
Garegin Zakharov;
Giorgi Tavadze;
Avtandil Khvadagiani;
Otar Okrotsvaridze
Aleksandre Berneri
(54) HARD ALLOY
DATE OF PATENT LAPSE: 2024 01 22
PATENT RESTORATION TERM: 2025 01 22

(21) AP 2013 12975
(11) P 2016 6447 B
(73) Zurab Aslamazashvili;
Giorgi Oniashvili;
Garegin Zakharov;
Giorgi Tavadze;
Avtandil Khvadagiani;
Otar Okrotsvaridze
Aleksandre Berneri
(54) HARD ALLOY
DATE OF PATENT LAPSE: 2024 01 22
PATENT RESTORATION TERM: 2025 01 22

(21) AP 2013 12976
(11) P 2016 6519 B
(73) Zurab Aslamazashvili;
Giorgi Oniashvili;
Garegin Zakharov;
Giorgi Tavadze;
Avtandil Khvadagiani;
Otar Okrotsvaridze
(54) METHOD FOR PRODUCING SYNTHETIC COMPOSITE CERAMIC MATERIALS - HARD ALLOY
HAVING ULTRAFINE STRUCTURE IN SYSTEMS TI-B-N-ME AND TI-B-N-C-ME
DATE OF PATENT LAPSE: 2024 01 22
PATENT RESTORATION TERM: 2025 01 22

(21) AP 2020 15709
(11) P 2022 7451 B
(73) Pfizer Inc.
(54) 3-CARBONYLAMINO-5-CYCLOPENTYL-1H-PYRAZOLE COMPOUNDS HAVING INHIBITORY
ACTIVITY ON CDK2
DATE OF PATENT LAPSE: 2024 01 28
PATENT RESTORATION TERM: 2025 01 28

EXPIRATION OF PATENTS RESTORATION TERM

(21) AP 2005 11830
(11) P 2013 5824 B
(73) Jeox S. P. A.
(54) SHOE WITH BREATHABLE AND WATERPROOF SOLE AND UPPER
DATE OF PATENT LAPSE: 2023 01 20
DATE OF EXPIRATION OF PATENT RESTORATION TERM: 2024 01 20

(21) AP 2005 9505
(11) P 2011 5256 B
(73) Jeox S. P. A.
(54) SHOE WITH BREATHABLE AND WATERPROOF SOLE AND UPPER
DATE OF PATENT LAPSE: 2023 01 20
DATE OF EXPIRATION OF PATENT RESTORATION TERM: 2024 01 20

UTILITY MODELS LAPSE OF PATENTS WITH THE RIGHT TO RESTORE

(21) AU 2021 15537
(11) U 2023 2144 Y
(73) Guram Kupatadze;
Shakro Kvirivia;
Anzor Japaridze
(54) BIOLOGICALLY ACTIVE FOOD ADITIVE
DATE OF PATENT LAPSE: 2024 01 17
PATENT RESTORATION TERM: 2025 01 17

(21) AU 2021 15545
(11) U 2021 2101 Y
(73) Giorgi Chiradze
(54) METHOD FOR MULTILAYER ARTICLE PREPARATION WITH PLYWOOD
DATE OF PATENT LAPSE: 2024 01 28
PATENT RESTORATION TERM: 2025 01 28

(21) AU 2021 16007
(11) U 2023 2155 Y
(73) Yevhen Olehovych Puhach
(54) CONTROLLED CLOSED TYPE STARTER
DATE OF PATENT LAPSE: 2024 01 26
PATENT RESTORATION TERM: 2025 01 26

EXPIRATION OF PATENT RESTORATION TERM

(21) AU 2019 14990
(11) U 2020 2045 Y
(73) Paata Gogoladze
(54) METHOD FOR RETICULAR TISSUE PRODUCTION FOR ARMORING ASPHALT CONCRETE
DATE OF PATENT LAPSE: 2023 01 25
DATE OF EXPIRATION OF PATENT RESTORATION TERM: 2024 01 25

DESIGNS

EXTENSION OF TERM OF INTERNATIONAL DESIGNS REGISTRATION

(11) D 2019 803 S
(73) Obshchestvo s Ogranichennoy Otvetstvennostiu "KB Stodol" (BY)
IV Lane Montazhnikov 9, Kab. 39, Minsk, 220019, Belorusia (BY)
(54) 1. FILLING STATION GARAGE, 2. FILLING STATION STELE
(28) 2
(24) 2018 06 27
(18) 2028 06 27
(58) 2024 01 31

(11) D 2014 570 S
(73) Gunsan Elektrik Malzemeleri Sanayi Ve Ticaret Anonim Sirketi (TR)
Osmangazi Mah. Yildirim Beyazit Cad. No. 29 Sancaktepe Istanbul 34887, Türkiye (TR)
(54) ELECTRIC DEVICE HOUSING
(28) 1
(24) 2013 07 12
(18) 2028 07 12
(58) 2024 01 24

(11) D 2014 571 S
(73) Gunsan Elektrik Malzemeleri Sanayi Ve Ticaret Anonim Sirketi (TR)
Osmangazi Mah. Yildirim Beyazit Cad. No. 29 Sancaktepe Istanbul 34887, Türkiye (TR)
(54) ELECTRIC SWITCH
(28) 1
(24) 2013 07 12
(18) 2028 07 12
(58) 2024 01 24

TRADEMARKS**EXTENSION OF TERM OF TRADEMARKS REGISTRATION**

(111) M 2004 15803 R2
(151) 2004 12 15
(186) 2034 12 15
(732) ITG Cigars Inc.
(a Delaware, U.S.A. Corporation)
714 Green Valley Road, Greensboro, North
Carolina 27408, USA

(111) M 2014 24454 R1
(151) 2014 02 03
(186) 2034 02 03
(732) Nikon Corporation
2-15-3, Konan, Minato-ku, Tokyo, Japan

(111) M 2014 24455 R1
(151) 2014 02 03
(186) 2034 02 03
(732) Nikon Corporation
2-15-3, Konan, Minato-ku, Tokyo, Japan

(111) M 2014 24421 R1
(151) 2014 01 21
(186) 2034 01 21
(732) Emilio Pucci International S.R.L.
Via Fieno 3 Cap 20123, Milano, Italy

(111) M 2014 24422 R1
(151) 2014 01 21
(186) 2034 01 21
(732) Emilio Pucci International S.R.L.
Via Fieno 3 Cap 20123, Milano, Italy

(111) M 2014 24509 R1
(151) 2014 02 18
(186) 2034 02 18
(732) LTD "Injoy & Joy"
Savaneli St. 20, 0105, Tbilisi, Georgia

(111) M 2014 24510 R1
(151) 2014 02 18
(186) 2034 02 18
(732) LTD "Injoy & Joy"
Savaneli St. 20, 0105, Tbilisi, Georgia

(111) M 2014 24616 R1
(151) 2014 03 31
(186) 2034 03 31
(732) LTD "Novator Pharma"
Vill. Irganchai, 1707, Dmanisi Region,
Georgia

(111) M 2014 24617 R1
(151) 2014 03 31
(186) 2034 03 31
(732) LTD "Novator Pharma"
Vill. Irganchai, 1707, Dmanisi Region,
Georgia

(111) M 2014 24618 R1
(151) 2014 03 31
(186) 2034 03 31
(732) LTD "Novator Pharma"
Vill. Irganchai, 1707, Dmanisi Region,
Georgia

(111) M 2014 24619 R1
(151) 2014 03 31
(186) 2034 03 31
(732) LTD "Novator Pharma"
Vill. Irganchai, 1707, Dmanisi Region,
Georgia

(111) M 2014 25096 R1
(151) 2014 07 28
(186) 2034 07 28
(732) LLC "Tifliski Vini Pogreb"
Iumashev St. 27, 0198, Tbilisi, Georgia

(111) M 2014 25360 R1
(151) 2014 11 10
(186) 2034 11 10
(732) LLC "Tifliski Vini Pogreb"
Iumashev St. 27, 0198, Tbilisi, Georgia

(111) M 2014 25361 R1
(151) 2014 11 10
(186) 2034 11 10
(732) LLC "Tifliski Vini Pogreb"
Iumashev St. 27, 0198, Tbilisi, Georgia

COMPLETE TRANSFER OF RIGHTS

(111) M 2021 34639 R
(732) JSC "Devcom"
Irakli Abashidze St. 34, Commercial
Space - №3, block I, Vake District,
Tbilisi, Georgia
(770) LLC "Champions 111"
Ilia Chavchavadze Av. 29, 5th floor, 0179,
Tbilisi, Georgia
(580) 2023 12 28

(111) M 2023 37264 R
(732) Grand Tobacco LLC
22 Hrant Vardanyan Street, Yerevan 0061,
Armenia
(770) Mikael Vardanyan
Bayron Str. 3, Ap. 38, Yerevan, Armenia
(580) 2023 12 19

(111) M 2023 37397 R
(732) Grand Tobacco LLC
22 Hrant Vardanyan Street, Yerevan 0061,
Armenia
(770) Mikayel Vardanyan
Bayron St. 3, Ap. 38, Yerevan, Armenia
(580) 2023 12 19

(111) M 1995 1264 R
(732) Lactalis Heritage Dairy Inc.
540 West Madison Street, Suite 300,
Chicago, Illinois 60661, USA
(770) Kraft Foods Group Brands LLC
200 East Randolph Street, Chicago,
Illinois 60601, USA
(580) 2024 01 08

(111) M 1995 1254 R
(732) Lactalis Heritage Dairy Inc.
540 West Madison Street, Suite 300,
Chicago, Illinois 60661, USA
(770) Kraft Foods Group Brands LLC
200 East Randolph Street, Chicago,
Illinois 60601, USA
(580) 2024 01 08

(111) M 2005 16238 R
(732) Grand Tobacco LLC
22 Hrant Vardanyan Street, Yerevan 0061,
Armenia
(770) Mikayel Vardanyan
Bayron Str. 3, Ap. 38, Yerevan, Armenia
(580) 2023 11 01

(111) M 2005 16185 R
(732) Grand Tobacco LLC
22 Hrant Vardanyan Street, Yerevan 0061,
Armenia
(770) Mikayel Vardanyan
Bayron Str. 3, Ap. 38, Yerevan, Armenia
(580) 2023 11 01

(111) M 1995 1309 R
(732) Lactalis Heritage Dairy Inc.
540 West Madison Street, Suite 300,
Chicago, Illinois 60661, USA
(770) Kraft Foods Group Brands LLC
200 East Randolph Street, Chicago,
Illinois 60601, USA
(580) 2024 01 08

(111) M 1995 1276 R
(732) Lactalis Heritage Dairy Inc.
540 West Madison Street, Suite 300,
Chicago, Illinois 60661, USA
(770) Kraft Foods Group Brands LLC
200 East Randolph Street, Chicago,
Illinois 60601, USA
(580) 2024 01 08

(111) M 2019 31047 R
(732) Tessengerlo Kerley Inc.
2910 North 44th Street, Suite 100,
Phoenix, Arizona 85018, USA
(770) Corteva Agriscience LLC
9330 Zionsville Road, Indianapolis,
Indiana 46268, USA
(580) 2024 01 10

(111) M 2019 31048 R
(732) Tessengerlo Kerley Inc.
2910 North 44th Street, Suite 100,
Phoenix, Arizona 85018, USA
(770) Corteva Agriscience LLC
9330 Zionsville Road, Indianapolis,
Indiana 46268, USA
(580) 2024 01 10

CHANGES OF NAME AND/OR ADDRESS OF TRADEMARKS OWNERS

(111) M 2004 15414 R
(732) LLC "GM Pharmaceuticals"
Rustavi Highway 52, 0114, Tbilisi, Georgia
(770) LLC "G-M-P"
Zemo Vedzisi St. 103, 0160, Tbilisi, Georgia
(580) 2024 01 18

(111) M 2009 20136 R
(732) Sheraton International IP LLC
7750 Wisconsin Avenue, Bethesda,
Maryland 20814, USA
(770) Sheraton International IP LLC
One StarPoint, Stamford, Connecticut
06902, USA
(580) 2023 12 15

(111) M 2014 24793 R
(732) LLC GM Pharmaceuticals
Rustavi Highway 52, 0114, Tbilisi, Georgia
(770) LLC "G-M-P"
Ponichala 65, 0165, Tbilisi, Georgia
(580) 2024 01 18

(111) M 2014 24496 R
(732) LLC GM Pharmaceuticals"
Rustavi Highway 52, 0114, Tbilisi, Georgia
(770) LLC "G-M-P"
Ponichala 65, 0165, Tbilisi, Georgia
(580) 2024 01 18

(111) M 2014 24497 R
(732) LLC "GM Pharmaceuticals"
Rustavi Highway 52, 0114, Tbilisi, Georgia
(770) LLC "G-M-P"
Ponichala 65, 0165, Tbilisi, Georgia
(580) 2024 01 18

(111) M 2014 24464 R
(732) IBay Inc.
2025 Hamilton Avenue, San Jose,
CA 95125, USA
(770) IBay Inc.
2145 Hamilton Avenue, San-Jose,
CA 95125, USA
(580) 2024 01 01

(111) M 2014 24673 R
(732) LLC "GM Pharmaceuticals"
Rustavi Highway 52, 0114, Tbilisi,
Georgia

(770) LLC "G-M-P"
Ponichala 65, 0165, Tbilisi, Georgia
(580) 2024 01 18

(111) M 2014 24677 R
(732) LLC "GM Pharmaceuticals"
Rustavi Highway 52, 0114, Tbilisi, Georgia
(770) LLC "G-M-P"
Ponichala 65, 0165, Tbilisi, Georgia
(580) 2024 01 18

(111) M 2014 24835 R
(732) LLC "GM Pharmaceuticals"
Rustavi Highway 52, 0114, Tbilisi, Georgia
(770) LLC "G-M-P"
Ponichala 65, 0165, Tbilisi, Georgia
(580) 2024 01 18

(111) M 2014 24689 R
(732) LLC "GM Pharmaceuticals"
Rustavi Highway 52, 0114, Tbilisi, Georgia
(770) LLC "G-M-P"
Ponichala 65, 0165, Tbilisi, Georgia
(580) 2024 01 18

(111) M 2014 24691 R
(732) LLC "GM Pharmaceuticals"
Rustavi Highway 52, 0114, Tbilisi, Georgia
(770) LLC "G-M-P"
Ponichala 65, 0165, Tbilisi, Georgia
(580) 2024 01 18

(111) M 2014 24692 R
(732) LLC "GM Pharmaceuticals"
Rustavi Highway 52, 0114, Tbilisi, Georgia
(770) LLC "G-M-P"
Ponichala 65, 0165, Tbilisi, Georgia
(580) 2024 01 18

(111) M 2014 24695 R
(732) JSC "PSP Insurance"
Davit Aghmashenebeli Av. 148, 0112, Tbilisi,
Georgia
(770) LLC "PSP Insurance"
Davit Aghmashenebeli Ave. 148, 0112, Tbilisi,
Georgia
(580) 2024 01 22

(111) M 2014 24877 R
(732) JSC "Miso Intelepress"
Davit Aghmashenebeli Av. 89/24, 0102,
Didubi district, Tbilisi, Georgia
(770) Microfinance Organization
"Intel Express Georgia" LLC
Marjanishvili St. 28, 0102, Tbilisi, Georgia
(580) 2024 01 22

(111) M 1997 7723 R
(732) Elanco Animal Health GmbH
Alfred-Nobel-Strasse 50, 40789 Monheim
am Rhein, Germany
(770) Bayer Animal Health GmbH
Kaiser-Wilhelm-Allee 20, 51373
Leverkusen, Germany
(580) 2023 12 19

CANCELLATION OF TRADEMARKS REGISTRATION

(111) M 2003 15203 R
(151) 2003 07 16
(732) Allied Global Tobacco Limited
Wey Court West, Union Road, Farnham
GU9 7PT, Surrey, United Kingdom
(141) 2024 01 31

(111) M 2003 15204 R
(151) 2003 07 16
(732) Upjohn US 2 LLC
235 East 42nd Street, New York,
N.Y. 10017, USA
(141) 2024 01 31

(111) M 2003 15214 R
(151) 2003 07 16
(732) PepsiCo Inc.
a North Carolina Corporation
700 Anderson Hill Road, Purchase,
New York 10577, USA
(141) 2024 01 31

(111) M 2003 15215 R
(151) 2003 07 17
(732) LLC "Standard Tobacco Incorporated"
Abuseridze-Tbeli St. 13, 0120, Tbilisi, Georgia
(141) 2024 01 31

(111) M 2003 15209 R
(151) 2003 07 16
(732) JSC "Media Holding"
Nutsbidze Slop. III m/r, I qu., bld. 4, 29,
Vake District, Tbilisi, Georgia
(141) 2024 02 01

(111) M 2003 15211 R
(151) 2003 07 16
(732) LLC "Standard Tobacco Incorporated"
Abuseridze-Tbeli St. 13, 0120, Tbilisi, Georgia
(141) 2024 01 31

(111) M 2003 15212 R
(151) 2003 07 16
(732) JSC "Gefa"
Sanapiro St. 6, 0108, Tbilisi, Georgia
(141) 2024 01 31

(111) M 2013 23846 R
(151) 2013 07 19
(732) JSC "Georgian Beer Company"
Vill. Saguramo, 3311, Mtskheta Region,
Georgia
(141) 2024 01 31

(111) M 2013 23847 R
 (151) 2013 07 19
 (732) JSC "Georgian Beer Company"
 Vill. Saguramo, 3311, Mtskheta Region,
 Georgia
 (141) 2024 01 31

(111) M 2013 23848 R
 (151) 2013 07 19
 (732) JSC "Georgian Beer Company"
 Vill. Saguramo, 3311, Mtskheta Region,
 Georgia
 (141) 2024 01 31

(111) M 2013 23849 R
 (151) 2013 07 19
 (732) JSC "Georgian Beer Company"
 Vill. Saguramo, 3311, Mtskheta Region,
 Georgia
 (141) 2024 01 31

(111) M 2013 23850 R
 (151) 2013 07 19
 (732) JSC "Georgian Beer Company"
 Vill. Saguramo, 3311, Mtskheta Region,
 Georgia
 (141) 2024 01 31

(111) M 2013 23851 R
 (151) 2013 07 19
 (732) JSC "Georgian Beer Company"
 Vill. Saguramo, 3311, Mtskheta Region,
 Georgia
 (141) 2024 01 31

(111) M 2013 23854 R
 (151) 2013 07 19
 (732) Svyatoslav Nechytailo
 Zankovetska St.4, flat 27, Kyiv, Ukraine
 (141) 2024 01 31

(111) M 2013 23855 R
 (151) 2013 07 19
 (732) Harrington Development Inc.
 Elvira Mendez Street, Vallarino bldg.,
 3rd Floor, Panama, Republic of Panama
 (141) 2024 01 31

(111) M 2013 23859 R
 (151) 2013 07 19
 (732) LTD "ImeretiV"
 Ilia Chavchavadze Av. 53s, 4600, Kutaisi,
 Georgia
 (141) 2024 01 31

(111) M 2013 23860 R
 (151) 2013 07 19
 (732) Ilia Ukhurgunashvili
 Saburtalo St. 30a, ap. 49, 0160, Tbilisi,
 Georgia
 (141) 2024 01 31

(111) M 2013 23861 R
 (151) 2013 07 19
 (732) Abraxic Bioscience LLC
 11755 Wilshire Blvd., 20 Floor,
 Los Angeles, CA 90025, USA
 (141) 2024 01 31

(111) M 2013 23863 R
 (151) 2013 07 19
 (732) LTD "Fermo Fenc"
 Didi Dighomi, Parnavaz Av., Next to the
 parking lot (bakery), 0131, Tbilisi, Georgia
 (141) 2024 01 31

(111) M 2013 23864 R
 (151) 2013 07 19
 (732) Magda Kevlishvili
 Jansugh Kakhidze (last krilov) St. 12, 0102,
 Tbilisi, Georgia
 (141) 2024 01 31

(111) M 2013 23839 R
 (151) 2013 07 16
 (732) Tengiz Abesadze
 M. Dvalishvili St. 15, 4600, Kutaisi, Georgia
 (141) 2024 01 25

(111) M 2013 23865 R
 (151) 2013 07 19
 (732) LTD "Stromos"
 The area around the 21st kilometer of the
 Tbilisi-Tsiteli Khidi Highway, 3700, Rustavi,
 Georgia
 (141) 2024 01 25

CLASSIFICATION INDEXES

INVENTIONS

CONCORDANCE TABLE OF INTERNATIONAL CLASSIFICATION INDEX AND PUBLICATION NUMBERS

INTERNATIONAL CLASSIFICATION INDEXES (51)	NUMBER OF PUBLISHED APPLICATION (10)
A 61 K 31/4188; A 61 P 35/02; A 61 P 35/00; A 61 P 31/00; C 07 D 519/00; C 07 D 498/16	AP 2024 15883 A
A 61 K 31/4353; A 61 P 35/00; C 07 D 403/04	AP 2024 15986 A
A 61 K 31/4545; A 61 P 35/00; C 07 D 471/04	AP 2024 15804 A
A 61 K 31/454; A 61 P 9/00; A 61 P 25/00; A 61 P 11/00; C 07 D 417/14; C 07 D 413/14	AP 2024 15966 A
B 01 F 17/00; C 10 L 10/02; C 10 L 1/32	AP 2024 15748 A
E 04 B 1/24; E 04 B 2/76; E 04 B 2/74; E 04 B 1/38; E 04 B 2/58; E 04 F 11/18	AP 2024 15522 A
E 04 G 3/10	AP 2024 15941 A

CONCORDANCE TABLE OF PUBLICATION NUMBERS AND INTERNATIONAL CLASSIFICATION INDEX

NUMBER OF PUBLISHED APPLICATION (10)	INTERNATIONAL CLASSIFICATION INDEXES (51)
AP 2024 15522 A	E 04 B 1/24; E 04 B 2/76; E 04 B 2/74; E 04 B 1/38; E 04 B 2/58; E 04 F 11/18
AP 2024 15748 A	B 01 F 17/00; C 10 L 10/02; C 10 L 1/32
AP 2024 15804 A	A 61 K 31/4545; A 61 P 35/00; C 07 D 471/04
AP 2024 15883 A	A 61 K 31/4188; A 61 P 35/02; A 61 P 35/00; A 61 P 31/00; C 07 D 519/00; C 07 D 498/16
AP 2024 15941 A	E 04 G 3/10
AP 2024 15966 A	A 61 K 31/454; A 61 P 9/00; A 61 P 25/00; A 61 P 11/00; C 07 D 417/14; C 07 D 413/14
AP 2024 15986 A	A 61 K 31/4353; A 61 P 35/00; C 07 D 403/04

**CONCORDANCE TABLE OF INTERNATIONAL CLASSIFICATION INDEX,
PATENT NUMBERS AND PUBLICATION NUMBERS**

INTERNATIONAL CLASSIFICATION INDEX (51)	NUMBER OF PATENT (11)	NUMBER OF PUBLISHED APPLICATION (10)
A 61 K 31/58; A 61 K 31/137; A 61 K 31/167; A 61 K 31/573; A 61 K 47/02; A 61 K 47/10; A 61 K 9/00; A 61 P 11/00	P 2024 7594 B	AP 2023 16025 A
A 61 K 31/4709; A 61 K 31/506; A 61 P 31/06; C 07 D 401/04; C 07 D 409/14; C 07 D 401/14; C 07 D 405/14	P 2023 7590 B	AP 2023 16014 A
A 61 K 39/395; A 61 K 45/06; C 07 K 16/40	P 2024 7593 B	AP 2023 15019 A
C 03 B 37/00	P 2024 7592 B	AP 2023 15931 A
E 04 H 6/06	P 2024 7591 B	AP 2023 16038 A
H 02 K 33/04	P 2024 7595 B	AP 2023 16203 A

**CONCORDANCE TABLE OF PATENT NUMBERS,
PUBLICATION NUMBERS AND INTERNATIONAL CLASSIFICATION INDEX**

NUMBER OF PATENT (11)	NUMBER OF PUBLISHED APPLICATION (10)	INTERNATIONAL CLASSIFICATION INDEX (51)
P 2023 7590 B	AP 2023 16014 A	A 61 K 31/4709; A 61 K 31/506; A 61 P 31/06; C 07 D 401/04; C 07 D 409/14; C 07 D 401/14; C 07 D 405/14
P 2024 7591 B	AP 2023 16038 A	E 04 H 6/06
P 2024 7592 B	AP 2023 15931 A	C 03 B 37/00
P 2024 7593 B	AP 2023 15019 A	A 61 K 39/395; A 61 K 45/06; C 07 K 16/40
P 2024 7594 B	AP 2023 16025 A	A 61 K 31/58; A 61 K 31/137; A 61 K 31/167; A 61 K 31/573; A 61 K 47/02; A 61 K 47/10; A 61 K 9/00; A 61 P 11/00
P 2024 7595 B	AP 2023 16203 A	H 02 K 33/04

**CONCORDANCE TABLE OF APPLICATION NUMBERS,
PUBLICATION NUMBERS AND PATENTS**

NUMBER OF APPLICATION (21)	NUMBER OF PUBLISHED APPLICATION (10)	NUMBER OF PATENT (11)
AP 2017 15019	AP 2023 15019 A	P 2024 7593 B
AP 2022 15931	AP 2023 15931 A	P 2024 7592 B
AP 2020 16014	AP 2023 16014 A	P 2023 7590 B
AP 2021 16025	AP 2023 16025 A	P 2024 7594 B
AP 2022 16038	AP 2023 16038 A	P 2024 7591 B
AP 2023 16203	AP 2023 16203 A	P 2024 7595 B

APPLICATIONS*****CONCORDANCE TABLE OF INTERNATIONAL CLASSIFICATION INDEX
AND PUBLICATION NUMBERS**

INTERNATIONAL CLASSIFICATION INDEXES (51)	NUMBER OF PUBLISHED APPLICATION (10)
A 61 K 31/4166; A 61 K 9/00; A 61 K 31/165; A 61 K 31/19; A 61 K 31/4015; A 61 K 31/41; A 61 K 31/435; A 61 P 25/00; A 61 P 25/08	AP 2024 16349 A
A 61 K 31/506; A 61 P 43/00; C 07 D 207/14; C 07 D 417/12; C 07 D 491/04; C 07 D 403/12	AP 2024 16395 A
A 61 K 31/517; A 61 K 31/4184; A 61 K 31/417	AP 2024 16425 A
A 61 K 39/395; A 61 P 29/00; A 61 P 1/00; C 07 K 16/28; C 07 K 16/24	AP 2024 16351 A
A 61 K 47/68; A 61 K 45/06; A 61 K 39/395; A 61 P 35/00	AP 2024 16383 A

**CONCORDANCE TABLE OF PUBLICATION NUMBERS
AND INTERNATIONAL CLASSIFICATION INDEX**

NUMBER OF PUBLISHED APPLICATION (10)	INTERNATIONAL CLASSIFICATION INDEXES (51)
AP 2024 16349 A	A 61 K 31/4166; A 61 K 9/00; A 61 K 31/165; A 61 K 31/19; A 61 K 31/4015; A 61 K 31/41; A 61 K 31/435; A 61 P 25/00; A 61 P 25/08
AP 2024 16351 A	A 61 K 39/395; A 61 P 29/00; A 61 P 1/00; C 07 K 16/28; C 07 K 16/24
AP 2024 16383 A	A 61 K 47/68; A 61 K 45/06; A 61 K 39/395; A 61 P 35/00
AP 2024 16395 A	A 61 K 31/506; A 61 P 43/00; C 07 D 207/14; C 07 D 417/12; C 07 D 491/04; C 07 D 403/12
AP 2024 16425 A	A 61 K 31/517; A 61 K 31/4184; A 61 K 31/417

UTILITY MODELS**CONCORDANCE TABLE OF INTERNATIONAL CLASSIFICATION INDEX,
PATENT NUMBERS AND PUBLICATION NUMBERS**

INTERNATIONAL CLASSIFICATION INDEX (51)	NUMBER OF PATENT (11)	NUMBER OF PUBLISHED APPLICATION (10)
A 23 F 3/00	U 2024 2163 Y	AU 2023 16196 U
B 24 D 3/10	U 2024 2162 Y	AU 2023 16092 U
E 21 B 43/01	U 2024 2165 Y	AU 2023 16069 U
F 28 D 9/00; F 28 F 3/02	U 2024 2164 Y	AU 2023 16194 U
H 05 B 3/00	U 2024 2166 Y	AU 2023 16234 U

**CONCORDANCE TABLE OF PATENT NUMBERS,
PUBLICATION NUMBERS AND INTERNATIONAL CLASSIFICATION INDEX**

NUMBER OF PATENT (11)	NUMBER OF PUBLISHED APPLICATION (10)	INTERNATIONAL CLASSIFICATION INDEX (51)
U 2024 2162 Y	AU 2023 16092 U	B 24 D 3/10
U 2024 2163 Y	AU 2023 16196 U	A 23 F 3/00
U 2024 2164 Y	AU 2023 16194 U	F 28 D 9/00; F 28 F 3/02
U 2024 2165 Y	AU 2023 16069 U	E 21 B 43/01
U 2024 2166 Y	AU 2023 16234 U	H 05 B 3/00

**CONCORDANCE TABLE OF APPLICATION NUMBERS,
PUBLICATION NUMBERS AND PATENTS**

NUMBER OF APPLICATION (21)	NUMBER OF PUBLISHED APPLICATION (10)	NUMBER OF PATENT (11)
AU 2022 16069	AU 2023 16069 U	U 2024 2165 Y
AU 2022 16092	AU 2023 16092 U	U 2024 2162 Y
AU 2023 16194	AU 2023 16194 U	U 2024 2164 Y
AU 2023 16196	AU 2023 16196 U	U 2024 2163 Y
AU 2023 16234	AU 2023 16234 U	U 2024 2166 Y

APPLICATION^{*}
CONCORDANCE TABLE OF INTERNATIONAL CLASSIFICATION INDEX
AND PUBLICATION NUMBERS**

INTERNATIONAL CLASSIFICATION INDEXES (51)	NUMBER OF PUBLISHED APPLICATION (10)
D 04 H 1/16	AU 2024 16304 U

**CONCORDANCE TABLE OF PUBLICATION NUMBERS
AND INTERNATIONAL CLASSIFICATION INDEX**

NUMBER OF PUBLISHED APPLICATION (10)	INTERNATIONAL CLASSIFICATION INDEXES (51)
AU 2024 16304 U	D 04 H 1/16

REGISTERED UTILITY MODEL***
**CONCORDANCE TABLE OF INTERNATIONAL CLASSIFICATION INDEX,
 REGISTRATION NUMBERS AND PUBLICATION NUMBERS**

INTERNATIONAL CLASSIFICATION INDEX (51)	NUMBER OF UTILITY MODEL REGISTRATION (11)	NUMBER OF PUBLISHED APPLICATION (10)
D 04 H 1/16	U 2024 2161 Y	AU 2024 16304 U

**CONCORDANCE TABLE OF REGISTRATION NUMBERS,
 PUBLICATION NUMBERS AND INTERNATIONAL CLASSIFICATION INDEX**

NUMBER OF UTILITY MODEL REGISTRATION (11)	NUMBER OF PUBLISHED APPLICATION (10)	INTERNATIONAL CLASSIFICATION INDEX (51)
U 2024 2161 Y	AU 2024 16304 U	D 04 H 1/16

**CONCORDANCE TABLE OF APPLICATION NUMBERS,
 PUBLICATION NUMBERS AND REGISTRATION NUMBERS**

NUMBER OF APPLICATION (21)	NUMBER OF PUBLISHED APPLICATION (10)	NUMBER OF UTILITY MODEL REGISTRATION (11)
AU 2023 16304	AU 2024 16304 U	U 2024 2161 Y

DESIGNS

**CONCORDANCE TABLE OF INTERNATIONAL CLASSIFICATION INDEX
 AND PUBLICATION NUMBERS**

INTERNATIONAL CLASSIFICATION INDEXES (51)	NUMBER OF PUBLISHED APPLICATION (10)
09-01	AD 2024 1329 S
15-09	AD 2024 1328 S

CONCORDANCE TABLE OF PUBLICATION NUMBERS
AND INTERNATIONAL CLASSIFICATION INDEX

NUMBER OF PUBLISHED APPLICATION (10)	INTERNATIONAL CLASSIFICATION INDEXES (51)
AD 2024 1328 S	15-09
AD 2024 1329 S	09-01

CONCORDANCE TABLE OF INTERNATIONAL CLASSIFICATION INDEX,
NUMBERS OF REGISTRATION AND PUBLICATION NUMBERS

INTERNATIONAL CLASSIFICATION INDEX (51)	NUMBER OF REGISTRATION (11)	NUMBER OF PUBLISHED APPLICATION (10)
11-01	D 2024 992 S	AD 2023 1313 S
21-01	D 2024 993 S	AD 2023 1315 S

CONCORDANCE TABLE OF NUMBERS OF REGISTRATION,
PUBLICATION NUMBERS AND INTERNATIONAL CLASSIFICATION INDEX

NUMBER OF REGISTRATION (11)	NUMBER OF PUBLISHED APPLICATION (10)	INTERNATIONAL CLASSIFICATION INDEX (51)
D 2024 992 S	AD 2023 1313 S	11-01
D 2024 993 S	AD 2023 1315 S	21-01

CONCORDANCE TABLE OF APPLICATION NUMBERS,
PUBLICATION NUMBERS AND NUMBERS OF REGISTRATION

NUMBER OF APPLICATION (21)	NUMBER OF PUBLISHED APPLICATION (10)	NUMBER OF REGISTRATION (11)
AD 2023 1313	AD 2023 1313 S	D 2024 992 S
AD 2023 1315	AD 2023 1315 S	D 2024 993 S

TRADEMARKS

CONCORDANCE TABLE OF REGISTRATION NUMBERS, APPLICATION NUMBERS, PUBLICATION NUMBERS AND BULLETIN NUMBERS

NUMBER OF REGISTRATION (111)	NUMBER OF APPLICATIONS (210)	NUMBER OF PUBLISHED APPLICATIONS (260)	NUMBER OF BULLETIN
1	2	3	4
M 2023 37798 R	AM 126452	–	3(630)2024
M 2023 37799 R	AM 126190	–	3(630)2024
M 2023 37800 R	AM 126362	–	3(630)2024
M 2023 37801 R	AM 126392	–	3(630)2024
M 2023 37802 R	AM 126004	–	3(630)2024
M 2023 37803 R	AM 126346	–	3(630)2024
M 2024 37804 R	AM 122006	AM 2023 122006 A	19(622)2023
M 2024 37805 R	AM 121660	AM 2023 121660 A	19(622)2023
M 2024 37806 R	AM 122204	AM 2023 122204 A	19(622)2023
M 2024 37807 R	AM 121659	AM 2023 121659 A	19(622)2023
M 2024 37808 R	AM 121763	AM 2023 121763 A	18(621)2023
M 2024 37809 R	AM 121661	AM 2023 121661 A	19(622)2023
M 2024 37810 R	AM 120704	AM 2023 120704 A	17(620)2023
M 2024 37811 R	AM 121214	AM 2023 121214 A	18(621)2023
M 2024 37812 R	AM 120825	AM 2023 120825 A	13(616)2023
M 2024 37813 R	AM 121307	AM 2023 121307 A	16(619)2023
M 2024 37814 R	AM 121215	AM 2023 121215 A	18(621)2023
M 2024 37815 R	AM 120614	AM 2023 120614 A	16(619)2023
M 2024 37816 R	AM 121051	AM 2023 121051 A	15(618)2023
M 2024 37817 R	AM 121132	AM 2023 121132 A	15(618)2023
M 2024 37818 R	AM 121352	AM 2023 121352 A	15(618)2023
M 2024 37819 R	AM 121040	AM 2023 121040 A	16(619)2023
M 2024 37820 R	AM 121321	AM 2023 121321 A	17(620)2023
M 2024 37821 R	AM 121418	AM 2023 121418 A	17(620)2023
M 2024 37822 R	AM 120702	AM 2023 120702 A	13(616)2023
M 2024 37823 R	AM 120833	AM 2023 120833 A	14(617)2023
M 2024 37824 R	AM 121340	AM 2023 121340 A	17(620)2023
M 2024 37825 R	AM 120613	AM 2023 120613 A	14(617)2023
M 2024 37826 R	AM 120610	AM 2023 120610 A	14(617)2023
M 2024 37827 R	AM 121427	AM 2023 121427 A	18(621)2023
M 2024 37828 R	AM 122027	AM 2023 122027 A	18(621)2023
M 2024 37829 R	AM 121416	AM 2023 121416 A	17(620)2023
M 2024 37830 R	AM 121415	AM 2023 121415 A	17(620)2023
M 2024 37831 R	AM 121516	AM 2023 121516 A	17(620)2023
M 2024 37832 R	AM 121527	AM 2023 121527 A	17(620)2023
M 2024 37833 R	AM 121528	AM 2023 121528 A	17(620)2023
M 2024 37834 R	AM 126260	–	3(630)2024
M 2024 37835 R	AM 126469	–	3(630)2024
M 2024 37836 R	AM 126477	–	3(630)2024
M 2024 37837 R	AM 126191	–	3(630)2024
M 2024 37838 R	AM 126451	–	3(630)2024
M 2024 37839 R	AM 126480	–	3(630)2024
M 2024 37840 R	AM 126464	–	3(630)2024
M 2024 37841 R	AM 126481	–	3(630)2024
M 2024 37842 R	AM 126497	–	3(630)2024
M 2024 37843 R	AM 126570	–	3(630)2024
M 2024 37844 R	AM 126571	–	3(630)2024

CONCORDANCE TABLE OF INDEX OF GOODS AND/OR SERVICES
AND APPLICATION NUMBERS

NUMBER OF PUBLISHED APPLICATIONS (260)	NUMBER OF APPLICATIONS (210)	1	2
1	2	AM 2024 123105 A	AM 123105
AM 2024 122028 A	AM 122028	AM 2024 123180 A	AM 123180
AM 2024 122429 A	AM 122429	AM 2024 123181 A	AM 123181
AM 2024 122569 A	AM 122569	AM 2024 123182 A	AM 123182
AM 2024 122577 A	AM 122577	AM 2024 123183 A	AM 123183
AM 2024 122580 A	AM 122580	AM 2024 123184 A	AM 123184
AM 2024 122586 A	AM 122586	AM 2024 123185 A	AM 123185
AM 2024 122651 A	AM 122651	AM 2024 123187 A	AM 123187
AM 2024 122672 A	AM 122672	AM 2024 123188 A	AM 123188
AM 2024 122738 A	AM 122738	AM 2024 123192 A	AM 123192
AM 2024 122739 A	AM 122739	AM 2024 123193 A	AM 123193
AM 2024 122740 A	AM 122740	AM 2024 123194 A	AM 123194
AM 2024 122747 A	AM 122747	AM 2024 123195 A	AM 123195
AM 2024 122827 A	AM 122827	AM 2024 123196 A	AM 123196
AM 2024 122839 A	AM 122839	AM 2024 123197 A	AM 123197
AM 2024 122841 A	AM 122841	AM 2024 123198 A	AM 123198
AM 2024 122852 A	AM 122852	AM 2024 123199 A	AM 123199
AM 2024 122857 A	AM 122857	AM 2024 123201 A	AM 123201
AM 2024 122858 A	AM 122858	AM 2024 123212 A	AM 123212
AM 2024 122860 A	AM 122860	AM 2024 123216 A	AM 123216
AM 2024 122861 A	AM 122861	AM 2024 123305 A	AM 123305
AM 2024 122862 A	AM 122862	AM 2024 123318 A	AM 123318
AM 2024 122939 A	AM 122939	AM 2024 123319 A	AM 123319
AM 2024 122940 A	AM 122940	AM 2024 123320 A	AM 123320
AM 2024 122941 A	AM 122941	AM 2024 123323 A	AM 123323
AM 2024 122942 A	AM 122942	AM 2024 123324 A	AM 123324
AM 2024 122944 A	AM 122944	AM 2024 123333 A	AM 123333
AM 2024 122967 A	AM 122967	AM 2024 123341 A	AM 123341
AM 2024 122974 A	AM 122974	AM 2024 123344 A	AM 123344
AM 2024 122975 A	AM 122975	AM 2024 123351 A	AM 123351
AM 2024 123066 A	AM 123066	AM 2024 123353 A	AM 123353
AM 2024 123068 A	AM 123068	AM 2024 123354 A	AM 123354
AM 2024 123074 A	AM 123074	AM 2024 123355 A	AM 123355
AM 2024 123078 A	AM 123078	AM 2024 123360 A	AM 123360
AM 2024 123079 A	AM 123079	AM 2024 123409 A	AM 123409
AM 2024 123080 A	AM 123080	AM 2024 123413 A	AM 123413
AM 2024 123081 A	AM 123081	AM 2024 123414 A	AM 123414
AM 2024 123083 A	AM 123083	AM 2024 123416 A	AM 123416
AM 2024 123084 A	AM 123084	AM 2024 123418 A	AM 123418
AM 2024 123086 A	AM 123086	AM 2024 123419 A	AM 123419
AM 2024 123088 A	AM 123088	AM 2024 123478 A	AM 123478
AM 2024 123089 A	AM 123089	AM 2024 123480 A	AM 123480
AM 2024 123092 A	AM 123092	AM 2024 123481 A	AM 123481
AM 2024 123094 A	AM 123094	AM 2024 123486 A	AM 123486
AM 2024 123096 A	AM 123096	AM 2024 123488 A	AM 123488
AM 2024 123098 A	AM 123098	AM 2024 123493 A	AM 123493
AM 2024 123099 A	AM 123099	AM 2024 123498 A	AM 123498
AM 2024 123101 A	AM 123101	AM 2024 123499 A	AM 123499
AM 2024 123102 A	AM 123102	AM 2024 123503 A	AM 123503
AM 2024 123103 A	AM 123103	AM 2024 123504 A	AM 123504
		AM 2024 123511 A	AM 123511
		AM 2024 123573 A	AM 123573
		AM 2024 123574 A	AM 123574

1	2
AM 2024 123575 A	AM 123575
AM 2024 123585 A	AM 123585
AM 2024 123586 A	AM 123586
AM 2024 123587 A	AM 123587
AM 2024 123592 A	AM 123592
AM 2024 123594 A	AM 123594
AM 2024 123596 A	AM 123596
AM 2024 123597 A	AM 123597
AM 2024 123602 A	AM 123602
AM 2024 123603 A	AM 123603
AM 2024 123606 A	AM 123606
AM 2024 123610 A	AM 123610
AM 2024 123612 A	AM 123612
AM 2024 123617 A	AM 123617
AM 2024 123618 A	AM 123618
AM 2024 123620 A	AM 123620
AM 2024 123621 A	AM 123621
AM 2024 123622 A	AM 123622
AM 2024 123651 A	AM 123651

1	2
AM 2024 123653 A	AM 123653
AM 2024 123676 A	AM 123676
AM 2024 123870 A	AM 123870
AM 2024 123871 A	AM 123871
AM 2024 123881 A	AM 123881
AM 2024 123882 A	AM 123882
AM 2024 123883 A	AM 123883
AM 2024 123884 A	AM 123884
AM 2024 123904 A	AM 123904
AM 2024 123912 A	AM 123912
AM 2024 123920 A	AM 123920
AM 2024 123921 A	AM 123921
AM 2024 123922 A	AM 123922
AM 2024 123923 A	AM 123923
AM 2024 123931 A	AM 123931
AM 2024 124008 A	AM 124008
AM 2024 124067 A	AM 124067
AM 2024 124069 A	AM 124069
AM 2024 124071 A	AM 124071

CONCORDANCE TABLE OF PUBLICATION NUMBERS
AND APPLICATION NUMBERS

INDEX OF GOODS AND/OR SERVICES (511)	NUMBER OF PUBLISHED APPLICATIONS (260)
1	2
1	AM 2024 123101 A
1	AM 2024 123102 A
1	AM 2024 123103 A
1	AM 2024 123341 A
2	AM 2024 123341 A
3	AM 2024 122672 A
3	AM 2024 122975 A
3	AM 2024 123353 A
4	AM 2024 123101 A
4	AM 2024 123102 A
4	AM 2024 123103 A
4	AM 2024 124069 A
5	AM 2024 122580 A
5	AM 2024 122739 A
5	AM 2024 123318 A
5	AM 2024 123319 A
5	AM 2024 123320 A
5	AM 2024 123323 A
5	AM 2024 123324 A
5	AM 2024 123333 A
5	AM 2024 123353 A
5	AM 2024 123480 A
5	AM 2024 123870 A
5	AM 2024 123871 A
5	AM 2024 123881 A

1	2
5	AM 2024 124008 A
7	AM 2024 122672 A
7	AM 2024 122841 A
7	AM 2024 123188 A
7	AM 2024 123498 A
7	AM 2024 123620 A
7	AM 2024 123621 A
9	AM 2024 122429 A
9	AM 2024 122738 A
9	AM 2024 122841 A
9	AM 2024 122967 A
9	AM 2024 123084 A
9	AM 2024 123089 A
9	AM 2024 123188 A
9	AM 2024 123201 A
9	AM 2024 123481 A
9	AM 2024 123486 A
9	AM 2024 123511 A
9	AM 2024 123617 A
9	AM 2024 123618 A
9	AM 2024 123883 A
9	AM 2024 123912 A
10	AM 2024 122672 A
11	AM 2024 123086 A
11	AM 2024 123096 A
11	AM 2024 123188 A
12	AM 2024 122672 A
12	AM 2024 122827 A
12	AM 2024 123066 A

1	2	1	2
12	AM 2024 123180 A	32	AM 2024 123602 A
12	AM 2024 123620 A	32	AM 2024 123606 A
12	AM 2024 123621 A	33	AM 2024 122569 A
12	AM 2024 123931 A	33	AM 2024 122747 A
12	AM 2024 124067 A	33	AM 2024 122852 A
14	AM 2024 122967 A	33	AM 2024 123068 A
15	AM 2024 123912 A	33	AM 2024 123088 A
16	AM 2024 122651 A	33	AM 2024 123094 A
16	AM 2024 122738 A	33	AM 2024 123344 A
16	AM 2024 123089 A	33	AM 2024 123416 A
16	AM 2024 123409 A	33	AM 2024 123419 A
16	AM 2024 123486 A	33	AM 2024 123597 A
16	AM 2024 123511 A	33	AM 2024 123651 A
18	AM 2024 122967 A	33	AM 2024 123653 A
19	AM 2024 123341 A	34	AM 2024 122857 A
20	AM 2024 123078 A	34	AM 2024 122858 A
20	AM 2024 123079 A	34	AM 2024 122860 A
20	AM 2024 123080 A	34	AM 2024 122861 A
20	AM 2024 123884 A	34	AM 2024 122862 A
21	AM 2024 122672 A	34	AM 2024 122939 A
21	AM 2024 122967 A	34	AM 2024 122940 A
21	AM 2024 123360 A	34	AM 2024 122941 A
24	AM 2024 123884 A	34	AM 2024 122942 A
25	AM 2024 122967 A	34	AM 2024 122944 A
25	AM 2024 123083 A	34	AM 2024 123181 A
25	AM 2024 123089 A	34	AM 2024 123182 A
25	AM 2024 123092 A	34	AM 2024 123183 A
25	AM 2024 123409 A	34	AM 2024 123184 A
25	AM 2024 123493 A	34	AM 2024 123185 A
26	AM 2024 122672 A	34	AM 2024 123187 A
26	AM 2024 122967 A	34	AM 2024 123192 A
27	AM 2024 122672 A	34	AM 2024 123193 A
27	AM 2024 122967 A	34	AM 2024 123194 A
28	AM 2024 122841 A	34	AM 2024 123195 A
28	AM 2024 122967 A	34	AM 2024 123196 A
28	AM 2024 123089 A	34	AM 2024 123197 A
28	AM 2024 123409 A	34	AM 2024 123198 A
28	AM 2024 123883 A	34	AM 2024 123199 A
29	AM 2024 123409 A	34	AM 2024 123212 A
29	AM 2024 123414 A	35	AM 2024 122028 A
29	AM 2024 123612 A	35	AM 2024 122586 A
30	AM 2024 123409 A	35	AM 2024 122651 A
30	AM 2024 123414 A	35	AM 2024 122672 A
30	AM 2024 123592 A	35	AM 2024 122738 A
30	AM 2024 123676 A	35	AM 2024 122839 A
30	AM 2024 123904 A	35	AM 2024 122841 A
31	AM 2024 123353 A	35	AM 2024 122967 A
31	AM 2024 123409 A	35	AM 2024 123074 A
31	AM 2024 123585 A	35	AM 2024 123083 A
31	AM 2024 123586 A	35	AM 2024 123084 A
31	AM 2024 123587 A	35	AM 2024 123098 A
31	AM 2024 123612 A	35	AM 2024 123188 A
32	AM 2024 122740 A	35	AM 2024 123305 A
32	AM 2024 123305 A	35	AM 2024 123351 A
32	AM 2024 123409 A	35	AM 2024 123409 A
32	AM 2024 123592 A	35	AM 2024 123413 A

1	2
35	AM 2024 123418 A
35	AM 2024 123478 A
35	AM 2024 123481 A
35	AM 2024 123486 A
35	AM 2024 123499 A
35	AM 2024 123511 A
35	AM 2024 123592 A
35	AM 2024 123883 A
35	AM 2024 123922 A
35	AM 2024 123923 A
36	AM 2024 122841 A
36	AM 2024 123074 A
36	AM 2024 123099 A
36	AM 2024 123354 A
36	AM 2024 123355 A
36	AM 2024 123594 A
36	AM 2024 123921 A
37	AM 2024 123078 A
37	AM 2024 123079 A
37	AM 2024 123080 A
37	AM 2024 123216 A
37	AM 2024 123354 A
37	AM 2024 123355 A
37	AM 2024 123478 A
37	AM 2024 123511 A
37	AM 2024 123573 A
37	AM 2024 123574 A
37	AM 2024 123575 A
37	AM 2024 123594 A
38	AM 2024 122738 A
38	AM 2024 123081 A
38	AM 2024 123084 A
38	AM 2024 123486 A
38	AM 2024 123883 A
39	AM 2024 123413 A
39	AM 2024 123418 A
39	AM 2024 123503 A
39	AM 2024 123511 A
39	AM 2024 123594 A
39	AM 2024 123610 A
40	AM 2024 123488 A
41	AM 2024 122028 A
41	AM 2024 122586 A
41	AM 2024 122672 A
41	AM 2024 122738 A
41	AM 2024 122841 A
41	AM 2024 122967 A

1	2
41	AM 2024 122974 A
41	AM 2024 123078 A
41	AM 2024 123079 A
41	AM 2024 123080 A
41	AM 2024 123081 A
41	AM 2024 123084 A
41	AM 2024 123089 A
41	AM 2024 123099 A
41	AM 2024 123201 A
41	AM 2024 123409 A
41	AM 2024 123413 A
41	AM 2024 123481 A
41	AM 2024 123486 A
41	AM 2024 123617 A
41	AM 2024 123618 A
41	AM 2024 123622 A
41	AM 2024 123883 A
41	AM 2024 123920 A
42	AM 2024 122672 A
42	AM 2024 122841 A
42	AM 2024 122967 A
42	AM 2024 123078 A
42	AM 2024 123079 A
42	AM 2024 123080 A
42	AM 2024 123481 A
42	AM 2024 123486 A
42	AM 2024 123511 A
42	AM 2024 123617 A
42	AM 2024 123618 A
42	AM 2024 123883 A
43	AM 2024 122028 A
43	AM 2024 122577 A
43	AM 2024 123099 A
43	AM 2024 123105 A
43	AM 2024 123409 A
43	AM 2024 123413 A
43	AM 2024 123418 A
43	AM 2024 123504 A
43	AM 2024 123596 A
43	AM 2024 123597 A
43	AM 2024 123603 A
43	AM 2024 123882 A
43	AM 2024 123920 A
43	AM 2024 123922 A
43	AM 2024 123923 A
43	AM 2024 124071 A
44	AM 2024 123351 A

CONCORDANCE TABLE OF INDEX OF GOODS AND/OR SERVICES
AND NUMBERS OF TRADEMARKS REGISTERED ACCORDING
TO THE ACCELERATED PROCEDURE

INDEX OF GOODS AND/OR SERVICES (511)	NUMBERS OF REGISTERED ACCORDING TO THE ACCELERATED PROCEDURE (111)
1	M 2024 37802 R
5	M 2024 37800 R
5	M 2024 37802 R
8	M 2024 37842 R
9	M 2024 37839 R
25	M 2024 37799 R
25	M 2024 37834 R
25	M 2024 37838 R
28	M 2024 37839 R
29	M 2024 37799 R
29	M 2024 37837 R
30	M 2024 37835 R
33	M 2024 37840 R
34	M 2024 37798 R
35	M 2024 37839 R
36	M 2024 37839 R
37	M 2024 37843 R
37	M 2024 37844 R
39	M 2024 37843 R
39	M 2024 37844 R
41	M 2024 37839 R
43	M 2024 37799 R
43	M 2024 37801 R
43	M 2024 37803 R
43	M 2024 37836 R
43	M 2024 37837 R
43	M 2024 37841 R

OFFICIAL BULLETIN OF THE INDUSTRIAL PROPERTY

INVENTIONS
UTILITY MODELS
DESIGNS
TRADEMARKS

3(630)

EDITOR-IN-CHIEF: N. Bebrishvili

EDITOR-TRANSLATOR: E. Gabunia

PROOFREADER: A. Shikhashvili

COMPUTER LAYOUT: M. Ordenidze
K. Svanidze

ISSN 2720-8486

info@sakpatenti.gov.ge
www.sakpatenti.gov.ge

**LIST OF CODES, IN ALPHABETIC SEQUENCE, AND THE CORRESPONDING (SHORT) NAMES OF STATES, OTHER ENTITIES AND INTERGOVERNMENTAL ORGANIZATIONS
(WIPO STANDARD ST.3)**

AD	Andorra				
AE	United Arab Emirates	GD	Grenada	NE	Niger
AF	Afghanistan	GG	Guernsey	NG	Nigeria
AG	Antigua and Barbuda	GH	Ghana	NI	Nicaragua
AI	Anguilla	GI	Gibraltar	NL	Netherlands
AL	Albania	GT	Guatemala	NO	Norway
AM	Armenia	GW	Guinea- Bissau	NP	Nepal
AN	Netherlands Antilles	GY	Guyana	NR	Nauru
AO	Angola	HK	The Hong Kong Special Administrative Region of the People's Republic of China	NZ	New Zealand
AP	African Regional Intellectual Property Organization (ARIPO)	HN	Honduras	OA	African Intellectual Property Organization (OAPI)
AR	Argentina	HR	Croatia	OM	Oman
AT	Austria	HT	Haiti	PA	Panama
AU	Australia	HU	Hungary	PE	Peru
AW	Aruba	IB	International Bureau of the World Intellectual Property Organization (WIPO)	PG	Papua New Guinea
AZ	Azerbaijan	ID	Indonesia	PH	Philippines
BA	Bosnia and Herzegovina	IE	Ireland	PK	Pakistan
BB	Barbados	IL	Israel	PL	Poland
BD	Bangladesh	IM	Isle of Man	PT	Portugal
BE	Belgium	IN	India	PW	Palau
BF	Burkina Faso	IQ	Iraq	PY	Paraguay
BG	Bulgaria	IR	Iran (Islamic Republic of)	QA	Qatar
BH	Bahrain	IS	Iceland	QZ	Community Plant Variety Office (European Community) (CPVO)
BI	Burundi	IT	Italy	RO	Romania
BJ	Benin	JE	Jersey	RS	Serbia
BM	Bermuda	JM	Jamaica	RU	Russian Federation
BN	Brunei Darussalam	JO	Jordan	RW	Rwanda
BO	Bolivia	JP	Japan	SA	Saudi Arabia
BR	Brazil	KE	Kenya	SB	Solomon Islands
BS	Bahamas	KG	Kyrgyzstan	SC	Seychelles
BT	Bhutan	KH	Cambodia	SD	Sudan
BV	Bouvet Island	KI	Kiribati	SG	Singapore
BW	Botswana	KM	Saint Kitts and Nevis	SH	Saint Helena
BX	Benelux Office for Intellectual Property (BOIP)	KP	Democratic People's Republic of Korea	SI	Slovenia
BY	Belarus	KR	Republic of Korea	SK	Slovakia
BZ	Belize	KW	Kuwait	SL	Sierra Leone
CA	Canada	KY	Cayman Islands	SM	San Marino
CD	Democratic Republic of the Congo	KZ	Kazakhstan	SN	Senegal
CF	Central African Republic	LA	Lao People's Democratic Republic	SO	Somalia
CG	Congo	LB	Lebanon	SR	Suriname
CH	Switzerland	LC	Saint Lucia	ST	Sao Tome and Principe
CI	Cote d'Ivoire	LI	Liechtenstein	SV	El Salvador
CK	Cook Islands	LK	Sri Lanka	SY	Syrian Arab Republic
CL	Chile	LR	Liberia	SZ	Swaziland
CM	Cameroon	LS	Lesotho	TC	Turks and Caicos Islands
CN	China	LT	Lithuania	TD	Chad
CO	Colombia	LU	Luxembourg	TG	Togo
CR	Costa Rica	LV	Latvia	TH	Thailand
CU	Cuba	LY	Libyan Arab Jamahiriya	TJ	Tajikistan
CV	Cape Verde	MA	Morocco	TL	Timor-Leste
CY	Cyprus	MC	Monaco	TM	Turkmenistan
CZ	Czech Republic	MD	Republic of Moldova	TN	Tunisia
DE	Germany	ME	Montenegro	TO	Tonga
DJ	Djibouti	MG	Madagascar	TR	Turkey
DM	Dominica	MK	The former Yugoslav Republic of Macedonia	SE	Sweden
DO	Dominican Republic	ML	Mali	TT	Trinidad and Tobago
DZ	Algeria	MM	Myanmar	TV	Tuvalu
EA	Eurasian Patent Organization (EAPO)	MN	Mongolia	TW	Taiwan, Province of China
EC	Ecuador	MO	Macao	TZ	United Republic of Tanzania
EE	Estonia	MP	Northern Mariana Islands	UA	Ukraine
EG	Egypt	MR	Mauritania	UG	Uganda
EH	Western Sahara	MS	Montserrat	US	United States of America
EM	Office for Harmonization in the Internal Market (Trademarks and Designs)(OHIM)	MT	Malta	UY	Uruguay
EP	European Patent Office (EPO)	MU	Mauritius	UZ	Uzbekistan
ER	Eritrea	MV	Maldives	VA	Holy See
ES	Spain	MW	Malawi	VC	Saint Vincent and the Grenadines
ET	Ethiopia	MX	Mexico	VE	Venezuela
FI	Finland	MY	Malaysia	VG	Virgin Islands (British)
FJ	Fiji	MZ	Mozambique	VN	Viet Nam
FK	Falkland Islands (Malvinas)	NA	Namibia	VU	Vanuatu
FO	Faroe Islands			WO	World Intellectual Property Organization (WIPO)
FR	France			WS	Samoa
GA	Gabon			XN	Nordic Patent Institute (NPI)
GB	United Kingdom			YE	Yemen
GC	Patent Office of the Cooperation Council for the Arab States of the Gulf (GCC)			ZA	South Africa
				ZM	Zambia
				ZW	Zimbabwe