



# Official Bulletin of the Industrial Property

Inventions

Utility Models

Designs

Trademarks



საქართველოს ინტელექტუალური  
საკუთრების ეროვნული ცენტრი  
**საქპატენტი**  
**SAKPATENTI**  
NATIONAL INTELLECTUAL PROPERTY  
CENTER OF GEORGIA  
[www.sakpatenti.gov.ge](http://www.sakpatenti.gov.ge)

Date of Publication – 2023 02 27

**4(607)**

# INID CODES FOR IDENTIFICATION OF BIBLIOGRAPHIC DATA

## INVENTIONS, UTILITY MODELS

- (10) Number of publication for application, which has been examined
- (11) Number of patent and kind of document
- (21) Serial number of application
- (22) Date of filing of the application
- (23) Date of exhibition or the date of the earlier filing and the number of application, if any
- (24) Date from which patent may have effect
- (31) Number of priority application
- (32) Date of filing of priority application
- (33) Code of the country or regional organization allotting priority application number
- (44) Date of publication of application not granted, but examined and number of bulletin
- (45) Date of publication of registered document
- (51) International Patent Classification Index

- (54) Title of the invention
- (57) Abstract
- (60) Number of examined patent document granted by foreign patent office, date from which patent has effect and country code
- (62) Number of the earlier application and in case of divided application, date of filing an application
- (71) Name, surname and address of applicant (country code)
- (72) Name, surname of inventor (country code)
- (73) Name, surname and address of patent owner (country code)
- (74) Name, surname of representative or patent attorney
- (85) Date of commencement of the national phase of International Application
- (86) Number and date of filing of international application
- (87) Number and date of publication of international application
- (94) Calculated date of expiry of the SPC or the duration of the SPC

## DESIGNS

- (10) Number of publication for application
- (11) Number of patent and kind of document or number of registration
- (15) Date of registration/Date of patent renewal
- (18) Expected expiration date of patent or registration
- (21) Serial number of application
- (22) Date of filing of the application
- (23) Date of exhibition or the date of the earlier filing and the number of application, if any
- (24) Date from which patent may have effect
- (28) Number of designs included in the application
- (30) Data relating to priority (number of application, date of filing of application, two-letter code identifying the authority with whom the priority application was made)
- (31) Number of priority application
- (32) Date of filing of priority application
- (33) Code of the country or regional organization allotting priority application number
- (34) Two-letter code according to WIPO St.3 identifying the authority with which the priority application was made
- (44) Date of publication of design and number of bulletin (the first publication)
- (45) Date of publication of design registered by WIPO and number of bulletin

- (51) International Classification for designs (class and subclass of the Locarno Classification)
- (54) Title of the invention
- (55) Reproduction of the design
- (57) Description of characteristic features of the design including indication of colors
- (58) Date of recording of any kind of amendment in the Register
- (62) Number of the earlier application, registration and document number and if available the date of filing an application in case of divided application
- (71) Name, surname and address of applicant (country code)
- (72) Name, surname of creator (country code)
- (73) Name, surname and address of patent owner (country code)
- (74) Name, surname of representative or patent attorney
- (81) Contracting states concerned  
II designated contracting states according to the 1960 Act  
III designated contracting states according to the 1999 Act
- (85) Owner's permanent address
- (86) Owner's nationality
- (87) Owner's residence
- (88) State in which the owner has a real and effective industrial or commercial establishment

## TRADEMARKS

- (111) - Number of registration
- (151) - Date of registration
- (156) - Date of the renewal
- (181) - Expected expiration date of registration
- (186) - Renewal expiration date of registration
- (141) - Date of cancel of duration of the mark
- (210) - Serial number of application
- (220) - Date of filing of the application
- (230) - Data concerning exhibition
- (260) - Number of application, for which favorable decision of examination about registration has been taken (publication number)
- (310) - Number of the first application
- (320) - Date of filing of the first application
- (330) - Code, identifying national or regional Office where the first application was made
- (511) - International Classification of Goods and Services for the purposes of registration of trade marks and/or list of goods and/or services classified according thereto
- (526) - Disclaimer
- (531) - Description of figurative elements of Trade Marks according to the International Classification of the Figurative Elements of Marks

- (540) - Reproduction of Trade Mark
- (550) - Nature and kind of Trade Mark
- (551) - Indication to the effect that the mark is a collective mark, a certification mark or a guarantee mark
- (554) - Three-dimensional mark
- (580) - Date of recording of any kind changes in respect of applications or registrations
- (591) - Information concerning colors claimed
- (731) - Name and address of the applicant
- (732) - Name and address of the holder of the registration
- (740) - Name and address of the representative
- (750) - Addreses for correspondence
- (770) - Name and address of the previous applicant or holder in case of change in ownership
- (771) - Previous name and address of the applicant or holder in case of change in ownership
- (791) - Name and address of the licensee
- (793) - Indication of conditions and/or restrictions under the license (Type of license, number of license agreement, data of license, data of validity of license)
- (800) - Certain data relating to the international registration of Trade Marks under the Protocol Relating to Madrid Agreement (International registration number)
- (852) - Partial cancellation of the list of goods and services
- (891) - Date of subsequent designation

## CODES FOR PUBLICATION IN BULLETIN

- (21) AP 0000 000000 - serial number of application for invention
- (10) AP 0000 0000 A - number of published application for invention (first publication)
- (11) P 0000 0000 B - number of patent for invention (second publication)
- (21) API 0000 000000 - number of application for imported patent
- (11) PI 0000 0000 A - number of imported patent (first publication)
- (21) AU 0000 000000 - serial number of application for utility model
- (10) AU 0000 000 U - number of published application for utility model (first publication)
- (11) U 0000 000 Y - number of patent for utility model (second publication)
- (21) AD 0000 000000 - serial number of application for design
- (10) AD 0000 000 S - number of published application for design (first publication)
- (11) D 0000 000 S - registered design

## INTERNATIONAL PATENT CLASSIFICATION FOR INVENTIONS AND UTILITY MODELS

- SECTION A - HUMAN NECESSITIES
- SECTION B - PERFORMING OPERATIONS; TRANSPORTING
- SECTION C - CHEMISTRY; METALLURGY
- SECTION D - TEXTILES; PAPER
- SECTION E - FIXED CONSTRUCTIONS
- SECTION F - MECHANICAL ENGINEERING; LIGHTING; HEATING; WEAPONS; BLASTING
- SECTION G - PHYSICS
- SECTION H - ELECTRICITY

- 
- M - Trade Mark
  - (210) AM 0000 000000 - Serial number of application;
  - (260) AAM 0000 00000 A - Publication number of application;
  - (111) M 0000 00000 R - Number of registration;
  - (111) MMM0000 00000 Rn - Number of renewals, in which n=1,2,3;
  - (111) M 0000 00000 R(P) - Number of registration under partial assignment of rights
-

# Official Bulletin of the Industrial Property

Inventions

Utility Models

Designs

Trademarks

# CONTENT

<b>PUBLISHED TITLES OF PROTECTION</b> .....	3
<b>INVENTIONS</b>	
▪ APPLICATIONS APPROVED FOR GRANTING PATENT .....	4
▪ PATENTED INVENTION .....	7
<b>UTILITY MODELS</b>	
▪ APPLICATION APPROVED FOR GRANTING PATENT .....	8
▪ PATENTED UTILITY MODEL .....	9
<b>DESIGNS</b>	
▪ APPLICATIONS APPROVED FOR REGISTRATION .....	10
▪ DESIGNS REGISTERED ACCORDING TO THE ACCELERATED PROCEDURE .....	12
▪ DESIGNS, WHICH HAVE BEEN REGISTERED WITH THE INTERNATIONAL BUREAU CLAIMING PRIORITY ON THE TERRITORY OF GEORGIA .....	18
<b>TRADEMARKS</b>	
▪ APPLICATIONS FILED UNDER THE NATIONAL PROCEDURE APPROVED FOR REGISTRATION .....	28
▪ REGISTERED TRADEMARKS .....	36
▪ TRADEMARKS REGISTERED ACCORDING TO THE ACCELERATED PROCEDURE .....	46
▪ INTERNATIONAL TRADEMARKS FOR WHICH A DECISION ON GRANTING PROTECTION IS TAKEN .....	52
▪ PUBLICATION BASED ON COURT DECISION .....	174
▪ INTERNATIONAL TRADEMARKS PROTECTED IN GEORGIA .....	175
<b>OFFICIAL NOTIFICATIONS</b>	
<b>INVENTIONS</b>	
▪ RESTORATION OF PATENTS .....	182
▪ ABOLITION OF PATENTS WITH THE RIGHT TO RESTORE .....	182
▪ DATE OF PATENTS RESTORATION EXPIRATION .....	183
▪ TRANSFER OF RIGHTS .....	185
<b>UTILITY MODELS</b>	
▪ RESTORATION OF PATENTS .....	186
▪ ABOLITION OF PATENTS WITH THE RIGHT TO RESTORE .....	186
<b>DESIGNS</b>	
▪ CANCELLATION OF DESIGN REGISTRATION .....	187
▪ CANCELLATION OF INTERNATIONAL DESIGNS REGISTRATION .....	187
<b>TRADEMARKS</b>	
▪ EXTENSION OF TERMS OF TRADEMARKS REGISTRATION .....	189
▪ COMPLETE TRANSFER OF RIGHTS .....	193
▪ CHANGES OF NAMES AND/OR ADDRESSES OF TRADEMARKS OWNERS .....	197
▪ CANCELLATION OF TRADEMARKS REGISTRATION .....	199
<b>CLASSIFICATION INDEXES</b>	
INVENTIONS .....	202
UTILITY MODELS .....	203
DESIGNS .....	204
TRADEMARKS .....	206

## **PUBLISHED TITLES OF PROTECTION**

### **INVENTIONS**

- **APPLICATIONS APPROVED FOR GRANTING PATENT:**  
15703; 15906; 15785; 15666; 15484; 15740
- **PATENTED INVENTION:**  
7475

### **UTILITY MODELS**

- **APPLICATION APPROVED FOR GRANTING PATENT:**  
15530
- **PATENTED UTILITY MODEL:**  
2145

### **DESIGNS**

- **APPLICATIONS APPROVED FOR REGISTRATION:**  
1276, 1277
- **DESIGNS REGISTERED ACCORDING TO THE ACCELERATED PROCEDURE:**  
960-964
- **DESIGNS, WHICH HAVE BEEN REGISTERED WITH THE INTERNATIONAL BUREAU CLAIMING PRIORITY ON THE TERRITORY OF GEORGIA:**  
225224; 225263; 225320; 225484; 225527; 220631

### **TRADEMARKS**

- **APPLICATIONS FILED UNDER THE NATIONAL PROCEDURE APPROVED FOR REGISTRATION:**  
106041, 106042; 116619\*; 117531; 117908; 118168; 118302; 118304; 118312; 118314; 118369-118374; 118378; 118396; 118407; 118549; 118558; 118643; 118648; 118729-118731; 118736; 118738-118752; 118757; 118762; 118767; 118830; 118842; 118844; 118860-118862
- **REGISTERED TRADEMARKS:**  
36390-36392; 36395-36399; 26418-36459; 36463-36525
- **TRADEMARKS REGISTERED ACCORDING TO THE ACCELERATED PROCEDURE:**  
36389; 36393, 36394; 36400-36417; 36460-36462; 36526-36533
- **INTERNATIONAL TRADEMARKS FOR WHICH A DECISION ON GRANTING PROTECTIONS IS TAKEN:**  
112854\*; 114635\*; 115581\*; 116605; 117203; 117676, 117677; 117702-117706; 117709; 117799, 117800; 117848, 117849; 117851-117853; 117857-117863; 117868; 117884; 117899; 117933-117935; 117937-117940; 117942-117955; 117961; 117963-117965; 117971-117973; 118025-118034; 118045-118055; 118057-118059; 118085-118099; 118110-118116; 118118-118129; 118176; 118187; 118196-118202; 118204-118206; 118211; 118213-118217; 118275-118277; 118327-118335; 118346; 118417-118419; 118421; 118426-118434
- **PUBLICATION BASED ON COURT DECISION:**  
94954
- **INTERNATIONAL TRADEMARKS PROTECTED IN GEORGIA:**  
116136; 116141; 116187; 116263-116266; 116269-116274; 116276; 116278-116280; 116283; 116286-116288; 116290-116296; 116298-116301; 116337-116343; 116347; 116351; 116357-116363; 116365-116387; 116441-116444; 116461; 116463-116465; 116467; 116473; 116475, 116476; 116478, 116479; 116575; 116577; 116583-116585; 116587-116590; 116592; 116606; 117119; 117121-117127; 117136

# INVENTIONS

## APPLICATIONS APPROVED FOR GRANTING PATENT

The decision can be appealed at the Chamber of Appeal of Sakpatenti within 3 months from the publication or at the Mtskheta District Court Administrative Cases Board (Address: №17, Samkhedro St., Mtskheta), within 1 month following the publication.

### PART A

#### A 61

- (10) AP 2023 15703 A (51) Int. Cl. (2006)  
A 61 K 31/5025  
A 61 P 35/00  
C 07 D 487/04  
C 07 D 471/04  
C 07 D 471/20
- (21) AP 2019 15703 (22) 2019 12 27  
(31) 62/785,519  
(32) 2018 12 27  
(33) US
- (71) Les Laboratoires Servier (FR)  
50 rue Carnot, 92284 Suresnes Cedex,  
France (FR)
- (72) KONTEATIS, Zenon, D. (US);  
LI, Mingzong (US);  
REZNIK, Samuel, K. (US);  
SUI, Zhihua (US)
- (74) Shalva Gvaramadze  
(85) 2021 07 23  
(86) PCT/US2019/068652, 2019 12 27
- (54) AZA-HETEROBICYCLIC INHIBITORS OF  
MAT2A AND METHODS OF USE FOR  
TREATING CANCER
- (57) Compound of formula I,

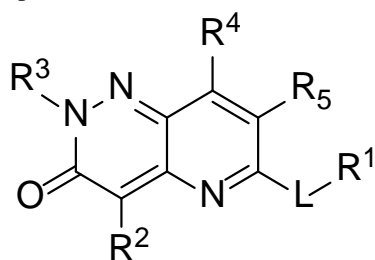

(I)

that are inhibitors of methionine adenosyltransferase isoform 2A (MAT2A), pharmaceutical compositions on the basis thereof, and usage thereof for cancer treatment.

Claims: 3 independents  
31 dependents

### PART B

#### B 21

- (10) AP 2023 15906 A (51) Int. Cl. (2006)  
B 21 B 17/02  
B 21 B 17/00
- (21) AP 2022 15906 (22) 2022 03 14
- (71) LEPL "Rafiel Dvali Institute of Machine  
Mechanics" (GE)  
Mindeli Str. 10, 0168, Tbilisi, Georgia (GE)
- (72) Tamaz Natriashvili (GE);  
Slava Mebonia (GE);  
Jemal Melkadze (GE);  
Revaz Kavtaradze (GE)
- (54) LONGITUDINAL PIPE ROLLING STRUT
- (57) A strut includes working cell 1 having calibrated rolls 2 and rollers 3, wherein casing 5 and friction 6 rollers are installed on strut front table 4 for parison delivery into the rolls, and receiving groove 7. Stationary support 8 with parison is attached onto front table 4 back torso clamp 9 installed thereon. Long-stroke pneumocylinder 10 on a stick 11 whereof the arbor 12 is fixed, is connected to the support 8. Strut back table includes a roller 13 for rolling pipe withdrawal from working cell.
- Claims: 1 independents  
Fig.: 1

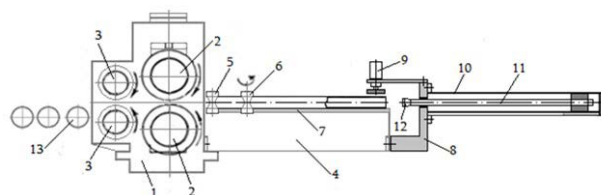

Fig. 1

#### B 61

- (10) AP 2023 15785 A (51) Int. Cl. (2006)  
B 61 H 7/08
- (21) AP 2021 15785 (22) 2021 11 05
- (71) Giorgi Tumanishvili (GE)  
Didi Dighomi, III mcr., bldg. 4, ap. 65, 0131,  
Tbilisi, Georgia (GE);  
Tengiz Nadiradze (GE)  
Bakhtrioni Str. 28, ap. 33, 0194, Tbilisi,  
Georgia (GE);

Giorgi Tumanishvili Junior (GE)  
Didi Dighomi, III mcr., bldg. 4, ap. 65, 0131,  
Tbilisi, Georgia (GE)

(72) Giorgi Tumanishvili (GE);  
Tengiz Nadiradze (GE);

Giorgi Tumanishvili Junior (GE)

(54) RAILWAY CREW WITH ELECTROMAGNETIC POWDER BRAKE

(57) Railway crew includes frictional (block, disk or magnetic-rail) brakes and pair wheels 1 having a frame; at that, universal hinge 3 one fork end 4 is rigidly connected to each of pair wheels 1 axis 2, and another fork end 5 is connected to electromagnetic powder brake 6 rotor by means of forward kinematic pair 7. At that, powder brake 6 is statically fixed onto a ring 8, the fingers 9 whereof are connected to the brackets 11 fastened rotatable to pair wheels frame 10.

Claims: 1 independents

Fig.: 1

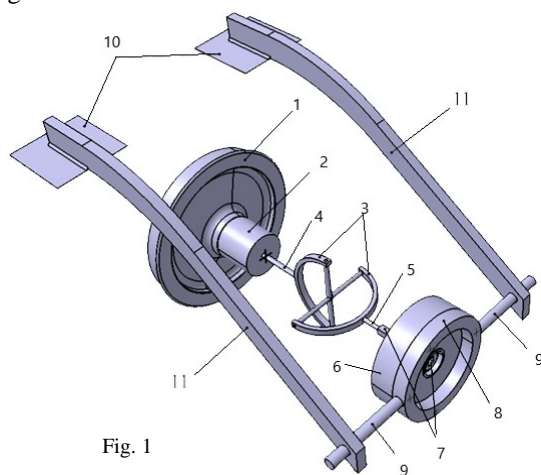

Fig. 1

## PART C

### C 22

(10) AP 2023 15666 A (51) Int. Cl. (2006)  
C 22 B 15/00  
C 22 B 3/00  
C 22 B 3/08  
C 22 B 47/00

(21) AP 2019 15666 (22) 2019 12 10

(31) 18215028.4

(32) 2018 12 21

(33) EP

(71) Umicore (BE)  
Rue du Marais 31, B-1000 Brussels,  
Belgium (BE)

(72) DANIELS, Michel (BE);  
SCOYER, Jean (BE);  
BALTES, Michael (BE);

NEVEN, Margot (BE);

LEYSSSEN, Jan (BE)

(74) Tamaz Shilakadze

(85) 2021 06 21

(86) PCT/EP2019/084306, 2019 12 10

(54) PROCESS FOR RECOVERY OF METALS FROM POLYMETALLIC NODULES

(57) Present disclosure concerns a process for the recovery of valuable metals. Two-stage process using SO<sub>2</sub> in an acidic aqueous media is disclosed. In a first step, performed in mildly acidic conditions, Mn, Ni, and Co are dissolved; in second, more acidic step, Cu is dissolved. Under these conditions, the leachate of first step contains most of the Mn, Ni, and Co, while being nearly Cu-free. The Ni and Co are precipitated as sulfides; the Mn can be recovered as sulfate by crystallization. Cu leached in the second step, is selectively precipitated, also as sulfide.

Claims: 1 independents

7 dependents

Table: 4

## PART E

### E 02

(10) AP 2023 15484 A (51) Int. Cl. (2006)  
E 02 B 9/00  
F 03 B 13/00

(21) AP 2020 15484 (22) 2020 11 03

(71) Savle Chkhitunidze (GE)

K. Timiryazev Str. 20, Sokhumi, Georgia (GE)

(72) Savle Chkhitunidze (GE)

(54) HESS ON WELL

(57) A hess on well includes two wells 1 and 2, disposed in parallel relative to each other, and connected by means of tunnel, a tank 3, vertical pipe 4 inserted into the well 1. The turbines 8 are placed into said pipe and switched to a generator 14 with a shaft 9. At that, the hess is equipped with exhausting pipe 5, as well, having diameter equal of vertical pipe diameter, and including vertical and inclined areas. Another exhausting pipe is inserted in another well, it has vertical area, and is connected to first well pipe by means of tunnel with lower end thereof; air valve 7 is disposed above exhausting pipe vertical area, lower of vertical pipe upper end, and another end thereof is located on soil surface providing connection thereto river bed; furthermore, connection place of exhausting pipe to the river is located lower than two wells connecting tunnel bottom indicator, and it is directed towards river stream, wherein a valve 6 is installed on the pipe providing water suction to provide control of water amount.

Claims: 1 independents

Fig.: 1

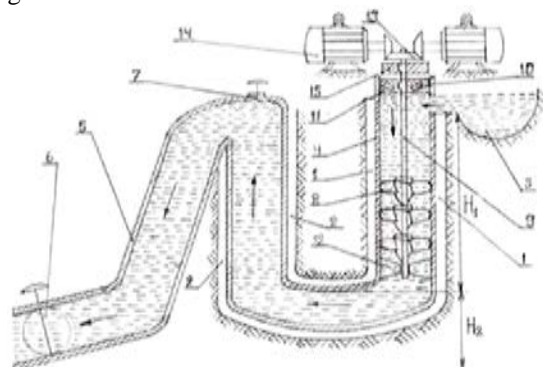

Fig. 1

## PART G

### G 01

(10) AP 2023 15740 A (51) Int. Cl. (2006)

G 01 N 21/00

(21) AP 2021 15740 (22) 2021 09 23

(71) LEPL "Shota Rustaveli National Science

Foundation of Georgia" (GE)

M. Aleksidze Str. 2, Lane II, 0193, Tbilisi,

Georgia (GE);

Aleksandre Rcheulishvili (GE)

Nutsubidze Plateau, II mcr., III qu., bldg. 3, ap.

21, 0183, Tbilisi, Georgia (GE);

LEPL "Ivane Javakhishvili Tbilisi State

University" (GE)

Ilia Chavchavadze Ave. 1, 0179, Tbilisi,

Georgia (GE)

(72) Aleksandre Rcheulishvili (GE)

(54) METHOD AND DEVICE TO CONTROL

ATOMIZATION QUALITY

(57) A method to control analytical sample atomization quality provides spraying of said sample, mixing therewith fuel and oxidizing gases, and receiving a fire and free atoms of determined componentry from obtained mixture. The method is distinguished with this that the fire is additionally supplied with gas or aerosol, and provided fair content and temperature control by vary of expended said gas or aerosol amount. There is represented a device for said method implementation, as well.

Claims: 2 independents

Fig.: 1





---

# UTILITY MODELS

## APPLICATION APPROVED FOR GRANTING PATENT

The decision can be appealed at the Chamber of Appeal of Sakpatenti within 3 months from the publication or at the Mtskheta District Court Administrative Cases Board (Address: №17, Samkhedro St., Mtskheta), within 1 month following the publication.

### PART G

#### G 02

(10) AU 2023 15530 U (51) Int. Cl. (2006)

G 02 B 23/16

(21) AU 2020 15530 (22) 2020 12 30

(71) Teimuraz Ghazhonia (GE)

Nutsubidze Plateau, III mcr., I qu., bldg. 10,  
ap. 3, 0183, Tbilisi, Georgia (GE)

(72) Teimuraz Ghazhonia (GE)

(54) OPTICAL TELESCOPE EQUATORIAL  
STAND

(57) Optical telescope equatorial stand includes a pillar 1 having supporting bracket 2 with supporting axis 3 inserted rotatable therein, and installed hingedly on supporting axis the rocker, a telescope 8 is installed rotatable and movable on one lever thereof, and fixable balance weight 9 – on another lever. The rocker is installed on supporting axis spherical hinge 4 equipped with clutch. A gasket made of low friction coefficient and high wear resistance materials is installed into spherical hinge. Another telescope installation is provided onto rocker another lever, as well.

Claims: 1 independent

3 dependents

Fig. 2

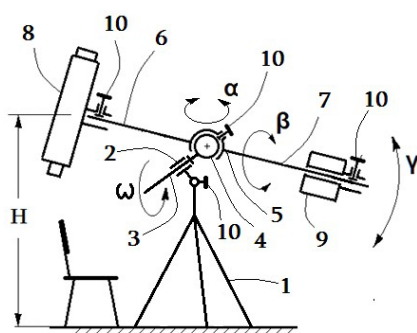

Fig. 1

---

**PATENTED UTILITY MODEL****PART H****H 01**

- (11) U 2023 2145 Y (51) Int. Cl. (2006)  
H 01 L 35/00  
H 01 L 35/24
- (10) AU 2022 15626 U (44) 21(600)/2022
- (21) AU 2021 15626
- (22) 2021 05 05
- (24) 2021 05 05
- (73) Vakhtangi Zhghamadze (GE)  
Varketili 3, I mcr, bld. 3, ap. 108, 0163, Tbilisi,  
Georgia (GE);  
Iamze Kvartskhava (GE)  
Demetre Tavadebuli St. 7, ap. 27, 4400, Poti,  
Georgia (GE);  
Nikoloz Margiani (GE)  
Vazha-Pshavela Ave., IV qu., bld. 4, ap. 27,  
0186, Tbilisi, Georgia (GE);  
Giorgi Mumladze (GE)  
Politkovskaya St. 47, ap. 91, 0186, Tbilisi,  
Georgia (GE);  
Levani Gabisonia (GE)  
Semerjiev St., IV Lane 4, 0000, Sokhumi,  
Georgia (GE)
- (72) Vakhtangi Zhghamadze (GE);  
Iamze Kvartskhava (GE);  
Nikoloz Margiani (GE);  
Giorgi Mumladze (GE);  
Levani Gabisonia (GE)
- (54) THERMOELECTRIC COMPOSITE WITH  
ENHANCED POWER FACTOR
-

---

# DESIGNS

## APPLICATIONS APPROVED FOR REGISTRATION

The decision can be appealed at the Chamber of Appeal of Sakpatenti within 3 months from the publication or at the Mtskheta District Court Administrative Cases Board (Address: №17, Samkhedro str., Mtskheta), within 1 month following the publication.

(10) AD 2023 1276 S (51) 09-01

(21) AD 2022 1276 (22) 2022 10 04

(28) 1

(71) Tovarischestvo S Ogranichennoy Otvetstvennostu "Asia Su Company" (KZ)

Ak Malinskaya Oblast, 020006, Kokshetau, Promyshlennaya Zona Severnaya, Proezd 11, bldg. 54/1,  
Kazakhstan (KZ)

(72) KOSPANOV, Erbolat Dulatovich (KZ)

(74) Liliana Darakhvelidze (GE)

(54) BOTTLE

(55)



- (10) AD 2023 1277 S (51) 09-01  
(21) AD 2022 1277 (22) 2022 10 04  
(28) 1  
(71) Tovarischestvo S Ogranichennoy Otvetstvennostu "Asia Su Company" (KZ)  
Ak Malinskaya Oblast, 020006, Kokshetau, Promyshlennaya Zona Severnaya, Proezd 11, bldg. 54/1,  
Kazakhstan (KZ)  
(72) KOSPANOV, Erbolat Dulatovich (KZ)  
(74) Liliana Darakhvelidze (GE)  
(54) BOTTLE  
(55)



## DESIGNS REGISTERED ACCORDING TO THE ACCELERATED PROCEDURE

The decision can be appealed at the Chamber of Appeal of Sakpatenti within 3 months from the publication.

- (11) D 2023 960 S
- (21) AD 2023 1292
- (24) 2023 01 26
- (28) 5
- (18) 2028 01 26
- (73) LTD "Legi" (GE)  
Vill. Khutsubani, 6200, Kobuleti, Georgia (GE)
- (72) Leonid Ezik (UA)
- (54) 1.-5. CONCRETE DECORATIVE PLATE
- (55)



(11) D 2023 961 S (51) 25-01  
(21) AD 2023 1293 (22) 2023 01 27  
(24) 2023 01 27  
(28) 3  
(18) 2028 01 27  
(73) LTD "Legi" (GE)  
Vill. Khutsubani, 6200, Kobuleti, Georgia (GE)

(72) Leonid Ezik (UA)  
(54) 1.-2. CONCRETE DECORATIVE PLATE; 3. CONCRETE DECORATIVE PLATES  
(55)

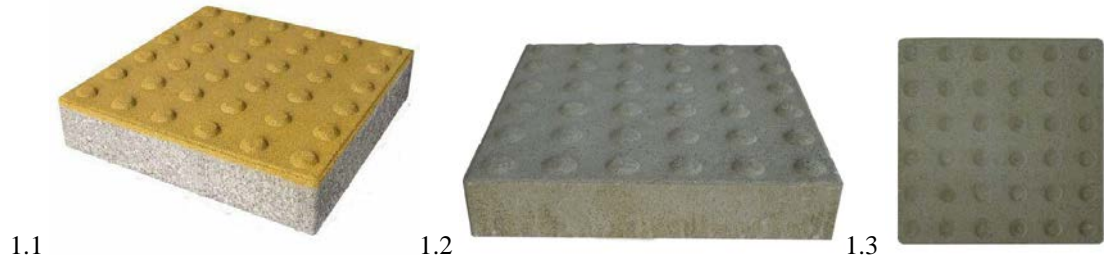

(11) D 2023 962 S  
(21) AD 2023 1294  
(24) 2023 01 27  
(28) 4  
(18) 2028 01 27  
(73) LTD "Legi" (GE)

(51) 25-01  
(22) 2023 01 27

Vill. Khutsubani, 6200, Kobuleti, Georgia (GE)

(72) Leonid Ezik (UA)

(54) 1.-3. CONCRETE DECORATIVE PLATE; 4. CONCRETE DECORATIVE PLATES

(55)

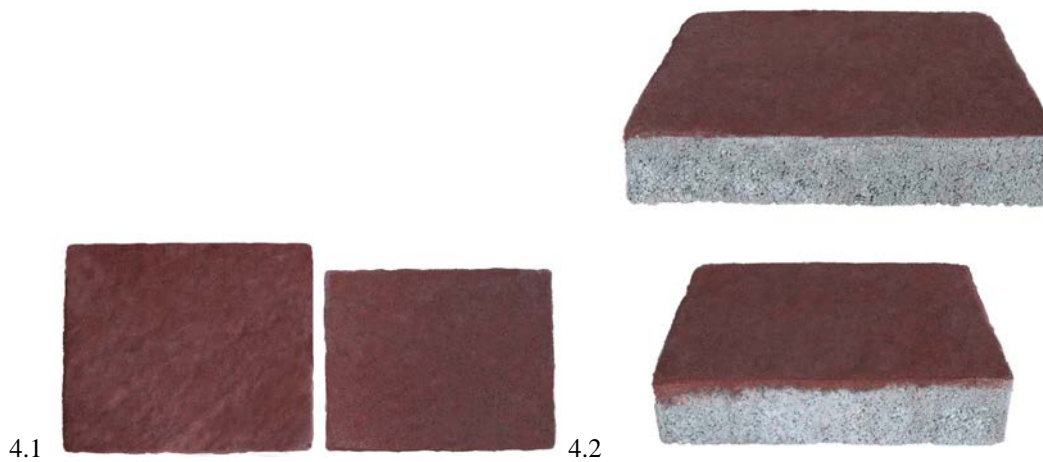
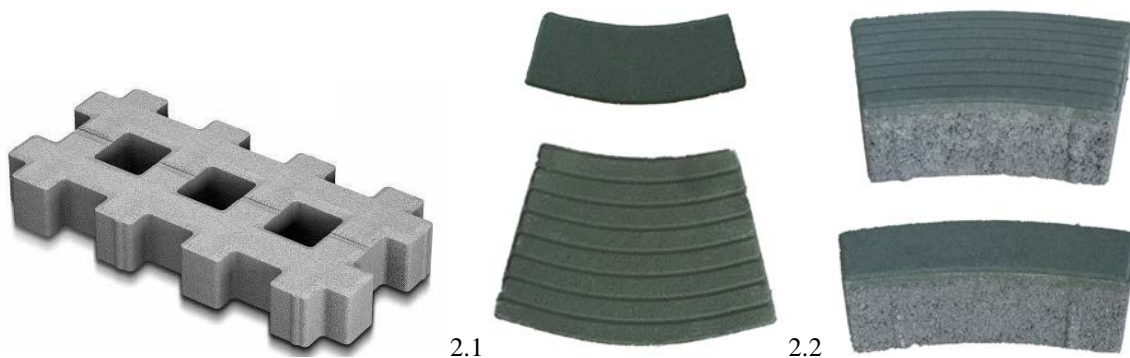
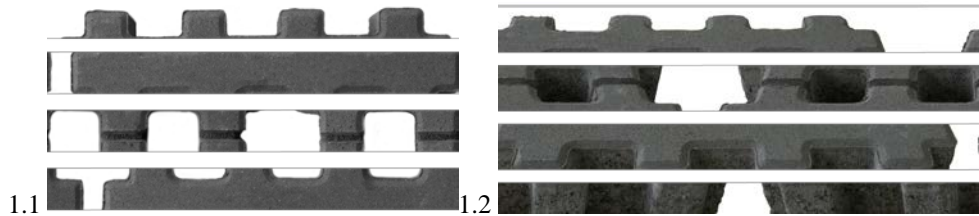



- (11) D 2023 963 S
- (21) AD 2023 1295
- (24) 2023 02 03
- (28) 1
- (18) 2028 02 03
- (73) LTD "Legi" (GE)  
Vill. Khutsubani, 6200, Kobuleti, Georgia (GE)
- (72) Leonid Ezik (UA)
- (54) CONCRETE DECORATIVE PLATES
- (55)



1.1

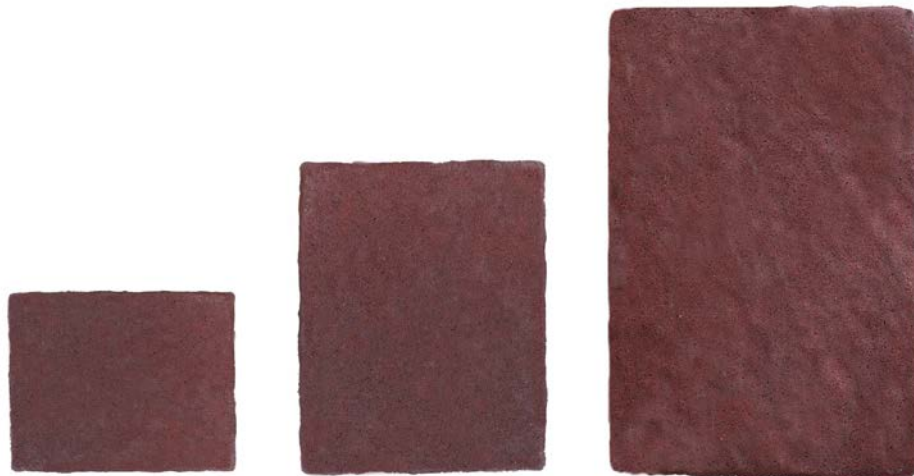

1.2

- (11) D 2023 964 S
- (21) AD 2023 1296
- (24) 2023 02 06
- (28) 2
- (18) 2028 02 06
- (73) LTD "Legi" (GE)  
Vill. Khutsubani, 6200, Kobuleti, Georgia (GE)
- (72) Leonid Ezik (UA)
- (54) 1. CONCRETE DECORATIVE PLATES; 2. CONCRETE KERB FOR PARK
- (55)



1.1



1.2



2.1



2.2



2.3

---

**DESIGNS, WHICH HAVE BEEN REGISTERED WITH THE INTERNATIONAL BUREAU CLAIMING PRIORITY ON THE TERRITORY OF GEORGIA**

The decision can be appealed at the Chamber of Appeal of Sakpatenti within 3 months from the publication or at the Mtskheta District Court Administrative Cases Board (Address: №17, Samkhedro St., Mtskheta), within 1 month following the publication.

- (11) DM/225 224 (51) 02-04  
(15) 2022 11 21 (44) 50/2022 (2022 12 16)  
(22) 2022 11 21  
(28) 2  
(73) Valentino S.p.A.  
Via Turati 16/18, I-20121 Milano (EM)  
(85) –  
(86) EM, IT  
(87) EM, IT  
(88) EM, IT  
(89) EM  
(81) III. AZ, EM, GB, GE, JP, KG, KR, RU, TJ, TR, UA  
(72) Pierpaolo PICCIOLI  
C/o VALENTINO S.p.A., Via Turati, 16/18, I-20121, Milano (IT)  
(74) Jacobacci & Partners S.p.A. / Salvatore Giovanni Pennacchio  
Via Senato, 8, I-20121 Milano (IT)  
(46) 2022 12 16  
(54) 1.-2. SHOE  
(55)

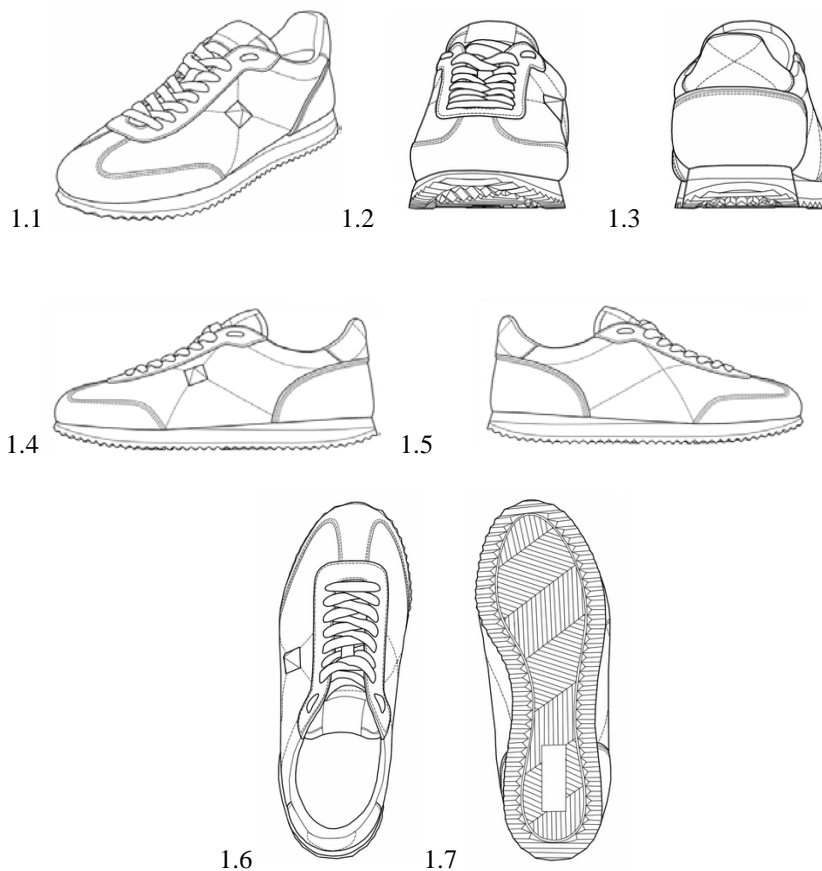

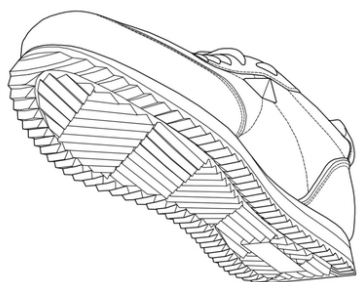

1.8



2.1

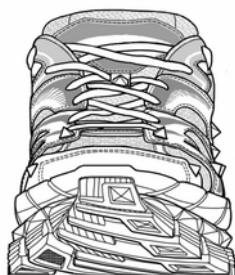

2.2

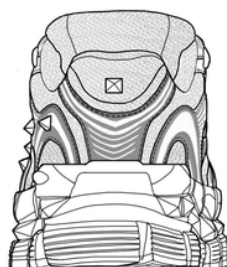

2.3



2.4



2.5



2.6

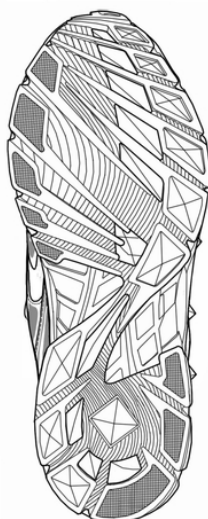

2.7

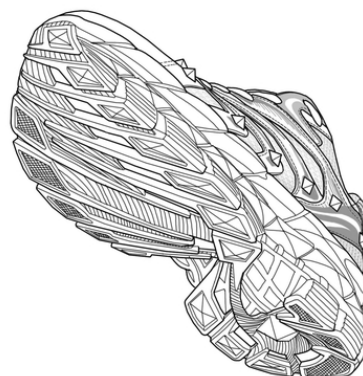

2.8

- (11) DM/225 263 (51) 07-02  
(15) 2022 12 02 (44) 50/2022 (2022 12 16)  
(22) 2022 12 02  
(28) 1  
(73) Silverline Endüstri Ve Ticaret Anonim Şirketi  
Organize Sanayi B. Ankara Asfaltı Üzeri Y/ Merzifon Amasya (TR)  
(85) TR  
(86) TR  
(87) TR  
(88) TR  
(89) TR  
(81) III. AZ, EM, GE, TM  
(72) Engin Akbaba  
Orta Mahalle, Topkapı Maltepe Caddesi, Silkar Plaza, No:6, Kat:3, İstanbul (TR);  
Yusuf Özbakış  
Organize Sanayi Bölgesi Ankara Asfaltı Üzeri Merzifon, Amasya (TR);  
Sakin Şimşek  
Orta Mahalle, Topkapı Maltepe Caddesi, Silkar Plaza, No:6, Kat:3, İstanbul (TR)  
(74) Ankara Patent Bureau  
Mustafa Kemal Mahallesi Dumlupınar Bulvarı Eskişehir Yolu 9.km No:274/7 B Blok 14. Kat No:161  
Çankaya Ankara (TR)  
(46) 2022 12 16  
(54) I. STEAM ASSISTED CHAMBER FOR COOKER AND OVEN  
(55)

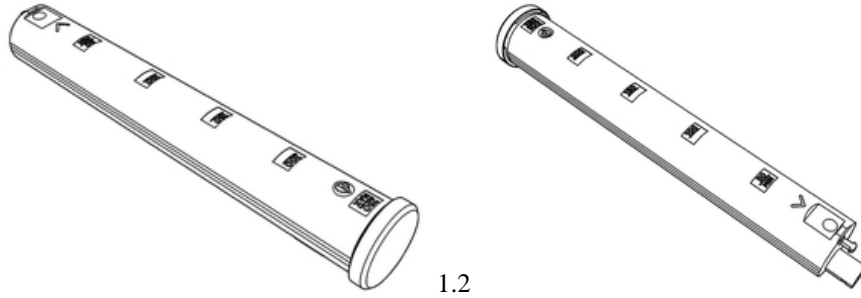

- (11) DM/225 320 (51) 28-03  
 (15) 2022 09 28 (44) 50/2022 (2022 12 16)  
 (22) 2022 09 28  
 (28) 2  
 (30) No1: 08.04.2022; 008931182-0001; EM; No2: 08.04.2022; 008931182-0002; EM  
 (73) Fenix Group Societa' A Responsabilita' Limitata  
 Via V. Agostinone, 9, 65015 Montesilvano (PE) (IT)  
 (85) –  
 (86) IT  
 (87) –  
 (88) EM  
 (89) EM  
 (81) III. AL, AM, AZ, BA, BY, CA, CH, CN, GB, GE, IL, IS, KG, MC, MD, ME, MK, MX, NO, RS, RU, SM,  
 TJ, TM, TR, UA, US  
 (72) Gianluca Cavalletti  
 Via V. Agostinone, 9, 65015, MONTESILVANO (PE) (IT)  
 (74) Praxi Intellectual Property S.P.A  
 Via G. Carducci, 6, 62012 Civitanova Marche (MC) (IT)  
 (46) 2022 12 16  
 (54) 1. COSMETIC APPARATUS FOR MASSAGING, ANTI-CELLULITE AND ANTI-WRINKLE  
 TREATMENT, 2. PORTION OF APPARATUS FOR MASSAGING, ANTI-CELLULITE AND  
 ANTI-WRINKLE TREATMENT  
 (55)

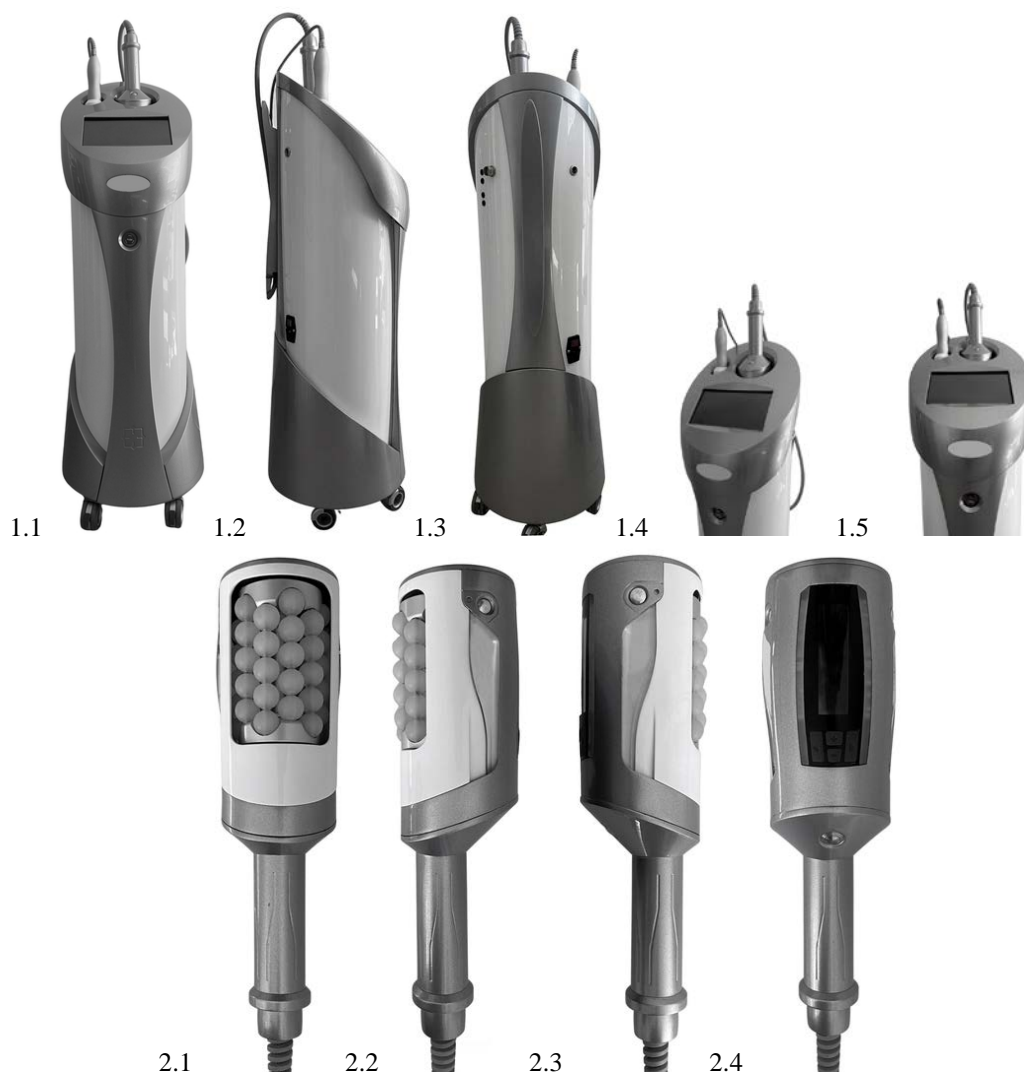

(11) DM/225 484

(51) 03-01

(15) 2022 12 05

(44) 51/2022 (2022 12 23)

(22) 2022 12 05

(28) 1

(73) Chanel SARL

Quai Du Général-Guisan 24, 1204 Genève (CH)

(85) CH

(86) CH

(87) CH

(88) CH

(89) CH

(81) II. GR III. BG, DK, EG, FI, GE, JP, MA, MX, NO, OA, PL, RU, TN, TR, UA

(72) Marianna Nitsch

135 Avenue Charles De Gaulle, 92521, Neuilly Sur Seine (FR)

(46) 2022 12 23

(54) 1. HANDBAG STRAP

(55)

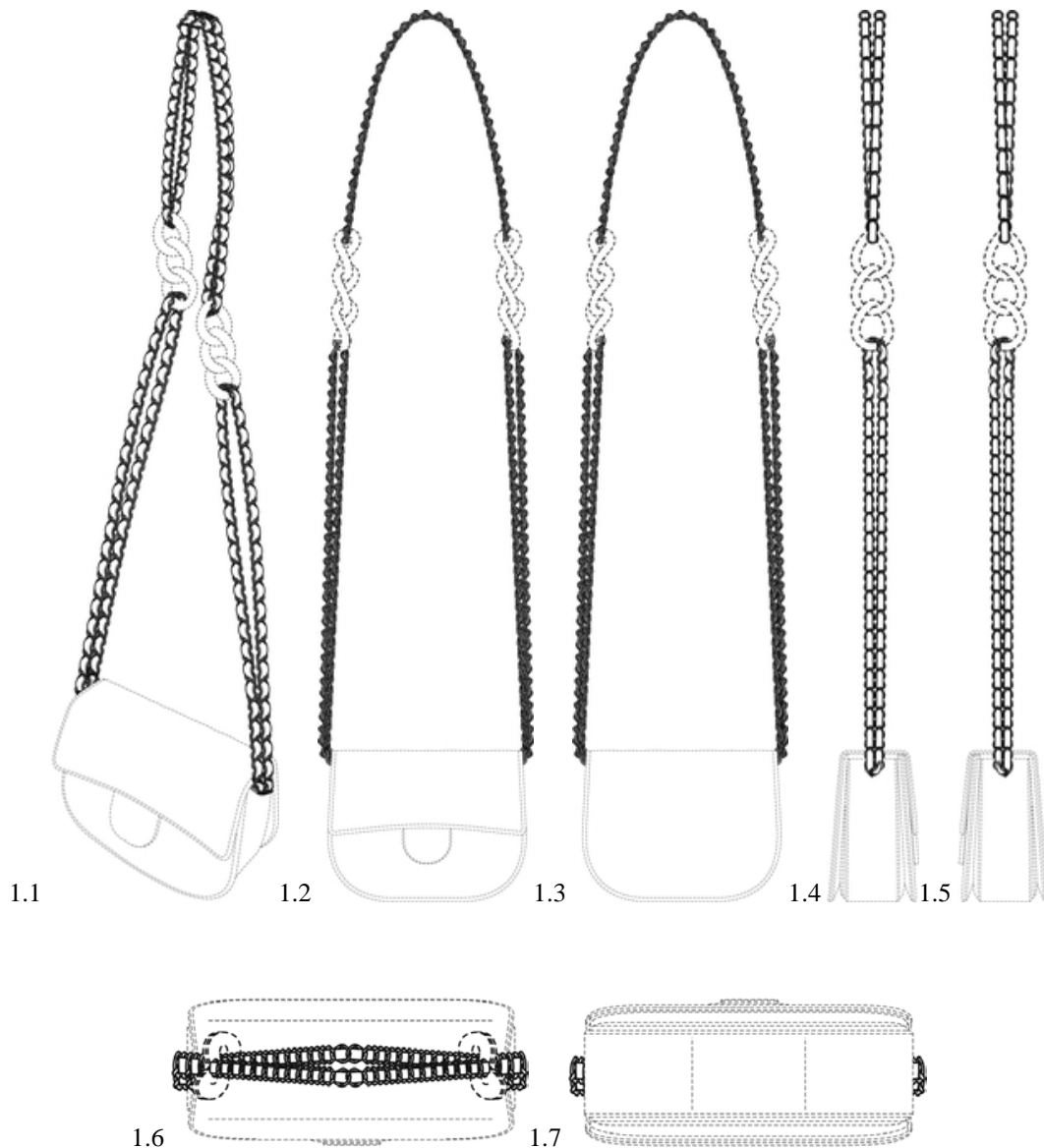



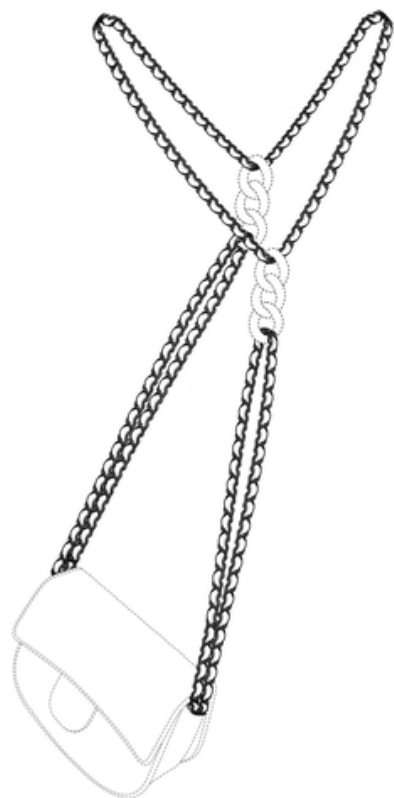

1.8

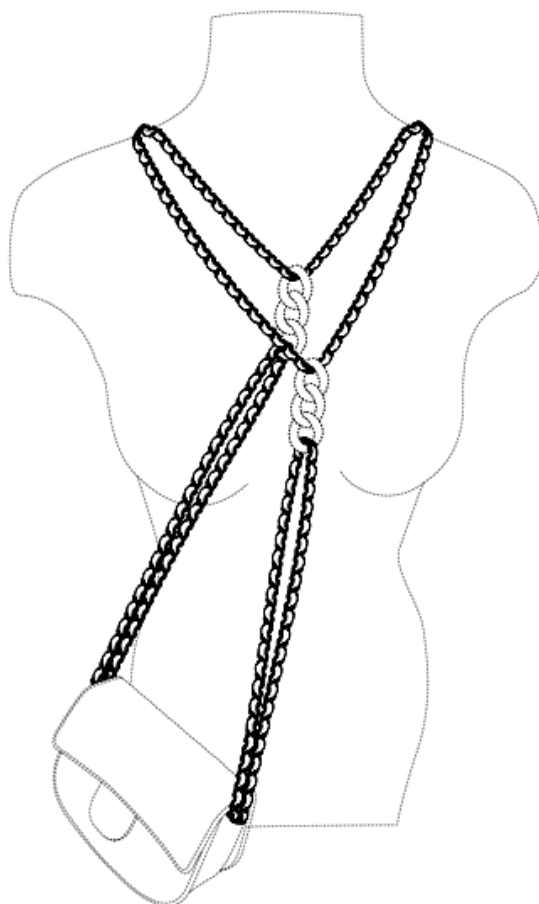

1.9

(11) DM/225 527

(51) 03-01

(15) 2022 12 05

(44) 51/2022 (2022 12 23)

(22) 2022 12 05

(28) 1

(73) Chanel SARL

Quai Du Général-Guisan 24, 1204 Genève (CH)

(85) CH

(86) CH

(87) CH

(88) CH

(89) CH

(81) II. GR III. BG, DK, EG, FI, GE, JP, MA, MX, NO, OA, PL, RU, TN, TR, UA

(72) Marianna Nitsch

35 Avenue Charles De Gaulle, 92521, Neuilly Sur Seine (FR)

(46) 2022 12 23

(54) 1. HANDBAG STRAP

(55)

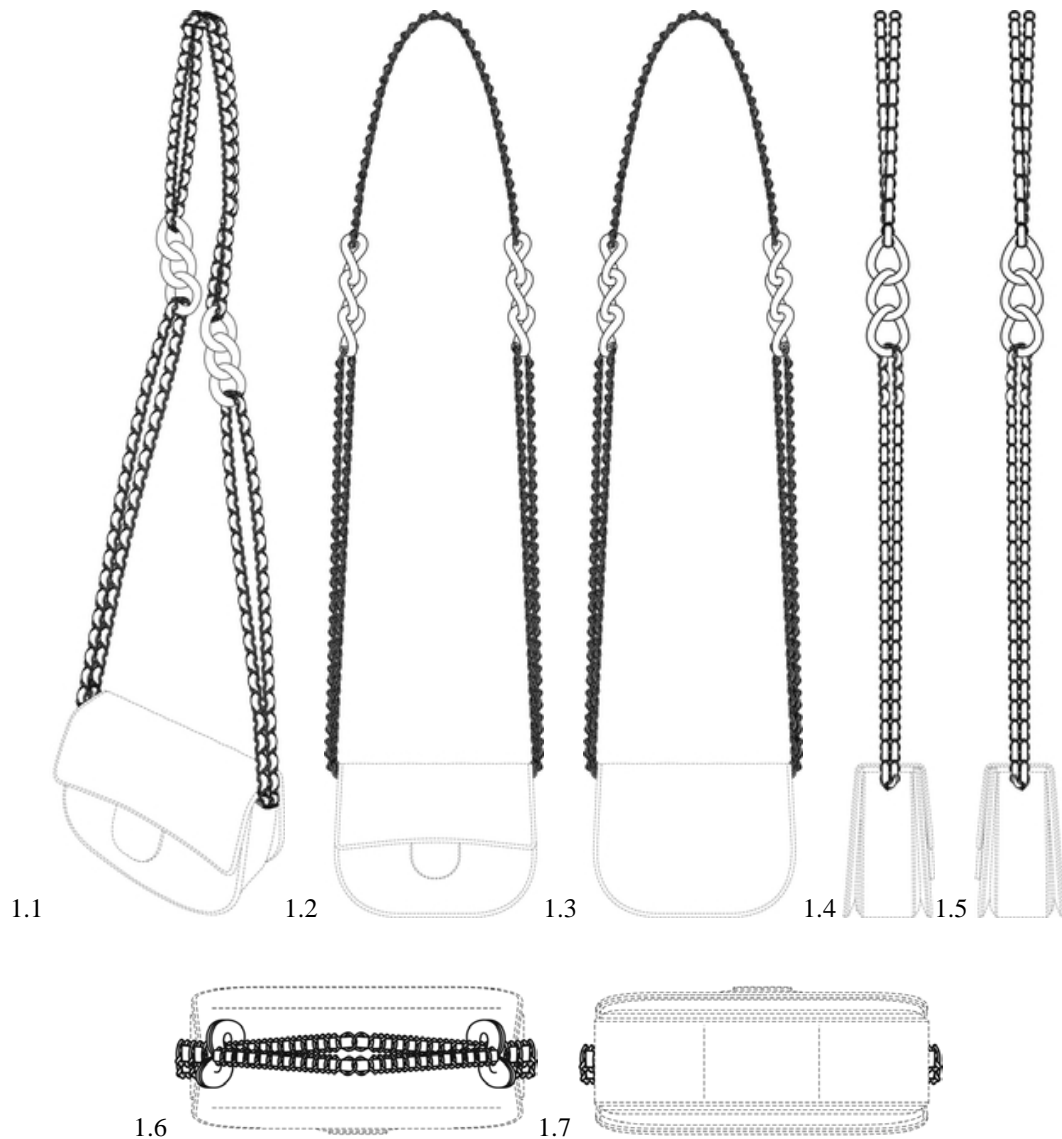



1.8

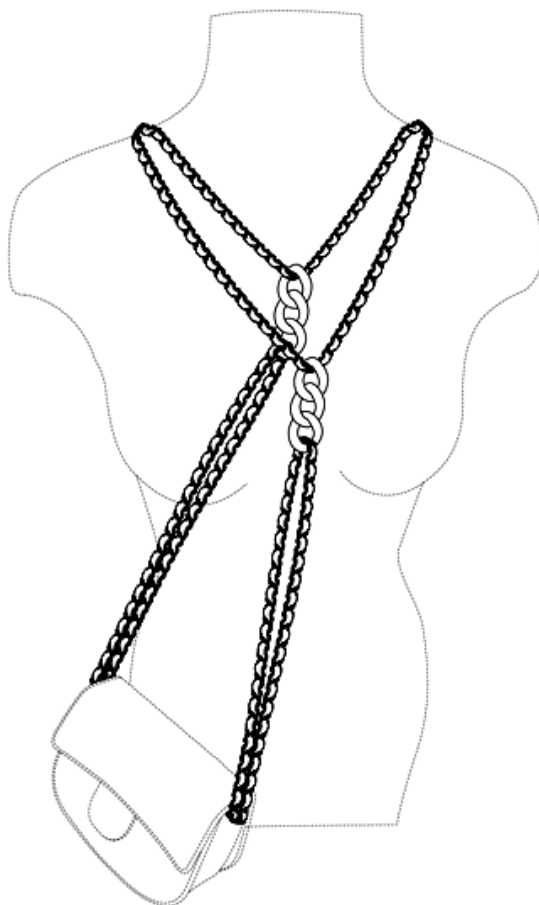

1.9

- (11) DM/220 631                   (51) 10-02
- (15) 2022 04 01                   (44) 01/2023 (2023 01 06)
- (22) 2022 04 01
- (28) 2
- (73) BLANCPAIN SA  
Le Rocher 12, 1348 LE BRASSUS (CH)
- (85) –
- (86) CH
- (87) CH
- (88) –
- (89) CH
- (81) II. MA III. AL, AM, AZ, BA, BZ, CH, EM, GB, GE, KG, LI, MC, MD, ME, MK, MN, NO, OM, SG, TN, TR, UA
- (72) Maximilian Borner  
c/o Blancpain SA (Blancpain Ltd) (Blancpain AG), Le Rocher 12, 1348 , Le Brassus (CH);  
Marc Hayek  
c/o Blancpain SA (Blancpain Ltd) (Blancpain AG), Le Rocher 12, 1348, Le Brassus (CH)
- (74) The Swatch Group SA (The Swatch Group AG) (The Swatch Group Ltd.)  
Faubourg du Lac 6, 2501 Biel/Bienne (CH)
- (46) 2023 01 06
- (54) 1. WATCH CASE, 2. WRIST WATCH
- (55)

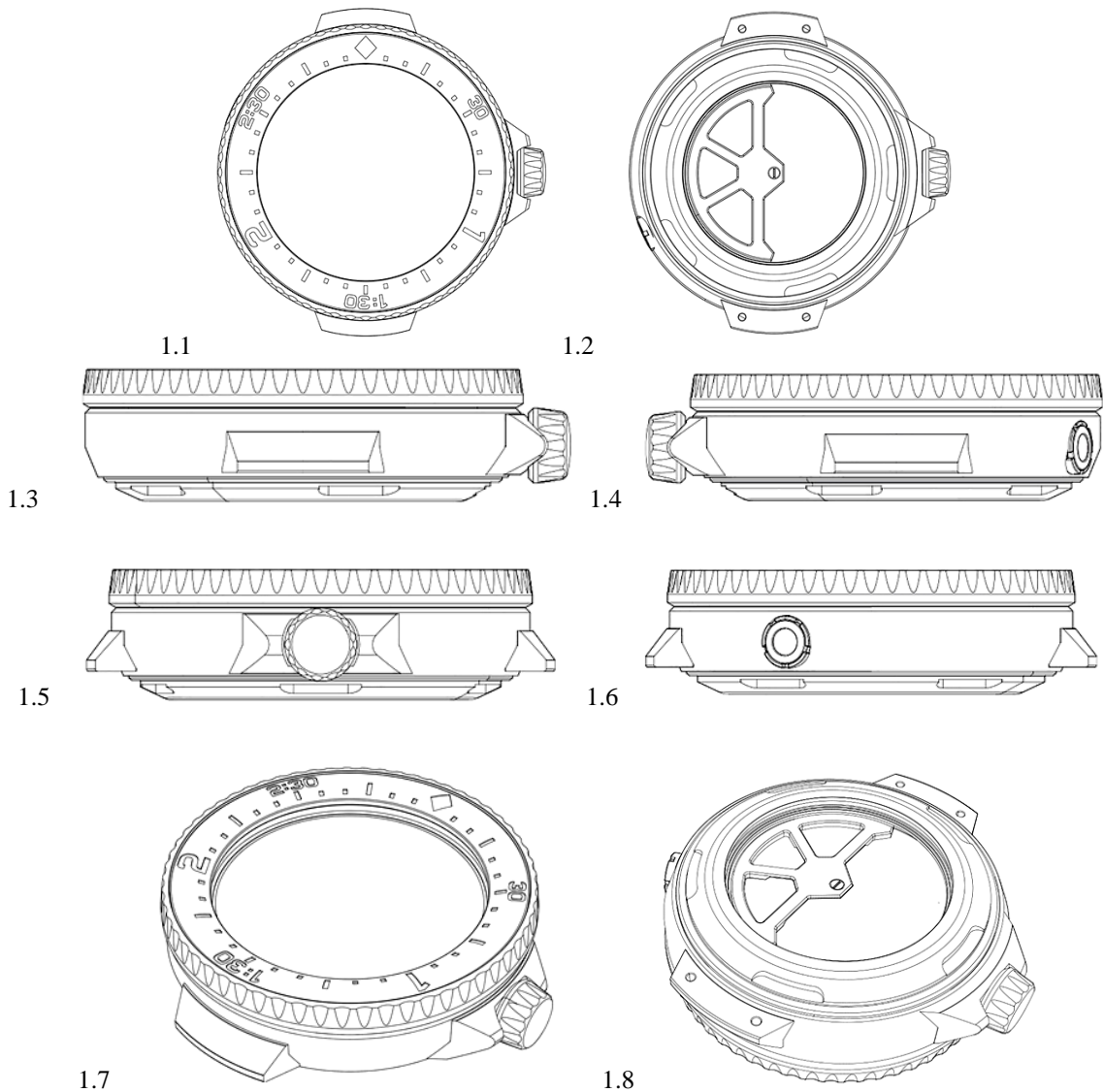



2.1



2.2

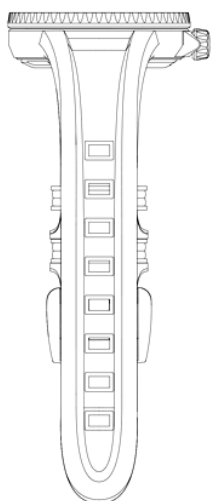

2.3

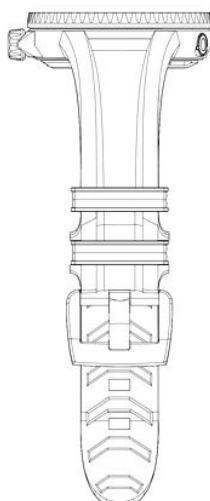

2.4

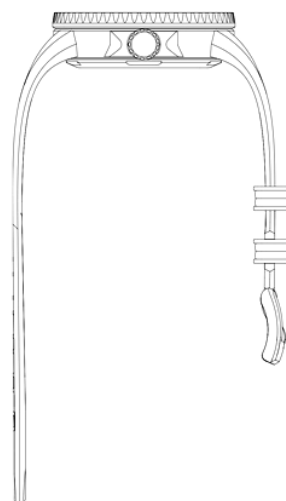

2.5

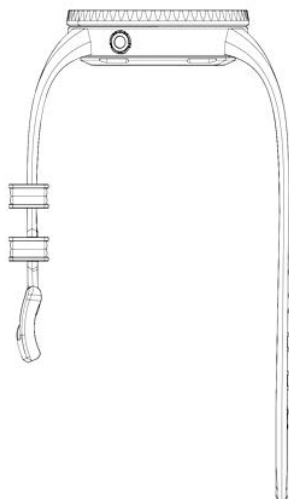

2.6

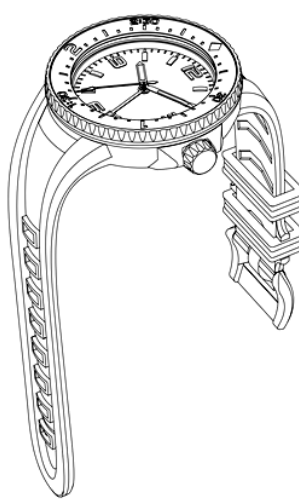

2.7

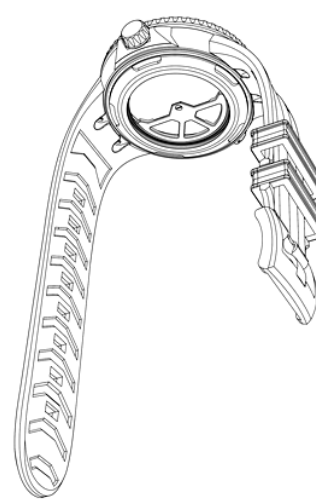

2.8

---

# TRADEMARKS

## APPLICATIONS FILED UNDER THE NATIONAL PROCEDURE APPROVED FOR REGISTRATION

The decision can be appealed at the Chamber of Appeal of Sakpatenti within 3 months from the publication or at the Mtskheta District Court Administrative Cases Board (Address: №17, Samkhedro St., Mtskheta), within 1 month following the publication.

(260) AM 2023 106041 A  
(210) AM 106041  
(220) 2019 12 06  
(731) GSH Trademarks Limited  
Afroditis, 25, 2nd floor, flat/office 204, Nicosia,  
Cyprus  
(740) Giorgi Taktakishvili  
(540)

**ШУСТОВ**

(591) Black-white  
(511) 33

(540)



(591) 000000 black, DE7C45 terracotta  
(531) 03.07.16; 27.05.01; 27.05.10; 29.01.12  
(526) ARTANA  
(511) 33

---

(260) AM 2023 106042 A  
(210) AM 106042  
(220) 2019 12 06  
(731) GSH Trademarks Limited  
Afroditis, 25, 2nd floor, flat/office 204, Nicosia,  
Cyprus  
(740) Giorgi Taktakishvili  
(540)

**SHUSTOFF**

(591) Black-white  
(511) 33

---

(260) AM 2023 117908 A  
(210) AM 117908  
(220) 2022 05 21  
(731) Vyeronika Gamiyeva  
Metrologichna Str. 113, ap. 42, Kyiv, Ukraine  
(740) Ivane Goglidze  
(540)

**VITARGIN®**

(591) 338B67 green  
(531) 26.01.18; 27.05.01; 29.01.03  
(511) 5

---

(260) AM 2023 116619 A\*  
(210) AM 116619  
(220) 2022 02 11  
(731) SOS-Kinderdorf  
Stafflerstraße 10a, 6020 Innsbruck, Austria  
(740) Tamaz Shilakadze  
(540)

**SOS ბავშვთა სოფელი**

(591) Black-white  
(511) 43

---

(260) AM 2023 118168 A  
(210) AM 118168  
(220) 2022 06 16  
(731)  
LTD "Georgian Wine House"  
Vill. Zegaani, 1500, Gurjaani, Georgia  
(740) Sopio Vacheishvili  
(540)

**ახალი საქართველო  
New Georgia  
Новая Грузия**

(591) Black-white  
(526) საქართველო Georgia Грузия  
(511) 33

---

(260) AM 2023 117531 A  
(210) AM 117531  
(220) 2022 04 18  
(731) Ekaterina Shahin  
Guram Panjikidze Str. 22, Block A, ap. 87,  
0160, Tbilisi, Georgia

(260) AM 2023 118302 A  
 (210) AM 118302  
 (220) 2022 06 28  
 (731) LTD "Agronomi"  
 B. Kvernadze Str. 35, II Entrance, fl. 3, 0171,  
 Tbilisi, Georgia  
 (540)



(591) Dark green, green, grey  
 (531) 05.03.15; 27.05.01; 29.01.13  
 (511)  
 1 – ტორფი.

1 Stephen Street, London W1T 1AL, United  
 Kingdom  
 (740) Tamaz Shilakadze  
 (540)



(591) Golden, light lilac, dark lilac, light blue,  
 dark blue  
 (531) 04.05.21; 25.12.03; 28.19; 29.01.13  
 (511) 9, 41

(260) AM 2023 118304 A  
 (210) AM 118304  
 (220) 2022 06 29  
 (731) Off-White LLC  
 360 Hamilton Ave., N100 White Plains,  
 New York, 10601, USA  
 (740) Nugzar Ksovreli  
 (540)



(591) Black-white  
 (531) 02.01.01; 02.01.16; 26.13.01  
 (511) 3, 4, 18, 20, 21, 25

(260) AM 2023 118369 A  
 (210) AM 118369  
 (220) 2022 07 01  
 (731) Nicoventures Holdings Limited  
 Globe House 1 Water Street, London, WC2R  
 3LA, United Kingdom  
 (740) Tamar Kochlamazashvili  
 (540)



(591) Red, dark red, light red  
 (531) 26.15.05; 26.15.25; 29.01.01  
 (511) 34

(260) AM 2023 118312 A  
 (210) AM 118312  
 (220) 2022 06 30  
 (731) The Procter & Gamble Company  
 One Procter & Gamble Plaza, Cincinnati,  
 Ohio 45202, USA  
 (540)



(591) Green, white, yellow  
 (531) 05.05.04; 05.05.20; 27.05.01; 27.05.13;  
 27.05.19; 29.01.13  
 (511) 5

(260) AM 2023 118370 A  
 (210) AM 118370  
 (220) 2022 07 01  
 (731) Nicoventures Holdings Limited  
 Globe House 1 Water Street, London, WC2R  
 3LA, United Kingdom  
 (740) Tamar Kochlamazashvili  
 (540)



(591) Yellow, dark yellow

(260) AM 2023 118314 A  
 (210) AM 118314  
 (220) 2022 06 30  
 (731) FremantleMedia Limited

(531) 26.15.09; 29.01.02  
(511) 34

---

(260) AM 2023 118371 A  
(210) AM 118371  
(220) 2022 07 01  
(731) Nicoventures Holdings Limited  
Globe House 1 Water Street, London, WC2R  
3LA, United Kingdom  
(740) Tamar Kochlamazashvili  
(540)

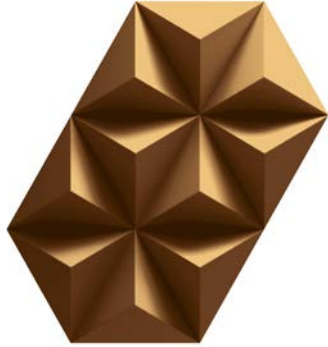

(591) Brown, dark brown, light brown, golden, light golden, dark golden  
(531) 26.15.05; 26.15.25; 29.01.02  
(511) 34

---

(260) AM 2023 118372 A  
(210) AM 118372  
(220) 2022 07 01  
(731) Nicoventures Holdings Limited  
Globe House 1 Water Street, London, WC2R  
3LA, United Kingdom  
(740) Tamar Kochlamazashvili  
(540)



(591) Green, dark green, light green  
(531) 05.05.20; 26.07.25; 26.15.05; 29.01.03  
(511) 34

---

(260) AM 2023 118373 A  
(210) AM 118373  
(220) 2022 07 01  
(731) Nicoventures Holdings Limited

Globe House 1 Water Street, London, WC2R  
3LA, United Kingdom  
(740) Tamar Kochlamazashvili  
(540)

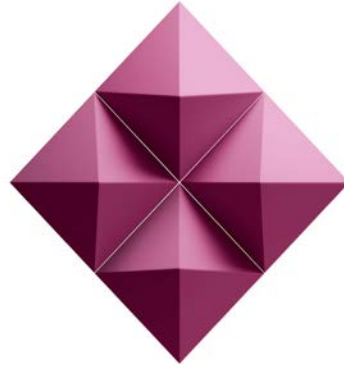

(591) Purple, light purple, dark purple, white  
(531) 26.15.07; 26.15.25; 29.01.05  
(511) 34

---

(260) AM 2023 118374 A  
(210) AM 118374  
(220) 2022 07 01  
(731) Nicoventures Holdings Limited  
Globe House 1 Water Street, London, WC2R  
3LA, United Kingdom  
(740) Tamar Kochlamazashvili  
(540)



(591) Red, light red, dark red  
(531) 26.02.05; 26.15.25; 29.01.01  
(511) 34

---

(260) AM 2023 118378 A  
(210) AM 118378  
(220) 2022 07 01  
(731) LTD "Impexpharm"  
Giorgi Saakadze Str., II Exit 17, 0160, Tbilisi,  
Georgia  
(740) Nugzar Ksovreli  
(540)

**Xylaspry**

(511) 5

---



(260) AM 2023 118396 A  
 (210) AM 118396  
 (220) 2022 07 06  
 (731) Fabson Import Export Limited  
 P.O. Box No. 61257, Jebel Ali, Dubai, United  
 Arab Emirates  
 (740) Irakli Gvilia  
 (540)



(591) Black-white  
 (531) 19.07.01; 19.07.02; 19.07.10; 19.07.12;  
 19.07.17; 27.05.01; 27.05.04; 27.05.21  
 (511) 3

(260) AM 2023 118407 A  
 (210) AM 118407  
 (220) 2022 07 06  
 (731) Crista La Santa S.A.P.I. DE C.V.  
 Plaza Mariscal Sucre No. 46 Int 31 Col. Del  
 Valle, Delgacion Benito Juarez, Mexico,  
 C.P. 03100, Mexico  
 (740) Liliana Darakhvelidze  
 (540)

**400 CONEJOS**

(591) Black-white  
 (511) 33

(260) AM 2023 118549 A  
 (210) AM 118549  
 (220) 2022 07 13  
 (731) Tamaz Bitchiashvili  
 Vill. Mukhrani, 15 Lane 8, Mtskheta, Georgia  
 (540)



(591) Green, blue  
 (531) 05.03.13; 05.03.14; 26.11.11; 26.11.22;  
 27.05.01; 29.01.12  
 (511) 9

(260) AM 2023 118558 A  
 (210) AM 118558  
 (220) 2022 07 13  
 (731) LTD "3D"  
 Nutsubidze Str. 10, ap. 9, Tbilisi, Georgia

(540)

**ფაურილი**  
**Фаурил**  
**Fauril**

(591) Black-white  
 (511) 5

(260) AM 2023 118643 A  
 (210) AM 118643  
 (220) 2022 07 19  
 (731) LLC Tbilisi Free University  
 Davit Aghmashenebeli alley 240, Tbilisi,  
 Georgia  
 (540)

**კომპიუტერული მეცნიერებების,**  
**მათემატიკისა და ინჟინერიის**  
**სკოლა - MACS[E]**

(591) Black-white  
 (511) 41

(260) AM 2023 118648 A  
 (210) AM 118648  
 (220) 2022 07 19  
 (731) Kerten Unlimited Company  
 13-18 City Quay, Dublin 2, Ireland  
 (740) Giorgi Kartvelishvili  
 (540)



(591) Green, lilac, sky-blue, yellow, white, black  
 (531) 26.13.25; 29.01.15  
 (511) 43

(260) AM 2023 118729 A  
 (210) AM 118729  
 (220) 2022 07 25  
 (731) LTD "S P Bar East"  
 Demetre Tavidadbuli Str. 50, ap. 91, 6000,  
 Batumi, Georgia  
 (540)

**ROYAL CASINO**

(591) Black-white  
 (511) 41

(260) AM 2023 118730 A  
 (210) AM 118730  
 (220) 2022 07 25  
 (731) LTD "S P Bar East"  
 Demetre Tavdadebuli Str. 50, ap. 91, 6000,  
 Batumi, Georgia

(540)  
**ROYAL CLUB**

(591) Black-white  
 (511) 41

(260) AM 2023 118731 A  
 (210) AM 118731  
 (220) 2022 07 25  
 (731) Natalia Pautova  
 Mukhiani Settlement 4b Micro, bld. 21,  
 ap. 29, Tbilisi, Georgia

(540)



(591) Golden, brown  
 (531) 02.09.04; 05.07.02; 05.07.05; 25.01.25;  
 27.05.01; 27.05.09; 27.05.10; 27.05.24;  
 29.01.12

(511) 3

(260) AM 2023 118736 A  
 (210) AM 118736  
 (220) 2022 07 26  
 (731) Limited Liability Company "Vintorg"  
 Kotelnicheskyy proezd, office No. 1, 3rd floor,  
 house 27A, Lyubertsy, Moscow region, 140000,  
 Russian Federation

(740) Tamaz Shilakadze

(540)

**GUARNERI**

(591) Black-white  
 (511) 33

(260) AM 2023 118738 A  
 (210) AM 118738  
 (220) 2022 07 26  
 (731) KT & G Corporation  
 71, Beotkkot-gil, Daedeok-gu, Daejeon,  
 Republic of Korea  
 (740) Pavle Meipariani

(540)

**ESSE BLACK**

(591) Black-white  
 (511) 34

(260) AM 2023 118739 A  
 (210) AM 118739  
 (220) 2022 07 26  
 (731) KT & G Corporation  
 71, Beotkkot-gil, Daedeok-gu, Daejeon,  
 Republic of Korea

(740) Pavle Meipariani

(540)

**ESSE BLACK COMPACT**

(591) Black-white  
 (511) 34

(260) AM 2023 118740 A  
 (210) AM 118740  
 (220) 2022 07 26  
 (731) KT & G Corporation  
 71, Beotkkot-gil, Daedeok-gu, Daejeon,  
 Republic of Korea

(740) Pavle Meipariani

(540)

**ESSE BLACK MINI**

(591) Black-white  
 (511) 34

(260) AM 2023 118741 A  
 (210) AM 118741  
 (220) 2022 07 26  
 (731) KT & G Corporation  
 71, Beotkkot-gil, Daedeok-gu, Daejeon,  
 Republic of Korea

(740) Pavle Meipariani

(540)

**ESSE BLUE**

(591) Black-white  
 (511) 34

(260) AM 2023 118742 A  
 (210) AM 118742  
 (220) 2022 07 26  
 (731) KT & G Corporation  
 71, Beotkkot-gil, Daedeok-gu, Daejeon,  
 Republic of Korea

(740) Pavle Meipariani

(540)

**ESSE CHANGE COMPACT**

(591) Black-white  
(511) 34

---

(260) AM 2023 118743 A  
(210) AM 118743  
(220) 2022 07 26  
(731) KT & G Corporation  
71, Beotkkot-gil, Daedeok-gu, Daejeon,  
Republic of Korea  
(740) Pavle Meipariani  
(540)

## **ESSE CHANGE MINI**

(591) Black-white  
(511) 34

---

(260) AM 2023 118744 A  
(210) AM 118744  
(220) 2022 07 26  
(731) KT & G Corporation  
71, Beotkkot-gil, Daedeok-gu, Daejeon,  
Republic of Korea  
(740) Pavle Meipariani  
(540)

## **ESSE GOLD**

(591) Black-white  
(511) 34

---

(260) AM 2023 118745 A  
(210) AM 118745  
(220) 2022 07 26  
(731) KT & G Corporation  
71, Beotkkot-gil, Daedeok-gu, Daejeon,  
Republic of Korea  
(740) Pavle Meipariani  
(540)

## **ESSE ONE**

(591) Black-white  
(511) 34

---

(260) AM 2023 118746 A  
(210) AM 118746  
(220) 2022 07 26  
(731) KT & G Corporation  
71, Beotkkot-gil, Daedeok-gu, Daejeon,  
Republic of Korea  
(740) Pavle Meipariani  
(540)

## **ESSE SILVER**

(591) Black-white  
(511) 34

---

(260) AM 2023 118747 A  
(210) AM 118747  
(220) 2022 07 26  
(731) KT & G Corporation  
71, Beotkkot-gil, Daedeok-gu, Daejeon,  
Republic of Korea  
(740) Pavle Meipariani  
(540)

## **ESSE SILVER COMPACT**

(591) Black-white  
(511) 34

---

(260) AM 2023 118748 A  
(210) AM 118748  
(220) 2022 07 26  
(731) KT & G Corporation  
71, Beotkkot-gil, Daedeok-gu, Daejeon,  
Republic of Korea  
(740) Pavle Meipariani  
(540)

## **ESSE SILVER MINI**

(591) Black-white  
(511) 34

---

(260) AM 2023 118749 A  
(210) AM 118749  
(220) 2022 07 26  
(731) KT & G Corporation  
71, Beotkkot-gil, Daedeok-gu, Daejeon,  
Republic of Korea  
(740) Pavle Meipariani  
(540)

## **ESSE SPECIAL GOLD**

(591) Black-white  
(511) 34

---

(260) AM 2023 118750 A  
(210) AM 118750  
(220) 2022 07 27  
(731) Huayao Intelligent Technology Co., Limited  
RM 1003,10 / F, Tower One, Lippo Centre, 89  
Queensway, Admiralty, Hong Kong  
(740) Khatuna Imnadze  
(540)

## **IREWI**

(591) Black-white  
(511) 9

---

(260) AM 2023 118751 A  
(210) AM 118751  
(220) 2022 07 27  
(731) Sunkist Growers Inc.

27770 N. Entertainment Drive, Valencia,  
California, 91355, USA  
(740) Shalva Gvaramadze  
(540)

## SUNKIST

(591) Black-white  
(511) 30

(260) AM 2023 118752 A  
(210) AM 118752  
(220) 2022 07 27  
(731) Sunkist Growers Inc.  
27770 N. Entertainment Drive, Valencia,  
California, 91355, USA  
(740) Shalva Gvaramadze  
(540)



(591) Black-white  
(531) 26.01.02; 26.01.05; 26.01.22; 27.01.12;  
27.05.02; 27.05.03  
(511) 30

(260) AM 2023 118757 A  
(210) AM 118757  
(220) 2022 07 28  
(731) Enriko Beridze  
G. Tsitsishvili Str. 18, Tbilisi, Georgia  
(740) Salome Jeladze  
(540)

## მეთუნე Metune

(591) Black-white  
(511) 33

(260) AM 2023 118762 A  
(210) AM 118762  
(220) 2022 07 28  
(731) LTD "Inexphone"  
Kote Marjanishvili Str. 28, Tbilisi, Georgia  
(540)



(591) FFFFFF white, 41920 black, DA364E  
red  
(531) 24.17.02; 26.04.02; 26.04.12; 26.04.22;  
26.04.24; 26.11.03; 26.11.06; 26.11.07;  
27.05.01; 27.05.24; 29.01.13  
(511) 38

(260) AM 2023 118767 A  
(210) AM 118767  
(220) 2022 07 29  
(731) KT & G Corporation  
71, Beotkkot-gil, Daedeok-gu, Daejeon,  
Republic of Korea  
(740) Pavle Meipariani  
(540)

## ESSE GOLDEN LEAF

(591) Black-white  
(511) 34

(260) AM 2023 118830 A  
(210) AM 118830  
(220) 2022 07 29  
(731) Hakan Oktar  
Ulus Mahallesi Leylak Sok Ulus Vadi  
Konutlari B3/7, Besiktas, Istanbul,  
1111, Türkiye  
(740) Lia Shikhiashvili;  
Zurab Bezhashvili;  
Ioane Iarajuli  
(540)

## Sunnybaby

(591) Black-white  
(511) 3, 5, 10, 16, 24, 25

(260) AM 2023 118842 A  
(210) AM 118842  
(220) 2022 08 03  
(731) LTD "Demasi"  
Right bank, Nearby 9 March Park, Tbilisi,  
Georgia  
(540)

## IDEALSYSTEM

## იდეალსისტემა

(591) Black-white  
(511) 35, 37

(260) AM 2023 118844 A  
(210) AM 118844  
(220) 2022 08 03  
(731) Nodar Mindiashvili  
Sairme Str., bld. 1, ap. 5, 0194, Tbilisi,  
Georgia

(540)



(591) Red, green, white, blue

(531) 01.05.02; 01.05.06; 01.05.09; 01.05.12;  
05.03.13; 05.03.17; 05.05.20; 25.05.02;  
26.01.18; 26.04.02; 26.04.22; 26.04.24;  
27.05.01; 27.05.24; 29.01.14

(511) 1, 5

(591) Black, grey, white, yellow

(531) 11.03.02; 26.01.01; 26.01.03; 26.01.16;  
26.01.22; 26.01.24; 26.04.10; 26.04.24;  
27.05.01; 27.05.10; 27.05.17; 27.05.24;  
29.01.13

(511) 25, 28, 32, 33, 35, 41, 43

(260) AM 2023 118860 A

(210) AM 118860

(220) 2022 08 04

(731) Philip Morris Products S.A.

Quai Jeanrenaud 3, 2000 Neuchâtel,  
Switzerland

(740) Pavle Meipariani

(540)

**ლ & მ ლოგოტ ნაით ბლუ**

(591) Black-white

(511) 34

(260) AM 2023 118861 A

(210) AM 118861

(220) 2022 08 04

(731) Philip Morris Products S.A.

Quai Jeanrenaud 3, 2000 Neuchâtel,  
Switzerland

(740) Pavle Meipariani

(540)

**ლ & მ ლოგოტ ბლუ**

(591) Black-white

(511) 34

(260) AM 2023 118862 A

(210) AM 118862

(220) 2022 08 04

(731) Tsothe Mandaria

Gldani, V mcr., bld. 1, ap. 25, 0107, Tbilisi,  
Georgia;  
Rati Mandaria  
Gldani, V mcr., bld. 1, ap. 25, 0107, Tbilisi,  
Georgia

(540)



## REGISTERED TRADEMARKS

(111) M 2023 36390 R  
 (151) 2023 02 06  
 (181) 2033 02 06  
 (260) AM 2022 116992 A  
 (220) 2022 03 10  
 (732) Alena Sturua  
 V. Petriashvili Str. 19, ap. 4, Tbilisi, Georgia

Hong Kong Rd., Chengdu City, Sichuan  
 Province, Public Republic of China

(111) M 2023 36391 R  
 (151) 2023 02 06  
 (181) 2033 02 06  
 (260) AM 2022 117191 A  
 (220) 2022 03 23  
 (732) LTD Medical Center "Cito"  
 Zakaria Paliashvili Str. 40, 0179, Tbilisi,  
 Georgia

(111) M 2023 36398 R  
 (151) 2023 02 06  
 (181) 2033 02 06  
 (260) AM 2022 117104 A  
 (220) 2022 03 17  
 (732) LLC "Impexpharm"  
 Giorgi Saakadze Str., II Exit 17, 0160, Tbilisi,  
 Georgia

(111) M 2023 36392 R  
 (151) 2023 02 06  
 (181) 2033 02 06  
 (260) AM 2022 116835 A  
 (220) 2022 02 25  
 (732) LTD "Rich Group"  
 Vill. Mughanlo, Marneuli Municipality,  
 Georgia

(111) M 2023 36399 R  
 (151) 2023 02 06  
 (181) 2033 02 06  
 (260) AM 2022 116535 A  
 (220) 2022 02 08  
 (732) LLC "Wine Company Shumi"  
 Lionidze Str. 33, Telavi, Georgia

(111) M 2023 36395 R  
 (151) 2023 02 06  
 (181) 2033 02 06  
 (260) AM 2022 117274 A  
 (220) 2022 03 29  
 (732) LTD "Lavapi"  
 Iliа Chavchavadze Ave. 80, (plot 1/37),  
 Commercial space 5, 0162, Tbilisi, Georgia

(111) M 2023 36418 R  
 (151) 2023 02 09  
 (181) 2033 02 09  
 (260) AM 2022 117076 A  
 (220) 2022 03 15  
 (732) LTD "Anapea"  
 Nikoloz Baratashvili Str. 6-8-10, fl. 3, 0105,  
 Tbilisi, Georgia

(111) M 2023 36396 R  
 (151) 2023 02 06  
 (181) 2033 02 06  
 (260) AM 2022 117081 A  
 (220) 2022 03 15  
 (732) Alena Sturua  
 V. Petriashvili Str. 19, ap. 4, Tbilisi, Georgia

(111) M 2023 36419 R  
 (151) 2023 02 09  
 (181) 2033 02 09  
 (260) AM 2021 115119 A  
 (220) 2021 10 27  
 (732) LTD "Tsiskvili Bazari"  
 Iliа Chavchavadze Ave. 57, Tbilisi, Georgia

(111) M 2023 36397 R  
 (151) 2023 02 06  
 (181) 2033 02 06  
 (260) AM 2022 116145 A  
 (220) 2022 01 10  
 (732) Sichuan Machinery Imp. & Exp. Corp. LTD  
 C-8F, Fengde International Plaza, NO.6

(111) M 2023 36420 R  
 (151) 2023 02 09  
 (181) 2033 02 09  
 (260) AM 2022 116647 A  
 (220) 2022 02 15  
 (732) LLC "Barambo"  
 Vill. Natakhtari, Mtskheta, Georgia

(111) M 2023 36421 R  
 (151) 2023 02 09  
 (181) 2033 02 09  
 (260) AM 2022 117097 A

(220) 2022 03 16  
(732) Mysten Labs Inc. (a Delaware Corporation)  
Suite 200 379 University Avenue Palo Alto,  
California, 94301, USA

---

(111) M 2023 36422 R  
(151) 2023 02 09  
(181) 2033 02 09  
(260) AM 2022 117098 A  
(220) 2022 03 16  
(732) Mysten Labs Inc. (a Delaware Corporation)  
Suite 200 379 University Avenue Palo Alto,  
California, 94301, USA

---

(111) M 2023 36423 R  
(151) 2023 02 09  
(181) 2033 02 09  
(260) AM 2022 116990 A  
(220) 2022 03 10  
(732) Avaya Inc.  
2605 Meridian Parkway, Suite 200, Durham,  
North Carolina, 27713, USA

---

(111) M 2023 36424 R  
(151) 2023 02 09  
(181) 2033 02 09  
(260) AM 2022 116991 A  
(220) 2022 03 10  
(732) Avaya Inc.  
2605 Meridian Parkway, Suite 200, Durham,  
North Carolina, 27713, USA

---

(111) M 2023 36425 R  
(151) 2023 02 09  
(181) 2033 02 09  
(260) AM 2022 116754 A  
(220) 2022 02 22  
(732) S C I P Limited  
13 Castle Street, Str. Helier, JE2 3BT, Jersey

---

(111) M 2023 36426 R  
(151) 2023 02 09  
(181) 2033 02 09  
(260) AM 2022 116987 A  
(220) 2022 03 10  
(732) Zhejiang Rifeshow Cosmetics Co., Ltd.  
No.67 Dashi Road, Fotang Town, Yiwu City,  
Zhejiang, People Republic of China

---

(111) M 2023 36427 R  
(151) 2023 02 09  
(181) 2033 02 09  
(260) AM 2022 116731 A

(220) 2022 02 18  
(732) Bayer Aktiengesellschaft  
Kaiser-Wilhelm-Allee,51373 Leverkusen,  
Germany

---

(111) M 2023 36428 R  
(151) 2023 02 09  
(181) 2033 02 09  
(260) AM 2022 116755 A  
(220) 2022 02 22  
(732) LTD "BG Era Games"  
Al. Kazbegi Ave. 10, ap. 17, 0160, Saburtalo  
District, Tbilisi, Georgia

---

(111) M 2023 36429 R  
(151) 2023 02 09  
(181) 2033 02 09  
(260) AM 2021 115120 A  
(220) 2021 10 27  
(732) LTD "Tsiskvili Bazari"  
Ilia Chavchavadze Ave. 57, Tbilisi, Georgia

---

(111) M 2023 36430 R  
(151) 2023 02 09  
(181) 2033 02 09  
(260) AM 2022 117087 A  
(220) 2022 03 16  
(732) LLC "Advanced Medical Technologies  
and Service"  
Ak. Beliashvili Str. 83, Tbilisi, Georgia

---

(111) M 2023 36431 R  
(151) 2023 02 09  
(181) 2033 02 09  
(260) AM 2022 117293 A  
(220) 2022 03 30  
(732) SBM International  
78/74, Palla Road, Bakoli, Delhi, 110036, India

---

(111) M 2023 36432 R  
(151) 2023 02 09  
(181) 2033 02 09  
(260) AM 2022 116552 A  
(220) 2022 02 10  
(732) Philip Morris Products S.A.  
Quai Jeanrenaud 3, Neuchâtel, 2000 Switzerland

---

(111) M 2023 36433 R  
(151) 2023 02 09  
(181) 2033 02 09  
(260) AM 2022 116233 A  
(220) 2022 01 18  
(732) Philip Morris Products S.A.

---

Quai Jeanrenaud 3, Neuchâtel, 2000 Switzerland	(111) M 2023 36440 R (151) 2023 02 09 (181) 2033 02 09 (260) AM 2022 116977 A (220) 2022 03 09 (732) LLC "Odrex Software" Tashkent Str., Lane 4, ap. 16, 0160, Tbilisi, Georgia
(111) M 2023 36434 R (151) 2023 02 09 (181) 2033 02 09 (260) AM 2022 116232 A (220) 2022 01 18 (732) Philip Morris Brands Sàrl Quai Jeanrenaud 3, Neuchâtel, 2000, Switzerland	(111) M 2023 36441 R (151) 2023 02 09 (181) 2033 02 09 (260) AM 2022 116978 A (220) 2022 03 09 (732) LLC "Odrex Software" Tashkent Str., Lane 4, ap. 16, 0160, Tbilisi, Georgia
(111) M 2023 36435 R (151) 2023 02 09 (181) 2033 02 09 (260) AM 2022 116231 A (220) 2022 01 17 (732) Philip Morris Brands Sàrl Quai Jeanrenaud 3, Neuchâtel, 2000, Switzerland	(111) M 2023 36442 R (151) 2023 02 09 (181) 2033 02 09 (260) AM 2022 116979 A (220) 2022 03 09 (732) LLC "Odrex Software" Tashkent Str., Lane 4, ap. 16, 0160, Tbilisi, Georgia
(111) M 2023 36436 R (151) 2023 02 09 (181) 2033 02 09 (260) AM 2022 116155 A (220) 2022 01 11 (732) Philip Morris Products S.A. Quai Jeanrenaud 3, Neuchâtel, 2000 Switzerland	(111) M 2023 36443 R (151) 2023 02 09 (181) 2033 02 09 (260) AM 2022 116980 A (220) 2022 03 09 (732) (732) LLC "Odrex Software" Tashkent Str., Lane 4, ap. 16, 0160, Tbilisi, Georgia
(111) M 2023 36437 R (151) 2023 02 09 (181) 2033 02 09 (260) AM 2022 116152 A (220) 2022 01 11 (732) Philip Morris Products S.A. Quai Jeanrenaud 3, 2000 Neuchâtel, Switzerland	(111) M 2023 36444 R (151) 2023 02 09 (181) 2033 02 09 (260) AM 2022 116154 A (220) 2022 01 11 (732) Philip Morris Products S.A. Quai Jeanrenaud 3, Neuchâtel, 2000 Switzerland
(111) M 2023 36438 R (151) 2023 02 09 (181) 2033 02 09 (260) AM 2022 116975 A (220) 2022 03 09 (732) LLC "Odrex Software" Tashkent Str., Lane 4, ap. 16, 0160, Tbilisi, Georgia	(111) M 2023 36445 R (151) 2023 02 09 (181) 2033 02 09 (260) AM 2022 116156 A (220) 2022 01 11 (732) Philip Morris Products S.A. Quai Jeanrenaud 3, Neuchâtel, 2000 Switzerland
(111) M 2023 36439 R (151) 2023 02 09 (181) 2033 02 09 (260) AM 2022 116976 A (220) 2022 03 09 (732) LLC "Odrex Software" Tashkent Str., Lane 4, ap. 16, 0160, Tbilisi, Georgia	

---



(111) M 2023 36446 R  
(151) 2023 02 09  
(181) 2033 02 09  
(260) AM 2022 116952 A  
(220) 2022 03 04  
(732) Nicoventures Holdings Limited  
Globe House, 1 Water Street, London,  
WC2R 3LA, United Kingdom

---

(111) M 2023 36447 R  
(151) 2023 02 09  
(181) 2033 02 09  
(260) AM 2022 116951 A  
(220) 2022 03 04  
(732) Nicoventures Holdings Limited  
Globe House, 1 Water Street, London,  
WC2R 3LA, United Kingdom

---

(111) M 2023 36448 R  
(151) 2023 02 09  
(181) 2033 02 09  
(260) AM 2022 116627 A  
(220) 2022 02 14  
(732) LTD "IDS Borjomi Beverages Co.N.V."  
Pareraweg 45, Curaçao

---

(111) M 2023 36449 R  
(151) 2023 02 09  
(181) 2033 02 09  
(260) AM 2022 116628 A  
(220) 2022 02 14  
(732) LTD "IDS Borjomi Beverages Co.N.V."  
Pareraweg 45, Curaçao

---

(111) M 2023 36450 R  
(151) 2023 02 09  
(181) 2033 02 09  
(260) AM 2022 116630 A  
(220) 2022 02 14  
(732) LTD "IDS Borjomi Beverages Co.N.V."  
Pareraweg 45, Curaçao

---

(111) M 2023 36451 R  
(151) 2023 02 09  
(181) 2033 02 09  
(260) AM 2022 116629 A  
(220) 2022 02 14  
(732) LTD "IDS Borjomi Beverages Co.N.V."  
Pareraweg 45, Curaçao

---

(111) M 2023 36452 R  
(151) 2023 02 09  
(181) 2033 02 09  
(260) AM 2022 116955 A  
(220) 2022 03 04  
(732) LTD "Kakhuri"  
Tbilisi Highway 1, Telavi, Georgia

---

(111) M 2023 36453 R  
(151) 2023 02 09  
(181) 2033 02 09  
(260) AM 2022 116954 A  
(220) 2022 03 04  
(732) LTD "Kakhuri"  
Tbilisi Highway 1, Telavi, Georgia

---

(111) M 2023 36454 R  
(151) 2023 02 09  
(181) 2033 02 09  
(260) AM 2022 116973 A  
(220) 2022 03 09  
(732) Zurab Krizhanovskiy  
Gogi Tsabadze Str. 4, ap. 33, Tbilisi, Georgia

---

(111) M 2023 36455 R  
(151) 2023 02 09  
(181) 2033 02 09  
(260) AM 2022 116401 A  
(220) 2022 01 31  
(732) LTD "AquaRoom"  
Bidzina Kvernadze Str. 35, app. 82, 0171,  
Saburtalo District, Tbilisi, Georgia

---

(111) M 2023 36456 R  
(151) 2023 02 09  
(181) 2033 02 09  
(260) AM 2021 116001 A  
(220) 2021 12 30  
(732) Yadea Technology Group Co., Ltd.  
Dongsheng Road, Dacheng Industrial Zone,  
Anzhen Town, Xishan District, Wuxi City,  
Jiangsu Province, People Republic of China

---

(111) M 2023 36457 R  
(151) 2023 02 09  
(181) 2033 02 09  
(260) AM 2022 116762 A  
(220) 2022 02 24  
(732) LTD "Chateau Ozhio"  
Borough Sioni, Tianeti, Georgia

---

(111) M 2023 36458 R  
(151) 2023 02 09  
(181) 2033 02 09  
(260) AM 2022 116540 A  
(220) 2022 02 09  
(732) LTD "Smart Feed"  
14<sup>th</sup> St, II Lane 15, 1306, Vill. Gamarjveba,  
Gardabani, Georgia

---

(111) M 2023 36459 R  
(151) 2023 02 09  
(181) 2033 02 09  
(260) AM 2022 117075 A  
(220) 2022 03 15  
(732) LTD "I. Bokeria Neurodevelopment Centre"  
Lubliana Str. 13/Mikheil Chiaureli Str. 6,  
Tbilisi, Georgia

---

(111) M 2023 36463 R  
(151) 2023 02 09  
(181) 2033 02 09  
(260) AM 2022 116151 A  
(220) 2022 01 11  
(732) J & B Limited  
3rd Floor, Yamraj Building, Market Square,  
P.O. Box 3175, Road Town, Tortola, Virgin  
Islands (British)

---

(111) M 2023 36464 R  
(151) 2023 02 09  
(181) 2033 02 09  
(260) AM 2022 117082 A  
(220) 2022 03 16  
(732) Tingyi (Cayman Islands) Holding Corp.  
P.O. Box 309 Uglan House, Grand Cayman  
KY1-1104, Cayman Islands

---

(111) M 2023 36465 R  
(151) 2023 02 09  
(181) 2033 02 09  
(260) AM 2022 117266 A  
(220) 2022 03 28  
(732) LTD "Gamo Digital"  
Davit Aghmashenebeli Ave. 76/1, 0102,  
Chughureti District, Tbilisi, Georgia

---

(111) M 2023 36466 R  
(151) 2023 02 09  
(181) 2033 02 09  
(260) AM 2022 117108 A  
(220) 2022 03 17  
(732) LLC "Producer Center Game-TV"  
Kikodze Str. 3, 0190, Tbilisi, Georgia

---

(111) M 2023 36467 R  
(151) 2023 02 09  
(181) 2033 02 09  
(260) AM 2022 116738 A  
(220) 2022 02 21  
(732) LLC "Wine Company Shumi"  
Lionidze Str. 33, Telavi, Georgia

---

(111) M 2023 36468 R  
(151) 2023 02 13  
(181) 2033 02 13  
(260) AM 2022 117062 A  
(220) 2022 03 11  
(732) LTD "Rich Group"  
Vill. Mughanlo, Marneuli Municipality,  
Georgia

---

(111) M 2023 36469 R  
(151) 2023 02 13  
(181) 2033 02 13  
(260) AM 2022 116833 A  
(220) 2022 02 25  
(732) LTD "Rich Group"  
Vill. Mughanlo, Marneuli Municipality,  
Georgia

---

(111) M 2023 36470 R  
(151) 2023 02 13  
(181) 2033 02 13  
(260) AM 2022 116837 A  
(220) 2022 02 25  
(732) LTD "Rich Group"  
Vill. Mughanlo, Marneuli Municipality,  
Georgia

---

(111) M 2023 36471 R  
(151) 2023 02 13  
(181) 2033 02 13  
(260) AM 2022 116831 A  
(220) 2022 02 25  
(732) LTD "Rich Group"  
Vill. Mughanlo, Marneuli Municipality,  
Georgia

---

(111) M 2023 36472 R  
(151) 2023 02 13  
(181) 2033 02 13  
(260) AM 2022 116832 A  
(220) 2022 02 25  
(732) LTD "Rich Group"  
Vill. Mughanlo, Marneuli Municipality,  
Georgia

---

(111) M 2023 36473 R  
(151) 2023 02 13  
(181) 2033 02 13  
(260) AM 2022 116830 A  
(220) 2022 02 25  
(732) LTD "Rich Group"  
Vill. Mughanlo, Marneuli Municipality,  
Georgia

---

(111) M 2023 36479 R  
(151) 2023 02 13  
(181) 2033 02 13  
(260) AM 2022 116838 A  
(220) 2022 02 25  
(732) LTD "Rich Group"  
Vill. Mughanlo, Marneuli Municipality,  
Georgia

---

(111) M 2023 36474 R  
(151) 2023 02 13  
(181) 2033 02 13  
(260) AM 2022 116747 A  
(220) 2022 02 21  
(732) LTD "Rich Group"  
Vill. Mughanlo, Marneuli Municipality,  
Georgia

---

(111) M 2023 36480 R  
(151) 2023 02 13  
(181) 2033 02 13  
(260) AM 2022 116834 A  
(220) 2022 02 25  
(732) LTD "Rich Group"  
Vill. Mughanlo, Marneuli Municipality,  
Georgia

---

(111) M 2023 36475 R  
(151) 2023 02 13  
(181) 2033 02 13  
(260) AM 2022 116839 A  
(220) 2022 02 25  
(732) LTD "Rich Group"  
Vill. Mughanlo, Marneuli Municipality,  
Georgia

---

(111) M 2023 36481 R  
(151) 2023 02 13  
(181) 2033 02 13  
(260) AM 2022 116146 A  
(220) 2022 01 10  
(732) Karium LTD  
The Capital Bld., Oldberry Castle, Brinkley,  
England RG12 8FZ, UK

---

(111) M 2023 36476 R  
(151) 2023 02 13  
(181) 2033 02 13  
(260) AM 2022 116748 A  
(220) 2022 02 21  
(732) LTD "Rich Group"  
Vill. Mughanlo, Marneuli Municipality,  
Georgia

---

(111) M 2023 36482 R  
(151) 2023 02 13  
(181) 2033 02 13  
(260) AM 2022 116827 A  
(220) 2022 02 25  
(732) LLC "Healpro"  
Vill. Mughanlo, Marneuli Region, Georgia

---

(111) M 2023 36477 R  
(151) 2023 02 13  
(181) 2033 02 13  
(260) AM 2022 116842 A  
(220) 2022 02 25  
(732) LTD "Rich Group"  
Vill. Mughanlo, Marneuli Municipality,  
Georgia

---

(111) M 2023 36483 R  
(151) 2023 02 13  
(181) 2033 02 13  
(260) AM 2022 116423 A  
(220) 2022 02 02  
(732) LLC "A-B-F"  
Vill. Martkopi, Vaziani Settlement, 1320,  
Gardabani, Georgia

---

(111) M 2023 36478 R  
(151) 2023 02 13  
(181) 2033 02 13  
(260) AM 2022 116840 A  
(220) 2022 02 25  
(732) LTD "Rich Group"  
Vill. Mughanlo, Marneuli Municipality,  
Georgia

---

(111) M 2023 36484 R  
(151) 2023 02 13  
(181) 2033 02 13  
(260) AM 2018 99510 A  
(220) 2018 09 25  
(732) LTD "Zhorzholiani Trading"  
Nutsbidze Plateau, II mcr., I qu., bld. 6,  
app. 6, 0183, Tbilisi, Georgia

---

(111) M 2023 36485 R  
(151) 2023 02 13  
(181) 2033 02 13  
(260) AM 2022 116332 A  
(220) 2022 01 26  
(732) LTD "Barmaglot Tbilisi"  
Giorgi Leonidze Str. 2a, space 2, floor 1, 0105,  
Mtatsminda District, Tbilisi, Georgia

(111) M 2023 36486 R  
(151) 2023 02 13  
(181) 2033 02 13  
(260) AM 2021 115843 A  
(220) 2021 12 17  
(732) JSC "Telavi Wine Cellar"  
Vill. Kurdghelauri, Telavi Region, Georgia

(111) M 2023 36487 R  
(151) 2023 02 13  
(181) 2033 02 13  
(260) AM 2018 99511 A  
(220) 2018 09 25  
(732) LTD "Zhorzholiani Trading"  
Nutsbidze Plateau, II mcr., I qu., bld. 6,  
app. 6, 0183, Tbilisi, Georgia

(111) M 2023 36488 R  
(151) 2023 02 13  
(181) 2033 02 13  
(260) AM 2022 116546 A  
(220) 2022 02 09  
(732) LTD "Biopolus"  
I. Noneshvili Str. 65, 6000, Batumi, Georgia

(111) M 2023 36489 R  
(151) 2023 02 13  
(181) 2033 02 13  
(260) AM 2022 116659 A  
(220) 2022 02 16  
(732) LTD "Biopolus"  
I. Noneshvili Str. 65, 6000, Batumi, Georgia

(111) M 2023 36490 R  
(151) 2023 02 13  
(181) 2033 02 13  
(260) AM 2021 114912 A  
(220) 2021 10 11  
(732) Obshchestvo s Ogranichenoy Otvetstvennostiy  
"Avtograf"  
Ul. Butlerova, Dom 17b, Etazh 2, Pomeshe-  
nie XI, Comnata 69, Office 137, 117342,  
Moscow, Russian Federation

(111) M 2023 36491 R  
(151) 2023 02 13  
(181) 2033 02 13  
(260) AM 2022 116621 A  
(220) 2022 02 11  
(732) Nicoventures Holdings Limited  
Globe House 1 Water Street, London,  
WC2R 3LA, United Kingdom

(111) M 2023 36492 R  
(151) 2023 02 13  
(181) 2033 02 13  
(260) AM 2021 114799 A  
(220) 2021 10 04  
(732) Obshchestvo s Ogranichenoy Otvetstvennostiy  
"Avtograf"  
Ul. Butlerova, Dom 17b, Etazh 2, Pomeshe-  
nie XI, Comnata 69, Office 137, 117342,  
Moscow, Russian Federation

(111) M 2023 36493 R  
(151) 2023 02 13  
(181) 2033 02 13  
(260) AM 2022 116222 A  
(220) 2022 01 14  
(732) Mollusca LTD  
Sharikopodshipnikovskaya Str., 11, bld. 1,  
floor 3, app. VI, office 11, 115088, Moscow,  
Russian Federation

(111) M 2023 36494 R  
(151) 2023 02 13  
(181) 2033 02 13  
(260) AM 2021 115761 A  
(220) 2021 12 16  
(732) The Coca-Cola Company  
One Coca-Cola Plaza, Atlanta, Georgia,  
30313, USA

(111) M 2023 36495 R  
(151) 2023 02 13  
(181) 2033 02 13  
(260) AM 2021 115760 A  
(220) 2021 12 16  
(732) The Coca-Cola Company  
One Coca-Cola Plaza, Atlanta, Georgia,  
30313, USA

(111) M 2023 36496 R  
(151) 2023 02 13  
(181) 2033 02 13  
(260) AM 2021 115681 A  
(220) 2021 12 07  
(732) The Coca-Cola Company

One Coca-Cola Plaza, Atlanta, Georgia 30313, USA	Eprem Zakaraia Str., I Lane 14, 0101, Tbilisi, Georgia
(111) M 2023 36497 R (151) 2023 02 13 (181) 2033 02 13 (260) AM 2021 115529 A (220) 2021 11 25 (732) Philip Morris Brands Sàrl Quai Jeanrenaud 3, 2000 Neuchâtel, Switzerland	(111) M 2023 36503 R (151) 2023 02 13 (181) 2033 02 13 (260) AM 2022 116153 A (220) 2022 01 11 (732) Avtandil Kartsivadze Nutsubidze Plateau, IV mcr., bld. 18, app 118, 0183, Tbilisi, Georgia; Giorgi Kvatashidze Vagan Mamasakhlisov Str. 5b, app. 36, 0186, Tbilisi, Georgia
(111) M 2023 36498 R (151) 2023 02 13 (181) 2033 02 13 (260) AM 2021 115526 A (220) 2021 11 24 (732) Troikaa Pharmaceuticals Ltd Commerce House 1, Satya Marg, Bodakdev, Ahmedabad, Gujarat 380054, India	(111) M 2023 36504 R (151) 2023 02 13 (181) 2033 02 13 (260) AM 2022 117090 A (220) 2022 03 16 (732) LLC "Kani" Giorgi Saakadze's Descent 11, Tbilisi, Georgia
(111) M 2023 36499 R (151) 2023 02 13 (181) 2033 02 13 (260) AM 2021 115525 A (220) 2021 11 24 (732) Troikaa Pharmaceuticals Ltd Commerce House 1, Satya Marg, Bodakdev, Ahmedabad, Gujarat 380054, India	(111) M 2023 36505 R (151) 2023 02 13 (181) 2033 02 13 (260) AM 2022 117091 A (220) 2022 03 16 (732) LLC "Kani" Giorgi Saakadze's Descent 11, Tbilisi, Georgia
(111) M 2023 36500 R (151) 2023 02 13 (181) 2033 02 13 (260) AM 2021 115517 A (220) 2021 11 23 (732) Philip Morris Products S.A. Quai Jeanrenaud 3, 2000 Neuchâtel, Switzerland	(111) M 2023 36506 R (151) 2023 02 13 (181) 2033 02 13 (260) AM 2022 117093 A (220) 2022 03 16 (732) LLC "Kani" Giorgi Saakadze's Descent 11, Tbilisi, Georgia
(111) M 2023 36501 R (151) 2023 02 13 (181) 2033 02 13 (260) AM 2022 116732 A (220) 2022 02 18 (732) LTD "Tfilisis Marani" (Tbilisi Cellar) Z. Paliashvili Str. 33, ap. 6, 0179, Tbilisi, Georgia	(111) M 2023 36507 R (151) 2023 02 13 (181) 2033 02 13 (260) AM 2022 117092 A (220) 2022 03 16 (732) LLC "Kani" Giorgi Saakadze's Descent 11, Tbilisi, Georgia
(111) M 2023 36502 R (151) 2023 02 13 (181) 2033 02 13 (260) AM 2021 115845 A (220) 2021 12 17 (732) LTD "Partner"	(111) M 2023 36508 R (151) 2023 02 13 (181) 2033 02 13 (260) AM 2022 116228 A (220) 2022 01 17 (732) LLC "Modi"

---

12th Str. 1, Village Sharabidzeebi, Khelvachauri Region, Georgia	(111) M 2023 36514 R (151) 2023 02 13 (181) 2033 02 13 (260) AM 2022 116958 A (220) 2022 03 04 (732) Yuga Labs Inc. 1430 S. Dixie Hwy, Ste. 105 1075 Coral Gables, FL, 33146-3108, USA
(111) M 2023 36509 R (151) 2023 02 13 (181) 2033 02 13 (260) AM 2022 116767 A (220) 2022 02 25 (732) Hangzhou Ulike Technology Co., LTD. RM 306, 3/F, BLDG 4, 735 Jianghong Rd Changhe Street, Binjiang District, Hangzhou, Zhejiang, People's Republic of China	(111) M 2023 36515 R (151) 2023 02 13 (181) 2033 02 13 (260) AM 2022 117099 A (220) 2022 03 16 (732) LLC "Elisbar 1918" Vill. Kisiskhevi, 17th Str. 19, 0222, Telavi, Georgia
(111) M 2023 36510 R (151) 2023 02 13 (181) 2033 02 13 (260) AM 2022 116766 A (220) 2022 02 25 (732) Hangzhou Ulike Technology Co., LTD. RM 306, 3/F, BLDG 4, 735 Jianghong Rd Changhe Street, Binjiang District, Hangzhou, Zhejiang, People's Republic of China	(111) M 2023 36516 R (151) 2023 02 13 (181) 2033 02 13 (260) AM 2022 116162 A (220) 2022 01 13 (732) Intersun Holding FZCO Jebal Ali Free Zone, Dubai, 61051, United Arab Emirates
(111) M 2023 36511 R (151) 2023 02 13 (181) 2033 02 13 (260) AM 2022 116394 A (220) 2022 01 30 (732) LTD "European Business School and Consulting" Nodar Tabidze St, I Lane 6, 0114, Tbilisi, Georgia	(111) M 2023 36517 R (151) 2023 02 13 (181) 2033 02 13 (260) AM 2022 116752 A (220) 2022 02 22 (732) LTD "GM Pharmaceuticals" Rustavi Highway 52, 0114, Tbilisi, Georgia
(111) M 2023 36512 R (151) 2023 02 13 (181) 2033 02 13 (260) AM 2022 117258 A (220) 2022 03 27 (732) LTD "Ins Group" Vakhtang Gorgasali Str. 159, 6000, Batumi, Georgia	(111) M 2023 36518 R (151) 2023 02 13 (181) 2033 02 13 (260) AM 2022 116750 A (220) 2022 02 22 (732) LTD "GM Pharmaceuticals" Rustavi Highway 52, 0114, Tbilisi, Georgia
(111) M 2023 36513 R (151) 2023 02 13 (181) 2033 02 13 (260) AM 2022 117186 A (220) 2022 03 22 (732) British American Tobacco (Brands) Inc. (a Delaware Corporation) 251 Little Falls Drive, Suite 100, Wilmington, Delaware, 19808-1674, USA	(111) M 2023 36519 R (151) 2023 02 13 (181) 2033 02 13 (260) AM 2022 116751 A (220) 2022 02 22 (732) LTD "GM Pharmaceuticals" Rustavi Highway 52, 0114, Tbilisi, Georgia

---

(111) M 2023 36520 R  
(151) 2023 02 13  
(181) 2033 02 13  
(260) AM 2022 117286 A  
(220) 2022 03 30  
(732) JSC "Corporation Kindzmarauli"  
Ilia Chavchavadze Str. 55, 4800, Kvareli,  
Georgia

---

(111) M 2023 36521 R  
(151) 2023 02 13  
(181) 2033 02 13  
(260) AM 2022 117192 A  
(220) 2022 03 23  
(732) JSC "Corporation Kindzmarauli"  
Ilia Chavchavadze Str. 55, 4800, Kvareli,  
Georgia

---

(111) M 2023 36522 R  
(151) 2023 02 13  
(181) 2033 02 13  
(260) AM 2022 116972 A  
(220) 2022 03 09  
(732) JSC "Corporation Kindzmarauli"  
Ilia Chavchavadze Str. 55, 4800, Kvareli,  
Georgia

---

(111) M 2023 36523 R  
(151) 2023 02 13  
(181) 2033 02 13  
(260) AM 2022 116957 A  
(220) 2022 03 04  
(732) LLC "Arson Technology"  
Giorgi Tsabadze Str. 8b, bld. 2, market 3, 0180,  
Tbilisi, Georgia

---

(111) M 2023 36524 R  
(151) 2023 02 13  
(181) 2033 02 13  
(260) AM 2022 116967 A  
(220) 2022 03 07  
(732) LTD "Outflat"  
Petre Kavtaradze Str. 74, app. 10, 0186,  
Tbilisi, Georgia

---

(111) M 2023 36525 R  
(151) 2023 02 13  
(181) 2033 02 13  
(260) AM 2022 117278 A  
(220) 2022 03 29  
(732) LTD "Popper"  
Zakaria Paliashvili Str. 63, Tbilisi, Georgia

---

## TRADEMARKS REGISTERED ACCORDING TO THE ACCELERATED PROCEDURE

The decision can be appealed at the Chamber of Appeal of Sakpatenti within 3 months from the publication.

(111) M 2023 36389 R

(151) 2023 02 06

(181) 2033 02 06

(210) AM 117738

(220) 2022 05 11

(732) LTD "Demes Georgia"

Kvishkheti Str. 14, ap. 8, Tbilisi, Georgia

(540)



(591) Black-white

(531) 03.13.01; 25.01.09; 25.01.10; 27.05.01;  
27.05.03; 27.05.09

(526) Georgia

(511) 3, 5, 16,

(111) M 2023 36393 R

(151) 2023 02 06

(181) 2033 02 06

(210) AM 121150

(220) 2023 01 12

(732) JSC "Pasha Bank Georgia"

Ilia Chavchavadze Ave. 37m, 0179, Tbilisi,  
Georgia

(740) Davit Jojishvili

(540)

**თანდათან**

(591) Black-white

(511) 36

(111) M 2023 36394 R

(151) 2023 02 06

(181) 2033 02 06

(210) AM 121350

(220) 2023 01 26

(732) LTD "Alali 2008"

Stepane Zubalashvili Str., Lane 4, 6000,  
Batumi, Georgia

(540)

**სცადე უკეთესი  
try better**

(591) Black-white

(511) 35

(111) M 2023 36400 R

(151) 2023 02 06

(181) 2033 02 06

(210) AM 121149

(220) 2023 01 12

(732) JSC "Pasha Bank Georgia"

Ilia Chavchavadze Ave. 37m, 0179, Tbilisi,  
Georgia

(740) Davit Jojishvili

(540)

**გზადაგზა**

(591) Black-white

(511) 36

(111) M 2023 36401 R

(151) 2023 02 06

(181) 2033 02 06

(210) AM 121154

(220) 2023 01 12

(732) LLC "Vestin 2017"

S. Dodashvili Str. 16, 0113, Tbilisi, Isani  
District, Georgia

(740) Ioane Iarajuli;

Zurab Bezhashvili;

Lia Shikhiashvili

(540)

**სულიკო  
Suliko  
Сулико**

(591) Black-white

(511) 43

(111) M 2023 36402 R

(151) 2023 02 08

(181) 2033 02 08

(210) AM 121431

(220) 2023 02 01

(732) Im Nikolay Kireev

Vill. Ozaani, 1607, Dedoplistskaro,  
Georgia

Im Aleksey Sivukhin

Vill. Grigolaantkari, 1805, Dusheti,  
Georgia



(540)

**AUDITORIA**

(591) Black-white  
 (531) 26.13.25; 27.05.01  
 (511) 16, 35, 41, 43

(111) M 2023 36403 R  
 (151) 2023 02 08  
 (181) 2033 02 08  
 (210) AM 121429  
 (220) 2023 02 01  
 (732) Im Sergey Kireev  
 Meskheti Str. 31g, 1200, Borjomi, Georgia  
 Im Nikolay Kireev  
 Vill. Ozaani, 1607, Dedoplistskaro, Georgia

(540)

**PRESIDENT JET**

– BUSINESS AVIATION –



THE HIGHEST FLIGHT EVER

(591) Black-white  
 (531) 06.07.04; 06.07.05; 06.07.06; 07.01.08;  
 18.05.01; 18.05.03; 27.05.01  
 (511) 39

(111) M 2023 36404 R  
 (151) 2023 02 08  
 (181) 2033 02 08  
 (210) AM 121349  
 (220) 2023 01 26  
 (732) LTD "Kazbegi 1881"  
 Dimitri Uznadze Str. 68a, 0102, Tbilisi, Georgia

(540)



(591) 775252 Brown, white  
 (531) 06.07.01; 06.07.02; 06.07.04; 07.01.01;  
 07.01.08; 07.01.12; 26.04.04; 26.04.22;  
 27.05.01; 27.07.01; 29.01.12  
 (511) 32

(111) M 2023 36405 R  
 (151) 2023 02 08  
 (181) 2033 02 08  
 (210) AM 121323  
 (220) 2023 01 24  
 (732) Aleksandre Buadze  
 Kavsadze Str. 7a, 0179, Tbilisi, Georgia

(540)

**კამპა**  
**CAMPA**

(591) Dark green  
 (531) 27.05.04; 28.19; 29.01.03  
 (511) 32

(111) M 2023 36406 R  
 (151) 2023 02 08  
 (181) 2033 02 08  
 (210) AM 121312  
 (220) 2023 01 23  
 (732) Carrefour  
 93 Avenue de Paris, 91300 Massy, France  
 (740) Giorgi Taktakishvili

(540)

**კარფური**

(591) Black-white  
 (511) 35

(111) M 2023 36407 R  
 (151) 2023 02 08  
 (181) 2033 02 08  
 (210) AM 120974  
 (220) 2022 12 29  
 (732) Philip Morris Products S.A.  
 Quai Jean Renaud 3, 2000 Neuchâtel,  
 Switzerland  
 (740) Pavle Meipariani

(540)

**VEEV NOW CORAL PINK**

(591) Black-white  
 (511) 34

(111) M 2023 36408 R  
 (151) 2023 02 08  
 (181) 2033 02 08  
 (210) AM 120973

(220) 2022 12 29  
 (732) Philip Morris Products S.A.  
 Quai Jean Renaud 3, 2000 Neuchâtel,  
 Switzerland  
 (740) Pavle Meipariani  
 (540)

**VEEV NOW BLUE RASPBERRY**

(591) Black-white  
 (511) 34

---

(111) M 2023 36409 R  
 (151) 2023 02 08  
 (181) 2033 02 08  
 (210) AM 120972  
 (220) 2022 12 29  
 (732) Philip Morris Products S.A.  
 Quai Jean Renaud 3, 2000 Neuchâtel,  
 Switzerland  
 (740) Pavle Meipariani  
 (540)

**VEEV NOW INDIBLUE**

(591) Black-white  
 (511) 34

---

(111) M 2023 36410 R  
 (151) 2023 02 08  
 (181) 2033 02 08  
 (210) AM 120971  
 (220) 2022 12 29  
 (732) Philip Morris Products S.A.  
 Quai Jean Renaud 3, 2000 Neuchâtel,  
 Switzerland  
 (740) Pavle Meipariani  
 (540)

**VEEV NOW MARIGOLD**

(591) Black-white  
 (511) 34

---

(111) M 2023 36411 R  
 (151) 2023 02 08  
 (181) 2033 02 08  
 (210) AM 120970  
 (220) 2022 12 29  
 (732) Philip Morris Products S.A.  
 Quai Jean Renaud 3, 2000 Neuchâtel,  
 Switzerland  
 (740) Pavle Meipariani  
 (540)

**VEEV NOW MAUVE**

(591) Black-white  
 (511) 34

---

(111) M 2023 36412 R  
 (151) 2023 02 08  
 (181) 2033 02 08  
 (210) AM 120969  
 (220) 2022 12 29  
 (732) Philip Morris Products S.A.  
 Quai Jean Renaud 3, 2000 Neuchâtel,  
 Switzerland  
 (740) Pavle Meipariani  
 (540)

**VEEV NOW YELLOW**

(591) Black-white  
 (511) 34

---

(111) M 2023 36413 R  
 (151) 2023 02 08  
 (181) 2033 02 08  
 (210) AM 120968  
 (220) 2022 12 29  
 (732) Philip Morris Products S.A.  
 Quai Jean Renaud 3, 2000 Neuchâtel,  
 Switzerland  
 (740) Pavle Meipariani  
 (540)

**VEEV NOW RED**

(591) Black-white  
 (511) 34

---

(111) M 2023 36414 R  
 (151) 2023 02 08  
 (181) 2033 02 08  
 (210) AM 120966  
 (220) 2022 12 29  
 (732) Philip Morris Products S.A.  
 Quai Jean Renaud 3, 2000 Neuchâtel,  
 Switzerland  
 (740) Pavle Meipariani  
 (540)

**VEEV NOW PEACH**

(591) Black-white  
 (511) 34

---

(111) M 2023 36415 R  
 (151) 2023 02 08  
 (181) 2033 02 08  
 (210) AM 120965  
 (220) 2022 12 29  
 (732) Philip Morris Products S.A.  
 Quai Jean Renaud 3, 2000 Neuchâtel,  
 Switzerland  
 (740) Pavle Meipariani  
 (540)

**VEEV NOW MANGO**

(591) Black-white  
(511) 34

---

(111) M 2023 36416 R  
(151) 2023 02 08  
(181) 2033 02 08  
(210) AM 120964  
(220) 2022 12 29  
(732) Philip Morris Products S.A.  
Quai Jean Renaud 3, 2000 Neuchâtel,  
Switzerland  
(740) Pavle Meipariani  
(540)

### VEEV NOW STRAWBERRY

(591) Black-white  
(511) 34

---

(111) M 2023 36417 R  
(151) 2023 02 08  
(181) 2033 02 08  
(210) AM 120963  
(220) 2022 12 29  
(732) Philip Morris Products S.A.  
Quai Jean Renaud 3, 2000 Neuchâtel,  
Switzerland  
(740) Pavle Meipariani  
(540)

### VEEV NOW WATERMELON

(591) Black-white  
(511) 34

---

(111) M 2023 36460 R  
(151) 2023 02 09  
(181) 2033 02 09  
(210) AM 121413  
(220) 2023 01 29  
(732) Philip Morris Products S.A.  
Quai Jean Renaud 3, 2000 Neuchâtel,  
Switzerland  
(740) Pavle Meipariani  
(540)



(591) Red, grey, white  
(531) 24.07.01; 24.07.13; 26.05.01; 26.05.22;  
26.05.24; 27.05.01; 27.05.10; 27.05.24;  
27.07.01; 29.01.13  
(511) 34

---

(111) M 2023 36461 R  
(151) 2023 02 09  
(181) 2033 02 09  
(210) AM 121412  
(220) 2023 01 29  
(732) Philip Morris Products S.A.  
Quai Jean Renaud 3, 2000 Neuchâtel,  
Switzerland  
(740) Pavle Meipariani  
(540)



(591) Golden, white  
(531) 24.07.01; 24.07.13; 24.07.23; 26.03.01;  
26.03.16; 26.03.17; 26.03.22; 26.03.24;  
27.05.01; 27.05.10; 27.05.24; 29.01.12  
(511) 34

---

(111) M 2023 36462 R  
(151) 2023 02 09  
(181) 2033 02 09  
(210) AM 121411  
(220) 2023 01 29  
(732) Philip Morris Products S.A.  
Quai Jean Renaud 3, 2000 Neuchâtel,  
Switzerland  
(740) Pavle Meipariani  
(540)



UNCOMPROMISED MARLBORO FLAVOR AND QUALITY.

(591) Black-white  
(531) 05.03.01; 05.03.15; 27.05.01  
(511) 34

---

(111) M 2023 36526 R  
(151) 2023 02 17  
(181) 2033 02 17  
(210) AM 121314  
(220) 2023 01 23  
(732) JSC "Nikora Trade"  
Al. Mrevlishvili Str. 2, 0180, Tbilisi, Georgia  
(740) Melano Gogisvanidze  
(540)



(591) Dark lilac, lilac, white, light lilac  
 (531) 25.03.01; 25.03.07; 26.04.02; 26.04.06;  
 26.04.22; 26.04.24; 27.05.01; 27.05.24;  
 29.01.12  
 (511) 3, 16, 29, 30, 31, 32, 33

(111) M 2023 36527 R  
 (151) 2023 02 17  
 (181) 2033 02 17  
 (210) AM 121122  
 (220) 2023 01 09  
 (732) Jacobs Douw Egberts DE GmbH  
 Langemarckstraße 4-20, D-281 99 Bremen,  
 Germany  
 (740) Giorgi Taktakishvili  
 (540)

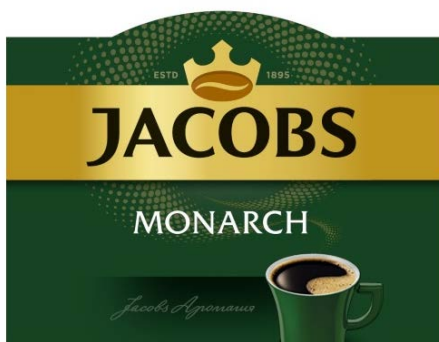

(591) Green, dark green, light green, yellow, brown,  
 black, white  
 (531) 05.07.27; 11.03.04; 24.09.02; 24.09.02;  
 24.09.03; 24.09.05; 24.09.05; 24.09.09;  
 25.03.07; 25.03.15; 27.05.01; 27.05.10;  
 27.05.24; 29.01.15  
 (511) 30

(111) M 2023 36528 R  
 (151) 2023 02 17  
 (181) 2033 02 17  
 (210) AM 121529  
 (220) 2023 02 08  
 (732) LLC "Domus Trees"  
 Kavsadze Str. 3, 0179, Tbilisi, Georgia  
 (540)

დავითიანი  
**Davitiani**

(591) Black-white  
 (511) 41, 43

(111) M 2023 36529 R  
 (151) 2023 02 17  
 (181) 2033 02 17  
 (210) AM 121434  
 (220) 2023 02 02

(732) LLC "Viani"  
 Akaki Belashvili Str. 142, 0159, Tbilisi,  
 Georgia  
 (540)

 **Vian**

(591) 701864 lilac  
 (531) 02.07.23; 26.13.25; 27.05.01; 29.01.05  
 (511) 44

(111) M 2023 36530 R  
 (151) 2023 02 17  
 (181) 2033 02 17  
 (210) AM 121433  
 (220) 2023 02 02  
 (732) LLC "Viani"  
 Akaki Belashvili Str. 142, 0159, Tbilisi,  
 Georgia  
 (540)

 ვიანი

(591) 701864 lilac  
 (531) 02.07.23; 26.13.25; 28.19; 29.01.05  
 (511) 44

(111) M 2023 36531 R  
 (151) 2023 02 17  
 (181) 2033 02 17  
 (210) AM 121409  
 (220) 2023 01 27  
 (732) Kakhaber Okriashvili  
 Iakob Tsurtaveli Str. 65, 1700, Dmanisi,  
 Georgia  
 (740) Nugzar Ksovreli  
 (540)

**Baumberg**

(591) Black-white  
 (511) 5

(111) M 2023 36532 R  
 (151) 2023 02 17  
 (181) 2033 02 17  
 (210) AM 121533  
 (220) 2023 02 09  
 (732) LLC "Georgian Agroproduct"  
 Chirnakhuli Str. 2, 0150, Tbilisi, Georgia  
 (540)

ბაობრა

(591) Black-white  
 (511) 29, 30, 32

(111) M 2023 36533 R

(151) 2023 02 17

(181) 2033 02 17

(210) AM 121346

(220) 2023 01 26

(732) Pavle Kotsebovi

Vazha Ivereli Str. 26, Tbilisi, Georgia

(540)



(591) Black-white

(531) 18.01.07; 18.01.09; 18.01.23; 26.04.02;

26.04.16; 26.04.22; 26.04.24; 26.11.12;

27.05.24

(511) 12

---

## INTERNATIONAL TRADEMARKS FOR WHICH A DECISION ON GRANTING PROTECTIONS IS TAKEN

The decision can be appealed at the Chamber of Appeal of Sakpatenti within 3 months from the publication or at the Mtskheta District Court Administrative Cases Board (Address: №17, Samkhedro St., Mtskheta), within 1 month following the publication.

(260) AM 2023 112854 A\*

(800) 1589196

(151) 2020 11 19

(891) 2020 11 19

(731) Zakrytoe aktsionernoe obshchestvo "Myasnaya galereya"

ul. Poliny Osipenko, d. 65, of. 10, RU-600009  
g. Vladimir, Russian Federation

(540)

# Горячая штучка

(591) Black, white

(531) 28.05

(511)

29 – Meat, fish, poultry and game; meat extracts; preserved, frozen, dried and cooked fruits and vegetables; jellies, jams, compotes; eggs; milk and milk products; edible oils and fats; alginates for culinary purposes; anchovy, not live; peanuts, prepared; albumen for culinary purposes; white of eggs; beans, preserved; soya beans, preserved, for food; broth; ginger jam; fatty substances for the manufacture of edible fats; edible birds' nests; peas, preserved; mushrooms, preserved; gelatine; meat jellies; jellies for food; fruit jellies; yolk of eggs; coconut fat; bone oil for food; lard; suet for food; fruit-based snack food; charcuterie; raisins; caviar; sauerkraut; isinglass for food; blood sausage; meat, canned; vegetables, canned; fish, canned; fruits, canned; broth concentrates; gherkins; shrimps, not live; buttercream; croquettes; silkworm chrysalis for human consumption; toasted laver; spiny lobsters, not live; salmon, not live; onions, preserved; margarine; marmalade; vegetable oils for food; peanut butter; cocoa butter for food; coconut oil for food; butter; mussels, not live; almonds, ground; animal marrow for food; mollusks, not live; soya milk; fish meal for human consumption; fruit pulp; meat, preserved; potato fritters; olives, preserved; lobsters, not live; coconut, desiccated; nuts, prepared; tomato paste; liver pâté; pectin for culinary purposes; liver; pickles; powdered eggs; products made from salted ham; kimchi; fish-based foodstuffs; prostokvasha [soured milk]; poultry, not live; pollen prepared as foodstuff; cranberry compote; apple purée; crustaceans, not live; fish, not live; fish, preserved; vegetable salads; fruit salads; bacon; sardines, not live; pork; herrings, not live; whipped cream; fat-containing mixtures for bread slices; tomato juice for cooking; vegetable juices for cooking; salted meats; sausages in batter; preparations

aking bouillon; preparations for making soup; tripe; soups; vegetable soup preparations; cheese; tahini; tofu; sea-cucumbers, not live; truffles, preserved; tuna, not live; oysters, not live; rennet; fish fillets; dates; frosted fruits; fruit preserved in alcohol; potato flakes; hummus; fruit peel; lentils, preserved; potato chips; fruit chips; seaweed extracts for food; snail eggs for consumption.

30 – Coffee; tea; cocoa; sugar; rice; tapioca; sago; artificial coffee; flour and preparations made from cereals; bread, pastry and confectionery; ice cream; honey; treacle; yeast; baking powder; salt; mustard; vinegar; condiments; spices; edible ices; aromatic preparations for food; food flavorings, other than essential oils; star aniseed; biscuits; pancakes; buns; bread rolls; vanillin [vanilla substitute]; vanilla flavorings for culinary purposes; waffles; vermicelli; coffee flavorings; natural sweeteners; sausage binding materials; binding agents for edible ices; sea water for cooking; glucose for culinary purposes; thickening agents for cooking foodstuffs; rice-based snack food; cereal-based snack food; vegetal preparations for use as coffee substitutes; confectionery for decorating Christmas trees; fruit jellies [confectionery]; cakes; peanut confectionery; almond confectionery; pasta; pasties; frozen yogurt [confectionery ices]; capers; caramels [sweets]; gruel, with a milk base, for food; quiches; gluten prepared as foodstuff; sweets; liquorice [confectionery]; peppermint sweets; unroasted coffee; starch for food; crackers; hominy grits; groats for human food; corn, milled; corn, roasted; meat pies; turmeric; couscous; farinaceous foods; noodles; ice for refreshment; ice, natural or artificial; lollipops [confectionery]; rice cakes; maltose; hominy; marzipan; custard; royal jelly; fruit ice cream; muesli; mint for confectionery; cocoa beverages with milk; coffee beverages with milk; coffee-based beverages; tea-based beverages; chocolate beverages with milk; chocolate-based beverages; cocoa-based beverages; infusions, not medicinal; crushed oats; husked oats; nutmegs; pastilles [confectionery]; molasses for food; pepper; petits fours; cookies; pies; pizzas; fondants [confectionery]; popcorn; powders for making ice cream; pralines; meat tenderizers for household purposes; oat-based food; bee glue; gingerbread; puddings; cake powder; ravioli; pelmeni; chewing gum; spring rolls; aniseed; cake dough; sugar confectionery; baking soda [bicarbonate of soda for cooking purposes]; malt for human consumption; salt for preserving foodstuffs; cooking salt; celery salt; spaghetti; seasonings; prepa-

rations for stiffening whipped cream; rusks; bread-crumbs; sushi; sandwiches; tabbouleh; tacos; soya bean paste; almond paste; tortillas; fruit and berry cakes; garden herbs, preserved [seasonings]; candy decorations for cakes; ferments for pastes; halvah; unleavened bread; chips [cereal products]; chicory [coffee substitute]; iced tea; chocolate; malt extract for food; essences for foodstuffs, except etheric essences and essential oils; piccalilli.

43 – Services for providing food and drink; providing temporary accommodation; accommodation bureau services [hotels, boarding houses]; rental of temporary accommodation; rental of meeting rooms; tourist home services; hotel reservations; boarding house bookings; temporary accommodation reservations; hotel services; snack-bar services; café services; cafeteria services; motel services; boarding house services; rental of chairs, tables, table linen, glassware; rental of tents; rental of transportable buildings; restaurant services; self-service restaurant services; canteen services; holiday camp services [lodging]; bar services; providing campground facilities; food and drink catering.

(260) AM 2023 114635 A\*

(800) 1613263

(151) 2021 06 15

(891) 2021 06 15

(731) IDAI NATURE, S.L.

C/ Moscú, 10, Pol. Ind. Mas de Tous La Pobla de Vallbona, E-46185 Valencia, Spain

(540)



— A ROVENSA COMPANY —

(591) Green and blue

(531) 05.03.11; 05.03.14; 05.03.15; 26.03.04;  
26.03.06; 26.11.02; 26.11.08; 26.13.25;  
27.05.07; 29.01.12

(526) We renounce our claim to exclusive rights of the following elements: nature; A; COMPANY

(511)

1 – Culture media, fertilizers and chemical products intended for agriculture, horticulture and forestry; chemical products for agricultural use, except fungicides, herbicides, insecticides and parasiticides; natural fertilizers; organic fertilizers; organic fertilizers; biofertilizers; biostimulants; compost, manures, fertilizers.

5 – Products and preparations for pest control; fungicides; herbicides; products for destroying vermin; biocides; biopesticides for agriculture; acaricides for agricultural use; fungicidal fungal agents; algicides for agricultural use; biological herbicides; herbicides

for agricultural use; insecticides for agricultural use; bofungicides for agricultural use; bioinsecticides for agricultural use; products and preparations from micro-organisms, botanical and mineral extracts for bio-control of pests.

(260) AM 2023 115581 A\*

(800) 1135754

(151) 2012 06 26

(891) 2021 10 15

(731) "INTERNATIONAL MASIS TABAK" LLC  
10 Hrant Vardanyan str., Masis, 0802 Ararat region, Armenia

(540)

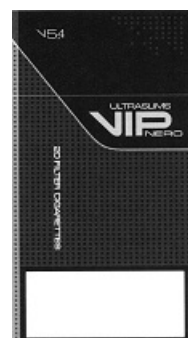

(591) Black and silver

(531) 19.03.03; 25.07.03; 29.01.12

(526) ULTRASLIMS, NERO, 20 FILTER CIGARETTES.

(511)

34 – Tobacco; smokers articles; matches.

(260) AM 2023 116605 A

(800) 1644101

(151) 2021 09 22

(891) 2021 09 22

(731) ENNA LLC

2/9, Ajami str.,; Nakhchivan city;  
AZ-7000 Nakhchivan Autonomous Republic,  
Azerbaijan

(540)



(591) Black, white

(531) 26.04.18; 27.05.01

(511)

32 – Mineral and carbonated waters and other non-alcoholic drinks; multivitamin drinks; fruit juice drinks, non-alcoholic; energy and fruit drinks; fruit juices, fruit concentrates and purees used as ingredients of beverages; syrups for making fruit-flavored drinks.

35 – Advertising and sale services of mineral and carbonated waters and other non-alcoholic drinks, multi-

vitamin drinks, fruit juice drinks, non-alcoholic, energy and fruit drinks, fruit juices, fruit concentrates and purees used as ingredients of beverages, syrups for making fruit-flavored drinks; business management, business administration; office functions.

(260) AM 2023 117203 A

(800) 1651222

(151) 2021 12 29

(891) 2021 12 29

(731) SUBSIDIARY COMPANY

"CONFECTIONERY CORPORATION

"ROSHEN"

1 Nauky Avenue, office 1, Kyiv 03039,

Ukraine

(540)



(591) Black, white

(531) 06.01.02; 06.01.04; 08.01.23; 09.01.10;  
20.05.24; 25.01.19; 26.13.25; 26.15.25;  
27.05.01; 27.05.08

(511)

30 – Chocolate-coated nuts; confectionery; sweets; chocolate.

(260) AM 2023 117676 A

(800) 1659072

(151) 2022 02 01

(891) 2022 02 01

(731) Apple Inc.

One Apple Park Way, Cupertino CA 95014,

USA

(540)



(591) Black, white

(531) 26.03.04; 26.13.25

(526) DIGITAL MASTER

(511)

41 – Audio engineering services, namely, mixing, recording, reproducing, manipulating, and equalizing sound and music recordings; providing consulting and

information services concerning audio and music production; providing audio and music production services; entertainment services, namely, providing prerecorded audio content, information and commentary in the field of music on-line via a global computer network; entertainment services, namely, recording, production, and post-production services in the field of music.

(260) AM 2023 117677 A

(800) 1659076

(151) 2022 02 01

(891) 2022 02 01

(731) Apple Inc.

One Apple Park Way, Cupertino CA 95014,  
USA

(540)



(591) Black, white

(531) 26.03.04; 26.13.25

(526) DIGITAL MASTER

(511)

9 – Computer software development tools for processing digital music files; computer software for use in digitalizing, authoring, downloading, transmitting, receiving, editing, playing, storing, and encoding audio files; computer software to enable users to program and distribute audio files via communications networks; audio recordings featuring music and artistic performances; computer software for computer data processing, data storage, file management and database management.

(260) AM 2023 117702 A

(800) 1659818

(151) 2021 12 09

(891) 2021 12 09

(731) PRIVATE JOINT-STOCK COMPANY

"VENTILATION SYSTEMS"

Vul. M. Kotsiubynskoho, 1, m. Kyiv 01030,

Ukraine

(540)



(591) Black, white

(531) 05.05.20; 05.07.11; 05.07.12; 05.07.22;  
15.01.13; 26.11.02; 26.11.06; 26.11.12;  
26.13.25; 27.05.01; 27.05.19

(511)

6 – Reinforcing materials of metal for pipes; hardware of metal, small; water-pipes of metal; gutter pipes of metal; sleeves [metal hardware]; street gutters of metal; accordion doors of metal; folding doors of metal;



swing doors of metal; chimney cowls of metal; chimneys of metal; chimney shafts of metal; drain pipes of metal; jalousies of metal; plugs of metal; hoop iron; outdoor blinds of metal; clips of metal for cables and pipes; junctions of metal for pipes; water-pipe valves of metal; drain traps [valves] of metal; valves of metal, other than parts of machines; chimney pots of metal; manifolds of metal for pipelines; elbows of metal for pipes; pipe muffs of metal; penstock pipes of metal; casings of metal for oilwells; branching pipes of metal; fireplace grates of metal; grilles of metal; furnace fireguards of metal; ducts of metal for ventilating and air-conditioning installations; ducts of metal, for central heating installations / ducts and pipes of metal for central heating installations; pipes of metal; steel pipes; pipework of metal; fittings of metal for compressed air lines.

7 – Vacuum pumps [machines]; fans for motors and engines; centrifugal pumps; suction machines for industrial purposes; motors, other than for land vehicles; flues for engine boilers; feeders [parts of machines]; feeding apparatus for engine boilers; valves [parts of machines]; compressors [machines]; compressors for refrigerators; steam condensers [parts of machines]; condensing installations; pumps [machines]; pumps [parts of machines, engines or motors]; pumps for heating installations; fittings for engine boilers; steam engines; fan belts for motors and engines; air suction machines; blowing machines; fans for the compression, sucking and carrying of grain; blowing machines for the compression, exhaustion and transport of gases; air condensers; air pumps [garage installations]; boiler tubes [parts of machines]; filters for cleaning cooling air, for engines; filters being parts of machines or engines; filter presses; filtering machines.

11 – Steam accumulators; heat accumulators; hot air apparatus; air deodorizing apparatus; ionization apparatus for the treatment of air or water; air cooling apparatus; desiccating apparatus; drying apparatus for fodder and forage; hand drying apparatus for washrooms; air purifying apparatus and machines; fans [air-conditioning]; fans [parts of air-conditioning installations]; electric fans for personal use; ventilation [air-conditioning] installations for vehicles; ventilation [air-conditioning] installations and apparatus; extractor hoods for kitchens; ventilation hoods; ventilation hoods for laboratories; pipes [parts of sanitary installations]; disinfectant apparatus; disinfectant apparatus for medical purposes; deodorizing apparatus, not for personal use; chimney flues; flues for heating boilers; safety accessories for water or gas apparatus and pipes; humidifiers; coils [parts of distilling, heating or cooling installations]; air valves for steam heating installations; furnace grates; air conditioners for vehicles; taps for pipes and pipelines; mixer taps for water pipes; boilers, other than parts of machines; steam boilers, other than parts of machines; cooling appliances and installations; air-conditioning apparatus; air

sterilizers; thermostatic valves [parts of heating installations]; pipes [parts of sanitary installations]; boiler pipes [tubes] for heating installations; air-conditioning installations; filters for air conditioning.

19 – Water-pipes, not of metal; roof gutters, not of metal; gutter pipes, not of metal; street gutters, not of metal; accordion doors, not of metal; folding doors, not of metal; swing doors, not of metal; chimney shafts, not of metal; lengthening pieces, not of metal, for chimneys; drain pipes, not of metal; jalousies, not of metal; water-pipe valves, not of metal or plastic; drain traps [valves], not of metal or plastic; chimney pots, not of metal; penstock pipes, not of metal; branching pipes, not of metal; ducts, not of metal, for ventilating and air-conditioning installations; rigid pipes, not of metal, for building.

(260) AM 2023 117703 A

(800) 1659824

(151) 2022 01 03

(891) 2022 01 03

(731) ELFA PHARM SPÓŁKA Z OGRANICZONĄ  
ODPOWIEDZIALNOŚCIĄ  
Chociw 99, PL-98-170 Widawa, Poland

(540)

**UKOI**

(591) Black, white

(511)

3 – Cosmetics; face and body creams; face and body emulsions; face and body lotions; face and body gels; face and body foams; non-medicated skin oils and lotions; non-medicated foot cleansers and foot care products; soap; non-medicinal washing and bathing preparations; hair cleansers and hair care products; shampoos; hair balm; hair nourishers; hair creams; hair emulsions; hair lotions; hair gel; hair mousse; perfumery products; perfumes; toilet water and eaux de cologne; ethereal oils; personal deodorants and antiperspirants; make-up and make-up remover; cleaning fluids; non-medicated lip care and painting products; nail care and painting products; cleansers for intimate personal hygiene purposes, non medicated; sunscreen and UV-protection products; self-tanning products; depilatory preparations; make-up powders; bath powders; body powder; non-medicinal dental and oral care products; non-medicated toiletries; non-medicated toiletry preparations; non-medicated cosmetics and toiletry preparations; shaving foam; shaving gel; after shave balms; interior & car fragrances.

5 – Dietary supplements and dietetic preparations; food supplements for medical and non-medical use; food supplements; dietary supplements for people with special dietary requirements; food supplements in jelly form; food supplements in jelly form; food supplements containing albumin; mineral food additives; nutritional supplements; glucose dietary supplements;

protein supplements; food supplements containing the enzyme; food supplements containing alginate; casein dietary supplements; lecithin dietary supplements; food supplements containing soy protein; health food supplements made primarily of minerals; dietetic substances adapted for medical use; vitamin tablets; vitamin and mineral supplements; vitamin preparations in the nature of food supplements; slimming tablets; medical preparations for slimming purposes; appetite stimulant preparations; vitamin drinks; medicated isotonic drinks; mineral drinks (medicated -); drinks to supplement the diet; medicated chemical preparations for skin protection and hygiene purposes; pharmaceuticals and natural remedies; cosmetics with healing properties; ointments, balms, creams, emulsions, liquids, gels, oils for therapeutic and medical purposes; herbal teas for medicinal purposes; teas made of herbs for medicinal purposes; dermatological preparations.

(260) AM 2023 117704 A

(800) 1659962

(151) 2022 02 09

(891) 2022 02 09

(731) TADIM GIDA MADDELERİ SANAYİ VE  
TİCARET ANONİM ŞİRKETİ  
GEBZE OSB2 MAH. 1100. SK. 1105 /2 1,  
Çayırova Kocaeli, Türkiye

(540)

## TADIM FISTIXX

(591) Black, white

(531) 27.05.01

(511)

29 – Dried, preserved, frozen, cooked, smoked or salted fruits and vegetables; tomato paste; prepared nuts and dried fruits as snacks.

(260) AM 2023 117705 A

(800) 182775

(151) 1955 02 15

(891) 2022 03 28

(731) Henkel AG & Co. KGaA

Henkelstrasse 67, 40589 Düsseldorf, Germany

(540)

## GLISS

(591) Black, white

(531) 27.05.01; 27.05.17

(511)

3 – Perfumery goods, body and beauty care products, essential oils, cosmetics, hair care and treatment substances, soaps, washing and bleaching substances, starch and starch preparations for laundering, laundry blueing.

(260) AM 2023 117706 A

(800) 968968

(151) 2008 06 06

(891) 2022 04 15

(731) LES PRODUITS PAUL BOCUSE

18 avenue Félix Faure, F-69007 LYON, France

(540)

## BOCUSE D'OR

(591) Black, white

(511)

35 – Organisation of exhibitions and events for commercial or advertising purposes, search for sponsors; services of sales promotion for others, rental of advertising space.

41 – Organisation of events for cultural or entertainment purposes, more specifically arranging and conducting of seminars, symposiums and conferences on cooking and the table arts, providing of training in culinary matters, organisation of competitions.

(260) AM 2023 117709 A

(800) 1379004

(151) 2017 10 11

(891) 2022 04 19

(731) LABORATOIRES PARIS DOME

Z.I de Droué sur Drouette, Lieu-dit la Queue  
d'Hirondelle, F-28230 ÉPERNON, France

(540)

## CALLIDERM

(591) Black, white

(511)

3 – Bleaching preparations and other substances for laundry use; cleaning, polishing, degreasing and abrasive preparations; soaps; perfumes, essential oils, hair lotions; dentifrices; depilatories; make-up removing products; lipstick; beauty masks; shaving products; preservatives for leather (polishes); creams for leather; all the aforesaid goods of French origin or made in France.

5 – Products for destroying vermin; herbicides; parasiticides.

44 – Agricultural, horticultural and forestry services; medical services; veterinary services; medical assistance; plastic surgery; hospital services; nursing homes; convalescence or rest homes; opticians' services; alternative medicine services; gardening; landscape gardening services.

(260) AM 2023 117799 A

(800) 1648167

(151) 2022 01 18

(891) 2022 04 13

(731) KT & G CORPORATION

71, Beotkkot-gil, Daedeok-gu, Daejeon,  
Republic of Korea

(540)

**il HYBRID Ez**

(591) Black, white

(511)

34 – Cigarettes; tobacco; tobacco substitutes; cigars; electronic cigarettes; liquid nicotine solutions for use in electronic cigarettes; liquid solutions for use in electronic cigarettes; flavorings, other than essential oils, for use in electronic cigarettes; humidors; cigar cutters; ashtrays for smokers; electronic cigarette cartridges; neck chains for electronic cigarettes; atomizers for electronic cigarettes; smokers' articles (including lighters for smokers); sticks for cleaning and disinfecting electronic cigarettes; cleaning brushes for electronic cigarettes; pads for cleaning electronic cigarettes; cleaners for electronic cigarettes; cleaning implements for electronic cigarettes; cleaning apparatus for electronic cigarettes; electric cleaners for electronic cigarettes; cases for electronic cigarettes; smokeless tobacco; smokeless cigarette vaporizer pipes; holders for electronic devices for the purpose of heating cigarettes or tobacco, tobacco products and tobacco substitutes; tobacco sticks for electronic cigarettes.

(260) AM 2023 117800 A

(800) 1648614

(151) 2022 01 18

(891) 2022 04 13

(731) KT &amp; G CORPORATION

71, Beotkot-gil, Daedeok-gu, Daejeon,  
Republic of Korea

(540)

**il SOLID Ez**

(591) Black, white

(511)

34 – Cigarettes; tobacco; tobacco substitutes; cigars; electronic cigarettes; liquid nicotine solutions for use in electronic cigarettes; liquid solutions for use in electronic cigarettes; flavorings, other than essential oils, for use in electronic cigarettes; humidors; cigar cutters; ashtrays for smokers; electronic cigarette cartridges; neck chains for electronic cigarettes; atomizers for electronic cigarettes; smokers' articles (including lighters for smokers); sticks for cleaning and disinfecting electronic cigarettes; cleaning brushes for electronic cigarettes; pads for cleaning electronic cigarettes; cleaners for electronic cigarettes; cleaning implements for electronic cigarettes; cleaning apparatus for electronic cigarettes; electric cleaners for electronic cigarettes; cases for electronic cigarettes; smokeless tobacco; smokeless cigarette vaporizer pipes; holders for electronic devices for the purpose of heating cigarettes or tobacco, tobacco products and tobacco substitutes; tobacco sticks for electronic cigarettes.

(260) AM 2023 117848 A

(800) 1661146

(151) 2022 04 08

(891) 2022 04 08

(731) Janssen Pharmaceutica NV

Turnhoutseweg 30, B-2340 Beerse, Belgium

(540)

**ZACLIPTA**

(591) Black, white

(511)

5 – Pharmaceutical preparations for human use.

(260) AM 2023 117849 A

(800) 1661151

(151) 2022 04 11

(891) 2022 04 11

(731) Ce Soir Inc

7th Floor, 323 Sunny Isles Boulevard,  
Sunny Isles Beach FL 33160, USA

(540)

**CE SOIR**

(591) Black, white

(511)

25 – Hats; hoodies; lingerie; pants; shirts; shorts; sports caps and hats; sweatshirts; panties; underwear; ladies' underwear; men's underwear; long-sleeved shirts; short-sleeved shirts; T-shirts; thong underwear; bras.

(260) AM 2023 117851 A

(800) 1661313

(151) 2022 03 17

(891) 2022 03 17

(731) Ricosta Schuhfabriken GmbH

Dürreimer Strasse 43, 78166 Donaueschingen,  
Germany

(540)



(591) Olive green and white

(531) 02.09.19; 24.03.07; 24.03.12; 24.03.18;  
29.01.12

(511)

25 – Footwear, in particular baby walking shoes, shoes for children, teens, men and women, boots.

(260) AM 2023 117852 A  
 (800) 1661404  
 (151) 2022 04 12  
 (891) 2022 04 12  
 (731) Kia Corporation  
 12, Heolleung-ro, Seocho-gu, Seoul 06797,  
 Republic of Korea

(540)

**wible**

(591) Black, white  
 (531) 27.05.01; 27.05.17  
 (511)  
 12 – Automobiles; parts and fittings for automobiles;  
 sports cars; vans; motor trucks; motor buses; electric  
 cars.

(260) AM 2023 117853 A  
 (800) 1661450  
 (151) 2022 01 12  
 (891) 2022 01 12  
 (731) Euro Games Technology Ltd.  
 4, "Maritsa" Str., "Vranya-Lozen-Triugulnika",  
 BG-1151 Sofia, Bulgaria

(540)

**GLORIOUS  
 ALEXANDER**

(591) Red and yellow  
 (531) 05.13.01; 27.05.01; 27.05.02; 27.05.03;  
 27.05.04; 27.05.08; 27.05.10; 29.01.12  
 (511)  
 9 – Software; computer gaming software; computer  
 software packages; computer operating system soft-  
 ware; computer software, recorded; software drivers;  
 virtual reality software; games software; entertain-  
 ment software for computer games; computer pro-  
 grams for network management; operating computer  
 software for main frame computers; monitors (com-  
 puter hardware); computer hardware; apparatus for re-  
 cording images; monitors (computer programs); com-  
 puter game programs; computer programs for recor-  
 ded games; apparatus for recording, transmission or  
 reproduction of sound or images; communications  
 servers [computer hardware]; electronic components  
 for gambling machines; computer application softwa-  
 re featuring games and gaming; computer software for  
 the administration of on-line games and gaming; co-  
 mputer hardware for games and gaming; electronic  
 components and computer software for gambling, ga-  
 mbling machines, gambling games on the Internet and  
 via telecommunication network.

28 – Gaming machines for gambling; chips for gam-  
 bling; mah-jong; arcade games; gambling machines  
 operating with coins, notes and cards; games; electro-  
 nic games; parlor games; gaming chips; gaming tab-

les; slot machines [gaming machines]; LCD game  
 machines; slot machines and gaming devices; coin-  
 operated amusement machines; roulette chips; poker  
 chips; chips and dice [gaming equipment]; gaming  
 equipment for casinos; roulette tables; gaming roulette  
 wheels; casino games; gambling machines and amuse-  
 ment machines, automatic and coin-operated; coin-  
 operated amusement machines and/or electronic coin-  
 operated amusement machines with or without the po-  
 ssibility of gain; boxes for coin-operated amusement  
 machines, slot machines and gaming machines; elec-  
 tronic or electrotechnical amusement machines and  
 apparatus, gaming machines, coin-operated entertain-  
 ment machines; housings for coin-operated amuse-  
 ment machines, gaming equipment, gaming machines,  
 machines for gambling; electropneumatic and electri-  
 cal gambling machines (slot machines).

41 – Gambling; entertainment services related to gam-  
 bling; gaming services for entertainment purposes;  
 casino, gaming and gambling services; training in the  
 development of software systems; provision of gam-  
 ing equipment for gambling halls; providing casino  
 equipment [gambling]; gaming machine entertainment  
 services; providing casino facilities [gambling]; ga-  
 ming hall services; amusement arcade services; games  
 equipment rental; rental of gaming machines; provi-  
 ding amusement arcade services; rental of gaming  
 machines with images of fruits; editing or recording  
 of sounds and images; sound recording and video en-  
 tertainment services; hire of sound reproducing appa-  
 ratus; provision of gaming equipment for casinos;  
 providing of casino facilities; online gambling servi-  
 ces; casino, gaming and gambling services; provision  
 of gaming facilities and gaming hall facilities, Internet  
 casinos and online gambling services.

(260) AM 2023 117857 A  
 (800) 1661593  
 (151) 2022 03 01  
 (891) 2022 03 01  
 (731) AGF88 HOLDING Srl  
 Via del Palù 7/D, I-35018 San Martino di  
 Lupari (PD), Italy

(540)



(591) Black, white  
 (531) 24.03.01; 24.03.07; 24.03.18; 24.17.25;  
 26.11.13; 27.05.17

(511)  
 3 – Hair care lotions; hair dyes; shampoo; hair gel; ha-  
 ir spray; hair creams; oils for hair; hair conditioners;

hair bleaching preparations; non-medical, non-oxygenated hair care products; non-medical anti-dandruff shampoo; non-medical lotions for preventing hair loss; hair tints.

(260) AM 2023 117858 A

(800) 1661643

(151) 2022 03 10

(891) 2022 03 10

(731) Yandex LLC

Leo Tolstoy Str., 16, RU-119021 Moscow,  
Russian Federation

(540)



(591) White and red

(531) 26.01.03; 26.01.18; 26.01.24; 28.05; 29.01.12

(511)

6 – Doors of metal; жалюзи of metal; outdoor blinds of metal; box fasteners of metal; locks of metal for bags; locks of metal for vehicles; locks of metal, other than electric; padlocks of metal, other than electronic; spring locks; road signs, non-luminous and non-mechanical, of metal; registration plates of metal; signs, non-luminous and non-mechanical, of metal; keys of metal; door fittings of metal; fittings of metal for windows; safes [metal or non-metal]; safes, electronic; bicycle parking installations of metal; letter boxes of metal.

7 – 3D printers; vending machines; moving walkways; coffee grinders, other than hand-operated; grinding machines; dishwashers; bottle filling machines; peeling machines; waste compacting machines; machines and apparatus for cleaning, electric; machines and apparatus for carpet shampooing, electric; kitchen machines, electric; wringing machines for laundry; washing machines [laundry]; coin-operated washing machines; spin driers [not heated]; vacuum cleaners; industrial robots; 3D printing pens; juice extractors, electric; washing installations for vehicles; washing apparatus; door openers, electric; beverage preparation machines, electromechanical; food preparation machines, electromechanical; shoe polishers, electric; electric fruit presses for household purposes; window closers, electric; window openers, electric.

9 – DVD players; ticket dispensers; coin-operated musical automata [juke boxes]; accumulators, electric, for vehicles; antennas; remote control apparatus; electro-dynamic apparatus for the remote control of signals; monitoring apparatus, other than for medical purposes; sound recording apparatus; Global Positioning

System [GPS] apparatus; intercommunication apparatus; projection apparatus; telephone apparatus; solar panels for the production of electricity; electronic tags for goods; computer memory devices; encoded identification bracelets, magnetic; connected bracelets [measuring instruments]; electronic key fobs being remote control apparatus; camcorders; video baby monitors; video projectors; video telephones; video screens; mechanical signs; signs, luminous; parking sensors for vehicles; joysticks for use with computers, other than for video games; floppy disks; sound recording discs; wearable video display monitors; electronic numeric displays; DNA chips; electronic interactive whiteboards; electronic notice boards; locks, electric; electric door bells; interfaces for computers; electronic pens [visual display units]; biometric identity cards; identity cards, magnetic; memory cards for video game machines; encoded magnetic cards; computer keyboards; thin client computers; downloadable cryptographic keys for receiving and spending cryptocurrency; encoded key cards; electronic book readers; electronic agendas; magnetic encoders; computers; laptop computers; tablet computers; notebook computers; wearable computers; downloadable e-wallets; vacuum tubes [radio]; darkroom lamps [photography]; thermionic tubes; amplifying tubes; flashlights [photography]; crash test dummies; resuscitation mannequins [teaching apparatus]; security tokens [encryption devices]; voting machines; money counting and sorting machines; mechanisms for coin-operated apparatus; coin-operated mechanisms for television sets; microprocessors; modems; monitors [computer hardware]; monitors [computer programs]; selfie sticks [hand-held monopods]; headphones; earpieces for remote communication; sound recording carriers; magnetic data media; optical data media; electronic sheet music, downloadable; computer software, recorded; computer hardware; selfie lenses; wrist rests for use with computers; spectacles; sunglasses; goggles for sports; electronic collars to train animals; signalling panels, luminous or mechanical; biometric passports; electronic pocket translators; transmitters [telecommunication]; telephone transmitters; transmitters of electronic signals; switches, electric; data gloves; computer software platforms, recorded or downloadable; wafers for integrated circuits; protective films adapted for computer screens; protective films adapted for smartphones; sound recording strips; digital signs; personal digital assistants [PDAs]; diagnostic apparatus, not for medical purposes; distance recording apparatus; distance measuring apparatus; speed measuring apparatus [photography]; speed checking apparatus for vehicles; teaching apparatus; time recording apparatus; apparatus and instruments for astronomy; surveying apparatus and instruments; navigational instruments; measuring apparatus; measuring devices, electric; meteorological instruments; observation instruments; navigation apparatus for vehicles [on-board computers]; satellite navigational apparatus;

tus; regulating apparatus, electric; telecommunication apparatus in the form of jewellery; precision measuring apparatus; audio- and video-receivers; computer software applications, downloadable; ticket printers; printers for use with computers; computer programs, recorded; computer game software, downloadable; computer game software, recorded; computer programs, downloadable; computer operating programs, recorded; computer screen saver software, recorded or downloadable; record players; processors [central processing units]; electronic publications, downloadable; distribution consoles [electricity]; control panels [electricity]; radar apparatus; transmitting sets [telecommunication]; radios; vehicle radios; walkie-talkies; security surveillance robots; laboratory robots; teaching robots; telepresence robots; humanoid robots with artificial intelligence for use in scientific research; electric sockets; signals, luminous or mechanical; electronic access control systems for interlocking doors; hand-held electronic dictionaries; integrated circuit cards [smart cards]; smartglasses; smartphones; smartwatches; audiovisual teaching apparatus; charging stations for electric vehicles; bags adapted for laptops; integrated circuits; parking meters; kilometer recorders for vehicles; revolution counters; taximeters; television apparatus; teleprinters; cordless telephones; mobile telephones; credit card terminals; interactive touch screen terminals; thermostats; thermostats for vehicles; climate control digital thermostats; step-up transformers; resuscitation training simulators; vehicle breakdown warning triangles; telephone receivers; headgear being protective helmets; gauges; amplifiers; electric installations for the remote control of industrial operations; baby monitors; steering apparatus, automatic, for vehicles; video recorders; sound reproduction apparatus; invoicing machines; railway traffic safety appliances; data processing apparatus; theft prevention installations, electric; devices for the projection of virtual keyboards; optical character readers; battery chargers; chargers for electric accumulators; chargers for electronic cigarettes; acoustic alarms; apparatus for editing cinematographic film; couplers [data processing equipment]; anti-theft warning apparatus; computer peripheral devices; acoustic couplers; alarms; fog signals, non-explosive; whistle alarms; adding machines; electric and electronic effects units for musical instruments; bar code readers; downloadable image files; downloadable music files; animated cartoons; filters for use in photography; USB flash drives; cameras [photography]; digital photo frames; enlarging apparatus [photography]; containers for contact lenses; spectacle cases; cases for smartphones; cases especially made for photographic apparatus and instruments; spectacle chains; sleeves for laptops; covers for personal digital assistants [PDAs]; covers for tablet computers; covers for smartphones; chips [integrated circuits]; cell phone straps; spectacle cords; workmen's protective face-shields; downloadable graphics for mobile phones; epi-

diascopes; ergometers; 3D spectacles; downloadable emoticons for mobile phones; mouse pads; screens [photography]; ear pads for headphones; mouse [computer peripheral]; trackballs [computer peripherals]; light dimmers [regulators], electric; safety restraints, other than for vehicle seats and sports equipment; wearable activity trackers; readers [data processing equipment]; downloadable ring tones for mobile phones; scanners [data processing equipment].

11 – Air deodorizing apparatus; hand drying apparatus for washrooms; fans [air-conditioning]; fans [parts of air-conditioning installations]; electric fans for personal use; water heaters; air-conditioning apparatus; air conditioners for vehicles; gas boilers; laundry room boilers; heating boilers; coffee machines, electric; electric lights for Christmas trees; acetylene flares; safety lamps; gas lamps; curling lamps; nail lamps; curing lamps, not for medical purposes; germicidal lamps for purifying air; light bulbs for directional signals for vehicles; ultraviolet ray lamps, not for medical purposes; electric lamps; chandeliers; multicookers; heating apparatus for defrosting vehicle windows; bread toasters; humidifiers; air-conditioning installations; kettles, electric.

12 – Motor buses; motor coaches; camping cars; driverless cars [autonomous cars]; motor racing cars; cars; robotic cars; sports cars; luggage carriers for vehicles; bumpers for automobiles; vehicle bumpers; bicycles; electric bicycles; helicopters; helicams; lorries; trucks with a crane feature incorporated; doors for vehicles; engines for land vehicles; military drones; civilian drones; delivery drones; camera drones; vehicle wheels; strollers; ships; mopeds; motor scooters; motorcycles; anti-theft devices for vehicles; push scooters [vehicles]; aeroplanes; anti-theft alarms for vehicles; reversing alarms for vehicles; safety seats for children, for vehicles; vehicle seats; snowmobiles; air vehicles; vehicles for locomotion by land, air, water or rail; ambulances; remote control vehicles, other than toys; electric vehicles; tricycles; delivery tricycles; yachts; self-balancing boards; self-balancing electric unicycles.

14 – Bracelets [jewelry]; watch bands; charms for key rings; alarm clocks; key rings [split rings with trinket or decorative fob]; retractable key rings; works of art of precious metal; jewellery; necklaces [jewelry]; split rings of precious metal for keys; rings [jewelry]; boxes of precious metal; presentation boxes for jewelry; watch cases [parts of watches]; clock cases; medals; lockets [jewelry]; coins; earrings; watch chains; dials [clock- and watchmaking]; watches; sundials; clocks and watches, electric; control clocks [master clocks]; clocks; wristwatches.

16 – Fountain pens; albums; banners of paper; name badges [office requisites]; tickets; baggage claim check tags of paper; forms, printed; announcement cards [stationery]; note books; pamphlets; booklets;

newsletters; signboards of paper or cardboard; newspapers; advertisement boards of paper or cardboard; magazines [periodicals]; periodicals; printed publications; graphic representations; calendars; pencils; pictures; cards; geographical maps; catalogues; books; boxes of paper or cardboard; flyers; teaching materials [except apparatus]; packing [cushioning, stuffing] materials of paper or cardboard; stickers [stationery]; covers [stationery]; passport holders; greeting cards; postcards; conical paper bags; loose-leaf binders; stands for pens and pencils; writing cases [sets]; writing materials; writing instruments; drawing materials; school supplies [stationery]; printed matter; arithmetical tables; placards of paper or cardboard; writing or drawing books; labels of paper or cardboard; posters; folders for papers.

18 – Pocket wallets; business card cases; umbrellas; cases of leather or leatherboard; purses; travelling sets [leatherware]; vanity cases, not fitted; clothing for pets; conference folders; briefcases; rucksacks; net bags for shopping; bags; key cases; suitcases; labels of leather.

19 – Outdoor blinds, not of metal and not of textile; jalousies, not of metal.

20 – Indoor window blinds [furniture]; indoor window blinds of paper; indoor window blinds of woven wood; indoor window blinds of textile.

25 – Footwear; clothing; headwear.

28 – Video game machines; toys; games; portable games and toys incorporating telecommunication functions; trading cards for games; video game consoles; hand-held consoles for playing video games; toy robots; slot machines [gaming machines]; remote-controlled toy vehicles; apparatus for games.

35 – Commercial information agency services; advertising agency services; rental of advertising space; computerized file management; demonstration of goods; opinion polling; market studies; marketing research; business management and organization consultancy; business organization consultancy; business management consultancy; consultancy regarding advertising communication strategies; layout services for advertising purposes; marketing services; marketing in the framework of software publishing; targeted marketing; scriptwriting for advertising purposes; news clipping services; updating and maintenance of information in registries; updating and maintenance of data in computer databases; updating of advertising material; word processing; online retail services for downloadable and pre-recorded music and movies; online retail services for downloadable ring tones; online retail services for downloadable digital music; organization of exhibitions for commercial or advertising purposes; arranging newspaper subscriptions for others; organization of fashion shows for promotional purposes; organization of trade fairs; shop window dressing;

data search in computer files for others; providing business information; providing business information via a web site; providing commercial and business contact information; providing commercial information and advice for consumers in the choice of products and services; providing user reviews for commercial or advertising purposes; web indexing for commercial or advertising purposes; providing user rankings for commercial or advertising purposes; retail services for works of art provided by art galleries; sales promotion for others; production of teleshopping programmes; production of advertising films; rental of advertising time on communication media; publicity material rental; rental of billboards [advertising boards]; rental of vending machines; rental of sales stands; consumer profiling for commercial or marketing purposes; publication of publicity texts; radio advertising; development of advertising concepts; bill-posting; distribution of samples; dissemination of advertising matter; direct mail advertising; registration of written communications and data; editing of publicity texts; advertising; online advertising on a computer network; advertising by mail order; television advertising; compilation of statistics; compilation of information into computer databases; business inquiries; systemization of information into computer databases; negotiation of business contracts for others; negotiation and conclusion of commercial transactions for third parties; compiling indexes of information for commercial or advertising purposes; telemarketing services; commercial administration of the licensing of the goods and services of others; business management of reimbursement programs for others; administration of consumer loyalty programs; administrative processing of purchase orders; public relations; market intelligence services; web site traffic optimization; search engine optimization for sales promotion; price comparison services; pay per click advertising; telephone switchboard services; provision of an online marketplace for buyers and sellers of goods and services; retail services for pharmaceutical, veterinary and sanitary preparations and medical supplies; media relations services; presentation of goods on communication media, for retail purposes; wholesale services for pharmaceutical, veterinary and sanitary preparations and medical supplies; retail or wholesale services for goods, including via the Internet.

36 – Financial analysis; rental of offices for co-working; savings bank services; capital investment; financial consultancy; crowdfunding; exchanging money; online banking; processing of debit card payments; processing of credit card payments; financial exchange of virtual currency; real estate affairs; organization of monetary collections; electronic funds transfer; providing rebates at participating establishments of others through use of a membership card; providing financial information; providing financial information via a web site; investment of funds; charitable fund

raising; stocks and bonds brokerage; financial sponsorship; mortgage banking; insurance underwriting; real estate management; financial management of reimbursement payments for others; real estate agency services; banking; stock brokerage services; e-wallet payment services; electronic transfer of virtual currencies; provident fund services; financing services.

37 – Vehicle battery charging; charging of electric vehicles; construction consultancy; vehicle washing; vehicle maintenance; vehicle polishing; vehicle breakdown repair services; providing information relating to repairs; providing construction information; motor vehicle maintenance and repair; vehicle greasing; vehicle service stations [refuelling and maintenance]; construction; heating equipment installation and repair; burglar alarm installation and repair; telephone installation and repair; installation and repair of air-conditioning apparatus; fire alarm installation and repair; freezing equipment installation and repair; electric appliance installation and repair; kitchen equipment installation; installation, maintenance and repair of computer hardware; machinery installation, maintenance and repair; office machines and equipment installation, maintenance and repair; interference suppression in electrical apparatus; vehicle cleaning; installation of doors and windows.

38 – News agency services; wireless broadcasting; television broadcasting; cable television broadcasting; electronic bulletin board services [telecommunications services]; providing user access to global computer networks; providing access to databases; providing telecommunications connections to a global computer network; providing telecommunication channels for teleshopping services; video-on-demand transmission; transmission of podcasts; message sending; computer aided transmission of messages and images; transmission of telegrams; transmission of digital files; providing information in the field of telecommunications; providing online forums; videoconferencing services; rental of message sending apparatus; rental of access time to global computer networks; rental of modems; rental of telecommunication equipment; rental of smartphones; rental of telephones; rental of facsimile apparatus; radio broadcasting; radio communications; transmission of electronic mail; communications by fiber optic networks; communications by cellular phones; communications by computer terminals; satellite transmission; communications by telegrams; communications by telephone; facsimile transmission; paging services [radio, telephone or other means of electronic communication]; teleconferencing services; telex services; voice mail services; streaming of data; telegraph services; telephone services; providing internet chatrooms; telecommunications routing and junction services; transmission of greeting cards online.

39 – Parking place rental; rental of warehouses; booking of seats for travel; travel reservation; transport reservation; delivery of newspapers; message delive-

ry; parcel delivery; delivery of goods; delivery of goods by mail order; replenishment of vending machines; arranging of passenger transportation services for others via an online application; arranging of transportation for travel tours; transport of travellers; bus transport; car transport; passenger transport; ambulance transport; transport brokerage; providing driving directions for travel purposes; providing traffic information; providing information relating to storage services; providing transportation information; car rental; rental of storage containers; rental of navigational systems; vehicle rental; carpooling services; wrapping of goods; car parking; chauffeur services; car sharing services; courier services [messages or merchandise]; taxi transport; transport; transport services for sightseeing tours; luggage storage; physical storage of electronically stored data or documents; storage of goods; storage.

40 – Recycling of waste and trash; photographic printing; rental of air-conditioning apparatus; rental of space heating apparatus; custom assembling of materials for others; sorting of waste and recyclable material [transformation]; custom 3D printing for others.

41 – Academies [education]; rental of artwork; lending library services; booking of seats for shows; videotaping; physical education; production of music; publication of books; layout services, other than for advertising purposes; correspondence courses; practical training [demonstration]; training services provided via simulators; providing recreation facilities; arranging and conducting of colloquiums; arranging and conducting of congresses; arranging and conducting of conferences; arranging and conducting of concerts; arranging and conducting of workshops [training]; arranging and conducting of seminars; arranging and conducting of symposiums; organization of competitions [education or entertainment]; vocational guidance [education or training advice]; television entertainment; vocational retraining; providing online videos, not downloadable; providing information in the field of education; providing information relating to recreational activities; providing information in the field of entertainment; providing online music, not downloadable; providing television programs, not downloadable, via video-on-demand services; providing films, not downloadable, via video-on-demand services; providing user reviews for entertainment or cultural purposes; providing user rankings for entertainment or cultural purposes; providing sports facilities; cinema presentations; providing online electronic publications, not downloadable; conducting fitness classes; educational examination; film production, other than advertising films; electronic desktop publishing; online publication of electronic books and journals; publication of texts, other than publicity texts; radio entertainment; entertainer services; entertainment services; writing of texts; news reporters services; film di-



recting, other than advertising films; party planning [entertainment]; music composition services; holiday camp services [entertainment]; video editing services for events; conducting guided tours; game services provided online from a computer network; club services; cultural, educational or entertainment services provided by art galleries; providing museum facilities [presentation, exhibitions]; teaching; educational services provided by schools; translation; ticket agency services [entertainment]; coaching [training]; sport camp services; recording studio services; photography; photographic reporting; timing of sports events; production of shows; organization of exhibitions for cultural or educational purposes; arranging and conducting of in-person educational forums.

42 – Computer system analysis; recovery of computer data; graphic design of promotional materials; industrial design; graphic arts design; computer virus protection services; installation of computer software; research and development of new products for others; scientific research; technological research; web site design consultancy; computer security consultancy; information technology [IT] consultancy; computer technology consultancy; consultancy in the design and development of computer hardware; internet security consultancy; computer software consultancy; data security consultancy; technological consultancy; updating of computer software; monitoring of computer systems to detect breakdowns; monitoring of computer systems for detecting unauthorized access or data breach; monitoring of computer systems by remote access; software as a service [SaaS]; maintenance of computer software; digitization of documents [scanning]; conversion of data or documents from physical to electronic media; providing information relating to computer technology and programming via a web site; providing search engines for the internet; conversion of computer programs and data, other than physical conversion; conducting technical project studies; computer system design; rental of web servers; computer rental; rental of computer software; hosting computer sites [web sites]; development of computer platforms; computer software design; software development in the framework of software publishing; server hosting; creating and designing website-based indexes of information for others [information technology services]; creating and maintaining web sites for others; computer programming; technical writing; copying of computer programs; cloud computing; information technology services provided on an outsourcing basis; off-site data backup; telecommunications technology consultancy; user authentication services using single sign-on technology for online software applications; user authentication services using technology for e-commerce transactions; weather forecasting; styling [industrial design]; cartography services; data encryption services; electronic data storage; electronic monitoring of credit card activity to detect fraud via the internet; electronic monitoring of persona-

lly identifying information to detect identity theft via the internet; platform as a service [PaaS].

43 – Rental of temporary accommodation; rental of meeting rooms; tourist home services; hotel reservations; boarding house bookings; temporary accommodation reservations; hotel services; snack-bar services; information and advice in relation to the preparation of meals; café services; cafeteria services; restaurant services; self-service restaurant services; reception services for temporary accommodation [management of arrivals and departures]; canteen services; food and drink catering.

45 – Leasing of internet domain names; legal research; intellectual property consultancy; monitoring intellectual property rights for legal advisory purposes; monitoring of burglar and security alarms; licensing [legal services] in the framework of software publishing; licensing of intellectual property; licensing of computer software [legal services]; registration of domain names [legal services]; personal background investigations; copyright management; legal administration of licences; dating services; alternative dispute resolution services; legal document preparation services; online social networking services; legal services in relation to the negotiation of contracts for others.

(260) AM 2023 117859 A

(800) 1661672

(151) 2021 11 30

(891) 2021 11 30

(731) Ekaterra Group IP Holdings B.V.

Weena 455, NL-3013 AL Rotterdam,  
Netherlands

(540)



(591) Green and white

(531) 05.03.13; 26.01.12; 26.01.15; 26.01.24;  
26.11.12; 26.13.25; 29.01.12

(511)

5 – Dietetic substances for medical use; herbal preparations for medical purposes; medicated herbal supplements and medicated herbal extracts; herbal tea for medicinal use; medicated herbal beverages; vitamins; minerals for human consumption; food supplements; nutritional supplements for human consumption.

30 – Coffee; artificial coffee; tea; tea products; tea extracts; iced tea; carbonated and non-carbonated iced tea; iced tea mix powders; non medicinal herbal tea and infusions; cocoa; flour and preparations made from cereals; pastries; confectionery; chocolate; bis-

cuits; ice cream; water ices; frozen confectionery; preserved herbs.

32 – Non-alcoholic beverages; soft drinks; sport drinks; energy drinks; mineral and aerated waters; flavoured water; carbonated and non-carbonated beverages; fruit beverages and fruit juices; vegetable juices; syrups and other non-alcoholic preparations for making beverages.

35 – Advertising; dissemination of advertising; publicity services; promotion services; market research; business management; accounts and book-keeping services; business administration; advertising consultancy services; office functions; clerical services; telephone answering services; retail, wholesale, online retail sale services relating to food and beverages; loyalty, incentive and bonus program services.

41 – Education and training advice, all in relation to food, refreshment and home consumer products; education and training advice, all in relation to food, beverages and wellbeing; arranging and conducting of seminars, workshops and discussion groups; sporting and cultural activities; publication of texts; organisation of exhibitions for cultural or educational purposes; presentation of works of visual art and literature to the public for cultural or educational purposes; entertainment services; entertainment information services; on-line electronic publications.

43 – Services for providing food and drink; catering; restaurants; information, advice and reservation services for the provision of food and drink.

(260) AM 2023 117860 A

(800) 1661673

(151) 2021 12 09

(891) 2021 12 09

(731) XINFAYOU

3rd Floor, Zixin Building, Donghai Street,  
362000 Quanzhou City, China

(540)

**JUST SO SO**

(591) Black, white

(511)

25 – Athletic shoes; athletic clothing; athletic tights; athletic uniforms; bathing costumes; bathing suits; beach shoes; beachwear; bib tights; blouses; body suits; jumpsuits; leisure shoes; mantles; rain boots; sandals; shoes; slippers; waterproof shoes; waterskiing suits; women's clothing; women's shoes; women's underwear; yoga pants; yoga shirts; men's and women's jackets, coats, trousers, vests; clothing; sports shoes; boots for sport.

(260) AM 2023 117861 A

(800) 1661683

(151) 2022 02 21

(891) 2022 02 21

(731) El Obour for Metallurgical Industries (GAIva METAL)

Plot 5 Block 13035, First Industrial Zone,  
El Obour, Kalyoubyah, Egypt

(540)



(591) Black, white

(531) 26.01.03; 26.01.18; 26.01.24; 26.04.05;

26.04.10; 26.04.18; 26.04.22; 27.05.01;

27.05.08; 27.05.09; 27.05.10; 27.05.24; 28.01

(511)

6 – Common metals and their alloys, ores; metal materials for building and construction; transportable buildings of metal; non-electric cables and wires of common metal; small items of metal hardware; metal containers for storage or transport; safes.

(260) AM 2023 117862 A

(800) 1661689

(151) 2022 04 05

(891) 2022 04 05

(731) Incyte Holdings Corporation

1801 Augustine Cut-Off, Wilmington  
DE 19803, USA

(540)

(591) Black, white

(531) 01.15.15

(511)

5 – Pharmaceutical preparations for the treatment of dermatological disorders.

16 – Printed publications, namely, brochures, newsletters, and pamphlets relating to medical issues, procedures, disease symptoms, patient support and community building.

44 – Providing medical information to healthcare providers and patients relating to dermatological disorders.

(260) AM 2023 117863 A

(800) 1661736

(151) 2021 12 14

(891) 2021 12 14

(731) DAW SE

Roßdörfer Str. 50, 64372 Ober-Ramstadt,  
Germany

(540)

## THE POWER OF SURFACE

(591) Black, white

(511)

1 – Industrial chemicals; preservatives and damp-proofing preparations for masonry, roofing tiles, cement and concrete, except paints and oils; raw artificial resins, synthetic resins and plastics; solvents (chemicals); solvents for paints; adhesives used in industry; adhesives for wallpaper; adhesives used in building; fillers for the treatment of subsurfaces before applying paint (not included in other classes).

2 – Primers; paint thickeners; fixatives [varnishes]; siccatives for paints; raw natural resins; solvents for thinning paints; preparations for preserving wood, wood mordants and wood preserving oils; paints, including structuring paints; bactericidal and/or fungicidal paints; anti-corrosion preparations; protective preparations for metals; metals in foil and powder form for painters, decorators, printers and artists; paints and washes, varnishes, lacquers, glazes, coating, preservatives against rust; colorants, dyestuffs, dye pastes, mordants; thinning and binding preparations for paints and lacquers.

6 – Building materials of metal or mainly of metal; expanded pierced metal; wire cloths of metal or mainly of metal; adjusting and levelling parts of metal or mainly of metal for building purposes; screws, pins and bolts (of metal or mainly of metal); spacers of metal or mainly of metal for building purposes; fixing anchors of metal or mainly of metal for building; sills of metal or mainly of metal; window sills of metal and components of metal for window sills.

7 – Machine tools; tools (not hand-operated) for painting and building namely special tools and instruments (not hand-operated) for coatings and facade facings, gluing apparatus (not hand-operated), mixers (not hand-operated), spray guns (not hand-operated) for filling compounds, spray guns (not hand-operated) for applying sealers; mixing machines for paints, lacquers and coating; compressed air guns for the extrusion of mastics; spray guns for paints; painting machines.

8 – Hand-operated tools and instruments for painting, other than paintbrushes and paint rollers; hand-operated tools and implements, namely instruments and special instruments for coatings and facade facings; hand-operated gluing devices, hand-operated mixers (tools), hand-operated spray guns for fillers; hand-operated spray guns for sealing compounds; hand

operated spray guns for the extrusion of paints.

16 – Paper, cardboard; printed matter; catalogues; brochures; stationery; adhesives for stationery or household purposes; artists' materials; marking chalk; chalk holders; rulers; teaching materials [except apparatus]; packaging materials; printed material in the nature of color samples, namely, color and/or sample cards, color and/or sample fans, color and/or sample card collections, color and/or sample boards made of paper, color and/or sample cardboard collections; colored paper; prospectuses; stickers (stationery); photographs; materials for painters and artists, namely, paintbrushes, drawing and writing brushes, paint rollers, painters' rollers, paper towels, paint applicators in the nature of sponges, paint trays, paint roller grid, paint and dirt protection paper.

17 – Sealants, thermal protectors and insulating materials; insulating paints, insulating varnishes, insulating fabrics, insulating plaster; substances for insulating buildings against moisture; artificial and synthetic resins (semi-finished products); insulating fabrics in the form of parts for composite heat insulation systems; insulating tapes; insulating panels; insulating grid mats of glass fiber fabric and/or plastic, in the form of parts for composite heat insulation systems; plastic films, other than for wrapping purposes; adhesive tapes and strips, bands and films for industrial purposes.

19 – Building materials, not of metal or mainly not of metal, in particular profile rails and corner irons, finishing profiles; adjusting and levelling parts, concrete spacers for building, sills, all not of metal or mainly not of metal; natural and artificial stone; mortar [building materials]; quartz; plaster [building materials]; coatings (building materials); wall and ceiling panels (not of metal or mainly not of metal, for building); fabric embedding compounds for building; concrete fillers (building materials); non-woven textiles made of synthetic fibers for use in the building industry, in particular, stabilising fabrics.

20 – Fixing materials (not of metal or mainly not of metal), in particular fixing anchors for building; bolts, plugs, pins, screws, nuts, not of metal or mainly not of metal.

24 – Textile wall hangings; non-woven fabrics; fabrics for textile use.

27 – Wall hangings, non textile, even structuring in connection with paints; wallpaper; floor coverings.

35 – Advertising, marketing and sales promotion; business management and administrative services; commercial information and advice for consumers in the choice of products and services; import and export agency services, as well as wholesaling and retailing services, including via the internet, in the fields of chemicals, paints, machines, tools and metal hardware, construction articles, building material; import and

export agency services, as well as wholesaling and retailing services, including via the internet, in the fields of DIY articles and gardening articles, craft supplies, sound recording carriers and data carriers, apparatus for sanitary purposes, printed matter, stationery, office requisites, furnishings and decorations, tents, awnings, wall hangings, agricultural products, horticultural products and forestry goods.

37 – Painting; construction; building construction; construction consultancy; building insulating; scaffolding; wallpapering; consultancy with regard to the use of paints, plasters and other coating materials in the construction industry.

42 – Architectural services; consultancy in the field of energy-saving; architectural consultancy with regard to the interior and exterior color designing for buildings.

(260) AM 2023 117868 A

(800) 1661960

(151) 2022 02 15

(891) 2022 02 15

(731) Individual entrepreneur Morgunova Elena

Yur'evna

ul. Dostoevskogo, d. 8, kv. 47, g. Novosibirsk,

RU-630091 Novosibirskaya oblast', Russian

Federation

(540)



(591) Purple and green

(531) 27.03.01; 29.01.12

(511)

3 – Abrasives; amber [perfume]; descaling preparations for household purposes; antistatic preparations for household purposes; aromatics [essential oils]; air fragrancing preparations; cake flavourings [essential oils]; flavourings for beverages [essential oils]; food flavourings [essential oils]; breath freshening sprays; canned pressurized air for cleaning and dusting purposes; balms, other than for medical purposes; basma [cosmetic dye]; lip glosses; nail glitter; body glitter; polishing stones; abrasive paper; emery paper; polishing paper; petroleum jelly for cosmetic purposes; shoe polish; cobblers' wax; cotton wool impregnated with make-up removing preparations; cotton wool for cosmetic purposes; sachets for perfuming linen; drying agents for dishwashing machines; adhesives for cosmetic purposes; scented water; Javelle water; lavender water; micellar water; toilet water; wax for parquet floors; floor wax; non-slipping wax for floors; depilatory wax; moustache wax; creams for leather; polish for furniture and flooring; shoemakers' wax; polishing wax; tailors' wax; shower gels; massage

gels, other than for medical purposes; heliotropine; dental bleaching gels; geraniol; make-up; deodorants for pets; deodorants for human beings or for animals; depilatory preparations; air fragrance reed diffusers; scented wood; perfumes; non-slipping liquids for floors; windscreen cleaning liquids; greases for cosmetic purposes; volcanic ash for cleaning; perfumery; decorative transfers for cosmetic purposes; ionone [perfumery]; shaving stones [astringents]; smoothing stones; eyebrow pencils; cosmetic pencils; silicon carbide [abrasive]; carbides of metal [abrasives]; alum stones [astringents]; tripoli stone for polishing; adhesives for affixing false eyelashes; adhesives for affixing false hair; hair conditioners; quillaia bark for washing; corundum [abrasive]; beard dyes; colorants for toilet purposes; cosmetic dyes; body paint for cosmetic purposes; starch for laundry purposes; starch glaze for laundry purposes; shoe cream; polishing creams; cosmetic creams; skin whitening creams; polishing rouge; incense; hair spray; nail varnish; liquid latex body paint for cosmetic purposes; hair lotions; lotions for cosmetic purposes; after-shave lotions; beauty masks; oils for cleaning purposes; oils for perfumes and scents; oils for cosmetic purposes; oils for toilet purposes; essential oils; essential oils of cedarwood; essential oils of lemon; essential oils of citron; bergamot oil; gaultheria oil; jasmine oil; lavender oil; almond oil; rose oil; oil of turpentine for degreasing; whitening; cleaning chalk; almond milk for cosmetic purposes; cleansing milk for toilet purposes; musk [perfumery]; soap; deodorant soap; shaving soap; soap for brightening textile; cakes of toilet soap; antiperspirant soap; soap for foot perspiration; almond soap; mint for perfumery; cosmetic kits; emery; gel eye patches for cosmetic purposes; nail art stickers; double eyelid tapes; false nails; eau de Cologne; joss sticks; pastes for razor strops; toothpaste; pumice stone; lipstick cases; shower and bath foam; hydrogen peroxide for cosmetic purposes; breath freshening strips; teeth whitening strips; sandcloth; glass cloth [abrasive cloth]; lipsticks; pomades for cosmetic purposes; breath freshening preparations for personal hygiene; shaving preparations; bath preparations, not for medical purposes; cosmetic preparations for baths; hair straightening preparations; hair waving preparations; laundry soaking preparations; grinding preparations; smoothing preparations [starching]; colour-removing preparations; leather bleaching preparations; polishing preparations; denture polishes; mouthwashes, not for medical purposes; cosmetic preparations for slimming purposes; laundry glaze; preparations to make the leaves of plants shiny; eye-washes, not for medical purposes; fabric softeners for laundry use; preparations for washing; dry-cleaning preparations; paint stripping preparations; lacquer-removing preparations; make-up removing preparations; floor wax removers [scouring preparations]; varnish-removing preparations; rust removing preparations; nail care preparations; cleaning preparations; preparations for cleaning

dentures; wallpaper cleaning preparations; preparations for unblocking drain pipes; chemical cleaning preparations for household purposes; collagen preparations for cosmetic purposes; bleaching preparations [decolorants] for household purposes; laundry bleach; aloe vera preparations for cosmetic purposes; sunscreen preparations; colour-brightening chemicals for household purposes [laundry]; shining preparations [polish]; make-up powder; diamantine [abrasive]; stain removers; nail varnish removers; vaginal washes for personal sanitary or deodorant purposes; scouring solutions; false eyelashes; colour run prevention laundry sheets; tissues impregnated with cosmetic lotions; tissues impregnated with make-up removing preparations; antistatic dryer sheets; baby wipes impregnated with cleaning preparations; safrol; massage candles for cosmetic purposes; laundry blueing; turpentine for degreasing; potpourris [fragrances]; bleaching soda; washing soda, for cleaning; bath salts, not for medical purposes; bleaching salts; fumigation preparations [perfumes]; leather preservatives [polishes]; ammonia [volatile alkali] [detergent]; astringents for cosmetic purposes; eyebrow cosmetics; make-up preparations; sun-tanning preparations [cosmetics]; hair dyes; neutralizers for permanent waving; cosmetic preparations for eyelashes; cosmetic preparations for skin care; shoe polish and creams; dentifrices; cosmetics; cosmetics for children; cosmetics for animals; mascara; detergents, other than for use in manufacturing operations and for medical purposes; cleansers for intimate personal hygiene purposes, non medicated; douching preparations for personal sanitary or deodorant purposes [toiletries]; degreasers, other than for use in manufacturing processes; bleaching preparations [decolorants] for cosmetic purposes; toiletry preparations; antiperspirants [toiletries]; phytocosmetic preparations; talcum powder, for toilet use; cotton swabs for cosmetic purposes; terpenes [essential oils]; emery cloth; cloths impregnated with a detergent for cleaning; henna [cosmetic dye]; shampoos; shampoos for animals [non-medicated grooming preparations]; shampoos for pets [non-medicated grooming preparations]; dry shampoos; sandpaper; soda lye; herbal extracts for cosmetic purposes; extracts of flowers [perfumes]; ethereal essences; badian essence; mint essence [essential oil].

5 – Amino acids for medical purposes; analgesics; anaesthetics; antibiotics; antiseptics; medicine cases, portable, filled; first-aid boxes, filled; germicides; oxygen cylinders, filled, for medical purposes; balms for medical purposes; bandages for dressings; diagnostic biomarker reagents for medical purposes; biocides; bracelets impregnated with insect repellent; paper for mustard plasters; fly catching paper; reagent paper for veterinary purposes; reagent paper for medical purposes; mothproofing paper; petroleum jelly for medical purposes; vaccines; oxygen baths; antiseptic cotton; aseptic cotton; absorbent cotton; wadding for medical purposes; cotton for medical purposes;

dietetic substances adapted for medical use; radiological contrast substances for medical purposes; nutritive substances for microorganisms; radioactive substances for medical purposes; bismuth subnitrate for pharmaceutical purposes; melissa water for pharmaceutical purposes; seawater for medicinal bathing; mineral waters for medical purposes; thermal water; dietary fibre; moulding wax for dentists; gases for medical purposes; guaiacol for pharmaceutical purposes; body gels for pharmaceutical purposes; massage gels for medical purposes; sexual stimulant gels; haematogen; haemoglobin; hydrastine; hydrastinine; glycerine for medical purposes; glycerophosphates; glucose for medical purposes; gentian for pharmaceutical purposes; hormones for medical purposes; mustard for pharmaceutical purposes; mustard plasters; mud for baths; medicinal mud; contraceptive sponges; gamboge for medical purposes; gurjun balsam for medical purposes; deodorants, other than for human beings or for animals; deodorizers for litter trays; air deodorizing preparations; deodorants for clothing and textiles; diastase for medical purposes; digitalin; vitamin supplement patches; mineral dietary supplements; dietary supplements; albumin dietary supplements; dietary supplements for animals; yeast dietary supplements; alginate dietary supplements; glucose dietary supplements; casein dietary supplements; lecithin dietary supplements; linseed oil dietary supplements; propolis dietary supplements; protein dietary supplements; protein supplements for animals; royal jelly dietary supplements; pollen dietary supplements; wheat germ dietary supplements; linseed dietary supplements; acai powder dietary supplements; dietary supplements with a cosmetic effect; enzyme dietary supplements; yeast for pharmaceutical purposes; gelatine for medical purposes; cod liver oil; isotopes for medical purposes; immunostimulants; insecticides; iodine for pharmaceutical purposes; iodides for pharmaceutical purposes; alkaline iodides for pharmaceutical purposes; iodoform; calomel [fungicide]; cream of tartar for pharmaceutical purposes; tartar for pharmaceutical purposes; camphor for medical purposes; capsules for medicines; cachets for pharmaceutical purposes; capsules made of dendrimer-based polymers, for pharmaceuticals; haemostatic pencils; wart pencils; caustic pencils; carbolineum [parasiticide]; caustics for pharmaceutical purposes; cachou for pharmaceutical purposes; quassia for medical purposes; quebracho for medical purposes; oxygen for medical purposes; gallic acid for pharmaceutical purposes; acids for pharmaceutical purposes; adhesives for dentures; surgical glues; stem cells for veterinary purposes; stem cells for medical purposes; cocaine for medical purposes; collagen for medical purposes; collodion for pharmaceutical purposes; corn rings for the feet; cannabis for medical purposes; medicated sweets; angostura bark for medical purposes; barks for pharmaceutical purposes; cedar wood for use as an insect repellent; condurango bark for medical purposes;

ses; croton bark; mangrove bark for pharmaceutical purposes; myrobalan bark for pharmaceutical purposes; quinquina for medical purposes; medicated animal feed; medicinal roots; rhubarb roots for pharmaceutical purposes; lint for medical purposes; starch for dietetic or pharmaceutical purposes; creosote for pharmaceutical purposes; blood for medical purposes; biological tissue cultures for veterinary purposes; biological tissue cultures for medical purposes; cultures of microorganisms for medical or veterinary use; curare; dental lacquer; liquorice for pharmaceutical purposes; milk sugar for pharmaceutical purposes; adhesive plasters; medicines for alleviating constipation; adhesive tapes for medical purposes; lecithin for medical purposes; lotions for veterinary purposes; medicated hair lotions; lotions for pharmaceutical purposes; medicated after-shave lotions; personal sexual lubricants; lupulin for pharmaceutical purposes; magnesia for pharmaceutical purposes; liniments; frostbite salve for pharmaceutical purposes; ointments for pharmaceutical purposes; sunburn ointments; mercurial ointments; gauze for dressings; medicinal oils; mustard oil for medical purposes; camphor oil for medical purposes; castor oil for medical purposes; oil of turpentine for pharmaceutical purposes; dill oil for medical purposes; dental mastics; dental abrasives; dental impression materials; teeth filling material; dressings, medical; surgical dressings; drugs for medical purposes; medicines for veterinary purposes; serotherapeutic medicines; medicines for human purposes; medicines for dental purposes; menthol; medicinal drinks; moleskin for medical purposes; almond milk for pharmaceutical purposes; powdered milk for babies; royal jelly for pharmaceutical purposes; milk ferments for pharmaceutical purposes; Irish moss for medical purposes; flour for pharmaceutical purposes; linseed meal for pharmaceutical purposes; fish meal for pharmaceutical purposes; fly glue; antibacterial soap; disinfectant soap; medicated soap; freeze-dried meat adapted for medical purposes; mint for pharmaceutical purposes; dietetic beverages adapted for medical purposes; malted milk beverages for medical purposes; injectable dermal fillers; bone void fillers comprised of living tissues; narcotics; medicinal infusions; tincture of iodine; eucalyptol for pharmaceutical purposes; tinctures for medical purposes; opium; opodeldoc; decoctions for pharmaceutical purposes; antiparasitic collars for animals; cotton swabs for medical purposes; stick liquorice for pharmaceutical purposes; sulfur sticks [disinfectants]; pastilles for pharmaceutical purposes; medicated toothpaste; pectin for pharmaceutical purposes; pepsins for pharmaceutical purposes; peptones for pharmaceutical purposes; hydrogen peroxide for medical purposes; pesticides; food for babies; leeches for medical purposes; blood plasma; nicotine patches for use as aids to stop smoking; eyepatches for medical purposes; poultices; compresses; scapulars for surgical purposes; babies' diapers; diapers for pets; swim diapers, reusable, for babies;

swim diapers, disposable, for babies; diapers for incontinence; diaper changing mats, disposable, for babies; breast-nursing pads; bunion pads; pomades for medical purposes; powder of cantharides; pyrethrum powder; chilblain preparations; mothproofing preparations; anti-uric preparations; bacterial preparations for medical and veterinary use; bacteriological preparations for medical and veterinary use; balsamic preparations for medical purposes; albuminous preparations for veterinary purposes; biological preparations for medical purposes; veterinary preparations; bismuth preparations for pharmaceutical purposes; vitamin preparations; diagnostic preparations for veterinary purposes; diagnostic preparations for medical purposes; bath preparations for medical purposes; therapeutic preparations for the bath; haemorrhoid preparations; preparations for callouses; lice treatment preparations [pediculicides]; acne treatment preparations; preparations to facilitate teething; preparations for the treatment of burns; fumigation preparations for medical purposes; opotherapy preparations; air purifying preparations; bronchodilating preparations; preparations for reducing sexual activity; sterilizing preparations; soil-sterilizing preparations; corn remedies; pharmaceutical preparations for treating dandruff; vermin destroying preparations; preparations for destroying noxious animals; herbicides; preparations for destroying dry rot fungus; larvae exterminating preparations; fly destroying preparations; preparations for destroying mice; slug exterminating preparations; pharmaceutical preparations for skin care; contact lens cleaning preparations; lime-based pharmaceutical preparations; preparations of microorganisms for medical or veterinary use; hemostatics for medical purposes; medicated eye-washes; medicinal hair growth preparations; nutraceutical preparations for therapeutic or medical purposes; opiates; anticryptogamic preparations; aloe vera preparations for pharmaceutical purposes; preparations of trace elements for human and animal use; sulfonamides [medicines]; pharmaceutical preparations; pharmaceutical preparations for treating sunburn; enzyme preparations for veterinary purposes; enzyme preparations for medical purposes; phytotherapy preparations for medical purposes; chemico-pharmaceutical preparations; chemical preparations for veterinary purposes; chemical preparations for the diagnosis of pregnancy; chemical preparations for medical purposes; chemical preparations for treating diseases affecting cereal plants; chemical preparations for treating wheat blight; chemical preparations for treating diseases affecting vine plants; chemical preparations for treating mildew; chemical preparations for treating phylloxera; chemical preparations for pharmaceutical purposes; collyrium; lead water; chemical conductors for electrocardiograph electrodes; albuminous foodstuffs for medical purposes; dietetic foods adapted for medical purposes; by-products of the processing of cereals for dietetic or medical purposes; homogenized

food adapted for medical purposes; freeze-dried food adapted for medical purposes; pharmaceuticals; sanitary towels; panty liners [sanitary]; propolis for pharmaceutical purposes; pearl powder for medical purposes; radium for medical purposes; solvents for removing adhesive plasters; hydrated chloral for pharmaceutical purposes; vaginal washes for medical purposes; solutions for contact lenses; chemical reagents for medical or veterinary purposes; gum for medical purposes; rubber for dental purposes; chewing gum for medical purposes; nicotine gum for use as an aid to stop smoking; insect repellents; insect repellent incense; repellents for dogs; tissues impregnated with pharmaceutical lotions; sarsaparilla for medical purposes; sugar for medical purposes; crystallized rock sugar for medical purposes; asthmatic tea; fumigating sticks; massage candles for therapeutic purposes; linseed for pharmaceutical purposes; tobacco-free cigarettes for medical purposes; siccatives [drying agents] for medical purposes; syrups for pharmaceutical purposes; turpentine for pharmaceutical purposes; milking grease; greases for veterinary purposes; greases for medical purposes; lacteal flour for babies; infant formula; soporifics; bicarbonate of soda for pharmaceutical purposes; mineral water salts; bath salts for medical purposes; salts for mineral water baths; salts for medical purposes; potassium salts for medical purposes; sodium salts for medical purposes; smelling salts; malt for pharmaceutical purposes; semen for artificial insemination; alcohol for pharmaceutical purposes; medicinal alcohol; alloys of precious metals for dental purposes; ergot for pharmaceutical purposes; cooling sprays for medical purposes; digestives for pharmaceutical purposes; nervines; antibacterial handwashes; adjuvants for medical purposes; astringents for medical purposes; vermifuges; disinfectants; disinfectants for hygiene purposes; disinfectants for chemical toilets; appetite suppressants for medical purposes; medical preparations for slimming purposes; parasiticides; mouthwashes for medical purposes; medicated dentifrices; febrifuges; depuratives; animal washes [insecticides]; detergents for medical purposes; cattle washes [insecticides]; dog washes [insecticides]; insecticidal veterinary washes; vesicants; purgatives; chemical contraceptives; antiparasitic preparations; remedies for perspiration; remedies for foot perspiration; sedatives; laxatives; tonics [medicines]; medicated toiletry preparations; bouillons for bacteriological cultures; steroids; headache relief sticks; strychnine; suppositories; serums; antioxidant pills; tanning pills; appetite suppressant pills; slimming pills; jujube, medicated; sanitary tampons; vulnerary sponges; thymol for pharmaceutical purposes; smoking herbs for medical purposes; medicinal herbs; transplants [living tissues]; surgical implants comprised of living tissues; babies' diaper-pants; pants, absorbent, for incontinence; sanitary panties; charcoal for pharmaceutical purposes; fennel for medical purposes; porcelain for dental prostheses; phenol for pharmaceutical pur-

poses; enzymes for veterinary purposes; enzymes for medical purposes; ferments for pharmaceutical purposes; formic aldehyde for pharmaceutical purposes; phosphates for pharmaceutical purposes; fungicides; quinine for medical purposes; chinoline for medical purposes; diabetic bread adapted for medical use; chloroform; flowers of sulfur for pharmaceutical purposes; cement for animal hooves; bone cement for surgical and orthopaedic purposes; dental cements; medicinal tea; herbal teas for medicinal purposes; insecticidal animal shampoos; medicated shampoos; medicated shampoos for pets; pediculicidal shampoos; medicated dry shampoos; pre-filled syringes for medical purposes; eucalyptus for pharmaceutical purposes; herbal extracts for medical purposes; plant extracts for pharmaceutical purposes; tobacco extracts [insecticides]; extracts of hops for pharmaceutical purposes; elixirs [pharmaceutical preparations]; ethers for pharmaceutical purposes; esters for pharmaceutical purposes; cellulose esters for pharmaceutical purposes; cellulose ethers for pharmaceutical purposes; rat poison; poisons; bacterial poisons; jalap.

(260) AM 2023 117884 A

(800) 626849

(151) 1994 10 06

(891) 2022 05 03

(731) Brunchco 21 S.A.

Rue de la Victoire 1, B-1060 Saint-Gilles,  
Belgium

(540)

## LE PAIN QUOTIDIEN

(591) Black, white

(531) 27.05.01

(511)

30 – Bread, pastry products, sandwiches.

35 – Sales assistance for the commercialization of goods, administrative management of stores.

42 – Services for providing food and beverages.

(260) AM 2023 117899 A

(800) 1650590

(151) 2022 01 19

(891) 2022 04 27

(731) BioNTech SE

An der Goldgrube 12, 55131 Mainz, Germany

(540)

## BIONTAINER

(591) Black, white

(511)

6 – Transportable buildings of metal; transportable buildings of metal for the manufacture and filling of pharmaceuticals, medical and veterinary preparations

and vaccines; metal containers; metal containers for storage or transport.

(260) AM 2023 117933 A  
(800) 1662642  
(151) 2022 03 10  
(891) 2022 03 10  
(731) Japan Tobacco Inc.

1-1, Toranomon 4-chome, Minato-ku, Tokyo,  
Japan

(540)

## WINSTON LEGEND BLUE

(591) Black, white

(511)

34 – Tobacco, raw or manufactured; smoking tobacco, pipe tobacco, rolling tobacco, chewing tobacco, snus; cigarettes, electronic cigarettes, liquid for electronic cigarettes, tobacco vaporizer, cigars, cigarillos; snuff; smokers' articles included in this class; cigarette paper, cigarette tubes and matches.

(260) AM 2023 117934 A  
(800) 1662667  
(151) 2022 02 07  
(891) 2022 02 07  
(731) Segway Inc.

14 Technology Drive, Bedford NH 03110, USA

(540)



(591) Black, white

(531) 02.01.23; 02.01.30; 03.07.17; 18.01.05;  
18.01.23; 26.11.03; 26.11.08; 26.11.21

(511)

9 – Humanoid robots with artificial intelligence for use in scientific research; laboratory robots; electric batteries; electrical and electronic burglar alarms; protective helmets; gloves for protection against accidents; sunglasses; downloadable computer operating programs; downloadable computer game programs; protective clothing especially made for use for wear by motorists for protection against accident or injury.

12 – All-terrain vehicle; four-wheeled motor vehicle; motorcycles; motorized, electric-powered, self-propelled, self-balancing, wheeled personal mobility, transportation device; bicycles; robotic transport vehicles; motors and engines for land vehicles; antitheft alarms

for vehicles; security alarms for vehicles; motor scooters; self-balancing two-wheeled electric scooters; electric bicycle; mobility kick scooter; tires.

39 – Vehicle rental; leasing and rental of transportation devices and vehicles; transportation services, namely, vehicle sharing services, namely, providing temporary use of land vehicles, all-terrain vehicles, motor vehicles, motorized wheeled personal mobility transportation devices, bicycles, robotic transport vehicles, and scooters; transportation services, namely, transportation of passengers by land vehicle; transportation services, namely, arrangement of transport for others; transportation services, namely, storage and delivery of transportation devices; leasing and rental of electric bicycles, motorized bicycles and motorized, self-propelled, wheeled personal mobility devices, namely, mobility scooters, utility carts, chariots, patrollers and related equipment and accessories; electric scooter rental for transportation purposes.

(260) AM 2023 117935 A  
(800) 1662669  
(151) 2022 03 25  
(891) 2022 03 25

(731) Limited Liability Company "ODEZHDA  
DOCHAKOM"

Inner-city territory, Sampsonievskoye  
Municipal District, Helsingforskaya str.3, lit.  
L, of. 201B, room 100, RU-194044 Saint-  
Petersburg, Russian Federation

(540)



(591) Black, white

(531) 26.13.25; 27.05.01; 27.05.17

(511)

25 – Bandanas [neckerchiefs]; underwear; sweat-absorbent underwear; berets; overalls; teddies [underclothing]; boxer shorts; ski boots; boots for sports; breeches for wear; trousers; football shoes; neckties; footless socks; jerseys [clothing]; waistcoats; sports jerseys; hosiery; hoods [clothing]; scarves; kimonos; sun visors [headwear]; tights; slippers [underclothing]; wet suits for water-skiing; combinations [clothing]; bodices [lingerie]; corsets [underclothing]; bathing suits; beach clothes; leotards; jackets [clothing]; sleep masks; furs [clothing]; muffs [clothing]; fur stoles; ear muffs [clothing]; socks; sweat-absorbent socks; footwear; beach shoes; sports shoes; cyclists' clothing; clothing for gymnastics; clothing of imitations of leather; clothing of leather; waterproof clothing; uniforms; overcoats; ski gloves; gloves [clothing]; pyjamas; bathing trunks; pocket squares; dresses; headbands [clothing]; garters; braces [suspenders] for clothing; half-boots; money belts [clothing]; belts [clothing];



hing]; shirts; sandals; boots; jumper dresses; sweaters; inner soles; bath slippers; knitwear [clothing]; under-pants; shoes; headwear; aprons [clothing]; judo uniforms; karate uniforms; tee-shirts; dressing gowns; bath robes; stockings; sweat-absorbent stockings; shower caps; bathing caps; hats; pelisses; esparto shoes or sandals; skirts; skorts; clothing; headgear.

(260) AM 2023 117937 A

(800) 1662760

(151) 2021 12 18

(891) 2021 12 18

(731) Dalinmehr co.

No. 54, 29th St., Asadabadi St., Yousefabad,  
Tehran, Islamic Republic of Iran;  
Master Foodeh Food Industries Co.  
No. 54, 29th St., Asadabadi St., Yousefabad,  
Tehran, Islamic Republic of Iran

(540)

**Dr. Bone** دکتر بن

(591) Black, white

(531) 28.19

(526) Dr.

(511)

30 – Chewing gum; cake mixes; cereal preparations; sugar; candies [sweets]; corn flakes; chewing gum, not for medical purposes; fruit jelly candy; sponge cake; cake paste; pastilles [confectionery]; gummy candies; hot chocolate mixes; muesli; teas; cocoa; breakfast chocolates; cocoa-based beverages; cocoa products; chocolate candies; fondants [confectionery]; cake flour; chocolate nectar; cocoa beverages with milk; coffee beverages with milk; tea-based beverages; chocolate-based beverages; cakes; coffee-based beverages; chocolate covered nuts; cake powder; rice; cube sugar; chocolate beverages with milk; golden syrup; powdered mixes for the preparation of chocolate drinks; tea-based preparations for making beverages; baslug [confectionery]; instant hot chocolate mixes; chocolate topping; mints for breath freshening.

(260) AM 2023 117938 A

(800) 1662769

(151) 2021 12 15

(891) 2021 12 15

(731) HUGO BOSS Trade Mark Management GmbH  
& Co KG

Dieselstraße 12, 72555 Metzingen, Germany

(540)

**HUGO JEANS**

(591) Black, white

(511)

18 – Leather and imitations of leather, and goods made of these materials (included in this class), namely brief bags, wallets, casings, of leather, for stationery, purses, card wallets [leather ware], garment bags

for travel, vanity cases, not fitted, credit card cases [wallets], toiletry bags, cosmetic bags sold empty, straps (leather), traveling sets, key bags, bum bags, bags [envelopes, pouches] of leather, for packaging; trunks and travelling bags; bags; backpacks; travel accessories, namely, travel cases of leather or leather-board and travelling trunks; umbrellas and parasols; carry case handles and umbrella handles; gym bags; satchels; luggage, wallets and other carrying bags.

25 – Clothing for men, women and children; stockings; headgear; underwear; nightwear; swimwear; bathrobes; belts; shawls; accessories, namely headscarves, neck scarves, shawls, dress handkerchiefs; ties; gloves; shoes; belts of leather.

35 – Business management, sales consultancy; marketing services; wholesale and retail services in relation to clothing, footwear, headgear and clocks and watches, jewellery, eyewear, fashion accessories, cosmetics and perfumery, goods of leather, namely trunks and bags, purses, card wallets [leather ware], garment bags for travel, vanity cases, not fitted, toiletry bags, straps (leather), backpacks, key bags, satchels, gym bags, bags [envelopes, pouches] of leather, for packaging, umbrellas and parasols, bed linen, home textiles, household articles, namely household containers, household textiles, household linen, household utensils and household fragrances, shoe polishing sets, wine openers and wine decanters, stationery, luggage, sporting articles and smoking articles; market research and market analysis; advertising; sales promotion; rental of advertising space; distribution of goods and advertising material for advertising purposes, including via electronic media and via the internet; presentation of goods, in particular shop and shop window dressing; organization of exhibitions for commercial or advertising purposes; promotion of business relationships by providing of commercial and business contacts; commercial provision of information and advice to consumers regarding the selection of products and items to be purchased; business consultancy and administration; business organization consulting; professional business consulting; fashion consultancy (business); organization of fashion shows for commercial, industrial and advertising purposes; management of retail stores, online wholesale and retail services and online ordering services, mail ordering services and computerized online-ordering services in relation to clothing, footwear, headgear and clocks and watches, jewellery, eyewear, fashion accessories, cosmetics and perfumery, goods of leather, namely trunks and bags, purses, card wallets [leather ware], garment bags for travel, vanity cases, not fitted, toiletry bags, straps (leather), backpacks, key bags, satchels, gym bags, bags [envelopes, pouches] of leather, for packaging, umbrellas and parasols, bed linen, home textiles, household articles, namely household containers, household textiles, household linen, household utensils and household fragrances, shoe polis-

hing sets, wine openers and wine decanters, stationery, luggage, sporting articles and smoking articles.

(260) AM 2023 117939 A

(800) 1662816

(151) 2022 02 09

(891) 2022 02 09

(731) Kraft Foods Schweiz Holding GmbH  
Chollerstrasse 4, CH-6300 Zug, Switzerland

(540)

**TOBLERONE**

(591) Red, gold and black

(531) 27.05.03; 29.01.13

(511)

29 – Dried, preserved, cooked and steamed fruits; jellies for food; jams; marmalades; cocoa butter; dairy products; dairy spreads; dairy products, particularly dairy desserts and chilled dairy desserts, including creams and yogurt-based products; cheeses; cream cheese; cheese-based products; cheese spread; fresh cheese; milk and dairy products; powdered milk; desserts and dessert preparations based on dairy products; yogurt; drinking yogurts; milkshakes; buttercream; crème fraîche; sour cream; lemon curd; Chantilly cream, whipped cream; cottage cheese; milk-based beverages; milk-based flavored beverages, including milk-based flavored beverages containing chocolate, white chocolate and coffee; dairy product substitutes; almond milk; soy milk; rice milk; coconut milk; oat milk; peanut milk; yogurt-based beverages; desserts based on milk substitutes; beverages based on milk substitutes; snacks based on potatoes, vegetables or fruits; roasted, dried, salted and seasoned nuts; hazelnut spreads; fruit spreads; nut-based spreads.

30 – Coffee; coffee extracts; coffee substitutes; cocoa; chocolate; cocoa beverages; chocolate beverages, coffee beverages; instant coffee; coffee powder; tea; pastries; sugar and natural sweeteners; pastry dough; biscuits and cookies; cookies; brownies; cheese cakes; cakes; waffles; wafers; confectionery, particularly sugar confectionery and chocolate confectionery; chocolate spreads; refrigerated and frozen confectionery; cereal and chocolate-based desserts; ice desserts based on cereals and chocolate; iced cakes; frozen yogurts; chilled desserts based on cereals and chocolate; dough-based products; cereal-based preparations; breakfast cereals; roasted and popped corn [popcorn]; ice cream; sherbets [ices]; honey; puddings; snacks in the form of popcorn and corn chips; snacks based on corn, rice, barley, rye or pastry dough; cream puddings; trifles.

32 – Non-alcoholic beverages; syrups for making beverages; non-alcoholic preparations for making beverages.

(260) AM 2023 117940 A

(800) 1662843

(151) 2021 08 17

(891) 2021 08 17

(731) ALPATA TEKNOLOJİ YAZILIM VE  
BİLİŞİM HİZMETLERİ SANAYİ VE  
TİCARET ANONİM ŞİRKETİ  
75. Yıl Osb Mah. Bilim Cad. 5 401,  
Odunpazarı, Eskişehir, Türkiye

(540)



**OCTAPULL**

(591) Black, white, red

(531) 01.15.21; 16.03.25; 27.03.15; 27.05.01;  
29.01.13

(511)

9 – Measurement apparatus and equipment including those for scientific, nautical, topographic, meteorologic, industrial and laboratory purposes, thermometers, not for medical purposes, barometers, ammeters, voltmeters, hygrometers, testing apparatus not for medical purposes, telescopes, periscopes, directional compasses, speed indicators, laboratory apparatus, microscopes, magnifying glasses, stills, binoculars, ovens and furnaces for laboratory experiments; apparatus for recording, transmission or reproduction of sound or images, cameras, photographic cameras, television apparatus, video recorders, CD and DVD players and recorders, MP3 players, computers, desktop computers, tablet computers, wearable technological devices (smart watches, wristbands, head-mounted devices) microphones, loudspeakers, earphones, telecommunications apparatus, apparatus for the reproduction of sound or images, computer peripheral devices, cell phones, covers for cell phones, telephone apparatus, computer printers, scanners [data processing equipment], photocopiers; magnetic and optic data carriers and computer software and programmes recorded thereto, downloadable and recordable electronic publications, encoded magnetic and optic cards, movies, tv series and video music clips recorded on magnetic, optical and electronic media; antennas, satellite antennas, amplifiers for antennas, parts of the aforementioned goods; ticket dispensers, automatic teller machines (ATM); electronic components used in the electronic parts of machines and apparatus, semi-conductors, electronic circuits, integrated circuits, chips [integrated circuits], diodes, transistors [electronic], magnetic heads for electronic apparatus, electronic locks, photocells, remote control apparatus for opening and closing doors, optical sensors; counters and quantity indicators for measuring the quantity of consumption, automatic time switches; clothing for protection against accidents, irradiation and fire, safety vests and life-saving apparatus and equipment; eye-

glasses, sunglasses, optical lenses and cases, containers, parts and components thereof; apparatus and instruments for conducting, transforming, accumulating or controlling electricity, electric plugs, junction boxes [electricity], electric switches, circuit breakers, fuses, lighting ballasts, battery starter cables, electrical circuit boards, electric resistances, electric sockets, transformers [electricity], electrical adapters, battery chargers, electric door bells, electric and electronic cables, batteries, electric accumulators, solar panels for production of electricity; alarms and anti-theft alarms, other than for vehicles, electric bells; signalling apparatus and instruments, luminous or mechanical signs for traffic use; fire extinguishing apparatus, fire engines, fire hose and fire hose nozzles; radar apparatus, sonars, night vision apparatus and instruments; decorative magnets; metronomes.

35 – Advertising, marketing and public relations; organization of exhibitions and trade fairs for commercial or advertising purposes; design of advertising material for others; provision of an online marketplace for buyers and sellers of goods and services; office functions; secretarial services; arranging newspaper subscriptions for others; compilation of statistics; rental of office machines; systemization of information into computer databases; telephone answering for unavailable subscribers; business management, business administration and business consultancy; accounting; commercial consultancy services; personnel recruitment, personnel placement, employment agencies, import-export agencies; temporary personnel placement services; auctioneering; the bringing together, for the benefit of others, of a variety of goods, namely, measurement apparatus and equipment including those for scientific, nautical, topographic, meteorologic, industrial and laboratory purposes, thermometers, not for medical purposes, barometers, ammeters, voltmeters, hygrometers, testing apparatus not for medical purposes, telescopes, periscopes, directional compasses, speed indicators, laboratory apparatus, microscopes, magnifying glasses, stills, binoculars, ovens and furnaces for laboratory experiments, apparatus for recording, transmission or reproduction of sound or images, cameras, photographic cameras, television apparatus, video recorders, CD and DVD players and recorders, MP3 players, computers, desktop computers, tablet computers, wearable technological devices (smart watches, wristbands, head-mounted devices) microphones, loudspeakers, earphones, telecommunications apparatus, apparatus for the reproduction of sound or images, computer peripheral devices, cell phones, covers for cell phones, telephone apparatus, computer printers, scanners [data processing equipment], photocopiers, magnetic and optic data carriers and computer software and programmes recorded thereto, downloadable and recordable electronic publications, encoded magnetic and optic cards, movies, TV series and video music clips recorded on magnetic, optical and electronic media, antennas, satellite

antennas, amplifiers for antennas, parts of the aforementioned goods, ticket dispensers, automatic teller machines (ATM), electronic components used in the electronic parts of machines and apparatus, semi-conductors, electronic circuits, integrated circuits, chips [integrated circuits], diodes, transistors [electronic], magnetic heads for electronic apparatus, electronic locks, photocells, remote control apparatus for opening and closing doors, optical sensors, counters and quantity indicators for measuring the quantity of consumption, automatic time switches, clothing for protection against accidents, irradiation and fire, safety vests and life-saving apparatus and equipment, eyeglasses, sunglasses, optical lenses and cases, containers, parts and components thereof, apparatus and instruments for conducting, transforming, accumulating or controlling electricity, electric plugs, junction boxes [electricity], electric switches, circuit breakers, fuses, lighting ballasts, battery starter cables, electrical circuit boards, electric resistances, electric sockets, transformers [electricity], electrical adapters, battery chargers, electric door bells, electric and electronic cables, batteries, electric accumulators, solar panels for production of electricity, alarms and anti-theft alarms, other than for vehicles, electric bells, signalling apparatus and instruments, luminous or mechanical signs for traffic use, fire extinguishing apparatus, fire engines, fire hose and fire hose nozzles, radar apparatus, sonars, night vision apparatus and instruments, decorative magnets, metronomes enabling customers to conveniently view and purchase those goods, such services may be provided by retail stores, wholesale outlets, by means of electronic media or through mail order catalogues.

42 – Scientific and industrial analysis and research services; engineering; engineering and architectural design services; testing services for the certification of quality and standards; computer services, namely, computer programming, computer virus protection services, computer system design, creating, maintaining and updating websites for others, computer software design, updating and rental of computer software, providing search engines for the internet, hosting websites, consultancy in the design and development of computer hardware, rental of computer hardware; industrial design services, other than engineering, computer and architectural design graphic arts designing; authenticating works of art.

(260) AM 2023 117942 A

(800) 1662879

(151) 2021 10 14

(891) 2021 10 14

(731) DOQU EV TEKSTILI SANAYI VE TICARET ANONIM SİRKETİ

Kayseriosb Mahallesi 12. Cad. No:86,  
TR-38070 Melikgazi Kayseri, Türkiye

(540)



(591) Gray, white

(531) 26.01.03; 26.01.20; 26.01.24; 27.05.09;  
27.05.24; 29.01.12

(511)

3 – Non-medicated cosmetics and toiletry preparations; non-medicated dentifrices; perfumery, essential oils; bleaching preparations and other substances for laundry use; cleaning, polishing, scouring and abrasive preparations; indoor or room perfumes; essential oils for room fragancing; air fragrances; air fragranc-ing preparations; potpourris [fragrances]; amber [per-fume]; air fragrance reed diffusers; air fragranc-ing preparations; air fresheners [air fragranc-ing preparati-ons]; air fresheners being air fragranc-ing preparations; air fresheners [fragrant preparations].

11 – Apparatus and installations for lighting, heating, cooling, steam generating, cooking, drying, ventilat-ing, water supply and sanitary purposes; chandeliers; lighting installations; lights for vehicles and interior-exterior spaces; electric and gas-powered devices, ins-tallations and apparatus for cooking, drying and boil-ing; cookers, electric cooking pots, electric water he-aters, barbecues, electric laundry driers; hair driers; hand drying apparatus; sanitary installations, taps [fa-ucets], shower installations, toilets [water-closets], shower and bathing cubicles, bath tubs, toilet seats, sinks, wash-hand basins [parts of sanitary installati-ons]; water softening apparatus; water purification ap-paratus; water purification installations; waste water purification installations; electric bed warmers and el-ectric blankets, not for medical use; electric pillow warmers; electric or non-electric footwarmers; hot water bottles; filters for aquariums and aquarium filtration apparatus; industrial type installations for cooking, drying and cooling purposes; pasteurizers and sterilizers.

20 – Furniture, mirrors, picture frames; containers, not of metal, for storage or transport; unworked or semi-worked bone, horn, whalebone or mother-of-pearl; shells; meerschaum; yellow amber; infant walkers; fi-gurines of wood, wax, plaster or plastic; bedsteads of wood; furniture partitions of wood; wood ribbon; bot-tle casings of wood; placards of wood or plastics; bo-xes of wood or plastic; ladders of wood or plastics; signboards of wood or plastics; keyboards for hanging keys; split rings, not of metal, for keys; footstools; mirrors [looking glasses]; luggage lockers; bamboo; bamboo curtains; bathroom vanities [furniture]; head-

rests [furniture]; bed bases; baby changing mats; bath seats for babies; anti-roll cushions for babies; head support cushions for babies; head positioning pillows for babies; cots for babies; playpens for babies; high chairs for babies; mats for infant playpens; Moses baskets; bassinets; trolleys for computers [furniture]; sideboards; chests of drawers; tea trolleys; coathooks, not of metal; flower-stands [furniture]; drafting tables; bead curtains for decoration; shelves for storage; ma-gazine racks; freestanding partitions [furniture]; valet stands; poles, not of metal; divans; index cabinets [furniture]; lap desks; chopping blocks [tables]; indo-or window blinds of woven wood; cupboards; cabinet work; stuffed animals; stuffed birds; mattresses; filing cabinets; shelves for file cabinets; shower chairs; wall-mounted baby changing platforms; medicine ca-binets; costume stands; garment covers [storage]; hand-held mirrors [toilet mirrors]; locks, other than electric, not of metal; hampers [baskets] for the trans-port of items; shelving units; nesting boxes for hou-sehold pets; kennels for household pets; beds for hou-sehold pets; pet cushions; vats, not of metal; bakers' bread baskets; mouldings for picture frames; wardro-bes; newspaper display stands; silvered glass [mir-rors]; wickerwork; straw mattresses; towel dispensers, fixed, not of metal; indoor window blinds [furniture]; display boards; house numbers, not of metal, non-lu-minous; work benches; armchairs; sofas; bumper gu-ards for cots, other than bed linen; crates; lockers; bo-okcases; library shelves; covers for clothing [wardro-be]; console tables; dog kennels; lecterns; washstands [furniture]; dressing tables; trestles [furniture]; massa-ge tables; desks; vice benches [furniture]; step stools, not of metal; tool boxes, not of metal, empty; tool chests, not of metal, empty; door bells, not of metal, non-electric; containers, not of metal [storage, trans-port]; baskets, not of metal; furniture of metal; tables of metal; dowels, not of metal; shoe dowels, not of metal; door handles, not of metal; door bolts, not of metal; furniture casters, not of metal; chests, not of metal; trays, not of metal; seats of metal; furniture; le-tter boxes, not of metal or masonry; furniture fittings, not of metal; towel stands [furniture]; furniture, mir-rors, picture frames; legs for furniture; doors for furni-ture; jewelry organizer displays; office furniture; school furniture; screens [furniture]; coatstands; curta-in rails; curtain rollers; curtain hooks; packaging con-tainers of plastic; portable desks; racks [furniture]; lounge chairs; picture frames; picture frame brackets; wind chimes [decoration]; flower-pot pedestals; chairs [seats]; hat stands; umbrella stands; display stands; chaise longues; bottle racks; inflatable furniture; con-tainers, not of metal, for liquid fuel; screens for firep-laces [furniture]; slatted indoor blinds; plate racks; stools; trolleys [furniture]; air cushions, not for medi-cal purposes; air pillows, not for medical purposes; air beds, not for medical purposes; air mattresses, not for medical purposes; sleeping pads; bolsters; showcases [furniture]; pillows; bedding, except linen; writing

desks; typing desks; dinner wagons [furniture]; loading pallets, not of metal; standing desks; nesting boxes.

24 – Textiles and substitutes for textiles; household linen; curtains of textile or plastic; cloth coasters; linings [textile]; bath mitts; silk fabrics for printing patterns; printed calico cloth; bed blankets; diaper changing cloths for babies; sleeping bags for babies; baby buntings; glass cloths [towels]; sheets [textile]; cot bumpers [bed linen]; upholstery fabrics; blankets for household pets; household linen; gauze [cloth]; silk [cloth]; table linen, not of paper; tablecloths, not of paper; place mats of textile; door curtains; diapered linen; hemp fabric; buckram; tick [linen]; eiderdowns [down coverlets]; oilcloth for use as tablecloths; mattress covers; covers for cushions; covers [loose] for furniture; furniture coverings of plastic; traced cloths for embroidery; knitted fabric; non-woven textile fabrics; picnic blankets; pillow shams; table runners, not of paper; printers' blankets of textile; towels of textile; coasters of textile; wall hangings of textile; table napkins of textile; furniture coverings of textile; handkerchiefs of textile; tablemats of textile; flags of textile or plastic; shower curtains of textile or plastic; curtains of textile or plastic; face towels of textile; tulle; cheese cloth; net curtains; fitted toilet lid covers of fabric; pillowcases; bed valances; bed covers; bed linen; ticks [mattress covers].

35 – Advertising; business management, organization and administration; office functions; the bringing together, for the benefit of others, of a variety of goods, namely, non-medicated cosmetics and toiletry preparations, non-medicated dentifrices, perfumery, essential oils, bleaching preparations and other substances for laundry use, cleaning, polishing, scouring and abrasive preparations, air fragrance reed diffusers, air fragrancing preparations, air fresheners, air fresheners being air fragrancing preparations, air fresheners [fragrant preparations], apparatus and installations for lighting, heating, cooling, steam generating, cooking, drying, ventilating, water supply and sanitary purposes, chandeliers, lighting installations, lights for vehicles and interior-exterior spaces, electric and gas-powered devices, installations and apparatus for cooking, drying and boiling, cookers, electric cooking pots, electric water heaters, barbecues, electric laundry driers, hair driers, hand drying apparatus, sanitary installations, taps [faucets], shower installations, toilets [water-closets], shower and bathing cubicles, bath tubs, toilet seats, sinks, wash-hand basins [parts of sanitary installations], water softening apparatus, water purification apparatus, water purification installations, waste water purification installations, electric bed warmers and electric blankets, not for medical use, electric pillow warmers, electric or non-electric footwarmers, hot water bottles, filters for aquariums and aquarium filtration apparatus, industrial type ins-

tallations for cooking, drying and cooling purposes, pasteurizers and sterilizers, furniture, mirrors, picture frames, containers, infant walkers, figurines of wood, wax, plaster or plastic, bedsteads of wood, furniture partitions of wood, wood ribbon, bottle casings of wood, placards of wood or plastics, boxes of wood or plastic, ladders of wood or plastics, signboards of wood or plastics, keyboards for hanging keys, split rings, not of metal, for keys, footstools, mirrors [looking glasses], luggage lockers, bamboo, bamboo curtains, bathroom vanities [furniture], head-rests [furniture], bed bases, baby changing mats, bath seats for babies, anti-roll cushions for babies, head support cushions for babies, head positioning pillows for babies, cots for babies, playpens for babies, high chairs for babies, mats for infant playpens, Moses baskets, bassinets, trolleys for computers [furniture], sideboards, chests of drawers, tea trolleys, coathooks, not of metal, flower-stands [furniture], drafting tables, bead curtains for decoration, shelves for storage, magazine racks, freestanding partitions [furniture], valet stands, poles, not of metal, divans, index cabinets [furniture], lap desks, chopping blocks [tables], indoor window blinds of woven wood, cupboards, cabinet work, stuffed animals, stuffed birds, mattresses, filing cabinets, shelves for file cabinets, shower chairs, wall-mounted baby changing platforms, medicine cabinets, costume stands, garment covers [storage], hand-held mirrors [toilet mirrors], locks, other than electric, not of metal, hampers [baskets] for the transport of items, shelving units, nesting boxes for household pets, kennels for household pets, beds for household pets, pet cushions, vats, not of metal, bakers' bread baskets, mouldings for picture frames, wardrobes, newspaper display stands, silvered glass [mirrors], wickerwork, straw mattresses, towel dispensers, fixed, not of metal, indoor window blinds [furniture], display boards, house numbers, not of metal, non-luminous, work benches, armchairs, sofas, bumper guards for cots, other than bed linen, crates, lockers, bookcases, library shelves, covers for clothing [wardrobe], console tables, dog kennels, lecterns, washstands [furniture], dressing tables, trestles [furniture], massage tables, desks, vice benches [furniture], step stools, not of metal, tool boxes, not of metal, empty, tool chests, not of metal, empty, door bells, not of metal, non-electric, containers, not of metal [storage, transport], baskets, not of metal, furniture of metal, tables of metal, dowels, not of metal, shoe dowels, not of metal, door handles, not of metal, door bolts, not of metal, furniture casters, not of metal, chests, not of metal, trays, not of metal, seats of metal, furniture, letter boxes, not of metal or masonry, furniture fittings, not of metal, towel stands [furniture], furniture, mirrors, picture frames, legs for furniture, doors for furniture, jewellery organizer displays, office furniture, school furniture, screens [furniture], coatstands, curtain rails, curtain rollers, curtain hooks, packaging containers of plastic, portable desks, racks [furniture], lounge chairs, picture frames,

picture frame brackets, wind chimes [decoration], flower-pot pedestals, chairs [seats], hat stands, umbrella stands, display stands, chaise longues, bottle racks, inflatable furniture, containers, not of metal, for liquid fuel, screens for fireplaces [furniture], slatted indoor blinds, plate racks, stools, trolleys [furniture], air cushions, not for medical purposes, air pillows, not for medical purposes, air beds, not for medical purposes, air mattresses, not for medical purposes, sleeping pads, bolsters, showcases [furniture], pillows, bedding, except linen, writing desks, typing desks, dinner wagons [furniture], loading pallets, not of metal, standing desks, nesting boxes, textiles and substitutes for textiles, household linen, curtains of textile or plastic, cloth coasters, linings [textile], bath mitts, silk fabrics for printing patterns, printed calico cloth, bed blankets, diaper changing cloths for babies, sleeping bags for babies, baby buntings, glass cloths [towels], sheets [textile], cot bumpers [bed linen], upholstery fabrics, blankets for household pets, household linen, gauze [cloth], silk [cloth], table linen, not of paper, tablecloths, not of paper, place mats of textile, door curtains, diapered linen, hemp fabric, buckram, tick [linen], eiderdowns [down coverlets], oilcloth for use as tablecloths, mattress covers, covers for cushions, covers [loose] for furniture, furniture coverings of plastic, traced cloths for embroidery, knitted fabric, non-woven textile fabrics, picnic blankets, pillow shams, table runners, not of paper, printers' blankets of textile, towels of textile, coasters of textile, wall hangings of textile, table napkins of textile, furniture coverings of textile, handkerchiefs of textile, tablemats of textile, flags of textile or plastic, shower curtains of textile or plastic, curtains of textile or plastic, face towels of textile, tulle, cheese cloth, net curtains, fitted toilet lid covers of fabric, pillowcases, bed valances, bed covers, bed linen, ticks [mattress covers], woollen cloth, zephyr [cloth] enabling customers to conveniently view and purchase those goods, such services may be provided by retail stores, wholesale outlets, by means of electronic media for example, through web sites or through mail order catalogues.

(260) AM 2023 117943 A

(800) 1662907

(151) 2022 01 26

(891) 2022 01 26

(731) YIWU WENYUAN STATIONERY CO., LTD.

Shenzhou Road, Houzhai Industrial District,  
Yiwu City, 322008 Zhejiang Province, China

(540)



The logo for SWORLD features a stylized 'S' symbol on the left, composed of two interlocking curved lines. To the right of the symbol, the word 'SWORLD' is written in a bold, black, sans-serif font.

(591) Black, white

(531) 26.11.02; 26.11.12; 26.13.25; 27.05.01;  
27.05.17

(511)

16 – Paper shredders for office use; paper cutters [office requisites]; pencil sharpeners, electric or non-electric; stapler for offices; staples for offices; pencil knife; pencil sharpener; staple remover [office requisites]; clips for offices; bookends; document files [stationery]; thumbtacks; moisteners [office requisites]; trays for sorting and counting money; jackets for papers; files [office requisites], correcting fluids [office requisites]; covers [stationery], rubber erasers; office requisites, except furniture; moisteners for gummed surfaces [office requisites]; paperweights; stationery; writing pads; elastic bands for offices; desktop cabinets for stationery [office requisites]; holders for cheque books; passport holders; writing board erasers; clipboards; pin [stationery]; paper clips; stamp pads; stamps [seals]; stamp cases; stamp inks; stamp pad inks; ink paste; numbering machine; pencils; pencil leads; fountain pens; bails for ball-point pens; writing instruments; oil pastels; whiteboard markers; adhesive tape dispensers [office requisites]; adhesive bands for stationery or household purposes; glue for stationery or household purposes; self-adhesive paper; square rulers for drawing; compasses for drawing; French curves; T-squares for drawing; drawing boards; paint boxes for use in schools; teaching materials [except apparatus]; writing chalk; terrestrial globes; blackboard erasers; magnetic drawing board, loose-leaf binders; note books; papers for painting and calligraphy; memo pads; paper boxes; inking ribbons; cardboard box (for industrial packaging); carbon paper; waxed paper; copying paper [stationery]; colored creped paper; albums; tags for index cards; paper clasps; ledgers [books]; indexes; forms, printed; manifolds [stationery]; bookmarks; greeting cards; pads; calendars; manuscript paper; self-adhesive index card; certificate; exercise book; covers for books; stapling presses [office requisites]; office perforators bookbinding cords.

(260) AM 2023 117944 A

(800) 1662916

(151) 2022 01 25

(891) 2022 01 25

(731) Kia Corporation

12, Heolleung-ro, Seocho-gu, Seoul 06797,  
Republic of Korea

(540)



Movement that inspires

(591) Black, white

(531) 27.05.01; 27.05.09; 27.05.17; 27.05.22

(511)

9 – Humanoid robots with artificial intelligence for use in scientific research; software for controlling ro-

bots; downloadable computer application software for use on smart phones for the provision of information relating to vehicle trip information history, parking location management, trip information, vehicle health management, driving information, and third-party promotional data for drivers; downloadable and recorded computer software for autonomous driving of motor vehicles; recorded software for data processing for autonomous driving control; downloadable and recorded computer software for autonomous vehicle navigation, steering, calibration, and management; downloadable software for parking location identification; downloadable and recorded computer software for vehicle navigation; recorded software for vehicle fleet launching, coordination, calibrating, direction, and management; downloadable and recorded computer software for controlling vehicle communications networks; downloadable and recorded computer software platforms for advanced safety and driver assistance systems for vehicles; downloadable software for the control and remote control of vehicles; computer operating system software for vehicles; computer application software relating to vehicles for use on cellphones; application software for metaverse; metaverse contents operating software; games software for metaverse; computer interfaces for metaverse; downloadable multimedia files; downloadable image files; downloadable computer graphics; downloadable images; computer programs and software for vehicles; telecommunication apparatus for use in cars; remote control apparatus for industrial automation instruments; remote control apparatus; GPS navigation devices; computer hardware; fire extinguishing apparatus for automobiles; theft prevention apparatus; air sensors for vehicles; black box cameras for cars; rear-view cameras for electronic parking assist apparatus for automobiles; proximity sensors for electronic parking assist apparatus for automobiles; computers for electronic parking assist apparatus for automobiles; computer operating software for electronic parking assist apparatus for automobiles; vehicle safety equipment, namely, cameras; blind-spot detection cameras for exposing and eliminating the blind spots on both sides of the vehicle; rearview cameras for electronic parking assist apparatus for vehicles; proximity sensors for electronic parking assist apparatus for vehicles; computers for electronic parking assist apparatus for vehicles; computer operating software for electronic parking assist apparatus for vehicles; black boxes for cars; automatic vehicle speed control apparatus [electronic]; blind spot motion detecting sensors; blind spot object detecting sensors; blind spot motion sensors; sensors for determining position, velocity, acceleration and temperature; motion sensors for automobiles; sensors for automobiles, namely, forward and backward distance sensors; sensors for automobiles, namely, forward and backward safety sensors; speed sensors for automobiles; electronic sensors for automobiles, namely, sensors for use in controlling

the actuation and operation of automotive safety apparatus and equipment; electronic sensors for automobiles, namely, detector units for use in controlling the actuation and operation of automotive safety apparatus and equipment; parking and locational sensors for automobiles; parking sensors for automobiles; crash sensors for automobiles; odometers; vehicle safety equipment, namely, back-up sensors; lateral safety sensor for cars; electronic sensors for vehicles; lateral distance sensor for cars; vehicle speed control apparatus; temperature and environmental sensors for measuring the presence of objects in the environment and the speed, trajectory, and heading of objects; electric power distribution machines; robotic electrical control apparatus; charging appliances for rechargeable equipment; charging stations for electric vehicles; batteries for automobiles; batteries for electric vehicles; electric batteries; electric cables, wires, conductors and connection fittings therefor; wearable computers; apparatus for broadcasting, recording, transmission or reproduction of sound, data or images; electronic keyless entry systems for automobiles; raster image processors; laser installations, other than for medical use, for sensing distance to objects; digital car driving recording apparatus; electronic control apparatus for autonomous driving of vehicles; computer apparatus for parking location identification; computer hardware for vehicle fleet launching, coordination, calibrating, direction, and management; computer hardware for transmission of data within a vehicle and for communications between and among vehicles and a cloud-based platform; LED information display apparatus for cars; laser object detectors for use on vehicles; computer apparatus for the control and remote control of vehicles; computer display monitors; eye glasses; OBD (on-board diagnosis) apparatus for automobiles; warning lamps for vehicles; electronic terminals for highway toll collection; wireless earphones; automobile motor controlling circuits; smartphones.

(260) AM 2023 117945 A

(800) 1662919

(151) 2022 02 07

(891) 2022 02 07

(731) Limited Liability Company "MELOFON"  
ulitsa Krzhizhanovskogo, dom 14, korpus 3,  
pom XVI, kom 22, RU-117218 Moscow,  
Russian Federation

(540)



(591) Mustard, grey and white

(531) 26.01.03; 26.01.12; 26.11.08; 27.05.09;  
27.05.11; 27.05.17; 29.01.12

(511)

41 – Gambling services.

(260) AM 2023 117946 A

(800) 1662922

(151) 2021 12 09

(891) 2021 12 09

(731) MUDO SATIŞ MAĞAZALARI ANONİM  
ŞİRKETİ

Fulya Mahallesi Ortaklar Cad., Bahçeler

Sokak No:10, TR-34394 Şişliİstanbul, Türkiye

(540)



(591) Black, white

(531) 27.05.01; 27.05.09

(511)

20 – Furniture, made of any kind of material; mattresses; pillows; air mattresses and cushions, not for medical purposes; water beds; mirrors; beehives; artificial honeycombs and sections of wood for honeycombs; bouncing chairs for babies; playpens for babies; cradles; infant walkers; display boards; frames for pictures and paintings; identification plates, identification tags, nameplates, identification labels made of wood or synthetic materials; packaging containers of wood or plastics; casks for use in transportation or storage; barrels, not of metal; storage drums of plastic; tanks, not of metal nor of masonry; boxes of wood or plastic; storage containers, not of metal; containers, not of metal, for transport; chests; loading pallets and closures for the aforementioned goods, of wood or plastics; small hardware goods of wood or synthetic materials; furniture fittings, of wood or synthetic materials; opening and closing mechanisms of wood or synthetic materials, namely door openers, not of metal, non-electric, window openers, not of metal, non-electric, hinges, not of metal; ornaments and decorative goods of wood, cork, reed, cane, wicker, horn, bone, ivory, whalebone, shell, amber, mother-of-pearl, meerscham, beeswax, plastic or plaster, namely, figurines, holiday ornaments for walls, sculptures, trophies; baskets, not of metal; fishing baskets; kennels; nesting boxes and beds for household pets; portable ladders and mobile boarding stairs of wood or synthetic materials; bamboo curtains; roller indoor blinds [for interiors]; slatted indoor blinds; indoor roller blinds; bead curtains for decoration; curtain hooks; curtain rings; curtain tie-backs; curtain rods; non-metal wheel chocks.

(260) AM 2023 117947 A

(800) 1662938

(151) 2022 02 08

(891) 2022 02 08

(731) Obshchestvo s ogranichennoy  
otvetstvennostyu "EVRA"

Solnechnogorskaya ul., 4, str. 6, RU-125413

Moscow, Russian Federation

(540)

**BOBSGREEN**

(591) Black, white

(511)

5 – Pharmaceuticals, medical and veterinary preparations; sanitary preparations for medical purposes; dietetic food and substances adapted for medical or veterinary use, food for babies; dietary supplements for humans and animals; plasters, materials for dressings; material for stopping teeth, dental wax; disinfectants; preparations for destroying vermin; fungicides, herbicides; dietary supplements, including dietary supplements, as additions to the routine food or used for health purposes; meal replacements, dietary food and beverages used for medical or veterinary purposes; mineral nutritional supplements; dietary additives including albumin dietary supplements, yeast dietary supplements, alginate dietary supplements, glucose dietary supplements, casein dietary supplements, le-cithin dietary supplements, flaxseed oil dietary supplements, propolis dietary supplements, protein dietary supplements, protein supplements for animals, royal jelly dietary supplements, pollen dietary supplements, wheat germ dietary supplements, linseed dietary supplements, enzyme dietary supplements; gelatine for medical purposes; medicated sweets; angostura bark for medical purposes; barks for pharmaceutical purposes; condurango bark for medical purposes; croton bark; mangrove bark for pharmaceutical purposes; myrobalan bark for pharmaceutical purposes; quinquina for medical purposes; cedar wood for use as an insect repellent; medicinal roots; liquorice for pharmaceutical purposes; lactose for pharmaceutical purposes; medicated candies; cough drops; vitamin drops; calcium fortified candy for medical purposes; medicines; menthol; medicinal drinks; mint for pharmaceutical purposes; dietetic beverages adapted for medical purposes; medicinal infusions; tinctures for medical purposes; decoctions for pharmaceutical purposes; stick liquorice for pharmaceutical purposes; lozenges for pharmaceutical purposes; pectin for pharmaceutical purposes; pepsins for pharmaceutical purposes; peptones for pharmaceutical purposes; bacterial preparations for medical and veterinary use; bacteriological preparations for medical or veterinary purposes; vitamin preparations; aloe vera preparations for pharmaceutical purposes; preparations of trace elements for human and animal use; pharmaceutical preparations; enzyme preparations for medical purposes; chemical preparations for medical purposes; chemical preparations for pharmaceutical purposes; albuminous



foodstuffs for medical purposes; dietetic foods adapted for medical purposes; propolis for pharmaceutical purposes; chewing gum for medical purposes; tissues impregnated with pharmaceutical lotions; sugar for medical purposes; linseed for pharmaceutical purposes; syrups for pharmaceutical purposes; lacteal flour for babies; adjuvants for medical purposes; medical preparations for slimming purposes; parasiticides; mouthwashes for medical purposes; tonics [medicines]; slimming pills; jujube, medicated; appetite suppressant pills; antioxidant pills; medicinal herbs; medicinal teas; herbal teas for medical purposes; eucalyptus for pharmaceutical purposes; extracts of hops for pharmaceutical purposes; elixirs [pharmaceutical preparations]; ethers for pharmaceutical purposes; esters for pharmaceutical purposes; dietary fibre; hemato-

30 – Coffee, tea, cocoa; coffee substitutes, including vegetal preparations for use as coffee substitutes, chicory [coffee substitute]; unroasted coffee; rice; tapioca and sago; flour, including bean meal, tapioca flour, potato flour, corn flour, nut flours, wheat flour, soya flour, barley meal; cereal preparations; baked goods; confectionery; chocolate; ice cream; sugar; honey; molasses syrup; yeast, baking-powder; salt; mustard; vinegar, including beer vinegar; condiments; spices; edible ices; food flavourings, other than essential oils, including coffee flavourings; food flavourings, other than essential oils, including those for cakes and beverages; star aniseed; high-protein cereal bars; biscuits; pancakes; noodle-based prepared meals; buns; bread rolls; vanillin [vanilla substitute]; vanilla flavorings for culinary purposes; vareniki [stuffed dumplings]; waffles; vermicelli, spaghetti, macaroni and noodles; natural sweeteners; sausage binding materials; binding agents for ice cream; sea water for cooking; seaweed [condiment]; malt biscuits; cloves [spice]; cake frosting [icing]; glucose for culinary purposes; gluten additives for culinary purposes; thickening agents for cooking foodstuffs; leaven; rice-based and cereal-based snack foods; dressings for salad; fruit jellies [confectionery]; pasta; candy decorations for cakes; confectionery for decorating christmas trees; cakes; pastries; peanut confectionery; almond confectionery; ginger [spice]; frozen yogurt [confectionery ices]; capers; caramels [sweets]; curry [spice]; milk-based gruels for food; ketchup [sauce]; quiches; gluten prepared as foodstuff; cinnamon [spice]; sweets, including chocolate candies, licorice [confectionery], peppermint sweets; starch for food; crackers; custard; groats for human food, including semolina, oatmeal, crushed barley, hominy grits; corn, milled; fried corn; meat pies; turmeric; couscous; lollipops; rice cakes; mayonnaise; maltose; hominy; marinades; marzipan; royal jelly; dessert mousses [confectionery]; chocolate mousses; muesli; mint for confectionery; coffee-based beverages, cocoa beverages with milk, coffee beverages with milk, tea-based beverages, chocolate-based beverages, chocolate beverages with milk, cocoa-ba-

sed beverages; infusions, not medicinal; nutmegs; chocolate-coated nuts; crushed oats; husked oats; stick liquorice [confectionery]; soybean paste [seasoning]; molasses for food; pepper; lozenges [confectionery]; pesto [sauce]; biscuits, including petit-beurre biscuits, macarons [pastries]; pâtés en croûte; pelmeni; pies; pizza; meat gravies; baking powder; powders for making ice cream; mustard powder; fondants [confectionery]; popcorn; gingerbread; pralines; meat tenderizers for household purposes; oat-based food; propolis; petits fours; puddings; cake powder; fruit coulis [sauces]; ravioli; chewing gum; relish [condiment]; wheat germ for human consumption; spring rolls; aniseed; linseed for culinary purposes [seasoning]; golden syrup; candy bars; baking soda [bicarbonate of soda for cooking purposes]; malt for human consumption; salt for preserving foodstuffs; cooking salt; celery salt; sorbets [ices]; ham glaze; sauces [condiments], including soy sauce, tomato sauce; preparations for stiffening whipped cream; rusks, including breadcrumbs; sushi; sandwiches; tabbouleh; tacos; cream of tartar for culinary purposes; tarts; dough; pastry dough, including cake dough; almond paste; tortillas; garden herbs, preserved [seasonings]; ferments for pastes; halva; bread; chips [cereal products], including corn flakes, oat flakes; chutneys [condiments]; cheeseburgers [sandwiches]; chow-chow [condiment]; saffron [seasoning]; malt extract for food; essences for foodstuffs, except etheric essences and essential oils; husked barley; chocolate decorations for cakes; flowers or leaves for use as tea substitutes; minced garlic [condiment].

(260) AM 2023 117948 A

(800) 1662955

(151) 2022 01 26

(891) 2022 01 26

(731) TİRYAK TÛTÛN MAMÛLLERİ SANAYİ VE TİCARET LİMİTED ŞİRKETİ  
ORTAKÖY MAH.İLTER BLV.146, Silivri,  
İstanbul, Türkiye

(540)



(591) Black and golden

(531) 10.01.12; 13.01.01; 13.01.02; 27.03.15;  
27.05.01; 29.01.12

(511)

34 – Tobacco, chewing tobacco, cigarettes, cigars, smokers' articles including those made of precious metals: pipes, mouthpieces for cigars and cigarettes, ashtrays, tobacco boxes, pocket apparatus for rolling

cigarettes, cigarette paper, tobacco pipes, firestones, lighters for smokers, electronic cigarettes and their cartridges, matches.

(260) AM 2023 117949 A  
 (800) 1662981  
 (151) 2022 04 01  
 (891) 2022 04 01  
 (731) MERCK KgaA  
 Frankfurter Str. 250, 64293 Darmstadt,  
 Germany  
 (540)

## MAVENCLAD

(591) Black, white  
 (511)  
 5 – Pharmaceutical products for human use.

(260) AM 2023 117950 A  
 (800) 1662992  
 (151) 2022 02 24  
 (891) 2022 02 24  
 (731) KRKA, tovarna zdravil, d.d., Novo mesto  
 Šmarješka cesta 6, SI-8000 Novo mesto,  
 Slovenia  
 (540)

## VARESTA

(591) Black, white  
 (511)  
 5 – Pharmaceutical preparations.

(260) AM 2023 117951 A  
 (800) 1663006  
 (151) 2022 04 19  
 (891) 2022 04 19  
 (731) CELLTRION, INC.  
 23, Academy-ro, Yeonsu-gu, Incheon 22014,  
 Republic of Korea  
 (540)

## Omlyclo

(591) Black, white  
 (511)  
 5 – Pharmaceutical preparations for respiratory organs; allergy medications; immunizing agent; immunosuppressant; pharmaceutical preparations for treating asthma; pharmaceutical preparations for treating chronic urticaria.

(260) AM 2023 117952 A  
 (800) 1663029  
 (151) 2022 04 01  
 (891) 2022 04 01  
 (731) Qingdao Pallyking Tires Technology Co., Ltd.  
 Room 029(A), #1, The Office Building East,

No. 43, Beijing Road, Qianwan Free Trade Port Zone, Qingdao Area of China (Shandong), Pilot Free Trade Zone, Shandong, China

(540)

## PALLYKING

(591) Black, white  
 (531) 27.05.01  
 (511)  
 12 – Solid tires for vehicle wheels; tires for vehicle wheels; treads for retreading tires; inner tubes for pneumatic tires; repair outfits for inner tubes; bicycle tires; automobile tires; pneumatic tires; inner tubes for automobile tires; casings for pneumatic tires.

(260) AM 2023 117953 A  
 (800) 1663088  
 (151) 2022 04 19  
 (891) 2022 04 19  
 (731) CELLTRION, INC.  
 23, Academy-ro, Yeonsu-gu, Incheon 22014,  
 Republic of Korea  
 (540)

## Omzanclo

(591) Black, white  
 (511)  
 5 – Pharmaceutical preparations for respiratory organs; allergy medications; immunizing agent; immunosuppressant; pharmaceutical preparations for treating asthma; pharmaceutical preparations for treating chronic urticaria.

(260) AM 2023 117954 A  
 (800) 1663090  
 (151) 2022 04 22  
 (891) 2022 04 22  
 (731) OFF-WHITE LLC  
 1 E. 57th St., New York NY 10022, USA  
 (540)



(591) Black, white  
 (531) 02.01.01; 02.01.23; 04.05.21  
 (511)  
 4 – Candles.

(260) AM 2023 117955 A  
 (800) 1663095  
 (151) 2022 04 28  
 (891) 2022 04 28  
 (731) Chen Ming

Room 101, Building C, No. 127, Tianyuan  
 Lane, Zhonghe Street, Yinzhou District, Ningbo  
 City, 315000 Zhejiang Province, China

(540)

**OWDEN**

(591) Black, white  
 (531) 27.05.01; 27.05.17  
 (511)

8 – Garden tools, hand-operated; livestock marking  
 tools; harpoons; punches [hand tools]; nail punches;  
 perforating tools [hand tools]; tweezers; scissors; ice  
 picks; cuticle nippers.

(260) AM 2023 117961 A  
 (800) 1663376  
 (151) 2022 04 12  
 (891) 2022 04 12  
 (731) Kia Corporation

12, Heolleung-ro, Seocho-gu, Seoul 06797,  
 Republic of Korea

(540)

**wible**

(591) Black, white  
 (531) 27.05.01  
 (511)

36 – Mileage brokerage for transportation payment;  
 brokerage of purchase payment; financial brokerage  
 services; issuance of tokens of value as part of a cus-  
 tomer membership scheme; brokerage of mobile and  
 internet payment; brokerage of mobile payment; pay-  
 ment services provided via wireless telecommunica-  
 tions apparatus and devices; issuance of tokens of va-  
 lue as part of a customer membership scheme relating  
 to electronic wallets; finance settlement services of  
 portage via wireless terminals; electronic payment  
 services involving electronic processing and subse-  
 quent transmission of bill payment data; e-wallet pay-  
 ment services; electronic payment for others; issuance  
 of membership credit card; issuance of prepaid card  
 with membership card function; electronic processing  
 of electronic payments via a global computer net-  
 work; processing of payment transactions via the In-  
 ternet; electronic payment services; financing relating  
 to automobiles; automobile lease financing; conduc-  
 ting of financial affairs on-line; insurance services;  
 vehicle financing; transport insurance brokerage; iss-  
 uance of transportation cards embedded with smart  
 chip; vehicle insurance information; providing vehicle  
 insurance rate quotes; vehicle insurance consultancy;  
 vehicle insurance services; vehicle insurance broke-

rage; automobile insurance services; consultancy and  
 brokerage services relating to vehicle insurance; auto-  
 mobile insurance consultancy; automobile insurance  
 information; motor vehicle insurance brokerage; fi-  
 nancial consultancy; automobile appraisal.

(260) AM 2023 117963 A  
 (800) 1663535  
 (151) 2022 03 29  
 (891) 2022 03 29  
 (731) PR INDUSTRIAL S.R.L.

Località il Piano SNC, I-53031 Casole D'Elsa  
 (Siena), Italy

(540)

**PRAMAC**

(591) Black, white  
 (511)

7 – Hydrogen dispensing pumps for service stations;  
 current generators; mobile electrical power genera-  
 tors; electrical generator groups; generating sets for  
 use with engines.

9 – Voltage transformers; power conditioners; power  
 units [batteries]; power distributors [electrical]; con-  
 verters, electric; electricity storage apparatus; appa-  
 ratus and instruments for accumulating electricity; appa-  
 ratus and instruments for transforming electricity;  
 electric control devices for energy management; appa-  
 ratus and instruments for accumulating and storing el-  
 ectricity; battery charging devices for motor vehicles.

37 – Charging of batteries and power storage devices,  
 and rental of equipment therefore; charging of electric  
 vehicles.

(260) AM 2023 117964 A  
 (800) 1663548  
 (151) 2022 03 01  
 (891) 2022 03 01  
 (731) Amusnet Interactive Ltd.

Garitage Park, Building No. 4, Floor 2 2 Donka  
 Ushlinova Str. BG-1766 Sofia, Bulgaria

(540)

**CANDY PALACE**

(591) Pink and purple  
 (531) 27.05.01; 27.05.03; 29.01.12  
 (511)

9 – Computer software for the administration of on-  
 line games and gaming; computer application softwa-  
 re featuring games and gaming; betting software; ga-  
 ming software that generates or displays wager out-  
 comes of gaming machines.

28 – Gaming machines for gambling; slot machines  
 [gaming machines].

41 – Providing of casino and gaming facilities; betting services.

(260) AM 2023 117965 A

(800) 1010502

(151) 2009 02 04

(891) 2022 04 12

(731) Aktsionernoe Obshchestvo "Nizhegorodsky khimiko- farmatsevtichesky zavod"

7, ul. Salganskaya, GSP-459, RU-603950

Nizhny Novgorod, Russian Federation

(540)

## БАКТИСТАТИН

(591) Black, white

(531) 28.05

(511)

5 – Biological active additives, nutritional additives for medical purposes, mineral food-supplements, pharmaceutical preparations and drugs for medical purposes.

29 – All food extracts, included in this class ICPS, nutritional additives (not for medical purposes).

(260) AM 2023 117971 A

(800) 1421377

(151) 2018 06 29

(891) 2022 04 01

(731) POMELLATO S.p.A.

Via Neera, 37, I-20141 MILANO, Italy

(540)



(591) Black, white

(531) 27.05.01; 27.05.19

(511)

14 – Gold; silver; platinum; precious metals and alloys thereof; products made of precious metals and their alloys, namely rings (jewelry) bracelets (jewelry), necklaces (jewelry), earrings (jewelry), brooches (jewelry), pendants (jewelry), medals, chains (jewelry), tie pins (jewelry) and amulets (jewelry); diamonds; cut diamonds (jewelry); precious stones; jewelry articles; jewels; cuff links and tie clips; wristwatches; clocks in general; strap-type watch straps; chronometers; jewelry articles plated with precious metals; cases and jewelry cases for clocks and jewelry.

(260) AM 2023 117972 A

(800) 1546286

(151) 2020 05 25

(891) 2022 04 26

(731) BTL Industries

8 Tzar Kaloyan str, BG-1000 Sofia, Bulgaria

(540)

## EMSCULPT NEO

(591) Black, white

(511)

10 – Medical and aesthetic apparatus and instruments, in particular apparatus and instruments generating electrical, magnetic, electromagnetic, mechanical or thermal therapeutic energy; medical and aesthetic apparatus and instruments, in particular apparatus and instruments for body shaping, fat removal, circumference reduction, skin tightening, cellulite reduction, skin rejuvenation, wrinkle reduction, scar reduction, stretch mark reduction, increase in muscle volume, increase in number of muscle fibres; the aforesaid medical apparatus with the exception of nasopharynx treatment, including inhalers and nasal irrigator; aesthetic massage apparatus, in particular apparatus for lymphatic drainage and increasing the circulation of bodily fluids; physical therapy apparatus, in particular apparatus for treating pain and preventing muscle cramps; esthetic massage apparatus; gynaecological and urological apparatus and instruments; dental equipment; rehabilitation apparatus (body -) for medical purposes; physical therapy equipment; physiotherapy and rehabilitation equipment; beds specially made for medical purposes; contraceptive devices; artificial limbs; orthopedic articles; suture materials.

(260) AM 2023 117973 A

(800) 1622125

(151) 2021 09 13

(891) 2022 05 10

(731) Coors Brewing Company

3939 W. Highland Boulevard, Milwaukee,

WI 53208, USA

(540)

## MILLER GENUINE DRAFT

(591) Black, white

(511)

32 – Beers, stout, lager, porter and ale; mineral and aerated waters and other non-alcoholic drinks; fruit drinks and fruit juices; syrups and other preparations for making beverages.

(260) AM 2023 118025 A

(800) 1663659

(151) 2022 03 25

(891) 2022 03 25

(731) INSTAL PROJEKT SPÓŁKA Z

OGRANICZONĄ ODPOWIEDZIALNOŚCIĄ

ul. Jana Pawła II 12 A, Nowa Wieś

k/Włocławka, PL-87-853 KRUSZYN, Poland

(540)



(591) Blue, grey  
 (531) 26.01.03; 26.01.18; 26.01.24; 26.04.05;  
 26.04.10; 26.04.18; 27.05.01; 27.05.09;  
 27.05.10; 27.05.22; 27.05.24; 29.01.13

(511)  
 11 – Heating apparatus; room heaters; central heating radiators; heating boilers; solar thermal collectors [heating]; heat accumulators; electric heaters; air heat recovery installations; warming panels; domestic radiators; electric radiators; heat recovery units; electric dryers.

(260) AM 2023 118026 A  
 (800) 1663676  
 (151) 2022 03 04  
 (891) 2022 03 04  
 (731) LKW WALTER Internationale  
 Transportorganisation AG  
 IZ NÖ-Süd, Straße 14, Objekt 15, A-2355  
 Wiener Neudorf, Austria

(540)



(591) Black, white  
 (531) 01.01.10; 18.01.08; 18.01.11; 18.01.23;  
 18.03.14; 18.03.23; 26.04.05; 26.04.16;  
 27.05.01

(511)  
 36 – Underwriting relating to transport insurance; transport insurance brokerage; financial services relating to the transportation of goods.

39 – Transport; transport by road; transport by rail; transport by sea; hauling; storage; transportation logistics; arrangement of transportation; consultancy services relating to transportation; providing transport information; tracking of freight vehicles by computer or via GPS.

(260) AM 2023 118027 A  
 (800) 1663741  
 (151) 2022 03 02  
 (891) 2022 03 02  
 (731) STADA Arzneimittel AG  
 Stadastr. 2-18, 61118 Bad Vilbel, Germany

(540)

**СНУППИК**

(591) Black, white  
 (531) 28.05  
 (511)  
 5 – Alpha adrenergic agonists (medicines); hygienic products for medical purposes; dietary food and sub-

tances for medical purposes; disinfectants; baby food; nasal drops; lotions for pharmaceutical purposes; medicines for humans; plasters, dressing materials; chemical preparations for medical purposes and pharmaceutical preparations; medical alcohol; ophthalmic products; decongestants; antiallergic products; pharmaceutical preparations; veterinary preparations; fungicides, herbicides; nutritional supplements; biologically active food supplements.

(260) AM 2023 118028 A  
 (800) 1663761  
 (151) 2021 03 31  
 (891) 2021 03 31  
 (731) Rumsfeld Foundation  
 B1, #366, 1030 15th Street, NW, Washington  
 DC 20005, USA

(540)

**CAMCA REGIONAL FORUM**

(591) Black, white

(511)

41 – Educational services, namely, conducting seminars, lectures and continuing education programs in the field of international economic and geopolitical issues in order to foster discussions to advance economic growth and development in Greater Central Asia; educational services, namely, providing panel discussions in the field of advancing economic growth and development in Greater Central Asia.

(260) AM 2023 118029 A  
 (800) 1663763  
 (151) 2021 12 16  
 (891) 2021 12 16  
 (731) Euro Games Technology Ltd.  
 4, "Maritsa" Str., "Vranya-Lozen-Triugulnika",  
 BG-1151 Sofia, Bulgaria

(540)

**Spanish Passion**

(591) Red, yellow and black

(531) 27.05.02; 29.01.13

(511)

9 – Software; computer gaming software; computer software packages; computer operating system software; computer software, recorded; software drivers; virtual reality software; games software; entertainment software for computer games; computer programs for network management; operating computer software for main frame computers; monitors (computer hardware); computer hardware; apparatus for recording images; monitors (computer programs); computer game programs; computer programs for recorded games; apparatus for recording, transmission or reproduction of sound or images; communications

servers [computer hardware]; electronic components for gambling machines; computer application software featuring games and gaming; computer software for the administration of on-line games and gaming; computer hardware for games and gaming; hardware and software for gambling, gambling machines, gambling games on the Internet and via telecommunication network.

28 – Gaming machines for gambling; chips for gambling; mah-jong; arcade games; gambling machines operating with coins, notes and cards; games; electronic games; parlor games; gaming chips; gaming tables; slot machines [gaming machines]; LCD game machines; slot machines and gaming devices; coin-operated amusement machines; roulette chips; poker chips; chips and dice [gaming equipment]; gaming equipment for casinos; roulette tables; gaming roulette wheels; casino games; gambling machines and amusement machines, automatic and coin-operated; coin-operated amusement machines and/or electronic coin-operated amusement machines with or without the possibility of gain; boxes for coin-operated machines, slot machines and gaming machines; electronic or electrotechnical amusement machines and apparatus, gaming machines, coin-operated entertainment machines; housings for coin-operated machines, gaming equipment, gaming machines, machines for gambling; electropneumatic and electrical gambling machines (slot machines).

41 – Gambling; entertainment services related to gambling; gaming services for entertainment purposes; casino, gaming and gambling services; training in the development of software systems; provision of gaming equipment for gambling halls; providing casino equipment [gambling]; gaming machine entertainment services; providing casino facilities [gambling]; gaming hall services; amusement arcade services; games equipment rental; rental of gaming machines; providing amusement arcade services; rental of gaming machines with images of fruits; editing or recording of sounds and images; sound recording and video entertainment services; hire of sound reproducing apparatus; provision of gaming equipment for casinos; providing of casino facilities; online gambling services; casino, gaming and gambling services; provision of gaming facilities, gaming hall facilities, Internet casinos and online gambling services.

(260) AM 2023 118030 A

(800) 1663764

(151) 2021 12 16

(891) 2021 12 16

(731) Euro Games Technology Ltd.

4, "Maritsa" Str., "Vranya-Lozen-Triugulnika",  
BG-1151 Sofia, Bulgaria

(540)

**40 EXTRA STARS**

(591) Orange, yellow, brown and black

(531) 01.01.04; 01.01.09; 01.01.15; 27.05.01;  
27.05.03; 27.05.08; 27.07.01; 27.07.03;  
29.01.14

(511)

9 – Software; computer gaming software; computer software packages; computer operating system software; computer software, recorded; software drivers; virtual reality software; games software; entertainment software for computer games; computer programs for network management; operating computer software for main frame computers; monitors (computer hardware); computer hardware; apparatus for recording images; monitors (computer programs); computer game programs; computer programs for recorded games; apparatus for recording, transmission or reproduction of sound or images; communications servers [computer hardware]; electronic components for gambling machines; computer application software featuring games and gaming; computer software for the administration of on-line games and gaming; computer hardware for games and gaming; hardware and software for gambling, gambling machines, gambling games on the Internet and via telecommunication network.

28 – Gaming machines for gambling; chips for gambling; mah-jong; arcade games; gambling machines operating with coins, notes and cards; games; electronic games; parlor games; gaming chips; gaming tables; slot machines [gaming machines]; LCD game machines; slot machines and gaming devices; coin-operated amusement machines; roulette chips; poker chips; chips and dice [gaming equipment]; gaming equipment for casinos; roulette tables; gaming roulette wheels; casino games; gambling machines and amusement machines, automatic and coin-operated; coin-operated amusement machines and/or electronic coin-operated amusement machines with or without the possibility of gain; boxes for coin-operated machines, slot machines and gaming machines; electronic or electrotechnical amusement machines and apparatus, gaming machines, coin-operated entertainment machines; housings for coin-operated machines, gaming equipment, gaming machines, machines for gambling; electropneumatic and electrical gambling machines (slot machines).

41 – Gambling; entertainment services related to gambling; gaming services for entertainment purposes; casino, gaming and gambling services; training in the development of software systems; provision of gaming equipment for gambling halls; providing casino equipment [gambling]; gaming machine entertainment services; providing casino facilities [gambling]; gaming hall services; amusement arcade services; games equipment rental; rental of gaming machines; provi-

ding amusement arcade services; rental of gaming machines with images of fruits; editing or recording of sounds and images; sound recording and video entertainment services; hire of sound reproducing apparatus; provision of gaming equipment for casinos; providing of casino facilities; online gambling services; casino, gaming and gambling services; provision of gaming facilities, gaming hall facilities, Internet casinos and online gambling services.

(260) AM 2023 118031 A

(800) 1663766

(151) 2021 10 25

(891) 2021 10 25

(731) SOMCA GIDA DAĞITIM VE PAZARLAMA ANONİM ŞİRKETİ  
ALTAYÇEŞME MAH. ÇAMLI SK., DAP  
ROYAL CENTER D BLOK 16 D/42,  
MALTEPE, İSTANBUL, Türkiye

(540)



(591) Orange, dark grey and ice blue

(531) 24.03.07; 24.03.18; 26.04.05; 26.04.16;  
26.04.18; 26.04.24; 27.01.12; 27.05.01;  
27.05.08; 27.05.09; 27.05.10; 27.05.24;  
29.01.13

(526) Döner soslu maydonoz'da yenir.

(511)

43 – Services for providing food and drink, temporary accommodation, reservation of temporary accommodation, rental of banquet and social function facilities for special occasions, namely, wedding receptions, conferences and meetings, day-nurseries (crèches), boarding for animals.

(260) AM 2023 118032 A

(800) 1663770

(151) 2022 01 13

(891) 2022 01 13

(731) Adalya Tobacco International GmbH  
Breitscheider Weg 117A, 40885 Ratingen,  
Germany

(540)

## Love 66

(591) Black, white

(511)

34 – Smokers' articles; matches; tobacco evaporators and electronic cigarettes; flavourings, other than essential oils, for tobacco, except flavourings with taste of alcoholic beverages; liquid solutions for use in electronic cigarettes, except flavorings with taste of al-

coholic beverages; tobacco and tobacco products (including substitutes).

(260) AM 2023 118033 A

(800) 1663818

(151) 2022 02 02

(891) 2022 02 02

(731) Euro Games Technology Ltd.

"Maritsa" Str. 4, "Vranya-Lozen-Triugulnika",  
BG-1151 Sofia, Bulgaria

(540)

## Jumboways

(591) Black, white

(511)

9 – Software; computer gaming software; computer software packages; computer operating system software; computer software, recorded; software drivers; virtual reality software; games software; entertainment software for computer games; computer programs for network management; operating computer software for main frame computers; monitors (computer hardware); computer hardware; apparatus for recording images; monitors (computer programs); computer game programs; computer programs for recorded games; apparatus for recording, transmission or reproduction of sound or images; communications servers [computer hardware]; electronic components for gambling machines; computer application software featuring games and gaming; computer software for the administration of on-line games and gaming; computer hardware for games and gaming; hardware and software in the field of gambling; software and hardware applicable to gambling machines; gambling games software; computer hardware for gambling machines; software for online gambling games; software for gambling games used via telecommunication network.

28 – Gaming machines for gambling; chips for gambling; mah-jong; arcade games; gambling machines operating with coins, notes and cards; games; electronic games; parlor games; gaming chips; gaming tables; slot machines [gaming machines]; LCD game machines; slot machines and gaming devices; coin-operated amusement machines; roulette chips; poker chips; chips and dice [gaming equipment]; equipment for casinos; roulette tables; gaming roulette wheels; games in the field of gambling; automats and gambling machines; coin-operated machines and / or electronic coin-operated machines with or without the possibility of gain; boxes for coin-operated machines, slot machines and gaming machines; electronic or electrotechnical gaming devices, automats and machines, coin-operated machines; housings for coin-operated machines, gaming equipment, gaming machines, machines for gambling; electropneumatic and electrical gambling machines (slot machines).

41 – Gambling; services related to gambling; gaming services for entertainment purposes; casino, gaming and gambling services; training in the development of software systems; provision of gaming equipment for gambling halls; providing casino equipment [gambling]; gaming machine entertainment services; providing casino facilities [gambling]; providing halls with gaming machines; amusement arcade services; games equipment rental; rental of gaming machines; providing amusement arcade services; rental of gaming machines with images of fruits; editing or recording of sounds and images; sound recording and video entertainment services; hire of sound reproducing apparatus; provision of gaming equipment for casinos; providing of casino facilities; online gambling services; casino, gaming and gambling services; operation of gaming establishments, gaming halls, internet casinos, online gambling sites.

(260) AM 2023 118034 A

(800) 1663982

(151) 2022 03 30

(891) 2022 03 30

(731) Obschestvo s ogranichennoy otvetstvennostyu "Zavod NARTIS"

Severnoye sh., d. 40V, RU-162608

g. Cherepovets, the Vologda Region,

Russian Federation

(540)



(591) Black, white

(531) 26.13; 26.13.25; 27.05.22; 28.05

(511)

9 – 3D spectacles; DVD players; ticket dispensers; juke boxes, musical; fire engines; answering machines; electrical adapters; batteries for electronic cigarettes; accumulators, electric; batteries, electric, for vehicles; accelerometers; actinometers; alidades; altimeters; ear pads for headphones; ammeters; nanoparticle size analysers; anemometers; anodes; aerials; anticathodes; apertometers [optics]; high-frequency apparatus; testing apparatus not for medical purposes; electro-dynamic apparatus for the remote control of railway points; electro-dynamic apparatus for the remote control of signals; remote control apparatus; monitoring apparatus, other than for medical purposes; sound recording apparatus; Global Positioning System [GPS] apparatus; distillation apparatus for scientific purposes; diffraction apparatus [microscopy]; air analysis apparatus; apparatus to check franking; sound transmitting apparatus; fermentation apparatus for laboratory use; breathing apparatus for underwater swimming; breathing apparatus, except for artificial respiration; apparatus and installations for the production

of X-rays, not for medical purposes; cash registers; electric apparatus for commutation; magnetic resonance imaging [MRI] apparatus, not for medical purposes; intercommunication apparatus; stills for laboratory experiments; projection apparatus; fire extinguishing apparatus; radiological apparatus for industrial purposes; X-ray apparatus not for medical purposes; blueprint apparatus; flashing lights [luminous signals]; stereoscopic apparatus; telephone apparatus; facsimile machines; phototelegraphy apparatus; igniting apparatus, electric, for igniting at a distance; acid hydrometers; salinometers; acidimeters for batteries; aerometers; beacons, luminous; battery jars; automated teller machines [ATM]; barometers; anode batteries; galvanic batteries; ignition batteries; solar batteries; solar panels for the production of electricity; batteries, electric; balances [steelyards]; betatrons; binoculars; biochips; electronic tags for goods; lens hoods; magnetic tape units for computers; computer memory devices; fire hose nozzles; encoded identification bracelets, magnetic; connected bracelets [measuring instruments]; safety tarpaulins; electronic key fobs being remote control apparatus; bullet-proof clothing; signalling buoys; life buoys; marking buoys; directional compasses; vacuum gauges; electrolytic cells; variometers; verniers; scales; baby scales; bathroom scales; letter scales; weighbridges; precision balances; scales with body mass analysers; levelling staffs [surveying instruments]; camcorders; video baby monitors; video cassettes; video projectors; video telephones; video screens; viewfinders, photographic; electric plugs; micrometer screws for optical instruments; viscosimeters; circuit closers; wavemeters; voltmeters; mechanical signs; signs, luminous; switchboxes [electricity]; current rectifiers; gas testing instruments; gasometers [measuring instruments]; galvanometers; hands-free kits for telephones; heliographic apparatus; hygrometers; hydrometers; weights; peepholes [magnifying lenses] for doors; hairdressing training heads [teaching apparatus]; holograms; plotters; loudspeakers; sounding leads; plumb bobs; range finders; parking sensors for vehicles; piezoelectric sensors; densimeters; densitometers; detectors; smoke detectors; infrared detectors; counterfeit coin detectors; joysticks for use with computers, other than for video games; transparencies [photography]; slide projectors; diaphragms [photography]; dictating machines; dynamometers; light-emitting diodes [LED]; quantum dot light-emitting diodes [QLED]; organic light-emitting diodes [OLED]; floppy disks; phonograph records; disks, magnetic; optical discs; circular slide rules; disk drives for computers; juke boxes for computers; wearable video display monitors; electronic numeric displays; DNA chips; electronic interactive whiteboards; electronic notice boards; electric wire harnesses for automobiles; bullet-proof vests; life jackets; reflective safety vests; identification threads for electric wires; nose clips for divers and swimmers; padlocks, electronic; locks, electric; bells [warning devices]; alarm



bells, electric; electric door bells; signal bells; acoustic conduits; mirrors for inspecting work; road signs, luminous or mechanical; downloadable emoticons for mobile phones; marine depth finders; probes for scientific purposes; buzzers; needles for surveying compasses; needles for record players; eyewear; reflective articles for wear, for the prevention of accidents; measures; pressure measuring apparatus; simulators for the steering and control of vehicles; inverters [electricity]; pressure indicators; automatic indicators of low pressure in vehicle tyres; temperature indicators; incubators for bacteria culture; measuring instruments; cosmographic instruments; mathematical instruments; levelling instruments; instruments containing eyepieces; surveying instruments; azimuth instruments; interfaces for computers; audio interfaces; ionization apparatus not for the treatment of air or water; satellite finder meters; spark-guards; coaxial cables; fibre optic cables; cables, electric; calipers; slide calipers; screw-tapping gauges; calorimeters; calculating machines; pocket calculators; decompression chambers; rearview cameras for vehicles; cinematographic cameras; thermal imaging cameras; mouth guards for sports; life-saving capsules for natural disasters; electronic pens [visual display units]; holders for electric coils; biometric identity cards; identity cards, magnetic; video game cartridges; toner cartridges, unfilled, for printers and photocopiers; ink cartridges, unfilled, for printers and photocopiers; memory cards for video game machines; encoded magnetic cards; riding helmets; protective helmets; carriers for dark plates [photography]; cathodes; spools [photography]; choking coils [impedance]; coils, electric; electromagnetic coils; cinematographic film, exposed; computer keyboards; solenoid valves [electromagnetic switches]; wire connectors [electricity]; thin client computers; downloadable cryptographic keys for receiving and spending crypto assets; encoded key cards; electronic book readers; electronic agendas; push buttons for bells; mouse pads; magnetic encoders; visors for helmets; collectors, electric; calibrating rings; smart rings; ring sizers; protective suits for aviators; commutators; compact discs [audio-video]; compact discs [read-only memory]; comparators; marine compasses; computers; laptop computers; tablet computers; notebook computers; wearable computers; condensers [capacitors]; contacts, electric; wind socks for indicating wind direction; traffic cones; branch boxes [electricity]; distribution boxes [electricity]; junction boxes [electricity]; connectors [electricity]; battery boxes; cabinets for loudspeakers; diving suits; downloadable e-wallets; galena crystals [detectors]; covers for electric outlets; logs [measuring instruments]; lasers, not for medical purposes; lactodensimeters; lactometers; vacuum tubes [radio]; darkroom lamps [photography]; thermionic valves; amplifying tubes; flashlights [photography]; head cleaning tapes [recording]; magnetic tapes; videotapes; surveying chains; fire escapes; rulers [measuring instruments]; square rulers for measu-

ring; slide-rules; contact lenses; correcting lenses [optics]; close-up lenses; optical lenses; optical condensers; sounding lines; electricity conduits; measuring spoons; magnifying glasses [optics]; thread counters; magnets; decorative magnets; crash test dummies; resuscitation mannequins [teaching apparatus]; mouse [computer peripheral]; trackballs [computer peripherals]; pressure gauges; security tokens [encryption devices]; divers' masks; solderers' helmets; protective masks, not for medical purposes; respiratory masks, other than for artificial respiration; materials for electricity mains [wires, cables]; voting machines; money counting and sorting machines; material testing instruments and machines; furniture especially made for laboratories; megaphones; portable media players; diaphragms [acoustics]; diaphragms for scientific apparatus; metal detectors for industrial or military purposes; digital weather stations; metronomes; rules [measuring instruments]; carpenters' rules; dressmakers' measures; mechanisms for coin-operated apparatus; mechanisms for counter-operated apparatus; coin-operated mechanisms for television sets; shutter releases [photography]; micrometers; microprocessors; microscopes; microtomes; microphones; audio mixers; modems; lightning conductors; monitors [computer hardware]; monitors [computer programs]; selfie sticks [hand-held monopods]; terminals [electricity]; junction sleeves for electric cables; teeth protectors; temperature indicator labels, not for medical purposes; knee-pads for workers; headphones; earpieces for remote communication; surveyors' levels; sound recording carriers; magnetic data media; optical data media; electronic sheet music, downloadable; computer game software, recorded; computer software, recorded; sheaths for electric cables; identification sheaths for electric wires; weighing machines; computer hardware; punched card machines for offices; life saving equipment; shoes for protection against accidents, irradiation and fire; objectives [lenses] [optics]; lenses for astrophotography; selfie lenses; egg-candlers; fire extinguishers; rescue laser signalling flares; electrified fences; limiters [electricity]; clothing for protection against accidents, irradiation and fire; clothing for protection against fire; asbestos clothing for protection against fire; clothing especially made for laboratories; survival blankets; ozonisers [ozonators]; octants; eyepieces; ohmmeters; wrist rests for use with computers; spectacle frames; oscillographs; plumb lines; mirrors [optics]; spectacles; sunglasses; goggles for sports; electronic collars to train animals; finger sizers; signalling panels, luminous or mechanical; biometric passports; wah-wah pedals; radio pagers; pince-nez; electronic pocket translators; transmitters [telecommunication]; telephone transmitters; transmitters of electronic signals; switches, electric; periscopes; data gloves; gloves for divers; gloves for protection against accidents; gloves for protection against X-rays for industrial purposes; asbestos gloves for protection against accidents; fur-

naces for laboratory use; droppers for measuring, other than for medical or household purposes; laboratory pipettes; pyrometers; planimeters; plane tables [surveying instruments]; plates for batteries; computer software platforms, recorded or downloadable; wafers for integrated circuits; printed circuit boards; compact disc players; cassette players; protective films adapted for computer screens; protective films adapted for smartphone screens; sound recording strips; X-ray films, exposed; films, exposed; life-saving rafts; animal signalling rattles for directing livestock; laboratory trays; digital signs; stands adapted for laptops; semi-conductors; polarimeters; personal digital assistants [PDAs]; fire pumps; measuring glassware; weight belts for divers; life belts; fuses; circuit breakers; converters, electric; telerupters; food analysis apparatus; diagnostic apparatus, not for medical purposes; distance recording apparatus; distance measuring apparatus; speed measuring apparatus [photography]; appliances for measuring the thickness of leather; apparatus for measuring the thickness of skins; speed checking apparatus for vehicles; teaching apparatus; time recording apparatus; apparatus and instruments for astronomy; surveying apparatus and instruments; weighing apparatus and instruments; nautical apparatus and instruments; navigational instruments; optical apparatus and instruments; apparatus and instruments for physics; chemistry apparatus and instruments; measuring apparatus; measuring devices, electric; boiler control instruments; meteorological instruments; naval signalling apparatus; observation instruments; navigation apparatus for vehicles [on-board computers]; satellite navigational apparatus; regulating apparatus, electric; telecommunication apparatus in the form of jewellery; precision measuring apparatus; audio- and video-receivers; prisms [optics]; computer software applications, downloadable; ticket printers; printers for use with computers; hemline markers; retorts' stands; apparatus for changing record player needles; drainers for use in photography; cleaning apparatus for phonograph records; fire beaters; sighting telescopes for firearms; telescopic sights for artillery; test tubes; pressure indicator plugs for valves; magnetic wires; telegraph wires; telephone wires; wires, electric; conductors, electric; copper wire, insulated; fuse wire; computer programs, recorded; computer game software, downloadable; computer programs, downloadable; computer operating programs, recorded; computer screen saver software, recorded or downloadable; record players; processors [central processing units]; rods for water diviners; electronic publications, downloadable; distribution consoles [electricity]; control panels [electricity]; radar apparatus; baby monitors; masts for wireless aerials; transmitting sets [telecommunication]; radios; vehicle radios; sprinkler systems for fire protection; frames for photographic transparencies; screens for photoengraving; flowmeters; walkie-talkies; voltage surge protectors; voltage regulators for vehicles; stage lighting regula-

tors; light dimmers [regulators], electric; speed regulators for record players; cell switches [electricity]; washing trays [photography]; marking gauges [joinery]; T-squares for measuring; time switches, automatic; relays, electric; safety restraints, other than for vehicle seats and sports equipment; body harnesses for support when lifting loads; X-ray photographs, other than for medical purposes; rheostats; respirators for filtering air; retorts; refractometers; refractors; grids for batteries; security surveillance robots; laboratory robots; teaching robots; telepresence robots; humanoid robots with artificial intelligence for use in scientific research; electric sockets; height measuring instruments; speaking tubes; horns for loudspeakers; subwoofers; saccharometers; optical fibres [light conducting filaments]; traffic-light apparatus [signalling devices]; dog whistles; signalling whistles; sports whistles; sextants; inductors [electricity]; safety nets; nets for protection against accidents; fire alarms; signals, luminous or mechanical; rescue flares, non-explosive and non-pyrotechnic; sirens; electronic access control systems for interlocking doors; scanners [data processing equipment]; hand-held electronic dictionaries; integrated circuit cards [smart cards]; smartglasses; smartphones; smartwatches; connections for electric lines; couplings, electric; sonars; sound locating instruments; lighting ballasts; resistances, electric; spectrograph apparatus; spectroscopes; speed indicators; alcoholmeters; satellites for scientific purposes; protection devices for personal use against accidents; audiovisual teaching apparatus; charging stations for electric vehicles; radiotelegraphy sets; radiotelephony sets; spectacle lenses; anti-glare glasses; optical glass; personal stereos; stereoscopes; stands for photographic apparatus; stroboscopes; fire boats; sulfimeters; bags adapted for laptops; drying racks [photography]; spherometers; integrated circuits; printed circuits; counters; parking meters; mileage recorders for vehicles; revolution counters; abacuses; egg timers [sandglasses]; taximeters; ear plugs for divers; tachometers; television apparatus; telegraphs [apparatus]; telescopes; teleprompters; teleprinters; mobile telephones; cordless telephones; theodolites; credit card terminals; interactive touch screen terminals; thermo-hygrometers; thermometers, not for medical purposes; thermostats; thermostats for vehicles; climate control digital thermostats; crucibles [laboratory]; tone arms for record players; totalizers; transistors [electronic]; transponders; protractors [measuring instruments]; transformers [electricity]; step-up transformers; resuscitation training simulators; vehicle breakdown warning triangles; triodes; starter cables for motors; discharge tubes, electric, other than for lighting; capillary tubes for laboratory use; neon signs; Pitot tubes; X-ray tubes not for medical purposes; telephone receivers; headgear being protective helmets; squares for measuring; quantity indicators; petrol gauges; water level indicators; electric loss indicators; light-emitting electronic pointers; slope indi-

cators; levels [instruments for determining the horizontal]; mercury levels; spirit levels; urinometers; amplifiers; particle accelerators; electric installations for the remote control of industrial operations; steering apparatus, automatic, for vehicles; balancing apparatus; video recorders; sound reproduction apparatus; invoicing machines; tape recorders; protection devices against X-rays, not for medical purposes; railway traffic safety appliances; data processing apparatus; oxygen transpiring apparatus; theft prevention installations, electric; devices for the projection of virtual keyboards; film cutting apparatus; drying apparatus for photographic prints; optical character readers; centering apparatus for photographic transparencies; dosage dispensers; battery chargers; chargers for electric accumulators; chargers for electronic cigarettes; acoustic alarms; sounding apparatus and machines; apparatus for editing cinematographic film; cathodic anti-corrosion apparatus; couplers [data processing equipment]; wearable activity trackers; anti-theft warning apparatus; computer peripheral devices; anti-interference devices [electricity]; demagnetizing apparatus for magnetic tapes; acoustic couplers; alarms; fog signals, non-explosive; whistle alarms; adding machines; readers [data processing equipment]; heat regulating apparatus; photocopiers [photographic, electrostatic, thermal]; electric and electronic effects units for musical instruments; bar code readers; downloadable ring tones for mobile phones; downloadable image files; downloadable music files; animated cartoons; filters for respiratory masks; filters for ultraviolet rays, for photography; filters for use in photography; USB flash drives; magic lanterns; optical lanterns; signal lanterns; cameras [photography]; glazing apparatus for photographic prints; shutters [photography]; dark-rooms [photography]; photometers; flash-bulbs [photography]; digital photo frames; enlarging apparatus [photography]; photovoltaic cells; containers for contact lenses; spectacle cases; containers for microscope slides; cases for smartphones; cases especially made for photographic apparatus and instruments; chromatography apparatus for laboratory use; chronographs [time recording apparatus]; laboratory centrifuges; spectacle chains; cyclotrons; compasses for measuring; frequency meters; time clocks [time recording devices]; Petri dishes; sleeves for laptops; covers for personal digital assistants [PDAs]; covers for tablet computers; covers for smartphones; fire blankets; chips [integrated circuits]; jigs [measuring instruments]; pedometers; meteorological balloons; electrified rails for mounting spot lights; asbestos screens for firemen; fire hose; virtual reality headsets; protective helmets for sports; head guards for sports; lifeboats; snorkels; cell phone straps; spectacle cords; tripods for cameras; switchboards; distribution boards [electricity]; equalizers [audio apparatus]; screens [photography]; workmen's protective face-shields; projection screens; radiology screens for industrial purposes; fluorescent screens; exposure meters [light

meters]; ducts [electricity]; galvanic cells; downloadable graphics for mobile phones; epidiascopes; ergometers; armatures [electricity]; black boxes [data recorders].

(260) AM 2023 118045 A  
 (800) 1664321  
 (151) 2022 03 02  
 (891) 2022 03 02  
 (731) Havatzelet Cultural & Educational Institutions  
 of Hashomer HAtzair Ltd.  
 3785000 Giv'at Haviva, Israel  
 (540)



(591) Black, white  
 (531) 05.05.02; 05.05.20; 05.13.01; 24.11.15;  
 25.01.06; 25.01.25; 26.01.03; 26.01.20

(511)  
 41 – Organization of cultural, educational and sporting activities in kibbutzim in Israel and worldwide; providing education and training to beginner artists in the fields of exhibitions and projects to encourage and support young persons in the fields of culture, education, science and sports; organization of cultural activities in the nature of youth movements and summer camps; organizing of community educational and cultural events, such as bar and bat mitzvahs, weddings, training workshops and knowledge development held in community and cultural centers; educational services such as operating kindergartens and schools.

(260) AM 2023 118046 A  
 (800) 1664357  
 (151) 2022 03 16  
 (891) 2022 03 16  
 (731) Oriflame Cosmetics AG  
 Bleicheplatz 3, CH-8200 Schaffhausen,  
 Switzerland  
 (540)

## ORIFLAME DUOLOGI

(591) Black, white  
 (511)  
 3 – Non-medicated conditioning and care preparations for application to the hair, scalp, skin and nails; shampoos; hair conditioner; soaps; perfumes; perfumery; eau de cologne; toilet waters; essential and herbal oils; cosmetics; make-up; make-up preparations; make-up removers; lipsticks; nail varnishes; nail varnish removers; eyeliner; mascara; non-medicated toilet prepara-

tions; hair styling preparations and treatments; hair lotions; hair sprays and hair gels; preparations for use in the bath or shower; bath and shower oils, gels, creams and foams; face and body masks; face and body scrubs; facial washes; skin cleansers and hydrators; skin toners; skin moisturizers; blemish creams and blemish gels; deodorants; antiperspirants; shaving soaps; shaving creams; shaving gels; after-shave preparations; pre-shave preparations; talcum powders; toiletries; dentifrices; toothpastes; mouth washes; foot care preparations (non-medicated); cotton for cosmetic purposes; cotton wool, sticks, buds, swabs, puffs, balls and pads; cotton wool in the form of wipes for cosmetic use; cotton puffs and pads impregnated with make-up removing preparations.

(260) AM 2023 118047 A

(800) 1664430

(151) 2021 10 13

(891) 2021 10 13

(731) KERRY GROUP PLC.

Prince's Street, Tralee, Ireland

(540)



(591) Navy blue, white and yellow

(531) 26.04.05; 26.04.06; 26.04.18; 26.04.24;

27.05.11; 27.05.17; 27.05.24; 29.01.13

(511)

1 – Proteins for the manufacture of human foodstuffs which form emulsions or have emulsifying properties; proteins for the manufacture of human foodstuffs which form gel or which have gelling properties; proteins for the manufacture of human foodstuffs which hold water or have water holding properties; gelling agents for human foodstuffs or beverages; absorption agents; emulsifiers for use in the manufacture of foods; wetting agents; stabilising agents for use in food; foaming agents; emulsifiers; texturing agents for use in the manufacture of foods; texturants for food and beverage; sweet particulates and inclusions, sweet sauces, texture systems, sweet and savoury flavours being chemical or organic compositions for use in manufacture of food and beverages; casein for the food industry, beverage industry and pharmaceutical industry; chemicals for the manufacture of flavour improvers for foods, beverages and oral care products; chemical additives for use in manufacture of food, drink and oral care products; chemicals for use in brewing; enzymes for the brewing industry; caseinates for the food industry, beverage industry and pharmaceutical industry; chemical products derived from milk for use in industry; chemical products for preserving foodstuffs or beverages; preserving agents for foods and beverages; proteins for use in industry; pro-

teins for the food industry; proteins for the beverage industry; proteins for use in manufacture; food protein as a raw material; proteins for use in the manufacture of foodstuffs or beverages; proteins for use in the manufacture of food supplements; enzymes for use in flavouring; chemicals for the manufacture of flavour enhancers for foods, beverages and oral care products; chemical products for the preparation of flavourings; enzymes (other than for medical or veterinary use); enzyme preparations for the food industry; enzyme preparations for the beverage industry; enzyme preparations for use in the baking, confectionery, dairy, meat, human nutrition or animal nutrition industries; fungal enzymes for use in the food industry or beverage industry; fungal enzymes for use in the baking, brewing, confectionery, dairy, meat, human nutrition or animal nutrition industries; fermentation extracts for industrial purposes; fermentation extracts for the food industry, beverage industry and pharmaceutical industry; chemical additives for use in fermentation; enzymes for use in fermentation; proteins for use in fermentation technology; ferments for use in the food industry or beverage industry; ferments for use in the baking, brewing, confectionery, dairy, meat, human nutrition or animal nutrition industries; chemical products for the fresh-keeping and preserving of food; chemical products for preserving products during storage; food preservative compositions; food preservatives; catalysts; catalysts for use in the food industry or beverage industry; catalysts for use in the baking, brewing, confectionery, dairy, meat, human nutrition or animal nutrition industries; natural extracts and distillates for use in the food industry or beverage industry; natural extracts and distillates for use in the baking, brewing, confectionery, dairy, meat, human nutrition or animal nutrition industries; beta glucan for use in the food industry or beverage industry; beta glucan for use in the baking, confectionery, dairy, meat, human nutrition or animal nutrition industries; prebiotic bacteria and probiotic bacteria for use in the food industry or beverage industry; prebiotic bacteria and probiotic bacteria for use in the baking, brewing, confectionery, dairy, meat, human nutrition or animal nutrition industries; prebiotic or probiotic bacterial formulations (other than for medical use); nutritional lipids and nutritional bases for use in the food industry or beverage industry; nutritional lipids and nutritional bases for use in the baking, confectionery, dairy, meat, human nutrition or animal nutrition industries; enzymes produced through fermentation of yeast, bacterial or fungal strains; whey proteins and demineralised whey proteins for use in the food industry or beverage industry; whey proteins and demineralised whey proteins for use in the manufacture of baking, confectionery, dairy, meat, human nutrition or animal nutrition products; nutrition agents for processing living cells (other than for medical use); nutrition agents for living cells (other than for medical use); protein hydrolysates for use in manufacture; recom-

binant proteins for nutrition of living cells (other than for medical use); media for cell culture for use in the biotechnical industry or in non-medical research laboratories; cultures of cell media (other than for medical or veterinary use); excipients, other than for medical use; chemical preparations for use in pharmaceuticals; chemical preparations for use in the manufacture of pharmaceuticals; chemical preparations for use in the pharmaceutical industry; chemical preparations for use in nutraceuticals; excipients used in the manufacture of pharmaceuticals; cellulose ethers; chemicals and polymers used for coating and/or encapsulating vitamin and/or mineral supplements, pharmaceuticals, food supplements, herbal products or food products; enzymes for use in the manufacture of nutraceuticals; hydrolysed vegetable protein; lipid mixtures for use as additives in foodstuffs; lipid mixtures for use as additives in beverages and mixes for making beverages; excipients for use in the manufacture of pharmaceutical preparations; excipients for use in the manufacture of pharmaceuticals; media for cell culture for use in medical research laboratories.

3 – Flavourings being essential oils for foodstuffs or beverages; flavour enhancers for foodstuffs or beverages (essential oils); food flavourings prepared from essential oils; flavourings for beverages (essential oils); substances imparting taste for addition to foodstuffs or beverages (essential oils).

5 – Pharmaceutical preparations; chemical preparations for pharmaceutical purposes; pharmaceutical preparations and substances; delivery agents in the form of coatings for tablets that facilitate the delivery of vitamin and/or mineral supplements, pharmaceutical preparations, food supplements or herbal products in this class; cellulose ethers for pharmaceutical, medical or dietetic purposes; casein dietary supplements; dietary supplements and dietetic preparations; enzyme dietary supplements; nutritional supplements; nutritional supplements consisting of fungal extracts; prebiotic supplements; probiotic supplements; protein supplements; food supplements; feed supplements for veterinary use; medicated food supplements; medicated supplements for animal feedstuffs; nutrition agents for processing living cells (for medical or veterinary use); nutrition agents for living cells (for medical or veterinary use); recombinant proteins for nutrition of living cells (for medical or veterinary use); cultures of cell media (for medical or veterinary use); nutraceuticals for therapeutic purposes; nutraceuticals for use as a dietary supplement; carbohydrate-based nutritional drink mixes for use as meal replacements for medical use; delivery agents in the form of coatings and encapsulating materials for tablets that facilitate the delivery of nutritional supplements.

29 – Dairy powders; cheese powder; cream powder; powdered butter; powdered cultured dairy products; milk powder; milk fat; milk fat preparations; powdered milk fat; curd; dairy products and dairy substi-

tutes; milk; milk products; edible oils and fats; lipids being edible fats; beverages consisting principally of milk; beverages having a milk base; beverages made with yoghurt; birds eggs and egg products; cheese; cheese products; cheese spreads; dairy desserts; dairy-based spreads; dairy puddings; dairy spreads; dairy-based beverages; dairy-based dips; cheese dips, dairy-based dips, bean dips, nut-based dips, meat-based dips; vegetable-based dips, plant-based dips; desserts made from milk products; dried milk powder; flavoured milk; flavoured milk beverages; flavoured milk powder for making drinks; milk based beverages [milk predominating]; milk beverages, milk predominating; milk-based beverages containing coffee; milk-based beverages containing fruit juice; milk-based beverages containing fruits; pre-cooked soup; preparations for making soup; vegetable-based spreads; whey; yoghurt; preparations for addition to, or for use in making dairy products, ice-cream, ice cream desserts, ice cream confections, frozen confections, frozen yoghurt, sorbet, sherbets, sundaes, yoghurt or milk shakes, namely, crystallized fruit, dried fruit, processed nuts, and nut butters; clusters made primarily with potato chips, dried fruits, and processed nuts; inclusions for dairy products, ice cream, ice cream desserts, ice cream confections, frozen confections, frozen yoghurt, sorbet, sherbets, sundaes, yoghurt or milk shakes, namely, dried and crystallized fruit, processed and candied nuts, and nut butters, including pieces of any of the foregoing; inclusions for dairy products, ice-cream, ice cream desserts, ice cream confections, frozen confections, frozen yoghurt, sorbet, sherbets, sundaes, yoghurt or milk shakes, namely, clusters made primarily of potato chips, dried and crystallized fruit, and processed and candied nuts; fruit and nut based sweet particulates and inclusions, namely candied nuts and dried fruits; dairy products that include added toppings or mix-ins; meat; fish; poultry; game; meat extracts; preserved fruits; preserved vegetables; dried fruits; dried vegetables; cooked fruits; cooked vegetables; jellies; jams; compotes; eggs; prepared meals, dishes and snack foods consisting primarily of meat, meat substitutes, fish, poultry, game, seafood, shellfish, fruit, nuts, seeds, vegetables, mushrooms, dairy products, dairy substitutes, eggs, legumes or tofu; dried mushrooms; preserved mushrooms; prepared mushrooms; banana crisps, coconut crisps, potato crisps, vegetable crisps; dried fruit; dried pulses; edible seeds; fish and seafood spreads; flavoured nuts; fruit salads; meat paste; meat spreads; meat stocks; meat, prepared; meat, preserved; meat, processed; nuts being cooked; nuts being dried; nuts being preserved; nuts, prepared; potato salad; prepared fruits; prepared legumes; prepared nuts; prepared pulses; prepared salads; prepared vegetable products; prepared vegetables; processed fruits; processed meat products; processed nuts; processed seafood products; processed vegetables; pulses, dried; pulses, prepared; pulses, preserved; pulses, processed; seafood pro-

ducts; seafood, not live; seafood, processed; seeds, prepared; shellfish, not live; snack mixes consisting of dehydrated fruit and processed nuts; soup mixes; soups; soya beans, preserved, for food; textured vegetable protein for use as a meat extender; tofu; vegetable extracts for culinary purposes; vegetable salads; vegetable-based meat substitutes; non-dairy creamers; dairy-based creamers; shortening enzyme-modified whole milk powder; non-dairy milk; stocks, broths and bouillons; pickles; fruit and vegetable-based extracts for culinary purposes; bases for making milk shakes.

30 – Food flavourings; flavourings, other than essential oils, for foods; flavourings, other than essential oils, for beverages; salts, seasonings, flavourings and condiments; flavorings, other than essential oils, for food or beverages; malt-based food preparations; malt extracts for food; malt extracts for use as flavouring; natural smoke condensates (flavourings) for foodstuffs or beverages; seasoned coatings, seasoning rubs, marinades and glazing products for foodstuffs; clusters made primarily with pretzels, rice, popcorn, crackers, processed and ready to eat cereals, processed grains, chocolate and candy; chocolate and candy for adding to dairy products, frozen yoghurt or ice cream; dairy confectionery, frozen yoghurt or ice cream that include added toppings or mix-ins; starch-based binding agents for ice cream; thickening agents for use in cooking; coffee; tea; cocoa; artificial coffee; preparations made from cereals; confectionery; edible ices; sauces (condiments); flavourings, other than essential oils, for milk shakes; blends of seasonings; chocolate based products; chocolate flavourings; condiments; cooking essences; dried herbs; dry seasonings; edible spices; extracts used as flavouring [not essential oils]; flavour enhancers for food [other than essential oils]; essences for foodstuffs, except etheric essences and essential oils; flavourings and seasonings; fruit sauces; marinades; processed herbs; relish [condiment]; sauces; savoury food flavourings for animal foods [other than essential oils]; savoury food flavourings for food [other than essential oils]; savoury sauces, chutneys and pastes; seasonings; spices; vegetable thickeners; cooking sauces; dressings for salad; gravies; gravy mixes; preparations for making up into sauces; preparations for making gravy; salsas; savoury sauces used as condiments; cereal bars and energy bars; bakery goods; candies [sweets]; chilled desserts; crackers; crème caramel; custard; dessert mousses [confectionery]; dessert puddings; foodstuffs containing chocolate [as the main constituent]; foodstuffs containing cocoa [as the main constituent]; imitation chocolate; sweets (candy), candy bars and chewing gum; pastries, cakes, tarts and biscuits (cookies); prepared desserts [chocolate based]; prepared desserts [confectionery]; savoury biscuits; snack foods consisting principally of confectionery; pastries; pasties; prepared desserts [pastries]; wafers; chocolate candies; chocolate bars; natural sweeteners; sweet glazes

and fillings; flavouring syrups; glucose syrups for food; topping syrup; frozen confectionery; frozen yoghurt [confectionery ices]; ice beverages with a chocolate base; ice beverages with a cocoa base; ice beverages with a coffee base; ice cream; ice cream mixes; ice cream substitute; non-dairy ice cream; artificial tea; beverages containing chocolate; beverages with a chocolate base; beverages with a cocoa base; beverages with coffee base; beverages with tea base; chocolate; chocolate-based beverages with milk; cocoa beverages with milk; coffee beverages with milk; coffee flavourings; preparations for making beverages [cocoa based]; preparations for making beverages [tea based]; preparations for making beverages [coffee based]; preparations for making beverages [chocolate based]; tea extracts; cereals; doughs, batters, and mixes therefor; dried and fresh pastas, noodles and dumplings; food preparations based on grains; organic thickening agents for cooking foodstuffs; natural starches for food; modified starches for food [not medical]; preparations for making bakery products; processed cereals for food for human consumption; processed grains for food for human consumption; thickening agents for cooking foodstuffs; yeast and leavening agents; pre-mixes ready for baking; bread mixes; pastry mixes; cocoa, cereal, sugar or confectionery based sweet particulates and inclusions, namely chocolate pieces, candy pieces, cookie pieces, popcorn pieces, pretzel pieces, cracker pieces, caramel pieces, toffee pieces, snack food (consisting of rolled oats, nuts and honey), sweet sauces, sweet and savoury food flavourings; yeast; yeast extracts; baking-powder; salt; mustard; vinegar; ice; prepared meals or dishes consisting of rice, with added meat, fish or vegetables; prepared meals, dishes or snack foods consisting primarily of cereals, grains, pasta, pastry, bread, confectionery, rice or noodles; dairy flavourings; natural-based extracts, other than essential oils, for flavouring foodstuffs; pickling solutions in the nature of vinegar and brine for pickling and cooking; pickling solutions in the nature of vinegar and brine for cooking used in baking products, confectionery products, dairy products, meat products, human foods or animal foods; inclusions for dairy products, ice-cream, ice cream desserts, ice cream confections, frozen confections, frozen yoghurt, sorbet, sherbets, sundaes, yoghurt or milk shakes, namely, popcorn, pretzels, crackers, hard candies, toffees, candy and chocolate brittles, candy and chocolate barks, cookie dough, chocolate, and caramel, including pieces of any of the foregoing; inclusions for dairy products, ice-cream, ice cream desserts, ice cream confections, frozen confections, frozen yoghurt, sorbet, sherbets, sundaes, yoghurt or milk shakes, namely, flavouring and topping syrups, sauces, processed and ready-to-eat cereal pieces and clusters made primarily of processed and ready-to-eat cereal pieces, pretzels, crackers, candy sprinkles and other confectionery pieces, namely, chocolate confectionery and confectionery made of sugar; carbohydra-

te-based nutritional drink mix for use as a meal replacement.

32 – Beers; non-alcoholic beverages; non-alcoholic wines; non-alcoholic cocktails; alcohol free cider; flavoured carbonated beverages; non-carbonated soft drinks; juices; waters; aerated waters; mineral waters; fruit beverages and fruit juices; syrups for making beverages; preparations for making beverages; beverages containing vitamins; energy drinks; frozen fruit-based beverages; frozen carbonated beverages; fruit-based soft drinks flavoured with tea; protein-enriched sports beverages; sherbets [beverages]; whey beverages; fruit-based beverages; non-alcoholic fruit extracts; smoothies; vegetable smoothies; concentrates for making fruit drinks; concentrates for use in the preparation of soft drinks; cordials; essences for making beverages; non-alcoholic fruit, vegetables and natural-based extracts for making beverages.

(260) AM 2023 118048 A

(800) 1664461

(151) 2022 01 15

(891) 2022 01 15

(731) Avon Products, Inc.

1 Avon Place, Suffern, New York NY 10901,  
USA

(540)

**AVON**

(591) Black, white

(511)

3 – Non-medicated toilet preparations; toiletries; skin care preparations; skin moisturizers; skin toners; body and beauty care preparations; powders, cleansers, creams and lotions, all for the face, hands and body; exfoliating scrubs for cosmetic purposes; cosmetic sun-tan preparations; sunscreen oils and lotions; soaps; shower and bath preparations; bath gel, bath oils, bath salts, bath beads, and effervescent bath preparations; beauty masks; talcum powder; nail polish; nail polish remover; false nails; adhesives for cosmetic purposes; cosmetics; eye cream; eye gels; eye lotions; eye make-up remover; eye shadow; eye liner; eyebrow cosmetics; mascara; lipstick; lip liner; lip-gloss; lip balm; make-up foundation; facial concealer; blusher; tissues impregnated with cosmetic lotions; powdered cosmetic tissues; cotton sticks for cosmetic purposes; cotton wool for cosmetic purposes; pumice stone; preparations for cleaning, moisturising, colouring and styling the hair; shampoos, conditioners, finishing spray, and gels, all for the hair; preparations for cleaning the teeth; shaving and aftershave preparations; perfumes; fragrances; toilet waters; cologne; room fragrances; incense sticks; deodorants for human beings; antiperspirants for personal use (toiletries); essential oils (cosmetic); oils for perfumes and scents; potpourri; cosmetic kits.

4 – Candles; scented and unscented candles, including scented pillar candles, scented tea light candles and scented filled candles; scented candle gift sets; scented candles incorporating candle plates and holders; scented candle gift sets incorporating scented candles in glass, wood and metal containers and candle plates; candle gardens [candles] incorporating scented candles in glass, wood and metal containers and candle plates together with coloured and white rocks.

21 – Hair and make-up brushes; cosmetic and personal cleaning sponges; household or kitchen utensils and containers (not of precious metal or coated therewith); hair make-up and cosmetic brushes, hair combs, nail brushes, body sponges, bath brushes, bath sponges, body scrubbing gloves, body scrubbing puffs, loofahs, sponge bags [fitted], candlesticks and candle holders not of precious metal, candle jars, aroma jars, pots and stands not of precious metal, shaving brush stands, fragrant oil burners, plates for diffusing aromatic oil; aromatic oil diffusers, other than reed diffusers, back scratchers, scent sprays (atomizers), perfume atomizers, cosmetic powder compacts, powder compacts (cases), soap dishes, toothbrush holders, tea strainers, cosmetic applicators and accessories, namely face/body brushes, facial sponges, cosmetic bags [fitted], brushes and combs for eyebrows and eyelashes, eyeliner brushes and combs, foam toe separators, foam cosmetic applicators, cosmetic sponges and powder puffs; articles for cleaning purposes; glassware, cookware, bakeware, porcelain and earthenware.

35 – Retail services connected with the sale of beauty and personal care products, cosmetics, fragrances, toiletries, skin care preparations and hair care preparations, fashion goods, wellness goods, household and kitchen utensils and goods for the home; retail services provided via the Internet connected with the sale of beauty and personal care products, cosmetics, fragrances, toiletries, skin care preparations and hair care preparations, fashion goods, wellness goods, household and kitchen utensils and goods for the home; retail services by telephone shop at home services and shop at home parties featuring beauty and personal care products, cosmetics, fragrances, toiletries, skin care preparations and hair care preparations, fashion goods, wellness goods, household and kitchen utensils and goods for the home; online ordering services featuring beauty and personal care products, cosmetics, fragrances, toiletries, skin care preparations, fashion goods, wellness goods, household and kitchen utensils and goods for the home; mail order retail services for beauty and personal care products, cosmetics, fragrances, toiletries, skin care preparations and hair care preparations, fashion goods, wellness goods, household and kitchen utensils and goods for the home; retail services connected with the sale of subscription boxes containing beauty and personal care products, cosmetics, fragran-

ces, toiletries, skin care preparations and hair care preparations, fashion goods, wellness goods, household and kitchen utensils and goods for the home; presentation of goods namely beauty and personal care products, cosmetics, fragrances, toiletries, skin care preparations and hair care preparations, fashion goods, wellness goods, household and kitchen utensils and goods for the home, on communication media for retail purposes; retail services via catalogues related to beauty and personal care products, cosmetics, fragrances, toiletries, skin care preparations and hair care preparations, fashion goods, wellness goods, household and kitchen utensils and goods for the home.

(260) AM 2023 118049 A  
 (800) 1664489  
 (151) 2022 03 16  
 (891) 2022 03 16  
 (731) Zim Integrated Shipping Services Ltd.  
 9 Sakharov Andrei St., Haifa, Israel  
 (540)



(591) Blue, red, yellow, green, purple, orange, black and white

(531) 01.17.01; 05.07.23; 17.03.01; 17.05.01;  
 19.01.03; 24.03.18; 27.05.21; 29.01.15

(511)  
 9 – Software for booking the transport or forwarding and shipping of end-to-end freight, by land by air and by sea; software for managing the transport or forwarding and shipping of end-to-end freight, by land by air and by sea; software for preparation of forms and online filing of freight transportation documents, shipping documents, government agency documents, customs clearances, customs bonds registrations, product classifications, cargo insurance, quality inspections and testing; software for tracking and tracing shipments and freight, managing shipments and freight, tracking, tracing, monitoring and controlling the cargo's environment; software for searching for supply chain transport and shipping data, creating and distributing reports related to supply chain and shipments, generating and providing quotes for freight transport and shipping, and for freight transport and shipment billing; software for managing supply chain logistics and reverse logistics, namely, the storage, transportation and delivery of freight for others; software for managing distribution of freight; software for managing logistics of transportation and shipping of freight; software for managing the leasing and rental of

containers.

12 – Vehicles for travelling and transport on water; vessels; ships; apparatus for locomotion and transport on water; land vehicles; apparatus for locomotion and transport on land; transport containers for use in vehicles.

35 – Business management of freight logistics and freight transport logistics for others; business management services in the field of freight transportation relating to shipment processing, preparing freight and freight transport documents and invoices, preparing shipping documents and invoices, tracking and tracing documents, packages and freight over computer networks, Intranets, and the Internet for business purposes; business administration services relating to electronic tracking and tracing of freight information to others; administrative processing of purchase orders; administrative services relating to customs clearance; regulatory submission management, namely, business administration assistance for others in preparing and filing documents related to customs and to cross-border transportation of freight, with governmental regulatory bodies.

39 – Transport, packaging, and storage of freight by land, sea and air; arranging transportation by land, sea and air; freight forwarding services by land, air and sea; freight transportation and freight transportation logistics services; consultation in the field of sea land and air freight transportation; freight loading and unloading services; warehousing and distribution services, namely, storage, distribution, pick-up, delivery and packing for shipment of documents, packages, goods, raw materials, and other freight for others; supply chain logistics and reverse logistics, namely, storage, transportation and delivery of documents, packages, goods, raw materials, and other freight for others; stevedoring; freight brokerage; rental and leasing of containers; arranging for pickup, delivery, storage and transportation of documents, packages, freight and parcels via ground, sea and air carriers.

42 – Software as a service (SAAS) featuring software for booking the transport or forwarding and shipping of end-to-end freight, by land by air and by sea; software as a service (SAAS) featuring software for managing the transport or forwarding and shipping of end-to-end freight, by land by air and by sea; software as a service (SAAS) featuring software for preparation of forms and online filing of freight transportation documents, shipping documents, government agency documents, customs clearances, customs bonds registrations, product classifications, cargo insurance, quality inspections and testing; software as a service (SAAS) featuring software for tracking and tracing shipments and freight, managing shipments and freight, tracking, tracing, monitoring and controlling the cargo's environment; software as a service (SAAS) featuring software for searching for supply chain trans-



port and shipping data, creating and distributing reports related to supply chain and shipments, generating and providing quotes for freight transport and shipping, and for freight transport and shipment billing; software as a service (SAAS) featuring software for managing supply chain logistics and reverse logistics, namely, the storage, transportation and delivery of freight for others; software as a service (SAAS) featuring software for managing distribution of freight; software as a service (SAAS) featuring software for managing logistics of transportation and shipping of freight; software as a service (SAAS) featuring software for managing the leasing and rental of containers.

(260) AM 2023 118050 A

(800) 1664503

(151) 2022 02 16

(891) 2022 02 16

(731) ÖZAK GEÇİŞ TEKNOLOJİLERİ SANAYİ  
TİCARET ANONİM ŞİRKETİ  
Çuhane Caddesi, No:130, Köseköy Kartepe,  
TR-41135 Kartepe – Kocaeli, Türkiye

(540)

**ÖZAK**

(591) Black, white

(511)

6 – Metal bollards; automatic turnstiles of metal; non-automatic turnstiles of metal; security barriers of metal; automated security barriers of metal; automated security gates of metal.

19 – Security barriers, not of metal; automated security gates, not of metal; automatic turnstiles, not of metal.

(260) AM 2023 118051 A

(800) 1664504

(151) 2022 04 06

(891) 2022 04 06

(731) Aktsionernoe Obshchestvo "Nizhegorodsky  
khimiko-farmatsevtichesky zavod"  
Salganskaya St., 7, RU-603950 Nizhny  
Novgorod, Russian Federation

(540)

**АРТРАКСИКАМ**

(591) Black, white

(531) 28.05

(511)

5 – Pharmaceuticals, medical and veterinary preparations; sanitary preparations for medical purposes; dietetic food and substances adapted for medical or veterinary use, food for babies; dietary supplements for human beings and animals; plasters, materials for dressings; material for stopping teeth, dental wax; disinfectants; preparations for destroying noxious ani-

mals; fungicides, herbicides; acaricides; aconitine; alkaloids for medical purposes; alginates for pharmaceutical purposes; algicides; aldehydes for pharmaceutical purposes; dental amalgams of gold; dental amalgams; amino acids for veterinary purposes; amino acids for medical purposes; analgesics; anaesthetics; antibiotics; antiseptics; medicine cases, portable, filled; first-aid boxes, filled; aluminium acetate for pharmaceutical purposes; acetates for pharmaceutical purposes; germicides; oxygen cylinders, filled, for medical purposes; balms for medical purposes; bandages for dressings; diagnostic biomarker reagents for medical purposes; biocides; bracelets impregnated with insect repellent; bromine for pharmaceutical purposes; paper for mustard plasters; fly catching paper; reagent paper for veterinary purposes; reagent paper for medical purposes; mothproof paper; petroleum jelly for medical purposes; vaccines; oxygen baths; antiseptic cotton; aseptic cotton; absorbent cotton; wadding for medical purposes; cotton for medical purposes; dietetic substances adapted for medical use; radiological contrast substances for medical purposes; nutritive substances for microorganisms; radioactive substances for medical purposes; bismuth subnitrate for pharmaceutical purposes; melissa water for pharmaceutical purposes; sea water for medicinal bathing; mineral waters for medical purposes; thermal water; dietary fiber; molding wax for dentists; gases for medical purposes; guaiacol for pharmaceutical purposes; massage gels for medical purposes; sexual stimulant gels; hematogen; hemoglobin; hydrastine; hydrastinine; glycerine for medical purposes; glycerophosphates; glucose for medical purposes; gentian for pharmaceutical purposes; hormones for medical purposes; mustard for pharmaceutical purposes; mustard plasters; mud for baths; medicinal mud; contraceptive sponges; gamboge for medical purposes; gurjun [gurjon, gurjan] balsam for medical purposes; deodorizers for litter trays; air deodorising preparations; deodorants, other than for human beings or for animals; deodorants for clothing and textiles; diastase for medical purposes; digitalin; vitamin supplement patches; mineral food supplements; nutritional supplements; albumin dietary supplements; yeast dietary supplements; alginate dietary supplements; glucose dietary supplements; casein dietary supplements; lecithin dietary supplements; linseed oil dietary supplements; propolis dietary supplements; protein dietary supplements; protein supplements for animals; royal jelly dietary supplements; pollen dietary supplements; wheat germ dietary supplements; linseed dietary supplements; acai powder dietary supplements; dietary supplements with a cosmetic effect; enzyme dietary supplements; yeast for pharmaceutical purposes; gelatine for medical purposes; cod liver oil; isotopes for medical purposes; immunostimulants; insecticides; iodine for pharmaceutical purposes; iodides for pharmaceutical purposes; alkaline iodides for pharmaceutical purposes; iodoform; calomel [fungicide]; cream of

tartar for pharmaceutical purposes; tartar for pharmaceutical purposes; camphor for medical purposes; capsules for medicines; cachets for pharmaceutical purposes; capsules made of dendrimer-based polymers, for pharmaceuticals; hemostatic pencils; wart pencils; caustic pencils; carbolineum [parasiticide]; caustics for pharmaceutical purposes; cachou for pharmaceutical purposes; quassia for medical purposes; quebracho for medical purposes; oxygen for medical purposes; gallic acid for pharmaceutical purposes; acids for pharmaceutical purposes; adhesives for dentures; surgical glues; stem cells for veterinary purposes; stem cells for medical purposes; cocaine; collagen for medical purposes; collodion for pharmaceutical purposes; corn rings for the feet; cannabis for medical purposes; candy, medicated; angostura bark for medical purposes; barks for pharmaceutical purposes; cedar wood for use as an insect repellent; condurango bark for medical purposes; croton bark; mangrove bark for pharmaceutical purposes; myrobalan bark for pharmaceutical purposes; cinchona for medical purposes; medicated animal feed; medicinal roots; rhubarb roots for pharmaceutical purposes; lint for medical purposes; starch for dietetic or pharmaceutical purposes; creosote for pharmaceutical purposes; blood for medical purposes; biological tissue cultures for veterinary purposes; biological tissue cultures for medical purposes; cultures of microorganisms for medical or veterinary use; curare; dental lacquer; liquorice for pharmaceutical purposes; lactose for pharmaceutical purposes; adhesive plasters; medicines for alleviating constipation; adhesive tapes for medical purposes; lecithin for medical purposes; lotions for veterinary purposes; medicated hair lotions; lotions for pharmaceutical purposes; medicated after-shave lotions; personal sexual lubricants; lupulin for pharmaceutical purposes; magnesia for pharmaceutical purposes; liniments; ointments for pharmaceutical purposes; sunburn ointments; mercurial ointments; frostbite salve for pharmaceutical purposes; gauze for dressings; medicinal oils; mustard oil for medical purposes; camphor oil for medical purposes; castor oil for medical purposes; oil of turpentine for pharmaceutical purposes; dill oil for medical purposes; dental mastics; dental abrasives; dental impression materials; dressings, medical; surgical dressings; drugs for medical purposes; medicines for veterinary purposes; serotherapeutic medicines; medicines for human purposes; medicines for dental purposes; menthol; medicinal drinks; moleskin for medical purposes; milk of almonds for pharmaceutical purposes; powdered milk for babies; royal jelly for pharmaceutical purposes; milk ferments for pharmaceutical purposes; irish moss for medical purposes; meal for pharmaceutical purposes; linseed meal for pharmaceutical purposes; fish meal for pharmaceutical purposes; fly glue; antibacterial soap; disinfectant soap; medicated soap; freeze-dried meat adapted for medical purposes; mint for pharmaceutical purposes; dietetic beverages adapted for medical pur-

poses; malted milk beverages for medical purposes; injectable dermal fillers; bone void fillers comprised of living tissues; narcotics; medicinal infusions; tincture of iodine; eucalyptol for pharmaceutical purposes; tinctures for medical purposes; opium; opodeldoc; decoctions for pharmaceutical purposes; antiparasitic collars for animals; cotton swabs for medical purposes; stick liquorice for pharmaceutical purposes; sulphur sticks [disinfectants]; pastilles for pharmaceutical purposes; medicated toothpaste; pectin for pharmaceutical purposes; pepsins for pharmaceutical purposes; peptones for pharmaceutical purposes; hydrogen peroxide for medical purposes; pesticides; leeches for medical purposes; blood plasma; nicotine patches for use as aids to stop smoking; eyepatches for medical purposes; poultices; compresses; scapulars for surgical purposes; babies' diapers; diapers for pets; swim diapers, reusable, for babies; swim diapers, disposable, for babies; diapers for incontinence; diaper changing mats, disposable, for babies; bunion pads; breast-nursing pads; pomades for medical purposes; powder of cantharides; pyrethrum powder; anti-uric preparations; bacterial preparations for medical and veterinary use; bacteriological preparations for medical and veterinary use; balsamic preparations for medical purposes; albuminous preparations for medical purposes; biological preparations for veterinary purposes; biological preparations for medical purposes; bismuth preparations for pharmaceutical purposes; vitamin preparations; diagnostic preparations for veterinary purposes; diagnostic preparations for medical purposes; douching preparations for medical purposes; bath preparations, medicated; therapeutic preparations for the bath; hemorrhoid preparations; preparations for callouses; lice treatment preparations [pediculicides]; acne treatment preparations; preparations to facilitate teething; preparations for the treatment of burns; fumigation preparations for medical purposes; opotherapy preparations; air purifying preparations; bronchodilating preparations; preparations for reducing sexual activity; sterilising preparations; soil-sterilizing preparations; corn remedies; pharmaceutical preparations for treating dandruff; preparations for repelling and destroying vermin; weedkillers; preparations for destroying dry rot fungus; larvae exterminating preparations; fly destroying preparations; preparations for destroying mice; slug exterminating preparations; pharmaceutical preparations for skin care; contact lens cleaning preparations; preparations of microorganisms for medical or veterinary use; lime-based pharmaceutical preparations; hemostatics for medical purposes; medicated eye-washes; medicinal hair growth preparations; nutraceutical preparations for therapeutic or medical purposes; opiates; anticryptogamic preparations; aloe vera preparations for pharmaceutical purposes; preparations of trace elements for human and animal use; sulphonamides [medicines]; pharmaceutical preparations; pharmaceutical preparations for treating sunburn; enzyme preparations for veterinary

purposes; enzyme preparations for medical purposes; phytotherapy preparations for medical purposes; chemico-pharmaceutical preparations; chemical preparations for veterinary purposes; chemical preparations for the diagnosis of pregnancy; chemical preparations for medical purposes; chemical preparations for treating diseases affecting cereal plants; chemical preparations to treat wheat smut; chemical preparations for treating diseases affecting vine plants; chemical preparations to treat mildew; chemical preparations for treating phylloxera; chemical preparations for pharmaceutical purposes; chilblain preparations; mothproofing preparations; collyrium; lead water; chemical conductors for electrocardiograph electrodes; albuminous foodstuffs for medical purposes; dietetic foods adapted for medical purposes; by-products of the processing of cereals for dietetic or medical purposes; homogenized food adapted for medical purposes; freeze-dried food adapted for medical purposes; pharmaceuticals; sanitary towels; panty liners [sanitary]; propolis for pharmaceutical purposes; pearl powder for medical purposes; radium for medical purposes; hydrated chloral for pharmaceutical purposes; solvents for removing adhesive plasters; vaginal washes for medical purposes; solutions for contact lenses; chemical reagents for medical or veterinary purposes; gum for medical purposes; rubber for dental purposes; chewing gum for medical purposes; nicotine gum for use as an aid to stop smoking; insect repellents; insect repellent incense; repellents for dogs; tissues impregnated with pharmaceutical lotions; sarsaparilla for medical purposes; sugar for medical purposes; crystallized rock sugar for medical purposes; asthmatic tea; fumigating sticks; massage candles for therapeutic purposes; linseed for pharmaceutical purposes; tobacco-free cigarettes for medical purposes; siccatives [drying agents] for medical purposes; syrups for pharmaceutical purposes; turpentine for pharmaceutical purposes; milking grease; greases for veterinary purposes; greases for medical purposes; lacteal flour for babies; infant formula; soporifics; bicarbonate of soda for pharmaceutical purposes; bath salts for medical purposes; salts for mineral water baths; salts for medical purposes; potassium salts for medical purposes; sodium salts for medical purposes; smelling salts; mineral water salts; malt for pharmaceutical purposes; semen for artificial insemination; alcohol for pharmaceutical purposes; medicinal alcohol; alloys of precious metals for dental purposes; ergot for pharmaceutical purposes; cooling sprays for medical purposes; antibacterial handwashes; adjuvants for medical purposes; astringents for medical purposes; vermifuges; disinfectants for hygiene purposes; disinfectants for chemical toilets; appetite suppressants for medical purposes; medical preparations for slimming purposes; parasiticides; mouthwashes for medical purposes; medicated dentifrices; febrifuges; depuratives; animal washes [insecticides]; detergents for medical purposes; cattle washes [insecticides]; dog washes [insecticides]; in-

secticidal veterinary washes; vesicants; purgatives; remedies for perspiration; remedies for foot perspiration; chemical contraceptives; antiparasitic preparations; sedatives; laxatives; tonics [medicines]; medicated toiletry preparations; digestives for pharmaceutical purposes; nervines; bacteriological culture mediums; steroids; headache relief sticks; strychnine; suppositories; serums; tanning pills; appetite suppressant pills; slimming pills; jujube, medicated; antioxidant pills; sanitary tampons; vulnery sponges; thymol for pharmaceutical purposes; smoking herbs for medical purposes; medicinal herbs; transplants [living tissues]; surgical implants comprised of living tissues; pants, absorbent, for incontinents; sanitary pants; babies' diaper-pants; charcoal for pharmaceutical purposes; fennel for medical purposes; porcelain for dental prostheses; phenol for pharmaceutical purposes; enzymes for veterinary purposes; enzymes for medical purposes; ferments for pharmaceutical purposes; formic aldehyde for pharmaceutical purposes; phosphates for pharmaceutical purposes; quinine for medical purposes; chinoline for medical purposes; diabetic bread adapted for medical use; chloroform; flowers of sulphur for pharmaceutical purposes; cement for animal hooves; bone cement for surgical and orthopaedic purposes; dental cements; medicinal tea; herbal teas for medicinal purposes; insecticidal animal shampoos; medicated shampoos; medicated shampoos for pets; pediculicidal shampoos; medicated dry shampoos; pre-filled syringes for medical purposes; eucalyptus for pharmaceutical purposes; herbal extracts for medical purposes; plant extracts for pharmaceutical purposes; tobacco extracts [insecticides]; extracts of hops for pharmaceutical purposes; elixirs [pharmaceutical preparations]; ethers for pharmaceutical purposes; esters for pharmaceutical purposes; cellulose esters for pharmaceutical purposes; cellulose ethers for pharmaceutical purposes; rat poison; poisons; bacterial poisons; jalap; angioprotectors; antiplatelet agents; anticoagulants; anti-inflammatory preparations; antithrombotic agents; decongestants; pharmaceutical preparations for the treatment of nervous system diseases; pharmaceutical preparations for the treatment of articular-ligamentous disorders; pharmaceutical preparations for the treatment of musculoskeletal disorders; pharmaceutical preparations for the treatment of various diseases; pharmaceutical preparations for treating injuries; pharmaceuticals for the treatment of thrombophlebitis; anti-itch pharmaceutical preparations; venotonic pharmaceuticals; pharmaceutical preparations for the treatment of venous system diseases; pharmaceutical preparations for the treatment of lymphatic system diseases; pharmaceutical preparations for the treatment of rheumatic lesion.

(260) AM 2023 118052 A  
 (800) 1664634  
 (151) 2022 02 22  
 (891) 2022 02 22  
 (731) S.C. LOOP PRODUCTIONS S.R.L.  
 Str. Ion Tuculescu, nr. 19, Sector 3, 031611  
 Bucuresti, Romania

(540)



(591) Black, white  
 (531) 26.11.03; 26.11.05; 26.11.12  
 (511)

25 – Clothing, footwear, headwear.

41 – Education; providing of training; entertainment; sporting and cultural activities.

(260) AM 2023 118053 A  
 (800) 1664686  
 (151) 2022 02 24  
 (891) 2022 02 24  
 (731) "NAVOIYAZOT" aksiyadorlik jamiyati  
 Navoiy-5, 210105 Navoiy city, Uzbekistan

(540)



(591) White and dark blue  
 (531) 26.04.04; 26.04.05; 26.13.25; 27.05.01;  
 27.05.08; 29.01.12

(526) N

(511)

1 – Chemicals for use in industry, science and photography, as well as in agriculture, horticulture and forestry; unprocessed artificial resins, unprocessed plastics; fire extinguishing and fire prevention compositions; tempering and soldering preparations; substances for tanning animal skins and hides, adhesives for use in industry; putties and other paste fillers; compost, manures, fertilizers; biological preparations for use in industry and science.

(260) AM 2023 118054 A  
 (800) 1664691  
 (151) 2022 02 24  
 (891) 2022 02 24  
 (731) "NAVOIYAZOT" aksiyadorlik jamiyati  
 Navoiy-5, 210105 Navoiy city, Uzbekistan

(540)



(591) White and dark blue  
 (531) 24.17.01; 26.04.04; 26.04.05; 26.13.25;  
 27.05.01; 27.05.09; 27.05.10; 29.01.12

(526) N, AJ

(511)

1 – Chemicals for use in industry, science and photography, as well as in agriculture, horticulture and forestry; unprocessed artificial resins, unprocessed plastics; fire extinguishing and fire prevention compositions; tempering and soldering preparations; substances for tanning animal skins and hides; adhesives for use in industry; putties and other paste fillers; compost, manures, fertilizers; biological preparations for use in industry and science.

(260) AM 2023 118055 A  
 (800) 1664692  
 (151) 2022 02 24  
 (891) 2022 02 24  
 (731) "NAVOIYAZOT" aksiyadorlik jamiyati  
 Navoiy-5, 210105 Navoiy city, Uzbekistan

(540)



(591) White, light blue and dark blue  
 (531) 26.01.04; 26.01.16; 26.01.18; 26.04.04;  
 26.04.09; 26.04.18; 26.04.24; 26.11.02;  
 26.11.08; 26.13.25; 27.05.01; 27.05.09;  
 27.05.10; 27.05.24; 29.01.12

(511)

1 – Chemicals for use in industry, science and photography, as well as in agriculture, horticulture and forestry; unprocessed artificial resins, unprocessed plastics; fire extinguishing and fire prevention compositions; tempering and soldering preparations; substances for tanning animal skins and hides; adhesives for use in industry; putties and other paste fillers; compost, manures, fertilizers; biological preparations for use in industry and science.

(260) AM 2023 118057 A  
 (800) 937436  
 (151) 2007 08 09  
 (891) 2022 05 17  
 (731) Clarios Technology and Recycling GmbH  
 Am Leineufer 51, 30419 Hannover, Germany

(540)



(591) Blue, grey and white

(531) 26.04.06; 26.04.18; 27.05.01; 29.01.13

(511)

7 – Machines for production of batteries, especially vehicle batteries.

9 – Apparatus and instruments for conducting, switching, transforming, accumulating, regulating or controlling electricity; accumulators, batteries and chargers therefor, including starter batteries for vehicles and chargers therefor; apparatus for monitoring of batteries (all included in this class).

(260) AM 2023 118058 A

(800) 1453032

(151) 2018 12 11

(891) 2022 05 17

(731) VITAGERMINE

Parc d'Activité du Courneau – Rue du Pré  
Meunier – CS 60003 – Lieu dit Canéjan,  
F-33612 CESTAS Cedex, France

(540)



(591) Black, white

(531) 02.09.04; 05.03.11; 05.03.14; 26.04.06;  
27.03.01; 27.03.02; 27.05.07

(511)

29 – Milk; powdered milk; milk beverages, milk predominating; flavored milk beverages; dairy products; milk-based breakfast preparations; cheeses; preserved, dried and cooked fruit and vegetables; jams; compotes; fruit and vegetable purees; potages (soups); pre-cooked soups; bouillons; cooked dishes and culinary preparations (excluding cooked dishes and culinary preparations for animals) based on fish, meat, ham, poultry, vegetables, rice, pasta and/or fruit; snack foods based on vegetables, meat and/or fruit; fruit pulps; fruit salads; compotes; fruit desserts; milk desserts; vegetable-milk-based desserts; all these goods produced by organic farming or made from goods produced by organic farming.

30 – Coffee; tea; cocoa; artificial coffee; flour and preparations made from cereals; bread; pastry and confectionery; biscuits, cookies; cakes; cereal-based

breakfast preparations; cereal bars; cereal-based snacks; edible ices; sauces (condiments); all these goods obtained from organic farming or made from goods obtained from organic farming.

32 – Mineral and aerated waters and other non-alcoholic beverages; fruit beverages and fruit juices; syrups and other preparations for making beverages; all these goods obtained from organic farming or made from goods obtained from organic farming.

(260) AM 2023 118059 A

(800) 1473222

(151) 2019 02 25

(891) 2022 04 25

(731) Bath & Body Works Brand Management, Inc.  
Seven Limited Parkway, Reynoldsburg  
OH 43068, USA

(540)

## WHITE BARN

(591) Black, white

(511)

3 – Room fragrance refills for electric room fragrance dispensers.

4 – Candles.

(260) AM 2023 118085 A

(800) 1664706

(151) 2022 02 02

(891) 2022 02 02

(731) Euro Games Technology Ltd.

"Maritsa" Str. 4, "Vranya-Lozen-Triugulnika",  
BG-1151 Sofia, Bulgaria

(540)



(591) Red, yellow, green, blue, purple, brown, black and pink

(531) 01.15.01; 05.03.06; 27.05.01; 27.05.02;  
27.05.03; 27.05.04; 27.05.07; 27.05.09;  
27.05.10; 29.01.15

(511)

9 – Software; computer gaming software; computer software packages; computer operating system software; computer software, recorded; software drivers; virtual reality software; games software; entertainment software for computer games; computer programs for network management; operating computer software for main frame computers; monitors (computer hardware); computer hardware; apparatus for recording images; monitors (computer programs); computer game programs; computer programs for recorded games; apparatus for recording, transmission or reproduction of sound or images; communications

servers [computer hardware]; electronic components for gambling machines; computer application software featuring games and gaming; computer software for the administration of on-line games and gaming; computer hardware for games and gaming; hardware and software in the field of gambling; software and hardware applicable to gambling machines; gambling games software; computer hardware for gambling machines; software for online gambling games; software for gambling games used via telecommunication network.

28 – Gaming machines for gambling; chips for gambling; mah-jong; arcade games; gambling machines operating with coins, notes and cards; games; electronic games; parlor games; gaming chips; gaming tables; slot machines [gaming machines]; LCD game machines; slot machines and gaming devices; coin-operated amusement machines; roulette chips; poker chips; chips and dice [gaming equipment]; equipment for casinos; roulette tables; gaming roulette wheels; games in the field of gambling; automats and gambling machines; coin-operated machines and / or electronic coin-operated machines with or without the possibility of gain; boxes for coin-operated machines, slot machines and gaming machines; electronic or electrotechnical gaming devices, automats and machines, coin-operated machines; housings for coin-operated machines, gaming equipment, gaming machines, machines for gambling; electropneumatic and electrical gambling machines (slot machines).

41 – Gambling; services related to gambling; gaming services for entertainment purposes; casino, gaming and gambling services; training in the development of software systems; provision of gaming equipment for gambling halls; providing casino equipment [gambling]; gaming machine entertainment services; providing casino facilities [gambling]; providing halls with gaming machines; amusement arcade services; games equipment rental; rental of gaming machines; providing amusement arcade services; rental of gaming machines with images of fruits; editing or recording of sounds and images; sound recording and video entertainment services; hire of sound reproducing apparatus; provision of gaming equipment for casinos; providing of casino facilities; online gambling services; casino, gaming and gambling services; operation of gaming establishments, gaming halls, internet casinos, online gambling sites.

(260) AM 2023 118086 A  
(800) 1664730  
(151) 2022 02 24  
(891) 2022 02 24  
(731) "NAVOIYAZOT" aksiyadorlik jamiyati  
Navoiy-5, 210105 Navoiy city, Uzbekistan

(540)



(591) White and dark blue  
(531) 26.04.04; 26.04.05; 26.13.25; 27.05.01;  
27.05.08; 27.05.09; 27.05.10; 29.01.12

(526) AJ  
(511)

1 – Chemicals for use in industry, science and photography, as well as in agriculture, horticulture and forestry; unprocessed artificial resins, unprocessed plastics; fire extinguishing and fire prevention compositions; tempering and soldering preparations; substances for tanning animal skins and hides; adhesives for use in industry; putties and other paste fillers; compost, manures, fertilizers; biological preparations for use in industry and science.

(260) AM 2023 118087 A  
(800) 1664732  
(151) 2022 03 15  
(891) 2022 03 15  
(731) Société des Produits Nestlé S.A.  
CH-1800 Vevey, Switzerland  
(540)

**NESTLÉ**

(591) Black, white  
(511)

9 – Downloadable electronic publications for nutritional evaluation of people; downloadable electronic publications for evaluation of food allergy risks in humans; application software for mobile telephones, mobile terminals or laptop and desktop computers; software which can be downloaded via smartphones, mobile telephones, mobile terminals or other applications for laptop and office computers; computer game programs downloaded via the Internet [software]; application software for mobile telephones, namely software for posting reviews and recommendations on the goods and services of others; compact disks, DVDs and other digital recording media; application software for mobile devices; educational software.

41 – Education; training; Staff training, organization of courses, seminars, conferences, exhibitions for cultural or educational purposes; publishing and editing of books, pamphlets, newspapers, films and recordings; production of videos and sound recordings for cultural or educational purposes; education regarding nutrition, all training and educational services in connection with nutrition and food, particularly training

courses relating to food technology, nutrition, cooking and catering; education, training, entertainment, cultural activities; providing museum facilities, presentation and organization of exhibitions; education, sporting, cultural and educational activities; all these services also provided online; education and training relating to nutrition, health and food; sporting and cultural activities; organization of sporting events and competitions; organization of sporting events and competitions, especially with the participation of animals; organization and conducting of concerts; entertainment; holiday camp services (entertainment); providing on line electronic publications; entertainment also provided via electronic networks and the Internet, particularly in the form of discussion forums or blogs; entertainment services, namely provision of on-line computer games via a computer network or mobile telephone network; electronic game services provided by means of the Internet.

43 – Provision of food and beverages, services provided by hotels, coffee shops, cafés, cafeterias, bars, restaurants, self-service restaurants, snack bars, canteens; catering services, provision of coffee machines; preparation of food, beverages and take-away food and beverage services; advice relating to cooking and culinary recipes from a computer network or mobile telephone network via Internet sites, on-line platforms, electronic mail or applications; provision of interactive information on line on the preparation of foodstuffs and beverages, the preparation of meals and catering via digital and mobile services; advice relating to cooking recipes; information and advice with respect to meal preparation; consultancy services in the field of culinary arts; providing information with respect to recipes and cooking from computer databases.

44 – Provision of advice relating to health, food and nutrition; medical services and provision of information in the medical field; medical diagnosis services; dietary counseling services and consulting relating to food in general; advisory services relating to weight reduction; organization of weight reduction programs; dietary and nutrition consulting services provided online by a computer network or mobile telephone network; provision of online information and advisory services relating to nutrition and health also via mobile telephones, smartphones, mobile terminals and other communication means; dietary advice and advice in the field of general nutrition provided via the Internet; provision of online information in the field of nutrition; online provision of interactive information in the field of nutrition, health and food; provision of information on nutrition; provision of information in the field of nutrition; advice in connection with dietetics and nutrition; provision of dietetic advice; dietary and nutritional recommendation services; advice regarding dietetics and nutrition; providing information regarding food supplements and nutrition; provi-

sion of information relating to dietary and nutritional recommendation services.

---

(260) AM 2023 118088 A

(800) 1664736

(151) 2022 03 16

(891) 2022 03 16

(731) SEPPmail AG

Industriestrasse 7, CH-5432 Neuenhof,  
Switzerland

(540)



(591) Black, white

(531) 14.05.23; 20.05.13; 24.13.01; 27.05.01;  
27.05.09

(511)

9 – Email security software of Swiss origin.

42 – Computer security consultancy; consultant services in the field of security software; computer programming services for electronic data security.

---

(260) AM 2023 118089 A

(800) 1664768

(151) 2021 11 08

(891) 2021 11 08

(731) Chrysanti Trading Limited

Agia Zoni, 33B, Flat 203, CY-3027 Limassol,  
Cyprus

(540)



(591) Golden yellow, black and red

(531) 24.07.01; 24.07.23; 27.03.15; 27.05.17;  
29.01.13

(511)

1 – Adhesives for use in industry; chemical and organic compositions for use in the manufacture of food and beverages; chemical preparations and materials for film, photography and printing; chemical substances, chemical materials and chemical preparations; combusting preparations [chemical additives to motor fuel]; additives, chemical, to motor fuel / chemical additives to motor fuel; antifreeze; fluids for hydraulic circuits / liquids for hydraulic circuits; oil-separating chemicals; distilled water; brake fluid; oil-purifying chemicals; power steering fluid; transmission fluid; anti-boil preparations for engine coolants; coolants for vehicle engines; radiator flushing chemicals; chemical additives for oils; transmission oils; detergents for use in manufacture and industry; filtering media of chemical and non-chemical substances included in the class; growing media, fertilizers and chemicals for use in agriculture, horticulture and forestry; putties, and fillers and pastes for use in industry; salts for industrial purposes; starches for use in manufacturing and in-

dustry; unprocessed artificial and synthetic resins; unprocessed plastics; fertilisers, and chemicals for use in agriculture, horticulture and forestry; unprocessed and synthetic resins; additives, chemical, to motor fuel; chemical additives to motor fuel; motor fuel (chemical additives to -); anti-boil preparations for engine coolants; antifreeze; anti-frothing solutions for accumulators; anti-frothing solutions for batteries; anti-incrustants; anti-knock substances for internal combustion engines; brake fluid; cement for pneumatic tires [tyres]; mastic for tires [tyres]; mastic for tires; mastic for tyres; combusting preparations [chemical additives to motor fuel]; coolants for vehicle engines; corrosive preparations; detergent additives to gasoline [petrol]; detergent additives to petrol [gasoline]; detergent additives to gasoline; engine-decarbonising chemicals; chemical preparations for decarbonising engines; fillers for automobile bodies; automobile body fillers; car body fillers; fillers for car bodies; filtering materials [chemical preparations]; filtering materials [mineral substances]; filtering materials [unprocessed plastics]; filtering materials [vegetable substances]; fluids for hydraulic circuits; liquids for hydraulic circuits; liquids for removing sulfates from accumulators; liquids for removing sulfates from batteries; magnetic fluid for industrial purposes; oil-bleaching chemicals; oil cement [putty]; oil dispersants; oil-purifying chemicals; oil-separating chemicals; oils for currying leather; oils for preparing leather in the course of manufacture; oils for tanning leather; oils for the preservation of food; power steering fluid; synthetic materials for absorbing oil; test paper, chemical; transmission fluid; transmission oil; benzene.

2 – Coatings; dyes, colorants, pigments and printing inks; raw natural resins; thinners and thickeners for coatings, dyes and inks; anti-corrosive bands; anti-corrosive preparations; anti-rust greases; anti-rust oils; anti-rust preparations; anti-tarnishing preparations for metals; undercoating for vehicle chassis; undersealing for vehicle chassis.

3 – Abrasives; animal grooming preparations; cleaning and fragrancing preparations; essential oils and aromatic extracts; tailors' and cobblers' wax; toiletries; abraders; abrasive cloth; sandcloth; abrasive paper; antistatic preparations for household purposes; canned pressurized air for cleaning and dusting purposes; carbides of metal [abrasives]; cleaning chalk; cleaning preparations; cloths impregnated with a detergent for cleaning; cobblers' wax; creams for leather; waxes for leather; degreasers, other than for use in manufacturing processes; dry-cleaning preparations; dry shampoos; floor wax; floor wax removers [scouring preparations]; non-slipping liquids for floors; oil of turpentine for degreasing; oils for cleaning purposes; polish for furniture and flooring; polishing creams; polishing paper; polishing preparations; polishing stones; polishing wax; preservatives for leather [polishes]; leather preservatives [polishes]; rust removing preparations;

shampoos; shining preparations [polish]; shoe cream; shoemakers' wax; shoe polish; shoe wax; stain removers; windshield cleaning liquids; windscreen cleaning liquids.

4 – Dust controlling compositions; electrical energy; fuels and illuminants; lubricants and industrial greases, waxes and fluids; additives, non-chemical, to motor fuel; alcohol [fuel]; benzene fuel; biomass fuel; bone oil for industrial purposes; carburants; motor fuel; carnauba wax; castor oil for industrial purposes; ceresine; coal tar oil; coke; combustible briquettes; cutting fluids; diesel oil; gas oil; dust absorbing compositions; dust binding compositions for sweeping; dust laying compositions; dust removing preparations; ethanol [fuel]; fuel; fuel gas; fuel oil; combustible oil; fuel with an alcoholic base; gas for lighting; gasoline; grease for arms [weapons]; grease for belts; grease for footwear; grease for leather; greases for the preservation of leather; illuminating grease; illuminating wax; industrial grease; industrial oil; industrial wax; kerosene; lanolin; wool grease; lignite; ligroin; lubricants; lubricating graphite; lubricating grease; lubricating oil; mazut; methylated spirit; mineral fuel; moistening oil; motor oil; naphtha; nightlights [candles]; non-slipping preparations for belts; oil-gas; oils for paints; oils for releasing form work [building]; oils for the preservation of leather; oils for the preservation of masonry; oleine; ozocerite [ozokerite]; paper spills for lighting fires; paraffin; peat briquettes [fuel]; peat [fuel]; perfumed candles; petrol; petroleum ether; petroleum jelly for industrial purposes; petroleum, raw or refined; producer gas; rape oil for industrial purposes; colza oil for industrial purposes; solidified gases [fuel]; soya bean oil preparations for non-stick treatment of cooking utensils; stearine; sunflower oil for industrial purposes; tallow; textile oil; tinder; vaporized fuel mixtures; wax for skis; wax [raw material]; wicks for candles; wood briquettes; wood spills for lighting fires; xylene fuel.

(260) AM 2023 118090 A

(800) 1664858

(151) 2022 04 08

(891) 2022 04 08

(731) VENIPHARM

4 Bureaux de la Colline, F-92210 SAINT-CLOUD, France

(540)

**VENIPHARM**

(591) Black, white

(511)

5 – Pharmaceutical products; veterinary products; hygienic products for medicine; disinfectant soaps; medicinal soaps; medicated shampoos; medicated dentifrices; dietetic foods for medical use; dietetic foodstuffs for veterinary use; food for babies pertaining to the pharmaceutical trade; dressings pertaining to the



pharmaceutical trade; teeth filling materials; dental impression materials; disinfectants; antibacterial products for washing hands; products for destroying vermin pertaining to the pharmaceutical trade; fungicides pertaining to the pharmaceutical trade; herbicides; bath preparations for medical use; sanitary panties; sanitary towels; chemical preparations for medical use; chemical preparations for pharmaceutical use; medicinal herbs; herbal teas for medicinal purposes; parasiticides pertaining to the pharmaceutical trade; alloys of precious metals for dental use.

(260) AM 2023 118091 A

(800) 1664921

(151) 2021 12 22

(891) 2021 12 22

(731) Akciju Sabiedrība "Olainfarm"

Rūpnīcu iela 5, LV-2114 Olaine, Latvia

(540)

**Nitromag**

(591) Black, white

(511)

5 – Pharmaceutical preparations.

(260) AM 2023 118092 A

(800) 1664946

(151) 2021 11 23

(891) 2021 11 23

(731) Obshchestvo s ogranichennoy otvetstvennostyu "Lazerny Centr"

Piskarevsky pr-kt, 25, pom. 132, RU-195176

St. Petersburg, Russian Federation

(540)

turbo  forma

(591) Red and white

(531) 20.05.07; 26.01.01; 26.01.03; 26.01.12;

26.01.16; 27.05.09

(511)

6 – Aluminium; fittings of metal for compressed air lines; fittings of metal for building; white metal; beacons of metal, non-luminous; vats of metal; beams of metal; joists of metal; bottles [containers] of metal for compressed gas or liquid air; balustrades of metal; preserve tins; reels of metal, non-mechanical, for flexible hoses; swimming pools [structures] of metal; beryllium [glucinium]; arbours [structures] of metal; blooms [metallurgy]; ingots of common metal; anchors; bolts of metal; eye bolts; casks of metal; mooring buoys of metal; barrels of metal; identification bracelets of metal; bronze; bells; bells for animals; letters and numerals of common metal, except type; silos of metal; busts of common metal; vanadium; bird baths [structures] of metal; valves of metal, other than parts of machines; screws of metal; aviaries [structures] of metal; tungsten; hoppers of metal, non-

mechanical; gates of metal; sleeves [metal hardware]; ferrules of metal for handles; signboards of metal; diving boards of metal; loading gauge rods of metal for railway wagons; nuts of metal; galena [ore]; celtium [hafnium]; nails; tacks [nails]; horseshoe nails; shoe pegs of metal; germanium; vice claws of metal; armoured doors of metal; doors of metal; folding doors of metal; metal automatic swing doors; swing doors of metal; chimney pots of metal; towel dispensers, fixed, of metal; door closers of metal, non-electric; prefabricated houses [kits] of metal; memorial plates of metal; chimney shafts of metal; wall plugs of metal; troughs of metal for mixing mortar; packaging containers of metal; containers of metal for storing acids; jealousies of metal; outdoor blinds of metal; iron, unwrought or semi-wrought; iron strip; roof gutters of metal; street gutters of metal; tinsplate; plugs [metal hardware]; iron slabs; door bolts of metal; window fasteners of metal; bolts, flat; clips of metal for sealing bags; binding screws of metal for cables; cramps of metal [crampons]; wheel clamps [boots]; rivets of metal; box fasteners of metal; locks of metal for bags; locks of metal for vehicles; locks of metal, other than electric; padlocks of metal, other than electronic; spring locks; closures of metal for containers; plugs of metal; latches of metal; tension links; couplings of metal for chains; road signs, non-luminous and non-mechanical, of metal; registration plates of metal; signs, non-luminous and non-mechanical, of metal; fences of metal; buckles of common metal [hardware]; bronzes [works of art]; works of art of common metal; ironmongery; indium; cabanas of metal; soundproof booths of metal, transportable; telephone booths of metal; cadmium; paint spraying booths of metal; telfer cables; ropes of metal; jerrycans of metal; horticultural frames of metal; greenhouse frames of metal; framework of metal for building; cornices of metal; skating rinks [structures] of metal; cermets; water-pipe valves of metal; drain traps [valves] of metal; metal cages for wild animals; keys of metal; mooring bollards of metal; cobalt, raw; chill-moulds [foundry]; elbows of metal for pipes; bed casters of metal; furniture casters of metal; manifolds of metal for pipelines; door bells of metal, non-electric; casings of metal for oilwells; pillars of metal for building; chimney cowls of metal; bottle caps of metal; sealing caps of metal; tent pegs of metal; pegs of metal; copper rings; split rings of common metal for keys; rings of metal; door fittings of metal; fittings of metal for windows; brackets of metal for building; buildings of metal; buildings, transportable, of metal; steel buildings; oil drainage containers of metal; containers of metal [storage, transport]; check rails of metal for railways; baskets of metal; door frames of metal; tool boxes of metal, empty; stringers [parts of staircases] of metal; crampons [climbing irons]; taps of metal for casks; tubing of metal; brackets of metal for furniture; roofing of metal; roofing of metal, incorporating photovoltaic cells; turntables [railways]; screw tops of

metal for bottles; manhole covers of metal; hooks [metal hardware]; pitons of metal; pot hooks of metal; hooks of metal for roofing slates; sash fasteners of metal for windows; hooks of metal for clothes rails; bag hangers of metal; clothes hooks of metal; chicken-houses of metal; chests of metal; brass, unwrought or semi-wrought; bands of metal for tying-up purposes; scaffolding of metal; staircases of metal; ladders of metal; limonite; steel sheets; cast steel; traps for wild animals; magnesium; manganese; reinforcing materials, of metal, for concrete; reinforcing materials of metal for machine belts; reinforcing materials of metal for pipes; reinforcing materials of metal for building; railway material of metal; materials of metal for funicular railway permanent ways; building materials of metal; refractory construction materials of metal; masts of metal; steel masts; copper, unwrought or semi-wrought; sheets and plates of metal; common metals, unwrought or semi-wrought; pyrophoric metals; metals in powder form; mouldings of metal for building; molybdenum; metal knockers; pipe muffs of metal; shoe dowels of metal; porches [structures] of metal; bronzes for tombstones; tombs of metal; flashing of metal for building; roof flashing of metal; fish plates [rails]; anvils; anvils [portable]; beak-irons; rope thimbles of metal; ferrules of metal for walking sticks; handcuffs; jets of metal; duckboards of metal; belt stretchers of metal; stretchers for metal bands [tension links]; wire stretchers [tension links]; stretchers for iron bands [tension links]; nickel silver; nickel; niobium; grease nipples; binding thread of metal for agricultural purposes; thread of metal for tying-up purposes; house numbers of metal, non-luminous; braces of metal for handling loads; wall claddings of metal for building; mouldings of metal for cornices; enclosures of metal for tombs; laths of metal; barrel hoops of metal; wall linings of metal for building; palings of metal; crash barriers of metal for roads; furnace fire screens; tree protectors of metal; latticework of metal; door stops of metal; stops of metal; window stops of metal; windows of metal; ironwork for doors; ironwork for windows; tin; shuttering of metal for concrete; filings of metal; posts of metal for power lines; props of metal; branching pipes of metal; monuments of metal; monuments of metal for tombs; metal ramps for use with vehicles; acoustic panels of metal; metal door panels; wainscoting of metal; signalling panels, non-luminous and non-mechanical, of metal; building panels of metal; partitions of metal; lintels of metal; casement windows of metal; strap-hinges of metal; shims; rocket launching platforms of metal; platforms, prefabricated, of metal; wall tiles of metal; floor tiles of metal; tiles of metal for building; anchor plates; paving slabs of metal; grave slabs of metal; tile floorings of metal; slabs of metal for building; lead seals; loading pallets of metal; handling pallets of metal; transport pallets of metal; trays of metal; stakes of metal for plants or trees; firedogs [andirons]; armour-plating of metal; paving blocks of metal; roof cove-

rings of metal; cladding of metal for building; linings of metal for building; fireplace mantles of metal; steel strip; floors of metal; sills of metal; bathtub grab bars of metal; ceilings of metal; brazing alloys; gold solder; silver solder; collars of metal for fastening pipes; winding spools of metal, non-mechanical, for flexible hoses; floating docks of metal, for mooring boats; aluminium wire; iron wire; wire of common metal; wire of common metal alloys, except fuse wire; barbed wire; copper wire, not insulated; soldering wire of metal; steel wire; springs [metal hardware]; rods of metal for welding; rods of metal for brazing and welding; rods of metal for brazing; peeled metal bars; drawn and polished metal bars; bright steel bars; hot-rolled steel bars; dispensers for dog waste bags, fixed, of metal; window frames of metal; frames of metal for building; crucifixes of common metal, other than jewellery; containers of metal for liquid fuel; containers of metal for compressed gas or liquid air; tanks of metal; floating containers of metal; rails of metal; straps of metal for handling loads; furnace fireguards of metal; gratings of metal; runners of metal for sliding doors; iron ores; ores of metal; chrome ores; door handles of metal; knobs of metal; sheet piles of metal; pigsties of metal; lead, unwrought or semi-wrought; safes [metal or non-metal]; safes, electronic; insect screens of metal; burial vaults of metal; door scrapers; cable joints of metal, non-electric; junctions of metal for pipes; nozzles of metal; anti-friction metal; silver-plated tin alloys; alloys of common metal; sheaf binders of metal; bindings of metal; bottle closures of metal; shutters of metal; steel alloys; steel, unwrought or semi-wrought; tinfoil; statues of common metal; figurines of common metal; cask stands of metal; tombstone stelae of metal; bars for metal railings; stables of metal; advertisement columns of metal; posts of metal; telegraph posts of metal; railway points; steps [ladders] of metal; slings of metal for handling loads; stair treads [steps] of metal; machine belt fasteners of metal; tombstone plaques of metal; nameplates of metal; step stools of metal; tantalum [metal]; greenhouses of metal, transportable; titanium; wire cloth; tombac; mobile boarding stairs of metal for passengers; cables of metal, non-electric; wire rope; pipework of metal; penstock pipes of metal; water-pipes of metal; gutter pipes of metal; ducts of metal for ventilating and air-conditioning installations; drain pipes of metal; chimneys of metal; pipes of metal; ducts of metal, for central heating installations; steel pipes; automatic turnstiles of metal; angle irons of metal; tinsplate packings; door fasteners of metal; bicycle parking installations of metal; window closers of metal, non-electric; door openers of metal, non-electric; window openers of metal, non-electric; wind-driven bird-repelling devices made of metal; tungsten iron; molybdenum iron; silicon iron; titanium iron; chrome iron; figures of common metal; flagpoles [structures] of metal; hand-held flagpoles of metal; flanges of metal [collars]; weather- or wind-vanes of metal; aluminium

foil; metals in foil or powder form for 3D printers; foils of metal for wrapping and packaging; ice moulds of metal; foundry moulds of metal; fittings of metal for coffins; fittings of metal for beds; fittings of metal for furniture; clips of metal for cables and pipes; chromium; cattle chains; chains of metal; safety chains of metal; zinc; zirconium; pantiles of metal; roofing tiles of metal; cast iron, unwrought or semi-wrought; washers of metal; balls of steel; hinges of metal; poles of metal; safety cashboxes; pulleys of metal, other than for machines; window pulleys of metal; railway sleepers of metal; window casement bolts; cotter pins of metal; spurs; pins [hardware]; roller blinds of steel; latch bars of metal; badges of metal for vehicles; labels of metal; lock bolts; cashboxes [metal or non-metal]; tool chests of metal, empty; boxes of common metal; letter boxes of metal.

7 – Vending machines; 3D printers; welding machines, electric; soldering apparatus, gas-operated; vulcanization apparatus; acetylene cleaning apparatus; high pressure washers; apparatus for drawing up beer under pressure; apparatus for aerating water; apparatus for aerating beverages; electrical apparatus for sealing plastics [packaging]; electric arc cutting apparatus; electric arc welding apparatus; electric welding apparatus; inking apparatus for printing machines; electric soldering apparatus; fittings for engine boilers; expansion tanks [parts of machines]; drums [parts of machines]; reels, mechanical, for flexible hoses; brake shoes, other than for vehicles; concrete mixers [machines]; reels [parts of machines]; bobbins for weaving looms; harrows; journal boxes [parts of machines]; bulldozers; hoppers [mechanical discharging]; mine borers; railway wagon lifts; rolling mill cylinders; crank shafts; printing rollers for machines; camshafts for vehicle engines; transmission shafts, other than for land vehicles; valves [parts of machines]; fans for motors and engines; saw benches [parts of machines]; winnowers; vibrators [machines] for industrial use; bearings [parts of machines]; water heaters being parts of machines; bellows [parts of machines]; agitators; drilling rigs, floating or non-floating; lawnmowers [machines]; card clothing [parts of carding machines]; nail extractors, electric; emergency power generators; alternators; dynamos; bicycle dynamos; current generators; generators of electricity; hydraulic controls for machines, motors and engines; mufflers for motors and engines; drilling heads [parts of machines]; drilling bits [parts of machines]; cylinder heads for engines; soldering blow pipes, gas-operated; gas-operated blow torches; raking machines; stalk separators [machines]; sieves [machines or parts of machines]; mud catchers and collectors [machines]; tarring machines; rubber tracks being parts of crawlers on mining machines; rubber tracks being parts of crawlers on snow ploughs; rubber tracks being parts of crawlers on loading-unloading machines and apparatus; rubber tracks being parts of crawlers on agricultural machines; rubber tracks being parts of crawlers

on construction machines; hydraulic engines and motors; aeronautical engines; aeroplane engines; engines for air cushion vehicles; compressed air engines; jet engines, other than for land vehicles; engines for boats; driving motors, other than for land vehicles; motors, other than for land vehicles; propulsion mechanisms, other than for land vehicles; de-aerators for feedwater; disintegrators; tympan [parts of printing presses]; holding devices for machine tools; turf removing ploughs; pump diaphragms; hydraulic door closers; pneumatic door closers; electric door closers; chisels for machines; jacks [machines]; rack and pinion jacks; moving walkways; electric hand drills; crushers for kitchen use, electric; flues for engine boilers; reapers; reapers and binders; millstones; rakes for raking machines; shredders [machines] for industrial use; kitchen grinders, electric; injectors for engines; incubators for eggs; tools [parts of machines]; ski edge sharpening tools, electric; hand-held tools, other than hand-operated; agricultural implements, other than hand-operated; air condensers; control cables for machines, engines or motors; capstans; calenders; rotary steam presses, portable, for fabrics; ditchers [ploughs]; carburettors; sliders for knitting machines; crankcases for machines, motors and engines; steamrollers; pressure valves [parts of machines]; clack valves [parts of machines]; pressure reducers [parts of machines]; cowlings [parts of machines]; machine wheels; freewheels, other than for land vehicles; scale collectors for machine boilers; lasts for shoes [parts of machines]; brake pads, other than for vehicles; piston segments; grease rings [parts of machines]; reapers and threshers; coal-cutting machines; compressors [machines]; air pumps [garage installations]; compressors for refrigerators; conveyors [machines]; belt conveyors; converters for steelworks; steam condensers [parts of machines]; aerocondensers; diggers [machines]; rams [machines]; thermic lances [machines]; mechanized livestock feeders; boxes for matrices [printing]; gear boxes, other than for land vehicles; grease boxes [parts of machines]; housings [parts of machines]; harvesting machines; steam engine boilers; coffee grinders, other than hand-operated; taps [parts of machines, engines or motors]; cranes [lifting and hoisting apparatus]; roller bridges; mobile cranes; water separators; spray guns for paint; cranks [parts of machines]; potters' wheels; grindstones [parts of machines]; cultivators [machines]; soldering lamps; winches; ploughshares; belts for conveyors; lubricators [parts of machines]; igniting magnetos; handling machines, automatic [manipulators]; churns; matrices for use in printing; machine fly-wheels; shearing machines for animals; blowing machines; knitting machines; galvanizing machines; bending machines; ironing machines; mineworking machines; blowing machines for the compression, exhaustion and transport of gases; blowing machines for the compression, sucking and carrying of grain; net hauling machines [fishing]; electroplating machines; bottle sealing machines; sea-

ling machines for industrial purposes; embossing machines; engraving machines; finishing machines; crushing machines; waste disposal units; blade sharpening [stropping] machines; earth moving machines; cord making machines; lace making machines; butter machines; cigarette machines for industrial purposes; sausage making machines; stereotype machines; hosiery looms; dyeing machines; bottle washing machines; dishwashers; bottle filling machines; cheese slicers, electric; racket stringing machines; leather-working machines; dairy machines; glass-working machines; tobacco processing machines; grain husking machines; painting machines; oil refining machines; peeling machines; machines for processing plastics; ore treating machines; printing machines for use on sheet metal; brewing machines; whitewashing machines; road sweeping machines, self-propelled; leather paring machines; bitumen making machines; papermaking machines; pasta making machines, electric; machines for the production of sugar; weeding machines; sifting machines; cinder sifters [machines]; puddling machines; notchers [machine tools]; bread cutting machines; road making machines; railroad constructing machines; machines for the textile industry; rammers [machines]; rail-laying machines; bottle capping machines; bottle stoppering machines; waste compacting machines; vegetable peelers, electric; die-stamping machines; stamping machines; darning machines; milking machines; drainage machines; wrapping machines; grain separators; bookbinding apparatus and machines for industrial purposes; machines and apparatus for cleaning, electric; machines and apparatus for carpet shampooing, electric; machines and apparatus for polishing [electric]; sizing machines; punching machines; riveting machines; kitchen machines, electric; foundry machines; smoothing presses; fleshing machines; flour mill machines; type-setting machines [printing]; hemming machines; grating machines for vegetables; braiding machines; rinsing machines; wringing machines for laundry; cutting machines; steam engines; printing machines; rotary printing presses; industrial inkjet printing machines; compressed air machines; tilling machines for agricultural purposes; trimming machines; spinning machines; filling machines; friezing machines; cutters [machines]; satinating machines; agricultural machines; mixing machines; sorting machines for industry; stitching machines; washing machines [laundry]; coin-operated washing machines; clippers [machines]; spinning frames; looms; kneading machines; typographic machines; type-setting machines [photocomposition]; beating machines; beaters, electric; packing machines; packaging machines; filtering machines; moulding machines; carding machines; sewing machines; typecasting machines; electromechanical machines for chemical industry; labellers [machines]; mills [machines]; mills for household purposes, other than hand-operated; pepper mills, other than hand-operated; centrifugal mills; machine wheelwork; feeders [parts of machi-

nes]; forge blowers; mixers [machines]; blenders, electric, for household purposes; vacuum cleaner bags; threshing machines; pneumatic hammers; hammers [parts of machines]; tilt hammers; power hammers; reeling apparatus, mechanical; motorized cultivators; motors for boats; clutches, other than for land vehicles; meat choppers [machines]; superchargers; brake linings, other than for vehicles; guides for machines; suction nozzles for vacuum cleaners; vacuum cleaner attachments for disseminating perfumes and disinfectants; pumps [machines]; pumps [parts of machines, engines or motors]; aerating pumps for aquaria; vacuum pumps [machines]; compressed air pumps; pumps for heating installations; beer pumps; pumps for counter-current swimming; lubricating pumps; self-regulating fuel pumps; fuel dispensing pumps for service stations; centrifugal pumps; hydrogen dispensing pumps for service stations; blades [parts of machines]; tin openers, electric; knives for mowing machines; chaff cutter blades; knives, electric; shears, electric; scissors, electric; vegetable spiralizers, electric; engine mounts, other than for land vehicles; bearing brackets for machines; pulverisers [machines]; axles for machines; steam traps; chucks [parts of machines]; drill chucks [parts of machines]; exhaust manifold for engines; soldering irons, gas-operated; soldering irons, electric; superheaters; gears, other than for land vehicles; reduction gears, other than for land vehicles; drilling machines; saws [machines]; chain saws; guns [tools using explosives]; glue guns, electric; compressed air guns for the extrusion of mastics; carburetter feeders; feeding apparatus for engine boilers; loading ramps; ploughs; pneumatic transporters; pneumatic controls for machines, motors and engines; hangers [parts of machines]; anti-friction bearings for machines; roller bearings; self-oiling bearings; bearings for transmission shafts; ball-bearings; elevators [lifts]; hoists; lifts, other than ski-lifts; pulleys; saw blades [parts of machines]; pistons [parts of machines or engines]; shock absorber plungers [parts of machines]; pistons for engines; pistons for cylinders; catalytic converters; torque converters, other than for land vehicles; fuel conversion apparatus for internal combustion engines; presses [machines for industrial purposes]; wine presses; fruit presses, electric, for household purposes; fodder presses; basket presses; printing presses; typographic presses; swaging machines; pedal drives for sewing machines; cleaning appliances utilizing steam; food processors, electric; springs [parts of machines]; spinning wheels; punches for punching machines; vacuum cleaners; tambours for embroidery machines; radiators [cooling] for motors and engines; sewage pulverizers; air brushes for applying colour; regulators [parts of machines]; pressure regulators [parts of machines]; speed governors for machines, engines and motors; knives [parts of machines]; cutting blow pipes, gas-operated; blade holders [parts of machines]; loom shafts; gears for weaving looms; belts for machines; elevator belts;

fan belts for motors and engines; dynamo belts; belts for motors and engines; adhesive bands for pulleys; industrial robots; 3D printing pens; kick starters for motorcycles; joysticks being parts of machines, other than for game machines; stuffing boxes [parts of machines]; paper feeders [printing]; whisks, electric, for household purposes; sparking plugs for internal combustion engines; glow plugs for Diesel engines; brake segments, other than for vehicles; bedding machines; steam/oil separators; cream/milk separators; ball rings for bearings; sowers [machines]; exhausts for motors and engines; pigs for cleaning pipes; snow ploughs; sheaf-binding machines; shaft couplings [machines]; joints [parts of engines]; juice extractors, electric; straw [chaff] cutters; suction cups for milking machines; stands for machines; machine tools; die-cutting and tapping machines; woodworking machines; sharpening machines; bicycle assembling machines; mortising machines; stone-working machines; metalworking machines; threading machines; straightening machines; planing machines; lathes [machine tools]; milling machines; trueing machines; metal drawing machines; rolling mills; starters for motors and engines; stators [parts of machines]; glaziers' diamonds [parts of machines]; tables for machines; derricks; slide rests [parts of machines]; spin dryers [not heated]; couplings, other than for land vehicles; heat exchangers [parts of machines]; transmissions for machines; transmissions, other than for land vehicles; boiler tubes [parts of machines]; wind turbines; hydraulic turbines; turbines, other than for land vehicles; turbocompressors; central vacuum cleaning installations; suction machines for industrial purposes; machines for the mineralization of drinking water; washing installations for vehicles; degreasers [machines]; dust exhausting installations for cleaning purposes; sifting installations; pneumatic tube conveyors; dust removing installations for cleaning purposes; condensing installations; floating production storage and offloading [FPSO] units; pneumatic waste oil drainers; lifting apparatus; air suction machines; dividing machines; igniting devices for internal combustion engines; window closers, hydraulic; window closers, pneumatic; window closers, electric; washing apparatus; binding apparatus for hay; haulage apparatus [mining]; door openers, hydraulic; door openers, pneumatic; door openers, electric; window openers, hydraulic; window openers, pneumatic; window openers, electric; curtain drawing devices, electrically operated; adhesive tape dispensers [machines]; anti-pollution devices for motors and engines; beverage preparation machines, electromechanical; food preparation machines, electromechanical; elevator operating apparatus; control mechanisms for machines, engines or motors; shoe polishers, electric; machines and apparatus for wax-polishing, electric; air cushion devices for moving loads; handling apparatus for loading and unloading; elevating apparatus; aprons [parts of machines]; filter presses; filters for cleaning cooling air, for engines; fil-

ters being parts of machines or engines; moulds [parts of machines]; printing plates; journals [parts of machines]; centrifugal machines; elevator chains [parts of machines]; driving chains, other than for land vehicles; transmission chains, other than for land vehicles; cylinders for motors and engines; cylinders for machines; printing cylinders; pneumatic jacks; shuttles [parts of machines]; universal joints [Cardan joints]; engine rods; connecting rods for machines; steam mops; pulleys [parts of machines]; vacuum cleaner hoses; screwdrivers, electric; brushes [parts of machines]; dynamo brushes; brushes for vacuum cleaners; brushes, electrically operated [parts of machines]; carbon brushes [electricity]; ejectors; robotic exoskeleton suits, other than for medical purposes; fuel economisers for motors and engines; excavators; shovels, mechanical; agricultural elevators; motors, electric, other than for land vehicles; electrodes for welding machines; electric hammers; parquet wax-polishers, electric; cartridges for filtering machines; moving staircases [escalators]; automatic grapnels for marine purposes; metal cutting machines; machines using laser radiation.

8 – Glaziers' diamonds [parts of hand tools]; apparatus for tattooing; laser hair removal apparatus, other than for medical purposes; razors, electric or non-electric; sharpening steels; scythe stones; gimlets [hand tools]; borers; augers [hand tools]; carpenters' augers; pickhammers; carving forks; table forks; weeding forks [hand tools]; agricultural forks [hand tools]; lawn clippers [hand instruments]; harpoons; harpoons for fishing; nail extractors, hand-operated; rakes [hand tools]; sand trap rakes; cutter bars [hand tools]; whetstone holders; priming irons [hand tools]; sculptors' chisels; lifting jacks, hand-operated; hand drills, hand-operated; truncheons; clamps for carpenters or coopers; spades [hand tools]; rabbeting planes; chisels; engraving needles; tattoo needles; cutlery; edge tools [hand tools]; garden tools, hand-operated; abrading instruments [hand instruments]; numbering punches; goffering irons; implements for decanting liquids [hand tools]; depilation appliances, electric and non-electric; sharpening instruments; blade sharpening instruments; livestock marking tools; nail clippers, electric or non-electric; oyster openers; polishing irons [glazing tools]; ear-piercing apparatus; tube cutting instruments; wire strippers [hand tools]; riveters [hand tools]; expanders [hand tools]; cutting tools; cutting tools [hand tools]; ski edge sharpening tools, hand-operated; hand tools, hand-operated; sterile body piercing instruments; stamping-out tools [hand tools]; picks [hand tools]; sharpening stones; punch rings [knuckle dusters]; trowels; centre punches [hand tools]; daggers; pickaxes; mallets [hand instruments]; pliers; punch pliers [hand tools]; blades [weapons]; annular screw plates; spanners [hand tools]; tap wrenches; ladles [hand tools]; foundry ladles [hand tools]; meat claws; breast drills; lasts [shoemakers' hand tools]; scythe rings; instruments for punching tickets;

diggers [hand tools]; rams [hand tools]; scythes; hain-ault scythes; fire irons; emery grinding wheels; grindstones [hand tools]; sledgehammers; thistle extractors [hand tools]; nail nippers; tree pruners; nail drawers [hand tools]; ice picks; blades [hand tools]; razor blades; blades for planes; plane irons; jig-saws; spoons; table knives, forks and spoons for babies; table knives, forks and spoons of plastic; crow bars; trowels [gardening]; shovels [hand tools]; palette knives; machetes; beard clippers; hair clippers for personal use, electric and non-electric; hair clippers for animals [hand instruments]; taps [hand tools]; fireplace bellows [hand tools]; swords; hammers [hand tools]; emergency hammers; fullers [hand tools]; stone hammers; masons' hammers; riveting hammers [hand tools]; mattocks; ditchers [hand tools]; mincing knives [hand tools]; manicure sets; manicure sets, electric; pedicure sets; needle files; bits [hand tools]; files [tools]; emery files; air pumps, hand-operated; hand pumps; shaving cases; knives; cheese slicers, non-electric; fruit segmenters; egg slicers, non-electric; vegetable knives; pizza slicers; scaling knives; hobby knives [scalpels]; fruit corers; moulding irons; ceramic knives; tin openers, non-electric; farriers' knives; budding knives; hunting knives; penknives; grafting tools [hand tools]; carving knives; braiders [hand tools]; box cutters; bill-hooks; paring knives; cleavers; scissors; wick trimmers [scissors]; shears; cattle shearers; border shears; pruning shears; shearers [hand instruments]; sword scabbards; kitchen mandolines; vegetable slicers, hand-operated; vegetable spiralizers, hand-operated; vegetable peelers, hand-operated; agricultural implements, hand-operated; side arms, other than firearms; stropping instruments; screwdrivers, non-electric; sabres; stirring sticks for mixing paint; reamer sockets; drill holders [hand tools]; perforating tools [hand tools]; rammers [hand tools]; emery boards; nail files; nail files, electric; saws [hand tools]; bow saws; tweezers; hair-removing tweezers; guns [hand tools]; non-electric caulking guns; guns, hand-operated, for the extrusion of mastics; dies [hand tools]; fruit pickers [hand tools]; saw blades [parts of hand tools]; shear blades; tool belts [holders]; hair braiders, electric; table cutlery [knives, forks and spoons]; crimping irons; hand implements for hair curling; vegetable choppers; money scoops; instruments and tools for skinning animals; fingernail polishers, electric or non-electric; hackles [hand tools]; pin punches; nail punches; fish tapes [hand tools]; punches [hand tools]; insecticide vaporizers [hand tools]; syringes for spraying insecticides; reamers; frames for handsaws; saw holders; rasps [hand tools]; paring irons [hand tools]; graving tools [hand tools]; milling cutters [hand tools]; razor strops; leather strops; planes; scythe handles; knife handles; handles for hand-operated hand tools; levers; marline spikes; bits [parts of hand tools]; hollowing bits [parts of hand tools]; pruning scissors; silver plate [knives, forks and spoons]; pruning knives; sickles; drawing knives; scra-

pers [hand tools]; scrapers for skis; mortise chisels; caulking irons; gouges [hand tools]; mortars for pounding [hand tools]; mitre boxes [hand tools]; branding irons; hatchets; adzes [tools]; vices; bench vices [hand implements]; hoop cutters [hand tools]; axes; holing axes; fulling tools [hand tools]; earth rammers [hand tools]; tube cutters [hand tools]; hoes [hand tools]; squares [hand tools]; extension pieces for braces for screw taps; embossers [hand tools]; apparatus for destroying plant parasites, hand-operated; metal wire stretchers [hand tools]; metal band stretchers [hand tools]; flat irons; irons [non-electric hand tools]; razor cases; ratchets [hand tools]; scraping tools [hand tools]; awls; choppers [knives]; spatulas [hand tools]; spatulas for use by artists; wine bottle foil cutters, hand-operated; bayonets; curling tongs; cuticle tweezers; eyelash curlers; metal-cutting saws; metal-cutting scissors [tin shears].

9 – 3D spectacles; DVD players; ticket dispensers; juke boxes, musical; fire engines; answering machines; electrical adapters; batteries for electronic cigarettes; accumulators, electric; batteries, electric, for vehicles; accelerometers; actinometers; alidades; altimeters; ear pads for earphones; ammeters; nanoparticle size analysers; anemometers; anodes; aerials; anticathodes; apertometers [optics]; high-frequency apparatus; testing apparatus not for medical purposes; remote control apparatus; electro-dynamic apparatus for the remote control of railway points; electro-dynamic apparatus for the remote control of signals; monitoring apparatus, other than for medical purposes; sound recording apparatus; Global Positioning System [GPS] apparatus; distillation apparatus for scientific purposes; diffraction apparatus [microscopy]; air analysis apparatus; apparatus to check franking; sound transmitting apparatus; apparatus for fermentation [laboratory apparatus]; breathing apparatus for underwater swimming; breathing apparatus, except for artificial respiration; apparatus and installations for the production of X-rays, not for medical purposes; cash registers; electric apparatus for commutation; magnetic resonance imaging [MRI] apparatus, not for medical purposes; intercommunication apparatus; stills for laboratory experiments; projection apparatus; fire extinguishing apparatus; radiological apparatus for industrial purposes; X-ray apparatus not for medical purposes; blueprint apparatus; flashing lights [luminous signals]; stereoscopic apparatus; telephone apparatus; facsimile machines; phototelegraphy apparatus; igniting apparatus, electric, for igniting at a distance; acid hydrometers; salinometers; acidimeters for batteries; aerometers; beacons, luminous; battery jars; automated teller machines [ATM]; barometers; anode batteries; galvanic batteries; ignition batteries; solar batteries; solar panels for the production of electricity; batteries, electric; balances [steelyards]; betatrons; binoculars; biochips; electronic tags for goods; lens hoods; magnetic tape units for computers; computer memory devices; fire hose nozzles; encoded identification bracelets,

magnetic; connected bracelets [measuring instruments]; safety tarpaulins; electronic key fobs being remote control apparatus; bullet-proof clothing; signalling buoys; life buoys; marking buoys; directional compasses; vacuum gauges; electrolyzers; variometers; verniers; scales; baby scales; bathroom scales; letter scales; weighbridges; precision balances; scales with body mass analysers; levelling staffs [surveying instruments]; camcorders; video baby monitors; video cassettes; video projectors; video telephones; video screens; viewfinders, photographic; electric plugs; micrometer screws for optical instruments; viscosimeters; circuit closers; wavemeters; voltmeters; mechanical signs; signs, luminous; switchboxes [electricity]; current rectifiers; gas testing instruments; gasometers [measuring instruments]; galvanometers; hands-free kits for telephones; heliographic apparatus; hygrometers; hydrometers; weights; peepholes [magnifying lenses] for doors; hairdressing training heads [teaching apparatus]; holograms; plotters; loudspeakers; sounding leads; plumb bobs; range finders; parking sensors for vehicles; piezoelectric sensors; densimeters; densitometers; detectors; smoke detectors; infrared detectors; counterfeit coin detectors; joysticks for use with computers, other than for video games; transparencies [photography]; slide projectors; diaphragms [photography]; dictating machines; dynamometers; light-emitting diodes [LED]; quantum dot light-emitting diodes [QLED]; organic light-emitting diodes [OLED]; floppy disks; phonograph records; disks, magnetic; optical discs; circular slide rules; disk drives for computers; juke boxes for computers; wearable video display monitors; electronic numeric displays; DNA chips; electronic interactive whiteboards; electronic notice boards; electric wire harnesses for automobiles; bullet-proof vests; life jackets; reflective safety vests; identification threads for electric wires; nose clips for divers and swimmers; padlocks, electronic; locks, electric; bells [warning devices]; alarm bells, electric; electric door bells; signal bells; acoustic conduits; mirrors for inspecting work; road signs, luminous or mechanical; downloadable emoticons for mobile phones; marine depth finders; probes for scientific purposes; buzzers; needles for surveying compasses; needles for record players; eyewear; reflective articles for wear, for the prevention of accidents; measures; pressure measuring apparatus; simulators for the steering and control of vehicles; inverters [electricity]; pressure indicators; automatic indicators of low pressure in vehicle tyres; temperature indicators; incubators for bacteria culture; measuring instruments; cosmographic instruments; mathematical instruments; levelling instruments; instruments containing eyepieces; surveying instruments; azimuth instruments; interfaces for computers; audio interfaces; ionization apparatus not for the treatment of air or water; satellite finder meters; spark-guards; coaxial cables; fibre optic cables; cables, electric; calipers; slide calipers; screw-tapping gauges; calorimeters; calculating ma-

chines; pocket calculators; decompression chambers; rearview cameras for vehicles; cinematographic cameras; thermal imaging cameras; mouth guards for sports; life-saving capsules for natural disasters; electronic pens [visual display units]; holders for electric coils; biometric identity cards; identity cards, magnetic; video game cartridges; toner cartridges, unfilled, for printers and photocopiers; ink cartridges, unfilled, for printers and photocopiers; memory cards for video game machines; encoded magnetic cards; riding helmets; protective helmets; carriers for dark plates [photography]; cathodes; spools [photography]; choking coils [impedance]; coils, electric; electromagnetic coils; cinematographic film, exposed; computer keyboards; solenoid valves [electromagnetic switches]; wire connectors [electricity]; thin client computers; downloadable cryptographic keys for receiving and spending cryptocurrency; encoded key cards; electronic book readers; electronic agendas; push buttons for bells; mouse pads; magnetic encoders; visors for helmets; collectors, electric; calibrating rings; smart rings; ring sizers; protective suits for aviators; commutators; compact discs [audio-video]; compact discs [read-only memory]; comparators; marine compasses; computers; laptop computers; tablet computers; notebook computers; wearable computers; condensers [capacitors]; contacts, electric; wind socks for indicating wind direction; traffic cones; branch boxes [electricity]; distribution boxes [electricity]; junction boxes [electricity]; connectors [electricity]; battery boxes; cabinets for loudspeakers; diving suits; downloadable e-wallets; galena crystals [detectors]; covers for electric outlets; logs [measuring instruments]; lasers, not for medical purposes; lactodensimeters; lactometers; vacuum tubes [radio]; darkroom lamps [photography]; thermionic valves; amplifying tubes; flashlights [photography]; head cleaning tapes [recording]; magnetic tapes; videotapes; surveying chains; fire escapes; rulers [measuring instruments]; square rulers for measuring; slide-rules; contact lenses; correcting lenses [optics]; optical lenses; optical condensers; sounding lines; electricity conduits; measuring spoons; magnifying glasses [optics]; thread counters; magnets; decorative magnets; close-up lenses; crash test dummies; resuscitation mannequins [teaching apparatus]; mouse [computer peripheral]; trackballs [computer peripherals]; pressure gauges; security tokens [encryption devices]; divers' masks; solderers' helmets; protective masks; respiratory masks, other than for artificial respiration; materials for electricity mains [wires, cables]; voting machines; money counting and sorting machines; material testing instruments and machines; furniture especially made for laboratories; megaphones; portable media players; diaphragms [acoustics]; diaphragms for scientific apparatus; metal detectors for industrial or military purposes; digital weather stations; metronomes; rules [measuring instruments]; carpenters' rules; dressmakers' measures; mechanisms for coin-operated apparatus; mechanisms for counter-

operated apparatus; coin-operated mechanisms for television sets; shutter releases [photography]; micro-meters; microprocessors; microscopes; microtomes; microphones; audio mixers; modems; lightning conductors; monitors [computer hardware]; monitors [computer programs]; selfie sticks [hand-held monopods]; terminals [electricity]; junction sleeves for electric cables; teeth protectors; temperature indicator labels, not for medical purposes; knee-pads for workers; ear pads for headphones; headphones; earpieces for remote communication; surveyors' levels; sound recording carriers; magnetic data media; optical data media; electronic sheet music, downloadable; laptops; recorded computer gaming software for gambling; computer software, recorded; sheaths for electric cables; identification sheaths for electric wires; weighing machines; computer hardware; punched card machines for offices; life saving equipment; shoes for protection against accidents, irradiation and fire; objectives [lenses] [optics]; lenses for astrophotography; selfie lenses; egg-candlers; fire extinguishers; rescue laser signalling flares; electrified fences; limiters [electricity]; clothing for protection against accidents, irradiation and fire; clothing for protection against fire; asbestos clothing for protection against fire; clothing especially made for laboratories; survival blankets; ozonisers [ozonators]; octants; eyepieces; ohmmeters; wrist rests for use with computers; spectacle frames; oscillographs; plumb lines; mirrors [optics]; spectacles; sunglasses; goggles for sports; electronic collars to train animals; finger sizers; signalling panels, luminous or mechanical; biometric passports; wah-wah pedals; radio pagers; pince-nez; electronic pocket translators; transmitters [telecommunication]; telephone transmitters; transmitters of electronic signals; switches, electric; periscopes; data gloves; gloves for divers; gloves for protection against accidents; gloves for protection against X-rays for industrial purposes; asbestos gloves for protection against accidents; furnaces for laboratory use; droppers for measuring, other than for medical or household purposes; laboratory pipettes; pyrometers; planimeters; plane tables [surveying instruments]; plates for batteries; computer software platforms, recorded or downloadable; wafers for integrated circuits; printed circuit boards; compact disc players; cassette players; protective films adapted for computer screens; protective films adapted for smartphones; sound recording strips; X-ray films, exposed; films, exposed; life-saving rafts; animal signalling rattles for directing livestock; laboratory trays; digital signs; stands adapted for laptops; semi-conductors; polarimeters; personal digital assistants [PDAs]; fire pumps; measuring glassware; weight belts for divers; life belts; fuses; circuit breakers; converters, electric; telerupters; food analysis apparatus; diagnostic apparatus, not for medical purposes; distance recording apparatus; distance measuring apparatus; speed measuring apparatus [photography]; appliances for measuring the thickness of leather; apparatus for mea-

asuring the thickness of skins; speed checking apparatus for vehicles; teaching apparatus; time recording apparatus; apparatus and instruments for astronomy; surveying apparatus and instruments; weighing apparatus and instruments; nautical apparatus and instruments; navigational instruments; optical apparatus and instruments; apparatus and instruments for physics; chemistry apparatus and instruments; measuring apparatus; measuring devices, electric; boiler control instruments; meteorological instruments; naval signalling apparatus; observation instruments; navigation apparatus for vehicles [on-board computers]; satellite navigational apparatus; regulating apparatus, electric; telecommunication apparatus in the form of jewellery; precision measuring apparatus; audio- and video-receivers; prisms [optics]; computer software applications, downloadable; ticket printers; printers for use with computers; hemline markers; retorts' stands; apparatus for changing record player needles; drainers for use in photography; cleaning apparatus for phonograph records; fire beaters; sighting telescopes for firearms; telescopic sights for artillery; test tubes; pressure indicator plugs for valves; magnetic wires; telegraph wires; telephone wires; wires, electric; conductors, electric; copper wire, insulated; fuse wire; computer programs, recorded; computer game software, downloadable; computer programs, downloadable; computer operating programs, recorded; computer screen saver software, recorded or downloadable; record players; processors [central processing units]; rods for water diviners; electronic publications, downloadable; distribution consoles [electricity]; control panels [electricity]; radar apparatus; masts for wireless aerials; transmitting sets [telecommunication]; radios; vehicle radios; sprinkler systems for fire protection; frames for photographic transparencies; screens for photoengraving; flowmeters; walkie-talkies; voltage surge protectors; voltage regulators for vehicles; stage lighting regulators; light dimmers [regulators], electric; speed regulators for record players; cell switches [electricity]; washing trays [photography]; marking gauges [joinery]; T-squares for measuring; time switches, automatic; relays, electric; safety restraints, other than for vehicle seats and sports equipment; body harnesses for support when lifting loads; X-ray photographs, other than for medical purposes; rheostats; respirators for filtering air; retorts; refractometers; refractors; grids for batteries; security surveillance robots; laboratory robots; teaching robots; telepresence robots; humanoid robots with artificial intelligence; electric sockets; height measuring instruments; speaking tubes; horns for loudspeakers; subwoofers; saccharometers; optical fibres [light conducting filaments]; traffic-light apparatus [signalling devices]; dog whistles; signalling whistles; sports whistles; sextants; inductors [electricity]; safety nets; nets for protection against accidents; fire alarms; signals, luminous or mechanical; rescue flares, non-explosive and non-pyrotechnic; sirens; electronic access control



systems for interlocking doors; scanners [data processing equipment]; hand-held electronic dictionaries; integrated circuit cards [smart cards]; smartglasses; smartphones; smartwatches; connections for electric lines; couplings, electric; sonars; sound locating instruments; lighting ballasts; resistances, electric; spectrograph apparatus; spectrometers; speed indicators; alcoholmeters; satellites for scientific purposes; protection devices for personal use against accidents; audiovisual teaching apparatus; charging stations for electric vehicles; radiotelegraphy sets; radiotelephony sets; spectacle lenses; anti-glare glasses; optical glass; personal stereos; stereoscopes; stands for photographic apparatus; stroboscopes; fire boats; sulfimeters; bags adapted for laptops; drying racks [photography]; spherometers; integrated circuits; printed circuits; counters; parking meters; mileage recorders for vehicles; revolution counters; abacuses; egg timers [sandglasses]; taximeters; ear plugs for divers; tachometers; television apparatus; telegraphs [apparatus]; telescopes; teleprompters; teleprinters; cordless telephones; mobile telephones; theodolites; credit card terminals; interactive touch screen terminals; thermo-hygrometers; thermometers, not for medical purposes; thermostats; thermostats for vehicles; climate control digital thermostats; crucibles [laboratory]; tone arms for record players; totalizers; transistors [electronic]; transponders; protractors [measuring instruments]; transformers [electricity]; step-up transformers; resuscitation training simulators; vehicle breakdown warning triangles; triodes; starter cables for motors; discharge tubes, electric, other than for lighting; capillary tubes; neon signs; Pitot tubes; X-ray tubes not for medical purposes; telephone receivers; headgear being protective helmets; squares for measuring; gauges; quantity indicators; petrol gauges; water level indicators; electric loss indicators; light-emitting electronic pointers; slope indicators; levels [instruments for determining the horizontal]; mercury levels; spirit levels; urinometers; amplifiers; particle accelerators; electric installations for the remote control of industrial operations; baby monitors; steering apparatus, automatic, for vehicles; balancing apparatus; video recorders; sound reproduction apparatus; invoicing machines; tape recorders; protection devices against X-rays, not for medical purposes; railway traffic safety appliances; data processing apparatus; oxygen transvasing apparatus; theft prevention installations, electric; devices for the projection of virtual keyboards; film cutting apparatus; drying apparatus for photographic prints; optical character readers; centering apparatus for photographic transparencies; dosage dispensers; battery chargers; chargers for electric accumulators; chargers for electronic cigarettes; acoustic alarms; sounding apparatus and machines; apparatus for editing cinematographic film; cathodic anti-corrosion apparatus; couplers [data processing equipment]; wearable activity trackers; anti-theft warning apparatus; computer peripheral devices; anti-interference devices [electricity];

demagnetizing apparatus for magnetic tapes; acoustic couplers; alarms; fog signals, non-explosive; whistle alarms; adding machines; readers [data processing equipment]; heat regulating apparatus; photocopiers [photographic, electrostatic, thermic]; electric and electronic effects units for musical instruments; bar code readers; downloadable ring tones for mobile phones; downloadable image files; downloadable music files; animated cartoons; filters for respiratory masks; filters for ultraviolet rays, for photography; filters for use in photography; USB flash drives; magic lanterns; optical lanterns; signal lanterns; cameras [photography]; glazing apparatus for photographic prints; shutters [photography]; darkrooms [photography]; photometers; flash-bulbs [photography]; digital photo frames; enlarging apparatus [photography]; photovoltaic cells; containers for contact lenses; spectacle cases; containers for microscope slides; cases for smartphones; cases especially made for photographic apparatus and instruments; chromatography apparatus for laboratory use; chronographs [time recording apparatus]; laboratory centrifuges; spectacle chains; cyclotrons; compasses for measuring; frequency meters; time clocks [time recording devices]; Petri dishes; sleeves for laptops; covers for personal digital assistants [PDAs]; covers for tablet computers; covers for smartphones; fire blankets; chips [integrated circuits]; jigs [measuring instruments]; pedometers; meteorological balloons; electrified rails for mounting spot lights; asbestos screens for firemen; fire hose; virtual reality headsets; protective helmets for sports; head guards for sports; lifeboats; snorkels; cell phone straps; spectacle cords; tripods for cameras; switchboards; distribution boards [electricity]; equalizers [audio apparatus]; screens [photography]; workmen's protective face-shields; projection screens; radiology screens for industrial purposes; fluorescent screens; exposure meters [light meters]; ducts [electricity]; galvanic cells; downloadable graphics for mobile phones; epidiascopes; ergometers; armatures [electricity]; black boxes [data recorders].

10 – Analysers for bacterial identification for medical purposes; cholesterol meters; blood testing apparatus; testing apparatus for medical purposes; anaesthetic apparatus; galvanic therapeutic appliances; apparatus for artificial respiration; apparatus for the treatment of deafness; physical exercise apparatus for medical purposes; body rehabilitation apparatus for medical purposes; dental apparatus and instruments; surgical apparatus and instruments; resuscitation apparatus; dental apparatus, electric; physiotherapy apparatus; bed vibrators; hot air therapeutic apparatus; diagnostic apparatus for medical purposes; traction apparatus for medical purposes; radiotherapy apparatus; microdermabrasion apparatus; fumigation apparatus for medical purposes; apparatus for the regeneration of stem cells for medical purposes; apparatus for DNA and RNA testing for medical purposes; apparatus and installations for the production of X-rays, for medical

purposes; magnetic resonance imaging [MRI] apparatus for medical purposes; orthodontic apparatus; medical cooling apparatus for treating heatstroke; medical cooling apparatus for use in therapeutic hypothermia; radiological apparatus for medical purposes; X-ray apparatus for medical purposes; hearing aids; nasal aspirators; trusses; maternity belts; support bandages; bandages, elastic; cupping glasses; dental burs; acupressure bands; bracelets for medical purposes; anti-nausea wristbands; anti-rheumatism bracelets; feeding bottles; air cushions for medical purposes; vaporizers for medical purposes; hot air vibrators for medical purposes; vibromassage apparatus; gastroscopes; hemocytometers; glucometers; lice combs; surgical sponges; pill cutters; defibrillators; dialyzers; containers especially made for medical waste; clips, surgical; mirrors for dentists; mirrors for surgeons; probes for medical purposes; urethral probes; artificial teeth; acupuncture needles; suture needles; needles for medical purposes; orthopedic articles; pill crushers; biodegradable bone fixation implants; surgical implants comprised of artificial materials; inhalers; hydrogen inhalers; injectors for medical purposes; incubators for medical purposes; incubators for babies; obstetric apparatus; obstetric apparatus for cattle; electric acupuncture instruments; surgical cutlery; insufflators; chambers for inhalers; endoscopy cameras for medical purposes; cannulae; droppers for medical purposes; dropper bottles for medical purposes; heart monitors; heart pacemakers; catheters; catgut; draw-sheets for sick beds; enema apparatus for medical purposes; clips for dummies; artificial skin for surgical purposes; menstrual cups; biomagnetic rings for therapeutic or medical purposes; teething rings; anti-rheumatism rings; compressors [surgical]; thermo-electric compresses [surgery]; oxygen concentrators for medical purposes; abdominal corsets; corsets for medical purposes; crutches; dentists' armchairs; armchairs for medical or dental purposes; waterbeds for medical purposes; air mattresses [air beds] for medical purposes; beds specially made for medical purposes; feeding bottle valves; love dolls [sex dolls]; lasers for medical purposes; lamps for medical purposes; curing lamps for medical purposes; quartz lamps for medical purposes; ultraviolet ray lamps for medical purposes; lancets; kinesiology tapes; lenses [intraocular prostheses] for surgical implantation; spoons for administering medicine; sanitary masks for medical purposes; masks for use by medical personnel; respiratory masks for artificial respiration; anaesthetic masks; LED masks for therapeutic purposes; therapeutic facial masks; gum massagers for babies; suture materials; childbirth mattresses; air mattresses for medical purposes; furniture especially made for medical purposes; water bags for medical purposes; douche bags; breast pumps; body fat monitors; body composition monitors; urinals being vessels; portable hand-held urinals; teeth protectors for dental purposes; temperature indicator labels for medical purposes; knee ban-

dages, orthopaedic; tips for crutches; nanorobots for medical purposes; finger guards for medical purposes; bone void fillers comprised of artificial materials; medical guidewires; pumps for medical purposes; thread, surgical; knives for surgical purposes; scissors for surgery; ambulance stretchers; stretchers, wheeled; boots for medical purposes; orthopaedic footwear; clothing especially for operating rooms; compression garments; blankets, electric, for medical purposes; supports for flat feet; ophthalmometers; ophthalmoscopes; cooling pads for first aid purposes; slings [supporting bandages]; gloves for massage; gloves for medical purposes; pessaries; saws for surgical purposes; ear picks; cooling patches for medical purposes; spittoons for medical purposes; plaster bandages for orthopaedic purposes; orthopaedic bandages for joints; abdominal pads; cushions for medical purposes; pads for preventing pressure sores on patient bodies; air pillows for medical purposes; soporific pillows for insomnia; heating cushions, electric, for medical purposes; patient hoists; abdominal belts; galvanic belts for medical purposes; hypogastric belts; belts for medical purposes; orthopaedic belts; umbilical belts; belts, electric, for medical purposes; condoms; aerosol dispensers for medical purposes; sphygmotensimeters; pulse meters; esthetic massage apparatus; massage apparatus; veterinary apparatus and instruments; medical apparatus and instruments; urological apparatus and instruments; brushes for cleaning body cavities; appliances for washing body cavities; corn knives; incontinence sheets; sterile sheets, surgical; surgical drapes; hair prostheses; artificial eyes; artificial breasts; dentures; artificial limbs; artificial jaws; ice bags for medical purposes; toe separators for orthopaedic purposes; surgical bougies; orthodontic rubber bands; X-ray photographs for medical purposes; respirators for artificial respiration; surgical robots; ear trumpets; strait jackets; sex toys; scalpels; tongue scrapers; dummies for babies; feeding bottle teats; baby feeding dummies; receptacles for applying medicines; spirometers [medical apparatus]; vaginal syringes; implantable subcutaneous drug delivery devices; hearing protectors; contraceptives, non-chemical; orthopaedic soles; stents; stethoscopes; medical examination tables; operating tables; commode chairs; basins for medical purposes; bed pans; instrument cases for use by doctors; arch supports for footwear; suspensory bandages; ear plugs [ear protection devices]; thermal packs for first aid purposes; thermometers for medical purposes; tomographs for medical purposes; trocars; walking sticks for medical purposes; drainage tubes for medical purposes; X-ray tubes for medical purposes; radium tubes for medical purposes; balling guns; protection devices against X-rays, for medical purposes; apparatus for acne treatment; filters for ultraviolet rays, for medical purposes; patient examination gowns; quad canes for medical purposes; wheeled walkers to aid mobility; walking frames for disabled persons; cases fitted for medical instruments; el-

astic stockings for surgical purposes; stockings for varices; splints, surgical; laser therapy helmets for treating alopecia; tongue depressors for medical purposes; syringes for injections; syringes for medical purposes; hypodermic syringes; uterine syringes; urethral syringes; pins for artificial teeth; castrating pin-cers; forceps for medical purposes; robotic exoske-leton suits for medical purposes; radiology screens for medical purposes; electrodes for medical use; electro-cardiographs; brain pacemakers; laser machines for medical purposes.

14 – Agates; diamonds; amulets [jewellery]; anchors [clock- and watchmaking]; barrels [clock- and watch-making]; bracelets [jewellery]; bracelets made of em-broidered textile [jewellery]; watch bands; charms for key rings; jewellery charms; brooches [jewellery]; alarm clocks; pins [jewellery]; ornamental pins; tie pins; jewellery hat pins; beads for making jewellery; pearls made of ambroid [pressed amber]; busts of pre-cious metal; jewellery rolls; jet, unwrought or semi-wrought; jewellery findings; key rings [split rings with trinket or decorative fob]; retractable key rings; pearls [jewellery]; copper tokens; tie clips; cuff links; clasps for jewellery; badges of precious metal; gold, unwrought or beaten; cloisonné jewellery; works of art of precious metal; jewellery; ivory jewellery; je-wellery of yellow amber; iridium; cabochons; preci-ous stones; semi-precious stones; spun silver [silver wire]; necklaces [jewellery]; split rings of precious metal for keys; rings [jewellery]; boxes of precious metal; presentation boxes for jewellery; watch cases [parts of watches]; clock cases; pendulums [clock-and watchmaking]; medals; lockets [jewellery]; preci-ous metals, unwrought or semi-wrought; movements for clocks and watches; clockworks; misbaha [prayer beads]; coins; gold thread [jewellery]; threads of pre-cious metal [jewellery]; silver thread [jewellery]; oli-vine [gems]; osmium; palladium; platinum [metal]; chronometric instruments; watch springs; crucifixes of precious metal, other than jewellery; crucifixes as jewellery; rhodium; ruthenium; stopwatches; silver, unwrought or beaten; earrings; ingots of precious met-als; alloys of precious metal; statues of precious metal; figurines of precious metal; watch glasses; paste jewellery; watch hands; clock hands; ornaments of jet; shoe jewellery; hat jewellery; presentation boxes for watches; chronographs [watches]; chronometers; chronoscopes; chains [jewellery]; watch chains; dials [clock- and watchmaking]; atomic clocks; watches; sundials; clocks and watches, electric; control clocks [master clocks]; clocks; wristwatches; rosaries; jewe-llery boxes; spinel [precious stones].

16 – Fountain pens; aquarelles; albums; almanacs; do-cument laminators for office use; mimeograph appara-tus and machines; atlases; posters; banknotes; banners of paper; paper bows, other than haberdashery or hair decorations; name badges [office requisites]; table li-nen of paper; tickets; baggage claim check tags of pa-

per; forms, printed; announcement cards [stationery]; glitter for stationery purposes; note books; pads [sta-tionery]; drawing pads; wristbands for the retention of writing instruments; pamphlets; booklets; paper; pa-per sheets [stationery]; waxed paper; paper for medi-cal examination tables; paper for recording machines; paper for radiograms; papers for painting and calli-graphy; electrocardiograph paper; drawer liners of pa-per, perfumed or not; wood pulp paper; carbon paper; copying paper [stationery]; parchment paper; writing paper; rice paper; luminous paper; toilet paper; wrap-ping paper; filter paper; japanese paper; blotters; new-letters; rollers for typewriters; house painters' rollers; composing sticks; modelling wax, not for dental pur-poses; signboards of paper or cardboard; sewing pa-tterns; bunting of paper; newspapers; electrotypes; hectographs; modelling clay; polymer modelling clay; terrestrial globes; drawing sets; engravings; slate pen-cils; pencil leads; document holders [stationery]; pen-cil holders; chalk holders; holders for cheque books; holders for stamps [seals]; page holders; name badge holders [office requisites]; diagrams; table runners of paper; engraving plates; writing slates; blackboards; galley racks [printing]; drawing boards; advertisement boards of paper or cardboard; duplicators; punches [office requisites]; cream containers of paper; magazi-nes [periodicals]; money clips; clips for name badge holders [office requisites]; tags for index cards; pen clips; bookmarks; etching needles; tracing needles for drawing purposes; periodicals; printed publications; paper shredders for office use; graphic representati-ons; credit card imprinters, non-electric; paper crea-sers [office requisites]; graining combs; drawing ins-truments; calendars; tracing paper; tracing cloth; tra-cing patterns; gums [adhesives] for stationery or hou-sehold purposes; lithographic stones; ink stones [ink reservoirs]; pencils; pencil lead holders; charcoal pen-cils; pictures; transfers [decalcomanias]; paintings [pi-ctures], framed or unframed; cardboard; wood pulp board [stationery]; hat boxes of cardboard; cards; in-dex cards [stationery]; geographical maps; paper tapes and cards for the recordal of computer programmes; trading cards, other than for games; perforated cards for Jacquard looms; catalogues; spools for inking ri-bbons; flower-pot covers of paper; paintbrushes; pain-ter's brushes; writing brushes; typewriter keys; glue for stationery or household purposes; isinglass for sta-tionery or household purposes; gluten [glue] for sta-tionery or household purposes; starch paste [adhesive] for stationery or household purposes; printing blocks; books; colouring books; manifolds [stationery]; comic books; drawing pins; cigar bands; envelopes [statione-ry]; boxes of paper or cardboard; cases for stamps [seals]; paint boxes for use in schools; correcting flu-ids [office requisites]; printed coupons; stencils [sta-tionery]; French curves; paper ribbons, other than ha-berdashery or hair decorations; gummed tape [statio-nerly]; typewriter ribbons; barcode ribbons; adhesive bands for stationery or household purposes; correcting

tapes [office requisites]; inking ribbons; self-adhesive tapes for stationery or household purposes; square rulers for drawing; drawing rulers; flyers; absorbent sheets of paper or plastic for foodstuff packaging; humidity control sheets of paper or plastic for foodstuff packaging; viscose sheets for wrapping; sheets of reclaimed cellulose for wrapping; plastic bubble packs for wrapping or packaging; steel letters; type [numerals and letters]; lithographs; letter trays; paint trays; architects' models; postage stamps; plastics for modelling; graphic prints; modelling materials; teaching materials [except apparatus]; sealing compounds for stationery purposes; adhesives [glues] for stationery or household purposes; padding materials of paper or cardboard; bookbinding material; packing [cushioning, stuffing] materials of paper or cardboard; packaging material made of starches; filtering materials of paper; table mats of paper; addressing machines; pencil sharpening machines, electric or non-electric; bookbinding apparatus and machines [office equipment]; typewriters, electric or non-electric; franking machines for office use; chalk for lithography; writing chalk; tailors' chalk; marking chalk; spray chalk; bags [envelopes, pouches] of paper or plastics, for packaging; garbage bags of paper or of plastics; plastic bags for pet waste disposal; painters' easels; hand-rests for painters; printing sets, portable [office requisites]; bibs of paper; bibs, sleeved, of paper; stickers [stationery]; fingerstalls for office use; writing cases [stationery]; cords for bookbinding; paper knives [letter openers]; printed sheet music; numbering apparatus; bottle envelopes of paper or cardboard; sealing wafers; covers [stationery]; passport holders; protective covers for books; plastic cling film, extensible, for palletization; embroidery designs [patterns]; handwriting specimens for copying; oleographs; musical greeting cards; greeting cards; postcards; etchings; conical paper bags; paper bags for use in the sterilization of medical instruments; bags for microwave cooking; palettes for painters; ink sticks; pantographs [drawing instruments]; loose-leaf binders; files [office requisites]; folders for papers; papier mâché; pastels [crayons]; modelling paste; pen cases; pen wipers; office perforators; pens [office requisites]; nibs of gold; nibs; steel pens; drawing pens; song books; seals [stamps]; sealing stamps; clipboards; address plates for addressing machines; handkerchiefs of paper; plastic film for wrapping; transparencies [stationery]; desk mats; trays for sorting and counting money; coasters of paper; bookends; stamp stands; mats for beer glasses; stands for pens and pencils; photograph stands; obliterating stamps; inking pads; stamp pads; adhesive tapes for stationery or household purposes; binding strips [bookbinding]; towels of paper; inking sheets for document reproducing machines; inking sheets for duplicators; cloth for bookbinding; gummed cloth for stationery purposes; printers' blankets, not of textile; portraits; paperweights; writing cases [sets]; inkstands; office requisites, except furniture; writing materials;

writing instruments; drawing materials; school supplies [stationery]; adhesive tape dispensers [office requisites]; hand labelling appliances; printed matter; lithographic works of art; prospectuses; printed time-tables; ledgers [books]; printers' reglets; indexes; paper cutters [office requisites]; rubber erasers; elastic bands for offices; T-squares for drawing; graphic reproductions; retractable reels for name badge holders [office requisites]; penholders; marking pens [stationery]; tissues of paper for removing make-up; paper wipes for cleaning; dental tray covers of paper; place mats of paper; tablemats of paper; tablecloths of paper; paper clasps; document files [stationery]; scrapers [erasers] for offices; paper-clips; clips for offices; erasing products; biological samples for use in microscopy [teaching materials]; histological sections for teaching purposes; figurines of papier mâché; steatite [tailor's chalk]; writing board erasers; composing frames [printing]; sealing wax; arithmetical tables; placards of paper or cardboard; writing or drawing books; fabrics for bookbinding; stationery; pencil sharpeners, electric or non-electric; stencil plates; stencils for decorating food and beverages; cardboard tubes; Indian inks; moisteners [office requisites]; moisteners for gummed surfaces [office requisites]; squares for drawing; chart pointers, non-electronic; bottle wrappers of paper or cardboard; envelope sealing machines for offices; sealing machines for offices; vignetting apparatus; apparatus for mounting photographs; stapling presses [office requisites]; manuals [handbooks]; paper coffee filters; flags of paper; silver paper; moulds for modelling clays [artists' materials]; photo-engravings; photographs [printed]; stencil cases; canvas for painting; chromolithographs [chromos]; animation cels; compasses for drawing; numbers [type]; artists' watercolour saucers; ink; correcting ink [heliography]; inkwells; blueprints; stencils; erasing shields; balls for ball-point pens; desktop cabinets for stationery [office requisites]; printing type; address stamps; stamps [seals]; shields [paper seals]; prints [engravings]; labels of paper or cardboard; advertising pamphlets; printed advertising boards of paper or cardboard.

40 – Paper finishing; applying finishes to textiles; beer brewing for others; upcycling [waste recycling]; vulcanization [material treatment]; skin dressing; fruit crushing; embroidering; galvanization; electroplating; engraving; decontamination of hazardous materials; air deodorizing; stripping finishes; tanning; metal tempering; freezing of foods; gilding; gold plating; cadmium plating; permanent-press treatment of fabrics; food and drink preservation; consultancy in the field of wine making; food smoking; leather staining; fur dyeing; shoe staining; textile dyeing; cloth dyeing; laminating; lithographic printing; metal casting; fur glossing; tin plating; boilermaking; taxidermy; magnetization; nickel plating; abrasion; paper treating; water treating; woodworking; processing of cinematographic films; leather working; cloth edging; metal

treating; fur conditioning; fur mothproofing; waste treatment [transformation]; textile mothproofing; cloth waterproofing; crease-resistant treatment for clothing; cloth fireproofing; textile treating; wool treating; framing of works of art; air freshening; fabric bleaching; air purification; soldering; pasteurizing of food and beverages; clothing alteration; recycling of waste and trash; processing of oil; pattern printing; photographic printing; offset printing; metal plating; printing; burnishing by abrasion; flour milling; dress-making; providing information relating to material treatment; wine making for others; custom manufacturing of bread; rental of boilers; knitting machine rental; rental of generators; rental of air-conditioning apparatus; rental of space heating apparatus; photographic film development; pottery firing; blacksmithing; custom assembling of materials for others; bookbinding; welding services; glass-blowing; saddlery working; grinding; cloth cutting; sawing of materials; refining services; timber felling and processing; fur satining; silver plating; incineration of waste and trash; laser scribing; warping [looms]; sorting of waste and recyclable material [transformation]; photo-composing services; quilting; planing of materials; fulling of cloth; tinting of car windows; window tinting treatment being surface coating; slaughtering of animals; destruction of waste and trash; cloth pre-shrinking; custom 3D printing for others; services of a dental technician; cryopreservation services; key cutting; dyeing services; sandblasting services; production of energy; custom tailoring; custom fashioning of fur; photogravure; millworking; chromium plating; colour separation services; silkscreen printing; optical glass grinding; treatment of materials by laser beam; die steel treating; custom manufacturing of stamps, matrices and seals.

42 – Water analysis; computer system analysis; handwriting analysis [graphology]; chemical analysis; rental of meters for the recording of energy consumption; energy auditing; recovery of computer data; business card design; graphic design of promotional materials; interior design; industrial design; graphic arts design; computer virus protection services; oil-field surveys; geological surveys; engineering; installation of computer software; meteorological information; clinical trials; material testing; textile testing; bacteriological research; biological research; geological research; research in the field of environmental protection; cosmetic research; mechanical research; research in the field of welding; research in the field of building construction; research in the field of telecommunications technology; research in the field of physics; chemical research; research and development of new products for others; medical research; scientific and technological research relating to patent mapping; scientific and technological research in the field of natural disasters; scientific research; analysis for oil-field exploitation; underwater exploration; technological research; calibration [measuring]; website design consul-

tancy; computer security consultancy; information technology [IT] consultancy; computer technology consultancy; consultancy in the design and development of computer hardware; architectural consultancy; internet security consultancy; computer software consultancy; data security consultancy; technological consultancy; oil-well testing; quality control; vehicle roadworthiness testing; land surveying; dress designing; updating of computer software; monitoring of computer systems to detect breakdowns; monitoring of computer systems for detecting unauthorized access or data breach; monitoring of computer systems by remote access; electronic monitoring of credit card activity to detect fraud via the internet; electronic monitoring of personally identifying information to detect identity theft via the internet; software as a service [SaaS]; maintenance of computer software; authenticating works of art; design of interior decor; quality evaluation of standing timber; quality evaluation of wool; digitization of documents [scanning]; conversion of data or documents from physical to electronic media; urban planning; providing information relating to computer technology and programming via a website; providing scientific information, advice and consultancy relating to carbon offsetting; providing search engines for the internet; platform as a service [PaaS]; conversion of computer programs and data, other than physical conversion; conducting technical project studies; computer system design; rental of web servers; computer rental; rental of computer software; unlocking of mobile phones; geological prospecting; oil prospecting; hosting computer sites [web sites]; server hosting; development of computer platforms; construction drafting; computer software design; software development in the framework of software publishing; cloud seeding; consultancy in the field of energy-saving; creating and designing website-based indexes of information for others [information technology services]; creating and maintaining websites for others; computer programming; technical writing; copying of computer programs; cloud computing; architectural services; information technology services provided on an outsourcing basis; chemistry services; packaging design; off-site data backup; telecommunications technology consultancy; scientific laboratory services; user authentication services using single sign-on technology for online software applications; user authentication services using technology for e-commerce transactions; weather forecasting; styling [industrial design]; cartography services; exploration services in the field of the oil, gas and mining industries; data encryption services; electronic data storage; surveying.

(260) AM 2023 118093 A  
 (800) 1664947  
 (151) 2022 01 10  
 (891) 2022 01 10  
 (731) Chekhlov Aleksei Gennad'evich  
 Dachnaya str., d. 9B, dp dsk "Michurinec",  
 RU-142784 Moscow, Russian Federation

(540)  

(591) White and green  
 (531) 28.05; 29.01.03  
 (511)  
 3 – Essential oils; cosmetics; hair lotions; non-medicated dentifrices.

(260) AM 2023 118094 A  
 (800) 1664963  
 (151) 2022 04 08  
 (891) 2022 04 08  
 (731) Tibet Summit Colove Motorcycle sales Co., Ltd  
 201, Unit 2, B Block, Headquarter Economic  
 Base, No.5, Gesang Road, Lhasa Economic  
 and Technical Development Zone, 850000  
 Tibet, China

(540)  

(591) Black, white  
 (531) 26.04.02; 26.04.05; 26.04.18; 26.04.24;  
 26.11.03; 26.11.09; 27.05.01; 27.05.09;  
 27.05.24  
 (511)  
 12 – Electric vehicles; motorcycle kickstands; side cars; motorcycle handlebars; motorcycle engines; saddle covers for motorcycles; motorcycle wheels; motorcycles; vehicles for locomotion by land, air, water or rail; motor scooters.

(260) AM 2023 118095 A  
 (800) 1664964  
 (151) 2022 05 05  
 (891) 2022 05 05  
 (731) XINJIANG FENGHUASHENZHOU  
 AUTOPARTS CO., LTD  
 NO.227, JINSHAN ROAD, TOUTUNHE  
 DISTRICT, URUMQI, XINJIANG, China

(540)  

(591) Black, white

(531) 26.03.01; 26.03.05; 26.03.24; 26.04.04;  
 26.04.24; 27.05.08; 27.05.10; 27.05.21  
 (511)  
 12 – Clutches for land vehicles; driving motors for land vehicles; brake pads for automobiles; transmissions for land vehicles; shock absorbers for automobiles; automobile tires [tyres]; balance weights for vehicle wheels; cars.

(260) AM 2023 118096 A  
 (800) 1665016  
 (151) 2022 03 07  
 (891) 2022 03 07  
 (731) Weichai Power Co., Ltd.  
 197, Section A, Fushou East Street, High  
 Technology Industrial Development Zone,  
 Weifang City 261061, 261061 Shandong  
 Province, China

(540)  

(591) Black, white  
 (531) 28.03  
 (511)  
 7 – Engines, other than for land vehicles; motors, electric, other than for land vehicles; engine mounts, other than for land vehicles; pistons for automobile engines; gasoline engines, other than for land vehicles; generators of electricity; control mechanisms for machines, engines or motors; internal combustion engines, other than for land vehicles; diesel engines (except for land vehicles); gasoline engines (except for land vehicles).

12 – Trucks; automobiles; automobile engines; internal combustion engines for land vehicles; gasoline engines for land vehicles; diesel engines for land vehicles; diesel motors for land vehicles; hydrogen fueled cars; hybrid cars; electric cars.

(260) AM 2023 118097 A  
 (800) 1665050  
 (151) 2022 04 02  
 (891) 2022 04 02  
 (731) Limited Liability Company "Consortium-PIQ"  
 Oruzheyniy pereulok, d. 25, str. 1, pomesch.  
 I/etazh1/komnata21, RU-125047 Moscow,  
 Russian Federation

(540)  

(591) Black, white  
 (511)  
 5 – Pharmaceutical and veterinary preparations; sanitary preparations for medical purposes; dietetic food

and substances adapted for medical or veterinary use; food for babies; dietary supplements for human beings and animals; plasters; material for dental fillings and dental impressions; disinfectants; preparations for destroying vermin; fungicides, herbicides.

(260) AM 2023 118098 A  
 (800) 1665063  
 (151) 2022 02 24  
 (891) 2022 02 24  
 (731) "NAVOIYAZOT" aksiyadorlik jamiyati  
 Navoiy-5, 210105 Navoiy city, Uzbekistan  
 (540)



(591) White, light blue and dark blue  
 (531) 01.15.05; 19.11.11; 24.17.01; 26.01.03;  
 26.01.24; 26.11.02; 26.11.08; 26.11.12;  
 27.05.01; 27.05.11; 29.01.04

(526) AJ  
 (511)  
 1 – Chemicals for use in industry, science and photography, as well as in agriculture horticulture and forestry; unprocessed artificial resins, unprocessed plastics; fire extinguishing and fire prevention compositions; tempering and soldering preparations, substances for tanning animal skins and hides; adhesives for use in industry putties and other paste fillers; compost, manures, fertilizer; biological preparations for use in industry and science.

(260) AM 2023 118099 A  
 (800) 1665097  
 (151) 2021 12 16  
 (891) 2021 12 16  
 (731) Airbnb, Inc.  
 888 Brannan St., San Francisco CA 94103,  
 USA  
 (540)

## AIRCOVER

(591) Black, white  
 (511)  
 35 – Business services, namely, providing information to renters and property owners in relation to short-term rental properties and short-term stays; business services, namely, providing information about programs that provide compensation to renters and property owners who have incurred financial costs relating to renting residential or vacation property; business administration of a reimbursement program for providing a guarantee for the reimbursement of costs

incurred by property owners when renting their properties, in exchange for meeting program requirements.

36 – Providing information regarding available insurance products that cover property owners from financial losses connected to rental properties; providing information regarding travelers insurance; providing information regarding renters insurance; customer services, namely, responding to customers inquiries for others in the field of insurance; insurance information services; compiling and organizing data in the field of insurance for others.

(260) AM 2023 118110 A  
 (800) 1665372  
 (151) 2022 01 26  
 (891) 2022 01 26  
 (731) Huawei Technologies Co., Ltd.  
 Administration Building Huawei Technologies  
 Co., Ltd., Bantian, Longgang District, 518129  
 Shenzhen, China

## Petal Maps

(591) Black, white  
 (531) 27.05.01  
 (511)  
 9 – Couplers [data processing equipment]; computer software platforms, recorded or downloadable; computer software applications, downloadable; computer programs, downloadable; downloadable image files; electronic publications, downloadable; black boxes [data recorders]; interactive touch screen terminals; smartphone software applications, downloadable; security tokens [encryption devices]; computer peripheral devices; computer programs [downloadable software]; face recognition devices; Global Positioning System [GPS] apparatus; electronic navigational and positioning apparatus and instruments; navigation apparatus for vehicles [on-board computers]; satellite navigational apparatus; electronic navigational instruments; navigational instruments; electronic key fobs being remote control apparatus.

39 – Rental of navigational systems; gift wrapping; traffic information; navigation services; GPS navigation services; vehicle breakdown towing services; replenishment of vending machines; air transport; car sharing services; car rental; storage information; luggage storage; distribution of energy; flower delivery; courier services [messages or merchandise]; escorting of travellers; travel route planning; arranging of transportation for travel tours; providing driving directions for travel purposes; transport by pipeline; arranging of passenger transportation services for others via an online application.

42 – Scientific and technological research relating to patent mapping; quality control; vehicle roadworthi-

ness testing; electronic data storage; off-site data backup; conversion of data or documents from physical to electronic media; data conversion of computer programs and data [not physical conversion]; monitoring of computer systems by remote access; software as a service [SaaS]; platform as a service [PaaS]; cloud computing; providing search engines for the internet; providing user authentication services using biometric hardware and software technology for e-commerce transactions; providing user authentication services using single sign-on technology for online software applications; cartography services.

---

(260) AM 2023 118111 A

(800) 1665391

(151) 2022 03 16

(891) 2022 03 16

(731) Zim Integrated Shipping Services Ltd.  
9 Sakharov Andrei St., Haifa, Israel

(540)

## **THE Z FACTOR**

(591) Black, white

(511)

9 – Software for booking the transport or forwarding and shipping of end-to-end freight, by land by air and by sea; software for managing the transport or forwarding and shipping of end-to-end freight, by land by air and by sea; software for preparation of forms and online filing of freight transportation documents, shipping documents, government agency documents, customs clearances, customs bonds registrations, product classifications, cargo insurance, quality inspections and testing; software for tracking and tracing shipments and freight, managing shipments and freight, tracking, tracing, monitoring and controlling the cargo's environment; software for searching for supply chain transport and shipping data, creating and distributing reports related to supply chain and shipments, generating and providing quotes for freight transport and shipping, and for freight transport and shipment billing; software for managing supply chain logistics and reverse logistics, namely, the storage, transportation and delivery of freight for others; software for managing distribution of freight; software for managing logistics of transportation and shipping of freight; software for managing the leasing and rental of containers.

12 – Vehicles for travelling and transport on water; vessels; ships; apparatus for locomotion and transport on water; land vehicles; apparatus for locomotion and transport on land; transport containers for use in vehicles.

35 – Business management of freight logistics and freight transport logistics for others; business management services in the field of freight transportation relating to shipment processing, preparing freight and freight transport documents and invoices, preparing

shipping documents and invoices, tracking and tracing documents, packages and freight over computer networks, Intranets, and the Internet for business purposes; business administration services relating to electronic tracking and tracing of freight information to others; administrative processing of purchase orders; administrative services relating to customs clearance; regulatory submission management, namely, business administration assistance for others in preparing and filing documents related to customs and to cross-border transportation of freight, with governmental regulatory bodies.

39 – Transport, packaging, and storage of freight by land, sea and air; arranging transportation by land, sea and air; freight forwarding services by land, air and sea; freight transportation and freight transportation logistics services; consultation in the field of sea land and air freight transportation; freight loading and unloading services; warehousing and distribution services, namely, storage, distribution, pick-up, delivery and packing for shipment of documents, packages, goods, raw materials, and other freight for others; supply chain logistics and reverse logistics, namely, storage, transportation and delivery of documents, packages, goods, raw materials, and other freight for others; stevedoring; freight brokerage; rental and leasing of containers; arranging for pickup, delivery, storage and transportation of documents, packages, freight and parcels via ground, sea and air carriers.

42 – Software as a service (SAAS) featuring software for booking the transport or forwarding and shipping of end-to-end freight, by land by air and by sea; software as a service (SAAS) featuring software for managing the transport or forwarding and shipping of end-to-end freight, by land by air and by sea; software as a service (SAAS) featuring software for preparation of forms and online filing of freight transportation documents, shipping documents, government agency documents, customs clearances, customs bonds registrations, product classifications, cargo insurance, quality inspections and testing; software as a service (SAAS) featuring software for tracking and tracing shipments and freight, managing shipments and freight, tracking, tracing, monitoring and controlling the cargo's environment; software as a service (SAAS) featuring software for searching for supply chain transport and shipping data, creating and distributing reports related to supply chain and shipments, generating and providing quotes for freight transport and shipping, and for freight transport and shipment billing; software as a service (SAAS) featuring software for managing supply chain logistics and reverse logistics, namely, the storage, transportation and delivery of freight for others; software as a service (SAAS) featuring software for managing distribution of freight; software as a service (SAAS) featuring software for managing logistics of transportation and shipping of freight; software as a service (SAAS) featuring soft-



ware for managing the leasing and rental of containers.

(260) AM 2023 118112 A

(800) 1665500

(151) 2022 02 24

(891) 2022 02 24

(731) "NAVOIYAZOT" aksiyadorlik jamiyati  
Navoiy-5, Navoiy city 210105, Uzbekistan

(540)



(591) White, light blue and dark blue

(531) 01.15.05; 19.11.11; 26.01.03; 26.01.24;

26.11.01; 26.11.12; 27.05.01; 27.05.09;

27.05.10; 29.01.11

(526) NAVOIY, AZOT

(511)

1 – Chemicals for use in industry, science and photography, as well as in agriculture, horticulture and forestry; unprocessed artificial resins, unprocessed plastics; fire extinguishing and fire prevention compositions; tempering and soldering preparations; substances for tanning animal skins and hides; adhesives for use in industry; putties and other paste fillers; compost, manures, fertilizers biological preparations for use in industry and science.

(260) AM 2023 118113 A

(800) 1665599

(151) 2021 10 14

(891) 2021 10 14

(731) Carine Europe GmbH  
Ammannstraße 12, 86167 Augsburg, Germany

(540)



(591) Medium blue

(531) 24.13.01; 24.17.25; 26.13.25; 27.05.01;

27.05.09; 27.05.10; 29.01.12

(511)

5 – Disposable babies' diapers of paper and cellulose; bee pollen for nutraceutical use; disinfectants for medical apparatus and instruments; digestants; dermatological preparations; forestry (chemicals for -), [fungicides]; biological tissue cultures for veterinary purposes; nutritional supplements; antispasmodics; paper diapers; bark for nutraceutical purposes; eucalyptus for pharmaceutical purposes; amino acid preparations for pharmaceutical use; biological herbicides;

surgical implants grown from stem cells; nappies for babies and incontinents; diaper changing mats, disposable, for babies; chondroitin preparations; bactericides; anti-inflammatory ointments; antacid preparations; ground flaxseed fiber for use as a dietary supplement; sanitizing preparations for hospital use; medical preparations for slimming purposes; anti-oxidant supplements; dietetic sweeteners for medical purposes; drug delivery agents in the form of coatings for tablets that facilitate the delivery of pharmaceutical preparations; ethers for medical use; mugwort for medical purposes; fat emulsions for medical infusions; dietetic foods adapted for medical purposes; respiratory stimulants; disposable napkins for incontinents; albuminous preparations for medical purposes; curare; infant formula; haematogen; deodorising room sprays; ectoparasite repellents; biological tissue for implantation; antimicrobial face washes; gentian for pharmaceutical purposes; amino acid preparations for medical purposes; disposable training pants of cellulose for infants; deodorants for clothing; eye ointment for medical use; bismuth preparations for pharmaceutical purposes; barks for pharmaceutical purposes; detergents for medical purposes; deodorizing preparations for carpets; anticoagulants; dental resins; cannabis for medical purposes; sanitizers for household use; antiseptic sprays in aerosol form for use on the skin; bacteriological preparations for pharmaceutical use; chlorine detoxification agents for medical purposes; greases for veterinary purposes; general anaesthetics; antiseptic sprays in aerosol form for use on hard surfaces; babies' diapers; dietetic infusions for medical use; food for babies; greases for medical purposes; esters for pharmaceutical purposes; dietetic food preparations adapted for medical use; bacterial preparations for medical purposes; antibiotics for human use; antimuscarinic antispasmodics; deodorants for upholstery; antibacterial gels; biopharmaceuticals for the treatment of cancer; decoctions for pharmaceutical purposes; disinfectants; disposable liners for incontinence diapers; antibiotics for detoxification purposes; enzymes for veterinary purposes; antisera for diagnostic purposes; antiparasitic preparations from chemical sources; activated charcoal for medical use; antibacterial hand lotions; electrolyte solutions for medical use; pharmaceuticals and natural remedies; soil fumigating preparations; cotton for medical purposes; extracts of medicinal plants; biological fungicides; disinfecting handwash; dental wax; medicated preparations for treating halitosis; bacteria fighting cleanser; anaesthetic preparations for inhalation; babies' diaper-pants; fennel for medical purposes; diagnostic preparations and materials; biochemical preparations for veterinary use; aseptic cotton; food supplements; alkaloids used as analgesics; anti-allergy sprays; chemical preparations for medical purposes; algicides for agricultural use; first aid dressings; elixirs for relieving asthma; disposable training pants [diapers]; nasal decongestants; appetite stimulant preparations; medicated su-

plements for foodstuffs for animals; anti-inflammatories; moisturising creams [pharmaceutical]; bacterial preparations for medical and veterinary use; analgesic balm; drug delivery agents in the form of dissolvable films that facilitate the delivery of pharmaceutical preparations; antiseptic cleansers; emollients for medical purposes; acaricides for industrial purposes; anaesthetic preparation for injection; dental impression materials; emetics; surgical plasters; antibiotics for veterinary use; automobile deodorizers; alcohol swabs for medical purposes; antiemetics used for treating vomiting; ethanol for pharmaceutical purposes; anti-toxins; diagnostic preparations for medical or veterinary purposes; alloys of precious metals for dental purposes; unit dose capsules sold empty for pharmaceutical use; anti-microbial preparations; bark extract for nutraceutical use; agricultural biopesticides; feminine hygiene products; antimigraine drugs; dissolvable strips to stop bleeding from minor cuts and grazes; enzymes for medical purposes; dietetic preparations for children; multi-purpose medicated antibiotic creams; allergy relief medication; diagnostic testing materials for medical use; chemical preparations for testing blood for medical purposes; creams for dermatological use; diagnostic agents for pharmaceutical use; deodorants for textiles; electrolyte drinks for medical purposes; drug detoxifying agents; chemical preparations for sanitary purposes; pediculicidal shampoos; disposable nappies made of cellulose for incontinents; antiseptics; medicated creams for the care of the feet; chemical preparations for treating diseases affecting vine plants; chemical preparations for pharmaceutical purposes; pharmaceutical preparations for inducing erections; appetite suppressants for medical purposes; antifungal medication; dietetic substances for babies; blood plasma; biochemical preparations for medical use; bacteriological preparations for veterinary purposes; dietetic sugar for medical use; medicines for intestinal disorders; dental resin cements; greases for medical or veterinary purposes; deodorants for clothing and textiles; dextrans for pharmaceutical use; elixirs for relieving chills; antibacterial lathering cleanser; preparations for making medicated beverages; antiseptic ointments; anesthetics for surgical use; disposable swim diapers for children and infants; elixirs for psoriasis; epsom salts; bath preparations for medical purposes; fabric deodorizers; anti-cancer preparations of chemical origin; chemical reagents for medical or veterinary purposes; analeptic stimulants; domestic biopesticides; sanitizing wipes; bacterial poisons; enzyme preparations for medical purposes; balms for pharmaceutical purposes; parasiticides; antiseptic cotton; biological preparations for the treatment of cancer; dental anaesthetics; electrolyte replacement beverages for medical purposes; bark extract for pharmaceutical use; chemically treated papers for use in the detection of fecal occult blood; protein supplement shakes; anti-oxidant food supplements; antiseptic body care preparations; mixed biological prepa-

rations for medical purposes; disinfectants for chemical toilets; contraceptive preparations; chemical preparations for the diagnosis of diabetes; diabetic fruit juice beverages adapted for medical purposes; elixirs for eczema; forestry (chemicals for -), [parasiticide]; ammonia inhalants; antigens; biological indicators for monitoring sterilization processes for medical or veterinary purposes; deodorizers for garbage disposals; chemical preparations for use in DNA analysis [medical]; antibacterial handwashes; chemical conductors for electrocardiograph electrodes; biological tissue cultures for medical purposes; eye pads for medical use; disinfectants for veterinary use; disinfectant swabs; antidepressants; elixirs for calming the skin; chloroform; disinfectant dressings; arterial grafts; vermin destroying preparations; alcohol for topical use; antibiotic tablets; dental materials for stopping the teeth; medicines for adjusting the menstrual cycle; disposable pants of paper for holding a babies napkin in place; aluminium acetate for pharmaceutical purposes; anti-neoplastic preparations from hormones and antagonists; first-aid boxes, filled; bark powder for medical use; dental amalgams; anoretics; drug delivery agents in the form of edible wafers for wrapping powdered pharmaceuticals; estrogen preparations; antibacterial pharmaceuticals; chromatographic supports for medical use; enema preparations; chemical preparations for veterinary purposes; moisturising body lotion [pharmaceutical]; astringents for medical purposes; powder of cantharides; hydrated chloral for pharmaceutical purposes; cantharides extract for pharmaceutical use; anti-inflammatory sprays; diagnostic reagents for medical use; decongestants; disinfectants for medical use; purgatives; balms for medical purposes; diagnostic preparations for medical purposes; depuratives; dental restoration compounds; collyrium; eye bandages for medical use; disinfectants for dental apparatus and instruments; absorbent diapers of cellulose for pets; amino acids for medical or veterinary purposes; surgical bandages; solid oxygen for medical use; aloe vera gel for therapeutic purposes; quinquina for medical purposes; pharmaceuticals for the treatment of erectile dysfunction; algae removing preparations; chemical reagents for veterinary use; biological preparations for medical purposes; sugar for medical purposes; amino acids for veterinary purposes; adjuvants for medical purposes; cantharides preparations for medical use; elixirs [pharmaceutical preparations]; decoctions of medicinal herb; antacids; surgical glues; antimicrobial clay; fat emulsions for parenteral hyperalimentation; diabetic bread adapted for medical use; dietetic foods for use in clinical nutrition; antibiotics for use in dentistry; biological adjuvants for medical purposes; elastic bandages [dressings]; sanitary towels; solutions for disinfecting contact lenses; dietetic foods adapted for invalids; anti-diabetic preparations; arisaema roots for medical purpose; medicines for the treatment of gastrointestinal diseases; biocides; antibiotic creams; analeptics; dermatological pharmaceu-

tical products; antibiotics in the form of lotions; alginates for pharmaceutical purposes; topical antivirals; sheep dips; anti-neoplastic preparations of chemical origin; endogenous antigens; carpet deodorizers; medicinal alcohol; bark extract for medical use; condurango bark for medical purposes; dietetic substances adapted for medical use; diastase for medical purposes; appetite suppressant pills; antifungal creams for medical use; erythromycin preparations; chemical preparations for treating phylloxera; processed human donor skin for the replacement of soft tissue; chromatic alginate dental impression material; anti-oxidants comprising enzymes; biological implants; antiviral agents; anti-oxidants obtained from herbal sources; dementholized peppermint oil for medical purposes; dental cements; surgical implants grown from stem cells [living tissues]; herbal dietary supplements for persons special dietary requirements; eye compresses; eucalyptol for pharmaceutical purposes; antineoplastics; antibacterial acne preparations; antibiotic food supplements for animals; eye drops; dietetic confectionery adapted for medical purposes; blood tonics; appetite suppressants; dietary supplements and dietetic preparations; cachets for pharmaceutical purposes; biological reagents for veterinary use; antioxidants; anti-fungal dermatological preparations for use on the nails; anti-epileptic pharmaceutical preparations; anti-seizure drugs; algicides; anti-bacterial preparations; dietetic sugar substitutes for medical use; chemicals for pharmaceutical use; dietetic food adapted for veterinary use; aquatic herbicides; enzyme preparations for veterinary purposes; antibacterial soap; antiviral prodrugs; angostura bark for medical purposes; pharmaceutical preparations acting on the central nervous system; alloys of precious metals for dental use; acne creams [pharmaceutical preparations]; anaesthetics; medicines for alleviating constipation; miticides for agricultural use; androgen preparations; double sided adhesive tapes for medical use; drugs for medical purposes; antitoxic sera; anesthetics for non-surgical use; medicines for prevention against milk fever; disposable nappies made of paper for incontinents; antihistamines; dental mastics; all purpose deodorizing preparations for household, commercial or industrial use; antiseptic liquid bandages; dietetic preparations adapted for medical use; drug delivery agents that facilitate the delivery of pharmaceutical preparations; alkaline iodides for pharmaceutical purposes; medicines for dental purposes; analgesics for pharmaceutical use; mosquito repellent coils; diagnostic biomarker reagents for medical purposes; antibacterial facial cleanser; dietetic products for invalids; autoantigens; digitalin; alcohol-based antibacterial skin sanitizer gels; contact lens wetting solutions; acetaminophen [for relief of pain]; chemical pessaries; antibiotics for fish; sterilizing preparations; topical analgesics; medicated eye-washes; animal feed supplements; ovulation test kits; activated charcoal used as an antidote to poisons; feeding stimulants for animals; ferments for medical

or veterinary use; haemostatic pencils; urinary tract disinfectants; topical first aid gels; antiseptic washing preparations; medicated animal feed; tanning pills; insect repelling tags; swim diapers, disposable, for babies; bee pollen for use as a dietary food supplement; antimicrobials for dermatologic use; bread products for diabetics; aloe vera preparations for therapeutic purposes; exogenous antigens; alkaloids used as stimulants for medical purposes; anti-inflammatory gels; activated charcoal for adsorption of toxins for medical purposes; dietary and nutritional preparations; chemical test reagents [veterinary]; allergy medication; bath salts for medical purposes; shoe deodorizers; antibodies; leeches for medical purposes; anti-oxidants for medicinal use; anti-emetics obtained from chemical sources; antibacterial handwash; medical and surgical dressings; alkaloids for medical purposes; anti-oxidants derived from honey; candy, medicated; nappy liners of paper for incontinents; algacides [chemicals for swimming pool maintenance]; antibacterial clay preparations; first aid kits for domestic use; antimicrobial preparations for inhibiting microbiological decomposition; expectorants; medicines for veterinary purposes; biological reagents for medical use; forestry (chemicals for -), [insecticides]; coca alkaloid preparations for medical use; preparations for the diagnosis of ovulation; aldehydes for pharmaceutical purposes; colouring reagents for detecting dental plaque; disposable pants of cellulose for holding a babies' napkin in place; dill oil for medical purposes; antiarrhythmic agents; diagnostic substances for medical use; aspirin in tablet form; amino acids for medical purposes; dietetic substances adapted for veterinary use; anti-inflammatory preparations; cyclooxygenase inhibitors; bacteriological preparations for medical and veterinary use; antiparasitic preparations; forestry (chemicals for -), [herbicides]; breath-freshening chewing gum for medicinal purposes; chemical preparations for treating mildew; dental etching materials; dietetic foods adapted for infants; disposable diapers; sanitizing wash for fruit and vegetables; anti-cancer drugs; dietary supplement drink mixes; acetates for pharmaceutical purposes; chemical adjuvants for medical purposes; cantarides preparations for veterinary use; antibacterial sprays; cholesterol reducers; dental ceramics; antiseptics with therapeutic effect; bacterial preparations for veterinary purposes; chemical preparations for pesticidal purposes; chinoline for medical purposes; acaricides; analgesics for medical use; alginate tablets for pharmaceutical purposes; antibiotic handwash; diagnostic preparations for veterinary purposes; dental wax for the preparation of dental moulds; surgical implants comprised of living tissues; blood cleaners for detoxification purposes; disinfectants for swimming pools; bark extract for veterinary use; bandages for making casts; antibacterial wipes; lead water; aloe vera preparations for pharmaceutical purposes; analgesics; blood for medical purposes; blood components; aquatic algacide; therapeutic preparations for

the bath; sanitary wear; dental materials for duplicating models of teeth; slimming pills; eyepatches for medical purposes; antiseptic mouthwashes; sedatives; quinine for medical purposes; surgical dyes; aconitine; autonomic drugs for medical purposes; anti-diabetic pharmaceuticals; blood substitutes; absorbent articles for personal hygiene; bismuth subnitrate for pharmaceutical purposes; dietary fiber to aid digestion; dental materials for making models of teeth; anti-emetics used for treating nausea; medicines for human purposes; compresses; diabetic fruit nectars adapted for medical purposes; diuretic preparations; nappy liners of cellulose for incontinents; amino acid preparations for veterinary use; barium for X-ray use; car deodorants; disinfectants for hygiene purposes; triangular-shaped nappies of paper for babies; antiviral drugs for treating influenza; chemotherapeutics; dragées [medicines]; disposable liners of cellulose for napkins; donkey-hide gelatin (ejiao) for Chinese medicinal use; chemical preparations for the diagnosis of pregnancy; calcium channel blockers; bark powder for veterinary use; balsamic preparations for medical purposes; dietetic beverages for babies adapted for medical purposes; astringents [pharmaceutical]; elixirs for preventing throat infections; beta blockers; chemical contraceptives; deodorants for refrigerators; disinfectants for medical instruments; deodorizing preparations for household, commercial or industrial use; miticides for domestic use; antimicrobial mouthwashes; anti-inflammatory analgesic plasters; antiseptics with prophylactic effect; diagnostic chemical reagents for medical use; blood protein fractions; bandages for dressings; anhidrotics; antibiotic dermatological products; disinfectant soap; antiviral drugs for treating HIV; asthmatic tea; anticonvulsants; deodorants, other than for human beings or for animals; disinfectants and antiseptics; algicides for swimming pools; anti-adhesion gels for use with wound drainage devices; antibiotics; demineralised water for medical purposes; alginate solutions for pharmaceutical purposes; chloramphenicol preparations; anti-oxidants for dietary use; chemical reagents for medical use; anti-microbial handwash; embedding material for dental use; dental stone; chemical preparations for treating diseases affecting cereal plants; chemico-pharmaceutical preparations; dietary supplements for pets in the nature of a powdered drink mix; dietetic beverages adapted for medical purposes; breath refreshers for medical purposes; biotechnological preparations for medical use; deodorisers for litter trays; mixed antibiotic preparations; sal ammoniac lozenges; chemical preparations to treat wheat blight; antibiotic ointments; alkaloids used as antipyretics; washes (disinfectant -) [other than soap]; antitumor drugs; antiseptic preparations for wound care; elixirs for preventing chills; electrolytes for medical use; antibacterial substances for medical purposes; decongestant capsules; medicine; laxative suppositories; dietary fibre; alcohol for pharmaceutical purposes; lice treatment preparations [pediculicides];

diuretics for detoxification purposes; bromine for pharmaceutical purposes; anti-itch creams; biological preparations for veterinary purposes; bathroom deodorants; bacteriological preparations for medical purposes; dietary supplements for pets; eye lotions for medical use; alkaloids used for pharmaceutical purposes; dihydropyridine calcium channel blockers; chemical test reagents [medical]; nutritional supplements for fitness and endurance sports; ferments for pharmaceutical purposes; general anesthetics; diagnostic agents for medical use; disposable pads for incontinence; antihypertensives; disinfectants for contact lenses; medicinal creams for the protection of the skin; gauze for dressings; fly catching paper; antipyretic preparations; athletes' foot powders; fish meal for pharmaceutical purposes; marine antifoulants; fungicides for horticultural use; antipyretics; moist wipes impregnated with a pharmaceutical lotion; formic aldehyde for pharmaceutical purposes; febrifuges; fissure sealant for dental and dental technical purposes; liquid vitamin supplements; gauze; dietary pet supplements in the form of pet treats; fly glue; rubbing alcohol; frostbite salve for pharmaceutical purposes; fixing materials for dental purposes; fungicides for killing vermin; flea sprays; liquid antipruritic; calamine lotion; fissure sealants for dental use; athlete's foot lotions; powders for killing fleas; feed supplements for veterinary use; gases for medical purposes; gallic acid for pharmaceutical purposes; antipyretic analgesics; gases for dental use; liquid bandages for skin wounds; lining materials for dental purposes; antipyretic drugs with sedative effect; fungicides; foot care preparations for medical use; fungicides for medical use; nutraceuticals for use as a dietary supplement; gas mixtures for medical use; gases and gas mixtures for medical imaging use; fly destroying preparations; animal flea collars; fish oil for medical purposes; flea exterminating preparations; male fertility test kits; adhesive tapes for medical purposes; folic acid synthesis inhibitors; flea collars; liquid herbal supplements; chilblain preparations; fungicides for domestic use; athlete's foot preparations; fungicides for agricultural use; food supplements in liquid form; extracts of hops for pharmaceutical purposes; odour absorbing materials; pond herbicides; freeze-dried meat adapted for medical purposes; dried Chinese boxthorn fruits for Chinese medicinal use; shaped metals for dentistry; adhesives for dental and dentistry use; glucose for use as an additive to foods for medical purposes; witch hazel; powdered fruit-flavored dietary supplement drink mix; guaiacol for pharmaceutical purposes; herbicide for agricultural use; air deodoriser gel; preparations for destroying dry rot fungus; skin care preparations for medical use; sticking plasters for medical use; cardiotonics; charcoal for pharmaceutical purposes; remedies for foot perspiration; adhesive bandages; lubricants for surgical purposes; gurjun balsam for medical purposes; transdermal patches; gypsum for dental purposes; yeast extracts for medical,

veterinary or pharmaceutical purposes; herbicides; sexual stimulant gels; skin care creams for medical use; antivenom for the treatment of bites; antidotes; extracts of medicinal herbs; hormones for medical purposes; adhesive bandages for skin wounds; mixed hormone preparations; adhesives for dentures; cardiovascular drugs used in treating arrhythmias; glycerophosphates; homeopathic pharmaceuticals; glossy ganoderma for pharmaceutical purposes; homeopathic anti-inflammatory ointments; dietary supplements consisting primarily of calcium; yeast for medical, veterinary or pharmaceutical purposes; medicinal herbs in dried or preserved form; human vaccine preparations; gelatine for medical purposes; shaped napkins of paper for babies; yeast for pharmaceutical purposes; remedies for perspiration; hand-sanitizing preparations; glucose preparations for medical purposes; oxygen cylinders, filled, for medical purposes; royal jelly for pharmaceutical purposes; belts for sanitary napkins [towels]; topical gels for medical and therapeutic use; glycerine for medical purposes; bonding and primer materials for dental purposes; gamboge for medical purposes; cement for animal hooves; diuretic pharmaceutical preparations; skin grafts; preparations for use in vaginal lubrication; adhesives for dental use; gelatin capsules for pharmaceuticals; lubricant gels for personal use; silicone-based personal lubricants; poisons; homogenized food adapted for medical purposes; gels for dermatological use; hormone preparations for pharmaceutical use; vaginal lubricants; skin tonics [medicated]; yeast extracts for pharmaceutical purposes; medicinal drinks; odor neutralizing preparations for clothing and textiles; repellents for dogs; gum for medical purposes; adrenal hormone preparations; homeopathic supplements; filled syringes for medical purposes [containing pharmaceuticals]; hand creams for medical use; lubricants for medical use; antivenom for the treatment of stings; ginseng capsules for medical purposes; tissues for surgical use; human immune globulin; genetic identity tests comprised of reagents for medical purposes; human coagulation factors; freeze-dried food adapted for medical purposes; herbicides for domestic use; adhesive strips for dentures; throat lozenges; royal jelly for medical purposes; ointments for treating nappy rash; vascular grafts [living tissue]; water-based personal lubricants; adhesive plasters; dental amalgams of gold; beverages for infants; ginseng for medicinal use; shaped napkins of cellulose for babies; ibuprofen for use as an oral analgesic; haemoglobin; cough mixtures; dog lotions for veterinary purposes; anti-cough drops; cough tablets; hemostatics for medical purposes; haemostatic preparations; hydrocortisone; cough medicine; hydrastine; immunostimulants; vaccines against flu; pantyliners; dog washes [insecticides]; linctus; hemorrhoidal ointments; cough capsules; hydrastinine; immunoassay reagents for medical use; anti-hemorrhoidal suppositories; sanitary pants for pets; immunosuppressants for use following transplantation in

the case of graft rejection; soporifics; antitussives; vaccines; sanitary preparations for medical purposes; hydrocortisone creams; corn remedies; cough suppressants; hygienic preparations for veterinary use; corn pads; immunomodulators; vaccine adjuvants; immunotherapeutic agents for bacterial infections; sanitary preparations and articles; haemorrhoid preparations; vaccines for cattle; hygienic lubricants; contrast media for use in medical imaging; capsules for medicines; isopropyl alcohol for medical use; vaccines for horses; linseed meal for pharmaceutical purposes; cod-liver oil capsules; contrast media for in vivo imaging; adhesives for affixing prostheses; herbal mud packs for therapeutic use; implantable medicines; bone cement for medical purposes; camphor oil for medical purposes; synthetic resins for medical use; cardiovascular drugs used in angina pectoris; living cells for veterinary use; injectable dermal fillers; empty capsules for pharmaceuticals; personal sexual lubricants; iodine; cod liver oil; bone void fillers comprised of living tissues; combinations of calcium salts for pharmaceutical use; cooling sprays for medical purposes; isotopes for medical purposes; germicides; Irish moss for medical purposes; collagen for medical purposes; insecticidal veterinary washes; insecticides for agricultural use; caffeine preparations for medical use; gravel as a digestive aid for birds; coronary artery bypass grafts; bone fillers consisting of living materials; preparations for destroying insects; caffeine preparations for stimulative use; crystals for therapeutic purposes; hypolipidemic agents; insulin; laxatives for detoxification purposes; living cells for medical use; carbolineum [parasiticide]; herbal honey throat lozenges; body creams for pharmaceutical use; artificial sweeteners adapted for diabetics; camphor for medical purposes; cachets for medicinal purposes; herbal beverages for medicinal use; liquorice for pharmaceutical purposes; lime-based pharmaceutical preparations; impregnated medicated swabs; contrasting agents for diagnostic ultrasound imaging; poultices; adhesive films for medical use; vaccines against pneumococcal infections; herbal male enhancement capsules; implants comprising living tissue; foot rot vaccines; chewing gum for medical purposes; injectable pharmaceuticals for treatment of anaphylactic reactions; artificial tears; contrast media for use with medical ultrasound apparatus; insulin injectors sold filled with insulin; capsules made of dendrimer-based polymers, for pharmaceuticals; calcium tablets as a food supplement; laxatives; anti-insect spray; calomel [fungicide]; calcium supplements; ceramics for use in the reconstruction of dentures; diapers for incontinence; insect repellents for use on animals; synthetic resins for use in dentistry; lactose free infant's formula; pharmaceutical preparations containing caffeine; smoking herbs for medical purposes; potassium preparations for pharmaceutical purposes; linseed for pharmaceutical purposes; inhalant anesthetics; insecticides; tincture of iodine; corrosive agents for the surface treat-

ment of teeth; cardiovascular drugs used in myocardial infarction; cardiovascular drugs used in treating shocks; cultures for veterinary use; intravenous fluids used for rehydration, nutrition and the delivery of pharmaceutical preparations; coconut oil for medical purposes; cardiovascular agents for medical purposes; herbal medicine; collodion for pharmaceutical purposes; calcium chews for medical use; bone cements for surgical purposes; tapes for strapping [medical]; dental alloys; rubber for dental purposes; cardiovascular drugs used in treating congestive heart failure (CHF); lecithin for medical purposes; adhesive compositions for medical use; vaccines for human use; dental resin for temporary bridges, crowns and veneers; germicidal preparations [other than soap]; potassium salts for medical purposes; bone cement for surgical and orthopaedic purposes; stick liquorice for pharmaceutical purposes; insecticidal animal shampoos; iodides for pharmaceutical purposes; conductive lacquers for dental use; herbal compounds for medical use; implantable textile material to encourage the growth of tissue; jalap; cultures for medical use; herbal extracts for medical purposes; herbal extracts for medicinal purposes; herbal sore skin ointments for pets; ceramics for the construction of dentures; clinical medical reagents; in vitro diagnostic preparations for medical use; mosquito repellants for application to the skin; inhalants; cocaine; insect repellents for use on humans; injectable pharmaceuticals; herbal sprays for medical use; live organs and tissues for surgical purpose; capsules sold empty for pharmaceuticals; in vitro preparations for predicting ovulation for home use; herbal anti-itch ointments for pets; camphor tablets being insect repellents; medicinal herbs; nappy pants for incontinents; contact lens cleaning preparations; body gels for pharmaceutical use; dental ceramic material; cachou for pharmaceutical purposes; ceramic materials for dental use for fillings; mint-flavored chewing gum for medical use; herbal creams for medical use; insect repellents; cod-liver oil drops; herbal preparations for medical use; cat repellents; inhaled pharmaceutical preparations for the treatment of respiratory diseases and disorders; insect growth regulators; croton bark; anti-infective products for veterinary use; insect attractants; bone cements for orthopaedic purposes; tisanes [medicated beverages]; herbal teas for medicinal purposes; incontinence pads; colostrum supplements; larvae inhibiting preparations; implants for guided tissue regeneration; camphor wood blocks for repelling moths; iodine for pharmaceutical purposes; egg sanitizing preparations; adhesive dressings; incontinence garments; allergy capsules; liniments; topical anti-infective substances for the treatment of infections of the eye; cardiovascular drugs for use in treating hypertension; crystallized rock sugar for medical purposes; indicators for medical diagnosis; contrast media for use with X-ray equipment; compresses for use as dressings; creosote for pharmaceutical purposes; iodoform; cultures of microorga-

nisms for medical or veterinary use; jujube, medicated; insecticides for domestic use; ceramic alloys used in dental crowns; culture media for veterinary use; impregnated medicated wipes; contrast media for use with medical equipment; germicidal detergents; impregnated antiseptic wipes; larvae exterminating preparations; cold cream for medical use; larvicides; car air deodorants; topical analgesic creams; solutions for sterilising contact lenses; air deodorising and air purifying preparations; gastrointestinal preparations; lotions for pharmaceutical purposes; solutions for neutralizing contact lenses; anti-fly lotion; air deodorizing preparations comprised of activated charcoal; solutions for medical use in washing the nasal passages; solvents for removing adhesive plasters; local anaesthetics; magnesia for pharmaceutical purposes; attractants for pet animals; lotions for veterinary purposes; solutions for contact lenses; air deodorizing preparations; air deodorizer sprays; air purifying preparations; lupulin for pharmaceutical purposes; lysine preparations; medicated talcum powder; medicated lotions for the hands; medicated shampoos; medicated anti-cavity mouthwashes; skin treatment [medicated] for animals; medicated food supplements; medicated lip balm; anti-neoplastic preparations of microbial origin; material for dental prostheses; medicated nappy rash ointments; metal primers for dental purposes; medicated nasal spray preparations; dressings, medical; magnesium oxide for medical use; milk ferments for pharmaceutical purposes; milk sugar for medical purposes [lactose]; medicinal tea; material for repairing teeth; medical adhesives for binding internal tissue; microbicides; creams (medicated -) for application after exposure to the sun; swim diapers, reusable, for babies; materials for surgical casts; medicated toiletry preparations; material for dental bridges; medicated toothpaste; medical diagnostic test strips; powdered milk for babies; medicinal sprays; fodder additives for medical purposes; medicated lozenges; methylxanthines; acne medications; human plasma protein; milking grease; medicinal hair growth preparations; materials for tooth restoration; face cream (medicated -); materials for dressings; milk powders [foodstuff for babies]; medicated throat sprays; medicated shampoos for pets; medicated lotions; malt extracts for pharmaceutical use; medicated hand wash; medicated preparations for skin treatment; medicated ointments for treating dermatological conditions; microbicides for wastewater treatment; medicated foot powder; medicated skin creams; medicated mouth care preparations; mineral drinks (medicated -); medicinal ointments; magnesium salts for pharmaceutical use; medical dressings and medical plasters; implantable materials for use in guided tissue regeneration; face scrubs (medicated -); emmenagogues; medicated mouthwash; babies' creams [medicated]; meal replacement powders; medicated ointments for application to the skin; milk sugar; multi-purpose medicated analgesic balms; medical adhesives for binding wounds; medi-

cated mouth spray; medicated additives for animal foods; medicated after-shave lotions; menthol; malt albumin for pharmaceutical use; massage candles for therapeutic purposes; powdered milk foods for infants; medicated hair lotions; flour for pharmaceutical purposes; burn relief medication; magnesium hydroxide for medicinal use; anti-bacterial face washes (medicated -); preparations for use as additives to food for human consumption [medicated]; medicated mouth treatment preparations; medicated hair care preparations; medical foodstuff additives for veterinary use; menstruation bandages; metal alloys for dental restoration purposes; foot balms (medicated -); night creams [medicated]; creams (medicated -) for the lips; medicated skin lotions; methionine preparations; medicated body gels; medicated handwash; medicated wines; sea water for medicinal bathing; anti-cancer preparations of microbial origin; medicinal herb infusions; materials for oral prophylaxis; materials for dressing wounds; medicated dry shampoos; creams (medicated -) for the feet; medicated and sanitising soaps and detergents; skin care lotions [medicated]; medicated baby powders; medicated baby oils; cellular function activating agents for medical purposes; melissa water for pharmaceutical purposes; medicinal healthcare preparations; preparations for use in naturopathy; materials for artificial teeth; malted milk beverages for medical purposes; almond milk for pharmaceutical purposes; medical preparations; malt for pharmaceutical purposes; medicinal preparations for the treatment of infectious diseases; medicated muscle soaks; multi-purpose medicated mentholated salves; medical diagnostic reagents and assays for testing of body fluids; scalp treatments (medicated -); material for dental crowns; medicated compresses; medicated plasters; medicated dental rinses; medicated oral care gels; hypoglycemic drugs; body creams [medicated]; medicated soap; medicated brush-on oral care gels; medicinal preparations and substances; talcum powder (medicated -) for babies; medicated creams; almond oil for pharmaceutical purposes; metal alloys for dental use; magnesium sulphate for pharmaceutical use; mangrove bark for pharmaceutical purposes; medicated swabs; medicated body powder; protective creams (medicated -); milk sugar for pharmaceutical purposes; therapeutic creams [medical]; menthol vapor bath preparations for babies; massage gels for medical purposes; medicated lip care preparations; medicated nappy rash lotions; medicated dentifrices; human allograft tissue; mineral preparations for medical purposes; moss killers; mineral dietary supplements; vitamin fortified beverages for medical purposes; dietary supplements for animals; mineral dietary supplements for humans; cord blood for medical purposes; douching preparations for medical purposes; mineral preparations and substances for medical use; moleskin for medical purposes; powdered nutritional supplement drink mix; impregnated medicated pads; multi-vitamin preparations; aquatic weed

killers; mosquito killing preparations for application to mosquito nets; nutritional supplements made of starch adapted for medical use; bone growth media consisting of biological materials for medical purposes; gauze compresses; mouthwashes for medical purposes; lactagogues; nutritional supplements for livestock feed; medicinal mud; food supplements consisting of amino acids; folic acid dietary supplements; nutritional drink mix for use as a meal replacement; casein dietary supplements; mineral supplements for feeding livestock; food supplements for sportsmen; antiparkinson agents; moulding wax for dentists; mineral dietary supplements for animals; ganoderma lucidum spore powder dietary supplements; anti-malarials; preparations for destroying mice; bracelets impregnated with insect repellent; linseed oil dietary supplements; metabolic detoxifying agents; wrist bands sold pre-filled with insect repelling preparations; mildewcides; mothballs; enzyme dietary supplements; preparations for inhibiting sexual coupling; pine pollen dietary supplements; dietary supplements for controlling cholesterol; anti-nauseants; royal jelly dietary supplements; cold sore treatment preparations; bird repellants; sanitary panties; cleaning cloths impregnated with disinfectant for hygiene purposes; pollen dietary supplements; moth repellents; food for medically restricted diets; preparations for preventing nail biting; glucose dietary supplements; antiemetics for morning sickness; linseed dietary supplements; propolis dietary supplements; ergot for pharmaceutical purposes; mineral salts for medical purposes; heatstroke treating agents; dietary food supplements used for modified fasting; compounds for treating correlated pulmonary syndromes; preparations for preventing sucking of the fingers; preparations for ocular lubrication; diarrhea medication; dietary supplements for human beings and animals; preparations for controlling insects; activated charcoal dietary supplements; preparations to facilitate teething; moleskin for use as a medical bandage; wheat dietary supplements; yeast dietary supplements; dysmenorrhea treatment preparations; evening primrose oil for medical use; dietary supplemental drinks; antifatulants; radiation sickness treating agents; motion sickness treatment preparations; hypoglycemic agents; mineral nutritional supplements; nail care preparations for medical use; mud for baths; refills for air deodorizers; salts for mineral water baths; impregnated pads containing medicated preparations; mosquito-repellent patches for babies; preparations for destroying noxious animals; preparations for the treatment of burns; mouth sprays for medical use; mineral water salts; muscle relaxants; shark repellents; alginate dietary supplements; mouthwashes [gargles] for medical purposes; alcohol detoxifying agents; substitutes for mother's milk; mosquito repellents; wheat germ dietary supplements; moist paper hand towels impregnated with a pharmaceutical lotion; zinc dietary supplements; anticatarrhals for detoxification purposes; dietary supplements with a cos-

metic effect; preparations for reducing sexual activity; mineral waters for medical purposes; chlorella dietary supplements; mothproofing preparations; acai powder dietary supplements; protein dietary supplements; anti-dermo-infectives; cord blood; myrobalan bark for pharmaceutical purposes; mothproofing paper; preparations for callouses; compounds for sanitising eggs; calcium fortified candy; dietary supplements consisting of vitamins; tooth prophylactics; nutritional supplements for veterinary use; protein powder dietary supplements; health food supplements for persons with special dietary requirements; albumin dietary supplements; food for diabetics; dietary supplements for humans; mycolic acid synthesis inhibitors; dietary supplements for humans not for medical purposes; lecithin dietary supplements; glue coated strips for use against vermin; tissues impregnated with pharmaceutical lotions; anti-uric preparations; food supplements consisting of trace elements; dietary supplements for infants; acne treatment preparations; soil-sterilizing preparations; gastrointestinal cleaning agents; nucleic acid sequences for medical and veterinary purposes; nematocides; naturally derived antimicrobials for dermatological use; natural clay for therapeutic purposes; bone void fillers consisting of natural materials; kretek (clove) cigarettes for medical use; nicotine gum for use as an aid to stop smoking; nervines; nose drops; sodium salts for medical purposes; niacinamide preparations for the treatment of acne; narcotics; nose drops for medical purposes; bicarbonate of soda for pharmaceutical purposes; food supplements for non-medical purposes; nutraceuticals for therapeutic purposes; nasal cleaning preparations for medical purposes; non-steroidal anti-inflammatory drugs; nasal spray for the treatment of allergies; nutraceutical preparations for humans; nasal rinse; by-products of the processing of cereals for medical purposes; nasal drops for the treatment of allergies; non-dihydropyridine calcium channel blockers; natural biocides; food esters for pharmaceutical purposes; by-products of the processing of cereals for dietetic or medical purposes; nicotine patches for use as aids to stop smoking; nutraceutical preparations for animals; pet odor neutralizer; nasal sprays for medical purposes; mineral food preparations for medical purposes; natural dietary supplements for treating claustrophobia; neo-antigens; nutraceutical preparations for therapeutic or medical purposes; culture media for medical use; protein supplements for animals; reactants for veterinary diagnosis; pharmaceutical preparations for the treatment of epilepsy; pharmaceutical preparations for regulating the immune system; air deodoriser sprays; plasters, materials for dressings; reagents and media for medical and veterinary diagnostic purposes; oral anti-epileptic pharmaceutical preparations; pharmaceutical preparations for animals; antiparasitic preparations for pets; paracetamol modified release preparations; pharmaceutical preparations for the treatment of inflammatory diseases; clinical diagnostic reagents;

reagents for use with analyzers [for veterinary purposes]; tonics for medical use; bandages for the oral cavity; strychnine poison; vasopressors; streptomycin preparations; vitamin supplement patches; anti-neoplastic preparations of plant origin; pharmaceutical cold preparations; phytotherapy preparations for medical purposes; pharmaceutical preparations and substances with anti-inflammatory properties; pain relief preparations; pyrethrum powder; peptones for pharmaceutical purposes; pharmaceutical preparations for treating sunburn; paper liners for diapers; pharmaceutical preparations for the prevention of diabetes; petroleum jelly for medical purposes; test strips for measuring blood glucose levels; pseudo-ginseng powder for medical purposes; sterile plastic films for use as bandaging; pharmaceutical preparations for preventing skin blemishes during pregnancy; stem cells; plant and herb extracts for medicinal use; dermatological pharmaceutical substances; cloth diapers; stool softeners; animal washes [insecticides]; oral contraceptives; urease for medical purposes; pharmacological preparations for skin care; pharmaceutical preparations for hair care; decongestant nasal sprays; digestives for pharmaceutical purposes; mouth cavity cleansers; pharmaceutical preparations for the treatment of Parkinson's disease; preparations for the treatment of asthma; pharmaceutical preparations for skin wounds; pharmaceutical preparations for the treatment of kidney disorders; regulatory proteins for medical use; bunion pads; pharmaceutical preparations for the treatment of gout; pharmaceutical preparations for human use; oral rehydration salts; tobacco-free cigarettes for medical purposes; tumor suppressing agents; vaginal moisturizers; pastilles for pharmaceutical purposes; ophthalmic muscle relaxants; pharmaceutical preparations for the treatment of central nervous system [CNS] diseases; reconstituted cells for clinical treatments for skin care; compounds for treating cancer; dental blanks; pheromones for medical use; tonics [medicines]; planaria destroying preparations; pharmaceutical preparations for the treatment of digestive diseases; stem cells for medical purposes; topical ophthalmic anti-infective substances for the treatment of infections; spermicides; quassia for medical purposes; preparations of trace elements for human and animal use; pharmaceutical products for treating respiratory diseases; pharmaceutical preparations for treating allergic rhinitis; pharmaceutical preparations for the treatment of diseases of the genitourinary system; preparations for cleansing the skin for medical use; vesicants; reagents for in-vitro laboratory use [for medical purposes]; probiotic preparations for medical use to help maintain a natural balance of flora in the digestive system; ovicides; pharmaceutical preparations for the treatment of bone fractures; mustard for pharmaceutical purposes; pharmaceutical drugs; pharmaceutical preparations for the prevention of ocular disorders; pharmaceutical preparations and substances for the prevention of cancer; phar-



maceutical products for the treatment of infectious diseases; preparations for the neutralising of odours; siccatives [drying agents] for medical purposes; glucose for medical purposes; pharmaceutical preparations for the treatment of eye diseases and conditions; salts for medical purposes; powders for killing fleas on animals; lint for medical purposes; nutritional supplements, namely energy bars used as nutritional supplements; pharmaceutical preparations for treating arthritis; pharmaceutical preparations for treating sports injuries; sarsaparilla for medical purposes; dental composite materials; pharmaceutical preparations and substances with analgesic properties; ointments for pharmaceutical purposes; oral vaccine preparations; sarkomycin preparations; animal semen for artificial insemination; semen for artificial insemination; oral analgesics; stem cells for veterinary purposes; clay for treating skin conditions; chemical contraceptive sponges; pharmaceutical preparations for the treatment of hormonal disorders; tobacco substitutes for medical purposes; sealed radioactive substances for medical use; vaginal washes for medical purposes; pharmaceutical preparations for the treatment of diseases of the endocrine system; pharmaceutical preparations for treating chloasma; epidermal growth factor preparations for the treatment of burns; herbal supplements; animal dips [preparations]; preparations for treating colds; starch for dietetic or pharmaceutical purposes; portable first-aid kits; pharmaceutical sweets; pharmaceutical products and preparations for hydrating the skin during pregnancy; weedicides; lacteal flour for babies; pharmaceutical preparations for the prevention of diseases of the immune system; spermicidal gels; Chinese traditional medicinal herbs; panthenol preparations for medical use; pharmaceutical preparations for treating epidermal problems; pharmaceutical preparations for hydrating the skin during pregnancy; anti-cancer preparations from hormones and antagonists; pearl powder for medical purposes; pharmaceutical preparations for the prevention of diseases of the endocrine system; pancreas hormone preparations; caustic pencils; ear drops; sandalwood for use as an insect repellent; pharmaceutical products for the treatment of bone diseases; radiopharmaceutical products; udder creams for agricultural use; orgasm creams; paracetamol; pharmaceutical preparations for the treatment of autoimmune diseases; thyroid and para-thyroid hormone preparations; contraceptive foams; oil of turpentine for pharmaceutical purposes; mercurial ointments; fungicidal fungal agents; surgical dressings; burn dressings; antiparasitic preparations from plant sources; hypnotic sedatives; flowers of sulfur for pharmaceutical purposes; pharmaceutical preparations for treating the symptoms of radiation sickness; quebracho for medical purposes; pain relieving creams; pharmaceutical agents for epidermis; veterinary preparations; pharmaceutical agents for treating physically caused lesions; pharmaceutical preparations and substances for use in oncology; saline solution for si-

nus and nasal irrigation; synthetic materials for dental use for fillings; trace element preparations for use by animals; solutions for rinsing contact lenses; parasympathomimetic agents; swabs for medical use; jellyfish repellent sunscreens; spermicidal creams; animal repellent formulations; probiotic bacterial formulations for veterinary use; anti-tussive expectorants; albuminous foodstuffs for medical purposes; opioid analgesics; anti-sarcoma preparations; diagnostic radiopharmaceutical preparations; reagent paper for veterinary purposes; pharmaceutical compositions; probiotic supplements; fertility enhancement preparations; pants, absorbent, for incontinence; hair growth stimulants; castor oil as a coating for pharmaceuticals; ophthalmology preparations; psychotropics; thiomersal; serums; pharmaceutical preparations for treating hypoglycemia; pharmaceutical preparations for use in oncology; barrier lotions for protection from toxic oils of poisonous plants; vasoconstrictors; steroids; absorbent cotton; pharmaceutical preparations for the treatment of worms in pets; reagents for use in medical genetic testing; pharmaceutical products for the treatment of depression; pharmaceutical preparations and substances; sunburn ointments; anti-syphilitics; antiparasitic collars for animals; babies' swim diapers; mustard oil for medical purposes; behaviour modifying chemicals for controlling pests; pharmaceutical preparations for treating diabetes; reagents for use with analyzers [for medical purposes]; turpentine for pharmaceutical purposes; pharmaceutical preparations and substances for use in the field of anesthesia; mustard powder for medical purposes; ophthalmologic preparations; bandages for skin wounds; absorbent diapers of paper for pets; sulfonamide preparations; cell growth media for growing cells for medical use; cleaning solvents for removing adhesive plasters; agricultural pesticides; reagents for use in diagnostic tests [for medical purposes]; pharmaceutical preparations for wounds; cleansing solutions for medical use; oxygen baths; wipes for medical use; sterilising substances; polygonatum sibiricum for pharmaceutical purposes; anti-infectives; pharmaceutical preparations and substances for the treatment of gastro-intestinal diseases; synthetic material for use in setting bones; diaphoretics; pills for tinnitus treatment; pharmaceutical preparations for treating gastrointestinal disorders; urinary tract preparations; pharmaceutical preparations in strip form; reagents for use in veterinary genetic testing; pharmaceutical preparations for the prevention of diseases of the metabolic system; penicillin preparations; pharmaceutical preparations for the treatment of kidney diseases; pesticides for horticultural use; tinctures for medical purposes; rat poison; pharmaceutical preparations for the treatment of autoimmune disorders; corn plasters; tryptophane preparations; dressing retention materials; transdermal patches for medical treatment; soy isoflavone dietary supplements; pharmaceutical preparations for the treatment of disorders caused by bacteria; pharmaceutical preparations for treating as-

thma; sealing agents for dental purposes; pharmaceutical preparations; clay for use in mud baths [health spas]; pharmaceutical products and preparations for preventing skin blemishes during pregnancy; pharmaceutical preparations for dental use; pregnancy testing preparations for home use; pharmaceutical preparations for treating dandruff; synthetic peptides for pharmaceutical purposes; aspirin; pharmaceutical preparations for the treatment of immune system related diseases and disorders; radiotherapeutic hormones; sanitary tampons; parasiticides for medical use; tissue-regenerative pharmaceutical preparations; pharmaceutical preparations for use in discouraging the smoking habit; preparations to prevent chewing or biting by animals; reconstituted cells for medical treatments for skin care; headache relief sticks; nail fungus treatment preparations; disinfectants impregnated into tissues; cotton wool for medical use; tumour antigens; pharmaceutical preparations for use in dermatology; abrasive fluids for dental use; veterinary diagnostic reagents; salivary gland hormone preparations; testosterone preparations; reagents for microbiological analysis [for medical purposes]; sponge material for healing wounds; thermal water; absorbent sanitary articles; reagent paper for medical purposes; tobacco extracts [insecticides]; ocular pharmaceuticals; organotherapeutics; vulnery sponges; probiotic bacterial formulations for medical use; barrier lotions for protection against poisonous plants; sandalwood oil for medical, pharmaceutical and veterinary purposes; radiological contrast substances for medical purposes; starch for pharmaceutical purposes; pharmaceutical products and preparations for pregnancy blemishes; pomades for medical purposes; pharmaceutical preparations and substances for use in gynecology; pharmaceutical preparations for the treatment of cardiovascular disease; opodeldoc; pharmaceutical preparations for the treatment of disorders of the genitourinary system; thymol for pharmaceutical purposes; ozone for medical use; pharmaceutical preparations for the treatment of diseases caused by bacteria; pharmaceutical preparations for the treatment of inflammatory disorders; preparations for detecting mutation in prion genes for medical purposes; protein synthesis inhibitors; pheromones; pharmaceutical preparations for treating digestive system disorders; nutritive substances for microorganisms; pharmaceutical preparations for the treatment of disorders of the endocrine system; sporicides; petroleum jelly for veterinary use; pharmaceutical preparations for treating hypertension; pregnancy testing preparations; thiolutin preparations; pharmaceutical preparations for animal skincare; sterilized dressing; fumigating sticks as disinfectants; sanitary sterilising preparations; pharmaceutical preparations for the prevention of osteoporosis; tampons for medical purposes; pectin for pharmaceutical purposes; pharmaceutical preparations for the prevention of disorders of the genitourinary system; bronchodilating preparations; nail sanitizing preparations; phar-

maceutical products and preparations for chloasma; pharmaceutical preparations for the treatment of bone diseases; pharmaceutical preparations for the prevention of stretch marks; mustard preparations for medical purposes; pesticides; substances in tablet form for use in the sterilisation of water; plant extracts for pharmaceutical purposes; ear candles; pharmaceutical preparations for the treatment of heart rhythm disorders; progesterone preparations; arachnicides; anti-cancer preparations; dental porcelain materials; pharmaceutical preparations for use in organ transplantation; propolis for pharmaceutical purposes; pain relief medication for veterinary purposes; panty liners [sanitary]; strychnine; radioactive substances for medical purposes; cleaners [preparations] for sterilising surgical instruments; pharmaceutical preparations for the treatment of viral diseases; food supplements for veterinary use; parenteral anti-epileptic pharmaceutical preparations; trypsin for medical purposes; opiates; phenol for pharmaceutical purposes; cough pastilles for medical use; anticryptogamic preparations; wound dressings; slimming tea for medical purposes; fumigants; domestic pesticides; spermicides for application to condoms; pharmaceutical preparations for the treatment of esophagitis; tissues impregnated with insect repellants; solidified gases for medical purposes; pharmaceutical preparations for the prevention of ocular diseases; reagent paper for medical or veterinary purposes; pharmaceutical preparations for treating dry skin caused by pregnancy; pharmaceutical preparations for the treatment of multiple sclerosis; pharmaceutical preparations for immunity adjustment; pant liners for incontinents; castor beans for pharmaceutical purposes; reagents for microbiological analysis [for veterinary purposes]; acne cleansers [pharmaceutical preparations]; fumigation preparations for medical purposes; sympathomimetic agents; anti-cancer preparations of plant origin; adhesive skin patches for medical use; RNA synthesis inhibitors; castor oil for medical purposes; preparations for supplementing the body with essential vitamins and microelements; soy protein dietary supplements; pharmaceutical preparations for the prevention of disorders of the metabolic system; vaginal antifungals; threonine preparations; mustard plasters; pharmaceutical preparations for the prevention of inflammatory disorders; migraine treatment preparations; pharmaceutical preparations and substances for the treatment of cancer; transplants [living tissues]; pharmaceutical preparations for use in chemotherapy; perilla for pharmaceutical purposes; pharmaceutical implants; pharmaceutical preparations for the prevention of diseases caused by bacteria; antiemetics obtained from plant sources; prebiotic supplements; animal sperm; pharmaceutical preparations for the treatment of hypercholesteremia; oxygen for medical purposes; reagents for use in diagnostic tests [for veterinary purposes]; reagents for in-vitro laboratory use [for veterinary purposes]; reagents for use in analysis [for medical purposes]; effervescent anal-

gesic pharmaceutical preparations; X-ray contrast media for medical use; veterinary vaccines; trace element preparations for human use; washes (sterilizing -); low-salt bread adapted for medical use; pharmaceutical preparations for treating skeletal diseases; synthetic material for use in producing casts; bandages for the prevention of blisters; pharmaceutical preparations for treating rheumatological diseases; reagents for use in diagnostic pregnancy tests; anti-tuberculous preparations; reagents for medical use; medicine cases, portable, filled; pharmaceutical preparations for the treatment of disorders of the metabolic system; pharmaceutical preparations for inhalation for the treatment of pulmonary hypertension; sulfonamides [medicines]; petroleum jelly for medical or veterinary purposes; pharmaceutical preparations for use in hematology; syrups for pharmaceutical purposes; pharmaceutical preparations for the prevention of diseases of the respiratory system; air sanitizing preparations; pharmaceutical agents affecting digestive organs; pharmaceutical preparations for the prevention of diseases of the musculo-skeletal system; sterilising solutions; pepsins for pharmaceutical purposes; pharmaceutical preparations for the prevention of diseases of the genitourinary system; scapulars for surgical purposes; paracetamol preparations for oral administration; anti-itch ointments; tissues impregnated with antibacterial preparations; pharmaceutical preparations for treating chemical imbalances; pharmaceutical agents affecting metabolism; pharmaceutical products for ophthalmological use; opium; mint for pharmaceutical purposes; hormone suppressing preparations; acids for pharmaceutical purposes; pharmaceutical preparations for the prevention of disorders caused by bacteria; pharmaceutical preparations for the prevention of disorders of the nervous system; pharmaceutical preparations for the treatment of cancer; pharmaceutical preparations for the treatment of osteoporosis; bouillons for bacteriological cultures; pharmaceutical products and preparations against dry skin caused by pregnancy; quebracho bark for medical use; pharmaceutical preparations for ear-related diseases; vermin repelling preparations; pharmaceutical products and preparations to prevent swelling in the legs; pharmaceutical preparations for the prevention of disorders of the respiratory system; cleaners [preparations] for sterilising dental instruments; trichomycin preparations; pharmaceutical preparations for veterinary use; styptic preparations; synthetic biocides; diluents for medical use; pharmaceutical preparations and substances with antipyretic properties; pharmaceutical preparations for the treatment of diseases of the metabolic system; intravenous fluids used for rehydration; sterile solutions for medical purposes; orthodontic alginate for dental impressions; pharmaceutical lipsalves; pituitary hormone preparations; suppositories; pharmaceutical preparations for the prevention of inflammatory diseases; plasters incorporating a magnet; pharmaceutical preparations for treating halitosis; pharmaceutical prepa-

rations for activating cellular function; medicinal clay preparations; clay for pharmaceutical use; herbal detoxification agents; medicinal radix glycyrrhizae; preparations for detecting genetic predispositions for medical purposes; compounds for treating respiratory diseases; pharmaceutical preparations for treating skin disorders; paracetamol preparations for intravenous administration; pharmaceutical preparations for inhalers; radium for medical purposes; pharmaceutical preparations for the treatment of musculo-skeletal disorders; dental abrasives; breast-nursing pads; veterinary preparations for treatment of intestinal bacteria; pharmaceutical creams; pharmaceutical anti-allergic preparations and substances; preparations for preventing the formation of algae in water; tetracycline preparations; pharmaceutical preparations and substances for use in urology; sulfur sticks [disinfectants]; scrubs [preparations] for medical use; serotherapeutic medicines; porcelain for dental prostheses; lipotropic factor preparations; rhubarb roots for pharmaceutical purposes; allergy tablets; reactants for medical diagnosis; pharmaceutical solutions used in dialysis; pharmaceutical preparations for use in urology; pharmaceutical cough preparations; ear bandages; synthetic narcotics; preparations for facilitating sexual coupling; reagents for analytical purposes [for veterinary purposes]; pharmaceutical preparations for the prevention of disorders of the immune system; pharmaceutical preparations for treating malignant tumors; rodenticides; pharmaceutical preparations for the prevention of autoimmune diseases; liquid bandage sprays; pharmaceutical preparations for the prevention of disorders of the endocrine system; artificial tea [for medicinal use]; radioactive elements for medical use; reagents for analytical purposes [for medical purposes]; abrasive pads for dental purposes; pharmaceutical preparations for skin care; pharmaceutical preparations for the prevention of diseases of the nervous system; mosquito-repellent incenses; psychomotor stimulants; pest control preparations and articles; paper for mustard plasters; preparations of microorganisms for medical or veterinary use; digestive enzymes; pharmaceutical preparations for the prevention of autoimmune disorders; contraceptive sponges; smelling salts; cardiovascular pharmaceuticals; therapeutic medicated bath preparations; pharmaceutical preparations for treating allergies; strengthening supplements containing par-pharmaceutical preparations for prophylactic purposes and for convalescents; crude drugs; pharmaceutical preparations for the treatment of hyperlipidemia; opium alkaloid preparations; starch for dietetic use; reagents for use in analysis [for veterinary purposes]; ear candles for therapeutic purposes; sanitary preparations for veterinary use; pharmaceutical products and preparations to prevent stretch marks; pharmaceutical preparations for the relief of insect bites; pharmaceutical agents affecting peripheral nervous system; reagents for blood grouping [for medical purposes]; molluscicides; pharmaceutical preparations for

treating sensory organ disorders; pharmaceutical preparations for the prevention of disorders of the musculo-skeletal system; pharmaceutical preparations for ocular or intraocular surgery; pharmaceutical agents affecting sensory organs; radio-isotope markers for therapeutic or diagnostic use; phosphates for pharmaceutical purposes; central nervous system stimulants; antioxidant pills; pharmaceutical preparations for use in tissue transplantation; nutritional additives to food-stuffs for animals, for medical purposes; pharmaceutical preparations for the prevention of allergies; pharmaceutical preparations for use in ophthalmology; radioactive preparations veterinary diagnosis; fumigating sticks; porcelain materials for use in dentistry; pharmaceutical preparations for peripheral nervous system; pharmaceuticals; slug exterminating preparations; diet capsules; caustics for pharmaceutical purposes; delivery agents in the form of dissolvable films that facilitate the delivery of nutritional supplements; insect repellent incense; cytostatic drugs for medical purposes; adult diapers; benzol detoxification agents for medical purposes; cotton wool for surgical use; cellulose wool for medical use; vitamin supplements for use in renal dialysis; dental varnishes for sealing teeth; cattle washes [insecticides]; nappies of paper for incontinents; dietary supplements consisting primarily of iron; viral antigens; dental lacquer; medicinal oils; hydrogen peroxide for medical purposes; disposable pet diapers; anti-horse-fly oils; cytostatics for medical purposes; disposable training pants of paper or cellulose; delivery agents in the form of coatings for tablets that facilitate the delivery of nutritional supplements; anti-leprotic agents; veterinary preparations and substances; wadding for medical purposes; vitamins and vitamin preparations; sugar substitutes for diabetics; vitamin and mineral supplements for pets; disposable liners for babies' diapers; cream of tartar for pharmaceutical purposes; diapers made of cellulose; cellulose esters for pharmaceutical purposes; teeth filling material; orthodontic alginate impression materials; cotton wool in the form of sticks for medical use; cellulose wadding for medical purposes; vitamin b preparations; oiled paper for medical purposes; nappy cream [medicated]; health food supplements made principally of vitamins; vitamins for animals; cellwall synthesis inhibitors; cotton wool for pharmaceutical purposes; babies' disposable diaper pants of cellulose; cellulose ethers for pharmaceutical purposes; drug delivery agents; cells for medical use; surgical cements; viscoelastic agents for eye use; dental rinse; vitamin drops; vitamin and mineral supplements; vitamins for pets; prenatal vitamins; babies' disposable diaper pants of paper; capillary stabilizing agents for medical purposes; nutritional supplements consisting of fungal extracts; disposable nappy liners; nutritional supplements consisting primarily of magnesium; vitamin drinks; disposable training pants; wart pencils; cotton swabs for medical purposes; disposable training pants of paper for infants; dental

bonding material; nappy covers; disposable babies' diaper-pants; dental preparations and articles; nutritional supplements consisting primarily of iron; virucides; dietary supplements consisting primarily of magnesium; vitamin tablets; disposable adult diapers; cytostatics for pharmaceutical purposes; viral vaccines; arsenic detoxification agents for medical purposes; vitamin supplements for animals; tartar for pharmaceutical purposes; worm repellents for use on turf or grass; cements for dental prostheses; ethers for pharmaceutical purposes; vitamin c preparations; mixed vitamin preparations; wart removing preparations; denture base materials; oxytocics; vitamin supplements; nutritional supplements consisting primarily of zinc; vitamin enriched bread for therapeutic purposes; health food supplements made principally of minerals; vermicides; dental cement for fillings; vitamin preparations in the nature of food supplements; gummy vitamins; cerebral hemorrhage prophylactic agents; pre-filled syringes for medical purposes; babies' diapers of cellulose or paper; vitamin d preparations; toilet deodorants; human growth hormone; teat dips for dairy cows; dental preparations and articles, and medicated dentifrices; cellulose for pharmaceutical purposes; vitamin preparations; vitamin preparations; diapers for pets; effervescent vitamin tablets; vitamin a preparations; zinc supplement lozenges; cedar wood for use as an insect repellent; medicinal roots; dental veneers for use in dental restoration; dental preparations for disclosing plaque; vitamin and mineral preparations; nutritional supplements consisting primarily of calcium; eye pads for surgical use.

10 – Apparatus for monitoring vital signs; boxes adapted for medical waste products; incentive spirometers for medical use; apparatus for use in the fitting of dental prostheses; acupuncture instruments; apparatus, devices and articles for nursing infants; exposed X-ray films for medical use; dental apparatus and instruments; anaesthesia respiration apparatus; containers especially made for medical waste; neonatal pacifiers; triangular bandages [supportive]; angioplasty balloon catheters; pelvic clamps; leg traction units for medical use; cardiac fulguration apparatus; automated blood collection instruments; materials for bandaging [suspensory]; apparatus and installations for the production of X-rays, for medical purposes; respiratory monitors [medical]; teething rings incorporating baby rattles; basins for medical purposes; haemostats; lithotomy leg holders; aerosol dispensers for medical purposes; balloon angioplasty inflation instruments; apparatus for the application of laser radiation for surgical purposes; endoscopic apparatus; bracelets for medical purposes; instruments for use in the fitting of artificial teeth; surgical amputaters; baths (hoists for assisting invalids out of -); battery-powered artificial larynxes; apparatus for the therapeutic toning of the muscles; body rehabilitation apparatus for medical purposes; apparatus for acne treatment; apparatus for the alleviation of breathing difficulties; constriction rings for

use in maintaining penile rigidity in men with erectile dysfunction; apparatus for the treatment of deafness; eye shields for medical use; apparatus for electrical muscle stimulation; cushioning devices for medical use; drape sheets of absorbent cellulose wadding for use during surgery; physical exercise apparatus for medical purposes; supportive anatomical bandages; apparatus for analysing bacteria in biological samples [for medical use]; automated blood separation instruments; apparatus for carrying-out diagnostic tests for medical purposes; bone setting apparatus; apparatus for the diagnosis of neurological diseases; respirators for artificial respiration; automated analyzers for foreign matter contained in body fluids [for medical use]; autotransfusion devices; graduated compression hosiery; apparatus for producing ultrasonic waves for medical application; apparatus for administering intravenous solutions; apparatus for use in alleviating hearing disorders; apparatus for the diagnosis of cerebrovascular diseases; apparatus for determining blood flow; humidifiers for use with respiratory therapy apparatus; dummies for babies; apparatus for the treatment of cellulite; bandage applicators; apparatus used in implementing diagnosis tests designed to detect the abnormal prion protein; bed pans; respiration monitors for medical use; apparatus for the diagnosis of inflammatory diseases; sexual activity apparatus; apparatus for analysing images [for medical use]; lavage apparatus for therapeutic purposes; curing lamps for medical purposes; teething chains for relieving teething pain; apparatus for use in treating hearing disorders; ligating clip applicators for medical use; chest percussors; pelvic rests; patient ventilation instruments; apparatus for measuring arterial blood flow in the eye; anastomosis devices; protective breathing masks for surgical applications; apparatus for use in exercising muscles for medical use; applicators for medications; air cushions for medical purposes; anaesthetic masks; respiratory masks for artificial respiration; automatic analyzers for medical diagnosis; anal plugs; magnetic resonance imaging spectrometers for medical use; eye drop guides; angioplasty catheters; bags for collecting body waste; feeding bottles; apparatus for cleansing blood during surgical procedures; protective breathing masks for artificial respiration; surgical drapes; apparatus for the stimulation of acupuncture points; apparatus for analysing alcohol in body fluids [for medical use]; respiratory helmets for artificial respiration; automatic medical apparatus for dosing humans by injection; bandages [supportive] for surgical purposes; eye droppers for medical use; acupuncture instruments [electric or non-electric]; protective breathing masks for medical applications; apparatus for the treatment of breathing difficulties; apparatus for medical rehabilitation; blood group analysers for medical use; autoinjectors for the administration of pharmaceutical preparations; apparatus for the thermal treatment of cancer; balloon inflating devices for balloon dilation catheters; acoustic amplifiers for par-

tially deaf persons; dental articulators; angiographic vascular introducers for the placement of catheters; balloons for use in arthroscopy; containers for transporting samples containing living human cells; apparatus for the prevention of leg ulcers; asymmetrical bars for physical exercise [adapted for medical use]; apparatus for use in toning muscles for medical rehabilitation; acupuncture needles; eye wash cups for medical purposes; dental impression trays; anus prolapse bands; wearable monitors used to measure biometric data for medical use; pads for preventing pressure sores on patient bodies; apparatus for the alleviation of lung ailments; apparatus for use in the preparation of dental prostheses; anoscopes; instruments for use in the preparation of artificial teeth; anaesthetic drapes; apparatus for the treatment of lung diseases; apparatus for the treatment of lung ailments; apparatus for the treatment of disease of the prostate; apparatus for nerve location; aspiration tubing; tonometers for measuring [medical purposes]; respiratory masks for medical purposes; apparatus and instruments used in foot surgery; ventilator breathing apparatus for artificial respiration; anaesthetic inhalers [sold empty]; applicators for pharmaceutical preparations; blood testing apparatus; audiometers; acoustic amplifiers [hearing aids] for partially deaf persons; anti-nausea wristbands; breast milk storage bottles; apparatus for the treatment of lymphoedema; automatic vaccination apparatus; radioisotope therapy apparatus and instruments; applicators for antibacterial preparations; breath gas analyzers for medical diagnostics; specimen cup holders; automatic medical apparatus for dosing animals by injection; microdermabrasion apparatus; apparatus for DNA and RNA testing for medical purposes; apparatus for the treatment of leg ulcers; magnetic resonance imaging [MRI] apparatus for medical purposes; apparatus for use in the repair of teeth; armboards [surgical splints]; apparatus for analysing brain wave frequencies; bed bases for beds especially made for medical purposes; respirators for medical purposes; apparatus for nursing infants; apparatus for artificial respiration; apparatus for taking body fluid samples; cannulae for anaesthetics with receptacles; teething rings; teething rings for relieving teething pain; lighting for medical use; apparatus for producing oxygen for medical use; clothing, headgear and footwear for medical personnel and patients; apparatus for the treatment of pressure sores; urethral catheterization instruments; annuloplasty rings; humidifying apparatus for medical use; air inflatable limb compression apparatus; apparatus for use in the repair of bones; protective breathing masks made of non-woven materials for surgical applications; apparatus for use in vein puncture; bags for surgical use in collecting urine; eye shields for surgical use; apparatus for acupressure therapy; autologous blood processing instruments; apparatus for the regeneration of stem cells for medical purposes; artificial anaesthetization apparatus; apparatus for analysing measured physical signals; banda-

ges, elastic; apparatus for the artificial insemination of animals; apparatus for the therapeutic toning of the body; apparatus for use in testing hearing disorders; receptacles for receiving surgical instruments; autologous blood recovery apparatus; cutlery for medical purposes; clothing, headgear and footwear, braces and supports, for medical purposes; feeding bottle teats; asphyxial neonates respirators; chromatographic instruments for medical use; beds for surgical use; apparatus for the electrical stimulation of groups of muscles; apparatus for use in the investigation of metabolic disorders; inflatable mattresses for orthopaedic purposes; eye baths; receptacles for applying medicines; applicators in the nature of sponges [for medical use]; acupressure bands; apparatus for the therapeutic stimulation of the body; ocular implants made from artificial materials; medical analytical apparatus for medical purposes; air inflatable garments for medical purposes; air mattresses for medical purposes; respiration monitors; apparatus for the turning of patients; materials for bandaging [elasticated]; apparatus for measuring lung function; amalgam carriers; laser light treatment instruments for medical use; apparatus for analysing alcohol in breath fluids [for medical use]; analysers for bacterial identification for medical purposes; bandages for orthopaedic purposes; sexual activity apparatus, devices and articles; bandages [supportive] for veterinary use; inflation syringes for medical or surgical use; ophthalmological instruments; ocular implants; apparatus for use in angiography; orthodontic appliances; callipers [splints]; applicators for antiseptic preparations; anti-rheumatism rings; analog hearing aids; anti-rheumatism bracelets; baths (hoists for assisting invalids entry into -); battery-operated scalp massagers; apparatus for the treatment of cancer; automated analyzers for body fluids [for medical use]; apparatus for use in the prevention of snoring; ventilator exhalation valves for artificial respiration; apparatus for the therapeutic stimulation of the muscles; humidifiers for use in medical treatment; apparatus for the application of laser radiation for medical purposes; apparatus for non-invasive surgery; apparatus for the prevention of pressure sores; inflation devices for balloon catheters; bags [fitted] for medical instruments; parallel bars for medical therapeutic use; balloon catheters; acupressure mats; apparatus for the diagnosis of cardiovascular diseases; arthroscopes; anti-pressure sore mattresses; respiratory therapy instruments; apparatus for medical cell sampling; real time filters being parts of X-ray cameras for medical use; blankets for medical purposes; surgical perforators; high filter surgical masks; elasticated supports for the elbow; dental colour guides; digital thermometers for medical purposes; pressure bandages for anatomical support purposes; electric air compressors for surgical use; electronic blood oxygen saturation recorders [for medical use]; inserts for breathing masks for surgical use; disposable protective gloves for medical purposes; chromatogram analyzers

for medical use; diagnostic apparatus for the detection of abnormal prion protein; electric massage apparatus for personal use; ice bags for medical purposes; processors for photosensitive films [for medical purposes]; chemically activated heating pads for medical purposes; clips for dummies; surgical bougies; haemostasis management instruments; electrically operated hearing aids; heating cushions, electric, for medical purposes; surgical masks; cushions (heating -), electric, for medical purposes; incubators for babies; surgical apparatus and instruments for veterinary use; surgical breathing masks; electronic apparatus for medical purposes; disposable needles for hypodermic syringes; surgical drills; electric drills for surgical use; electronic temperature recorders for medical use; haemocytometers; electric scalp massagers for household use; electrocardiograph instruments; electric massage apparatus for household use; cholesterol meters; blood filters; surgical robots; nipple shields for breastfeeding; introducers for implanting anti-embolic filters; endoscopes for diagnostic use; drilling jigs for surgical applications; electronic blood pressure recorders [for medical use]; endotracheal tubes; endoscopy cameras for medical purposes; surgical forceps; drilling templates for surgical use; scissors for surgery; electronic nerve stimulators for medical use; ingestible capsules containing circuits for collecting, transmitting and storing patient data; electronic carbon dioxide recorders used for medical purposes; chemically activated hot gel packs for medical use; biopsy forceps; insoles for corrective treatment of conditions of the lower limbs; trusses; dental pins; disposable nozzles for dental syringes; belts, electric, for medical purposes; endoscopic occlusion balloons; cardiac defibrillation electrodes; electronic carbon dioxide monitors used for medical purposes; expandable braids for insertion in tubular organs of the body for the treatment of stenosis; diagnostic measuring apparatus for medical use; introducers for implanting vena-cava filters; surgical bypass devices; elastrators for veterinary purposes; blood transfusion apparatus; surgical skin staplers; drilling jigs for dental applications; surgical mirrors; electronic drop counters for medical use; surgical instruments; surgical lamps; processors for X-ray plates [for medical purposes]; electrophysiology electrodes; disposable teats; electrodes for picking up biological parameters; electronic monitoring instruments for medical use; dental drill bits; endoscopes for medical use; power operated sprayers for medical purposes; electronic blood pressure meters [for medical use]; forceps for repositioning; insoles for corrective treatment of conditions of the feet; surgical apparatus and instruments; post-operative enterostomy bags; blood collection tubes for surgical use; elasticated bandages incorporating copper compounds; processors for X-ray films [for medical purposes]; endoscopes; pressure garments for medical treatment; elasticated supports for the ankle; chest drainage devices for removal of fluids from the pleu-

ral cavity of patients; sponge material for surgical use; epidural analgesia apparatus for medical use; CO2 irrigators for urological diagnosis; disposable speculums; blood collection tubes for medical use; thread, surgical; chromatographic columns for medical use; surgical shoe covers; computer controlled training apparatus for therapeutic use; blood pressure monitors; thermo-electric compresses [surgery]; blood collection bags for veterinary purposes; electronic temperature monitors for medical use; electric scalp massagers for commercial use; diagnostic test kits for the detection of haemoglobin in faeces; electrocardiographs for veterinary use; computer controlled exercise apparatus for therapeutic use; electronic stimulation apparatus for physiotherapy; elasticated supports for the wrist; low frequency electric therapy apparatus; electronic blood pressure monitors [for medical use]; biomagnetic rings for therapeutic or medical purposes; apparatus for use in surgery in the drainage of wounds; electronic hearing aids; breast pumps; abdominal hernia belts; pressurised suits for medical use; CO2 irrigators for endoscopic diagnosis; elasticated bandages for supportive use; dialyzers; bags for endoscopic retrieval of tissue; nasal irrigators, electric; electromagnetic medical apparatus; surgical probes; surgical apparatus and instruments for dental use; apparatus for dialysis for veterinary use; electrodes for use with medical apparatus; electrocardiographic recorders; bags for collecting body fluids; permanent magnets for medical use; tractions [medical apparatus]; electronic thermometers for medical use; permanent magnets for therapeutic use; nuclear medicine diagnostic imaging apparatus; electrically operated massagers; cerclage wires; defibrillator monitors; electrodes for medical use; electronic heart rate recorders [for medical use]; surgical drill bits; CO2 insufflators for endoscopic therapy; chemically activated cold compresses for medical use; screwing-in tools for surgical use; digital electronic sphygmomanometers; electric sputum aspirators; diagnostic testing instruments for use in immunoassay procedure [medical]; artificial breasts; surgical cutlery; tubular elastic bandages for supporting joints; chemiluminescent light sources for use in endoscopy; endodontic devices; radioscopy [fluoroscopy] apparatus for medical use; electric massage rollers; electric foot warmers for medical use; dynamic tomography apparatus for medical use; transfusion sets; pressure microsensor catheters; surgical mesh comprised primarily of artificial materials; disposable microtome blades; nozzles for dental syringes; power filters for medical use; biodegradable prostheses; suture materials; electrodes for picking up electrophysiological parameters; surgical headlamps; breast pumps for use by nursing mothers; suture needles; computerised tomography apparatus; endoscopes for therapeutic use; suturing instruments; dialysis membranes; throughflow operated centrifuges filters for medical use; chiropractic instruments; CO2 irrigators for urological therapy; electrodes for exter-

nal defibrillators; elbow guards for medical purposes; cochlea implants; electronic stimulator for medical use; medical elbow braces; pressure monitors for medical use; diagnostic instruments for ophthalmology; breast implants; electric vaporisers for administering steam inhalants; electronic endoscopes for surgical use; endoscopes for surgical use; epidural analgesia apparatus for surgical use; endobronchial tubes; chromatographic columns for analytical chromatography [medical]; electronic acupuncture instruments; electrical utensils for use by dentists in the care of the teeth; electronic heart rate monitors [for medical use]; blood warmers; biopsy needles; dental picks for use in dental treatment; diagnostic apparatus for medical purposes; drainage tubes for medical purposes; detecting instruments for medical use; bioresonance pulse device; electronic heart signal monitors [for medical use]; elastic compression bandages for surgical purposes; surgical raspatories; disposable gloves for surgical use; electronic medical instruments; stockinets for surgical support purposes; electromedical diagnostic instruments; ostomy bags; CO2 irrigators for endoscopic therapy; socks for diabetics; surgical and wound treating equipment; breast shields; metering pumps for delivering drugs in measured quantities [medical use]; wound drainage pouches; electric cauteries for surgical use; electronic muscle stimulators for medical use; dialysis machines for medical use; plastic thumb covers to discourage thumb sucking; insole-shells [orthopaedic]; chromatography plates for medical use; dental probes; surgical staplers; electroencephalographs; blood glucose monitoring apparatus; electric heating covers for medical use; surgical sponges; electrodes for medical use made from glass; clamps for surgical use; electric acupuncture instruments; elasticated bandages incorporating copper; tubular elastic bandages for supporting limbs; ice bag pillows for medical purposes; electronic blood oxygen saturation monitors [for medical use]; disposable prophylactic angles; cardiac electrodes; expandable braids for insertion in blood vessels for treating stenosis; post-operative pressure garments; ladies' stockings [surgical]; blood centrifuging tubules [for medical use]; surgical instruments for use in orthopedic surgery; surgical retractors; nipple shields for personal use; surgical knives; stirrups for use with medical examination tables; real time filters being parts of X-ray monitors for medical use; chemiluminescent light for use in endoscopic exams; electrical oral irrigators for use by dentists; electric instruments for medical use in the diagnosis of blood; CO2 insufflators for urological therapy; biodegradable bone fixation implants; CO2 insufflators for urological diagnosis; saws for surgical purposes; blood lancets; diaphyseal plugs; electrocardiograph monitoring apparatus; electrophoresis apparatus; surgical mesh; blood glucose testing apparatus; glucometers; biodegradable implants; splints, surgical; electrocardiographs; defibrillators; cochlear implants made from artificial materials; orthotic inserts for footwear;

powered respirators for artificial respiration; surgical apparatus and instruments for medical use; mats for effervescent bath massage; clips, surgical; expandable braids for insertion in oesophagus for the treatment of stenosis; electronic endoscopes for medical use; digital hearing aids; diaphragms for contraception; expandable braids for insertion in bile ducts for treating stenosis; enteral feeding pumps; ice packs for the treatment of injuries; bronchoscopes; electrophysiology diagnostic catheters; electrical nerve stimulators; dental drills; massage apparatus, electric or non-electric; electrical utensils for use by dentists in the care of the mouth; electric esthetic massage apparatus for household purposes; incubators for medical purposes; inserts for breathing masks for medical use; blood filters for extracorporeal use; disposable syringes; blood collection bags for medical purposes; substitutes for ligaments; video electrocardiogram detectors; surgical tubing for wound drainage; pressure relief pads and cushions; suture and wound closing materials and products; elastic compression bandages for medical purposes; electromedical instruments for firming treatments; buccal tubes; apparatus for taking blood; dental devices for the treatment of obstructive sleep apnea; electric scalpels [for surgical purposes]; electromedical instruments for slimming treatments; endoprostheses; apparatus for use in surgery in the drainage of incisions; elastomeric material for medical use; electric blankets [bed] for medical use; stainless steel cutlery for surgical use; blood pressure testing apparatus; contraceptive devices; diagnostic apparatus for pregnancy testing; X-ray tomography apparatus for medical use; electronic analyzers for medical purposes; high frequency electromagnetic therapy apparatus; biocompatible coated stents; elasticated supports for the knee; surgical caps; disposable lancets for finger puncture; CO<sub>2</sub> insufflators for endoscopic diagnosis; elbow guard for epicondylitis; leads for pacemakers; elastic stockings [for medical purposes]; surgical staple removers; sun lamps for medical purposes; chemically activated cold gel packs for medical use; endobrachial tubes; insufflators; sphygmotensimeters; diathermic handles for medical use; electric esthetic massage apparatus; transparent face shields for use by medical personnel; surgical cutting instruments; stitch cutters [surgical]; enuresis alarms; dental apparatus, electric; coronary balloon dilatation catheters for angioplasty; bio therapeutic facial masks; diagnostic imaging apparatus for medical use; surgical implants comprised of artificial materials; surgical implants [artificial materials]; chemically activated hot compresses for medical use; biological bone implant material; electro medical instruments; blood pumps; disposable gloves for veterinary use; surgical blades; bone scrapers; tips for crutches; stapling guns (electric -) for surgical use; electric bone operating machines; dilatation catheters; mastectomy brassieres; fistula needles; dental burs; fecal pouches; guide wires for use with balloon dilatation catheters; colour pyrometers

for medical use; fibre optic instruments for medical purposes; assistive devices adapted for persons with disabilities; optical fibre temperature probes for medical diagnostic use; fingerstalls for medical purposes; caulking guns for surgical use; filters for temporary placement within veins; flexible esophagoscopes; fluid collection containers for medical use; foam massage rollers; diagnostic fingerstalls; lasers for medical purposes; filters for ultraviolet rays, for medical purposes; fibrescopes for medical use; therapeutic devices adapted for persons with disabilities; stretchers, wheeled; liquid chromatography instruments for medical use; therapeutic and assistive devices adapted for persons with disabilities; fibre optic viewers for medical purposes; detecting instruments for veterinary use; cardiac fulguration electrodes; flexible medical endoscopes; intravenous feeding bottles; anti-embolic filters; external defibrillators; filters for blood and blood components; photometric instruments for medical use; foot orthoses; filters for use within veins; heel pads for orthopaedic use; moisture exchangers for medical use in transferring the heat of exhaled breath to inhaled breath; thread for medical use; foot bandages [supportive]; feeding bottles for babies; liquid chromatography injectors for medical use; slides for surgical use; liquid chromatography columns for medical use; clinical thermometers; flexible bronchoscopes; arch cushions [orthopaedic]; orthopaedic supports for heels; finger splints; flasks for parenteral nutrition; fetal pulse monitors; photometric analyzers for medical use; gum massagers for babies; implants [prosthesis] for use in facial surgery; plaster for medical or surgical purposes; bone forceps; haemoperfusion cartridges; galvanic belts for medical purposes; medical prostheses; implants [prosthesis] for ligaments; medical drainage bags for collection of abscess; lip retractors; implants [prosthesis] for use in jawbone surgery; high frequency cutting instruments for dental purposes; draw-sheets for sick beds; sources of ultrasonic fields for use in medical diagnosis; injection device for pharmaceuticals; urinary drainage bags; heart signal monitors; enema syringes; medical instruments for use as aids to hearing; artificial cartilage made from synthetic materials; capillary tubes for delivering reagents; lamps for use with dental instruments; abdominal belts; medical instruments for application in human bodies; retentive belts for use by colostomy patients; dressing forceps [for surgical use]; stapling presses for surgical use; blood collection bags for veterinary purposes, empty; weights for physical exercise [adapted for medical use]; medical compression tights; carbon arc lamp units for therapeutic purposes; intravenous bags for medical purposes; cardiographic instruments; jet injectors for medical use; medical radiation apparatus; medical apparatus for controlling pulmonary gas exchange parameters; padded neck supports for surgical use; luer tapers for medical use; obstetric apparatus for cattle; body mass index (BMI) measuring devices for medical use; gloves for use du-



ring operations; cardiovascular catheters; wearable walking assistive robots for medical purposes; medical apparatus and instruments; knives for medical use; incision foils for surgical use; adhesive sutures; therapeutic and assistive devices adapted for the disabled; gloves for medical purposes; apparatus for veterinary purposes; knee crutches; medical instruments for the removal of warts by freezing; hearing aids; gas laser apparatus for medical treatment; latex gloves for surgical use; bone detectors for the measurement of bone mineral content; compressing screws in the nature of orthopaedic surgical instruments; keratoscopes; implantable defibrillators; urethral syringes; implant materials [prosthesis] for use in dental surgery; hip joint endoprostheses; inhalers for the evaporation of para-medical substances; apparatus for phototherapy; sources of electromagnetic fields for use in medical diagnosis; rubber gloves for surgical use; instruments for use in gastrointestinal surgery; physical exercise articles for physical training [for medical purposes]; medical devices for dosimetry purposes in the field of radiotherapy; silicone preparations for cosmetic implantation; cushions [pads] (heating -), for medical purposes; implantable pacemakers; lancing devices for surgical use; medical apparatus for detecting carbon dioxide in the airways; prosthetic implant instruments; padded neck supports [cushions] for surgical use; medical apparatus for testing the level of glucose in the blood; obstetric beds; body limb compression sleeves; apparatus for use in assessing periodontal disease; laser pointers for medical use; medical apparatus for hyperhidrosis treatment; apparatus for destroying hypodermic needles [specifically adapted for medical use]; infusion apparatus for therapeutic purposes; cooling pads for first aid purposes; apparatus for radionuclide imaging; medical apparatus for the relief of pain; inoculating apparatus; artificial sleep apparatus; artificial orthopaedic implants; medical gowns; apparatus for nerve stimulation; appliances for washing body cavities; cardiac catheters; urinals for medical purposes [vessels]; interdental immobilization instruments; face shields for surgical use; vascular punches; infrared apparatus for surgical purposes; medical instruments for infectious disease testing; elizabethan collars for veterinary use; medical furniture and bedding, equipment for moving patients; instruments for treating snake bites; latex gloves for medical use; instruments for cardiac stimulation; stretcher straps; invalid lifts; artificial teeth; magnetic treatment apparatus for medical use; face masks for medical use for anti bacterial protection; denture parts; sanitary masks for dust isolation for medical purposes; medical apparatus for strengthening muscles of the pelvic floor; assist poles for lifting patients; syringes for injections; catheters; intraocular implants for changing eye color made from artificial materials; lancets; obstetric apparatus; templates for orthopedic purposes; lab units for the transfer of liquids [for medical use]; implants [prosthesis] for use in bone grafting;

incontinence bed pads; hand held mirrors for use in dental inspection; catheter skin anchor instruments; laser beam delivery instruments for medical use; medical apparatus for facilitating the inhalation of pharmaceutical preparations; hemostatic suture instruments; artificial vascular grafts; air pillows for infants [medical purposes]; medical cooling units to control body wound temperatures; injection instruments without needles; kinesiology tapes; lamps for use with medical instruments; medical instruments for use in relation to hearing; implanted prosthesis; apparatus for use in identifying periodontal disease; catheters for medical use; medical tubing; stockings for varices; bone plates; cotyloid implants made from artificial materials; feeding aids and pacifiers; laser instruments for medical use; medical apparatus for assisting breathing; apparatus for analysing substances [for medical use]; medical apparatus for spinal disc repair; corsets for curative purposes; medical apparatus for neurographic purposes; inhalers for medical purposes [sold empty]; heartbeat measuring apparatus; bone substitutes for surgical use; medical devices, namely, intravascular implants comprised of artificial material; lenses [intraocular prostheses] for surgical implantation; colposcopes; magnetic bracelets for medical purposes; retentive belts for use by ileostomy patients; protective bonnets for the hair for wear by medical practitioners; trays for holding medical instruments; bone void fillers comprised of artificial materials; orthodontic rubber bands; gloves for medical examinations; support mattresses for medical use; bone chisels; devices for nursing infants; hemodialysis apparatus; ureteral stents being surgical support; capillary reagent tubes; implant materials [prosthesis] for use in surgery; medical vessel dilators; costotomes; assistive devices adapted for the disabled; compression garments; hearing protection devices; birthing chairs; post-operative colostomy bags; inadvertent peep reducers being parts of medical ventilators for maintaining pressure; apparatus for use by colostomy patients; cannulae; bone prostheses; treadmills for medical use in physiotherapeutic exercise; gloves for veterinary use; massage apparatus; cardiovascular angioscopes; medical apparatus for urological purposes; body-scraping plates for meridian scraping therapy; infrared lamps for curative purposes; medical apparatus for use in laparoscopy; braces for joint fixation; limb compression instruments; sprayers [hand-operated] for medical use; apparatus for administering drugs by inhalation; mallets for surgical use; catheters incorporating filters; artificial breast implants; artificial penises, being adult sexual aids; urethral probe syringes; casting splints; droppers for administering medication, sold empty; catheters for urological purposes; light sources for medical use; medical instrument tables; carbon dioxide detectors for medical use; ankle supports for medical use; medical drainage bags for collection of biliary; latex gloves for dental use; pillows for therapeutic use; visible light treatment instruments; intrao-

cular lenses; laser scalpels for medical use; sheets [drapes] for medical use; substitutes for cartilage; latex gloves for veterinary use; irrigation pouches for medical use; contrivances made from natural rubber for prophylactic purposes; medical instruments for application on animal bodies; adhesive drapes for surgical use; medical instruments incorporating lasers; medical instruments for percutaneous tracheostomy; apparatus for administering pharmaceuticals; injection needles for medical use; compression panty hose; ambulance stretchers; cardioversion and/or defibrillator leads; rubber gloves for medical use; joint endoprotheses; cryoprobes for medical use; dermabraders; abdominal belts [for medical purposes]; cardiovascular instruments; lasers for dental purposes; medical apparatus for the treatment of respiratory conditions; electrocautery apparatus; medical pressure chambers; heart rate monitoring apparatus; intraocular lens biometers; implantable urologic prostheses; articular protheses; apparatus for blood monitoring [for medical use]; apparatus for achieving physical fitness [for medical use]; catheter apparatus for gastroenterological use; physical therapy equipment; knee guards in the nature of supports [other than sports articles]; compression socks for medical or therapeutic use; lice combs; artificial cardiac valves; lymphoedema sleeves; medical skin enhancement apparatus using lasers; medical hearing instruments; cooling gel sheet for fever; spoons for administering medicine; medical instruments for recording heart activity; galvanic therapeutic appliances; corsets for medical purposes; massage chairs with built-in massage apparatus; gas detectors for medical use; orthodontic retainers; crutch sockets; furniture adapted for medical treatment purposes; medical apparatus for use in endoscopy; lung function test apparatus for medical use; cardiopulmonary perfusion apparatus; instruments for rubber band ligation of haemorrhoids; body composition analyzers for medical purposes; insulin pens; air beds for medical purposes; medical aids for use in stoma care; apparatus for drug administration; intraocular lenses for surgical implantation; tape cutters for medical purposes; hip joint implants and their parts made of artificial materials; medical knee braces; trays for holding veterinary instruments; immunological analysers; magnetic resonance tomography apparatus; apparatus for use in medicine in the drainage of wounds; orthodontic instruments; magnets for therapeutic use; artificial implants; sexual activity devices; protective face masks for medical use; apparatus for enteral feeding; padded cushions for medical purposes; heat therapy instruments; interpupillometers; contrivances of rubber for prophylactic purposes; gloves for dental use; capillary tubes for blood; artificial parts for teeth; dermarollers; X-ray apparatus for medical purposes; manometers for medical use; pumps for medical purposes; cushions for medical use for supporting infants being examined; bags for medical use in storing urine samples; internal nasal dilators; injection sleeves for

medical use; stapling guns (hand-operated -) for surgical use; high frequency coagulation instruments for medical purposes; artificial hip joints; artificial kidneys; medical apparatus for renal dialysis; face masks for surgical use for toxic substance protection; heart monitors; heart pacemakers; inhalers for therapeutic use; medical instruments; medical blankets for the warming of patients; inhalers for medical use; artificial organs and implants; implant abutments; apparatus for analysing gases [for medical use]; laryngeal masks; maxillo-mandibular splints for use in maxillofacial surgery; cushions for medical use, adapted to support the face; embolic devices; clips adapted for use with ostomy bags; beds specially made for use by burn patients; infusion columns; hooks for limb replacement; medical blankets for the cooling of patients; massage chairs; high frequency cutting instruments for medical purposes; cold packs for medical purposes; devices for measuring intracranial pressure; cystometric instruments; intramedullary plugs; apparatus for echocardiography imaging; pillows for orthopedic use; walking frames for disabled persons; lymphoedema hosiery; curettes; cardiovascular needles; bandages for supporting the human body; medical pulse pressure transducers; injectors for medical purposes; osseous implants; medical specimen cups; medical heating units to control body wound temperatures; medical procedure chairs; ocular speculums; mattresses for medical use; led masks for therapeutic purposes; hearing apparatus for the deaf; gamma cameras for medical purposes; contrivances made from synthetic rubber for prophylactic purposes; cardiac vascular prosthesis for surgical protheses; massaging apparatus for personal use; obstetric forceps; artificial ligaments; medical implants; compressors [surgical]; medical infusion pumps; chambers for inhalers; medical ankle braces; heparin control apparatus for surgical procedures; arthroscopy irrigation instruments; brain pacemakers; medical heating units with body contact applicators to control body wound temperatures; intra-vascular blood gas monitoring systems; body composition monitors; artificial tympanic membranes; high frequency coagulation instruments dental purposes; medical implants made of artificial materials; sanitary masks for medical use; intravenous catheters; medical gas-insufflators; medical apparatus for measuring the oxygen content of blood; medical braces; cardiovascular monitors; prosthesis joint sockets; hypodermic injectors; compression bandages; medical instruments for therapeutic drug monitoring; exercising apparatus for medical rehabilitative purposes; catheters for surgical use; cervical collars; medical scissors; knee prostheses; face shields for medical use; condom catheters; medication injectors; lice combs for pets; post-operative ileostomy bags; condoms; walking sticks for medical purposes; apparatus for tumour diagnosis; hammers for medical or surgical use; apparatus for displaying dental images; heart rate recorders; massage apparatus for eyes; artificial

larynxes; laser installations for medical use; medical hand tools; medical drapes of non-woven textile materials; apparatus for blood tests [for medical use]; catheters for use in embolectomy; castrating pincers; artificial penises [adult sexual stimulation aids]; medical apparatus for use in cardiac surgery; infrared lamps for surgical purposes; medical robots for use in cognitive therapy for children; medical apparatus for urethral catheterization; medical drainage bags for collection of nephrostomy; massage balls; body limb compression sleeves for athletic use; inner lumens for balloon catheters; pads for medical use in applying a fluid to the skin; adhesive bandages (suspensory -); medical devices for spinal disc repair in the nature of spinal disc implants made from artificial substances; implant models; testing apparatus for medical purposes; gynaecological instruments; genetic testing apparatus for medical purposes; belts for surgical purposes; implant bridges for dental purposes; lithotripters; compression bandages [elastic or supportive]; gloves for use in hospitals; artificial lenses for implantation in the eye; instruments for intraluminal sclerosation of varicose veins; haematology analysers; medical operating lamps; intra-corneal implants; mattresses for hospital patient trolleys; intracardiac catheter; implantable subcutaneous drug delivery devices; benwa balls, being adult sexual aids; contoured cushions for patients' use on chairs [adapted for medical purposes]; inhalers; scalp massagers; knee bandages [supportive]; massage apparatus [for medical purposes]; urethral dilators; body fat monitors; medical apparatus for introducing pharmaceutical preparations into the human body; ligating clips for medical use; artificial bones; gynecological dilators; cardiac probes; tools for medical diagnostics; capsule endoscopes; implant abutments for dental purposes; medical isolation gowns; artificial internal organ apparatus; childbirth mattresses; surgical catgut; lasers for ophthalmic purposes; medical tubing for irrigation purposes; personal hip prosthesis; masks for use by medical personnel; hooks being fracture fixation devices; lab units for the mixing of liquids [for medical use]; trays for holding surgical instruments; medical ice bag holders; heat pads for therapeutic treatment; leads for use with implantable cardiac stimulators; laser therapy helmets for treating alopecia; sexual activity articles; physical exercise apparatus for therapeutic use; medical screw connections; apparatus for use in the control of incontinence; cardiopulmonary resuscitation masks; artificial skin replacing membranes; infrared thermometers for medical purposes; calibration catheters; staplers for medical purposes; condoms for hygienic purposes; douche bags; medical diagnostic apparatus for medical purposes; intravenous bags for surgical purposes; invalids' hoists; light sources for electronic endoscopes for medical purposes; infrared apparatus for curative purposes; bone retractors; insufflation needles; intravenous infusion pumps for medical purposes; compressor modules being parts of ventilators [medi-

cal]; radiation oncology apparatus for medical use; medical apparatus for the display of tomographic data; intra-ocular implants; instruments for extracting human body fluids; infusion pumps; blankets, electric, for medical purposes; orthopaedic belts; intravenous administration instruments for medical purposes; medical guidewires and parts and fittings therefor; articles for nursing infants; latex examination gloves for medical use; medical instruments for recording physiological data; ear plugs for medical purposes; compressing screws in the nature of orthopaedic surgical implants; enema apparatus for medical purposes; belts for attaching medical monitors to patients; manual massage instruments; protective face masks for dental use; length gauges for medical use; condoms having spermicidal properties; lab units for the dilution of liquids [for medical use]; carbon dioxide indicators for medical use; masks and equipment for artificial respiration; face masks for surgical use for anti bacterial protection; biliary drainage catheters; hospital gurneys; fleams; contoured inflated pads for patients; medical devices for placing and securing catheters; capillary tubes for samples; intravenous catheter sets; orthopaedic detachable insoles; artificial hearts; forceps; artificial parts for the body; sources of ultrasonic fields for use in medical treatment; therapeutic devices adapted for the disabled; hot air vibrators for medical purposes; otolaryngology instruments; face masks for medical use; ear trumpets; artificial bones for implantation; medical instruments for interstitial thermotherapy of biological tissue; medical cooling apparatus for use in therapeutic hypothermia; medical apparatus for diagnosing suspected heart attacks; clasps for surgical use; luer lock needles for medical use; tissue expanders for use in surgery; dental dams; medical compression stockings; soporific pillows for insomnia; implantable leads for cardiac pacing; gas chromatography apparatus for medical use; uterine syringes; capillary drainage tubes; nurses' tweezers; vascular access ports for medical use; sources of magnetic fields for use in medical diagnosis; urethral probes; medical cooling apparatus for treating heat-stroke; medical cooling units with body contact applicators; mechanical valves for implantation in human hearts; skin temperature indicators for medical use; crutches; artificial sponges for medical purposes; hand exercisers for therapeutic use; skinfold calipers for medical purposes; heart rate calculators; goniometers for orthopaedic use; infrared radiator units for therapeutic purposes; screws for bone; vessels for histological purposes; medical instruments for drug abuse testing; isolation bags for medical use; infrared apparatus for medical purposes; apparatus for use by dental hygienists; foot massagers; apparatus for orthopaedic purposes; artificial skin for surgical purposes; hybrid beds being soft sided waterbeds [for medical use]; artificial vaginas, being adult sexual aids; adult sexual aids; cardiovascular guidewires; medical heating units with body contact applicators; implants

[prosthesis] for bone surgery; cushions for medical purposes; artificial cranial components; body massagers; implants for osteosynthesis; heart monitors to be worn during exercise; insulin syringes; medical devices for closing wounds; medical instruments for reproducing physiological data; medical angular deformity correction apparatus; infrared lamps for medical purposes; lumbar belts; heating cushions [pads], non-electric for medical purposes; apparatus for the application of laser radiation for dental purposes; nuclear magnetic resonance installations for medical scanning; obstetric tables; apparatus for blood analysis [for medical use]; cushions for medical use for supporting infants while being bathed; gas analyzers for medical analysis; medical devices for moxibustion therapy; catgut; colorimetric comparators for medical use; sources of magnetic fields for use in medical treatment; lasers capable of producing pulsating laser beams [for medical use]; compressors for medical [treatment] purposes; sanitary masks for dust isolation for medical purposes; devices [oral irrigators] for use by dentists in washing the gums; magnetic field generators for medical use; artificial facial components; condoms for medical purposes; pads for inhibiting snoring; nuclear resonance spectrometers for medical use; artificial bone parts to be implanted in natural bones; implants [prosthesis] for dental surgery; air mattresses for infants [for medical purposes]; sound excluding instruments for medical use; instrument cases for use by doctors; staplers for surgical purposes; implants [prosthesis] for use in tendons; apparatus for cardiac defibrillation; medical tubing for administering drugs; medical guidewires; bags for medical use in collecting urine samples; medical tubing for use in vascular procedures; laryngoscopes; invalid walkers; hair prostheses; artificial eyes; medical skin abraders; lasers incorporating optical fibres for medical use; lung forceps; hydrophilic guide wire to track catheters; compresses for supporting the body; apparatus for use by ileostomy patients; gynecological medical instruments for examining women's reproductive organs; knee supports for medical use; sources of electromagnetic fields for use in medical treatment; belts for medical purposes; implantable cardiac pulse generators; aural prostheses; bone graft substitutes; shaped padding for supporting parts of the body [medical use]; orthopaedic implants; immunoadsorption columns for diagnostic use; lamps for producing polarised light for medical use; incontinence sheets for use with infants; crutch cushion covers; laser machining tools for medical use; medical cooling units with body contact applicators to control body wound temperatures; weight training apparatus adapted for medical use; spermicidal condoms; body warming devices for medical use; magnetic resonance imaging scanners; infusion pumps to deliver medication; instruments for use in prosthetic dentistry; paediatric pacifiers; gloves for massage; incontinence mattress protectors; vision testing apparatus; immunoadsorption columns for the-

rapeutic use; cardiovascular pumps; massage beds for medical purposes; cardio-pulmonary diagnostic instrumentation; adhesive flanges for use with ostomy bags; lab units for the incubation of liquids [for medical use]; implants [prosthesis] for use in dentistry; hearing protectors without the ability to reproduce or transmit sound; noise protection means in the form of deformable ear plugs; cooling patches for medical purposes; artificial heart-lung oxygenators; artificial jaws; plaster bandages for orthopaedic purposes; esthetic massage apparatus; suspensory bandages for joints; artificial limbs; hooks for spondylolysis; high frequency generators for use in medical treatment; gastroscopes; inhalers for the evaporation of aromatherapeutic substances; castrating apparatus [for veterinary purposes]; artificial cartilage; medical cutting devices; mallets for medical use; implants consisting of artificial materials; incontinence sheets; keratometers; blood collection bags for medical purposes, empty; air pillows for medical purposes; laser cutting tools for medical use; bandages for joints; light filters for medical use; gowns for surgical use; elastic stockings for surgical purposes; insulin pumps; mittens for medical use; walking aids [for medical purposes]; implantable pacemaking leads; wheels for pets [mobility aids]; linear accelerators for medical use in radiotherapy; hard elastic sutures; heads for hip prostheses; implantable urethral stents; manual sputum aspirators; condoms for prophylactic purposes; bone implants made from artificial materials; abdominal corsets; lamps for medical purposes; coagulation instruments; hearing aids for the deaf [acoustic aids]; instruments for applying dental filling; haemoglobinometers; manometer lines for medical use; medical apparatus for training breathing techniques; impulse measuring instruments for medical use; pillows (soporific -) filled with down; goniometers for surgical use; apparatus for use in medicine in the drainage of incisions; intramedullary nails; hypodermic needles; artificial heart-lung machines; lab units for the dispensing of liquids [for medical use]; medical bags designed to hold medical instruments; incubation units; lithotomical instruments; orthodontic brackets [braces] for use in straightening teeth; bone implants composed of artificial materials; magnetic resonance CT apparatus; corn knives; hip implants; face masks for medical use for toxic substance protection; enema apparatus; skin moisture analyzers for medical purposes; massage apparatus for neck and shoulders; wrist supports for medical use; artificial bone implants made of ceramic; lasers for veterinary purposes; hysteroscopes; lasers for use in surgery; medical stretchers; incontinence sheets for use with babies; medical instruments for cutting tissue; surgical gloves; ozone generators for use in administering ozone therapy; tweezers for surgical use; disposable medical devices for treating constipation; electrocardiograph monitors; inserts for the nose; ultrasonic diagnostic instruments for medical use; orthopaedic sheets adapted for use during ortho-

paedic operations; membranes for filtration [medical]; mesh nerve connecting tubes for veterinary use; orthopaedic bandages; collimating position indicating apparatus for veterinary use; medical and surgical cutters for cutting human or animal tissue and organs; suture materials for medical use; orthopaedic splints; pads for slippers [orthopaedic]; nail pinches for medical use; medical diagnostic saliva pads; cutlery for surgical purposes; nuclear medicine tomographic scanners; medical ultrasound apparatus; blood collection needles; medical and surgical knives for cutting human or animal tissue and organs; specimen samplers for medical use; penis enlargers, being adult sexual aids; measuring devices for medical use; measuring instruments adapted for medical use; physical analyzers for medical use; probes for medical purposes; anaesthesia screens; spine seats [medical apparatus]; transplant sutures for use in surgery; pharmaceutical instruments; orthopaedic soles; polyurethane foam bandage [supportive]; optometric instruments; orthopaedic inner soles incorporating arch supports; percutaneous insertion trays; polymerisation apparatus for dental purposes; oral syringes; cushions (heating -), non-electric for medical purposes; orthopaedic instruments; tweezers for medical use; pipetting instruments for medical use; medical tables for examination or treatment purposes; protective nose masks for veterinary use; femoral nails; medical stents; medical support tights; collimating position indicating apparatus for dental X-ray machines; proctoscopes; arch supports for footwear; orthopaedic footwear; orthopaedic compression supports; patient monitoring instruments; non-selective electrodes being chemically sensitive probes [for medical use]; padding for orthopedic casts; spatulas for medical use; pipetting instruments for surgical use; orthopaedic hosiery; optical scanners for medical inspection purposes; tympanostomy tubes; medical ventilators; ozone monitors for use in administering ozone therapy; papillotomes; medical stockings with decreasing compression; penile sheaths; anaesthesia monitoring apparatus; pins of precious materials for dental use; ozonizers [ozonators] for medical use; trace organic concentrators for medical use in diagnosis; patient examination tables; medical stethoscopes; furniture for endoscopic examination purposes; kidney horns; oxygenators for medical use; polypectomy snares; tubes for perfusion; needle holders for surgical use; collimating position indicating apparatus for surgical use; nasal aspirators; pessaries; clothing especially for operating rooms; pads for shoes [orthopaedic]; collimating position indicating apparatus for medical use; needles for surgical purposes; meters for body fluids; medical hosiery; needles for medical purposes; periodontal irrigators for use in dental treatment; otological prosthetic appliances; eye droppers; protective nose masks for medical use; medical test kits for diabetes monitoring for home use; silicone orthopedic devices; medical imaging apparatus; medical examination tables; orthopedic joint im-

plant prostheses; peak flow meters; orthopaedic hip prostheses; oral irrigators; orthopaedic braces; patient litters in the nature of stretchers; medical and surgical catheters; oral irrigators for use in dentistry; knife blades [surgical]; menstrual cups; orthopaedic foot cushions; earmoulds being parts of hearing aids; otological prostheses; otological implants; optical instruments for medical endoscopy; protective mouth masks for dental use; medical examination sheets; surgical scrub suits; operating tables; ostomy instruments; ear inserts for medical use; medical supports for the body; multispectral fluorescence imaging system [MFIS] for medical use; neurosurgical adaptors; plates in the nature of orthopaedic surgical instruments; plates for anastomosis of bones; knee bandages, orthopaedic; physiological monitoring apparatus for medical use; nanorobots for medical purposes; nebulisers; ear plugs for protection against noise; mobility aids; protective mouth masks for medical use; waterbeds for medical purposes; protective mouth masks for veterinary use; orthopedic articles; physiological apparatus for medical use; medical support hosiery; knives for surgical purposes; orthopedic cushions; sanitary masks for medical purposes; nephelometric analyzers for medical diagnosis; ear plugs for sleeping; surgical instruments for use in spinal surgery; bone mineral detectors for the in-vivo measurement of bone mineral content; pep activators being parts of medical ventilators for maintaining pressure; ear plugs [hearing protection devices]; membrane test plates for use in medical research; mesh nerve connecting tubes for medical use; orthopaedic strappings; medical and veterinary apparatus and instruments; orthopedic support bandages; orthopedic fixation devices; emesis basins; neck massage apparatus; balling guns; measuring spoons for administering medicine; physiological measuring apparatus for medical use; non-electric massage apparatus; non-elastic bandages [supportive]; nerve muscle stimulators; otoscopes; pelvimeters; pneumatically operated medical instruments; orthopaedic femur prostheses; orthopedic apparatus for talipes; orthokeratology lenses; needles for dental purposes; vertebral orthopedic apparatus; orthopaedic supports for feet; periurethral prostheses; optical temperature measuring instruments for medical inspection purposes; orthoses; nasal douches; optometric autorefractors; ear picks; silicone orthopedic implants; ultrasonic medical diagnostic apparatus; ophthalmic microsurgical knives; emergency pelvic clamps; orthopaedic bandages for joints; percutaneous renal access sets; ear adaptors for hearing aids; platinum cauteries [for surgical use]; nasal dilators; membrane test plates for use in medical diagnostics; protective nose masks for dental use; non-electric acupuncture instruments; orthopedic joint implants; plates in the nature of orthopaedic surgical implants; programmers for rate-programmable pacemakers; tables for use in the treatment of patients; syringes for medical purposes; patient examination gowns; ear thermometers; medical examination

lamps; medical syringe needles; optomedical examination instruments; suspensory bandages for use in athletics; moxibustion apparatus; umbilical belts; medical therapy instruments; abdominal pads for medical use; nasal irrigators, non-electric; programmable hearing aids; corsetry for surgical purposes; patient monitoring sensors and alarms; contoured cushions for patients' use on beds [adapted for medical purposes]; anaesthetic apparatus; ophthalmoscopes; multishot needle syringes; contraceptives, non-chemical; orthopaedic healing aids; commode chairs; detectors for medical applications; spittoons for medical purposes; tongue depressors; armchairs especially made for surgical purposes; thermo-electric compresses; pads for medical use adapted for wheelchair seats; urine testing instruments for medical diagnostic purposes; oxygen inhalators for therapeutic purposes; test probes for medical use; prostheses constructed in high strength porcelain affixed to the dentine structure; cell culture instruments for medical use; valves for the treatment of hydrocephalus; mercury thermometers for medical use; external fixators [splints]; examination chairs specially made for dental use; exercise boots for medical rehabilitative purposes; urological imaging systems; splinting materials for medical use; synthetic bandages [supportive]; syringes in the nature of pens; sheets made of rubber for incontinence; vibrators for heating dental waxes; pliers for dental use; female urinary incontinence devices; prostheses for implantation into the jaw bone; retaining belts for restraining patients on stretchers; examination couches specially made for dental use; stents; spine plates [medical apparatus]; dental implants; support mattresses for preventing pressure sores; dental X-ray film hangers; substitutes for tendons; trocars; rachitomes; X-ray film mounts for surgical use; operating field boundary cloths; thoracic vents; urological instruments; dental prostheses; brushes for cleaning body cavities; X-ray spectroscopy apparatus for medical use; retention belts; hypothermia analysis instruments; furniture especially made for medical purposes; transcutaneous electrical nerve stimulators; suction bottles for medical use; sex aids; X-ray film frames for surgical use; spectrum analyzers for use in medical diagnosis; spinal syringes; thermal packs for first aid purposes; armchairs for medical or dental purposes; protective sleeves for components of inter-aortic balloons; prosthetic parts for dentistry; toe relief pads [orthopaedic]; refractometers for veterinary use; bandage clips; mirrors for surgeons; ultrasonic blood flow meters; prosthetic suspension sleeves for limbs; tennis elbow supports; cups for administering medicine; suction drainage sets for medical use; support garments for medical use; dental X-ray film duplicators; prosthetic socks for limbs; teeth aligners; temperature sensitive testing instruments for medical use; transcutaneous electrical nerve stimulation electrodes; arch supports [orthopaedic]; rigid medical endoscopes; central venous catheters; radiology screens for medi-

cal purposes; ultrasound apparatus for veterinary use; pumps for use in liquid chromatography [medical]; scalpels; zippers adapted for use as temporary wound closures; hypogastric belts; beds specially made for medical purposes; dental broaches; mirrors for medical examination purposes; veterinary apparatus and instruments; wheeled trolleys adapted for use as walking aids; slings [support bandages]; protective masks for use by persons working in the dentistry; dropper bottles for medical purposes; crutch handle covers; dental apparatus for paralleling; pipes for medical applications; electromagnetic wave therapeutic instruments; dental root posts; patient stretchers; radiological apparatus for medical purposes; urine bags; non-spill medicine spoons for infants; ultraviolet ray lamps for medical purposes; medical and surgical laparoscopes; tubes for transfusion; vibrators, being adult sexual aids; silicone gel sheeting for the treatment of scars; dental descaling apparatus; temperature indicator labels for medical purposes; alternating pressure supports for medical use; examination fingercoats; subcutaneous valves for implantation; speculae; cupping glasses; love dolls [sex dolls]; silicone lace combined with a needle for use in the retraction of arteries during surgery; nurses' trolleys adapted to contain drugs for dispensing to patients; cervical pillows for medical use; radiotherapy instruments for medical use; pliers for veterinary use; hospital examination chairs; X-ray photographs for medical purposes; hypodermic syringes; dentists' armchairs; testing instruments for medical diagnostic purposes; loop ostomy rods; vertebra spreaders; tables specially made for medical examination; prosthetic instruments for dental purposes; protective gloves for use by surgeons during operations; therapeutic garments for animals; X-ray film mounts for dental use; X-ray film mounts for veterinary use; flight socks; operating theatre sheets; examination chairs specially made for medical use; pins for artificial teeth; ultrasonic probes for medical use; X-ray tubes for medical purposes; protective clothing for surgical purposes; pumps for medical use in delivering pharmaceuticals from containers; telemetry apparatus for medical use; testing probes for medical diagnostic purposes; dental spectrocolumeters for determining colours of dental prostheses; test electrodes for medical use; oxygen electrodes for medical use; containers especially adapted for the disposal of medical instruments, syringes and other contaminated medical waste; spectrocolumeters for use in the detection of colour blindness; support socks to prevent deep vein thrombosis; splinting bandages for preparing casts; ultrasonic aspirators for separating soft tissue parts; prosthetic tissues for vascular use; toe props [orthopaedic]; hypodermic syringes for injections for medical purposes; patient positioning tools; heat wrap massage apparatus; X-ray apparatus for veterinary use; tubes for veterinary use; transcutaneous electrical muscle stimulators; interdental stimulators for use in dental treatment; shoe insoles for orthopedic use; high

risk delivery resuscitation instruments; radio cardiographic apparatus for medical purposes; probes for use with integrated circuits [for medical diagnosis]; contrivances of synthetic rubber for contraceptive purposes; therapeutic instruments for ophthalmology; cutting discs for dental applications; blunt curettes [for surgical use]; X-ray scanners for medical use; protective screens for protection whilst exposed to X-rays [medical use]; separation instruments for medical use; vaporizers for medical purposes; heat exchange anti-viral filters for medical use; rigid endoscopes; stethoscopes; rowing machines for physical exercise [for medical use]; portable urination aids for women; suspensory bandages; dental equipment; sensor apparatus for medical use in diagnosis; dental clips for securing pre-existing dentures; hypodermic syringes for use in administering injection substances; precision sensors for medical use; armchairs especially made for medical purposes; furniture especially made for dental use; pipes for surgical applications; protective breathing masks made of non-woven materials for medical applications; dental curing lights; slings specially adapted for transporting persons with disabilities; mirrors for dentists; cut-off wheels for dental purposes; pulse counters [medical apparatus]; cervical dilators; cell counting units for medical use; veterinary obstetric aids for use in the birth of live animals; therapeutic weighted blankets; dropper bottles for administering medication; specula for otoscopes; venous catheters for human use; portable nebulisers for medical purposes; retinoscopes; toe regulators [orthopaedic]; uterine dilators; protective visors for dental use; water therapy apparatus for medical use; nebulizers for medical use; pads (abdominal -) for surgical use; alternating pressure pads for medical use; bed vibrators; time programmable intravenous perfusion pumps; tomographic instruments for medical use; dental caps; rectal instruments; hose systems for peritoneal dialysis; periosteal elevators; cardiac pulse generators; baby feeding dummies; stockings for therapeutic purposes; syringes for dental purposes; protective gloves for medical use; sharp curettes; test probe assemblies for medical use; pulse measuring devices; protective bonnets for the hair for wear by veterinary practitioners; strait jackets; scalpel handles; tracheotomy tubes; protective visors for veterinary use; fumigation apparatus for medical purposes; hypodermic needles for use in wound drainage; armchairs especially made for dental purposes; cases fitted for medical instruments; shoulder supports for medical use; spirometers for examining the function of the lungs; disposable hypodermic syringes for surgical use; therapeutic nose clips for the prevention of snoring; quad canes for medical purposes; suction bags for medical use; maternity support belts for medical purposes; sterile clothing for surgical use; transplant prostheses for use in surgery; X-ray film frames for dental use; prosthetic hip joint implants; X-ray appliances for dental and medical use; water bags for medical purposes;

rectal dilators; protective masks for use by surgeons during operations; ultrasonic therapy apparatus; medical instrument cabinets; hypodermic needles for injection; dental crowns; solaria for medical purposes; ultrasonic diagnostic instruments for therapeutic purposes; tooth polishing appliances for use by dentists; bases for waterbeds [adapted for medical use]; X-ray CT scanners; ultrasonic cleaning instruments for medical use; suction apparatus for dental use; robotic exoskeleton suits for medical purposes; rigid esophagoscopes; therapeutic mouthpieces for the prevention of snoring; protective gloves for use by persons working in the dentistry; posterior spinal fixation devices for the correction of spinal defects; forceps for medical use; ostomy seals; columns for affinity chromatography [for medical use]; ultrasonic diagnostic instruments for dental use; containers especially adapted for the disposal of syringes; dissecting tables; heat lamps for medical use; quartz lamps for medical purposes; maternity belts; eye testing apparatus; hydrocephalus valves; oxygen concentrators for medical applications; dental apparatus for milling; X-ray film mounts for medical use; slings for medical use; subcutaneous valves comprised of artificial materials for implantation; stretchers [for patient transport]; pill cutters; thermographic instruments for medical purposes; dental foundation supports; valves for use in medical infusion instruments; tubing for use with cannulas; ultrasonic aspirators for washing out soft tissue parts; resuscitators; shields for medical instruments; shunts for use in the blood circulatory system; test clips for medical use; radiation shielding textiles for use in therapeutic treatment; hyperbaric oxygen chambers for medical purposes; silicone prosthetic implants; radiation shielding textiles for use in the therapeutic treatment of animals; cystoscopes; heat exchange anti-bacterial filters for medical use; blood collecting tubules; particle analyzers for medical use; sigmoidoscopes; cases fitted for surgical instruments; surgical examination drapes; tools for veterinary diagnostics; beds specially made for use by burn patients; suspensory bandages for use in sports; oxygen inhalers for medical use; braces for application to the human body; sex toys; toe inserts for footwear [orthopaedic]; pupillometers for measuring pupillary distance (PD); protective visors for medical use; retractors [medical instruments]; lag screws in the nature of orthopaedic surgical implants; arch supports for orthopaedic shoes; wheeled walkers to aid mobility; electro-stimulation apparatus for use in therapeutic treatment; alternating pressure mattresses for medical use; electrotherapy instruments for slimming treatments; interdental brushes for use in dental treatment; stockings for prophylactic purposes; contrivances made from natural rubber for contraceptive purposes; intravenous feeding tubes; bariatric patient stretchers; shoulder cups for medical use; droppers for medical purposes; radium tubes for medical purposes; protective visors for surgical use; pulse meters for medical purposes; therapeutic garments for

people; esophagoscopes; prophy angles; therapeutic apparatus for children with autism; radioisotope apparatus for medical use; X-ray film frames for veterinary use; vacuum probes for medical use; wound suction apparatus; grinding discs for dental applications; dropping pipettes for medical purposes; tables for radiology; cervical portio adapters; thermometers for medical purposes; pulse oximeters; urine test glasses; centro-medullary nails; heat dispensing containers for relieving pain in the ear; stair climbing machines for medical therapeutic use; dental syringes; arch supports for flat feet; powder jet devices for dental use; warmers for medical use; pumps for medical use in the extraction of vapour; tubular bandages [supportive]; vaporizers for the treatment of upper respiratory conditions; tongue blade holders; step-up machines for use in physiotherapy; dental bridges; synthetic padding bandages [supportive]; silicone prosthetic devices; traction apparatus for medical purposes; teeth protectors for dental purposes; slings for patient lifting hoists; teething soothers; separation cartridges for medical use in chromatography; tourniquet monitors; cytofluorometric apparatus; prosthesis shafts; tubing for use with catheters; dental onlays; spinal implants composed of artificial material; hypodermic injection apparatus; disposable hypodermic syringes for medical use; holders for X-ray films for use in the mouth; teeth regulating [bracing] devices; cupping glasses for moxibustion therapy; dental spectroradiometers; boots for medical purposes; toe separators for orthopaedic purposes; heat beds for medical treatment; X-ray structure analysis instruments for medical use; exercisers [expanders] for medical therapy; push syringes for medical use; portable instruments for medical use in monitoring oxygen levels in gaseous mixtures; covers for baby feeding bottles; cups for dispensing medicine; trace material analyzers for medical use in diagnosis; radiotherapy apparatus; sterilised sheets for use on patients during surgery; pumps for surgical purposes; lithotomy forceps; prosthetic stump shrinkers for limbs; voice simulating prostheses; apparatus (medical -) for extracting oxygen from the atmosphere; protective gloves for veterinary use; refractometers for medical use; cervical balloon catheters; oxygen inhalers for medical purposes sold empty; medical procedure tables; portable hand-held urinals; laryngectomy protectors; mastoid retractors; dental hand pieces; patient safety restraints; thorascopes; prosthetic sleeves for limbs; contrivances of rubber for the prevention of the transmission of disease; sample preparation columns for medical use; medical instrument stands; splinting (supportive -) for medical use; pill crushers; low air loss sectional pneumatic therapeutic mattresses; tomographs for medical purposes; apparatus for use by dental technicians; oxygen concentration monitors for medical use; centro-medullary nails for tibia; X-ray film frames for medical use; reversed osmosis membranes for medical use; vagino-tonographs; ultrasonic diagnostic instruments for surgical

use; hot air therapeutic apparatus; prosthetic sockets used to fasten prosthetic limbs to the body; uterine probes; X-ray apparatus for dental imaging; feeding bottle valves; thermal electric compresses for medical use; prosthetic tissues for parietal use; oxygen masks for medical use; heat dispensing containers for relieving pressure on the ear; protective masks for use by persons working in medicine; heat dispensing containers for relieving muscle pain; pipes for dental applications; cardiac arrhythmia control devices; abdominal pads; forceps for dental technical purposes; protective clothing for medical purposes; blood roller mixers; forceps elevators; slings for supporting injured limbs; corsets for therapeutic use; tubes for enteral feeding; vibromassage apparatus; splinting bandages for preparing splints; bags [fitted] for use by surgeons; vaginal syringes; silicone lace combined with a needle for use in the retraction of veins during surgery; supports for flat feet; stoma protectors; medical apparatus and instruments relating to neurovegetative reactivity; corneal shields; shock wave apparatus for medical use; temperature sensing apparatus for medical use; pupillometers for measuring pupillary reactivity to stimulus; temperature sensors for medical use; feeding cups [for medical purposes]; therapeutic apparatus incorporating massaging facilities; thermal massage pads; dental braces; cytology brushes; clips for pacifiers; static electric therapy apparatus; pumps for medical use in the extraction of liquids; medical diagnostic saliva vials; suction bag holders for medical use; resuscitation apparatus; urinals being vessels; tenaculums; mucus extractors; pulse meters; urinary flow monitors; protective gloves for use by persons working in medicine; hypodermic needles for use in renal dialysis; rigid bronchoscopes; therapeutic facial masks; dental prostheses in the form of inlays; tubes for surgical purposes; dental moulding devices; shears [surgical instruments]; deep heat massage apparatus; dental picks, other than for personal use; exercise machines for therapeutic purposes; ultrasonic apparatus for medical use in scanning the body; support panty hose for surgical use; oxygen concentration analyzers for medical use; tonometers; spirometers [medical apparatus]; splinting materials for surgical use; straws for veterinary use; examination couches specially made for medical use; pumps for veterinary use; furniture especially made for surgical use; percussion hammers for diagnostic purposes; medical patient treatment chairs; tongue depressors for medical purposes; telemetry devices for medical applications; dental X-ray apparatus; protective bonnets for the hair for wear by dental practitioners; grafts for surgical use; support bandages for medical purposes; ultrasonic eye axis length meters; urological apparatus and instruments; water pillows for medical purposes; wall-mounted oxygen inhalers; lag screws in the nature of orthopaedic surgical instruments; abrasive wheels for dental purposes; dental implants made from artificial materials; temperature monitors for medical use; sphincteroto-



mes; hospital examination tables; prostheses in the form of full crown restorations; posterior spinal fixation devices for the correction of back defects; fetal heart monitors; thermotherapy apparatus for medical purposes; tracheal tubes; prostheses constructed in high strength porcelain affixed to the enamel structure; hypodermic needles for use in infusion therapy; nebulizers for respiration therapy; vaginal specula; medical portable epilators; protective structures against radiation [for medical use]; pliers for surgical use; back massage apparatus; pipes for veterinary applications; prostheses in the form of partial crown restorations; prosthetic tissues for visceral use; prostheses for medical treatment; suction tubes for medical purposes; temperature measuring instruments for medical use; therapeutic support bandages; ultrasonic cleaning instruments for veterinary use; prosthetic ligaments; pulse rate monitors; dental X-ray mouth props; sterile sheets, surgical; evaporators for liquid anaesthetics; pumps for medical use in dispensing pharmaceuticals from containers; exercise boots [orthopaedic footwear]; vaginal dilators; ultrasonic sensors for medical use; ultraviolet radiator units for therapeutic purposes; venom extraction syringes; protective cups for teeth; scanners for medical diagnosis; chairs especially made for medical use; tongue scrapers; speech aid [therapy] apparatus; exercise simulating apparatus for medical purposes; ultrasonic diagnostic instruments for veterinary use; mercury arc lamp units for therapeutic purposes; X-ray analyzers for medical use; insulin pens sold empty; respiratory exercisers; medical trays; bags [fitted] for use by doctors; dental intra-oral cameras; separation columns for medical use in gas chromatography; soles made of leather [orthopaedic]; carbon dioxide monitors for use in measuring levels in patients; back supports for medical purposes; horsehair gloves for massage; oxygen sensors for medical use; sensor apparatus for medical use in monitoring the vital signs of patients; oxygen monitors for medical use; scalpels emitting electromagnetic rays; soft insoles [orthopaedic]; temperature scanners for medical use; protective guards for catheters; centro-medullary nails for femur; prostheses for surgical treatment; therapeutic hosiery; dental excavators; X-ray diagnostic apparatus; hydrogen inhalers; prosthetics and artificial implants; heat treatment apparatus; protection devices against X-rays, for medical purposes; arch supports for orthopaedic boots; trocar cannulas; ultrasonic cleaning instruments for surgical use; gum massaging instruments; suction apparatus for medical use; columns for liquid affinity chromatography [for medical use]; pumps for medical use in the extraction of gases; electrotherapy instruments for firming treatments; tapes for varicose veins; heating patches for medical purposes.

35 – Retail services relating to automobile parts; retail services in relation to clothing; retail services relating to bakery products; retail services in relation to horticulture equipment; retail services in relation to animal

grooming preparations; retail services in relation to bicycle accessories; retail services in relation to hair products; retail services in relation to cleaning articles; retail services in relation to cooling equipment; retail services in relation to fashion accessories; retail services in relation to wearable computers; retail services in relation to floor coverings; retail services in relation to desserts; retail services in relation to chemicals for use in forestry; retail of third-party pre-paid cards for the purchase of multimedia content; retail services in relation to dietetic preparations; retail services in relation to veterinary apparatus; retail services in relation to toys; retail services in relation to sanitation equipment; retail store services in the field of clothing; retail services in relation to furnishings; retail of third-party pre-paid cards for the purchase of entertainment services; retail services in relation to dairy products; retail services in relation to yarns; retail services relating to audiovisual equipment; retail services in relation to jewellery; retail services in relation to chemicals for use in horticulture; retail services in relation to hygienic implements for humans; retail services relating to flowers; retail services relating to books by means of a book club to its members; retail services in relation to water supply equipment; retail services via global computer networks related to non-alcoholic beverages; retail services in relation to smartwatches; retail services in relation to agricultural equipment; retail services in relation to fabrics; retail services in relation to cocoa; retail services in relation to articles for use with tobacco; retail services in relation to car accessories; retail services in relation to cookware; retail services in relation to chemicals for use in agriculture; retail services via global computer networks related to alcoholic beverages (except beer); retail services in relation to smartphones; retail services in relation to toiletries; retail services relating to horticultural equipment; retail services in relation to tableware; retail services in relation to games; retail services in relation to fodder for animals; retail services in relation to veterinary instruments; retail services in relation to computer hardware; retail services relating to batteries; retail services in relation to medical apparatus; retail services relating to home textiles; retail services in relation to seafood; retail services in relation to construction equipment; retail services in relation to threads; retail services relating to fragranting preparations; retail or wholesale services for pharmaceutical, veterinary and sanitary preparations and medical supplies; retail services in relation to safes; retail of third-party pre-paid cards for the purchase of clothing; retail services in relation to clothing accessories; retail services in relation to beer; retail services in relation to educational supplies; retail services relating to candy; retail services in relation to audio-visual equipment; retail services connected with stationery; retail services in relation to lubricants; retail services in relation to tobacco; retail services in relation to dietary supplements; retail services in rela-

tion to hand-operated implements for construction; retail services in relation to veterinary articles; retail services connected with the sale of subscription boxes containing cosmetics; retail services in relation to weapons; retail services in relation to pet products; retail services in relation to teas; retail services in relation to cups and glasses; retail services in relation to mobile phones; retail services relating to alcoholic beverages; retail services in relation to chocolate; retail services via global computer networks related to foodstuffs; retail services relating to delicatessen products; retail services in relation to musical instruments; retail of third-party pre-paid cards for the purchase of telecommunication services; retail services in relation to stationery supplies; retail services in relation to works of art; retail services in relation to fuels; retail services in relation to printed matter; retail services in relation to preparations for making beverages; retail services in relation to saddlery; retail services in relation to non-alcoholic beverages; retail services relating to automobile accessories; retail services in relation to sanitary installations; retail services in relation to beauty implements for animals; retail services in relation to gardening products; retail services in relation to pushchairs; retail services in relation to earthmoving equipment; retail services in relation to vehicles; retail services in relation to furniture; retail services in relation to coffee; retail services in relation to confectionery; retail services connected with the sale of subscription boxes containing food; retail services in relation to paints; retail services relating to fruit; retail services in relation to bags; retail services relating to food preparation implements; retail services in relation to art materials; retail services in relation to wall coverings; shop retail services connected with carpets; retail services in relation to kitchen appliances; retail services in relation to foodstuffs; retail services in relation to meats; retail services in relation to freezing equipment; retail services connected with the sale of clothing and clothing accessories; retail services in relation to frozen yogurts; retail services in relation to time instruments; retail services in relation to navigation devices; retail services connected with the sale of subscription boxes containing chocolates; retail services in relation to downloadable electronic publications; retail services in relation to refrigerating equipment; retail services relating to furs; retail services in relation to physical therapy equipment; retail services in relation to disposable paper products; retail services relating to accumulators; retail services in relation to lighting; retail services in relation to bedding for animals; retail services in relation to cutlery; retail services in relation to gardening articles; retail services in relation to footwear; retail services in relation to sporting equipment; retail services in relation to horticulture products; retail services in relation to domestic electronic equipment; retail services in relation to diving equipment; retail services in relation to beauty implements for humans; retail services in relation to

veterinary preparations; retail services in relation to hand-operated tools for construction; retail services in relation to sun tanning appliances; retail services in relation to recorded content; retail services for pharmaceutical, veterinary and sanitary preparations and medical supplies; retail services relating to food; retail services in relation to sex aids; retail services in relation to bicycles; retail services in relation to headgear; retail services relating to live animals; retail services in relation to sewing articles; retail services in relation to festive decorations; retail services in relation to information technology equipment; retail services connected with the sale of subscription boxes containing beers; retail services in relation to computer software; retail services relating to horticultural products; retail services in relation to alcoholic beverages (except beer); retail services via global computer networks related to beer; retail services for works of art provided by art galleries; retail services in relation to food cooking equipment; retail services in relation to hygienic implements for animals; retail services in relation to ice creams; retail services in relation to umbrellas; retail services in relation to building materials; retail services in relation to downloadable music files; retail services in relation to sporting articles; retail services in relation to medical instruments; retail services in relation to litter for animals; retail services in relation to hearing protection devices; retail services in relation to cleaning preparations; retail services relating to fake furs; retail services in relation to sorbets; retail services in relation to domestic electrical equipment; retail services in relation to preparations for making alcoholic beverages; retail services in relation to luggage; retail services relating to sporting goods; retail services in relation to heating equipment; retail services in relation to heaters; retail services in relation to metal hardware; retail services relating to kitchen knives; wholesale services in relation to dietetic preparations; wholesale services in relation to clothing; wholesale services in relation to beauty implements for animals; wholesale services in relation to foodstuffs; wholesale services in relation to chemicals for use in agriculture; wholesale services in relation to animal grooming preparations; wholesale services in relation to furniture; wholesale services in relation to cleaning preparations; wholesale services in relation to jewellery; wholesale services in relation to sanitary installations; wholesale services in relation to food preparation implements; wholesale services in relation to medical apparatus; wholesale services in relation to preparations for making beverages; wholesale services in relation to chemicals for use in horticulture; wholesale services in relation to fragrancings preparations; wholesale services in relation to footwear; wholesale services in relation to heaters; wholesale services in relation to lubricants; wholesale services in relation to cleaning articles; wholesale services in relation to medical instruments; wholesale services in relation to veterinary instruments; wholesale services in

relation to veterinary apparatus; wholesale services in relation to beauty implements for humans; wholesale services in relation to hygienic implements for animals; wholesale services in relation to yarns; wholesale services in relation to hygienic implements for humans; wholesale services in relation to headgear; wholesale services in relation to dietary supplements; wholesale services for pharmaceutical, veterinary and sanitary preparations and medical supplies; wholesale services in relation to chemicals for use in forestry; wholesale services in relation to veterinary articles; wholesale services in relation to saddlery; wholesale services in relation to toiletries; wholesale services in relation to threads; wholesale services in relation to fabrics; wholesale services in relation to veterinary preparations and articles; wholesale services in relation to veterinary preparations; wholesale services in relation to preparations for making alcoholic beverages; online retail store services relating to cosmetic and beauty products; online retail store services relating to clothing; mail order retail services connected with clothing accessories; mail order retail services for cosmetics; online retail services relating to jewelry; mail order retail services for clothing; online retail services relating to clothing; online retail services relating to handbags; online retail services relating to luggage; online retail services relating to cosmetics.

(260) AM 2023 118114 A

(800) 1665616

(151) 2022 03 09

(891) 2022 03 09

(731) Winner Star Holdings Limited

Room 306, Yip Fung Building, 2-12 D'Aguiar,  
Street Central, Hong Kong, China

(540)

极兔

(591) Black, white

(531) 28.03

(511)

39 – Freighting; transport; freight brokerage; wrapping of goods; marine transport; car transport; air transport; car rental; storage of goods; warehousing; parcel delivery; courier services [messages or merchandise]; transport services for sightseeing tours.

(260) AM 2023 118115 A

(800) 1665640

(151) 2022 04 05

(891) 2022 04 05

(731) KRKA, tovarna zdravil, d.d., Novo mesto

Šmarješka cesta 6, SI-8000 Novo mesto,  
Slovenia

(540)

**DAPAFORSE**

(591) Black, white

(511)

5 – Pharmaceutical preparations.

(260) AM 2023 118116 A

(800) 1665655

(151) 2022 04 21

(891) 2022 04 21

(731) ARKEMA FRANCE

420 rue d'Estienne d'Orves, F-92700 Colombes,  
France

(540)

**ARKEMA**

(591) Black, white

(531) 27.05.01

(511)

1 – Chemical products for use in industry, science, photography, as well as in agriculture, horticulture and forestry; unprocessed artificial resins; unprocessed plastic materials; soil fertilizers; fire-extinguishing compositions; tempering and soldering preparations; chemical substances for preserving foodstuffs; tanning materials; adhesives for use in industry; chemical products for the manufacture of adhesives; adhesives (adhesive materials) for industry; adhesives for ceiling coverings, for floor coverings, for wall coverings; glues for repair and assembly of objects; glues for wallpaper; separating and unsticking [ungluing] products; size for finishing and priming; solvents (chemical products for use in industry) for glues; unprocessed epoxy, acrylic and synthetic resins.

16 – Adhesives (glues) for stationery or household purposes; paintbrushes; artists' materials; glues for wood for household use; glues for fabrics for household use.

17 – Rubber, gutta-percha, gum, asbestos, mica; products made of semi-finished plastic materials; packing, stopping and insulating materials; flexible pipes not of metal; Epoxy, acrylic and synthetic resins (semi-finished products); sealant compounds for joints; insulating coatings; insulating varnish; adhesive tapes and strips other than for medical, stationery or household purposes; waterproof packings.

42 – Industrial research and analysis, technological and scientific services, namely research and development of new products, chemical research, mechanical research, biological research, chemical analysis; technical project studies in the field of chemistry.

(260) AM 2023 118118 A  
 (800) 1665678  
 (151) 2022 03 05  
 (891) 2022 03 05  
 (731) Seylانه Sabz manufacturing and commercial Co  
 No.1, Alley 1st Apadana St, Golshan St, Sohrevard i Ave, Tehran, Islamic Republic of Iran

(540)

**COME ON**

کامان

(591) Black, white  
 (531) 28.01; 28.19  
 (511)

3 – Ethereal essences; nail varnish; soaps; cosmetic creams; scented water; depilatory preparations; antiperspirants [toiletries]; hair colorants; hair waving preparations; cosmetics; sun-tanning preparations [cosmetics]; lotions for cosmetic purposes; cotton wool for cosmetic use; petroleum jelly for cosmetic purposes; make-up powder; shaving preparations; cleaning preparations; cosmetic kits; talcum powder, for toilet use; mouth washes, not for medical purposes; eau de cologne; make-up; deodorants for personal use; washing preparations; perfumes; bleaching preparations [decolorants] for cosmetic purposes; toothpaste; hair lotions; after-shave lotions; shampoos; cosmetic pencils; beauty masks; tissues impregnated with cosmetic lotions; preparations for unblocking waste pipes; blushers.

(260) AM 2023 118119 A  
 (800) 1665679  
 (151) 2022 03 13  
 (891) 2022 03 13  
 (731) Seylانه Sabz manufacturing and commercial Co  
 No.1, Alley 1st Apadana St, Golshan St, Sohrevard i Ave, Tehran, Islamic Republic of Iran

(540)

**KODEX**

کدکس

(591) Black, white  
 (531) 28.01  
 (511)

10 – Gloves for medical purposes; condoms.

(260) AM 2023 118120 A  
 (800) 1665697  
 (151) 2022 04 12  
 (891) 2022 04 12  
 (731) Kia Corporation  
 12, Heolleung-ro, Seocho-gu, Seoul 06797, Republic of Korea

(540)

**wible**

(591) Black, white  
 (531) 27.05.01; 27.05.17  
 (511)

9 – Software for commerce over a global communications network; navigation software; computer software to automate data warehousing; satellite imagery photo-interpretation software; application software for smartphones; computer programs for telecommunication using the internet and the worldwide web; communications processing computer software; computer software for data processing; computer programs for network management; monitors [computer programs]; computer software for providing security to networks; computer software for biometric systems for the identification and authentication of persons; computer software for controlling the operation of audio and video devices; downloadable computer software for remote monitoring and analysis; business management software; telecommunications software; virtual reality software; computer software for personal information management; educational software; computer software relating to the handling of financial transactions; downloadable software for virtual money; downloadable software for electronic money payment; interactive computer software; computer software to enhance the audiovisual capabilities of multimedia applications; computer software for wireless network communications; computer software for wireless content delivery; computer application software for use in implementing the internet of things (IoT); computer software for analysing market information; computer programs for video and computer games; software for GPS navigation systems; computer software for Global Positioning Systems [GPS]; recorded computer software storing electronic map; recorded computer software for safe car driving; computer e-commerce software; privacy protection software; computer software for controlling the operation of audio and video devices; speech recognition software; GPS used in cars; satellite receiver attached to cars; digital car driving recording apparatus; batteries for automobiles; OBD (On-Board Diagnosis) apparatus for automobiles; electronic driver-interface displays for automobiles; car telephone installations.

(260) AM 2023 118121 A

(800) 1665708

(151) 2022 04 13

(891) 2022 04 13

(731) Scientific Technological Pharmaceutical Firm  
"POLYSAN" Ltd.

Salova Street, 72, Bldg. 2, Liter A, RU-192102

Saint Petersburg, Russian Federation

(540)

# Процитол

(591) Black, white

(531) 28.05

(511)

5 – Drugs for medical purposes; veterinary preparations; pharmaceutical preparations; chemico-pharmaceutical preparations.

(260) AM 2023 118122 A

(800) 1665716

(151) 2022 04 08

(891) 2022 04 08

(731) Wemade Co., Ltd.

Wemade Tower, 49, Daewangpangyo-ro 644  
beon-gil, Bundang-gu, Seongnam-si, Gyeonggi-do, Republic of Korea

(540)

# KLEVA

(591) Black, white

(511)

9 – Virtual reality game software; interactive multimedia software for playing games; computer game software downloadable via a global computer network and wireless devices; recorded computer game software; recorded computer game programs; downloadable mobile game software; downloadable electronic game programs; downloadable computer game software; downloadable computer game programs; interactive computer game programs; computer game software for use on mobile and cellular phones; computer programs and software for image processing used for mobile telephones; electronic game software for mobile telephones; computer game programs downloadable via the internet; interactive game programs; electronic game software; electronic game programs; computer software for controlling and managing access server applications; computer game programs; electronic game software for hand-held electronic devices; downloadable software for electronic money payments; downloadable computer programs for electronic money payments; downloadable software for virtual money; virtual reality software; downloadable software for generating cryptographic keys for receiving and spending cryptocurrency.

36 – Issuance of discount coupons in the nature of tokens of value; brokerage services relating to exchange

between virtual currencies; provision of information relating to virtual currencies; virtual currency brokerage; mining of virtual currency for others; financial affairs; on-line real-time currency trading; issuance of mobile discount coupons in the nature of tokens of value; rental of real estate; brokerage services relating to virtual currency, via online portal services; processing of electronic cash transactions; electronic wallet services (electronic payment services); electronic payment for others; issuance of electronic wallets for electronic payment; payment transaction processing services of electronic money; provision of information relating to payment transaction processing of electronic money; capital management; issuance of electronic coupons in the nature of tokens of value via smart phones; providing information relating to financial and monetary affairs; financing services; money transfer; electronic funds transfer and payment services.

42 – Designing, creating, maintaining and hosting of mobile applications; development of software for electronic commerce based on blockchain technology; internet platform development based on blockchain technology; computer system development; providing PaaS (platform as a service); Platform as a Service [PaaS]; designing, creating, maintaining and hosting of websites; constructing internet platforms for electronic commerce; computer programming; computer software development; development of software relating to virtual currency; computer technical consulting services in the field of virtual currency and blockchain technology.

(260) AM 2023 118123 A

(800) 1665743

(151) 2022 01 13

(891) 2022 01 13

(731) European Society of Anaesthesiology and Intensive Care

Rue des Comédiens 24, B-1000 Bruxelles,  
Belgium

(540)

# CEEA

(591) Black, white

(511)

16 – Printed matter, all in the field of anesthesiology, medical science and intensive care medicine; printed matter for instructional purposes, all in the field of anesthesiology, medical science and intensive care medicine; educational publications, all in the field of anesthesiology, medical science and intensive care medicine; printed publications, all in the field of anesthesiology, medical science and intensive care medicine; promotional publications, all in the field of anesthesiology, medical science and intensive care medicine; newsletters, all in the field of anesthesiology, medical science and intensive care medicine; news bulletins, all in the field of anesthesiology, medical sci-

ence and intensive care medicine; periodicals, all in the field of anesthesiology, medical science and intensive care medicine; printed reports, all in the field of anesthesiology, medical science and intensive care medicine; books, all in the field of anesthesiology, medical science and intensive care medicine; booklets, all in the field of anesthesiology, medical science and intensive care medicine; pamphlets, all in the field of anesthesiology, medical science and intensive care medicine; instructional and teaching materials, all in the field of anesthesiology, medical science and intensive care medicine; printed certificates, all in the field of anesthesiology, medical science and intensive care medicine; directories, all in the field of anesthesiology, medical science and intensive care medicine.

41 – Education, teaching and training, all in the field of anesthesiology, medical science and intensive care medicine; publication of educational materials, all in the field of anesthesiology, medical science and intensive care medicine; publication of printed matter, all in the field of anesthesiology, medical science and intensive care medicine; publication of printed matter in electronic form, all in the field of anesthesiology, medical science and intensive care medicine; arranging, conducting and organisation of seminars, all in the field of anesthesiology, medical science and intensive care medicine; arranging and conducting of conferences, congresses and symposiums, all in the field of anesthesiology, medical science and intensive care medicine.

(260) AM 2023 118124 A

(800) 1665779

(151) 2022 03 28

(891) 2022 03 28

(731) MARKOSYAN ANNA

ALEKSANDROVNA

g. Zelenograd, korp. 534, kv. 279, 280,

RU-124482 Moscow, Russian Federation

(540)



(591) Black, white

(531) 02.01.15; 02.01.18; 02.01.23; 02.01.24;

05.11.15; 11.03.02; 14.09.01; 25.01.25;

26.11.02; 26.11.08; 27.05.01; 27.05.03;

27.05.11

(511)

43 – Rental of meeting rooms; snack-bar services; cafe services; cafeteria services; rental of cooking apparatus; rental of chairs, tables, table linen, glassware;

restaurant services; self-service restaurant services; food sculpting; bar services; food and drink catering; washoku restaurant services.

(260) AM 2023 118125 A

(800) 1665806

(151) 2022 02 17

(891) 2022 02 17

(731) Fédération Internationale de Football

Association (FIFA)

FIFA-Strasse 20, CH-8044 Zürich, Switzerland

(540)

**FIFA**

(591) Black, white

(511)

35 – Advertising; commercial business management; commercial administration; employment agency services; personnel recruitment; advertising services through sponsorship; sales promotion of media rights; promotion of sports events in the field of soccer; on-line advertising services; information and advisory services in relation to commercial business management and commercial administration provided online or via the Internet; advertising and promotional services; dissemination of advertising and promotional materials; provision and rental of advertising space and advertising material; publication of advertising material and texts; rental of advertising time in film credits; television advertising, radio advertising; promotion of sports events in the field of football; promotion of the goods and services of third parties; company sponsorship research (sponsoring via advertising promotion) in relation to football competitions; compilation of advertisements for use as web pages on the Internet or on wireless electronic communication devices; provision of space on web sites for advertising goods and services; provision of an online marketplace for buyers and sellers of goods and services; on-line auction services; collection of directories for publication on the Internet and on wireless electronic communication networks; promotional marketing services; services provided by an agency for sports promotion and public relations; market study services; marketing research services; public opinion polling services; organization of events, exhibitions, trade fairs and shows for commercial, promotional purposes; organization of advertising for trade fairs; data bank management services; compilation of statistics; collection of data, statistics and other information on sports performances; organization advice and business management; business consulting for companies; organization of promotional competitions; provision of commercial information; advertising for sports events in the field of football; retailing services, including online retailing services, in relation to articles of common metals, tools and utensils, optical, audiovisual, magnetic, electric and electronic apparatus and equipment, medical apparatus and equipment, lighting, he-

ating, cooking, refrigeration, drying and ventilation apparatus and equipment, vehicles and accessories therefor, articles of precious metals, jewelry and horological and chronometric instruments, badges and pins, musical instruments, articles of paper and cardboard, printed and stationery articles, tickets for sports events, articles of leather and imitation leather, luggage and bags, umbrellas, furniture, promotional and exhibition articles, textile articles, clothing, headgear and footwear, ribbons, cords and derivatives, floor coverings, games, toys, sports articles, food and foodstuffs, non-alcoholic and alcoholic beverages, solvents, paraffin, wax, bitumen and petroleum, motor spirits, oils, lubricants, transmission fluids, brake fluids, antifreeze solution, coolant fluids, hydraulic fluids, fats, gasoline, gasoline for engines, diesel fuel, mazut, fuel gas, combustible gas, biofuel, hubcaps, tires, tire casings, alloys for wheels, sun screens, roof rails, carriers for transporting sports equipment, seat covers, car covers, potato chips, French fries, milk, milk beverages, drinking yogurts, milkshakes, dairy products, cheeses, soy milk (milk substitute), non-alcoholic beverages, mineral and aerated waters, energy drinks, isotonic drinks, fruit and vegetable drinks and juices, beers, lagers and ales, alcohol-free beers, coffee, tea, cocoa, cakes, cookies (biscuits), crackers, candy, edible ices, confectionery, chocolate confectionery, chocolate, corn chips, mustard, vinegar, sauces (condiments), hamburgers (sandwiches), cheeseburgers (sandwiches), sandwiches with fish, meat or vegetables, hotdogs (sandwiches), enabling customers to conveniently view and purchase those goods in stores or on the Internet or via wireless electronic communication; retail services for foodstuffs and beverages; retailing of vending machines with food and beverages enabling the consumer to view and purchase such food and beverages conveniently; retailing services for food in restaurants, school dining rooms, cafeterias, bakeries, delicatessens, company dining rooms, specialty food stores (ice cream stores, yogurt stores, cafés, cookie stores); retail services, including online retail services, in connection with fuel, kerosene, fuel gas, bio-fuel, motor oils and greases, lubricants and greases, hydraulic transmission oils and fluids, fluids for hydraulic circuits and hydraulic oils, enabling customers to view and purchase those goods in stores or via the Internet or via wireless electronic communication; commercial administration services for the processing of sales made on the Internet or on wireless electronic communication devices; business administration services, namely, billing; sales promotion, namely creation of preferential programs for customers; ticket sale promotion services; customer loyalty services and customer club services for commercial, promotional and/or advertising purposes; compilation of data into a central file, namely still or animated images; retailing service for footwear, headwear, eyewear articles, articles of apparel, bags, sports bags, backpacks, sports equipment, balls for football

games, works of art, trophies, toys and non-downloadable virtual accessories; providing Internet sites for online marketplaces for the sale and purchase of virtual goods; organizing and conducting events, exhibitions and conferences for commercial purposes in the field of interactive entertainment, virtual reality, consumer electronics and video games; online retailing service for virtual reality and augmented reality software and hardware; online retailing service for virtual reality content and digital content, especially, pre-recorded music, video, images, text, audiovisual content and virtual reality and augmented reality game software.

(260) AM 2023 118126 A  
 (800) 714381  
 (151) 1999 06 15  
 (891) 2022 05 02  
 (731) LOHR INDUSTRIE, société anonyme  
 29, rue du 14 Juillet, F-67980  
 HANGENBIETEN, France  
 (540)

## VALOHR

(591) Black, white  
 (511)  
 12 – Road or rail vehicles for transporting people, namely buses, trolleybuses, streetcars (trams), motor coaches, railcars, omnibuses, trains, subways; multi-articulated land vehicles for transporting persons or goods; commercial road vehicles; car-carrying road vehicles; non-agricultural tractors; trailers and semi-trailers; road machinery.

(260) AM 2023 118127 A  
 (800) 1465448  
 (151) 2019 01 18  
 (891) 2022 05 24  
 (731) GEN İLAÇ VE SAĞLIK ÜRÜNLERİ  
 SANAYİ VE TİCARET ANONİM ŞİRKETİ  
 Mustafa Kemal Mahallesi 2119., Sokak  
 No:3 D:2-3, Çankaya, TR-06520 Ankara,  
 Türkiye  
 (540)



(591) Blue (Pantone 660 C), gray (Pantone Cool Gray 11 C) and green (Pantone 354 C).  
 (531) 01.13.15; 27.05.01; 27.05.17; 29.01.13  
 (511)  
 2 – Paints, varnishes, lacquers; preservatives against rust and against deterioration of wood; colorants, dyes; inks for printing, marking and engraving; raw na-

tural resins; metals in foil and powder form for use in painting, decorating, printing and art.

5 – Pharmaceuticals, medical and veterinary preparations; sanitary preparations for medical purposes; dietetic food and substances adapted for medical or veterinary use, food for babies; dietary supplements for humans and animals; plasters, materials for dressings; material for stopping teeth, dental wax; disinfectants; preparations for destroying vermin; fungicides, herbicides.

10 – Surgical, medical, dental and veterinary apparatus and instruments; artificial limbs, eyes and teeth; orthopedic articles; suture materials; therapeutic and assistive devices adapted for the disabled; massage apparatus; apparatus, devices and articles for nursing infants; sexual activity apparatus, devices and articles.

35 – The bringing together, for the benefit of others, of a variety of goods, namely, paints, varnishes, lacquers, preservatives against rust and against deterioration of wood, colorants, dyes, inks for printing, marking and engraving, raw natural resins, metals in foil and powder form for use in painting, decorating, printing and art, pharmaceuticals, medical and veterinary preparations, sanitary preparations for medical purposes, dietetic food and substances adapted for medical or veterinary use, food for babies, dietary supplements for humans and animals, plasters, materials for dressings, material for stopping teeth, dental wax, disinfectants, preparations for destroying vermin, fungicides, herbicides, surgical, medical, dental and veterinary apparatus and instruments, artificial limbs, eyes and teeth, orthopedic articles, suture materials, therapeutic and assistive devices adapted for the disabled, massage apparatus, apparatus, devices and articles for nursing infants, sexual activity apparatus, devices and articles, enabling costumers to conveniently view and purchase those goods, such services may be provided by retail stores, wholesale outlets by means of electronic media or through mail order catalogues, advertising, business management, business administration, office functions concerning, paints, varnishes, lacquers, preservatives against rust and against deterioration of wood, colorants, dyes, inks for printing, marking and engraving, raw natural resins, metals in foil and powder form for use in painting, decorating, printing and art, pharmaceuticals, medical and veterinary preparations, sanitary preparations for medical purposes, dietetic food and substances adapted for medical or veterinary use, food for babies, dietary supplements for humans and animals, plasters, materials for dressings, material for stopping teeth, dental wax, disinfectants, preparations for destroying vermin, fungicides, herbicides, surgical, medical, dental and veterinary apparatus and instruments, artificial limbs, eyes and teeth, orthopedic articles, suture materials, therapeutic and assistive devices adapted for the disabled, massage apparatus, apparatus, devices and articles for nursing infants, sexual activity apparatus, devices and

articles.

44 – Medical services; veterinary services; hygienic and beauty care for human beings or animals; agriculture, horticulture and forestry services.

(260) AM 2023 118128 A

(800) 1506171

(151) 2018 11 09

(891) 2022 05 05

(731) SANDVIK INTELLECTUAL PROPERTY AB  
SE-811 81 Sandviken, Sweden

(540)



(591) Black, white

(531) 26.04.02; 26.04.05; 26.04.07; 26.04.24;  
26.11.01; 26.11.06; 26.11.08

(511)

4 – Lubricants, lubricating and cutting fluids, industrial oils and greases; lubricating oils; non-chemical additives for fuels, lubricants and greases; dust absorbing compositions; dust binding compositions; dust controlling and removing compositions.

6 – Common metals, unwrought or semi-wrought; alloys of common metal; irons and steels; strip steel springs; casting alloys, wire, ores of metal, barrels of metal, barrel hoops of metal, pipes and tubes of metal, pipe muffers of metal, metal pipe fittings, cables of metal, non-electric, clamping sleeves, metal pipe collars, elbows of metal for pipes, nozzles of metal, steel strip, iron strip, rods of metal, plates of metal, sheets of metal, metal bars for further manufacture, metal billets, blooms [metallurgy]; common metals in powder form [semi-wrought], ring-shaped fittings of metal, metal shims, housings, packages, modules, tubs, holders, wafers and wire bonders being metal modular hardware of metal; brazing alloys, solder pastes; common metal powders used in manufacturing; centralizers and centralizer locks (metal hardware); casing shoes; guide shoes for oilfield tubular goods; cement shoes for oilfield tubular goods.

7 – Anti-friction bearings for machines; anti-friction pads for machines; machines and machine tools for the cutting and forming of materials; conveyers; conveyor belts; power operated metal machine tools, namely, wire drawing tools, pressing tools, grinding tools, threading tools, sharpening tools, chiseling tools, shearing tools, punching tools, piercing tools, broaching tools, reaming tools, drilling tools, milling tools, cutting and turning tools; inserts for power-operated chiseling tools, shearing tools, punching tools, piercing tools, broaching tools, reaming tools, cutting and turning tools; machine tool holders; machines parts, namely, blades and blade holders, wear plates and



strips, bearings, as parts of machines; rock bolting rigs; cargo handling machines; cranes; casting machines; double belt presses; machine parts, namely, mandrels; mechanical diggers; mechanical disintegrators; earth moving machines, namely, excavators, loaders, scrapers; loading and unloading machines; mechanical and hydraulic lifts hoists; forging machines; foundation work machines; granulating machines for chemical processes; hauling apparatus, used in the mining industry; lathes; lathe tools for metalworking; earth-moving, construction, oil and gas extraction and mining machines; mine working machines; fuel pumps for land vehicles; pneumatic transporters; pneumatic controls for machines, motors and engines; hydraulic and pneumatic hammers; pulleys being parts of machines; rolls for rolling mills; rolling mills; sifting machines; power-operated sprayers; sieves being machines; sieves being machine parts; gravel and dirt sorting and screening machines; mechanical spreaders; mechanical separators; motors and engines except for land vehicles; machine couplings and transmission components except for land vehicles; automatic vending machines; automated dispensing machines for tools and metal cutting tools; grinding machines for metal cutting; power-operated grinding wheels; grinding tools for grinding machines; earth moving machines, namely graders, grading tools; mine carbide tip tools, truck boards drilling pipes, hammer lifting bails, foot valve rods, drill tubes, shank adapters, drill bits, hand held rock drilling tools, integral drill steels, tapered and threaded rods, guide and drill tubes, drilling and bolting tools, shank adapters, raise boring tools, reaming heads, continuous miner cutting tools, drilling accessories for the installation of strata support products, casing accessories and completion tools, reamers and reaming apparatus, drills, drill rigs and drilling equipment and apparatus, hydraulic rock drills, mining and tunneling jumbos, screw boosters, raise boring machines and reaming heads, bolters, excavators, hydraulic rotation heads, cone splitters, blast hole splitters, miners, bolter miners, borer miners, road headers, drill rods, extension rods, spanners for installing rock bolts and drill chuck extension spanners, pullers and extractors, pliers, mineral ground tools, blocks and sleeves, crushers and crushing apparatus, crushing chambers, mantels and jaw plates, crusher wear parts, screens [parts of machines], scalpers, breakers, chisel and compacting tools, filters and filtration cartridges, hydraulic cylinders, blocks and valves, hydraulic pumps, drive shafts, radiators [cooling] for motors and engines, oil coolers, axles, hydraulic hoses, pipes, fittings and adapters, air compressors, hydraulic oil filtering units, exhaust systems, pressure accumulators, liners for crushing and screening equipment, wear plates, impact bars, ground engaging tools, including buckets, shrouds, lips, adapters and teeth; all the aforesaid goods being machines or power tools, or parts of machines and power tools included in this class.

12 – Vehicles; apparatus for locomotion by land, air or water, namely, motor vehicles, namely, automobiles, trucks, vans, sport utility vehicles and structural parts therefor; vehicles incorporating bucket loaders; bulk hauling vehicles; apparatus for locomotion by land, air or water; trailers; gearboxes; structural parts of the aforesaid goods.

(260) AM 2023 118129 A

(800) 1506255

(151) 2018 10 29

(891) 2022 05 05

(731) SANDVIK INTELLECTUAL PROPERTY AB  
SE-811 81 Sandviken, Sweden

(540)

## SANDVIK

(591) Black, white

(511)

4 – Lubricants, lubricating and cutting fluids, industrial oils and greases; lubricating oils; non-chemical additives for fuels, lubricants and greases; dust absorbing compositions; dust binding compositions; dust controlling and removing compositions.

6 – Common metals, unwrought or semi-wrought; alloys of common metal; irons and steels; strip steel springs; casting alloys, wire, ores of metal, barrels of metal, barrel hoops of metal, pipes and tubes of metal, pipe muffs of metal, metal pipe fittings, cables of metal, non-electric, clamping sleeves, metal pipe collars, elbows of metal for pipes, nozzles of metal, steel strip, iron strip, rods of metal, plates of metal, sheets of metal, metal bars for further manufacture, metal billets, blooms [metallurgy]; common metals in powder form [semi-wrought], ring-shaped fittings of metal, metal shims, housings, packages, modules, tubs, holders, wafers and wire bonders being metal modular hardware of metal; brazing alloys, solder pastes; common metal powders used in manufacturing; centralizers and centralizer locks (metal hardware); casing shoes; guide shoes for oilfield tubular goods; cement shoes for oilfield tubular goods.

7 – Anti-friction bearings for machines; anti-friction pads for machines; machines and machine tools for the cutting and forming of materials; conveyers; conveyor belts; power operated metal machine tools, namely, wire drawing tools, pressing tools, grinding tools, threading tools, sharpening tools, chiseling tools, shearing tools, punching tools, piercing tools, broaching tools, reaming tools, drilling tools, milling tools, cutting and turning tools; inserts for power-operated chiseling tools, shearing tools, punching tools, piercing tools, broaching tools, reaming tools, cutting and turning tools; machine tool holders; machine parts, namely, blades and blade holders, wear plates and strips, bearings, as parts of machines; rock bolting rigs; cargo handling machines; cranes; casting machines; double belt presses; machine parts, namely, man-

drels; mechanical diggers; mechanical disintegrators; earth moving machines, namely, excavators, loaders, scrapers; loading and unloading machines; mechanical and hydraulic lifts hoists; forging machines; foundation work machines; granulating machines for chemical processes; hauling apparatus, used in the mining industry; lathes; lathe tools for metalworking; earth-moving, construction, oil and gas extraction and mining machines; mine working machines; fuel pumps for land vehicles; pneumatic transporters; pneumatic controls for machines, motors and engines; hydraulic and pneumatic hammers; pulleys being parts of machines; rolls for rolling mills; rolling mills; sifting machines; power-operated sprayers; sieves being machines; sieves being machine parts; gravel and dirt sorting and screening machines; mechanical spreaders; mechanical separators; motors and engines except for land vehicles; machine couplings and transmission components except for land vehicles; automatic vending machines; automated dispensing machines for tools and metal cutting tools; grinding machines for metal cutting; power-operated grinding wheels; grinding tools for grinding machines; earth moving machines, namely graders, grading tools; mine carbide tip tools, truck boards drilling pipes, hammer lifting bails, foot valve rods, drill tubes, shank adapters, drill bits, hand held rock drilling tools, integral drill steels, tapered and threaded rods, guide and drill tubes, drilling and bolting tools, shank adapters, raise boring tools, reaming heads, continuous miner cutting tools, drilling accessories for the installation of strata support products, casing accessories and completion tools, reamers and reaming apparatus, drills, drill rigs and drilling equipment and apparatus, hydraulic rock drills, mining and tunneling jumbos, screw boosters, raise boring machines and reaming heads, bolters, excavators, hydraulic rotation heads, cone splitters, blast hole splitters, miners, bolter miners, borer miners, road headers, drill rods, extension rods, spanners for installing rock bolts and drill chuck extension spanners, pullers and extractors, pliers, mineral ground tools, blocks and sleeves, crushers and crushing apparatus, crushing chambers, mantels and jaw plates, crusher wear parts, screens [parts of machines], scalpers, breakers, chisel and compacting tools, filters and filtration cartridges, hydraulic cylinders, blocks and valves, hydraulic pumps, drive shafts, radiators [cooling] for motors and engines, oil coolers, axles, hydraulic hoses, pipes, fittings and adapters, air compressors, hydraulic oil filtering units, exhaust systems, pressure accumulators, liners for crushing and screening equipment, wear plates, impact bars, ground engaging tools, including buckets, shrouds, lips, adapters and teeth; all the aforesaid goods being machines or power tools, or parts of machines and power tools included in this class.

12 – Vehicles; apparatus for locomotion by land, air or water, namely, motor vehicles, namely, automobiles, trucks, vans, sport utility vehicles and structural

parts therefor; vehicles incorporating bucket loaders; bulk hauling vehicles; apparatus for locomotion by land, air or water; trailers; gearboxes; structural parts of the aforesaid goods.

(260) AM 2023 118176 A

(800) 1666086

(151) 2022 05 05

(891) 2022 05 05

(731) Like house (Haikou) Network Technology Co., Ltd.

No. 224, 2F, A Building, Zhongxian Residece, Meipo Road No.9, Bailong Street, Meilan District, Haikou City, Hainan Province, China

(540)

## WISH HOUSE

(591) Black, white

(531) 27.05.01

(511)

35 – Advertising; presentation of goods on communication media, for retail purposes; commercial administration of the licensing of the goods and services of others; providing business information via a website; provision of an online marketplace for buyers and sellers of goods and services; sales promotion for others; personnel management consultancy; updating and maintenance of data in computer databases; accounting.

(260) AM 2023 118187 A

(800) 1666434

(151) 2021 12 01

(891) 2021 12 01

(731) Unisys Corporation

Mailstop 2NW, 801 Lakeview Drive, Suite 100, Blue Bell PA 19424, USA

(540)



(591) The color(s) blue and white is/are claimed as a feature of the mark

(531) 01.05.06; 27.05.21; 29.01.12

(511)

35 – Business management consulting services; business consulting services and business strategic planning of information management and information technology.

42 – Providing temporary use of online non-downloadable computer software applications for managing, monitoring, optimizing, organizing, tracking, securing

and troubleshooting of messages, text, images, files, audio, video and audio-visual content and other data for the facilitation of communications between two or multiple users via computer networks, communication networks and the global information network; providing temporary use of online non-downloadable computer software applications for use as an application programming interface (API) for communications software facilitating voice over internet protocol (VOIP) calls, phone calls, video calls, text messages, instant message and online social networking services; computer technical support services, namely, 24/7 help desk services for IT infrastructure, operating systems, database systems, and web applications; managed information technology services for others, namely, remote management of virtual infrastructure and cloud computing systems, networking, computer software applications; technical support in the form of monitoring global computer network systems; technical support services in the form of troubleshooting of computer hardware and software problems; data security consultancy; computer security threat analysis for protecting data; computer network security services; computer software consulting; consulting services in the field of cloud computing; computer services, namely, cloud hosting provider services and cloud migration services; consulting services in the field of design, selection, implementation and use of computer hardware and software systems for others; providing temporary use of non-downloadable software for accessing business analytics reports and business data analysis in the field of information technology, namely, computers, computer hardware, computer networks, and computer software; providing temporary use of non-downloadable software for computer system and application development, deployment and management to improve the security, stability and operation of information technology systems, namely, computers, computer hardware, computer networks, and computer software systems; development of customized software for others for use in business analysis; software as a service (SaaS) services delivered on-demand and via cloud-based and cloud-hosted offerings, featuring software for indexing, searching, and monitoring third party client data from any application, server, or network device; software as a service (SaaS) services delivered on-demand and via cloud-based and cloud-hosted offerings, featuring business software applications for providing operation intelligence and business analytics for others in the field of the operation of information technology systems, namely, computers, computer hardware, computer networks, and computer software systems; software as a service (SaaS) services for managing, monitoring, optimizing, organizing, tracking, securing and troubleshooting of messages, text, images, files, audio, video and audio-visual content and other data for the facilitation of communications between two or multiple users via computer networks, communication net-

works and the global information network; software as a service (SaaS) services for use as an application programming interface (API) for communications software facilitating voice over internet protocol (VOIP) calls, phone calls, video calls, text messages, instant message and online social networking services; computerized data storage services.

(260) AM 2023 118196 A

(800) 1666839

(151) 2022 04 13

(891) 2022 04 13

(731) MEY ALKOLLÜ İÇKİLER SANAYİ VE  
TİCARET ANONİM ŞİRKETİ  
ESEANTEPE MAH. BAHAR SK. ÖZDİLEK,  
13 25 Şişli, İstanbul, Türkiye

(540)



(591) Black, white

(531) 01.15.15; 05.05.19; 05.05.20; 11.03.02;  
25.01.06

(511)

32 – Beers, mineral water, carbonated waters, non-alcoholic soft drinks; fruit beverages, fruit juices, syrups and other preparations for making beverages.

33 – Alcoholic beverages (except beers).

(260) AM 2023 118197 A

(800) 1666896

(151) 2022 02 16

(891) 2022 02 16

(731) Obshestvo s ogranichennoy otvetstvennostyu  
"TOSHKENT INDENIM"  
OOO "TOSHKENT INDENIM", na  
peresechenii ulits Farxod I Lyutfi, kvartal-12,  
Uchtepiniskiy rayon, gorod Tashkent,  
Uzbekistan

(540)



(591) Orange, white and black

(531) 27.05.02; 27.05.03; 29.01.13

(511)

25 – Clothing, footwear, headwear.

(260) AM 2023 118198 A

(800) 1666995

(151) 2022 01 11

(891) 2022 01 11

(731) Chekhlov Aleksei Gennad'evich

Dachnaya str., d. 9B, dp dsk "Michurinec",

RU-142784 Moscow, Russian Federation

(540)

## ОКЕАНОЛ

(591) Black, white

(531) 28.05

(511)

5 – Sanitary preparations for medical purposes; dietetic substances adapted for medical use; food for babies; all-purpose disinfectants; balms for medical purposes; petroleum jelly for medical purposes; mineral waters for medical purposes; thermal water; mud for baths; medicinal mud; deodorants, other than for human beings or for animals; mineral food supplements; food supplements for medical purposes; cod liver oil; capsules for medicines; cachets for pharmaceutical purposes; medicated sweets; medicinal roots; starch for dietetic or pharmaceutical purposes; milk sugar [nutritional supplement]; medicines for alleviating constipation; lotions for pharmaceutical purposes; liniments; ointments for pharmaceutical purposes; sunburn ointments; frostbite salve for pharmaceutical purposes; medicinal oils; dressings, medical; drugs for medical purposes; medicinal drinks; flour for pharmaceutical purposes; dietetic beverages adapted for medical purposes; medicinal infusions; tinctures for medical purposes; opodeldoc; decoctions for pharmaceutical purposes; pills for pharmaceutical purposes; albuminous preparations for medical purposes; biological preparations for medical purposes; vitamin preparations; therapeutic preparations for the bath; haemorrhoid preparations; preparations for callouses; preparations for the treatment of burns; fumigation preparations for medical purposes; opotherapy preparations; bronchodilating preparations; corn remedies; pharmaceutical preparations for treating dandruff; vermin destroying preparations; pharmaceutical preparations for skin care; medicinal hair growth preparations; preparations of trace elements for human and animal use; pharmaceutical preparations; enzyme preparations for medical purposes; chemical preparations for medical purposes; chilblain preparations; albuminous foodstuffs for medical purposes; dietetic food and substances adapted for medical or veterinary use, food for babies; by-products of the processing of cereals for medical purposes; tissues impregnated with pharmaceutical lotions; sarsaparilla for medical purposes; sugar for medical purposes; asthmatic tea; fumigating sticks; suppositories; linseed for pharmaceutical purposes; syrups for pharmaceutical purposes; turpentine for pharmaceutical purposes; soporifics; salts for mineral water baths; medicated bath salts; salts for medical purposes; malt for pharmaceutical purposes; antiseptic washing preparations; antiseptic body care

products; analgesic preparations; disinfectants for hygiene purposes; appetite suppressants for medical purposes; medical preparations for slimming purposes; detergents for medical purposes; vesicants; remedies for perspiration; remedies for foot perspiration; laxatives; tonics [medicines]; nervines; digestives for pharmaceutical purposes; serums; medicinal herbs; enzymes for medical purposes; ferments for pharmaceutical purposes; diabetic bread adapted for medical use; herbal teas for medicinal purposes; slimming tea for medical purposes; eucalyptus for pharmaceutical purposes; elixirs [pharmaceutical preparations].

(260) AM 2023 118199 A

(800) 1667064

(151) 2022 02 28

(891) 2022 02 28

(731) Santen Pharmaceutical Co., Ltd.

4-20 Ofuka-cho, Kita-ku, Osaka-shi,

Osaka 530-8552, Japan

(540)

## UPNEVE

(591) Black, white

(511)

5 – Collyrium; eye drops; ophthalmic pharmaceutical preparations; ophthalmological preparations; pharmaceutical preparations for treatment of cataracts; pharmaceutical preparations for treatment of glaucoma; pharmaceutical preparations for treatment of ocular hypertension; ophthalmic ointments, creams, lotions and gels; pharmaceutical preparations for use in eye injections; pharmaceutical preparations for treatment of pinguecula; pharmaceutical preparations for treatment of chalazion; pharmaceutical preparations for treatment of uveitis; pharmaceutical preparations for improving focus-adjustment function declined by accommodative asthenopia; pharmaceutical preparations for treatment of accommodative asthenopia; eye drops for treatment of keratoconjunctival epithelial disorder; antibacterial eye drops; antiallergic eye drops; pharmaceutical preparations; reagent paper for medical purposes; oiled paper for medical purposes; adhesive tapes for medical purposes; drug delivery agents in the form of edible wafers for wrapping powdered pharmaceuticals; gauze for medical use; capsules for medicines; eyepatches for medical purposes; ear bandages for medical purposes; menstruation bandages; menstruation tampons; sanitary napkins; sanitary panties; absorbent cotton; adhesive plasters; bandages for dressings; liquid bandages; breast-nursing pads; cotton sticks for medical purposes; diapers; diaper covers; dietary supplements for humans; nutritional supplements; dietetic beverages adapted for medical purposes; dietetic foods adapted for medical purposes; beverages for babies; food for babies; dietary supplements for animals.

(260) AM 2023 118200 A  
 (800) 1667066  
 (151) 2022 02 28  
 (891) 2022 02 28  
 (731) Santen Pharmaceutical Co., Ltd.  
 4-20 Ofuka-cho, Kita-ku, Osaka-shi,  
 Osaka 530-8552, Japan

(540)

## OPYNIE

(591) Black, white

(511)

5 – Collyrium; eye drops; ophthalmic pharmaceutical preparations; ophthalmological preparations; pharmaceutical preparations for treatment of cataracts; pharmaceutical preparations for treatment of glaucoma; pharmaceutical preparations for treatment of ocular hypertension; ophthalmic ointments, creams, lotions and gels; pharmaceutical preparations for use in eye injections; pharmaceutical preparations for treatment of pinguecula; pharmaceutical preparations for treatment of chalazion; pharmaceutical preparations for treatment of uveitis; pharmaceutical preparations for improving focus-adjustment function declined by accommodative asthenopia; pharmaceutical preparations for treatment of accommodative asthenopia; eye drops for treatment of keratoconjunctival epithelial disorder; antibacterial eye drops; antiallergic eye drops; pharmaceutical preparations; reagent paper for medical purposes; oiled paper for medical purposes; adhesive tapes for medical purposes; drug delivery agents in the form of edible wafers for wrapping powdered pharmaceuticals; gauze for medical use; capsules for medicines; eyepatches for medical purposes; ear bandages for medical purposes; menstruation bandages; menstruation tampons; sanitary napkins; sanitary panties; absorbent cotton; adhesive plasters; bandages for dressings; liquid bandages; breast-nursing pads; cotton sticks for medical purposes; diapers; diaper covers; dietary supplements for humans; nutritional supplements; dietetic beverages adapted for medical purposes; dietetic foods adapted for medical purposes; beverages for babies; food for babies; dietary supplements for animals.

(260) AM 2023 118201 A

(800) 1667099

(151) 2021 12 24

(891) 2021 12 24

(731) HANGZHOU TECHDERM BIOLOGICAL PRODUCTS CO., LTD.

Floor 2nd, East Building 6, No. 88 Jiangling Road, Binjiang District, Hangzhou City, Zhejiang Province, China

(540)

## SOFIDERM DEEP

(591) Black, white

(531) 27.05.01

(511)

3 – Soap; detergents other than for use in manufacturing operations and for medical purpose; polishing preparations; grinding preparations; perfumery; cosmetics; dentifrices; incense; cosmetics for animals; air fragrancing preparations.

5 – Pesticides; babies' diapers; medical dressings; adhesive bands for medical purposes; surgical dressings; scapulars for surgical purposes; wadding for medical purposes; teeth filling material; diapers for pets.

10 – Stents; ophthalmological instruments; sterilised medical instruments; surgical apparatus and instruments; cushions for medical purposes; feeding bottles; condoms; orthopedic articles.

(260) AM 2023 118202 A

(800) 1667140

(151) 2022 01 28

(891) 2022 01 28

(731) LUXVIDE FINANZIARIA PER INIZIATIVE AUDIOVISIVE E TELEMATICHE – S.P.A.  
 VIA L. SETTEMBRINI 17/A, I-00195 ROMA (RM), Italy

(540)



(591) Dark sky blue, golden yellow, white, black and blue

(531) 26.11.09; 26.11.21; 27.05.10; 29.01.15

(511)

41 – Production and distribution of motion picture films, television programmes, radio programmes and pre-recorded video tapes, pre-recorded video cassettes, pre-recorded video discs; entertainment services in the nature of production and distribution of audio materials and other audio and audio-visual works, in particular films and broadcasts; rental of motion pictures; cinema theatres; television and film production services; providing cinema facilities; all the above except any service or activity related to the photography field.

(260) AM 2023 118204 A

(800) 1667243

(151) 2022 04 01

(891) 2022 04 01

(731) Perfetti Van Melle S.p.a.

Via XXV Aprile, 7, I-20045 Lainate (MI), Italy

(540)



(591) Black, white

(531) 01.15.21; 08.01.18; 11.03.01; 27.05.02

(511)

30 – Caramels [candies]; confectionery; pastry; cakes; chewing gum; chocolate; fruit jellies [confectionery]; wine gums; lollipops; toffee; mints for breath freshening; pastilles [confectionery]; liquorice [confectionery]; sugar; coffee; cocoa.

(260) AM 2023 118205 A

(800) 1667371

(151) 2021 11 19

(891) 2021 11 19

(731) MULTINODE NETWORK S.R.L.

etaj 3, str. Emil Racovita, numar 20, Oras  
Voluntari, judet Ilfov, Romania

(540)

**UNCLEBOB**

(591) Black, white

(511)

35 – Retail services relating to food; retail services in relation to foodstuffs; retail services in relation to alcoholic beverages (except beer); retail services in relation to dairy products; retail services relating to candy; unmanned retail store services relating to food; unmanned retail store services relating to drink; on-line ordering services in the field of restaurant take-out and delivery; online ordering services; retail services relating to bakery products; retail services in relation to beer; retail services in relation to meats; retail services in relation to teas; retail services in relation to coffee; retail services in relation to cocoa; retail services in relation to non-alcoholic beverages; retail services in relation to chocolate; retail services in relation to desserts; retail services in relation to confectionery; retail services relating to fruit; retail services relating to alcoholic beverages; advertising, including on-line advertising on a computer network; publicity and sales promotion services; advertising; online advertisements (term considered linguistically incorrect by the International Bureau – Rule 13 (2) (b) of the Regulations); promotion [advertising] of business.

43 – Preparation of meals; preparation and provision of food and drink for immediate consumption; food preparation for others on an outsourcing basis; take-away food and drink services; take-away food ser-

vices; food preparation services; take-out restaurant services; services for providing food; services for providing drink; services for the preparation of food and drink.

(260) AM 2023 118206 A

(800) 437196A

(151) 1978 05 10

(891) 2022 06 02

(731) Crown Technics LTD

Seestrasse 161, CH-8266 Steckborn,  
Switzerland

(540)

**VERITAS®**

(591) Black, white

(531) 27.05.01

(511)

7 – Sewing machines, including automatic sewing machines, for industry, crafts and household purposes; ribbon edging machines, flat-lock machines, interlock machines, looping machines, quilting machines, ironing machines, edge incorporating machines, quilting machines, tufting machines, table welting machines, cutting machines, yarn-marking apparatus; ironing machines, knitting machines and embroidery machines for industry, crafts and household purposes; shape fixing installations.

20 – Sewing tables, furniture and racks for sewing machines, for knitting machines and for ironing machines.

(260) AM 2023 118211 A

(800) 1440497

(151) 2018 07 26

(891) 2022 05 06

(731) Pirelli Tyre S.p.A.

Viale Piero e Alberto Pirelli, 25, I-20126 Milan,  
Italy

(540)

**DIABLO**

(591) Black, white

(531) 04.01.05; 27.03.03; 27.05.04; 27.05.17

(511)

12 – Tyres; tyres for motorcycles; pneumatic and solid tyres, especially for vehicle wheels; wheels for vehicles; inner tubes for wheels; rims; valves, safety rims for vehicle wheels; motorcycle parts.

(260) AM 2023 118213 A

(800) 1491915

(151) 2019 04 23

(891) 2022 04 21

(731) Kirin Holdings Kabushiki Kaisha (also trading as Kirin Holdings Company, Limited)  
10-2, Nakano 4-Chome, Nakano-Ku,  
Tokyo 164-0001, Japan

(540)

# KIRIN

(591) Black, white

(531) 27.05.17

(511)

5 – Milk ferments for pharmaceutical purposes; collyrium; nasal spray preparations for medical purposes; nasal spray preparations; medicated lip creams; vaginal moisturizers; vaginal moisturizers in cream form; vaginal pharmaceuticals; pharmaceutical cold preparations; liniments; pharmaceutical preparations and other preparations for destroying vermin, fungicides, herbicide; pharmaceuticals, medical and veterinary preparations; vitamin preparations and substances; amino acid preparations; nutritional additives for medical purposes, medicinal tonics and substitutes therefore; calcium pharmaceutical preparations; reagent paper for medical purposes; first aid kits; first-aid boxes, filled; drug delivery agents in the form of edible wafers for wrapping powdered pharmaceuticals; gauze for dressings; empty capsules for pharmaceuticals; eyepatches for medical purposes; ear bandages; menstruation bandages; menstruation tampons; sanitary napkins; sanitary panties; absorbent cotton; adhesive plasters; bandages for dressings; liquid bandages; breast-nursing pads; cotton swabs for medical use; mothproofing paper; lacteal flour for babies; dietary and nutritional supplements; dietary and nutritional supplements in tablet, chewable, powder, capsule, liquid or gel form; lactic acid bacteria-based food supplements in gel, tablet, chewable, powder, capsule or liquid form; dietary and nutritional supplements; dietetic pharmaceuticals adapted for medical or veterinary use; food for chewing and/or swallowing disorders for medical purposes; food thickener for dysphagia (swallowing assisting food) for medical purposes; dietetic beverages adapted for medical purposes; dietetic food adapted for medical purposes; beverages for babies; food for babies; nutritional supplements for animal foodstuffs; dietary supplements for animals; semen for artificial insemination; cultures of microorganisms for medical or veterinary use.

(260) AM 2023 118214 A

(800) 1562015

(151) 2020 10 20

(891) 2022 04 07

(731) Aramara Beauty LLC.

43 West 24th Street, Suite 702, New York  
NY 10010, USA

(540)

## Glow Recipe

(591) Black, white

(511)

3 – Body and beauty care cosmetics; make-up; non-medicated skin care preparations.

(260) AM 2023 118215 A

(800) 1598504

(151) 2021 05 13

(891) 2022 05 12

(731) DAEWOONG PHARMACEUTICAL CO.,  
LTD.

35-14, Jeyakgongdan 4-gil, Hyangnam-eup,  
Hwaseong-si, Gyeonggi-do, Republic of Korea

(540)

## FEXUCLUE

(591) Black, white

(511)

5 – Pharmaceutical agents affecting digestive organs; medicines for treating intestinal disorders; proton-pump inhibitors; medicines for the treatment of gastrointestinal diseases; medicines for human purposes; pharmaceutical preparations; ethical medicinal preparations.

(260) AM 2023 118216 A

(800) 1639779

(151) 2021 06 29

(891) 2022 02 07

(731) Dirk Rossmann GmbH

Isernhägener Straße 16, 30938 Burgwedel,  
Germany

(540)



(591) Black, white

(531) 01.15.11; 02.09.01; 04.02.01; 27.05.01

(511)

3 – Toiletries; essential oils and aromatic extracts; cleaning and fragrancing preparations; body cleaning and beauty care preparations; oral hygiene preparations; balms, other than for medical purposes; massage gels, other than for medical purposes; cotton swabs for cosmetic purposes; massage oils; tissues impregnated with cosmetic lotions; tissues impregnated with cosmetics; dentifrices; dentifrices; toothpaste; bath preparations; skin care preparations; soaps and gels; shower and bath gel; shower and bath foam; disposable wipes impregnated with cleansing compounds for use on the face; pre-moistened cosmetic wipes; soap; soap; cream soaps; shower creams; liquid bath soaps; liquid soaps for hands and face; soaps in liquid form; facial soaps; hand soaps; cosmetic soaps; soaps for body care; bath salts, not for medical purposes; bath

preparations, not for medical purposes; cosmetic preparations for baths; bath flakes; bath milk; bath gel; bath foam; bath soap; bubble bath; cosmetic creams; cosmetic preparations for skin care; lotions for cosmetic purposes; oils for cosmetic purposes; cleansing milk for toilet purposes; sunscreen preparations; baby powder; skin fresheners; moisturising creams, lotions and gels; skin moisturisers; face creams for cosmetic use; facial washes [cosmetic]; cosmetic facial lotions; skin lotion; skin cleansing lotion; body cream; wipes impregnated with a skin cleanser; suntan oils for cosmetic purposes; topical skin sprays for cosmetic purposes; waterproof sunscreen; ethereal oils; lavender oil; almond oil; colour-removing preparations; stain removers; cleaning agents for household purposes; cleaning agents for household purposes; laundry preparations; dishwashing detergents; soap powder; liquid soap for laundry; laundry soap; baby oils; baby shampoo; baby bath mousse; baby lotions; baby bubble bath; baby shampoo mousse; baby body milks; baby wipes; baby suncreams; babies' creams [non-medicated]; baby care products (non-medicated -); talcum powder (non-medicated -) for babies; cotton wool for cosmetic purposes; baby hair conditioner; baby bottom balm; baby wipes impregnated with cleaning preparations; cotton balls for cosmetic purposes; cosmetics for children; colour cosmetics for children; cotton wool in the form of wipes for cosmetic use.

5 – Infant formula; babies' diapers; babies' diaper pants; food for babies; medicated baby oils; milk powders [foodstuff for babies]; medicated baby powders; babies' creams [medicated]; nappies for babies and incontinents; beverages for infants; paper diapers; powdered milk for babies; swim diapers, disposable, for babies; babies' swim diapers; disposable liners for babies' diapers; dietetic substances for babies; talcum powder (medicated -) for babies; lacteal flour for babies; dietetic beverages for babies adapted for medical purposes; disposable pants of paper for holding a babies napkin in place; disposable pants of cellulose for holding a babies' napkin in place; dietary supplements and dietetic preparations; cachets for pharmaceutical purposes; sanitary preparations and articles; colostrum supplements; lactose free infant's formula; substitutes for mother's milk; dietary fibre; medicinal tea; nutritional supplements; glucose dietary supplements; vitamin preparations; vitamin preparations; chemical preparations for the diagnosis of pregnancy; pharmaceutical preparations for hydrating the skin during pregnancy; pharmaceutical preparations for preventing skin blemishes during pregnancy; pharmaceutical products and preparations against dry skin caused by pregnancy; pharmaceutical preparations for treating dry skin caused by pregnancy; pharmaceutical products and preparations for hydrating the skin during pregnancy; pharmaceutical products and preparations for pregnancy blemishes; pharmaceutical products and preparations for preventing skin blemishes during pregnancy; disinfectants and antiseptics; pharmaceutical

preparations for treating chloasma; first-aid boxes, filled; breast-nursing pads; feminine hygiene products; sanitary towels; dressings, medical; veterinary preparations; antiseptics; disinfectants; sterilizing preparations; sanitary tampons; panty liners [sanitary]; sanitary panties; menstruation bandages; pharmaceuticals and natural remedies; adhesive plasters; bandages for making casts; antibacterial soap; disinfectant soap; disposable training pants of cellulose for infants; mosquito-repellent patches for babies; dietary and nutritional supplements; food supplements; dietetic foods adapted for infants; dietetic preparations for children; milk sugar; dietary and nutritional preparations; powdered milk foods for infants; powdered milk for babies and infants; lactagogues; sanitizing wipes; sanitizers for household use; disinfectants impregnated into tissues; cleaning cloths impregnated with disinfectant for hygiene purposes; cloth diapers; paper pads for changing diapers.

7 – Electric babies' food processors; kitchen machines, electric; kitchen machines, electric; grinders (electric -) for food preparation; food preparation machines, electromechanical; beverage preparation machines, electromechanical; electromechanical machines for food or beverage preparation; food and beverage processing and preparation machines and apparatus.

8 – Cutlery for use by babies; kitchen knives; table cutlery [knives, forks and spoons]; table forks; spoons; spoons; spoons; cutlery, kitchen knives, and cutting implements for kitchen use; nail scissors; nail clippers, electric or non-electric.

9 – Thermometers; thermometers, not for medical purposes; digital thermometers, other than for medical purposes; baby scales; baby monitors; baby alarms; electronic baby monitoring devices; video baby monitors; listening devices for monitoring babies; information technology and audiovisual equipment; safety, security, protection and signalling devices; audio/visual and photographic devices; communications equipment; phototelegraphy apparatus; alarms and warning equipment; acoustic alarms; alarms; reflective safety vests; helmets for bicycles; measuring instruments; monitoring instruments; calibrating apparatus; covers for electric outlets; measuring, detecting, monitoring and controlling devices; closed circuit television cameras; monitoring units [electric]; electronic surveillance apparatus; video cameras adapted for monitoring purposes.

10 – Feeding aids and pacifiers; feeding bottles; dummies for babies; feeding bottle teats; incontinence sheets for use with babies; teething rings; teething rings incorporating baby rattles; feeding bottles for babies; covers for baby feeding bottles; air pillows for infants [medical purposes]; air mattresses for infants [for medical purposes]; incontinence sheets for use with infants; clips for pacifiers; neonatal pacifiers; ear plugs



for protection against noise; feeding bottle valves; breast pumps; breast shields; breast milk storage bottles; cushions for medical purposes; nasal aspirators; medical apparatus for strengthening muscles of the pelvic floor; cushions for medical use, adapted to support the face; cushions for medical use for supporting infants while being bathed; gum massagers for babies; paediatric pacifiers; incontinence sheets.

11 – Baby bottle warmers; baby food warmers; heaters, electric, for feeding bottles; sterilisers for babies' feeding bottles; electric night lights; curling lamps; lighting and lighting reflectors; heating, ventilating, and air conditioning and purification equipment (ambient); refrigerating and freezing equipment; sterilizers; disinfectant apparatus; steam sterilizers for household use; steam sterilizers; sterilizers for household use; water sterilizers; radiant heaters; sterilization, disinfection and decontamination equipment; electric radiant heating apparatus; lighting apparatus and installations; ceiling lights; electric lamps; lanterns for lighting; safety lamps; electric torches; food steamers, electric; heating apparatus; bed warmers; footmuffs, electrically heated; hot water bottles; heating cushions, electric, not for medical purposes; blankets, electric, not for medical purposes; child safe protective covers for bathtub spouts; disinfectant dispensers for toilets; toilet seats; water filtering apparatus for domestic use; kettles; cooking, heating, cooling and refrigerating equipment for food and beverages; electric warmers for baby wet wipes; domestic baby food warmers [electric]; toilet bowls for children; toilet seats for children; air purifiers for strollers.

12 – Small wagons for transporting children; fitted pushchair mosquito nets; tires for children's bicycles; pushchair hoods; children's car seats; children's bicycles; prams; carrycot restraints for use in vehicles; portable babies' seats for vehicles; perambulators incorporating carry cots; safety seats for babies for use in vehicles; vehicle safety harness for carry cots; mirrors for vehicles; rearview mirrors; sun visors for automobiles; baby carriage canopies; fitted footmuffs for prams; baskets for perambulators; rubber baby buggy bumpers; pushchair covers and hoods; cup holders for vehicles; drinks holders adapted for use in land vehicles; seat back organizers specially adapted for use in vehicles; backrests for vehicle seats; backrests adapted for use in vehicles; parts and fittings for vehicles.

16 – Plastic disposable diaper bags; books for children; modeling clay for children; painting sets for children; children's storybooks; baby books; paper baby bibs; bags of plastics for lining refuse bins; rubbish bags; napkins of cellulose for cosmetic purposes; paper tissues for cosmetic use; bibs of paper; baby memory books; children's activity books; children's paint-boxes; children's slates; sticker activity books; children's books incorporating an audio component; printed matter, and stationery and educational sup-

plies; artists' and drawing materials; tissues; bags and articles for packaging, wrapping and storage of paper, cardboard or plastics.

18 – Nappy bags; pouch baby carriers; slings for carrying infants; backpacks for carrying infants; baby carriers worn on the body; sling bags for carrying infants; umbrellas for children; umbrellas and parasols; luggage, bags, wallets and carrying bags; beach bags; book bags; ladies' handbags; net bags for shopping; shopping bags; flexible bags for garments; luggage tags; knitting bags; small clutch purses; handbags; garment bags for travel; overnight bags; small rucksacks; cosmetic bags sold empty; multi-purpose purses; trunks and suitcases; travelling bags; rucksacks; shoe bags for travel; shoulder bags; daypacks; kit bags; carrying bags; gym bags; nappy wallets; children's shoulder bags; reins for guiding children; back frames for carrying children; leather pouches; drawstring pouches.

19 – Statues and works of art made of materials such as stone, concrete and marble, included in the class; plaster for casting [not medical]; spackling compound; plaster; stone, rock, clay and minerals.

20 – Seats adapted for babies; wall-mounted baby changing platforms; baby gates; baby bolsters; head support cushions for babies; mats for infant playpens; portable baby bath seats for use in bath tubs; nursing pillows; non-metal safety gates for babies, children, and pets; high chairs for babies; infant walkers; children's mats used for sleeping; locks, other than electric, not of metal; locks and keys, non-metallic; containers, and closures and holders therefor, non-metallic; bins, not of metal; boxes of wood or plastic; corner protectors of plastics for furniture; extruded plastics edge beadings for furniture; children's beds; baby changing mats; children's beds made of cloth in the form of a bag; corner beads (non-metallic -) for furniture; Moses baskets; babies' bouncing chairs; Moses baskets [bassinets]; portable bassinets; furniture for children; cots for babies; bath seats for babies; support pillows for use in baby seating; electric baby cradles; anti-roll cushions for babies; support pillows for use in baby car safety seats; layette boxes [of wood or plastic]; babies' baskets; babies' chairs; seats for children; shelves being nursery furniture; cushions [other than for medical use] for supporting infants being examined; furniture and non-metallic furniture fittings; furniture locks (non-metallic -); mechanical locks [non-electric, non-metallic]; self-opening non-metallic locks for belt reels; tumblers (non-metallic -) [parts of locks]; keys (non-metallic -) for opening locks; locks [other than electric], not of metal, for vehicles.

21 – Brushes and brush-making articles; combs; combs; tableware, cookware and containers; cleaning articles; chamber pots; feeding bottle brushes; baby baths, portable; heaters for feeding bottles, non-electric; training cups for babies and children; sippy cups

for babies; diaper disposal pails; statues of porcelain, ceramic, earthenware or glass; busts of porcelain, ceramic, earthenware or glass; brushes; brushes; brushes; nail brushes; toothbrushes; mugs; buckets; bottles; ice cube moulds; moulds [kitchen utensils]; containers for household or kitchen use; glasses [receptacles]; utensils for household purposes; heat-insulated containers; insulating flasks; heat-insulated containers for beverages; thermally insulated containers for food; cooking utensils, non-electric; kitchen containers; refrigerating bottles; isothermic bags; cups of paper or plastic; paper plates; cookie [biscuit] cutters; dishes; cups; tableware, except forks, knives and spoons; teapots; table plates; funnels; straws for drinking; drinking vessels; dustbins; gloves for household purposes; furniture dusters; cloths for cleaning; sponges for household purposes; soap dispensers; dishwashing brushes; boxes for dispensing paper towels; soap holders; shoe horns; clothes-pegs; household utensils for cleaning, brushes and brush-making materials; cosmetic and toilet utensils; baby bath tubs; baby finger toothbrushes; stands for portable baby baths; children's potties; training chopsticks for children; cotton ball jars; cups and mugs; tumblers; inflatable drink holders; insulating sleeve holder for beverage cups; lunch boxes; serving scoops [household or kitchen utensil].

24 – Insect protection nets; baby blankets; diaper changing cloths for babies; towels [textile] for use in connection with babies; children's blankets; children's towels; textiles and substitutes for textiles; linens; labels of textile; textile material; fabrics; bath linen; bed linen and blankets; kitchen and table linens; bath linen, except clothing; face towels of textile; towels of textile; bath mitts; sheets [textile]; bed covers; travelling rugs [lap robes]; mattress covers; pillowcases; pillow shams; eiderdowns [down coverlets]; covers for cushions; bed covers of paper; bed blankets; sleeping bags for babies; baby buntings; cot sheets; cot blankets; infants' bed linen; cot covers; cloths for washing the body [other than for medical use]; interfacings; mitts made of non-woven fabric for washing the body; muslin fabric.

25 – Bibs, not of paper; plastic baby bibs; babies' pants [underwear]; baby doll pyjamas; baby tops; baby bottoms; layettes [clothing]; maternity lingerie; maternity clothing; maternity sleepwear; maternity smocks; maternity bands; maternity leggings; maternity tops; maternity pants; brassieres; sports bras; underpants; trousers for children; children's headwear; infants' footwear; infant wear; snap crotch shirts for infants and toddlers; rompers; leotards; stockings; body stockings; tights; baby bodysuits; baby shoes; baby boots; baby sandals; pram suits; babies' undergarments; baby clothes; babies' outerclothing; sleep-suits; bootees (woollen baby shoes); baby bibs [not of paper]; knitted baby shoes; children's wear; children's footwear; children's outerclothing; swimwear for children; costumes for use in children's dress up play;

clothing for men, women and children; infants' boots; clothing; clothing; headgear; footwear; footwear; footwear; articles of clothing, footwear, headgear; kerchiefs [clothing]; headscarves; bandanas [neckerchiefs]; neckerchiefs; caps being headwear.

28 – Sporting articles and equipment; toys; games; games; games; toys; appliances for gymnastics; trampolines; swimming kickboards; flippers for swimming; water wings; swimming belts; swimming jackets; swimming aids; rattles [playthings]; board games; building blocks [toys]; building games; kites; parlour games; playing cards; marbles for games; spinning tops [toys]; matryoshka dolls; toy mobiles; paper party hats; toys made of plastics; stuffed toys; plush toys; dolls; dolls' beds; dolls' feeding bottles; dolls' houses; dolls' clothes; dolls' rooms; jigsaw puzzles; ring games; slides [playthings]; scooters [toys]; rocking horses; soap bubbles [toys]; balls for games; playing balls; dice; toy cars; toy vehicles; toy figures; toy whistles; toy animals; toy models; teddy bears; swings; cups for dice; bathtub toys; infants' swings; children's playthings; baby rattles incorporating teething rings; multiple activity toys for babies; wooden toys; toys made of wood; toys for use in perambulators; toy pushchairs.

29 – Fish, not live; meat; dairy products and dairy substitutes; fruit, processed; meat extracts; meat, tinned; meat, preserved; fish-based foodstuffs; fish, tinned; cheese; yoghurt; curd; powdered milk; powdered milk; milk; milk beverages, milk predominating; fat-containing mixtures for bread slices; coconut fat; linseed oil for food; oils for food; rape oil for food; fruit chips; fruit jellies; fruit pulp; fruit-based snack food; cooked fruits; vegetables, tinned; vegetables, cooked; potato flakes; berries, preserved; vegetables, preserved; fruit, preserved; fruit salads; raisins; apple purée; jellies for food; potato fritters; soups; compotes; broth; preparations for making soup; soya milk; rice milk; milk-based beverages containing fruit juice; milk-based beverages flavored with chocolate; potato crisps; potato snacks; vegetable chips; vegetable-based snack foods; meat and meat products; fish, seafood and molluscs, not live; edible oils and fats; soups and stocks, meat extracts; processed fruits, fungi, vegetables, nuts and pulses; instant soup; prepared meals containing [principally] chicken; prepared meals containing [principally] eggs; prepared dishes consisting principally of meat; prepared meals consisting primarily of duck; prepared meals consisting primarily of turkey; prepared meals consisting primarily of kebab; prepared meals consisting primarily of fish; prepared meals consisting principally of vegetables; dried fruit; dried fruit-based snacks; fruit desserts; dried fruit products; fruit-based meal replacement bars; fruit- and nut-based snack bars; snack mixes consisting of dehydrated fruit and processed nuts; sliced fruit; jellies, jams, compotes, fruit and vegetable spreads; coconut chips; coconut flakes; coconut-based snacks; sunflo-

wer seeds, prepared; edible sunflower seeds; processed chia seed for food; seeds, prepared; seeds, prepared; nut and seed-based snack bars; processed almonds; peanuts, prepared; organic nut and seed-based snack bars; canned peanuts; low-fat potato crisps; roasted nuts; crystallized fruits; candied nuts; crystallized ginger; nut-based snack foods; prepared insects and larvae; edible insects, not live; processed nuts; dried nuts; edible nuts; salted nuts; snack foods based on nuts; pressed fruit paste; apple chips; air-dried sausages; oat milk; soya yoghurt; milk substitutes; organic milk; milk-based snacks; milk products; non-dairy milk substitutes.

30 – Chocolate; processed grains, starches, and goods made thereof, baking preparations and yeasts; coffee, teas and cocoa and substitutes therefor; chips [cereal products]; cereal-based snack food; popcorn; rice cakes; rice-based snack food; millet cakes; bread; pastries, cakes, tarts and biscuits (cookies); cereal bars and energy bars; sweets (candy), candy bars and chewing gum; candy; edible paper; fruit jellies [confectionery]; crackers; creamed rice; puddings; waffles; rusks; pastries; gingerbread; high-protein cereal bars; cereal bars; muesli bars; chocolate beverages with milk; infusions, not medicinal; tea; tea; tea; chocolate-based beverages; flowers or leaves for use as tea substitutes; tea-based beverages; cereals; pasta; biscuits; cakes; noodles; oat flakes; oatmeal; husked barley; crushed oats; oat-based food; processed corn; processed wheat; processed cereals; processed oats; breakfast cereals, porridge and grits; corn flakes; muesli; savory sauces, chutneys and pastes; salts, seasonings, flavourings and condiments; food condiment consisting primarily of ketchup and salsa; sugars, natural sweeteners, sweet coatings and fillings, bee products; cereal based food bars; bars based on wheat; cereal products in bar form; grain-based chips; food mixtures consisting of cereal flakes and dried fruits; ice, ice creams, frozen yogurts and sorbets; chocolate-coated bars; biscuits flavoured with fruit; fruit gums [other than for medical use]; grape sugar; glucose preparations for food; waffles with a chocolate coating; chocolate waffles; chocolate-coated rice cakes; rice cake snacks; snack foods prepared from maize; processed corn; foodstuffs made from maize; porridge; linseed for culinary purposes [seasoning]; cereal preparations consisting of oatbran; wheat germ; wheat germ for human consumption; sweeteners [condiments] flavoured with fruit concentrates; natural sweeteners; candy bars; chocolate candies; filled chocolate; chocolate-coated nuts; biscuits having a chocolate coating; chocolate chips; chocolate cakes; chocolates; truffles [confectionery]; pralines made of chocolate; peanut confectionery; almond cookies; almond confectionery; corn chips; nachos; tortillas; taco chips; macarons [pastry]; muffins; petits fours [cakes]; filled chocolate bars; milk chocolates; chocolate bars; confectionery; cheese-flavored biscuits; savory biscuits; butterscotch chips; salt crackers; hardtack [bis-

cuits]; cookie mixes; wafers; pretzels; cocoa-based beverages; cocoa beverages with milk; cocoa powder; sweetmeats [candy]; shortbread biscuits coated with chocolate; petit-beurre biscuits; porridge oats; flapjacks; snack foods made of whole wheat; snack food products made from cereal starch; snack food products made from maize flour.

31 – Unprocessed fruits; maize; crop seeds; unprocessed flax seeds; edible linseed, unprocessed; sunflower seeds; unprocessed chia seeds; sowing seeds; natural seeds; oats.

32 – Non-alcoholic beverages; flavoured carbonated beverages; juices; waters; isotonic beverages; whey beverages; vegetable juices [beverages]; non-alcoholic fruit juice beverages; non-alcoholic fruit extracts; fruit nectars, non-alcoholic; waters [beverages]; syrups for beverages; essences for making beverages; smoothies; non-alcoholic preparations for making beverages; lemonades; syrups for making soft drinks; still water; aerated water; fruit flavoured waters; nutritionally fortified water; mineral enriched water [beverages]; apple juice beverages; beverages consisting of a blend of fruit and vegetable juices; squashes [non-alcoholic beverages]; orange juice; orange juice drinks; lemon squash; fruit drinks; smoked plum beverages; soft drinks; fruit flavored soft drinks; concentrates for use in the preparation of soft drinks; rice-based beverages, other than milk substitutes; oat-based beverages [not being milk substitutes]; brown rice beverages other than milk substitutes.

35 – Business assistance, management and administrative services; advertising, marketing and promotional services; provision of advertising space, time and media; product demonstrations and product display services; distribution of advertising, marketing and promotional material; public relations services; loyalty, incentive and bonus program services; advertising, marketing and promotional consultancy, advisory and assistance services; marketing; administrative processing of purchase orders; negotiation and conclusion of commercial transactions for third parties; commercial administration of the licensing of the goods and services of others; telemarketing services; commercial information and advice for consumers [consumer advice shop]; consumers (commercial information and advice for -) [consumer advice shop]; auctioneering services; import-export agency services; procurement services for others [purchasing goods and services for other businesses]; provision of an online marketplace for buyers and sellers of goods and services; market research; wholesale services in relation to dairy products; retail services in relation to dairy products; retail and wholesale services relating to baby, infant and children's articles, pregnancy articles, household and kitchen goods, drugstore goods, personal care products, essential oils, food supplements, baby food, hygiene preparations and articles, medical preparations and articles, feminine hygiene articles, baby

and incontinence nappies, feeding aids and dummies, pregnancy diagnostic articles, clothing, food and beverages.

(260) AM 2023 118217 A

(800) 1649934

(151) 2021 12 30

(891) 2022 04 27

(731) NS Retail Co., Ltd.

2F, 12, Tojeong-ro, Mapo-gu, Seoul 04085,  
Republic of Korea

(540)

**Neos : Lab**

(591) Black, white

(531) 24.17.01; 27.05.01

(511)

3 – Soaps for personal use; shampoos for personal use; mask packs for cosmetic purposes; body essence; hand cream; cleansing creams; body lotions; tissues impregnated with cosmetic lotions; astringents for cosmetic purposes; sunscreen lotions.

(260) AM 2023 118275 A

(800) 1668388

(151) 2022 03 16

(891) 2022 03 16

(731) Vasiliev Alexander Sergeevich

Michurina str., 3 sq. 56, RU-630099  
Novosibirsk, Russian Federation

(540)

**DECORUS**

(591) Red and white

(531) 26.04.04; 26.04.05; 26.04.18; 26.04.24;  
27.05.01; 27.05.24; 29.01.12

(511)

8 – Hand drills, hand-operated; clamps for carpenters or coopers; edge tools [hand tools]; garden tools, hand-operated; abrading instruments [hand instruments]; sharpening instruments; polishing irons [glazing tools]; wire strippers [hand tools]; riveters [hand tools]; expanders [hand tools]; cutting tools [hand tools]; trowels [gardening]; shovels [hand tools]; hammers [hand tools]; guns [hand tools]; non-electric caulking guns; guns, hand-operated, for the extrusion of mastics; tool belts [holders]; handles for hand-operated hand tools; scrapers [hand tools]; spatulas [hand tools]; spatulas for use by artists; tile laying tools [hand tools]; devices for leveling laid tiles [hand tools].

16 – House painters' rollers; artists' brushes; paint-brushes; writing brushes; glue for stationery or household purposes; adhesive tapes for stationery or household purposes.

17 – Padding materials of rubber or plastics; packing [cushioning, stuffing] materials of rubber or plastics; stops of rubber; gaskets; draught excluder strips.

19 – Building materials, not of metal; duckboards, not of metal; wall tiles, not of metal; floor tiles, not of metal; tiles, not of metal, for building; mortar for building.

20 – Dowels, not of metal; troughs, not of metal, for mixing mortar; packaging containers of plastic; rivets, not of metal; jerrycans, not of metal; baskets, not of metal; tool boxes, not of metal, empty; door fasteners, not of metal; window fasteners, not of metal; window closers, not of metal, non-electric; door openers, not of metal, non-electric; hand-held flagpoles, not of metal; door fittings, not of metal; furniture fittings, not of metal; window fittings, not of metal; labels of plastic; tool chests, not of metal, empty; boxes of wood or plastic; chocks for clamping laid tiles, not of metal; stops for ceramic tiles, not of metal or rubber; clamps for tile work, not of metal; chocks for tile work, not of metal; plastic clamp; plastic wedge.

21 – Brushes.

(260) AM 2023 118276 A

(800) 1668411

(151) 2022 03 02

(891) 2022 03 02

(731) NOVARTIS AG

CH-4002 Basel, Switzerland

(540)

**OneGene**  
program

(591) Dark blue, light blue and gray

(531) 27.05.10; 29.01.12

(511)

35 – Business administration of a patient assistance program for providing prescription drugs at reduced cost.

36 – Financial administration of prescription drug reimbursement services and programs and information relating thereto; Providing financial information regarding reimbursement for prescription drugs; financial administration of a patient assistance program for providing prescription drugs at reduced cost; financial management of reimbursement payments for third parties; providing consulting and information concerning insurance.

41 – Providing information in the field of education in the health care sector regarding the diagnostic, prophylactic and therapeutic properties of prescription drugs and disease treatment.

(260) AM 2023 118277 A

(800) 1668465

(151) 2022 03 07

(891) 2022 03 07

(731) ARTEMISIA S.R.L.

STRADA ACQUAFREDDA, 14L/K, I-46042

CASTEL GOFFREDO (MN), Italy

(540)

**RISALTI**

(591) Black, white

(531) 27.05.01

(511)

25 – Clothing; underwear and nightwear; leisure suits; sportswear; sports caps and hats; neckwear; bandanas [neckerchiefs]; bermuda shorts; berets; underwear; blazers; blue jeans; blouses; leotards; bomber jackets; boxer shorts; suspenders; tights; footwear; stockings; socks; sports socks; shirts; sports shirts with short sleeves; tank tops; sports singlets; headgear; hats; casual jackets; hoods [clothing]; cardigans; stuff jackets [clothing]; slippers; waist belts; chemises; bustiers; bathing suits; cravats; bonnets; tap pants; turtlenecks; sweat shirts; jackets [clothing]; sports jackets; overcoats; gilets; blousons; skirts; overalls; gloves [clothing]; raincoats; flip-flops; leggings [leg warmers]; jerseys [clothing]; undershirts; sweaters; pants; face mask [clothing]; short trousers; trousers; moisture-wicking sports pants; bowties; pelisses; polo shirts; brassieres; moisture-wicking sports bras; sandals; shoes; training shoes; neck tube scarves; underpants; sneakers; boots; tee-shirts; combinations [clothing]; uniforms; dressing gowns; visors.

35 – Shop window dressing; product sampling; demonstration of goods; fashion show exhibitions for commercial purposes; business merchandising display services; layout services for advertising purposes; marketing; organization of fashion shows for promotional purposes; presentation of goods on communication media, for retail purposes; advertising; public relations services; sponsorship search; issuing of publicity leaflets; conducting interactive virtual auctions; advertising services relating to clothing; retail services connected with the sale of clothing and clothing accessories; online retail store services relating to clothing; retail services in relation to fashion accessories; retail services in relation to footwear; wholesale services relating to sporting goods; retail services relating to sporting goods.

(260) AM 2023 118327 A

(800) 1669054

(151) 2022 04 11

(891) 2022 04 11

(731) JAQUAR &amp; COMPANY PRIVATE LIMITED

C-20, S.M.A. Co-operative Industrial Estate

Ltd, Gt Karnal Road, New Delhi 110033, India

(540)



(591) The "J Jaquar" logo is in green colour, against a white background

(531) 26.11.02; 26.11.12; 27.05.01; 29.01.04

(511)

11 – Bath fittings, apparatus and installations for water supply and sanitary purposes falling in this class.

(260) AM 2023 118328 A

(800) 1669071

(151) 2021 12 29

(891) 2021 12 29

(731) "Institute Hyalual" Limited liability company  
vul. Narodnoho Opolchennia, 19, Kyiv 03151,  
Ukraine

(540)

**ULAIZER**

(591) Black, white

(511)

5 – Pharmaceuticals and veterinary preparations; sanitary preparations for medical purposes; dietetic food and substances adapted for medical use; food for babies; plasters, materials for dressings; material for dental fillings and dental impressions; disinfectants; vermin destroying preparations; fungicides, herbicides.

10 – Medical, in particular surgical and dental, and veterinary apparatus and instruments; artificial limbs, eyes and teeth; orthopedic articles; suture materials.

(260) AM 2023 118329 A

(800) 1669137

(151) 2021 11 19

(891) 2021 11 19

(731) Telewizja Polska S.A.

ul. Woronicza 17, PL-00-999 Warszawa,  
Poland

(540)



(591) Blue, white

(531) 26.04.08; 26.04.18; 26.04.24; 27.05.01;  
27.05.09; 27.05.10; 27.05.15; 27.05.24;  
29.01.12

(511)

9 – Magnetic data carriers, recorded discs; coin-operated mechanisms; data processing hardware, compu-

ters; sound, image and film recordings recorded on cinematographic film, video tapes, magnetic tapes, optical discs, in MP3 format, in a version adapted for playing on multimedia computers and on compact disc and DVD players; apparatus for recording, writing, playing and reproduction of sound, images, data and film recordings in analog and digital formats; audio-visual teaching apparatus; apparatus for multimedia broadcasting, television programmes, broadcasts, films and reports recorded in multimedia file format; TV games (software); downloadable computer games; computer programs, programs for running computer games, competitions for use with a television receiver, computer programs for use with interactive television; access cards; drying racks (photography).

16 – Printed matter, paper publications, magazines, books, albums, brochures, periodicals and other publications in paper form, paper, paperboard, cardboard, stationery, photographs, photos [printed]; signed photographs; photographic albums; photographs [printed]; mini photo albums; apparatus for mounting photographs; unmounted and mounted photographs; adhesive corners for photographs; adhesive corners for photographs; adhesive corners for photographs; photo storage boxes; photo albums and collectors' albums; photograph album pages; collector's photographs of players; photograph stands; brag books [photo albums]; paper for printing photographs; stationery.

25 – Clothing; shoes; hats.

28 – Games and playthings; hand-held computer games, other than those adapted for use with television receivers; handheld computer games; table-top games; games adapted for use with television receivers; gymnastic and sporting articles not included in other classes; decorations for Christmas trees.

35 – Advertising; production of multimedia advertisements, arranging and conducting of advertising campaigns, rental and selling of advertising space and time for advertising purposes in mass media, creating advertised and sponsored texts, production of radio advertisements and advertising films for television, the film industry and the internet (term considered too vague by the International Bureau – Rule 13 (2) (b) of the Regulations); organisation of shows and exhibitions for commercial and advertising purposes; marketing and public relations; merchandise (term considered too vague by the International Bureau – Rule 13 (2) (b) of the Regulations); advertising; the bringing together, for the benefit of others, of the following goods: multi-media equipment, multimedia articles and multimedia programs, computer and television games, games, toys, glassware, porcelain and earthenware and cosmetics, sanitary articles and medical dressing articles, clothing, food, sports articles and printed publications, via retailing, wholesaling, online sale or remote sale, enabling consumers to conveniently purchase those goods (term considered too

vague by the International Bureau – Rule 13 (2) (b) of the Regulations); promotion of musical concerts; promotion [advertising] of concerts.

38 – Transmission of sound and/or images, including by means of digital transmission, communication networks, including via television, satellite, terrestrial, cable and fibre optic networks and the internet; organising of sound, image and digital signal transmission systems (term considered too vague by the International Bureau – Rule 13 (2) (b) of the Regulations); broadcasting of television programmes, documentaries and feature films, entertainment and sports shows, and programmes with interactive viewer participation, broadcasting and transmission of interactive television and interactive entertainment; collecting and providing of information by means of communication networks (term considered too vague by the International Bureau – Rule 13 (2) (b) of the Regulations); providing online information via computer databases (term considered too vague by the International Bureau – Rule 13 (2) (b) of the Regulations); teletext and audiotext services; providing an advertising website, including providing an online interactive bulletin board (term considered too vague by the International Bureau – Rule 13 (2) (b) of the Regulations); providing teletext and audiotext services; access to content, websites and portals.

41 – Training; providing of training; entertainment services; sporting and cultural activities; publishing, writing and publication of texts, other than publicity texts, publication of books and periodicals; production of radio and television programmes; organisation, production of artistic, stage, sporting and recreational programmes and events (term considered too vague by the International Bureau – Rule 13 (2) (b) of the Regulations); organising of studies and training in the field of multimedia; organising of competitions, organising of educational and cultural events; providing interactive applications and games played via computer and communication networks (entertainment, cultural and educational services); rental of recordings and recording studios; production of films, serials; production of shows; radio, film, television and cinema production; arranging and conducting of concerts; presentation of concerts; arranging and conducting of concerts; concert booking; arranging and conducting of concerts; arranging and conducting of concerts; arranging and conducting of concerts; arranging and conducting of concerts; presentation of musical concerts; singing concert services; production of music concerts; live musical concerts; booking of seats for concerts; entertainment by means of concerts; pop music concerts (organisation of -); ranging and conducting of concerts; booking agencies for concert tickets; musical concerts by television; musical concerts by radio; reservation services for concert tickets; arranging, conducting and organisation of concerts; arranging and conducting of music concerts; entertain-

ment services in the form of concert performances; reservation services for concert and theatre tickets; ticket reservation and booking services for music concerts; consultancy and information services relating to arrang.

42 – Design services; web site design and creation services; consultancy in the field of computers (term considered too vague by the International Bureau – Rule 13 (2) (b) of the Regulations); graphic design; web hosting; creation of internet web sites.

(260) AM 2023 118330 A

(800) 1669138

(151) 2021 11 19

(891) 2021 11 19

(731) Telewizja Polska S.A.

ul. Woronicza 17, PL-00-999 Warszawa,  
Poland

(540)



(591) Black, white

(531) 26.04.08; 26.04.18; 26.04.24; 27.05.01;

27.05.09; 27.05.10; 27.05.15; 27.05.24

(511)

9 – Magnetic data carriers, recorded discs; coin-operated mechanisms; data processing hardware, computers; sound, image and film recordings recorded on cinematographic film, video tapes, magnetic tapes, optical discs, in MP3 format, in a version adapted for playing on multimedia computers and on compact disc and DVD players; apparatus for recording, writing, playing and reproduction of sound, images, data and film recordings in analog and digital formats; audio-visual teaching apparatus; apparatus for multimedia broadcasting, television programmes, broadcasts, films and reports recorded in multimedia file format; TV games (software); downloadable computer games; computer programs, programs for running computer games, competitions for use with a television receiver, computer programs for use with interactive television; access cards; drying racks (photography).

16 – Printed matter, paper publications, magazines, books, albums, brochures, periodicals and other publications in paper form, paper, paperboard, cardboard, stationery, photographs, photos [printed]; signed photographs; photographic albums; photographs [printed]; mini photo albums; apparatus for mounting photographs; unmounted and mounted photographs; adhesive corners for photographs; adhesive corners for photographs; adhesive corners for photographs; photo storage boxes; photo albums and collectors' albums; photograph album pages; collector's photographs of players; photograph stands; brag books [photo albums]; paper for printing photographs; stationery.

25 – Clothing; shoes; hats.

28 – Games and playthings; hand-held computer games, other than those adapted for use with television receivers; handheld computer games; table-top games; games adapted for use with television receivers; gymnastic and sporting articles not included in other classes; decorations for Christmas trees.

35 – Advertising; production of multimedia advertisements, arranging and conducting of advertising campaigns, rental and selling of advertising space and time for advertising purposes in mass media, creating advertised and sponsored texts, production of radio advertisements and advertising films for television, the film industry and the internet (term considered too vague by the International Bureau – Rule 13 (2) (b) of the Regulations); organisation of shows and exhibitions for commercial and advertising purposes; marketing and public relations; merchandise (term considered too vague by the International Bureau – Rule 13 (2) (b) of the Regulations); advertising; the bringing together, for the benefit of others, of goods such as multimedia equipment and multimedia articles and programs, television and computer games, games, toys, glassware, porcelain and earthenware, cosmetics, sanitary articles and medical dressing articles, clothing, food, sports articles and printed publications, via retailing, wholesaling, online sale or remote sale, enabling consumers to conveniently purchase those goods; promotion of musical concerts; promotion [advertising] of concerts.

38 – Transmission of sound and/or images, including by means of digital transmission, communication networks, including via television, satellite, terrestrial, cable and fibre optic networks and the internet; organising of sound, image and digital signal transmission systems (term considered too vague by the International Bureau – Rule 13 (2) (b) of the Regulations); broadcasting of television programmes, documentaries and feature films, entertainment and sports shows, and programmes with interactive viewer participation, broadcasting and transmission of interactive television and interactive entertainment; collecting and providing of information by means of communication networks (term considered too vague by the International Bureau – Rule 13 (2) (b) of the Regulations); providing online information via computer databases (term considered too vague by the International Bureau – Rule 13 (2) (b) of the Regulations); teletext and audiotext services; providing an advertising website, including providing an online interactive bulletin board (term considered too vague by the International Bureau – Rule 13 (2) (b) of the Regulations); providing teletext and audiotext services; access to content, websites and portals.

41 – Training; providing of training; entertainment services; sporting and cultural activities; publishing, writing and publication of texts, other than publicity

texts, publication of books and periodicals; production of radio and television programmes; organisation, production of artistic, stage, sporting and recreational programmes and events (term considered too vague by the International Bureau – Rule 13 (2) (b) of the Regulations); organising of studies and training in the field of multimedia; organising of competitions, organising of educational and cultural events; providing interactive applications and games played via computer and communication networks (entertainment, cultural and educational services); rental of recordings and recording studios; production of films, serials; production of shows; radio, film, television and cinema production; arranging and conducting of concerts; presentation of concerts; arranging and conducting of concerts; concert booking; arranging and conducting of concerts; arranging and conducting of concerts; arranging and conducting of concerts; arranging and conducting of concerts; arrangement of musical concerts; singing concert services; production of music concerts; live musical concerts; booking of seats for concerts; entertainment by means of concerts; pop music concerts (organisation of -); arranging and conducting of concerts; booking agencies for concert tickets; musical concerts by television; musical concerts by radio; reservation services for concert tickets; arranging, conducting and organisation of concerts; arranging and conducting of music concerts; entertainment services in the form of concert performances; reservation services for concert and theatre tickets; ticket reservation and booking services for music concerts; consultancy and information services relating to arranging, conducting and organisation of concerts; news reporting.

42 – Web hosting; web site design and creation services; consultancy in the field of computers (term considered too vague by the International Bureau – Rule 13 (2) (b) of the Regulations); graphic design.

(260) AM 2023 118331 A

(800) 1669156

(151) 2021 12 15

(891) 2021 12 15

(731) PROMOMED HOLDINGS (Cyprus) Limited  
Agias Elenis, 36, GALAXIAS BUILDING,  
Block A, Floor 6, Flat 601, CY-1061 Nicosia,  
Cyprus

(540)

**АРЕПЛИВИР**

**AREPLIVIR**

(591) Black, white

(531) 28.05

(511)

5 – Acaricides; aconitine; alkaloids for medical purposes; alginates for pharmaceutical purposes; algi-

cides; aldehydes for pharmaceutical purposes; dental amalgams of gold; dental amalgams; amino acids for veterinary purposes; amino acids for medical purposes; analgesics; anaesthetics; antibiotics; antiseptics; medicine cases, portable, filled; first-aid boxes, filled; aluminium acetate for pharmaceutical purposes; acetates for pharmaceutical purposes; germicides; oxygen cylinders, filled, for medical purposes; balms for medical purposes; bandages for dressings; diagnostic biomarker reagents for medical purposes; biocides; bracelets impregnated with insect repellent; bromine for pharmaceutical purposes; paper for mustard plasters; fly catching paper; reagent paper for veterinary purposes; reagent paper for medical purposes; moth-proofing paper; petroleum jelly for medical purposes; vaccines; oxygen baths; antiseptic cotton; aseptic cotton; absorbent cotton; wadding for medical purposes; cotton for medical purposes; dietetic substances adapted for medical use; radiological contrast substances for medical purposes; nutritive substances for microorganisms; radioactive substances for medical purposes; bismuth subnitrate for pharmaceutical purposes; melissa water for pharmaceutical purposes; seawater for medicinal bathing; mineral waters for medical purposes; thermal water; dietary fibre; moulding wax for dentists; gases for medical purposes; guaiacol for pharmaceutical purposes; massage gels for medical purposes; sexual stimulant gels; haematogen; haemoglobin; hydrastine; hydrastinine; glycerine for medical purposes; glycerophosphates; glucose for medical purposes; gentian for pharmaceutical purposes; hormones for medical purposes; mustard for pharmaceutical purposes; mud for baths; medicinal mud; contraceptive sponges; gamboge for medical purposes; gurjun balsam for medical purposes; deodorants, other than for human beings or for animals; air deodorizing preparations; deodorants for clothing and textiles; diastase for medical purposes; digitalin; vitamin supplement patches; mineral food supplements; nutritional supplements; albumin dietary supplements; dietary supplements for animals; yeast dietary supplements; alginate dietary supplements; glucose dietary supplements; casein dietary supplements; lecithin dietary supplements; linseed oil dietary supplements; propolis dietary supplements; protein dietary supplements; protein supplements for animals; royal jelly dietary supplements; pollen dietary supplements; wheat germ dietary supplements; linseed dietary supplements; acai powder dietary supplements; dietary supplements with a cosmetic effect; enzyme dietary supplements; yeast for pharmaceutical purposes; gelatine for medical purposes; cod liver oil; isotopes for medical purposes; immunostimulants; insecticides; iodine for pharmaceutical purposes; iodides for pharmaceutical purposes; alkaline iodides for pharmaceutical purposes; iodoform; calomel [fungicide]; cream of tartar for pharmaceutical purposes; tartar for pharmaceutical purposes; camphor for medical purposes; capsules for medicines; cachets for



pharmaceutical purposes; capsules made of dendrimer-based polymers, for pharmaceuticals; haemostatic pencils; wart pencils; caustic pencils; carbolineum [parasiticide]; caustics for pharmaceutical purposes; cachou for pharmaceutical purposes; quassia for medical purposes; quebracho for medical purposes; oxygen for medical purposes; gallic acid for pharmaceutical purposes; acids for pharmaceutical purposes; adhesives for dentures; adhesive tapes for medical purposes; surgical glues; stem cells for veterinary purposes; stem cells for medical purposes; cocaine; collagen for medical purposes; collodion for pharmaceutical purposes; corn rings for the feet; cannabis for medical purposes; medicated sweets; angostura bark for medical purposes; barks for pharmaceutical purposes; cedar wood for use as an insect repellent; condurango bark for medical purposes; croton bark; mangrove bark for pharmaceutical purposes; myrobalan bark for pharmaceutical purposes; quinquina for medical purposes; medicated animal feed; medicinal roots; rhubarb roots for pharmaceutical purposes; lint for medical purposes; starch for dietetic or pharmaceutical purposes; creosote for pharmaceutical purposes; blood for medical purposes; cultures of microorganisms for medical or veterinary use; curare; dental lacquer; liquorice for pharmaceutical purposes; milk sugar for pharmaceutical purposes; adhesive plasters; medicines for alleviating constipation; lecithin for medical purposes; lotions for veterinary purposes; medicated hair lotions; lotions for pharmaceutical purposes; medicated after-shave lotions; personal sexual lubricants; lupulin for pharmaceutical purposes; magnesium for pharmaceutical purposes; liniments; ointments for pharmaceutical purposes; sunburn ointments; frostbite salve for pharmaceutical purposes; mercurial ointments; gauze for dressings; medicinal oils; mustard oil for medical purposes; camphor oil for medical purposes; castor oil for medical purposes; oil of turpentine for pharmaceutical purposes; dill oil for medical purposes; dental mastics; dental abrasives; dental impression materials; teeth filling material; dressings, medical; surgical dressings; drugs for medical purposes; medicines for veterinary purposes; serotherapeutic medicines; medicines for human purposes; medicines for dental purposes; menthol; medicinal drinks; moleskin for medical purposes; almond milk for pharmaceutical purposes; powdered milk for babies; royal jelly for pharmaceutical purposes; milk ferments for pharmaceutical purposes; Irish moss for medical purposes; linseed meal for pharmaceutical purposes; flour for pharmaceutical purposes; fish meal for pharmaceutical purposes; fly glue; antibacterial soap; disinfectant soap; medicated soap; freeze-dried meat adapted for medical purposes; mint for pharmaceutical purposes; dietetic beverages adapted for medical purposes; malted milk beverages for medical purposes; injectable dermal fillers; bone void fillers comprised of living tissues; narcotics; medicinal infusions; tincture of iodine; eucalyptol for pharmaceu-

tical purposes; tinctures for medical purposes; opium; opodeldoc; decoctions for pharmaceutical purposes; antiparasitic collars for animals; cotton swabs for medical purposes; stick liquorice for pharmaceutical purposes; sulfur sticks [disinfectants]; pastilles for pharmaceutical purposes; medicated toothpaste; pectin for pharmaceutical purposes; diagnostic preparations for veterinary purposes; pepsins for pharmaceutical purposes; peptones for pharmaceutical purposes; hydrogen peroxide for medical purposes; pesticides; food for babies; leeches for medical purposes; blood plasma; nicotine patches for use as aids to stop smoking; eyepatches for medical purposes; poultices; compresses; scapulars for surgical purposes; babies' diapers; diapers for pets; swim diapers, reusable, for babies; swim diapers, disposable, for babies; diapers for incontinence; diaper changing mats, disposable, for babies; breast-nursing pads; bunion pads; pomades for medical purposes; powder of cantharides; pyrethrum powder; anti-uric preparations; bacterial preparations for medical and veterinary use; bacteriological preparations for medical and veterinary use; balsamic preparations for medical purposes; albuminous preparations for medical purposes; biological preparations for veterinary purposes; biological preparations for medical purposes; veterinary preparations; bismuth preparations for pharmaceutical purposes; vitamin preparations; diagnostic preparations for medical purposes; bath preparations for medical purposes; therapeutic preparations for the bath; haemorrhoid preparations; preparations for callouses; lice treatment preparations [pediculicides]; acne treatment preparations; preparations to facilitate teething; preparations for the treatment of burns; fumigation preparations for medical purposes; opotherapy preparations; air purifying preparations; bronchodilating preparations; preparations for reducing sexual activity; sterilizing preparations; soil-sterilizing preparations; corn remedies; pharmaceutical preparations for treating dandruff; preparations for destroying noxious animals; herbicides; preparations for destroying dry rot fungus; larvae exterminating preparations; fly destroying preparations; preparations for destroying mice; slug exterminating preparations; vermin destroying preparations; pharmaceutical preparations for skin care; contact lens cleaning preparations; lime-based pharmaceutical preparations; preparations of microorganisms for medical or veterinary use; chilblain preparations; medicated eye-washes; medicinal hair growth preparations; nutraceutical preparations for therapeutic or medical purposes; opiates; mothproofing preparations; anticryptogamic preparations; aloe vera preparations for pharmaceutical purposes; preparations of trace elements for human and animal use; sulfonamides [medicines]; pharmaceutical preparations; pharmaceutical preparations for treating sunburn; enzyme preparations for veterinary purposes; enzyme preparations for medical purposes; phytotherapy preparations for medical purposes; chemico-pharmaceutical preparations;

chemical preparations for veterinary purposes; chemical preparations for the diagnosis of pregnancy; chemical preparations for medical purposes; chemical preparations for treating diseases affecting cereal plants; chemical preparations for treating wheat blight; chemical preparations for treating diseases affecting vine plants; chemical preparations for treating mildew; chemical preparations for treating phyloxera; chemical preparations for pharmaceutical purposes; collyrium; lead water; chemical conductors for electrocardiograph electrodes; albuminous foodstuffs for medical purposes; dietetic foods adapted for medical purposes; by-products of the processing of cereals for dietetic or medical purposes; homogenized food adapted for medical purposes; freeze-dried food adapted for medical purposes; pharmaceuticals; sanitary towels; propolis for pharmaceutical purposes; pearl powder for medical purposes; radium for medical purposes; solvents for removing adhesive plasters; hydrated chloral for pharmaceutical purposes; vaginal washes for medical purposes; solutions for contact lenses; chemical reagents for medical or veterinary purposes; gum for medical purposes; rubber for dental purposes; chewing gum for medical purposes; nicotine gum for use as an aid to stop smoking; insect repellents; insect repellent incense; repellents for dogs; tissues impregnated with pharmaceutical lotions; sarsaparilla for medical purposes; sugar for medical purposes; crystallized rock sugar for medical purposes; asthmatic tea; fumigating sticks; massage candles for therapeutic purposes; suppositories; linseed for pharmaceutical purposes; tobacco-free cigarettes for medical purposes; siccatives [drying agents] for medical purposes; syrups for pharmaceutical purposes; turpentine for pharmaceutical purposes; milking grease; greases for veterinary purposes; greases for medical purposes; lacteal flour for babies; infant formula; soporifics; bicarbonate of soda for pharmaceutical purposes; mineral water salts; bath salts for medical purposes; salts for mineral water baths; salts for medical purposes; potassium salts for medical purposes; sodium salts for medical purposes; smelling salts; malt for pharmaceutical purposes; semen for artificial insemination; alcohol for pharmaceutical purposes; medicinal alcohol; alloys of precious metals for dental purposes; ergot for pharmaceutical purposes; cooling sprays for medical purposes; antibacterial handwashes; adjuvants for medical purposes; styptic preparations; astringents for medical purposes; vermifuges; disinfectants; disinfectants for hygiene purposes; disinfectants for chemical toilets; douching preparations for medical purposes; appetite suppressants for medical purposes; medical preparations for slimming purposes; parasiticides; mouthwashes for medical purposes; medicated dentifrices; febrifuges; depuratives; animal washes [insecticides]; detergents for medical purposes; cattle washes [insecticides]; dog washes [insecticides]; insecticidal veterinary washes; vesicants; purgatives; chemical contraceptives; antiparasitic pre-

parations; remedies for perspiration; remedies for foot perspiration; sedatives; laxatives; digestives for pharmaceutical purposes; tonics [medicines]; medicated toiletry preparations; nervines; bouillons for bacteriological cultures; steroids; headache relief sticks; strychnine; serums; antioxidant pills; tanning pills; appetite suppressant pills; slimming pills; jujube, medicated; sanitary tampons; vulnerary sponges; thymol for pharmaceutical purposes; biological tissue cultures for veterinary purposes; biological tissue cultures for medical purposes; smoking herbs for medical purposes; medicinal herbs; transplants [living tissues]; surgical implants comprised of living tissues; pants, absorbent, for incontinence; sanitary panties; babies' diaper-pants; charcoal for pharmaceutical purposes; fennel for medical purposes; porcelain for dental prostheses; phenol for pharmaceutical purposes; enzymes for veterinary purposes; enzymes for medical purposes; ferments for pharmaceutical purposes; formic aldehyde for pharmaceutical purposes; phosphates for pharmaceutical purposes; fungicides; quinine for medical purposes; chinoline for medical purposes; diabetic bread adapted for medical use; chloroform; flowers of sulfur for pharmaceutical purposes; cement for animal hooves; bone cement for surgical and orthopaedic purposes; dental cements; medicinal tea; herbal teas for medicinal purposes; insecticidal animal shampoos; medicated shampoos; medicated shampoos for pets; pediculicidal shampoos; medicated dry shampoos; pre-filled syringes for medical purposes; eucalyptus for pharmaceutical purposes; herbal extracts for medical purposes; plant extracts for pharmaceutical purposes; tobacco extracts [insecticides]; extracts of hops for pharmaceutical purposes; elixirs [pharmaceutical preparations]; ethers for pharmaceutical purposes; esters for pharmaceutical purposes; cellulose esters for pharmaceutical purposes; cellulose ethers for pharmaceutical purposes; rat poison; poisons; bacterial poisons; jalap.

---

(260) AM 2023 118332 A  
 (800) 1669220  
 (151) 2022 03 15  
 (891) 2022 03 15  
 (731) KRKA, tovarna zdravil, d.d., Novo mesto  
 Šmarješka cesta 6, SI-8000 Novo mesto,  
 Slovenia  
 (540)

## **ABOXOMA**

(591) Black, white  
 (511)  
 5 – Pharmaceutical preparations.

---

(260) AM 2023 118333 A  
 (800) 1669335  
 (151) 2022 04 01  
 (891) 2022 04 01

(731) ACCOR  
82 rue Henri Farman, F-92130 Issy-les-Moulineaux, France

(540)

S O U L  
COLLECTION

(591) Black, white

(531) 27.05.01

(511)

43 – Hotels; hotel services; services for providing food and beverages; restaurants; cafeteria, tea room and bar services (with the exception of clubs); temporary accommodation; tourist homes; hotel room reservation services for travelers; booking services for temporary accommodation; consultancy services relating to temporary accommodation; provision of information relating to food and beverage services; rental of rooms for conferences and meetings; provision of facilities for conferences and meetings; hotel and restaurant reservation services; provision of information on-line relating to hotel and restaurant reservations; butler services, namely serving food and beverages for guests.

(260) AM 2023 118334 A

(800) 1669340

(151) 2022 04 26

(891) 2022 04 26

(731) LABORATOIRE NATIVE

4 rue Euler, F-75008 PARIS, France

(540)

## LABORATOIRE NATIVE

(591) Black, white

(511)

3 – Soaps; perfumery products; essential oils; eau de Cologne; cosmetics particularly creams, milks, lotions, gels and powders; beauty masks; non-medical cosmetic preparations for skin, face and body care, maintenance and beautification; make-up and make-up removing products; cosmetic shaving and after-shave preparations; cosmetic sun and after-sun preparations; cosmetic products for slimming purposes; deodorants; cosmetic products for bathing and showering; sunscreen hair preparations; non-medical preparations for hair care, maintenance and embellishment; hair lotions; shampoos; hair care and styling creams, gels, foams, balms and masks; hair sprays; hair coloring and hair bleaching products; hair waving and setting products.

5 – Food supplements; dietetic substances for medical use; pharmaceutical products, namely, dermatological products, specialties for physiological and therapeutic purposes.

(260) AM 2023 118335 A

(800) 1669343

(151) 2022 04 26

(891) 2022 04 26

(731) LABORATOIRE NATIVE

4 rue Euler, F-75008 PARIS, France

(540)

NATIVE  
LABORATOIRE · PARIS

(591) Black, green

(531) 27.05.01; 29.01.12

(511)

3 – Soaps; perfumery products; essential oils; eau de Cologne; cosmetics particularly creams, milks, lotions, gels and powders; beauty masks; non-medical cosmetic preparations for skin, face and body care, maintenance and beautification; make-up and make-up removing products; cosmetic shaving and after-shave preparations; cosmetic sun and after-sun preparations; cosmetic products for slimming purposes; deodorants; bath and shower products; sunscreen hair preparations; non-medical preparations for hair care, maintenance and embellishment; hair lotions; shampoos; hair care and styling creams, gels, foams, balms and masks; hair sprays; hair coloring and hair bleaching products; hair waving and setting products; all these goods are of French origin or made in France.

5 – Food supplements; dietetic substances for medical use; pharmaceutical products, namely, dermatological products, specialties for physiological and therapeutic purposes.

(260) AM 2023 118346 A

(800) 1669771

(151) 2022 02 10

(891) 2022 02 10

(731) New Restoration and Recovery Services, LLC

2510 Meridian Parkway, Suite 350, Durham  
NC 27713, USA

(540)

## AQUALIS

(591) Black, white

(511)

35 – Business consulting services in the field of natural resource management, namely, storm water quality monitoring, storm water quality data collection, storm water quality data management, storm water quality monitoring instrumentation, storm water discharge and hydrology measurements; preparation of operating business reports for others, namely, preparation of operating business reports regarding accident prevention planning, hazardous waste management planning, non-hazardous waste management planning, state and federal licensing, storm water transmission, and storm water discharge all for business purposes; busi-

ness consulting services, namely, providing assistance in development of business strategies in the area of environmental regulations for storm water management; business services in the field of permitting, namely, obtaining environmental, design, zoning and other governmental permits for the disposal of hazardous and non-hazardous waste; permitting, namely, obtaining environmental, design, zoning and other governmental permits for ground and surface storm water discharge for construction and clean-up projects.

37 – Construction services, namely, maintenance and repair of storm water and drainage systems; renovation and restoration of utility power plant property; construction services, namely, installation of environmental containment systems; construction of storm water control infrastructure.

39 – Utility services, namely, providing collection services for storm water.

40 – Environmental remediation treatment of soil and storm water being emergency response services following release of chemicals or other toxic substances; waste management consultation services in the field of storm water reprocessing; storm site water reclamation services; management of wastewater collection systems for others; waste management consultation services in the field of sewer services for handling storm water.

42 – Technological consulting services in the field of environmental assessment and planning of storm water management for sites; technological consulting services in the field of storm water and water management systems, namely, planning, design, and engineering of storm water management systems; engineering services in the field of environmental compliance in the field of municipal storm water requirements; planning, design, and engineering of storm water treatment best management practices, storage systems, and conveyance and distribution systems; consultation services in the field of designing and engineering of environmentally-conscious buildings and irrigation systems, storm water capture and use systems, water storage and water treatment systems, water distribution systems, and infrastructure systems, namely, green roofs and green streets, and storm water management systems; analysis of storm water quality; engineering design services in the field of storm water management, for rehabilitated residential, commercial institutional and mixed-use facilities; waste management consultation services in the field of the detection of contaminants in storm water; waste management engineering consultation services in the field of storm water impact; waste management consultation services in the field of environmental assessment and planning relating to storm water.

45 – Waste management legal consultation services in the field of environmental regulatory matters relating to storm water.

(260) AM 2023 118417 A

(800) 1669981

(151) 2022 05 06

(891) 2022 05 06

(731) Honor Device Co., Ltd.

Suite 3401, Unit A, Building 6, Shum Yip Sky Park, No. 8089, Hongli West Road, Xiangmihu Street, Futian District, Shenzhen, 518040 Guangdong, China

(540)



(591) Orange, white

(531) 02.09.01; 24.17.20; 26.04.04; 26.04.16; 29.01.13

(511)

9 – Smartphone software applications, downloadable; computer software applications, downloadable; tablet computers; smartwatches [data processing apparatus]; notebook computers; computers; computer hardware; computer software, recorded; pedometers; bathroom scales; smartphones; routers; television apparatus; earphones; virtual reality headsets; cameras [photography]; connected bracelets [measuring instruments]; chips [integrated circuits]; digital door locks; 3D spectacles; mobile power (rechargeable battery).

(260) AM 2023 118418 A

(800) 1669986

(151) 2022 05 16

(891) 2022 05 16

(731) Medytox Inc.

78, Gangni 1-gil, Ochang-eup, Cheongwon-gu, Cheongju-si, Chungcheongbuk-do, Republic of Korea

(540)

**NEWLUX**

(591) Black, white

(511)

5 – Pharmaceutical agents affecting sensory organs; muscle relaxants; preparations for the treatment of muscle fatigue; pharmaceutical agents affecting peripheral nervous system; vaccines; pharmaceuticals containing botulinum toxin; bacteria poisons; pharmacological preparations for skin care; chemico-pharmaceutical preparations; pharmaceutical agents for epidermis; biological preparations for medical or veterinary purposes; medicated lotions; pharmaceutical syringes prefilled with medical botulinum toxin as the main ingredient; infusions (medicinal -); injectable dermal fillers; implantable medicines; pharmaceutical

preparations acting on the central nervous system; pain relief medication; dermatological pharmaceutical products; pharmaceutical preparations for treating skin disorders.

(260) AM 2023 118419 A

(800) 1670001

(151) 2022 03 28

(891) 2022 03 28

(731) GUANGZHOU WANG LAO JI GREAT HEALTH INDUSTRY CO., LTD.

Room 106 (Not using as Factory Building),

No. 3 Shuangshan Road, Nansha District,

Guangzhou City, Guangdong Province, China

(540)

荔小吉

(591) Black, white

(531) 28.03

(511)

32 – Non-alcoholic fruit juice beverages; low calorie soft drinks; sports energy drinks; non-alcoholic energy drinks; non-alcoholic beverages flavoured with tea; non-alcoholic beverages containing vitamins; energy drinks; non-alcoholic beverages; plant-based beverages; non-alcoholic preparations for making beverages.

(260) AM 2023 118421 A

(800) 1670048

(151) 2022 05 06

(891) 2022 05 06

(731) Heshan Empolo Sanitary Ware Co., Ltd.

One and four of No. 8 Xincheng Avenue,

Zhishan Town, Heshan City, Guangdong

Province, China

(540)

**EMPOLO**

(591) Black, white

(531) 27.05.17

(511)

11 – Faucets for pipes; fountains; heating installations [water]; bath fittings; bath plumbing fixtures; water flushing installations; water intake apparatus; pipes [parts of sanitary installations]; heaters for baths; pipe accessory for hot-water heating device.

(260) AM 2023 118426 A

(800) 1670342

(151) 2022 04 07

(891) 2022 04 07

(731) Six Continents Limited

Broadwater Park, Denham, Buckinghamshire

UB9 5HR, United Kingdom

(540)

IHG  ONE REWARDS

(591) Black, white

(531) 26.13.25; 27.05.01; 27.05.09; 27.05.10;

27.07.01; 27.07.01

(511)

35 – Customer loyalty services; customer incentive program services; administration of customer loyalty program; administration of customer incentive programs; promoting hotel, resort, travel, and vacation services through a customer loyalty program; promoting hotel, resort, travel, and vacation services through a customer incentive program.

(260) AM 2023 118427 A

(800) 1670346

(151) 2022 04 08

(891) 2022 04 08

(731) Teslenko Nailya Sabitovna

ul. Leningradskaya, d. 3, kv. 1269, mkr. Noviy,

Okkervil, g. Kudrovo, Vsevolozhskiy rayon,

RU-188691 Leningradskaya oblast, Russian

Federation

(540)

**MOODNAIL**

(591) Black, white

(511)

3 – Cosmetic nail preparations; nail glitter; nail polish; nail art stickers; false nails; nail care preparations; nail varnish removers.

35 – Wholesale or retail store services; retail and wholesale services, including retail and wholesale services via the internet; sales promotion for others; demonstration of goods; presentation of goods on communication media, for retail purposes; administrative processing of purchase orders; procurement services for others [purchasing goods and services for other businesses]; import-export agency services; advertising; online advertising on a computer network; providing commercial information and advice for consumers in the choice of products and services; organization of fashion shows for promotional purposes; provision of an online marketplace for buyers and sellers of goods and services.

41 – Education; entertainment services; cultural activities; publication of books; providing information in the field of education; layout services, other than for advertising purposes; videotape editing; production of radio and television programmes; practical training [demonstration]; full-time education; organization of exhibitions for cultural and educational purposes; arranging and conducting of conferences; arranging and conducting of concerts; arranging and conducting of workshops [training]; arranging and conducting of in-

person educational forums; arranging and conducting of seminars; organization of competitions [education or entertainment]; arranging of beauty contests; organization of lotteries; know-how transfer [training]; vocational retraining; providing online videos, not downloadable; providing online electronic publications, not downloadable; educational examination; online publication of electronic books and journals; publication of texts, other than publicity texts; news reporters services; tutoring; coaching [training]; photographic reporting.

44 – Hygienic and beauty care for human beings; depilatory waxing; manicuring; massage; hairdressing; beauty salon services; visagists' services; solarium services.

(260) AM 2023 118428 A

(800) 1670376

(151) 2021 12 30

(891) 2021 12 30

(731) BTL Industries

Tzar Kaloyan str 8, BG-1000 Sofia, Bulgaria

(540)

**BTL**

(591) Black, white

(511)

10 – Medical apparatus and instruments; aesthetic apparatus and aesthetic therapy instruments; veterinary apparatus and instruments; diagnostic apparatus for medical purposes; surgical apparatus and instruments; therapeutic apparatus and instruments; aesthetic massage apparatus; apparatus for the treatment of cellulite; therapeutic facial masks; apparatus for nerve stimulation; gynaecological and urological apparatus and instruments; cardiovascular instruments and apparatus; cardiographic apparatus and instruments; electrocardiograph monitoring apparatus; physical therapy equipment; physiotherapy and rehabilitation equipment; dental apparatus and instruments; beds specially made for medical purposes; contraceptives, non-chemical; artificial limbs; orthopedic articles; suture materials; masks and equipment for artificial respiration; apparatus for the alleviation of breathing difficulties; respirators for medical purposes; face masks for medical use; lung ventilators; protective visors for medical use; protective clothing for medical purposes.

(260) AM 2023 118429 A

(800) 1670378

(151) 2022 01 25

(891) 2022 01 25

(731) GINLONG TECHNOLOGIES CO., LTD.

No. 57 Jintong Road, Binhai Industrial Park,  
Economic Development Zone, Xiangshan,  
Ningbo, Zhejiang, China

(540)



(591) Black, white

(531) 01.03.02; 01.03.17; 27.05.01

(511)

9 – Electromagnetic coils; transformers [electricity]; step-up transformers; solar batteries; high tension batteries; battery jump starters; inverters [electricity]; stabilized voltage supply; current rectifiers; accumulator jars.

(260) AM 2023 118430 A

(800) 1670394

(151) 2022 05 05

(891) 2022 05 05

(731) JOINT STOCK COMPANY "FATS AND OIL INTEGRATED WORKS"

UL. TITOVA, 27, EKATERINBURG,

RU-620085 SVERDLOVSKAYA OBLAST,

Russian Federation

(540)



(591) White, blue, light blue, green, dark green, light green, yellow, light yellow, dark yellow, red, light red, pink, beige and brown

(531) 02.09.01; 05.07.14; 05.07.22; 05.09.17;  
08.07.11; 08.07.25; 28.05; 29.01.15

(511)

30 – Mayonnaise; mayonnaise sauce.

(260) AM 2023 118431 A

(800) 1670485

(151) 2022 05 12

(891) 2022 05 12

(731) SHENZHEN IVPS TECHNOLOGY CO. LTD.

101, Building B8, No. 2, Cengyao Industrial

Area, Yulv Community, Yutang Subdistrict,

Guangming District, Shenzhen, 518000

Guangdong, China

(540)

**SPACEMAN**

(591) Black, white

(511)

34 – Chewing tobacco; cigarettes containing tobacco substitutes, not for medical purposes; cigarettes; electronic cigarettes; flavorings, other than essential oils, for tobacco; flavorings, other than essential oils, for use in electronic cigarettes; herbs for smoking; lighters for smokers; liquid solutions for use in electronic cigarettes; oral vaporizers for smokers.

(260) AM 2023 118432 A

(800) 1670516

(151) 2022 04 13

(891) 2022 04 13

(731) KRONOSPAN ORMAN ÜRÜNLERİ  
SANAYİ VE TİCARET ANONİM ŞİRKETİ  
Barbaros Mah. Begonya Sok., Nidakule  
Ataşehir Kuzey Sitesi No:3/140, Ataşehir  
İstanbul, Türkiye

(540)



(591) Black, white

(531) 26.01.25; 26.04.05; 26.04.10; 26.04.12;  
27.05.01; 27.05.09

(511)

35 – Advertising, marketing and public relations; organization of exhibitions and trade fairs for commercial or advertising purposes; advertising for others; provision of an online marketplace for buyers and sellers of goods and services; secretarial services; arranging newspaper subscriptions for others; compilation of statistics; rental of office machines; systemization of information into computer databases; telephone answering for unavailable subscribers business management, business administration and business consultancy; accounting; commercial consultancy services; personnel recruitment, personnel placement, employment agencies, import-export agencies; temporary personnel placement services auctioneering the bringing together, for the benefit of others, of a variety of goods, namely, sand, gravel, crushed stone, asphalt, bitumen, cement, gypsum, plaster, concrete, marble blocks for construction, building materials (as finished products) made of concrete, gypsum, clay, potters' clay, stone, marble, wood, plastics and synthetic materials for building, construction, road construction purposes, non-metallic buildings, non-metallic building materials, poles not of metal for power lines, barriers not of metal, natural and synthetic coatings in the form of panels and sheets, being building materials, bitumen cardboard coatings for roofing, bitumen coating for roofing, doors and windows of wood and synthetic materials, traffic signs not of metal, non-luminous and non-mechanical, for roads, monuments and statuettes of stone, concrete and marble, building glass, prefabricated swimming pools not of metal (structures), aquarium sand, enabling customers to

conveniently view and purchase those goods, such services may be provided by retail stores, wholesale outlets, by means of electronic media or through mail order catalogues.

(260) AM 2023 118433 A

(800) 1670537

(151) 2021 10 08

(891) 2021 10 08

(731) TŘINECKÉ ŽELEZÁRNY, a. s.  
Průmyslová 1000, CZ-739 61 Třinec, Staré  
Město, Czech Republic

(540)



(591) Black, white

(531) 14.07.01; 26.01.03; 26.01.10; 26.01.16;  
26.03.01; 26.13.25

(511)

6 – Common metals and alloys of common metal unwrought or semi-wrought (antifriction metal), namely iron and cast iron unwrought or semi-wrought, steel and steel alloys, unwrought or semi-wrought (cast steel), for different use, metallurgical products of steel works, iron and steel foundry, rolling mills, forges and machinery products from metal, included in this class especially intermediate products, namely ingots of common metal, semi-finished products in process of continuous casting, namely round, squared or rectangular continuously cast semi-finished products, hot rolled semi-finished products, blooms, slabs, billets, sheet bars, chill-molds/chillmoulds (foundry), foundry moulds of metal, rails of metal, rails of metal; railway points, guard/check rails of metal for railways, hoops iron/iron strips, hoops steel/steel strips, round, squared and other profiles poles of metal and hot-rolled steel bars, beams of metal, angle irons of metal and other profiles of steel (for parabolic springs, wedge or plough cutting edges), iron wires, steel wires, reinforcing materials of metal/ materials of metal for concrete, railway material of metal, materials of metal for railway permanent ways and funicular railway permanent ways i.e. rail fishplates/jumpers, railway sole plates, railroad ties/sleepers of metal, common metals forgings and open die forgings, not included in other classes, metallurgical rolled or machinery metal rotating round products, namely rings, flanges of metal (collars), pipes of metal, pipework of metal, penstock pipes of metal, elbows of metal for pipes, junctions of metal for pipes, pipe muffs of metal, steel pipes, reinforcing materials of metal for pipes (casings), casings of metal for oilwells, metal connecting

products of all kinds i.e. bolts/screws, rives, nuts, wire of common metal, thread of metal for tying-up purposes, iron wire, drawn and polished metal bars, bright steel bars, bright-drawn wire from alloys steel and from plain carbon steel, bright-drawn patented steel wire, peeled steel, peeled metal bars, products from metals and their alloys of all kinds determined for different kinds of industry and included in this class, and their parts from metals included in this class and metallic products not included in other classes i.e. springs (metal hardware), ropes of metal, wire rope, telpher cables, chains of metal, couplings of metal for chains.

40 – Metalworking; treatment of materials, namely iron ore and metals, machining of metals, especially planning, stamping, rolling and welding of metals, powder metallurgy, smithery, metallurgical processing of foundry works, heat processing and metal finish, tempering of metals, hardening of metals, metal plating and cladding of metallic materials, electroplating, chrome plating, cadmium plating, nickel plating, information of working and treatment of materials, custom assembling of materials for others, purification of metallurgical waste, refining services, waste treatment (transformation), recycling and metallurgical waste and secondary raw materials disposal treatment, production of energy, all included in this class 40.

---

(260) AM 2023 118434 A  
 (800) 1670578  
 (151) 2022 02 26  
 (891) 2022 02 26  
 (731) Padideh Paydar Sanat Sakhteman Co.  
 No.10, Parian dead end, Pardis St., Vanak,  
 Tehran, Islamic Republic of Iran

(540)



(591) Black, white  
 (531) 26.04.02; 26.04.05; 26.04.18; 26.04.24;  
 27.05.10; 27.05.17; 27.05.24; 28.01

(526) wall

(511)

1 – Agglutinants for concrete; concrete expander; antifreeze for concrete; concrete lubricant (chemical material); concrete antifreeze; concrete adhesives.

19 – Concrete; building's concrete elements; prefabricated concrete wall; non flat wall blocks made of concrete; concrete repair [building material]; concrete curbs [building materials]; concrete pipe; water pipes, made of concrete; waterproof membrane made of concrete; concrete-based sealants [building materials]; concrete coatings; ready-to-use concrete repair mortars; prefabricated concrete parts; concrete water reducers; concrete coagulation material (building material); concrete wall blocks for building; normal concrete wall block; concrete coagulation material (building material); concrete admixtures, concrete roof tiles.

---

## PUBLICATION BASED ON COURT DECISION

(210) 94954

(800) 1372648

(540) SCOTCH TERRIER

(732) LLC "Vinokonyachny Zavod Alliance-1892"

Ul. Gogolya 9A, Chernyakhovsk, RU-238150 Kaliningrad Region, Russian Federation

(511) Expanded List Based on Court Decision:

33 - Alcoholic beverages (except beer), but in so far as whiskey and whiskey based liqueurs are concerned only Scotch whiskey and Scotch whiskey based liqueurs produced in Scotland.

(851)

GROUNDS: The Article 15.2<sup>1</sup> of the "Law of Georgia on Trademarks".

---



---

**INTERNATIONAL TRADEMARKS PROTECTED IN GEORGIA**

(260) AM 2023 116136 A  
(800) 1421702  
(151) 2018 06 08  
(181) 2028 06 08  
(891) 2021 08 18  
(511) 32

---

(260) AM 2023 116141 A  
(800) 1542181  
(151) 2020 05 26  
(181) 2030 05 26  
(891) 2021 09 28  
(511) 09, 42

---

(260) AM 2023 116187 A  
(800) 1638744  
(151) 2021 12 07  
(181) 2031 12 07  
(891) 2021 12 07  
(511) 01, 16

---

(260) AM 2023 116263 A  
(800) 1639470  
(151) 2021 07 30  
(181) 2031 07 30  
(891) 2021 07 30  
(511) 08, 34

---

(260) AM 2023 116264 A  
(800) 1639500  
(151) 2021 11 05  
(181) 2031 11 05  
(891) 2021 11 05  
(511) 09, 35, 38, 42

---

(260) AM 2023 116265 A  
(800) 1639547  
(151) 2021 09 03  
(181) 2031 09 03  
(891) 2021 09 03  
(511) 16, 41, 42

---

(260) AM 2023 116266 A  
(800) 1639549  
(151) 2021 11 10  
(181) 2031 11 10

(891) 2021 11 10  
(511) 09

---

(260) AM 2023 116269 A  
(800) 1639603  
(151) 2021 12 08  
(181) 2031 12 08  
(891) 2021 12 08  
(511) 02, 07, 19

---

(260) AM 2023 116270 A  
(800) 1639608  
(151) 2021 12 07  
(181) 2031 12 07  
(891) 2021 12 07  
(511) 05

---

(260) AM 2023 116271 A  
(800) 1639609  
(151) 2021 10 19  
(181) 2031 10 19  
(891) 2021 10 19  
(511) 05

---

(260) AM 2023 116272 A  
(800) 1639613  
(151) 2021 11 22  
(181) 2031 11 22  
(891) 2021 11 22  
(511) 04

---

(260) AM 2023 116273 A  
(800) 1639614  
(151) 2021 12 06  
(181) 2031 12 06  
(891) 2021 12 06  
(511) 05

---

(260) AM 2023 116274 A  
(800) 1639615  
(151) 2021 12 06  
(181) 2031 12 06  
(891) 2021 12 06  
(511) 05

---

(260) AM 2023 116276 A  
(800) 1639617  
(151) 2021 12 06  
(181) 2031 12 06  
(891) 2021 12 06  
(511) 05

---

(260) AM 2023 116288 A  
(800) 1639728  
(151) 2021 11 10  
(181) 2031 11 10  
(891) 2021 11 10  
(511) 34

---

(260) AM 2023 116278 A  
(800) 1639627  
(151) 2021 07 20  
(181) 2031 07 20  
(891) 2021 07 20  
(511) 09, 36, 38, 42

---

(260) AM 2023 116290 A  
(800) 1639833  
(151) 2021 11 22  
(181) 2031 11 22  
(891) 2021 11 22  
(511) 04

---

(260) AM 2023 116279 A  
(800) 1639628  
(151) 2021 07 15  
(181) 2031 07 15  
(891) 2021 07 15  
(511) 06, 09, 35, 36, 38, 42

---

(260) AM 2023 116291 A  
(800) 1639834  
(151) 2021 11 22  
(181) 2031 11 22  
(891) 2021 11 22  
(511) 04

---

(260) AM 2023 116280 A  
(800) 1639641  
(151) 2021 11 23  
(181) 2031 11 23  
(891) 2021 11 23  
(511) 35

---

(260) AM 2023 116292 A  
(800) 1639835  
(151) 2021 11 22  
(181) 2031 11 22  
(891) 2021 11 22  
(511) 04

---

(260) AM 2023 116283 A  
(800) 1639658  
(151) 2021 08 03  
(181) 2031 08 03  
(891) 2021 08 03  
(511) 35, 39, 41, 43

---

(260) AM 2023 116293 A  
(800) 1639836  
(151) 2021 11 22  
(181) 2031 11 22  
(891) 2021 11 22  
(511) 04

---

(260) AM 2023 116286 A  
(800) 1639666  
(151) 2021 08 03  
(181) 2031 08 03  
(891) 2021 08 03  
(511) 29, 30

---

(260) AM 2023 116294 A  
(800) 1639858  
(151) 2021 11 17  
(181) 2031 11 17  
(891) 2021 11 17  
(511) 34

---

(260) AM 2023 116287 A  
(800) 1639695  
(151) 2021 12 14  
(181) 2031 12 14  
(891) 2021 12 14  
(511) 32

---

(260) AM 2023 116295 A  
(800) 1639859  
(151) 2021 11 10  
(181) 2031 11 10  
(891) 2021 11 10  
(511) 34

---

(260) AM 2023 116296 A  
(800) 1639860  
(151) 2021 11 17  
(181) 2031 11 17  
(891) 2021 11 17  
(511) 34

---

(260) AM 2023 116298 A  
(800) 1640047  
(151) 2021 11 16  
(181) 2031 11 16  
(891) 2021 11 16  
(511) 28

---

(260) AM 2023 116299 A  
(800) 855614  
(151) 2005 04 27  
(181) 2025 04 27  
(891) 2021 12 16  
(511) 05, 29, 32

---

(260) AM 2023 116300 A  
(800) 1593615  
(151) 2021 03 02  
(181) 2031 03 02  
(891) 2021 11 24  
(511) 09

---

(260) AM 2023 116301 A  
(800) 1599936  
(151) 2021 05 06  
(181) 2031 05 06  
(891) 2021 11 24  
(511) 09

---

(260) AM 2023 116337 A  
(800) 1640161  
(151) 2021 12 08  
(181) 2031 12 08  
(891) 2021 12 08  
(511) 41, 44

---

(260) AM 2023 116338 A  
(800) 1640168  
(151) 2021 12 17  
(181) 2031 12 17  
(891) 2021 12 17  
(511) 05

---

(260) AM 2023 116339 A  
(800) 1640209  
(151) 2021 11 22  
(181) 2031 11 22  
(891) 2021 11 22  
(511) 04

---

(260) AM 2023 116340 A  
(800) 1640274  
(151) 2021 07 09  
(181) 2031 07 09  
(891) 2021 07 09  
(511) 05

---

(260) AM 2023 116341 A  
(800) 1640282  
(151) 2021 12 17  
(181) 2031 12 17  
(891) 2021 12 17  
(511) 30

---

(260) AM 2023 116342 A  
(800) 1640283  
(151) 2021 08 07  
(181) 2031 08 07  
(891) 2021 08 07  
(511) 06, 07

---

(260) AM 2023 116343 A  
(800) 1640288  
(151) 2021 12 24  
(181) 2031 12 24  
(891) 2021 12 24  
(511) 12

---

(260) AM 2023 116347 A  
(800) 1640321  
(151) 2021 12 17  
(181) 2031 12 17  
(891) 2021 12 17  
(511) 05

---

(260) AM 2023 116351 A  
(800) 1640407  
(151) 2021 10 29  
(181) 2031 10 29  
(891) 2021 10 29  
(511) 29, 30

---

(260) AM 2023 116357 A  
(800) 1640533  
(151) 2021 12 09  
(181) 2031 12 09  
(891) 2021 12 09  
(511) 31, 36, 44

---

(260) AM 2023 116365 A  
(800) 1640654  
(151) 2021 12 15  
(181) 2031 12 15  
(891) 2021 12 15  
(511) 09, 28, 41

---

(260) AM 2023 116358 A  
(800) 1640539  
(151) 2021 12 14  
(181) 2031 12 14  
(891) 2021 12 14  
(511) 32, 33

---

(260) AM 2023 116366 A  
(800) 1640764  
(151) 2021 12 15  
(181) 2031 12 15  
(891) 2021 12 15  
(511) 12

---

(260) AM 2023 116359 A  
(800) 1640553  
(151) 2021 12 17  
(181) 2031 12 17  
(891) 2021 12 17  
(511) 27, 35

---

(260) AM 2023 116367 A  
(800) 1640830  
(151) 2021 11 02  
(181) 2031 11 02  
(891) 2021 11 02  
(511) 34

---

(260) AM 2023 116360 A  
(800) 1640577  
(151) 2021 08 12  
(181) 2031 08 12  
(891) 2021 08 12  
(511) 09, 28, 41

---

(260) AM 2023 116378 A  
(800) 1117700  
(151) 2011 11 04  
(181) 2031 11 04  
(891) 2021 12 24  
(511) 25

---

(260) AM 2023 116361 A  
(800) 1640579  
(151) 2021 08 11  
(181) 2031 08 11  
(891) 2021 08 11  
(511) 03, 05

---

(260) AM 2023 116379 A  
(800) 1201001  
(151) 2013 12 13  
(181) 2023 12 13  
(891) 2021 12 24  
(511) 18, 25

---

(260) AM 2023 116362 A  
(800) 1640583  
(151) 2021 08 04  
(181) 2031 08 04  
(891) 2021 08 04  
(511) 34

---

(260) AM 2023 116380 A  
(800) 1212108  
(151) 2014 05 30  
(181) 2024 05 30  
(891) 2022 01 11  
(511) 33

---

(260) AM 2023 116363 A  
(800) 1640626  
(151) 2021 12 02  
(181) 2031 12 02  
(891) 2021 12 02  
(511) 30

---

(260) AM 2023 116381 A  
(800) 1269796  
(151) 2015 06 19  
(181) 2025 06 19  
(891) 2021 12 03  
(511) 07, 08, 09, 11

---

(260) AM 2023 116382 A  
(800) 1325017  
(151) 2016 06 07  
(181) 2026 06 07  
(891) 2021 12 06  
(511) 18

---

(260) AM 2023 116383 A  
(800) 1428841  
(151) 2018 07 13  
(181) 2028 07 13  
(891) 2021 12 20  
(511) 25, 35

---

(260) AM 2023 116384 A  
(800) 1450377  
(151) 2018 08 07  
(181) 2028 08 07  
(891) 2021 12 24  
(511) 01, 04

---

(260) AM 2023 116385 A  
(800) 1592876  
(151) 2020 10 21  
(181) 2030 10 21  
(891) 2022 01 12  
(511) 05

---

(260) AM 2023 116386 A  
(800) 1616175  
(151) 2021 07 01  
(181) 2031 07 01  
(891) 2022 01 06  
(511) 34

---

(260) AM 2023 116387 A  
(800) 1629915  
(151) 2021 10 27  
(181) 2031 10 27  
(891) 2022 01 06  
(511) 05

---

(260) AM 2023 116441 A  
(800) 1641355  
(151) 2021 12 07  
(181) 2031 12 07  
(891) 2021 12 07  
(511) 01, 16

---

(260) AM 2023 116442 A  
(800) 1641359  
(151) 2021 12 06  
(181) 2031 12 06  
(891) 2021 12 06  
(511) 05

---

(260) AM 2023 116443 A  
(800) 1641369  
(151) 2021 12 06  
(181) 2031 12 06  
(891) 2021 12 06  
(511) 05

---

(260) AM 2023 116444 A  
(800) 1641370  
(151) 2021 12 06  
(181) 2031 12 06  
(891) 2021 12 06  
(511) 05

---

(260) AM 2023 116461 A  
(800) 1641532  
(151) 2021 12 02  
(181) 2031 12 02  
(891) 2021 12 02  
(511) 09

---

(260) AM 2023 116463 A  
(800) 1641543  
(151) 2021 12 06  
(181) 2031 12 06  
(891) 2021 12 06  
(511) 34

---

(260) AM 2023 116464 A  
(800) 1641547  
(151) 2021 11 16  
(181) 2031 11 16  
(891) 2021 11 16  
(511) 34

---

(260) AM 2023 116465 A  
(800) 1641548  
(151) 2021 11 12  
(181) 2031 11 12  
(891) 2021 11 12  
(511) 35, 43

---

(260) AM 2023 116467 A  
(800) 1641594  
(151) 2021 12 01  
(181) 2031 12 01  
(891) 2021 12 01  
(511) 25

---

(260) AM 2023 116473 A  
(800) 1641799  
(151) 2021 08 01  
(181) 2031 08 01  
(891) 2021 08 01  
(511) 03, 05

---

(260) AM 2023 116475 A  
(800) 1641950  
(151) 2021 11 30  
(181) 2031 11 30  
(891) 2021 11 30  
(511) 32, 33

---

(260) AM 2023 116476 A  
(800) 1641965  
(151) 2021 11 16  
(181) 2031 11 16  
(891) 2021 11 16  
(511) 34

---

(260) AM 2023 116478 A  
(800) 1642010  
(151) 2021 11 16  
(181) 2031 11 16  
(891) 2021 11 16  
(511) 38

---

(260) AM 2023 116479 A  
(800) 1642036  
(151) 2021 11 17  
(181) 2031 11 17  
(891) 2021 11 17  
(511) 02, 17, 19, 37

---

(260) AM 2023 116575 A  
(800) 1643011  
(151) 2021 12 29  
(181) 2031 12 29  
(891) 2021 12 29  
(511) 12

---

(260) AM 2023 116577 A  
(800) 1643154  
(151) 2021 10 04  
(181) 2031 10 04  
(891) 2021 10 04  
(511) 35, 36, 42

---

(260) AM 2023 116583 A  
(800) 1643359  
(151) 2021 05 11  
(181) 2031 05 11  
(891) 2021 05 11  
(511) 01, 04, 07, 09, 10, 11, 12

---

(260) AM 2023 116584 A  
(800) 1643361  
(151) 2021 05 11  
(181) 2031 05 11  
(891) 2021 05 11  
(511) 01, 04, 07, 09, 10, 11, 12

---

(260) AM 2023 116585 A  
(800) 1643397  
(151) 2021 07 22  
(181) 2031 07 22  
(891) 2021 07 22  
(511) 30

---

(260) AM 2023 116587 A  
(800) 1643483  
(151) 2021 10 21  
(181) 2031 10 21  
(891) 2021 10 21  
(511) 03, 05, 35, 41, 44

---

(260) AM 2023 116588 A  
(800) 1643486  
(151) 2021 10 21  
(181) 2031 10 21  
(891) 2021 10 21  
(511) 03, 05, 35, 41, 44

---

(260) AM 2023 116589 A  
(800) 1643493  
(151) 2021 09 03  
(181) 2031 09 03  
(891) 2021 09 03  
(511) 07, 08, 09

---

(260) AM 2023 116590 A  
(800) 1643516  
(151) 2021 10 19  
(181) 2031 10 19  
(891) 2021 10 19  
(511) 09

---

(260) AM 2023 116592 A  
(800) 1643563  
(151) 2021 12 03  
(181) 2031 12 03  
(891) 2021 12 03  
(511) 05

---

(260) AM 2023 116606 A  
(800) 1644109  
(151) 2021 10 06  
(181) 2031 10 06  
(891) 2021 10 06  
(511) 03

---

(260) AM 2023 117119 A  
(800) 1650124  
(151) 2021 12 23  
(181) 2031 12 23  
(891) 2021 12 23  
(511) 03

---

(260) AM 2023 117121 A  
(800) 1650142  
(151) 2021 11 02  
(181) 2031 11 02  
(891) 2021 11 02  
(511) 09, 42

---

(260) AM 2023 117122 A  
(800) 1650144  
(151) 2021 08 10  
(181) 2031 08 10  
(891) 2021 08 10  
(511) 41, 43, 44, 45

---

(260) AM 2023 117123 A  
(800) 1650196  
(151) 2022 01 17  
(181) 2032 01 17  
(891) 2022 01 17  
(511) 05

---

(260) AM 2023 117124 A  
(800) 1650229  
(151) 2021 07 13  
(181) 2031 07 13  
(891) 2021 07 13  
(511) 02, 03, 07, 08, 09, 10, 11, 12, 14, 15, 16, 18, 21,  
24, 28, 35, 36, 37, 38, 39, 41, 42, 45

---

(260) AM 2023 117125 A  
(800) 1650349  
(151) 2021 10 21  
(181) 2031 10 21  
(891) 2021 10 21  
(511) 07, 09, 11, 12, 35, 42

---

(260) AM 2023 117126 A  
(800) 1650429  
(151) 2022 02 08  
(181) 2032 02 08  
(891) 2022 02 08  
(511) 30

---

(260) AM 2023 117127 A  
(800) 1650469  
(151) 2022 01 20  
(181) 2032 01 20  
(891) 2022 01 20  
(511) 10

---

(260) AM 2023 117136 A  
(800) 1650673  
(151) 2021 11 24  
(181) 2031 11 24  
(891) 2021 11 24  
(511) 02, 19, 35, 37, 42

---

---

**OFFICIAL NOTIFICATIONS  
INVENTIONS  
RESTORATION OF PATENTS**

(21) AP 2013 13850  
(11) P 2017 6739 B  
(73) H. Lundbeck A/S  
(54) COMPOSITIONS COMPRISING VORTIOXETINE AND DONEPEZIL  
DATE OF PATENT CANCELLATION: 2022 12 12  
DATE OF PATENT RESTORATION: 2023 02 27

---

(21) AP 2019 15413  
(11) P 2022 7412 B  
(73) Assa Abloi Ziherrhaitstekhnik GmbH  
(54) FLAT KEY PROFILE FOR LOCK-KEY SYSTEM  
DATE OF PATENT CANCELLATION: 2023 01 18  
DATE OF PATENT RESTORATION: 2023 02 27

---

(21) AP 2005 9607  
(11) P 2009 4804 B  
(73) Bristol-Myers Squibb Holdings Ireland Unlimited Company  
(54) PROCESS FOR PREPARING 2-AMINOTHIAZOLE-5-AROMATIC CARBOXAMIDES AS KINASE  
INHIBITORS  
DATE OF PATENT CANCELLATION: 2023 02 04  
DATE OF PATENT RESTORATION: 2023 02 27

---

**ABOLITION OF PATENTS WITH THE RIGHT TO RESTORE**

(21) AP 2008 11451  
(11) P 2013 5727 B  
(73) Columbia Laboratories (Bermuda) Limited (BM)  
(54) PROGESTERONE FOR PRETERM BIRTH PREVENTION  
DATE OF PATENT CANCELLATION: 2023 02 05  
LIMITED DATE OF PATENT RESTORATION: 2024 02 05

---

(21) AP 2005 11830  
(11) P 2013 5824 B  
(73) Geox S.P.A.  
(54) SHOE WITH BREATHABLE AND WATERPROOF SOLE AND UPPER  
DATE OF PATENT CANCELLATION: 2023 01 20  
LIMITED DATE OF PATENT RESTORATION: 2024 01 20

---

(21) AP 2013 13572  
(11) P 2016 6552 B  
(73) Aziende Chimiche Riunite Angelini Francesco A.C.R.A.F. S.p.A.  
(54) USE OF 1H-INDAZOLE-3-CARBOXAMIDE COMPOUNDS AS GLYCOGEN SYNTHASE KINASE  
3 BETA INHIBITORS



---

DATE OF PATENT CANCELLATION: 2023 02 08  
LIMITED DATE OF PATENT RESTORATION: 2024 02 08

---

(21) AP 2015 13728  
(11) P 2016 6478 B  
(73) Tamaz Shioshvili  
(54) DEVICE FOR GETTING HAIR ROOT AND TRANSPLANTATION THEREOF  
DATE OF PATENT CANCELLATION: 2023 02 06  
LIMITED DATE OF PATENT RESTORATION: 2024 02 06

---

(21) AP 2017 14871  
(11) P 2020 7163 B  
(73) Guy SCOTT;  
Lindsay MOLONEY  
(54) A SYSTEM AND METHOD FOR DOCUMENT INFORMATION AUTHENTICITY VERIFICATION  
DATE OF PATENT CANCELLATION: 2023 02 07  
LIMITED DATE OF PATENT RESTORATION: 2024 02 07

---

(21) AP 2005 9607  
(11) P 2009 4804 B  
(73) Bristol-Myers Squibb Holdings Ireland Unlimited Company  
(54) PROCESS FOR PREPARING 2-AMINOTHIAZOLE-5-AROMATIC CARBOXAMIDES AS KINASE  
INHIBITORS  
DATE OF PATENT CANCELLATION: 2023 02 04  
LIMITED DATE OF PATENT RESTORATION: 2025 02 04

## DATE OF PATENTS RESTORATION EXPIRATION

---

(21) AP 2011 12842  
(11) P 2017 6587 B  
(73) Corteva Agriscience LLC  
(54) ENGINEERED LANDING PADS FOR GENE TARGETING IN PLANTS  
DATE OF PATENT CANCELLATION: 2022 01 21  
DATE OF PATENT RESTORATION EXPIRATION: 2023 01 21

---

(21) AP 2011 12848  
(11) P 2015 6229 B  
(73) Boehringer Ingelheim International GMBH  
(54) 5-ALKYNYL-PYRIMIDINES  
DATE OF PATENT CANCELLATION: 2022 01 26  
DATE OF PATENT RESTORATION EXPIRATION: 2023 01 26

---

(21) AP 2014 13369  
(11) P 2015 6323 B  
(73) Avtandil Tevdoradze  
(54) SPRINKLER KNAPSACK  
DATE OF PATENT CANCELLATION: 2022 01 31  
DATE OF PATENT RESTORATION EXPIRATION: 2023 01 31

---

(21) AP 2015 13727  
(11) P 2017 6652 B  
(73) Bitchiko Surguladze;  
Nugzar Svianadze;  
Levan Pirkulashvili  
(54) PRELIMINARILY TENSED FRAME CONSTRUCTION  
DATE OF PATENT CANCELLATION: 2022 02 06  
DATE OF PATENT RESTORATION EXPIRATION: 2023 02 06

---

(21) AP 2014 13925  
(11) P 2019 7049 B  
(73) Boris GORINSHTEYN  
(54) COMPOSITIONS AND METHODS FOR TREATING SURFACE WOUNDS  
DATE OF PATENT CANCELLATION: 2022 01 29  
DATE OF PATENT RESTORATION EXPIRATION: 2023 01 29

---

(21) AP 2017 14402  
(11) P 2018 6897 B  
(73) LEPL "Technical University of Georgia";  
LEPL "Shota Rustaveli National Science Foundation of Georgia"  
(54) METHOD FOR CEMENT PRODUCTION  
DATE OF PATENT CANCELLATION: 2022 02 02  
DATE OF PATENT RESTORATION EXPIRATION: 2023 02 02

---

(21) AP 2016 14833  
(11) P 2020 7176 B  
(73) Natco Pharma LTD  
(54) PHARMACEUTICAL COMPOSITIONS COMPRISING PHENYLAMINOPYRIMIDINE DERIVATIVE  
DATE OF PATENT CANCELLATION: 2022 01 30  
DATE OF PATENT RESTORATION EXPIRATION: 2023 01 30

---

(21) AP 2017 14845  
(11) P 2021 7312 B  
(73) Tolmar International Limited  
(54) VENTED COVER PLATE FOR AN ARRAY OF SYRINGES  
DATE OF PATENT CANCELLATION: 2022 02 03  
DATE OF PATENT RESTORATION EXPIRATION: 2023 02 03

---

(21) AP 2020 15272  
(11) P 2021 7283 B  
(73) Ramaz Tkemaladze;  
Zaur Chitidze;  
Zaur Balamtsarashvili;  
Malkhaz Akhvlediani;  
Guram Bosikov;  
Irakli Grdzelishvili;  
Nikoloz Gelashvili;  
Giorgi Kvaratskhelia;  
Tinatin Darsavelidze;  
Davit Mosulishvili;  
Igor Gelashvili;  
Maya Gogotishvili  
(54) LOG DRAWING SELF-LOADING AGGREGATE BODY-ARROW MECHANISM WITH  
HYDROMECHANICAL ACTUATOR

DATE OF PATENT CANCELLATION: 2022 02 06  
DATE OF PATENT RESTORATION EXPIRATION: 2023 02 06

---

## TRANSFER OF RIGHTS

(21) AP 2005 10009  
(11) P 2009 4832 B  
(54) FUNGICIDAL MIXTURES OF THIOPHENE DERIVATIVE  
NAME AND ADDRESS OF NEW PATENT OWNER: Corteva Agriscience LLC (US)  
9330 Zionsville Road, Indianapolis, Indiana, 46268,  
USA (US)  
NAME AND ADDRESS OF FORMER PATENT OWNER: E.I. Du Pont De Nemours and Company  
1007 Market Street, Wilmington, DE 19898,  
USA (US)  
DATE OF REGISTRATION: 2023 02 14

---

(21) AP 2007 11072  
(11) P 2012 5505 B  
(54) FUNGICIDAL AZOCYCLIC AMIDES  
NAME AND ADDRESS OF NEW PATENT OWNER: Corteva Agriscience LLC (US)  
9330 Zionsville Road, Indianapolis, Indiana, 46268,  
USA (US)  
NAME AND ADDRESS OF FORMER PATENT OWNER: E.I. Du Pont De Nemours and Company  
1007 Market Street, Wilmington, DE 19898,  
USA (US)  
DATE OF REGISTRATION: 2023 02 14

---

(21) AP 2008 11803  
(11) P 2013 5758 B  
(54) FUNGICIDAL COMPOUNDS AND MIXTURES  
NAME AND ADDRESS OF NEW PATENT OWNER: Corteva Agriscience LLC (US)  
9330 Zionsville Road, Indianapolis, Indiana, 46268,  
USA (US)  
NAME AND ADDRESS OF FORMER PATENT OWNER: E.I. Du Pont De Nemours and Company  
1007 Market Street, Wilmington, DE 19898,  
USA (US)  
DATE OF REGISTRATION: 2023 02 14

---

(21) AP 2004 9528  
(11) P 2012 5626 B  
(54) HERBICIDAL PYRIMIDINES  
NAME AND ADDRESS OF NEW PATENT OWNER: Corteva Agriscience LLC (US)  
9330 Zionsville Road, Indianapolis, Indiana, 46268,  
USA (US)  
NAME AND ADDRESS OF FORMER PATENT OWNER: E.I. Du Pont De Nemours and Company  
1007 Market Street, Wilmington, DE 19898,  
USA (US)  
DATE OF REGISTRATION: 2023 02 14

---

## UTILITY MODELS RESTORATION OF PATENTS

(21) AU 2021 15548  
(11) U 2022 2104 Y  
(73) LTD "Novacia"  
(54) ADVERTISING EQUIPMENT  
DATE OF PATENT CANCELLATION: 2023 02 02  
DATE OF PATENT RESTORATION: 2023 02 27

---

(21) AU 2021 15550  
(11) U 2022 2116 Y  
(73) Shota Tchedia  
(54) MOBILE ADVERTISING SYSTEM  
DATE OF PATENT CANCELLATION: 2023 02 03  
DATE OF PATENT RESTORATION: 2023 02 27

---

## ABOLITION OF PATENTS WITH THE RIGHT TO RESTORE

(21) AU 2020 15267  
(11) U 2021 2078 Y  
(73) Avtandil Bitsadze  
(54) HELIODRYER FOR AGRICULTURAL PRODUCTION  
DATE OF PATENT CANCELLATION: 2023 01 30  
LIMITED DATE OF PATENT RESTORATION: 2024 01 30

---

(21) AU 2020 15270  
(11) U 2021 2080 Y  
(73) Nino Mtchedlishvili  
(54) MULTIPLE USAGE PAD FOR LADY  
DATE OF PATENT CANCELLATION: 2023 02 04  
LIMITED DATE OF PATENT RESTORATION: 2024 02 04

---

(21) AU 2021 15545  
(11) U 2021 2101 Y  
(73) Giorgi Tchiradze  
(54) METHOD FOR MULTILAYER ARTICLE PREPARATION WITH PLYWOOD  
DATE OF PATENT CANCELLATION: 2023 01 28  
LIMITED DATE OF PATENT RESTORATION: 2024 01 28

---

(21) AU 2021 15548  
(11) U 2022 2104 Y  
(73) LTD "Novacia"  
(54) ADVERTISING EQUIPMENT  
DATE OF PATENT CANCELLATION: 2023 02 02  
LIMITED DATE OF PATENT RESTORATION: 2025 02 02

---

(21) AU 2021 15550  
(11) U 2022 2116 Y  
(73) Shota Tchedia  
(54) MOBILE ADVERTISING SYSTEM  
DATE OF PATENT CANCELLATION: 2023 02 03  
LIMITED DATE OF PATENT RESTORATION: 2025 02 03

---

## DESIGNS

### CANCELLATION OF DESIGN REGISTRATION

(11) D 2018 756 S  
(73) Angelini Beauty S.P.A. (IT)  
Via Tortona, 15, I-20144 Milano, Italy (IT)  
(54) PERFUME FLACON  
(18) 2022 07 18  
(58) 2023 02 10

---

### CANCELLATION OF INTERNATIONAL DESIGNS REGISTRATION

(11) DM/96231  
(73) PEUGEOT CITROËN AUTOMOBILES SA  
Route de Gisy, F-78140 VELIZY-VILLACOUBLAY (FR)  
DATE OF REGISTRATION CANCELLATION: 2022 02 24  
(58) 2023 02 07

---

(11) DM/96236  
(73) PEUGEOT CITROËN AUTOMOBILES SA  
Route de Gisy, F-78140 VELIZY-VILLACOUBLAY (FR)  
DATE OF REGISTRATION CANCELLATION: 2022 02 24  
(58) 2023 02 07

---

(11) DM/96239  
(73) PEUGEOT CITROËN AUTOMOBILES SA  
Route de Gisy, F-78140 Velizy-Villacoublay (FR)  
DATE OF REGISTRATION CANCELLATION: 2022 03 30  
(58) 2023 02 07

---

(11) DM/96285  
(73) PEUGEOT CITROËN AUTOMOBILES SA  
Route de Gisy, F-78140 Velizy-Villacoublay (FR)  
DATE OF REGISTRATION CANCELLATION: 2022 04 14  
(58) 2023 02 07

---

(11) DM/96865  
(73) SEAT S.A.  
Autovía A-2, Km. 585, E-08760 Martorell (Barcelona) (ES)  
DATE OF REGISTRATION CANCELLATION: 2022 03 27  
(58) 2023 02 07

---

(11) DM/96968  
(73) BUDMAT WIĘCEK BOGDAN  
ul. Otolińska 25, PL-09-407 Plock (PL)  
DATE OF REGISTRATION CANCELLATION: 2022 02 06  
(58) 2023 02 07

---

(11) DM/97196  
(73) PSA AUTOMOBILES SA  
2-10 Boulevard de l'Europe, F-78300 Poissy (FR)  
DATE OF REGISTRATION CANCELLATION: 2022 07 27  
(58) 2023 02 07

---

(11) DM/98226  
(73) PEUGEOT CITROËN AUTOMOBILES SA  
Route de Gisy, F-78140 Velizy-Villacoublay (FR)  
DATE OF REGISTRATION CANCELLATION: 2022 05 04  
(58) 2023 02 07

---

(11) DM/98227  
(73) PEUGEOT CITROËN AUTOMOBILES SA  
Route de Gisy, F-78140 Velizy-Villacoublay (FR)  
DATE OF REGISTRATION CANCELLATION: 2022 05 04  
(58) 2023 02 07

---

(11) DM/98228  
(73) PEUGEOT CITROËN AUTOMOBILES SA  
Route de Gisy, F-78140 Velizy-Villacoublay (FR)  
DATE OF REGISTRATION CANCELLATION: 2022 03 31  
(58) 2023 02 07

---

(11) DM/98291  
(73) PEUGEOT CITROËN AUTOMOBILES SA  
Route de Gisy, F-78140 Velizy-Villacoublay (FR)  
DATE OF REGISTRATION CANCELLATION: 2022 06 20  
(58) 2023 02 07

---

(11) DM/99541  
(73) DOCK TECHNOLOGIES INC.  
30 W. Mifflin St. 6th Floor, Madison WI 53703 (US)  
DATE OF REGISTRATION CANCELLATION: 2021 07 06  
(58) 2023 02 07

---

**TRADEMARKS****EXTENSION OF TERMS OF TRADEMARKS REGISTRATION**

(111) M 2003 14924 R2

(151) 2003 01 30

(186) 2033 01 30

(732) CNH Industrial N.V.

25 ST. James's Street, London, SW1A 1HA,  
United Kingdom

(111) M 2003 15058 R2

(151) 2003 03 28

(186) 2033 03 28

(732) N.V. Organon

Kloosterstraat 6, 5349 AB Oss,  
Netherlands

(111) M 2003 14925 R2

(151) 2003 01 30

(186) 2033 01 30

(732) CNH Industrial N.V.

25 ST. James's Street, London, SW1A 1HA,  
United Kingdom

(111) M 2003 15208 R2

(151) 2003 07 16

(186) 2033 07 16

(732) ABRO Industries, Inc.

3580 Blackthorn Court, South Bend, IN 46628,  
USA

(111) M 2003 14937 R2

(151) 2003 01 30

(186) 2033 01 30

(732) Kellogg Europe Trading Limited

3 Dublin Airport Central (DAC), Dublin  
Airport, Dublin, K67X4X5, Ireland

(111) M 2003 15358 R2

(151) 2003 12 15

(186) 2033 12 15

(732) Novartis AG

4002 Basel, Switzerland

(111) M 2003 14919 R2

(151) 2003 01 30

(186) 2033 01 30

(732) Hilton Worldwide Manage Limited

Maple Court Central Park, Reeds Crescent,  
Watford, WD24 4QQ, United Kingdom

(111) M 2012 22997 R1

(151) 2012 10 09

(186) 2032 10 09

(732) LTD "Aspharma – Georgian Pharmaceutical  
Company"

Mtskheta Str. 8, 0179, Tbilisi, Georgia

(111) M 2003 15042 R2

(151) 2003 03 28

(186) 2033 03 28

(732) Pfizer Products Inc.,

a Connecticut Corporation  
Eastern Point Road, Groton, Connecticut  
06340, USA

(111) M 2012 22999 R1

(151) 2012 10 09

(186) 2032 10 09

(732) LTD "Aspharma – Georgian Pharmaceutical  
Company"

Mtskheta Str. 8, 0179, Tbilisi, Georgia

(111) M 2003 15040 R2

(151) 2003 03 28

(186) 2033 03 28

(732) Pfizer Products Inc.,

a Connecticut Corporation  
Eastern Point Road, Groton, Connecticut  
06340, USA

(111) M 2012 23001 R1

(151) 2012 10 09

(186) 2032 10 09

(732) LTD "Aspharma – Georgian Pharmaceutical  
Company"

Mtskheta Str. 8, 0179, Tbilisi, Georgia

(111) M 2012 23002 R1

(151) 2012 10 09

(186) 2032 10 09

(732) LTD "Aspharma – Georgian Pharmaceutical  
Company"

Mtskheta Str. 8, 0179, Tbilisi, Georgia

(111) M 2013 23316 R1  
 (151) 2013 02 12  
 (186) 2033 02 12  
 (732) Corporacion Habanos S.A.  
 Avenida Tercera entre 78 y 80, Centro de  
 Negocios Miramar, Edificio Habana,  
 3er. Piso, Playa, La Habana, Cuba

---

(111) M 2013 23368 R1  
 (151) 2013 02 27  
 (186) 2033 02 27  
 (732) British American Tobacco Western Europe  
 Commercial Trading Limited  
 Globe House, 1 Water Street, London,  
 WC2R 3LA, United Kingdom

---

(111) M 2013 23321 R1  
 (151) 2013 02 12  
 (186) 2033 02 12  
 (732) Biogen MA Inc.  
 a Massachusetts Corporation  
 225 Binney Street, Cambridge, Massachussets  
 02142, USA

---

(111) M 2013 23297 R1  
 (151) 2013 01 25  
 (186) 2033 01 25  
 (732) Abro Industries Inc.  
 3580 Blackthorn Court, South Bend, Indiana  
 46628, USA

---

(111) M 2013 23298 R1  
 (151) 2013 01 25  
 (186) 2033 01 25  
 (732) Abro Industries Inc.  
 3580 Blackthorn Court, South Bend, Indiana  
 46628, USA

---

(111) M 2013 23561 R1  
 (151) 2013 04 12  
 (186) 2033 04 12  
 (732) Abro Industries Inc.  
 3580 Blackthorn Court, South Bend, Indiana  
 46628, USA

---

(111) M 2013 23299 R1  
 (151) 2013 01 25  
 (186) 2033 01 25  
 (732) Abro Industries Inc.  
 3580 Blackthorn Court, South Bend, Indiana  
 46628, USA

---

(111) M 2013 23330 R1  
 (151) 2013 02 12  
 (186) 2033 02 12  
 (732) Abro Industries Inc.  
 3580 Blackthorn Court, South Bend, Indiana  
 46628, USA

---

(111) M 2013 23440 R1  
 (151) 2013 03 13  
 (186) 2033 03 13  
 (732) Bunge SA  
 13 Route de Florissant, 1206 Geneve,  
 Switzerland

---

(111) M 2013 23442 R1  
 (151) 2013 03 13  
 (186) 2033 03 13  
 (732) Kingston Technologi Corporation  
 17600 Newhope Street, Fountain Valley,  
 California 92708, USA

---

(111) M 2013 23340 R1  
 (151) 2013 02 12  
 (186) 2033 02 12  
 (732) Kingston Technologi Corporation  
 17600 Newhope Street, Fountain Valley,  
 California 92708, USA

---

(111) M 2013 23387 R1  
 (151) 2013 02 27  
 (186) 2033 02 27  
 (732) Kingston Technologi Corporation  
 17600 Newhope Street, Fountain Valley,  
 California 92708, USA

---

(111) M 2013 23352 R1  
 (151) 2013 02 12  
 (186) 2033 02 12  
 (732) Sun Pharmaceutical Industries Limited  
 [Sun Pharmaceutical Industries Ltd]  
 SPARK, Tandalja, Vadodara – 390 020,  
 Gujarat; Sun House, 201 B/1, Western Express  
 Highway, Goregaon (E), Mumbai - 400 063,  
 India

---

(111) M 2013 23627 R1  
 (151) 2013 04 26  
 (186) 2033 04 26  
 (732) Millennium Pharmaceuticals Inc.  
 40 Landsdowne Street, Cambridge,  
 Massachusetts, USA

---



(111) M 2013 23593 R1  
(151) 2013 04 12  
(186) 2033 04 12  
(732) Canon Kabushiki Kaisha  
30-2, Shimomaruko 3-chome, Ohta-ku,  
Tokyo, Japan

---

(111) M 2013 23636 R1  
(151) 2013 04 26  
(186) 2033 04 26  
(732) Millennium Pharmaceuticals Inc.  
40 Landsdowne Street, Cambridge,  
Massachusetts, USA

---

(111) M 2013 23637 R1  
(151) 2013 04 26  
(186) 2033 04 26  
(732) Millennium Pharmaceuticals Inc.  
40 Landsdowne Street, Cambridge,  
Massachusetts, USA

---

(111) M 2013 23642 R1  
(151) 2013 04 26  
(186) 2033 04 26  
(732) The Coca-Cola Company  
One Coca-Cola Plaza, Atlanta,  
Georgia 30313, USA

---

(111) M 2013 23646 R1  
(151) 2013 04 26  
(186) 2033 04 26  
(732) Limited Liability Company "VMPAUTO"  
Ulica Promishlennaia, Dom 40, Liter A,  
Ofis 301, Sankt-peterburgi, 198099,  
Russian Federation

---

(111) M 2013 23908 R1  
(151) 2013 08 14  
(186) 2033 08 14  
(732) Nicoventures Limited  
1 Water Street, London WC2R 3LA,  
United Kingdom

---

(111) M 2013 24165 R1  
(151) 2013 10 17  
(186) 2033 10 17  
(732) LTD "Bibludi"  
Iosebidge Str. 49, 0160, Tbilisi, Georgia

---

(111) M 2013 24233 R1  
(151) 2013 11 04  
(186) 2033 11 04  
(732) American-Cigarette Company (Overseas)  
Limited  
Route De France 17, Boncourt, 2926,  
Switzerland

---

(111) M 2013 24181 R1  
(151) 2013 10 17  
(186) 2033 10 17  
(732) British American Tobacco (Brands) Inc.  
251 Little Falls Drive, Suite 100, Delaware,  
19808-1674, Wilmington, USA

---

(111) M 2013 24235 R1  
(151) 2013 11 04  
(186) 2033 11 04  
(732) British American Tobacco (Brands) Inc.  
(a Delaware corporation)  
251 Little Falls Drive, Suite 100, Delaware,  
19808-1674, Wilmington, USA

---

(111) M 2013 24236 R1  
(151) 2013 11 04  
(186) 2033 11 04  
(732) British American Tobacco (Brands) Inc.  
(a Delaware corporation)  
251 Little Falls Drive, Suite 100, Delaware,  
19808-1674, Wilmington, USA

---

(111) M 2013 24237 R1  
(151) 2013 11 04  
(186) 2033 11 04  
(732) British American Tobacco (Brands) Inc.  
(a Delaware corporation)  
251 Little Falls Drive, Suite 100, Delaware,  
19808-1674, Wilmington, USA

---

(111) M 2013 24243 R1  
(151) 2013 11 04  
(186) 2033 11 04  
(732) British American Tobacco (Brands) Inc.  
(a Delaware corporation)  
251 Little Falls Drive, Suite 100, Delaware,  
19808-1674, Wilmington, USA

---

(111) M 2013 24390 R1  
(151) 2013 12 30  
(186) 2033 12 30  
(732) British American Tobacco (Brands) Limited  
Globe House, 4 Temple Place, London  
WC2R 2 PG, United Kingdom

---

(111) M 2013 24366 R1  
(151) 2013 12 13  
(186) 2033 12 13  
(732) Novartis AG  
4002 Basel, Switzerland

---

One Apple Park Way, Cupertino, California  
95014, USA

---

(111) M 2013 24404 R1  
(151) 2013 12 30  
(186) 2033 12 30  
(732) British American Tobacco (Brands) Inc.  
(a Delaware corporation)  
251 Little Falls Drive, Suite 100, Wilmington,  
DE 19808-1674, USA

---

(111) M 2013 23604 R1  
(151) 2013 04 24  
(186) 2033 04 24  
(732) LTD "Kvareli Cellar"  
Vill. Tchikaani, 4814, Kvareli Region, Georgia

---

(111) M 2013 24405 R1  
(151) 2013 12 30  
(186) 2033 12 30  
(732) British American Tobacco (Brands) Inc.  
(a Delaware corporation)  
251 Little Falls Drive, Suite 100, Delaware,  
19808-1674, Wilmington, USA

---

(111) M 2013 24378 R1  
(151) 2013 12 25  
(186) 2033 12 25  
(732) McDonald's International Property  
Company LTD.  
110 North Carpenter Street, Chicago,  
Illinois 60607, USA

---

(111) M 2013 23419 R1  
(151) 2013 03 13  
(186) 2033 03 13  
(732) LTD "Alfa"  
Tevdore Mghvdeli Str. 53, 0154, Tbilisi,  
Georgia

---

(111) M 2013 23466 R1  
(151) 2013 03 15  
(186) 2033 03 15  
(732) LTD "CBD Development"  
Melikishvili Ave. 10, Tbilisi, Georgia

---

(111) M 2013 23467 R1  
(151) 2013 03 15  
(186) 2033 03 15  
(732) LTD "CBD Development"  
Melikishvili Ave. 10, Tbilisi, Georgia

---

(111) M 2013 23468 R1  
(151) 2013 03 15  
(186) 2033 03 15  
(732) LTD "CBD Development"  
Melikishvili Ave. 10, Tbilisi, Georgia

---

(111) M 2013 23954 R1  
(151) 2013 08 14  
(186) 2033 08 14  
(732) Apple Inc.

---

## COMPLETE TRANSFER OF RIGHTS

- 
- (111) M 2020 32977 R  
 (732) Merck Sharp & Dohme LLC  
 126 East Lincoln Ave., P.O. Box 2000,  
 Rahway New Jersey 07065, USA  
 (770) Merck Sharp & Dohme Corp.  
 One Merck Drive, Whitehouse Station,  
 New Jersey 08889, USA  
 (580) 2022 11 14
- 
- (111) M 2020 32978 R  
 (732) Merck Sharp & Dohme LLC  
 126 East Lincoln Ave., P.O. Box 2000,  
 Rahway New Jersey 07065, USA  
 (770) Merck Sharp & Dohme Corp.  
 One Merck Drive, Whitehouse Station,  
 New Jersey 08889, USA  
 (580) 2022 11 14
- 
- (111) M 2020 32979 R  
 (732) Merck Sharp & Dohme LLC  
 126 East Lincoln Ave., P.O. Box 2000,  
 Rahway New Jersey 07065, USA  
 (770) Merck Sharp & Dohme Corp.  
 One Merck Drive, Whitehouse Station,  
 New Jersey 08889, USA  
 (580) 2022 11 14
- 
- (111) M 2020 32980 R  
 (732) Merck Sharp & Dohme LLC  
 126 East Lincoln Ave., P.O. Box 2000,  
 Rahway New Jersey 07065, USA  
 (770) Merck Sharp & Dohme Corp.  
 One Merck Drive, Whitehouse Station,  
 New Jersey 08889, USA  
 (580) 2022 11 14
- 
- (111) M 2020 33148 R  
 (732) Merck Sharp & Dohme LLC  
 126 East Lincoln Ave., P.O. Box 2000,  
 Rahway New Jersey 07065, USA  
 (770) Merck Sharp & Dohme Corp.  
 One Merck Drive, Whitehouse Station,  
 New Jersey 08889, USA  
 (580) 2022 11 14
- 
- (111) M 2020 33149 R  
 (732) Merck Sharp & Dohme LLC  
 126 East Lincoln Ave., P.O. Box 2000,  
 Rahway New Jersey 07065, USA  
 (770) Merck Sharp & Dohme Corp.
- One Merck Drive, Whitehouse Station,  
 New Jersey 08889, USA  
 (580) 2022 11 14
- 
- One Merck Drive, Whitehouse Station,  
 New Jersey 08889, USA  
 (580) 2022 11 14
- 
- (111) M 2020 33150 R  
 (732) Merck Sharp & Dohme LLC  
 126 East Lincoln Ave., P.O. Box 2000,  
 Rahway New Jersey 07065, USA  
 (770) Merck Sharp & Dohme Corp.  
 One Merck Drive, Whitehouse Station,  
 New Jersey 08889, USA  
 (580) 2022 11 14
- 
- (111) M 2020 33151 R  
 (732) Merck Sharp & Dohme LLC  
 126 East Lincoln Ave., P.O. Box 2000,  
 Rahway New Jersey 07065, USA  
 (770) Merck Sharp & Dohme Corp.  
 One Merck Drive, Whitehouse Station,  
 New Jersey 08889, USA  
 (580) 2022 11 14
- 
- (111) M 2020 33120 R  
 (732) Merck Sharp & Dohme LLC  
 126 East Lincoln Ave., P.O. Box 2000,  
 Rahway New Jersey 07065, USA  
 (770) Merck Sharp & Dohme Corp.  
 One Merck Drive, Whitehouse Station,  
 New Jersey 08889, USA  
 (580) 2022 11 14
- 
- (111) M 2021 33919 R  
 (732) Applied Nutrition Limited  
 2C Trio, Acornfield Rd, Knowsley,  
 L33 7UG, United Kingdom  
 (770) LTD "Geo Olymp"  
 R. Eristavi Str. 16, Tbilisi, Georgia  
 (580) 2023 01 20
- 
- (111) M 2022 34991 R  
 (732) Merck Sharp & Dohme LLC  
 126 East Lincoln Ave., P.O. Box 2000,  
 Rahway New Jersey 07065, USA  
 (770) Merck Sharp & Dohme Corp.  
 One Merck Drive, Whitehouse Station,  
 New Jersey 08889, USA  
 (580) 2022 11 15
-

(111) M 2022 34992 R  
(732) Merck Sharp & Dohme LLC  
126 East Lincoln Ave., P.O. Box 2000,  
Rahway New Jersey 07065, USA  
(770) Merck Sharp & Dohme Corp.  
One Merck Drive, Whitehouse Station,  
New Jersey 08889, USA  
(580) 2022 11 15

---

(111) M 2022 34959 R  
(732) Merck Sharp & Dohme LLC  
126 East Lincoln Ave., P.O. Box 2000,  
Rahway New Jersey 07065, USA  
(770) Merck Sharp & Dohme Corp.  
One Merck Drive, Whitehouse Station,  
New Jersey 08889, USA  
(580) 2022 11 15

---

(111) M 2022 35250 R  
(732) Merck Sharp & Dohme LLC  
126 East Lincoln Ave., P.O. Box 2000,  
Rahway New Jersey 07065, USA  
(770) Merck Sharp & Dohme Corp.  
One Merck Drive, Whitehouse Station,  
New Jersey 08889, USA  
(580) 2022 11 15

---

(111) M 2022 35255 R  
(732) Merck Sharp & Dohme LLC  
126 East Lincoln Ave., P.O. Box 2000,  
Rahway New Jersey 07065, USA  
(770) Merck Sharp & Dohme Corp.  
One Merck Drive, Whitehouse Station,  
New Jersey 08889, USA  
(580) 2022 11 15

---

(111) M 1997 5881 R  
(732) Merck Sharp & Dohme LLC  
126 East Lincoln Ave., P.O. Box 2000,  
Rahway New Jersey 07065, USA  
(770) Merck Sharp & Dohme Corp.  
One Merck Drive, Whitehouse Station,  
New Jersey 08889, USA  
(580) 2022 11 14

---

(111) M 1997 5882 R  
(732) Merck Sharp & Dohme LLC  
126 East Lincoln Ave., P.O. Box 2000,  
Rahway New Jersey 07065, USA  
(770) Merck Sharp & Dohme Corp.  
One Merck Drive, Whitehouse Station,  
New Jersey 08889, USA  
(580) 2022 11 14

---

(111) M 1998 10614 R  
(732) Merck Sharp & Dohme LLC  
126 East Lincoln Ave., P.O. Box 2000,  
Rahway New Jersey 07065, USA  
(770) Merck Sharp & Dohme Corp.  
One Merck Drive, Whitehouse Station,  
New Jersey 08889, USA  
(580) 2022 11 14

---

(111) M 2001 13924 R  
(732) Merck Sharp & Dohme LLC  
126 East Lincoln Ave., P.O. Box 2000,  
Rahway New Jersey 07065, USA  
(770) Merck Sharp & Dohme Corp.  
One Merck Drive, Whitehouse Station,  
New Jersey 08889, USA  
(580) 2022 11 14

---

(111) M 2006 16795 R  
126 East Lincoln Ave., P.O. Box 2000,  
Rahway New Jersey 07065, USA  
(770) Merck Sharp & Dohme Corp.  
One Merck Drive, Whitehouse Station,  
New Jersey 08889, USA  
(580) 2022 11 14

---

(111) M 2006 16724 R  
(732) Merck Sharp & Dohme LLC  
126 East Lincoln Ave., P.O. Box 2000,  
Rahway New Jersey 07065, USA  
(770) Merck Sharp & Dohme Corp.  
One Merck Drive, Whitehouse Station,  
New Jersey 08889, USA  
(580) 2022 11 14

---

(111) M 2007 17524 R  
(732) Merck Sharp & Dohme LLC  
126 East Lincoln Ave., P.O. Box 2000,  
Rahway New Jersey 07065, USA  
(770) Merck Sharp & Dohme Corp.  
One Merck Drive, Whitehouse Station,  
New Jersey 08889, USA  
(580) 2022 11 14

---

(111) M 2010 20223 R  
(732) LTD "Divase Servise"  
Dighomi, III qu., bld. 19, ap. 45, 0159,  
Tbilisi, Georgia  
(770) LTD "Alliance Cor"  
Kandelaki Str. 37, 0160, Tbilisi, Georgia  
(580) 2023 01 20

---

(111) M 2013 23332 R  
(732) Merck Sharp & Dohme LLC  
126 East Lincoln Ave., P.O. Box 2000,  
Rahway New Jersey 07065, USA  
(770) Merck Sharp & Dohme Corp.  
One Merck Drive, Whitehouse Station,  
New Jersey 08889, USA  
(580) 2022 11 14

---

(111) M 2013 23594 R  
(732) Merck Sharp & Dohme LLC  
126 East Lincoln Ave., P.O. Box 2000,  
Rahway New Jersey 07065, USA  
(770) Merck Sharp & Dohme Corp.  
One Merck Drive, Whitehouse Station,  
New Jersey 08889, USA  
(580) 2022 11 14

---

(111) M 1998 10435 R  
(732) Merck Sharp & Dohme LLC  
126 East Lincoln Ave., P.O. Box 2000,  
Rahway New Jersey 07065, USA  
(770) Merck Sharp & Dohme Corp.  
One Merck Drive, Whitehouse Station,  
New Jersey 08889, USA  
(580) 2022 11 14

---

(111) M 2015 25946 R  
(732) Merck Sharp & Dohme LLC  
126 East Lincoln Ave., P.O. Box 2000,  
Rahway New Jersey 07065, USA  
(770) One Merck Sharp & Dohme Corp.,  
One Merck Drive, Whitehouse Station,  
New Jersey, 08889 USA  
(580) 2022 11 14

---

(111) M 2015 26409 R  
(732) Merck Sharp & Dohme LLC  
126 East Lincoln Ave., P.O. Box 2000,  
Rahway New Jersey 07065, USA  
(770) Merck Sharp & Dohme Corp.  
One Merck Drive, Whitehouse Station,  
New Jersey, 08889, USA  
(580) 2022 11 14

---

(111) M 2015 26410 R  
(732) Merck Sharp & Dohme LLC  
126 East Lincoln Ave., P.O. Box 2000,  
Rahway New Jersey 07065, USA  
(770) Merck Sharp & Dohme Corp.  
One Merck Drive, Whitehouse Station,  
New Jersey, 08889, USA  
(580) 2022 11 14

---

(111) M 2017 28152 R  
(732) Merck Sharp & Dohme LLC  
126 East Lincoln Ave., P.O. Box 2000,  
Rahway New Jersey 07065, USA  
(770) Merck Sharp & Dohme Corp.  
One Merck Drive, Whitehouse Station,  
New Jersey, 08889, USA  
(580) 2022 11 14

---

(111) M 2017 28153 R  
(732) Merck Sharp & Dohme LLC  
126 East Lincoln Ave., P.O. Box 2000,  
Rahway New Jersey 07065, USA  
(770) Merck Sharp & Dohme Corp.  
One Merck Drive, Whitehouse Station,  
New Jersey, 08889, USA  
(580) 2022 11 14

---

(111) M 2017 28154 R  
(732) Merck Sharp & Dohme LLC  
126 East Lincoln Ave., P.O. Box 2000,  
Rahway New Jersey 07065, USA  
(770) Merck Sharp & Dohme Corp.  
One Merck Drive, Whitehouse Station,  
New Jersey, 08889, USA  
(580) 2022 11 14

---

(111) M 2018 29671 R  
(732) Merck Sharp & Dohme LLC  
126 East Lincoln Ave., P.O. Box 2000,  
Rahway New Jersey 07065, USA  
(770) Merck Sharp & Dome Korp.  
Uan Merk Draivi, Uaithauz–steisheni,  
Niu-Jerzi, 08889, USA  
(580) 2022 11 14

---

(111) M 2018 29686 R  
(732) Merck Sharp & Dohme LLC  
126 East Lincoln Ave., P.O. Box 2000,  
Rahway New Jersey 07065, USA  
(770) Merck Sharp & Dohme Corp.  
One Merck Drive, Whitehouse Station,  
New Jersey, 08889, USA  
(580) 2022 11 14

---

(111) M 2018 29687 R  
(732) Merck Sharp & Dohme LLC  
126 East Lincoln Ave., P.O. Box 2000,  
Rahway New Jersey 07065, USA  
(770) Merck Sharp & Dohme Corp.  
One Merck Drive, Whitehouse Station,  
New Jersey, 08889, USA  
(580) 2022 11 14

---

(111) M 2018 29688 R  
(732) Merck Sharp & Dohme LLC  
126 East Lincoln Ave., P.O. Box 2000,  
Rahway New Jersey 07065, USA  
(770) Merck Sharp & Dohme Corp.  
One Merck Drive, Whitehouse Station,  
New Jersey, 08889, USA  
(580) 2022 11 14

---

(111) M 2018 29689 R  
(732) Merck Sharp & Dohme LLC  
126 East Lincoln Ave., P.O. Box 2000,  
Rahway New Jersey 07065, USA  
(770) Merck Sharp & Dohme Corp.  
One Merck Drive, Whitehouse Station,  
New Jersey, 08889, USA  
(580) 2022 11 14

---

(111) M 2018 29690 R  
(732) Merck Sharp & Dohme LLC  
126 East Lincoln Ave., P.O. Box 2000,  
Rahway New Jersey 07065, USA  
(770) Merck Sharp & Dohme Corp.  
One Merck Drive, Whitehouse Station,  
New Jersey, 08889, USA  
(580) 2022 11 14

---

(111) M 2018 29691 R  
(732) Merck Sharp & Dohme LLC  
126 East Lincoln Ave., P.O. Box 2000,  
Rahway New Jersey 07065, USA  
(770) Merck Sharp & Dohme Corp.  
One Merck Drive, Whitehouse Station,  
New Jersey, 08889, USA  
(580) 2022 11 14

---

(111) M 2018 30310 R  
(732) Merck Sharp & Dohme LLC  
126 East Lincoln Ave., P.O. Box 2000,  
Rahway New Jersey 07065, USA  
(770) Merck Sharp & Dohme Corp.  
One Merck Drive, Whitehouse Station,  
New Jersey, 08889, USA  
(580) 2022 11 14

---

(111) M 2018 30429 R  
(732) Merck Sharp & Dohme LLC  
126 East Lincoln Ave., P.O. Box 2000,  
Rahway New Jersey 07065, USA  
(770) Merck Sharp & Dohme Corp.  
One Merck Drive, Whitehouse Station,  
New Jersey, 08889, USA  
(580) 2022 11 14

---

(111) M 2019 30707 R  
(732) Merck Sharp & Dohme LLC  
126 East Lincoln Ave., P.O. Box 2000,  
Rahway New Jersey 07065, USA  
(770) Merck Sharp & Dohme Corp.  
One Merck Drive, Whitehouse Station,  
New Jersey, 08889, USA  
(580) 2022 11 14

---

(111) M 2019 30754 R  
(732) Merck Sharp & Dohme LLC  
126 East Lincoln Ave., P.O. Box 2000,  
Rahway New Jersey 07065, USA  
(770) Merck Sharp & Dohme Corp.  
Uan Merk Draivi, Uaithauz–steisheni,  
Niu-Jerzi 08889, USA  
(580) 2022 11 14

---

(111) M 2019 30708 R  
(732) Merck Sharp & Dohme LLC  
126 East Lincoln Ave., P.O. Box 2000,  
Rahway New Jersey 07065, USA  
(770) Merck Sharp & Dohme Corp.  
Uan Merk Draivi, Uaithauz–steisheni,  
Niu-Jerzi 08889, USA  
(580) 2022 11 14

---

(111) M 2018 30083 R  
(732) LTD "Company Besini"  
Gamrekeli Str. 19, 0160, Tbilisi, Georgia  
(770) LTD "Vite Vera"  
Z. Paliashvili Str. 33, 0179, Tbilisi, Georgia  
(580) 2023 01 18

---

## CHANGES OF NAMES AND/OR ADDRESSES OF TRADEMARKS OWNERS

(111) M 2003 15081 R  
(732) LTD "G M Pharmaceuticals"  
Rustavi Highway 52, 0114, Tbilisi, Georgia  
(770) LTD "G M P"  
Zemo Vedzisi Str. 103, 0160, Tbilisi,  
Georgia  
(580) 2023 01 17

---

(111) M 2003 15082 R  
(732) LTD "G M Pharmaceuticals"  
Rustavi Highway 52, 0114, Tbilisi, Georgia  
(770) LTD "G M P"  
Zemo Vedzisi Str. 103, 0160, Tbilisi,  
Georgia  
(580) 2023 01 17

---

(111) M 2003 15083 R  
(732) LTD "G M Pharmaceuticals"  
Rustavi Highway 52, 0114, Tbilisi, Georgia  
(770) LTD "G M P"  
Zemo Vedzisi Str. 103, 0160, Tbilisi,  
Georgia  
(580) 2023 01 17

---

(111) M 2003 15084 R  
(732) LTD "G M Pharmaceuticals"  
Rustavi Highway 52, 0114, Tbilisi, Georgia  
(770) LTD "G M P"  
Zemo Vedzisi Str. 103, 0160, Tbilisi,  
Georgia  
(580) 2023 01 17

---

(111) M 2003 15105 R  
(732) LTD "G M Pharmaceuticals"  
Rustavi Highway 52, 0114, Tbilisi, Georgia  
(770) LTD "G M P"  
Zemo Vedzisi Str. 103, 0160, Tbilisi,  
Georgia  
(580) 2023 01 17

---

(111) M 2003 15106 R  
(732) LTD "G M Pharmaceuticals"  
Rustavi Highway 52, 0114, Tbilisi, Georgia  
(770) LTD "G M P"  
Zemo Vedzisi Str. 103, 0160, Tbilisi,  
Georgia  
(580) 2023 01 17

---

(111) M 2003 15085 R  
(732) LTD "G M Pharmaceuticals"  
Rustavi Highway 52, 0114, Tbilisi, Georgia  
(770) LTD "G M P"  
Zemo Vedzisi Str. 103, 0160, Tbilisi,  
Georgia  
(580) 2023 01 17

---

(111) M 2003 15086 R  
(732) LTD "G M Pharmaceuticals"  
Rustavi Highway 52, 0114, Tbilisi, Georgia  
(770) LTD "G M P"  
Zemo Vedzisi Str. 103, 0160, Tbilisi,  
Georgia  
(580) 2023 01 17

---

(111) M 2003 15087 R  
(732) LTD "G M Pharmaceuticals"  
Rustavi Highway 52, 0114, Tbilisi, Georgia  
(770) LTD "G M P"  
Zemo Vedzisi Str. 103, 0160, Tbilisi,  
Georgia  
(580) 2023 01 17

---

(111) M 2003 15088 R  
(732) LTD "G M Pharmaceuticals"  
Rustavi Highway 52, 0114, Tbilisi, Georgia  
(770) LTD "G M P"  
Zemo Vedzisi Str. 103, 0160, Tbilisi,  
Georgia  
(580) 2023 01 17

---

(111) M 2003 15099 R  
(732) LTD "G M Pharmaceuticals"  
Rustavi Highway 52, 0114, Tbilisi, Georgia  
(770) LTD "G M P"  
Zemo Vedzisi Str. 103, 0160, Tbilisi,  
Georgia  
(580) 2023 01 17

---

(111) M 2003 15089 R  
(732) LTD "G M Pharmaceuticals"  
Rustavi Highway 52, 0114, Tbilisi, Georgia  
(770) LTD "G M P"  
Zemo Vedzisi Str. 103, 0160, Tbilisi,  
Georgia  
(580) 2023 01 17

---

(111) M 2003 15090 R  
(732) LTD "G M Pharmaceuticals"  
Rustavi Highway 52, 0114, Tbilisi, Georgia  
(770) LTD "G M P"  
Zemo Vedzisi Str. 103, 0160, Tbilisi,  
Georgia  
(580) 2023 01 17

---

(111) M 2003 15091 R  
(732) LTD "G M Pharmaceuticals"  
Rustavi Highway 52, 0114, Tbilisi, Georgia  
(770) LTD "G M P"  
Zemo Vedzisi Str. 103, 0160, Tbilisi,  
Georgia  
(580) 2023 01 17

---

(111) M 2003 15092 R  
(732) LTD "G M Pharmaceuticals"  
Rustavi Highway 52, 0114, Tbilisi, Georgia  
(770) LTD "G M P"  
Zemo Vedzisi Str. 103, 0160, Tbilisi,  
Georgia  
(580) 2023 01 17

---

(111) M 2003 15093 R  
(732) LTD "G M Pharmaceuticals"  
Rustavi Highway 52, 0114, Tbilisi, Georgia  
(770) LTD "G M P"  
Zemo Vedzisi Str. 103, 0160, Tbilisi,  
Georgia  
(580) 2023 01 17

---

(111) M 2003 15094 R  
(732) LTD "G M Pharmaceuticals"  
Rustavi Highway 52, 0114, Tbilisi, Georgia  
(770) LTD "G M P"  
Zemo Vedzisi Str. 103, 0160, Tbilisi,  
Georgia  
(580) 2023 01 17

---

(111) M 2003 15095 R  
(732) LTD "G M Pharmaceuticals"  
Rustavi Highway 52, 0114, Tbilisi, Georgia  
(770) LTD "G M P"  
Zemo Vedzisi Str. 103, 0160, Tbilisi,  
Georgia  
(580) 2023 01 17

---

(111) M 2003 15096 R  
(732) LTD "G M Pharmaceuticals"  
Rustavi Highway 52, 0114, Tbilisi, Georgia  
(770) LTD "G M P"  
Zemo Vedzisi Str. 103, 0160, Tbilisi,  
Georgia  
(580) 2023 01 17

---

(111) M 2003 15097 R  
(732) LTD "G M Pharmaceuticals"  
Rustavi Highway 52, 0114, Tbilisi, Georgia  
(770) LTD "G M P"  
Zemo Vedzisi Str. 103, 0160, Tbilisi,  
Georgia  
(580) 2023 01 17

---

(111) M 2003 15098 R  
(732) LTD "G M Pharmaceuticals"  
Rustavi Highway 52, 0114, Tbilisi, Georgia  
(770) LTD "G M P"  
Zemo Vedzisi Str. 103, 0160, Tbilisi,  
Georgia  
(580) 2023 01 17

---

(111) M 2003 15153 R  
(732) LTD "G M Pharmaceuticals"  
Rustavi Highway 52, 0114, Tbilisi, Georgia  
(770) LTD "G M P"  
Zemo Vedzisi Str. 103, 0160, Tbilisi,  
Georgia  
(580) 2023 01 17

---

(111) M 2003 15154 R  
(732) LTD "G M Pharmaceuticals"  
Rustavi Highway 52, 0114, Tbilisi, Georgia  
(770) LTD "G M P"  
Zemo Vedzisi Str. 103, 0160, Tbilisi,  
Georgia  
(580) 2023 01 17

---

(111) M 2013 23249 R  
(732) Solutia Singapore PTE. Ltd.  
9 Nort Buona Vista Draivi, #05-01,  
Ze Metropolis, 138588, Singapore  
(770) Solutia Singapore PTE. Ltd.  
12 Jalan Kilang Barat #06-01,  
Singapore 159354, Singapore  
(580) 2023 01 18

---



## CANCELLATION OF TRADEMARKS REGISTRATION

(111) M 2002 14569 R  
(151) 2002 07 29  
(732) Alstom  
48 rue Albert Dralenne, 93400 Saint-Ouen,  
France  
(141) 2023 02 06

---

(111) M 2002 14560 R  
(151) 2002 07 29  
(732) Unilever N.V.  
Weena 455, NL-3013 AL Rotterdam,  
Netherlands  
(141) 2023 02 06

---

(111) M 2002 14559 R  
(151) 2002 07 29  
(732) LTD "Georgian Post"  
Vakzali Square 2, 0100, Tbilisi, Georgia  
(141) 2023 02 06

---

(111) M 2012 22808 R  
(151) 2012 07 30  
(732) LTD "Unimed Group Corp"  
Adam Mitskevich Str. 29, ap. 61, 0194,  
Tbilisi, Georgia  
(141) 2023 02 07

---

(111) M 2012 22810 R  
(151) 2012 07 30  
(732) LTD "Unimed Group Corp"  
Giorgi Saakadze Descent 6, floor. 3,  
Commercial Space 11, 0177, Tbilisi,  
Georgia  
(141) 2023 02 07

---

(111) M 2012 22811 R  
(151) 2012 07 30  
(732) LTD "Unimed Group Corp"  
Adam Mitskevich Str. 29, ap. 61, 0194,  
Tbilisi, Georgia  
(141) 2023 02 07

---

(111) M 2012 22812 R  
(151) 2012 07 30  
(732) LTD "Pharmaceutical House"  
Lvovi Str. 92, Tbilisi, Georgia  
(141) 2023 02 07

---

(111) M 2011 21788 R  
(151) 2011 09 19  
(732) Astellas Deutschland GmbH  
Ridlerstrasse 57, D-80339, MÜNICH,  
Germany

---

(111) M 2011 21789 R  
(151) 2011 09 19  
(732) Astellas Deutschland GmbH  
Ridlerstrasse 57, D-80339, MÜNICH,  
Germany

---

(111) M 2011 21791 R  
(151) 2011 09 19  
(732) Astellas Deutschland GmbH  
Ridlerstrasse 57, D-80339, MÜNICH,  
Germany

---

(111) M 2012 22813 R  
(151) 2012 07 30  
(732) Bagi professional Cleaning products LTD  
194 Acco Road, Kiryat Bialik 27232, Israel  
(141) 2023 02 07

---

(111) M 2012 22815 R  
(151) 2012 07 30  
(732) JSC "Management Group of Hotels and  
Restaurants - EM/Group"  
Marshall Gelovani Ave. 2, 5th floor, 0159,  
Tbilisi, Georgia  
(141) 2023 02 07

---

(111) M 2012 22816 R  
(151) 2012 07 30  
(732) JSC "Management Group of Hotels and  
Restaurants - EM/Group"  
Marshall Gelovani Ave. 2, 5th floor, 0159,  
Tbilisi, Georgia  
(141) 2023 02 07

---

(111) M 2012 22817 R  
(151) 2012 07 30  
(732) JSC "Management Group of Hotels and  
Restaurants - EM/Group"  
Marshall Gelovani Ave. 2, 5th floor, 0159,  
Tbilisi, Georgia  
(141) 2023 02 07

---

(111) M 2012 22818 R  
(151) 2012 07 30  
(732) JSC "Management Group of Hotels and  
Restaurants - EM/Group"  
Marshall Gelovani Ave. 2, 5th floor, 0159,  
Tbilisi, Georgia  
(141) 2023 02 07

---

(111) M 2012 22819 R  
(151) 2012 07 30  
(732) LTD "Arte"  
Uznadze Str. 4, 0102, Tbilisi, Georgia  
(141) 2023 02 07

---

(111) M 2012 22820 R  
(151) 2012 07 30  
(732) General Motors LLC  
300 Renaissance Center, City of Detroit,  
State of Michigan 48265-3000, USA  
(141) 2023 02 07

---

(111) M 2012 22822 R  
(151) 2012 07 30  
(732) General Motors LLC  
300 Renaissance Center, City of Detroit,  
State of Michigan 48265-3000, USA  
(141) 2023 02 07

---

(111) M 2012 22829 R  
(151) 2012 07 30  
(732) Nine West Development LLC  
1411 Broadway, New York, NY 10018, USA  
(141) 2023 02 07

---

(111) M 2012 22830 R  
(151) 2012 07 30  
LTD "Pharmaceutical House+"  
Lvovi Str. 92, Tbilisi, Georgia  
(141) 2023 02 07

---

(111) M 2012 22832 R  
(151) 2012 07 30  
(732) LTD "BTM Textile"  
Melikishvili Str. 25, ap. 3, 6000, Batumi,  
Georgia  
(141) 2023 02 07

---

(111) M 2012 22833 R  
(151) 2012 07 30  
(732) LTD "BTM Textile"  
Melikishvili Str. 25, ap. 3, 6000, Batumi,  
Georgia  
(141) 2023 02 07

---

(111) M 2012 22851 R  
(151) 2012 08 02  
(732) Professional Teachers National  
Development Center  
Hero Cadets Str. 1, 0167, Tbilisi, Georgia  
(141) 2023 02 10

---

(111) M 2012 22853 R  
(151) 2012 08 02  
(732) LTD "Pemash"  
26 May Str. V3, 3000, Marneuli, Georgia  
(141) 2023 02 10

---

(111) M 2012 22805 R  
(151) 2012 07 27  
(732) LTD "Malti Food"  
Vill. Dvabzu, Ozurgeti Region, Georgia  
(141) 2023 02 06

---

(111) M 2012 22806 R  
(151) 2012 07 27  
(732) LTD "Georgian Air Service Agency"  
Bazha-Pshavela Ave. 65/67, fl. 5, 0120,  
Tbilisi, Georgia  
(141) 2023 02 06

---

(111) M 2012 22852 R  
(151) 2012 08 02  
(732) Vlaktor Trading Limited  
Zinonos Kitieos, 8, Kato Lakatamia,  
P.C. 2322 Nicosia, Cyprus  
(141) 2023 02 10

---

(111) M 2012 22854 R  
(151) 2012 08 02  
(732) Vlaktor Trading Limited  
Zinonos Kitieos, 8, Kato Lakatamia,  
P.C. 2322 Nicosia, Cyprus  
(141) 2023 02 10

---

(111) M 2015 26437 R  
(151) 2015 10 27  
(732) Astellas Deutschland GmbH  
Georg-Brauchle-Ring 64-66, Munich 80992,  
Germany  
(141) 2023 02 15

---

(111) M 2015 26548 R  
(151) 2015 12 07  
(732) Astellas Deutschland GmbH  
Georg-Brauchle-Ring 64-66, Munich 80992,  
Germany  
(141) 2023 02 15

---

(111) M 2015 26549 R  
(151) 2015 12 07  
(732) Astellas Deutschland GmbH  
Georg-Brauchle-Ring 64-66, Munich 80992,  
Germany  
(141) 2023 02 15

---

# CLASSIFICATION INDEXES

## INVENTIONS

### CONCORDANCE TABLE OF INTERNATIONAL CLASSIFICATION INDEX AND PUBLICATION NUMBERS

INTERNATIONAL CLASSIFICATION INDEXES (51)	NUMBER OF PUBLISHED APPLICATION (10)
A 61 K 31/5025; A 61 P 35/00; C 07 D 487/04; C 07 D 471/04; C 07 D 471/20	AP 2023 15703 A
B 21 B 17/02; B 21 B 17/00	AP 2023 15906 A
B 61 H 7/08	AP 2023 15785 A
C 22 B 15/00; C 22 B 3/00; C 22 B 3/08; C 22 B 47/00	AP 2023 15666 A
E 02 B 9/00; F 03 B 13/00	AP 2023 15484 A
G 01 N 21/00	AP 2023 15740 A

### CONCORDANCE TABLE OF PUBLICATION NUMBERS AND INTERNATIONAL CLASSIFICATION INDEX

NUMBER OF PUBLISHED APPLICATION (10)	INTERNATIONAL CLASSIFICATION INDEXES (51)
AP 2023 15484 A	E 02 B 9/00; F 03 B 13/00
AP 2023 15666 A	C 22 B 15/00; C 22 B 3/00; C 22 B 3/08; C 22 B 47/00
AP 2023 15703 A	A 61 K 31/5025; A 61 P 35/00; C 07 D 487/04; C 07 D 471/04; C 07 D 471/20
AP 2023 15740 A	G 01 N 21/00
AP 2023 15785 A	B 61 H 7/08
AP 2023 15906 A	B 21 B 17/02; B 21 B 17/00

### CONCORDANCE TABLE OF INTERNATIONAL CLASSIFICATION INDEX, PATENT NUMBERS AND PUBLICATION NUMBERS

INTERNATIONAL CLASSIFICATION INDEX (51)	NUMBER OF PATENT (11)	NUMBER OF PUBLISHED APPLICATION (10)
A 47 L 9/28; A 61 L 2/20; G 05 D 1/00	P 2023 7475 B	AP 2022 15711 A

### CONCORDANCE TABLE OF PATENT NUMBERS, PUBLICATION NUMBERS AND INTERNATIONAL CLASSIFICATION INDEX

NUMBER OF PATENT (11)	NUMBER OF PUBLISHED APPLICATION (10)	INTERNATIONAL CLASSIFICATION INDEX (51)
P 2023 7475 B	AP 2022 15711 A	A 47 L 9/28; A 61 L 2/20; G 05 D 1/00

**CONCORDANCE TABLE OF APPLICATION NUMBERS,  
PUBLICATION NUMBERS AND PATENTS**

NUMBER OF APPLICATION (21)	NUMBER OF PUBLISHED APPLICATION (10)	NUMBER OF PATENT (11)
AP 2021 15711	AP 2022 15711 A	P 2023 7475 B

**UTILITY MODELS**

**CONCORDANCE TABLE OF INTERNATIONAL CLASSIFICATION INDEX  
AND PUBLICATION NUMBERS**

INTERNATIONAL CLASSIFICATION INDEXES (51)	NUMBER OF PUBLISHED APPLICATION (10)
G 02 B 23/16	AU 2023 15530 U

**CONCORDANCE TABLE OF PUBLICATION NUMBERS  
AND INTERNATIONAL CLASSIFICATION INDEX**

NUMBER OF PUBLISHED APPLICATION (10)	INTERNATIONAL CLASSIFICATION INDEXES (51)
AU 2023 15530 U	G 02 B 23/16

**CONCORDANCE TABLE OF INTERNATIONAL CLASSIFICATION INDEX,  
PATENT NUMBERS AND PUBLICATION NUMBERS**

INTERNATIONAL CLASSIFICATION INDEX (51)	NUMBER OF PATENT (11)	NUMBER OF PUBLISHED APPLICATION (10)
H 01 L 35/00; H 01 L 35/24	U 2023 2145 Y	AU 2022 15626 U

**CONCORDANCE TABLE OF PATENT NUMBERS,  
PUBLICATION NUMBERS AND INTERNATIONAL CLASSIFICATION INDEX**

NUMBER OF PATENT (11)	NUMBER OF PUBLISHED APPLICATION (10)	INTERNATIONAL CLASSIFICATION INDEX (51)
U 2023 2145 Y	AU 2022 15626 U	H 01 L 35/00; H 01 L 35/24

**CONCORDANCE TABLE OF APPLICATION NUMBERS,  
PUBLICATION NUMBERS AND PATENTS**

NUMBER OF APPLICATION (21)	NUMBER OF PUBLISHED APPLICATION (10)	NUMBER OF PATENT (11)
AU 2021 15626	AU 2022 15626 U	U 2023 2145 Y

**DESIGNS**

**CONCORDANCE TABLE OF INTERNATIONAL CLASSIFICATION INDEX  
AND PUBLICATION NUMBERS**

INTERNATIONAL CLASSIFICATION INDEXES (51)	NUMBER OF PUBLISHED APPLICATION (10)
09-01	AD 2023 1276 S
09-01	AD 2023 1277 S

**CONCORDANCE TABLE OF PUBLICATION NUMBERS  
AND INTERNATIONAL CLASSIFICATION INDEX**

NUMBER OF PUBLISHED APPLICATION (10)	INTERNATIONAL CLASSIFICATION INDEXES (51)
AD 2023 1276 S	09-01
AD 2023 1277 S	09-01

**DESIGNS REGISTERED ACCORDING TO THE ACCELERATED  
PROCEDURE**

**CONCORDANCE TABLE OF INTERNATIONAL CLASSIFICATION INDEX  
AND PUBLICATION NUMBERS**

INTERNATIONAL CLASSIFICATION INDEXES (51)	NUMBER OF REGISTRATION (11)
25-01	D 2023 960 S
25-01	D 2023 961 S
25-01	D 2023 962 S
25-01	D 2023 963 S
25-01	D 2023 964 S

CONCORDANCE TABLE OF PUBLICATION NUMBERS  
AND INTERNATIONAL CLASSIFICATION INDEX

NUMBER OF REGISTRATION (11)	INTERNATIONAL CLASSIFICATION INDEXES (51)
D 2023 960 S	25-01
D 2023 961 S	25-01
D 2023 962 S	25-01
D 2023 963 S	25-01
D 2023 964 S	25-01

CONCORDANCE TABLE OF APPLICATION NUMBERS,  
PUBLICATION NUMBERS AND PATENTS

NUMBER OF APPLICATION (21)	NUMBER OF REGISTRATION (11)
AD 2023 1292	D 2023 960 S
AD 2023 1293	D 2023 961 S
AD 2023 1294	D 2023 962 S
AD 2023 1295	D 2023 963 S
AD 2023 1296	D 2023 964 S

## TRADEMARKS

### CONCORDANCE TABLE OF REGISTRATION NUMBERS, APPLICATION NUMBERS, PUBLICATION NUMBERS AND BULLETIN NUMBERS

NUMBER OF REGISTRATION (111)	NUMBER OF APPLICATIONS (210)	NUMBER OF PUBLISHED APPLICATIONS (260)	NUMBER OF BULLETIN
1	2	3	4
M 2023 36389 R	AM 117738	–	4(607)2023
M 2023 36390 R	AM 116992	AM 2022 116992 A	19(598)2022
M 2023 36391 R	AM 117191	AM 2022 117191 A	19(598)2022
M 2023 36392 R	AM 116835	AM 2022 116835 A	18(597)2022
M 2023 36393 R	AM 121150	–	4(607)2023
M 2023 36394 R	AM 121350	–	4(607)2023
M 2023 36395 R	AM 117274	AM 2022 117274 A	20(599)2022
M 2023 36396 R	AM 117081	AM 2022 117081 A	19(598)2022
M 2023 36397 R	AM 116145	AM 2022 116145 A	16(595)2022
M 2023 36398 R	AM 117104	AM 2022 117104 A	20(599)2022
M 2023 36399 R	AM 116535	AM 2022 116535 A	18(597)2022
M 2023 36400 R	AM 121149	–	4(607)2023
M 2023 36401 R	AM 121154	–	4(607)2023
M 2023 36402 R	AM 121431	–	4(607)2023
M 2023 36403 R	AM 121429	–	4(607)2023
M 2023 36404 R	AM 121349	–	4(607)2023
M 2023 36405 R	AM 121323	–	4(607)2023
M 2023 36406 R	AM 121312	–	4(607)2023
M 2023 36407 R	AM 120974	–	4(607)2023
M 2023 36408 R	AM 120973	–	4(607)2023
M 2023 36409 R	AM 120972	–	4(607)2023
M 2023 36410 R	AM 120971	–	4(607)2023
M 2023 36411 R	AM 120970	–	4(607)2023
M 2023 36412 R	AM 120969	–	4(607)2023
M 2023 36413 R	AM 120968	–	4(607)2023
M 2023 36414 R	AM 120966	–	4(607)2023
M 2023 36415 R	AM 120965	–	4(607)2023
M 2023 36416 R	AM 120964	–	4(607)2023
M 2023 36417 R	AM 120963	–	4(607)2023
M 2023 36418 R	AM 117076	AM 2022 117076 A	19(598)2022
M 2023 36419 R	AM 115119	AM 2022 115119 A	19(598)2022
M 2023 36420 R	AM 116647	AM 2022 116647 A	19(598)2022
M 2023 36421 R	AM 117097	AM 2022 117097 A	19(598)2022
M 2023 36422 R	AM 117098	AM 2022 117098 A	19(598)2022
M 2023 36423 R	AM 116990	AM 2022 116990 A	18(597)2022
M 2023 36424 R	AM 116991	AM 2022 116991 A	19(598)2022
M 2023 36425 R	AM 116754	AM 2022 116754 A	17(596)2022
M 2023 36426 R	AM 116987	AM 2022 116987 A	18(597)2022
M 2023 36427 R	AM 116731	AM 2022 116731 A	18(597)2022
M 2023 36428 R	AM 116755	AM 2022 116755 A	18(597)2022
M 2023 36429 R	AM 115120	AM 2022 115120 A	19(598)2022
M 2023 36430 R	AM 117087	AM 2022 117087 A	20(599)2022
M 2023 36431 R	AM 117293	AM 2022 117293 A	19(598)2022
M 2023 36432 R	AM 116552	AM 2022 116552 A	16(595)2022
M 2023 36433 R	AM 116233	AM 2022 116233 A	15(594)2022
M 2023 36434 R	AM 116232	AM 2022 116232 A	15(594)2022



1	2	3	4
M 2023 36435 R	AM 116231	AM 2022 116231 A	15(594)2022
M 2023 36436 R	AM 116155	AM 2022 116155 A	15(594)2022
M 2023 36437 R	AM 116152	AM 2022 116152 A	15(594)2022
M 2023 36438 R	AM 116975	AM 2022 116975 A	19(598)2022
M 2023 36439 R	AM 116976	AM 2022 116976 A	19(598)2022
M 2023 36440 R	AM 116977	AM 2022 116977 A	19(598)2022
M 2023 36441 R	AM 116978	AM 2022 116978 A	19(598)2022
M 2023 36442 R	AM 116979	AM 2022 116979 A	19(598)2022
M 2023 36443 R	AM 116980	AM 2022 116980 A	19(598)2022
M 2023 36444 R	AM 116154	AM 2022 116154 A	14(593)2022
M 2023 36445 R	AM 116156	AM 2022 116156 A	14(593)2022
M 2023 36446 R	AM 116952	AM 2022 116952 A	20(599)2022
M 2023 36447 R	AM 116951	AM 2022 116951 A	20(599)2022
M 2023 36448 R	AM 116627	AM 2022 116627 A	19(598)2022
M 2023 36449 R	AM 116628	AM 2022 116628 A	19(598)2022
M 2023 36450 R	AM 116630	AM 2022 116630 A	19(598)2022
M 2023 36451 R	AM 116629	AM 2022 116629 A	18(597)2022
M 2023 36452 R	AM 116955	AM 2022 116955 A	20(599)2022
M 2023 36453 R	AM 116954	AM 2022 116954 A	20(599)2022
M 2023 36454 R	AM 116973	AM 2022 116973 A	19(598)2022
M 2023 36455 R	AM 116401	AM 2022 116401 A	17(596)2022
M 2023 36456 R	AM 116001	AM 2022 116001 A	14(593)2022
M 2023 36457 R	AM 116762	AM 2022 116762 A	19(598)2022
M 2023 36458 R	AM 116540	AM 2022 116540 A	17(596)2022
M 2023 36459 R	AM 117075	AM 2022 117075 A	19(598)2022
M 2023 36460 R	AM 121413	-	4(607)2023
M 2023 36461 R	AM 121412	-	4(607)2023
M 2023 36462 R	AM 121411	-	4(607)2023
M 2023 36463 R	AM 116151	AM 2022 116151 A	14(593)2022
M 2023 36464 R	AM 117082	AM 2022 117082 A	19(598)2022
M 2023 36465 R	AM 117266	AM 2022 117266 A	20(599)2022
M 2023 36466 R	AM 117108	AM 2022 117108 A	20(599)2022
M 2023 36467 R	AM 116738	AM 2022 116738 A	18(597)2022
M 2023 36468 R	AM 117062	AM 2022 117062 A	18(597)2022
M 2023 36469 R	AM 116833	AM 2022 116833 A	18(597)2022
M 2023 36470 R	AM 116837	AM 2022 116837 A	18(597)2022
M 2023 36471 R	AM 116831	AM 2022 116831 A	18(597)2022
M 2023 36472 R	AM 116832	AM 2022 116832 A	18(597)2022
M 2023 36473 R	AM 116830	AM 2022 116830 A	18(597)2022
M 2023 36474 R	AM 116747	AM 2022 116747 A	18(597)2022
M 2023 36475 R	AM 116839	AM 2022 116839 A	18(597)2022
M 2023 36476 R	AM 116748	AM 2022 116748 A	18(597)2022
M 2023 36477 R	AM 116842	AM 2022 116842 A	18(597)2022
M 2023 36478 R	AM 116840	AM 2022 116840 A	18(597)2022
M 2023 36479 R	AM 116838	AM 2022 116838 A	18(597)2022
M 2023 36480 R	AM 116834	AM 2022 116834 A	18(597)2022
M 2023 36481 R	AM 116146	AM 2022 116146 A	16(595)2022
M 2023 36482 R	AM 116827	AM 2022 116827 A	18(597)2022
M 2023 36483 R	AM 116423	AM 2022 116423 A	18(597)2022
M 2023 36484 R	AM 99510	AM 2022 99510 A	11(590)2022
M 2023 36485 R	AM 116332	AM 2022 116332 A	17(596)2022
M 2023 36486 R	AM 115843	AM 2022 115843 A	16(595)2022
M 2023 36487 R	AM 99511	AM 2022 99511 A	11(590)2022
M 2023 36488 R	AM 116546	AM 2022 116546 A	17(596)2022
M 2023 36489 R	AM 116659	AM 2022 116659 A	17(596)2022
M 2023 36490 R	AM 114912	AM 2022 114912 A	14(593)2022

1	2	3	4
M 2023 36491 R	AM 116621	AM 2022 116621 A	18(597)2022
M 2023 36492 R	AM 114799	AM 2022 114799 A	14(593)2022
M 2023 36493 R	AM 116222	AM 2022 116222 A	14(593)2022
M 2023 36494 R	AM 115761	AM 2022 115761 A	13(592)2022
M 2023 36495 R	AM 115760	AM 2022 115760 A	13(592)2022
M 2023 36496 R	AM 115681	AM 2022 115681 A	13(592)2022
M 2023 36497 R	AM 115529	AM 2022 115529 A	13(592)2022
M 2023 36498 R	AM 115526	AM 2022 115526 A	13(592)2022
M 2023 36499 R	AM 115525	AM 2022 115525 A	13(592)2022
M 2023 36500 R	AM 115517	AM 2022 115517 A	13(592)2022
M 2023 36501 R	AM 116732	AM 2022 116732 A	18(597)2022
M 2023 36502 R	AM 115845	AM 2022 115845 A	13(592)2022
M 2023 36503 R	AM 116153	AM 2022 116153 A	14(593)2022
M 2023 36504 R	AM 117090	AM 2022 117090 A	19(598)2022
M 2023 36505 R	AM 117091	AM 2022 117091 A	19(598)2022
M 2023 36506 R	AM 117093	AM 2022 117093 A	19(598)2022
M 2023 36507 R	AM 117092	AM 2022 117092 A	19(598)2022
M 2023 36508 R	AM 116228	AM 2022 116228 A	15(594)2022
M 2023 36509 R	AM 116767	AM 2022 116767 A	19(598)2022
M 2023 36510 R	AM 116766	AM 2022 116766 A	19(598)2022
M 2023 36511 R	AM 116394	AM 2022 116394 A	17(596)2022
M 2023 36512 R	AM 117258	AM 2022 117258 A	19(598)2022
M 2023 36513 R	AM 117186	AM 2022 117186 A	19(598)2022
M 2023 36514 R	AM 116958	AM 2022 116958 A	19(598)2022
M 2023 36515 R	AM 117099	AM 2022 117099 A	19(598)2022
M 2023 36516 R	AM 116162	AM 2022 116162 A	16(595)2022
M 2023 36517 R	AM 116752	AM 2022 116752 A	19(598)2022
M 2023 36518 R	AM 116750	AM 2022 116750 A	19(598)2022
M 2023 36519 R	AM 116751	AM 2022 116751 A	19(598)2022
M 2023 36520 R	AM 117286	AM 2022 117286 A	19(598)2022
M 2023 36521 R	AM 117192	AM 2022 117192 A	19(598)2022
M 2023 36522 R	AM 116972	AM 2022 116972 A	19(598)2022
M 2023 36523 R	AM 116957	AM 2022 116957 A	19(598)2022
M 2023 36524 R	AM 116967	AM 2022 116967 A	19(598)2022
M 2023 36525 R	AM 117278	AM 2022 117278 A	19(598)2022
M 2023 36526 R	AM 121314	–	4(607)2023
M 2023 36527 R	AM 121122	–	4(607)2023
M 2023 36528 R	AM 121529	–	4(607)2023
M 2023 36529 R	AM 121434	–	4(607)2023
M 2023 36530 R	AM 121433	–	4(607)2023
M 2023 36531 R	AM 121409	–	4(607)2023
M 2023 36532 R	AM 121533	–	4(607)2023
M 2023 36533 R	AM 121346	–	4(607)2023

CONCORDANCE TABLE OF PUBLICATION NUMBERS  
AND APPLICATION NUMBERS

NUMBER OF PUBLISHED APPLICATION (260)	NUMBER OF APPLICATION (210)	1	2
1	2	AM 2023 118730 A	AM 118730
AM 2023 106041 A	AM 106041	AM 2023 118731 A	AM 118731
AM 2023 106042 A	AM 106042	AM 2023 118736 A	AM 118736
AM 2023 116619 A*	AM 116619	AM 2023 118738 A	AM 118738
AM 2023 117531 A	AM 117531	AM 2023 118739 A	AM 118739
AM 2023 117908 A	AM 117908	AM 2023 118740 A	AM 118740
AM 2023 118168 A	AM 118168	AM 2023 118741 A	AM 118741
AM 2023 118302 A	AM 118302	AM 2023 118742 A	AM 118742
AM 2023 118304 A	AM 118304	AM 2023 118743 A	AM 118743
AM 2023 118312 A	AM 118312	AM 2023 118744 A	AM 118744
AM 2023 118314 A	AM 118314	AM 2023 118745 A	AM 118745
AM 2023 118369 A	AM 118369	AM 2023 118746 A	AM 118746
AM 2023 118370 A	AM 118370	AM 2023 118747 A	AM 118747
AM 2023 118371 A	AM 118371	AM 2023 118748 A	AM 118748
AM 2023 118372 A	AM 118372	AM 2023 118749 A	AM 118749
AM 2023 118373 A	AM 118373	AM 2023 118750 A	AM 118750
AM 2023 118374 A	AM 118374	AM 2023 118751 A	AM 118751
AM 2023 118378 A	AM 118378	AM 2023 118752 A	AM 118752
AM 2023 118396 A	AM 118396	AM 2023 118757 A	AM 118757
AM 2023 118407 A	AM 118407	AM 2023 118762 A	AM 118762
AM 2023 118549 A	AM 118549	AM 2023 118767 A	AM 118767
AM 2023 118558 A	AM 118558	AM 2023 118830 A	AM 118830
AM 2023 118643 A	AM 118643	AM 2023 118842 A	AM 118842
AM 2023 118648 A	AM 118648	AM 2023 118844 A	AM 118844
AM 2023 118729 A	AM 118729	AM 2023 118860 A	AM 118860
		AM 2023 118861 A	AM 118861
		AM 2023 118862 A	AM 118862

CONCORDANCE TABLE OF INDEX OF GOODS AND/OR SERVICES  
AND APPLICATION NUMBERS

INDEX OF GOODS AND/OR SERVICES (511)	NUMBER OF PUBLISHED APPLICATIONS (260)	1	2
1	2		
1	AM 2023 118302 A	33	AM 2023 118407 A
1	AM 2023 118844 A	33	AM 2023 118736 A
3	AM 2023 118304 A	33	AM 2023 118757 A
3	AM 2023 118396 A	33	AM 2023 118862 A
3	AM 2023 118731 A	34	AM 2023 118369 A
3	AM 2023 118830 A	34	AM 2023 118370 A
4	AM 2023 118304 A	34	AM 2023 118371 A
5	AM 2023 117908 A	34	AM 2023 118372 A
5	AM 2023 118312 A	34	AM 2023 118373 A
5	AM 2023 118378 A	34	AM 2023 118374 A
5	AM 2023 118558 A	34	AM 2023 118378 A
5	AM 2023 118830 A	34	AM 2023 118739 A
5	AM 2023 118844 A	34	AM 2023 118739 A
5	AM 2023 118844 A	34	AM 2023 118740 A
9	AM 2023 118314 A	34	AM 2023 118741 A
9	AM 2023 118549 A	34	AM 2023 118742 A
9	AM 2023 118750 A	34	AM 2023 118743 A
10	AM 2023 118830 A	34	AM 2023 118744 A
16	AM 2023 118830 A	34	AM 2023 118745 A
18	AM 2023 118304 A	34	AM 2023 118746 A
20	AM 2023 118304 A	34	AM 2023 118747 A
21	AM 2023 118304 A	34	AM 2023 118748 A
24	AM 2023 118830 A	34	AM 2023 118749 A
25	AM 2023 118304 A	34	AM 2023 118767 A
25	AM 2023 118830 A	34	AM 2023 118860 A
25	AM 2023 118862 A	34	AM 2023 118861 A
25	AM 2023 118862 A	35	AM 2023 118842 A
28	AM 2023 118862 A	35	AM 2023 118862 A
30	AM 2023 118751 A	37	AM 2023 118842 A
30	AM 2023 118752 A	38	AM 2023 118762 A
32	AM 2023 118862 A	41	AM 2023 118314 A
33	AM 2023 106041 A	41	AM 2023 118643 A
33	AM 2023 106042 A	41	AM 2023 118729 A
33	AM 2023 117531 A	41	AM 2023 118730 A
33	AM 2023 118168 A	41	AM 2023 118862 A
		43	AM 2023 116619 A*
		43	AM 2023 118648 A
		43	AM 2023 118862 A

CONCORDANCE TABLE OF INDEX OF GOODS AND/OR SERVICES  
AND NUMBERS OF TRADEMARKS REGISTERED ACCORDING  
TO THE ACCELERATED PROCEDURE

INDEX OF GOODS AND/OR SERVICES (511)	NUMBERS OF REGISTERED ACCORDING TO THE ACCELERATED PROCEDURE (111)
M 2023 36389 R	3
M 2023 36526 R	3
M 2023 36389 R	5
M 2023 36531 R	5
M 2023 36533 R	12
M 2023 36389 R	16
M 2023 36402 R	16
M 2023 36526 R	16
M 2023 36526 R	29
M 2023 36532 R	29
M 2023 36526 R	30
M 2023 36527 R	30
M 2023 36532 R	30
M 2023 36526 R	31
M 2023 36404 R	32
M 2023 36405 R	32
M 2023 36526 R	32
M 2023 36532 R	32
M 2023 36526 R	33
M 2023 36407 R	34
M 2023 36408 R	34
M 2023 36409 R	34
M 2023 36410 R	34
M 2023 36411 R	34
M 2023 36412 R	34
M 2023 36413 R	34
M 2023 36414 R	34
M 2023 36415 R	34
M 2023 36416 R	34
M 2023 36417 R	34
M 2023 36460 R	34
M 2023 36461 R	34
M 2023 36462 R	34
M 2023 36394 R	35
M 2023 36402 R	35
M 2023 36406 R	35
M 2023 36393 R	36
M 2023 36400 R	36
M 2023 36403 R	39
M 2023 36402 R	41
M 2023 36528 R	41
M 2023 36401 R	43
M 2023 36402 R	43
M 2023 36528 R	43
M 2023 36529 R	44
M 2023 36530 R	44

# OFFICIAL BULLETIN OF THE INDUSTRIAL PROPERTY

INVENTIONS  
UTILITY MODELS  
DESIGNS  
TRADEMARKS

**4(607)**

EDITOR-IN-CHIEF: N. Bebrishvili

EDITOR-TRANSLATOR: E. Gabunia

PROOFREADER: A. Shixashvili

COMPUTER LAYOUT: M. Ordenidze  
K. Svanidze

ISSN 2720-8486

[info@sakpatenti.gov.ge](mailto:info@sakpatenti.gov.ge)  
[www.sakpatenti.gov.ge](http://www.sakpatenti.gov.ge)