



**NATIONAL INTELLECTUAL PROPERTY CENTER OF GEORGIA
SAKPATENTI**

**OFFICIAL BULLETIN
OF THE INDUSTRIAL PROPERTY**

5(489)

**2018
TBILISI**

INID CODES FOR IDENTIFICATION OF BIBLIOGRAPHIC DATA

INVENTIONS, UTILITY MODELS

- (10) Number of publication for application, which has been examined
- (11) Number of patent and kind of document
- (21) Serial number of application
- (22) Date of filing of the application
- (23) Date of exhibition or the date of the earlier filing and the number of application, if any
- (24) Date from which patent may have effect
- (31) Number of priority application
- (32) Date of filing of priority application
- (33) Code of the country or regional organization allotting priority application number
- (44) Date of publication of application not granted, but examined and number of bulletin
- (45) Date of publication of registered document
- (51) International Patent Classification Index
- (54) Title of the invention
- (57) Abstract
- (60) Number of examined patent document granted by foreign patent office, date from which patent has effect and country code
- (62) Number of the earlier application and in case of divided application, date of filing an application
- (71) Name, surname and address of applicant (country code)
- (72) Name, surname of inventor (country code)
- (73) Name, surname and address of patent owner (country code)
- (74) Name, surname of representative or patent attorney
- (85) Date of commencement of the national phase of International Application
- (86) Number and date of filing of international application
- (87) Number and date of publication of international application

DESIGNS

- (10) Number of publication for application
- (11) Number of patent and kind of document or number of registration
- (15) Date of registration/Date of patent renewal
- (18) Expected expiration date of patent or registration
- (21) Serial number of application
- (22) Date of filing of the application
- (23) Date of exhibition or the date of the earlier filing and the number of application, if any
- (24) Date from which patent may have effect
- (28) Number of designs included in the application
- (30) Data relating to priority (number of application, date of filing of application, two-letter code identifying the authority with whom the priority application was made)
- (31) Number of priority application
- (32) Date of filing of priority application
- (33) Code of the country or regional organization allotting priority application number
- (34) Two-letter code according to WIPO St.3 identifying the authority with which the priority application was made
- (44) Date of publication of design and number of bulletin (the first publication)
- (45) Date of publication of design registered by WIPO and number of bulletin
- (51) International Classification for designs (class and subclass of the Locarno Classification)
- (54) Title of the invention
- (55) Reproduction of the design
- (57) Description of characteristic features of the design including indication of colors
- (58) Date of recording of any kind of amendment in the Register
- (62) Number of the earlier application, registration and document number and if available the date of filing an application in case of divided application
- (71) Name, surname and address of applicant (country code)
- (72) Name, surname of creator (country code)
- (73) Name, surname and address of patent owner (country code)
- (74) Name, surname of representative or patent attorney
- (81) Contracting states concerned
 - II designated contracting states according to the 1960 Act
 - III designated contracting states according to the 1999 Act
- (85) Owner's permanent address
- (86) Owner's nationality
- (87) Owner's residence
- (88) State in which the owner has a real and effective industrial or commercial establishment

TRADEMARKS

- (111) – Number of registration
- (151) – Date of registration
- (156) – Date of the renewal
- (181) – Expected expiration date of registration
- (186) – Renewal expiration date of registration
- (141) – Date of cancel of duration of the mark
- (210) – Serial number of application
- (220) – Date of filing of the application
- (230) – Date concerning exhibition
- (260) – Number of application, for which favorable decision of examination about registration has been taken (publication number)
- (310) – Number of the first application
- (320) – Date of filing of the first application
- (330) – Code, identifying national or regional Office where the first application was made
- (511) – International Classification of Goods and Services for the purposes of registration of trade marks and/or list of goods and/or services classified according thereto
- (531) – Description of figurative elements of Trade Marks according to the International Classification of the Figurative Elements of Marks
- (540) – Reproduction of Trade Mark
- (550) – Nature and kind of Trade Mark
- (580) – Date of recording of any kind changes in respect of applications or registrations
- (591) – Information concerning colors claimed
- (731) – Name and address of the applicant
- (732) – Name and address of the holder of the registration
- (740) – Name and address of the representative
- (750) – Address for correspondence
- (770) – Name and address of the previous applicant or holder in case of change in ownership
- (771) – Previous name and address of the applicant or holder in case of change in ownership
- (791) – Name and address of the licensee
- (793) – Indication of conditions and/or restrictions under the license (Type of license, number of license agreement, data of license, data of validity of license)
- (800) – Certain data relating to the international registration of Trade Marks under the Protocol Relating to Madrid Agreement (International registration number)

CODES FOR PUBLICATION IN BULLETIN

- (21) AP 0000 000000 – serial number of application for invention
- (10) AP 0000 0000 A – number of published application for invention (first publication)
- (11) P 0000 0000 B – number of patent for invention (second publication)
- (21) API 0000 000000 – number of application for imported patent
- (11) PI 0000 0000 A – number of imported patent (first publication)
- (21) AU 0000 000000 – serial number of application for utility model
- (10) AU 0000 000 U – number of published application for utility model (first publication)
- (11) U 0000 000 Y – number of patent for utility model (second publication)
- (21) AD 0000 000000 – serial number of application for design
- (10) AD 0000 000 S – number of published application for design (first publication)
- (11) D 0000 000 S – number of patent for design (second publication)

INTERNATIONAL PATENT CLASSIFICATION FOR INVENTIONS AND UTILITY MODELS

- SECTION A – HUMAN NECESSITIES
- SECTION B – PERFORMING OPERATIONS; TRANSPORTING
- SECTION C – CHEMISTRY; METALLURGY
- SECTION D – TEXTILES; PAPER
- SECTION E – FIXED CONSTRUCTIONS
- SECTION F – MECHANICAL ENGINEERING; LIGHTING; HEATING; WEAPONS; BLASTING
- SECTION G – PHYSICS
- SECTION H – ELECTRICITY

-
- M – Trade Mark
 - (210) AM 0000 000000 – Serial number of application;
 - (260) AAM 0000 00000 A – Publication number of application;
 - (111) M 0000 00000 R – Number of registration;
 - (111) MMM0000 00000 Rn – Number of renewals, in which n=1,2,3;
 - (111) M 0000 00000 R(P) – Number of registration under partial assignment of rights
-

**NATIONAL INTELLECTUAL PROPERTY CENTER OF GEORGIA
SAKPATENTI**

**OFFICIAL BULLETIN
OF THE INDUSTRIAL PROPERTY**

5(489)

**INVENTIONS
UTILITY MODELS
DESIGNS
TRADEMARKS**

**DATE OF PUBLICATION
2018 03 12**

CONTENTS

PUBLISHED TITLES OF PROTECTION	2
INVENTIONS	
▪ APPLICATIONS APPROVED FOR GRANTING PATENTS	4
▪ PATENTED INVENTIONS	7
UTILITY MODELS	
▪ APPLICATION APPROVED FOR GRANTING PATENT	9
▪ PATENTED UTILITY MODELS	10
DESIGNS	
▪ APPLICATIONS APPROVED FOR REGISTRATION	11
▪ REGISTERED DESIGNS	14
▪ DESIGNS, WICH HAVE BEEN REGISTERED WITH THE INTERNATIONAL BUREAU CLAIMING PRIORITY ON THE TERRITORY OF GEORGIA	15
TRADEMARKS	
▪ APPLICATIONS FILED UNDER THE NATIONAL PROCEDURE APPROVED FOR REGISTRATION	93
▪ REGISTERED TRADEMARKS	102
▪ TRADEMARKS REGISTERED ACCORDING TO THE ACCELERATED PROCEDURE	107
▪ INTERNATIONAL TRADEMARKS FOR WHICH A DECISION ON GANTING PROTECTION IS TAKEN	108
▪ INTERNATIONAL TRADEMARKS PROTECTED IN GEORGIA	181
OFFICIAL NOTIFICATIONS	
TRADEMARKS	
▪ RENEWAL OF REGISTRATIONS	185
▪ COMPLETE TRANSFER OF RIGHTS	195
▪ CHANGES IN NAMES AND/OR ADDRESSES OF OWNERS	197
CLASSIFICATION INDEXES	
INVENTIONS	202
UTILITY MODELS	203
DESIGNS	204
TRADEMARKS	206

PUBLISHED TITLES OF PROTECTION

INVENTIONS

- **APPLICATIONS APPROVED FOR GRANTING PATENT:**
14045; 13882; 14220; 14046; 14034; 13996
- **PATENTED INVENTIONS:**
6831-6835

UTILITY MODELS

- **APPLICATION APPROVED FOR GRANTING PATENT:**
14175
- **PATENTED UTILITY MODELS:**
1962, 1963

DESIGNS

- **APPLICATIONS APPROVED FOR REGISTRATION:**
985; 995
- **REGISTERED DESIGNS:**
749, 750
- **DESIGNS, WHICH HAVE BEEN REGISTERED WITH THE INTERNATIONAL BUREAU CLAIMING PRIORITY ON THE TERRITORY OF GEORGIA:**
96015, 96016; 98191; 98225-98229; 96085; 96364; 98389, 98390; 96831; 98518; 98536

TRADEMARKS

- **APPLICATIONS FILED UNDER THE NATIONAL PROCEDURE APPROVED FOR REGISTRATION:**
90306; 91088; 91518; 91524, 91525; 91740; 91763; 91865; 92047; 92106; 92112; 92128; 92184; 92193, 92194; 92344; 92354; 92361; 92382; 92384; 92440, 92441; 92456; 92550; 92559; 92561; 92563; 92581; 92583; 92595; 92712; 92717; 92738; 92769; 92782; 92852; 92864; 92958, 92959; 92963; 92966; 92968; 93053; 93100; 93105; 93139; 93143; 93146; 93149; 93226; 93264; 93272; 93429; 93438; 93440; 93509; 93530; 93563
- **REGISTERED TRADEMARKS:**
29421; 29424-29474
- **TRADEMARKS REGISTERED ACCORDING TO THE ACCELERATED PROCEDURE:**
29422, 29423
- **INTERNATIONAL TRADEMARKS FOR WHICH A DECISION ON GRANTING PROTECTIONS IS TAKEN:**
88867; 89443*; 90704; 90707; 90848; 91122; 91299; 91313; 91639; 91653, 91654; 91656; 91664; 91666; 91669; 91709; 91712; 91727; 91765, 91766, 91770; 91778-91780; 91784, 91785; 91789; 91881; 91896; 91904, 91905; 91907; 91930; 91936; 91966; 91968; 91979; 91992; 91995; 92003; 92034; 92051; 92053, 92054; 92056; 92060-92062; 92082; 92107; 92131; 92133, 92134; 92136; 92147, 92148; 92150; 92152-92154; 92162; 92168; 92170; 92197; 92278; 92286, 92287; 92289-92297; 92299-92302; 92305; 92307; 92318; 92321; 92323-92325; 92327; 92401, 92402; 92405; 92409; 92416, 92417; 92426-92429; 92431-92434; 92443; 92448, 92449; 92451; 92454; 92512, 92513; 92524; 92526-92529; 92532, 92533; 92546-92549; 92551; 92555; 92558; 92560; 92562; 92582; 92593, 92594; 92596-92598; 92609; 92614; 92630-92632; 92634; 92636; 92699; 92701-92703; 92714; 92718, 92719; 92722; 92832, 92833; 92841; 92843; 92846; 92890; 93051, 93052; 93184; 93186-93188; 93193, 93194; 93199; 93213; 93215; 93218
- **INTERNATIONAL TRADEMARKS PROTECTED IN GEORGIA:**
76435; 84832; 86354; 86356; 86629; 88936; 89407; 89414; 89422, 89423; 90221; 90292; 90435; 90471; 90473; 90485; 90621; 90623, 90624; 90637; 90639-90641; 90643; 90653-90658; 90703; 91020; 91115, 91116; 91119; 91295; 91303; 91463; 91465; 91467; 91469; 91471, 91472; 91478; 91481; 91484; 91612, 91613; 91621; 91625; 91630

INVENTIONS

APPLICATIONS APPROVED FOR GRANTING PATENTS

The decision can be appealed at the Chamber of Appeal of Sakpatenti within 3 months from the publication or at the Mtskheta District Court Administrative Cases Board (Address: №17, Samkhedro str., Mtskheta), within 1 month following the publication.

PART A

A 61

(10) AP 2018 14045 A (51) Int. Cl. (2006)

A 61 K 8/362

A 61 K 8/41

A 61 Q 5/00

A 61 Q 5/04

A 61 Q 5/08

A 61 Q 5/10

(21) AP 2014 014045 (22) 2014 08 01

(31) 61/867,872; 61/861,281; 61/885,898;
61/903,239; 14/257,089; 14/257,056;
14/257,076; 62/000,340

(32) 2013 08 20; 2013 08 01; 2013 10 02;
2013 11 12; 2014 04 21; 2014 04 21;
2014 04 21; 2014 05 19

(33) US; US; US; US; US; US; US; US

(71) LIQWD, INC. (US)

1482 East Valley Road #701 Santa Barbara,
California 93108 (US)

(72) PRESSLY, Eric D. (US)

HAWKER, Craig J. (US)

(74) Tamar Kochlamazashvili

(85) 2016 01 28

(86) PCT/US2014/049388, 2014 08 01

(54) **METHODS FOR FIXING HAIR AND SKIN**

(57) A method for treating hair, by applying thereon, includes composition containing binding agent of formula (I),

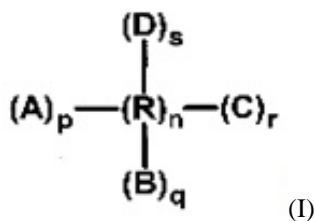

wherein A, B, C and D are reactive fragments, wherefrom each has one or more charges, wherein each from A, B, C and D reactive fragments independently contains a fragment selected from a group consisting of vinyl sulfonyl, and acrylate, methacrylate, styrene, acrylamide, methacrylamide, fumarate, and itaconate groups; R is a linker having two or more charges; at that, said charges are opposite of reactive fragments charges, wherein

n=1-10, R is not a polymer, and sum of said charges is zero; reactive fragments are bound with the linker with ionic binding, wherein p, q, r and s always independently represent whole numbers from 0 to 25, and wherein p + q + r + s is equal or more of 2.

Claims: 6 independent

62 dependent

PART B

B 28

(10) AP 2018 13882 A (51) Int. Cl. (2006)
B 28 B 19/00

(21) AP 2012 013882 (22) 2012 12 12

(31) PCT/EP2012/075266

(32) 2012 12 12

(33) EP

(71) KNAUF GIPS KG (DE)

Am Bahnhof 7 97346 Iphofen (DE)

(72) HALBACH, Martin (DE);

MARTIN, Jürgen (DE);

GREBNER, Gosbert (DE);

HANAUER, Andreas (DE)

(74) Tamar Kochlamazashvili

(85) 2015 07 10

(86) PCT/EP2012/075266, 2012 12 12

(54) **CLOCKED REGULATION OF THE AMOUNT OF PLASTER PASTE**

(57) The invention relates to a method for producing a plaster board having the steps: - provision of a conveyor belt apparatus (10) having a carrying belt (11), -application of a first sheath (12) to the carrying belt (11), -application of a plaster slurry (13) to the first sheath (12) to form a plaster coat (14) and -application of a second sheath (15) to the applied plaster slurry (13) to form a plaster layer (16) comprising first sheath (12), plaster layer (14) and second sheath (15), -levelling of the plaster layer (16) with a levelling bar (17) or a levelling roller, wherein the amount $V_{(t)}$ of the plaster slurry (13) introduced between the first sheath (12) and the second sheath (15) is reduced at a predefined clock frequency f over a predefined time period t_{Δ} compared to a target amount V_v ,

provided with restrictive plate or roller (29) reducing plaster coat amount in perpendicular relative to conveyor belt motion direction with predetermined course h.

Claims: 3 independent
14 dependent

Fig.: 5

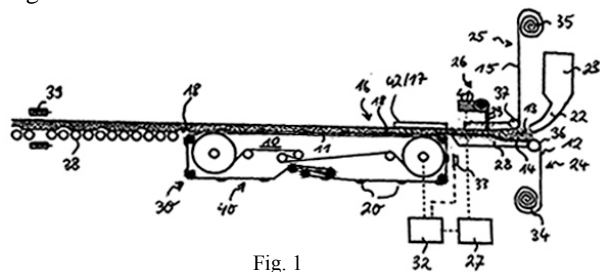

Fig. 1

PART C

C 07

(10) AP 2018 14220 A (51) Int. Cl. (2006)
C 07 C 237/22

- (21) AP 2014 014220 (22) 2014 12 23
(31) 61/920,672
(32) 2013 12 24
(33) US
(71) ONCOTARTIS, INC. (US)
480 640 Ellicott Street Buffalo, NY 14203 (US)
(72) POLINSKY, Alexander (US);
KOROTCHKINA, Lioubov (US);
VUJCIC, Slavoljub (US);
CHERNOVA, Olga (US)
(74) Tamar Kochlamazashvili
(85) 2016 07 22
(86) PCT/US2014/072150, 2014 12 23
(54) BENZAMIDE AND NICOTINAMIDE
COMPOUNDS AND METHODS OF
USING SAME

(57) Present invention relates to benzamide and nicotinamide compounds and usage thereof cancer treatment, for example.

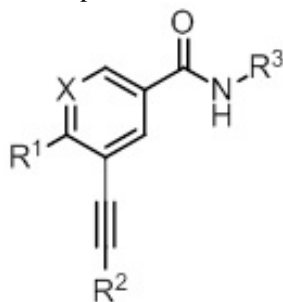

Claims: 2 independent
15 dependent

Fig.: 3

(10) AP 2018 14046 A (51) Int. Cl. (2006)

C 07 D 401/14
C 07 D 413/14
A 61 K 31/454
A 61 K 31/497
A 61 K 31/506
A 61 K 31/519
A 61 K 31/5355
C 07 D 401/04
C 07 D 407/14
C 07 D 413/04
C 07 D 417/14
C 07 D 471/04
C 07 D 487/04
A 61 P 29/02
A 61 P 37/08

- (21) AP 2014 014046 (22) 2014 07 24
(31) 61/861,709
(32) 2013 08 02
(33) US
(71) PFIZER INC. (US)
235 East 42nd Street New York, NY 10017 (US)
(72) BLINN, James, Robert (US);
FLICK, Andrew, Christopher (US);
WENNERSTÅL, Göran, Mattias (SE);
JONES, Peter (US);
KAILA, Neelu (US);
KIEFER, James, Richard, Jr. (US);
KURUMBAIL, Ravi, G. (US);
MENTE, Scot, Richard (US);
MEYERS, Marvin, Jay (US);
SCHNUTE, Mark, Edward (US);
THORARENSEN, Atli (US);
XING, Li (US);
ZAMARATSKI, Edouard (SE);
ZAPF, Christoph, Wolfgang (US)
(74) Shalva Gvaramadze
(85) 2016 01 29
(86) PCT/IB2014/063383, 2014 07 24
(54) HETEROBICYCLOARYL RORC2
INHIBITORS AND METHODS OF USE
THEREOF
(57) Compound of formula (I),

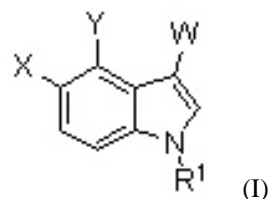

which values R¹, X, Y, W are provided in the claims or pharmaceutically acceptable salt, pharmaceutical composition on a basis thereof, and usage of said compound or salt at the treatment of atrophic arthritis, psoriasis, multiple sclerosis, etc.

Claims: 2 independent
5 dependent

Table: 7

(10) **AP 2018 14034 A** (51) **Int. Cl. (2006)**
C 07 D 403/06
A 61 K 31/506
A 61 K 31/7072
A 61 P 35/00
A 61 P 43/00

(21) AP 2014 014034 (22) 2014 06 17
 (31) 2013-126567
 (32) 2013 06 17
 (33) JP
 (71) TAIHO PHARMACEUTICAL CO., LTD
 1-27 Kandanshiki-cho, Chiyoda-ku, Tokyo
 1018444 (JP)
 (72) KAZUNO, Hideki (JP);
 MUTSUMI, Tomonobu (JP)
 (74) Shalva Gvaramadze
 (85) 2016 01 12
 (86) PCT/JP2014/065985, 2014 06 17

(54) **STABILIZED CRYSTAL OF TIPIRACIL
 HYDROCHLORIDE, AND CRYSTALLI-
 ZATION METHOD FOR SAME**

(57) Crystal of 5-chloro-6-[(2- iminopyrrolidin-1-yl)methyl]pyrimidine-2,4(1H,3H)-dione monohydrochloride having characteristic peaks at diffraction angles ($2\theta \pm 0.1^\circ$) of 11.6° , 17.2° , 17.8° , 23.3° , 27.1° and 29.3° in powder X-ray diffraction, and pharmaceutical composition on a basis thereof.

Claims: 3 independent
 6 dependent

Fig.: 3
 Table: 3

(10) **AP 2017 13996 A** (51) **Int. Cl. (2006)**
C 07 F 9/45
A 61 P 35/04
A 61 K 31/662

(21) AP 2015 013996 (22) 2015 04 07
 (31) PV 2013-308; PV 2014-66
 (32) 2013 04 24; 2014 01 29
 (33) CZ; CZ
 (71) SMART BRAIN S.R.O. (CZ)
 Videňská 1083 14220 Praha 4 (CZ);
 NEUŽIL, Jiří (CZ)
 Polianovova 3158/5, 14300 Praha 4 (CZ);
 KKCG AG (CH)
 Kappelergasse 21, 6004 Luzern (CH)
 (72) NEUŽIL, Jiří (CZ);
 ŠTURSA, Jan (CZ);
 WERNER, Lukáš (CZ)
 (74) Larisa Amirkhanyan
 (85) 2015 11 20
 (86) PCT/CZ2014/000035, 2015 04 07

(54) **TAMOXIFEN DERIVATIVES FOR
 TREATMENT OF NEOPLASTIC
 DISEASES, ESPECIALLY WITH HIGH
 HER2 PROTEIN LEVEL**

(57) Targeted on mitochondrion E and/or Z isomers of triphenylphosphonium derivatives of tamoxifen

with aliphatic chain, which is alkyl or alkenyl, and their corresponding tertiary amine salts and/or their mixture (MitoTAX). Alkyl triphenylphosphonium derivatives of tamoxifen have the general formula (I),

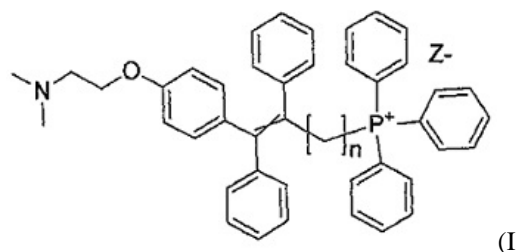

(I)

and Alkenyl triphenylphosphonium derivatives of tamoxifen have the general formula IA,

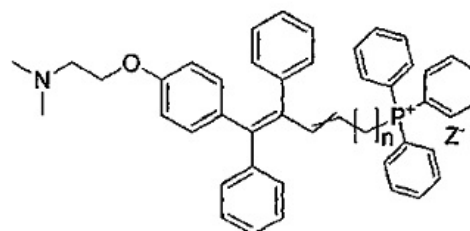

(IA)

which values of Z-group and n variable are provided in the claims; method for their preparation and usage thereat tumor diseases treatment.

Claims: 9 independent
 5 dependent

Fig.: 19
 Table: 3

PATENTED INVENTIONS
PART A**A 01**

- (11) P 2018 6832 B** **(51) Int. Cl. (2006)**
A 01 D 41/00
A 01 F 12/00
- (10) AP 2017 13994 A (44) 16(476)/2017
(21) AP 2015 013994
(22) 2015 11 16
(24) 2015 11 16
(73) LEPL SCIENTIFIC RESEARCH CENTER
OF AGRICULTURE (GE)
Marshal Gelovanis gamz. 6, 0159, Tbilisi (GE)
(72) Vladimer Miruashvili (GE)
(54) **GRAIN COMBINE**
-

PART B**B 65**

- (11) P 2018 6834 B** **(51) Int. Cl. (2006)**
B 65 D 19/00
- (10) AP 2017 14098 A (44) 22(482)/2017
(21) AP 2014 014098
(22) 2014 08 19
(24) 2014 08 19
(31) VE2013A000044; PCT/IB2014/001562
(32) 2013 08 23; 2014 08 19
(33) IT; IB
(86) PCT/IB2014/001562, 2014 08 19
(73) PISANO, Roberto (IT)
Via C. Goldoni, 29, I-31100-Treviso (IT)
(72) PISANO, Roberto (IT)
(74) Aleksandre Gegechkori
(54) **METAL PALLET WITH**
ASSEMBLABLE COMPONENTS
-

PART C**C 07**

- (11) P 2018 6833 B** **(51) Int. Cl. (2006)**
C 07 D 207/267
C 07 D 213/40
C 07 D 233/58
C 07 D 239/34
C 07 D 277/28
C 07 D 401/04
C 07 D 401/06
C 07 D 401/12
C 07 D 405/12
C 07 D 409/04
C 07 D 409/14
C 07 D 413/04
C 07 D 413/12
C 07 D 417/04
C 07 D 417/06
C 07 D 417/12
C 07 D 471/04
C 07 D 487/04
C 07 D 491/048
C 07 D 491/052
C 07 D 491/20
C 07 D 495/14
A 61 K 31/33
A 61 K 31/14
- (10) AP 2017 14095 A (44) 21(481)/2017
(21) AP 2014 014095
(22) 2014 08 19
(24) 2014 08 19
(31) 61/945,048; 61/868,519
(32) 2013 08 21; 2014 02 26
(33) US; US
(86) PCT/US2014/051642, 2014 08 19
(73)) ALIOS BIOPHARMA, INC. (US)
260 E. Grand Avenue, 2nd Floor South
San Francisco, CA 94080 (US)
(72) WANG, Guangyi (US);
BEIGELMAN, Leonid (US);
TRUONG, Anh (US);
NAPOLITANO, Carmela (IT);
ANDREOTTI, Daniele (IT);
STEIN, Karin, Ann (US);
HE, Haiying (CN)
(74) Aleksandre Gegechkori
(54) **ANTIVIRAL COMPOUNDS**
-

C 10

- (11) P 2018 6831 B (51) Int. Cl. (2006)
C 10 G 9/00
C 10 G 9/24
C 10 G 9/08
C 10 G 47/00
- (10) AP 2017 13972 A (44) 20(480)/2017
(21) AP 2015 013972
(22) 2015 10 23
(24) 2015 10 23
(73) LEPL SHOTA RUSTAVELI
NATIONAL SCIENCE FOUNDATION (GE)
D. Aleksidzis q. 3, 0179, Tbilisi (GE);
LEPL IV. JAVAKHISHVILI TBILISI STATE
UNIVERSITY (GE)
I. Chavchavadzis gamz. 1, 0179, Tbilisi (GE);
Guram Khitiri (GE)
M. Kostavas q. 67/85, korp. 5, b. 18, Tbilisi (GE);
Ioseb Chikvaidze (GE)
Guramishvilis gamz. 9, b. 91, Tbilisi (GE)
- (72) Guram Khitiri (GE);
Ioseb Chikvaidze (GE)
- (74) Ioseb Chikvaidze
- (54) **METHOD FOR PIPELINE SEDIMENTA-
TION WASTE-FREE UTILIZATION**
-

PART F

F 17

- (11) P 2018 6835 B (51) Int. Cl. (2006)
F 17 D 1/04
- (10) AP 2017 14294 A (44) 21(481)/2017
(21) AP 2016 014294
(22) 2016 10 07
(24) 2016 10 07
(73) Ilia Kherodinashvili (GE)
Zh. Shartavas q. 18a, b. 21, 0160, Tbilisi (GE)
- (72) Ilia Kherodinashvili (GE)
- (54) **METHOD FOR CITY OR VILLAGE
COMMUNITY GAS SUPPLEMENT**
-

UTILITY MODELS

APPLICATION APPROVED FOR GRANTING PATENT

The decision can be appealed at the Chamber of Appeal of Sakpatenti within 3 months from the publication or at the Mtskheta District Court Administrative Cases Board (Address: №17, Samkhedro str., Mtskheta), within 1 month following the publication.

PART A

A 61

(10) AU 2018 14175 U (51) Int. Cl. (2006)
A 61 K 33/36
A 01 N 59/22
C 01 G 28/00

(21) AU 2016 014175 (22) 2016 06 13

(71) LTD "COMPANY TM RG" (GE)
Vazha-Pshavelas gamz. I, shes. 3, b. 219,
0177, Tbilisi (GE)

(72) Temur Kemularia (GE);
Rusudan Gigauri (GE);
Naira Gigauri (GE)

(54) **METHOD FOR TIN HYDRO
ARSENATE PREPARATION**

(57) A method for tin hydro arsenate (II) preparation provides arsenous acid 10-12% and tin chloride water suspension interaction, in ratio 1:3; filtration of base product prepared as a sediment, and washing and drying thereof.

Claims: 1 independent

PATENTED UTILITY MODELS
PART B**B 03**

(11) U 2018 1962 Y (51) **Int. Cl. (2006)**
B 03 B 13/04

- (10) AU 2017 13949 U (44) 20(480)/2017
 (21) AU 2015 013949
 (22) 2015 10 02
 (24) 2015 10 02
 (73) Mikheil Gamtsemlidze (GE)
 Panaskertelis q. korp. 15a, b. 43, 0194,
 Tbilisi (GE);
 Roin Enageli (GE)
 Nikoladzis q. 8, b. 4, 3700, Rustavi (GE);
 Teimuraz Rukhadze (GE)
 Cholokashvilis q. 47, 0113, Tbilisi (GE);
 Manana Tutberidze (GE)
 Panaskertelis q. korp. 15, b. 17, 0194,
 Tbilisi (GE);
 Neli Ghughunishvili (GE)
 Zugdidis q. 3, 0154, Tbilisi (GE);
 Nukri Samkharadze (GE)
 G. Tabidzis q. 19, 0105, Tbilisi (GE)
 (72) Mikheil Gamtsemlidze (GE);
 Roin Enageli (GE);
 Teimuraz Rukhadze (GE);
 Manana Tutberidze (GE);
 Neli Ghughunishvili (GE);
 Nukri Samkharadze (GE)
 (54) **METHOD FOR DIAPHRAGM
 JIG AUTOCONTROL**
-

PART C**C 25**

(11) U 2018 1963 Y (51) **Int. Cl. (2006)**
C 25 B 1/40
C 25 B 9/14

- (10) AU 2017 14309 U (44) 22(482)/2017
 (21) AU 2016 014309
 (22) 2016 10 27
 (24) 2016 10 27
 (73) Temur Chakhunashvili (GE)
 Panaskertelis q., korp. 17, b. 15, 0194,
 Tbilisi (GE);
 Teimuraz Rokva (GE)
 Vazha-Pshavelas V kvart., korp. 1, b. 32,
 0186, Tbilisi (GE);
 Zhiuli Keadze (GE)
 Nutsbidzis me-3 mkr., kvart. 2, korp. 2, b. 69,
 0183, Tbilisi (GE);
 Zinaida Vatsadze (GE)
 Giorgi Brtskinvales q. 25, b. 34, 0153,
 Tbilisi (GE)
 (72) Temur Chakhunashvili (GE);
 Teimuraz Rokva (GE);
 Zhiuli Keadze (GE);
 Zinaida Vatsadze (GE)
 (54) **ELECTROLYTIC BATH FOR
 RECEIVING MANGANESE DIOXIDE**
-

DESIGNS

APPLICATIONS APPROVED FOR REGISTRATIONS

The decision can be appealed at the Chamber of Appeal of Sakpatenti within 3 months from the publication or at the Mtskheta District Court Administrative Cases Board (Address: №17, Samkhedro str., Mtskheta), within 1 month following the publication.

(10) AD 2018 985 S

(21) AD 2017 985

(28) 1

(71) Levan Khmiadashvili (GE)

Kavtiskhevis q.16, 0180, Tbilisi, Georgia (GE)

(72) Levan Khmiadashvili (GE)

(54) BOOK CASE

(55)

(51) 19-04

(22) 2017 09 06



1.1



1.2



1.3

(10) AD 2018 995 S

(21) AD 2017 995

(28) 10

(71) LTD "BATONO" (GE)

Gotuas q. 8, Vake-Saburtalos r-ni, 0139, Tbilisi, Georgia (GE)

(72) Zviad Matiashvili (GE)

(74) Zviad Matiashvili (GE)

(54) 1.-10. LOGO

(55)

(51) 32-00

(22) 2017 10 04

1.1 

2.1 

3.1 

4.1 

5.1 

Kvevruli



6.1

QVEVRULI

7.1

Qvevruli

8.1

Qvevruli



9.1

Qvevruli

10.1

REGISTERED DESIGNS

(11) D 2018 750 S **(51) 07-06**
(10) AD 2017 974 S (44) 22(482)/2017
(21) AD 2017 974
(22) 2017 08 01
(24) 2017 08 01
(28) 2
(18) 2022 08 01
(73) Tea Kurtanidze (GE)
 Tsminda Ninos q. 22, 3300, Mtskheta **(GE)**
(72) Tea Kurtanidze (GE)
(54) **KHINKALI-SHAPED VESSELS:**
 SALTCELLAR AND PEPPER POT

(11) D 2018 749 S **(51) 09-05**
(10) AD 2017 973 S (44) 22(482)/2017
(21) AD 2017 973
(22) 2017 07 31
(24) 2017 07 31
(28) 4
(18) 2022 07 31
(73) Davit Zurabishvili (GE)
 I. Grishashvilis q. 30, 0181, daba Tskneti,
 Tbilisi (GE)
(72) Davit Zurabishvili (GE)
(74) Davit Dzamukashvili (GE)
(54) **BAG FOR CEMENT**

DESIGNS, WHICH HAVE BEEN REGISTERED WITH THE INTERNATIONAL BUREAU CLAIMING PRIORITY ON THE TERRITORY OF GEORGIA

The decision can be appealed at the Chamber of Appeal of Sakpatenti within 3 months from the publication or at the Mtskheta District Court Administrative Cases Board (Address: №17, Samkhedro Str., Mtskheta), within 1 month following the publication.

(11) DM/096015

(15) 2017 05 04

(22) 2017 05 04

(28) 2

(73) PEUGEOT CITROËN AUTOMOBILES SA

Route de Gisy, F-78140 VELIZY-VILLACOUBLAY (FR)

(85) FR, EM

(86) FR, EM

(87) FR, EM

(88) FR, EM

(89) FR

(81) II. BJ, BX, BZ, CI, GA, GR, IT, MA, ML, NE, SN, SR III. AL, AM, AZ, BA, BG, BN, BW, CH, DE, DK, EE, EG, ES, FI, FR, GE, GH, HR, HU, IS, JP, KG, KH, KP, KR, LI, LT, LV, MC, MD, ME, MK, MN, NA, NO, OA, OM, PL, RO, RS, RW, SG, SI, ST, SY, TJ, TM, TN, TR, UA

(72) Jean-Pierre Ploué

Route de Gisy, 78140 VELIZY-VILLACOUBLAY, France

(54) 1. Front light for vehicle; 2. Vehicle taillight

(55)

1.1



1.2



2.1



2.2



(11) DM/096016

(15) 2017 05 04

(22) 2017 05 04

(28) 2

(73) PEUGEOT CITROËN AUTOMOBILES SA

Route de Gisy, F-78140 VELIZY-VILLACOUBLAY (FR)

(85) FR, EM

(86) FR, EM

(87) FR, EM

(88) FR, EM

(89) FR

(81) II. BJ, BX, BZ, CI, GA, GR, IT, MA, ML, NE, SN, SR III. AL, AM, AZ, BA, BG, BN, BW, CH, DE, DK, EE, EG, ES, FI, FR, GE, GH, HR, HU, IS, JP, KG, KH, KP, KR, LI, LT, LV, MC, MD, ME, MK, MN, NA, NO, OA, OM, PL, RO, RS, RW, SG, SI, ST, SY, TJ, TM, TN, TR, UA

(72) Jean-Pierre Ploué

Route de Gisy, 78140 VELIZY-VILLACOUBLAY, France

(54) 1. Front light for vehicle; 2. Taillight for vehicles

(55)

1.1



1.2



2.1



2.2



(11) DM/098191**(51) 13-99**

(15) 2017 08 04

(45) 2017/44 (2017 11 10)

(22) 2017 08 04

(28) 1

(73) SOLARISFLOAT LD^a

Rua da Guarda 675, P-4455-466 Matosinhos (PT)

(85) EM

(86) EM

(87) EM

(88) EM

(89) EM

(81) III. AL, AM, AZ, BA, BN, BW, CH, EG, GE, GH, IS, JP, KG, KH, KP, KR, LI, MC, MD, ME, MK, MN, NA, NO, OA, OM, RS, RW, SG, ST, SY, TJ, TM, TN, TR, UA, US

(30) No. 1: 06.02.2017; 003741743-0001; EM

(72) Nuno André Curado Mateus Correia

Rua Dr. Roberto Frias, 400, 4200-465 Porto, Portugal;

Carla Filipa Sousa Gomes

Rua Dr. Roberto Frias, 400, 4200-465 Porto, Portugal;

Ricardo Fernando Rodrigues Pinto

Rua Dr. Roberto Frias, 400, 4200-465 Porto, Portugal;

Luís Miguel Pereira Pina

Rua Dr. Roberto Frias, 400, 4200-465 Porto, Portugal;

Jorge Manuel Teixeira da Silva

Rua Dr. Roberto Frias, 4200-465 Porto, Portugal;

Nuno José Eleutério da Silva Moita

Rua Dr. Roberto Frias, 400, 4200-465 Porto, Portugal

(54) 1. Support for solar panels

(55)

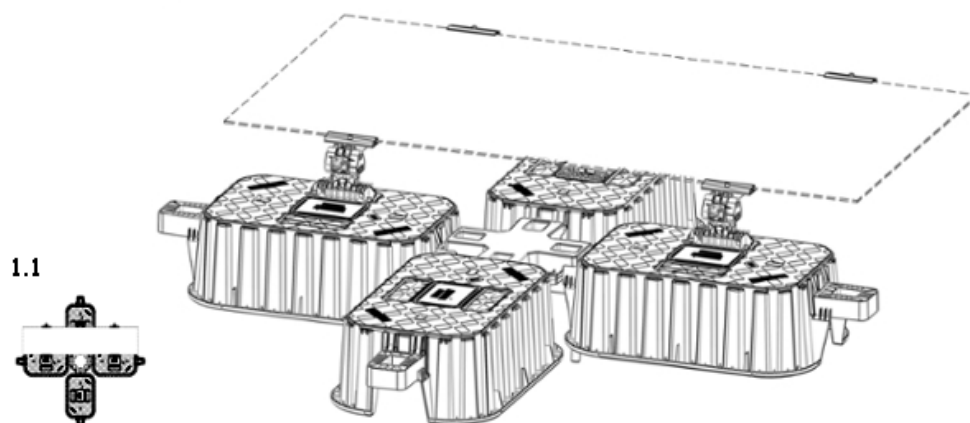
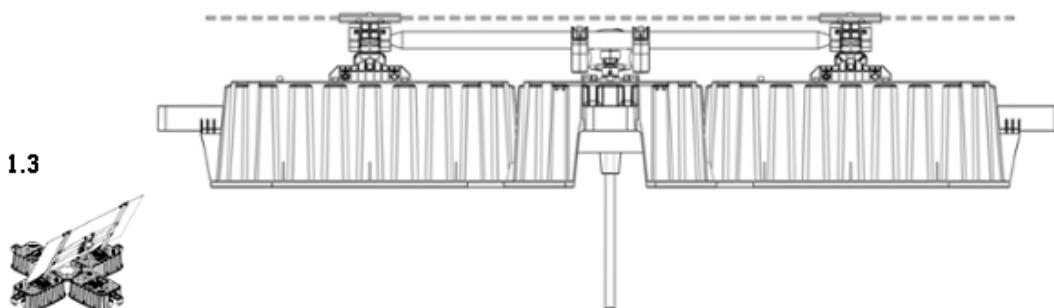
1.2**1.4****1.3**

1.5

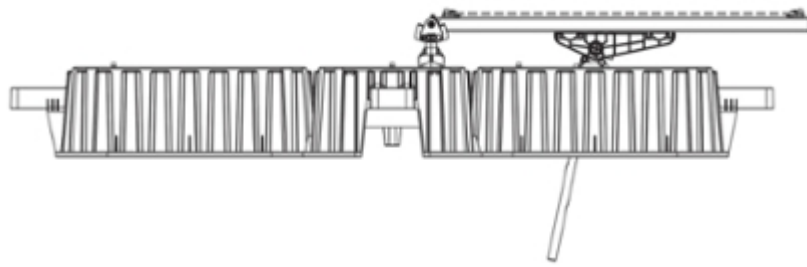

1.6



1.7

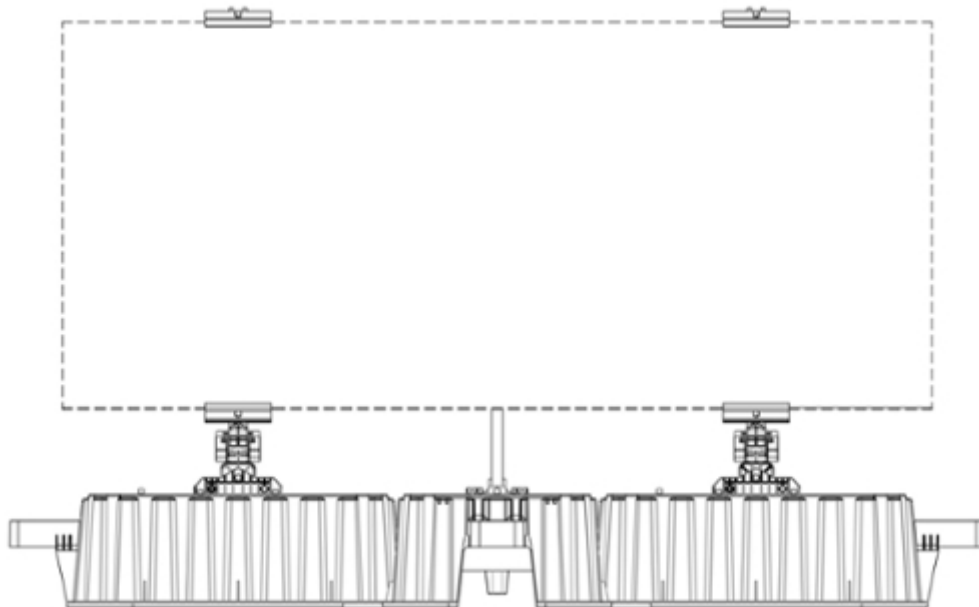

(11) DM/098225**(51) 12-16**

(15) 2017 04 14

(45) 2017/44 (2017 11 10)

(22) 2017 04 14

(28) 9

(73) PEUGEOT CITROËN AUTOMOBILES SA

Route de Gisy, F-78140 VELIZY-VILLACOUBLAY (FR)

(85) FR, EM

(86) FR, EM

(87) FR, EM

(88) FR, EM

(89) FR

(81) II. BJ, BX, BZ, CI, GA, GR, IT, MA, ML, NE, SN, SR III. AL, AM, AZ, BA, BG, BN, BW, CH, DE, DK, EE, EG, ES, FI, FR, GE, GH, HR, HU, IS, JP, KG, KH, KP, KR, LI, LT, LV, MC, MD, ME, MK, MN, NA, NO, OA, OM, PL, RO, RS, RW, SG, SI, ST, SY, TJ, TM, TN, TR, UA

(72) Jean-Pierre Ploué

Route de Gisy, 78140 VELIZY-VILLACOUBLAY, France

(54) 1. Front wing for motor vehicles; 2. Motor vehicle radiator grille; 3. Vehicle roof bar pair;

4. Hood for motor vehicles; 5.-6. Protection devices for vehicle doors; 7.-8. Rear bumpers for motor vehicles;

9. Front bumper block for motor vehicles

(55)

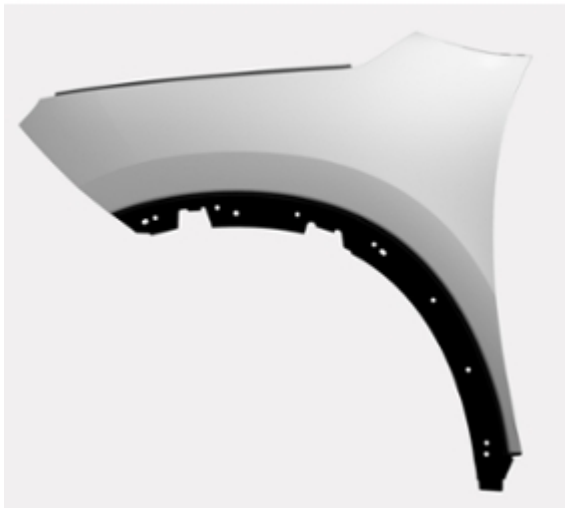
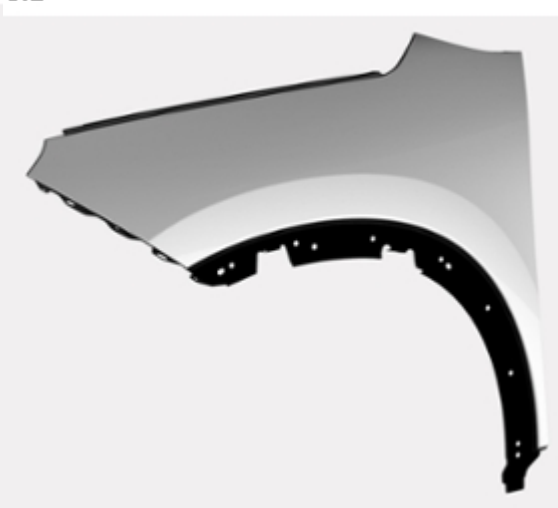
1.1**1.2****2.1****2.2**

3.1



3.2



4.1



4.2



5.1



5.2



6.1



6.2



7.1



7.2



8.1



8.2



9.1



9.2

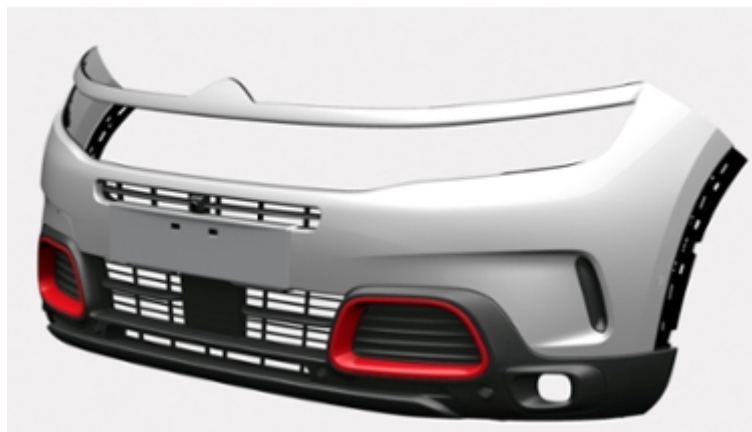

(11) DM/098226

(15) 2017 05 04

(22) 2017 05 04

(28) 4

(73) PEUGEOT CITROËN AUTOMOBILES SA

Route de Gisy, F-78140 VELIZY-VILLACOUBLAY (FR)

(85) FR, EM

(86) FR, EM

(87) FR, EM

(88) FR, EM

(89) FR

(81) II. BJ, BX, BZ, CI, GA, GR, IT, MA, ML, NE, SN, SR III. AL, AM, AZ, BA, BG, BN, BW, CH, DE, DK, EE, EG, ES, FI, FR, GE, GH, HR, HU, IS, JP, KG, KH, KP, KR, LI, LT, LV, MC, MD, ME, MK, MN, NA, NO, OA, OM, PL, RO, RS, RW, SG, SI, ST, SY, TJ, TM, TN, TR, UA

(72) Jean-Pierre Ploué

Route de Gisy, 78140 VELIZY-VILLACOUBLAY, France

(54) 1. Front bumper block for motor vehicles; 2. Rear bumper for motor vehicles; 3. Hood for motor vehicles; 4. Exterior rearview mirror for motor vehicles

(55)

1.1



1.2



2.1



2.2



3.1



3.2



4.1



4.2



(11) DM/098227

(15) 2017 05 04

(22) 2017 05 04

(28) 2

(73) PEUGEOT CITROËN AUTOMOBILES SA

Route de Gisy, F-78140 VELIZY-VILLACOUBLAY (FR)

(85) FR, EM

(86) FR, EM

(87) FR, EM

(88) FR, EM

(89) FR

(81) II. BJ, BX, BZ, CI, GA, GR, IT, MA, ML, NE, SN, SR III. AL, AM, AZ, BA, BG, BN, BW, CH, DE, DK, EE, EG, ES, FI, FR, GE, GH, HR, HU, IS, JP, KG, KH, KP, KR, LI, LT, LV, MC, MD, ME, MK, MN, NA, NO, OA, OM, PL, RO, RS, RW, SG, SI, ST, SY, TJ, TM, TN, TR, UA

(72) Jean-Pierre Ploué

Route de Gisy, 78140 VELIZY-VILLACOUBLAY, France

(54) 1. Front bumper block for motor vehicles; 2. Rear bumper for motor vehicles

(55)

1.1



1.2

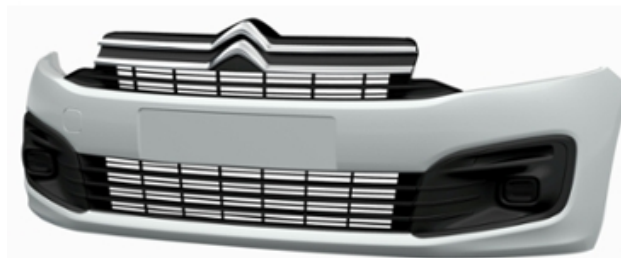

2.1

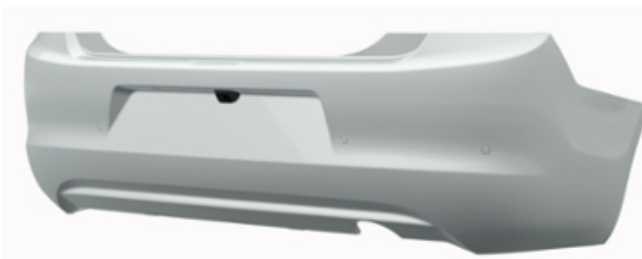

2.2



(11) DM/098228

(51) 12-16

(15) 2017 03 31

(45) 2017/44 (2017 11 10)

(22) 2017 03 31

(28) 10

(73) PEUGEOT CITROËN AUTOMOBILES SA

Route de Gisy, F-78140 VELIZY-VILLACOUBLAY (FR)

(85) FR, EM

(86) FR, EM

(87) FR, EM

(88) FR, EM

(89) FR

(81) II. BJ, BX, BZ, CI, GA, GR, IT, MA, ML, NE, SN, SR III. AL, AM, AZ, BA, BG, BN, BW, CH, DE, DK, EE, EG, ES, FI, FR, GE, GH, HR, HU, IS, JP, KG, KH, KP, KR, LI, LT, LV, MC, MD, ME, MK, MN, NA, NO, OA, OM, PL, RO, RS, RW, SG, SI, ST, SY, TJ, TM, TN, TR, UA

(72) Jean-Pierre Ploué

Route de Gisy, 78140 VELIZY-VILLACOUBLAY, France

(54) 1. Rear wing for motor vehicles; 2.-3. Front bumper blocks for motor vehicles; 4. Hood for motor vehicles; 5.-6. Rear bumpers for motor vehicles; 7. Rear door for motor vehicles; 8. Front door for motor vehicles; 9. Exterior rearview mirror for motor vehicles; 10. Rear trunk door for motor vehicles

(55)

1.1

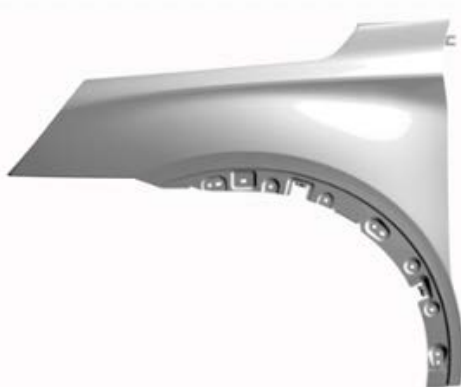

1.2



2.1

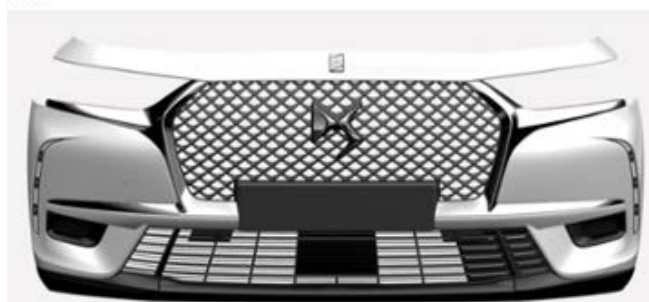

2.2

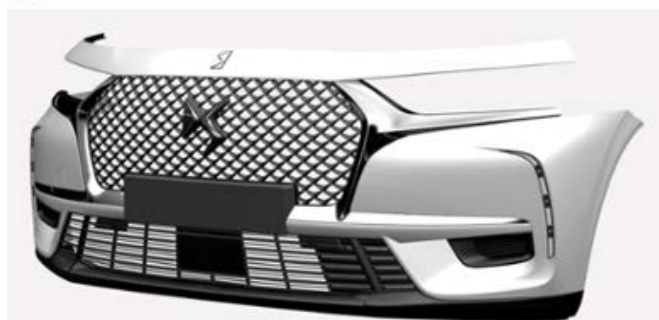

3.1

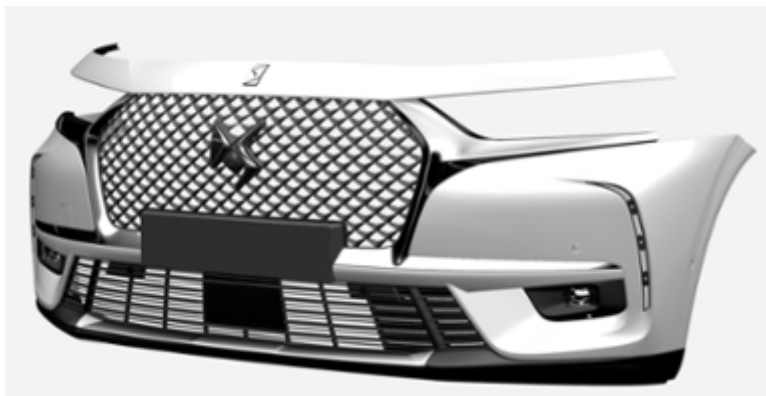

3.2

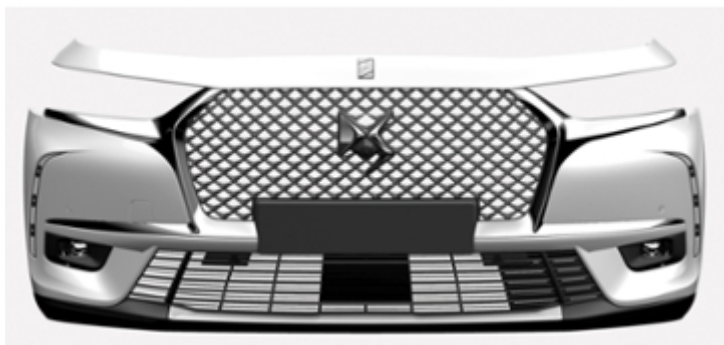

4.1



4.2



5.1



5.2



6.1



6.2



7.1



7.2



8.1



8.2



9.1



9.2

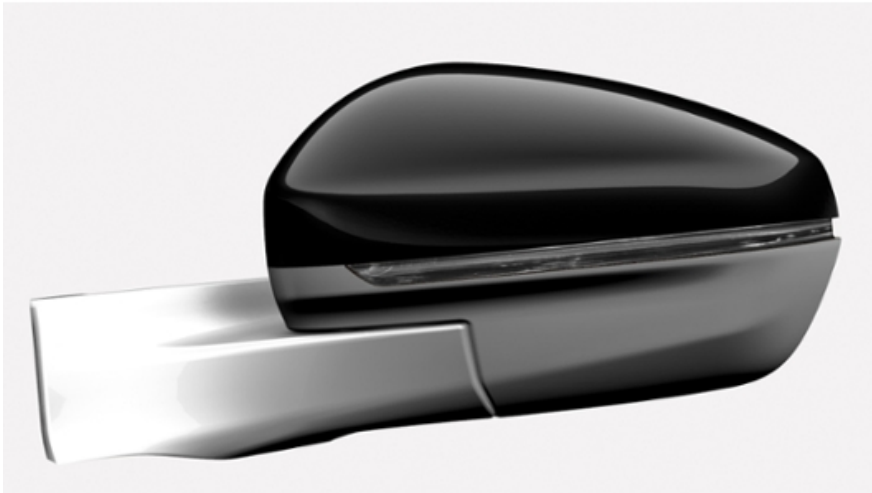

10.1



10.2



(11) DM/098229

(15) 2017 07 19

(22) 2017 07 19

(28) 2

(30) Nos. 1, 2: 19.01.2017; 003661834; EM

(73) MAGNISENSE SE

16 avenue Hoche, F-75008 PARIS (FR)

(85) FR, EM

(86) FR, EM

(87) FR, EM

(88) FR, EM

(89) FR

(81) II. MA III. CH, GE, JP, MC, NO, TN, TR, US

(72) Thibaut FREZAL

16 avenue Hoche, 75008 Paris, France

(54) 1. Reader for medical or non-medical diagnostic use; 2. Housing with an integrated test strip for diagnosis for medical, veterinary or non-medical use

(55)

1.1**1.2****1.3****1.4****1.5****1.6****1.7****2.2****2.1**

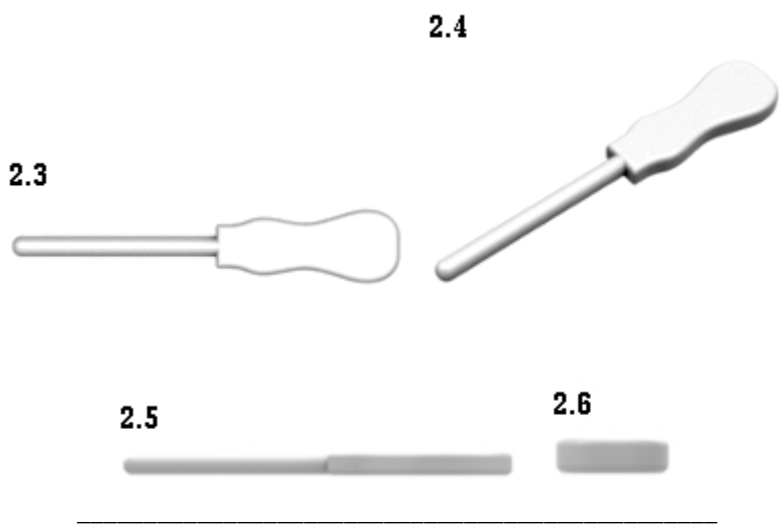

(11) DM/096085

(15) 2017 05 15

(22) 2017 05 15

(28) 1

(73) UNION UHRENFABRIK GMBH

Frühlingsweg 5, 01768 Glashütte (DE)

(85) DE, EM

(86) DE, EM

(87) DE, EM

(88) DE, EM

(89) DE

(81) II. BZ, MA III. AL, AM, AZ, BA, CH, EM, GE, KG, LI, MC, MD, ME, MK, MN, NO, OM, SG, TN, TR, UA

(72) Marco SCARINZI

Chemin de la Pierre-Grise 24, 2502 Biel/Bienne, Suisse;

Renato SCARINZI

Lehmgrubenweg 20, 2504 Biel/Bienne, Suisse

(54) 1. Watch dial with watch hands

(55)

1.1

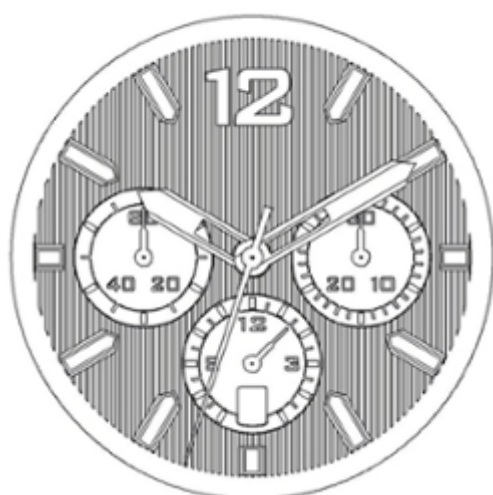

1.2

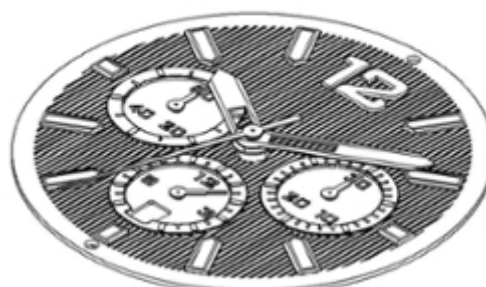

(11) DM/096364

(15) 2017 05 24

(22) 2017 05 24

(28) 1

(73) THOMAS GORGOSILITS

Weidengasse 2, A-2362 Biedermannsdorf (AT)

(85) –

(86) EM

(87) EM

(88) –

(89) EM

(81) III. AL, AM, BA, CH, EM, GE, IS, LI, MC, MD, ME, MK, NO, RS, TR, UA

(72) Thomas Gorgosilits

Weidengasse 2, 2362 Biedermannsdorf, Austria

(54) I. Advertising device

(55)

(51) 20-03

(45) 2017/46 (2017 11 24)

1.1**1.2****1.3****1.4**

(11) DM/098389

(15) 2017 02 24

(22) 2017 02 24

(28) 6

(73) PEUGEOT CITROËN AUTOMOBILES SA

Route de Gisy, F-78140 VELIZY-VILLACOUBLAY (FR)

(85) FR, EM

(86) FR, EM

(87) FR, EM

(88) FR, EM

(89) FR

(81) II. BJ, BX, BZ, CI, GA, GR, IT, MA, ML, NE, SN, SR III. AL, AM, AZ, BA, BG, BN, BW, CH, DE, DK, EE, EG, ES, FI, FR, GE, GH, HR, HU, IS, JP, KG, KP, KR, LI, LT, LV, MC, MD, ME, MK, MN, NA, NO, OA, OM, PL, RO, RS, RW, SG, SI, ST, SY, TJ, TM, TN, TR, UA

(72) Jean-Pierre Ploué

Route de Gisy, 78140 VELIZY-VILLACOUBLAY, France

(54) 1. Spoiler for vehicles; 2.-3. Rear bumpers for vehicles; 4. Front bumper block for vehicles;

5. Rear door for vehicles; 6. Rear trunk door for vehicles

(55)

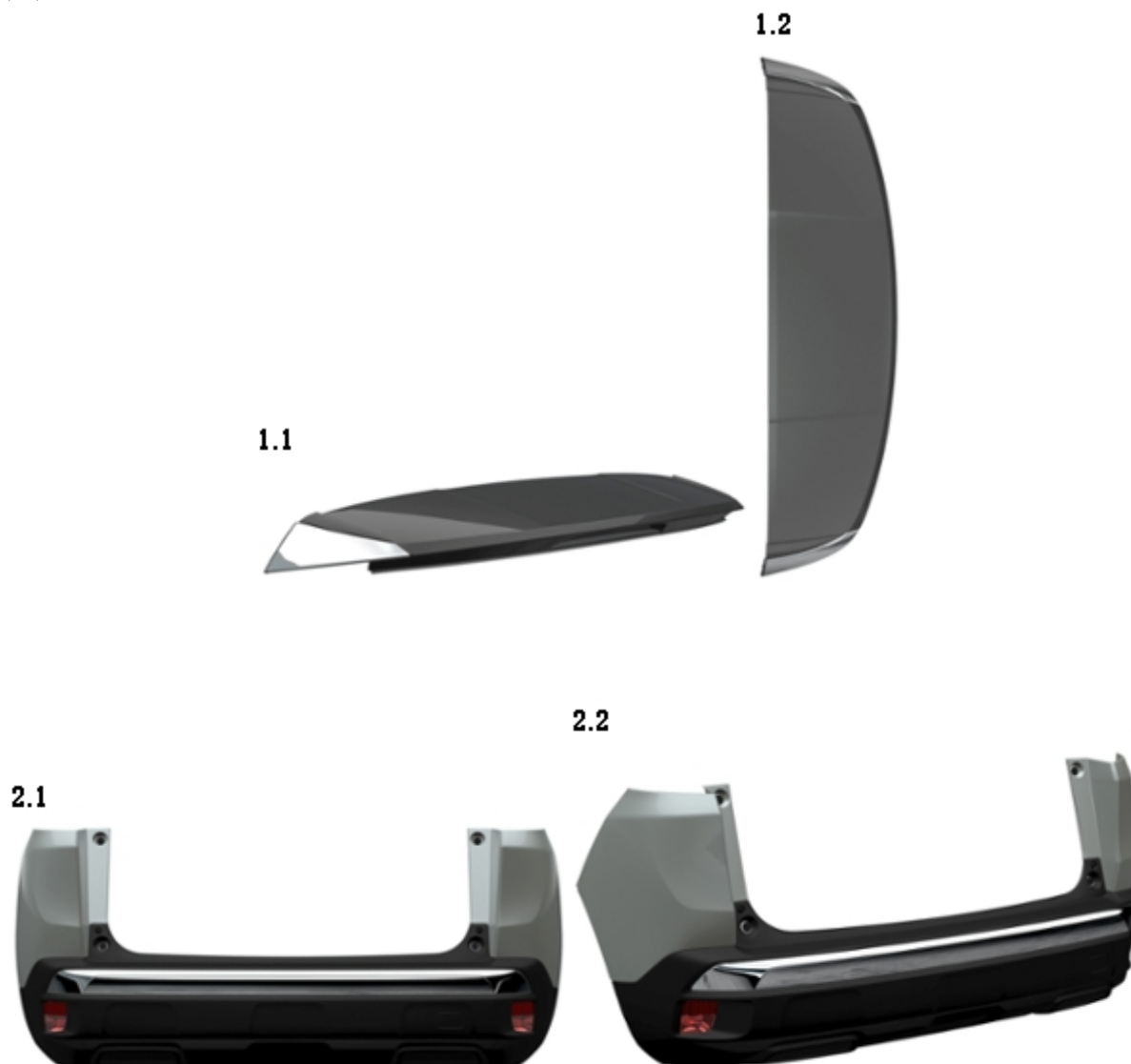

3.1



3.2



4.1

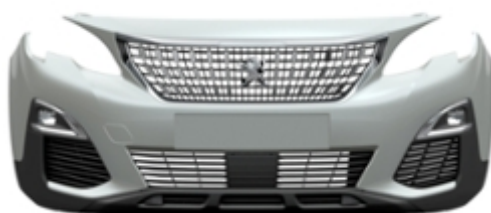

4.2



5.1



5.2



6.1



6.2



(11) DM/098390

(15) 2017 02 27

(22) 2017 02 27

(28) 10

(73) PEUGEOT CITROËN AUTOMOBILES SA

Route de Gisy, F-78140 VELIZY-VILLACOUBLAY (FR)

(85) FR, EM

(86) FR, EM

(87) FR, EM

(88) FR, EM

(89) FR

(81) II. BJ, BX, BZ, CI, GA, GR, IT, MA, ML, NE, SN, SR III. AL, AM, AZ, BA, BG, BN, BW, CH, DE, DK, EE, EG, ES, FI, FR, GE, GH, HR, HU, IS, JP, KG, KP, KR, LI, LT, LV, MC, MD, ME, MK, MN, NA, NO, OA, OM, PL, RO, RS, RW, SG, SI, ST, SY, TJ, TM, TN, TR, UA

(72) Jean-Pierre Ploué

Route de Gisy, 78140 VELIZY-VILLACOUBLAY, France

(54) 1. Front wing for motor vehicles; 2. Hood for motor vehicles; 3.-4. Front bumper blocks for motor vehicles; 5. Spoiler for vehicles; 6.-7. Rear bumpers for motor vehicles; 8. Rear door for motor vehicles; 9. Front door for motor vehicles; 10. Rear trunk door for motor vehicles

(55)

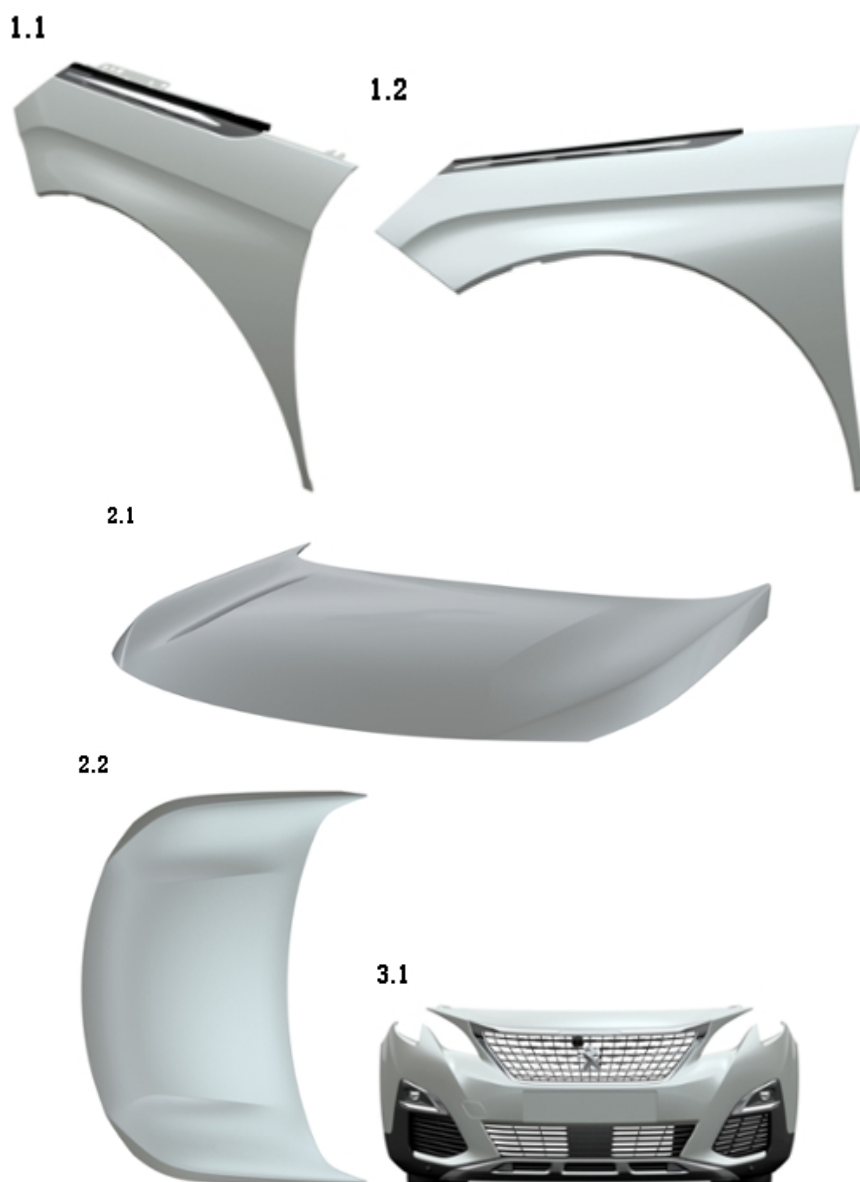

3.2



4.1



4.2



5.1



5.2



6.1



6.2

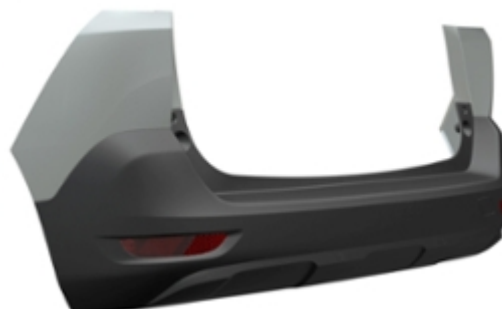

7.1



7.2



8.1



8.2



9.1



9.2



10.1



10.2



(11) DM/096831**(51) 06-04**

(15) 2017 05 29

(45) 2017/47 (2017 12 01)

(22) 2017 05 29

(28) 2

(30) No. 1: 01.12.2016; 003494152-001; EM; No. 2: 01.12.2016; 003494152-002; EM

(73) GÜHRING KG

Herderstrasse 50-54, 72458 Albstadt (DE)

(85) –

(86) –

(87) –

(88) EM

(89) EM

(81) III. AM, AZ, CH, GE, IS, JP, KG, KR, LI, MC, MD, NO, OA, RS, SG, TJ, TM, TR, UA, US

(72) Dr. Jörg Gühring

Herderstraße 50-54, 72458 Albstadt, Germany

(54) 1.-2. Tool cabinets

(55)

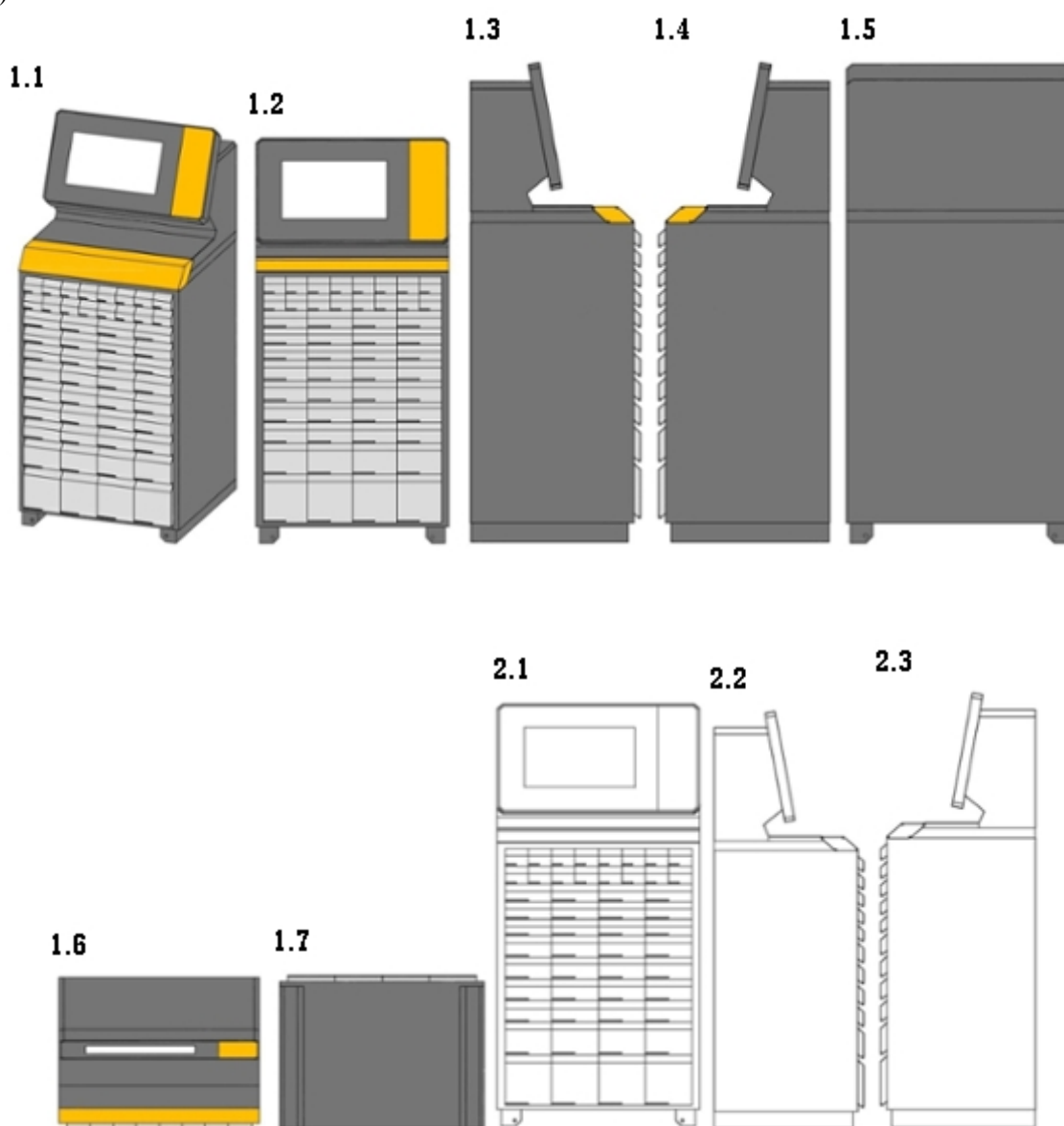

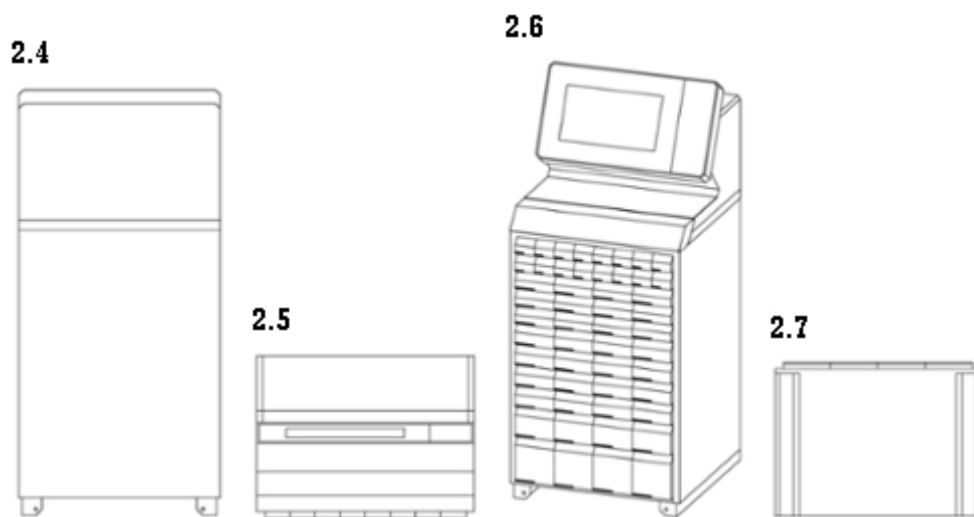
**(11) DM/098518**

(15) 2017 06 27

(22) 2017 06 27

(28) 36

(30) No. 1: 28.12.2016; 003549005-0001; EM; No. 2: 28.12.2016; 003549005-0006; EM;
 No. 3: 28.12.2016; 003549005-0007; EM; No. 4: 28.12.2016; 003549005-0014; EM;
 No. 5: 28.12.2016; 003549005-0016; EM; No. 6: 28.12.2016; 003549005-0017; EM;
 No. 7: 28.12.2016; 003549005-0019; EM; No. 8: 28.12.2016; 003549005-0020; EM;
 No. 9: 28.12.2016; 003549005-0025; EM; No. 10: 28.12.2016; 003549005-0026; EM;
 No. 11: 28.12.2016; 003549005-0029; EM; No. 12: 28.12.2016; 003549005-0030; EM;
 No. 13: 28.12.2016; 003549005-0053; EM; No. 14: 28.12.2016; 003549005-0054; EM;
 No. 15: 28.12.2016; 003549005-0055; EM; No. 16: 28.12.2016; 003549005-0056; EM;
 No. 17: 28.12.2016; 003549005-0060; EM; No. 18: 28.12.2016; 003549005-0061; EM;
 No. 19: 28.12.2016; 003549005-0063; EM; No. 20: 28.12.2016; 003549005-0064; EM;
 No. 21: 28.12.2016; 003549005-0072; EM; No. 22: 28.12.2016; 003549005-0073; EM;
 No. 23: 28.12.2016; 003549005-0074; EM; No. 24: 28.12.2016; 003549005-0075; EM;
 No. 25: 28.12.2016; 003549005-0076; EM; No. 26: 28.12.2016; 003549005-0077; EM;
 No. 27: 28.12.2016; 003549005-0078; EM; No. 28: 28.12.2016; 003549005-0079; EM;
 No. 29: 28.12.2016; 003549005-0080; EM; No. 30: 28.12.2016; 003549005-0086; EM;
 No. 31: 28.12.2016; 003549005-0087; EM; No. 32: 28.12.2016; 003549005-0088; EM;
 No. 33: 28.12.2016; 003549005-0093; EM; No. 34: 28.12.2016; 003549005-0094; EM;
 No. 35: 28.12.2016; 003549005-0097; EM; No. 36: 28.12.2016; 003549005-0098; EM

(73) SEAT S.A.

Autovía A-2, Km. 585, E-08760 Martorell (Barcelona) (ES)

(85) –

(86) ES, EM

(87) –

(88) –

(89) ES

(81) III. AZ, BA, CH, EG, GE, IS, LI, MD, MK, NO, OM, RS, SG, TN, TR, UA

(72) Alejandro Mesonero-Romanos Aguilar

Autovía A-2, Km 585, 08760 Martorell (Barcelona), España

(54) 1. Automobile; 2.-3. Vehicle rims; 4. Rear bumper; 5. Complete front bumper; 6. Front bumper;
 7.-8. Front grilles; 9. Complete rear bumper; 10. Rear bumper; 11. Complete rear bumper; 12. Rear bumper;
 13.-15. Front bumpers; 16. Complete front bumper; 17. Front grille; 18. Rear trim; 19.-20. Rear bumpers;
 21.-28. Vehicle rims; 29. Hubcap for vehicles; 30.-31. Front bumpers; 32. Complete front bumper;
 33.-34. Front grilles; 35.-36. Rear bumpers

(55)

1.1



1.2



1.3



1.4



1.5

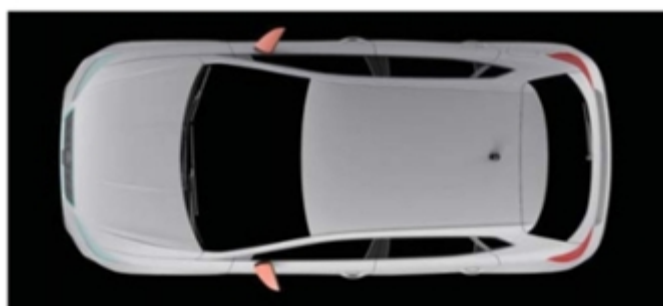

1.6



2.1



1.7



2.2



2.3



2.4



2.5



2.6



2.7

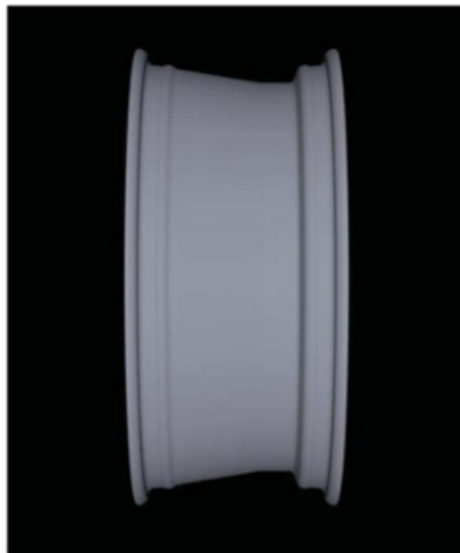

3.1



3.2



3.3

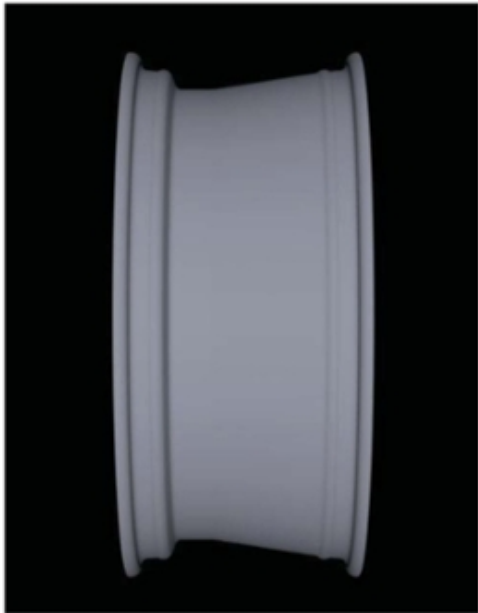

3.4



3.5



3.6



3.7



4.1



4.2

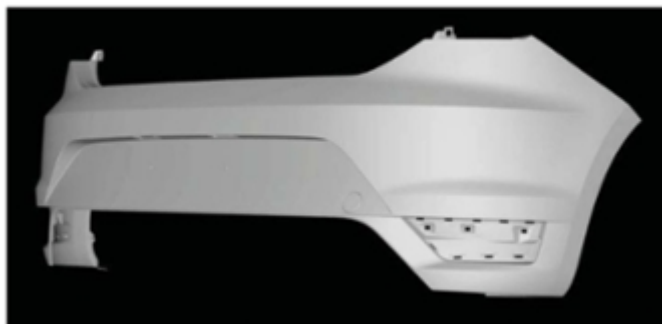

4.3

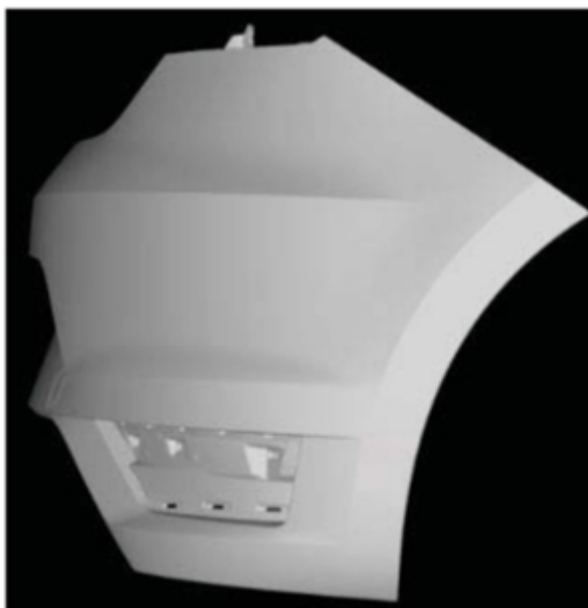

4.4

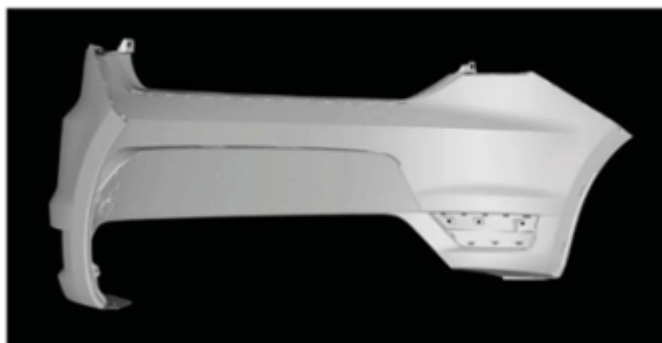

4.5



4.6

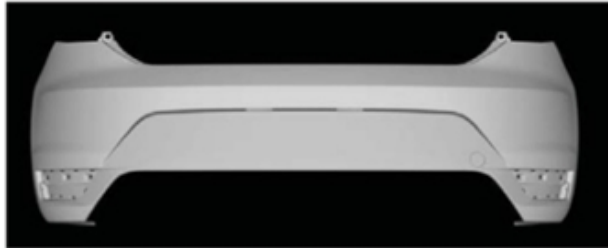

4.7

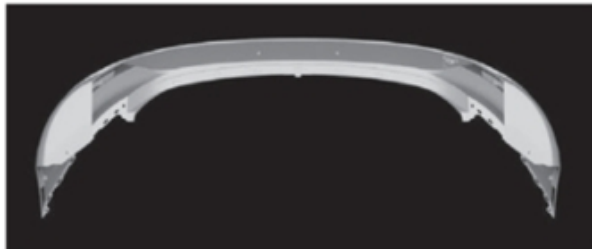

5.1



5.2



5.3

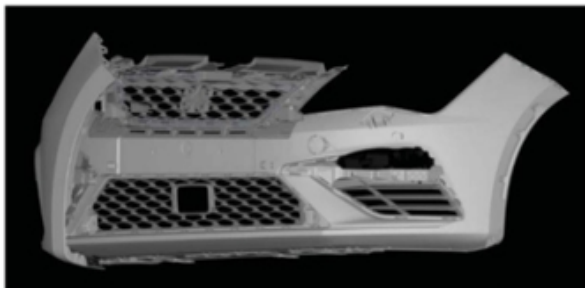

5.4

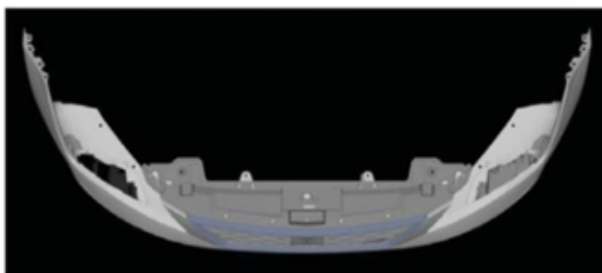

5.5

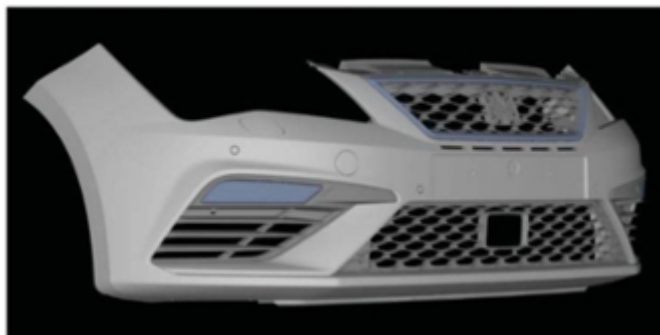

5.6



5.7



6.1

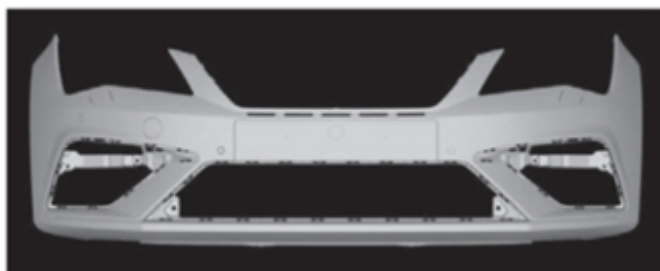

6.2

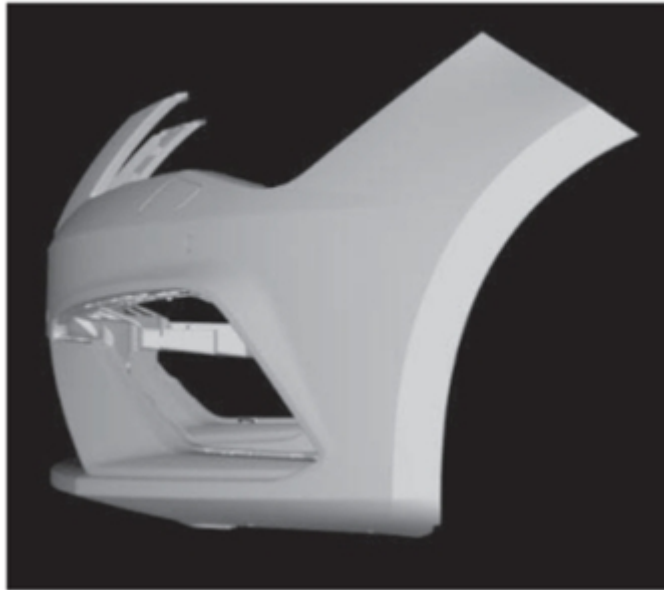

6.3

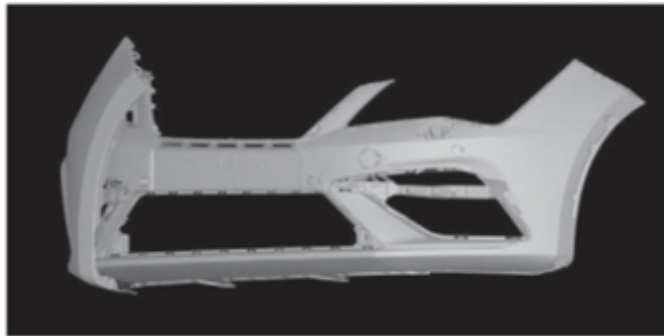

6.4

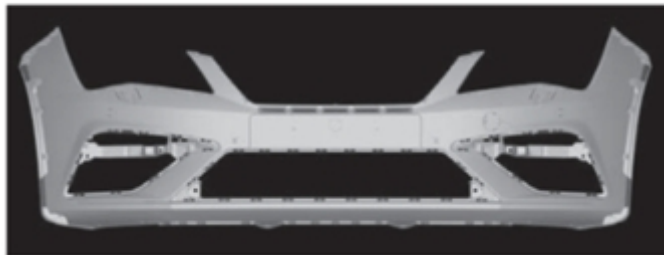

6.5



6.6

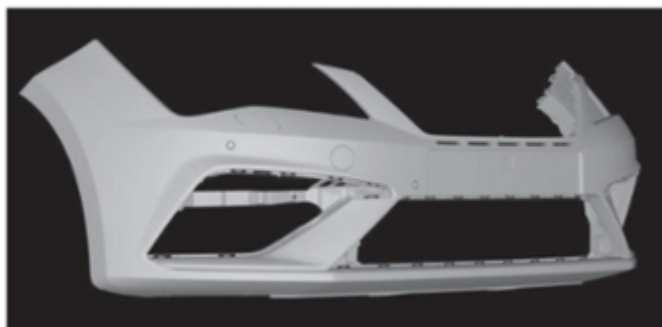

6.7



7.1



7.3



7.2

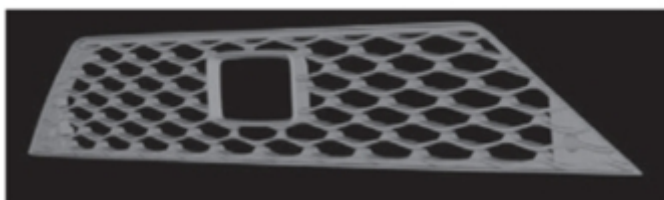

7.4



7.5

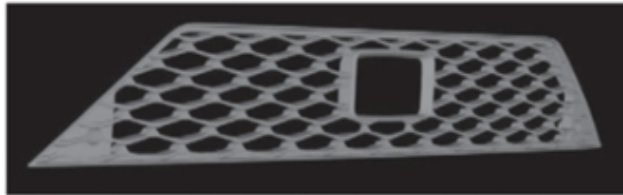

7.6



7.7



8.1



8.2

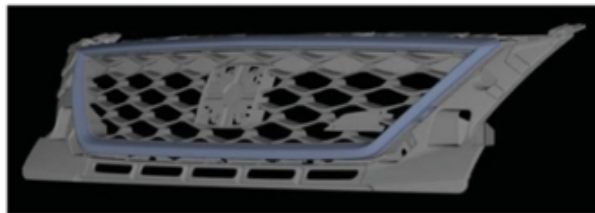

8.3

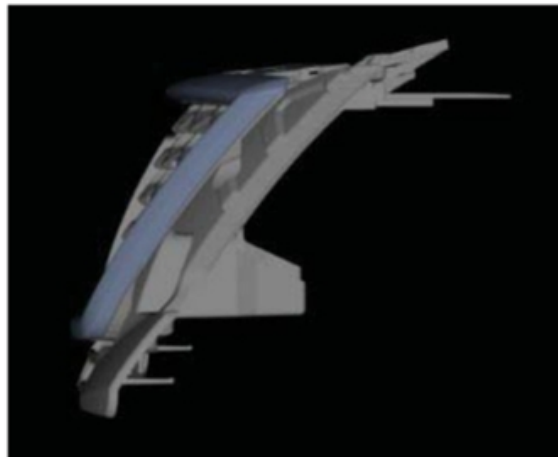

8.4

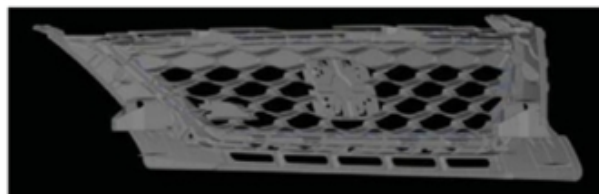

8.5

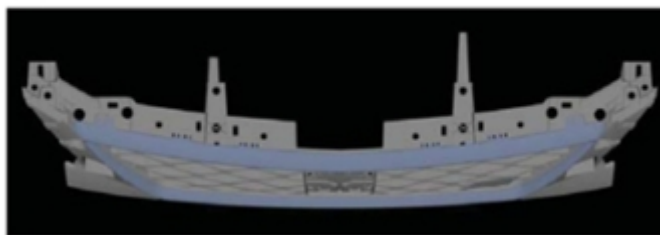

8.6



8.7



9.1



9.3



9.2



9.4

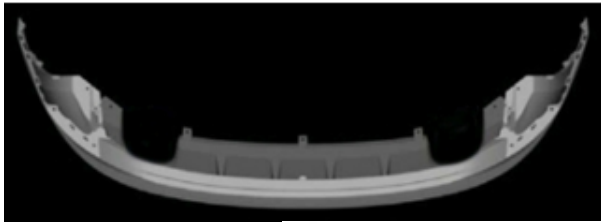

9.5

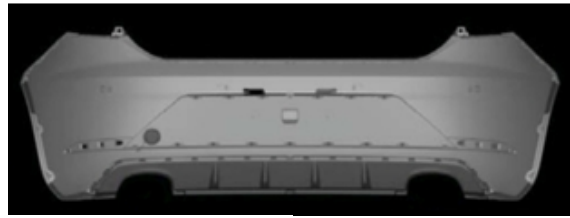

9.6



9.7

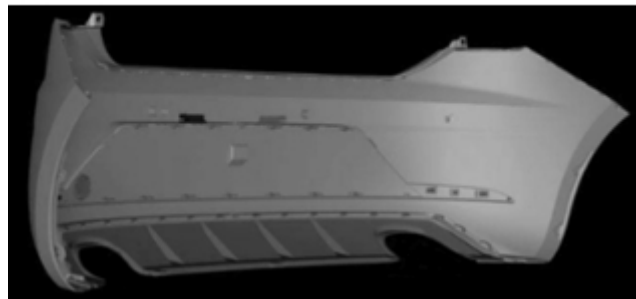

10.1

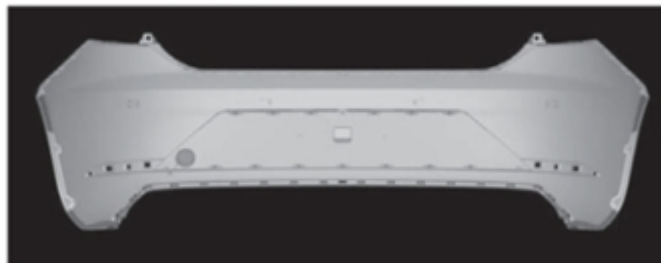

10.2

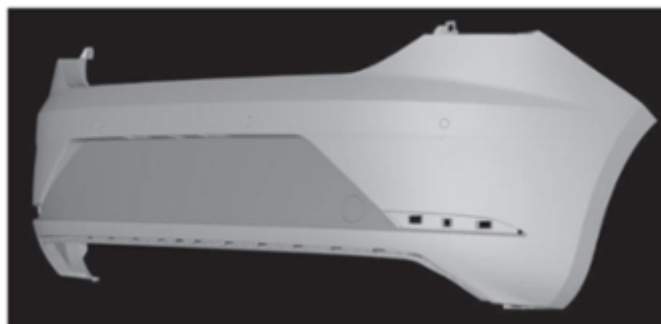

10.3



10.4

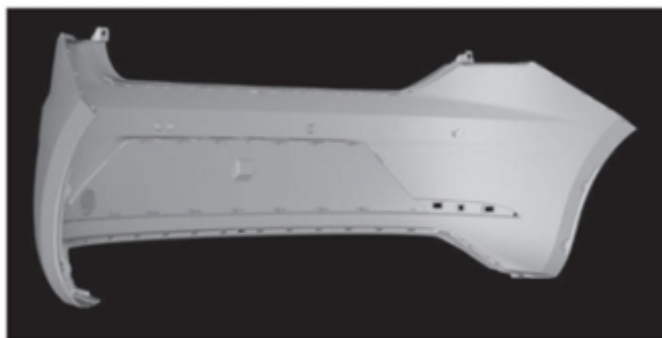

10.5



10.6

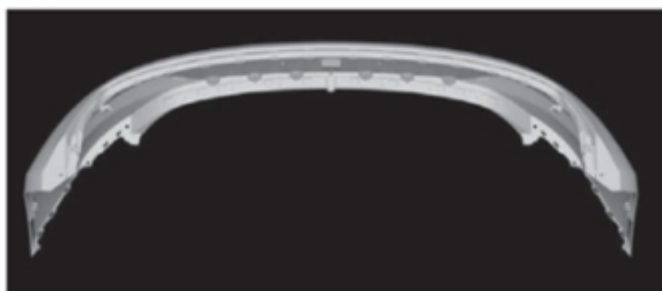

10.7



11.1



11.2



11.3

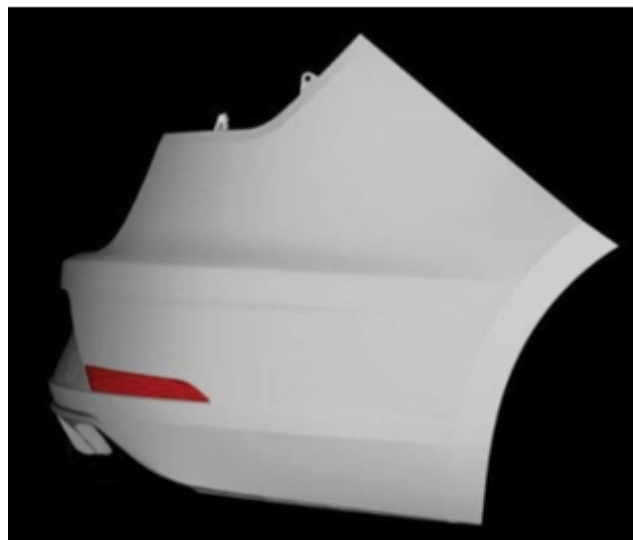

11.4

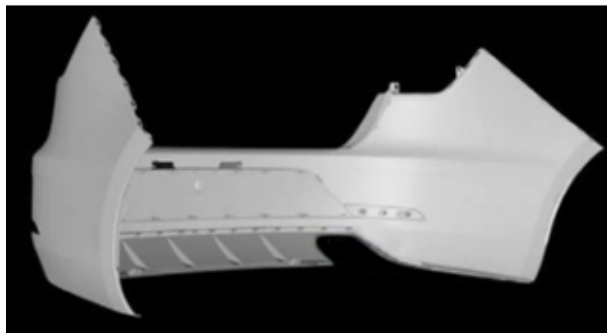

11.5



11.6



11.7



12.1



12.2

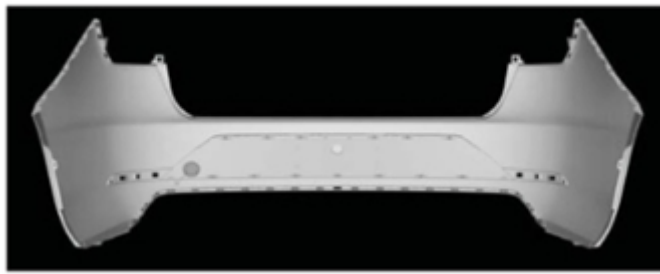

12.3

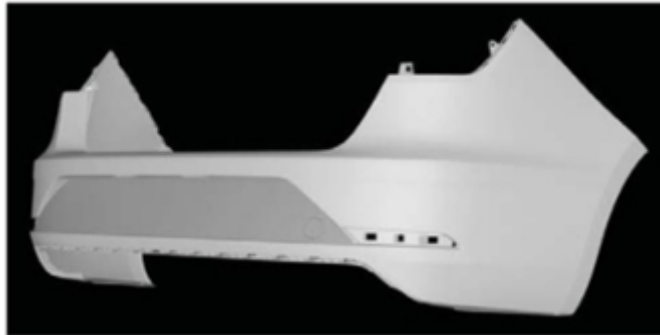

12.4

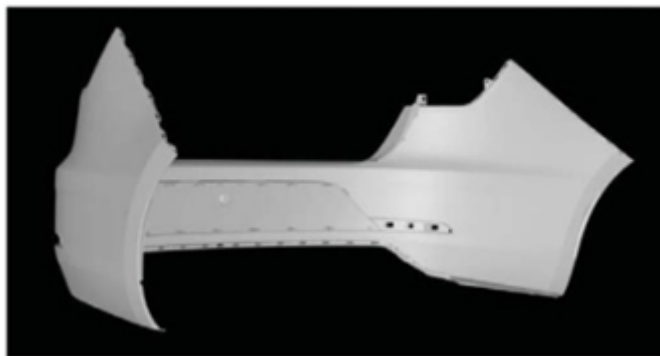

12.5

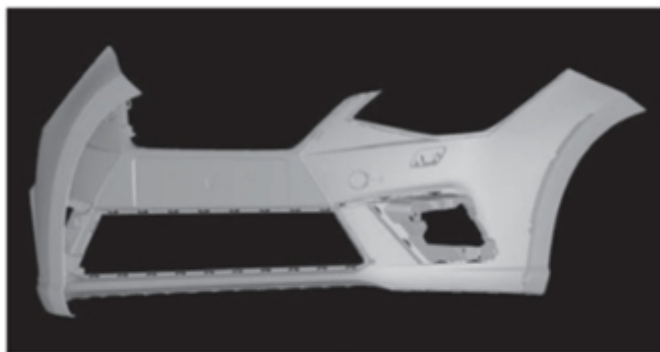

12.6



12.7



13.1



13.3

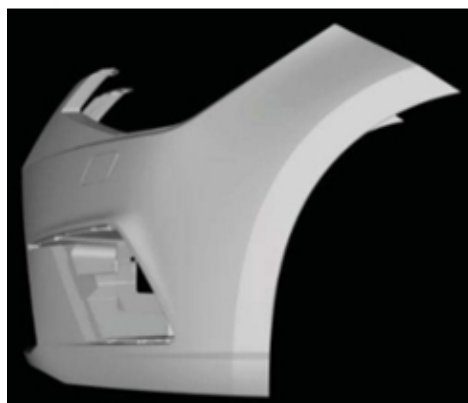

13.2

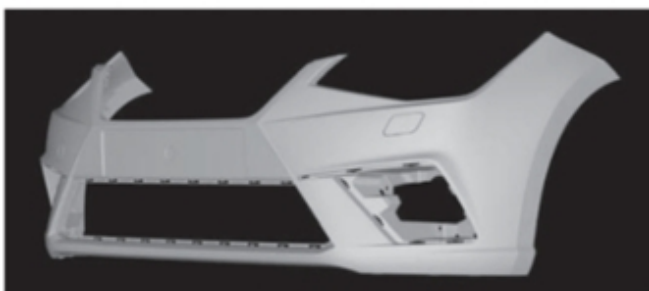

13.4



13.5

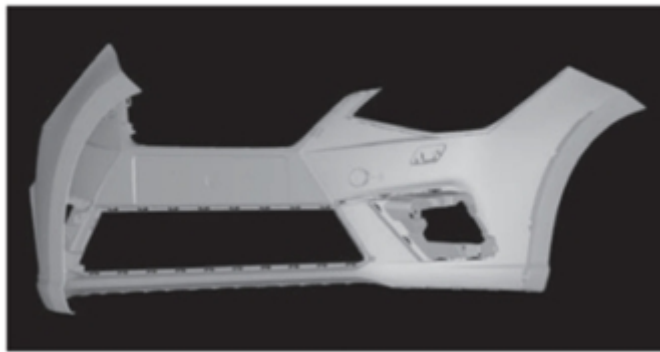

13.6



13.7

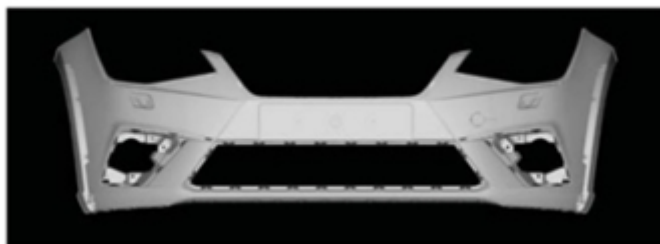

14.1

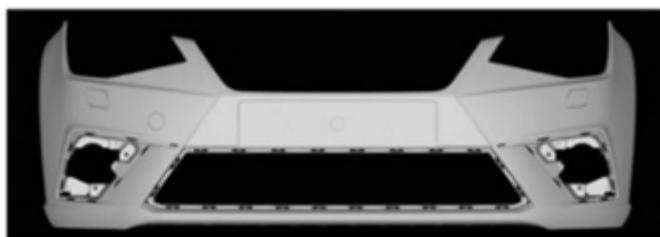

14.2

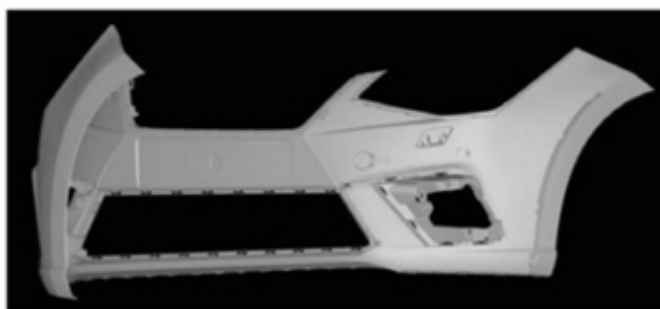

14.3

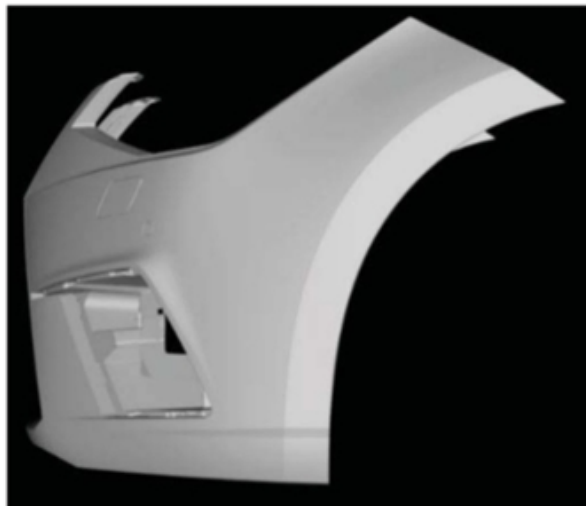

14.4



14.5



14.6

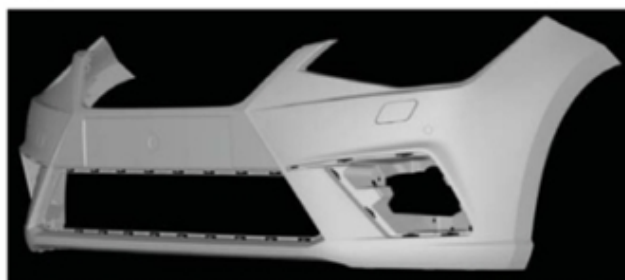

14.7



15.1

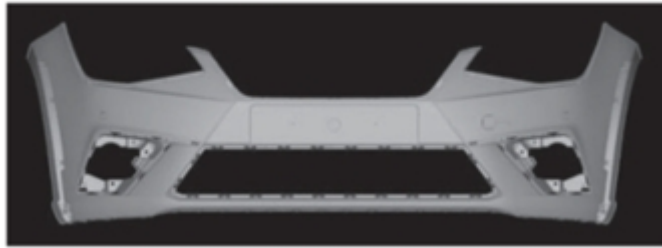

15.2

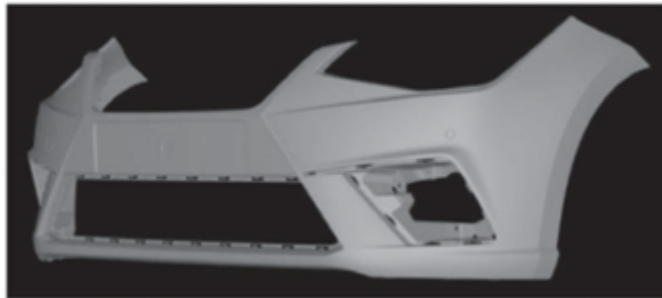

15.3

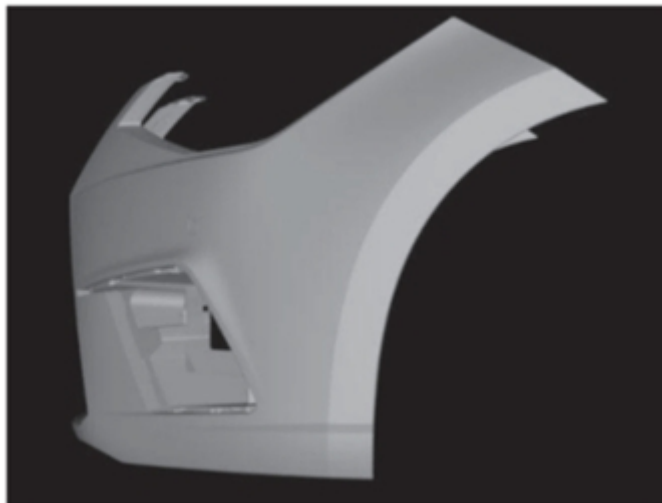

15.4



15.5

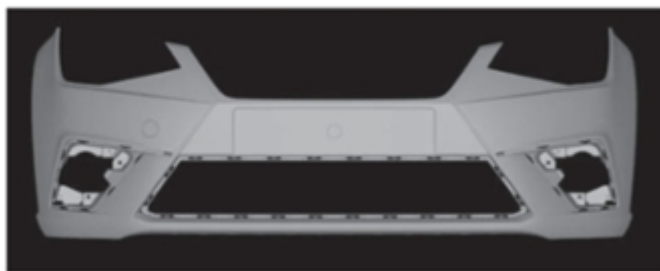

15.6

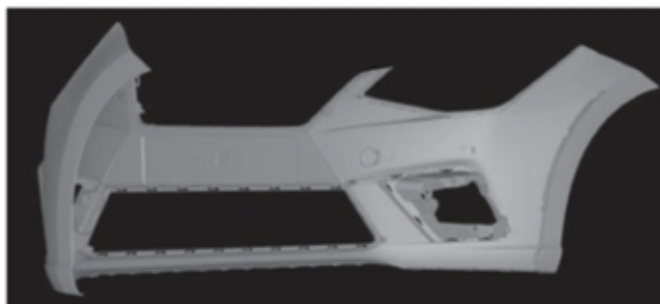

15.7



16.1



16.2

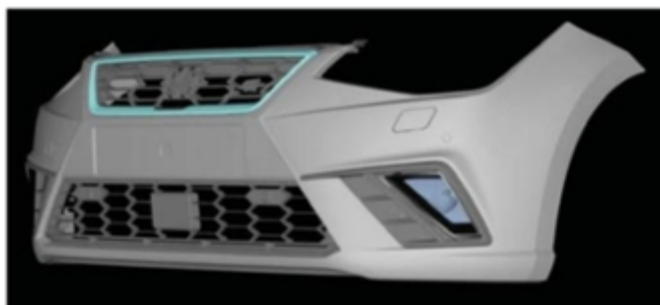

16.3

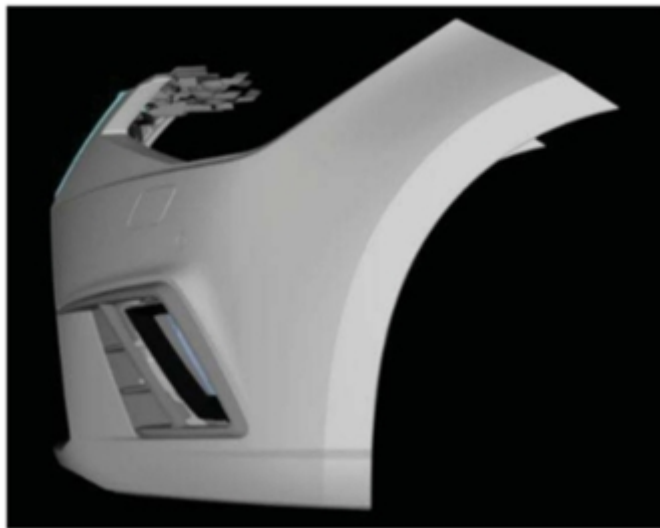

16.4

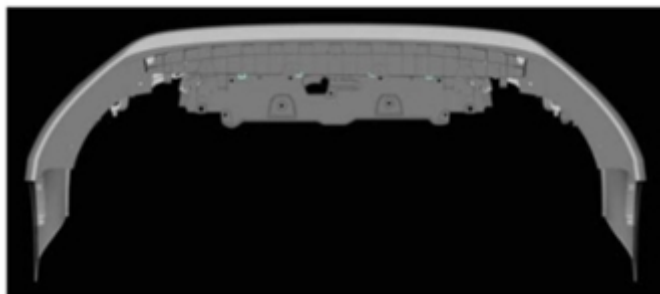

16.5



16.6

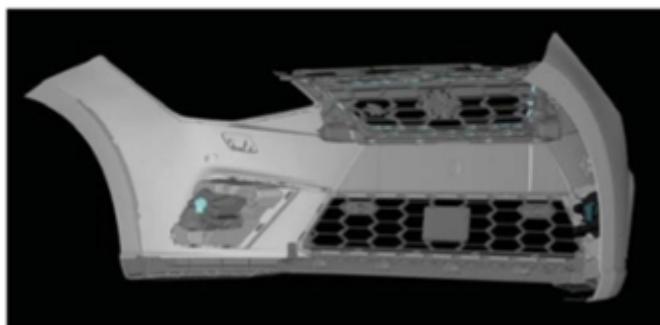

16.7



17.1



17.2

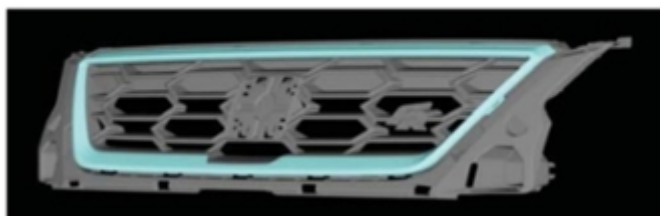

17.3

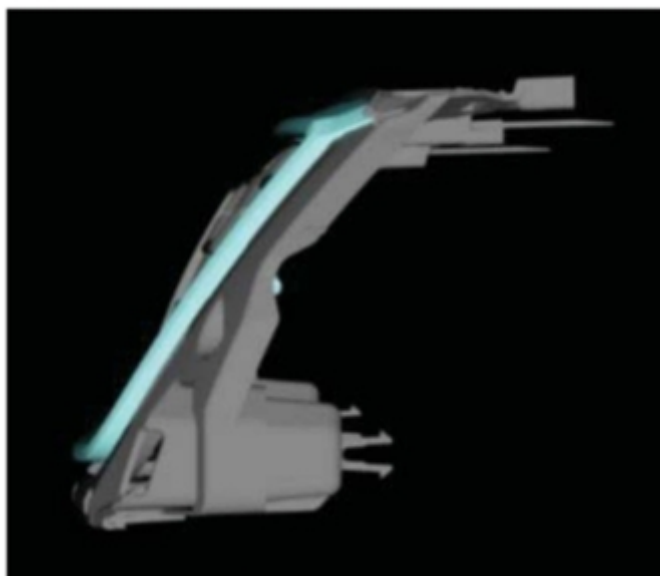

17.4

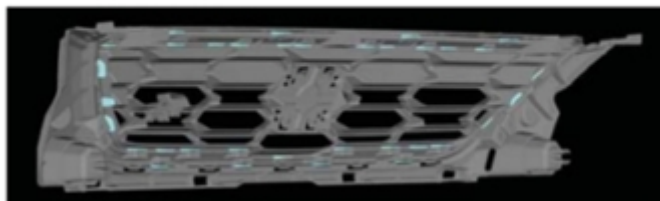

17.5

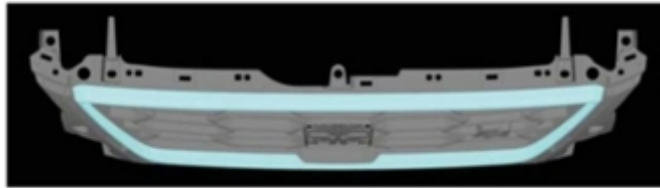

17.6

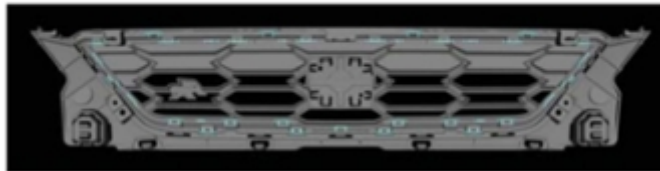

17.7



18.1



18.2



18.3

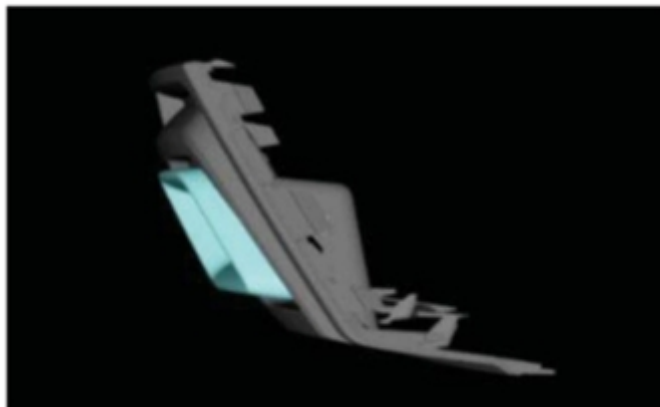

18.4



18.5



18.6



18.7



19.1



19.2

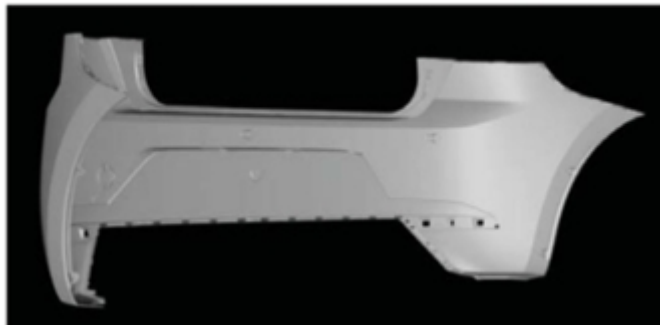

19.3

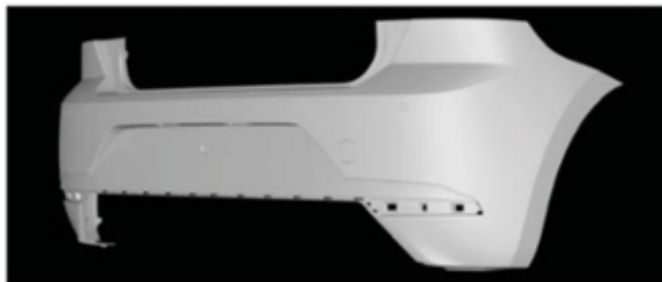

19.4



19.5



19.6



20.1



20.2



20.3



20.4



20.5



20.6



20.7

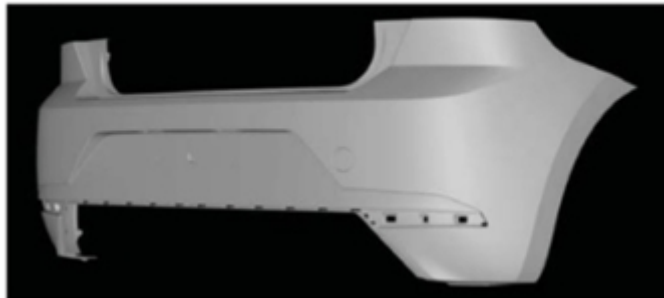

21.1

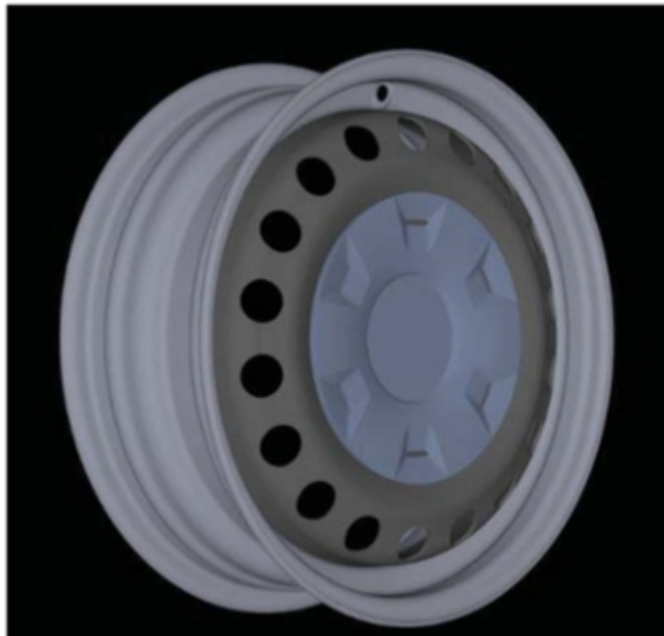

21.2



21.3



21.4



21.5



21.6



21.7

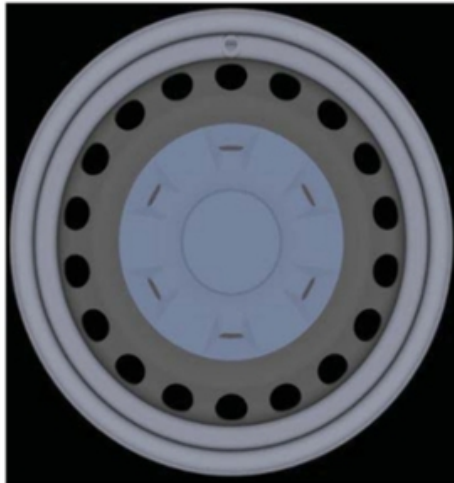

22.1



22.2



22.3



22.4



22.5

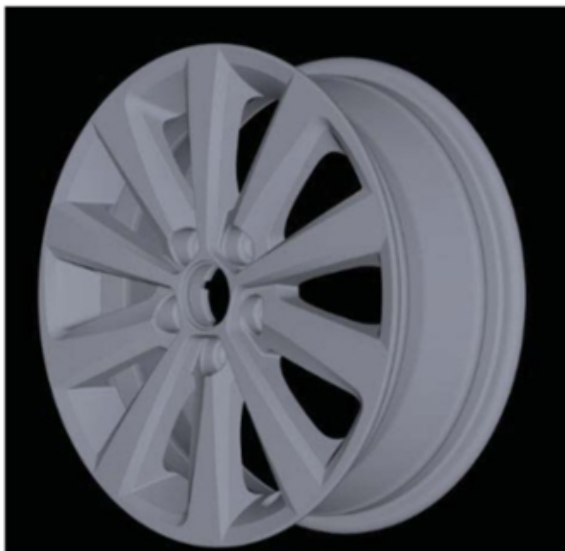

22.6



22.7



23.1



23.2



23.3

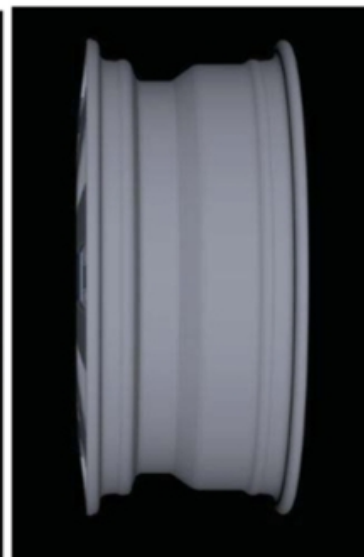

23.4



23.5



23.6

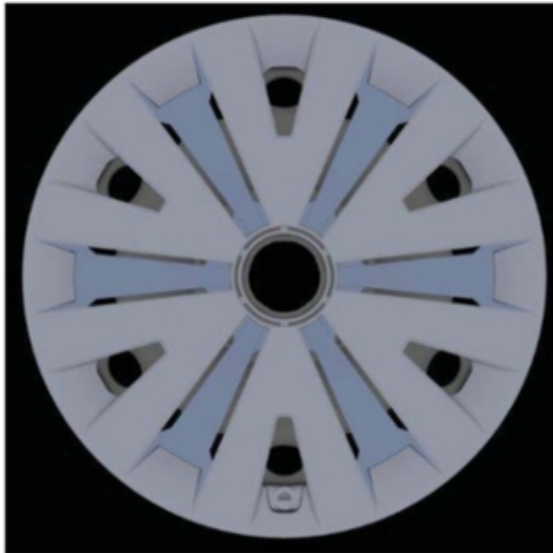

23.7



24.1



24.2



24.3



24.4



24.5

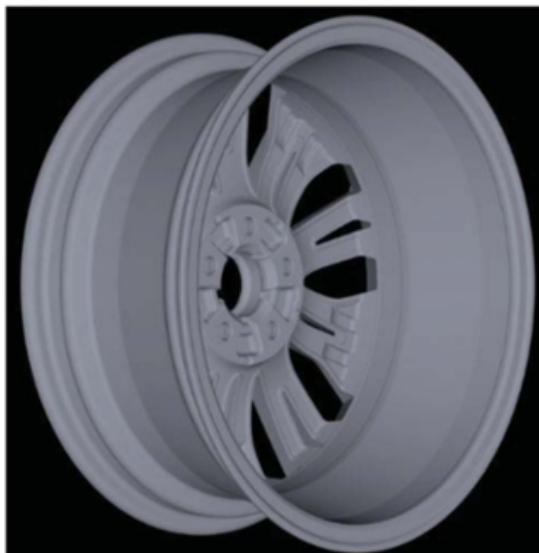

24.6



24.7



25.1



25.2

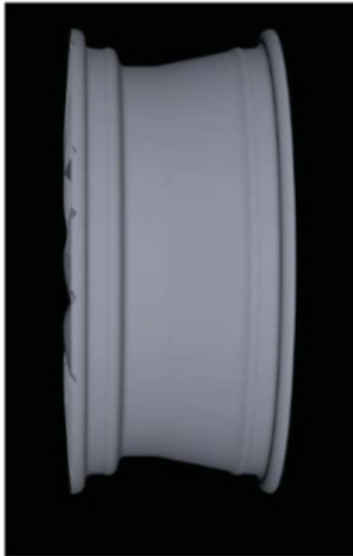

25.3



25.4



25.5



25.6



25.7



26.1



26.2



26.3



26.4



26.5



26.6



26.7



27.1



27.2



27.3



27.4



27.5



27.6



27.7



28.1



28.2



28.3



28.4



28.5



28.6



28.7



29.1



29.2



29.3

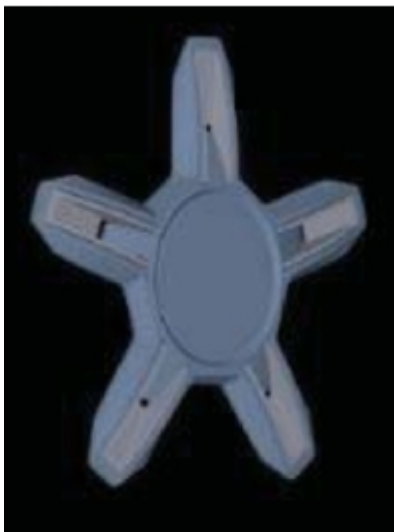

29.4



29.5

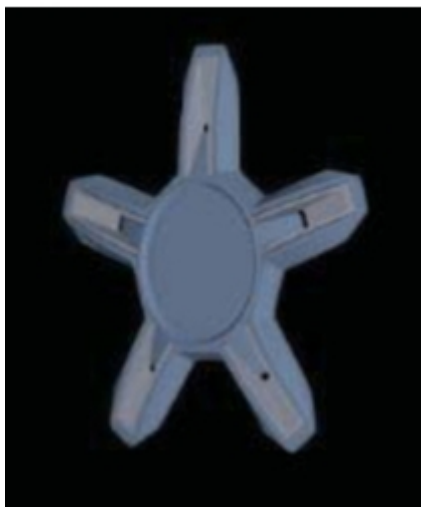

29.6

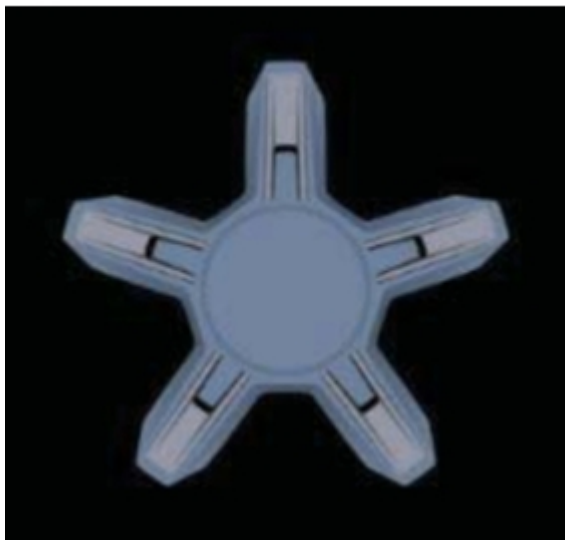

29.7



30.1

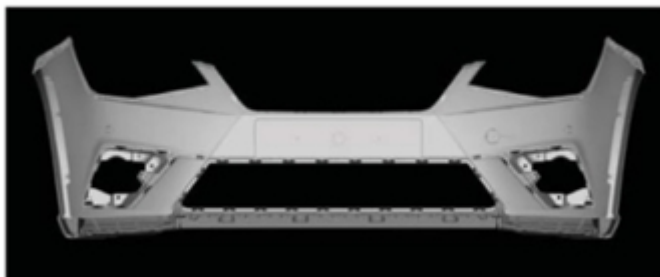

30.2



30.3

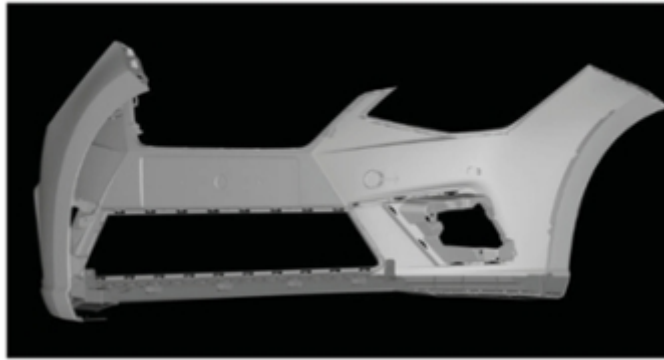

30.4

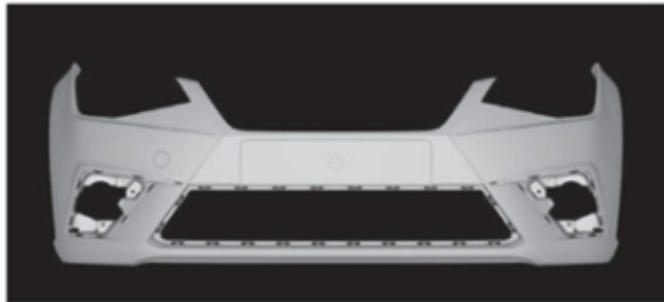

30.5

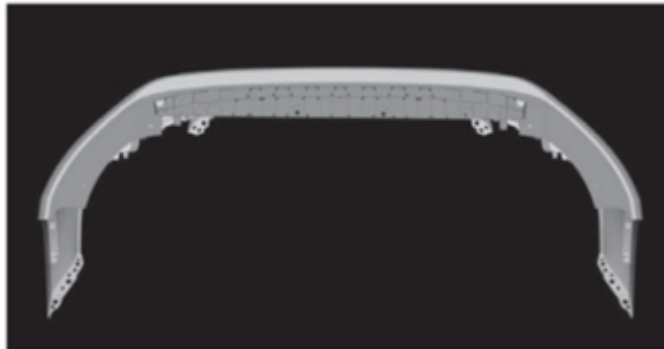

30.6

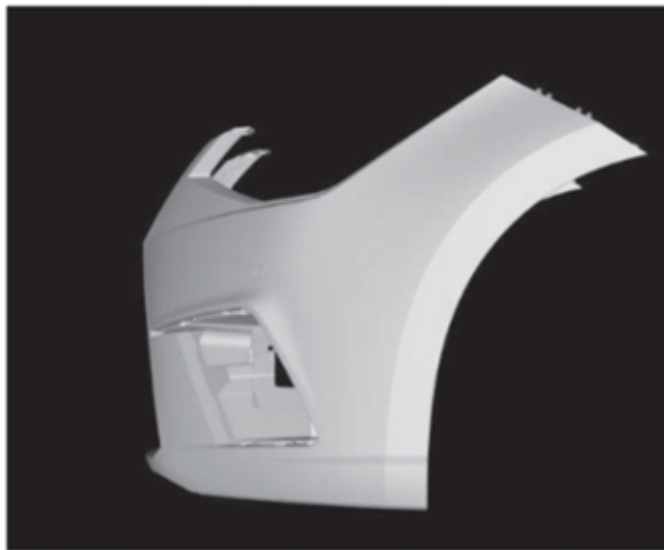

30.7

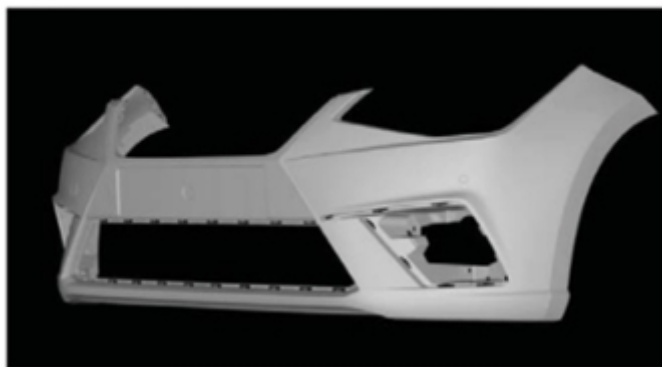

31.1



31.2

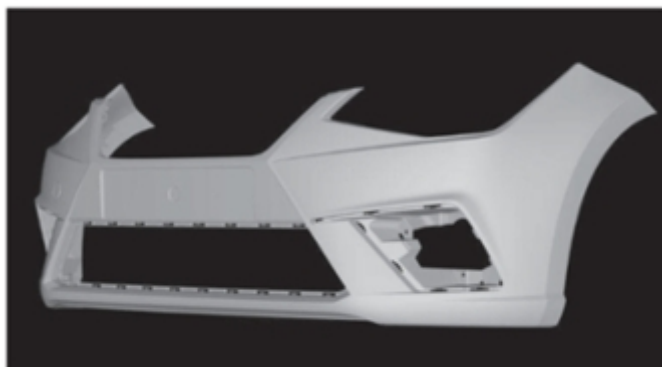

31.3

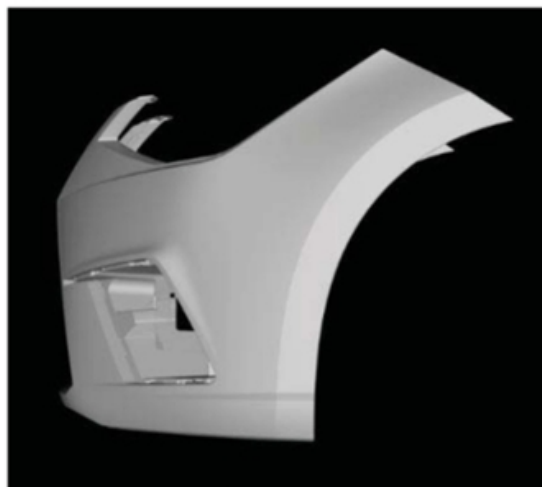

31.4



31.5

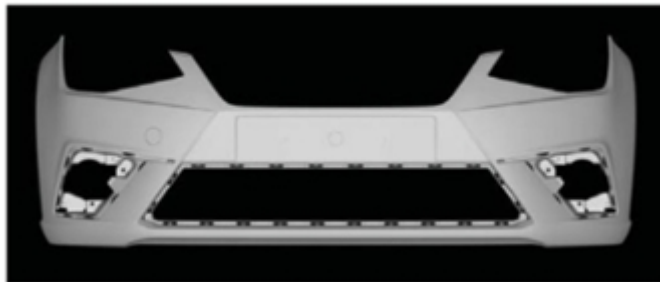

31.6

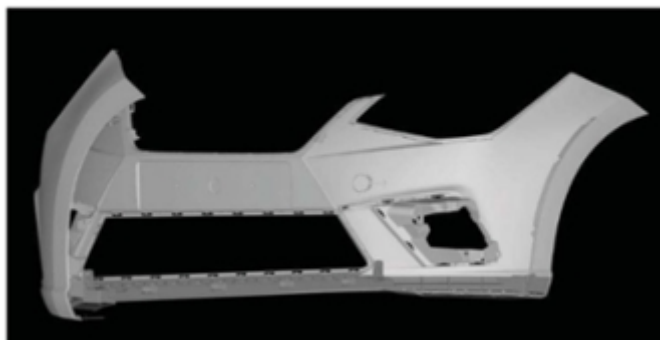

31.7

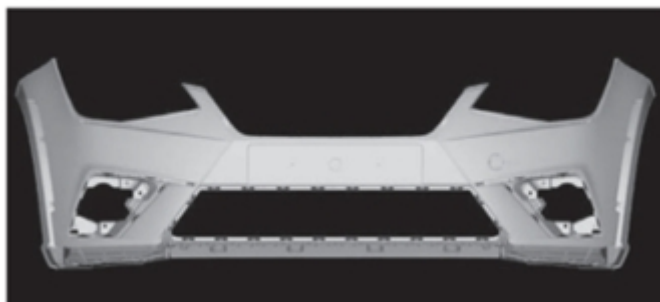

32.1

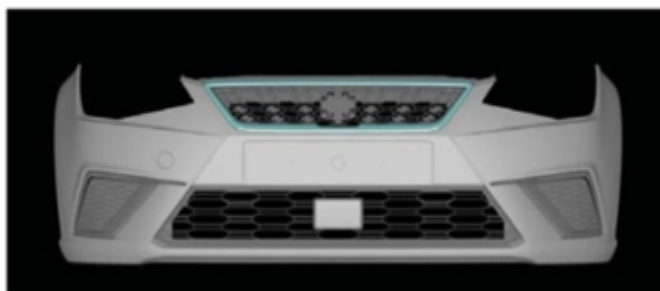

32.2



32.3

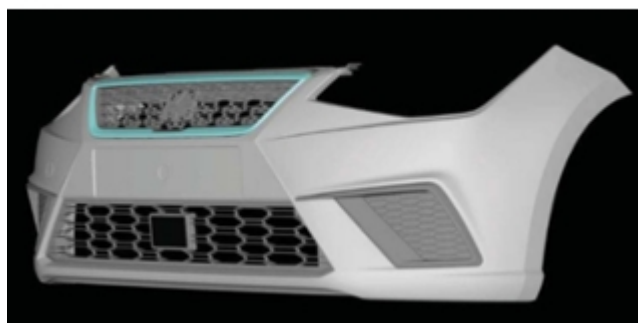

32.4



32.5



32.6

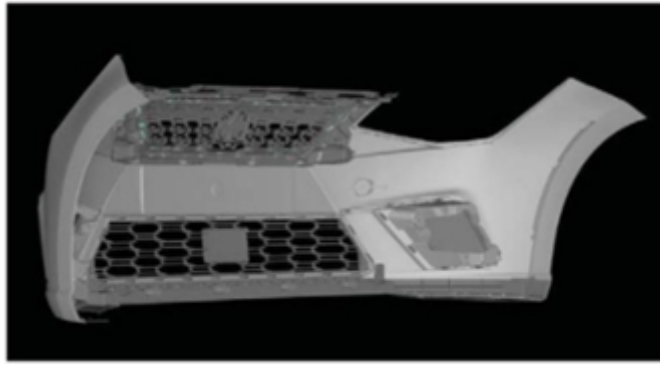

32.7

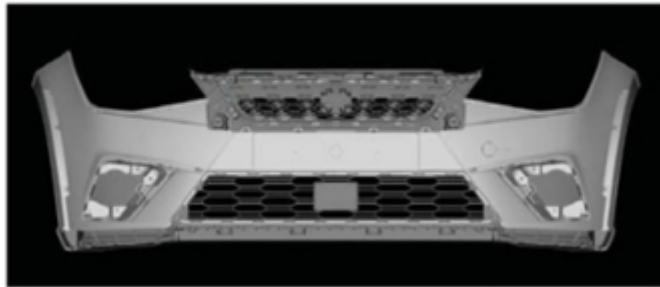

33.1

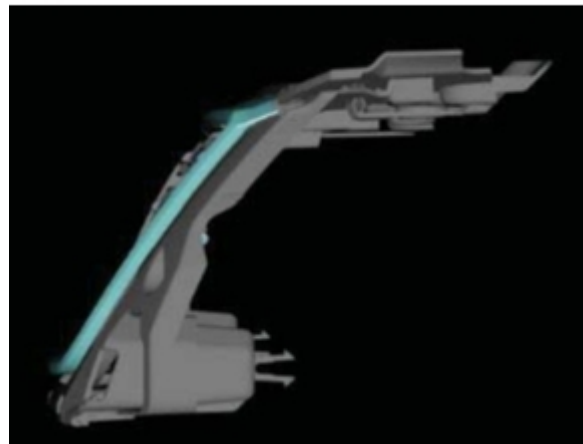

33.2

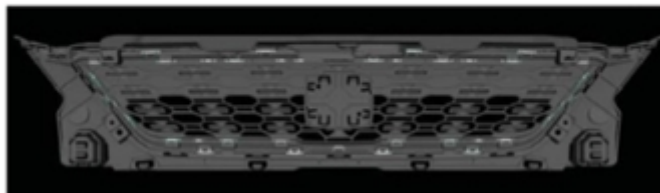

33.3



33.4

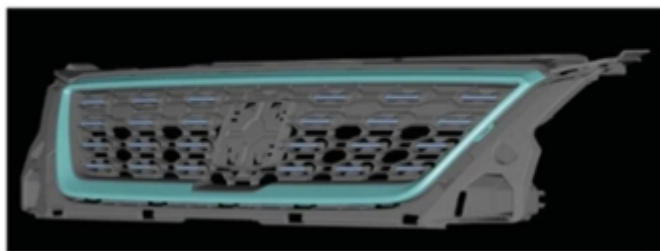

33.5



33.6

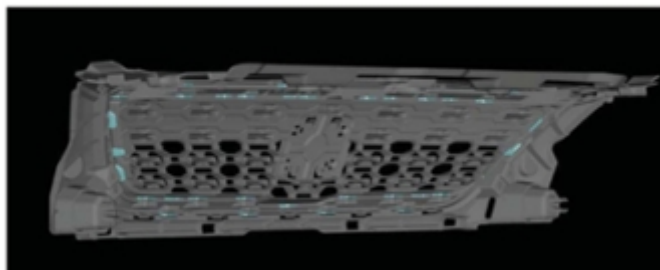

33.7

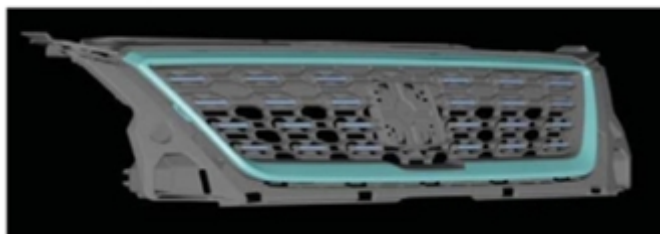

34.1



34.2



34.3

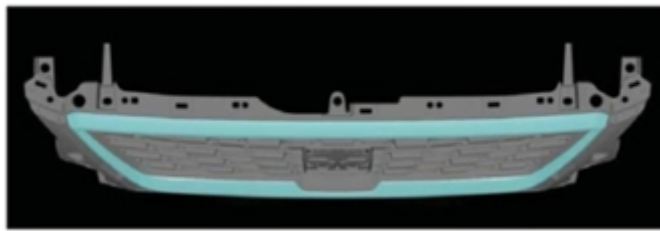

34.4

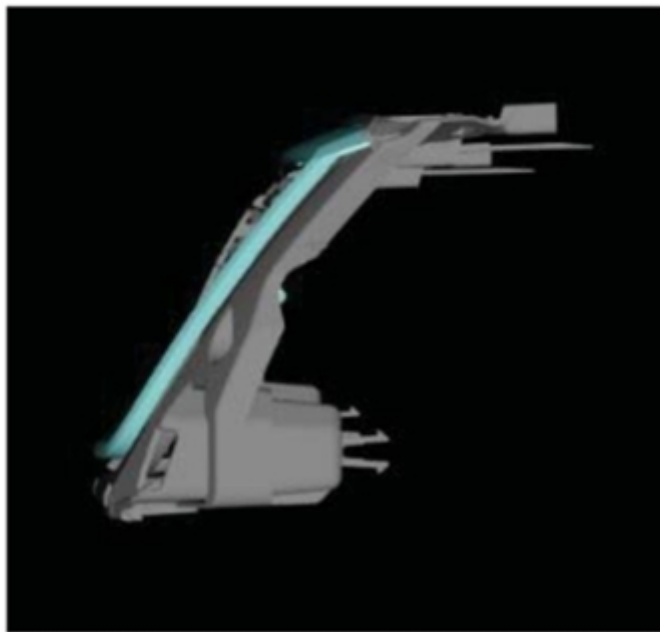

34.5

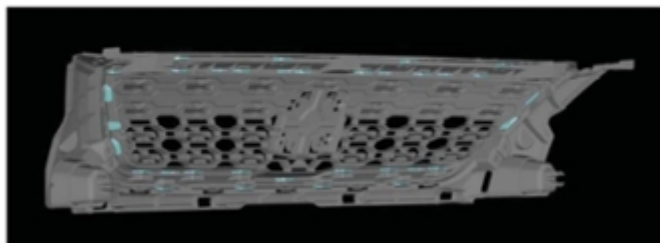

34.6

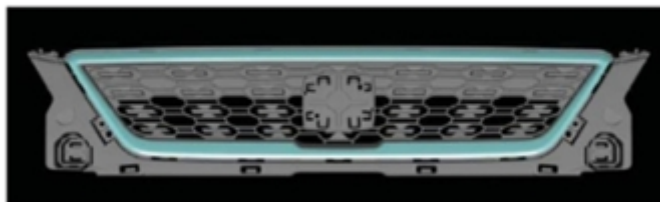

34.7

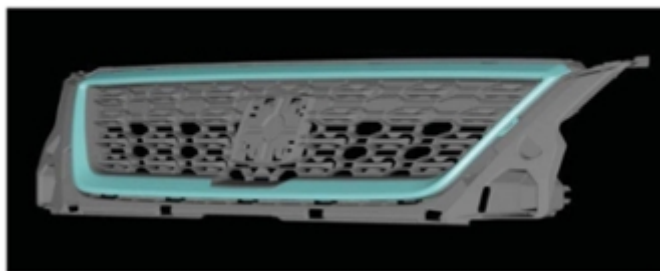

35.1



35.2



35.3



35.4

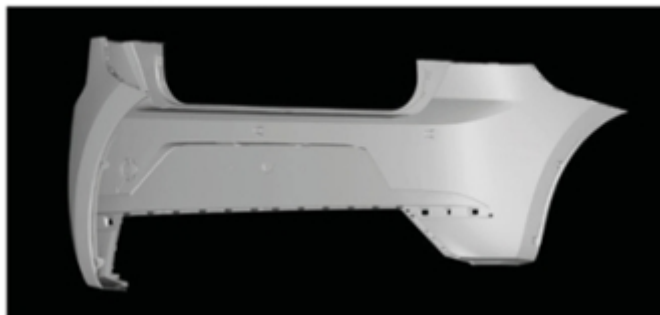

35.5

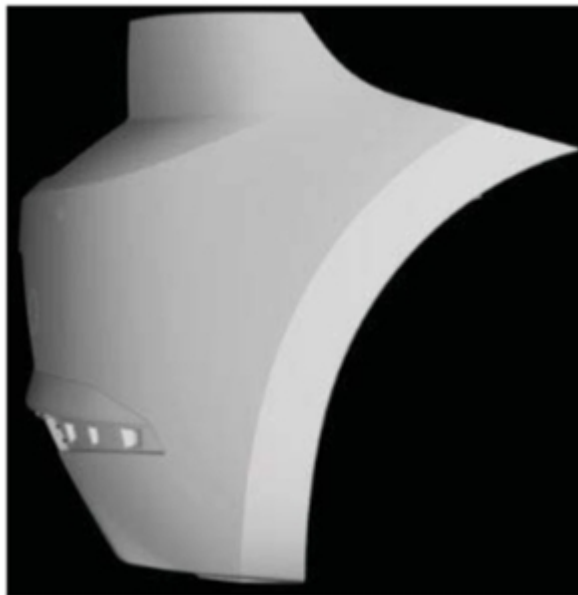

35.6

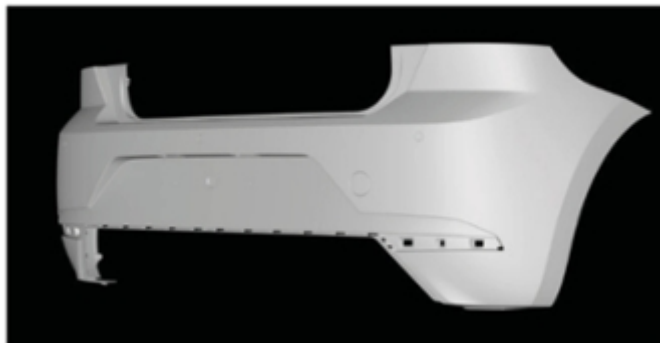

35.7



36.1



36.2

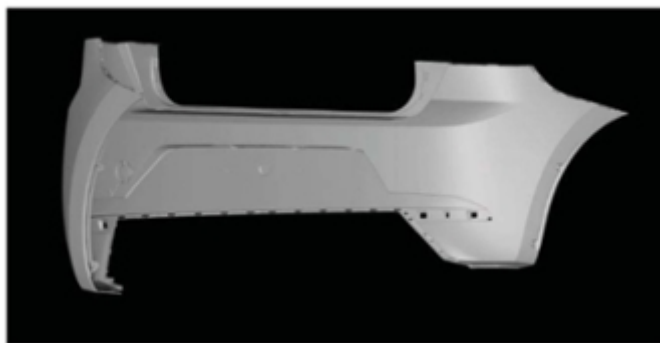

36.3



36.4



36.5



36.6



36.7

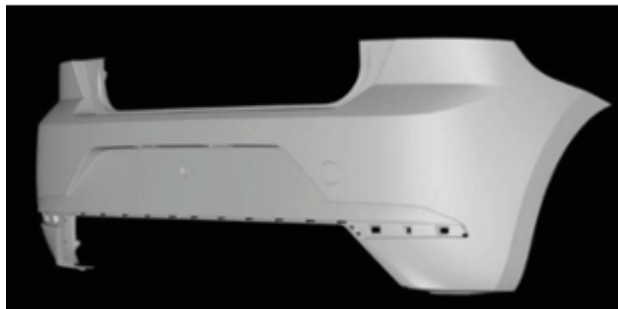

(11) DM/098536

(51) 15-07

(15) 2017 11 16

(45) 2017/47 (2017 12 01)

(22) 2017 11 16

(28) 2

(30) Nos. 1, 2: 17.05.2017; 6012560; GB; Nos. 1, 2: 17.05.2017; 6012561; GB

(73) B MEDICAL SYSTEMS S.À R.L.

17, op der Hei, L-9809 Hosingen (LU)

(85) EM

(86) BX, EM

(87) BX, EM

(88) BX, EM

(89) EM

(81) II. BX, BZ, MA III. AM, BW, CH, EG, EM, GE, GH, KH, NA, OA, RW, TN, TR

(72) Vincent SADLER

17 Op der Hei, 9809 Hosingen, Luxembourg; Eric GROENENDAEL, 17 Op der Hei, 9809 Hosingen,

Luxembourg

(54) 1.-2. Refrigerating apparatus

(55)

1.1

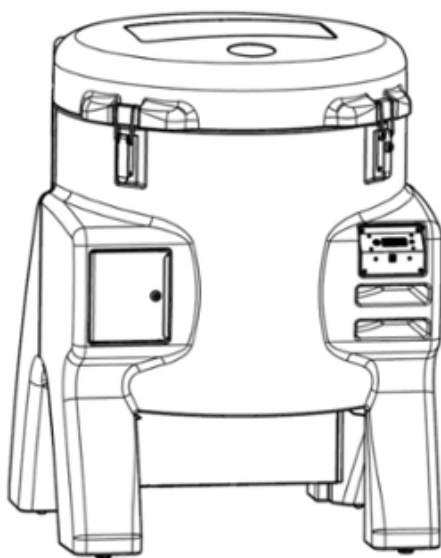

1.2



1.3

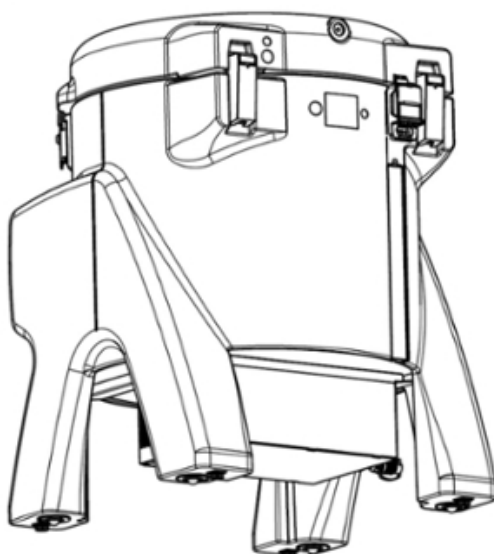

2.1



2.2



2.3

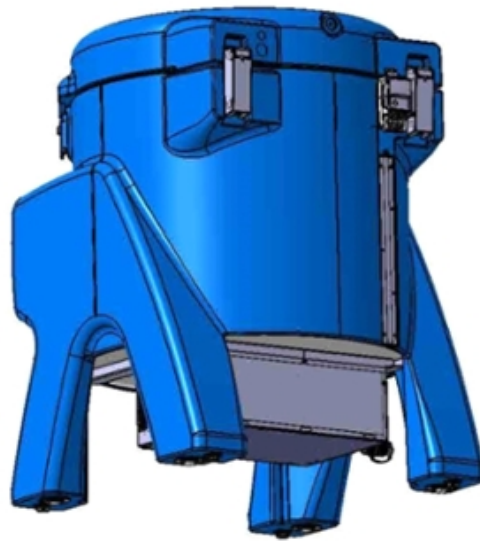

TRADEMARKS

APPLICATIONS FILED UNDER THE NATIONAL PROCEDURE APPROVED FOR REGISTRATION

The decision can be appealed at the Chamber of Appeal of Sakpatenti within 3 months from the publication or at the Mtskheta District Court Administrative Cases Board (Address: №17, Samkhedro St., Mtskheta), within 1 month following the publication.

(210) AM 2018 90306 A
(220) 2017 01 06
(731) LTD "LABORATORY KOLKHIKA"
Sanapiros q. 10, 0105, Tbilisi, Georgia
(740) Salome Jeladze
(540)



(591) Black
(531) 03.04.01; 03.04.24
(511) 5

(260) AM 2018 91088 A
(210) AM 91088
(220) 2017 03 01
(731) LTD "ASPHARMA GEORGIA
PHARMACEUTICAL COMPANY"
Mckhetis q. 8, 0179, Tbilisi, Georgia
(740) Maia Samadashvili
(540)

GYNO-ZOLIN
ГИНО-ЗОЛИН
გინო-ზოლინო

(511) 5

(260) AM 2018 91518 A
(210) AM 91518
(220) 2017 03 29
(731) THE PROCTER & GAMBLE COMPANY
One Procter & Gamble Plaza, Cincinnati,
Ohio 45202, United States of America
(740) Merab Kvimsadze
(540)

PAMPERS SPLASHERS

(591) Black, white
(531) 27.05.01
(511) 5

(260) AM 2018 91524 A
(210) AM 91524
(220) 2017 03 30
(731) FADER ALLIANCE LTD VAT
59-A LONGLEY ROAD, LONDON,
ENGLAND, SW 17 9LA, United Kingdom
(740) Irma Kartoza
(540)

ფობოსი

(511) 1, 44

(260) AM 2018 91525 A
(210) AM 91525
(220) 2017 03 30
(731) FADER ALLIANCE LTD VAT
59-A LONGLEY ROAD, LONDON,
ENGLAND, SW 17 9LA, United Kingdom
(740) Irma Kartoza
(540)

სამბა

(511) 1, 44

(260) AM 2018 91740 A
(210) AM 91740
(220) 2017 04 19
(731) GULF INTERNATIONAL LUBRICANTS,
LTD. (a Bermuda corporation)
Qenon's Qourt, 22 Vigtoria Striti, Hamiltoni,
HM12, Bermuda
(740) Shalva Gvaramadze
(540)

AirGulf

(511) 39

(260) AM 2018 91763 A
(210) AM 91763
(220) 2017 04 19

(731) ETİ GIDA SANAYİ VE TİCARET ANONİM ŞİRKETİ
ORGANİZE SANAYİ BÖLGESİ 11. CADDE
ESKİŞEHİR, Turkey
(740) Merab Kvimsadze
(540)



(591) Red, white, black, dark brown, beige, yellowish-grey
(531) 05.11.19; 07.03.02; 08.01.15; 27.05.23; 27.05.24; 29.01.15
(511) 30

(260) AM 2018 91865 A
(210) AM 91865
(220) 2017 04 27
(731) JSC "TIERRAS DE ARMENIA"
1st Blind Alley, M. Khorenatsi Street,
Building 8, Apartment A2, Yerevan, Armenia
(740) Giorgi Meipariani
(540)

GRAN KARAS

(591) Black, white
(511) 33

(260) AM 2018 92047 A
(210) AM 92047
(220) 2017 05 08
(731) LTD "VANILA IVENT"
N. Jvanias g. 10, b. 32, 0179, Tbilisi, Georgia
(740) Tamar Buadze
(540)

ვანილა Vanilla Ванила

(591) Black, white
(511) 43

(260) AM 2018 92106 A
(210) AM 92106
(220) 2017 05 15
(731) Vakhtang Iurievich Kasradze
Ul. Maiakovskogo D. 49 Kv. 19., Omsk,
644010, Russian Federation
(740) Tamar Kochlamazashvili

(540)

JEZVIN

(591) Black, white
(511) 30, 32, 35, 43

(260) AM 2018 92112 A
(210) AM 92112
(220) 2017 05 15
(731) LTD "TEACHING UNIVERSITY
GEOMEDI"
Mepe Solomon II-is q. 4, 0114, Tbilisi,
Georgia
(740) Paata Chikovani
(540)

სანსტრუქტორული უნივერსიტეტი
გეომედი



Teaching University
Geomedi LLC

(531) 02.01.23; 26.01.14; 26.11.12; 27.05.01; 28.19;
29.01.12
(511) 41

(260) AM 2018 92128 A
(210) AM 92128
(220) 2017 05 16
(731) LTD "MINING COMPANY PARAVAN-
PERLITE"
Vazha-Pshavelas gamz., VII kvart., korp. 8,
b. 54, 0186, Tbilisi, Georgia
(740) Giorgi Taktakishvili
(540)



(591) White, green, beige, black
(531) 06.01.04; 26.15.01; 27.05.10; 27.05.17;
29.01.13
(511) 1, 17, 19

(260) AM 2018 92184 A
(210) AM 92184
(220) 2017 05 17
(731) JSC "M2 REAL ESTATE"
I. Chavchavadzis gamz. 29, Sart. 3, Tbilisi,
Georgia
(740) Nikoloz Jalaghania
(540)

m2 უძრავი ქონება

(511) 36, 37

(260) AM 2018 92193 A
 (210) AM 92193
 (220) 2017 07 27
 (731) LTD "IBERCOMPANY"
 Al. Kazbegis gamz. 12a, 0160, Tbilisi,
 Georgia
 (740) Tamar Tchavtchanidze
 (540)



(591) Green and blue
 (531) 26.03.01; 26.11.09; 28.19; 29.01.13
 (511) 35, 37

(260) AM 2018 92194 A
 (210) AM 92194
 (220) 2017 07 27
 (731) LTD "IBERCOMPANY"
 Al. Kazbegis gamz. 12a, 0160, Tbilisi,
 Georgia
 (740) Tamar Tchavtchanidze
 (540)



(591) Green and blue
 (531) 26.03.01; 26.11.09; 27.05.01; 29.01.12
 (511) 35, 37

(260) AM 2018 92344 A
 (210) AM 92344
 (220) 2017 05 24
 (731) MCDONALD'S INTERNATIONAL
 PROPERTY COMPANY, LTD.
 251 Little Falls Drive, Wilmington, Delaware
 19808, USA
 (740) Shalva Gvaramadze

(540)



(591) Black, white
 (531) 26.01.06; 26.01.18; 27.05.21
 (511) 39, 43

(260) AM 2018 92354 A
 (210) AM 92354
 (220) 2017 05 24
 (731) LTD "GMP"
 Sop. Ponitchala 65, 0165, Tbilisi, Georgia
 (740) Nugzar Ksovreli
 (540)

ფოსფა-ჯო
 ΦΟΣΦΑ-Γ
 FOSFA-G

(511) 5

(260) AM 2018 92361 A
 (210) AM 92361
 (220) 2017 05 25
 (731) LTD "ASPHARMA GEORGIA
 PHARMACEUTICAL COMPANY"
 Mtckhetis q. 8, 0179, Tbilisi, Georgia
 (740) Maia Samadashvili
 (540)

FUBITER
 ФУБИТЕР
 ფუბიტერი

(511) 5

(260) AM 2018 92382 A
 (210) AM 92382
 (220) 2017 05 25
 (731) NPFA LLP Representative Office in Georgia
 Besiki st. 4 (plot 46/10), 0108, Tbilisi,
 Georgia
 (740) Keso Antelidze

(540)

ნო სპლიტი
Но сплит
No split

(511) 5

(260) AM 2018 92384 A
 (210) AM 92384
 (220) 2017 05 25
 (731) NPHA LLP Representative Office in Georgia
 Besiki st. 4 (plot 46/10), 0108, Tbilisi,
 Georgia
 (740) Keso Antelidze
 (540)

ბორაციდი
Борацид
Boracid

(511) 5

(260) AM 2018 92440 A
 (210) AM 92440
 (220) 2017 05 30
 (731) LTD "BMC GORGIA"
 Sokhumis q. 10, Batumi, Georgia
 (740) Giorgi Taktakishvili
 (540)



(591) White, turquoise
 (531) 12.03.03; 28.19; 29.01.12
 (511) 35, 39

(260) AM 2018 92441 A
 (210) AM 92441
 (220) 2017 05 30
 (731) LTD "BMC GORGIA"
 Sokhumis q. 10, Batumi, Georgia
 (740) Giorgi Taktakishvili
 (540)



(591) White, turquoise
 (531) 12.03.03; 12.03.04; 27.05.01; 29.01.12
 (511) 35, 39

(260) AM 2018 92456 A
 (210) AM 92456
 (220) 2017 05 30
 (731) SOCIÉTÉ DES PRODUITS NESTLÉ S.A.
 1800 Vevey, Switzerland
 (740) Tamaz Shilakadze
 (540)



(554) Three-dimensional
 (591) Golden, transparent color
 (531) 19.07.02; 19.07.12; 29.01.12
 (511) 30

(260) AM 2018 92550 A
 (210) AM 92550
 (220) 2017 06 06
 (731) LTD "GLOBALPHARMI"
 Almasianis q. 13a/ Berbutis q. 8, 0171, Tbilisi,
 Georgia
 (740) Giorgi Taktakishvili
 (540)

სომინი
СОМИН
SOMINI

(591) Black, white
 (511) 35, 43

(260) AM 2018 92559 A
 (210) AM 92559
 (220) 2017 06 06
 (731) LTD "Dogning City Tianchi Trade CO."
 Dongning-Chzen, Czinlao-Uaninan, Dongning
 Town, 157200, China
 (740) Megi Diasamidze
 (540)

MEILKENA

(591) Black, white
 (531) 27.05.01
 (511) 32, 33

(260) AM 2018 92561 A
 (210) AM 92561
 (220) 2017 06 06
 (731) LTD "Dogning City Tianchi Trade CO."
 Dongning-Chzen, Czinlao-Uaninan, Dongning
 Town, 157200, China
 (740) Megi Diasamidze
 (540)



CHEZ PAULETTE

(591) Black, white
 (531) 27.05.01; 27.05.19
 (511) 32, 33

(260) AM 2018 92563 A
 (210) AM 92563
 (220) 2017 06 06
 (731) LTD "Dogning City Tianchi Trade CO."
 Dongning-Chzen, Czinlao-Uaninan, Dongning
 Town, 157200, China
 (740) Megi Diasamidze
 (540)



(591) Black, white
 (531) 02.01.01; 02.01.02; 24.01.08
 (511) 32, 33

(260) AM 2018 92581 A
 (210) AM 92581
 (220) 2017 06 06
 (731) LTD "VIVO MEDICAL GROUP"

Lublianas q. 5, Tbilisi, Georgia
 (740) Natia Kakhetelidze
 (540)



(591) Green, black
 (531) 26.03.06; 28.19; 29.01.12
 (511) 44

(260) AM 2018 92583 A
 (210) AM 92583
 (220) 2017 06 06
 (731) LTD "VIVO MEDICAL GROUP"
 Lublianas q. 5, Tbilisi, Georgia
 (740) Natia Kakhetelidze
 (540)



(591) Green, black
 (531) 26.03.01; 26.03.06; 26.03.19; 26.03.24;
 27.05.10; 29.01.12
 (511) 44

(260) AM 2018 92595 A
 (210) AM 92595
 (220) 2017 06 07
 (731) LUTTON ASSOCIATES INC
 With offices at 50 th and Aquilino de la
 Guardia streets, Plaza Banko General, 14 th
 floor, Panama, Republica of Panama
 (740) Ana Murachashvili-Oniani
 (540)

პრიმა ლუქსი

(511) 34

(260) AM 2018 92712 A
 (210) AM 92712
 (220) 2017 06 09

(731) NPHA LLP Representative Office in Georgia
Besiki st. 4 (plot 46/10), 0108, Tbilisi,
Georgia
(740) Keso Antelidze
(540)

მულტი-როიალი
Мульти-рояль
Multi-Royal

(511) 5

(260) AM 2018 92717 A
(210) AM 92717
(220) 2017 06 09
(731) NPHA LLP Representative Office in Georgia
Besiki st. 4 (plot 46/10), 0108, Tbilisi,
Georgia
(740) Keso Antelidze
(540)

ნარივენტი
Наривент
Narivent

(511) 5

(260) AM 2018 92738 A
(210) AM 92738
(220) 2017 06 12
(731) LTD "GLOBALPHARMI"
Almasianis q. 13a/ Berbutis q. 8, 0171, Tbilisi,
Georgia
(740) Giorgi Taktakishvili
(540)

ნომსი
НОМС
NOMS

(591) Black, white
(511) 35, 43

(260) AM 2018 92769 A
(210) AM 92769
(220) 2017 06 13
(731) SOCIÉTÉ DES PRODUITS NESTLÉ S.A.
1800 Vevey, Switzerland
(740) Tamaz Shilakadze
(540)

СЕНСАЦИЯ

(591) Black, white
(511) 31

(260) AM 2018 92782 A
(210) AM 92782
(220) 2017 06 14
(731) CILAG GMBH INTERNATIONAL
Gubelstrasse 34, CH-6300, Zug, Switzerland
(740) Giorgi Taktakishvili
(540)

ГЕКСО БРОНХО

(591) Black, white
(511) 5

(260) AM 2018 92852 A
(210) AM 92852
(220) 2017 06 20
(731) HARRINGTON DEVELOPMENT INC.
Elvira Mendez Street, Vallarino Bldg, 3-rd
Floor, Panama, Republic of Panama
(740) Givi Akopashvili
(540)



(591) Blue, white, red, green, grey
(531) 10.01.05; 19.03.24; 25.01.01; 27.05.24;
29.01.14
(511) 34

(260) AM 2018 92864 A
(210) AM 92864
(220) 2017 06 21
(731) DAVIT GAGUA
Andronikashvilis q. 6, Tbilisi, Georgia
(740) Giorgi Taktakishvili
(540)



(591) White, yellow, green, dark blue
 (531) 02.07.09; 02.07.23; 28.19; 29.01.13
 (511) 44

(260) AM 2018 92958 A
 (210) AM 92958
 (220) 2017 06 23
 (731) PARIJAT INDUSTRIES (INDIA) PRIVATE LIMITED
 M-77, M-Block Market, 1st & 2nd Floor,
 Greater Kailash-II, New Delhi 110048, India
 (740) Pavle Meipariani
 (540)

Indazole

(591) Black, white
 (511) 5

(260) AM 2018 92959 A
 (210) AM 92959
 (220) 2017 06 23
 (731) PARIJAT INDUSTRIES (INDIA) PRIVATE LIMITED
 M-77, M-Block Market, 1st & 2nd Floor,
 Greater Kailash-II, New Delhi 110048, India
 (740) Pavle Meipariani
 (540)

Malafos

(591) Black, white
 (511) 5

(260) AM 2018 92963 A
 (210) AM 92963
 (220) 2017 06 23
 (731) PARIJAT INDUSTRIES (INDIA) PRIVATE LIMITED
 M-77, M-Block Market, 1st & 2nd Floor,
 Greater Kailash-II, New Delhi 110048, India
 (740) Pavle Meipariani
 (540)

Insacar

(591) Black, white
 (511) 5

(260) AM 2018 92966 A
 (210) AM 92966
 (220) 2017 06 23
 (731) PARIJAT INDUSTRIES (INDIA) PRIVATE LIMITED
 M-77, M-Block Market, 1st & 2nd Floor,
 Greater Kailash-II, New Delhi 110048, India
 (740) Pavle Meipariani

(540)

Sultan

(591) Black, white
 (511) 5

(260) AM 2018 92968 A
 (210) AM 92968
 (220) 2017 06 23
 (731) PARIJAT INDUSTRIES (INDIA) PRIVATE LIMITED
 M-77, M-Block Market, 1st & 2nd Floor,
 Greater Kailash-II, New Delhi 110048, India
 (740) Pavle Meipariani
 (540)

Locslay

(591) Black, white
 (511) 5

(260) AM 2018 93053 A
 (210) AM 93053
 (220) 2017 06 28
 (731) JSC "GEPHA"
 Sanapiro q.6, 0108, Tbilisi, Georgia
 (740) Salome Jeladze
 (540)

ვენოლექსი Venolex Венолекс

(511) 5

(260) AM 2018 93100 A
 (210) AM 93100
 (220) 2017 07 03
 (731) LTD "BEST"
 Iumashevis q. 8, 0151, Tbilisi, Georgia
 (740) Rasim Aslanov
 (540)

ჰაუსბერგი HAUSBERG

(591) Black, white
 (511) 1, 2

(260) AM 2018 93105 A
 (210) AM 93105
 (220) 2017 07 04
 (731) CELGENE CORPORATION
 86 Morris Avenue, Summit, New Jersey
 07901, United States of America
 (740) Tamaz Shilakadze

(540)

РИБЛЮЗЕЛ

(591) Black, white
(511) 5

(260) AM 2018 93139 A

(210) AM 93139

(220) 2017 07 05

(731) LTD "ANAGI"

Kostavas q. 37/39, 0171, Tbilisi, Georgia

(740) Mariam Dvalishvili

(540)



(591) Green and yellow

(531) 26.04.03; 27.01.01; 27.05.10; 29.01.12

(511) 37

(260) AM 2018 93143 A

(210) AM 93143

(220) 2017 07 05

(731) LTD "ANAGI"

Kostavas q. 37/39, 0171, Tbilisi, Georgia

(740) Mariam Dvalishvili

(540)



(591) Green and yellow

(531) 26.04.03; 27.01.01; 28.19; 29.01.12

(511) 37

(260) AM 2018 93146 A

(210) AM 93146

(220) 2017 07 05

(731) LTD "ANAGI"

Kostavas q. 37/39, 0171, Tbilisi, Georgia

(740) Mariam Dvalishvili

(540)



(591) Combination of gray

(531) 26.04.03; 27.01.01; 27.05.01

(511) 37

(260) AM 2018 93149 A

(210) AM 93149

(220) 2017 07 05

(731) LTD "ANAGI"

Kostavas q. 37/39, 0171, Tbilisi, Georgia

(740) Mariam Dvalishvili

(540)



(591) Combination of gray

(531) 26.04.03; 27.01.01; 27.05.10; 28.19

(511) 37

(260) AM 2018 93226 A

(210) AM 93226

(220) 2017 07 07

(731) ALTUNKAYA İNŞAAT NAKLİYAT GIDA
TİCARET ANONİM ŞİRKETİ

4. Organize Sanayi Bölgesi, 83409 nolu Cadde
No:8, Gaziantep, Turkey

(740) Giorgi Meipariani

(540)



(591) Sky-blue, blue, black, white

(531) 02.09.04; 26.01.15; 27.05.03; 29.01.13

(511) 5

(260) AM 2018 93264 A

(210) AM 93264

(220) 2017 07 11

(731) LTD "MAXSIMAL COSMETIC"

R. Mamisashvilis q. 9, 0182, Tbilisi, Georgia

(540)



(591) Red, yellow, orange, green, black and white
 (531) 05.05.20; 05.13.09; 25.01.01; 25.01.25;
 27.05.01; 27.05.11; 27.05.22; 28.19; 29.01.15
 (511) 3, 35

(260) AM 2018 93272 A
 (210) AM 93272
 (220) 2017 07 11
 (731) Mubadala Trade Marks Holding
 Company – LLC
 P. O. Box 45005, Abu Dhabi, United Arab
 Emirates
 (740) Merab Kvimsadze
 (540)



MUBADALA

(591) Black, white
 (531) 01.05.06; 01.13.01; 01.13.05
 (511) 16, 25, 28, 35, 36, 37, 40, 42

(260) AM 2018 93429 A
 (210) AM 93429
 (220) 2017 07 19
 (731) ALTIA PLC
 P.O. Box 350, FI-00101 Helsinki, Finland
 (740) Merab Kvimsadze
 (540)

VALHALLA

(591) Black, white
 (531) 27.05.01
 (511) 33

(260) AM 2018 93438 A
 (210) AM 93438
 (220) 2017 07 21
 (731) LTD "GMP"
 Sop. Ponitchala 65, 0165, Tbilisi, Georgia
 (740) Nugzar Ksovreli
 (540)

პენტაპარინი
ПЕНТАПАРИН
PENTAPARIN

(511) 5

(260) AM 2018 93440 A
 (210) AM 93440
 (220) 2017 07 21
 (731) LTD "GMP"
 Sop. Ponitchala 65, 0165, Tbilisi, Georgia

(740) Nugzar Ksovreli
 (540)

ოქსიპარი
ОКСИПАР
OXIPAR

(511) 5

(260) AM 2018 93509 A
 (210) AM 93509
 (220) 2017 07 26
 (731) LTD "Newton's Free School"
 Vazha-Pshavelas gamz. 40, 0177, Tbilisi,
 Georgia
 (540)



(591) Red, black, green
 (531) 05.01.16; 05.07.13; 29.01.13
 (511) 41

(260) AM 2018 93530 A
 (210) AM 93530
 (220) 2017 07 27
 (731) LTD "KAKHETIAN TRADITIONAL
 WINEMAKING"
 S. Tsintsadze q. 12, 3 floor, non-residential
 space 3-6, 0160, Tbilisi, Georgia
 (540)

KTWINO

(511) 33

(260) AM 2018 93563 A
 (210) AM 93563
 (220) 2017 07 31
 (731) BEST WESTERN INTERNATIONAL INC.
 6201 North 24th Parkway Phoenix., Arizona,
 85016, United States of America
 (740) Tamar Kochlamazashvili
 (540)

Sure Hotel by Best Western

(591) Black, white
 (511) 43

REGISTERED TRADEMARKS

(111) M 2018 29421 R

(151) 2018 02 23

(181) 2028 02 23

(260) AM 2014 75837 A

(220) 2014 02 10

(732) LTD "GVMT Group"

Krtsanisis me-2 gas., 11, Isani-Samgoris r-ni,
0114, Tbilisi, Georgia

(111) M 2018 29428 R

(151) 2018 03 06

(181) 2028 03 06

(260) AM 2016 89992 A

(220) 2016 12 15

(731) CJSC "TECHNONIKOL"

Krimskiy Val 8, 119049, Moscow, Russian
Federation

(111) M 2018 29424 R

(151) 2018 03 06

(181) 2028 03 06

(260) AM 2016 88102 A

(220) 2016 07 29

(732) IRMA PATARAIA

Varketili 3, I mkr., korp. 28, b. 26, 0163, Tbilisi,
Georgia

(111) M 2018 29429 R

(151) 2018 03 06

(181) 2028 03 06

(260) AM 2016 89993 A

(220) 2016 12 15

(731) CJSC "TECHNONIKOL"

Krimskiy Val 8, 119049, Moscow,
Russian Federation

(111) M 2018 29425 R

(151) 2018 03 06

(181) 2028 03 06

(260) AM 2016 88103 A

(220) 2016 07 29

(732) IRMA PATARAIA

Varketili 3, I mkr., korp. 28, b. 26, 0163, Tbilisi,
Georgia

(111) M 2018 29430 R

(151) 2018 03 06

(181) 2028 03 06

(260) AM 2016 89995 A

(220) 2016 12 15

(732) CJSC "DOMINANTA SERVICE"

Ul. Komsomolskaya d. 1, Podolsk, 142100,
Moskovskaya Oblast, Russian Federation

(111) M 2018 29426 R

(151) 2018 03 06

(181) 2028 03 06

(260) AM 2016 89793 A

(220) 2016 12 05

(732) ZIYLAN MAĞAZACILIK PAZARLAMA

ANONIM ŞİRKETİ
Merkez Mahallesi Taşocağı Caddesi No.24 K.3
Mahmutbey Bağcılar İstanbul / Turkey
stambuli, Turkey

FLO MAĞAZACILIK VE PAZARLAMA

ANONIM ŞİRKETİ
Merkez Mahallesi Taşocağı Caddesi No.24 K.3
Mahmutbey Bağcılar İstanbul/Turkey, Turkey

(111) M 2018 29431 R

(151) 2018 03 06

(181) 2028 03 06

(260) AM 2016 89996 A

(220) 2016 12 15

(732) CJSC "DOMINANTA-SERVICE"

Ul. Komsomolskaya dom 1, Podolsk,
Moskovskaya Oblast, 142100, Russian
Federation

(111) M 2018 29427 R

(151) 2018 03 06

(181) 2028 03 06

(260) AM 2016 89884 A

(220) 2016 12 09

(732) CELLTRION, INC.

Principal Business Place: 23, Academy-ro,
Yeonsu-gu, Incheon, Republic of Korea

(111) M 2018 29432 R

(151) 2018 03 06

(181) 2028 03 06

(260) AM 2016 89998 A

(220) 2016 12 15

(732) CJSC "DOMINANTA-SERVICE"

Ul. Komsomolskaya, d. 1, Podolsk, 142100,
Moskovskaya Oblast, Russian Federation

(111) M 2018 29433 R

(151) 2018 03 06

(181) 2028 03 06

(260) AM 2016 90031 A

(220) 2016 12 20
 (732) LTD "EUROPHARMA GEORGIA"
 Machabelis q. 5, 0114, Tbilisi, Georgia

(732) LTD "GEORGIAN WINE AND SPIRITS
 COMPANY"
 Sop. Achinebuli, 2200, Telavi, Georgia

(111) M 2018 29434 R
 (151) 2018 03 06
 (181) 2028 03 06
 (260) AM 2016 90033 A
 (220) 2016 12 20
 (732) LTD "EUROPHARMA GEORGIA"
 Machabelis q. 5, 0114, Tbilisi,
 Georgia

(111) M 2018 29440 R
 (151) 2018 03 06
 (181) 2028 03 06
 (260) AM 2016 90094 A
 (220) 2016 12 23
 (732) LTD "GEORGIAN WINE AND SPIRITS
 COMPANY"
 Sop. Achinebuli, 2200, Telavi, Georgia

(111) M 2018 29435 R
 (151) 2018 03 06
 (181) 2028 03 06
 (260) AM 2016 90038 A
 (220) 2016 12 21
 (732)) LTD "IVERCO"
 T. Tabidzis q. I shes. 10, Vake-Saburtalos
 r-ni, Tbilisi, Georgia

(111) M 2018 29441 R
 (151) 2018 03 06
 (181) 2028 03 06
 (260) AM 2016 90141 A
 (220) 2016 12 26
 (732) SANCTUARY HEALTH SDN. BHD
 16 PERSIARAN PERINDUSTRIAN
 KANTHAN
 1 KAWASAN PERINDUSTRIAN
 KANTHAN, Peraki Chemori, 31200,
 Malaysia

(111) M 2018 29436 R
 (151) 2018 03 06
 (181) 2028 03 06
 (260) AM 2016 90039 A
 (220) 2016 12 21
 (732)) LTD "IVERCO"
 T. Tabidzis q. I shes. 10, Vake-Saburtalos
 r-ni, Tbilisi, Georgia

(111) M 2018 29442 R
 (151) 2018 03 06
 (181) 2028 03 06
 (260) AM 2017 90357 A
 (220) 2017 01 10
 (732) Dubai Aviation Corporation
 (Trading as Flydubai)
 Flydubai Headquarters Terminal 2,
 P.O. Box 353, Dubai, United Arab Emirates

(111) M 2018 29437 R
 (151) 2018 03 06
 (181) 2028 03 06
 (260) AM 2016 90048 A
 (220) 2016 12 22
 (732) LEVAN TSAGURIA
 Sop. Shalauri, Telavis r-ni, Georgia

(111) M 2018 29443 R
 (151) 2018 03 06
 (181) 2028 03 06
 (260) AM 2017 90366 A
 (220) 2017 01 10
 (732) LTD "INGAPHARM"
 Ul. Generala Dorokhogo, d. 18, str. 2,
 119530, Moskow, Russian Federtion

(111) M 2018 29438 R
 (151) 2018 03 06
 (181) 2028 03 06
 (260) AM 2016 90054 A
 (220) 2016 12 22
 (732) ALLIANCE TIRE COMPANY LTD
 P.O. Box 48, 1 Friedlander Street, Hadera,
 Israel

(111) M 2018 29444 R
 (151) 2018 03 06
 (181) 2028 03 06
 (260) AM 2017 90482 A
 (220) 2017 01 18
 (732) SHALVA KHARGELIA
 Isakadzis q. 12b, b.44, Tbilisi, Georgia

(111) M 2018 29439 R
 (151) 2018 03 06
 (181) 2028 03 06
 (260) AM 2016 90091 A
 (220) 2016 12 23

(111) M 2018 29445 R
(151) 2018 03 06
(181) 2028 03 06
(260) AM 2017 90487 A
(220) 2017 01 18
(732) LLC "EUROPHARMA GEORGIA"
Machabelis q. 5, 0114, Tbilisi, Georgia

(111) M 2018 29446 R
(151) 2018 03 06
(181) 2028 03 06
(260) AM 2017 90551 A
(220) 2017 01 20
(732) TIUMSUN RUBBER TIRE (WEIHAI)
CO., LTD
No.1, Tengsen Road, Weihai Economic and
Technological Development Zone, Shandong
Province, China

(111) M 2018 29447 R
(151) 2018 03 06
(181) 2028 03 06
(260) AM 2017 90597 A
(220) 2017 01 25
(732) NUCTECH COMPANY LIMITED
2nd Floor, Block A, TongFang Building,
Shuangqinglu, Haidian District, Beijing,
China

(111) M 2018 29448 R
(151) 2018 03 06
(181) 2028 03 06
(260) AM 2017 90635 A
(220) 2017 01 30
(732) LTD "GEORGIAN VINE AND WINE
COMPANY"
D. Aghmasheneblis gamz. 179a, b. 25, 0112,
Tbilisi, Georgia

(111) M 2018 29449 R
(151) 2018 03 06
(181) 2028 03 06
(260) AM 2017 90786 A
(220) 2017 02 13
(732) LTD "GEORGIAN VINE AND WINE
COMPANY"
D. Aghmasheneblis gamz. 179a, b. 25, 0112,
Tbilisi, Georgia

(111) M 2018 29450 R
(151) 2018 03 06
(181) 2028 03 06
(260) AM 2017 90940 A
(220) 2017 02 22

(732) BRITISH AMERICAN TOBACCO
(BRANDS) INC. (a Delaware corporation)
2711 Centerville Road, Suite 300,
Wilmington, Delaware 19808, USA

(111) M 2018 29451 R
(151) 2018 03 06
(181) 2028 03 06
(260) AM 2017 90962 A
(220) 2017 02 22
(732) LTD "KVARELI WINE COMPANY"
Lermontovis q. 3, 4800, Kvareli, Georgia

(111) M 2018 29452 R
(151) 2018 03 06
(181) 2028 03 06
(260) AM 2017 90964 A
(220) 2017 02 22
(732) LTD "KVARELI WINE COMPANY"
Lermontovis q. 3, 4800, Kvareli, Georgia

(111) M 2018 29453 R
(151) 2018 03 06
(181) 2028 03 06
(260) AM 2017 90997 A
(220) 2017 02 24
(732) LTD "ALGETI GEORGIA"
Bolo Aghmartis q. 1, Tbilisi, Georgia

(111) M 2018 29454 R
(151) 2018 03 06
(181) 2028 03 06
(260) AM 2017 90998 A
(220) 2017 02 24
(732) LTD "ALGETI GEORGIA"
Bolo Aghmartis q. 1, Tbilisi, Georgia

(111) M 2018 29455 R
(151) 2018 03 06
(181) 2028 03 06
(260) AM 2017 90999 A
(220) 2017 02 24
(732) LTD "ALGETI GEORGIA"
Bolo Aghmartis q. 1, Tbilisi, Georgia

(111) M 2018 29456 R
(151) 2018 03 06
(181) 2028 03 06
(260) AM 2017 91000 A
(220) 2017 02 24
(732) LTD "ALGETI GEORGIA"
Bolo Aghmartis q. 1, Tbilisi, Georgia

(111) M 2018 29457 R
(151) 2018 03 06
(181) 2028 03 06
(260) AM 2017 91001 A
(220) 2017 02 24
(732) LTD "ALGETI GEORGIA"
Bolo Aghmartis q. 1, Tbilisi, Georgia

(111) M 2018 29463 R
(151) 2018 03 06
(181) 2028 03 06
(260) AM 2017 91152 A
(220) 2017 03 06
(732) JSC "CHATEAU MUKHRANI"
Sop. Mukhrani, 3309, Mtskheta, Georgia

(111) M 2018 29458 R
(151) 2018 03 06
(181) 2028 03 06
(260) AM 2017 91053 A
(220) 2017 02 28
(732) LUKA CHKHAIDZE
Didi Digomi, IV M/r, Me-10 korp. II sad. b. 28,
Tbilisi, Georgia

(111) M 2018 29464 R
(151) 2018 03 06
(181) 2028 03 06
(260) AM 2017 91153 A
(220) 2017 03 06
(732) JSC "CHATEAU MUKHRANI"
Sop. Mukhrani, 3309, Mtskheta, Georgia

(111) M 2018 29459 R
(151) 2018 03 06
(181) 2028 03 06
(260) AM 2017 91080 A
(220) 2017 02 28
(732) CHOICE HOTELS INTERNATIONAL INC.
1 Choice Hotels Circle, Rockville, Maryland
20850, USA

(111) M 2018 29465 R
(151) 2018 03 06
(181) 2028 03 06
(260) AM 2017 91154 A
(220) 2017 03 06
(732) JSC "CHATEAU MUKHRANI"
Sop. Mukhrani, 3309, Mtskheta, Georgia

(111) M 2018 29460 R
(151) 2018 03 06
(181) 2028 03 06
(260) AM 2017 91096 A
(220) 2017 03 01
(732) LTD "G-M-P"
Sop. Ponitchala 65, 0165, Tbilisi, Georgia

(111) M 2018 29466 R
(151) 2018 03 06
(181) 2028 03 06
(260) AM 2017 91181 A
(220) 2017 03 07
(732) COLGATE-PALMOLIVE COMPANY
a Delaware corporation
300 Park Avenue, New York, New York
10022, USA

(111) M 2018 29461 R
(151) 2018 03 06
(181) 2028 03 06
(260) AM 2017 91109 A
(220) 2017 03 02
(732) PJSC "OIL COMPANY "ROSNEFT"
Sophiiskaya Naberezhnaya, d. 26/1, 115035,
Moskow, Russian Federation

(111) M 2018 29467 R
(151) 2018 03 06
(181) 2028 03 06
(260) AM 2017 91191 A
(220) 2017 03 10
(732) LTD "S-G-S GRUUP"
Pushkinis q. 19, dzveli Tbilisis r-i, 0105,
Tbilisi, Georgia

(111) M 2018 29462 R
(151) 2018 03 06
(181) 2028 03 06
(260) AM 2017 91110 A
(220) 2017 03 02
(732) PJSC "OIL COMPANY "ROSNEFT"
Sophiiskaya Naberezhnaya, d. 26/1, 115035,
Moskow, Russian Federation

(111) M 2018 29468 R
(151) 2018 03 06
(181) 2028 03 06
(260) AM 2017 91198 A
(220) 2017 03 10
(732) TAKEDA PHARMA A/S
Dybendal Alle 10, 2630 TAASTRUP, Denmark

(111) M 2018 29469 R
(151) 2018 03 06
(181) 2028 03 06
(260) AM 2017 91280 A
(220) 2017 03 16
(732) MERCK SHARP & DOHME CORP.
One Merck Drive, Whitehouse Station,
New Jersey, 08889, USA

(111) M 2018 29470 R
(151) 2018 03 06
(181) 2028 03 06
(260) AM 2017 91379 A
(220) 2017 03 23
(732) ALEKSANDR LEVAKOV
N. Kipshidzis q. 3b, b. 80, 0162, Tbilisi,
Georgia

(111) M 2018 29471 R
(151) 2018 03 06
(181) 2028 03 06
(260) AM 2017 91399 A
(220) 2017 03 27
(732) KENTUCKY FRIED CHICKEN
INTERNATIONAL HOLDINGS, LTD.
7100 Corporate Drive, Plano, TX 75024, USA

(111) M 2018 29472 R
(151) 2018 03 06
(181) 2028 03 06
(260) AM 2017 91400 A
(220) 2017 03 27
(732) KENTUCKY FRIED CHICKEN
INTERNATIONAL HOLDINGS, LTD.
7100 Corporate Drive, Plano, TX 75024, USA

(111) M 2018 29473 R
(151) 2018 03 06
(181) 2028 03 06
(260) AM 2017 94790 A
(220) 2017 10 27
(732) FINCA INTERNATIONAL, INC.
8th Floor, 1201 15th Street NW, Washington
DC 20005, United States of America

(111) M 2018 29474 R
(151) 2018 03 06
(181) 2028 03 06
(260) AM 2017 95178 A
(220) 2017 11 22
(732) TATRALIFT a.s
Pol'ná 4, SK-060 01 Kežmarok, Slovakia

TRADEMARKS REGISTERED ACCORDING TO THE ACCELERATED PROCEDURE

The decision can be appealed at the Chamber of Appeal of Sakpatenti within 3 months from the publication.

(111) M 2018 29422 R
(151) 2018 02 26
(181) 2028 02 26
(210) AM 96301
(220) 2018 02 09
(732) LTD "GEOPHARMA"
Mitskevichis q. 27b, 0194, Tbilisi, Georgia
(740) Khatia Chkhapelia
(540)



(591) Black and pink
(531) 03.11.02; 27.05.01; 27.05.10; 29.01.12
(511) 5

(111) M 2018 29423 R
(151) 2018 03 01
(181) 2028 03 01
(210) AM 96239
(220) 2018 02 05
(732) LTD L+COMPANY
D. Bakradzis q. 6, 0119, Tbilisi, Georgia
(540)



(591) Yellow, red, black, white
(531) 18.05.01; 18.05.03; 19.03.24; 29.01.14
(511) 34

INTERNATIONAL TRADEMARKS FOR WHICH A DECISION ON GRANTING PROTECTIONS IS TAKEN

The decision can be appealed at the Chamber of Appeal of Sakpatenti within 3 months from the publication or at the Mtskheta District Court Administrative Cases Board (Address: №17, Samkhedro str., Mtskheta), within 1 month following the publication.

(260) AM 2018 88867 A

(800) 1311245

(891) 2016 06 02

(731) Publichne aktsionerne tovarystvo

"MONPHARM"

vul. Zavodska, 8, m. Monastyryshche,

Cherkaska oblast 19100, Ukraine

(540)

Анальдим

(591) Black and white

(531) 28.05

(511)

5 – Pharmaceutical preparations.

(260) AM 2018 89443 A*

(800) 1318300

(891) 2016 08 01

(731) Obshchestvo s ogranichennoy

otvetstvennost'yu "Koordiniruyushchy

raspreditel'ny tsentr "EFKO-Kaskad"

ul. Frunze 4, g. Alekseevka RU-309850

Belgorodskaya obl., Russian Federation

(540)



(591) Red, vinous, black, white and pink.

(531) 26.01.02; 28.05; 29.01.12

(511)

30 – Sauces [condiments], namely ketchup [sauce].

35 – Advertising of ketchup [sauce], sales promotion for others, retail and wholesale services for ketchup [sauce].

(260) AM 2018 90704 A

(800) 1329277

(891) 2016 04 25

(731) LABORATOIRE DE LA MER

Avenue du Général Patton, ZAC de la

Madeleine, F-35400 Saint-Malo, France

(540)

LABORATOIRE DE LA MER

(511)

5 – Pharmaceutical products and/or preparations; parapharmaceutical products and/or preparations; medicines for human medicine; elixirs [pharmaceutical preparations]; sanitary products for medical purposes; medicinal herbs; medicinal drinks; medicinal infusions; medicinal tea; herbal teas; pharmaceutical or parapharmaceutical preparations and/or products in the nature of milk, foam, lotion, oil, serum, solution, drinkable emulsion, syrup, infusion, herbal tea, carbonated solution, essence, sticks, cachets, tablets, coated tablets, capsules, gel caps, chewing gum, granules, pellets, pills, lozenges, tissues impregnated with pharmaceutical lotions, powder for oral intake or dermal application, pomade, cream, gel, paste, spray, balm; biological preparations for medical use; chemical preparations for medical use; tonics [medicines]; remedies for human medicine; pharmaceutical or parapharmaceutical preparations and/or products made from marine products, essential oils, plant extracts, naturally or chemically derived products, vitamins, minerals, yeast and/or omega 3; therapeutic preparations for the bath; bath salts for medical use; sea water for medicinal bathing; saline preparations for medical use; marine extracts for medical use; algae extracts for medical use; active marine ingredients for medical use; salts for medical use; hypertonic marine serum; isotonic marine serum; antioxidants; immunostimulants; antiseptics; analgesic products; homeopathic parapharmaceutical and/or pharmaceutical preparations and/or products; phytotherapeutic parapharmaceutical and/or pharmaceutical preparations and/or products; parapharmaceutical and/or pharmaceutical preparations and/or products for the care and treatment of the hair or scalp; parapharmaceutical and/or pharmaceutical hair growth preparations and/or products; preparations to facilitate teething; dental mastics; fumigation products for medical use; parapharmaceutical and/or pharmaceutical preparations and/or products for the treatment of the respiratory tract; parapharmaceutical and/or pharmaceutical preparations and/or products for the care and/or treatment of the muscles; dietetic substances, foods, and/or beverages for medical use; dietary supplements for medical use; dietetic food supplements; nutritional supplements; food for babies; dietary fibers; trace element preparations for human consumption; mineral food supp-

lements; nutritional supplements for cosmetic use; nutritional supplements for cosmetic use in solid or liquid form, and particularly milk, foam, lotion, oil, serum, solution, drinkable emulsion, syrup, infusion, herbal tea, carbonated solution, sticks, cachets, tablets, coated tablets, capsules, gel caps, chewing gum, granules, pellets, pills, lozenges, powder for oral intake; eye-washes.

10 – Medical apparatus and/or instruments; dental apparatus and/or instruments; physical exercise apparatus for medical purposes; vaporizers for medical use; appliances for washing body cavities; brushes for cleaning body cavities; massage apparatus; aesthetic massage apparatus; rolling massage apparatus for applying pharmaceutical and cosmetic preparations for slimming purposes; apparatus intended for exercising the muscles, for medical use; apparatus for therapeutic muscle toning; medical apparatus for strengthening pelvic floor muscles; vaginal syringes; douche bags.

(260) AM 2018 90707 A
 (800) 1329398
 (891) 2016 11 16
 (731) MONTRES TUDOR SA
 Rue François-Dussaud 3, CH-1211 Genève
 26, Switzerland
 (540)

S&G

(511)
 14 – Timepieces, namely watches, wristwatches, component parts of timepieces and accessories for timepieces not included in other classes, clocks and other chronometric instruments, chronometers, chronographs (timepieces), apparatus for timing sports events, time measuring and marking apparatus and instruments not included in other classes; watch bands, dials (clock and watchmaking), cases and presentation cases for timepieces and jewelry, watch movements and their parts; jewelry; precious stones and semi-precious stones; precious metals and their alloys.

(260) AM 2018 90848 A
 (800) 1330531
 (891) 2016 09 02
 (731) ROADS LUXURY GROUP LIMITED
 149 Lower Baggot Street, Dublin 2, Ireland
 (540)

ROADS

(511)
 4 – Candles; perfumed candles; scented candles; wicks; illuminants; candles for night lights; oils for paints.

(260) AM 2018 91122 A
 (800) 1333019
 (891) 2016 11 30
 (731) IMPERIAL S.p.A.
 Via dei Lanaioli, 42, Blocco 11 – Centergross,
 I-40050 Funo di Argelato (Bologna), Italy
 (540)

ИМПЕРИАЛ

(511)
 9 – Spectacles [optics]; spectacle frames; spectacle cases.

14 – Jewels; precious stones; time instruments; chronometric instruments; rings [jewellery]; bracelets [jewellery]; watch straps; charms; necklaces [jewellery]; chronographs [watches]; chronometers; tie bars; earrings; wristwatches; key rings [trinkets or fobs]; boxes of precious metal; tie pins; pins being jewelry; ornamental pins.

25 – Clothing articles; dresses; skirts; trousers; polo tops; short-sleeved t- shirts; t- shirts (long-sleeved); shirts; jackets [clothing]; sweaters; pullovers; blouses; coats; overcoats; waterproof clothing; pelisses; combination [clothing]; wind resistant jackets; scarves; head scarves; shawls; neckties; braces for clothing [suspenders]; gloves [clothing]; stockings; socks; belts; bathing suits; swimming trunks; beach dresses; bathrobes; pyjamas; underwear; brassieres; tank tops; underpants; hats; bonnets (headgear); berets; visors [headwear]; shoes; gymnastic shoes; boots; sandals; flip-flops; slippers; wooden shoes.

(260) AM 2018 91299 A
 (800) 1334530
 (891) 2016 08 24
 (731) OLAM INTERNATIONAL LIMITED
 7 Straits View, #20-01 Marina One East
 Tower, Singapore 018936, Singapore
 (540)



(591) Black and white
 (531) 05.03.15; 26.01.12; 26.07.03; 27.05.01
 (511)

1 – Fertilizers; fertilizing preparations; phosphates [fertilisers]; superphosphates [fertilisers]; salts [fertilisers]; nitrogen; nitrogenous fertilisers; potash; potash water; ammoniacal salts; ammonia alum; anhydrous ammonia.

17 – Rubber, raw or semi-worked; liquid rubber; rubber solutions; latex [rubber].

19 – Wood, semi-worked; building timber; manufactured timber; sawn timber; wood panelling; plywo-

od; planks of wood for building; wood pulp board, for building; mouldable wood.

22 – Raw cotton; cotton tow; cotton waste [flock] for padding and stuffing; textile fibres; raw fibrous textile; raw silk; raw or treated wool; raw linen [flax]; hemp.

29 – Milk and milk products; dairy products containing milk; dairy products; dairy products flavoured with cheese; cheese products; butter; butter preparations; cocoa butter; milk beverages, milk predominating; edible nuts; preserved soya beans for food; edible seeds; prepared seeds; roasted nuts; salted nuts; edible oils and fats; cooking oils; vegetable oils; maize oil; corn oil; palm kernel oil for food; sesame oil; palm oil for food; olive oil for food; sunflower oil for food; coconut oil; flaxseed oil for culinary purposes; processed nuts; mixtures of processed nuts and of raisins; preserved beans; prepared savoury meals in this class predominantly containing seafood, vegetables, meat, egg, cheese, mushrooms or tofu; preserved lentils; pulses (foodstuffs); ground almonds; prepared hazelnuts; prepared peanuts; prepared sesame seeds; cream [dairy products]; processed chickpeas; processed soybeans; tomato juices for cooking; tomato paste; tomato preserves; tomato puree; tomatoes (cooked); tomatoes (dried); tomatoes (preserved); preserved onions; preserved garlic; preserved vegetables; cooked vegetables; dried vegetables; frozen vegetables; frozen fruits; preserved fruits; stewed fruit; fruit pulp; preparations for making soup; tinned fish; tinned meat; tinned vegetables; tinned fruits; vegetable juices for cooking; all included in this class.

30 – Coffee beans; coffee; instant coffee; cocoa powder; cocoa and foodstuffs containing cocoa as the main constituent; sugar; palm sugar; rice; artificial coffee; preparations made from cereals; pastry; confectionery; spices; allspice; cinnamon [spice]; curry [spice]; cloves [spice]; ginger [spice]; saffron [seasoning]; peppers [seasonings]; pepper; garden herbs, preserved [seasonings]; cocoa-based beverages; cocoa beverages with milk; coffee-based beverages; coffee beverages with milk; chocolate-based beverages; tea-based beverages; unroasted coffee; coffee flavorings; biscuits; maize flakes; maize flour; milled maize; roasted maize; husked barley; crushed barley; crushed oats; processed sorghum; rye flour; flaxseed for human consumption; pasta; noodles; instant noodles; noodle-based prepared meals; prepared savoury meals in this class predominantly containing rice or pasta; prepared savoury meals in the form of pizza; corn flour; maize flour; soya flour; wheat flour; potato flour; tapioca flour; nut flours; milled corn; dried parsley; all included in this class.

31 – Agricultural, horticultural and forestry products and grains; wheat; maize; fresh soya beans; edible

seeds (unprocessed); unprocessed cereals; raw cocoa beans; nuts [fruit]; raw nut kernels; unprocessed nuts; malts; almonds [fruits]; fresh hazelnuts; fresh peanuts; unprocessed edible sesame; unprocessed barley; unprocessed sorghum; rye; unprocessed edible flaxseed; fresh chickpeas; rice, unprocessed; sugarcane; fresh fruit; fresh vegetables; fresh onions; fresh garlic; fresh parsley; peppers [plants]; all included in this class.

36 – Insurance services; insurance services relating to property and transit, motor loss or damage, cash and cash in transit, fidelity guarantee, and excess legal liability insurance; financial customs brokerage services; risk management (financial); investment of funds; financial management; financial information; stocks and bonds brokerage.

39 – Transportation services; delivery of goods; shipping of goods; packaging and storage of goods; warehousing and storage services; delivery and distribution (transport) services; logistics (transport) services; rental of vehicles and storage containers; cargoes unloading, crating of goods; warehousing of goods in a warehouse in view of their preservation and guarding; refrigerator rental; garage rental; provision of information, advisory and consultancy services in relation to the aforesaid.

40 – Processing of agricultural products; milk processing; fruit crushing; processing of seeds; material treatment; distillation, fruit crushing and milling of agricultural products for others; sawing [saw mill]; planing of timber [saw mill]; dyeing services, sawing of timber, burnishing by abrasion; timber preservation; woodworking; abrasion; cloth dyeing; dyeing of clothing; textile dyeing; textile treating; textile fireproofing; fabric waterproofing; cloth treating; flour milling; grinding; food smoking; freezing of foods; refining services; processing of oil; food and drink preservation.

44 – Consultancy, advisory and information services relating to agriculture; agriculture services relating to environmental conservation; provision of agricultural information services in the form of agricultural reports; pest control in agriculture; weed control in agriculture; all included in this class.

(260) AM 2018 91313 A

(800) 1334981

(891) 2016 11 28

(731) ARVEN İLAÇ SANAYİ VE TİCARET ANONİM ŞİRKETİ

İstinye Mahallesi, Balabandere Caddesi
No:14, TR-34460 SARIYER/İSTANBUL,
Turkey

(540)

arvohaler

(511)

5 – Pharmaceutical and veterinary preparations for medical purposes; chemical preparations for medical and veterinary purposes, chemical reagents for pharmaceutical and veterinary purposes; dietary supplements for pharmaceutical and veterinary purposes; dietary supplements; nutritional supplements; medicinal preparations for slimming purposes; food for babies; herbs and herbal beverages adapted for medicinal purposes; dental preparations and articles; teeth filling material, dental impression material, dental adhesives and material for repairing teeth; sanitary preparations for medical use; hygienic pads; hygienic tampons; plasters; materials for dressings; diapers, including those made of paper and textiles; preparations for destroying vermin; fungicides, herbicides; deodorants, other than for human beings or for animals; air deodorising preparations; disinfectants; antiseptics; detergents for medical purposes.

10 – Surgical, medical, dental and veterinary apparatus and instruments; furniture especially made for medical purposes; artificial limbs and prostheses; medical orthopaedic articles; corsets for medical purposes, orthopaedic shoes, elastic bandages and supportive bandages; surgical gowns and surgical sterile sheets; adult sexual aids; condoms; babies' bottles; babies' pacifiers; teats; teethingers for babies.

(260) AM 2018 91639 A

(800) 1337269

(891) 2016 10 24

(731) ADP GAUSELMANN GMBH

Merkur-Allee 1-15, 32339 Espelkamp,
Germany

(540)

Evostar

(511)

9 – Scientific, nautical, surveying, photographic, cinematographic, optical, weighing, measuring, signalling, checking (supervision), life-saving and teaching apparatus and instruments; apparatus and instruments for conducting, switching, transforming, accumulating, regulating or controlling electricity; apparatus for recording, transmission or reproduction of sound or images; magnetic data carriers, recording discs; compact discs, DVDs and other digital recording media; cash registers, calculating machines, data processing equipment, computers; computer software; fireextinguishing apparatus; musical jukeboxes and parts for the aforesaid automatic machines; automatic cash dispensers, automatic money counting and money changing machines; coin-operated mechanisms; computer and video games software; games software for use on any computer platform, including electronic entertainment and games consoles; computer game programs; computer ga-

mes programs; video games (software); computer games provided through a global computer network or supplied by means of multimedia electronic broadcast or through telecommunications or electronic transmission or via the Internet; computer games, leisure and recreational software, video games and computer software, all being provided in the form of storage media; programs for operating electric and electronic apparatus for games, amusement and/or entertainment purposes; automatic lottery machines; computer software for computer games on the Internet; online games (software), in particular for online betting games, online prize games, online gambling games, online games of skill and online casino games; computer software in the form of an app for mobile devices and computers; calculating apparatus in coin-operated machines and parts for the aforesaid goods; apparatus for recording, transmission, processing or reproduction of data, including sound or images, including parts for all the aforesaid goods, except radio sets, television receivers, hi-fi systems, video recorders, telephone apparatus, fax machines and telephone answering machines; computer hardware and software for casino and amusement arcade games, for gaming machines, slot machines or video lottery gaming machines or games of chance via the Internet; electric, electronic, optical or automatic apparatus, for identifying data carriers, identity cards and credit cards, bank notes and coins; electric, electronic or optical alarm and monitoring installations, including video cameras and apparatus for image transmission and image processing; data processing apparatus and computers, NOTIFICATION (continued) including data processing apparatus and computers being components for data networks and parts facilitating data network communications; electric wiring harnesses; circuit boards, printed circuit boards (electronic components) and combinations thereof, being assemblies and parts for apparatus, included in class 9; specifically excluding batteries.

28 – Games; toys; gymnastic and sporting articles not included in other classes; decorations for Christmas trees; gaming apparatus (including coin-operated apparatus); coin-operated arcade games (machines); games for amusement arcades (included in class 28); coin-operated video gaming apparatus; video games adapted for use with external screens or monitors only; casino fittings, namely roulette tables, roulette wheels; coin-operated automatic gaming machines and gaming machines, in particular for gaming arcades, with or without a prize payout; electronic or electrotechnical gaming apparatus, automatic gaming machines, gaming machines, slot machines operated by coins, tokens, banknotes, tickets or by means of electronic, magnetic or biometric storage media, in particular for commercial use in casinos and amusement arcades, with or without a prize payout; automatic gaming machines and gaming machines, in particular for commercial use in casinos and gaming arcades, with or without a prize payout;

coin-operated gaming machines and/of electronic moneybased gaming apparatus (machines), with or without prizes; housings adapted for gaming machines, gaming apparatus and automatic gaming machines, operated by means of coins, tokens, tickets or by means of electronic, magnetic or biometric storage media, in particular for commercial use in casinos and gaming arcades, with or without a prize payout; electronic games; electronic game entertainment apparatus and accessories; video output game machines; drawing apparatus for prize games and lotteries, draws or raffles; housings of metal, plastic and/or wood for coin-operated automatic machines; apparatus for games (including video games), other than adapted for use with external screens or monitors only; electropneumatic and electric pulling machines (gaming machines); gaming tables, in particular for table football, billiards, sliding games; flying discs (toys) and darts; electric, electronic or electromechanical apparatus for bingo games, lotteries or video lottery games and for betting offices, networked or unnetworked; LCD games consoles; automatic gaming machines; including all the aforesaid automatic machines, machines and apparatus operating in networks; apparatus and devices for accepting and storing money, being fittings for the aforesaid automatic machines, included in class 28.

(260) AM 2018 91653 A

(800) 1337484

(891) 2016 11 30

(731) HEIDI CHOCOLAT S.A.

B-dul Biruintei 87, 077145 Pantelimon,
Romania

(540)

CHOCOMOODS

(511)

5 – Dietetic foodstuffs namely confectionery for medical use; dietetic foodstuffs namely confectionary made of chocolate for medical use; dietetic foodstuffs; dietetic foodstuffs made of chocolate; dietetic foodstuffs namely chocolate, pralines, sweetmeats (candy) and candy for diabetics.

30 – Chocolate; cocoa; pastry and confectionery products; petits fours (cakes); chocolate candy; candy and sugar confectionery; edible ices.

35 – Advertising; business management; business administration; office functions; retail sale and wholesale of chocolate, chocolate candy, petits fours (pastry), candy, sugar confectionery and edible ices; on-line retail store services for chocolate, chocolate candy, petits fours (pastry), candy, sugar confectionery and edible ices.

35 – Advertising; commercial business management; commercial administration; office functions; wholesale and retail sale; on-line retail store services.

(260) AM 2018 91654 A

(800) 1337503

(891) 2016 12 22

(731) NOVARTIS AG

CH-4002 Basel, Switzerland

(540)

VERIFEYE

(511)

9 – Computer hardware and software for carrying out, processing, recording, storing and transmitting optical measurements; computer hardware and software for performing optical diagnostics.

10 – Ophthalmic and optometric instruments for carrying out, processing, recording, storing and transmitting optical measurements and for performing diagnostic tests; lasers for ophthalmic and optometric purposes.

(260) AM 2018 91656 A

(800) 1337511

(891) 2017 01 19

(731) SOREMARTEC SA

Findel Business Center, Complexe B, Rue
de Trèves, L-2632 Findel, Luxembourg

(540)

KINDER BISCOCOVERY

(511)

30 – Pastry and confectionery; cakes, biscuits and cookies, chocolate and chocolate-based products; cereal-based snacks; candy; edible ices; sugar; honey.

(260) AM 2018 91664 A

(800) 1337523

(891) 2016 12 19

(731) Obshchestvo s ogranichennoy

otvetstvennostyu "WINER"

ul. Aviatsionnaya, 66, RU-123182 Moscow,
Russian Federation

(540)

DELUNE

(591) Black and white

(531) 27.05.17

(511)

18 – Bags for campers; bags for climbers; bags for sports; beach bags; handbags; haversacks; rucksacks; school satchels; shopping bags; sling bags for carrying infants; tool bags, empty; travelling sets [leatherware]; travelling bags; valises; wheeled shopping bags.

(260) AM 2018 91666 A

(800) 1337538

(891) 2016 08 29

(731) POLFARMEX S.A
ul. Józefów 9, PL-99-300 Kutno, Poland

(540)

vixam

(591) Black and white

(531) 27.05.01

(511)

5 – Pharmaceutical preparations.

(260) AM 2018 91669 A

(800) 1337547

(891) 2016 11 18

(731) YARA INTERNATIONAL ASA
P.O. Box 343 Skøyen, N-0213 Oslo,
Norway

(540)

Frutrel

(511)

1 – Chemicals for use in agriculture, horticulture and forestry; fertilizers and manures; compost; plant growth regulators; seed and seed grain treatment preparations; soil treatment preparations; chemicals for coating of fertilizers and seeds and seed grain; granulated lime; chemical additives; nitrates.

(260) AM 2018 91709 A

(800) 1337843

(891) 2017 01 17

(731) PREDO SAGLIK ÜRÜNLERİ SANAYİ VE
TİCARET LİMİTED SİRKETİ
Organize Sanayi Bölgesi Bati 4, Nolu Cadde
No.2, Başpınar Gaziantep, Turkey

(540)

Slipers

(591) Black, white

(531) 27.05.17

(511)

5 – Sanitary preparations for medical use; hygienic pads; hygienic tampons; plasters; materials for dressings; diapers, including those made of paper and textiles.

(260) AM 2018 91712 A

(800) 1337912

(891) 2016 12 15

(731) SHISEIDO COMPANY, LIMITED
7-5-5 Ginza, Chuo-ku, Tokyo 104-0061,
Japan

(540)

SHISEIDO
GINZA TOKYO
ROUGE ROUGE

(591) Black, white

(531) 27.05.10; 27.05.15

(511)

3 – Soaps and detergents; cosmetics; perfumery; incense; dentifrices.

(260) AM 2018 91727 A

(800) 1338046

(891) 2016 12 19

(731) Naked Wolfe Footwear Pty. Ltd.
C/ – Abound Business Solutions Pty Ltd,
Level 1, 426 Mt Alexander Road, Ascot
Vale VIC 3032, Australia

(540)

Naked Wolfe

(511)

18 – Handbags; leather wallets; pocket wallets; pouches (bags); travel goods (luggage); work bags; backpacks; casual bags; clutch bags; messenger bags; overnight bags; articles made from animal hides; articles made from animal skins; articles made from fur; articles made from imitation leather; articles made from leather; articles made from the skin of amphibians; articles made from the skin of birds; articles made from the skin of mammals; articles made from the skin of reptiles; purses.

25 – Clothing; headwear; footwear; footwear for children; footwear for men; footwear for women; shoes; boots; slippers; sandals.

(260) AM 2018 91765 A

(800) 1339329

(891) 2017 01 11

(731) FERRERO TRADING LUX SA
Findel Business Center, Complexe B, Rue de
Trèves, FINDEL L-2632, Luxembourg

(540)

HCo
Hazelnut Company

(591) Brown

(531) 27.05.10; 29.01.07

(511)

31 – Grains and agricultural, horticultural and forestry products, not included in other classes; fresh fruits and vegetables; seeds; natural plants and flowers; animal foodstuffs; malt, fresh hazelnuts, walnuts, coconuts, peanuts and almonds.

35 – Advertising; commercial business management; commercial administration; commercial or industrial company management assistance; import-export agency services; promotion services with a view to exporting (advertising); service provided by consultants in commercial business in the field of agriculture; administrative management of inventory and

supply chains; presentation of goods on all communication media, for retail sale; commercial information and advice for consumers (consumer advice shop); sales promotion.

44 – Agricultural, horticultural and forestry services; landscape design, vermin exterminating for agriculture, horticulture and forestry, weed killing, aerial and surface spreading of fertilizers and other agricultural chemicals, tree planting in the framework of carbon offsetting, farming equipment rental.

(260) AM 2018 91766 A

(800) 1339343

(891) 2016 05 13

(731) BESTRENT s. r. o.

Tomášikova 10/B, SK-821 03 Bratislava, Slovakia

(540)



(591) Blue and white

(531) 26.05.02; 26.05.22; 26.05.24; 27.05.24; 29.01.12

(511)

7 – Construction machines.

8 – Hand-operated hand tools.

12 – Apparatus for locomotion by land; vehicles for locomotion by land.

35 – Business consultation; retail or wholesale services for construction machines; commercial business intermediary services relating to machines for construction.

37 – Maintenance and repair of motor vehicles in the building industry; rental of construction equipment; machinery installation, maintenance and repair; maintenance and repair of electric machines in the building industry; maintenance and repair of electric apparatus in the building industry; installation of apparatus and installations for measuring and regulating; repair of apparatus and installations for measuring and regulating.

41 – Education and training services in connection with construction.

(260) AM 2018 91770 A

(800) 1339015

(891) 2016 12 30

(731) SLOBOZHANSKY SOAP-BOILER, LTD.

vul. Sumskyi Shliakh, 53, s. Podvirky, Derhachivskyi r-n Kharkivska obl. 62371, Ukraine

(540)



(591) Red, dark blue, white, pink, green, blue and crimson

(531) 28.05; 29.01.15

(511)

3 – Laundry bleaching preparations; laundry soaking preparations; capsules for washing laundry; laundry additives; cakes of soap; detergents other than for use in manufacturing operations and for medical purposes, including: dishwashing detergents, floor and carpet detergents, detergents for baths and toilet; soap; fabric softeners for laundry use; refurbishing preparations; pastes for laundry use; hands-washing pastes; hand cleaning pastes; laundry blueing; laundry glaze; laundry preparations; laundry powders; detergents for household use; cleaning preparations for household use; liquid soap; dry shampoos; laundry tablets; dishwasher tablets; shampoos; shampoos for cleaning of automobiles; hair shampoos and conditioners.

(260) AM 2018 91778 A

(800) 1339393

(891) 2016 11 14

(731) Huvepharma EOOD

Nikolay Haitov Str. 3A, 5th floor, BG-1113 Sofia, Bulgaria

(540)

PIGFEN

(511)

5 – Antiparasitic preparations; anthelmintics; veterinary preparations; nutritional additives to foodstuffs for animals, for medical purposes; medicines for veterinary purposes; parasiticides; vermin destroying preparations; pharmaceutical preparations.

(260) AM 2018 91779 A

(800) 1339401

(891) 2016 12 14

(731) BLIZZARD SPORT GMBH

Klausgasse 32, A-5730 Mittersill, Austria

(540)



(591) Black, white

(531) 26.01.03; 26.01.24; 26.03.04; 26.03.06

(511)

9 – Protective helmets, in particular ski helmets; sunglasses and ski goggles.

18 – Sports bags, travelling bags and rucksacks.

25 – Clothing, footwear and headgear.

28 – Gymnastic and sporting articles not included in other classes, in particular skis, ski bindings, ski poles, snowboards, snowboard bindings and bags especially designed for skis and snowboards.

(260) AM 2018 91780 A
 (800) 1339404
 (891) 2016 10 28
 (731) Closed joint-stock Company
 "DOMINANTA-SERVIS"
 Komsomolskaya str., 1, Podolsk, RU-142100
 Moscow Region, Russian Federation
 (540)

KARO

(511)
 3 – Laundry preparations; laundry bleach; cleaning, polishing, degreasing and abrasive preparations; cream soaps; soaps in gel form; shower gels; perfume; essential oils; cosmetics; body oils for cosmetic purposes; body milk for cosmetic purposes; gels for cleaning hands; liquid talcum powder for toilet use; bath foam; tissues impregnated with cosmetic lotions; detergents other than for use in manufacturing operations and for medical purposes; lotions and gels for cosmetic purposes; hair sprays; hair gels; hair lotions; dentifrices; toilet water; deodorants for human beings; cosmetic pencils; cosmetic kits; hair dyes; cosmetic creams; nail polish; lotions for cosmetic purposes; almond oil; rose oil; almond soap; antibacterial soap; lipsticks; shaving preparations; toiletries; mouth washes, not for medical purposes; bleaching preparations [decolorants] for cosmetic purposes; fabric softeners for laundry use; mascara for eyelashes; shampoos; shampoos for pets; medicated toothpaste.

5 – Pharmaceutical preparations and veterinary preparations; sanitary preparations for medical purposes; dietetic substances adapted for medical use, food for babies; plasters, materials for dressings; material for dental fillings and dental impressions; disinfectants; preparations for destroying noxious animals; fungicides; herbicides; amino acids for veterinary purposes; nutritional supplements for medical purposes, including, nutritional supplements based on protein or fat with vitamins and fatty acids and also nutritional supplements based on carbohydrates or vitamins; candy, medicated; lotions for veterinary, pharmaceutical purposes; medicinal oils; biologically active preparations for medical purposes; vitamin preparations in the form of granules, powders, emulsions, pills, candy, drops, juices or capsules; pharmaceutical preparations for skin care; repellent creams.

(260) AM 2018 91784 A
 (800) 1339045
 (891) 2016 08 30
 (731) LINK SNACKS, INC.
 One Snackfood Lane, P.O. Box 397, Minong
 WI 54859, United States of America
 (540)



(591) Black and white
 (531) 03.04.01; 03.04.13
 (511)
 29 – Food products, namely, jerky, food package combinations consisting primarily of meat, cheese and pickled sausages, dry smoked beef jerky, packaged meats, meat snacks; processed meat; sausages; pepperoni; beef jerky chew.

(260) AM 2018 91785 A
 (800) 1339064
 (891) 2016 09 22
 (731) DIACHUK SERHII IVANOVYCH
 vul. Ozerna, 10, s. Ivankovychi, Vasylykivskyi
 raion, Kyivska obl. 08632, Ukraine
 (540)

Saflora

(591) Black and white
 (531) 05.03.14; 27.05.08
 (511)
 3 – Abrasives; abrasive cloth; glass cloth; abrasive paper; breath freshening sprays; diamantine [abrasive]; alum stones [astringents]; amber [perfume]; antistatic preparations for household purposes; balms other than for medical purposes; beard dyes; hair colorants; colorants for toilet purposes; bergamot oil; joss sticks; lip glosses; nail polish; shining preparations [polish]; badian essence; petroleum jelly for cosmetic purposes; cotton wool for cosmetic purposes; cotton sticks for cosmetic purposes; bleaching soda; laundry bleach; bleaching salts; bleaching preparations [decolorants] for cosmetic purposes; leather bleaching preparations; decorative transfers for cosmetic purposes; shoe wax; creams for leather; moustache wax; laundry' wax; volcanic ash for cleaning; astringents for cosmetic purposes; cloths impregnated with a detergent for cleaning; gaultheria oil; dental bleaching gels; heliotropine; geraniol; make-up; lipsticks; disinfectant soap; deodorants for pets; deodorants for human beings or for animals; deodorant soap; depilatories; depilatory wax; scen-

ted water; scented wood; ethereal essences; essential oils; essential oils of cedarwood; javelle water; jasmine oil; greases for cosmetic purposes; laundry soaking preparations; flavorings for beverages [essential oils]; cake flavorings [essential oils]; food flavorings [essential oils]; leather preservatives [polishes]; lacquer-removing preparations; varnish-removing preparations; color-removing preparations; degreasers other than for use in manufacturing processes; scale removing preparations for household purposes; dentifrices; ionone [perfumery]; shaving stones [astringents]; silicon carbide [abrasive]; carbides of metal [abrasives]; extracts of flowers [perfumes]; adhesives for affixing false hair; adhesives for affixing false eyelashes; adhesives for cosmetic purposes; collagen preparations for cosmetic purposes; hair conditioners; quillaia bark for washing; corundum [abrasive]; cosmetics; eyebrow cosmetics; cosmetic preparations for eyelashes; cosmetics for animals; make-up powder; beauty masks; cosmetic kits; hair straightening preparations; cosmetic preparations for skin care; sun-tanning preparations [cosmetics]; cosmetic preparations for slimming purposes; cosmetic preparations for baths; tailors' wax; whitening; shoe cream; cream for whitening the skin; cosmetic creams; laundry starch; starch glaze for laundry purposes; cakes of soap; lavender water; lavender oil; incense; hair spray; essential oils of lemon; polishing wax; polishing paper; polishing stones; polishing creams; polishing preparations; shoe polish; denture polishes; polish for furniture and flooring; medicated soap; hair lotions; lotions for cosmetic purposes; after-shave lotions; smoothing preparations [starching]; massage gels other than for medical purposes; floor wax; almond oil; almond soap; almond milk for cosmetic purposes; washing soda, for cleaning; detergents other than for use in manufacturing operations and for medical purposes; soap; shaving soap; soap for brightening textile; soap for foot perspiration; musk [perfumery]; fabric softeners for laundry use; mint for perfumery; mint essence [essential oil]; emery; emery cloth, emery paper; nail art stickers; ammonia [volatile alkali] [detergent]; neutralizers for permanent waving; fumigation preparations [perfumes]; eyebrow pencils; cosmetic pencils; oils for perfumes and scents; oils for cosmetic purposes; oils for toilet purposes; oils for cleaning purposes; oil of turpentine for degreasing; mouthwashes, not for medical purposes; bases for flower perfumes, drying agents for dishwashing machines; cleansing milk for toilet purposes; refurbishing preparations; perfumery; perfumes; pastes for razor strops; pumice stone; hydrogen peroxide for cosmetic purposes; jewellers' rouge; pomades for cosmetic purposes; laundry blueing; laundry glaze; laundry preparations; air fragrancing preparations; shaving preparations; stain removers; rust removing preparations; paint stripping preparations; make-up preparations; nail care preparations; make-up removing pre-

parations; hair waving preparations; preparations to make shiny the leaves of plants; preparations for unblocking drain pipes; dry-cleaning preparations; preparations for cleaning dentures; bath preparations, not for medical purposes; aloe vera preparations for cosmetic purposes; non-slipping wax for floors; non-slipping liquids for floors; antiperspirants [toiletries]; antiperspirant soap; toiletries; windscreen cleaning liquids; floor wax removers [scouring preparations]; safrol; sachets for perfuming linen; tissues impregnated with cosmetic lotions; tissues impregnated with make-up removing preparations; turpentine, for degreasing; glass paper; teeth whitening strips; breath freshening strips; soda lye; bath salts, not for medical purposes; sunscreen preparations; douching preparations for personal sanitary or deodorant purposes [toiletries]; canned pressurized air for cleaning and dusting purposes; potpourris [fragrances]; dry shampoos; talcum powder, for toilet use; terpenes [essential oils]; grinding preparations; tripoli stone for polishing; rose oil; toilet water; mascara; cosmetic dyes; lipstick cases; color- [colour-] brightening chemicals for household purposes [laundry]; henna [cosmetic dye]; essential oils of citron; cleaning chalk; cleaning preparations; wall-paper cleaning preparations; scouring solutions; shampoos; shampoos for pets; shoemakers' wax; cobblers' wax; smoothing stones; false eyelashes; false nails.

(260) AM 2018 91789 A

(800) 1339180

(891) 2017 01 24

(731) SMARTLYNX AIRLINES, SIA

"Mazrūdas", LV-2167 Mārupes novads, Latvia

(540)



(591) Dark blue, red, yellow, orange and brown

(531) 01.01.01; 01.01.02; 01.01.12; 01.01.25;

27.05.01; 29.01.15

(511)

39 – Transport; packaging and storage of goods; travel arrangement; transportation of passengers, goods and cargo by air transport; aircraft chartering; aircraft rental; transport brokerage; piloting; arranging of travel tours; travel reservation; booking of seats for air travel.

(260) AM 2018 91881 A

(800) 1340729

(891) 2016 09 29

(731) LOUISIANA SPIRITS, LLC

P.O. Box 110 Lacassine LA 70650, United States of America

(540)

THE SPIRIT OF LOUISIANA

(526) LOUISIANA

(511)

33 – Distilled spirits, alcoholic beverages except beers.

(260) AM 2018 91896 A

(800) 1339907

(891) 2017 01 09

(731) Toruńskie Zakłady Materiałów
Opatrunkowych, Spółka Akcyjna
Żółkiewskiego 20/26 PL-87-100 Toruń,
Turkey

(540)



(591) White and navy blue

(531) 24.07.01; 26.04.06; 26.04.24; 27.05.17;
27.05.24; 29.01.13

(511)

3 – Cotton wool for cosmetic purposes, goods made from cotton wool for cosmetic purposes, cotton sticks for cosmetic purposes, cosmetic pads, cotton pads, tissues impregnated with cosmetic liquids, wipes for removing make-up.

5 – Sanitary towels, panty liners, menstruation tampons, tissues for intimate hygiene, liquids for intimate hygiene, urological pads.

(260) AM 2018 91904 A

(800) 1340939

(891) 2016 05 25

(731) PREMIQAMED HOLDING GMBH
Heiligenstädter Straße 46-48, A-1190 Wien,
Austria

(540)

Medical
Excellence
Austria



PremiQaMed
Group

(591) Grass-green

(531) 01.15.23; 27.05.10; 29.01.12

(511)

5 – Pharmaceuticals; sanitary preparations for medical purposes; dietetic substances adapted for medical use; plasters, materials for dressings; disinfectants.

10 – Surgical and medical instruments and apparatus, orthopaedic articles; testing apparatus for medical purposes.

35 – Advertising; business management; business administration; office functions; business management and organization consultancy, business management consultancy, personnel management consultancy, advisory services for business management, procurement services for others, professional business consultancy, planning of hospitals, sanatoriums, rehabilitation centres and convalescent homes with regard to organisational and professional business matters; franchising, namely providing and dissemination of professional business know-how; business project management for construction projects.

36 – Financing services; development of usage concepts for hospitals, sanatoriums, rehabilitation centres and convalescent homes with regard to financial matters; brokerage of financial business investments, in particular concerning hospitals, sanatoriums, rehabilitation centres and convalescent homes; franchising, namely providing of financial know-how, financial analysis, financial consultancy.

37 – Maintenance, repair and cleaning services in the domestic sector (caretaker services); installation, maintenance and repair of computer hardware; operating disinfecting and sterilisation facilities.

42 – Scientific services and research, namely in the field of health care and medicine; scientific testing services, namely in the field of health care and medicine; medical research laboratory services, scientific laboratory services, updating of computer software; computer software consultancy, consultancy relating to the design of websites; design and creation of websites; design of computer software; services of an EDP programmer; electronic data back-up; design and development of computer hardware and software; installation and maintenance of software; server administration; technical project management in the field of electronic data processing; rental of computer hardware and software; material testing and quality control; consultancy in the field of telecommunications engineering; technological consultancy; computer hardware and computer software consultancy; technical project planning of hospitals, sanatoriums, rehabilitation centres and convalescent homes.

43 – Services for providing food and drink; temporary accommodation; services for providing food and drinks in cafés, cafeterias, canteens, restaurants, snack bars, self-service restaurants and fast food restaurants; catering services.

44 – Medical services; hygienic and beauty care for human beings; cosmetic and plastic surgery; hospital services, medical services, medical clinic services and hospital services; medical nursing; sanatorium

services, health center services, midwife services, chiropractic, dentistry services, beauty salon services, health counselling, in vitro fertilization services, nursing services, orthodontic services, physical therapy, plastic and aesthetic surgery, consultancy in the field of health care and medicine; medical and clinical examinations; medical care.

45 – Security services for the protection of property and individuals; night guard services; security consultancy, intellectual property consultancy, litigation services, licensing of intellectual property, mediation, legal research, arbitration services, monitoring intellectual property rights for legal advisory purposes.

(260) AM 2018 91905 A

(800) 1340983

(891) 2017 02 01

(731) SHANDONG HENGYU SCIENCE & TECHNOLOGY CO., LTD.

Guangrao Economic Development Zone,
Dongying City, 257335 Shandong Province,
China

(540)

HEMISPHERE

(591) Black, white

(531) 27.05.17

(511)

12 – Automobile tires; tires for vehicle wheels; vehicle wheel tires; pneumatic tires; spikes for tires; tires for bicycles, cycles; treads for retreading tires; adhesive rubber patches for repairing inner tubes; repair outfits for inner tubes; casings for pneumatic tires.

(260) AM 2018 91907 A

(800) 1339981

(891) 2017 01 11

(731) VIPORI LIMITED

33 Lordou Vyrona Laiki Megaro, 5th Floor,
Office 54 CY-6023, LARNACA, Cyprus

(540)

MI
MIACHETE

(591) Black and white

(531) 26.13.25; 27.05.01; 27.05.21; 27.05.25

(511)

9 – Accumulators, electric, for vehicles; antennas; remote control apparatus; sound recording apparatus;

sound transmitting apparatus; loudspeakers; coaxial cables; fibre [fiber (Am.)] optic cables; cables, electric; contacts, electric; cabinets for loudspeakers; megaphones; diaphragms [acoustics]; microphones; headphones; sheaths for electric cables; transmitters [telecommunication]; transmitters of electronic signals; switches, electric; converters, electric; satellite navigational apparatus; telegraph wires; telephone wires; wires, electric; conductors, electric; copper wire, insulated; record players; control panels [electricity]; voltage surge protectors; horns for loudspeakers; couplings, electric; amplifiers; sound reproduction apparatus; ducts [electricity].

(260) AM 2018 91930 A

(800) 1340137

(891) 2016 12 21

(731) PUBLIC JOINT STOCK COMPANY

GAZPROM NEFT

Galernaya Ul, 5, Lit A RU-190000

St-Petersburg, Russian Federation

(540)



(591) Grey, yellow, black, orange, beige

(531) 26.04.04; 26.04.08; 26.04.09; 26.04.12;

26.04.24; 26.11.12; 27.05.10; 27.05.24;

29.01.15

(511)

4 – Petrol; benzine; gasoline; producer gas; solidified gases [fuel]; oil-gas; fuel gas; gas for lighting; fuel; diesel oil; additives, non-chemical, to motor fuel; cutting fluids; industrial grease; lubricating oil; industrial oil; motor oil; lubricating grease; petroleum, raw or refined; biodiesel fuel; jet biofuel; dust absorbing compositions; anthracite; benzene; benzol; wood briquettes; combustible briquettes; petroleum jelly for industrial purposes; wax [raw material]; ozocerite [ozokerite]; illuminating wax; industrial wax; belting wax; carnauba wax; beeswax; firewood; paper spills for lighting; fish oil, not edible; illuminating grease; grease for leather; grease for footwear; tallow; kerosene; coke; xylene; xylol; ligroin; wood spills for lighting; mazut; fuel oil; oils for paints; oils for releasing form work [building]; oil for the preservation of masonry; oil for the preservation of leather; textile oil; moistening oil; coal tar oil; coal naphtha; castor oil for industrial purposes; bone oil for industrial purposes; rape oil for industrial purposes; lubricants; naphtha; nightlights [candles]; oleine; paraffin; dust removing preparations; soya bean oil preparations for non-stick treatment of cooking utensils; non-slipping preparations for belts; coal dust [fuel]; firelighters; perfumed candles; Christmas tree candles; candles; grease for arms [weapons]; grease for belts; vaporized fuel mixtures; dust binding compositions for sweeping; dust laying

compositions; alcohol [fuel]; methylated spirit; stearine; lighting fuel; mineral fuel; carburants; fuel with an alcoholic base; peat [fuel]; peat briquettes [fuel]; tinder; lignite; charcoal [fuel]; coal; coal briquettes; lamp wicks; wicks for candles; ceresine; electrical energy; ethanol [fuel]; petroleum ether; sunflower oil for industrial purposes.

37 – Drilling of deep oil or gas-wells; drilling of wells; retreading of tires [tyres]; vulcanization of tires [tyres] [repair]; anti-rust treatment for vehicles; vehicle maintenance; vehicle polishing; motor vehicle maintenance and repair; construction; asphaltting; rebuilding engines that have been worn or partially destroyed; rebuilding machines that have been worn or partially destroyed; building sealing; linen ironing; pressing of clothing; disinfecting; rat exterminating; mining extraction; refilling of toner cartridges; knife sharpening; building insulating; repair information; construction information; bricklaying; riveting; construction consultancy; varnishing; retinning; scaffolding; road paving; window cleaning; vehicle washing; building construction supervision; upholstery; renovation of clothing; rustproofing; sanding; pumicing; paper hanging; painting or repair of signs; cleaning of buildings [exterior surface]; vehicle breakdown repair services; rental of bulldozers; rental of road sweeping machines; rental of cleaning machines; rental of cranes [construction equipment]; rental of construction equipment; rental of excavators; plumbing; masonry; roofing services; painting, interior and exterior; carpentry services; underwater repair; plastering; quarrying services; repair of security locks; umbrella repair; parasol repair; burner maintenance and repair; film projector repair and maintenance; airplane maintenance and repair; safe maintenance and repair; clock and watch repair; pump repair; upholstery repair; shoe repair; clothing repair; photographic apparatus repair; furniture restoration; restoration of musical instruments; restoration of works of art; vehicle lubrication [greasing]; demolition of buildings; warehouse construction and repair; vehicle service stations [refuelling and maintenance]; washing; washing of linen; pipeline construction and maintenance; pier breakwater building; underwater construction; harbour construction; factory construction; building of fair stalls and shops; shipbuilding; cleaning of buildings [interior]; street cleaning; vermin exterminating, other than for agriculture; artificial snow-making services; laundering; installation of doors and windows; irrigation devices installation and repair; elevator installation and repair; heating equipment installation and repair; burglar alarm installation and repair; furnace installation and repair; telephone installation and repair; air conditioning apparatus installation and repair; fire alarm installation and repair; freezing equipment installation and repair; electric appliance installation and repair; kitchen equipment installation; installation, maintenance and

repair of computer hardware; machinery installation, maintenance and repair; office machines and equipment installation, maintenance and repair; interference suppression in electrical apparatus; swimming-pool maintenance; furniture maintenance; chimney sweeping; boiler cleaning and repair; cleaning of clothing; dry cleaning; vehicle cleaning; diaper cleaning; leather care, cleaning and repair; fur care, cleaning and repair.

(260) AM 2018 91936 A

(800) 1333211

(891) 2017 04 03

(731) AKYLBEK ZHUMABAEVICH
ZHUMABAEV

Gogolya Str., 2, Apt-33, 720040 Bishkek City,
Kyrgyzstan

(540)



(591) White, black, gray, silver-metallic

(531) 17.05.02; 17.05.19; 19.07.01; 19.07.09; 28.05

(554) Three-dimensional

(526) ВОДКА, VODKA, and numerical symbols on
bottle

(511)

21 – Bottles.

33 – Vodka.

(260) AM 2018 91966 A

(800) 1340487

(891) 2015 12 21

(731) ZHO CORPORATION PRIVATE
LIMITED

Plot no.140, 151, GST road, Estancia IT park,
Vallanchery, Guduvanchery (post) Kancheepuram
Tamilnadu, India

(540)

ManageEngine

(591) Black, white

(531) 27.05.17

(511)

9 – Computer programmes.

(260) AM 2018 91968 A

(800) 1340505

(891) 2016 10 24

(731) ZHEJIANG YIDUN MECHANICAL & ELECTRICAL CO., LTD.
CHANGHONG INDUSTRIAL DISTRICT,
ZEGUO TOWN, WENLING CITY
ZHEJIANG PROVINCE, China

(540)



(591) Black, white

(531) 26.01.18; 26.01.24; 27.05.01; 27.05.24

(511)

7 – Aerating pumps for aquaria; machines for electric accumulator industry; cutting machines; hand-held tools, other than hand-operated; dynamos; driving motors other than for land vehicles; motors, electric, other than for land vehicles; pumps [machines]; air pumps [garage installations]; vacuum pumps [machines]; valves [parts of machines]; compressed air pumps; turbocompressors; blowing machines for the compression, exhaustion and transport of gases; suction machines for industrial purposes; bellows [parts of machines]; compressed air machines; blowing machines; pressure reducers [parts of machines]; welding machines, electric; welding apparatus, gas-operated; electric welding apparatus; soldering apparatus, electric; electric arc welding apparatus; electric arc cutting apparatus; washing apparatus; filter presses; pneumatic transporters.

(260) AM 2018 91979 A

(800) 1341893

(891) 2016 09 15

(731) Selskokhoziaistvennyi proizvodstvennyi kooperativ Rybolovetskii kolkhoz Prostor
ul. Proletarskaia 4, r.p Lososina, Sovetsko-Gavanskii r-n RU-682848 Khabarovsk krai,
Russian Federation

(540)

LAMIFAREN

(531) 27.05.01

(511)

3 – Facial make-up; make-up for the face and body; cosmetics for personal use; body and beauty care cosmetics; cosmetics and toiletries; cosmetic preparations for slimming purposes; cosmetic preparations for skin care; cosmetics; shampoos; cosmetic creams; cosmetic creams and lotions for face and body care; lotions for cosmetic purposes; hair care lotions

[for cosmetic use]; lotions, creams and preparations for care of the face, body, scalp, nails and hair; skin and body topical lotions, creams and oils for cosmetic use; beauty masks; preparations for the care of the scalp and hair; nail care preparations; beauty care preparations.

5 – Nutritional supplements; mineral food supplements; vitamin and mineral dietary supplements; pharmaceutical preparations; dietetic foods adapted for medical purposes; medical preparations for slimming purposes; digestives for pharmaceutical purposes; tonics [medicines]; nervines; dietetic substances adapted for medical use; dietary supplements for controlling cholesterol; dietetic food supplements; dietary and nutritionally fortified food products adapted for medical purposes; enzyme dietary supplements; therapeutic drugs and agents.

29 – Kelp, processed; seaweed extracts for food.

35 – Import-export agency services; commercial information agency services; demonstration of goods; market studies; organization of trade fairs for commercial or advertising purposes; presentation of goods on communication media, for retail purposes; retail or wholesale services for pharmaceutical, veterinary and sanitary preparations and medical supplies; sales promotions at point of purchase or sale, for others; procurement services for others [purchasing goods and services for other businesses].

(260) AM 2018 91992 A

(800) 1341074

(891) 2016 03 16

(731) ZHEJIANG TIME NEW MATERIAL CO., LTD.

Bankeng silkworm field, Yongfeng town,
Linhai city Zhejiang province, China

(540)



(591) Black and white

(531) 26.13.25; 27.05.01; 27.05.08; 27.05.17

(511)

1 – Glue for industrial purposes; gelatine for industrial purposes; adhesives for industrial purposes; firming agent (terms considered too vague by the International Bureau – Rule 13(2)(b) of the Common Regulations); polyvinyl acetate emulsion (terms considered too vague by the International Bureau – Rule 13(2)(b) of the Common Regulations); leather glues; adhesives for wall tiles; multi-use mucilage (terms considered too vague by the International Bureau – Rule 13(2)(b) of the Common Regulations); viscose; adhesive for glass.

(260) AM 2018 91995 A
 (800) 1341099
 (891) 2016 12 20
 (731) ADP GAUSELMANN GMBH
 Merkur-Allee 1-15 32339 Espelkamp,
 Germany
 (540)

Stone Cold Fire

(591) Black and white

(511)

9 – Scientific, nautical, surveying, photographic, cinematographic, optical, weighing, measuring, signalling, checking (supervision), life-saving and teaching apparatus and instruments; apparatus and instruments for conducting, switching, transforming, accumulating, regulating or controlling electricity; apparatus for recording, transmission or reproduction of sound or images; magnetic data carriers, recording discs; compact discs, DVDs and other digital recording media; cash registers, calculating machines, data processing equipment, computers; computer software; fire-extinguishing apparatus; musical jukeboxes and parts for the aforesaid automatic machines; automatic cash dispensers, automatic money counting and money changing machines; coin-operated mechanisms; computer and video games software; games software for use on any computer platform, including electronic entertainment and games consoles; computer game programs; computer games programs; video games (software); computer games provided through a global computer network or supplied by means of multimedia electronic broadcast or through telecommunications or electronic transmission or via the internet; computer games, leisure and recreational software, video games and computer software, all being provided in the form of storage media; programs for operating electric and electronic apparatus for games, amusement and/or entertainment purposes; automatic lottery machines; computer software for computer games on the internet; online games (software), in particular for online betting games, online prize games, online gambling games, online games of skill and online casino games; computer software in the form of an app for mobile devices and computers; calculating apparatus in coin-operated machines and parts for the aforesaid goods; apparatus for recording, transmission, processing or reproduction of data, including sound or images, including parts for all the aforesaid goods, except radio sets, television receivers, hi-fi systems, video recorders, telephone apparatus, fax machines and telephone answering machines; computer hardware and software for casino and amusement arcade games, for gaming machines, slot machines or video lottery gaming machines or games of chance via the internet; electric, electronic, optical or automatic apparatus, for identifying data carriers, identity cards and credit cards, bank notes and coins; electric, electronic or optical alarm and monitoring installations,

including video cameras and apparatus for image transmission and image processing; data processing apparatus and computers, including data processing apparatus and computers being components for data networks and parts facilitating data network communications; electric wiring harnesses; circuit boards, printed board assemblies (electronic components) and combinations thereof being assemblies and equipment parts, included in this class.

28 – Games; toys; gymnastic and sporting articles not included in other classes; decorations for Christmas trees; gaming apparatus (including coin-operated apparatus); coin-operated arcade games (machines); arcade games (included in this class); coin-operated video gaming apparatus; video games apparatus adapted for use with external screens or monitors only; casino fittings, namely roulette tables, roulette wheels; coin-operated automatic gaming machines and gaming machines, in particular for gaming arcades, with or without a prize payout; electronic or electrotechnical gaming apparatus, automatic gaming machines, gaming machines, slot machines operated by coins, tokens, banknotes, tickets or by means of electronic, magnetic or biometric storage media, in particular for commercial use in casinos and amusement arcades, with or without a prize payout; automatic gaming machines and gaming machines, in particular for commercial use in casinos and gaming arcades, with or without a prize payout; coin-operated gaming machines and/or electronic money-based gaming apparatus (machines), with or without prizes; housings adapted for gaming machines, gaming apparatus and automatic gaming machines, operated by means of coins, tokens, tickets or by means of electronic, magnetic or biometric storage media, in particular for commercial use in casinos and gaming arcades, with or without a prize payout; electronic games; electronic game entertainment apparatus and parts thereof; video output game machines; drawing apparatus for prize games and lotteries, draws or raffles; housings of metal, plastic and/or wood for coin-operated automatic machines; apparatus for games (including video games), other than adapted for use with external screens or monitors only; electropneumatic and electric slot machines with pulling handles (gaming machines); gaming tables, in particular for table football, billiards, sliding games; flying discs (toys) and darts; electric, electronic or electromechanical gaming apparatus for bingo games, lotteries or video lottery games and for betting offices, connected or unconnected to a computer network; LCD games consoles; automatic gaming machines; automatic gaming machines operating in networks; apparatus and devices for accepting and storing money, being fittings for the aforesaid automatic machines, included in this class.

(260) AM 2018 92003 A

(800) 1341475

(891) 2016 12 23

(731) fashiontv.com GmbH c/o R.A.W. Unternehmensberatung GmbH
Elsenheimerstrasse 43 80687 München,
Germany

(540)



(591) Red and white

(531) 17.02.01; 17.02.02; 26.04.04; 26.04.10;
26.05.18; 27.05.21; 29.01.12

(511)

9 – Electrical engineering and electronic apparatus and instruments, as far as included in this class; photographic, cinematographic and optical apparatus and instruments; electrical controlling, measuring, signalling, electrical checking (supervision), electrical regulating and switching apparatus; apparatus for recording, transmission or reproduction of sound or images; magnetic data carriers; sound and image recordings; exposed and cinematographic films; video tapes and cassettes; recording discs and pre-recorded magnetic tapes; data processing apparatus and computers; parts of the aforesaid goods (included in this class); glasses, sunglasses; computer programmes stored on data carriers, data carriers, as far as included in this class; pre-recorded and un-recorded data carriers; computer hardware; computer software (downloadable); CDs, DVDs, video games (computer games).

38 – Telecommunications services; broadcasting of radio programs; broadcasting of cable television programs and television programs; provision of access to information in the Internet, namely electronic communication in the fields of fashion and music; broadcasting of radio and television programs via the Internet; collection and transmission of news (news agencies); transmission of sound and images via satellites; providing user access to computer programmes in data networks.

41 – Film production, motion picture rental, projection of films; radio and television entertainment; services in the field of education and entertainment (included in this class), musical, singing, theatre and dancing performances, live and via media; education via radio or television; production of radio and television programs; sporting and cultural activities; production, rental and showing of films (entertain-

ment), educational and entertainment films, stored on recorded video carriers and CDs, CD ROMs and DVDs; organization of award shows; organization and arranging of fashion shows for entertainment purposes; providing of training; education; entertainment.

45 – Legal services; security services for the protection of property and individuals; escorting in society (chaperoning), marriage agencies, agency services for arranging personal introductions, matchmaking services; dating services, internet dating services, dating agency services, video dating services, computer dating services.

(260) AM 2018 92034 A

(800) 1341820

(891) 2017 01 03

(731) CHANGZHOU TRINA SOLAR ENERGY CO., LTD.

No.2 Trina Road, Trina PV Park, Xinbei District, Changzhou 213031 Jiangsu, China

(540)

Trina smart energy

(591) Black, white

(511)

4 – Lubricating oil; gas for lighting; fuel; industrial wax; candles; tapers; dust removing preparations; electrical energy; atomic energy; energy produced by nuclear fusion.

9 – Cables, electric; wafers for integrated circuits; semi-conductors; solar batteries; solar panels for the production of electricity; batteries, electric; battery boxes; battery chargers; distribution consoles [electricity].

39 – Transport; wrapping of goods; car transport; car rental; storage of goods; distribution of energy; operating canal locks; courier services [messages or merchandise]; transport services for sightseeing tours; transport by pipeline.

40 – Laminating; electroplating; optical glass grinding; pottery firing; firing pottery; dressmaking; recycling of waste and trash; air purification; water treating; production of energy; rental of generators.

(260) AM 2018 92051 A

(800) 1341330

(891) 2016 11 08

(731) MEWS SYSTEMS, s.r.o.

Maiselova 25/4 CZ-110 00 Praha 1, Czech Republic

(540)

(591) Black and white

(531) 24.07.01; 24.07.13; 27.05.17

(511)

9 – Apparatus for recording, transmission and reproduction of sound or images; data processing equipment and computers; all computer programs and software.

38 – Electronic mail; communication services; communication by computer terminals; communication by mobile phones; providing telecommunications connections to a global computer network; transmission of messages and images via computer; phone communication; teleconferencing services; cable television broadcasting services.

41 – Editing and publishing; recording, production and distribution of films, video and audio recordings, radio and television programs; providing on-line electronic publications.

(260) AM 2018 92053 A

(800) 1341337

(891) 2016 12 27

(731) Gree Electric Appliances, Inc.
of Zhuhai Jinji West Road, Qianshan
Zhuhai Guangdong, Czech Republic

(540)



(591) Black and white

(531) 26.01.12; 27.05.01; 27.05.17; 27.05.21

(511)

12 – Automobiles; engines for land vehicles; upholstery for vehicles; motorcycles; bicycle pumps; cable cars; luggage trucks; omnibuses; tires for land vehicles; airplanes; boats.

(260) AM 2018 92054 A

(800) 1341393

(891) 2015 12 11

(731) HAPPY BRANDS INTERNATIONAL PTE.
LTD.

14 Robinson Road, #03-03 Far East Finance
Building Singapore 048545, Singapore

(540)



(591) Pink

(531) 02.09.01; 27.05.07; 27.05.08; 29.01.01

(511)

18 – Leather and imitations of leather, animal skins, hides; trunks and travelling bags; umbrellas, parasols and walking sticks; whips, harness and saddlery; bags, namely, handbags, vacation bag, athletic bags, backpacks, sports bag, clutch bag, gym bag, hobo bag, kit bag, sling bags, wristlet bag, travel bag, school bag, shopping bag, suitcases, belt bag, shoul-

der bag, vanity cases sold empty, wallets, namely, leather pouches, purses, calling card case, key wallets.

35 – Retail services relating to clothing, headgear and footwear, jewellery, watches, fashion accessories, textiles, eyewear, carrying cases, vanity cases sold empty, leather and imitations of leather, animal skins, hides, wallets, namely, leather pouches, purses, calling card case, key wallets, umbrellas, parasols and walking sticks, whips, harness and saddlery, handbags and all manner of bags; the bringing together for the benefit of others of clothing, headgear and footwear, jewellery, watches, fashion accessories, textiles, eyewear, carrying cases, vanity cases sold empty, leather and imitations of leather, animal skins, hides, wallets, namely, leather pouches, purses, calling card case, key wallets, umbrellas, parasols and walking sticks, whips, harness and saddlery, handbags and all manner of bags; enabling customers to conveniently view and purchase those goods; the provision of retail services via a mail order catalogue in relation to clothing, headgear and footwear, jewellery, watches, fashion accessories, textiles, eyewear, carrying cases, vanity cases sold empty, leather and imitations of leather, animal skins, hides, wallets, namely, leather pouches, purses, calling card case, key wallets, umbrellas, parasols and walking sticks, whips, harness and saddlery, handbags and all manner of bags; the provision of on-line retail services from an internet website in relation to clothing, headgear and footwear, jewellery, watches, fashion accessories, textiles, eyewear, carrying cases, vanity cases sold empty, leather and imitations of leather, animal skins, hides, wallets, namely, leather pouches, purses, calling card case, key wallets, umbrellas, parasols and walking sticks, whips, harness and saddlery, handbags and all manner of bags; the provision of retail services via a television channel in relation to clothing, headgear and footwear, jewellery, watches, fashion accessories, textiles, eyewear, carrying cases, vanity cases sold empty, leather and imitations of leather, animal skins, hides, wallets, namely, leather pouches, purses, calling card case, key wallets, umbrellas, parasols and walking sticks, whips, harness and saddlery, handbags and all manner of bags; the provision of retail services via a telephone or mobile phone, portable Internet-enabled device, or other telecommunications device in relation to clothing, headgear and footwear, jewellery, watches, fashion accessories, textiles, eyewear, carrying cases, vanity cases sold empty, leather and imitations of leather, animal skins, hides, wallets, namely, leather pouches, purses, calling card case, key wallets, umbrellas, parasols and walking sticks, whips, harness and saddlery, handbags and all manner of bags; the provision of retail services by way of direct marketing in connection with clothing, headgear and footwear, jewellery, watches, fashion accessories, textiles, eyewear, carrying cases, vanity

cases sold empty, leather and imitations of leather, animal skins, hides, wallets, namely, leather pouches, purses, calling card case, key wallets, umbrellas, parasols and walking sticks, whips, harness and saddlery, handbags and all manner of bags; the provision of information and advice in relation to retail services; business management consultancy; provision of advice and assistance in the selection of goods; promotion services through provision of sponsored links to third party websites; advertising and business services; advertising for others; advertising, marketing, promotion, endorsement and publicity services; distribution of samples.

(260) AM 2018 92056 A

(800) 1341921

(891) 2017 01 04

(731) AKZO NOBEL COATINGS
INTERNATIONAL B.V.

Velperweg 76, NL-6824 BM Arnhem,
Netherlands

(540)

WANDA

(511)

1 – Putties, fillers and pastes, all for use in the automotive and car repair industry.

2 – Coatings, paints, varnishes, lacquers, primers; thinners for paints, thickeners for paints; preservatives against rust; colouring matters; dyes, dyestuffs; mordants; natural resins, metals in foil and powder form for painters and decorators, all for use in the automotive and car repair industry.

3 – Bleaching preparations; cleaning, polishing, scouring and abrasive preparations, all for use in the automotive and car repair industry.

(260) AM 2018 92060 A

(800) 1341452

(891) 2016 11 12

(731) Tovarystvo z obmezheniou vidpovidalnistiu
promyslove pidpriemstvo "ZIP"
vul. Shyroka, 107 A, m. Dniprodzerzhynsk
Dnipropetrovska obl. 51901, Ukraine

(540)



(591) Red, orange, yellow, gold, green, lilac, dark blue, brown, black and white

(531) 03.03.01; 03.03.15; 03.03.24; 26.01.04;
26.01.15; 26.11.12; 26.11.21; 28.05; 29.01.15

(511)

1 – Chemicals used in industry, science and photography, as well as in agriculture, horticulture and forestry; unprocessed artificial resins, unprocessed plastics; fertilizers; fire extinguishing compositions; tempering and soldering preparations; chemical substances for preserving foodstuffs; tanning substances; adhesives for industrial purposes; antistatic preparations, other than for household purposes; anti-freeze; lead arsenate; acetone; textile-brightening chemicals; biochemical catalysts; bleaching preparations (decolorants) for industrial purposes; separating and unsticking (ungluing) preparations; glaziers' putty; fireproofing preparations; brake fluid; detergents for use in manufacturing processes; oil dispersants; distilled water; detergent additives to gasoline (petrol); additives, chemical, to motor fuel; enamel-staining chemicals; disincrustants; moistening (wetting) preparations for use in dyeing; degumming preparations; adhesives for industrial purposes; glue for industrial purposes; adhesives for billposting; cement for footwear; cement for mending broken articles; leather glues; adhesives for wall tiles; cement for pneumatic tires (tyres); adhesives for wallpaper; mastic for leather; plasticizers; surface-active chemical agents; ceramic glazings; fuel-saving preparations; preparations for preventing the tarnishing of glass; purification preparations; polish removing substances; opacifiers for enamel; opacifiers for glass; solvents for varnishes; synthetic materials for absorbing oil; glass-staining chemicals; sal ammoniac spirits; transmission fluid; chemicals, except pigments, for the manufacture of enamel; chemicals for the manufacture of pigments; chemicals for the manufacture of paints; color- (colour-) brightening chemicals for industrial purposes; chemical additives for oils; radiator flushing chemicals; fillers for automobile bodies; oil cement (putty).

2 – Paints, varnishes, lacquers; preservatives against rust and against deterioration of wood; colorants; mordants; raw natural resins; metals in foil and powder form for use in painting, decorating, printing and art; asbestos paints; watercolor paints for use in art; alizarine dyes; aluminium powder for painting; aluminium paints; aniline dyes; annatto (dyestuff); anti-corrosive preparations; auramine; bactericidal paints; toner cartridges, filled for printers and photocopiers; shoe dyes; ink for leather; wood stains; ink for skin-dressing; colorants for butter; dyewood; dyes; bitumen varnish; bronze powder for painting; fireproof paints; litharge; primers; titanium dioxide (pigment); printers' pastes (ink); printing ink; engraving ink; dyewood extracts; enamels for painting; enamels (varnishes); silver emulsions (pigments); thickeners for paints; undercoating for vehicle chassis; protective preparations for metals; indigo (colorant); edible inks; gum resins; Canada balsam; colophony; caramel (food colorant); carbonyl (wood preservative); edible ink cartridges, filled, for printers; ceramic

paints; binding preparations for paints; badigeon; copal; copal varnish; cochineal carmine; creosote for wood preservations; turmeric (colorant); black japan; bronzing lacquers; marking ink for animals; anti-rust oils; metal foil for use in painting, decorating, printing and art; cobalt oxide (colorant); zinc oxide (pigment); oils for the preservation of wood; oil paints for use in art; paper for dyeing Easter eggs; pigments; coatings (paints); wood coatings (paints); glazes (paints, lacquers); silvering powders; anti-rust preparations; anti-fouling paints; anti-corrosive bands; wood preservatives; anti-tarnishing preparations for metals; mordants; mordants for leather; wood mordants; thinners for paints; thinners for lacquers; whitewash; soot (colorant); carbon black (pigment); lamp black (pigment); sandarac; white lead; minium; siccatives (drying agents) for paints; Sienna earth; turpentine (thinner for paints); malt caramel (food colorant); malt colorants; silver paste; sumac for varnishes; distempers; toners (ink) for photocopiers; automobile paints; coatings for roofing felt (paints); repositionable paint patches; fixatives (varnishes); fixatives for watercolors (watercolours); yellowwood (colorant); food dyes; saffron (colorant); gum-lac.

19 – Building materials, not of metal; rigid pipes, not of metal, for building; asphalt, pitch and bitumen; buildings, transportable, not of metal; monuments, not of metal; asbestos mortar; asbestos cement; alabaster; reinforcing materials, not of metal, for building; asphalt; asphalt paving; balustrades, not of metal; concrete; concrete building elements; bitumen; bituminous products for building; bituminous coatings for roofing; bitumen paper for building; beams, not of metal; building glass; building stone; building paper; building materials, not of metal; building timber; building panels, not of metal; lime; limestone; calcareous marl; windows, not of metal; doors, not of metal; window glass for building; tanks of masonry; grog (fired refractory material); fire burrs; refractory construction materials, not of metal; fireproof cement coatings; water-pipes, not of metal; gates, not of metal; binding agents for making briquettes; binding material for road repair; geotextiles; gypsum; gypsum grout; gypsum dry mix; clay; gravel; granite; trellises, not of metal; road tar; hips for roofing; roof coverings, not of metal; roofing, not of metal; door panels, not of metal; wood for making household utensils; wood, semi-worked; wood pulp board, for building; wood veneers; wood panelling; wooden floor boards; chimney cowls, not of metal; chimneys, not of metal; chimney shafts, not of metal; road marking sheets and strips of synthetic material; paving slabs, not of metal; macadam; road coating materials; wood paving; paving blocks, not of metal; furrings of wood; dado rails of wood; drain pipes, not of metal; pantiles, not of metal; slag (building material); clinker stone; flashing, not of metal, for building; prefabricated houses (kits), not of me-

tal; outdoor blinds, not of metal and not of textile; insulating glass for building; stone; coal tar; framework, not of metal, for building; cornices, not of metal; paperboard for building; quartz; sandstone pipes; drain traps (valves), not of metal or plastic; clinker ballast; chimney pots, not of metal; pillars, not of metal, for building; agglomerated cork for building; raw chalk; silica (quartz); brackets, not of metal, for building; xylolith; chicken-houses, not of metal; angle irons, not of metal; coatings (building materials); wainscoting, not of metal; manufactured timber; sawn timber; slate; manhole covers, not of metal; magnesia cement; marble; materials for making and coating roads; linings, not of metal, for building; wall linings, not of metal, for building; cladding, not of metal, for building; wall claddings, not of metal, for building; mosaics for building; penstock pipes, not of metal; crash barriers, not of metal, for roads; duckboards, not of metal; fences, not of metal; moldings, not of metal, for building; moldings, not of metal, for cornices; shuttering, not of metal, for concrete; palisading, not of metal; parquet flooring; branching pipes, not of metal; partitions, not of metal; scantlings (carpentry); porches (structures), not of metal; floors, not of metal; props, not of metal; sand, except foundry sand; sandstone for building; planks of wood for building; platforms, prefabricated, not of metal; slabs, not of metal, for building; cement slabs; tiles, not of metal, for building; floor tiles, not of metal; tile floorings, not of metal; felt for building; stringers (parts of staircases), not of metal; luminous paving blocks; roofing shingles; roofing tiles, not of metal; roofing slates; roof flashing, not of metal; roof gutters, not of metal; roofing, not of metal; roofing, not of metal, incorporating solar cells; mantlepieces; lintels, not of metal; joists, not of metal; sills, not of metal; tarred strips, for building; tar; gutter pipes, not of metal; scaffolding, not of metal; mortar for building; thin mortar for building; plate glass (windows), for building; double glazed windows; buildings, not of metal; buildings, transportable, not of metal; works of stonemasonry; silver sand; jalousies, not of metal; ceilings, not of metal; wall tiles, not of metal; posts, not of metal; casement windows and folding doors, not of metal; stair-treads (steps), not of metal; staircases, not of metal; construction mix for floor leveling; building mixes for plastering; gypsum plaster; dry mortars; plaster; ducts, not of metal, for ventilating and air-conditioning installations; rigid pipes, not of metal, for building; tufa; plywood; veneer wood; moldable wood; works of art of stone, marble, concrete, artificial stone; earth for bricks; bricks; cement; cement for furnaces; cement for blast furnaces; cement slabs; cement posts; cement and perlite plaster; schists; sheet piles, not of metal; plaster construction materials; artificial stone; masts (poles), not of metal.

(260) AM 2018 92061 A

(800) 1341970

(891) 2016 10 27

(731) LORMAR S.r.l.

Via dell'Agricoltura, 23, I-41012 Carpi
(Modena), Italy

(540)

LORMAR

(511)

25 – Clothing; lingerie; lingerie; brassieres; under-pants; tap pants; panties; thongs; boy shorts [underwear]; tights; tank tops; waist cinchers; leotards; stocking suspenders; nightwear; leg warmers; slippers [undergarments]; long johns; socks; stockings; knitted underwear; robes; pajamas (Am.); short trousers; swimming trunks; suits; beach clothes; bathing suits; bikinis; coverups; dresses; beach robes; bandanas [neckerchiefs]; berets; footwear; breeches; shirts; blouses; headgear; waist belts; flip-flops; sundresses; scarfs; pocket squares; esparto shoes or sandals; sweat shirts; neckerchiefs; overalls; gloves [clothing]; denim jeans; hosiery; undershirts; sweaters; gym shorts; trousers; slippers; polo shirts; pullovers; salopettes; sandals; shoes; beach shoes; galoshes; training shoes; shawls; neck scarves [mufflers]; overcoats; stoles; tee-shirts; bermuda shorts; jackets [clothing]; gilets; ear muffs [clothing].

(260) AM 2018 92062 A

(800) 1341462

(891) 2016 08 08

(731) Tovarystvo z obmezheniu vidpovidalnistiu
promyslove pidpriemstvo "ZIP"
vul. Shyroka, 107 A, m. Dniprodzerzhynsk
Dnipropetrovska obl. 51901, Ukraine

(540)

(591) Red, orange, yellow, green, dark blue, blue,
lilac, black and white

(531) 03.03.01; 03.03.15; 26.11.12; 28.05; 29.01.15

(511)

1 – Chemicals for use in industry, science and photography, as well as in agriculture, horticulture and forestry; unprocessed artificial resins, unprocessed plastics; fertilizers; fire extinguishing compositions; tempering and soldering preparations; chemical substances for preserving foodstuffs; tanning substances; adhesives for industrial purposes; biochemical catalysts; bleaching preparations (decolorants) for industrial purposes; separating and unsticking (ungluing) preparations; glaziers' putty; enamel-staining chemicals; disincrustants; moistening preparations for use in dyeing; wetting preparations for use in dyeing; degumming preparations; gums (adhesives),

other than for stationery or household purposes; adhesives for billposting; cement for footwear; cement for mending broken articles; leather glues; adhesives for wall tiles; cement for pneumatic tires (tyres); adhesives for wallpaper; adhesives for industrial purposes; glue for industrial purposes; gluten (glue), other than for stationery or household purposes; gluten for industrial purposes; starch paste (adhesive), other than for stationery or household purposes; mastic for leather; plasticizers; ceramic glazings; anti-tarnishing chemicals for windows; compositions for repairing tires (tyres); polish removing substances; opacifiers for enamel; opacifiers for glass; solvents for varnishes; chemicals for the manufacture of paints; glass-frosting chemicals; color- [colour-] brightening chemicals for industrial purposes; chemicals, except pigments, for the manufacture of enamel; oil cement (putty).

2 – Paints, varnishes, lacquers; preservatives against rust and against deterioration of wood; dyes; mordants; raw natural resins; metals in foil and powder form for use in painting, decorating, printing and art; asbestos paints; alizarine dyes; aluminium paints; aniline dyes; annatto (dyestuff); auramine; bactericidal paints; toner cartridges, filled for printers and photocopiers; dyewood extracts; shoe dyes; wood stains; lacquer dyes; dyewood; bitumen varnish; bronze powder for painting; fireproof paints; primers; undercoating for vehicle chassis; titanium dioxide (pigment); printers' pastes (ink); engraving ink; dyewood extracts; enamels for painting; enamels (varnishes); silver emulsions (pigments); protective preparations for metals; thickeners for paints; indigo (colorant); gum resins; colophony; carbonyl (wood preservative); cochineal carmine; binding preparations for paints; badigeon; copal; copal varnish; creosote for wood preservation; turmeric (colorant); black japan; bronzing lacquers; mastic (natural resin); anti-rust greases; cobalt oxide (colorant); zinc oxide (pigment); oils for the preservation of wood; anti-rust oils; silver paste; pigments; coatings (paints); coatings for roofing felt (paints); wood coatings (paints); glazes (paints, lacquers); silvering powders; anti-fouling paints; anti-rust preparations; anti-corrosive preparations; anti-corrosive bands; wood preservatives; anti-tarnishing preparations for metals; mordants for wood; mordants; thinners for lacquers; thinners for paints; whitewash; sandarac; white lead; minium; siccatives (drying agents) for paints; Sienna earth; turpentine (thinner for paints); sumac for varnishes; toners (ink) for photocopiers; automobile paints; ceramic paints; marking ink for animals; repositionable paint patches; fixatives (varnishes); fixatives for watercolors (watercolours); silver foil (leaf); yellowwood (colorant); gum-lac.

19 – Building materials, not of metal; rigid pipes, not of metal, for building; asphalt, pitch and bitu-

men; buildings, transportable, not of metal; monuments, not of metal; asbestos mortar; asbestos cement; alabaster; reinforcing materials, not of metal, for building; asphalt; asphalt paving; balustrades, not of metal; concrete; concrete building elements; bitumen; bituminous products for building; bituminous coatings for roofing; bitumen paper for building; beams, not of metal; building glass; building stone; building paper; building materials, not of metal; building timber; building panels, not of metal; lime; limestone; calcareous marl; windows, not of metal; doors, not of metal; window glass for building; tanks of masonry; grog (fired refractory material); fire burrs; refractory construction materials, not of metal; fireproof cement coatings; water-pipes, not of metal; gates, not of metal; binding agents for making briquettes; binding material for road repair; geotextiles; gypsum; gypsum grout; gypsum dry mix; clay; gravel; granite; trellises, not of metal; road tar; hips for roofing; roof coverings, not of metal; roofing, not of metal; door panels, not of metal; wood for making household utensils; wood, semi-worked; wood pulp board, for building; wood veneers; wood panelling; wooden floor boards; chimney cowls, not of metal; chimneys, not of metal; chimney shafts, not of metal; road marking sheets and strips of synthetic material; paving slabs, not of metal; macadam; road coating materials; wood paving; paving blocks, not of metal; furrings of wood; dado rails of wood; drain pipes, not of metal; pantiles, not of metal; slag (building material); clinker stone; flashing, not of metal, for building; prefabricated houses (kits), not of metal; outdoor blinds, not of metal and not of textile; insulating glass for building; stone; coal tar; framework, not of metal, for building; cornices, not of metal; paperboard for building; quartz; sandstone pipes; drain traps (valves), not of metal or plastic; clinker ballast; chimney pots, not of metal; pillars, not of metal, for building; agglomerated cork for building; raw chalk; silica (quartz); brackets, not of metal, for building; xylolith; chicken-houses, not of metal; angle irons, not of metal; coatings (building materials); wainscoting, not of metal; manufactured timber; sawn timber; slate; manhole covers, not of metal; magnesia cement; marble; materials for making and coating roads; linings, not of metal, for building; wall linings, not of metal, for building; cladding, not of metal, for building; wall claddings, not of metal, for building; mosaics for building; penstock pipes, not of metal; crash barriers, not of metal, for roads; duckboards, not of metal; fences, not of metal; moldings, not of metal, for building; moldings, not of metal, for cornices; shuttering, not of metal, for concrete; palisading, not of metal; parquet flooring; branching pipes, not of metal; partitions, not of metal; scantlings (carpentry); porches (structures), not of metal; floors, not of metal; props, not of metal; sand, except foundry sand; sandstone for building; planks of wood for building;

platforms, prefabricated, not of metal; slabs, not of metal, for building; cement slabs; tiles, not of metal, for building; floor tiles, not of metal; tile floorings, not of metal; felt for building; stringers (parts of staircases), not of metal; luminous paving blocks; roofing shingles; roofing tiles, not of metal; roofing slates; roof flashing, not of metal; roof gutters, not of metal; roofing, not of metal; roofing, not of metal, incorporating solar cells; mantlepieces; lintels, not of metal; joists, not of metal; sills, not of metal; tarred strips, for building; tar; gutter pipes, not of metal; scaffolding, not of metal; mortar for building; thin mortar for building; plate glass (windows), for building; double glazed windows; buildings, not of metal; buildings, transportable, not of metal; works of stonemasonry; silver sand; jalousies, not of metal; ceilings, not of metal; wall tiles, not of metal; posts, not of metal; casement windows and folding doors, not of metal; stair-treads (steps), not of metal; staircases, not of metal; construction mix for floor leveling; building mixes for plastering; gypsum plaster; dry mortars; plaster; ducts, not of metal, for ventilating and air-conditioning installations; rigid pipes, not of metal, for building; tufa; plywood; veneer wood; moldable wood; works of art of stone, marble, concrete, artificial stone; earth for bricks; bricks; cement; cement for furnaces; cement for blast furnaces; cement slabs; cement posts; cement and perlite plaster; schists; sheet piles, not of metal; plaster construction materials; artificial stone; masts (poles), not of metal.

(260) AM 2018 92082 A

(800) 1342159

(891) 2017 01 23

(731) BIOFARMA, Société par actions simplifiée
50 rue Carnot F-92284 SURESNES cedex,
France

(540)

ASAPRESTAM

(591) Black, white

(511)

5 – Pharmaceutical and veterinary products; sanitary products for medical purposes; dietetic food and substances for medical or veterinary use, food for babies; food supplements for humans and animals; plasters, materials for dressings; material for dental fillings and dental impressions; disinfectants; products for destroying vermin; fungicides, herbicides.

(260) AM 2018 92107 A

(800) 1343124

(891) 2016 06 17

(731) GERRY WEBER INTERNATIONAL AG
Neulehenstraße 8 33790 Halle, Germany

(540)



(591) Black, white

(531) 27.05.22

(511)

3 – Perfumery; cosmetics; deodorants for personal use; soaps; shampoos; hair lotions; after-shave lotions; sunscreen preparations.

9 – Spectacles [optics]; sunglasses; spectacle frames and spectacle cases.

14 – Jewelry; ornaments; clocks; watch bands.

18 – Leather cases; cases of leather or leather board; boxes of leather or leather board; hatboxes of leather; custom luggage tags [leather goods]; purses; pocket wallets; credit card wallets; key cases of leather or imitations of leather; briefcases; attaché cases; traveling trunks and suitcases; vanity cases, not fitted; toiletry bags, vanity cases sold empty, bags, envelopes, pouches of leather for the storage and transport of fashion articles and fashion accessories; jewelry and costume jewelry, cosmetics as well as home accessories [as far as included in this class]; traveling sets [fine leather goods]; umbrellas; parasols; garment bags; rucksacks and bags, in particular handbags [as far as included in this class]; animal skins and hides.

24 – Textile materials, textiles and textile goods, knitted fabric [as far as included in this class]; bed blankets, bed linen and bed clothes; covers for cushions; table covers, tablecloths, table runners and table linen [in any case not of paper], sleeping bag liners; curtains of textile or of plastic; curtains; linings [textile]; home textiles; furniture coverings of plastic or textile; coverings for furniture; place mats [sets], not of paper; quilts, bed covers, lap robes; towels of textile, table napkins of textile, handkerchiefs of textile.

25 – Clothing, in particular skirts, dresses, trousers, leggings [trousers], hosiery, blouses, shirts, tops, T-shirts, pullovers, cardigans, blazers, coats, sack coats, jackets, coats; underwear; lingerie, bathing suits, bikinis, bathing trunks, bath robes, belts [clothing]; gloves [clothing]; pocket squares [clothing]; shawls [clothing]; scarfs [clothing]; sleep masks; footwear and parts thereof [as far as included in this class]; soles for footwear; headgear for wear.

26 – Buttons, snap fasteners, hooks and eyes [haberdashery] as well as needles; zippers; zip pullers; ribbons and laces; lace and embroidery.

35 – Demonstration of goods for advertising purposes; advertising; online advertising on a computer network; retail and wholesale services [including via teleshopping programs] as well as online and catalogue mail-order services for the following goods: perfumery, cosmetics, deodorants for personal use, soaps, shampoos, hair lotions, after-shave lotions, sunscreen preparations, shavers [including cases], razors, razor blades, shaving cases, blade sharpening instruments, nail files, nail scissors, both individually and combined to form a set, tongs, knives, scissors, manicure sets, cutlery, forks and spoons, also made of precious metal as well as silver-plated, learning-to-eat and children's cutlery, hand-operated tools, as far as included in class 8, spectacles [optics], sunglasses, spectacle frames and spectacle cases, lighting apparatuses, [electric] lamps, lamp shades [including holders], sockets for electric lights, suspension rails [not electrified] for lamps, sanitary apparatus and installations, pocket searchlights, bed warmers, electric blankets, hot water bottles, jewelry, ornaments, clocks, watch bands, paper, cardboard [card], printed matter, photographs, stationery, wrapping materials made of paper or of plastic, as far as not included in other classes, albums, calendars, notebooks, pencil cases, seals and sealing wax, stamp and stamp pad, writing paper, books, newspapers and periodicals, magazines, office requisites except furniture, pictures of wood or plastic, leather cases, cases of leather or leather board, boxes of leather or leather board, hatboxes of leather, custom luggage tags [leather goods], purses, pocket wallets, credit card wallets, key cases of leather or imitations of leather, briefcases, attaché cases, traveling trunks and suitcases, vanity cases, not fitted, toiletry bags, vanity cases sold empty, bags, envelopes, pouches of leather for the storage and transport of fashion articles and fashion accessories, jewelry and costume jewelry, cosmetics as well as home accessories [as far as included in class 18], traveling sets [fine leather goods], umbrellas, parasols, garment bags, rucksacks and bags, in particular handbags [as far as included in class 18], animal skins and hides, mirrors, furniture, frames, works of art made of wood, plaster, plastic or wax, boxes of wood or plastic, picture frames, clothes hangers and clothes hooks, not of metal [furnishing items], mannequins and tailors' dummies, coatstands [furniture], curtain rods, hooks and rings, garment covers [storage], mattresses, air mattresses and inflatable pillows [in each case not for medical purposes], sleeping bags for sports and camping, corks for bottles and bottle closures and stoppers [in any case not of metal], space dividers [furniture], indoor window blinds (roll-up curtains) of wood or bamboo, wickerwork, high chairs for babies, security closures and protectors for furniture, in particular drawer locks, drawer stops, corner beads, door stops, window and refrigerator locks [afore-mentioned goods]

not of metal], shaving brushes, clothing stretchers, brushes [as far as included in class 21], in particular for cleaning of garments and footwear as well as for personal care and cosmetic use, flasks, glassware, trouser presses, trouser stretchers, insulating flasks, insulated containers for beverages, insulated containers for food, combs, comb cases, corkscrews, tie presses, picnic baskets [including dishes], polishing gloves, polishing leather, shaving brush stands, basting spoons, shoe horns, shoe trees, soap dispensers, boot jacks, drinking vessels, drinking glasses, tooth brushes, textile materials, textiles and textile goods, knitted fabric [as far as included in class 24], bed blankets, bed linen and bed clothes, covers for cushions, curtains of textile, curtains, home textiles, furniture coverings of plastic or textile, place mats [sets], not of paper, quilts, bed covers, lap robes, towels of textile, table napkins of textile, handkerchiefs of textile, clothing, in particular skirts, dresses, trousers, leggings [trousers], hosiery, blouses, shirts, tops, T-shirts, pullovers, cardigans, blazers, coats, sack coats, jackets, coats, underwear, lingerie, bathing suits, bikinis, bathing trunks, bath robes, belts [clothing], gloves [clothing], pocket squares [clothing], shawls [clothing], scarfs [clothing], sleep masks, footwear and parts thereof [as far as included in class 25], soles for footwear, headgear for wear, buttons, snap fasteners, hooks and eyes [haberdashery] as well as needles, zippers, zip pullers, ribbons and laces, lace and embroidery, games, gymnastic and sporting articles, as far as not included in other classes, golf club bags, golf gloves, billiard balls, billiard cues, billiard tables, board games, parlor games, golf clubs, golf bags, with or without wheels, playing cards, nordic walking poles, chess games, skis, snowboards, bags especially designed for sports equipment, tennis rackets.

41 – Sporting and cultural activities; entertainment; presentation of live performances; party planning [entertainment]; organization of sports competitions; providing online electronic publications, not downloadable; modelling for artists; production of films and radio programs; publication of printed matter, filed on electronic storage media, in particular CDs and DVDs; production of sound and image recordings, on machine readable data storage media, in particular on videotapes, CDs and DVDs, writing of texts; rental of motion pictures and video films; exhibition of motion pictures and video films; publication and editing of books, newspapers and periodicals; creating animated cartoons.

45 – Granting of licenses relating to franchising concepts; licensing of computer software; granting of licenses relating to industrial property rights and copyrights, in particular to trademark rights; trading with film, TV and video licenses; administration of copyrights; rental of dresses and costumes.

(260) AM 2018 92131 A
 (800) 1342609
 (891) 2016 12 21
 (731) PUBLIC JOINT STOCK COMPANY
 GAZPROM NEFT
 Galernaya Ul, 5, Lit A, RU-190000
 St-Petersburg, Russian Federation

(540)



(591) Grey, black, orange, beige, blue, white.
 (531) 25.01.01; 25.07.03; 25.07.04; 26.11.12;
 27.05.17; 27.05.21; 29.01.14

(511)

4 – Benzene; gasoline; producer gas; solidified gases [fuel]; oil-gas; fuel gas; gas for lighting; fuel; diesel oil; additives, non-chemical, to motor fuel; cutting fluids; industrial grease; lubricating oil; industrial oil; motor oil; lubricating grease; petroleum, raw or refined; biodiesel fuel; jet biofuel; dust absorbing compositions; anthracite; benzol; wood briquettes; combustible briquettes; petroleum jelly for industrial purposes; wax [raw material]; ozocerite [ozokerite]; illuminating wax; industrial wax; belting wax; carnauba wax; beeswax; firewood; paper spills for lighting; fish oil, not edible; illuminating grease; grease for leather; grease for footwear; tallow; kerosene; coke; xylene; xylol; ligroin; wood spills for lighting; mazut; fuel oil; oils for paints; oils for releasing form work [building]; oil for the preservation of masonry; oil for the preservation of leather; textile oil; moistening oil; coal tar oil; coal naphtha; castor oil for industrial purposes; bone oil for industrial purposes; rape oil for industrial purposes; lubricants; naphtha; nightlights [candles]; oleine; paraffin; dust removing preparations; soya bean oil preparations for non-stick treatment of cooking utensils; non-slipting preparations for belts; coal dust [fuel]; firelighters; perfumed candles; Christmas tree candles; candles; grease for arms [weapons]; grease for belts; vaporized fuel mixtures; dust binding compositions for sweeping; dust laying compositions; alcohol [fuel]; methylated spirit; stearine; lighting fuel; mineral fuel; carburants; fuel with an alcoholic base; peat [fuel]; peat briquettes [fuel]; tinder; lignite; charcoal [fuel]; coal; coal briquettes; lamp wicks; wicks for candles; ceresine; electrical energy; ethanol [fuel]; petroleum ether; sunflower oil for industrial purposes.

37 – Drilling of deep oil or gas-wells; drilling of wells; retreading of tires [tyres]; vulcanization of tires [tyres] [repair]; anti-rust treatment for vehicles; vehicle maintenance; vehicle polishing; motor vehicle maintenance and repair; construction; asphaltting; rebuilding engines that have been worn or partially

destroyed; rebuilding machines that have been worn or partially destroyed; building sealing; linen ironing; pressing of clothing; disinfecting; rat exterminating; mining extraction; refilling of toner cartridges; knife sharpening; building insulating; repair information; construction information; bricklaying; riveting; construction consultancy; varnishing; re-tinting; scaffolding; road paving; window cleaning; vehicle washing; building construction supervision; upholstery; renovation of clothing; rustproofing; sanding; pumicing; paper hanging; painting or repair of signs; cleaning of buildings [exterior surface]; vehicle breakdown repair services; rental of bulldozers; rental of road sweeping machines; rental of cleaning machines; rental of cranes [construction equipment]; rental of construction equipment; rental of excavators; plumbing; masonry; roofing services; painting, interior and exterior; carpentry services; underwater repair; plastering; quarrying services; repair of security locks; umbrella repair; parasol repair; burner maintenance and repair; film projector repair and maintenance; airplane maintenance and repair; safe maintenance and repair; clock and watch repair; pump repair; upholstery repair; shoe repair; clothing repair; photographic apparatus repair; furniture restoration; restoration of musical instruments; restoration of works of art; vehicle lubrication [greasing]; demolition of buildings; warehouse construction and repair; vehicle service stations [refuelling and maintenance]; washing; washing of linen; pipeline construction and maintenance; pier breakwater building; underwater construction; harbour construction; factory construction; building of fair stalls and shops; shipbuilding; cleaning of buildings [interior]; street cleaning; vermin exterminating, other than for agriculture; artificial snow-making services; laundering; installation of doors and windows; irrigation devices installation and repair; elevator installation and repair; heating equipment installation and repair; burglar alarm installation and repair; furnace installation and repair; telephone installation and repair; air conditioning apparatus installation and repair; fire alarm installation and repair; freezing equipment installation and repair; electric appliance installation and repair; kitchen equipment installation; installation, maintenance and repair of computer hardware; machinery installation, maintenance and repair; office machines and equipment installation, maintenance and repair; interference suppression in electrical apparatus; swimming-pool maintenance; furniture maintenance; chimney sweeping; boiler cleaning and repair; cleaning of clothing; dry cleaning; vehicle cleaning; diaper cleaning; leather care, cleaning and repair; fur care, cleaning and repair.

(260) AM 2018 92133 A
 (800) 1342641
 (891) 2016 05 10

(731) SAFE IP S.A., société anonyme
 11, Avenue Emile Reuter L-2420, Luxembourg
 (540)



L'esprit industriel

(591) Gray, blue and white.
 (531) 26.04.04; 26.04.06; 26.04.22; 27.05.01;
 29.01.13
 (511)

6 – Common metals and their alloys; building materials of metal; transportable buildings of metal; materials of metal for railway tracks; non-electric cables and wires of metal; ironmongery and small items of metal hardware; pipes of metal; safes; ores, casting alloys, cast iron, projection screens of metal.

7 – Compressed air machines; belts for machines; packaging machines; filters (parts of machines); foundry machines; milling machines; washing apparatus; handling machines (loading and unloading); metalworking machines, metal-shaping machines; grinding machines; loading bridge (machines); roller bridges (machines); planing machines; electric welding machines; gas-operated welding apparatus; electric welding apparatus; electrical apparatus for sealing plastic packages; electric apparatus for welding; electric arc welding apparatus; machine tools; motors and engines (other than for land vehicles); machine couplings and transmission components (other than for land vehicles); agricultural implements other than hand-operated; incubators for eggs, withdrawal of the covered product by piston segments, brake segments other than for vehicles; piston segments; machines for carrying; gaskets (parts of machines); joints (parts of engines); machines and machine tools for the assembly, badge affixing, welding, injection molding and extrusion of plastic components; molds (parts of machines); couplings for machine tools; tools (parts of machines); buckets for machines; industrial hammers (machines); mechanical shears (machines).

11 – Apparatus for lighting, heating, steam generation, cooking, refrigerating, drying, ventilation, water supply and sanitary installations, incinerators, particularly for household waste, ovens, excluding ovens for experiments, loading apparatus for ovens, oven fittings, oven linings, cooling trays, loading supports for furnaces, oven linings, electrically heated carpets.

12 – Vehicles; apparatus for locomotion by land, air or water; brake segments for vehicles; automobiles, caps for vehicle fuel tanks, safety belts for vehicle seats, housings for vehicle safety belts; air bags (sa-

fety devices for automobiles); cases, covers and shells for air bags (safety devices for automobiles) for vehicles; control buttons for vehicles, front panels for vehicle dashboards; safety seats for children, for vehicles; hub caps, direction signals for vehicles, vehicle bumpers, rear-view mirrors and rear-view mirror housings, vehicle seats, headrests for vehicle seats, ski carriers for cars, vehicle convertible tops, luggage carriers for vehicles, steering wheels, components and subassemblies made of plastic for vehicle safety devices; control levers for vehicles; special panniers for two-wheel vehicles.

14 – Precious metals and their alloys.

17 – Semi-processed plastics, semi-processed plastics for making components for vehicles; clutch linings, connecting hoses for vehicle radiators, plastic pipes for air bags (safety devices for automobiles); water-tight rings; metal sealing rings; parts not included in other classes of plastics in extruded form for automobile applications; water-tight rings.

19 – Non-metal foundry molds, namely molds for plastics used for making vehicle components.

26 – Ornamental badges for affixing to plastic components.

40 – Treatment of materials, treatment and selection of waste, recycling of waste; treatment of metals for purposes of metal shielding, metal treatment; water treatment; recycling of batteries; assembling of products for the benefit of others.

(260) AM 2018 92134 A

(800) 1342649

(891) 2016 12 19

(731) BITTO S.R.L.

Via Risorgimento, 10 I-20017 Rho (MI), Italy

(540)



(591) Bordeaux and beige

(531) 26.04.22; 27.05.15; 27.05.25; 29.01.12

(511)

18 – Leather and imitations of leather; fur; artificial fur; animal skins; bags; handbags; briefcases; document cases; waist packs; shopping bags; backpacks; school rucksacks; schoolbags; wallets; purses; key cases of leather or imitation of leather; pouches for holding keys, make-up and other personal items; tro-

ley bags; travelling bags; trunks and suitcases; luggage tags of leather or imitation leather; vanity cases sold empty; parts and accessories for all the aforesaid goods included in this class.

25 – Furs being clothing; blousons; heavy jackets; overcoats; coats; parkas; mantles; ponchos; jackets being clothing; gilets; trousers; jeans; blazers; skirts; dresses; men's suits; sweatshirts; shirts; sweaters; tops being clothing; T-shirts; polo shirts; blouses; pullovers; turtlenecks; neckties; cardigans; shorts; salopettes; waist belts; leggings; shawls; foulards being clothing; scarves; stoles; gloves being clothing; muffs being clothing; socks; belts for clothing; hats; caps; fur hats; bandanas; headbands for clothing; shoes; clothing and headgear made of fur, artificial fur, leather, imitation leather or suede; clothing and headgear made of fur, artificial fur, leather, imitation leather or suede combined with fabric or knitted fabric; parts and accessories for all the aforesaid goods included in this class.

(260) AM 2018 92136 A

(800) 1342669

(891) 2017 01 11

(731) COVESTRO DEUTSCHLAND AG

Kaiser-Wilhelm-Allee 60 51373 Leverkusen,
Germany

(540)

LENSAVIS

(591) Black, white

(511)

1 – Chemicals used in industry; unprocessed artificial resins; unprocessed plastics; adhesives used in industry; unprocessed synthetic casting resins for the manufacture of optical lenses and lens blanks.

9 – Optical lenses and lens blanks.

(260) AM 2018 92147 A

(800) 1342293

(891) 2016 11 23

(731) HUAWEI TECHNOLOGIES CO., LTD.

Administration Building Huawei Technologies
Co., Ltd. Bantian, Longgang District, Shenzhen,
China

(540)

GOWI

(591) Black and white

(531) 27.05.17

(511)

9 – Mobile phones; smartphones; smartglasses; smartwatches; wearable activity trackers; tablet computers; selfie sticks (hand-held monopods); holograms; connected bracelets (measuring instruments); protective films adapted for computer screens; covers for smartphones; cases for smartphones;

network communication equipment; computer memories; audio and video receivers; portable media players; computers; notebook computers; computer hardware; modems; measuring instruments; video recorders; camcorders; protective films adapted for screens for mobile phones; mobile power source (rechargeable batteries); electric batteries; loudspeakers; cabinets for loudspeakers; switchboards, electric switching apparatus; headphones; earphones; magnetic encoded identification bracelets; personal stereos.

(260) AM 2018 92148 A

(800) 1342312

(891) 2017 02 20

(731) Aktsionernoe Obshchestvo
"NIZHEGORODSKY KHIMIKO-FARMA-
TSEVTICHESKY ZAVOD"
Salganskaya St., 7, RU-603950 Nizhny
Novgorod, Russian Federation

(540)

TRANEXAM

(591) Black and white

(531) 27.05.17

(511)

5 – Pharmaceutical tablets, capsules, injection solutions for prevention and treatment of hemorrhages caused by a general or local increase in fibrinolysis, hemophilia, bleeding complications caused by a fibrinolytic therapy, idiopathic thrombocytopenic purpura, aplastic anaemia, leukaemia, bleeding during operations and postoperative period, uterine (child-birth), pulmonary, nasal, gastrointestinal, menorrhagia and metrorrhagia, macrohematuria caused by a lower urinary tract bleeding, aphthous stomatitis, quinsy, laryngopharyngitis, hereditary angioedema, eczemas, allergic dermatitis, nettle rash, drug and toxic skin eruptions.

(260) AM 2018 92150 A

(800) 1342336

(891) 2016 11 23

(731) HUAWEI TECHNOLOGIES CO., LTD.
Administration Building, Huawei Technolo-
gies Co., Ltd., Bantian, Longgang District
Shenzhen, China

(540)

HUAWEI C9

(591) Black and white

(531) 27.05.01; 27.07.01

(511)

9 – Mobile phones; smartphones; cellular phones; smartglasses; smartwatches; wearable activity trackers; tablet computers; selfie sticks (hand-held monopods); holograms; connected bracelets (measuring instruments); protective films adapted for computer

screens; protective films adapted for screens for mobile phones; covers for smartphones; cases for smartphones; smart cards (integrated circuit cards); integrated circuit cards (smart cards); laptop computers; network communication equipment; computer memories; audio and video receivers; portable media players; computers; notebook computers; computer hardware; modems; measuring instruments; video recorders; camcorders; cameras (photography); mobile power source (rechargeable batteries); electric batteries; loudspeakers; cabinets for loudspeakers; switchboards, electric switching apparatus; headphones; earphones; magnetic encoded identification bracelets; personal stereos.

(260) AM 2018 92152 A

(800) 1342363

(891) 2017 01 23

(731) MMag. Dr. Jakob Margreiter, LL.M.

Höhenstraße 42a A-6020 Innsbruck, Austria

(540)

DUCATUS

(591) Black and white

(511)

35 – Advertising services relating to financial services; presentation of financial products on communication media, for retail purposes.

36 – Computerised financial services; conducting of financial transactions on-line; financial consulting; financial and monetary services, and banking; banking and financing services; conducting of financial transactions.

(260) AM 2018 92153 A

(800) 1342441

(891) 2017 01 25

(731) ALBRECHT JUNG GMBH & Co. KG

Volmestraße 1 58579 Schalksmühle,

Germany

(540)



(591) Black and white

(531) 26.04.22; 26.04.24; 27.05.02

(511)

9 – Electric connectors, in particular electric connection devices, couplings, adapters, electric sockets, plugs, terminals for electric cables; branch boxes (electricity); junction boxes (electricity); antennas; switchboards; alarms and alarm systems; indicators (electric/electronic); adapted covering plates for covering of electro-technical and electronic apparatus for home and building technology; limiters (electricity); computer programs, recorded; computer sof-

ware (recorded); inductor coils; anti-interference devices (electricity); remote control devices; fire alarms; electric/electronic devices/apparatus, for home and building technology, connected using wireless and/or cable technology, in particular via an installation bus system, and for transmitting commands to modulate regulating, control, checking (supervision), measuring, transmission and recording devices/apparatus; interfaces, in particular for home automation and building technology; couplers (data processing equipment); optical lamps; light emitting diodes (leds); light regulators, light signalling apparatus, in particular dimmers; photometers; regulating, control, checking (supervision), measuring, monitoring, switching and recording devices/apparatus, in particular for home automation and building technology; electric/electronic switches, in particular installation switches, built-in switches for devices, toggle switches, rocker switches, rotary switches, press-button switches, touch contacts, pull switches, slide switches and multiple-circuitbreakers; control consoles and panels (electricity); transmitters of electric and electronic signals; smart cards [integrated circuit cards]; coils (electric and electromagnetic); electrical controls; rectifiers; converters, electric; sensors for detecting movements (movement indicators), sounds, brightness, gases, smoke, temperature and other physical variables for home automation and building technology, in particular for the control of lighting, room and building surveillance; electric/electronic transformers (combinational circuit parts); distribution boxes and boards (electricity); time switch apparatus, in particular for controlling electric devices, lighting devices, blinds, roller blinds.

11 – Lighting apparatus and installations; lighting apparatus utilising light emitting diodes (leds); lamps (electric and electronic); light diffusers; protective casings for lighting [parts of lighting apparatus].

37 – Installation, maintenance and repair of electrical apparatus (servicing).

(260) AM 2018 92154 A
(800) 1342454
(891) 2016 12 22
(731) Nemiroff Intellectual Property
Establishment
Städtle 31 FL-9490 Vaduz,
Liechtenstein

(540)



(591) Red, pink, black, white grey, silver and golden
(531) 24.05.07; 25.01.15; 27.05.24; 29.01.14

(511)
33 – Alcoholic beverages (except beers).

(260) AM 2018 92162 A
(800) 142345
(891) 2017 04 18
(731) Record Watch Co. SA c/o Compagnie des
Montres Longines, Francillon SA
CH-2610 Saint-Imier, Switzerland

(540)

RECORD

(591) Black, white
(511)
14 – Components of timepieces of all kinds and their parts.

(260) AM 2018 92168 A
(800) 607752
(891) 2017 04 19
(731) S.I.F.I. S.p.A.
Via Ercole Patti, 36 I-95020 Lavinaio (CT), Italy

(540)

EYESTIL

(591) Black, white
(511)
5 – Pharmaceutical products.

(260) AM 2018 92170 A
(800) 974513
(891) 2017 04 07
(731) APPLE INC.
1 Infinite Loop, Cupertino, CA 95014-2084,
United States of America

(540)

SAFARI

(591) Black, white
(511)
9 – Internet browser software; downloadable internet browser software.

(260) AM 2018 92197 A
(800) 1342796
(891) 2016 09 23
(731) ŠKODA AUTO a.s.
tř. Václava Klementa 869,CZ-293 01 Mladá
Boleslav II, Czech Republic

(540)



(591) Black, white, green
 (531) 18.01.05; 27.03.01; 27.03.15; 29.01.13
 (511)
 25 – Clothing.

28 – Toys and games, hand-held computers games, sport's equipment and articles, included in this class.

35 – Advertisement, advertising activities and services.

41 – Education, educational services, entertainment sport and cultural activities.

(260) AM 2018 92278 A
 (800) 1344017
 (891) 2016 11 09
 (731) GEELY HOLDING GROUP CO., LTD.
 1760 Jiangling Road, Binjiang District,
 Hangzhou, Zhejiang, China
 (540)



(591) Black, white
 (531) 07.03.02; 26.07.19; 26.07.25
 (511)
 12 – Vehicles for locomotion by land, air, water or rail; electric vehicles; automobiles; automobile chassis; propulsion mechanisms for land vehicles; gear boxes for land vehicles; motorcycles; mobility scooters; tires for vehicle wheels; seat covers for vehicles.

37 – Machinery installation, maintenance and repair; installation and repair of air conditioning apparatus; motor vehicle maintenance and repair; disinfecting of vehicles; vehicle service stations, namely, refuelling and maintenance; emergency roadside assistance services, namely, responding to calls for roadside assistance, flat tire changing, emergency fuel supplying, and battery jump starting; varnishing; repair of tires [tyres]; Burglar alarm installation and repair.

(260) AM 2018 92286 A
 (800) 1112929
 (891) 2017 03 07
 (731) ALMIRALL, S.A.
 Ronda General Mitre, 151, E-08022
 Barcelona, Spain

(540)
SKILARENCE

(591) Black, white
 (511)
 5 – Pharmaceutical preparations.

(260) AM 2018 92287 A
 (800) 1121414
 (891) 2017 04 23
 (731) B.C. STRATEGY LTD.
 3 Mazeh Street, 6521311 Tel-Aviv, Israel
 (540)

BLACK CUBE

(591) Black, white
 (511)
 35 – Business management, business administration; business development; business and personal consulting services, development, marketing and sales promotion consulting; all included in this class.

(260) AM 2018 92289 A
 (800) 1191718
 (891) 2017 04 24
 (731) ADAMA AGAN LTD.
 Northern Industrial Zone 77102 Ashdod (IL),
 Israel
 (540)



(591) Black, white
 (531) 26.03.02; 26.03.06
 (511)
 1 – Chemicals used in agriculture, horticulture and forestry; manures; plant growth regulators.
 5 – Pesticides, herbicides, insecticides, fungicides, nematocides, parasiticides.
 44 – Agriculture, horticulture and forestry services.

(260) AM 2018 92290 A
 (800) 1344056
 (891) 2017 02 14
 (731) CELGENE CORPORATION
 86 Morris Avenue, Summit NJ 07901,
 United States of America
 (540)

RYBLOZEL

(591) Black, white
(531) 27.05.01; 27.05.17
(511)

5 – Pharmaceutical preparations for use in the treatment of beta thalassemia and myelodysplastic syndromes, autoinflammatory disease, autoimmune disease, blood disease, cancer, arthritis, musculoskeletal and skin diseases in the fields of oncology, immunology and inflammation; pharmaceutical preparations, namely, cytokine inhibitory drugs; pharmaceutical preparations that modulate the immune system.

(260) AM 2018 92291 A
(800) 1242113
(891) 2017 04 20
(731) INVICTA GROUP

Zone Industrielle -, LIEUDIT LA GRAVETTE, F-08350 DONCHERY, France

(540)

CHASSEUR

(591) Black, white
(511)

11 – Apparatus for heating, steam generating, cooking, drying; barbecues; electric cooking plates; cookers (cooking stoves); cooking rings; ovens; rotisseries.

21 – Household and kitchen utensils and containers; non-electric cooking utensils; glassware, porcelain and earthenware; kitchen utensils of cast iron; kitchen containers of cast iron; trivets (table utensils); cooking pot sets; stew-pans; cauldrons; non-electrically heated hot pots; frying pans; earthenware saucepans; pots; pressure cookers; cookery molds; heat-insulated containers; grills (cooking utensils); cooking pots; woks; soup bowls; bowls [basins]; dishes; services (dishes); fitted picnic baskets (including dishes).

(260) AM 2018 92292 A
(800) 1243780
(891) 2017 01 30
(731) CAFFITALY SYSTEM S.p.A.

Via Panigali, 38-38A, I-40041 Gaggio Montano (Bologna), Italy

(540)

CAFFITALY

(591) Black, white
(511)

11 – Electric coffee machines; electric coffee pots; electric coffee percolators.

30 – Coffee, coffee extracts and preparations for making beverages [coffee based]; coffee substitutes; tea; tea extracts and preparations for making beverages [tea based]; cocoa and preparations based on

cocoa; chocolate; chocolate based products; sugar; natural sweeteners; honey and honey substitutes.

(260) AM 2018 92293 A
(800) 1344072
(891) 2017 02 21

(731) EUROPEAN CAR AUCTION AND DISTRIBUTION SOLUTIONS
afgekort ECADIS, naamloze vennootschap
Grijpenlaan 19, B-3300 TIENEN, Belgium

(540)



**We sell the best
cars on the web**

(591) Orange, black and white
(531) 27.05.10; 27.05.17; 27.05.19; 29.01.13
(511)

12 – Vehicles; apparatus for locomotion by land; automotive vehicles; motor vehicles; vans [vehicles]; land vehicles; campers [recreational vehicles]; passenger cars; passenger motor cars; light trucks; delivery vans.

35 – Advertising; business management; retail sale and wholesale of vehicles, also via the internet; auctioneering; business investigations; marketing studies; arranging of auctions; auctioning of vehicles, also on the internet; arranging of auction sales; carrying out auction sales; conducting of auction sales; auctioneering provided on the internet; import and export services.

39 – Transport; information in the field of transport; transport by land; arranging transportation of goods; car transport services; vehicle transport services.

(260) AM 2018 92294 A
(800) 1248845
(891) 2017 01 18
(731) SEDICISEI SRL

Via Paolo Da Cannobio, 9, MILANO (IT), Italy

(540)



(591) Black, white
 (531) 14.05.21; 27.03.15
 (511)
 8 – Handbags for woman.

(260) AM 2018 92295 A
 (800) 1262478
 (891) 2016 09 29
 (731) TAXIFY OÜ

Altmetsa põik 1, Laiaküla küla, Viimsi vald,
 EE-74008 Harju maakond (EE), Estonia

(540)

TAXIFY

(591) Black, white
 (511)
 9 – Magnetic data carriers, recording discs; compact discs, dvds and other digital recording media; cash registers, calculating machines, data processing equipment, computers; computer software; computer operating programs, recorded; computer programs [downloadable software]; computer software downloaded from the internet; computer software applications, downloadable; interfaces for computers; downloadable graphics for mobile phones; computer application software for mobile phones, namely, software for electronic booking of taxis, minicabs, and private hire vehicles.

35 – Advertising; business management; business administration; office functions; business intermediary and advisory services in the field of selling products and rendering services; price comparison services; tariff information and advisory services (business information); arranging of commercial and business contacts; procurement of contracts [for others]; administrative processing of purchase orders; telephone order-taking services for others; ordering services for third parties; data processing; compilation of computer databases; systemization of information into computer databases; updating and maintenance of data in computer databases; data search in computer files for others; providing business information, also via internet, the cable network or other forms of data transfer; business analysis; preparing business reports; economic information services for business purposes; provision of sales analyses; business statistical information services; market research and marketing studies; market reporting services; service to assist in establishing a network of business contacts; loyalty, incentive and bonus program services; provision of advertising space, time and media.

39 – Transport; packaging and storage of goods; travel arrangement; taxi services; arranging of transport; transportation information; computerised reservation services relating to the carriage of passengers; transport brokerage; computerised transport informa-

tion services; computerised information services relating to the carriage of passengers; computerised information services relating to travel reservations; provision of information relating to travel routes.

42 – Scientific and technological services and research and design relating thereto; industrial analysis and research services; design and development of computer hardware and software; software as a service [saas]; rental of computer software and programs; rental and maintenance of computer software; providing temporary use of on-line, non-downloadable software; data warehousing services (electronic data storage); rental of data processing equipment and computers; providing information, advice and consultancy services in the field of computer software; advisory services relating to man-machine interfaces for computer software; advisory services relating to the rental of computers or computer software.

(260) AM 2018 92296 A

(800) 1344080

(891) 2017 01 25

(731) ALBRECHT JUNG GMBH & CO. KG

Volmestraße 1,58579 Schalksmühle, Germany

(540)

JUNG

(591) Black, white

(531) 27.05.02

(511)

9 – Electric connectors, in particular electric connection devices, couplings, adapters, electric sockets, plugs, terminals for electric cables; branch boxes (electricity); junction boxes (electricity); antennas; switchboards; alarms and alarm systems; indicators (electric/electronic); adapted covering plates for covering of electro-technical and electronic apparatus for home and building technology; limiters (electricity); computer programs, recorded; computer software (recorded); inductor coils; anti-interference devices (electricity); remote control devices; fire alarms; electric/electronic devices/apparatus, for house and building technology, connected using wireless and/or cable technology, in particular via an installation bus system, and for transmitting commands to modulate regulating, control, checking (supervision), measuring, transmission and recording devices/apparatus; interfaces, in particular for home automation and building technology; couplers (data processing equipment); optical lamps; light emitting diodes (LEDs); light regulators, light signalling apparatus, in particular dimmers; photometers; regulating, control, checking (supervision), measuring, monitoring, switching and recording devices/apparatus, in particular for home automation and build-

ding technology; electric/electronic switches, in particular installation switches, built-in switches for equipment, toggle switches, rocker switches, rotary switches, press-button switches, touch contacts, pull switches, slide switches and multiple-circuit breakers; control consoles and panels (electricity); transmitters of electric and electronic signals; smart cards [integrated circuit cards]; coils (electric and electromagnetic); electrical controls; rectifiers; converters, electric; sensors for detecting movements (movement indicators), sounds, brightness, gases, smoke, temperature and other physical variables for home automation and building technology, in particular for the control of lighting, room and building surveillance; electric/electronic transformers (combinational circuit parts); distribution boxes and boards (electricity); time switch apparatus, in particular for controlling devices, lighting devices, blinds, roller blinds.

11 – Lighting apparatus and installations; lighting apparatus utilising light emitting diodes (LEDs); lamps (electric and electronic); light diffusers; protective casings for lighting [parts of lighting apparatus].

37 – Installation, maintenance and repair of electrical apparatus (servicing).

(260) AM 2018 92297 A

(800) 1304467

(891) 2017 01 13

(731) Joint Stock Company "TAKF"
ul. Oktyabrskaya, d. 22, RU-392000 Tambov,
Russian Federation

(540)

МОРЕХОД

(591) Black, white

(511)

30 – Confectionery, namely sweetmeats [candy]; chocolate; pralines; fondants [confectionery]; pastries; waffles; gingerbread; crackers.

(260) AM 2018 92299 A

(800) 1327865

(891) 2017 01 17

(731) HEYNER GMBH
Kurzer Weg 1-5, 15859 Storkow, Germany

(540)

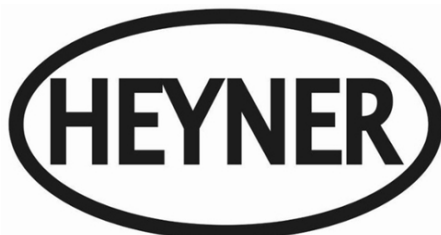

(591) Black, white

(531) 26.01.02; 26.01.20; 27.05.17

(511)

1 – Coolants for vehicle engines; anti-boil preparations for engine coolants; chemical additives to motor fuel; antifreeze; chemical additives for oils.

2 – Anti-rust preparations for preservation.

3 – Detergents; windshield cleaning liquids; air fragrancing preparations.

6 – Locks and keys.

9 – Fire extinguishing apparatus for automobiles; battery chargers; fuses; batteries; speedometers; speed indicators; alcohol testing apparatus.

11 – Vehicle lighting installations; lamps for motor land vehicles; ventilation [air-conditioning] installations for vehicles.

12 – Parts and fittings for vehicles; windscreen wipers; seat covers for vehicles; children's car seats.

(260) AM 2018 92300 A

(800) 1331134

(891) 2016 03 16

(731) RIGO TRADING S.A.
Route de Trèves 6 EBBC, Building E L-2633
Senningerberg, Luxembourg

(540)

CRUSHER

(591) Black, white

(511)

30 – Soft chew candy, fruit bubble gum.

(260) AM 2018 92301 A

(800) 1344105

(891) 2017 03 06

(731) YILDIZ HOLDİNG ANONİM ŞİRKETİ
Kisikli Mah. Çeşme Çikmazi Sokak
No:6/1, Üsküdar, İstanbul, Turkey

(540)



(591) Black, white, zed, bzown

(531) 01.15.15; 08.01.09; 08.01.19; 19.03.05;
19.03.25; 27.05.02; 27.05.07; 27.05.09;
27.05.10; 29.01.15

(511)

30 – Confectionery, chocolate, biscuits, crackers, wafers; chewing gums; ice-cream, edible ices.

(260) AM 2018 92302 A
 (800) 1344108
 (891) 2017 03 21
 (731) BIOVERATIV THERAPEUTICS INC.
 225 Second Avenue Waltham MA 02451,
 United States of America

(540)
The logo for Bioverativ features the word "Bioverativ" in a bold, purple, sans-serif font. To the right of the text is a stylized graphic consisting of three horizontal bars of varying lengths, colored blue, red, and blue from top to bottom.

(591) The color(s) blue, purple, and red is/are
 claimed as a feature of the mark.
 (531) 26.04.04; 26.04.09; 26.11.08; 27.05.01;
 29.01.13
 (511)
 42 – Pharmaceutical drug development services.

(260) AM 2018 92305 A
 (800) 1344128
 (891) 2016 09 29
 (731) COMPAGNIE GERVAIS DANONE, Société
 Anonyme
 17 Boulevard Haussmann F-75009 PARIS,
 France
 (540)



(591) Green, gold.
 (531) 26.04.03; 26.04.07; 29.01.12
 (511)
 29 – Milk, powdered milks, flavored jellified milks
 and whipped milk products; dairy products particu-
 larly: desserts based on milk, yogurts, drinking
 yogurts, soft white cheese, petit suisse cheese; bever-
 ages mainly consisting of milk or dairy products,
 milk beverages with milk predominating, milk bever-
 ages containing fruits; unflavored or flavored fer-
 mented dairy products; milk ferments for culinary
 use.

30 – Cocoa, chocolate, cocoa-based beverages, cho-
 colate-based beverages, coffee-based beverages, tea-
 based beverages; custard; chocolate mousses, dessert
 mousses [confectionery], confectionery, sugar con-
 fectionery, sugar, puffed rice, preparations made
 from cereals, breakfast cereals; biscuits (sweet or
 savory); cakes; pastries; waffles; cereal-based des-
 serts; rice cakes; semolina cakes; rice pudding, rice-
 based snack food, cereal-based snack food; edible

ices, edible ices primarily consisting of yogurt, ice
 creams, sherbets (edible ices), frozen yogurts (edible
 ices), flavored frozen water; fruit coulis [sauces].

32 – Still or sparkling waters (mineral or other), fru-
 it or vegetable juices, beverages with fruits or vege-
 tables, lemonades, soda water, sherbets (beverages),
 preparations for beverages, syrups for beverages,
 vegetable or fruit extracts without alcohol, non-alco-
 holic beverages.

(260) AM 2018 92307 A
 (800) 1344135
 (891) 2016 12 20
 (731) Organisation Internationale de Métrologie
 Légale, Organisation Internationale
 11 Rue Turgot, F-75009 PARIS, France
 (540)



(591) Black, white
 (531) 01.05.02; 01.05.06
 (511)
 35 – Advertising; commercial business management;
 commercial administration; office functions; disse-
 mination of advertising material (leaflets, prospectu-
 ses, printed matter, samples); newspaper subscrip-
 tion services (for others); arranging subscriptions to
 telecommunication services for others; presentation
 of goods on all communication media, for retail sale;
 business management and organization consultancy;
 accounting; document reproduction; employment
 agency services; business management for freelance
 service providers; computerized file management;
 Web site traffic optimization; organization of exhibi-
 tions for commercial or advertising purposes; online
 advertising on a computer network; rental of adverti-
 sing time on all communication media; publication
 of advertising texts; rental of advertising space; dis-
 semination of advertisements; public relations; com-
 pany audits (commercial analyses); commercial in-
 termediation services.

42 – Technical evaluations concerning design (engi-
 neers' services); scientific research; technical rese-
 arch; design of computers for others; development of
 computers; software design; software development;
 research and development of new products for oth-
 ers; technical project study services; architecture;
 design of interior decor; software development (de-
 sign); software installation; software maintenance;
 updating of software; software rental; programming
 for computers; computer system analysis; computer

system design; consultancy in the design and development of computers; digitization of documents; software as a service (SaaS); cloud computing; information technology (IT) consultancy; hosting of servers; vehicle roadworthiness testing; graphic arts design services; styling (industrial design); authentication of works of art; energy auditing; electronic data storage.

45 – Legal services; mediation; security services for the protection of property and individuals; marriage agency services; horoscope casting; undertaking; cremation services; night guards services; monitoring of burglar alarms; security consultancy; opening of security locks; clothing rental; detective agency services; legal research; intellectual property consultancy; online social networking services; baby sitting.

(260) AM 2018 92318 A

(800) 1344195

(891) 2016 10 25

(731) SHANGHAI BAIFENG INVESTMENT CO., LTD

Room 309D, No. 21, Lane 596, Yanan Central Road, Jingan District, Shanghai City, China

(540)

三生花

(591) Black, white

(531) 28.03

(511)

3 – Shampoo; cleaning preparations; laundry glazing; essential oils; cosmetics; toothpaste; incense; cosmetics for animals; air fragrancing preparations; laundry preparations; grinding preparations.

(260) AM 2018 92321 A

(800) 1344209

(891) 2016 12 13

(731) THOLSTRUP CHEESE A/S

Sønderhøj 14, DK-8260 Viby J, Denmark

(540)



(591) Gold

(531) 04.03.01; 25.01.25; 27.05.01; 27.05.17; 27.07.01; 29.01.02

(511)

29 – Milk and milk products, including cheese; edible oils and fats, butter, spreadables (mixed products with butter), blends made of butter and vegetable oil, liquid blends made of butter and vegetable oil.

(260) AM 2018 92323 A

(800) 1344308

(891) 2017 03 08

(731) ASSAN PANEL SANAYİ VE TİCARET ANONİM ŞİRKETİ

E-5 Karayolu Üzeri 32. Km., Assan Tesisleri, Tuzla İSTANBUL, Turkey

(540)



(591) Blue-Light blue.

(531) 26.01.03; 26.01.12; 26.11.03; 27.05.10; 29.01.04

(511)

17 – Rubber, gutta-percha, gum, asbestos, mica or semi-finished synthetic materials made from these materials in the form of powder, panels, bars and foils; Insulation, stopping and sealing materials: insulation paints, insulation fabrics, insulating bands, insulation covers, sealant compounds, gaskets, O-rings (excluding engine and cylinder gaskets).

(260) AM 2018 92324 A

(800) 1344314

(891) 2017 03 10

(731) CHINA TOBACCO HUNAN INDUSTRIAL CO., LTD

No.188, Section 3, Wanjiali Middle Road, Changsha Hunan, China

(540)



(591) Black, white

(531) 24.01.15; 27.05.21; 27.05.22

(511)

34 – Tobacco; chewing tobacco; electronic cigarettes; cigarettes; snuff; tobacco pipes; ashtrays for smokers; matches; lighters for smokers; cigarette filters.

(260) AM 2018 92325 A
 (800) 1344333
 (891) 2016 12 05
 (731) SOCIÉTÉ AIR FRANCE SOCIÉTÉ
 ANONYME
 45 rue de Paris, F-95747 ROISSY-
 CHARLES-DE-GAULLE, France

(540)

AIRFRANCE

(591) Black, white

(531) 27.05.15

(511)

43 – Services for providing food and drink, in-flight provision of food and drink, provision of food and drink on board airplanes, provision of food and drink in airports, temporary accommodation, rental or provision of meeting rooms, waiting rooms, recreation or relaxation areas especially in airports, rental or provision of electric household apparatus, rental of chairs, tables, furniture, table linen, washing or bath linen, glassware, services for restaurants, self-service restaurants, bars, cafés, cafeterias, hotel services, bookings for hotels, restaurants, bars, cafés, self-service restaurants, information services relating to hotel or restaurant services, catering services, preparation and provision of meals, beverages and food products particularly on board airplanes.

(260) AM 2018 92327 A
 (800) 1344416
 (891) 2016 12 20
 (731) Otkrytoe aktsionernoe obshchestvo
 "BORISOVSKY ZAVOD MEDITSINSKIKH
 PREPARATOV"
 ul. Chapaeva 64, Minskaya obl. 222518
 Borisov, Belarus

(540)



(591) Black, white

(531) 02.09.25; 26.02.09; 26.13.25

(511)

5 – Pharmaceutical and veterinary preparations; sanitary preparations for medical purposes; dietetic food and substances adapted for medical or veterinary use, food for babies; dietary supplements for humans and animals; plasters, materials for dressings; material for stopping teeth, dental wax; disin-

fectants; preparations for destroying vermin; fungicides, herbicides.

(260) AM 2018 92401 A

(800) 1344717

(891) 2017 02 14

(731) AFFINITY PETCARE, S.A.

PLAÇA EUROPA 54-56 E-08902
 L'HOSPITALET DE LLOBREGAT
 (Barcelona), Spain

(540)

TRUE INSTINCT

(591) Black and white

(511)

31 – Foodstuffs and fodder for animals; pet food; confectionery for pets.

(260) AM 2018 92402 A

(800) 1344870

(891) 2017 01 27

(731) GUCCIO GUCCIO S.P.A.

Via Tornabuoni, 73/R, I-50123 FIRENZE,
 Italy

(540)

DIONYSUS

(591) Black, white

(531) 27.05.17

(511)

25 – Clothing, footwear, headgear.

(260) AM 2018 92405 A

(800) 1344980

(891) 2017 02 27

(731) MONTRES TUDOR SA

Rue François-Dussaud 3, CH-1211 Genève 26,
 Switzerland

(540)

LONG RANGE

(591) Black, white

(511)

14 – Timepieces, namely watches, wristwatches, component parts of timepieces and accessories for timepieces not included in other classes, clocks and other chronometric instruments, chronometers, chronographs (timepieces), apparatus for timing sports events, time measuring and marking apparatus and instruments not included in other classes; watch bands, dials (clock and watchmaking), cases and presentation cases for timepieces and jewelry, watch movements and their parts; jewelry; precious stones and semi-precious stones; precious metals and their alloys.

(260) AM 2018 92409 A
 (800) 1344749
 (891) 2017 01 18
 (731) HANWHA TECHWIN CO., LTD.
 1204, Changwon-daero, Seongsan-gu,
 Changwon-si Gyeongsangnam-do, Korea
 (Republic of)

(540)
The logo for Wisenet features the word "Wisenet" in a bold, sans-serif font. The letter "i" is stylized with a vertical bar to its left, and the letter "e" has a horizontal bar extending to the right.

(531) 26.03.01; 26.03.05; 26.03.24; 27.05.08;
 27.05.10; 29.01.12

(511)
 9 – Mounting devices for cameras and monitors;
 lenses; cameras; cameras for CCTVs; CCTV camera
 control units; cameras for smartphones; cameras for
 vehicles; video presenter; electronic sensors; optical
 sensors; security surveillance apparatus; battery
 charging apparatus for camera/digital camera; closed
 circuit television adapters; batteries for cameras;
 electric batteries; video recorders and video repro-
 ducing apparatus; CCTV recorders; network video
 recorders; closed-circuit TV; computer software;
 downloadable smart phone application (software);
 monitors; digital signal processing apparatus for mon-
 itoring video based on network; electronic signal
 receiving apparatus for monitoring video based on
 network; security equipment for face recognition;
 cloud server; wearable computers; wearable compu-
 ter peripherals.

(260) AM 2018 92416 A
 (800) 1345020
 (891) 2017 01 20
 (731) FERRERO S.P.A.
 Piazzale Pietro Ferrero,1,I-12051 ALBA,
 CUNEO, Italy

(540)



(591) White, gold, brown and grey
 (531) 08.01.19; 08.01.23; 19.03.03; 29.01.13
 (554) Three-dimensional
 (511)

30 – Pastries; confectionery; chocolate; chocolate
 products; filled wafer; pralines.

(260) AM 2018 92417 A
 (800) 1344840
 (891) 2017 01 23

(731) NAKED JUICE CO OF GLENDORA, INC.
 (CA Corp.)
 1333 S. Mayflower Avenue Monrovia CA
 91016, United States of America

(540)



(591) White, blue, light blue, light green and green
 (531) 05.03.14; 25.03.25; 27.05.08; 27.05.24;
 29.01.13

(511)
 32 – Non-alcoholic beverages; non-alcoholic fruit
 juice beverages; fruit nectars, non-alcoholic; smoot-
 hies; vegetable juices [beverages]; fruit juices.

(260) AM 2018 92426 A
 (800) 1345192
 (891) 2017 02 24
 (731) LABORATOIRES INNOTHERA
 22 avenue Aristide Briand, F-94110
 ARCUEIL, France

(540)

PHLEBODIA
 Флебодиа

(591) Black, white
 (531) 27.05.01; 28.05
 (511)

3 – Cosmetics, particularly cosmetic products in the
 form of creams and gels for the legs.

5 – Pharmaceutical and veterinary products; phar-
 maceutical products namely phlebotonic products.

(260) AM 2018 92427 A
 (800) 1345422
 (891) 2016 04 20
 (731) HU HONGJIA
 No.92, Ximachi Community, Shanxi village,
 Xiangzhu town, Yongkang City, Zhejiang
 province, China

(540)

SALI

(591) Black, white
 (531) 27.05.17
 (511)

7 – Grindstones [parts of machines]; cutting tools
 (including mechanical blades) being parts of ma-

chines; drill bit (machine part); circular saw blade (machine parts); hand tools, other than hand operated; spray gun; carbon brush (electric); pulleys [parts of machines]; agricultural machines; run saw machines.

(260) AM 2018 92428 A

(800) 1345437

(891) 2016 06 22

(731) AYT KUMAŞÇILIK SANAYİ VE DIŞ
TİCARET LIMITED ŞİRKETİ
Aksaray Mahallesi Küçüklanga, Aralığı Cad.
No:19 K:1 Fatih, Istanbul, Turkey

(540)



(591) Black and grey

(531) 26.04.22; 26.04.24; 27.05.01; 27.05.09;
27.05.12; 27.05.13; 27.05.24; 29.01.12

(511)

24 – Woven or non-woven textile fabrics, textile goods for household use, not included in other classes; curtains, bed covers, sheets (textile), pillowcases, bed blankets, quilts, towels, flags, cloth pennants, felt pennants, labels of textile, swaddling blankets.

35 – Advertising, marketing and public relations; organization of exhibitions and trade fairs for commercial or advertising purposes, office functions; secretarial services; arranging newspaper subscriptions for others; compilation of statistics; rental of office machines; systemization of information into computer databases; telephone answering for unavailable subscribers, business management, business administration and business consultancy; accounting; commercial consultancy services; personnel recruitment, personnel placement, employment agencies, import-export agencies; temporary personnel placement services, auctioneering; the bringing together, for the benefit of others, of a variety of goods, namely, woven or non-woven textile fabrics, curtains, bed covers, sheets (textile), pillowcases, bed blankets, quilts, flags, cloth pennants, felt pennants, labels of textile, swaddling blankets, footwear, shoes, slippers, sandals, headgear, hats, caps with visors, berets, caps [headwear], skull caps, laces and embroidery, guipures, festoons, ribbons (haberdashery), ribbons and braid, fastening tapes for clothing, cords for clothing, letters and numerals for marking linen, embroidered emblems, badges for wear, not of precious metal, shoulder pads for clothing carpets, rugs,

mats, linoleum, artificial turf, linoleum for covering floors, gymnasium mats, wallpaper, wall hangings not of textile, bleaching and cleaning preparations, detergents other than for use in manufacturing operations and for medical purposes, laundry bleach, fabric softeners for laundry use, stain removers, dishwasher detergents, perfumery, cosmetics, fragrances, deodorants for personal use and animals, soaps, dental care preparations, dentifrices, denture polishes, tooth whitening preparations, mouth washes, not for medical purposes, surgical gowns and surgical sterile sheets, jewellery, imitation jewellery, gold, precious stones and jewellery made thereof, cufflinks, tie pins, statuettes and figurines of precious metal, clocks, watches and chronometrical instruments, chronometers and their parts, watch straps, unworked or semi-worked leather and animal skins, imitations of leather, stout leather, leather used for linings, goods made of leather, imitations of leather or other materials, designed for carrying items, bags, wallets, boxes and trunks made of leather or stout leather, trunks [luggage], suitcases, umbrellas, parasols, sun umbrellas, walking sticks, whips, harness, saddlery, stirrups, straps of leather (saddlery), furniture, made of any kind of material, mattresses, pillows, air mattresses and cushions, not for medical purposes, sleeping bags for camping, water beds, not for medical purposes, mirrors, beehives, artificial honeycombs and sections of wood for honeycombs, bouncing chairs for babies, playpens for babies, cradles, infant walkers, display boards, frames for pictures and paintings, identification plates, identification tags, nameplates, identification labels made of wood or synthetic materials, packaging containers of wood or plastics, casks for use in transportation or storage, barrels, storage drums, tanks, boxes, storage containers, transportation containers, chests, loading pallets and closures for the aforementioned goods, of wood or plastics, small hardware goods of wood or synthetic materials, furniture fittings, of wood or synthetic materials, opening and closing mechanisms of wood or synthetic materials, ornaments and decorative goods of wood, cork, reed, cane, wicker, horn, bone, ivory, whalebone, shell, amber, mother-of-pearl, meerschaum, beeswax, plastic or plaster, figures, holiday ornaments for walls and sculptures, all made of wood, cork, reed, cane, wicker, horn, bone, ivory, whalebone, shell, amber, mother-of-pearl, meerschaum, beeswax, plastic or plaster, baskets, fishing baskets, kennels, nesting boxes and beds for household pets, portable ladders and mobile boarding, stairs of wood or synthetic materials, bamboo curtains, roller indoor blinds [for interiors], slatted indoor blinds, trip curtains, bead curtains for decoration, curtain hooks, curtain rings, curtain tie-backs, curtain rods, non-metal wheel chocks, ropes, strings, rope ladders, hammocks, fishing nets, tents, awnings, tarpaulins, sails, vehicle covers, not fitted, bags of textile, for packaging, padding and stuffing

materials, except of rubber and plastics, including those of wool and cotton, textile fibers, raw spun fiber, glass fibers for textile use, yarns and threads for textile use, threads and yarns for sewing, embroidery and knitting, thread, elastic yarns and threads for textile use, enabling customers to conveniently view and purchase those goods, such services may be provided by retail stores, wholesale outlets, by means of electronic media or through mail order catalogues.

(260) AM 2018 92429 A
(800) 1345195
(891) 2016 02 17
(731) LA CRISTALLERIE DES PARFUMS
10 rue des Bernardins, F-75005 Paris,
France

(540)
AERIA AURORA

(591) Black, white
(531) 27.05.01
(511)
3 – Perfumes; eau de toilette; eau de parfum; eau de Cologne; soaps; aromatic preparations; deodorants for personal use.

(260) AM 2018 92431 A
(800) 1345324
(891) 2016 07 29
(731) BRUSAFERRI & C. S.R.L.
Viale Premuda,14 I-20129 MILANO (MI), Italy

(540)
Lemi

(591) Black, white
(531) 27.05.01; 27.05.17
(511)
10 – Lamps for medical use; lamps for surgical use; adjustable beds for medical and dental exams; adjustable beds for surgical use; massage beds; armchairs and special chairs for medical, surgical, dental, physiotherapeutic use; mirrors for medical exams and for surgical use; specific furniture for medical, surgical and dental use; cabinets for medical instruments; trays for medical instruments; trolleys for nurses to contain drugs and medicines; electric massagers; massagers for the feet.
20 – Cabinets for drugs and medicines; cabinets with mirrors; cabinets of sink; stools; ergonomic chairs for massage; armchairs for hairdressers/barbers and beauty treatments; massage tables; drawers; boxes for drugs and medicines; carts [furnishings].

(260) AM 2018 92432 A
(800) 1345359
(891) 2017 01 18
(731) MERCK KGAA
Frankfurter Str. 250,64293 Darmstadt,
Germany

(540)
MAVANCLAD

(591) Black, white
(511)
5 – Dietetic preparations adapted for medical use and dietetic food supplements; hygiene preparations and articles for medical purposes; medical and veterinary preparations and articles; pharmaceutical products.

(260) AM 2018 92433 A
(800) 1345521
(891) 2016 06 14
(731) WORLD MEDICINE İLAÇ SANAYİ VE
TİCARET ANONİM ŞİRKETİ
Evren Mah. Camiyolu Cad. No. 50 Kat 1
B Zemin 4-5-6 Günesli / Bağcılar / İstanbul,
Turkey

(540)
ADAKTA-D
АДАКТА-Д

(591) Black, white
(511)
5 – Medicines for human purposes, medicines for veterinary purposes, vitamin preparations, chemical preparations for medical purposes, dietetic substances adapted for medical use; dietetic foods adapted for medical purposes; baby foods, medicinal herbs, herbal beverages adapted for medical purposes, nutritional supplements, pollen dietary supplements, mineral food supplements, protein dietary supplements; dietary supplements for animals; fodder supplements for veterinary purposes; medicines for dental purposes, hygienic products for medical purposes, including sanitary pads, breast-nursing pads and bunion pads, wadding for medical purposes, plasters for medical purposes, dressings for medical purposes, babies' napkins, preparations for destroying noxious plants, preparations for destroying noxious animals, fungicides, deodorants other than for human beings or for animals, air deodorising preparations, disinfectants for hygiene purposes, antiseptics, detergents for medical purposes.

(260) AM 2018 92434 A
 (800) 1345398
 (891) 2017 02 23
 (731) ZHEJIANG CANWELL MEDICAL CO.,
 LTD
 No.466 Xianhua South Street,Wucheng
 District, Jinhua City 321000 Zhejiang
 Province, China

(540)



(591) Black, white
 (531) 26.01.06; 26.11.01; 26.11.12; 27.05.09;
 27.05.10

(526) MEDICAL LTD

(511)

10 – Surgical apparatus and instruments; body reha-
 bilitation apparatus for medical purposes; medical
 apparatus and instruments; apparatus for use in me-
 dical analysis; apparatus for artificial respiration;
 physical exercise apparatus, for medical purposes;
 anaesthetic apparatus; apparatus for use in medical
 analysis; nursing appliances; cushions for medical
 purposes.

(260) AM 2018 92443 A

(800) 882879

(891) 2017 03 02

(731) APPLE INC.

1 Infinite Loop Cupertino, CA 95014,
 United States of America

(540)

FRONT ROW

(591) Black, white

(511)

9 – Remote controllers for audio devices, video de-
 vices and personal computers; computer software for
 controlling the operation of audio and video devices
 and for viewing, searching and/or playing audio, vi-
 deo, television, Internet radio, photographs and other
 digital images, and other multimedia content.

(260) AM 2018 92448 A

(800) 1169975

(891) 2017 02 09

(731) NORDBRAND NORDHAUSEN GMBH

Bahnhofstrasse 25, 99734 Nordhausen,
 Germany

(540)

ECKES

(591) Black, white

(511)

33 – Alcoholic beverages (except beers).

(260) AM 2018 92449 A

(800) 1220559

(891) 2017 05 04

(731) IMMERGAS S.p.A.

Via Cisa Ligure, 95 I-42041 BRESCELLO
 (REGGIO EMILIA), Italy

(540)



(591) Black, white

(531) 01.15.05; 02.01.02; 26.04.04

(511)

9 – Anti-theft devices; smoke detectors and detec-
 tors; sensors in general; diagnostic instruments; sig-
 nalling and alarm instruments; electricity generating
 apparatus utilising solar power; solar panels; solar
 roof tiles and panels; solar energy apparatus, electric
 and electronic, including radios and telephones; sen-
 sors, electronic, for measuring solar radiation; photo-
 voltaic solar modules; photovoltaic cells; photo-
 voltaic roof elements; photovoltaic covering pa-
 nels; photovoltaic hybrid solar-thermal modules; so-
 lar batteries; solar battery chargers.

11 – Apparatus and installations for heating, steam
 generating, cooking, refrigerating, drying, ventila-
 ting, water supply and sanitary purposes; safety ac-
 cessories for water and/or gas apparatus and water
 and/or gas pipes; solar energy heaters; solar energy
 water heater; solar powered torches; solar energy
 lamps; solar heating panels; heating elements; heat
 pumps; boilers and parts therefor.

37 – Installation and repair of boilers and heating ap-
 paratus; installation and repair of solar panel in-
 stallations or photovoltaic installations.

(260) AM 2018 92451 A

(800) 1204756

(891) 2016 12 14

(731) Obshestvo s ogranichennoy otvetstvennostyu
 "ORBITA"

ul. Nijnyaya, 7 RU-125040 Moscow (RU),
 Russian Federation

(540)



(591) White and dark-red

(531) 28.05; 29.01.01

(511)

9 – DVD players; ticket dispensers; coin-operated musical automata [juke boxes]; fire engines; answering machines; accumulators, electric; accumulators, electric, for vehicles; actinometers; alidades; altimeters; ammeters; anemometers; anodes; antennas; anticathodes; apertometers [optics]; high-frequency apparatus; remote control apparatus; electro-dynamic apparatus for the remote control of railway points; electro-dynamic apparatus for the remote control of signals; monitoring apparatus, electric; sound recording apparatus; distillation apparatus for scientific purposes; diffraction apparatus [microscopy]; air analysis apparatus; apparatus to check franking; sound transmitting apparatus; breathing apparatus for underwater swimming; electric apparatus for commutation; intercommunication apparatus; stills for laboratory experiments; projection apparatus; radiological apparatus for industrial purposes; blueprint apparatus; stereoscopic apparatus; telephone apparatus; facsimile machines; phototelegraphy apparatus; igniting apparatus, electric, for igniting at a distance; salinometers; acidimeters for batteries; aerometers; barometers; anode batteries; galvanic batteries; batteries for lighting; solar batteries; batteries, electric; betatrons; binoculars; electronic tags for goods; computer memory devices; fire hose nozzles; encoded identification bracelets, magnetic; safety tarpaulins; signalling buoys; life buoys; marking buoys; directional compasses; vacuum gauges; electrolyzers; variometers; scales; letter scales; precision balances; levelling staffs [surveying instruments]; camcorders; video cassettes; video telephones; video screens; micrometer screws for optical instruments; flashing lights [luminous signals]; apparatus for fermentation [laboratory apparatus]; apparatus and installations for the production of X-rays, not for medical purposes; viscosimeters; circuit closers; wavemeters; voltmeters; mechanical signs; switchboxes [electricity]; current rectifiers; electrical plugs and sockets; gas testing instruments; galvanometers; heliographic apparatus; hygrometers; hydrometers; weights; holograms; plotters; loudspeakers; plumb bobs; range finders; densimeters; densitometers; optical goods; detectors; smoke detectors; counterfeit [false] coin detectors; transparencies [photography]; slide projectors; dictating machines; dynamometers; floppy disks; disks, magnetic; optical discs; circular slide rules; disk drives for computers; DNA chips; electronic notice boards; bullet-proof waistcoats [vests (Am.)]; life jackets; identification threads for electric wires; nose clips for divers and swimmers; bells [warning devices]; alarm bells, electric; electric door bells; signal bells; acoustic conduits; mirrors for inspecting work; road signs, luminous or mechanical; signs, luminous; marine depth finders; probes for scientific purposes; buzzers; needles for record

players; measures; pressure measuring apparatus; simulators for the steering and control of vehicles; inverters [electricity]; pressure indicators; temperature indicators; incubators for bacteria culture; measuring instruments; mathematical instruments; levelling instruments; surveying instruments; azimuth instruments; spark-guards; coaxial cables; fibre [fiber (Am.)] optic cables; cables, electric; calipers; slide calipers; screw-tapping gauges; calculating machines; pocket calculators; decompression chambers; cinematographic cameras; electronic pens [visual display units]; holders for electric coils; identity cards, magnetic; video game cartridges; encoded magnetic cards; riding helmets; carriers for dark plates [photography]; automated teller machines [ATM]; cathodes; choking coils [impedance]; coils, electric; electromagnetic coils; cinematographic film, exposed; computer keyboards; solenoid valves [electromagnetic switches]; electronic agendas; push buttons for bells; magnetic encoders; anti-glare visors; collectors, electric; calibrating rings; protective suits for aviators; commutators; compact discs [audio-video]; comparators; marine compasses; notebook computers; condensers [capacitors]; contacts, electric; battery boxes; cabinets for loudspeakers; reflecting discs for wear, for the prevention of traffic accidents; covers for electric outlets; logs [measuring instruments]; lasers, not for medical purposes; lactodensimeters; lactometers; darkroom lamps [photography]; thermionic tubes; amplifying tubes; flashlights [photography]; head cleaning tapes [recording]; magnetic tapes; videotapes; surveying chains; fire escapes; yardsticks; slide-rules; contact lenses; optical lenses; optical condensers; sounding lines; electricity conduits; measuring spoons; thread counters; magnets; decorative magnets; resuscitation mannequins [teaching apparatus]; pressure gauges; divers' masks; solderers' helmets; protective masks; voting machines; money counting and sorting machines; material testing instruments and machines; megaphones; diaphragms for scientific apparatus; metal detectors for industrial or military purposes; metronomes; rules [measuring instruments]; carpenters' rules; dressmakers' measures; coin-operated mechanisms for television sets; micrometers; microprocessors; microscopes; microtomes; microphones; modems; lightning conductors [rods]; monitors [computer hardware]; junction sleeves for electric cables; teeth protectors; knee-pads for workers; headphones; surveyors' levels; verniers; sound recording carriers; optical data media; socks, electrically heated; mouse [computer peripheral]; magnifying glasses [optics]; mouse pads; sheaths for electric cables; identification sheaths for electric wires; weighing machines; punched card machines for offices; lenses for astrophotography; egg-candlers; fire extinguishers; electrified fences; clothing for protection against accidents, irradiation and fire; clothing for protection against fire; asbestos clothing for protec-

tion against fire; clothing especially made for laboratories; ozonisers [ozonators]; octants; eyepieces; ohmmeters; spectacle frames; eyeglass frames; oscillographs; plumb lines; spectacles [optics]; sunglasses; goggles for sports; signalling panels, luminous or mechanical; radio pagers; pince-nez; electronic pocket translators; transmitters [telecommunication]; transmitters of electronic signals; switches, electric; periscopes; gloves for divers; furnaces for laboratory use; pipettes; pyrometers; planimeters; plane tables [surveying instruments]; plates for batteries; compact disc players; cassette players; sound recording strips; X-ray films, exposed; films, exposed; life-saving rafts; laboratory trays; semiconductors; polarimeters; fire pumps; measuring glassware; life belts; fuses; converters, electric; telerupters; distance measuring apparatus; appliances for measuring the thickness of leather; speed checking apparatus for vehicles; time recording apparatus; apparatus and instruments for astronomy; navigational instruments; apparatus and instruments for physics; chemistry apparatus and instruments; measuring apparatus; measuring devices, electric; boiler control instruments; meteorological instruments; naval signalling apparatus; observation instruments; navigation apparatus for vehicles [on-board computers]; satellite navigational apparatus; regulating apparatus, electric; precision measuring apparatus; audio- and video-receivers; retorts' stands; drainers for use in photography; cleaning apparatus for sound recording discs; fire beaters; sighting telescopes for firearms; test tubes; pressure indicator plugs for valves; magnetic wires; telegraph wires; telephone wires; wires, electric; conductors, electric; copper wire, insulated; fuse wire; computer programmes [programs], recorded; computer programs [downloadable software]; record players; processors [central processing units]; rods for water diviners; objectives [lenses] [optics]; wrist rests for use with computers; electronic publications, downloadable; radar apparatus; vacuum tubes; masts for wireless aerials; radios; vehicle radios; frames for photographic transparencies; walkie-talkies; voltage regulators for vehicles; stage lighting regulators; speed regulators for record players; marking gauges [joinery]; relays, electric; rheostats; respirators for filtering air; retorts; refractometers; refractors; grids for batteries; horns for loudspeakers; saccharometers; traffic lights; sextants; safety nets; fire alarms; signals, luminous or mechanical; sirens; scanners [data processing equipment]; connections for electric lines; couplings, electric; sonars; sound locating instruments; lighting ballasts; resistances, electric; spectrograph apparatus; spectrosopes; speed indicators; alcoholmeters; satellites for scientific purposes; audiovisual teaching apparatus; radiotelegraphy sets; radiotelephony sets; spectacle lenses; personal stereos; stereoscopes; fire boats; sulfitometers; spherometers; integrated circuits; printed circuits; counters; parking meters; kilometer recorders

for vehicles; revolution counters; abacuses; taximeters; ear plugs for divers; tachometers; television apparatus; telescopes; teleprompters; teleprinters; portable telephones; theodolites; thermostats; thermostats for vehicles; crucibles [laboratory]; tone arms for record players; totalizers; transistors [electronic]; protractors [measuring instruments]; step-up transformers; vehicle breakdown warning triangles; starter cables for motors; capillary tubes; telephone receivers; integrated circuit cards [smart cards]; quantity indicators; automatic indicators of low pressure in vehicle tires [tyres]; gasoline gauges; water level indicators; light-emitting electronic pointers; slope indicators; levels [instruments for determining the horizontal]; mercury levels; spirit levels; urinometers; amplifiers; particle accelerators; steering apparatus, automatic, for vehicles; balancing apparatus; video recorders; sound reproduction apparatus; invoicing machines; railway traffic safety appliances; data processing apparatus; oxygen transvasing apparatus; theft prevention installations, electric; film cutting apparatus; drying apparatus for photographic prints; optical character readers; centering apparatus for photographic transparencies; dosage dispensers; chargers for electric batteries; acoustic [sound] alarms; sounding apparatus and machines; editing appliances for cinematographic films; cathodic anti-corrosion apparatus; couplers [data processing equipment]; computer peripheral devices; demagnetizing apparatus for magnetic tapes; acoustic couplers; alarms; adding machines; readers [data processing equipment]; heat regulating apparatus; photocopiers [photographic, electrostatic, thermic]; bar code readers; filters for respiratory masks; filters for ultraviolet rays, for photography; magic lanterns; optical lamps; signal lanterns; cameras [photography]; glazing apparatus for photographic prints; shutters [photography]; darkrooms [photography]; photometers; flash-bulbs [photography]; enlarging apparatus [photography]; photovoltaic cells; containers for contact lenses; spectacle cases; pince-nez cases; containers for microscope slides; cases especially made for photographic apparatus and instruments; chromatography apparatus for laboratory use; chronographs [time recording apparatus]; eyeglass chains; cyclotrons; frequency meters; fire blankets; chips [integrated circuits]; pedometers; meteorological balloons; electrified rails for mounting spot lights; asbestos screens for firemen; protective helmets for sports; eyeglass cords; tripods for cameras; switchboards; workmen's protective face-shields; projection screens; radiology screens for industrial purposes; fluorescent screens; ducts [electricity]; galvanic cells; epidiascopes; ergometers.

16 – Fountain pens; albums; almanacs; atlases; posters; paper bows; table linen of paper; tickets; forms, printed; note books; drawing pads; loose-leaf binders; wristbands for the retention of writing instruments; pamphlets; booklets; waxed paper; paper for

recording machines; paper for radiograms; electrocardiograph paper; wood pulp paper; parchment paper; writing paper; luminous paper; toilet paper; wrapping paper; blotters; newsletters; rollers for typewriters; house painters' rollers; obliterating stamps; signboards of paper or cardboard; patterns for dressmaking; newspapers; electrotypes; hectographs; terrestrial globes; engravings; slate pencils; pencil leads; pencil holders; chalk holders; diagrams; engraving plates; writing slates; blackboards; galley racks [printing]; drawing boards; cream containers of paper; money clips; tags for index cards; book-markers; etching needles; printed publications; cardboard articles; graphic representations; graining combs; calendars; tear-off calendars; tracing paper; tracing patterns; gums [adhesives] for stationery or household purposes; lithographic stones; pencils; pencil lead holders; charcoal pencils; pictures; transfers [decalcomanias]; hat boxes of cardboard; files [office requisites]; cards; geographical maps; perforated cards for Jacquard looms; catalogues; covers of paper for flower pots; paintbrushes; painters' brushes; writing brushes; typewriter keys; glue for stationery or household purposes; books; comic books; drawing pins; cigar bands; boxes of cardboard or paper; paint boxes [articles for use in school]; French curves; paper ribbons; typewriter ribbons; adhesive tapes for stationery purposes; square rulers; viscose sheets for wrapping; steel letters; type [numerals and letters]; lithographs; architects' models; postage stamps; graphic prints; modelling materials; teaching materials [except apparatus]; sealing compounds for stationery purposes; packaging material made of starches; addressing machines; chalk for lithography; writing chalk; tailors' chalk; marking chalk; painters' easels; hand-rests for painters; bibs of paper; cords for bookbinding; numbering apparatus; bottle envelopes of cardboard or paper; sealing wafers; passport holders; plastic cling film, extensible, for palletization; handwriting specimens for copying; oleographs; musical greeting cards; greeting cards; postcards; etchings; bags for microwave cooking; palettes for painters; ink sticks; folders for papers; papier mâché; pastels [crayons]; pen cases; bookbindings; pen wipers; nibs of gold; steel pens; drawing pens; song books; sealing stamps; clipboards; address plates for addressing machines; handkerchiefs of paper; plastic film for wrapping; letter trays; trays for sorting and counting money; coasters of paper; bookends; stamp stands; mats for beer glasses; stands for pens and pencils; photograph stands; stamp pads; towels of paper; gummed cloth for stationery purposes; printers' blankets, not of textile; portraits; paperweights; writing cases [sets]; writing materials; hand labelling appliances; prospectuses; printed timetables; indexes; graphic reproductions; face towels of paper; staples for offices; erasing products; writing board erasers; sealing wax; arithmetical tables; placards of paper or cardboard;

writing or drawing books; cardboard tubes; Indian inks; chart pointers, non-electronic; bottle wrappers of cardboard or paper; envelope sealing machines, for offices; sealing machines for offices; vignetting apparatus; apparatus for mounting photographs; stapling presses [office requisites]; textbooks; paper coffee filters; silver paper; molds for modelling clays [artists' materials]; photo-engravings; stencil cases; canvas for painting; correcting ink [heliography]; ink; inkwells; blueprints; rosaries; balls for ball-point pens; printing type; address stamps; pads [stationery]; labels, not of textile; prints [engravings]; stamps [seals]; flags of paper; figurines [statuettes] of papier mâché; pencil sharpening machines, electric or non-electric; school supplies [stationery]; covers [stationery]; stickers [stationery]; index cards [stationery]; paintings [pictures], framed or unframed.

35 – Advertising; arranging subscriptions to telecommunication services for others; import-export agencies; commercial information agencies; advertising agencies; cost price analysis; rental of advertising space; employment agencies; computerized file management; invoicing; demonstration of goods; opinion polling; marketing studies; business information; business investigations; personnel recruitment; business management and organization consultancy; business organization consultancy; business management consultancy; professional business consultancy; layout services for advertising purposes; business management of performing artists; news clipping services; updating of advertising material; word processing; organization of exhibitions for commercial or advertising purposes; organization of trade fairs for commercial or advertising purposes; shop window dressing; business appraisals; payroll preparation; sponsorship search; business management assistance; commercial or industrial management assistance; economic forecasting; auctioneering; office machines and equipment rental; publicity material rental; rental of vending machines; rental of photocopying machines; publication of publicity texts; radio advertising; bill-posting; distribution of samples; dissemination of advertising matter; writing of publicity texts; on-line advertising on a computer network; document reproduction; compilation of statistics; business inquiries; systemization of information into computer databases; tax preparation; drawing up of statements of accounts; commercial administration of the licensing of the goods and services of others; public relations; modelling for advertising or sales promotion; relocation services for businesses; price comparison services; procurement services for others [purchasing goods and services for other businesses]; business efficiency expert services; photocopying services; telephone answering for unavailable subscribers; administrative processing of purchase orders; compilation of information into computer databases; advertising by

mail order; television advertising; commercial information and advice for consumers [consumer advice shop]; presentation of goods on communication media, for retail purposes; rental of advertising time on communication media; promoting the goods and services of others on the Internet.

39 – Packaging and storage of goods; arranging of travel tours; air transport; boat rental; parking place rental; booking of seats for travel; transport reservation; towing; water distribution; delivery of newspapers; message delivery; parcel delivery; delivery of goods; delivery of goods by mail order; flower delivery; launching of satellites for others; transportation information; storage information; arranging of cruises; hauling; carting; transporting furniture; ferry-boat transport; transport of travellers; bus transport; car transport; boat transport; railway transport; marine transport; passenger transport; river transport; portering; refloating of ships; shipbrokerage; transport brokerage; freight brokerage [forwarding (Am.)]; car rental; railway truck rental; rental of diving bells; rental of motor racing cars; rental of wheelchairs; rental of storage containers; horse rental; refrigerator rental; vehicle rental; stevedoring; unloading cargo; electricity distribution; distribution of energy; packaging of goods; ice-breaking; piloting; water supplying; escorting of travellers; streetcar transport; transport by pipeline; car parking; chauffeur services; courier services [messages or merchandise]; transport; franking of mail; freighting; physical storage of electronically-stored data or documents; boat storage; storage; freight forwarding; travel reservation; pleasure boat transport.

(260) AM 2018 92454 A
(800) 1232759
(891) 2017 02 09
(731) F5 NETWORKS, INC.
401 Elliott Avenue West, Seattle
WA 98119, United States
of America
(540)

F5

(591) Black, white
(511)
9 – Computer hardware and software for enhancing the performance of a plurality of servers connected together by a network.

(260) AM 2018 92512 A
(800) 1346568
(891) 2016 12 22
(731) H. LUNDBECK A/S
Ottiliavej 9, DK-2500 Valby,
Denmark

(540)



(591) Red, orange, golden and black
(531) 01.01.01; 01.01.02; 01.01.10; 29.01.01;
29.01.12

(511)
5 – Pharmaceuticals and medical preparations and substances; vaccines; pharmaceutical preparations and substances for the prevention and treatment of disorders and diseases in, generated by or acting on the central nervous system; pharmaceutical preparations and substances acting on the central nervous system; central nervous system stimulants; pharmaceutical preparations and substances for the prevention and treatment of psychiatric and neurological disorders and diseases; pharmaceutical preparations and substances for the prevention and treatment of dementia, Alzheimer's disease and disorder, dizziness, seizures, stroke, depression, cognitive impairment, cognitive disorders and diseases, mood disorders, psychosis, anxiety, apathy, epilepsy, Lennox-Gastaut syndrome (LGS), sclerosis, porphyria, Huntington's disease and disorder, insomnia, Parkinson's disease and disorder, falls, movement disorders and diseases, schizophrenia, bipolar disorder and disease, ADHD, cancer, migraine, pain, alcoholism and dependency; preparations, substances, reagents and agents for diagnostic and medical purposes.

(260) AM 2018 92513 A
(800) 1346588
(891) 2016 12 22
(731) OPTEX CO., LTD.
5-8-12, Ogoto, Otsu-shi, SHIGA 520-0101,
Japan
(540)



(591) Black, white
(531) 26.01.12; 26.11.09; 27.05.01; 27.05.17
(511)

42 – Water analysis; provision of scientific information, advice and consultancy in relation to carbon offsetting; research in the field of environmental protection; leasing of measuring apparatus; technical project studies; providing application software through telecommunications networks; leasing of application software; maintenance of computer softwa-

re; computer programming; computer technology consultancy; scientific research; scientific laboratory services; consultancy relating to development of water resources; remote monitoring of a variety of information and data from sensors; analysis of a variety of information and data from sensors and providing information relating thereto; monitoring of telecommunication signals; analysis of telecommunication signals and providing information relating thereto; monitoring of computer systems by remote access; monitoring of computer programs by remote access; analysis of computer systems and providing information relating thereto; analysis of computer programs and providing information relating thereto; testing, research and consultancy in the field of energy-saving and providing information relating thereto; designing of machines, apparatus or systems in the field of energy-saving; consultancy in the field of energy-saving; cloud computing; designing of machines, apparatus, instruments (including their parts) or systems composed of such machines, apparatus and instruments; computer software design, computer programming, or maintenance of computer software; testing, inspection or research of pharmaceuticals, cosmetics or foodstuff; research relating to building construction or city planning; testing or research on prevention of pollution; testing or research on electricity; testing or research on civil engineering; testing, inspection or research on agriculture, livestock breeding or fisheries; testing or research on machines, apparatus and instruments; leasing of measuring apparatus; rental of computers; providing computer programs on data networks; leasing of laboratory apparatus and instruments.

(260) AM 2018 92524 A

(800) 1345666

(891) 2016 04 14

(731) HANGZHOU TAIJI BAGS & LUGGAGE CO., LTD.

No.9 Taiji Road, Economic Development District, Yuhang, Hangzhou Zhejiang, China

(540)

 HENNEWAY

(591) Black and white

(531) 26.04.03; 26.04.18; 27.05.05; 27.05.21

(511)

18 – Imitation leather; pocket wallets; travelling bags; trunks [luggage]; laces (leather -); trimmings of leather for furniture; umbrellas; canes; clothing for pets; gut for making sausages.

25 – Clothing; ready-made clothing; children's clothing; motorists' clothing; shoes; hats; hosiery; gloves [clothing]; scarfs; waterproof clothing.

35 – Advertising; presentation of goods on communication media, for retail purposes; business management and organization consultancy; outsourcing services [business assistance]; provision of an on-line marketplace for buyers and sellers of goods and services; marketing; personnel management consultancy; accounting; sponsorship search; update and maintain data in a computer database.

(260) AM 2018 92526 A

(800) 1345705

(891) 2017 03 22

(731) SOREMARTEC SA

Findel Business Center, Complexe B, Rue de Trèves B-2632 FINDELLU, Belgium

(540)

Kinder Молочный ломтик

(591) Black and white

(531) 27.05.01; 28.05

(511)

30 – Pastry and confectionery, cakes, biscuits, cookies, edible ices.

(260) AM 2018 92527 A

(800) 1345709

(891) 2017 03 20

(731) LABORATOIRE INNOTECH

INTERNATIONAL

22 avenue Aristide Briand F-94110 Arcueil, France

(540)

Симпатил

(591) Black and white

(531) 28.05

(511)

5 – Pharmaceutical products.

(260) AM 2018 92528 A

(800) 1345710

(891) 2017 03 20

(731) LABORATOIRE INNOTECH

INTERNATIONAL

22 avenue Aristide Briand F-94110 Arcueil, France

(540)

**FLUDITEC
ФЛЮДИТЕК**

(591) Black and white

(531) 27.05.01; 28.05

(511)

5 – Pharmaceutical products.

(260) AM 2018 92529 A
 (800) 1345728
 (891) 2017 02 21
 (731) LANGUAGE-LINK LIMITED
 62 Wilson Street London EC2A 2BU, United
 Kingdom
 (540)



(591) Green, dark green and black
 (531) 02.01.23; 02.03.23; 02.07.23; 27.05.17
 (511)
 9 – Educational materials in the form of computer programmes for teaching languages; language translating apparatus; audiovisual teaching apparatus.
 16 – Books pertaining to language comprehension; printed educational materials for the teaching of languages.
 41 – Education and providing of training, including educational services for the teaching of languages.

(260) AM 2018 92532 A
 (800) 1345803
 (891) 2016 09 20
 (731) LOUISIANA SPIRITS LLC
 P.O. Box 110 Lacassine LA 70650, USA
 (540)

BAYOU

(591) Black and white
 (531) 27.05.17
 (511)
 33 – Distilled spirits, alcoholic beverages except beers.

(260) AM 2018 92533 A
 (800) 1345810
 (891) 2017 02 02
 (731) HUAWEI TECHNOLOGIES CO., LTD.
 Administration Building Huawei Technologies
 Co., Ltd., Bantian, Longgang District
 Shenzhen, China
 (540)

HUAWEI GT3

(591) Black and white
 (531) 27.05.17
 (511)
 9 – Smartglasses; smartwatches; protective films adapted for computer screens; wearable activity trackers; covers for smartphones; cases for smartphones;

protective films adapted for screens for mobile phones; selfie sticks (hand-held monopods); couplers (data processing equipment); transponders; cabinets for loudspeakers; audio and video receivers; video screens; network communication equipment; sleeves for laptops; smartphones; electric batteries; mobile power source (rechargeable batteries); tablet computers; bags adapted for laptops; headphones; earphones; television apparatus; sound transmitting apparatus; camcorders; digital photo frames; cell phone straps; computer keyboards; mouse (computer peripheral); modems; telephone sheath; portable media players; magnetic encoded identification bracelets; pedometers; electric monitoring apparatus; connected bracelets (measuring instruments).

(260) AM 2018 92546 A
 (800) 1346104
 (891) 2017 01 26
 (731) SILESIA GERHARD HANKE GMBH & Co.
 KG
 Am Alten Bach 20-24,41470 Neuss, Germany
 (540)

Silarom

(591) Black, white
 (511)
 3 – Food flavorings [essential oils]; aromatics; flavourings for beverages (essential oils); ethereal essences; essential oils and aromatic extracts.
 29 – Meat extracts; extracts for soups (bouillon); vegetable extracts for food; fruit extracts for food.
 30 – Flavourings, other than essential oils; flavouring substances, other than essential oils; flavouring substances for food [other than essential oils]; flavourings, other than essential oils, for beverages; flavouring additives; flavourings for beverages; flavouring additives for food; essences for food [other than essential oils]; essences for foodstuffs, except etheric essences and essential oils; extracts used as flavoring [not essential oils]; plant extracts for food.
 32 – Essences for making beverages; extracts for making beverages; hops (extracts of -) for making beer.
 33 – Alcoholic essences; alcoholic extracts.

(260) AM 2018 92547 A
 (800) 1346116
 (891) 2017 01 24
 (731) TORUŃSKIE ZAKŁADY MATERIAŁÓW
 OPATRUNKOWYCH, SPÓŁKA AKCYJNA
 Żółkiewskiego 20/26, PL-87-100 Toruń, Poland
 (540)

tzmo

(591) Black, white

(511)

3 – Cotton wool for cosmetic purposes, goods made from cotton wool for cosmetic purposes, cotton sticks for cosmetic purposes, cosmetic pads, cotton pads, tissues impregnated with cosmetic liquids, wipes for removing make-up, lotion, creams for body care, lotions for body wash, cosmetics for children, lotion bath, baby oil, baby powder, shampoo, cosmetics kits for children.

5 – Sanitary towels, panty liners, menstruation tampons, tissues for intimate hygiene, liquids for intimate hygiene, urological pads, lactation pads, urological pads for men, anatomic pads for incontinence women, disposable diapers for incontinence persons, disposable diaper-pants for incontinence persons, disposable pants for incontinence persons, disposable diapers made from paper and/or cellulose, disposable diaper-pants made from paper and/or cellulose, gynaecological towels, compresses, set of compresses, dressings, bags for corpse, operation serviettes, operation sets, gauze dressing, eye dressing pads, nose dressings, cotton and cotton wool for hygienic and medical purposes, goods made from cotton or cotton wool for hygienic and medical purposes, cotton wool made from cellulose for medical purposes, sterility tests, orthopedic paddings, supporting dressings, plasters, adhesive tapes, medical trays, operating foil, tubular bandages sleeves, clips for bandages, adhesive tapes with sterilization indicators; diapers for baby made from textile.

10 – Elastic bandages, supporting bandages, bandages from plasters, lining beneath cast bandages, protective bedclothes, bed underpads, bed underpads for incontinence persons, surgical gowns, apron for operating, caps for surgeon, gloves for medical purposes, liquid pouches, pouches for organs; shoe covers, protective clothing.

16 – Disposable bibs made from paper, disposable paper napkins, toilet paper, paper towels, tissues of paper for removing make-up, bags and purses for packaging, disposable reels for packaging.

24 – Bedclothes, sheets, napkins textile, handkerchiefs for children.

25 – Clothing made from paper, disposable clothing, waterproof clothing, nursing caps, aprons and reusable clothing, bibs made from textile materials.

(260) AM 2018 92548 A

(800) 1346122

(891) 2017 02 07

(731) HUAWEI TECHNOLOGIES CO., LTD.

Administration Building, Huawei Technologies Co., Ltd., Bantian, Longgang District Shenzhen, China

(540)



(591) Black, white

(531) 03.07.04; 03.07.17; 03.07.19; 27.05.01

(511)

9 – Electronic tags for goods; joysticks for use with computers, other than for video games; smartglasses; smartwatches; protective films adapted for computer screens; holograms; wearable activity trackers; covers for smartphones; cases for smartphones; protective films adapted for cell phones; selfie sticks (hand-held monopods).

(260) AM 2018 92549 A

(800) 1346123

(891) 2017 02 07

(731) HUAWEI TECHNOLOGIES CO., LTD.

Administration Building, Huawei Technologies Co., Ltd., Bantian, Longgang District Shenzhen, China

(540)

HUAWEI

(591) Black, white

(531) 27.05.17

(511)

9 – Electronic tags for goods; joysticks for use with computers, other than for video games; smartglasses; smartwatches; protective films adapted for computer screens; holograms; wearable activity trackers; covers for smartphones; cases for smartphones; protective films adapted for cell phones; selfie sticks (hand-held monopods).

(260) AM 2018 92551 A

(800) 1346124

(891) 2017 02 07

(731) HUAWEI TECHNOLOGIES CO., LTD.

Administration Building, Huawei Technologies Co., Ltd., Bantian, Longgang District Shenzhen, China

(540)



(591) Black, white
 (531) 03.07.04; 03.07.17; 03.07.19
 (511)

9 – Electronic tags for goods; joysticks for use with computers, other than for video games; smartglasses; smartwatches; protective films adapted for computer screens; holograms; wearable activity trackers; covers for smartphones; cases for smartphones; protective films adapted for cell phones; selfie sticks (hand-held monopods).

(260) AM 2018 92555 A

(800) 1345915

(891) 2016 05 04

(731) ALLPA B.V.

Kerkenbos 10-15 NL-6546 BB Nijmegen,
 Netherlands

(540)



(591) Red black

(531) 18.03.21; 26.01.10; 26.03.06; 27.05.17;
 29.01.13

(511)

3 – Bleaching preparations and other substances for laundry; cleaning, polishing, scouring and abrasive preparations; soap; perfumery, essential oils, cosmetics, hair lotions; dentifrices.

4 – Industrial oils and greases; lubricants; products for absorbing, wetting and binding dust; fuels (including motor spirit) and illuminants; candles and wicks for lighting.

6 – Metal building materials; transportable buildings of metal; metal materials for railways; non-electric metal cables and wires; locksmith's products and ironmongery; metal pipes; safes; ores; pipes and tubes of metal; metal swivel and twist and connectors – fittings and flanges; metal folding stairs, platforms and gangways; anchors, metal chains for boats; non-electric metal cables and wires.

7 – Boat motors and components therefor; motors (except for land vehicles); machine coupling and transmission components (except for land vehicles); machines for water transport; engines and parts therefor (except engines for land vehicles); generators; clutches, transmission components (except for land vehicles); pumps (included in this class); parts and fitting for ships and yachts, not included in other classes, bearings, couplings, grease boxes [parts of machines].

9 – Scientific, nautical, measuring, signaling and life-saving apparatus and instruments; diving equipment and – instruments; protective clothing for diving, including undergarments for divers; diving

suits; life jackets; inflatable vests and jackets for diving; protective headgear for sports; protective boots; diving gloves and mittens; goggles; nose clips and protective ear plugs for diving and water sports; weights for diving; underwater telephone for divers; compasses; depth gauges; snorkels.

11 – Apparatus for lighting, heating, steam generating, cooking, refrigerating, drying, ventilating, water supply and sanitary purposes.

12 – Vehicles; apparatus for locomotion by water including ships, boats, canoes, pedal boats, water scooters and jet skis; parts and accessories for boats (not included in other classes), including deck equipment, oars, boat hooks, cleats and bollards, deck fittings, mast fittings, chain plates, tillers, deck accessories (boat), construction material, schoot- and anchor winches, wipers, steering wheels; fender; components for ships and yachts, not included in other classes, such as propeller shafts.

17 – Rubber, gutta-percha, gum, asbestos, mica; semi-finished plastic products; packing, stopping and insulating materials; non-metallic flexible pipes.

20 – Furniture, mirrors, picture frames; flexible tanks, water tanks not of metal for liquid fuel, including the cover and filler caps, deck chairs.

21 – Utensils and containers for household or kitchen (not of precious metal or coated therewith); combs and sponges; brushes (except paint brushes); materials for the brush manufacturing; cloths for cleaning; steel wool; unworked or semi-worked glass (except glass used in building); glassware, porcelain and earthenware not included in other classes.

22 – Ropes, string, nets, tents, tarpaulins, sails, sacks and bags (not included in other classes); stuffing materials for cushions not of rubber or plastics; raw fibrous textile materials.

24 – Textiles and textile goods, not included in other classes; bed and table covers; mosquito nets.

25 – Sportswear, namely wetsuits, drysuits and waders; boots, gloves, mittens and hats mainly made of neoprene for sports purposes, belts.

28 – Swimming flippers and fins; surfboards, knee boards, wakeboards (being a kind of wide mono water skiing); water skis, tubes, fun tubes, ski lines and their parts.

35 – Advertising and business management; retail services in the field of water sports equipment and vessels; trade information relating to water sports, water sports and vessels; organization of fairs and exhibitions for commercial purposes; the aforesaid services whether or not via the internet.

(260) AM 2018 92558 A
 (800) 1345937
 (891) 2017 02 09
 (731) FERRER INTERNACIONAL S.A.
 Gran Vía de Carlos III, 94 E-08028
 BARCELONA, Spain
 (540)

АНГИНОВАГ

(591) Black and white
 (511)
 5 – Pharmaceutical products, preparations for medical and veterinary use; sanitary products for medical use; dietetic food and substances for medical or veterinary use, food for babies; food supplements for humans or animals; plasters, material for dressings; teeth filling and dental impression materials; disinfectants; products for destroying vermin; fungicides, herbicides.

(260) AM 2018 92560 A
 (800) 1345952
 (891) 2016 11 07
 (731) DAIMLER AG
 Mercedesstraße 137, 70327 Stuttgart,
 Germany
 (540)



(591) Black, gray and white
 (531) 26.03.06; 26.03.18; 27.05.22; 29.01.13
 (511)
 9 – Scientific, nautical, surveying, photographic, cinematographic, optical, weighing, measuring, signalling, checking [supervision], life-saving and teaching apparatus and instruments; apparatus and instruments for conducting, switching, transforming, accumulating, regulating or controlling electricity; apparatus for recording, transmission or reproduction of sound or images; magnetic data carriers, recording discs; compact discs, DVDs and other digital recording media; USB flash drives; computer software, apps, calculating machines, data processing equipment, computers; spectacles, sun glasses, spectacle frames, spectacle cases; mousepads.
 12 – Vehicles; apparatus for locomotion by land, air or water.
 14 – Precious metals and their alloys; jewellery, precious stones; horological and chronometric instruments, key fobs, jewel cases.

16 – Paper and cardboard; printed matter; bookbinding material; photographs; stationery; adhesives for stationery or household purposes; artists' materials; airtbrushes; typewriters and office requisites [except furniture]; instructional and teaching material [except apparatus]; plastic materials for packaging.

18 – Leather and imitations of leather; animal skins, hides; trunks and travelling bags; handbags; rucksacks; wallets; umbrellas and parasols; walking sticks; whips, harness and saddlery; purses; dog leashes.

20 – Furniture, mirrors, picture frames; unworked or semi-worked bone, horn, ivory, whalebone or mother-of-pearl; shells; meerschaum; yellow amber.

21 – Household or kitchen utensils and containers; combs and sponges; brushes [except paintbrushes]; brush-making materials; articles for cleaning purposes; steelwool; unworked or semi-worked glass [except glass used in building]; glassware, porcelain and earthenware.

24 – Textiles and substitutes for textiles; bed covers; table covers.

25 – Clothing, footwear, headgear; belts.

28 – Games and playthings; gymnastic and sporting articles; golf gloves; decorations for Christmas trees.

34 – Tobacco; smokers' articles; matches; lighters for smokers; humidors.

(260) AM 2018 92562 A
 (800) 1345973
 (891) 2017 02 07
 (731) BEIJING HUANGJIHUANG RESTAURANT
 MANAGEMENT CO., LTD
 Room 308, Block 1, No. 18 Shuanghe Street,
 Linhe Development Zone, Shunyi District
 Beijing, China
 (540)

simmer huang

(591) Black and white
 (511)
 43 – Accommodation bureaux [hotels, boarding houses]; café services; canteen services; self-service restaurant services; hotel services; bar services; retirement home services; day-nursery [crèche] services; boarding for animals; rental of cooking apparatus.

(260) AM 2018 92582 A
 (800) 1346227
 (891) 2017 02 24
 (731) OSRAM GmbH
 Marcel-Breuer-Straße, 80807 München,
 Germany

(540)



(591) Orange and blue.
 (531) 01.15.09; 25.05.02; 26.01.13; 26.04.02;
 26.11.01; 26.11.08; 29.01.13

(511)
 11 – Lighting apparatus, especially electric lamps and luminaires; lighting apparatus; lighting apparatus and lighting systems based on LEDs (also organic LEDs); LED-lamps and LED-luminaires and their parts; lighting modules and systems and their parts based on LEDs.

(260) AM 2018 92593 A
 (800) 1346310
 (891) 2017 01 12
 (731) YANMAOLI
 No.234-2. Fuqian road,Lanjiang street, Lanxi
 city Zhejiang province, China

(540)



(591) Black, white
 (531) 26.04.01; 26.04.22; 26.04.24; 27.05.24; 28.03
 (511)

14 – Alloys of precious metal; jewelry cases; silver jewelry; small ornaments [jewellery]; jewelry [jewellery]; necklaces [jewellery]; earrings; rings [jewellery]; key rings [small ornaments or short chain ornaments]; wrist watches.

(260) AM 2018 92594 A
 (800) 1346345
 (891) 2017 03 16
 (731) JANSSEN PHARMACEUTICA NV
 Turnhoutseweg 30,B-2340 Beerse,
 Netherlands

(540)

ESKANZA

(591) Black, white
 (531) 27.05.01
 (511)
 5 – Human pharmaceutical preparations for the prevention and treatment of viral diseases, auto-immune and inflammatory diseases, cardiovascular diseases, central nervous system diseases, pain, dermatologic diseases, gastro-intestinal diseases, infectious-related diseases, metabolic diseases, oncologic diseases, ophthalmic diseases and respiratory diseases.

(260) AM 2018 92596 A
 (800) 1346347
 (891) 2017 03 29
 (731) BORA CREATIONS S.L.
 Calle Rey Sancho,7, Local 3, Santa Ponsa
 E-07180 Mallorca, Spain

(540)



(591) Black, white
 (531) 26.04.06; 26.04.19; 26.04.22; 26.04.24;
 27.05.23; 27.05.24

(511)
 3 – Preparations for cleaning, caring for and beautifying the skin, nails, lips, eyes and hair; perfumery; cosmetics; decorative cosmetics; nailcare products; haircare products; setting preparations for the hair.

(260) AM 2018 92597 A
 (800) 1346359
 (891) 2017 01 26
 (731) FERRER INTERNACIONAL S.A.
 Gran Vía Carlos III,94, E-08028 Barcelona,
 Spain

(540)

ГАМАЛАТЕ

(591) Black, white
 (531) 28.05
 (511)
 5 – Pharmaceutical products, preparations for medical and veterinary use; sanitary products for medical use; dietetic food and substances for medical or veterinary use, food for babies; food supplements for humans or animals; plasters, material for dressings; teeth filling and dental impression materials; disinfectants; products for destroying vermin; fungicides, herbicides.

(260) AM 2018 92598 A
 (800) 1346361
 (891) 2017 03 10
 (731) CAROLINA HERRERA LTD
 501 Seventh Avenue, 17th Floor New York,
 New York 10018, United Kingdom
 (540)

BAD BOY

(591) Black, white
 (511)
 3 – Bleaching preparations and other substances for laundry use; cleaning, polishing, degreasing and abrasive preparations; soaps; perfumery products, essential oils, cosmetics, hair lotions; dentifrices; toiletries; perfumery and fragrances; eau de Cologne; perfumes; scented preparations; mouth wash products; body care and cleaning preparations; deodorants and antiperspirants; soaps and gels for personal use; bath preparations; preparations for skin care; exfoliants; talcum powders; wet wipes, cotton balls and hand wipes for sanitary, cosmetic and perfume purposes; cosmetics, toiletries and perfumery products for the care and beauty of eyelashes, eyebrows, eyes, lips and nails; lip balm (non-medicated); nail polish; adhesives for cosmetic use; cosmetic preparations for slimming; hair preparations and treatments; make-up products; make-up removing products; products for hair removal and shaving; pre-shave preparations; after-shave preparations; non-medicated beauty preparations; cosmetic tanning and self-tanning preparations; cosmetic kits; preparations for perfuming; fragrances for the home; sachets for perfuming linen; aromatic extracts; products for the care and cleaning of animals; abrasives; shoemakers' and tailors' wax; preparations for cleaning and polishing leather and footwear.

(260) AM 2018 92609 A
 (800) 1346676
 (891) 2016 08 25
 (731) ENKA HİJYEN ÜRÜNLERİ SANAYİ VE
 TİCARET ANONİM ŞİRKETİ
 5. Organize Sanayi Bölgesi, 83535, nolu Cadde
 No:15, Şehitkamil, Gaziantep, Turkey
 (540)



(531) 26.13.25; 27.05.17; 27.05.24; 29.01.13
 (511)
 3 – Bleaching and cleaning preparations; detergents other than for use in manufacturing operations and

for medical purposes; laundry bleach; fabric softeners for laundry use; stain removers; dishwasher detergents; perfumery; cosmetics; fragrances; deodorants for personal use and animals; soaps; dental care preparations; dentifrices; denture polishes; tooth whitening preparations; mouth washes, not for medical purposes; abrasive preparations; emery cloth; sandpaper; pumice stone; abrasive pastes; polishing preparations for leather, vinyl, metal and wood; polishes and creams for leather, vinyl, metal and wood; wax for polishing; baby wipes.

5 – Pharmaceutical and veterinary preparations for medical purposes; chemical preparations for medical and veterinary purposes; chemical reagents for pharmaceutical and veterinary purposes; dietary supplements for pharmaceutical and veterinary purposes; dietary supplements; nutritional supplements; medical preparations for slimming purposes; food for babies; herbs and herbal beverages adapted for medicinal purposes; dental preparations and articles; teeth filling material; dental impression materials; dental adhesives and material for repairing teeth; sanitary preparations for medical use; hygienic pads; hygienic tampons; plasters; materials for dressings; diapers, including those made of paper and textiles; preparations for destroying vermin; fungicides, herbicides; deodorants, other than for human beings or for animals; air deodorizing preparations; disinfectants; antiseptics; detergents for medical purposes; babies' diapers of textile, babies' diapers of paper.

16 – Paper and cardboard; paper and cardboard for packaging and wrapping purposes, cardboard boxes; paper towels; toilet paper; paper napkins; plastic materials for packaging and wrapping purposes; printing blocks and types; bookbinding material; printed publications; printed matter; books, magazines, newspapers, bill books, printed dispatch notes, printed vouchers, calendars; posters; photographs [printed]; paintings; stickers [stationery]; postage stamps; stationery, office stationery; instructional and teaching material [except furniture and apparatus]; writing and drawing implements; artists' materials; paper products for stationery purposes; adhesives for stationery purposes, pens, pencils, erasers, adhesive tapes for stationery purposes, cardboard cartons [artists' materials], writing paper, copying paper, paper rolls for cash registers, drawing materials, chalkboards, painting pencils, watercolors [paintings]; office requisites; paint rollers and paintbrushes for painting; rosaries.

(260) AM 2018 92614 A
 (800) 1346751
 (891) 2016 11 07
 (731) 404 KİMYA SANAYİ VE TİCARET
 ANONİM ŞİRKETİ
 İ Merkez Mah. Akçe Sok. Güzle İs Merkez
 No:3 Kat; 1Çekmeköy Ümraniye İstanbul
 (TR), Turkey

(540)



(591) Black, red and white.

(531) 26.04.17; 26.04.24; 27.07.02; 29.01.14

(511)

1 – Cyanoacrylate.

16 – Glue for stationary or household purposes.

17 – Sealant compounds for joints, caulking materials.

(260) AM 2018 92630 A

(800) 1347552

(891) 2016 10 19

(731) EURO GAMES TECHNOLOGY LTD.
"Maritsa" Str. 4, "Vranya-Lozen-Triugulnika"
BG-1151 Sofia, Bulgaria

(540)



(591) Black, orange, gray, red, brown, yellow and white

(531) 26.11.12; 27.05.03; 29.01.13

(511)

9 – Apparatus for recording, transmission or reproduction of sound or images; coin-operated mechanisms for vending machines; data processing equipment and computers.

28 – Games and playthings; amusement machines, automatic and coin-operated.

(260) AM 2018 92631 A

(800) 1347582

(891) 2017 02 23

(731) QINGDAO TOPSCOMM
COMMUNICATION CO., LTD
ZONE B, FLOOR 5, BUILDING 6, NO.288
NINGXIA ROAD, SHINAN DISTRICT,
QINGDAO SHANDONG, China

(540)



(591) Black and white

(531) 27.05.17

(511)

9 – Carrier wave facility; electricity meter; electric measure manostat; printed circuits; chips [integrated circuits]; mono-crystalline silicon; electronic chip; silicon epitaxial wafers; wafers [silicon slices]; low

voltage power supply; stable electrical source; step-up transformers; protectors (voltage surge -); inverters [electricity]; couplings, electric; collectors, electric; printed circuit boards; transformers [electricity]; semi-conductors; integrated circuits; galena crystals [detectors]; commutation (electric apparatus for -); power station automatization equipment; alarms (fire -); smoke detectors.

(260) AM 2018 92632 A

(800) 1347609

(891) 2017 03 21

(731) BIOVERATIV THERAPEUTICS INC.
225 Second Avenue CAMBRIDGE MA
02451, United States of America

(540)



(591) Black and white

(531) 26.04.09; 26.04.24; 26.11.03; 26.11.08

(511)

42 – Pharmaceutical drug development services.

(260) AM 2018 92634 A

(800) 1347615

(891) 2017 04 04

(731) FERRERO OHG MBH
Rheinstr. 12 35260 Stadtallendorf, Germany

(540)

Yogurette

(591) Black and white

(511)

30 – Chocolate, including filled chocolate, chocolate goods, cakes and pastries and long-life cakes and pastries.

(260) AM 2018 92636 A

(800) 1347635

(891) 2017 01 09

(731) AGORA DISTRIBUTION
13/15 rue de la Metallurgie F-93210 SAINT-DENIS LA PLAINE, France

(540)



(591) Black and white

(531) 26.01.22; 26.11.12; 27.05.01

(511)

3 – Perfumery products; perfumes; fragrances; eaux de toilette; eau de Cologne; deodorants [perfumery]; essential oils; cosmetics; massage gels other than for medical use; cosmetic products for skin care; nail care products; cosmetic preparations for slimming; lotions for cosmetic use; skin lotions (cosmetics); skin creams (cosmetics); fluid creams (cosmetics); pomades for cosmetic use; almond milk for cosmetic use; cosmetic oils; cleansing milk for toilet purposes; tissues and wipes impregnated with cosmetic lotions; hand lotions; beauty masks; hand creams (cosmetics); skin-whitening creams (cosmetics); lip care products (cosmetics); hair care products; hair care creams (cosmetics); hair straightening preparations; hair-conditioning products; hair masks; detangling hair products; hair lotions; depilatories; depilatory wax; shaving products; shaving soap; shaving foam; after-shave lotions; sun care lotions and creams; self-tanning cosmetic preparations; toiletries; dentifrices; breath freshening sprays; mouthwashes, not for medical use; teeth whitening strips; dental bleaching gels; cosmetic soaps; soaps for toilet purposes; shampoos; dry shampoos; shower gels not for medical use; bath gels not for medical use; bath oils not for medical use; bath salts for cosmetic use; foaming bath products; bath beads; talcum powder for toilet use; cleansing milk for toilet purposes; make-up products; make-up foundations; make-up removing products; lipstick; lip-stick cases; balms other than for medical use; lip balms; lip glosses; mascaras for eyelashes; hair mascaras; nail polish; nail-polish removing products; blushers; eye shadows; make-up powders; eye shadows; pencils for cosmetic use; eye pencils; eyebrow pencils; blusher pencils; hair bleaches; hair waving preparations; beard dyes; mustache wax; hair dyes; cosmetic dyes; hair styling creams or gels; hair sprays; brilliantine; bleaching preparations [decolorants] for cosmetic use; false nails; nail art stickers; eyebrow cosmetics; false eyelashes; adhesives and decorative transfers for cosmetic use; temporary tattoos for cosmetic use; henna ink [cosmetic dye]; cotton sticks for cosmetic use; make-up removing cotton; cotton wool for cosmetic use; cosmetic kits; shaving stones [astringents]; alum stones [astringents]; body scrub.

21 – Cosmetic and toiletry utensils; applicators for cosmetics; make-up removing apparatus; combs; comb cases; toilet sponges; brushes; toilet brushes; brushes for cosmetic use; cleaning brushes; hair brushes; toothbrushes; dental floss; brush-making materials; animal bristles [brushes]; hand-operated cleaning instruments; bottles; toilet utensils or cases; trash cans; glasses (receptacles); glass jars [carboys]; boxes for dispensing tissues; toilet paper dispensers; soap boxes; dishes for soap; soap dispensers; sponge holders, towel holders; lip brushes; make-up brus-

hes; hair combs; exfoliating gloves; eyebrow combs; eyebrow brushes; make-up sponges; toe separators for pedicures; containers for cosmetics; flasks; pots; cases for cosmetic utensils; shaving brush holders; cosmetic product dispensers; nail brushes; vanity cases; spatulas for cosmetic use; powder compacts; cosmetic sponges, powder puffs; baskets for domestic use; large-toothed combs for the hair; vanity cases; deodorizing apparatus for personal use.

(260) AM 2018 92699 A

(800) 1347235

(891) 2017 01 24

(731) PHILIP MORRIS PRODUCTS S.A.

Quai Jeanrenaud 3, CH-2000 Neuchâtel, China

(540)



(591) Green, blue-green and blue.

(531) 05.03.14; 27.05.21; 29.01.12

(511)

9 – Batteries for electronic cigarettes; batteries for electronic devices that are used for heating tobacco, chargers for electronic devices that are used for heating tobacco; USB chargers for electronic devices that are used for heating tobacco; car chargers for electronic cigarettes; car chargers for devices that are used for heating tobacco; battery chargers for electronic cigarettes.

11 – Electronic vaporizers except electronic cigarettes; apparatus for heating liquids; apparatus for generating vapor.

34 – Wired vaporizers for electronic cigarettes and electronic smoking devices; tobacco, raw or manufactured; tobacco products, including cigars, cigarettes, cigarillos, tobacco for roll-your-own cigarettes, pipe tobacco, chewing tobacco, snuff tobacco, kretek; snus; tobacco substitutes (not for medical purposes); smokers' articles, including cigarette paper and tubes, cigarette filters, tobacco tins, cigarette cases and ashtrays, pipes, pocket apparatus for rolling cigarettes, lighters; matches; tobacco sticks, tobacco products for the purpose of being heated, electronic devices and their parts for the purpose of heating cigarettes or tobacco in order to release nicotine-containing aerosol for inhalation; liquid nicotine solutions for use in electronic cigarettes; electronic smoking devices; electronic cigarettes; electronic cigarettes as substitute for traditional cigarettes; electronic devices for the inhalation of nicotine-containing aerosol; oral vaporizing devices for use

by smokers, tobacco products and tobacco substitutes; smokers' articles for electronic cigarettes; parts and fittings for the aforesaid products included in this class; extinguishers for heated cigarettes and cigars as well as heated tobacco sticks; electronic rechargeable cigarette cases.

35 – Operating an electronic marketing platform via a global computer network; advertising, marketing, commercial administration of licenses for third-party goods and services, commercial information and advice for consumers, assistance for management of industrial or commercial companies, organization of exhibitions for commercial or advertising purposes, organization of exhibitions and trade fairs for commercial or advertising purposes; advertising promotion and retail services (including online retail services) for tobacco products to be heated and related accessories.

42 – Providing/hosting software applications and platforms on the Internet.

(260) AM 2018 92701 A

(800) 1347250

(891) 2017 03 17

(731) Public Joint Stock Company
"EGORJEVSK SHOES"

Vladimirskaya ul., d. 8, Egorjevsk

RU-140301Moscowskaya oblast,

Russian Federation

(540)



(591) Black, white

(531) 27.05.01; 27.05.17; 27.05.25; 29.01.04

(511)

3 – Abrasives; amber [perfume]; descaling preparations for household purposes; antistatic preparations for household purposes; air fragrancing preparations; cake flavorings [essential oils]; flavorings for beverages [essential oils]; aromatics [essential oils]; breath freshening sprays; canned pressurized air for cleaning and dusting purposes; balms, other than for medical purposes; lip glosses; polishing stones; abrasive paper; emery paper; polishing paper; petroleum jelly for cosmetic purposes; shoe wax; shoe polish; cobblers' wax; cotton wool for cosmetic purposes; sachets for perfuming linen; drying agents for dishwashing machines; adhesives for cosmetic purposes; scented water; Javelle water; lavender water; toilet water; laundry wax; non-slipping wax for floors; depilatory wax; mustache wax; creams for leather; polish for furniture and flooring; shoemakers' wax; polishing wax; tailors' wax; massage gels, other than for medical purposes; heliotropine; dental bleaching gels; geraniol; make-up; deodorants for pets; deo-

rants for human beings or for animals; depilatory preparations; scented wood; perfumes; non-slipping liquids for floors; windshield cleaning liquids; greases for cosmetic purposes; volcanic ash for cleaning; perfumery; decorative transfers for cosmetic purposes; ionone [perfumery]; shaving stones [astringents]; smoothing stones; eyebrow pencils; cosmetic pencils; silicon carbide [abrasive]; carbides of metal [abrasives]; alum stones [astringents]; tripoli stone for polishing; adhesives for affixing false eyelashes; adhesives for affixing false hair; hair conditioners; quillaia bark for washing; corundum [abrasive]; beard dyes; colorants for toilet purposes; cosmetic dyes; laundry starch; laundry glaze; shoe cream; polishing creams; cosmetic creams; skin whitening creams; polishing rouge; incense; hair spray; nail polish; hair lotions; lotions for cosmetic purposes; after-shave lotions; beauty masks; oils for perfumes and scents; oils for cleaning purposes; oils for cosmetic purposes; oils for toilet purposes; essential oils; essential oils of cedarwood; essential oils of lemon; essential oils of citron; bergamot oil; gaultheria oil; jasmine oil; lavender oil; almond oil; rose oil; oil of turpentine for degreasing; whiting; cleaning chalk; almond milk for cosmetic purposes; cleansing milk for toilet purposes; musk [perfumery]; soap; deodorant soap; shaving soap; soap for brightening textile; cakes of toilet soap; antiperspirant soap; soap for foot perspiration; almond soap; mint for perfumery; cosmetic kits; emery; nail art stickers; false nails; eau de Cologne; bases for flower perfumes; joss sticks; pastes for razor strops; dentifrices; pumice stone; lipstick cases; hydrogen peroxide for cosmetic purposes; breath freshening strips; abrasive cloth; glass cloth [abrasive cloth]; lipsticks; pomades for cosmetic purposes; shaving preparations; cosmetic preparations for baths; bath preparations, not for medical purposes; hair straightening preparations; hair waving preparations; laundry soaking preparations; grinding preparations; douching preparations for personal sanitary or deodorant purposes [toiletries]; smoothing preparations [starching]; color-removing preparations; leather bleaching preparations; polishing preparations; denture polishes; mouthwashes, not for medical purposes; cosmetic preparations for slimming purposes; starch glaze for laundry purposes; refurbishing preparations; fabric softeners for laundry use; laundry bleach; dry-cleaning preparations; paint stripping preparations; lacquer-removing preparations; make-up removing preparations; floor wax removers [scouring preparations]; varnish-removing preparations; rust removing preparations; nail care preparations; cleaning preparations; preparations for cleaning dentures; wallpaper cleaning preparations; preparations for unblocking drain pipes; laundry preparations; aloe vera preparations for cosmetic purposes; sunscreen preparations; color- [colour-] brightening chemicals for household purposes [laundry]; shining preparations [po-

lish]; make-up powder; diamantine [abrasive]; stain removers; scouring solutions; false eyelashes; tissues impregnated with cosmetic lotions; tissues impregnated with make-up removing preparations; safrol; laundry blueing; turpentine for degreasing; potpourris [fragrances]; bleaching soda; washing soda, for cleaning; bath salts, not for medical purposes; bleaching salts; fumigation preparations [perfumes]; preservatives for leather [polishes]; ammonia [volatile alkali] [detergent]; astringents for cosmetic purposes; eyebrow cosmetics; make-up preparations; sun-tanning preparations [cosmetics]; hair dyes; neutralizers for permanent waving; preparations to make the leaves of plants shiny; cosmetic preparations for eyelashes; cosmetic preparations for skin care; cosmetics; cosmetics for animals; mascara; detergents, other than for use in manufacturing operations and for medical purposes; degreasers, other than for use in manufacturing processes; bleaching preparations [decolorants] for cosmetic purposes; antiperspirants [toiletries]; talcum powder, for toilet use; cotton sticks for cosmetic purposes; terpenes [essential oils]; emery cloth; cloths impregnated with a detergent for cleaning; henna [cosmetic dye]; shampoos; shampoos for pets [non-medicated grooming preparations]; dry shampoos; sandpaper; soda lye; extracts of flowers [perfumes]; ethereal essences; badian essence; mint essence [essential oil].

9 – 3D spectacles; DVD players; ticket dispensers; coin-operated musical automata [juke boxes]; fire engines; answering machines; electrical adapters; accumulators, electric; accumulators, electric, for vehicles; accelerometers; actinometers; alidades; altimeters; ammeters; anemometers; anodes; antennas; anticathodes; apertometers [optics]; high-frequency apparatus; testing apparatus not for medical purposes; remote control apparatus; electro-dynamic apparatus for the remote control of railway points; electro-dynamic apparatus for the remote control of signals; monitoring apparatus, electric; sound recording apparatus; Global Positioning System [GPS] apparatus; distillation apparatus for scientific purposes; diffraction apparatus [microscopy]; air analysis apparatus; apparatus to check franking; sound transmitting apparatus; apparatus for fermentation [laboratory apparatus]; breathing apparatus for underwater swimming; breathing apparatus, except for artificial respiration; apparatus and installations for the production of X-rays, not for medical purposes; cash registers; electric apparatus for commutation; intercommunication apparatus; stills for laboratory experiments; projection apparatus; radiological apparatus for industrial purposes; X-ray apparatus not for medical purposes; blueprint apparatus; flashing lights [luminous signals]; stereoscopic apparatus; telephone apparatus; facsimile machines; phototelegraphy apparatus; igniting apparatus, electric, for igniting at a distance; acid hydrometers; salinometers; acidimeters for batteries; aerometers; beacons, lumi-

nous; battery jars; barometers; anode batteries; galvanic batteries; batteries for lighting; solar batteries; solar panels for the production of electricity; batteries, electric; balances [steelyards]; betatrons; binoculars; electronic tags for goods; lens hoods; magnetic tape units for computers; computer memory devices; fire hose nozzles; encoded identification bracelets, magnetic; safety tarpaulins; bullet-proof clothing; signaling buoys; life buoys; marking buoys; directional compasses; vacuum gauges; electrolyzers; variometers; verniers; scales; letter scales; weighbridges; precision balances; levelling staffs [surveying instruments]; camcorders; video baby monitors; video cassettes; video telephones; video screens; viewfinders, photographic; sockets, plugs and other contacts [electric connections]; micrometer screws for optical instruments; viscosimeters; circuit closers; wavemeters; voltmeters; mechanical signs; signs, luminous; switchboxes [electricity]; current rectifiers; gas testing instruments; gasometers [measuring instruments]; galvanometers; hands-free kits for telephones; heliographic apparatus; hygrometers; hydrometers; weights; peepholes [magnifying lenses] for doors; holograms; plotters; loudspeakers; sounding leads; plumb bobs; range finders; densimeters; densitometers; optical goods; detectors; smoke detectors; counterfeit [false] coin detectors; transparencies [photography]; slide projectors; diaphragms [photography]; dictating machines; dynamometers; light-emitting diodes [LED]; floppy disks; sound recording discs; disks, magnetic; optical discs; circular slide rules; disk drives for computers; juke boxes for computers; DNA chips; electronic notice boards; bullet-proof waistcoats [vests (Am.)]; life jackets; identification threads for electric wires; nose clips for divers and swimmers; locks, electric; alarm bells, electric; electric door bells; signal bells; bells [warning devices]; acoustic conduits; mirrors for inspecting work; road signs, luminous or mechanical; marine depth finders; probes for scientific purposes; buzzers; needles for record players; measures; pressure measuring apparatus; simulators for the steering and control of vehicles; inverters [electricity]; pressure indicators; temperature indicators; incubators for bacteria culture; measuring instruments; cosmographic instruments; mathematical instruments; levelling instruments; instruments containing eyepieces; surveying instruments; azimuth instruments; interfaces for computers; ionization apparatus not for the treatment of air or water; spark-guards; coaxial cables; fibre [fiber (Am.)] optic cables; cables, electric; calipers; slide calipers; screw-tapping gauges; calculating machines; pocket calculators; decompression chambers; cinematographic cameras; life-saving capsules for natural disasters; electronic pens [visual display units]; holders for electric coils; identity cards, magnetic; video game cartridges; toner cartridges, unfilled, for printers and photocopiers; memory cards for video game machines; enco-

ded magnetic cards; riding helmets; protective helmets; carriers for dark plates [photography]; automated teller machines [ATM]; cathodes; choking coils [impedance]; spools [photography]; coils, electric; electromagnetic coils; cinematographic film, exposed; computer keyboards; solenoid valves [electromagnetic switches]; wire connectors [electricity]; encoded key cards; electronic book readers; electronic agendas; push buttons for bells; mouse pads; magnetic encoders; anti-glare visors; collectors, electric; calibrating rings; protective suits for aviators; commutators; compact discs [audio-video]; compact discs [read-only memory]; comparators; marine compasses; computers; laptop computers; tablet computers; notebook computers; condensers [capacitors]; contacts, electric; wind socks for indicating wind direction; traffic cones; branch boxes [electricity]; distribution boxes [electricity]; junction boxes [electricity]; battery boxes; cabinets for loudspeakers; diving suits; galena crystals [detectors]; reflecting discs for wear, for the prevention of traffic accidents; covers for electric outlets; logs [measuring instruments]; lasers, not for medical purposes; lactodensimeters; lactometers; vacuum tubes [radio]; flashlights [photography]; darkroom lamps [photography]; thermionic tubes; amplifying tubes; head cleaning tapes [recording]; magnetic tapes; videotapes; surveying chains; fire escapes; rulers [measuring instruments]; slide-rules; optical condensers; contact lenses; correcting lenses [optics]; optical lenses; electricity conduits; sounding lines; measuring spoons; magnifying glasses [optics]; thread counters; magnets; decorative magnets; close-up lenses; crash test dummies; resuscitation mannequins [teaching apparatus]; mouse [computer peripheral]; pressure gauges; divers' masks; solderers' helmets; protective masks; materials for electricity mains [wires, cables]; voting machines; money counting and sorting machines; material testing instruments and machines; furniture especially made for laboratories; megaphones; portable media players; diaphragms [acoustics]; diaphragms for scientific apparatus; metal detectors for industrial or military purposes; metronomes; carpenters' rules; rules [measuring instruments]; dressmakers' measures; mechanisms for coin-operated apparatus; mechanisms for counter-operated apparatus; coin-operated mechanisms for television sets; shutter releases [photography]; micrometers; microprocessors; microscopes; microtomes; microphones; modems; lightning conductors [rods]; monitors [computer hardware]; monitors [computer programs]; terminals [electricity]; junction sleeves for electric cables; teeth protectors; temperature indicator labels, not for medical purposes; knee-pads for workers; headphones; surveyors' levels; sound recording carriers; magnetic data media; optical data media; computer software, recorded; sheaths for electric cables; identification sheaths for electric wires; weighing machines; computer hardware; punc-

hed card machines for offices; life saving apparatus and equipment; shoes for protection against accidents, irradiation and fire; lenses for astrophotography; objectives [lenses] [optics]; egg-candlers; fire extinguishers; electrified fences; limiters [electricity]; clothing for protection against accidents, irradiation and fire; clothing for protection against fire; asbestos clothing for protection against fire; clothing especially made for laboratories; ozonisers [ozonators]; octants; eyepieces; ohmmeters; wrist rests for use with computers; eyeglass frames; oscillographs; plumb lines; mirrors [optics]; eyeglasses; sunglasses; goggles for sports; signalling panels, luminous or mechanical; radio pagers; pince-nez; electronic pocket translators; transmitters [telecommunication]; telephone transmitters; transmitters of electronic signals; switches, electric; periscopes; gloves for divers; gloves for protection against accidents; gloves for protection against X-rays for industrial purposes; asbestos gloves for protection against accidents; furnaces for laboratory use; pipettes; pyrometers; planimeters; plane tables [surveying instruments]; plates for batteries; wafers for integrated circuits; printed circuit boards; compact disc players; cassette players; sound recording strips; X-ray films, exposed; films, exposed; life-saving rafts; laboratory trays; digital signs; semi-conductors; polarimeters; fire pumps; measuring glassware; life belts; fuses; circuit breakers; converters, electric; telerupters; food analysis apparatus; diagnostic apparatus, not for medical purposes; distance recording apparatus; distance measuring apparatus; speed measuring apparatus [photography]; appliances for measuring the thickness of leather; apparatus for measuring the thickness of skins; speed checking apparatus for vehicles; teaching apparatus; time recording apparatus; hemline markers; measuring apparatus; measuring devices, electric; apparatus and instruments for astronomy; surveying apparatus and instruments; weighing apparatus and instruments; nautical apparatus and instruments; navigational instruments; optical apparatus and instruments; chemistry apparatus and instruments; apparatus and instruments for physics; boiler control instruments; meteorological instruments; naval signalling apparatus; observation instruments; navigation apparatus for vehicles [on-board computers]; satellite navigational apparatus; regulating apparatus, electric; precision measuring apparatus; audio- and video-receivers; prisms [optics]; computer software applications, downloadable; printers for use with computers; retorts' stands; apparatus for changing record player needles; drainers for use in photography; cleaning apparatus for sound recording discs; fire beaters; telescopic sights for firearms; telescopic sights for artillery; test tubes; pressure indicator plugs for valves; magnetic wires; telegraph wires; telephone wires; wires, electric; conductors, electric; copper wire, insulated; fuse wire; computer progra-

mmes [programs], recorded; computer game software; computer programs [downloadable software]; computer operating programs, recorded; record players; processors [central processing units]; rods for water diviners; electronic publications, downloadable; distribution consoles [electricity]; control panels [electricity]; radar apparatus; masts for wireless aerials; transmitting sets [telecommunication]; radios; vehicle radios; sprinkler systems for fire protection; frames for photographic transparencies; screens for photoengraving; walkie-talkies; voltage surge protectors; voltage regulators for vehicles; stage lighting regulators; light dimmers [regulators], electric; speed regulators for record players; cell switches [electricity]; washing trays [photography]; marking gauges [joinery]; time switches, automatic; relays, electric; safety restraints, other than for vehicle seats and sports equipment; X-ray photographs, other than for medical purposes; rheostats; respirators for filtering air; retorts; refractometers; refractors; grids for batteries; speaking tubes; horns for loudspeakers; saccharometers; optical fibers [fibres] [light conducting filaments]; traffic-light apparatus [signalling devices]; dog whistles; signalling whistles; sextants; inductors [electricity]; safety nets; nets for protection against accidents; fire alarms; signals, luminous or mechanical; sirens; scanners [data processing equipment]; integrated circuit cards [smart cards]; smartphones; connections for electric lines; couplings, electric; connectors [electricity]; sonars; sound locating instruments; lighting ballasts; resistances, electric; spectrograph apparatus; spectrocopes; speed indicators; alcoholmeters; satellites for scientific purposes; protection devices for personal use against accidents; audiovisual teaching apparatus; radiotelegraphy sets; radiotelephony sets; spectacle lenses; anti-glare glasses; optical glass; personal stereos; stereoscopes; stands for photographic apparatus; stroboscopes; fire boats; sulfimeters; bags adapted for laptops; drying racks [photography]; spherometers; integrated circuits; printed circuits; counters; parking meters; kilometer recorders for vehicles; revolution counters; abacuses; egg timers [sandglasses]; taximeters; ear plugs for divers; tachometers; television apparatus; telegraphs [apparatus]; telescopes; teleprompters; teleprinters; cordless telephones; cellular phones; theodolites; thermometers, not for medical purposes; thermostats; thermostats for vehicles; crucibles [laboratory]; tone arms for record players; totalizers; transistors [electronic]; transponders; protractors [measuring instruments]; step-up transformers; transformers [electricity]; vehicle breakdown warning triangles; triodes; starter cables for motors; discharge tubes, electric, other than for lighting; capillary tubes; neon signs; Pitot tubes; X-ray tubes not for medical purposes; telephone receivers; gauges; quantity indicators; automatic indicators of low pressure in vehicle tires [tyres]; gasoline gauges; water level indicators;

electric loss indicators; light-emitting electronic pointers; slope indicators; levels [instruments for determining the horizontal]; mercury levels; spirit levels; urinometers; amplifiers; particle accelerators; electric installations for the remote control of industrial operations; baby monitors; steering apparatus, automatic, for vehicles; balancing apparatus; video recorders; sound reproduction apparatus; invoicing machines; protection devices against X-rays, not for medical purposes; railway traffic safety appliances; data processing apparatus; oxygen transvasing apparatus; theft prevention installations, electric; film cutting apparatus; drying apparatus for photographic prints; optical character readers; centering apparatus for photographic transparencies; dosage dispensers; battery chargers; chargers for electric batteries; acoustic alarms; sounding apparatus and machines; editing appliances for cinematographic films; cathodic anti-corrosion apparatus; couplers [data processing equipment]; anti-theft warning apparatus; computer peripheral devices; anti-interference devices [electricity]; demagnetizing apparatus for magnetic tapes; acoustic couplers; alarms; fog signals, non-explosive; whistle alarms; adding machines; readers [data processing equipment]; bar code readers; heat regulating apparatus; photocopiers [photographic, electrostatic, thermic]; downloadable ring tones for mobile phones; downloadable image files; downloadable music files; animated cartoons; filters for respiratory masks; filters for ultraviolet rays, for photography; filters [photography]; USB flash drives; magic lanterns; signal lanterns; optical lamps; cameras [photography]; glazing apparatus for photographic prints; shutters [photography]; darkrooms [photography]; photometers; flash-bulbs [photography]; digital photo frames; enlarging apparatus [photography]; photovoltaic cells; containers for contact lenses; eyeglass cases; containers for microscope slides; cases especially made for photographic apparatus and instruments; chromatography apparatus for laboratory use; chronographs [time recording apparatus]; laboratory centrifuges; eyeglass chains; cyclotrons; compasses for measuring; frequency meters; time clocks [time recording devices]; Petri dishes; sleeves for laptops; fire blankets; chips [integrated circuits]; jigs [measuring instruments]; pedometers; meteorological balloons; electrified rails for mounting spot lights; asbestos screens for firemen; fire hose; protective helmets for sports; cell phone straps; eyeglass cords; tripods for cameras; switchboards; distribution boards [electricity]; workmen's protective face-shields; projection screens; radiology screens for industrial purposes; fluorescent screens; screens [photography]; exposure meters [light meters]; ducts [electricity]; galvanic cells; epidiascopes; ergometers; armatures [electricity].

10 – Blood testing apparatus; anaesthetic apparatus; galvanic therapeutic appliances; apparatus for artificial respiration; apparatus for the treatment of

deafness; testing apparatus for medical purposes; physical exercise apparatus for medical purposes; body rehabilitation apparatus for medical purposes; dental apparatus and instruments; surgical apparatus and instruments; resuscitation apparatus; dental apparatus, electric; physiotherapy apparatus; bed vibrators; hot air therapeutic apparatus; diagnostic apparatus for medical purposes; traction apparatus for medical purposes; radiotherapy apparatus; microdermabrasion apparatus; fumigation apparatus for medical purposes; apparatus and installations for the production of X-rays, for medical purposes; radiological apparatus for medical purposes; X-ray apparatus for medical purposes; hearing aids; trusses; maternity belts; bandages, elastic; cupping glasses; dental burs; feeding bottles; air cushions for medical purposes; hot air vibrators for medical purposes; vibromassage apparatus; gastroscopes; hemocytometers; lice combs; surgical sponges; defibrillators; dialyzers; containers especially made for medical waste; clips, surgical; mirrors for dentists; mirrors for surgeons; probes for medical purposes; urethral probes; artificial teeth; acupuncture needles; suture needles; needles for medical purposes; orthopedic articles; surgical implants comprised of artificial materials; inhalers; injectors for medical purposes; incubators for medical purposes; incubators for babies; obstetric apparatus; obstetric apparatus for cattle; electric acupuncture instruments; surgical cutlery; insufflators; endoscopy cameras for medical purposes; cannulae; droppers for medical purposes; dropper bottles for medical purposes; heart pacemakers; heart rate monitoring apparatus; catheters; catgut; draw-sheets for sick beds; enema apparatus for medical purposes; artificial skin for surgical purposes; teething rings; compressors [surgical]; thermo-electric compresses [surgery]; abdominal corsets; corsets for medical purposes; crutches; dentists' armchairs; armchairs for medical or dental purposes; beds specially made for medical purposes; feeding bottle valves; love dolls [sex dolls]; lasers for medical purposes; lamps for medical purposes; quartz lamps for medical purposes; ultraviolet ray lamps for medical purposes; lancets; lenses [intraocular prostheses] for surgical implantation; spoons for administering medicine; masks for use by medical personnel; anaesthetic masks; suture materials; childbirth mattresses; air mattresses for medical purposes; hydrostatic [water] beds for medical purposes; furniture especially made for medical purposes; water bags for medical purposes; douche bags; breast pumps; urinals [vessels]; temperature indicator labels for medical purposes; knee bandages, orthopaedic; tips for crutches; finger guards for medical purposes; medical guidewires; pumps for medical purposes; thread, surgical; knives for surgical purposes; scissors for surgery; ambulance stretchers; stretchers, wheeled; boots for medical purposes; orthopaedic footwear; clothing especially for operating rooms; compres-

sion garments; blankets, electric, for medical purposes; supports for flat feet; ophthalmometers; ophthalmoscopes; slings [supporting bandages]; gloves for massage; gloves for medical purposes; pessaries; saws for surgical purposes; ear picks; spittoons for medical purposes; plaster bandages for orthopaedic purposes; supportive bandages; suspensory bandages; abdominal pads; heating cushions [pads], electric, for medical purposes; cushions for medical purposes; pads [pouches] for preventing pressure sores on patient bodies; air pillows for medical purposes; soporific pillows for insomnia; abdominal belts; galvanic belts for medical purposes; hypogastric belts; belts for medical purposes; orthopaedic belts; umbilical belts; belts, electric, for medical purposes; condoms; aerosol dispensers for medical purposes; sphygmomanometers; pulse meters; esthetic massage apparatus; massage apparatus; veterinary apparatus and instruments; medical apparatus and instruments; urological apparatus and instruments; orthodontic appliances; nursing appliances; brushes for cleaning body cavities; invalids' hoists; appliances for washing body cavities; corn knives; incontinence sheets; sterile sheets, surgical; surgical drapes; hair prostheses; artificial eyes; artificial breasts; dentures; artificial limbs; artificial jaws; ice bags for medical purposes; surgical bougies; X-ray photographs for medical purposes; respirators for artificial respiration; ear trumpets; strait jackets; sex toys; scalpels; tongue scrapers; feeding bottle teats; babies' pacifiers [teats]; receptacles for applying medicines; spirometers [medical apparatus]; vaginal syringes; hearing protectors; contraceptives, non-chemical; orthopaedic soles; stents; stethoscopes; operating tables; commode chairs; basins for medical purposes; bed pans; instrument cases for use by doctors; arch supports for footwear; ear plugs [ear protection devices]; thermal packs for first aid purposes; thermometers for medical purposes; tomographs for medical purposes; trocars; drainage tubes for medical purposes; X-ray tubes for medical purposes; radium tubes for medical purposes; balling guns; protection devices against X-rays, for medical purposes; apparatus for acne treatment; filters for ultraviolet rays, for medical purposes; quad canes for medical purposes; walking frames for disabled persons; cases fitted for medical instruments; stockings for varices; elastic stockings for surgical purposes; splints, surgical; syringes for injections; syringes for medical purposes; hypodermic syringes; uterine syringes; urethral syringes; pins for artificial teeth; forceps; castrating pincers; radiology screens for medical purposes; electrodes for medical use; electrocardiographs.

16 – Fountain pens; aquarelles; albums; almanacs; document laminators for office use; mimeograph apparatus and machines; atlases; posters; paper bows; table linen of paper; tickets; forms, printed; announcement cards [stationery]; note books; drawing pads; pads [stationery]; loose-leaf binders; wristbands for

the retention of writing instruments; pamphlets; booklets; paper; paper sheets [stationery]; waxed paper; paper for recording machines; paper for radiograms; electrocardiograph paper; drawer liners of paper, perfumed or not; wood pulp paper; carbon paper; copying paper [stationery]; parchment paper; writing paper; luminous paper; Xuan paper for Chinese painting and calligraphy; toilet paper; wrapping paper; filter paper; blotters; newsletters; rollers for typewriters; house painters' rollers; composing sticks; modelling wax, not for dental purposes; signboards of paper or cardboard; sewing patterns; newspapers; electrotypes; hectographs; modelling clay; polymer modelling clay; terrestrial globes; drawing sets; engravings; slate pencils; pencil leads; document holders [stationery]; pencil holders; chalk holders; holders for checkbooks [cheque books]; holders for stamps [seals]; page holders; diagrams; engraving plates; writing slates; blackboards; galley racks [printing]; drawing boards; advertisement boards of paper or cardboard; duplicators; punches [office requisites]; cream containers of paper; magazines [periodicals]; money clips; tags for index cards; pen clips; bookmarkers; etching needles; tracing needles for drawing purposes; periodicals; printed publications; paper shredders for office use; graphic representations; credit card imprinters, non-electric; graining combs; drawing instruments; calendars; tracing paper; tracing cloth; tracing patterns; gums [adhesives] for stationery or household purposes; lithographic stones; ink stones [ink reservoirs]; pencils; pencil lead holders; charcoal pencils; pictures; transfers [decalcomanias]; paintings [pictures], framed or unframed; cardboard; wood pulp board [stationery]; hat boxes of cardboard; files [office requisites]; cards; index cards [stationery]; geographical maps; paper tapes and cards for the recordal of computer programmes; trading cards, other than for games; perforated cards for Jacquard looms; catalogues; spools for inking ribbons; covers of paper for flower pots; painters' brushes; writing brushes; typewriter keys; glue for stationery or household purposes; gluten [glue] for stationery or household purposes; isinglass for stationery or household purposes; starch paste [adhesive] for stationery or household purposes; printing blocks; books; manifolds [stationery]; comic books; drawing pins; cigar bands; envelopes [stationery]; cases for stamps [seals]; paint boxes [articles for use in school]; correcting fluids [office requisites]; stencils [stationery]; French curves; paper ribbons; typewriter ribbons; adhesive bands for stationery or household purposes; gummed tape [stationery]; correcting tapes [office requisites]; inking ribbons; inking ribbons for computer printers; adhesive tapes for stationery or household purposes; self-adhesive tapes for stationery or household purposes; drawing rulers; square rulers for drawing; flyers; absorbent sheets of paper or plastic for foodstuff packaging; humidity control

sheets of paper or plastic for foodstuff packaging; viscose sheets for wrapping; sheets of reclaimed cellulose for wrapping; plastic bubble packs for wrapping or packaging; steel letters; type [numerals and letters]; lithographs; paint trays; architects' models; postage stamps; plastics for modelling; graphic prints; modelling materials; teaching materials [except apparatus]; sealing compounds for stationery purposes; adhesives [glues] for stationery or household purposes; stuffing of paper or cardboard; book-binding material; packaging material made of starches; packing [cushioning, stuffing] materials of paper or cardboard; filtering materials [paper]; addressing machines; pencil sharpening machines, electric or non-electric; bookbinding apparatus and machines [office equipment]; typewriters, electric or non-electric; folders [stationery]; franking machines for office use; chalk for lithography; writing chalk; tailors' chalk; marking chalk; garbage bags of paper or of plastics; bags [envelopes, pouches] of paper or plastics, for packaging; painters' easels; hand-rests for painters; printing sets, portable [office requisites]; bibs of paper; stickers [stationery]; finger-stalls [office requisites]; writing cases [stationery]; cords for bookbinding; paper knives [cutters] [office requisites]; numbering apparatus; bottle envelopes of paper or cardboard; sealing wafers; passport holders; covers [stationery]; plastic cling film, extensible, for palletization; embroidery designs [patterns]; handwriting specimens for copying; oleographs; musical greeting cards; greeting cards; postcards; etchings; conical paper bags; bags for microwave cooking; palettes for painters; ink sticks; pantographs [drawing instruments]; folders for papers; papier mâché; pastels [crayons]; modelling paste; pen cases; pen wipers; office perforators; pens [office requisites]; nibs of gold; nibs; steel pens; drawing pens; song books; sealing stamps; seals [stamps]; clipboards; address plates for addressing machines; handkerchiefs of paper; plastic film for wrapping; desk mats; letter trays; trays for sorting and counting money; coasters of paper; bookends; stamp stands; mats for beer glasses; stands for pens and pencils; photograph stands; obliterating stamps; inking pads; stamp pads; binding strips [bookbinding]; towels of paper; inking sheets for document reproducing machines; inking sheets for duplicators; bookbinding cloth; gummed cloth for stationery purposes; printers' blankets, not of textile; portraits; paperweights; writing cases [sets]; inkstands; office requisites, except furniture; writing materials; writing instruments; drawing materials; school supplies [stationery]; adhesive tape dispensers [office requisites]; hand labelling appliances; printed matter; lithographic works of art; prospectuses; printed timetables; ledgers [books]; printers' reglets; indexes; rubber erasers; elastic bands for offices; T-squares for drawing; graphic reproductions; marking pens [stationery]; penholders; tissues of paper for removing make-up; face towels of pa-

per; table napkins of paper; place mats of paper; tablemats of paper; tablecloths of paper; paper clasps; document files [stationery]; scrapers [erasers] for offices; paper-clips; staples for offices; erasing products; biological samples for use in microscopy [teaching materials]; histological sections for teaching purposes; steatite [tailor's chalk]; writing board erasers; composing frames [printing]; sealing wax; arithmetical tables; placards of paper or cardboard; writing or drawing books; fabrics for bookbinding; stationery; pencil sharpeners, electric or non-electric; transparencies [stationery]; stencil plates; cardboard tubes; Indian inks; moisteners for gummed surfaces [office requisites]; moisteners [office requisites]; squares for drawing; chart pointers, non-electronic; bottle wrappers of paper or cardboard; envelope sealing machines for offices; sealing machines for offices; vignetting apparatus; apparatus for mounting photographs; stapling presses [office requisites]; manuals [handbooks]; figurines [statuettes] of papier mâché; paper coffee filters; flags of paper; silver paper; molds for modelling clays [artists' materials]; photo-engravings; photographs [printed]; stencil cases; canvas for painting; chromolithographs [chromos]; compasses for drawing; numbers [type]; artists' watercolor saucers; ink; correcting ink [heliography]; inkwells; blueprints; stencils; erasing shields; balls for ball-point pens; cabinets for stationery [office requisites]; printing type; address stamps; stamps [seals]; shields [paper seals]; prints [engravings]; labels of paper or cardboard.

18 – Mountaineering sticks; slings for carrying. Infants; pocket wallets; credit card cases [wallets]; business card cases; reins; harness fittings; parts of rubber for stirrups; chamois leather, other than for cleaning purposes; umbrellas; parasols; saddlery; frames for umbrellas or parasols; handbag frames; card cases [notecases]; cases of leather or leatherboard; valves of leather; whips; imitation leather; leather, unworked or semi-worked; leatherboard; casings, of leather, for springs; umbrella rings; hat boxes of leather; boxes of leather or leatherboard; boxes of vulcanised fibre; purses; chain mesh purses; butts [parts of hides]; fastenings for saddles; saddle trees; bags [envelopes, pouches] of leather, for packaging; moleskin [imitation of leather]; travelling sets [leatherware]; knee-pads for horses; muzzles; halters; vanity cases, not fitted; leather thread; furniture coverings of leather; clothing for pets; trimmings of leather for furniture; collars for animals; music cases; goldbeaters' skin; cat o' nine tails; leather leashes; pads for horse saddles; horseshoes; girths of leather; horse blankets; garment bags for travel; shoulder belts [straps] of leather; briefcases; traces [harness]; fur; haversacks; leather straps; straps for soldiers' equipment; harness straps; straps for skates; straps of leather [saddlery]; chin straps, of leather; stirrup leathers; umbrella handles; walking stick handles; suitcase handles; rucksacks; travelling

bags; riding saddles; net bags for shopping; umbrella or parasol ribs; stirrups; bags; bags for climbers; pouch baby carriers; bags for campers; handbags; tool bags, empty; beach bags; bags for sports; shopping bags; wheeled shopping bags; school satchels; travelling trunks; nose bags [feed bags]; bridoons; walking sticks; umbrella sticks; walking stick seats; bits for animals [harness]; bridles [harness]; harness for animals; key cases; horse collars; suitcases; trunks [luggage]; valises; attache cases; covers for horse saddles; umbrella covers; kid; curried skins; animal skins; cattle skins; leather laces; blinkers [harness]; game bags [hunting accessories].

25 – Wimples; bandanas [neckerchiefs]; underwear; sweat-absorbent underwear; berets; overalls; boas [necklets]; teddies [underclothing]; boxer shorts; boots; ski boots; boots for sports; breeches for wear; trousers; football boots; brassieres; valenki [felted boots]; collars [clothing]; detachable collars; shirt yokes; veils [clothing]; gabardines [clothing]; galoshes; neckties; ascots; leggings [leg warmers]; gaiters; boot uppers; corselets; jerseys [clothing]; vests; sports jerseys; hosiery; heels; hoods [clothing]; hat frames [skeletons]; pockets for clothing; neck scarfs [mufflers]; visors [headwear]; cap peaks; tights; slips [underclothing]; wet suits for water-skiing; combinations [clothing]; bodices [lingerie]; corsets [underclothing]; suits; bathing suits; masquerade costumes; beach clothes; stuff jackets [clothing]; jackets [clothing]; fishing vests; leggings [trousers]; liveries; camisoles; sports singlets; cuffs; short-sleeve shirts; mantillas; coats; sleep masks; furs [clothing]; mittens; miters [hats]; footmuffs, not electrically heated; muffs [clothing]; heelpieces for footwear; bibs, not of paper; fur stoles; ear muffs [clothing]; socks; footwear; beach shoes; sports shoes; clothing; paper clothing; outerclothing; ready-made clothing; motorists' clothing; cyclists' clothing; clothing for gymnastics; clothing of imitations of leather; clothing of leather; waterproof clothing; uniforms; fittings of metal for footwear; maniples; overcoats; panties; parkas; pelerines; ski gloves; gloves [clothing]; pajamas (Am.); bathing trunks; shirt fronts; scarfs; pocket squares; dresses; headbands [clothing]; garters; sock suspenders; stocking suspenders; ready-made linings [parts of clothing]; dress shields; soles for footwear; braces for clothing [suspenders]; half-boots; ponchos; girdles; money belts [clothing]; belts [clothing]; layettes [clothing]; non-slipping devices for footwear; heelpieces for stockings; welts for footwear; chasubles; shirts; wooden shoes; sandals; bath sandals; jumper dresses; saris; sarongs; sweaters; footwear uppers; inner soles; albs; bath slippers; togas; knitwear [clothing]; underpants; shoes; gymnastic shoes; slippers; skull caps; turbans; headgear for wear; aprons [clothing]; tee-shirts; dressing gowns; bath robes; top hats; tips for footwear; stockings; sweat-absorbent stockings; shawls; paper hats [clothing]; caps [headwear]; shower caps; bat-

hing caps; sashes for wear; studs for football boots; hats; babies' pants [underwear]; trouser straps; pelisses; esparto shoes or sandals; skirts; petticoats; skorts.

28 – Arcade video game machines; video game machines; gaming machines for gambling; amusement machines, automatic and coin-operated; toy vehicles; swimming pools [play articles]; trampolines; novelties for parties, dances [party favors, favours]; scratch cards for playing lottery games; starting blocks for sports; bodyboards; skating boots with skates attached; dolls' feeding bottles; stationary exercise bicycles; creels [fishing traps]; shuttlecocks; spinning tops [toys]; dumb-bells; jigsaw puzzles; clay pigeons [targets]; punching bags; bite sensors [fishing tackle]; hang gliders; flying discs [toys]; discuses for sports; dolls' houses; dominoes; swimming kick boards; surfboards; spring boards [sports articles]; skateboards; sailboards; chessboards; checkerboards; darts; Christmas trees of synthetic material; cups for dice; swimming jackets; ascenders [mountaineering equipment]; kites; toys; toys for pets; stuffed toys; plush toys; mobiles [toys]; practical jokes [novelties]; games; parlor games; building games; board games; ring games; kaleidoscopes; bladders of balls for games; rosin used by athletes; edges of skis; bingo cards; playing cards; fairground ride apparatus; reels for fishing; rocking horses; swings; skittles; skittles [games]; billiard cues; golf clubs; hockey sticks; seal skins [coverings for skis]; bells for Christmas trees; dolls' rooms; controllers for game consoles; controllers for toys; confetti; explosive bonbons [Christmas crackers]; ice skates; roller skates; in-line roller skates; dice; paintball guns [sports apparatus]; ski bindings; dolls' beds; roulette wheels; fish hooks; building blocks [toys]; dolls; flippers for swimming; fishing lines; gut for fishing; bows for archery; skis; water-skis; surf skis; mah-jong; hunting game calls; puppets; masks [playthings]; carnival masks; theatrical masks; fencing masks; matryoshka dolls; masts for sailboards; ball pitching machines; teddy bears; chalk for billiard cues; targets; electronic targets; toy models; scale model kits [toys]; scale model vehicles; kite reels; balls for games; artificial fishing bait; billiard table cushions; knee guards [sports articles]; billiard cue tips; elbow guards [sports articles]; backgammon games; dolls' clothes; fencing weapons; twirling batons; paragliders; pachinkos; baseball gloves; boxing gloves; golf gloves; gloves for games; batting gloves [accessories for games]; fencing gauntlets; pinatas; toy pistols; toy air pistols; caps for pistols [toys]; percussion caps [toys]; rattles [playthings]; horseshoe games; candle holders for Christmas trees; Christmas tree stands; sole coverings for skis; water wings; floats for fishing; portable games with liquid crystal displays; swimming belts; decoys for hunting or fishing; scent lures for hunting or fishing; archery implements; soap bubbles [toys]; divot

repair tools [golf accessories]; billiard markers; protective paddings [parts of sports suits]; rackets; surfboard leashes; harness for sailboards; weight lifting belts [sports articles]; sling shots [sports articles]; rollers for stationary exercise bicycles; harpoon guns [sports articles]; scooters [toys]; bob-sleighs; sleds [sports articles]; butterfly nets; landing nets for anglers; nets for sports; tennis nets; bite indicators [fishing tackle]; slot machines [gaming machines]; appliances for gymnastics; quoits; bar-bells; climbers' harness; fishing tackle; artificial snow for Christmas trees; snowshoes; snowboards; clay pigeon traps; billiard tables; coin-operated billiard tables; tables for table tennis; strings for rackets; gut for rackets; cricket bags; golf bags, with or without wheels; golf bag carts; slides [playthings]; remote-controlled toy vehicles; body-building apparatus; machines for physical exercises; men's athletic supporters [sports articles]; rods for fishing; ornaments for Christmas trees, except illumination articles and confectionery; tennis ball throwing apparatus; conjuring apparatus; apparatus for games; bowling apparatus and machinery; toy figures; chips for gambling; counters [discs] for games; foosball tables; bags especially designed for skis and surfboards; marbles for games; billiard balls; playing balls; play balloons; paintballs [ammunition for paintball guns] [sports apparatus]; snow globes; chess games; checkers [games]; poles for pole vaulting; paper party hats; shin guards [sports articles]; camouflage screens [sports articles]; chest expanders [exercisers].

35 – Arranging subscriptions to telecommunication services for others; import-export agency services; commercial information agency services; advertising agency services; cost price analysis; rental of advertising space; business auditing; employment agency services; computerized file management; bookkeeping; outsourced administrative management for companies; invoicing; demonstration of goods; transcription of communications [office functions]; opinion polling; market studies; business information; commercial information and advice for consumers [consumer advice shop]; business investigations; business research; marketing research; personnel recruitment; business management and organization consultancy; business organization consultancy; business management consultancy; personnel management consultancy; professional business consultancy; layout services for advertising purposes; marketing; business management of performing artists; business management of sports people; writing of résumés for others; news clipping services; updating and maintenance of data in computer databases; updating of advertising material; word processing; organization of exhibitions for commercial or advertising purposes; arranging newspaper subscriptions for others; organization of fashion shows for promotional purposes; organization of trade fairs for commercial or advertising purposes; shop window dres-

sing; design of advertising materials; business appraisals; payroll preparation; data search in computer files for others; sponsorship search; business management assistance; commercial or industrial management assistance; commercial intermediation services; providing business information via a web site; provision of commercial and business contact information; provision of an on-line marketplace for buyers and sellers of goods and services; presentation of goods on communication media, for retail purposes; economic forecasting; auctioneering; retail or wholesale services for pharmaceutical, veterinary and sanitary preparations and medical supplies; sales promotion for others; wholesale and retail store services featuring goods of 03, 09, 10, 16, 18, 25, 28 classes; wholesale and retail online store services of goods of 03, 09, 10, 16, 18, 25, 28 classes; production of advertising films; office machines and equipment rental; rental of advertising time on communication media; publicity material rental; rental of vending machines; rental of sales stands; rental of photocopying machines; publication of publicity texts; radio advertising; bill-posting; distribution of samples; dissemination of advertising matter; direct mail advertising; writing of publicity texts; advertising; on-line advertising on a computer network; advertising by mail order; television advertising; document reproduction; compilation of information into computer databases; compilation of statistics; business inquiries; systemization of information into computer databases; advisory services for business management; negotiation and conclusion of commercial transactions for third parties; tax preparation; drawing up of statements of accounts; telemarketing services; psychological testing for the selection of personnel; business management of hotels; business management for freelance service providers; business project management services for construction projects; commercial administration of the licensing of the goods and services of others; business management of reimbursement programs for others; administrative processing of purchase orders; public relations; modelling for advertising or sales promotion; typing; web site traffic optimization; relocation services for businesses; tax filing services; search engine optimization for sales promotion; price comparison services; pay per click advertising; secretarial services; procurement services for others [purchasing goods and services for other businesses]; shorthand; outsourcing services [business assistance]; telephone answering for unavailable subscribers; photocopying services; business efficiency expert services.

40 – Paper finishing; applying finishes to textiles; upcycling [waste recycling]; vulcanization [material treatment]; skin dressing; fruit crushing; embroidering; galvanization; electroplating; engraving; decontamination of hazardous materials; air deodorising; stripping finishes; tanning; metal tempering; free-

zing of foods; gilding; gold plating; material treatment information; cadmium plating; permanent-press treatment of fabrics; food and drink preservation; food smoking; leather staining; fur dyeing; shoe staining; textile dyeing; cloth dyeing; laminating; lithographic printing; metal casting; fur glossing; tin plating; boilermaking; taxidermy; magnetization; nickel plating; abrasion; paper treating; water treating; woodworking; processing of cinematographic films; leather working; cloth edging; metal treating; fur conditioning; fur mothproofing; waste treatment [transformation]; textile mothproofing; fabric waterproofing; crease-resistant treatment for clothing; cloth fireproofing; textile treating; wool treating; framing of works of art; window tinting treatment, being surface coating; air freshening; fabric bleaching; air purification; soldering; clothing alteration; recycling of waste and trash; processing of oil; pattern printing; photographic printing; offset printing; metal plating; printing; burnishing by abrasion; flour milling; dressmaking; rental of boilers; knitting machine rental; rental of generators; rental of air-conditioning apparatus; rental of space heating apparatus; photographic film development; pottery firing; blacksmithing; custom assembling of materials for others; bookbinding; welding services; glass-blowing; saddlery working; grinding; cloth cutting; sawing of materials; refining services; timber felling and processing; fur satining; silver plating; incineration of waste and trash; laser scribing; warping [looms]; sorting of waste and recyclable material [transformation]; photocomposing services; quilting; planing of materials; fulling of cloth; slaughtering of animals; destruction of waste and trash; cloth pre-shrinking; services of a dental technician; cryopreservation services; key cutting; dyeing services; sandblasting services; custom tailoring; production of energy; custom fashioning of fur; photogravure; millworking; chromium plating; colour separation services; silkscreen printing; optical glass grinding.

42 – Water analysis; computer system analysis; handwriting analysis [graphology]; chemical analysis; energy auditing; recovery of computer data; industrial design; graphic arts design; computer virus protection services; oil-field surveys; geological surveys; engineering; installation of computer software; meteorological information; clinical trials; material testing; textile testing; bacteriological research; biological research; geological research; research in the field of environmental protection; cosmetic research; mechanical research; chemical research; research and development of new products for others; scientific research; analysis for oil-field exploitation; underwater exploration; technical research; calibration [measuring]; web site design consultancy; information technology [IT] consultancy; consultancy in the design and development of computer hardware; architectural consultancy; computer software consultancy; technological consultancy; oil-well testing;

quality control; vehicle roadworthiness testing; land surveying; dress designing; updating of computer software; monitoring of computer systems by remote access; software as a service [SaaS]; maintenance of computer software; authenticating works of art; design of interior decor; quality evaluation of standing timber; quality evaluation of wool; digitization of documents [scanning]; conversion of data or documents from physical to electronic media; urban planning; providing information on computer technology and programming via a web site; provision of scientific information, advice and consultancy in relation to carbon offsetting; providing search engines for the internet; conversion of computer programs and data, other than physical conversion; conducting technical project studies; computer system design; rental of web servers; computer rental; rental of computer software; geological prospecting; oil prospecting; hosting computer sites [web sites]; server hosting; duplication of computer programs; construction drafting; computer software design; cloud seeding; consultancy in the field of energy-saving; creating and maintaining web sites for others; computer programming; architectural services; outsource service providers in the field of information technology; chemistry services; packaging design; off-site data backup; computer technology consultancy; telecommunications technology consultancy; scientific laboratory services; cloud computing; weather forecasting; styling [industrial design]; cartography services; physics [research]; electronic data storage; surveying.

(260) AM 2018 92702 A

(800) 1347254

(891) 2017 02 24

(731) OSRAM GmbH

Marcel-Breuer-Straße 6, 80807 München,
Germany

(540)



(591) Orange and grey

(531) 01.15.09; 25.05.02; 25.07.06; 26.01.06;
26.11.01; 26.11.08; 26.15.01; 29.01.13

(511)

11 – Lighting apparatus, especially electric lamps and luminaires; lighting apparatus; lighting appara-

tus and lighting systems based on LEDs (also organic LEDs); LED-lamps and LED-luminaires and their parts; lighting modules and systems and their parts based on LEDs.

(260) AM 2018 92703 A

(800) 1347275

(891) 2013 10 10

(731) SPIESS-URANIA CHEMICALS GMBH

Frankenstraße 18 b, 22097 Hamburg, Germany

(540)

FUNGURAN

(591) Black, white

(531) 27.05.01

(511)

1 – Chemicals used in industry, science and photography; unprocessed artificial resins, unprocessed plastics; manures; fire extinguishing compositions; tempering and soldering preparations; chemicals used in electroplating; chemical substances for preserving foodstuffs; tanning substances; adhesives used in industry; chemicals, including chemicals with biological bases, for use in agriculture, horticulture and forestry, including for landscaping and sports ground construction, for soil preservation, stockpiling; plant protecting agents, substances for preserving animal foodstuffs and flowers; manures, including natural manures; soil-enhancing preparations including soil-conditioning preparations and soil-strengthening and soil-aerating preparations and preparations for fortifying plants; plant granulate for covering plant roots; chemical composting aid; peat (fertiliser); de-icing chemicals; preparations for treating seeds, including mordants for seeds and seed denaturants; chemical substances for preserving foodstuffs; plant growth regulators.

3 – Bleaching preparations and other substances for laundry use; cleaning, polishing, scouring and abrasive preparations; soaps; perfumery, essential oils, cosmetics, hair lotions; dentifrices; leaf shine compositions; cleaning preparations for gardens and containers; chemicals, namely preparations for cleaning gardens and containers.

5 – Fungicides, herbicides; preparations for destroying weeds and vermin and chemicals with a biological base for the protection of plants (stored product protection), namely preparations for combating plant, fungal, animal and microbial parasites; repellents, namely animal and insect repellents, animal and insect attractants preparations for disorientating insects and hygienic preparations for the household against parasites and pests, chemicals, including chemicals with a biological base for combating parasites, disinfectants.

(260) AM 2018 92714 A

(800) 1347292

(891) 2016 08 16

(731) CONSULTING POINT LTD

Sea Meadow House, Blackburne Highway,
P.O.Box 116, Road Town Tortola, Virgin
Islands (British)

(540)



(591) Black, white

(531) 27.05.01; 27.05.17

(511)

7 – Air brushes for applying colour; apparatus for aerating beverages; apparatus for aerating water; acetylene cleaning apparatus; apparatus for drawing up beer under pressure; blade sharpening [stropping] machines; brewing machines; vacuum pumps [machines]; wringing machines for laundry; centrifugal pumps; window openers, hydraulic; window openers, electric; window openers, pneumatic; window closers, hydraulic; window closers, electric; window closers, pneumatic; water separators; water heaters [parts of machines]; winches; alternators; dynamos; current generators; door openers, hydraulic; door openers, electric; door openers, pneumatic; door closers, hydraulic; door closers, electric; door closers, pneumatic; de-aerators for feedwater; disintegrators; pump diaphragms; dividing machines; punching machines; electric hand drills; electric welding apparatus; shoe polishers, electric; parquet wax-polishers, electric; electric hammers; generators of electricity; emergency power generators; bicycle dynamos; motors, electric, other than for land vehicles; electrodes for welding machines; electric arc welding apparatus; electric arc cutting apparatus; food preparation machines, electromechanical; beverage preparation machines, electromechanical; electromechanical machines for chemical industry; moving staircases (escalators); labellers [machines]; igniting devices for internal combustion engines; bottle sealing machines; whisks, electric, for household purposes; welding machines, electric; soldering apparatus, gas-operated; raking machines; grain separators; blenders, electric, for household purposes; stitching machines; incubators for eggs; capstans; coffee grinders, other than hand-operated; calendars; elevator operating apparatus; glue guns, electric; riveting machines; bottle capping machines; machine wheels; compressors [machines]; compressors for refrigerators; compressed air pumps; condensing installations; bottle stoppering machines; gear boxes other than for land vehicles; housings [parts of machines]; cranes (lifting and hoisting apparatus); hangers (parts of machines); food processors, electric; kitchen machines, electric; gas-operated blow torches;

chain saws; meat choppers [machines]; machines and apparatus for carpet shampooing, electric; machines and apparatus for wax-polishing, electric; washing installations for vehicles; washing apparatus; high pressure washers; pumps [machines]; pumps [parts of machines, engines or motors]; beer pumps; pumps for heating installations; can openers, electric; chaff cutter blades; knives, electric; knives for mowing machines; soldering irons, gas-operated; soldering irons, electric; soldering apparatus, electric; soldering blow pipes, gas-operated; soldering lamps; fuel conversion apparatus for internal combustion engines; pepper mills other than hand-operated; saws [machines]; saw blades [parts of machines]; dust removing installations for cleaning purposes; dust exhausting installations for cleaning purposes; vacuum cleaners; spray guns for paint; hammers [parts of machines]; air suction machines; blowing machines for the compression, exhaustion and transport of gases; blowing machines for the compression, sucking and carrying of grain; aerating pumps for aquaria; air condensers; air pumps [garage installations]; crushers for kitchen use, electric; dishwashers; washing machines [laundry]; coin-operated washing machines; ironing machines; vacuum cleaner attachments for disseminating perfumes and disinfectants; pressure regulators [parts of machines]; reduction gears other than for land vehicles; pressure reducers [parts of machines]; hand-held tools, other than hand-operated; self-regulating fuel pumps; glow plugs for Diesel engines; sparking plugs for internal combustion engines; separators; snow ploughs; fruit presses, electric, for household purposes; starters for motors and engines; heat exchangers [parts of machines]; grating machines for vegetables; beating machines; beaters, electric; kneading machines; vacuum cleaner bags; central vacuum cleaning installations; spin driers [not heated]; machines and apparatus for cleaning, electric; vacuum cleaner hoses.

9 – Scientific, nautical, surveying, photographic, cinematographic, optical, weighing, measuring, signalling, checking (supervision), life-saving and teaching apparatus and instruments; apparatus and instruments for conducting, switching, transforming, accumulating, regulating or controlling electricity; apparatus for recording, transmission or reproduction of sound or images; magnetic data carriers, recording discs; compact discs, DVDs and other digital recording media; mechanisms for coin-operated apparatus; cash registers, calculating machines, data processing equipment, computers; computer software; fire extinguishing apparatus; 3D spectacles; ticket dispensers; automated teller machines [ATM]; steering apparatus, automatic, for vehicles; automatic indicators of low pressure in vehicle tires; parking meters; aerometers; actinometers; accumulators, electric; accumulators, electric, for vehicles; acoustic couplers; alidades; altimeters; ammeters; anemome-

ters; anodes; anode batteries; antennas; anticathodes; apparatus to check stamping mail; electric apparatus for remote ignition; apparatus and installations for the production of X-rays, not for medical purposes; remote control apparatus; testing apparatus not for medical purposes; apertometers [optics]; acidimeters for batteries; apparatus and instruments for astronomy; audio- and video-receivers; audiovisual teaching apparatus; beacons, luminous; lighting ballasts; accumulator jars; toner cartridges, unfilled, for printers and photocopiers; barometers; batteries for lighting; batteries, electric; lever scales [steelyards]; betatrons; binoculars; computer memory devices; directional compasses; scales; tone arms for record players; plumb bobs; vacuum gauges; variometers; terminals [electricity]; plugs, sockets and other contacts [electric connections]; switches, electric; switchboxes [electricity]; gauges; measuring instruments; measuring apparatus; measuring devices, electric; measures; current rectifiers; high-frequency apparatus; branch boxes [electricity]; video baby monitors; video screens; camcorders; video cassettes; video telephones; answering machines; viewfinders, photographic; viscosimeters; peepholes [magnifying lenses] for doors; marking buoys; fire extinguishers; fibre [fiber (Am.)] optic cables; voltmeters; battery chargers; gas testing instruments; gasometers [measuring instruments]; discharge tubes, electric, other than for lighting; galena crystals [detectors]; galvanic batteries; galvanic cells; galvanometers; hands-free kits for telephones; heliographic apparatus; surveying apparatus and instruments; weights; hygrometers; hydrometers; needles for record players; holograms; lightning conductors [rods]; sounding leads; buzzers; loudspeakers; range finders; decompression chambers; densimeters; densitometers; detectors; smoke detectors; counterfeit [false] coin detectors; juke boxes for computers; bells [warning devices]; mirrors for inspecting work; mirrors [optics]; dictating machines; dynamometers; floppy disks; disks, magnetic; disk drives for computers; telerupters; distillation apparatus for scientific purposes; diffraction apparatus [microscopy]; breathing apparatus for underwater swimming; breathing apparatus, except for artificial respiration; diagnostic apparatus, not for medical purposes; transparency projection apparatus; diaphragms for scientific apparatus; diaphragms [photography]; DNA chips; adding machines; dosage dispensers; road signs, luminous or mechanical; traffic cones; jigs [measuring instruments]; wires of metal alloys [fuse wire]; choking coils [impedance]; furnaces for laboratory use; screens [photography]; exposure meters [light meters]; electrified rails for mounting spot lights; electric installations for the remote control of industrial operations; electric door bells; electricity conduits; electrified fences; electrodynamic apparatus for the remote control of signals; electromagnetic coils; electronic publications, downloadable; electronic tags for goods; electronic pocket

translators; electronic pens [visual display units]; electronic notice boards; epidiascopes; ergometers; wire connectors [electricity]; junction boxes [electricity]; couplers [data processing equipment]; connections for electric lines; connections, electric; connectors [electricity]; encoded identification bracelets, magnetic; locks, electric; electronic agendas; voltage surge protectors; fuses; protection devices against X-rays, not for medical purposes; protective masks; goggles for sports; protective helmets for sports; protective helmets; balancing apparatus; acoustic [sound] alarms; sound reproduction apparatus; sound recording discs; sound recording carriers; sound recording strips; sound recording apparatus; sound transmitting apparatus; acoustic conduits; mechanical signs; signs, luminous; probes for scientific purposes; sounding apparatus and machines; readers [data processing equipment]; bar code readers; inverters [electricity]; pressure indicators; slope indicators; incubators for bacteria culture; interfaces for computers; ionization apparatus not for the treatment of air or water; spark-guards; cables, electric; calipers; calibrating rings; pocket calculators; capillary tubes; holders for electric coils; memory cards for video game machines; integrated circuit cards [smart cards]; encoded key cards; video game cartridges; carriers for dark plates [photography]; cassette players; cathodes; cathodic anti-corrosion apparatus; mouse pads; acid hydrometers; cinematographic film, exposed; cinematographic cameras; push buttons for bells; coaxial cables; covers for electric outlets; encoded magnetic cards; collectors, electric; dog whistles; computer game software; computer keyboards; computer peripheral devices; magnetic tape units for computers; computer programs [downloadable software]; computer programmes [programs], recorded; computer operating programs, recorded; compact discs [read-only memory]; comparators; marine compasses; electric apparatus for commutation; condensers [capacitors]; contacts, electric; contact lenses; boiler control instruments; correcting lenses [optics]; cabinets for loudspeakers; accumulator boxes; cosmographic instruments; clothing for protection against fire; pipettes; pedometers; compasses [measuring instruments]; circular slide rules; azimuth instruments; laboratory trays; logs [measuring instruments]; lasers, not for medical purposes; lactodensimeters; lactometers; darkroom lamps [photography]; spectacle chains; laptop computers; spectacle lenses; rulers [measuring instruments]; carpenters' rules; flashlights [photography]; optical lamps; counters; revolution counters; distance recording apparatus; kilometer recorders for vehicles; slide-rules; sounding lines; magnifying glasses [optics]; magnets; decorative magnets; magnetic encoders; magnetic wires; magnetic tapes; videotapes; crash test dummies; manometers; solderers' helmets; mathematical instruments; materials for electricity mains [wires, cables]; weighing machines;

money counting and sorting machines; material testing instruments and machines; furniture especially made for laboratories; megaphones; portable media players; diaphragms [acoustics]; metal detectors for industrial or military purposes; meteorological instruments; meteorological balloons; rules [measuring instruments]; dressmakers' measures; metronomes; mechanisms for counter-operated apparatus; mouse [computer peripheral]; copper wire, insulated; micrometers; micrometer screws for optical instruments; microprocessors; microscopes; microtomes; microphones; surveying chains; measuring spoons; modems; monitors [computer programs]; monitors [computer hardware]; apparatus for editing cinematographic film; nautical apparatus and instruments; marine depth finders; naval signalling apparatus; coin-operated musical automata [juke boxes]; animated cartoons; junction sleeves for electric cables; coils, electric; inductors [electricity]; navigation apparatus for vehicles [on-board computers]; navigational instruments; teaching apparatus; headphones; knee-pads for workers; semi-conductors; screw-tapping gauges; chargers for electric batteries; neon signs; identification threads for electric wires; thread counters; surveyors' levels; levelling instruments; verniers; nose clips for divers and swimmers; notebook computers; objectives [lenses] [optics]; lenses for astrophotography; close-up lenses; limiters [electricity]; sheaths for electric cables; egg-candlers; clothing for protection against accidents, irradiation and fire; clothing especially made for laboratories; ozonisers [ozonators]; octants; eyeglasses; sunglasses; eyepieces; ohmmeters; eyeglass frames; frames for pince-nez; optical glass; optical goods; optical discs; optical character readers; optical condensers; optical lenses; optical data media; optical apparatus and instruments; telescopic sights for firearms; protection devices for personal use against accidents; oscillographs; cleaning apparatus for sound recording discs; safety restraints, other than for vehicle seats and sports equipment; pince-nez; stills for laboratory experiments; intercommunication apparatus; speaking tubes; transmitters [telecommunication]; transmitters of electronic signals; mechanisms for coin-operated apparatus; coin-operated mechanisms for television sets; oxygen transvasing apparatus; switchboards; commutators; spools [photography]; cordless telephones; circuit breakers; converters, electric; periscopes; personal stereos; punched card machines for offices; divers' masks; drying racks [photography]; wrist rests for use with computers; pyrometers; hourglasses; planimeters; plane tables [surveying instruments]; tablet computers; plates for batteries; wafers for integrated circuits; printed circuit boards; films, exposed; plotters; graduated glassware; fire engines; fire escapes; fire pumps; fire alarms; fire boats; fire beaters; fire hose; levels [instruments for determining the horizontal]; electric loss indicators; quantity indicators; wind

socks for indicating wind direction; petrol gauges; water level indicators; sprinkler systems for fire protection; polarimeters; vehicle breakdown warning triangles; amplifying tubes; amplifiers; letter scales; prisms [optics]; computer software applications, downloadable; air analysis apparatus; food analysis apparatus; distance measuring apparatus; speed checking apparatus for vehicles; time recording apparatus; weighing apparatus and instruments; Global Positioning System [GPS] apparatus; instruments containing eyepieces; printers for use with computers; particle accelerators; hemline markers; speed measuring apparatus [photography]; invoicing machines; video recorders; tape recorders; apparatus for changing record player needles; data processing apparatus; film cutting apparatus; electronic book readers; test tubes; conductors, electric; wires, electric; ducts [electricity]; record players; compact disc players; DVD players; computer software, recorded; projection apparatus; projection screens; washing trays [photography]; respirators, other than for artificial respiration; anti-interference devices [electricity]; anti-glare glasses; anti-glare visors; theft prevention installations, electric; anti-theft warning apparatus; fire blankets; processors [central processing units]; plumb lines; control panels [electricity]; starter cables for motors; radar apparatus; vehicle radios; baby monitors; vacuum tubes [radio]; radiological apparatus for industrial purposes; radiology screens for industrial purposes; radio pagers; transmitting sets [telecommunication]; radios; radiotelegraphy sets; radiotelephony sets; masts for wireless aerials; frames for photographic transparencies; screens for photoengraving; abacuses; calculating machines; voting machines; walkie-talkies; resuscitation mannequins [teaching apparatus]; regulating apparatus, electric; stage lighting regulators; voltage regulators for vehicles; light regulators [dimmers], electric; speed regulators for record players; reducers [electricity]; resistances, electric; marking gauges [joinery]; relays, electric; cell phone straps; rheostats; respirators for filtering air; retorts; refractometers; refractors; grids for batteries; downloadable ring tones for mobile phones; demagnetizing apparatus for magnetic tapes; identification sheaths for electric wires; identity cards, magnetic; distribution consoles [electricity]; distribution boxes [electricity]; distribution boards [electricity]; circuit closers; gloves for divers; horns for loudspeakers; life saving apparatus and equipment; safety tarpaulins; life buoys; life jackets; life-saving rafts; life belts; life nets; whistle alarms; reflecting discs for wear, for the prevention of traffic accidents; light conducting filaments [optical fibers [fibres]]; lens hoods; blueprint apparatus; light-emitting diodes [LED]; light-emitting electronic pointers; filters [photography]; traffic-light apparatus [signalling devices]; signals, luminous or mechanical; signal bells; alarm bells, electric; signal lanterns; alarms; signalling whistles;

signalling panels, luminous or mechanical; sirens; scanners [data processing equipment]; smartphones; salinometers; solenoid valves [electromagnetic switches]; sonars; solar batteries; blinkers [signalling lights]; spectrograph apparatus; spectroscopes; spirit levels; alcoholmeters; speed indicators; monitoring apparatus, electric; observation instruments; shutter releases [photography]; fire hose nozzles; stereoscopes; stereoscopic apparatus; head cleaning tapes [recording]; stroboscopes; sulfimeters; bags adapted for laptops; satellite navigational apparatus; time clocks [time recording devices]; taximeters; tachometers; television apparatus; telegraphs [apparatus]; teleprinters; telegraph wires; telescopes; teleprompters; telephone apparatus; telephone transmitters; telephone wires; telephone receivers; temperature indicators; temperature indicator labels, not for medical purposes; theodolites; heat regulating apparatus; thermionic tubes; thermometers, not for medical purposes; thermostats; thermostats for vehicles; crucibles [laboratory]; pressure measuring apparatus; pressure indicator plugs for valves; totalizers; precision balances; precision measuring apparatus; transistors [electronic]; transponders; protractors [measuring instruments]; transformers [electricity]; step-up transformers; retorts' stands; tripods for cameras; triodes; Pitot tubes; urinometers; downloadable image files; downloadable music files; facsimile machines; apparatus and instruments for physics; filters for ultraviolet rays, for photography; filters for respiratory masks; USB flash drives; fluorescent screens; cameras [photography]; flash-bulbs [photography]; glazing apparatus for photographic prints; drainers for use in photography; photovoltaic cells; shutters [photography]; enlarging apparatus [photography]; photocopiers [photographic, electrostatic, thermic]; darkrooms [photography]; photometers; phototelegraphy apparatus; containers for contact lenses; eyeglass cases; pince-nez cases; containers for microscope slides; cases especially made for photographic apparatus and instruments; chronographs [time recording apparatus]; centering apparatus for photographic transparencies; cyclotrons; digital photo frames; saccharometers; magic lanterns; time switches, automatic; frequency meters; Petri dishes; sleeves for laptops; socks, electrically heated; pince-nez cords; eyeglass cords; riding helmets; stands for photographic apparatus; sound locating instruments; workmen's protective face-shields; armatures [electricity].

11 – Apparatus for lighting, heating, steam generating, cooking, refrigerating, drying, ventilating, water supply and sanitary purposes; lamp shades; aquarium lights; aquarium heaters; aquarium filtration apparatus; steam accumulators; heat accumulators; hot air apparatus; air deodorising apparatus; ionization apparatus for the treatment of air or water; coffee roasters; tanning apparatus [sun beds]; hand drying apparatus for washrooms; air purifying appa-

ratus and machines; hydromassage bath apparatus; acetylene generators; acetylene flares; acetylene burners; germicidal lamps for purifying air; petrol burners; bidets; laundry room boilers; washing coppers; bath tubs; spa baths [vessels]; waffle irons, electric; bicycle lights; fans [air-conditioning]; fans [parts of air-conditioning installations]; electric fans for personal use; ventilation [air-conditioning] installations for vehicles; ventilation [air-conditioning] installations and apparatus; safety lamps; kilns; evaporators; ventilation hoods; ventilation hoods for laboratories; vehicle reflectors; pressure water tanks; whirlpool-jet apparatus; water conduits installations; water heaters [apparatus]; water intake apparatus; water softening apparatus and installations; water heaters; water purification installations; water purifying apparatus and machines; water supply installations; water distribution installations; flushing tanks; water flushing installations; water filtering apparatus; carbon for arc lamps; gas lighters; gas boilers; gas burners; gas condensers, other than parts of machines; gas lamps; gas scrubbers [parts of gas installations]; gas scrubbing apparatus; discharge tubes, electric, for lighting; hydrants; hearths; rotisseries; hot water bottles; warming pans; footwarmers, electric or non-electric; bed warmers; stoves; disinfectant apparatus; deodorising apparatus, not for personal use; ornamental fountains; flares; chimney flues; stills; distillation apparatus; distillation columns; arc lamps; showers; shower cubicles; electric appliances for making yogurt; electric lamps; electrically heated carpets; heating cushions [pads], electric, not for medical purposes; roasters; malt roasters; roasting apparatus; roasting spits; flues for heating boilers; feeding apparatus for heating boilers; loading apparatus for furnaces; immersion heaters; lighters; safety accessories for water or gas apparatus and pipes; chimney blowers; humidifiers for central heating radiators; coils [parts of distilling, heating or cooling installations]; mixer taps for water pipes; desalination plants; ash pits for furnaces; watering installations, automatic; coffee machines, electric; oil lamps; lava rocks for use in barbecue grills; hot air ovens; oxyhydrogen burners; Chinese lanterns; fairy lights for festive decoration; pocket warmers; level controlling valves in tanks; air valves for steam heating installations; blankets, electric, not for medical purposes; furnace grates; fireplaces, domestic; air conditioning apparatus; air conditioners for vehicles; taps [faucets]; taps [faucets] for pipes; drip irrigation emitters [irrigation fittings]; cooking utensils, electric; cooking apparatus and installations; cooking rings; kitchen ranges [ovens]; cookers; laboratory lamps; laboratory burners; curling lamps; lamps for directional signals of automobiles; light bulbs for directional signals for vehicles; lamp glasses; lamp reflectors; lamp chimneys; lamp casings; electric lights for Christmas trees; street lamps; lights for automobiles; lights for vehicles; pocket

searchlights; pocket torches, electric; standard lamps; lanterns for lighting; ice boxes; chandeliers; magnesium filaments for lighting; barbecues; ice machines and apparatus; microwave ovens [cooking apparatus]; microwave ovens for industrial purposes; freezers; motorcycle lights; footmuffs, electrically heated; heating elements; hot plates; glue-heating appliances; heaters, electric, for feeding bottles; heaters for baths; heaters for heating irons; air reheaters; plate warmers; heating apparatus for defrosting windows of vehicles; radiator caps; brackets for gas burners; heating filaments, electric; filaments for electric lamps; roasting jacks; heating plates; stoves [heating apparatus]; fumigation apparatus, not for medical purposes; disposable sterilization pouches; heating installations; hot water heating installations; heaters for vehicles; heating apparatus; heating apparatus, electric; heating apparatus for solid, liquid or gaseous fuels; heating boilers; kiln furniture [supports]; light-emitting diodes [LED] lighting apparatus; cooling vats for furnaces; purification installations for sewage; fuel economisers; burners; germicidal burners; burners for lamps; oil burners; fabric steamers; boilers, other than parts of machines; steam boilers, other than parts of machines; pasteurisers; sockets for electric lights; Turkish bath cabinets, portable; coffee percolators, electric; furnaces, other than for laboratory use; diving lights; urinals [sanitary fixtures]; ceiling lights; globes for lamps; heated display cabinets; ash conveyor installations, automatic; steam facial apparatus [saunas]; flashlights [torches]; washers for water taps; anti-splash tap nozzles; anti-dazzle devices for automobiles [lamp fittings]; anti-glare devices for vehicles [lamp fittings]; defrosters for vehicles; radiators [heating]; radiators, electric; central heating radiators; sinks; refining towers for distillation; heat regenerators; regulating and safety accessories for water apparatus; regulating and safety accessories for gas pipes; regulating and safety accessories for gas apparatus; regulating accessories for water or gas apparatus and pipes; dampers [heating]; refrigerators; incandescent burners; disinfectant distributors for toilets; expansion tanks for central heating installations; sanitary apparatus and installations; luminous house numbers; lamps; lighting apparatus for vehicles; lighting apparatus and installations; light bulbs; light bulbs, electric; lighting installations for air vehicles; light diffusers; bath tubs for sitz baths; pressure cookers [autoclaves], electric; pressure cooking saucepans, electric; scrubbers [parts of gas installations]; incinerators; solar furnaces; solar thermal collectors [heating]; alcohol burners; sterilizers; water sterilizers; clean chambers [sanitary installations]; drying apparatus; desiccating apparatus; hair driers [dryers]; drying apparatus for fodder and forage; tobacco roasters; fruit roasters; laundry dryers, electric; drying apparatus and installations; heat pumps; heat exchangers, not parts of machines; thermostatic val-

ves [parts of heating installations]; friction lighters for igniting gas; bread toasters; lampshade holders; boiler pipes [tubes] for heating installations; water-pipes for sanitary installations; luminous tubes for lighting; toilets [water-closets]; toilets, portable; toilet seats; ultraviolet ray lamps, not for medical purposes; wash-hand basins [parts of sanitary installations]; toilet bowls; steam generating installations; installations for conditioning air; air cooling apparatus; air filtering installations; air sterilisers; air driers [dryers]; swimming pool chlorinating apparatus; sauna bath installations; bath installations; flare stacks for use in the oil industry; headlights for automobiles; vehicle headlights; shaped fittings for furnaces; filters for air conditioning; filters for drinking water; bath fittings; hot air bath fittings; fountains; deep fryers, electric; extractor hoods for kitchens; bread baking machines; bread-making machines; bakers' ovens; cooling installations for water; cooling installations for liquids; cooling installations for tobacco; cooling installations and machines; milk cooling installations; beverage cooling apparatus; refrigerating apparatus and machines; refrigerating containers; refrigerating chambers; refrigerating display cabinets; cooling appliances and installations; refrigerating appliances and installations; refrigerating cabinets; chromatography apparatus for industrial purposes; kettles, electric; dental ovens; miners' lamps.

35 – Advertising; business management; business administration; office functions; retail or wholesale services for aforementioned goods of 7, 9, 11 classes; procurement services for others (purchasing goods and services for other businesses) relating to aforementioned goods of 7, 9, 11 classes; presentation of goods of 7, 9, 11 classes on communication media, for retail purposes; sales promotion of a variety of goods 7, 9, 11 classes for others; the bringing together, for the benefit of others, of a variety of goods 7, 9, 11 classes (excluding the transport thereof), enabling customers to conveniently view and purchase those goods; such services may be provided by retail stores, wholesale outlets, through mail order catalogues or by means of electronic media, for example, through web sites or television shopping programmes; commercial information agency services; administrative processing of purchase orders; cost price analysis; business auditing; auctioneering; accounting; market studies; opinion polling; organization of exhibitions for commercial or advertising purposes; organization of fashion shows for promotional purposes; organization of trade fairs for commercial or advertising purposes; payroll preparation; demonstration of goods; business research; business information; business appraisals; business investigations; business inquiries; business management assistance; commercial or industrial management assistance; advisory services for business management; market studies; economic forecasting;

business efficiency expert services; transcription of communications [office functions]; compilation of information into computer databases; compilation of statistics; import-export agency services; invoicing; on-line advertising on a computer network; computerized file management; business management of performing artists; business management of hotels; business management for freelance service providers; business management of sports people; commercial information and advice for consumers [consumer advice shop]; commercial administration of the licensing of the goods and services of others; personnel management consultancy; business management consultancy; business organization consultancy; layout services for advertising purposes; marketing; typing; document reproduction; providing business information via a web site; provision of commercial and business contact information; rental of advertising space; office machines and equipment rental; publicity material rental; rental of vending machines; rental of billboards [advertising boards]; rental of sales stands; rental of photocopying machines; rental of advertising time on communication media; writing of publicity texts; word processing; updating and maintenance of data in computer databases; updating of advertising material; web site traffic optimization; shop window dressing; arranging newspaper subscriptions for others; arranging subscriptions to telecommunication services for others; business management and organization consultancy; price comparison services; procurement services for others [purchasing goods and services for other businesses]; modelling for advertising or sales promotion; secretarial services; shorthand; telephone answering for unavailable subscribers; business project management services for construction projects; public relations; commercial intermediation services; news clipping services; relocation services for businesses; photocopying services; sponsorship search; search engine optimisation for sales promotion; presentation of goods on communication media, for retail purposes; psychological testing for the selection of personnel; publication of publicity texts; radio advertising; direct mail advertising; advertising by mail order; publicity agency services; pay per click advertising; bill-posting; distribution of samples; dissemination of advertising matter; drawing up of statements of accounts; tax filing services; employment agency services; sales promotion for others; production of advertising films; television advertising; telemarketing services; negotiation and conclusion of commercial transactions for third parties; systemization of information into computer databases; professional business consultancy; data search in computer files for others.

(260) AM 2018 92718 A
(800) 1347303
(891) 2016 12 21

(731) IVOCLAR VIVADENT AG
Bendererstrasse 2, FL-9494 Schaan,
Liechtenstein

(540)
SR Orthotyp S DCL

(591) Black, white

(531) 27.05.05

(511)

5 – Materials and auxiliary materials for use in dentistry; materials and auxiliary materials for the manufacture of prostheses and artificial teeth; artificial veneers.

10 – Apparatus, devices, tools, and instruments for dental use; dental shade guides; artificial teeth.

(260) AM 2018 92719 A

(800) 1347306

(891) 2017 01 23

(731) SHANDONG DESHI PETROLEUM
ENGINEERING GROUP CO., LTD.
Petroleum Business Park, Dongying
Shandong Province, China

(540)



德仕集团
DESHI GROUP

(591) Black, white

(531) 01.15.15; 27.05.01; 27.05.21; 28.03

(511)

37 – Construction consultation; commercial housing construction; mining extraction; drilling of wells; drilling of deep oil or gas-wells; quarrying services; machinery installation, maintenance and repair; motor vehicle maintenance and repair; rustproofing; rubber tyre repair.

(260) AM 2018 92722 A

(800) 1347320

(891) 2017 01 18

(731) FUTURE ENTERPRISES PTE. LTD
31 Harrison Road, #08-01 Food Empire
Building Singapore 369649, Singapore

(540)

TAZZANERA

(591) Black, brown

(531) 26.04.22; 27.05.17; 29.01.12

(511)

30 – Coffee, coffee extracts, coffee based preparations and beverages; artificial coffee, artificial coffee

extracts, preparations and beverages made with artificial coffee; tea, tea extracts, preparations and beverages made with tea; cocoa and cocoa based preparations and beverages; chocolate based preparations and beverages; coffee capsules, tea capsules, cocoa capsules, cappuccino capsules.

(260) AM 2018 92832 A
 (800) 1348769
 (891) 2016 08 24
 (731) EXPTEL İLAÇ SANAYİ MAKİNA TİCARET LİMİTED ŞİRKETİ
 Şakirpaşa Mah. Turhan Cemal Beriker
 Bulvarı No:233 ADANA, Turkey

(540)



(591) Black and white
 (531) 26.11.12; 27.05.01; 27.05.17

(526) ®

(511)

5 – Disinfectants; antiseptics; detergents for medical purposes; deodorants, other than for human beings or for animals; air deodorising preparations; preparations for destroying vermin; fungicides, herbicides; rat poison; mothproofing preparations; vermin destroying preparations; animal washes; chemical preparations to treat mildew; parasiticides; pharmaceutical and veterinary preparations for medical purposes; chemical preparations for medical and veterinary purposes, chemical reagents for pharmaceutical and veterinary purposes; vaccines; serums; vitamin preparations; diagnostic preparations for veterinary purposes; radioactive substances for medical purposes; media for bacteriological cultures; bacteriological preparations for medical and veterinary use; alcohol for pharmaceutical purposes; medicinal alcohol; sanitary preparations for medical use; hygienic pads; hygienic tampons; plasters; materials for dressings; diapers, including those made of paper and textiles; sanitary panties; pants, absorbent, for incontinents; bandages for dressings; gases for medical purposes; dental preparations and articles; teeth filling material, dental impression material, dental adhesives and material for repairing teeth; dental mastics; dietary supplements for pharmaceutical and veterinary purposes; dietary supplements; nutritional supplements; medical preparations for slimming purposes; food for babies; herbs and herbal beverages adapted for medicinal purposes.

(260) AM 2018 92833 A
 (800) 1348782
 (891) 2017 03 02
 (731) JANSSEN SCIENCES IRELAND UC
 Eastgate Village, Little Island Co. Cork,
 Ireland

(540)

ENSEMBYS

(591) Black and white
 (511)
 5 – Human pharmaceutical preparations.

(260) AM 2018 92841 A
 (800) 1349207
 (891) 2016 08 01
 (731) APLISENS S.A.
 ul. Morelowa 7, PL-03-192 Warszawa, Poland

(540)

APLISENS

(591) Black, white
 (511)
 9 – Electric apparatus for measuring and checking of non-electric physical quantities, included in this class, such as pressure transmitters, pressure difference transmitters, manometers, barometers, level meters, depth meters, flowmeters, humidity transmitters, hygrometers, temperature transmitters, temperature sensors, thermometers, digital displays, recorders, electric threshold signalling devices, transmitters and separators of electric signals, elektropneumatic positioners.

(260) AM 2018 92843 A
 (800) 1349217
 (891) 2016 10 11
 (731) MBPT, LLC
 44191 Plymouth Oaks Blvd, Suite 600,
 Plymouth MI 48170, United States of America

(540)

Barwis Methods

(591) Black, white
 (511)
 20 – Storage racks for physical fitness equipment, namely, dumbbells, kettlebells, exercise balls, bands and training bars.
 28 – Exercise bars; exercise benches; exercise machines; physical fitness equipment, namely, exercise and stretching bands and balance balls; weight lifting equipment, namely, weight lifting stations, cable crossover machines, barbells, benches, weight plates, weight lifting machines; exercise equipment, namely, stationary exercise machines, treadmills and stationary bicycles.

(260) AM 2018 92846 A

(800) 1349237

(891) 2016 11 03

(731) EURO GAMES TECHNOLOGY LTD.

"Maritsa" Str. 4, "Vranya-Lozen-Triugulnika",
BG-1151 Sofia, Bulgaria

(540)



(591) Red, white, light blue and black. Red, white,
light blue, black for the word elements

(531) 27.05.02; 27.05.03; 29.01.14

(511)

9 – Apparatus for recording, transmission or reproduction of sound or images, computer software (recorded), monitors [computer hardware].

28 – Games that are not included in other classes; amusement machines, automatic and coin-operated; gaming machines /for gambling/, adapted for use with external screen or monitor.

41 – Providing amusement arcade services; games equipment rental; entertainment; providing casino facilities [gambling].

(260) AM 2018 92890 A

(800) 1348994

(891) 2017 03 16

(731) CHINA COSCO SHIPPING

CORPORATION LIMITED

628 Minsheng Road, Shanghai Pilot Free

Trade Zone Shanghai, China

(540)

COSCO SHIPPING

(591) Black, white

(531) 27.05.01; 27.05.17

(526) SHIPPING

(511)

6 – Buildings, transportable, of metal; loading pallets of metal; containers of metal for storage and transport of goods; storage containers; floating docks of metal, for mooring boats; anchors; floating containers of metal.

12 – Hydroplanes; vehicle chassis; boats; ships' hulls; ships; yachts; davits for boats; barges; funnels for ships; spars for ships.

36 – Insurance underwriting; insurance brokerage; financing services; banking; capital investment; art appraisal; real estate management; financial customs brokerage services; surety services; charitable fund raising; trusteeship; lending against security; marine insurance underwriting.

37 – Construction consultancy, namely providing information related to marine construction and construction of offshore rigs and ships; construction,

namely construction of offshore rigs and ships; underwater construction; harbour construction; drilling of wells; machinery installation, maintenance and repair, namely installation, maintenance and repair of offshore rigs and ships, construction, installation, relating to offshore and marine vessels, ships and structures; vehicle repair services; shipbuilding; rust-proofing; maintenance and repair of storage containers; underwater repair.

39 – Transport; transport brokerage; transport of travelers; wrapping of goods; piloting; boat rental; shipbrokerage; air transport; vehicle rental; warehousing; rental of storage containers; operating canal locks; courier services for messages or merchandise; arranging of travel tours; transport by pipeline; transportation logistics; lighterage services; stevedoring; river transport; marine transport; car transport; freighting; hauling; pleasure boat transport; freight, namely shipping of goods; boat transport; barge transport; railway truck rental.

(260) AM 2018 93051 A

(800) 1047863

(891) 2017 05 09

(731) DAW SE

Roßdörfer Str. 50, 64372 Ober-Ramstadt,
Germany

(540)

KRAUTOL

(591) Black, white

(511)

1 – Chemical products for use in industry; chemicals for making paints, preparations for preserving and sealing cement and concrete (included in this class); unprocessed artificial resins in the form of powders, granules or liquids being additives to building materials; synthetic resins, unprocessed; adhesives used in industry; glue for industrial purposes; wallpaper adhesive, adhesives used for building construction, waterproofing chemicals for masonry, except paints, masonry preservatives, except paints, silicates; silicones; agglutinants for concrete, concrete preservatives, solvents for varnishes and lacquers.

2 – Paints, fireproof paints, varnishes, lacquers, glazes; preservatives against deterioration of wood, wood mordants, wood stains, wood oils, primers (included in this class), preservatives against rust, anti-rust greases, anti-rust oils; fillers (included in this class); binding agents for paints; bactericidal/fungicidal paints; building lacquers, colorants, dyes, dye pastes (included in this class), thinners for paints; paint thickeners; fixing preparations, siccatives; anti-corrosive preparations; protective preparations for metals; natural resins, mordants, metals in foil form for painters and decorators, mordants for leather.

17 – Packing, thermal protection and insulating materials (included in this class); sealing compounds, substances for insulating buildings against moisture; fibreglass and plastic textiles for insulation, fire-resistant insulating and sealing preparations; fibreglass for insulation, insulators, insulating paint, insulating varnishes, insulating fabric, insulating plaster, soundproofing materials, non-conducting materials for retaining heat; coating materials, namely preparations for coating heat protection and insulating materials for protection against damp or against chemical or mechanical reactions; fibreglass fabrics for insulation; adhesive tapes and adhesive strips, except for medical, stationery or household purposes; (colour) paints for waterproofing roofs, walls and floors.

19 – Building materials (non-metallic), fireproof building materials (non-metallic); mortar, natural and artificial stone for building; plaster (included in this class); protective agents for buildings, included in this class; bituminous products for building; building materials, namely fabrics of fibreglass and plastic, being inserts for layers of screed and plaster (included in this class); fabric embedding compounds with an artificial resin and/or silicate base; floors (not of metal), wall claddings (not of metal); all the aforesaid goods for building; design elements (not of metal) for the interiors and exteriors of buildings; design elements made from insulating materials, for the interiors and exteriors of buildings.

(260) AM 2018 93052 A

(800) 1292204

(891) 2017 06 07

(731) MAPED, Société par Actions Simplifiée
30 route de Pringy, F-74370 ARGONAY,
France

(540)

COLOR ' PEPS

(591) Black, white

(531) 27.05.01

(511)

2 – Paints, varnishes, lacquers, paints for drawing; metals in foil and powder form for painters, decorators, printers and artists.

16 – Stationery; adhesives (glues) for stationery or household purposes; artists' materials; paintbrushes; office requisites (except furniture); pencils, color pencils, drawing and writing instruments; paint boxes (articles for use in school).

(260) AM 2018 93184 A

(800) 1352637

(891) 2017 03 16

(731) ZONBUSI LIMITED

14 Souliou, Aglantzia, P.C. 2102 Nicosia,
Cyprus

(540)

NETIZEN

(591) Black, white

(531) 27.05.17

(511)

35 – Arranging subscriptions to telecommunication services for others; commercial information agency services; advertising agency services; cost price analysis; rental of advertising space; business auditing; employment agency services; computerized file management; book-keeping; invoicing; demonstration of goods; transcription of communications [office functions]; opinion polling; market studies; business information; commercial information and advice for consumers [consumer advice shop]; business investigations; business research; marketing research; personnel recruitment; business management and organization consultancy; business organization consultancy; business management consultancy; personnel management consultancy; professional business consultancy; layout services for advertising purposes; marketing; business management of performing artists; business management of sports people; news clipping services; updating of advertising material; word processing; organization of exhibitions for commercial or advertising purposes; arranging newspaper subscriptions for others; organization of fashion shows for promotional purposes; organization of trade fairs for commercial or advertising purposes; shop window dressing; business appraisals; payroll preparation; data search in computer files for others; sponsorship search; business management assistance; commercial or industrial management assistance; presentation of goods on communication media, for retail purposes; economic forecasting; auctioneering; retail or wholesale services for pharmaceutical, veterinary and sanitary preparations and medical supplies; sales promotion for others; production of advertising films; office machines and equipment rental; rental of advertising time on communication media; publicity material rental; rental of vending machines; rental of photocopying machines; publication of publicity texts; radio advertising; billposting; distribution of samples; dissemination of advertising matter; direct mail advertising; writing of publicity texts; advertising; on-line advertising on a computer network; advertising by mail order; television advertising; document reproduction; compilation of statistics; compilation of information into computer databases; business inquiries; systemization of information into computer databases; advisory services for business management; tax preparation; drawing up of statements of accounts; copywriting; telemarketing services; psychological testing for the selection of personnel; business management of hotels; commercial administration of the

licensing of the goods and services of others; administrative processing of purchase orders; public relations; modelling for advertising or sales promotion; typing; relocation services for businesses; price comparison services; secretarial services; procurement services for others [purchasing goods and services for other businesses]; shorthand; outsourcing services [business assistance]; telephone answering for unavailable subscribers; photocopying services; business efficiency expert services.

43 – Accommodation bureau services [hotels, boarding houses]; rental of temporary accommodation; rental of meeting rooms; tourist home services; hotel reservations; boarding house bookings; temporary accommodation reservations; hotel services; retirement home services; snack-bar services; café services; cafeteria services; motel services; boarding house services; boarding for animals; rental of cooking apparatus; rental of chairs, tables, table linen, glassware; rental of lighting apparatus; rental of tents; rental of transportable buildings; restaurant services; self-service restaurant services; canteen services; holiday camp services [lodging]; bar services; providing campground facilities; food and drink catering; day-nursery [crèche] services.

(260) AM 2018 93186 A

(800) 1352656

(891) 2017 05 05

(731) COLGATE-PALMOLIVE COMPANY
300 Park Avenue, New York NY 10022,
United States of America

(540)

SMARTGEN

(591) Black, white

(531) 27.05.05

(511)

3 – Bleaching preparations and substances for laundry use, namely, fabric softeners and conditioners, cleaning, polishing, scouring and abrasive preparations; soaps; perfumery, essential oils, cosmetics, hair lotions; dentifrices.

(260) AM 2018 93187 A

(800) 1352685

(891) 2016 06 16

(731) XIAOMI INC.
Floor 13, Rainbow City Shopping, Mall II of
China Resources, No.68, Qinghe Middle
Street, Haidian District 100085 Beijing,
China

(540)

XIAOMI

(591) Black, white

(531) 27.05.17

(511)

12 – Strollers; repair outfits for inner tubes; wheelchairs; trolleys; adhesive rubber patches for repairing inner tubes; pumps for bicycle tires; bicycles.

14 – Jewelry boxes; bracelets [jewellery, jewelry (am.)]; brooches [jewellery, jewelry (am.)]; paste jewellery [costume jewelry (am.)]; chains [jewellery, jewelry (am.)]; charms [jewellery, jewelry (am.)]; necklaces [jewellery, jewelry (am.)]; tie clips; coins; key rings [trinkets or fobs]; badges of precious metal; tie pins; pins [jewellery, jewelry (am.)]; earrings; hat ornaments of precious metal; rings [jewellery, jewelry (am.)]; ornaments [jewellery, jewelry (am.)]; medals; clocks; wristwatches; stopwatches; boxes for timepieces; watch cases [parts of watches]; watches; clocks and watches, electric; watch chains; watch bands; precious metals, unwrought or semi-wrought; ingots of precious metals; iridium; gold, unwrought or beaten; osmium; palladium; platinum [metal]; rhodium; alloys of precious metal; silver, unwrought or beaten; spun silver [silver wire]; silver thread [jewellery, jewelry (am.)]; shoe ornaments of precious metal; amulets [jewellery, jewelry (am.)]; cloisonné jewellery [jewelry (am.)]; chronoscopes; alarm clocks; silver jewellery; cap jewelry; timer (watch); clock and watch box (gift); clockworks; clock boxes.

16 – Mats for beer glasses; pamphlets; booklets; manuals [handbooks]; bookmarkers; printed matter; scrapbook albums; envelopes [stationery]; postcards; flags' of paper; albums; calendars; periodicals; posters; printed publications; prospectuses; atlases; books; pictures; lithographic works of art; bags [envelopes, pouches] of paper or plastics, for packaging; boxes of cardboard or paper; pencil sharpening machines, electric or non-electric; stationery; paperclips; office requisites, except furniture; files [office requisites]; folders for papers; writing cases [stationery]; document files [stationery]; bookends; staples for offices; money clips; stamps [seals]; pencils; steel pens; gummed tape [stationery]; adhesive tape dispensers [office requisites]; paper; carbon paper; placards of paper or cardboard; ink; drawing instruments; painters' easels; typewriters, electric or non-electric; teaching materials [except apparatus]; modelling materials; rosaries; note books; almanacs; comic books; paper knives [cutters] [office requisites]; adhesive tapes for stationery or household purposes; compasses for drawing; toilet paper; towels of paper; greeting cards; cards; table coasters of paper; notebook or drawing book; tear-off calendars; hand pressure stapler (office equipment); pad.

20 – Stands for calculating machines; baskets, not of metal; picture frames; photograph frames; wind chimes [decoration]; works of art of wood, wax, plaster or plastic; busts of wood, wax, plaster or

plastic; pillows; bolsters; tool handles, not of metal; plaited straw, except matting; nameplates, not of metal; decorations of plastic for foodstuffs; kennels for household pets; identification bracelets, not of metal; funerary urns; hooks, not of metal, for clothes rails; curtain hooks; door handles, not of metal; furniture; counters [tables]; divans; cradles; mirrors [looking glasses]; stuffed animals; mannequins; pet cushions; cushions; sleeping bags for camping; chests for toy; pillow cushion.

21 – Bowls [basins]; basins [bowls]; blenders, non-electric, for household purposes; utensils for household purposes; lunch boxes; chopsticks; kitchen utensils; containers for household or kitchen use; pitchers; jugs; candy boxes; urns; tableware, other than knives, forks and spoons; cups; dishes; pots; fruit cups; bottles; glass bulbs [receptacles]; boxes of glass; ceramics for household purposes; porcelain ware; pottery; liqueur sets; tea services [tableware]; tea caddies; drinking glasses; coffee services [tableware]; teapots; candelabra [candlesticks]; clothes drying racks; vases; combs; cosmetic utensils; works of art of porcelain, ceramic, earthenware or glass; toothbrushes; toothpick holders; cleaning instruments, hand-operated; polishing apparatus and machines, for household purposes, non-electric; crystal [glassware]; half-produced glass tubes; birdcages; indoor aquaria; insect traps; glasses [receptacles]; pepper pots; waste paper baskets; window-boxes; dustbins; toothbrushes, electric; toothpicks; make-up removing appliances; gloves for household purposes.

25 – Sleep masks; wedding dresses; chasubles; sashes for wear; wimples; shower caps; money belts [clothing]; girdles; maniples.

28 – Apparatus for games; jigsaw puzzles; dolls; play balloons; toys; games; mobiles [toys]; plush toys; playing cards; board games; skateboards; protective paddings [parts of sports suits]; body-building apparatus; archery implements; swimming pools [play articles]; ornaments for Christmas trees, except illumination articles and confectionery; scratch cards for playing lottery games; fishing tackle; camouflage screens [sports articles]; portable games with liquid crystal displays; radio-controlled toy vehicles; mah-jong; chess games; rackets; roller skates; shin guards [sports articles]; lines for fishing; living room game toys; board games; poker; protective pad (complete set of sportswear components); sports racket; plastic race track; sweat absorption band for racket; swimming belts; cheering squad toys.

36 – Financial management; financial information; financial evaluation [insurance, banking, real estate]; financial consultancy; business liquidation services, financial; repair costs evaluation [financial appraisal]; banking; investment of funds; insurance consultancy; insurance information; insurance services;

financial analysis; financing services; lease-purchase financing; stock exchange quotations; capital investment; rent collection; home banking; exchanging money; electronic funds transfer; real estate management; brokerage; surety services; trusteeship; deposits of valuables; art appraisal; stamp appraisal; numismatic appraisal; jewellery [jewelry (am.)] appraisal; antique appraisal; real estate brokerage; charitable fund raising; pawnbrokerage; lending against security; processing of credit card payments; health insurance; savings bank; credit card services.

37 – Repair information; repair and maintenance of computer; electric appliance installation and repair; interference suppression in electrical apparatus; installation, maintenance and repair of computer hardware; photographic apparatus repair; rustproofing; telephone installation and repair; elevator installation and repair; installation and maintenance of entertainment or sports apparatus; burglar alarm installation and repair; shoe repair; knife sharpening; pump repair; umbrella repair; parasol repair; artificial snow-making services; restoration of works of art; restoration of musical instruments; swimming-pool maintenance; repair of hand tools; maintenance of jewelry ornaments; fire alarm installation and repair; installation and repair of electrical equipment; cellphone repairs; mobile terminal maintenance; construction; mining extraction; upholstery repair; heating equipment installation and repair; motor vehicle maintenance and repair; airplane maintenance and repair; shipbuilding; clock and watch repair; safe maintenance and repair; retreading of tires [tyres]; furniture installation and repair; fur care, cleaning and repair; disinfecting.

(260) AM 2018 93188 A

(800) 1352698

(891) 2017 02 08

(731) SOCIÉTÉ DES PRODUITS NESTLÉ S.A.
CH-1800 Vevey, Switzerland

(540)



(591) Yellow, white, brown and chestnut brown.

(531) 02.07.10; 07.03.02; 07.03.04; 25.01.01;
27.05.01; 29.01.14

(511)
30 – Ice cream, water ices, sherbets, frozen confectionery, frozen cakes, frozen yogurts; powders and binding agents (included in this class) for making ice cream, water ices, sherbets, frozen confectionery, frozen cakes, frozen yogurts.

(260) AM 2018 93193 A
(800) 1352788
(891) 2016 11 03
(731) ENNEPI S.r.l.
Via Querce,15,I-80036 PALMA CAMPANIA
(NA), Italy

(540)

ZUIKI

(591) Black, white

(511)

25 – Hats; raincoats; clothing of leather or imitations of leather; belts made from imitation leather; leather belts; leather coats; leather headgear; leather jackets; leather trousers; leather shoes; leather slippers; dresses; suits; jumper dresses; bath robes; bandanas; bibs, not of paper; caps; berets; underwear; sweat-absorbent underwear; boas; teddies; braces for clothing; corsets; gaiters; galoshes; skull caps; footwear; boots for sports; stockings; sweat-absorbent stockings; socks; breeches for wear; bathing trunks; albs; shirts; short-sleeve shirts; sports singlets; top hats; coats; hoods; chasubles; belts; money belts; tights; collars; detachable collars; camisoles; layettes; corselets; bathing suits; masquerade costumes; neckties; ascots; bathing caps; shower caps; panties; headbands; pocket squares; scarfs; boot uppers; gaiters; jackets; garters; fishing vests; stuff jackets; skirts; overalls; girdles; gloves; mittens; ski gloves; welts for footwear; jerseys; leggings [leg warmers]; liveries; hosiery; sports jerseys; sweaters; muffs; maniples; pelerines; mantillas; sleep masks; skorts; boxer shorts; babies' pants; underpants; wet suits for water-skiing; vests; trousers; slippers; ear muffs; parkas; fur jackets; shirt yokes; pajamas; cuffs; ponchos; tips for footwear; stocking suspenders; sock suspenders; brassieres; heelpieces for stockings; sandals; bath sandals; saris; sarongs; neck scarfs; shoes; esparto shoes or sandals; bath slippers; gymnastic shoes; beach shoes; football boots; sports shoes; ski boots; shawls; sashes for wear; wimples; inner soles; overcoats; dress shields; petticoats; slips; shirt fronts; half-boots; lace boots; boots; fur stoles; soles for footwear; studs for football boots; heels; heelpieces for footwear; pockets for clothing; tee-shirts; togas; footwear uppers; turbans; combinations; uniforms; dressing gowns; visors; cap peaks; wooden shoes; wedding dresses.

(260) AM 2018 93194 A
(800) 1352796
(891) 2016 12 19
(731) BAYER INTELLECTUAL PROPERTY
GMBH
Alfred-Nobel-Str.10,40789 Monheim am
Rhein, Germany

(540)

ПИТЕНСИС

(591) Black, white

(531) 28.05

(511)

5 – Pharmaceutical preparations.

(260) AM 2018 93199 A
(800) 1352833
(891) 2017 03 29
(731) BECTON, DICKINSON AND COMPANY
1 Becton Drive, MC 090 Franklin Lakes NJ
07417, United States of America

(540)

BD FACSDUET

(591) Black, white

(511)

9 – Automated sample preparation systems and flow cytometers for research purposes.

10 – Automated sample preparation systems and flow cytometers for clinical purposes.

(260) AM 2018 93213 A
(800) 1212925
(891) 2017 03 16
(731) Limited liability company
"INTERVISION GROUP"
Ryazansky prospect, 6A, str. 47, RU-109428
Moscow, Russian Federation

(540)

DONKA

(591) Black, white

(531) 27.05.17

(511)

33 – Aperitifs; arak [arrack]; brandy; wine; piquette; whisky; vodka; anisette [liqueur]; kirsch; gin; digesters [liqueurs and spirits]; cocktails; curacao; anise [liqueur]; liqueurs; pre-mixed alcoholic beverages, other than beer-based; alcoholic beverages, except beer; alcoholic beverages containing fruit; spirits [beverages]; distilled beverages; hydromel [mead]; peppermint liqueurs; bitters; nira [sugarcane-based alcoholic beverage]; rum; sake; perry; cider; rice alcohol; alcoholic extracts; fruit extracts, alcoholic; alcoholic essences.

(260) AM 2018 93215 A

(800) 1276693

(891) 2017 03 27

(731) TD TECH DESIGN MOBİLYA SANAYİ VE
TİCARET ANONİM ŞİRKETİNecip Fazıl Mah., Dilektaşı Sok. No:30,
Ümraniye, İstanbul (TR), Turkey

(540)

(591) Black, white

(531) 27.05.01; 27.05.05

(511)

20 – Furniture, made of any kind of material; mattresses, pillows, air mattresses and cushions, not for medical purposes, sleeping bags for camping, water beds, not for medical purposes; mirrors; beehives, artificial honeycombs and sections of wood for honeycombs; bouncing chairs for babies, playpens for babies, cradles, infant walkers; display boards, frames for pictures and paintings, identification plates, identification tags, nameplates, identification labels made of wood or synthetic materials; packaging containers of wood or plastics, casks for use in transportation or storage, barrels, storage drums, tanks, boxes, storage containers, transportation containers, chests, loading pallets and closures for the aforementioned goods, of wood or plastics; small hardware goods of wood or synthetic materials included in this class, furniture fittings, of wood or synthetic materials, opening and closing mechanisms of wood or synthetic materials; ornaments and decorative goods of wood, wax, beeswax, plastic or plaster bone, ivory or plaster, included in this class; baskets, fishing baskets; kennels, nesting boxes and beds for household pets; portable ladders and mobile boarding stairs of wood or synthetic materials, bamboo curtains, roller indoor blinds, slatted indoor blinds, trip curtains, bead curtains for decoration, curtain hooks, curtain rings, curtain tie-backs, curtain rods.

(260) AM 2018 93218 A

(800) 1339713

(891) 2017 05 03

(731) ADP GAUSELMANN GMBH

Merkur-Allee 1-15, 32339 Espelkamp,
Germany

(540)

Sonnenkäfer

(591) Black, white

(511)

9 – Scientific, nautical, surveying, photographic, cinematographic, optical, weighing, measuring, signalling, checking (supervision), life-saving and teaching apparatus and instruments; apparatus and ins-

truments for conducting, switching, transforming, accumulating, regulating or controlling electricity; apparatus for recording, transmission or reproduction of sound or images; magnetic data carriers, recording discs; compact discs, DVDs and other digital recording media; cash registers, calculating machines, data processing equipment, computers; computer software; fire-extinguishing apparatus; musical jukeboxes and parts for the aforesaid automatic machines; automatic cash dispensers, automatic money counting and money changing machines; coin-operated mechanisms; computer and video games software; games software for use on any computer platform, including electronic entertainment and games consoles; computer game programs; computer games programs; video games (software); computer games provided through a global computer network or supplied by means of multi-media electronic broadcast or through telecommunications or electronic transmission or via the Internet; computer games, leisure and recreational software, video games and computer software, all being provided in the form of storage media; programs for operating electric and electronic apparatus for games, amusement and/or entertainment purposes; automatic lottery machines; computer software for computer games on the Internet; online games (software), in particular for online betting games, online prize games, online gambling games, online games of skill and online casino games; computer software in the form of an app for mobile devices and computers; calculating apparatus in coin-operated machines and parts for the aforesaid goods; apparatus for recording, transmission, processing or reproduction of data, including sound or images, including parts for all the aforesaid goods, except radio sets, television receivers, hi-fi systems, video recorders, telephone apparatus, fax machines and telephone answering machines; computer hardware and software for casino and amusement arcade games, for gaming machines, slot machines or video lottery gaming machines or games of chance via the Internet; electric, electronic, optical or automatic apparatus, for identifying data carriers, identity cards and credit cards, bank notes and coins; electric, electronic or optical alarm and monitoring installations, including video cameras and apparatus for image transmission and image processing; data processing apparatus and computers, including data processing apparatus and computers being components for data networks and parts facilitating data network communications; electric wiring harnesses; circuit boards, printed circuit boards (electronic components) and combinations thereof, being assemblies and parts for apparatus, included in class 9.

INTERNATIONAL TRADEMARKS PROTECTED IN GEORGIA

(260) AM 2018 76435 A
(800) 1195002
(151) 2013 12 17
(181) 2023 12 17
(891) 2013 12 17
(511) 30

(260) AM 2018 84832 A
(800) 1274456
(151) 2015 04 02
(181) 2025 04 02
(891) 2015 04 02
(511) 30

(260) AM 2018 86354 A
(800) 1258056
(151) 2015 06 24
(181) 2025 06 24
(891) 2016 01 22
(511) 07

(260) AM 2018 86356 A
(800) 1258079
(151) 2015 06 19
(181) 2025 06 19
(891) 2016 01 22
(511) 07

(260) AM 2018 86629 A
(800) 1291475
(151) 2016 01 22
(181) 2026 01 22
(891) 2016 01 22
(511) 07

(260) AM 2018 88936 A
(800) 1149796
(151) 2012 12 12
(181) 2022 12 12
(891) 2016 09 06
(511) 12, 35, 36, 37, 39

(260) AM 2018 89407 A
(800) 1316959
(151) 2016 06 15
(181) 2026 06 15

(891) 2016 06 15
(511) 09, 42

(260) AM 2018 89414 A
(800) 1317044
(151) 2016 04 04
(181) 2026 04 04
(891) 2016 04 04
(511) 09, 35, 39

(260) AM 2018 89422 A
(800) 1317180
(151) 2016 07 05
(181) 2026 07 05
(891) 2016 07 05
(511) 11, 21, 30, 35

(260) AM 2018 89423 A
(800) 1317226
(151) 2016 06 23
(181) 2026 06 23
(891) 2016 06 23
(511) 16

(260) AM 2018 90221 A
(800) 1325993
(151) 2016 01 29
(181) 2026 01 29
(891) 2016 01 29
(511) 09

(260) AM 2018 90292 A
(800) 1325920
(151) 2016 06 08
(181) 2026 06 08
(891) 2016 06 08
(511) 28, 41

(260) AM 2018 90435 A
(800) 1327133
(151) 2016 06 21
(181) 2026 06 21
(891) 2016 06 21
(511) 29, 30, 33, 43

(260) AM 2018 90471 A
(800) 1328072
(151) 2016 09 13
(181) 2026 09 13
(891) 2016 09 13
(511) 03, 11, 24, 27, 37

(260) AM 2018 90639 A
(800) 808376
(151) 2003 03 13
(181) 2023 03 13
(891) 2016 08 02
(511) 07, 09, 37

(260) AM 2018 90473 A
(800) 1328091
(151) 2016 06 21
(181) 2026 06 21
(891) 2016 06 21
(511) 29, 30, 33, 43

(260) AM 2018 90640 A
(800) 1044729
(151) 2010 06 02
(181) 2020 06 02
(891) 2016 05 04
(511) 11, 20, 21, 37, 42

(260) AM 2018 90485 A
(800) 1328133
(151) 2016 10 11
(181) 2026 10 11
(891) 2016 10 11
(511) 02

(260) AM 2018 90641 A
(800) 1165855
(151) 2013 06 05
(181) 2023 06 05
(891) 2016 09 26
(511) 09

(260) AM 2018 90621 A
(800) 1329082
(151) 2016 04 13
(181) 2026 04 13
(891) 2016 04 13
(511) 09

(260) AM 2018 90643 A
(800) 1197341
(151) 2013 12 24
(181) 2023 12 24
(891) 2016 10 04
(511) 43

(260) AM 2018 90623 A
(800) 1329123
(151) 2016 08 31
(181) 2026 08 31
(891) 2016 08 31
(511) 05

(260) AM 2018 90653 A
(800) 1328679
(151) 2016 07 20
(181) 2026 07 20
(891) 2016 07 20
(511) 09, 11, 34

(260) AM 2018 90624 A
(800) 1329141
(151) 2016 05 03
(181) 2026 05 03
(891) 2016 05 03
(511) 11, 20, 21

(260) AM 2018 90654 A
(800) 1328692
(151) 2016 08 09
(181) 2026 08 09
(891) 2016 08 09
(511) 35, 39

(260) AM 2018 90637 A
(800) 1329143
(151) 2016 05 17
(181) 2026 05 17
(891) 2016 05 17
(511) 03

(260) AM 2018 90655 A
(800) 1328728
(151) 2016 05 12
(181) 2026 05 12
(891) 2016 05 12
(511) 05

(260) AM 2018 90656 A
(800) 1328729
(151) 2016 05 12
(181) 2026 05 12
(891) 2016 05 12
(511) 05

(260) AM 2018 90657 A
(800) 1328730
(151) 2016 05 12
(181) 2026 05 12
(891) 2016 05 12
(511) 05

(260) AM 2018 90658 A
(800) 1328734
(151) 2016 06 23
(181) 2026 06 23
(891) 2016 06 23
(511) 03, 05

(260) AM 2018 90703 A
(800) 1329259
(151) 2016 08 09
(181) 2026 08 09
(891) 2016 08 09
(511) 03

(260) AM 2018 91020 A
(800) 1332757
(151) 2016 11 21
(181) 2026 11 21
(891) 2016 11 21
(511) 09, 38, 42

(260) AM 2018 91115 A
(800) 1332896
(151) 2016 06 28
(181) 2026 06 28
(891) 2016 06 28
(511) 09, 11, 34

(260) AM 2018 91116 A
(800) 1332915
(151) 2016 07 28
(181) 2026 07 28
(891) 2016 07 28
(511) 01

(260) AM 2018 91119 A
(800) 1332942
(151) 2016 10 28

(181) 2026 10 28
(891) 2016 10 28
(511) 03, 05

(260) AM 2018 91295 A
(800) 1335335
(151) 2016 10 12
(181) 2026 10 12
(891) 2016 10 12
(511) 25, 35

(260) AM 2018 91303 A
(800) 1334605
(151) 2016 11 29
(181) 2026 11 29
(891) 2016 11 29
(511) 14

(260) AM 2018 91463 A
(800) 1336049
(151) 2016 11 11
(181) 2026 11 11
(891) 2016 11 11
(511) 42

(260) AM 2018 91465 A
(800) 985323
(151) 2008 10 17
(181) 2018 10 17
(891) 2017 01 16
(511) 03

(260) AM 2018 91467 A
(800) 1335819
(151) 2016 11 07
(181) 2026 11 07
(891) 2016 11 07
(511) 39, 43

(260) AM 2018 91469 A
(800) 1047930
(151) 2010 06 17
(181) 2020 06 17
(891) 2016 11 30
(511) 33

(260) AM 2018 91471 A
(800) 1336060
(151) 2016 06 03
(181) 2026 06 03

(891) 2016 06 03
(511) 07, 12, 35, 42

(891) 2016 06 28
(511) 06, 20, 21

(260) AM 2018 91472 A
(800) 1082498
(151) 2011 03 22
(181) 2021 03 22
(891) 2017 01 20
(511) 27

(260) AM 2018 91625 A
(800) 1337036
(151) 2016 10 12
(181) 2026 10 12
(891) 2016 10 12
(511) 03, 05

(260) AM 2018 91478 A
(800) 1325666
(151) 2016 08 29
(181) 2026 08 29
(891) 2017 03 06
(511) 32

(260) AM 2018 91630 A
(800) 1275419
(151) 2015 08 21
(181) 2025 08 21
(891) 2017 03 14
(511) 05

(260) AM 2018 91481 A
(800) 1325667
(151) 2016 08 29
(181) 2026 08 29
(891) 2017 03 06
(511) 32

(260) AM 2018 91484 A
(800) 1336073
(151) 2016 11 21
(181) 2026 11 21
(891) 2016 11 21
(511) 07, 09, 11, 12, 36, 37, 39, 41

(260) AM 2018 91612 A
(800) 1336830
(151) 2016 10 21
(181) 2026 10 21
(891) 2016 10 21
(511) 01

(260) AM 2018 91613 A
(800) 1336859
(151) 2016 12 09
(181) 2026 12 09
(891) 2016 12 09
(511) 42

(260) AM 2018 91621 A
(800) 1336946
(151) 2016 06 28
(181) 2026 06 28

OFFICIAL NOTIFICATIONS**TRADEMARKS****RENEWAL OF REGISTRATIONS**

(111) M 1997 6409 R2

(156) 2017 08 15

(186) 2027 08 15

(732) Citizen Watch Company of America, Inc.
d/b/a Bulova
350 Fifth Avenue, 29 th Floor, New York,
New York 10118, USA

(111) M 1997 6715 R2

(156) 2017 09 09

(186) 2027 09 09

(732) DENYO KABUSHIKI KAISHA
(also trading as DENYO Co., LTD)
2-8-5, Nihonbashi-horidomecho, Chuo-ku,
Tokyo, Japan

(111) M 1997 7358 R2

(156) 2017 11 03

(186) 2027 11 03

(732) DELL INC. (a Delaware corporation)
One Dell Way, Round Rock, Texas 78682,
USA

(111) M 1997 7359 R2

(156) 2017 11 03

(186) 2027 11 03

(732) DELL INC. (a Delaware corporation)
One Dell Way, Round Rock, Texas 78682,
USA

(111) M 1997 7565 R2

(156) 2017 11 18

(186) 2027 11 18

(732) BASF SE
Carl-Bosch-Strasse 38, Ludwigshafen am
Rhein, Germany

(111) M 1997 7598 R2

(156) 2017 11 19

(186) 2027 11 19

(732) BASF SE
Carl-Bosch-Strasse 38, 67056 Ludwigshafen,
Germany

(111) M 1997 7599 R2

(156) 2017 11 19

(186) 2027 11 19

(732) BASF SE
Carl-Bosch-Strasse 38, 67056 Ludwigshafen,
Germany

(111) M 1997 7639 R2

(156) 2017 11 20

(186) 2027 11 20

(732) BASF SE
Carl-Bosch-Strasse 38, 67056 Ludwigshafen,
Germany

(111) M 1997 7852 R2

(156) 2017 12 15

(186) 2027 12 15

(732) FRATELLI BRANCA DISTILLERIE S. r. L.
Via Broletto 35, I-20121 Milano, Italy

(111) M 1997 7873 R2

(156) 2017 12 16

(186) 2027 12 16

(732) FRATELLI BRANCA DISTILLERIE S. r. L.
Via Broletto 35, I-20121 Milano, Italy

(111) M 1998 8222 R2

(156) 2018 02 02

(186) 2028 02 02

(732) BAYER INTELLECTUAL PROPERTY
GMBH
Alfred-Nobel-Strasse 10, 40789 Monheim am
Rhein, Germany

(111) M 1998 8101 R2

(156) 1998 01 20

(186) 2028 01 20

(732) GLAXO GROUP LIMITED
980 Great West Road, Brentford, Middlesex
TW8 9GS, United Kingdom

(111) M 1998 8579 R2 (156) 1998 03 06 (186) 2028 03 06 (732) FRIESLANDCAMPINA NEDERLAND BV Stationsplein 4, NL-3818 LE AMERSFOORT, Netherlands	980 Great West Road, Brentford, Middlesex TW8 9GS, United Kingdom
(111) M 1998 9714 R2 (156) 1998 06 11 (186) 2028 06 11 (732) GLAXO GROUP LIMITED 980 Great West Road, Brentford, Middlesex TW8 9GS, United Kingdom	(111) M 1998 8876 R2 (156) 1998 04 10 (186) 2028 04 10 (732) INBEV BELGIUM SPRL Boulevard Industriel 21, 1070 Brussels, Belgium
(111) M 1998 9715 R2 (156) 1998 06 11 (186) 2028 06 11 (732) GLAXO GROUP LIMITED 980 Great West Road, Brentford, Middlesex TW8 9GS, United Kingdom	(111) M 1997 7901 R2 (156) 1997 12 18 (186) 2027 12 18 (732) FILA LUXEMBOURG S.A.R.L. 26, Boulevard Royal, L-2449, Luxembourg, Luxembourg
(111) M 1998 11220 R2 (156) 1998 12 09 (186) 2028 12 09 (732) SIEMENS AKTIENGESELLSCHAFT Werner-von-Siemens-Str. 1, 80333 Munchen, Germany	(111) M 1998 8121 R2 (156) 1998 01 22 (186) 2028 01 22 (732) DISCOVERY COMMUNICATIONS, LLC One Discovery Place, Silver Spring, Maryland 20910, USA
(111) M 1998 9203 R2 (156) 1998 05 05 (186) 2028 05 05 (732) THE BLACK & DECKER CORPORATION Towson, Mariland 21286, United States of America	(111) M 1998 8123 R2 (156) 1998 01 22 (186) 2028 01 22 (732) UNILEVER N.V. Weena 455, NL-3013 AL Rotterdam, Netherlands
(111) M 1998 9204 R2 (156) 1998 05 05 (186) 2028 05 05 (732) THE BLACK & DECKER CORPORATION Towson, Mariland 21286, United States of America	(111) M 1998 8804 R2 (156) 1998 04 07 (186) 2028 04 07 (732) ST. IVES LABORATORIES, INC., a corporation of the State of Delaware 700 Sylvan Avenue, Englewood Cliffs, NJ 07632, USA
(111) M 1998 9013 R2 (156) 1998 04 27 (186) 2028 04 27 (732) GLAXO GROUP LIMITED 980 Great West Road, Brentford, Middlesex TW8 9GS, United Kingdom	(111) M 1998 9837 R3 (156) 1998 06 23 (186) 2038 06 23 (732) SEIKO EPSON KABUSHIKI KAISHA (also trading as SEIKO EPSON CORPORATION) 1-6, Shinjuku 4-chome, Shinjuku-ku, Tokyo, Japan
(111) M 1998 9015 R2 (156) 1998 04 27 (186) 2028 04 27 (732) GLAXO GROUP LIMITED	(111) M 1998 8143 R2 (156) 1998 01 23 (186) 2028 01 23 (732) UNILEVER N.V.

Weena 455, NL-3013 AL Rotterdam,
Netherlands

TW8 9GS, United Kingdom

(111) M 1998 8810 R2
(156) 1998 04 07
(186) 2028 04 07
(732) PFIZER PRODUCTS INC.
a Connecticut Corporation
Eastern Point Road, Groton, Connecticut
06340, USA

(111) M 1998 9914 R2
(156) 1998 06 26
(186) 2028 06 26
(732) GLAXOSMITHKLINE CONSUMER
HEALTHCARE (UK) IP LIMITED
980 Great West Road, Brentford,
Middlesex TW8 9GS, United Kingdom

(111) M 1998 8173 R2
(156) 1998 01 29
(186) 2028 01 29
(732) GLAXO GROUP LIMITED
980 Great West Road, Brentford, Middlesex
TW8 9GS, United Kingdom

(111) M 1998 9921 R2
(156) 1998 06 26
(186) 2028 06 26
(732) GLAXOSMITHKLINE CONSUMER
HEALTHCARE (UK) IP LIMITED
980 Great West Road, Brentford,
Middlesex TW8 9GS, United Kingdom

(111) M 1998 8199 R2
(156) 1998 01 30
(186) 2028 01 30
(732) J. URIACH Y CIA, S.A.
Decano Bahi, 59-67, 08026 Barcelona,
Spain

(111) M 1998 9931 R2
(156) 1998 07 07
(186) 2028 07 07
(732) GLAXO GROUP LIMITED
980 Great West Road, Brentford, Middlesex
TW8 9GS, United Kingdom

(111) M 1998 9885 R2
(156) 1998 06 26
(186) 2028 06 26
(732) HSBC GROUP MANAGMENT SERVICES
LIMITED
8 Canada Square, London, E14 5HQ, United
Kingdom

(111) M 1998 9941 R2
(156) 1998 07 07
(186) 2028 07 07
(732) SMITHKLINE BEECHAM LIMITED
980 Great West Road, Brentford, Middlesex
TW8 9GS, United Kingdom

(111) M 1998 9886 R2
(156) 1998 06 26
(186) 2028 06 26
(732) HSBC GROUP MANAGMENT SERVICES
LIMITED
8 Canada Square, London, E14 5HQ, United
Kingdom

(111) M 1998 9942 R2
(156) 1998 07 07
(186) 2028 07 07
(732) SMITHKLINE BEECHAM LIMITED
980 Great West Road, Brentford, Middlesex
TW8 9GS, United Kingdom

(111) M 1998 9899 R2
(156) 1998 06 26
(186) 2028 06 26
(732) SMITHKLINE BEECHAM LIMITED
980 Great West Road, Brentford, Middlesex
TW8 9GS, United Kingdom

(111) M 1998 9943 R2
(156) 1998 07 07
(186) 2028 07 07
(732) SMITHKLINE BEECHAM LIMITED
980 Great West Road, Brentford, Middlesex
TW8 9GS, United Kingdom

(111) M 1998 8210 R2
(156) 1998 01 30
(186) 2028 01 30
(732) GLAXO GROUP LIMITED
980 Great West Road, Brentford, Middlesex

(111) M 1998 9976 R2
(156) 1998 07 07
(186) 2028 07 07
(732) GLAXO GROUP LIMITED
980 Great West Road, Brentford, Middlesex
TW8 9GS, United Kingdom

(111) M 1998 8702 R2
(156) 1998 03 20
(186) 2028 03 20
(732) BAYER INTELLECTUAL PROPERTY
GMBH
Alfred-Nobel-Strasse 10, 40789 Monheim am
Rhein, Germany

(111) M 1998 8705 R2
(156) 1998 03 20
(186) 2028 03 20
(732) BAYER INTELLECTUAL PROPERTY
GMBH
Alfred-Nobel-Strasse 10, 40789 Monheim am
Rhein, Germany

(111) M 1998 10380 R2
(156) 1998 08 19
(186) 2028 08 19
(732) PERFETTI VAN MELLE BENELUX B.V.
Zoete Inval 20, 4815 HK Breda, Netherlands

(111) M 1998 10410 R2
(156) 1998 08 20
(186) 2028 08 20
(732) UNILEVER N.V.
Weena 455, NL-3013 AL Rotterdam,
Netherlands

(111) M 1998 9979 R2
(156) 1998 07 07
(186) 2028 07 07
(732) GLAXO GROUP LIMITED
980 Great West Road, Brentford, Middlesex
TW8 9GS, United Kingdom

(111) M 1998 10721 R2
(156) 1998 09 10
(186) 2028 09 10
(732) UNILEVER N.V.
Weena 455, NL-3013 AL Rotterdam,
Netherlands

(111) M 1998 10503 R2
(156) 1998 08 26
(186) 2028 08 26
(732) ADLER MODEMÄRKTE AG
Industriestr. Ost 1-7, D-63808, Heibach,
Germany

(111) M 1998 10963 R2
(156) 1998 10 28
(186) 2028 10 28

(732) MCDONALD'S INTERNATIONAL
PROPERTY COMPANY, LTD
251 Little Falls Drive, Wilmington, Delaware
19808, USA

(111) M 1998 10964 R2
(156) 1998 10 28
(186) 2028 10 28
(732) MCDONALD'S INTERNATIONAL
PROPERTY COMPANY, LTD
251 Little Falls Drive, Wilmington, Delaware
19808, USA

(111) M 1998 10965 R2
(156) 1998 10 28
(186) 2028 10 28
(732) MCDONALD'S INTERNATIONAL
PROPERTY COMPANY, LTD
251 Little Falls Drive, Wilmington, Delaware
19808, USA

(111) M 1998 10969 R2
(156) 1998 10 28
(186) 2028 10 28
(732) MCDONALD'S INTERNATIONAL
PROPERTY COMPANY, LTD
251 Little Falls Drive, Wilmington, Delaware
19808, USA

(111) M 1998 10970 R2
(156) 1998 10 28
(186) 2028 10 28
(732) MCDONALD'S INTERNATIONAL
PROPERTY COMPANY, LTD
251 Little Falls Drive, Wilmington, Delaware
19808, USA

(111) M 198 10971 R2
(156) 1998 10 28
(186) 2028 10 28
(732) MCDONALD'S INTERNATIONAL
PROPERTY COMPANY, LTD
251 Little Falls Drive, Wilmington, Delaware
19808, USA

(111) M 1998 11294 R2
(156) 1998 12 14
(186) 2028 12 14
(732) PFIZER PRODUCTS INC.
a Connecticut Corporation
Eastern Point Road, Groton, Connecticut
06340, USA

(111) M 1998 11077 R2
(156) 1998 11 09
(186) 2028 11 09
(732) UNILEVER N.V.
Weena 455, NL-3013 AL Rotterdam,
Netherlands

(111) M 1998 11313 R2
(156) 1998 12 16
(186) 2028 12 16
(732) GLAXO GROUP LIMITED
980 Great West Road, Brentford, Middlesex
TW8 9GS, United Kingdom

(111) M 1998 8264 R2
(156) 1998 02 06
(186) 2028 02 06
(732) JIM BEAM BRANDS CO.
222 West Merchandise Mart Plaza, Suite
1600, Chicago, Illinois 60654, United States
of America

(111) M 1998 10835 R2
(156) 1998 09 22
(186) 2028 09 22
(732) GENERAL CIGAR CO., INC.
10900 Nuckols Road, Suite 100, Glen Allen,
Virginia 23060, USA

(111) M 1998 9099 R2
(156) 1998 04 30
(186) 2028 04 30
(732) GENERAL CIGAR CO., INC.
10900 Nuckols Road, Suite 100, Glen Allen,
Virginia 23060, USA

(111) M 1998 8285 R2
(156) 1998 02 06
(186) 2028 02 06
(732) GENERAL CIGAR CO., INC.
10900 Nuckols Road, Suite 100, Glen Allen,
Virginia 23060, USA

(111) M 1998 10671 R2
(156) 1998 09 10
(186) 2028 09 10
(732) PUIG FRANCE, Societe par Actions
Simpliffee
65-67 Avenue des Champs Elysees, 75008
Paris, France

(111) M 1998 8258 R2
(156) 1998 02 06
(186) 2028 02 06
(732) JIM BIM BRENDZ KO.
222 West Merchandise Mart Plaza, Suite
1600, Chicago, Illinois 60654, United States
of America

(111) M 1997 7067 R3
(156) 1997 10 08
(186) 2037 10 08
(732) TETRA LAVAL HOLDINGS & FINANCE
S.A.
Avenue General-Giusan 70, CH-1009 Pully,
Switzerland

(111) M 1998 8302 R2
(156) 1998 02 10
(186) 2028 02 10
(732) BAHLSEN GmbH & Co.KG
Podbielskistrasse 11, 30163 Hannover,
Germany

(111) M 2007 17625 R1
(156) 2007 07 12
(186) 2027 07 12
(732) NATIONAL PAINTS FACTORIES CO.
LTD
P.O. Box 533, Abu Alanda 11592, Jordan

(111) M 1998 8371 R2
(156) 1998 02 19
(186) 2028 02 19
(732) SOCIETE DES PRODUITS NESTLE S.A.
1800 Vevey, Switzerland

(111) M 1998 9464 R2
(156) 1998 05 29
(186) 2028 05 29
(732) CONOPCO INC.
700 Sylvan Avenue, Englewood Cliffs,
NJ07632, USA

(111) M 1998 8309 R2
(156) 1998 02 10
(186) 2028 02 10
(732) S.C. JOHNSON & SON, INC.
a Wisconsin corporation
1525 Howe Street, Racine, Wisconsin 53403,
USA

(111) M 1998 9107 R2
(156) 1998 04 30
(186) 2028 04 30
(732) TACO BELL CORPORATION
1 Glen Bell Way, Irvine, California 92618,
USA

(111) M 2007 17973 R1
(156) 2007 10 29
(186) 2027 10 29
(732) saaqtsio sazogadoeba "JORJIAN QARDI"
Khodashenis q. 5, 0105, Tbilisi, Georgia

(111) M 2008 18204 R1
(156) 2008 02 15
(186) 2028 02 15
(732) SIX CONTINENT HOTELS, INC.
3 Ravinia Drive, Atlanta, Georgia 30346,
USA

(111) M 2008 18194 R1
(156) 2008 01 28
(186) 2028 01 28
(732) I D BIOMEDICAL CORPORATION OF
QUEBEC
525 Cartier Blvd. West, Laval QC H7V 3S8,
Canada

(111) M 2008 18275 R1
(156) 2008 02 28
(186) 2028 02 28
(732) REPUBLIC TECHNOLOGIES (NA) LLC.
2301 Ravine Way Glenview, Illinois 60025,
USA

(111) M 2008 18489 R1
(156) 2008 05 27
(186) 2028 05 27
(732) LTD "QARTULI BRENDIS KOMPANIA"
Kakhetis gzat. 110a, lilo, 0198, Tbilisi,
Georgia

(111) M 1998 9467 R2
(156) 1998 05 29
(186) 2028 05 29
(732) PIZZA HUT INTERNATIONAL LLC
7100 Corporate Drive, Plano, Texas 75024,
USA

(111) M 2008 18977 R1
(156) 2008 12 15
(186) 2028 12 15

(732) GLAXO GROUP LIMITED
980 Great West Road, Brentford, Middlesex
TW8 9GS, United Kingdom

(111) M 2008 18978 R1
(156) 2008 12 15
(186) 2028 12 15
(732) GLAXO GROUP LIMITED
980 Great West Road, Brentford, Middlesex
TW8 9GS, United Kingdom

(111) M 1998 8659 R2
(156) 1998 03 13
(186) 2028 03 13
(732) UNILEVER N.V.
Weena 455, NL-3013 AL Rotterdam,
Netherlands

(111) M 1998 8661 R2
(156) 1998 03 17
(186) 2028 03 17
(732) PIONEER CORPORATION
28-8, Honkomagome 2-chome, Bunkyo-ku,
Tokyo, Japan

(111) M 1998 8662 R2
(156) 1998 03 17
(186) 2028 03 17
(732) PIONEER CORPORATION
28-8, Honkomagome 2-chome, Bunkyo-ku,
Tokyo, Japan

(111) M 2009 19070 R1
(156) 2009 01 28
(186) 2029 01 28
(732) Kovalenko Vadim Aleksandrovich
Ul. Sums kaya d.100, kv. 2, Kharkov,
61002, Ukraina

(111) M 1998 8314 R2
(156) 1998 02 10
(186) 2028 02 10
(732) PUIG FRANCE, Societe par Actions
Simpliffee
65-67 Aveniu De Shanz-elize, 75008
Parizi, France

(111) M 1998 8411 R2
(156) 1998 02 23
(186) 2028 02 23
(732) SOREMARTEC S.A.

Findel Business Center, Complexe B, Rue de
Treves, L-2632 Findel, Luxembourg

(111) M 1998 8413 R2

(156) 1998 02 23

(186) 2028 02 23

(732) FERRERO S.P.A.

Piazzale Pietro Ferrero 1, 12051 Alba,
Cuneo, Italy

(111) M 1998 8729 R2

(156) 1998 03 25

(186) 2028 03 25

(732) UNILEVER N.V.

Weena 455, NL-3013 AL Rotterdam,
Netherlands

(111) M 1998 8712 R2

(156) 1998 03 20

(186) 2028 03 20

(732) UNILEVER N.V.

Weena 455, NL-3013 AL Rotterdam,
Netherlands

(111) M 1998 8730 R2

(156) 1998 03 25

(186) 2028 03 25

(732) UNILEVER N.V.

Weena 455, NL-3013 AL Rotterdam,
Netherlands

(111) M 1998 8718 R2

(156) 1998 03 25

(186) 2028 03 25

(732) UNILEVER N.V.

Weena 455, NL-3013 AL Rotterdam,
Netherlands

(111) M 1998 8254 R2

(156) 1998 02 05

(186) 2028 02 05

(732) HANSGROHE AG

Auestrasse 9, 77761 Schiltach, Germany

(111) M 1998 8279 R2

(156) 1998 02 06

(186) 2028 02 06

(732) ANHEUSER-BUSCH, LLC

One Busch Place, St.Louis, Missouri, United
States of America

(111) M 1998 8280 R2

(156) 1998 02 06

(186) 2028 02 06

(732) ANHEUSER-BUSCH, LLC

One Busch Place, St.Louis, Missouri, United
States of America

(111) M 1996 3713 R3

(156) 1996 10 28

(186) 2036 10 28

(732) SIEMENS AKTIENGESELLSCHAFT

Werner-von-Siemens-Str. 1, 80333
Munchen, Germany

(111) M 1996 3715 R3

(156) 1996 10 28

(186) 2036 10 28

(732) SIEMENS AKTIENGESELLSCHAFT

Werner-von-Siemens-Str. 1, 80333
Munchen, Germany

(111) M 1996 3716 R3

(156) 1996 10 28

(186) 2036 10 28

(732) SIEMENS AKTIENGESELLSCHAFT

Werner-von-Siemens-Str. 1, 80333
Munchen, Germany

(111) M 1998 8423 R2

(156) 1998 02 24

(186) 2028 02 24

(732) THE PROCTER & GAMBLE CO.

(OHIO CORPORATION)
ONE PROCTER & GAMBLE PLAZA,
CINCINNATI, OHIO, USA

(111) M 1998 8445 R2

(156) 1998 02 26

(186) 2028 02 26

(732) GUERLAIN SOCIETE ANONYME

68, Avenue de Champs-Elysees, F-75008
Paris, France

(111) M 1998 8446 R2

(156) 1998 02 26

(186) 2028 02 26

(732) GUERLAIN SOCIETE ANONYME

68, Avenue de Champs-Elysees, F-75008
Paris, France

(111) M 1998 8628 R2
(156) 1998 03 11
(186) 2028 03 11
(732) TEAC CORPORATION
3-7-3, Naka-Cho, Musashino-Shi, Tokyo, Japan

(111) M 1998 8629 R2
(156) 1998 03 11
(186) 2028 03 11
(732) TEAC CORPORATION
3-7-3, Naka-Cho, Musashino-Shi, Tokyo, Japan

(111) M 1998 8739 R2
(156) 1998 03 26
(186) 2028 03 26
(732) UNILEVER N.V.
Weena 455, Rotterdam, 3013 AL, Netherlands

(111) M 1998 8632 R2
(156) 1998 03 11
(186) 2028 03 11
(732) Barilla G.e.R. Fratelli-Società per Azioni
Via Mantova 166, Parma, Italy

(111) M 1998 8621 R2
(156) 1998 03 11
(186) 2028 03 11
(732) THE YOKOHAMA RUBBER CO., LTD
36-11, Shimbashi 5-chome, Minato-ku,
Tokyo, Japan

(111) M 1998 8677 R2
(156) 1998 03 17
(186) 2028 03 17
(732) UNILEVER N.V.
Weena 455, NL-3013 AL Rotterdam,
Netherlands

(111) M 1998 8263 R2
(156) 1998 02 06
(186) 2028 02 06
(732) ANHEUSER-BUSCH, LLC
One Busch Place, St.Louis, Missouri, USA

(111) M 1998 9322 R2
(156) 1998 05 13
(186) 2028 05 13
(732) CONOPCO INC.
700 Sylvan Avenue, Englewood Cliffs, NJ
07632, USA

(111) M 1998 9333 R2
(156) 1998 05 14
(186) 2028 05 14
(732) PUIG FRANCE, Societe par Actions
Simplifíee
65-67 Avenue des Champs Elysées, 75008
Paris, France

(111) M 1998 9337 R2
(156) 1998 05 14
(186) 2028 05 14
(732) PUIG FRANCE, Societe par Actions
Simplifíee
65-67 Avenue des Champs Elysées, 75008
Paris, France

(111) M 1998 9339 R2
(156) 1998 05 14
(186) 2028 05 14
(732) PARFUMS CHRISTIAN DIOR
33, Avenue Hoche, F-75008 Paris, France

(111) M 1998 9340 R2
(156) 1998 05 14
(186) 2028 05 14
(732) PARFUMS CHRISTIAN DIOR
33, Avenue Hoche, F-75008 Paris, France

(111) M 1998 9341 R2
(156) 1998 05 15
(186) 2028 05 15
(732) PARFUMS CHRISTIAN DIOR
33, Avenue Hoche, F-75008 Paris, France

(111) M 1998 9342 R2
(156) 1998 05 18
(186) 2028 05 18
(732) PARFUMS CHRISTIAN DIOR
33, Avenue Hoche, F-75008 Paris, France

(111) M 1998 9343 R2
(156) 1998 05 18
(186) 2028 05 18
(732) PARFUMS CHRISTIAN DIOR
33, Avenue Hoche, F-75008 Paris, France

(111) M 1998 10195 R2
(156) 1998 08 05
(186) 2028 08 05
(732) PARFUMS CHRISTIAN DIOR
33, Avenue Hoche, F-75008 Paris, France

(111) M 1998 8480 R2
 (156) 1998 02 27
 (186) 2028 02 27
 (732) MHCS
 9, avenue de Champagne, 51200 Epernay,
 France

(111) M 1998 8482 R2
 (156) 1998 02 27
 (186) 2028 02 27
 (732) MHCS
 9, avenue de Champagne, 51200 Epernay,
 France

(111) M 1998 8483 R2
 (156) 1998 02 27
 (186) 2028 02 27
 (732) MHCS
 9, avenue de Champagne, 51200 Epernay,
 France

(111) M 1998 8484 R2
 (156) 1998 02 27
 (186) 2028 02 27
 (732) MHCS
 9, avenue de Champagne, 51200 Epernay,
 France

(111) M 1998 9514 R2
 (156) 1998 06 02
 (186) 2028 06 02
 (732) UNILEVER N.V.
 Weena 455, 3013 AL Rotterdam, Netherlands

(111) M 1998 10949 R2
 (156) 1998 10 27
 (186) 2028 10 27
 (732) CASTROL LIMITED
 Technology Centre, Whitchurch Hill,
 Pangbourne, Reading RG8 7QR, United
 Kingdom

(111) M 1998 8490 R2
 (156) 1998 03 02
 (186) 2028 03 02
 (732) VEEDOL INTERNATIONAL LIMITED
 1, Roial Bank Place, Buchanan Street,
 Glasgow, G1 3AA, United Kingdom

(111) M 1998 8244 R1
 (156) 1998 02 05
 (186) 2018 02 05

(732) HANSGROHE AG
 Auestrasse 9, 77761 Schiltach, Germany

(111) M 1998 8326 R2
 (156) 1998 02 12
 (186) 2028 02 12
 (732) JIM BEAM BRANDS CO.
 222 West Merchandise Mart Plaza, Suite
 1600, Chicago, Illinois 60654, United States
 of America

(111) M 1998 8501 R2
 (156) 1998 03 02
 (186) 2028 03 02
 (732) PUIG FRANCE, Societe par Actions
 Simpliffee
 65-67 Avenue des Champs Elysées, 75008
 Paris, France

(111) M 1998 8505 R2
 (156) 1998 03 02
 (186) 2028 03 02
 (732) HUSQVARNA AKTIEBOLAG
 SE-561, 82 Huskvarna, Sweden

(111) M 1998 8521 R2
 (156) 1998 03 04
 (186) 2028 03 04
 (732) FERRERO S.P.A.
 Piazzale Pietro Ferrero 1, 12051 Alba,
 Cuneo, Italy

(111) M 1998 8523 R2
 (156) 1998 03 04
 (186) 2028 03 04
 (732) FERRERO S.P.A.
 Piazzale Pietro Ferrero 1, 12051 Alba,
 Cuneo, Italy

(111) M 1998 8544 R2
 (156) 1998 03 05
 (186) 2028 03 05
 (732) GLAXO GROUP LIMITED
 980 Great West Road, Brentford, Middlesex
 TW8 9GS, United Kingdom

(111) M 1998 8757 R2
 (156) 1998 03 30
 (186) 2028 03 30
 (732) VISA INTERNATIONAL SERVICE
 ASSOCIATION

900 Metro Center Boulevard, Foster City,
California 94404, USA

(111) M 1998 8760 R2
(156) 1998 03 30
(186) 2028 03 30
(732) ALBEMARLE CORPORATION
451 Florida Street, Baton Rouge, Louisiana,
70801, USA

(111) M 1998 8552 R2
(156) 1998 03 05
(186) 2028 03 05
(732) CARESTREAM HEALTH, INC
150 Verona Street, Rochester, NY 14608,
USA

(111) M 1998 8555 R2
(156) 1998 03 05
(186) 2028 03 05
(732) CARESTREAM HEALTH, INC
150 Verona Street, Rochester, NY 14608,
USA

(111) M 1998 11211 R2
(156) 1998 12 02
(186) 2028 12 02
(732) HYUNDAI MOTOR COMPANY
140-2, Kye-Dong, Jongro-ku, Seoul, Korea
(Republic of)

(111) M 1998 8327 R2
(156) 1998 02 12
(186) 2028 02 12
(732) THE PROCTER & GAMBLE COMPANY
One Procter & Gamble Plaza, Cincinnati,
Ohio, USA

COMPLETE TRANSFER OF RIGHTS

(111) M 1998 8086 R
 (732) HENKELL & CO. SEKTKELLEREI KG
 Biebricher Allee 142, 65187 Wiesbaden,
 Germany
 (770) HENKELL & SOHNLEIN
 SEKTKELLEREIN KG
 Biebricher Allee 142, 65187 Wiesbaden,
 Germany
 (580) 2017 12 29

(111) M 1999 11702 R
 (732) ESSILOR INTERNATIONAL
 147, rue de Paris, 94220 Charenton le Pont,
 France
 (770) ESSILOR INTERNATIONAL
 (COMPAGNIE GENERAL D'OPTIQUE)
 147, rue de Paris, 94220 Charenton le Pont,
 France
 (580) 2018 01 18

(111) M 1998 8813 R
 (732) SIGMA ALIMENTOS, S.A. De S.V.
 Avenida Gomez Morin No:1111 sur,
 Colonia Carriazalejo, Codigo Postal 66254,
 San Pedro Garza Garsia, Nuevo Leon,
 Mexico
 (770) BAR-S FOODS CO.
 3838 North Central Avenue, Suite 1900
 PHOENIX, ARIZONA 85012, United States
 of America
 (580) 2018 02 05

(111) M 2011 22007 R
 (732) LTD "MULTIPHARMA"
 Bakhtrionis q. 20, Tbilisi, Georgia
 (770) LTD "ABE"
 Chitaias q. 37, 0164, Tbilisi, Georgia
 (580) 2018 02 05

(111) M 1998 8814 R
 (732) SIGMA ALIMENTOS, S.A. De S.V.
 Avenida Gomez Morin No:1111 sur,
 Colonia Carriazalejo, Codigo Postal 66254,
 San Pedro Garza Garsia, Nuevo Leon, Mexico
 (770) BAR-S FOODS CO.
 3838 North Central Avenue, Suite 1900
 PHOENIX, ARIZONA 85012, United States
 of America
 (580) 2018 02 05

(111) M 2011 22008 R
 (732) LTD "MULTIPHARMA"
 Bakhtrionis q. 20, Tbilisi, Georgia
 (770) LTD "ABE"
 Chitaias q. 37, 0164, Tbilisi, Georgia
 (580) 2018 02 05

(111) M 1998 8820 R
 (732) BRAUN GMBH
 Frankfuter Str. 145, 61476 Kronberg im
 taunus, Germany
 (770) THE GILLETTE COMPANY LLC
 One Gillette Park, Boston, Massachusetts
 02127, USA
 (580) 2018 02 08

(111) M 2011 22009 R
 (732) LTD "MULTIPHARMA"
 Bakhtrionis q. 20, Tbilisi, Georgia
 (770) LTD "ABE"
 Chitaias q. 37, 0164, Tbilisi, Georgia
 (580) 2018 02 05

(111) M 1995 767 R
 (732) FLENDER GMBH
 Alfred-Flender-Straße 77, 46395 Bocholt,
 Germany
 (770) SIEMENS ACTIENGESSELLSCHAFT
 Wittelsbacherplatz 2, 80333 MUNCHEN,
 Germany
 (580) 2018 02 02

(111) M 2011 22010 R
 (732) LTD "MULTIPHARMA"
 Bakhtrionis q. 20, Tbilisi, Georgia
 (770) LTD "ABE"
 Chitaias q. 37, 0164, Tbilisi, Georgia
 (580) 2018 02 05

(111) M 2011 22011 R
 (732) LTD "MULTIPHARMA"
 Bakhtrionis q. 20, Tbilisi, Georgia
 (770) LTD "ABE"
 Chitaias q. 37, 0164, Tbilisi, Georgia
 (580) 2018 02 05

(111) M 2011 22014 R
 (732) LTD "MULTIPHARMA"
 Bakhtrionis q. 20, Tbilisi, Georgia

(770) LTD "ABE"
Chitaias q. 37, 0164, Tbilisi, Georgia
(580) 2018 02 05

(111) M 1999 12139 R
(732) REMA TIP TOP AG
Gruber Strasse 65, 85586 Poing, Germany
(770) STAHLGRUBER OTTO GRUBER AG
Gruber Strasse 65, 85586 Poing, Germany
(580) 2018 02 09

(111) M 1999 12140 R
(732) REMA TIP TOP AG
Gruber Strasse 65, 85586 Poing, Germany
(770) STAHLGRUBER OTTO GRUBER AG
Gruber Strasse 65, 85586 Poing, Germany
(580) 2018 02 09

(111) M 2017 28825 R
(732) E. MIROGLIO GEORGIA
Rustavelis gamz. 40-40a, Tbilisi, Georgia
(770) LTD "DIKA"
Rustavelis gamz. 40, 0108, Tbilisi, Georgia
(580) 2017 12 18

CHANGES IN NAMES AND/OR ADDRESSES OF OWNERS

(111) M 1998 8086 R
 (732) HENKELL & CO. SEKTKELLEREI KG
 Biebricher Allee 142, 65187 Wiesbaden,
 Germany
 (770) HENKELL & SOHNLEIN
 SEKTKELLEREIN KG
 Biebricher Allee 142, 65187 Wiesbaden,
 Germany
 (580) 2017 12 29

(111) M 1998 8086 R
 (732) HENKELL & CO. SEKTKELLEREI KG
 Biebricher Allee 142, 65187 Wiesbaden,
 Germany
 (770) HENKELL & SOHNLEIN
 SEKTKELLEREIN KG
 Biebricher Allee 142, 65187 Wiesbaden,
 Germany
 (580) 2017 12 29

(111) M 1998 8097 R
 (732) MITSUI CHEMICALS AGRO, INC.
 1-19-1, Nihonbashi, Chuo-ku, Tokyo
 103-0027, Japan
 (770) MICUI QEMIKALS AGRO, INK.
 23-14, Hongo 4-chome, Bunyo-ku, Tokio,
 Japan
 SANKYO AGRO COMPANY LIMITED
 5-2, Higashi-Shimbashi 1-chome, Minato-ku,
 Tokyo, Japan
 (580) 2017 12 29

(111) M 1996 1982 R
 (732) SIEMENS AKTIENGESELLSCHAFT
 Werner-von-Siemens-Str. 1, 80333 Munchen,
 Germany
 (770) SIEMENS AKTIENGESELLSCHAFT
 Wittelsbacherplatz 2, D-80333 Munchen,
 Germany
 (580) 2018 01 26

(111) M 1998 11220 R
 (732) SIEMENS AKTIENGESELLSCHAFT
 Werner-von-Siemens-Str. 1, 80333 Munchen,
 Germany
 (770) SIEMENS AKTIENGESELLSCHAFT
 Wittelsbacherplatz 2, D-80333 Munchen,
 Germany
 (580) 2018 01 26

(111) M 1997 5735 R
 (732) CONSTELLATION BRANDS U.S.
 OPERATIONS, INC.
 235 N. Bloomfield Road, Canandeigua, New
 York 14424, USA
 (770) CONSTELLATION WINES U.S., INC.
 235 N. Bloomfield Road, Canandeigua, New
 York 14424, USA
 (580) 2017 12 26

(111) M 1998 9058 R
 (732) ASTRAZENKA UK LIMITED
 Cambridge Biomedical Campus, 1 Francis
 Crick Avenue, Cembridge, CB2 0AA, United
 Kingdom
 (770) ASTRAZENKA UK LIMITED
 15 Stanhope Gate, London W1Y 6LN, United
 Kingdom
 (580) 2018 01 15

(111) M 1998 9812 R
 (732) WM WRIGLEY JR. COMPANY
 1132 West Blackhawk Street, Chicago,
 Illinois 60642, USA
 (770) NEW UNO HOLDINGS CORPORATION
 6885 Elm Street, Mclean, Virginia
 22101-3883, USA;
 MARS, INCORPORATED
 6885, Elm Street, McLean, Virginia, United
 States of America;
 WM.WRIGLEY JR.COMPANY
 410 North Michigan Avenue, Chicago,
 Illinois 60611, USA
 (580) 2018 01 11

(111) M 1998 10356 R
 (732) SHIVAKI (JAPAN) INDUSTRIES
 LIMITED
 3806, Central Plaza, 18 Harbour Road,
 Wanchai, Hong Kong, China
 (770) SHIVAKI (JAPAN) INDUSTRIES
 LIMITED
 001, Central Plaza, 18 Harbour road,
 Wanchai, Hong Kong
 (580) 2018 01 08

(111) M 1998 10503 R
 (732) ADLER MODEMÄRKTE AG
 Industriestr. Ost 1-7, D-63808,Heibach,
 Germany

(770) KLAUS STEILMANN GmbH & Co. KG
Industriestrasse 24, 59192 Bergkamen, Germany;
KLAUS STEILMANN GmbH & Co. KG
Feldstrasse 4, D-44867 Bochum, Germany
(580) 2018 01 04

(111) M 1998 10963 R
(732) MCDONALD'S INTERNATIONAL
PROPERTY COMPANY, LTD
251 Little Falls Drive, Wilmington, Delaware
19808, USA
(770) MCDONALD'S INTERNATIONAL
PROPERTY COMPANY, LTD
2711 Centerville Road, Suite 400,
Wilmington, Delaware, USA
(580) 2018 02 02

(111) M 1999 11566 R
(732) MOLINOS RIO DE LA PLATA S.A.
Avenida Presidente Manuel Quintana 192,
Piso 1, CP C1014ACO, Buenos-airesi,
Argentina
(770) MOLINOS RIO DE LA PLATA S.A.
Osvaldo Cruz 3350, Buenos Aires,
Argentina;
MOLINOS RIO DE LA PLATA S.A.
Paseo Colon 746, (1323) Buenos Aires,
Argentina
(580) 2017 12 26

(111) M 1999 12210 R
(732) SIEMENS AKTIENGESELLSCHAFT
Werner-von-Siemens-Str. 1, 80333 Munchen,
Germany
(770) SIEMENS AKTIENGESELLSCHAFT
Wittelsbacherplatz 2, D-80333 Munchen,
Germany
(580) 2018 01 26

(111) M 1998 8264 R
(732) JIM BEAM BRANDS CO.
222 West Merchandise Mart Plaza, Suite
1600, Chicago, Illinois 60654, USA
(770) JIM BEAM BRANDS Co.
510 Lake Cook Road, Deerfield, Illinois, USA
(580) 2018 02 06

(111) M 2001 13836 R
(732) SIEMENS AKTIENGESELLSCHAFT
Erner-fon-simens-shtr. 1, 80333 Munchen,
Germany
(770) SIEMENS AKTIENGESELLSCHAFT

Wittelsbacherplatz 2, D-80333 Munchen,
Germany
(580) 2018 01 26

(111) M 1998 10835 R
(732) GENERAL CIGAR CO., INC.
10900 Nuckols Road, Suite 100, Glen Allen,
Virginia 23060, USA
(770) GENERAL CIGAR CO., INC.
7300 Beaufont Springs Drive, Richmond,
Virginia 23225, USA
(580) 2018 02 14

(111) M 1998 9099 R
(732) GENERAL CIGAR CO., INC.
10900 Nuckols Road, Suite 100, Glen Allen,
Virginia 23060, USA
(770) GENERAL CIGAR CO., INC.
7300 Beaufont Springs Drive, Richmond,
Virginia 23225, USA
(580) 2018 02 14

(111) M 1998 8285 R
(732) GENERAL CIGAR CO., INC.
10900 Nuckols Road, Suite 100, Glen Allen,
Virginia 23060, USA
(770) GENERAL CIGAR CO., INC.
7300 Beaufont Springs Drive, Richmond,
Virginia 23225, USA
(580) 2018 02 14

(111) M 1998 8359 R
(732) MITSUI CHEMICALS AGRO, INC.
1-19-1, Nihonbashi, Chuo-ku, Tokyo
103-0027, Japan
(770) SANKYO COMPANY LIMITED
5-1, Nihonbashi Honcho 3-chome, Chuo-ku,
Tokyo, Japan;
SANKYO AGRO COMPANY LIMITED
5-2, Higashi-Shimbashi 1-chome, Minato-ku,
Tokyo, Japan;
MITSUI CHEMICALS AGRO, INC.
23-14, Hongo 4-chome, Bunkyo-ku, Tokyo,
Japan
(580) 2017 12 29

(111) M 1998 8258 R
(732) JIM BIM BRENDZ KO.
222 West Merchandise Mart Plaza, Suite
1600, Chicago, Illinois 60654, USA
(770) JIM BIM BRENDZ KO.
510 Lake Cook Road, Deerfield, Illinois, USA
(580) 2018 02 06

(111) M 1998 9464 R
(732) CONOPCO INC.
700 Sylvan Avenue, Englewood Cliffs,
NJ07632, USA
(770) CONOPCO, INC.
390 Park Avenue, New York, New York
10022, USA
(580) 2018 01 16

(111) M 2008 18172 R
(732) LTD "GMP"
Sop. Ponitchala 65, Georgia
(770) LTD "GMP"
Zemo Vedzisi q. 103, 0160, Tbilisi,
Georgia
(580) 2018 01 16

(111) M 2008 18173 R
(732) LTD "GMP"
Sop. Ponitchala 65, Georgia
(770) LTD "GMP"
Zemo Vedzisi q. 103, 0160, Tbilisi, Georgia
(580) 2018 01 16

(111) M 2008 18175 R
(732) LTD "GMP"
Sop. Ponitchala 65, Georgia
(770) LTD "GMP"
Zemo Vedzisi q. 103, 0160, Tbilisi, Georgia
(580) 2018 01 22

(111) M 1995 798 R
(732) MCDONALD'S INTERNATIONAL
PROPERTY COMPANY, LTD
251 Little Falls Drive, Wilmington, Delaware
19808, USA
(770) MCDONALD'S INTERNATIONAL
PROPERTY COMPANY, LTD
2711 Centerville Road, Suite 400,
Wilmington, Delaware, USA
(580) 2018 02 02

(111) M 1998 8662 R
(732) PIONEER CORPORATION
28-8, Honkomagome 2-chome, Bunkyo-ku,
Tokyo, Japan
(770) PIONEER CORPORATION
4 - 1, Meguro 1-chome, meguro-ku, Tokyo,
Japan
(580) 2018 01 16

(111) M 1998 8695 R
(732) WM. WRIGLEY JR. COMPANY
1132 West Blackhawk Street, Chicago,
Illinois 60642, USA
(770) MARS, INCORPORATED
6885 Elm Street Mclean, Virginia
22101-3883, USA;
NEW UNO HOLDINGS CORPORATION
6885 Elm Street, Mclean, Virginia
22101-3883, USA;
WM.WRIGLEY JR.COMPANY
410 North Michigan Avenue, Chicago,
Illinois 60611, USA
(580) 2018 01 11

(111) M 1998 8672 R
(732) WM. WRIGLEY JR. COMPANY
1132 Vest Bleqhok Striti, Chikago, Illinois
60642, USA
(770) MARS, INCORPORATED
6885 Elm Street Mclean, Virginia
22101-3883, USA;
WM.WRIGLEY JR.COMPANY
410 North Michigan Avenue, Chicago,
Illinois 60611, USA;
NEW UNO HOLDINGS CORPORATION
6885 Elm Street, Mclean, Virginia
22101-3883, USA
(580) 2018 01 11

(111) M 1996 3713 R
(732) SIEMENS AKTIENGESELLSCHAFT
Werner-von-Siemens-Str. 1, 80333 Munchen,
Germany
(770) SIEMENS AKTIENGESELLSCHAFT
Wittelsbacherplatz 2, D-80333 Munchen,
Germany
(580) 2018 01 26

(111) M 1996 3715 R
(732) SIEMENS AKTIENGESELLSCHAFT
Werner-von-Siemens-Str. 1, 80333 Munchen,
Germany
(770) SIEMENS AKTIENGESELLSCHAFT
Wittelsbacherplatz 2, D-80333 Munchen,
Germany
(580) 2018 01 26

(111) M 1996 1909 R
(732) SIEMENS AKTIENGESELLSCHAFT
Werner-von-Siemens-Str. 1, 80333 Munchen,
Germany
(770) SIEMENS AKTIENGESELLSCHAFT

Wittelsbacherplatz 2, D-80333 Munchen,
Germany
(580) 2018 01 26

(111) M 1996 1917 R
(732) SIEMENS AKTIENGESELLSCHAFT
Werner-von-Siemens-Str. 1, 80333 Munchen,
Germany
(770) SIEMENS AKTIENGESELLSCHAFT
Wittelsbacherplatz 2, D-80333 Munchen,
Germany
(580) 2018 01 26

(111) M 1996 1919 R
(732) SIEMENS AKTIENGESELLSCHAFT
Werner-von-Siemens-Str. 1, 80333 Munchen,
Germany
(770) SIEMENS AKTIENGESELLSCHAFT
Wittelsbacherplatz 2, D-80333 Munchen,
Germany
(580) 2018 01 26

(111) M 1996 1920 R
(732) SIEMENS AKTIENGESELLSCHAFT
Werner-von-Siemens-Str. 1, 80333 Munchen,
Germany
(770) SIEMENS AKTIENGESELLSCHAFT
Wittelsbacherplatz 2, D-80333 Munchen,
Germany
(580) 2018 01 26

(111) M 1996 3716 R
(732) SIEMENS AKTIENGESELLSCHAFT
Werner-von-Siemens-Str. 1, 80333 Munchen,
Germany
(770) SIEMENS AKTIENGESELLSCHAFT
Wittelsbacherplatz 2, D-80333 Munchen,
Germany
(580) 2018 01 26

(111) M 1996 1922 R
(732) SIEMENS AKTIENGESELLSCHAFT
Werner-von-Siemens-Str. 1, 80333 Munchen,
Germany
(770) SIEMENS AKTIENGESELLSCHAFT
Wittelsbacherplatz 2, D-80333 Munchen,
Germany
(580) 2018 01 26

(111) M 2011 22105 R
(732) JSC "M2 UDZRAVI QONEBA"
I. Chavchavadzis gamz. 29, sart. III,
Georgia

(770) JSC "SB UDZRAVI QONEBA"
Tavisuplebis moedani 4, 0105, Tbilisi,
Georgia
(580) 2017 12 22

(111) M 2011 22106 R
(732) JSC "M2 UDZRAVI QONEBA"
I. Chavchavadzis gamz. 29, sart. III, Georgia
(770) JSC "SB UDZRAVI QONEBA"
Tavisuplebis moedani 4, 0105, Tbilisi, Georgia
(580) 2017 12 22

(111) M 2012 22563 R
(732) AVOCENT HUNTSVILLE LLC
4991 Korporeit Draivi, Hanstvili, Alabama
35805, USA
(770) AVOCENT HUNTSVILLE CORP.
4991 Corporate Drive, Huntsville, Alabama
35805, USA
(580) 2018 02 06

(111) M 1998 8722 R
(732) FEDERAL EXPRESS CORPORATION
3620 Haks Kros Roudi, Biding B, 3 Flori,
Memfisi, Tenesi, USA
(770) FEDERAL EXPRESS CORPORATION
2005, Corporate Avenue, Memphis,
Tennessee 38132-1842, USA
(580) 2018 02 14

(111) M 1998 8634 R
(732) ASTRAZENKA AB
SE-151 85 Södertälje, Sweden
(770) ASTRA AKTIEBOLAG
Vastra Malarehamnen 9, S-15185
Sodertalje, Sweden;
ASTRAZENKA AB
Vastra Malarehamnen 9, 15185 Sodertalje,
Sweden
(580) 2018 01 22

(111) M 1998 8742 R
(732) ESAB AKTIEBOLAG
Boqs 8004, S-40277 Geteborgi, Sweden
(770) ESAB AKTIEBOLAG
Herkulesgatan 72, Box 8004, S-40277
Goteborg, Sweden
(580) 2018 02 14

(111) M 2014 25035 R
(732) LTD "FRANKO"
Kakhetis gzat., Me-20 km., Tbilisi, Georgia

(770) LTD "FRANKO"
Sop. Karajala, Telavis r-ni, Georgia
(580) 2017 12 18

(111) M 1998 9748 R
(732) SCHNEIDER ELECTRIC
INDUSTRIES SAS
35, rue Joseph Monier, 92500 RUEIL-
MALMAISON, France
(770) SCHNEIDER ELECTRIC INDUSTRIES
S.A.
89, boulevard Franklin Roosevelt, 92500
Rueil-Malmaison, France
(580) 2017 12 26

(111) M 2015 25774 R
(732) Publichnoe Akcionernoe Obschestvo
"MIRONOVSKI KHLEBOPRODUCT"
Ul. Elevatornaia,1, G. Mironovka,
Mironovski Raioni, Kievskaja Obl., 08800,
Ukraine
(770) LTD "VEST INVEST"
Kairos q. N13a (nakveti 2/64), Georgia;
LTD "VEST INVEST"
Tevdore Mgvdlis q.27, 0154, Tbilisi, Georgia
(580) 2018 02 02

(111) M 2016 27400 R
(732) LTD "MIKADO GEORGIA"
Dosaapis mimdebare teritoria, Rustavi,
Georgia
(770) LTD "MIKADO GEORGIA"
D. Aghmasheneblis gamz. 150, 0112, Tbilisi,
Georgia
(580) 2017 12 18

(111) M 1998 8490 R
(732) VEEDOL INTERNATIONAL LIMITED
1, Roial Bank Place, Buchanan Street,
Glasgow, G1 3AA, United Kingdom
(770) VEEDOL INTERNATIONAL LIMITED
Burnside Road, Farburn Industrial Estate,
Dyce, Aberdeen, AB21 7PB, Scotland,
United Kingdom
(580) 2018 01 29

(111) M 1998 8326 R
(732) JIM BEAM BRANDS CO.
222 West Merchandise Mart Plaza, Suite
1600, Chicago, Illinois 60654, USA
(770) JIM BEAM BRANDS CO.
510 Lake Cook Road, Deerfield, Illinois,
USA

(580) 2018 02 06

(111) M 1998 8326 R
(732) JIM BEAM BRANDS CO.
222 West Merchandise Mart Plaza, Suite
1600, Chicago, Illinois 60654, USA
(770) JIM BEAM BRANDS CO.
510 Lake Cook Road, Deerfield, Illinois, USA
(580) 2018 02 06

(111) M 2017 28212 R
(732) LTD "GEMOVANI"
Krtsanisis q. 22/24, b. 44, Tbilisi, Georgia
(770) LTD "KARTULI KHORBLIS PURI"
Krtsanisis q. 22/24, b. 44, Tbilisi, Georgia
LTD "MZETAMZE"
Krtsanisis q. 22/24, Georgia
(580) 2018 01 02

(111) M 2017 29119 R
(732) SIEMENS AKTIENGESELLSCHAFT
Werner-von-Siemens-Str. 1, 80333 Munchen,
Germany
(770) SIEMENS AKTIENGESELLSCHAFT
Wittelsbacherplatz 2, Munchen, Germany
(580) 2018 01 26

CLASSIFICATION INDEXES

INVENTIONS

CONCORDANCE TABLE OF INTERNATIONAL CLASSIFICATION INDEX AND PUBLICATION NUMBERS

INTERNATIONAL CLASSIFICATION INDEXES (51)	NUMBER OF PUBLISHED APPLICATION (10)
A 61 K 8/362; A 61 K 8/41; A 61 Q 5/00; A 61 Q 5/04; A 61 Q 5/08; A 61 Q 5/10	AP 2018 14045 A
B 28 B 19/00	AP 2018 13882 A
C 07 C 237/22	AP 2018 14220 A
C 07 D 401/14, 413/14; A 61 K 31/454, 31/497, 31/506, 31/519, 31/5355; C 07 D 401/04, 407/14, 413/04, 417/14, 471/04, 487/04; A 61 P 29/02, 37/08	AP 2018 14046 A
C 07 D 403/06; A 61 K 31/506; A 61 K 31/7072; A 61 P 35/00; A 61 P 43/00	AP 2018 14034 A
C 07 F 9/45; A 61 P 35/04; A 61 K 31/662	AP 2018 13996 A

CONCORDANCE TABLE OF PUBLICATION NUMBERS AND INTERNATIONAL CLASSIFICATION INDEX

NUMBER OF PUBLISHED APPLICATION (10)	INTERNATIONAL CLASSIFICATION INDEXES (51)
AP 2018 13882 A	B 28 B 19/00
AP 2018 13996 A	C 07 F 9/45; A 61 P 35/04; A 61 K 31/662
AP 2018 14034 A	C 07 D 403/06; A 61 K 31/506; A 61 K 31/7072; A 61 P 35/00; A 61 P 43/00
AP 2018 14045 A	A 61 K 8/362; A 61 K 8/41; A 61 Q 5/00; A 61 Q 5/04; A 61 Q 5/08; A 61 Q 5/10
AP 2018 14046 A	C 07 D 401/14, 413/14; A 61 K 31/454, 31/497, 31/506, 31/519, 31/5355; C 07 D 401/04, 407/14, 413/04, 417/14, 471/04, 487/04; A 61 P 29/02, 37/08
AP 2018 14220 A	C 07 C 237/22

CONCORDANCE TABLE OF INTERNATIONAL CLASSIFICATION INDEX, PATENT NUMBERS AND PUBLICATION NUMBERS

INTERNATIONAL CLASSIFICATION INDEX (51)	NUMBER OF PATENT (11)	NUMBER OF PUBLISHED APPLICATION (10)
1	2	3
A 01 D 41/00; A 01 F 12/00	P 2018 6832 B	AP 2017 13994 A
B 65 D 19/00	P 2018 6834 B	AP 2017 14098 A
C 07 D 207/267; C 07 D 213/40; C 07 D 233/58; C 07 D 239/34; C 07 D 277/28; C 07 D 401/04; C 07 D 401/06; C 07 D 401/12; C 07 D 405/12; C 07 D 409/04; C 07 D 409/14; C 07 D 413/04; C 07 D 413/12; C 07 D 417/04; C 07 D 417/06;	P 2018 6833 B	AP 2017 14095 A

1	2	3
C 07 D 417/12; C 07 D 471/04; C 07 D 487/04; C 07 D 491/048; C 07 D 491/052; C 07 D 491/20; C 07 D 495/14; A 61 K 31/33; A 61 K 31/14		
C 10 G 9/00, 9/24, 9/08, 47/00	P 2018 6831 B	AP 2017 13972 A
F 17 D 1/04	P 2018 6835 B	AP 2017 14294 A

**CONCORDANCE TABLE OF PATENT NUMBERS,
PUBLICATION NUMBERS AND INTERNATIONAL CLASSIFICATION INDEX**

NUMBER OF PATENT (11)	NUMBER OF PUBLISHED APPLICATION (10)	INTERNATIONAL CLASSIFICATION INDEX (51)
P 2018 6831 B	AP 2017 13972 A	C 10 G 9/00, 9/24, 9/08, 47/00
P 2018 6832 B	AP 2017 13994 A	A 01 D 41/00; A 01 F 12/00
P 2018 6833 B	AP 2017 14095 A	C 07 D 207/267; C 07 D 213/40; C 07 D 233/58; C 07 D 239/34; C 07 D 277/28; C 07 D 401/04; C 07 D 401/06; C 07 D 401/12; C 07 D 405/12; C 07 D 409/04; C 07 D 409/14; C 07 D 413/04; C 07 D 413/12; C 07 D 417/04; C 07 D 417/06; C 07 D 417/12; C 07 D 471/04; C 07 D 487/04; C 07 D 491/048; C 07 D 491/052; C 07 D 491/20; C 07 D 495/14; A 61 K 31/33; A 61 K 31/14
P 2018 6834 B	AP 2017 14098 A	B 65 D 19/00
P 2018 6835 B	AP 2017 14294 A	F 17 D 1/04

**CONCORDANCE TABLE OF APPLICATION NUMBERS, PUBLICATION NUMBERS
AND PATENTS**

NUMBER OF APPLICATION (21)	NUMBER OF PUBLISHED APPLICATION (10)	NUMBER OF PATENT (11)
AP 2015 013972	AP 2017 13972 A	P 2018 6831 B
AP 2015 013994	AP 2017 13994 A	P 2018 6832 B
AP 2014 014095	AP 2017 14095 A	P 2018 6833 B
AP 2014 014098	AP 2017 14098 A	P 2018 6834 B
AP 2016 014294	AP 2017 14294 A	P 2018 6835 B

UTILITY MODELS

**CONCORDANCE TABLE OF INTERNATIONAL CLASSIFICATION INDEX
AND PUBLICATION NUMBERS**

INTERNATIONAL CLASSIFICATION INDEXES (51)	NUMBER OF PUBLISHED APPLICATION (10)
A 61 K 33/36; A 01 N 59/22; C 01 G 28/00	AU 2018 14175 U

**CONCORDANCE TABLE OF PUBLICATION NUMBERS
AND INTERNATIONAL CLASSIFICATION INDEX**

NUMBER OF PUBLISHED APPLICATION (10)	INTERNATIONAL CLASSIFICATION INDEXES (51)
AU 2018 14175 U	A 61 K 33/36; A 01 N 59/22; C 01 G 28/00

**CONCORDANCE TABLE OF INTERNATIONAL CLASSIFICATION INDEX,
PATENT NUMBERS AND PUBLICATION NUMBERS**

INTERNATIONAL CLASSIFICATION INDEX (51)	NUMBER OF PATENT (11)	NUMBER OF PUBLISHED APPLICATION (10)
B 03 B 13/04	U 2018 1962 Y	AU 2017 13949 U
C 25 B 1/40, 9/14	U 2018 1963 Y	AU 2017 14309 U

**CONCORDANCE TABLE OF PATENT NUMBERS,
PUBLICATION NUMBERS AND INTERNATIONAL CLASSIFICATION INDEX**

NUMBER OF PATENT (11)	NUMBER OF PUBLISHED APPLICATION (10)	INTERNATIONAL CLASSIFICATION INDEX (51)
U 2018 1962 Y	AU 2017 13949 U	B 03 B 13/04
U 2018 1963 Y	AU 2017 14309 U	C 25 B 1/40, 9/14

**CONCORDANCE TABLE OF APPLICATION NUMBERS, PUBLICATION NUMBERS
AND PATENTS**

NUMBER OF APPLICATION (21)	NUMBER OF PUBLISHED APPLICATION (10)	NUMBER OF PATENT (11)
AU 2015 013949	AU 2017 13949 U	U 2018 1962 Y
AU 2016 014309	AU 2017 14309 U	U 2018 1963 Y

DESIGNS

**CONCORDANCE TABLE OF INTERNATIONAL CLASSIFICATION INDEX
AND PUBLICATION NUMBERS**

INTERNATIONAL CLASSIFICATION INDEXES (51)	NUMBER OF PUBLISHED APPLICATION (10)
19-04	AD 2018 985 S
32-00	AD 2018 995 S

**CONCORDANCE TABLE OF PUBLICATION NUMBERS
AND INTERNATIONAL CLASSIFICATION INDEX**

NUMBER OF PUBLISHED APPLICATION (10)	INTERNATIONAL CLASSIFICATION INDEXES (51)
AD 2018 985 S	19-04
AD 2018 995 S	32-00

**CONCORDANCE TABLE OF INTERNATIONAL CLASSIFICATION INDEX,
PATENT NUMBERS AND PUBLICATION NUMBERS**

INTERNATIONAL CLASSIFICATION INDEX (51)	NUMBER OF PATENT (11)	NUMBER OF PUBLISHED APPLICATION (10)
07-06	D 2018 750 S	AD 2017 974 S
09-05	D 2018 749 S	AD 2017 973 S

**CONCORDANCE TABLE OF PATENT NUMBERS,
PUBLICATION NUMBERS AND INTERNATIONAL CLASSIFICATION INDEX**

NUMBER OF PATENT (11)	NUMBER OF PUBLISHED APPLICATION (10)	INTERNATIONAL CLASSIFICATION INDEX (51)
D 2018 749 S	AD 2017 973 S	09-05
D 2018 750 S	AD 2017 974 S	07-06

**CONCORDANCE TABLE OF APPLICATION NUMBERS, PUBLICATION NUMBERS
AND PATENTS**

NUMBER OF APPLICATION (21)	NUMBER OF PUBLISHED APPLICATION (10)	NUMBER OF PATENT (11)
AD 2017 000973	AD 2017 973 S	D 2018 749 S
AD 2017 000974	AD 2017 974 S	D 2018 750 S

TRADEMARKS

CONCORDANCE TABLE OF REGISTRATION NUMBERS, APPLICATION NUMBERS, PUBLICATION NUMBERS AND BULLETIN NUMBERS

NUMBER OF REGISTRATION (111)	NUMBER OF APPLICATIONS (210)	NUMBER OF PUBLISHED APPLICATIONS (260)	NUMBER OF BULLETIN
M 2018 29421 R	AM 75837	AM 2014 75837 A	24(412)2014
M 2018 29422 R	AM 96301	-	5(489)2018
M 2018 29423 R	AM 96239	-	5(489)2018
M 2018 29424 R	AM 88102	AM 2016 88102 A	20(480)2017
M 2018 29425 R	AM 88103	AM 2016 88103 A	20(480)2017
M 2018 29426 R	AM 89793	AM 2016 89793 A	14(474)2017
M 2018 29427 R	AM 89884	AM 2016 89884 A	15(475)2017
M 2018 29428 R	AM 89992	AM 2016 89992 A	15(475)2017
M 2018 29429 R	AM 89993	AM 2016 89993 A	15(475)2017
M 2018 29430 R	AM 89995	AM 2016 89995 A	14(474)2017
M 2018 29431 R	AM 89996	AM 2016 89996 A	17(477)2017
M 2018 29432 R	AM 89998	AM 2016 89998 A	15(475)2017
M 2018 29433 R	AM 90031	AM 2016 90031 A	15(475)2017
M 2018 29434 R	AM 90033	AM 2016 90033 A	15(475)2017
M 2018 29435 R	AM 90038	AM 2016 90038 A	15(475)2017
M 2018 29436 R	AM 90039	AM 2016 90039 A	15(475)2017
M 2018 29437 R	AM 90048	AM 2016 90048 A	15(475)2017
M 2018 29438 R	AM 90054	AM 2016 90054 A	20(480)2017
M 2018 29439 R	AM 90091	AM 2016 90091 A	19(479)2017
M 2018 29440 R	AM 90094	AM 2016 90094 A	19(479)2017
M 2018 29441 R	AM 90141	AM 2016 90141 A	19(479)2017
M 2018 29442 R	AM 90357	AM 2017 90357 A	15(475)2017
M 2018 29443 R	AM 90366	AM 2017 90366 A	15(475)2017
M 2018 29444 R	AM 90482	AM 2017 90482 A	17(477)2017
M 2018 29445 R	AM 90487	AM 2017 90487 A	16(476)2017
M 2018 29446 R	AM 90551	AM 2017 90551 A	16(476)2017
M 2018 29447 R	AM 90597	AM 2017 90597 A	16(476)2017
M 2018 29448 R	AM 90635	AM 2017 90635 A	18(478)2017
M 2018 29449 R	AM 90786	AM 2017 90786 A	18(478)2017
M 2018 29450 R	AM 90940	AM 2017 90940 A	20(480)2017
M 2018 29451 R	AM 90962	AM 2017 90962 A	19(479)2017
M 2018 29452 R	AM 90964	AM 2017 90964 A	19(479)2017
M 2018 29453 R	AM 90997	AM 2017 90997 A	20(480)2017
M 2018 29454 R	AM 90998	AM 2017 90998 A	20(480)2017
M 2018 29455 R	AM 90999	AM 2017 90999 A	20(480)2017
M 2018 29456 R	AM 91000	AM 2017 91000 A	20(480)2017
M 2018 29457 R	AM 91001	AM 2017 91001 A	20(480)2017
M 2018 29458 R	AM 91053	AM 2017 91053 A	19(479)2017
M 2018 29458 R	AM 91080	AM 2017 91080 A	20(480)2017
M 2018 29460 R	AM 91096	AM 2017 91096 A	21(481)2017
M 2018 29461 R	AM 91109	AM 2017 91109 A	21(481)2017
M 2018 29462 R	AM 91110	AM 2017 91110 A	21(481)2017
M 2018 29463 R	AM 91152	AM 2017 91152 A	19(479)2017
M 2018 29464 R	AM 91153	AM 2017 91153 A	19(479)2017
M 2018 29465 R	AM 91154	AM 2017 91154 A	20(480)2017
M 2018 29466 R	AM 91181	AM 2017 91181 A	21(481)2017

1	2	3	4
M 2018 29467 R	AM 91191	AM 2017 91191 A	19(479)2017
M 2018 29468 R	AM 91198	AM 2017 91198 A	19(479)2017
M 2018 29469 R	AM 91280	AM 2017 91280 A	20(480)2017
M 2018 29470 R	AM 91379	AM 2017 91379 A	21(481)2017
M 2018 29471 R	AM 91399	AM 2017 91399 A	20(480)2017
M 2018 29472 R	AM 91400	AM 2017 91400 A	20(480)2017
M 2018 29473 R	AM 94790	AM 2017 94790 A	–
M 2018 29474 R	AM 95178	AM 2017 95178 A	–

**CONCORDANCE TABLE OF PUBLICATION NUMBERS
AND APPLICATION NUMBERS**

NUMBER OF PUBLISHED APPLICATION (260)	NUMBER OF APPLICATION (210)	1	2
		1	2
AM 2018 90306 A	AM 90306	AM 2018 92581 A	AM 92581
AM 2018 91088 A	AM 91088	AM 2018 92583 A	AM 92583
AM 2018 91518 A	AM 91518	AM 2018 92595 A	AM 92595
AM 2018 91524 A	AM 91524	AM 2018 92712 A	AM 92712
AM 2018 91525 A	AM 91525	AM 2018 92717 A	AM 92717
AM 2018 91740 A	AM 91740	AM 2018 92738 A	AM 92738
AM 2018 91763 A	AM 91763	AM 2018 92769 A	AM 92769
AM 2018 91865 A	AM 91865	AM 2018 92782 A	AM 92782
AM 2018 92047 A	AM 92047	AM 2018 92852 A	AM 92852
AM 2018 92106 A	AM 92106	AM 2018 92864 A	AM 92864
AM 2018 92112 A	AM 92112	AM 2018 92958 A	AM 92958
AM 2018 92128 A	AM 92128	AM 2018 92959 A	AM 92959
AM 2018 92184 A	AM 92184	AM 2018 92963 A	AM 92963
AM 2018 92193 A	AM 92193	AM 2018 92966 A	AM 92966
AM 2018 92194 A	AM 92194	AM 2018 92968 A	AM 92968
AM 2018 92344 A	AM 92344	AM 2018 93053 A	AM 93053
AM 2018 92354 A	AM 92354	AM 2018 93100 A	AM 93100
AM 2018 92361 A	AM 92361	AM 2018 93105 A	AM 93105
AM 2018 92382 A	AM 92382	AM 2018 93139 A	AM 93139
AM 2018 92384 A	AM 92384	AM 2018 93143 A	AM 93143
AM 2018 92440 A	AM 92440	AM 2018 93146 A	AM 93146
AM 2018 92441 A	AM 92441	AM 2018 93149 A	AM 93149
AM 2018 92456 A	AM 92456	AM 2018 93226 A	AM 93226
AM 2018 92550 A	AM 92550	AM 2018 93264 A	AM 93264
AM 2018 92559 A	AM 92559	AM 2018 93272 A	AM 93272
AM 2018 92561 A	AM 92561	AM 2018 93429 A	AM 93429
AM 2018 92563 A	AM 92563	AM 2018 93438 A	AM 93438
		AM 2018 93440 A	AM 93440
		AM 2018 93509 A	AM 93509
		AM 2018 93530 A	AM 93530
		AM 2018 93563 A	AM 93563

CONCORDANCE TABLE OF INDEX OF GOODS AND/OR SERVICES
AND APPLICATION NUMBERS

INDEX OF GOODS AND/OR SERVICES (511)	NUMBER OF PUBLISHED APPLICATIONS (26)	1	2
1	2		
1	AM 2018 91524 A	33	AM 2018 92559 A
1	AM 2018 91525 A	33	AM 2018 92561 A
1	AM 2018 92128 A	33	AM 2018 92563 A
1	AM 2018 93100 A	33	AM 2018 93429 A
2	AM 2018 93100 A	33	AM 2018 93530 A
3	AM 2018 93264 A	34	AM 2018 92595 A
5	AM 2018 90306 A	34	AM 2018 92852 A
5	AM 2018 91088 A	35	AM 2018 92106 A
5	AM 2018 91518 A	35	AM 2018 92193 A
5	AM 2018 92354 A	35	AM 2018 92194 A
5	AM 2018 92361 A	35	AM 2018 92440 A
5	AM 2018 92382 A	35	AM 2018 92441 A
5	AM 2018 92384 A	35	AM 2018 92550 A
5	AM 2018 92712 A	35	AM 2018 92738 A
5	AM 2018 92717 A	35	AM 2018 93264 A
5	AM 2018 92782 A	35	AM 2018 93272 A
5	AM 2018 92958 A	35	AM 2018 93272 A
5	AM 2018 92959 A	36	AM 2018 92184 A
5	AM 2018 92963 A	36	AM 2018 93272 A
5	AM 2018 92966 A	37	AM 2018 92184 A
5	AM 2018 92968 A	37	AM 2018 92193 A
5	AM 2018 93053 A	37	AM 2018 92194 A
5	AM 2018 93105 A	37	AM 2018 93139 A
5	AM 2018 93226 A	37	AM 2018 93143 A
5	AM 2018 93438 A	37	AM 2018 93146 A
5	AM 2018 93440 A	37	AM 2018 93149 A
16	AM 2018 93272 A	37	AM 2018 93272 A
17	AM 2018 92128 A	37	AM 2018 93272 A
19	AM 2018 92128 A	39	AM 2018 91740 A
25	AM 2018 93272 A	39	AM 2018 92344 A
28	AM 2018 93272 A	39	AM 2018 92440 A
30	AM 2018 91763 A	39	AM 2018 92441 A
30	AM 2018 92106 A	40	AM 2018 93272 A
30	AM 2018 92456 A	41	AM 2018 92112 A
31	AM 2018 92769 A	41	AM 2018 93509 A
32	AM 2018 92106 A	42	AM 2018 93272 A
32	AM 2018 92559 A	43	AM 2018 92047 A
32	AM 2018 92561 A	43	AM 2018 92106 A
32	AM 2018 92563 A	43	AM 2018 92344 A
33	AM 2018 91865 A	43	AM 2018 92550 A
		43	AM 2018 92738 A
		43	AM 2018 93563 A
		44	AM 2018 91524 A
		44	AM 2018 91525 A
		44	AM 2018 92581 A
		44	AM 2018 92583 A
		44	AM 2018 92864 A

CONCORDANCE TABLE OF INDEX OF GOODS AND/OR SERVICES
AND NUMBERS OF TRADEMARKS REGISTERED ACCORDING
TO THE ACCELERATED PROCEDURE

INDEX OF GOODS AND/OR SERVICES (511)	NUMBERS OF REGISTERED ACCORDING TO THE ACCELERATED PROCEDURE (111)
5	M 2018 29422 R
34	M 2018 29423 R

OFFICIAL BULLETIN OF THE INDUSTRIAL PROPERTY

INVENTIONS
UTILITY MODELS
DESIGNS
TRADEMARKS

5(489)

EDITOR-IN-CHIEF: N. Bebrishvili

EDITOR-TRANSLATOR: E. Gabunia

PROOFREADER: A. Shikhashvili

COMPUTER LAYOUT: M. Ordenidze
K. Svanidze

www.sakpatenti.gov.ge

E-mail: info@sakpatenti.org.ge