



საქართველოს ინტელექტუალური საკუთრების ეროვნული ცენტრი
NATIONAL INTELLECTUAL PROPERTY CENTER OF GEORGIA

საქპატენტი
SAKPATENTI

**OFFICIAL BULLETIN
OF THE INDUSTRIAL PROPERTY**

5(537)

2020
TBILISI

INID CODES FOR IDENTIFICATION OF BIBLIOGRAPHIC DATA

INVENTIONS, UTILITY MODELS

- (10) Number of publication for application, which has been examined
- (11) Number of patent and kind of document
- (21) Serial number of application
- (22) Date of filing of the application
- (23) Date of exhibition or the date of the earlier filing and the number of application, if any
- (24) Date from which patent may have effect
- (31) Number of priority application
- (32) Date of filing of priority application
- (33) Code of the country or regional organization allotting priority application number
- (44) Date of publication of application not granted, but examined and number of bulletin
- (45) Date of publication of registered document
- (51) International Patent Classification Index

- (54) Title of the invention
- (57) Abstract
- (60) Number of examined patent document granted by foreign patent office, date from which patent has effect and country code
- (62) Number of the earlier application and in case of divided application, date of filing an application
- (71) Name, surname and address of applicant (country code)
- (72) Name, surname of inventor (country code)
- (73) Name, surname and address of patent owner (country code)
- (74) Name, surname of representative or patent attorney
- (85) Date of commencement of the national phase of International Application
- (86) Number and date of filing of international application
- (87) Number and date of publication of international application
- (94) Calculated date of expiry of the SPC or the duration of the SPC

DESIGNS

- (10) Number of publication for application
- (11) Number of patent and kind of document or number of registration
- (15) Date of registration/Date of patent renewal
- (18) Expected expiration date of patent or registration
- (21) Serial number of application
- (22) Date of filing of the application
- (23) Date of exhibition or the date of the earlier filing and the number of application, if any
- (24) Date from which patent may have effect
- (28) Number of designs included in the application
- (30) Data relating to priority (number of application, date of filing of application, two-letter code identifying the authority with whom the priority application was made)
- (31) Number of priority application
- (32) Date of filing of priority application
- (33) Code of the country or regional organization allotting priority application number
- (34) Two-letter code according to WIPO St.3 identifying the authority with which the priority application was made
- (44) Date of publication of design and number of bulletin (the first publication)
- (45) Date of publication of design registered by WIPO and number of bulletin

- (51) International Classification for designs (class and subclass of the Locarno Classification)
- (54) Title of the invention
- (55) Reproduction of the design
- (57) Description of characteristic features of the design including indication of colors
- (58) Date of recording of any kind of amendment in the Register
- (62) Number of the earlier application, registration and document number and if available the date of filing an application in case of divided application
- (71) Name, surname and address of applicant (country code)
- (72) Name, surname of creator (country code)
- (73) Name, surname and address of patent owner (country code)
- (74) Name, surname of representative or patent attorney
- (81) Contracting states concerned
 - II designated contracting states according to the 1960 Act
 - III designated contracting states according to the 1999 Act
- (85) Owner's permanent address
- (86) Owner's nationality
- (87) Owner's residence
- (88) State in which the owner has a real and effective industrial or commercial establishment

TRADEMARKS

- (111) - Number of registration
- (151) - Date of registration
- (156) - Date of the renewal
- (181) - Expected expiration date of registration
- (186) - Renewal expiration date of registration
- (141) - Date of cancel of duration of the mark
- (210) - Serial number of application
- (220) - Date of filing of the application
- (230) - Data concerning exhibition
- (260) - Number of application, for which favorable decision of examination about registration has been taken (publication number)
- (310) - Number of the first application
- (320) - Date of filing of the first application
- (330) - Code, identifying national or regional Office where the first application was made
- (511) - International Classification of Goods and Services for the purposes of registration of trade marks and/or list of goods and/or services classified according thereto
- (526) - Disclaimer
- (531) - Description of figurative elements of Trade Marks according to the International Classification of the Figurative Elements of Marks

- (540) - Reproduction of Trade Mark
- (550) - Nature and kind of Trade Mark
- (551) - Indication to the effect that the mark is a collective mark, a certification mark or a guarantee mark
- (554) - Three-dimensional mark
- (580) - Date of recording of any kind changes in respect of applications or registrations
- (591) - Information concerning colors claimed
- (731) - Name and address of the applicant
- (732) - Name and address of the holder of the registration
- (740) - Name and address of the representative
- (750) - Addreses for correspondence
- (770) - Name and address of the previous applicant or holder in case of change in ownership
- (771) - Previous name and address of the applicant or holder in case of change in ownership
- (791) - Name and address of the licensee
- (793) - Indication of conditions and/or restrictions under the license (Type of license, number of license agreement, data of license, data of validity of license)
- (800) - Certain data relating to the international registration of Trade Marks under the Protocol Relating to Madrid Agreement (International registration number)
- (852) - Partial cancellation of the list of goods and services
- (891) - Date of subsequent designation

CODES FOR PUBLICATION IN BULLETIN

- (21) AP 0000 000000 - serial number of application for invention
- (10) AP 0000 0000 A - number of published application for invention (first publication)
- (11) P 0000 0000 B - number of patent for invention (second publication)
- (21) API 0000 000000 - number of application for imported patent
- (11) PI 0000 0000 A - number of imported patent (first publication)
- (21) AU 0000 000000 - serial number of application for utility model
- (10) AU 0000 000 U - number of published application for utility model (first publication)
- (11) U 0000 000 Y - number of patent for utility model (second publication)
- (21) AD 0000 000000 - serial number of application for design
- (10) AD 0000 000 S - number of published application for design (first publication)
- (11) D 0000 000 S - registered design

INTERNATIONAL PATENT CLASSIFICATION FOR INVENTIONS AND UTILITY MODELS

- SECTION A - HUMAN NECESSITIES
- SECTION B - PERFORMING OPERATIONS; TRANSPORTING
- SECTION C - CHEMISTRY; METALLURGY
- SECTION D - TEXTILES; PAPER
- SECTION E - FIXED CONSTRUCTIONS
- SECTION F - MECHANICAL ENGINEERING; LIGHTING; HEATING; WEAPONS; BLASTING
- SECTION G - PHYSICS
- SECTION H - ELECTRICITY

-
- M - Trade Mark
 - (210) AM 0000 000000 - Serial number of application;
 - (260) AAM 0000 00000 A - Publication number of application;
 - (111) M 0000 00000 R - Number of registration;
 - (111) MMM0000 00000 Rn - Number of renewals, in which n=1,2,3;
 - (111) M 0000 00000 R(P) - Number of registration under partial assignment of rights
-

**LIST OF CODES, IN ALPHABETIC SEQUENCE, AND THE CORRESPONDING (SHORT) NAMES OF STATES, OTHER ENTITIES AND INTERGOVERNMENTAL ORGANIZATIONS
(WIPO STANDARD ST.3)**

AD	Andorra				
AE	United Arab Emirates	GD	Grenada	NE	Niger
AF	Afghanistan	GG	Guernsey	NG	Nigeria
AG	Antigua and Barbuda	GH	Ghana	NI	Nicaragua
AI	Anguilla	GI	Gibraltar	NL	Netherlands
AL	Albania	GT	Guatemala	NO	Norway
AM	Armenia	GW	Guinea- Bissau	NP	Nepal
AN	Netherlands Antilles	GY	Guyana	NR	Nauru
AO	Angola	HK	The Hong Kong Special Administrative Region of the People's Republic of China	NZ	New Zealand
AP	African Regional Intellectual Property Organization (ARIPO)	HN	Honduras	OA	African Intellectual Property Organization (OAPI)
AR	Argentina	HR	Croatia	OM	Oman
AT	Austria	HT	Haiti	PA	Panama
AU	Australia	HU	Hungary	PE	Peru
AW	Aruba	IB	International Bureau of the World Intellectual Property Organization (WIPO)	PG	Papua New Guinea
AZ	Azerbaijan	ID	Indonesia	PH	Philippines
BA	Bosnia and Herzegovina	IE	Ireland	PK	Pakistan
BB	Barbados	IL	Israel	PL	Poland
BD	Bangladesh	IM	Isle of Man	PT	Portugal
BE	Belgium	IN	India	PW	Palau
BF	Burkina Faso	IQ	Iraq	PY	Paraguay
BG	Bulgaria	IR	Iran (Islamic Republic of)	QA	Qatar
BH	Bahrain	IS	Iceland	QZ	Community Plant Variety Office (European Community) (CPVO)
BI	Burundi	IT	Italy	RO	Romania
BJ	Benin	JE	Jersey	RS	Serbia
BM	Bermuda	JM	Jamaica	RU	Russian Federation
BN	Brunei Darussalam	JO	Jordan	RW	Rwanda
BO	Bolivia	JP	Japan	SA	Saudi Arabia
BR	Brazil	KE	Kenya	SB	Solomon Islands
BS	Bahamas	KG	Kyrgyzstan	SC	Seychelles
BT	Bhutan	KH	Cambodia	SD	Sudan
BV	Bouvet Island	KI	Kiribati	SG	Singapore
BW	Botswana	KM	Saint Kitts and Nevis	SH	Saint Helena
BX	Benelux Office for Intellectual Property (BOIP)	KP	Democratic People's Republic of Korea	SI	Slovenia
BY	Belarus	KR	Republic of Korea	SK	Slovakia
BZ	Belize	KW	Kuwait	SL	Sierra Leone
CA	Canada	KY	Cayman Islands	SM	San Marino
CD	Democratic Republic of the Congo	KZ	Kazakhstan	SN	Senegal
CF	Central African Republic	LA	Lao People's Democratic Republic	SO	Somalia
CG	Congo	LB	Lebanon	SR	Suriname
CH	Switzerland	LC	Saint Lucia	ST	Sao Tome and Principe
CI	Cote d'Ivoire	LI	Liechtenstein	SV	El Salvador
CK	Cook Islands	LK	Sri Lanka	SY	Syrian Arab Republic
CL	Chile	LR	Liberia	SZ	Swaziland
CM	Cameroon	LS	Lesotho	TC	Turks and Caicos Islands
CN	China	LT	Lithuania	TD	Chad
CO	Colombia	LU	Luxembourg	TG	Togo
CR	Costa Rica	LV	Latvia	TH	Thailand
CU	Cuba	LY	Libyan Arab Jamahiriya	TJ	Tajikistan
CV	Cape Verde	MA	Morocco	TL	Timor-Leste
CY	Cyprus	MC	Monaco	TM	Turkmenistan
CZ	Czech Republic	MD	Republic of Moldova	TN	Tunisia
DE	Germany	ME	Montenegro	TO	Tonga
DJ	Djibouti	MG	Madagascar	TR	Turkey
DM	Dominica	MK	The former Yugoslav Republic of Macedonia	SE	Sweden
DO	Dominican Republic	ML	Mali	TT	Trinidad and Tobago
DZ	Algeria	MM	Myanmar	TV	Tuvalu
EA	Eurasian Patent Organization (EAPO)	MN	Mongolia	TW	Taiwan, Province of China
EC	Ecuador	MO	Macao	TZ	United Republic of Tanzania
EE	Estonia	MP	Northern Mariana Islands	UA	Ukraine
EG	Egypt	MR	Mauritania	UG	Uganda
EH	Western Sahara	MS	Montserrat	US	United States of America
EM	Office for Harmonization in the Internal Market (Trademarks and Designs)(OHIM)	MT	Malta	UY	Uruguay
EP	European Patent Office (EPO)	MU	Mauritius	UZ	Uzbekistan
ER	Eritrea	MV	Maldives	VA	Holy See
ES	Spain	MW	Malawi	VC	Saint Vincent and the Grenadines
ET	Ethiopia	MX	Mexico	VE	Venezuela
FI	Finland	MY	Malaysia	VG	Virgin Islands (British)
FJ	Fiji	MZ	Mozambique	VN	Viet Nam
FK	Falkland Islands (Malvinas)	NA	Namibia	VU	Vanuatu
FO	Faroe Islands			WO	World Intellectual Property Organization (WIPO)
FR	France			WS	Samoa
GA	Gabon			XN	Nordic Patent Institute (NPI)
GB	United Kingdom			YE	Yemen
GC	Patent Office of the Cooperation Council for the Arab States of the Gulf (GCC)			ZA	South Africa
				ZM	Zambia
				ZW	Zimbabwe

OFFICIAL BULLETIN OF THE INDUSTRIAL PROPERTY

5(537)

**INVENTIONS
UTILITY MODELS
DESIGNS
TRADEMARKS**

DATE OF PUBLICATION: 2020 03 10

CONTENTS

PUBLISHED TITLES OF PROTECTION	3
INVENTIONS	
▪ APPLICATIONS APPROVED FOR GRANTING PATENTS	4
▪ PATENTED INVENTIONS	7
UTILITY MODELS	
▪ APPLICATIONS APPROVED FOR GRANTING PATENTS	9
DESIGNS	
▪ DESIGNS, WHICH HAVE BEEN REGISTERED WITH THE INTERNATIONAL BUREAU CLAIMING PRIORITY ON THE TERRITORY OF GEORGIA	10
TRADEMARKS	
▪ APPLICATIONS FILED UNDER THE NATIONAL PROCEDURE APPROVED FOR REGISTRATION	83
▪ REGISTERED TRADEMARKS	89
▪ TRADEMARKS REGISTERED ACCORDING TO THE ACCELERATED PROCEDURE	92
▪ INTERNATIONAL TRADEMARKS FOR WHICH A DECISION ON GRANTING PROTECTION IS TAKEN	94
▪ INTERNATIONAL TRADEMARKS PROTECTED IN GEORGIA	143
OFFICIAL NOTIFICATIONS	
INVENTIONS	
▪ EXPIRATION OF PATENTS RESTORATION	162
▪ ABOLITION OF PATENTS WITH THE RIGHT TO RESTORE	163
▪ EXPIRATION OF TERM OF RESTORATION OF PATENTS	165
▪ REGISTRATION OF LICENSE AGREEMENT	166
UTILITY MODELS	
▪ EXPIRATION OF PATENT RESTORATION	167
▪ ABOLITION OF PATENT WITH THE RIGHT TO RESTORE	167
▪ EXPIRATION OF TERM OF RESTORATION OF PATENTS	167
▪ TRANSFER OF RIGHT	168
DESIGNS	
▪ EXTENSION OF REGISTRATION OF DESIGNS	168
▪ CANCELLATION OF DESIGNS REGISTRATION	169
▪ TRANSFER OF RIGHT	169
▪ EXTENSION OF REGISTRATION OF INTERNATIONAL DESIGNS	170
TRADEMARKS	
▪ RENEWAL OF REGISTRATIONS	174
▪ COMPLETE TRANSFER OF RIGHTS	177
▪ CHANGES OF NAMES AND/OR ADDRESSES OF OWNERS	178
▪ LICENSE AGREEMENTS	178
CLASSIFICATION INDEXES	
INVENTIONS	179
UTILITY MODELS	180
TRADEMARKS	181

PUBLISHED TITLES OF PROTECTION

INVENTIONS

- **APPLICATIONS APPROVED FOR GRANTING PATENT:**
14778; 14820; 14858; 14908
- **PATENTED INVENTIONS:**
7074-7078

UTILITY MODELS

- **APPLICATIONS APPROVED FOR GRANTING PATENT:**
15133; 15122

DESIGNS

- **DESIGNS, WHICH HAVE BEEN REGISTERED WITH THE INTERNATIONAL BUREAU CLAIMING PRIORITY ON THE TERRITORY OF GEORGIA:**
204350; 204475; 204434; 102706; 203176; 202880; 203042; 204564; 204445; 204906; 204894; 204879; 204908; 204853; 204917; 204914; 205048; 204975; 205062; 203139; 205081; 205078

TRADEMARKS

- **APPLICATIONS FILED UNDER THE NATIONAL PROCEDURE APPROVED FOR REGISTRATION:**
103559; 103692; 103780; 103879; 103943; 103952; 103956; 103970; 103974, 103975; 104060; 104073; 104084; 104088; 104106; 104177; 104199; 104207; 104209; 104216, 104217; 104307; 104316; 104331; 104402, 104403; 104425-104429; 104535; 104537
- **REGISTERED TRADEMARKS:**
32396-32429
- **TRADEMARKS REGISTERED ACCORDING TO THE ACCELERATED PROCEDURE:**
32388-23395; 32430
- **INTERNATIONAL TRADEMARKS FOR WHICH A DECISION ON GRANTING PROTECTIONS IS TAKEN:**
96791; 99740; 100722*; 102447; 102614; 102852; 102855; 102903; 102943; 102945; 102954; 102962-102964; 102966; 102983-102986; 103039-103042; 103055, 103056; 103064; 103066; 103074; 103076-103078; 103127; 103134; 103136, 103137; 103158, 103159; 103162; 103164, 103165; 103226; 103228; 103249; 103251; 103255; 103259-103261; 103263-103266; 103268-103271; 103280; 103287; 103350; 103354; 103357; 103360; 103372, 103373; 103377; 103381; 103409-103412; 103420, 103421; 103423-103425; 103488; 103497, 103498; 103509-103511; 103514, 103515; 103526-103528; 103543-103546; 103549; 103598; 103611; 103625; 103645; 103649; 103744; 103793-103796; 103814, 103815; 103921, 103922; 103989; 104004; 104015; 104130; 104136; 104232-104236; 104243, 104244; 104293-104296; 106196
- **INTERNATIONAL TRADEMARKS PROTECTED IN GEORGIA:**
97315; 97663; 99117, 99606; 101100; 101121; 101147; 101166, 101362-101368; 101429; 101431, 101440; 101446; 101448; 101472; 101482; 101530-101532; 101534; 101536; 101539-101553; 101555, 101556; 101563, 101564; 101566-101571; 101573; 101577-101579; 101581-101585; 101596; 101696-101703; 101705-101707; 101709; 101711-101714; 101717-101724; 101726-101728; 101737-101739; 101741-101745; 101750, 101751; 101753; 101755, 101756; 101759-101761; 101764-101772; 101798; 101800, 101801; 101803; 101830; 101832; 101836-101845; 101847-101859; 101868-101871; 101875-101879; 101892; 101944; 101947; 101949; 101965-101977; 101979; 101981-101985; 101997, 101998; 102016-102018; 102020; 102084-102088; 102099-102107; 102120; 102123; 102186; 102196; 102206; 102208; 102210; 102219; 102275-102280; 102293; 102302, 102303; 102305; 102307-102310; 102337; 102339, 102340; 102414-102420; 102441; 102445; 102467; 102480, 102481; 102483; 102582; 102584-102592; 102671-102675; 102679-102681; 102773-102779; 102794; 102797; 102800; 102885, 102886; 102888-102892; 102947-102951; 103054; 103631

INVENTIONS

APPLICATIONS APPROVED FOR GRANTING PATENTS

The decision can be appealed at the Chamber of Appeal of Sakpatenti within 3 months from the publication or at the Mtskheta District Court Administrative Cases Board (Address: №17, Samkhedro str., Mtskheta), within 1 month following the publication.

PART A

A 61

(10) AP 2020 14778 A (51) Int. Cl. (2006)

A 61 P 25/02
A 61 P 25/04
A 61 K 31/496
A 61 K 45/06
A 61 K 31/195

(21) AP 2016 14778 (22) 2016 10 17

(31) 15191024.7

(32) 2015 10 22

(33) EP

(71) AZIENDE CHIMICHE RIUNITE ANGELINI
FRANCESCO A.C.R.A.F. S.P.A. (IT)
Viale Amelia, 70 00181 Roma (IT)

(72) GARRONE, Beatrice (IT);

DURANDO, Lucia (IT);

CALISTI, Fabrizio (IT)

(74) Liliana Darakhvelidze

(85) 2018 05 11

(86) PCT/EP2016/074835, 2016 10 17

(54) **COMBINATION OF TRAZODONE AND
GABAPENTIN FOR THE TREATMENT
OF PAIN**

(57) The present invention relates to pharmaceutical composition comprising combination of trazodone and gabapentin for the usage in the treatment of pain.

Claims: 1 independent

9 dependent

Fig.: 4

(10) AP 2020 14820 A (51) Int. Cl. (2006)

A 61 K 31/506
A 61 P 37/00
A 61 P 9/00
A 61 P 25/30
A 61 P 35/00
A 61 P 25/02
A 61 P 3/10
A 61 P 3/06
A 61 P 7/02
C 07 D 403/14
C 07 D 403/04
C 07 D 401/14

(21) AP 2016 14820 (22) 2016 12 16

(31) 62/272,598; 62/423,549

(32) 2015 12 29; 2016 11 17

(33) US; US

(71) PFIZER INC. (US)

235 East 42nd Street New York, New York
10017 (US)

(72) DOWLING, Matthew (US);

HUARD, Kim (US);

FERNANDO, Dilinie (US);

THUMA, Benjamin (US);

FUTATSUGI, Kentaro (US);

MAGEE, Thomas Victor (US);

TSAI, Andy (US);

SHAVNYA, Andre (US);

RAYMER, Brian (US);

SMITH, Aaron (US);

TU, Meihua (US)

(74) Tamar Kochlamazashvili

(85) 2018 06 28

(86) PCT/IB2016/057728, 2016 12 16

(54) **SUBSTITUTED 3-AZABICYCLO [3.1.0]
HEXANES AS KETOHEXOKINASE
INHIBITORS**

(57) Present invention relates to substituted 3-azabicyclo[3.1.0]hexanes of formula I,

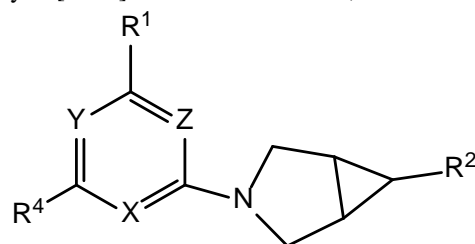

as ketoheokinase inhibitors, compositions comprising them, and their usage at the treatment of diabetes and various diseases of liver.

Claims: 9 independent

12 dependent

Fig.: 5

(10) AP 2020 14858 A (51) Int. Cl. (2006)

A 61 K 31/661
A 61 K 31/519
A 61 P 35/00
C 07 D 495/04
C 07 F 9/6561

- (21) AP 2016 14858 (22) 2016 12 19
 (31) 16/50411
 (32) 2016 01 19
 (33) FR
 (71) LES LABORATOIRES SERVIER (FR)
 35 rue de Verdun 92284 Suresnes (FR);
 VERNALIS (R&D) LIMITED (GB)
 100 Berkshire Place Wharfedale Road
 Berkshire Winnersh Berkshire RG41
 5RD (GB)
 (72) GENESTE, Olivier (FR);
 MARAGNO, Ana Leticia (FR);
 BÁLINT, Balázs (HU);
 CHANRION, Maïa (FR);
 KOTSCHY, András (HU);
 SZLÁVIK, Zoltán (HU);
 PACZAL, Attila (HU);
 SIPOS, Szabolcs (HU);
 DEMARLES, Didier (FR)

(74) Tamaz Shilakadze

(85) 2018 08 14

(86) PCT/EP2016/081688, 2016 12 19

(54) **NEW AMMONIUM DERIVATIVES, A
 PROCESS FOR THEIR PREPARATION
 AND PHARMACEUTICAL
 COMPOSITIONS CONTAINING THEM**

(57) Compound of formula (I),

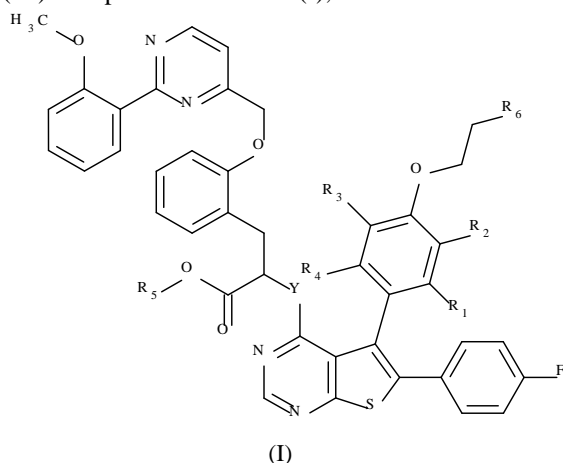

preparation method thereof, and their usage for the treatment of cancer or autoimmune and immune diseases.

Claims: 15 independent

16 dependent

Table: 1

PART C

C 07

- (10) AP 2020 14908 A (51) Int. Cl. (2006)
 C 07 D 285/12
 C 07 D 285/08
 C 07 D 277/26
 C 07 D 495/04
 C 07 D 271/06
 C 07 D 263/32
 C 07 D 261/08
 C 07 D 249/08
 C 07 D 249/06
 C 07 D 417/04
 C 07 D 413/10
 C 07 D 413/06
 C 07 D 413/04
 C 07 D 233/64
 C 07 D 231/12

(21) AP 2017 14908 (22) 2017 03 20

(31) 62/369,778; 62/311,888

(32) 2016 08 02; 2016 03 22

(33) US; US

(71) MERCK SHARP & DOHME CORP. (US)

126 East Lincoln Avenue Rahway, New Jersey
 07065-0907 (US)

(72) SANDERS, John, M. (US);

CAMPBELL, Brian, T. (US);

BELL, Ian, M. (US);

SUEN, Linda, M. (US);

SHIPE, William, D. (US);

RADA, Vanessa, L. (US);

LEAVITT, Kenneth, J. (US);

HUFF, Belinda, C. (AU);

HARVEY, Andrew John (AU);

GUIADEEN, Deodial, G. (US);

GRESHOCK, Thomas, J. (US);

DUFFY, Joseph, L. (US);

CROWLEY, Brendan, M. (US)

(74) Tamaz Shilakadze

(85) 2018 10 18

(86) PCT/US2017/023127, 2017 03 20

(54) **ALLOSTERIC MODULATORS OF
 NICOTINIC ACETYLCHOLINE
 RECEPTORS**

(57) Compounds of formula (I),

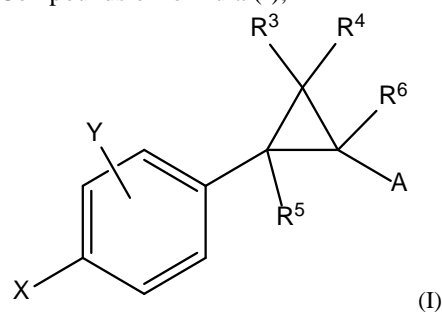

pharmaceutical compositions on the basis thereof, and their usage at the treatment of disorders of CNS (central nervous system), such as cognitive disorders at Alzheimer's disease, Parkinson and schizophrenia.

Claims: 34 independent

9 dependent

PATENTED INVENTIONS

PART A

A 43

- (11) P 2020 7077 B (51) Int. Cl. (2006)
A 43 B 17/14
C 08 L 9/06
- (10) AP 2019 14777 A (44) 18(526)/2019
(21) AP 2018 14777
(22) 2018 05 10
(24) 2018 05 10
(73) Merab Shalamberidze (GE)
Rozevich St. 8/2, 4600, Kutaisi (GE);
Ak. Tsereteli State University (GE)
Queen Tamara Ave. 59, 4600, Kutaisi (GE)
(72) Merab Shalamberidze (GE);
Malvina Tatvidze (GE)
(74) Archil Geguchadze
(54) **POLYMERIC COMPOSITION FOR
ORTHOPAEDIC SUPINATORS
PRODUCTION**

A 61

- (11) P 2020 7074 B (51) Int. Cl. (2006)
A 61 K 31/519
A 61 P 35/00
A 61 P 37/00
C 07 D 495/04
- (10) AP 2019 14678 A (44) 21(529)/2019
(21) AP 2016 14678
(22) 2016 06 22
(24) 2016 06 22
(31) 1555752
(32) 2015 06 23
(33) FR
(86) PCT/EP2016/064433, 2016 06 22
(73) LES LABORATOIRES SERVIER (FR)
35 rue de Verdun 92284 Suresnes Cedex (FR);
VERNALIS (R&D) LIMITED (GB)
100 Berkshire Place Wharfedale Road
Winnersh Berkshire RG41 5RD (GB)
(72) SIPOS, Szabolcs (HU);
PACZAL, Attila (HU);
CHANRION, Maïa (FR);
DEMARLES, Didier (FR);
SZLÁVIK, Zoltán (HU);
BÁLINT, Balázs (HU);
DAVIDSON, James Edward Paul (GB);
KOTSCHY, András (HU);
MURRAY, James Brooke (GB);
GENESTE, Olivier (FR)
(74) Tamaz Shilakadze

- (54) **NEW HYDROXYESTER
DERIVATIVES, PROCESS FOR THEIR
PREPARATION AND PHARMACEU-
TICAL COMPOSITIONS CONTAINING
THEM**

- (11) P 2020 7076 B (51) Int. Cl. (2006)
A 61 P 37/00
A 61 P 35/00
A 61 K 31/519
C 07 D 495/04
- (10) AP 2019 14680 A (44) 21(529)/2019
(21) AP 2016 14680
(22) 2016 06 22
(24) 2016 06 22
(31) 1555753
(32) 2015 06 23
(33) FR
(86) PCT/EP2016/064417, 2016 06 22
(73) LES LABORATOIRES SERVIER (FR)
35 rue de Verdun 92284 Suresnes Cedex (FR);
VERNALIS (R&D) LIMITED (GB)
100 Berkshire Place Wharfedale Road
Winnersh Berkshire RG41 5RD (GB)
(72) PROSZENYÁK, Ágnes (HU);
DAVIDSON, James Edward Paul (GB);
CHANRION, Maïa (FR);
GENESTE, Olivier (FR);
KOTSCHY, András (HU);
MURRAY, James Brooke (GB);
PACZAL, Attila (HU);
SZLÁVIK, Zoltán (HU);
SIPOS, Szabolcs (HU);
BÁLINT, Balázs (HU)
(74) Tamaz Shilakadze
(54) **NEW HYDROXYACID DERIVATIVES,
A PROCESS FOR THEIR PREPARA-
TION AND PHARMACEUTICAL
COMPOSITIONS CONTAINING THEM**

- (11) P 2020 7075 B (51) Int. Cl. (2006)
A 61 P 37/00
A 61 P 35/00
A 61 K 31/519
C 07 D 495/04
- (10) AP 2019 14679 A (44) 21(529)/2019
(21) AP 2016 14679
(22) 2016 06 22
(24) 2016 06 22
(31) 1555747
(32) 2015 06 23
(33) FR
(86) PCT/EP2016/064436, 2016 06 22

UTILITY MODELS

APPLICATIONS APPROVED FOR GRANTING PATENT

The decision can be appealed at the Chamber of Appeal of Sakpatenti within 3 months from the publication or at the Mtskheta District Court Administrative Cases Board (Address: №17, Samkhedro str., Mtskheta), within 1 month following the publication.

PART E

E 04

(10) AU 2020 15133 U (51) Int. Cl. (2006)
E 04 C 1/00

(21) AU 2019 15133 (22) 2019 07 05

(71) Evgeni Gogotishvili (GE)
Il. Chavchavadze Av. 27, ap. 1, 0179,
Tbilisi (GE)

(72) Evgeni Gogotishvili (GE)

(54) **CONSTRUCTIONAL WALL HOLLOW
STONE**

(57) Wall hollow stone has one through and one blind vertical cavities 6 and 7, and blind from upper bed the facilitating cavity 10 in the middle. Two by two ledges 4 are executed on the both sides of stone trunks, and cavity 17 between them is appointed to force compaction between adjacent stones in a row. The stone has a groove 8 on upper supporting bed 1, and the scrapes 9 on front and rear walls to show middle of stone.

Claims: 1 independent
2 dependent

Fig.: 5

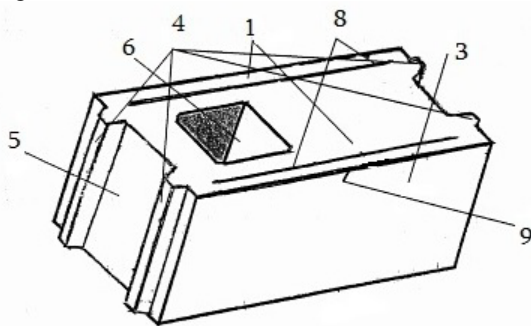

Fig. 1

PART F

F 03

(10) AU 2020 15122 U (51) Int. Cl. (2006)
F 03 D 3/02

F 03 D 3/00

(21) AU 2019 15122 (22) 2019 06 27

(71) Aleksandre Moseshvili (GE)
Vazha-Pshavela Av. 35, ap. 51, 0177,
Tbilisi (GE)

(72) Aleksandre Moseshvili (GE)

(54) **WIND POWER DEVICE**

(57) A device includes a turbine connected to generator 8 and disposed on vertical axle 2; at that, at least one section having two couples of blading 1, each wherefrom are disposed on horizontal axles 3 passed through turbine axle rotatable, blading are rigid onto the axles with upper edges, and one couple therefrom is placed on the axle so that each blade plane creates angle of 90° relative to another, and blading couples axles create 90° relative to each other in horizontal plane; at that, set of sections can be disposed along turbine vertical axle on various levels, and each therefrom can be turned relative to previous one in horizontal plane.

Claims: 1 independent
1 dependent

Fig.: 7

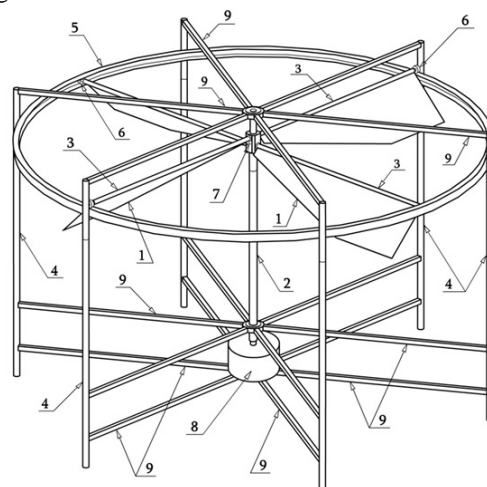

Fig. 6

DESIGNS

DESIGNS, WHICH HAVE BEEN REGISTERED WITH THE INTERNATIONAL BUREAU CLAIMING PRIORITY ON THE TERRITORY OF GEORGIA

The decision can be appealed at the Chamber of Appeal of Sakpatenti within 3 months from the publication or at the Mtskheta District Court Administrative Cases Board (Address: №17, Samkhedro Str., Mtskheta), within 1 month following the publication.

- (11) **DM/204 350** (51) **02-04**
(15) 2019 11 15 (44) 49/2019 (2019 12 06)
(22) 2019 11 15
(28) 2
(73) Valentino S.p.A.
Via Turati, 16/18, I-20121 Milan (IT)
(85) –
(86) IT, EM
(87) IT, EM
(88) IT, EM
(89) EM
(81) III. GE, TR, UA, KG, AZ, EM, KR, JP, TJ, RU
(72) Stefano Sassi
c/o Valentino S.p.A. Via Turati, 16/18, I-20121, Milan (IT)
(74) Salvatore Giovanni
Pennacchio, c/o Jacobacci & Partners S.p.A. Via Senato, 8, I-20121 Milan (IT)
(54) 1.-2. Shoe
(55)

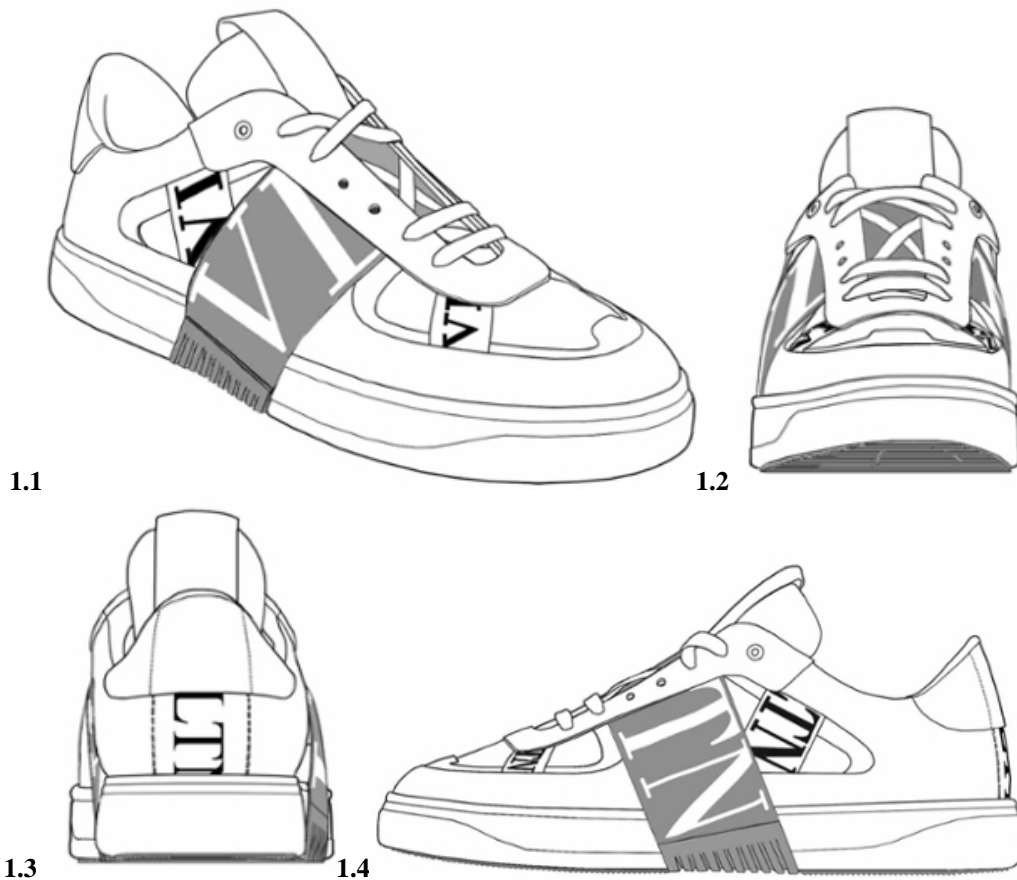

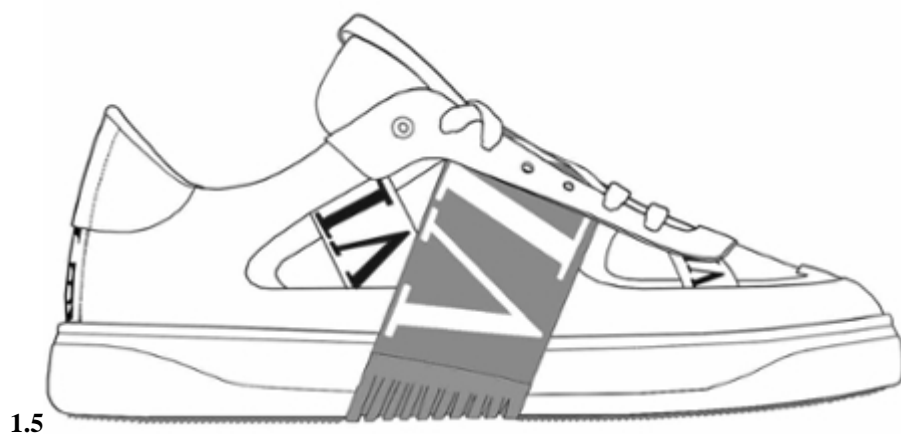

1.5

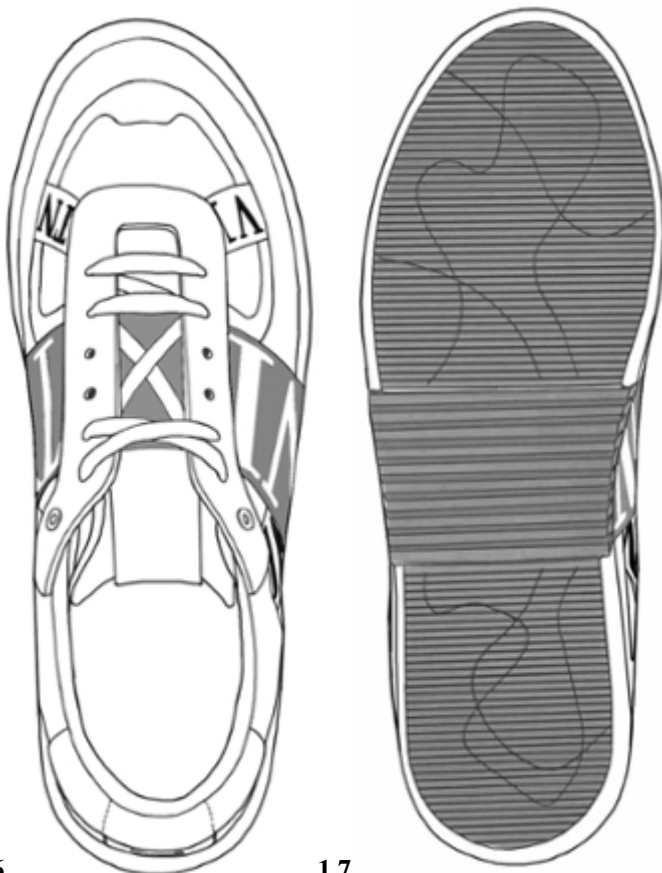

1.6

1.7



2.1

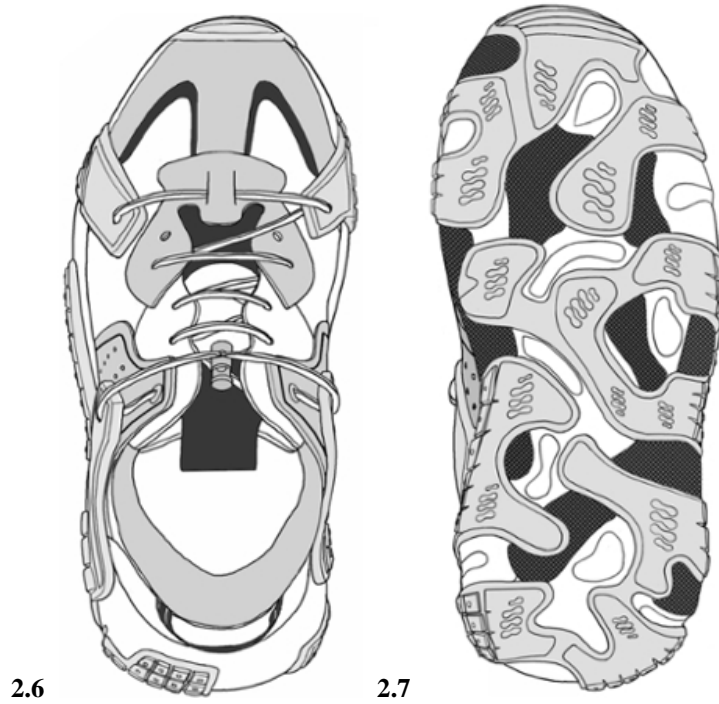
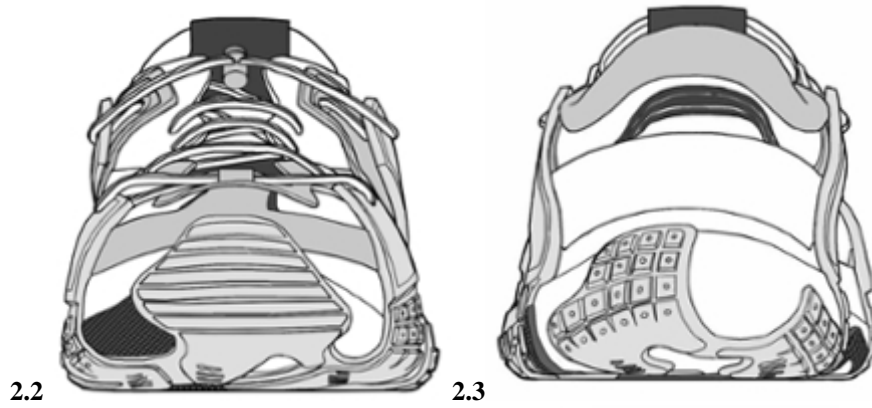

(11) DM/204 475

(15) 2019 01 29

(22) 2019 01 29

(28) 3

(30) No1: 07.08.2018; 30-2018-0036561; KR;

No2: 05.10.2018; 30-2018-0045900; KR;

No3: 16.11.2018; 30-2018-0053182; KR

(73) Grip At Co., Ltd.

N104-904, 34, Sanhyeon-ro, Ilsanseo-gu Goyang-si, Gyeonggi-do (KR)

(85) –

(86) KR

(87) KR

(88) –

(89) KR

(81) III. AM, IS, MD, TJ, BW, ST, MN, GH, TR, KH, TN, JP, KP, CH, UA, BN, AL, AZ, TM, ME, MC, SG,

NA, OA, RS, NO, BA, GE, OM, MK, US, CA, LI, KG, EM, SY, RW, RU, EG

(72) Kwang Sun HWANG

24-5, Dongho-ro 11da-gil, Jung-gu, Seoul (KR)

(74) INNO PATENT LAW FIRM

8F Shinhankook Bldg, 164, Seochojungang-ro, Seocho-gu , 06605 Seoul (KR)

(54) 1.-3. Lid for disposable cup

(55)

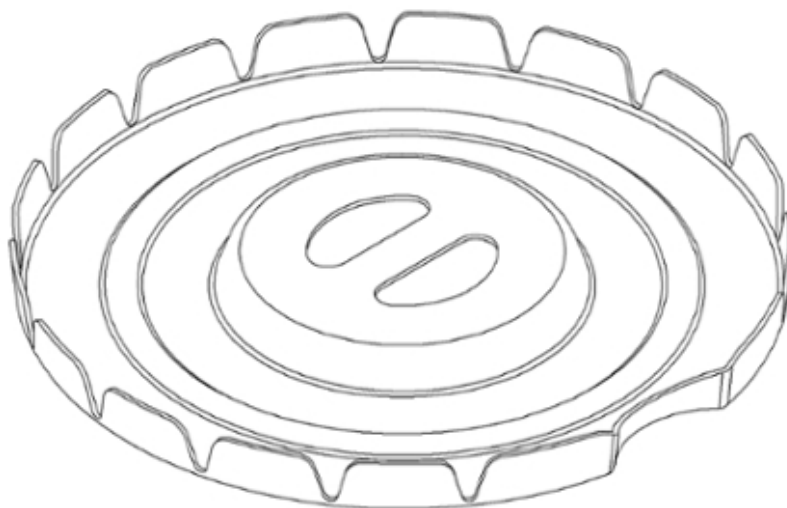
1.1**1.2****1.3****1.4**

1.5



1.6

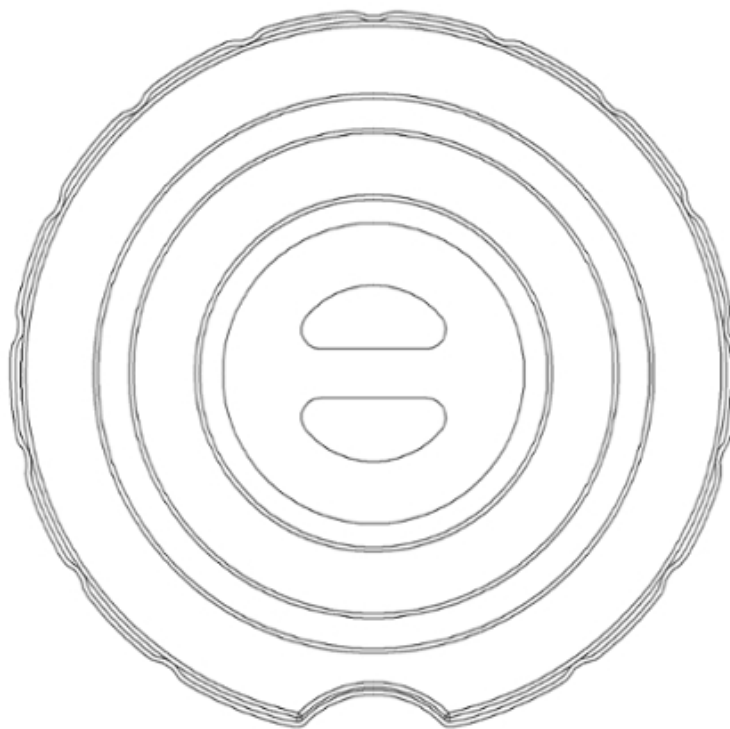

1.7

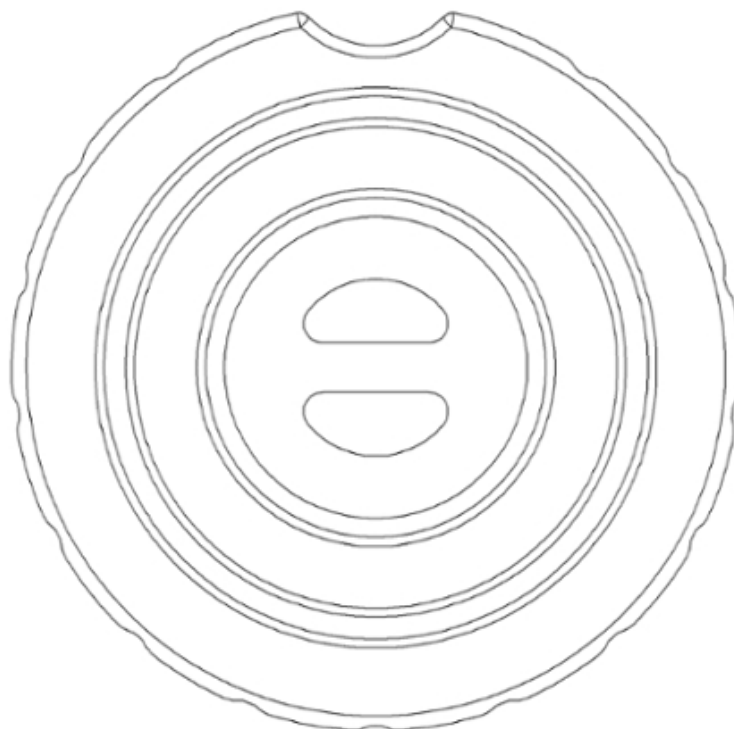

1.8

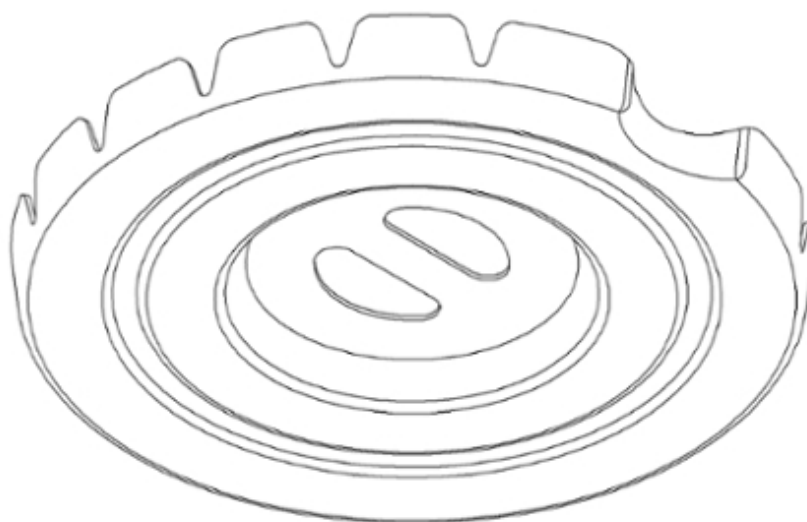

2.1

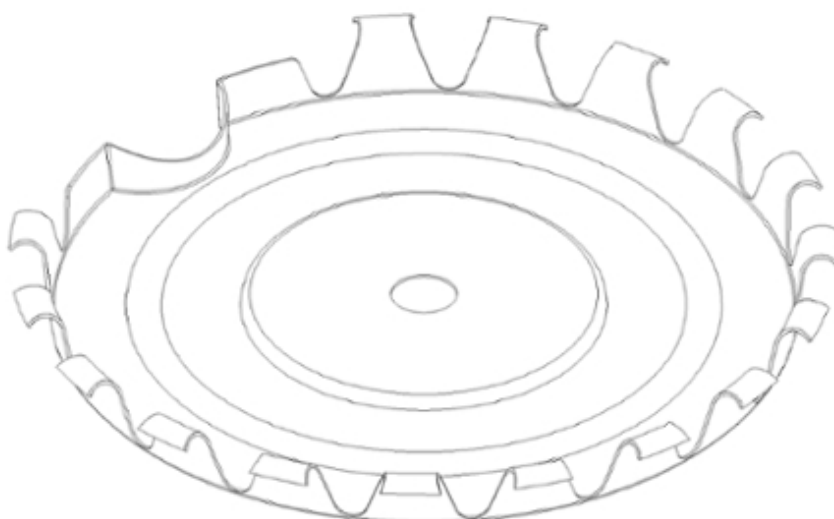

2.2



2.3



2.4



2.5

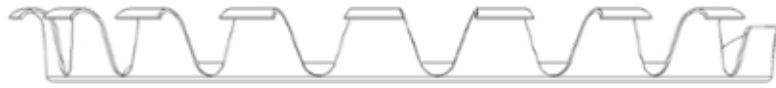

2.6

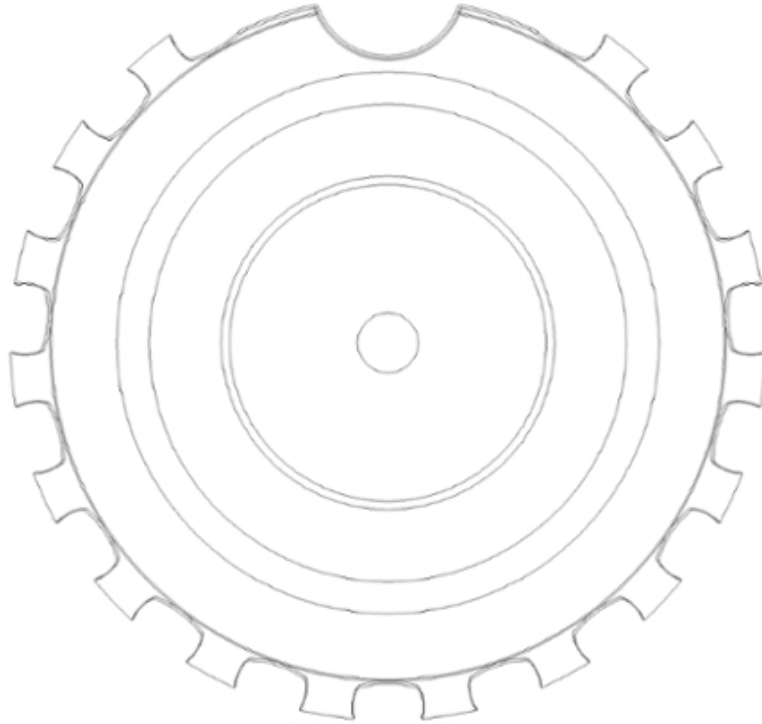

2.7

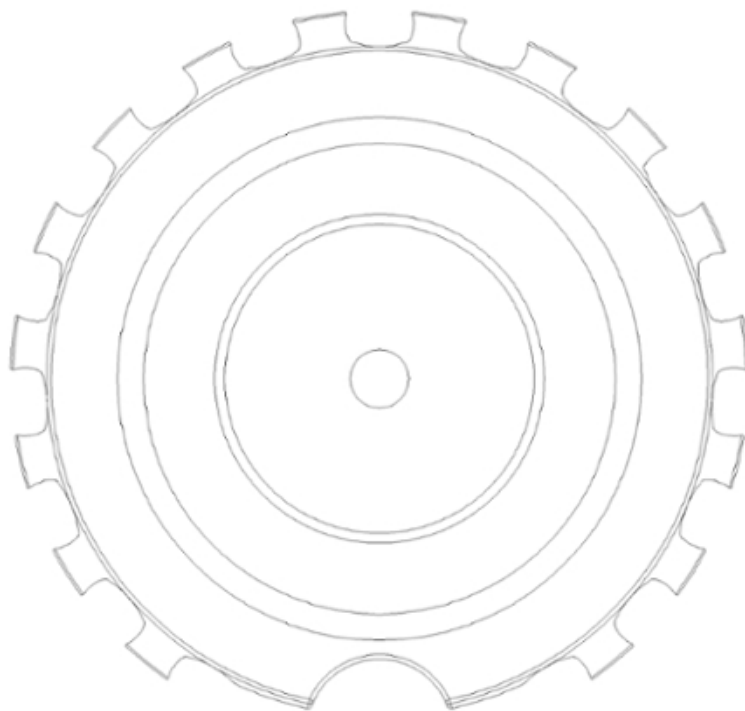

2.8

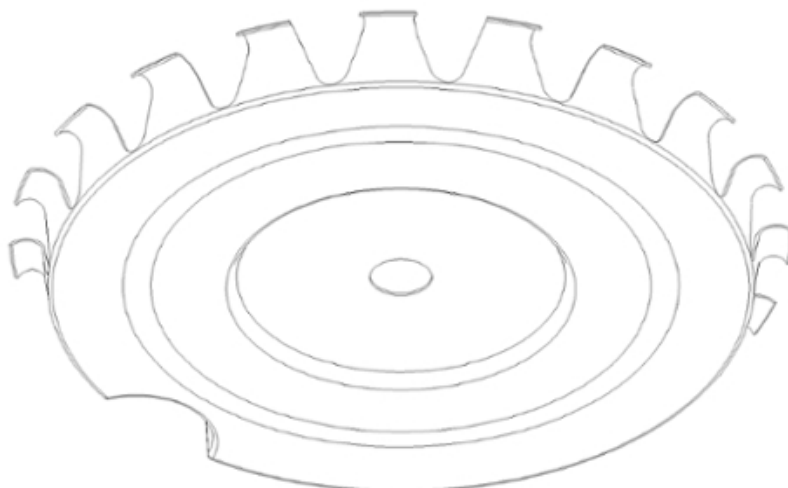

3.1

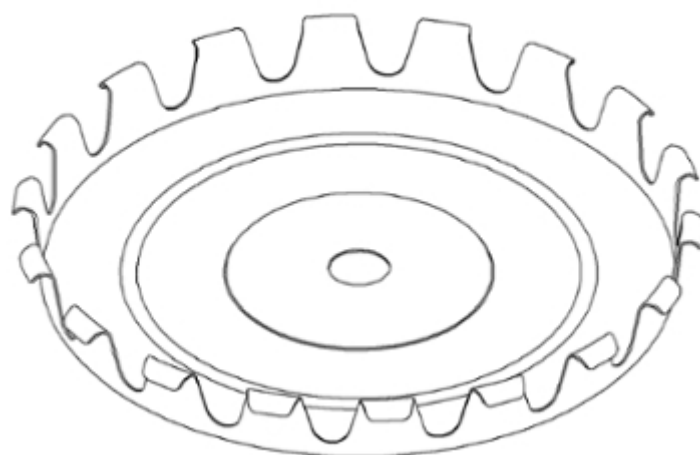

3.2



3.3



3.4



3.5

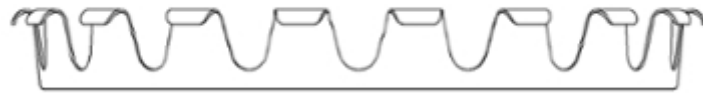

3.6

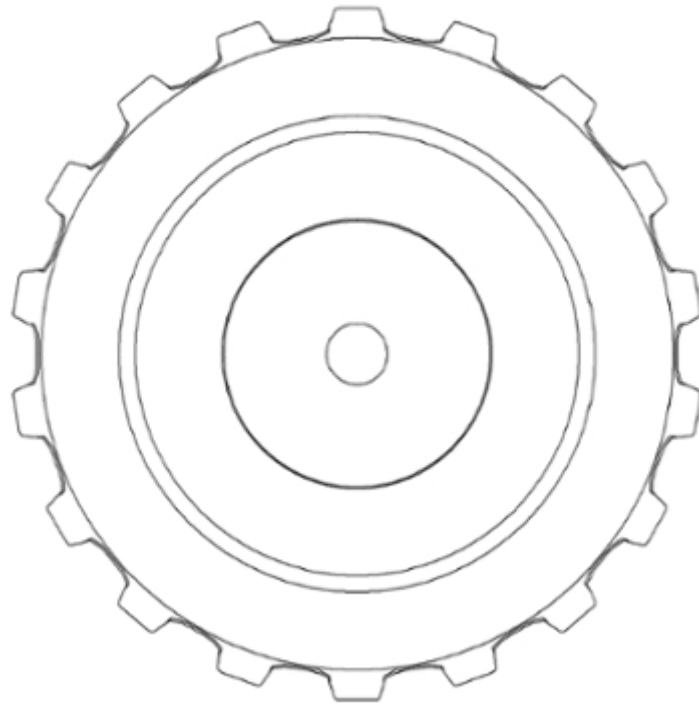

3.7

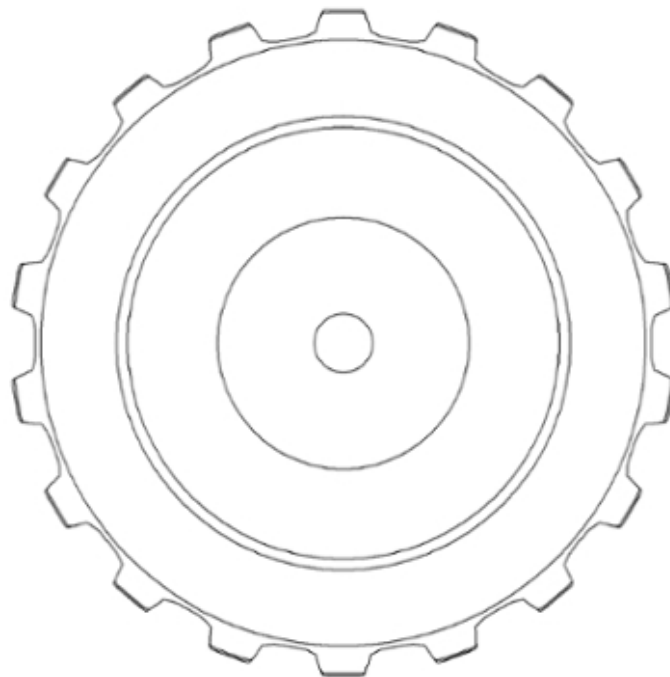

(11) DM/204 434

(51) 09-01

(15) 2018 12 14

(44) 49/2019 (2019 12 06)

(22) 2018 12 14

(28) 1

(73) CHRISTIAN LAURENT Sp. Z O.o.

Ul. Piękna 24/26A, 00-549 Warszawa (PL)

(85) –

(86) –

(87) –

(88) PL

(89) PL

(81) III. BA, GE, TR, UA, TN, HR, AZ, ME, SG, RU, EG

(54) 1. Packaging for cosmetics

(55)

1.1



1.2



1.3



- (11) **DM/102 706** (51) **10-07**
 (15) 2018 09 06 (44) 49/2019 (2019 12 06)
 (22) 2018 09 06
 (28) 6
 (73) TISSOT SA (Tissot AG) (Tissot Ltd)
 Chemin des Tourelles 17 Le Locle, CH-2400 (CH)
 (85) CH
 (86) CH
 (87) CH
 (88) CH
 (89) CH
 (81) III. AM, AL, AZ, ME, MD, SG, MN, BA, TR, MK, OM, GE, LI, KG, TN, EM, CH
 (72) 1-2 Fernando SOARES
 5 rue Fleury, 2000 Neuchâtel (CH);
 3-6 Sonia KAYA
 15 rue Girardet, 2400 Le Locle (CH);
 Patricia GONZALEZ
 11 Chemin de La Mère-Jeanne, 1242 Satigny (CH);
 Gilles HABEGGER
 1 rue de l'Oratoire, 2000 Neuchâtel (CH)
 (74) The Swatch Group AG (The Swatch Group SA) (The Swatch Group Ltd)
 Faubourg du Lac 6 Biel/Bienne, CH-2501 (CH)
 (46) 2019 12 06
 (54) 1.-4. Dials, 5.-6. Watch strap parts
 (55)

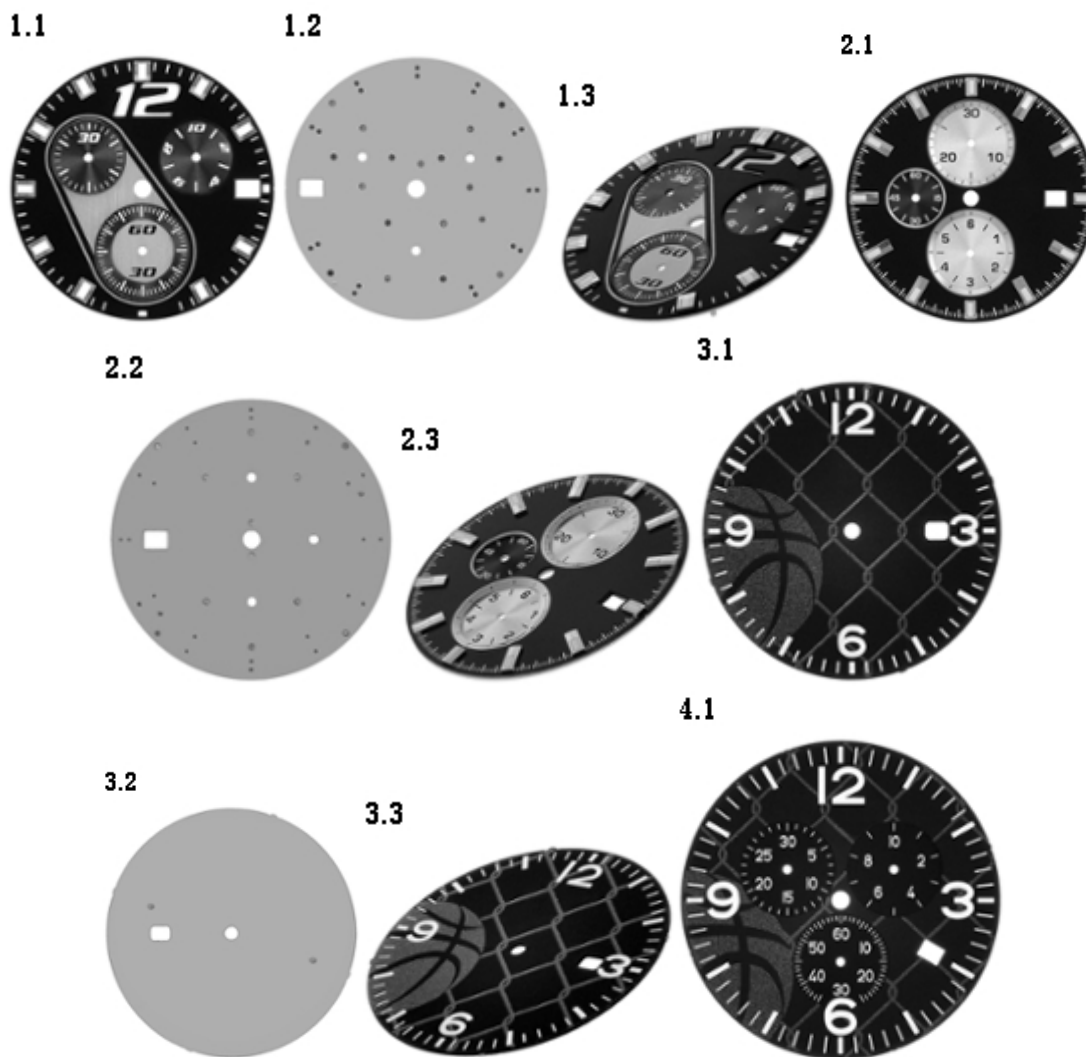

4.2

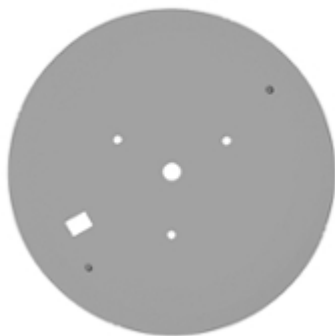

4.3



5.1

5.2

5.3



6.1

6.2

6.3

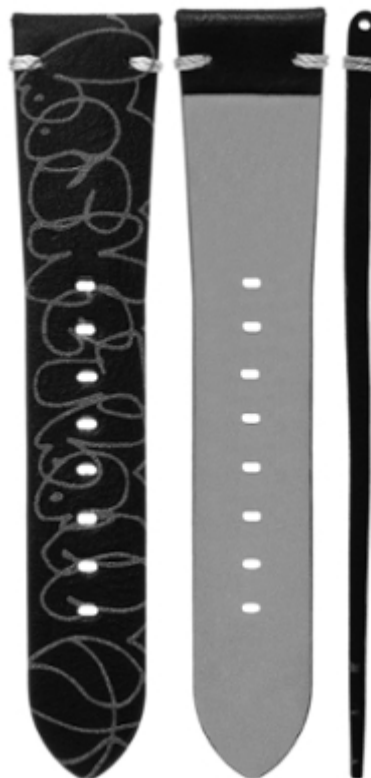

5.4



6.4



(11) DM/203 176

(15) 2019 06 03

(22) 2019 06 03

(28) 3

(73) HARRY WINSTON SA

Chemin Du Tourbillon 8, 1228 Plan-les-Ouates (CH)

(85) CH

(86) CH

(87) CH

(88) CH

(89) CH

(81) II. MA III. AM, MD, MN, TR, GB, TN, CH, UA, AL, AZ, ME, BZ, MC, SG, NO, BA, GE, MK, CA, OM, LI, KG, EM, RU

(72) Maurice GALLI

C/o Harry Winston Inc. 718 Fifth Avenue, 10019, New York (US)

(74) The Swatch Group AG (The Swatch Group SA) (The Swatch Group Ltd.)

Faubourg Du Lac 6, 2501 Biel/Bienne (CH)

(54) 1. Necklace, 2. Pair of earrings, 3. Ring

(55)

1.1

1.2



1.3



1.4



1.5



1.6



1.7



1.8



2.1



2.2



2.3



2.4



2.5



2.7

2.6

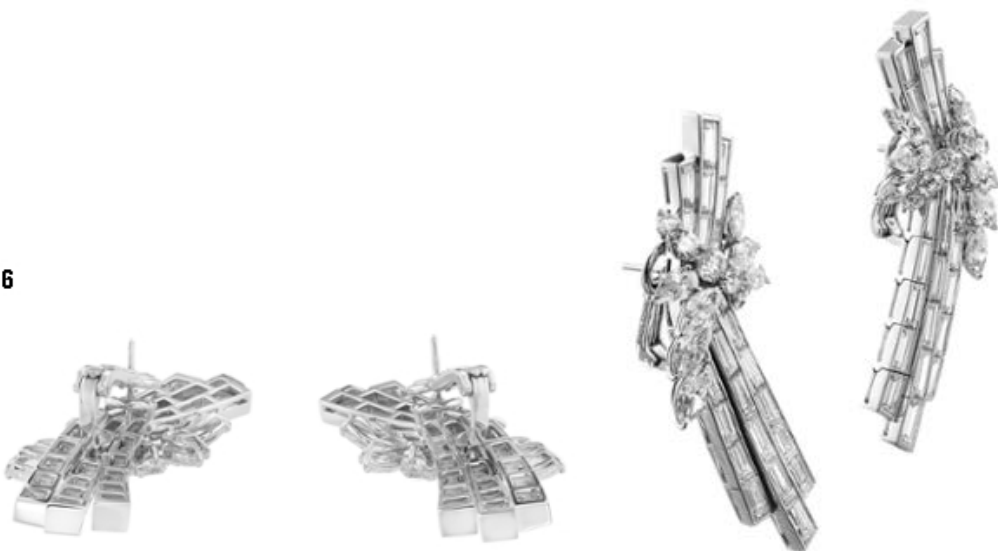

2.8



3.1



3.2



3.3



3.4



3.5



3.6



3.7



3.8



(11) DM/202 880

(15) 2019 06 07

(22) 2019 06 07

(28) 2

(73) HARRY WINSTON SA

Chemin Du Tourbillon 8, 1228 Plan-les-Ouates (CH)

(85) CH

(86) CH

(87) CH

(88) CH

(89) CH

(81) IL, MA, III, AM, MD, MN, TR, GB, TN, CH, UA, AL, AZ, BZ, ME, MC, SG, NO, BA, CA, GE, OM, MK, LI, KG, EM, RU

(72) 1 Chaeree KWON

C/o Harry Winston Inc. 718 Fifth Avenue, 10019, New York (US);

2 Dominique RIVIERE

C/o Harry Winston Inc. 718 Fifth Avenue, 10019, New York (US)

(74) The Swatch Group AG (The Swatch Group SA) (The Swatch Group Ltd.)

Faubourg Du Lac 6, 2501 Biel/Bienne (CH)

(54) 1.-2. Finger ring

(55)

(51) 11-01

(44) 50/2019 (2019 12 13)



1.1



1.2



1.3



1.4

1.5



1.6



1.7



1.8



2.1





2.2



2.3



2.4



2.5



2.6



2.7



2.8



2.9

(11) DM/203 042

(15) 2019 06 11

(22) 2019 06 11

(28) 1

(73) HARRY WINSTON SA

Chemin Du Tourbillon 8, 1228 Plan-les-Ouates (CH)

(85) CH

(86) CH

(87) CH

(88) CH

(89) CH

(81) II. MA III. AM, MD, MN, TR, GB, TN, CH, UA, AL, AZ, BZ, ME, MC, SG, NO, BA, MK, OM, CA, GE, LI, KG, EM, RU

(72) Rie YATSUGI-KANG

C/o Harry Winston Inc., 718 Fifth Avenue, 10019, New York (US)

(74) The Swatch Group AG (The Swatch Group SA) (The Swatch Group Ltd.)

Faubourg Du Lac 6, 2501 Biel/Bienne (CH)

(54) 1. Necklace

(55)

1.1**1.2****1.3**

1.4



1.5



1.6



1.7



1.8



(11) DM/204 564

(51) 20-02

(15) 2019 07 09

(44) 50/2019 (2019 12 13)

(22) 2019 07 09

(28) 1

(73) Any Pte. Ltd.

30 Cecil Street, #19-08 Prudential Tower, 049712 Singapore (SG)

(85) –

(86) SG

(87) –

(88) –

(89) SG

(81) III. ES, HU, IS, MN, PL, GB, LT, KR, JP, FR, BN, AL, LV, HR, TM, BZ, MC, SG, NA, DE, BA, MK, US, LI, KG, FI, RU, EG, AM, MD, TJ, BW, GH, ST, TR, KH, TN, KP, CH, UA, AZ, ME, SI, BX, OA, NO, RS, EE, OM, GE, CA, RO, SM, EM, DK, SY, RW, BG

(72) Olav Beruto

Millennium Residence 112/048 19 C2 Floor Tower B, Sukhumvit Soi 20, Klongtoei, 10110, Bangkok (TH)

(74) Aedificare Law Corporation

20 Collyer Quay N23-01, 049319 Singapore (SG)

(54) 1. Display unit

(55)

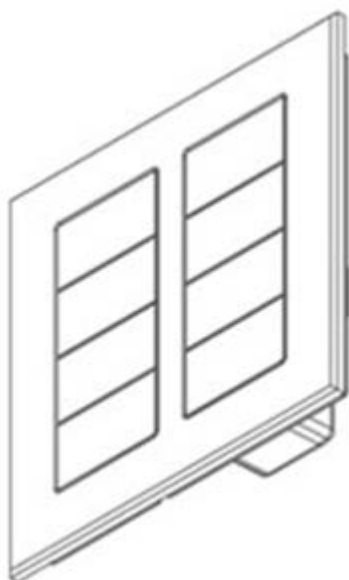

1.1

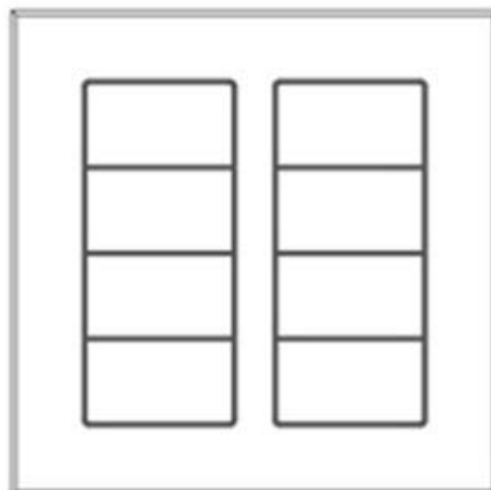

1.2

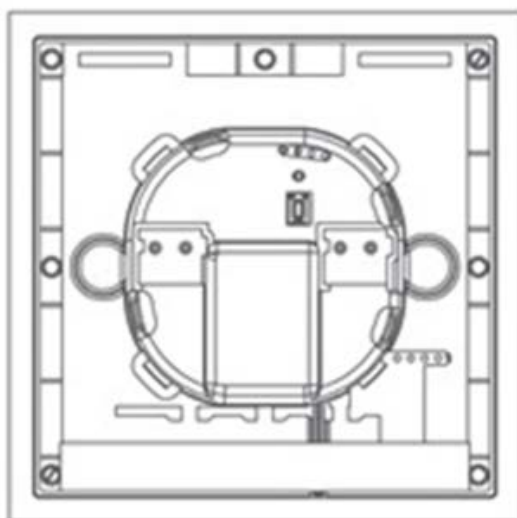

1.3

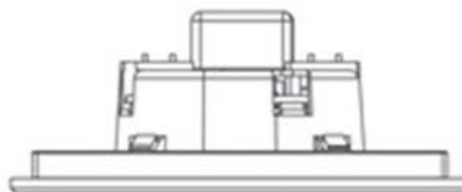

1.4

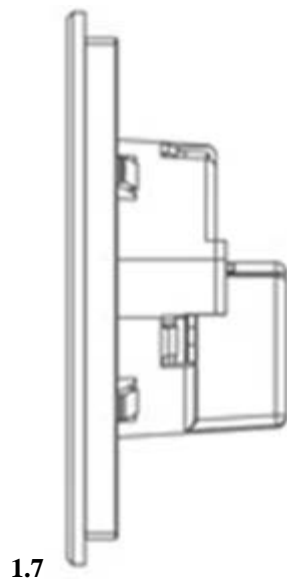
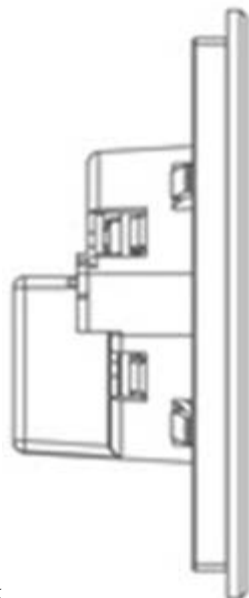
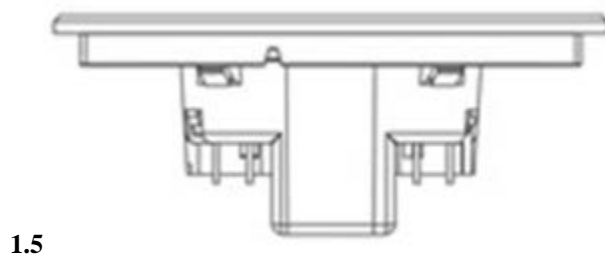

- (11) **DM/204 445** (51) **21-02**
(15) 2019 06 12 (44) 50/2019 (2019 12 13)
(22) 2019 06 12
(28) 1
(73) **TECNOCOMPONENT SRL**
Via Fossalta, 3895, I-47522 CESENA (FC) (IT)
(85) EM
(86) IT, EM
(87) IT, EM
(88) IT, EM
(89) EM
(81) III. US, TR, GE, MD, JP, RU
(72) **LUCA BETTINI**
Via Fossalta, 3895, I-47522, Cesena (FC) (IT)
(74) **APTA S.R.L.**
Piazza Dei Martiri, 1, I-40121 Bologna (BO) (IT)
(54) 1. Ring stretch band for physical exercise
(55)

1



(11) DM/204 906

(15) 2019 11 22

(22) 2019 11 22

(28) 1

(73) Valentino S.p.A.

Via Turati, 16/18, 20121 Milan (IT)

(85) –

(86) IT, EM

(87) IT,EM

(88) IT, EM

(89) EM

(81) III. GE, US, TR, KG, UA, AZ, EM, KR, TJ, JP, RU

(72) Stefano Sassi

c/o Valentino S.p.A., Via Turati, 16/18, 20121, Milan (IT)

(74) Matteo Mozzi

c/o Jacobacci & Partners S.p.A., Via Senato, 8, 20121 Milan (IT)

(54) 1. Shoe

(55)

(51) 02-04

(44) 51/2019 (2019 12 20)



1.1



1.2

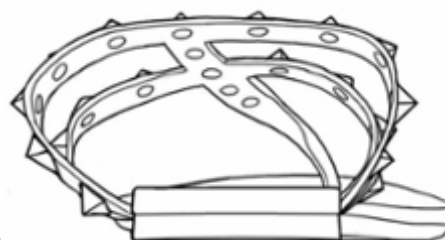

1.3



1.4

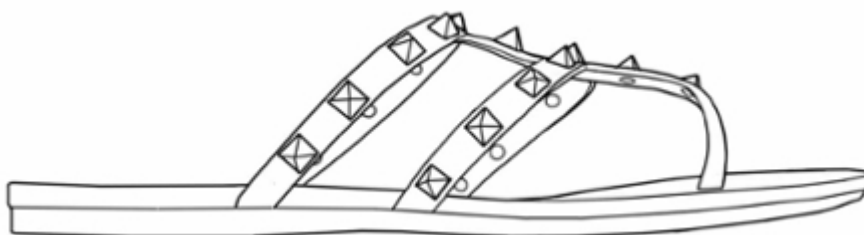

1.5

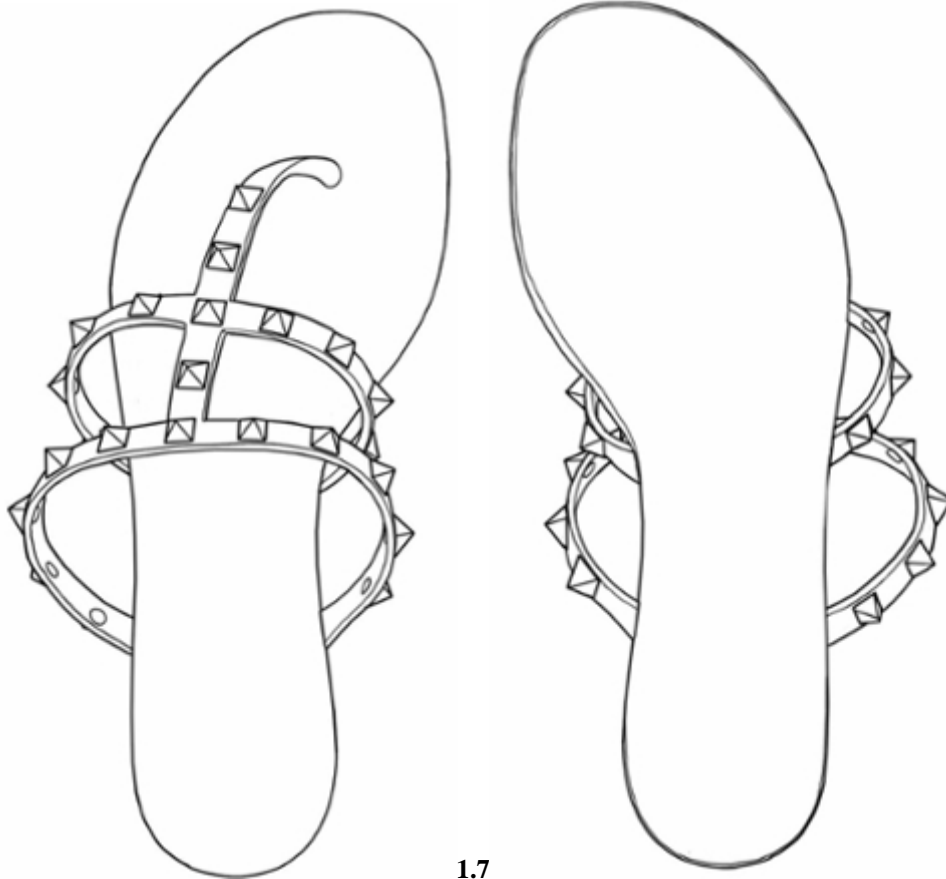

1.6

1.7

(11) DM/204 894

(15) 2019 11 22

(22) 2019 11 22

(28) 1

(73) Valentino S.p.A.

Via Turati, 16/18, 20121 Milan (IT)

(85) –

(86) IT, EM

(87) IT, EM

(88) IT, EM

(89) EM

(81) III. US, TR, GE, KG, UA, AZ, EM, KR, JP, TJ, RU

(72) Stefano Sassi

c/o Valentino S.p.A., Via Turati, 16/18, 20121, Milan (IT)

(74) Matteo Mozzi

c/o Jacobacci & Partners Spa, Via Senato, 8, 20121 Milan (IT)

(54) 1. Bag

(55)

(51) 03-01

(44) 51/2019 (2019 12 20)

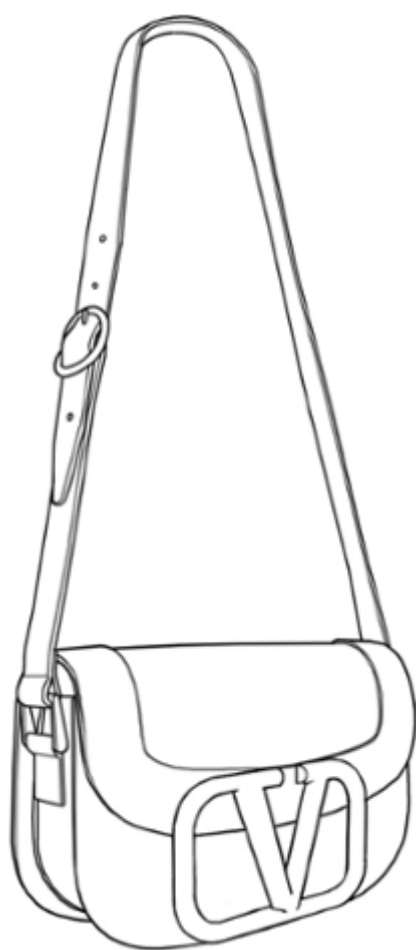

1.1



1.2

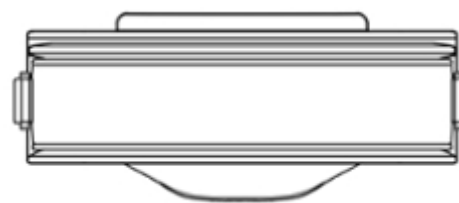
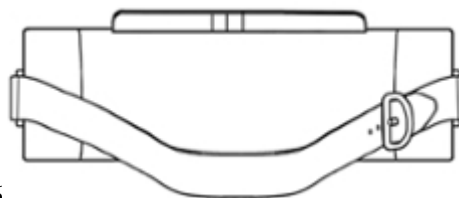

(11) DM/204 879

(15) 2019 10 10

(22) 2019 10 10

(28) 2

(73) COGNAC FERRAND

4 RUE DE SAINT-PÉTERSBOURG, 75008 PARIS (FR)

(85) FR

(86) FR

(87) FR

(88) FR

(89) FR

(81) III. AM, IS, MD, TJ, MN, TR, GB, KR, JP, CH, UA, AL, AZ, TM, ME, MC, SG, RS, NO, GE, CA, MK, LI, KG, EM, RU, EG

(72) IVAN BELL

AGENCE STRANGER & STRANGER 161 Rosebery Avenue, EC1R 4QX, LONDON, (GB)

(74) IPSILON LE CENTRALIS

63, Avenue Du Général Leclerc, 92340 BOURG LA REINE (FR)

(54) 1.-2 Bottle

(55)

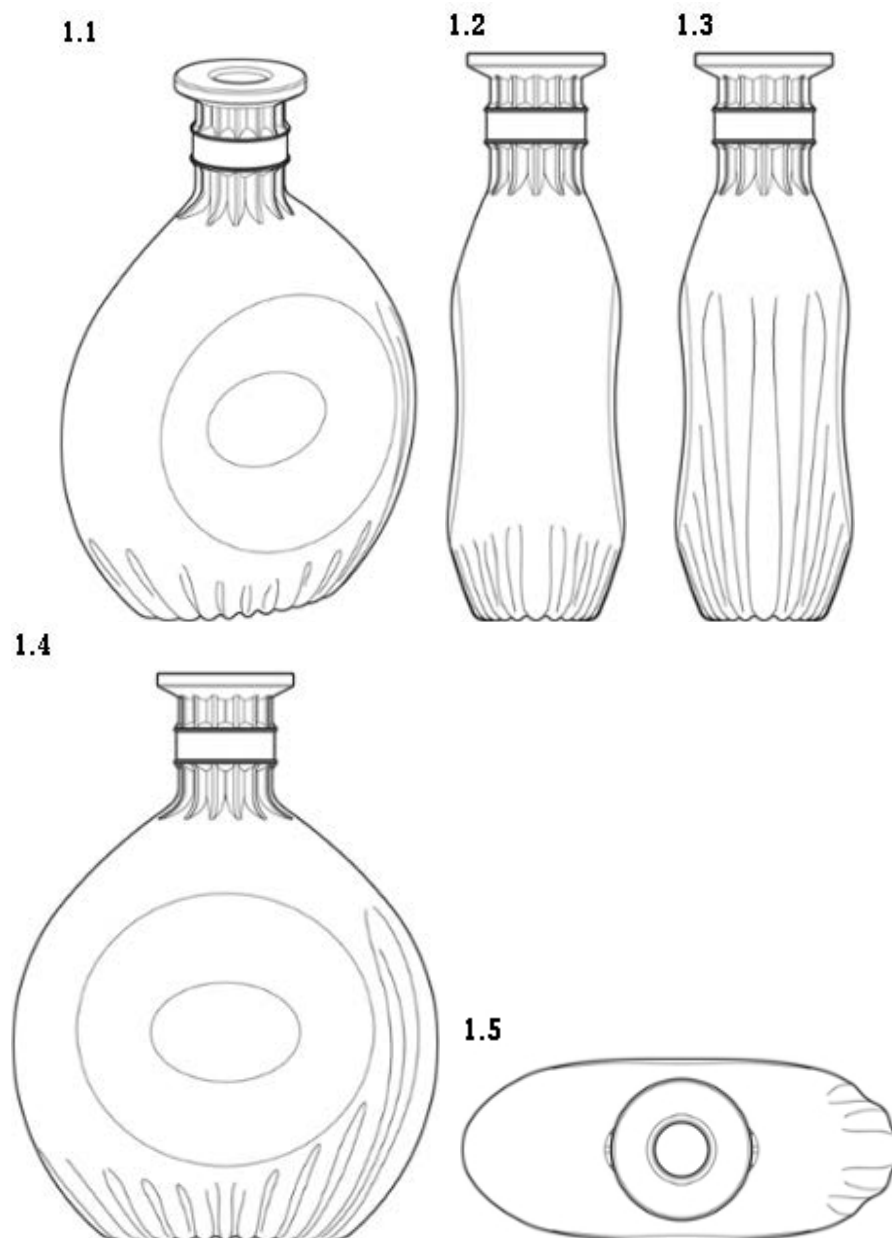

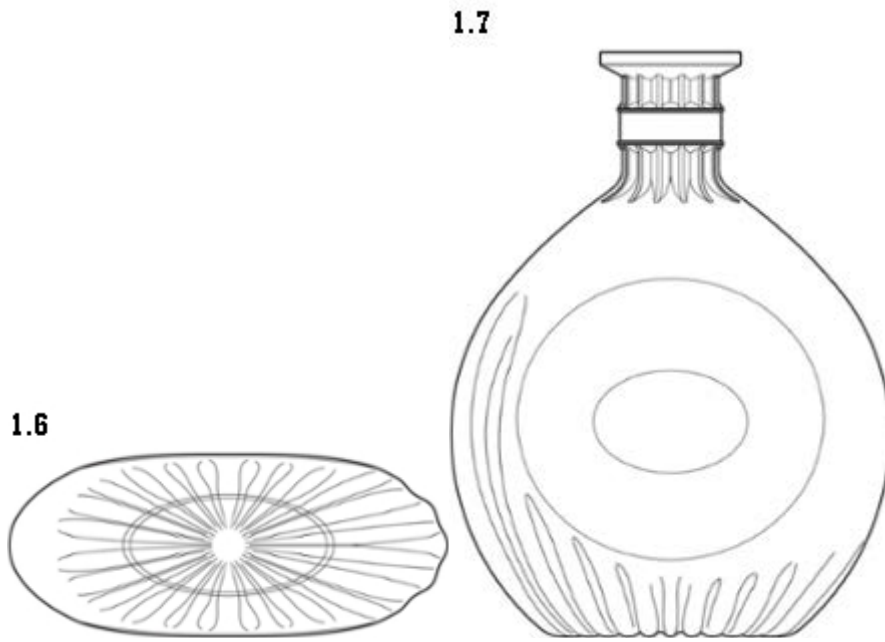

2.4



2.5

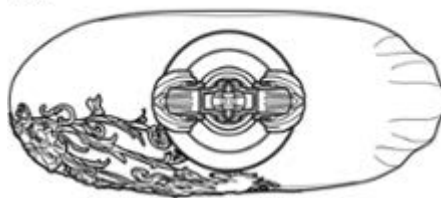

2.7



2.6

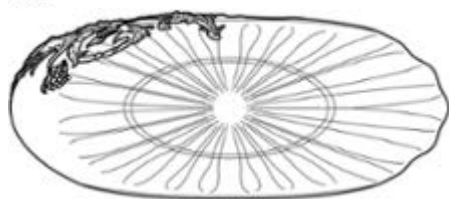

(11) DM/204 908

(15) 2019 10 04

(22) 2019 10 04

(28) 2

(30) No1: 04.04.2019; 006370664_01; EM; No2: 04.04.2019; 006370664_02; EM

(73) McPhy Energy Italia Società A Responsabilità Limitata

Via Ayrton Senna, 22, 56028 San Miniato, (PI) (IT)

(85) EM

(86) IT

(87) IT

(88) IT

(89) EM

(81) II. MA III. UA, AL, ME, RS, EE, BA, GE, US, CA, TR, TN, JP, CH, FI, RU, EG

(72) Davide RASTELLI

31, Via Benedetto Dei, 50127, Florence (IT)

(74) Marco CELESTINO

ABM Agenzia Brevetti & Marchi S.r.l., viale Giovanni Pisano 31, 56123 Pisa (IT)

(54) 1.-2. Electrolytic generator

(55)

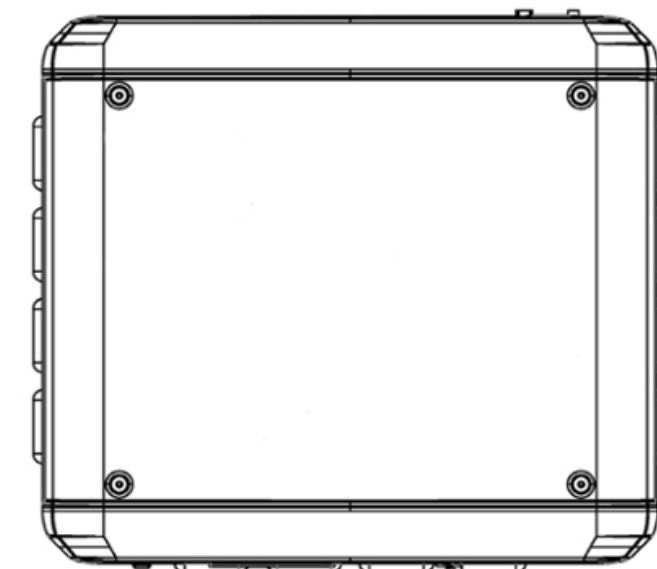

1.1

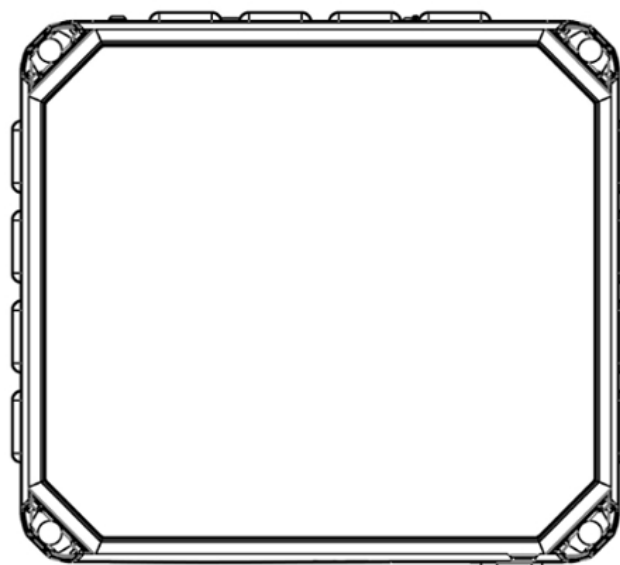

1.2

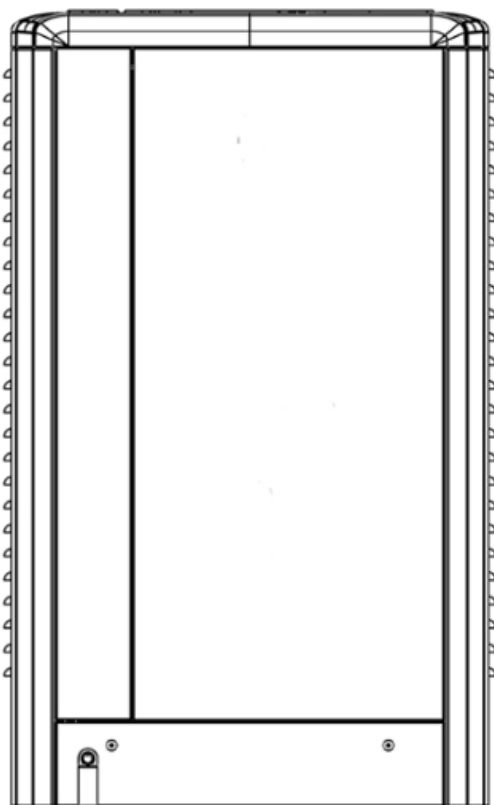

1.3

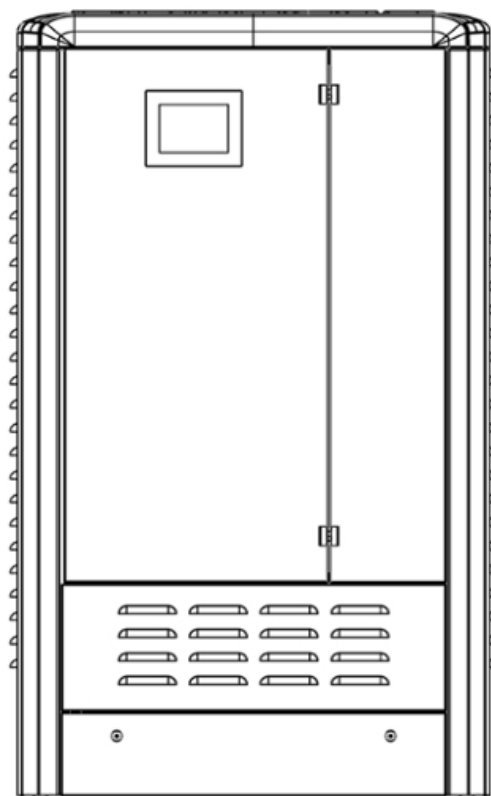

1.4

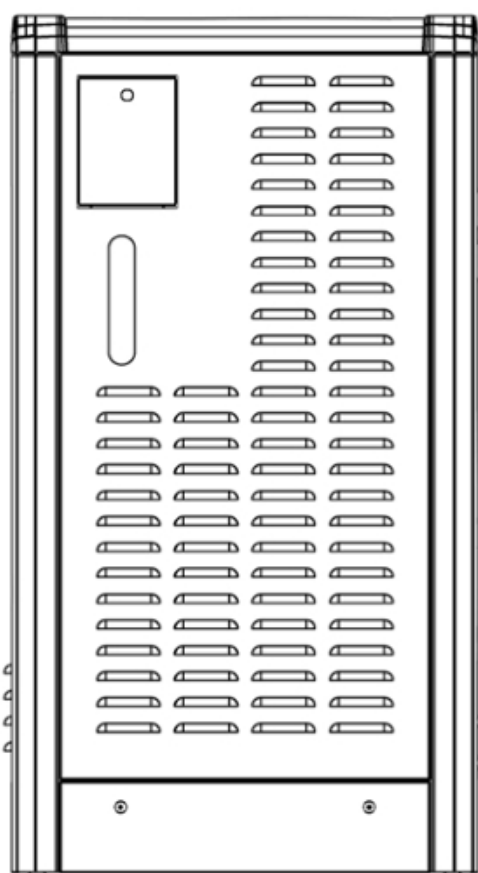

1.5

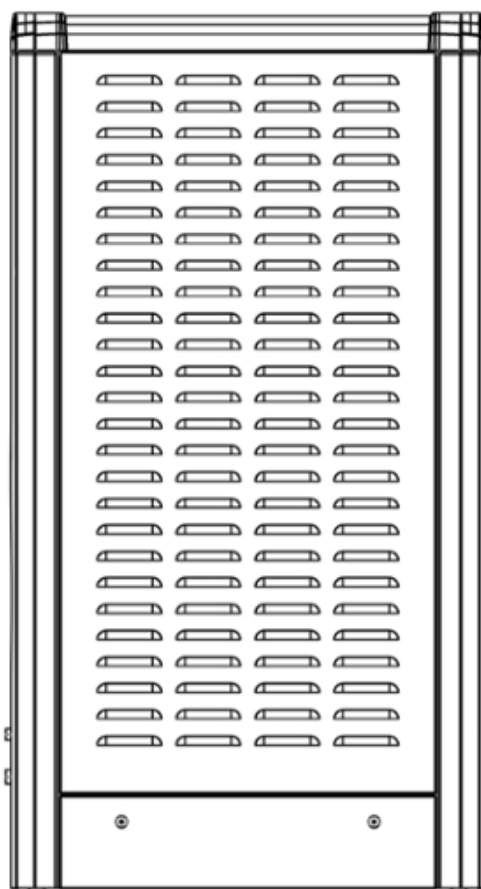

1.6

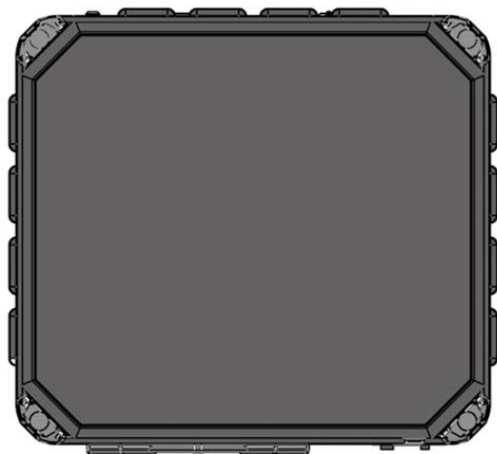

2.1

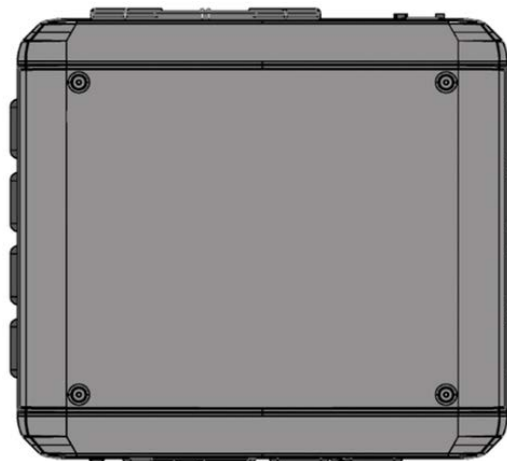

2.2

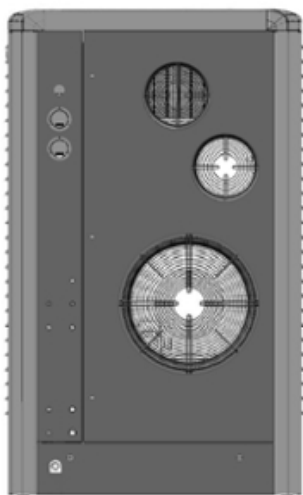

2.3

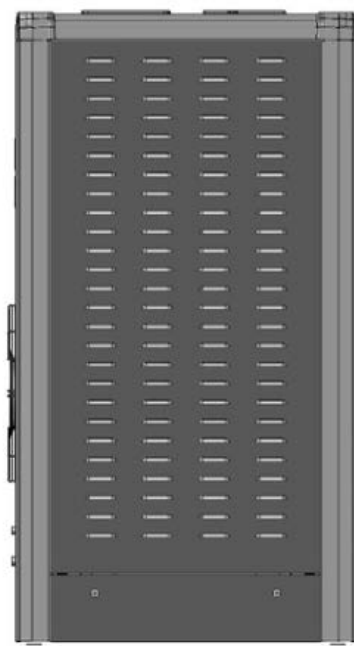

2.4



2.5

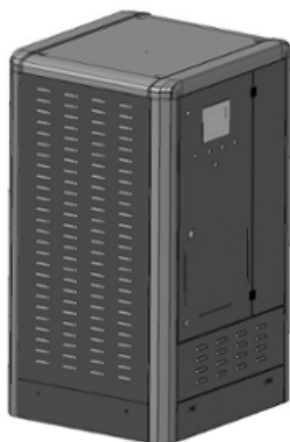

2.6

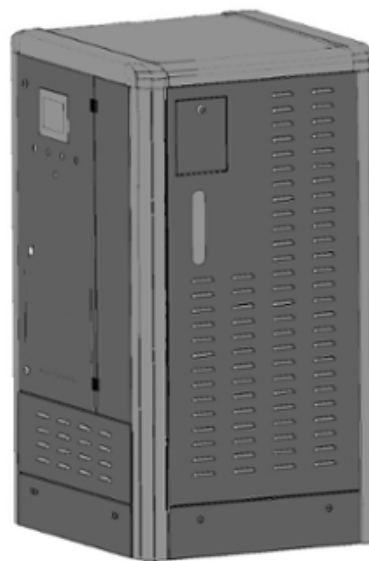

2.7

(11) DM/204 853

(15) 2019 02 06

(22) 2019 02 06

(28) 1

(30) No1: 07.08.2018; 201814675; AU

(73) Traitel Technologies Corporation

3422 Old Capitol Trail, 19801 Wilmington, Delaware (US)

(85) –

(86) –

(87) –

(88) US

(89) US

(81) III. ES, HU, IS, MN, PL, GB, LT, KR, JP, BN, FR, AL, LV, HR, TM, MC, SG, NA, DE, BA, MK, US, LI, KG, FI, RU, EG, AM, MD, TJ, BW, GH, ST, TR, KH, TN, CH, KP, UA, AZ, ME, SI, BX, OA, RS, NO, EE, CA, OM, GE, RO, SM, EM, DK, SY, RW, BG

(72) Eli M. Traitel

Level 6, 757 Elizabeth Street, 2017, Zetland NSW (AU)

(74) Erickson Law Group PC

1749 S. Naperville Rd., 60189 Wheaton, Illinois (US)

(54) 1. Computing device

(55)

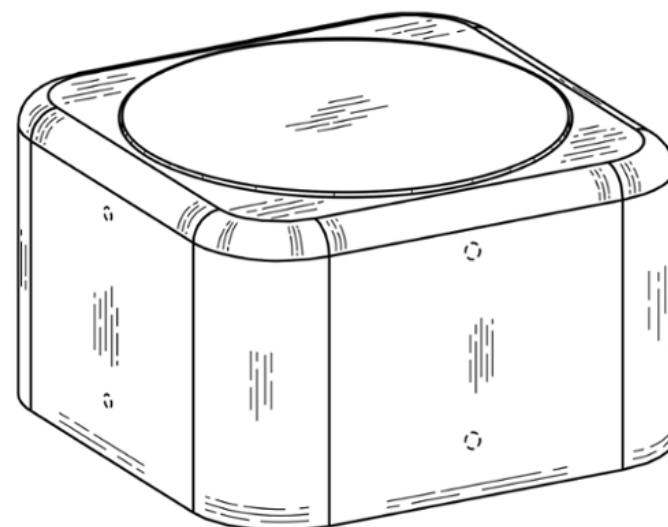

1.1

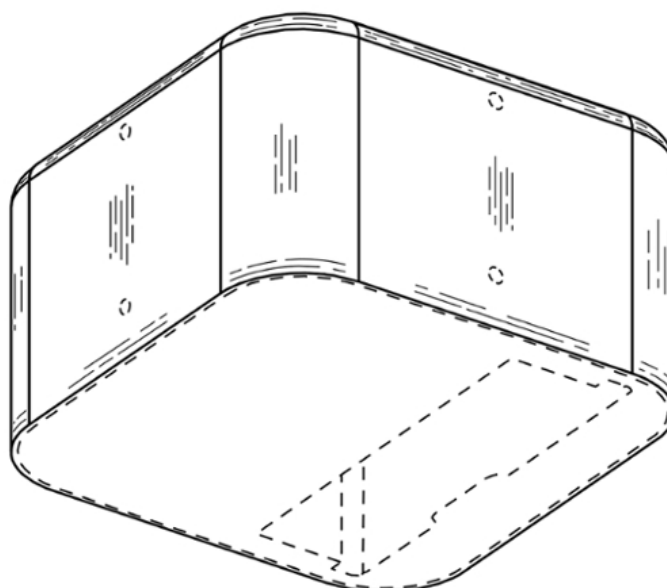

1.2

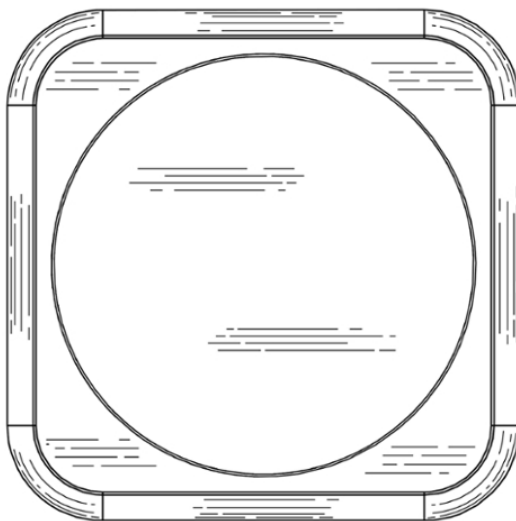

1.3

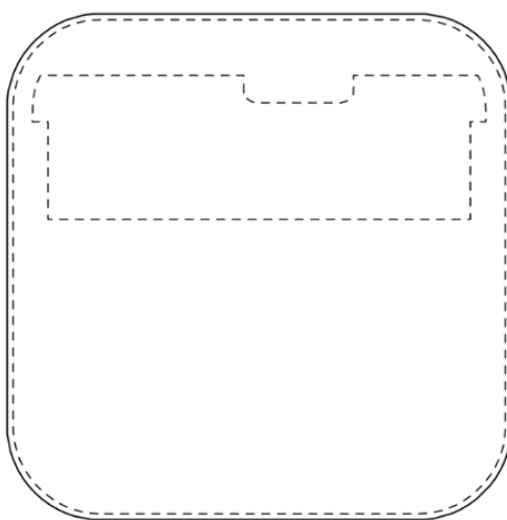

1.4

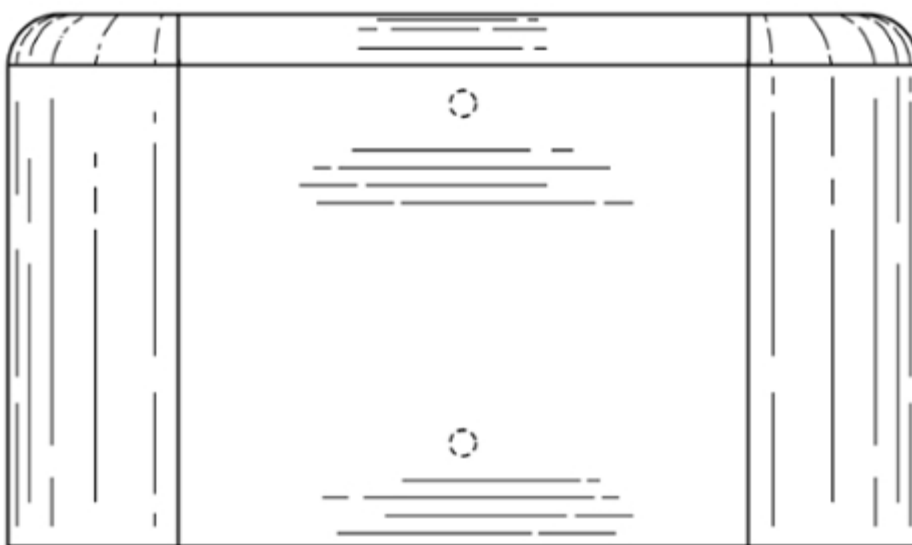

1.5

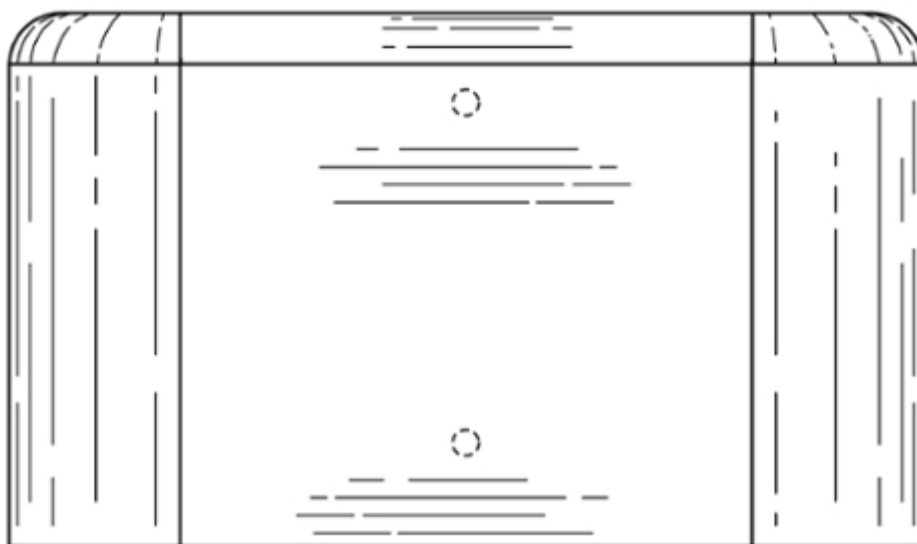

1.6

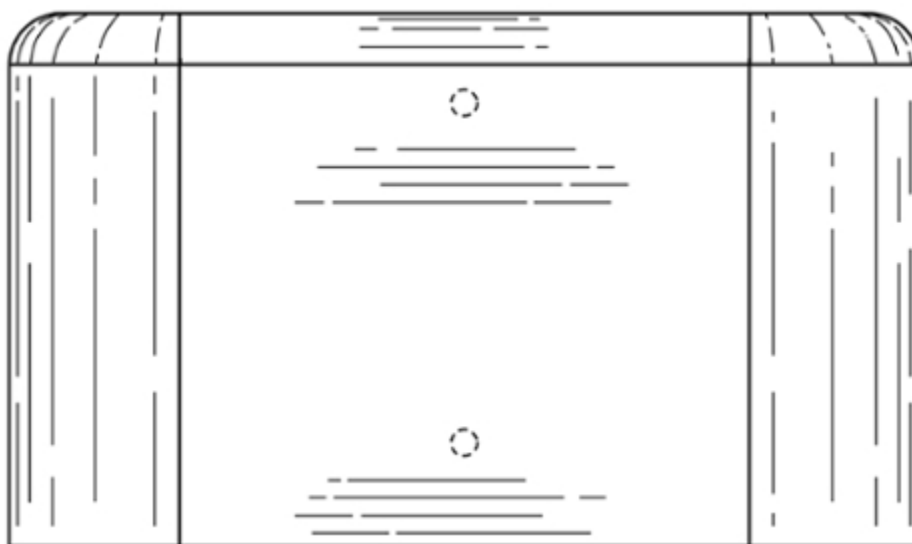

1.7

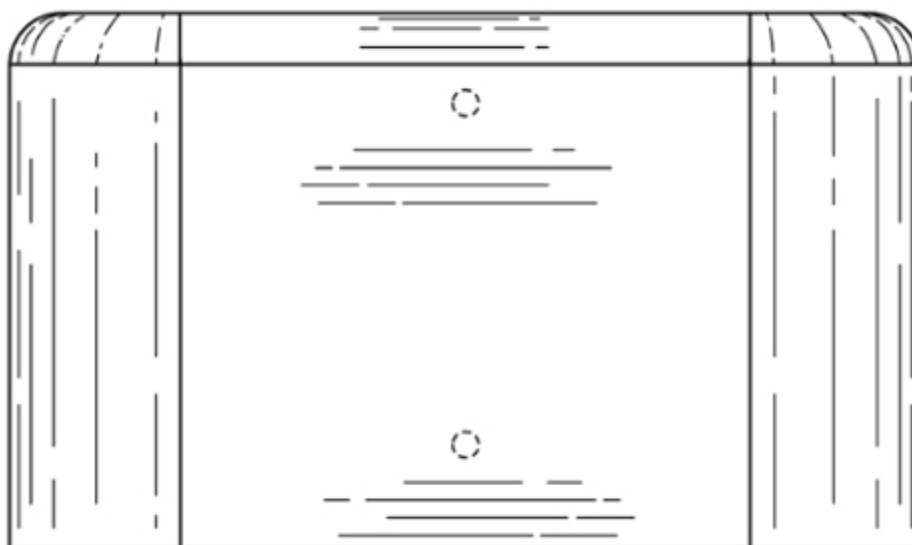

1.8

(11) DM/204 917

(15) 2019 01 31

(22) 2019 01 31

(28) 2

(73) BUDMAT Bogdan Wiecek

ul. Otolińska 25, 09-407 Plock (PL)

(85) PL

(86) PL

(87) PL

(88) PL

(89) PL

(81) III. NO, CA, GE, US, AM, KG, GB, EM, CH, RU

(72) Bogdan Wiecek

ul. Otolinska 25, 09-407, Plock (PL)

(74) Wojciech Zielinski

Armii Polskiej 18/5, 66-400 Gorzow Wielkopolski (PL)

(54) 1.-2. Ridge tile

(55)

(51) 25-02

(44) 51/2019 (2019 12 20)

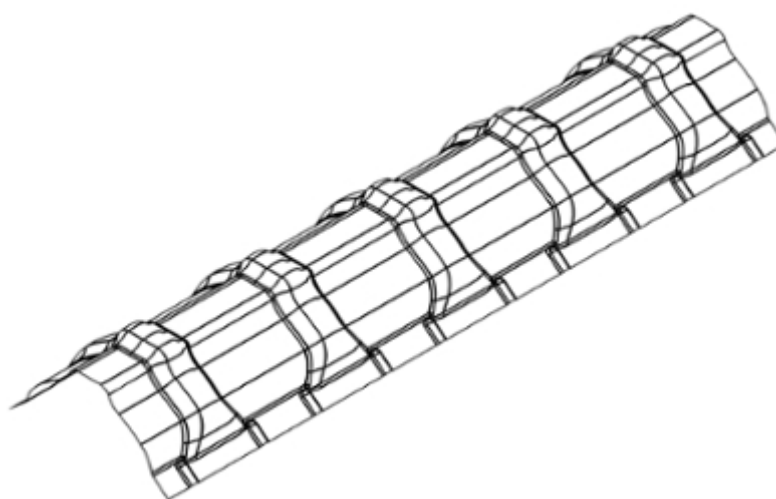

1.1

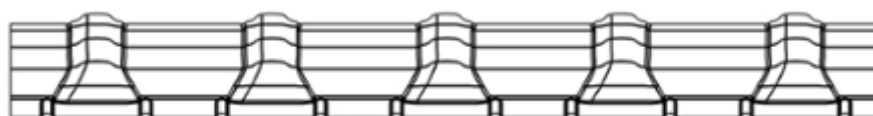

1.2

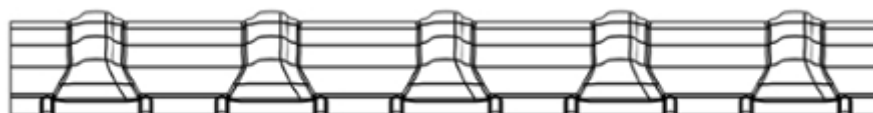

1.3

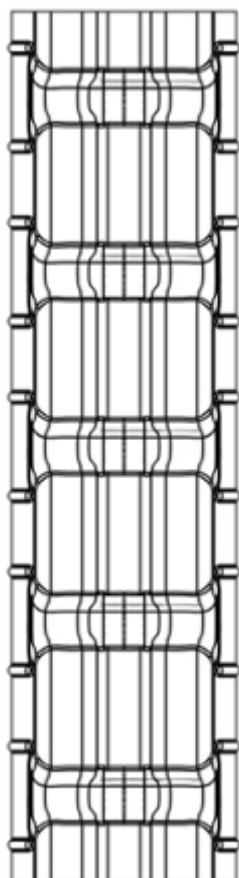

1.4

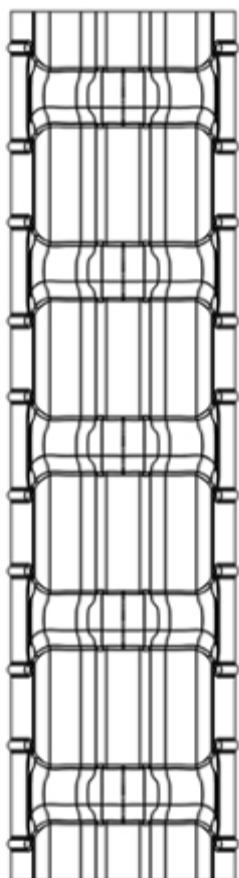

1.5

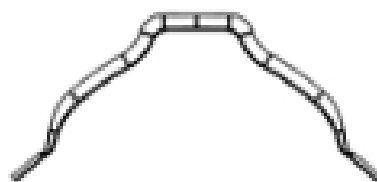

1.6

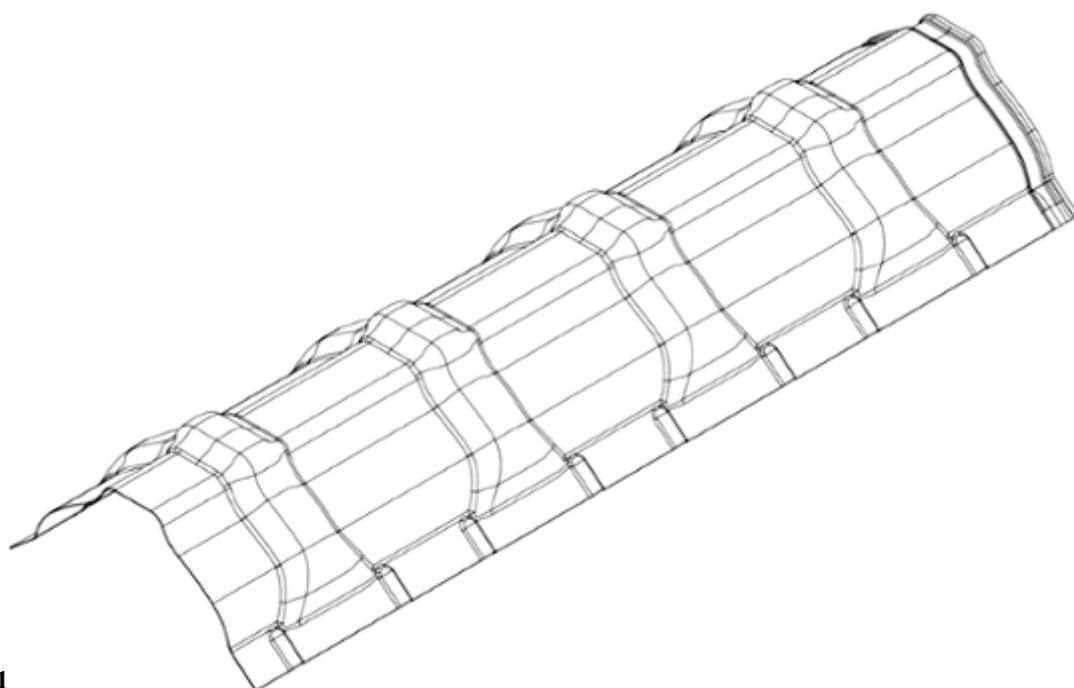

2.1

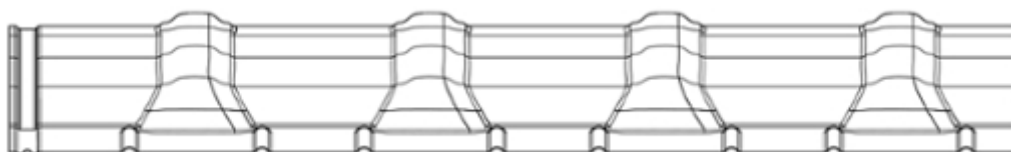

2.2

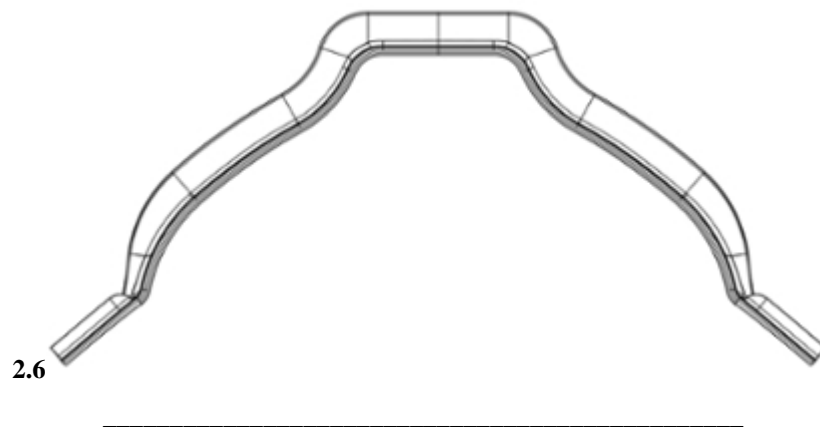
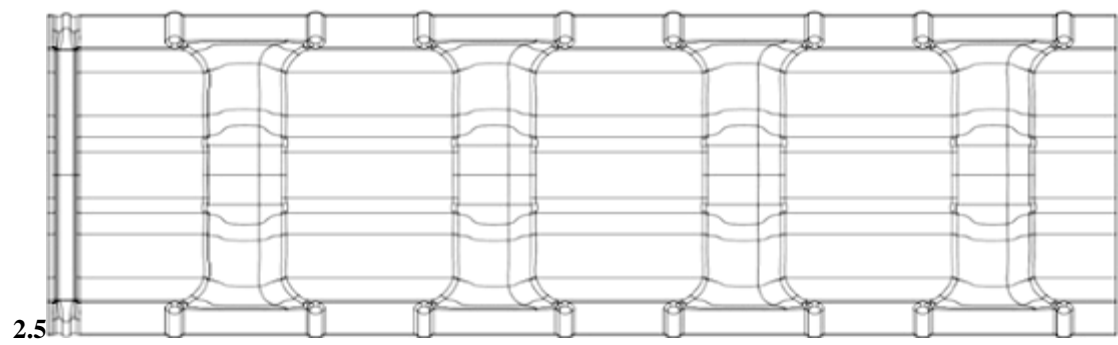
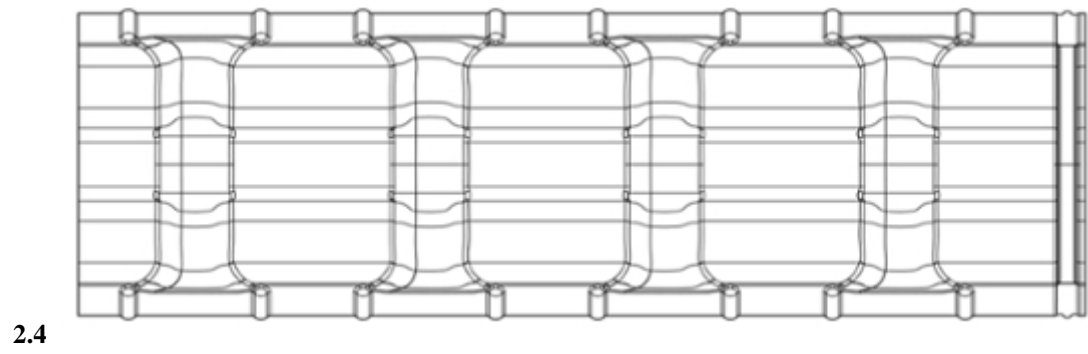
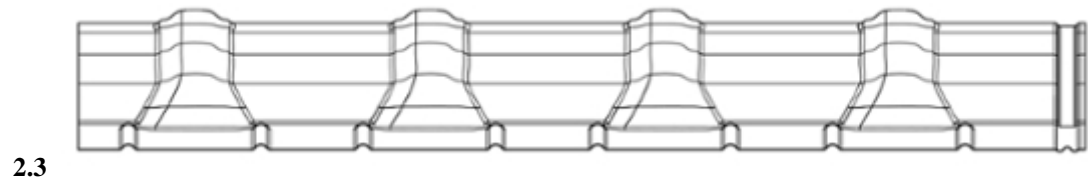

(11) DM/204 914

(15) 2019 11 18

(22) 2019 11 18

(28) 3

(30) No1: 16.05.2019; 144708; CH; No2: 16.05.2019; 144708; CH; No3: 16.05.2019; 144708; CH

(73) Hugo Schumacher GmbH

Schützenweg 14, 4542 Luterbach (CH)

(85) CH

(86) CH

(87) CH

(88) CH

(89) CH

(81) III. AM, AL, AZ, ME, BZ, MD, SG, OA, RS, NO, BA, US, TR, GE, CA, MK, LI, GB, EM, KR, JP, RU

(72) Hugo Schumacher

Schützenweg 14, 4542, Luterbach (CH)

(74) Schluep | Degen Attorneys-at-Law

Falkenplatz 7 P.O. Box, 3001 Bern (CH)

(54) 1.-2. House, 3. Building complex

(55)

(51) 25-03

(44) 51/2019 (2019 12 20)

1.1



1.2



2.1



2.2



3.1



3.2



(11) DM/205 048

(15) 2019 12 11

(22) 2019 12 11

(28) 1

(73) Valentino S.p.A

Via Turati 16/18, 20121 Milano (IT)

(85) –

(86) IT, EM

(87) IT, EM

(88) IT, EM

(89) EM

(81) III. TR, GE, US, UA, KG, AZ, EM, KR, TJ, JP, RU

(72) Stefano Sassi

C/o Valentino S.p.A., Via Turati 16/18, 20121, Milano (IT)

(74) Salvatore Giovanni Pennacchio

C/o Jacobacci & Partners, Via Senato, 8, 20121 Milano (IT)

(54) 1. Shoe

(55)

(51) 02-04

(44) 52/2019 (2019 12 27)



1.1



1.2



1.3

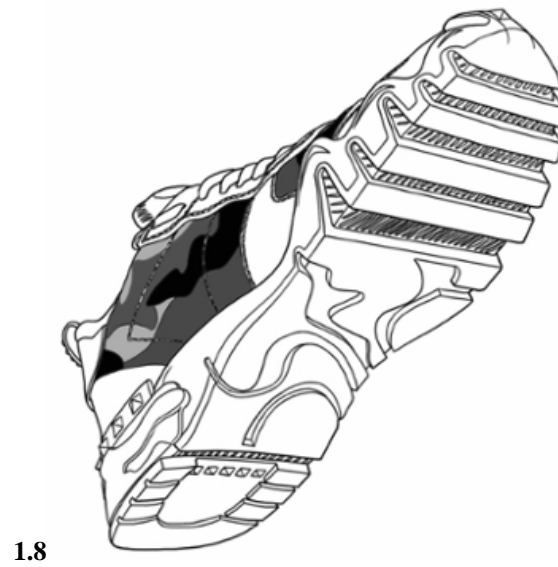
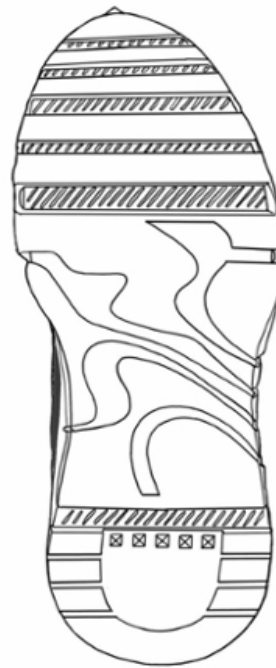
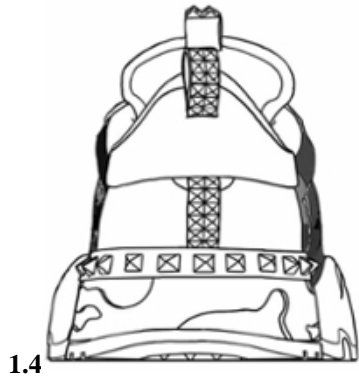

(11) DM/204 975

(51) 07-02

(15) 2019 04 19

(44) 52/2019 (2019 12 27)

(22) 2019 04 19

(28) 5

(73) FEMAF METAL SANAYİ VE TİCARET ANONİM ŞİRKETİ

Organize Sanayi Bölgesi 9. Cad. No: 17 Melikgazi, 38070 Kayseri (TR)

(85) TR

(86) TR

(87) TR

(88) TR

(89) TR

(81) III. AM, IS, MD, TJ, BW, GH, ST, MN, PL, TN, CH, UA, BN, AL, AZ, TM, ME, MC, SG, NA, OA, RS, NO, BA, OM, GE, LI, KG, EM, RW

(72) ALİ ERKAN MAMUR

LEFKOŞE CAD. NM OFİS PARK B BLOK NO:36/5 BEŞEVLER NİLÜFER BURSA (TR)

(74) DESTEK PATENT ANONİM ŞİRKETİ

LEFKOŞE CAD. NM OFİS PARK B BLOK NO:36/5 BEŞEVLER NİLÜFER BURSA (TR)

(54) 1.-5. Cooking hob

(55)

1.1



1.2



1.3

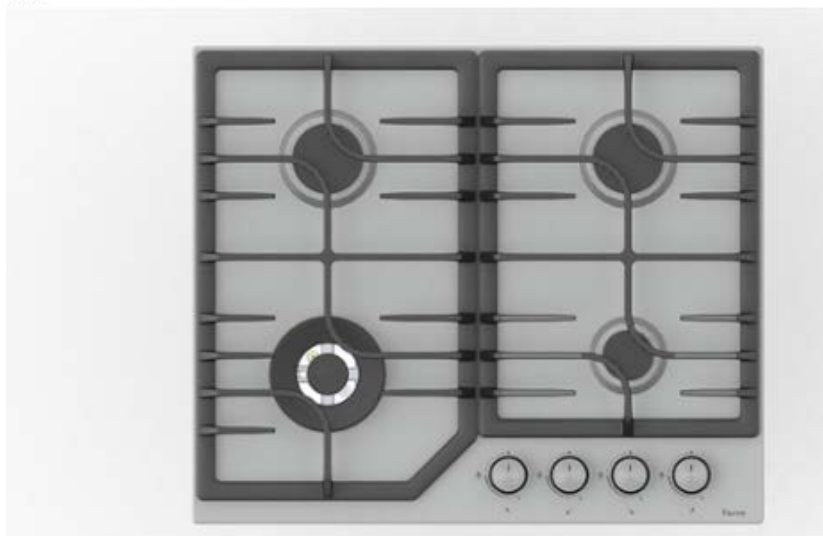

1.4



2.1

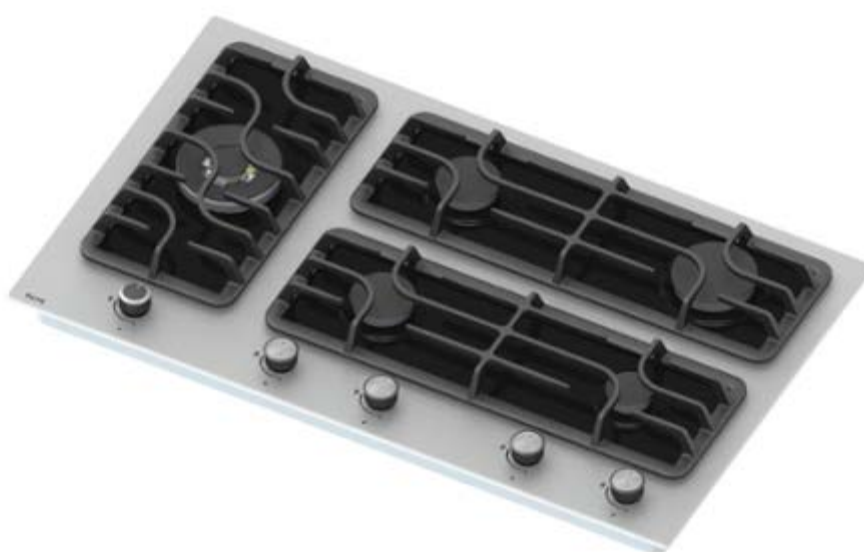

2.2



2.3

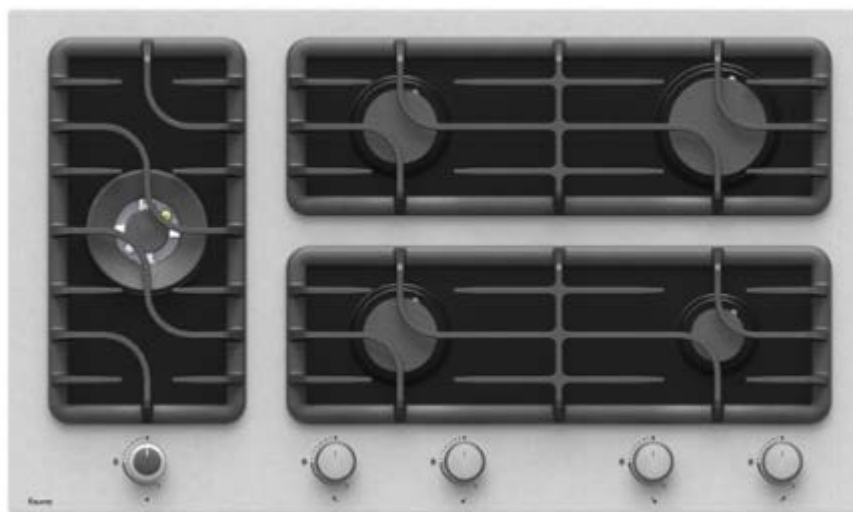

2.4

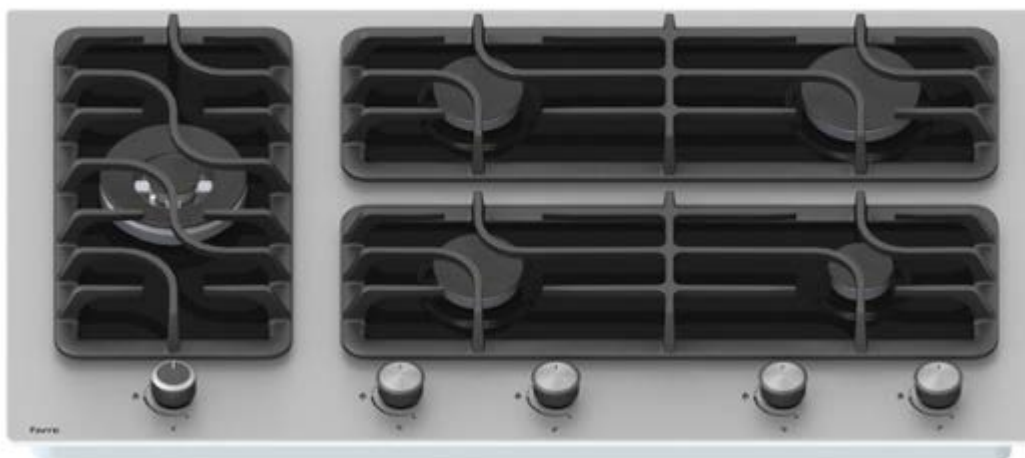

3.1

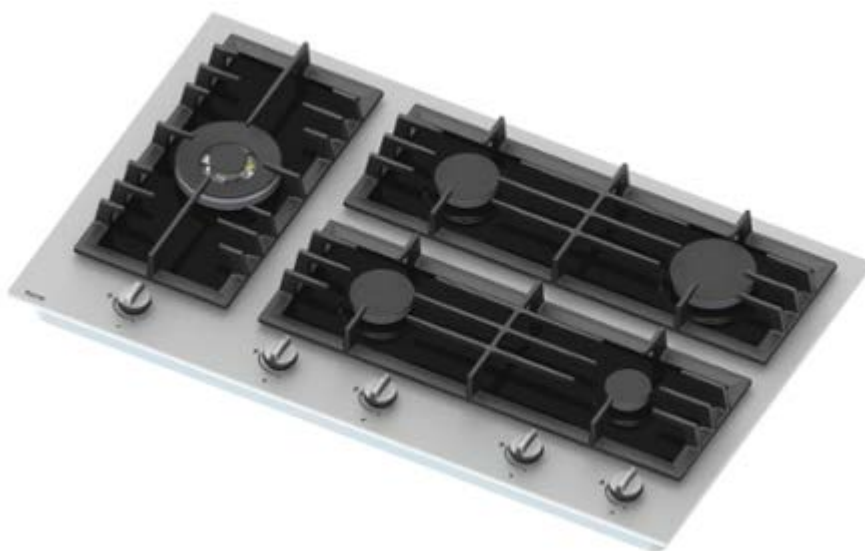

3.2



3.3

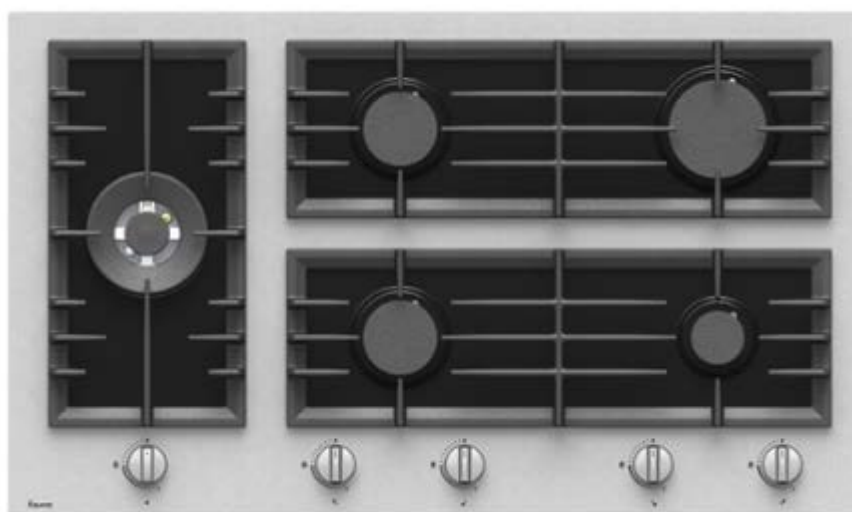

3.4

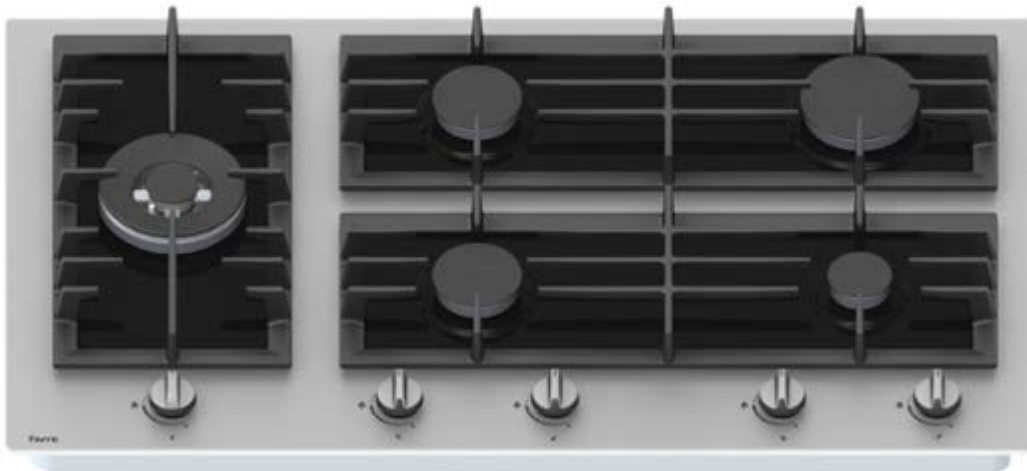

4.1



4.2

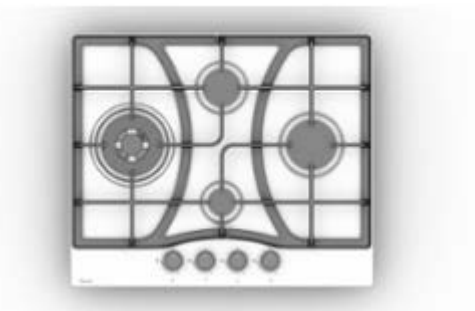

4.3



4.4

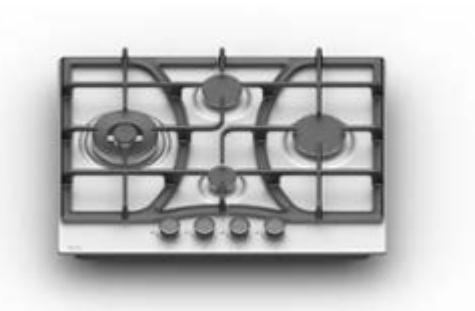

5.1

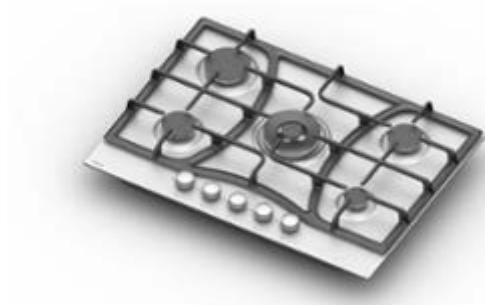

5.2



5.3

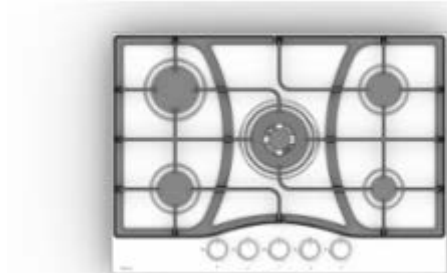

5.4



(11) DM/205 062

(15) 2019 07 01

(22) 2019 07 01

(28) 20

(73) FEMAF METAL SANAYİ VE TİCARET ANONİM ŞİRKETİ

Organize Sanayi Bölgesi 9. Cad. No: 17 Melikgazi, 38070 Kayseri (TR)

(85) TR

(86) TR

(87) TR

(88) TR

(89) TR

(81) III. AM, UA, AL, AZ, TM, ME, MD, BX, TJ, MC, SG, OA, RS, BA, OM, GE, MK, KG, TN, EM, CH

(72) ALİ ERKAN MAMUR

Organize Sanayi Bölgesi 9. Cadde No:17 Melikgazi, 38070, Kayseri (TR)

(74) DESTEK PATENT ANONİM ŞİRKETİ

LEFKOŞE CAD. NM OFİS PARK B BLOK NO:36/5 BEŞEVLER NİLÜFER BURSA (TR)

(54) 15.-20. Knob for cook tops, 1.-5. Grate for gas burners, 6. Grates for gas burners,

7.-8. Grate for gas burners, 9.-14. Cook top

(55)

1.1

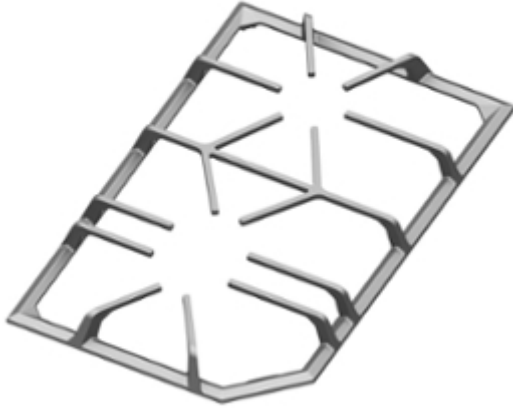

1.2

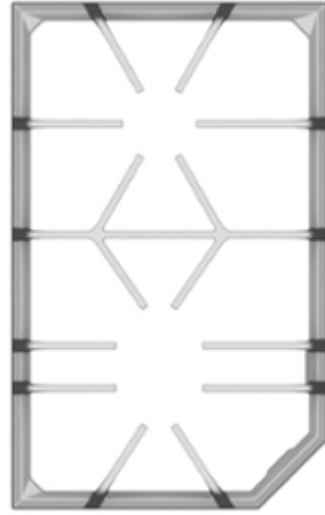

1.3



2.1



2.2

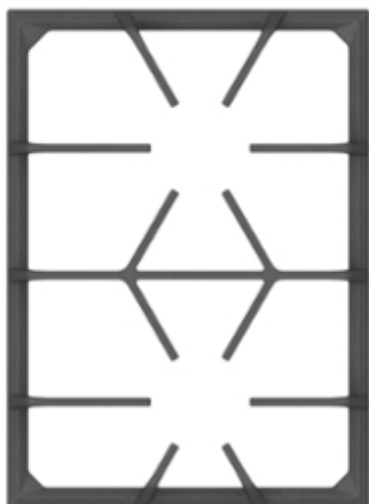

2.3



3.1



3.2

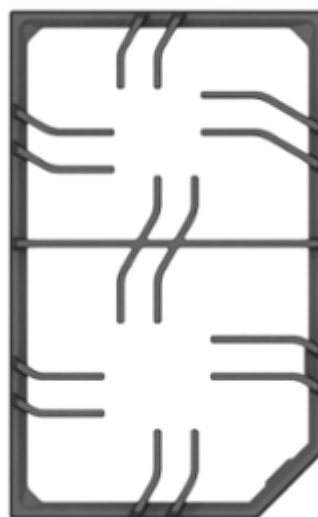

3.3



4.1



4.2

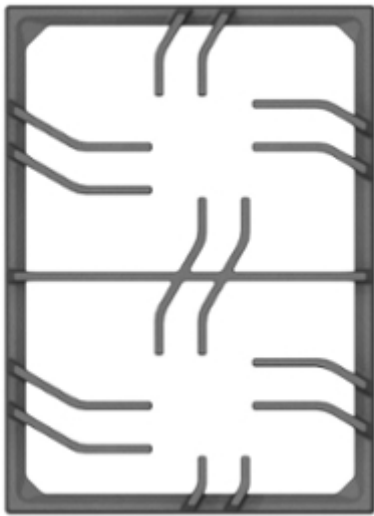

4.3



5.1



5.2



5.3



6.1

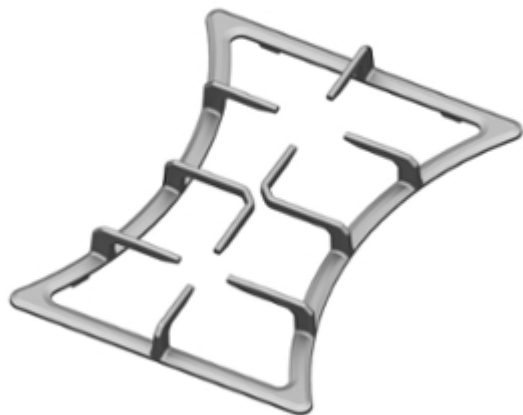

6.2

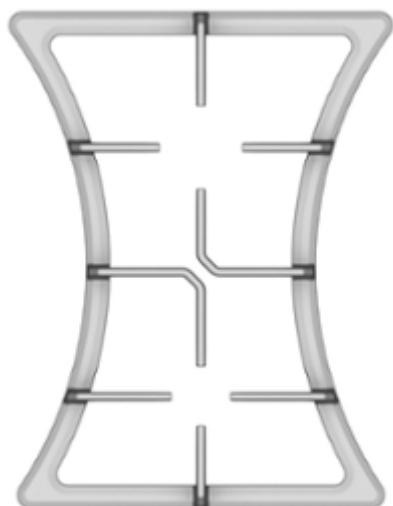

6.3



7.1



7.2



8.1



8.2



8.3



8.4



9



10



11



12



13

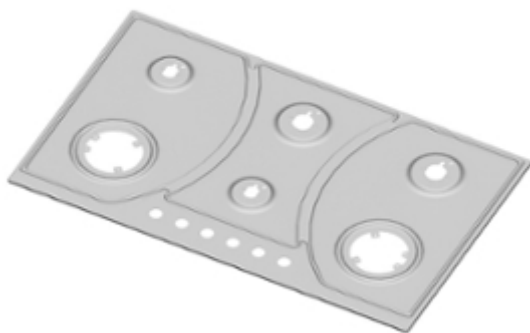

14

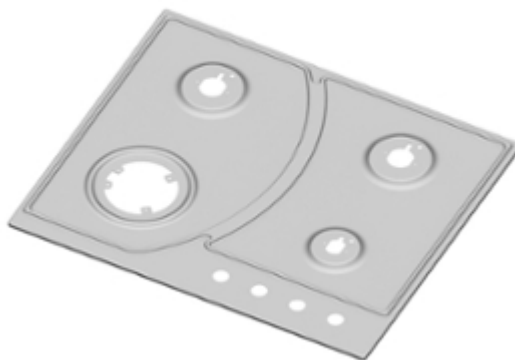

15.1



15.2



15.3



16.1



16.2



16.3



17.1



17.2



17.3



18.1



18.2



18.3



19.1



19.2



19.3



20.1



20.2



20.3



(11) DM/203 139

(15) 2019 06 21

(22) 2019 06 21

(28) 2

(73) HARRY WINSTON SA

Chemin Du Tourbillon 8, 1228 Plan-les-Ouates (CH)

(85) CH

(86) CH

(87) CH

(88) CH

(89) CH

(81) IL, MA, III, AM, MD, MN, TR, GB, TN, CH, UA, AL, AZ, BZ, ME, MC, SG, NO, BA, MK, GE, CA, OM, LI, KG, EM, RU

(72) Rie YATSUGI-KANG

C/o Harry Winston Inc. 718 Fifth Avenue, 10019, New York (US)

(74) The Swatch Group AG (The Swatch Group SA) (The Swatch Group Ltd.)

Faubourg Du Lac 6, 2501 Biel/Bienne (CH)

(54) 1. Ring, 2. Necklace

(55)

(51) 11-01

(44) 52/2019 (2019 12 27)



1.1



1.2



1.3



1.4



1.5



1.6



1.7



1.8



2.1



2.2



2.3



2.4



2.5



2.6



2.7



2.8

(11) DM/205 081

(15) 2019 11 13

(22) 2019 11 13

(28) 2

(30) No1: 14.05.2019; 006453825; EM; No2: 14.05.2019; 006453825; EM

(73) Daniel Wellington AB

Vasagatan 12, 111 20 Stockholm (SE)

(85) EM

(86) EM

(87) –

(88) EM

(89) EM

(81) III. AM, IS, MD, TJ, BW, MN, GH, ST, TR, KH, GB, TN, KR, JP, KP, CH, BN, UA, AL, TM, AZ, BZ, ME, MC, SG, NA, OA, RS, NO, BA, CA, GE, US, OM, MK, LI, KG, SM, SY, RW, RU, EG

(72) Filip Tysander

Vasagatan 12, 111 20, Stockholm (SE)

(74) AWA Sweden AB

Box 45086, 104 30 Stockholm (SE)

(54) 1.-2. Finger ring

(55)

(51) 11-01

(44) 52/2019 (2019 12 27)

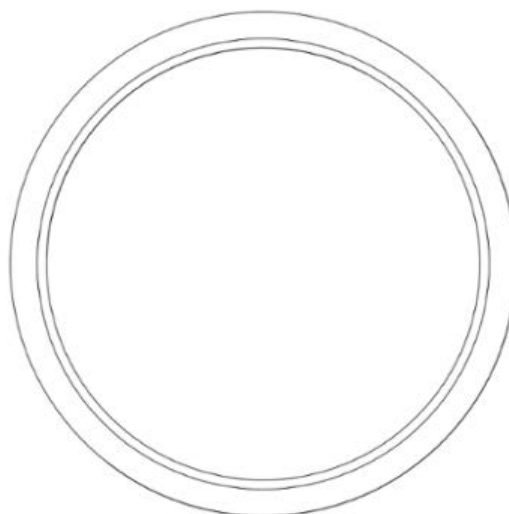
**1.1****1.2****1.3**

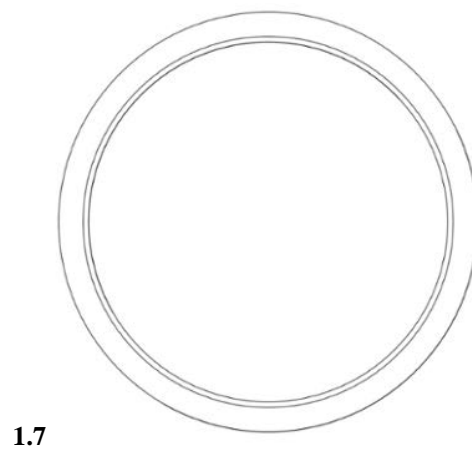

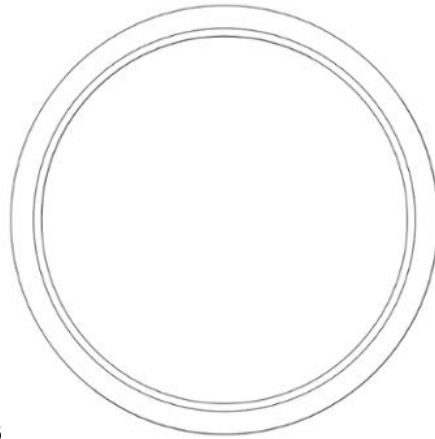

2.3

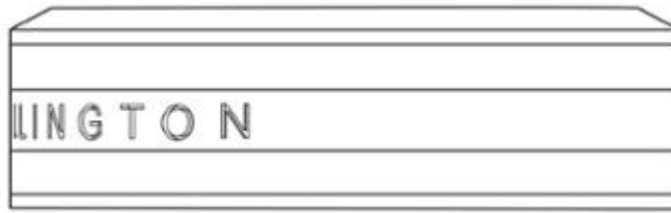

2.4



2.5

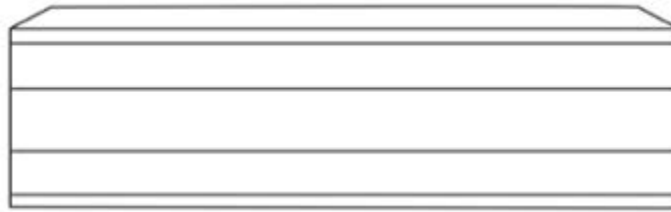

2.6

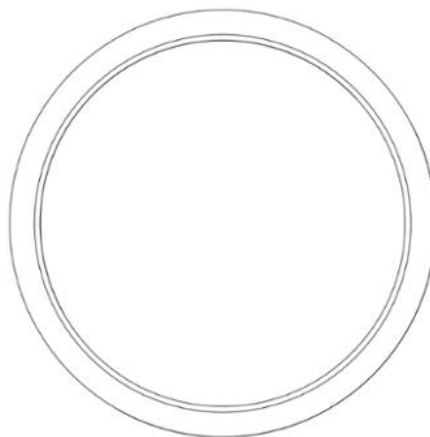

2.7

(11) DM/205 078

(51) 31-00

(15) 2019 10 31

(44) 52/2019 (2019 12 27)

(22) 2019 10 31

(28) 1

(30) No1: 21.06.2019; 6588281-0001; EM

(73) BL Balanced Lifestyle Food And Beverages GmbH
Klopstockgasse 26, 1170 Wien (AT) (EM)

(85) –

(86) EM

(87) EM

(88) EM

(89) EM

(81) III. UA, IS, ME, MC, NO, RS, BA, MK, TR, GE, US, LI, SM, CH, RU

(72) Roland Herrmann

Friedenszeile 16, 1130, Wien (AT)

(74) SONN & PARTNER Patentanwälte

Riemergasse 14, 1010 Wien (AT)

(54) 1. Apparatus for preparing drinks

(55)

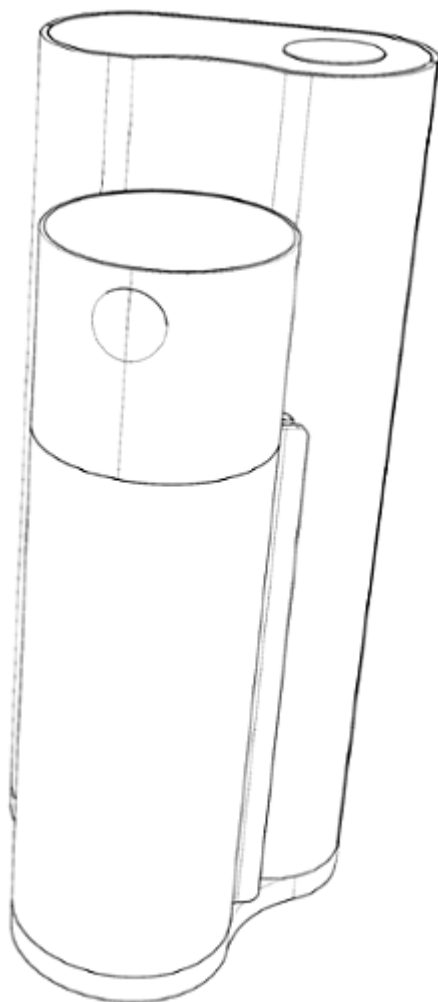

1.1

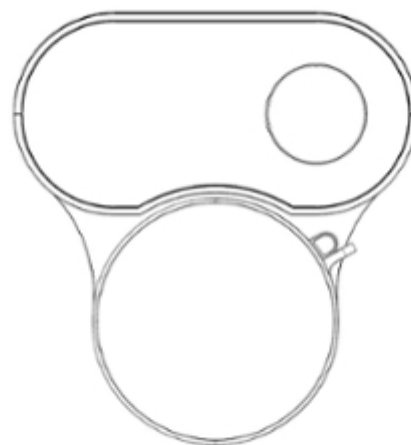

1.2

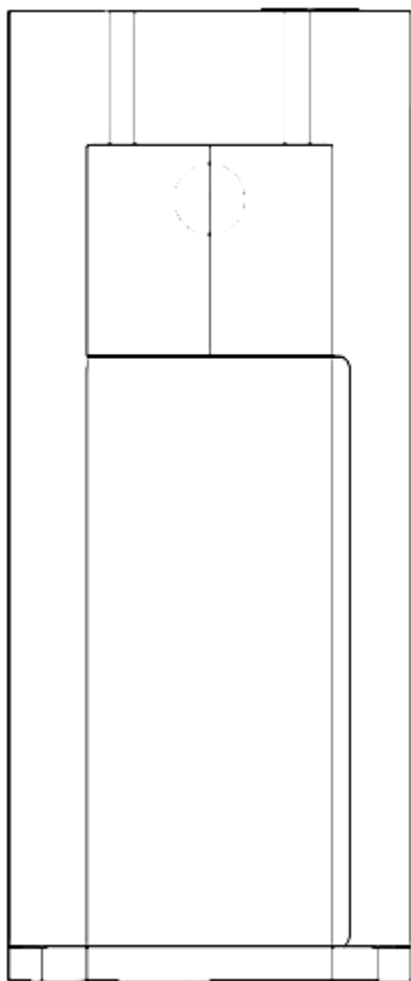

1.3

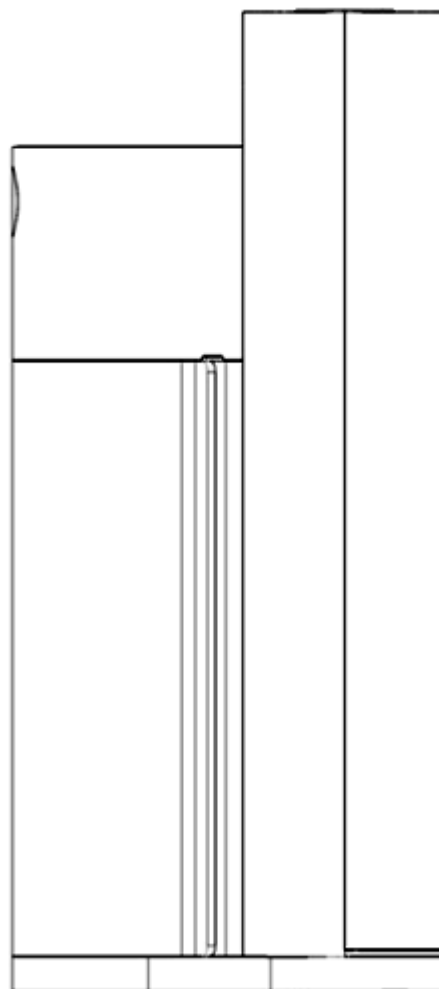

1.4

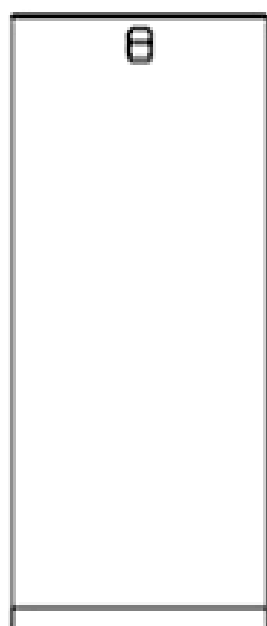

1.5

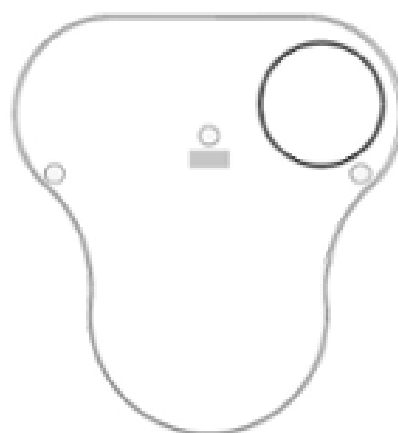

1.6

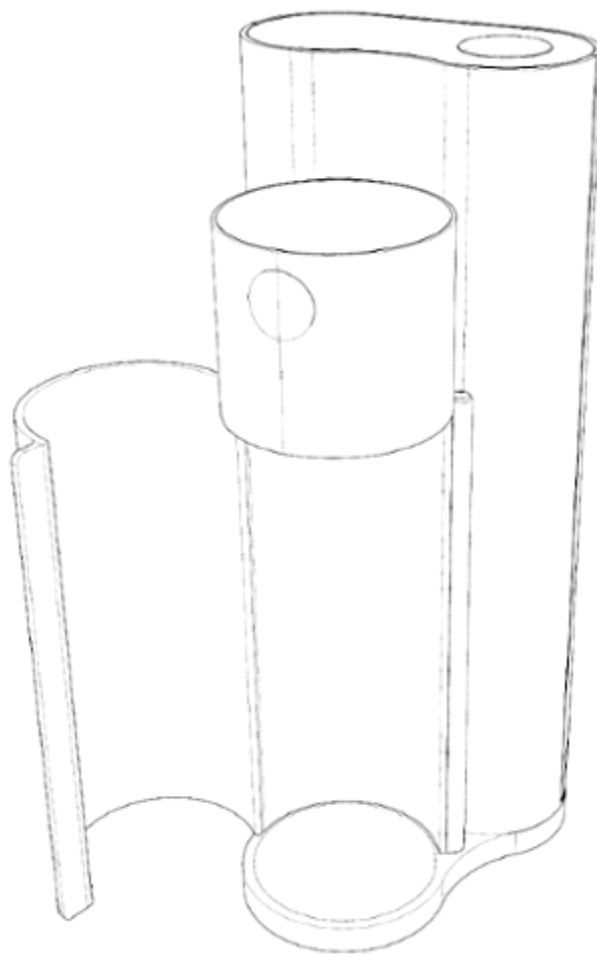

1.7

TRADEMARKS

APPLICATIONS FILED UNDER THE NATIONAL PROCEDURE APPROVED FOR REGISTRATION

The decision can be appealed at the Chamber of Appeal of Sakpatenti within 3 months from the publication or at the Mtskheta District Court Administrative Cases Board (Address: №17, Samkhedro St., Mtskheta), within 1 month following the publication.

(260) AM 2020 103559 A
(210) AM 103559
(220) 2019 06 10
(731) LTD "MY OFFICE"
Ak. Beliashvili St. 9, 0159, Tbilisi,
Georgia
(540)



(591) White, black, red
(531) 27.05.01; 27.05.09; 27.05.22; 29.01.12
(511) 9, 16, 37, 40

(260) AM 2020 103692 A
(210) AM 103692
(220) 2019 06 21
(731) LTD "Bolero & Company"
Kuchishvili St. 12-14-16, fl. 6, 0179,
Tbilisi, Georgia
(540)

დარო
DARI
ДАРИ

(591) Black, white
(511) 33

(260) AM 2020 103780 A
(210) AM 103780
(220) 2019 06 26
(731) JSC "BADAGONI"
Vill. Zemo Khodasheni, Akhmeta District,
Georgia
(740) Tamar Machavariani
(540)

BADAGONI
ბადაგონი
Бадагони

(591) Black, white
(511) 43

(260) AM 2020 103879 A
(210) AM 103879
(220) 2019 07 04
(731) Mehmet Safak KIRAN
Guzeloba Mahallesi 2245 Sokak, Kurtoglu 2
Sitesi B blok No:14 Muratpasa, Antalya,
Turkey
(740) Merab Kvimsadze
(540)

DALLANT

(591) Black, white
(531) 27.05.01
(511) 1, 29, 30, 35

(260) AM 2020 103943 A
(210) AM 103943
(220) 2019 07 05
(731) Davit Chkopoia
D. Aghmashenebeli Alley 12th km, korp. 2,
ap. 43, 0131, Tbilisi, Georgia
(540)



(591) Golden, black, brown
(531) 03.04.11; 03.06.05; 03.06.06; 03.06.11;
05.03.04; 25.01.17; 25.01.19; 26.01.15;
27.05.01; 29.01.02
(526) KOLKHA
(511) 33, 35

(260) AM 2020 103952 A
 (210) AM 103952
 (220) 2019 07 08
 (731) LTD "VESOLT CORPORATION"
 Vazha-Pshavela Av. 35, ap. 115, 0101,
 Tbilisi, Georgia
 (540)



(591) Red, dark blue, beige
 (531) 11.03.18; 27.05.10; 27.05.17; 27.05.25;
 29.01.12
 (511) 43

(260) AM 2020 103956 A
 (210) AM 103956
 (220) 2019 07 09
 (731) CILAG GMBH INTERNATIONAL
 Gubelstrasse 34, CH-6300, Zug, Switzerland
 (740) Giorgi Taktakishvili
 (540)

OGX

(591) Black, white
 (511) 3

(260) AM 2020 103970 A
 (210) AM 103970
 (220) 2019 07 10
 (731) LTD "INTER PHARM"
 D. Bakradze St. 6, 0119, Tbilisi, Georgia
 (540)

ნავაგრა

(591) Black, white
 (511) 5

(260) AM 2020 103974 A
 (210) AM 103974
 (220) 2019 07 11
 (731) GIORGI IUKURIDZE
 Gukovskiy St. 19, flat 6, Odessa, Ukraine

(740) Giorgi Taktakishvili
 (540)

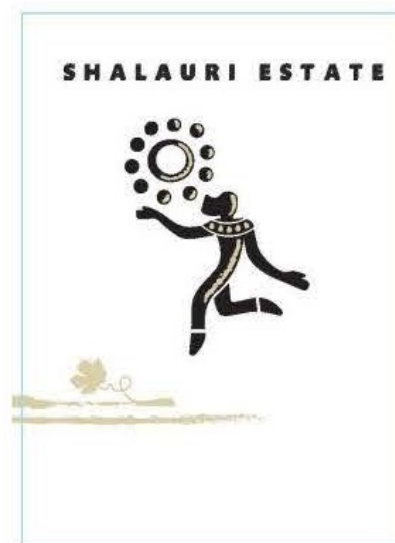

(591) Golden, white, black
 (531) 01.03.02; 02.03.08; 02.03.16; 02.03.23;
 05.03.04; 25.01.19; 29.01.13
 (526) SHALARI
 (511) 33, 41, 43

(260) AM 2020 103975 A
 (210) AM 103975
 (220) 2019 07 11
 (731) LTD "Georgian Legends"
 I. Chavchavadze Av. 29/13, ap. 32, 0179,
 Tbilisi, Georgia
 (740) Giorgi Taktakishvili
 (540)



(591) Strawy, white, beige, light green, gray, black
 (531) 01.17.14; 01.17.25; 05.07.10; 25.01.19;
 29.01.15
 (526) VACHNADZIANI
 (511) 33, 41, 43

(260) AM 2020 104060 A
 (210) AM 104060
 (220) 2019 07 12
 (731) Gigi Tevzadze

Japaridze St. 6, 0172, Tbilisi, Georgia;
Aliosha Bakuridze
Akhvlediani St. 22, 0131, Tbilisi, Georgia

(540)

ქვობჰო
Qviskey
КВИСКИ

(591) Black, white
(511) 33

(260) AM 2020 104073 A
(210) AM 104073
(220) 2019 07 12
(731) HANGZHOU EZVIZ NETWORK CO. LTD.
No.555 Qianmo Road, Binjiang District,
Hangzhou, China
(740) Shalva Gvaramadze
(540)



(591) Black, white
(531) 05.05.20; 26.01.04
(511) 7, 9, 11, 14, 35, 38, 42, 45

(260) AM 2020 104084 A
(210) AM 104084
(220) 2019 07 15
(731) LTD "Georgian Wine And Alcoholic
Beverage Company"
Village Achinebuli, 2200, Telavi,
Georgia
(740) Irine Pilauri;
Elene Totibadze
(540)

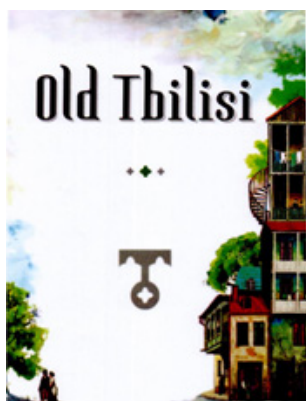

(591) Red, green, blue, sky-blue, turquoise, brown,
yellow
(531) 07.01.08; 07.01.12; 25.01.19; 27.05.01;
29.01.15
(526) Tbilisi
(511) 33

(260) AM 2020 104088 A
(210) AM 104088
(220) 2019 07 15
(731) TUANFANG LIU
Room 1603, Building 4, Shajingxi Garden,
No. 8230, Bao'an Avenue, Bao'an
District, Shenzhen, Guangdong, China
(740) Giorgi Kartvelishvili
(540)

imoto

(591) Black, white
(531) 01.15.15
(511) 34

(260) AM 2020 104106 A
(210) AM 104106
(220) 2019 07 18
(731) LTD "Zhorzholiani Ttrading"
Nutsubidze II mkr., I kvart., korp. 6, ap. 6,
Tbilisi, Georgia
(540)



(591) Red, blue, white
(531) 01.17.11; 01.17.13; 24.07.01; 24.07.23;
24.13.01; 27.05.02; 27.05.24; 29.01.14
(511) 30, 43

(260) AM 2020 104177 A
(210) AM 104177
(220) 2019 07 19
(731) FERRARI S.P.A.
Via Emilia Est 1163, Modena, Italy
(740) Giorgi Taktakishvili
(540)



(591) Black, white
(531) 03.03.01; 03.03.17
(511) 12

(260) AM 2020 104199 A
(210) AM 104199
(220) 2019 07 23
(731) LTD "Lady Healthcare"
Yuri Gagarin St. 5, Office Space 6,
Tbilisi, Georgia
(740) Davit Chikhladze
(540)

DUOMAG
დუომაგ
ДУОМАГ

(591) Black-white
(511) 5

(260) AM 2020 104207 A
(210) AM 104207
(220) 2019 07 24
(731) Education, Science, Culture and Sport
Ministry of Georgia
Uznadze St. 52, Sanapiro St. 4, Tbilisi,
Georgia

(540)



(591) Blue, lilac, red, white, black
(531) 01.15.21; 24.17.20; 26.03.23; 26.04.01;
26.04.04; 26.04.05; 26.04.12; 26.04.16;
26.04.24; 29.01.14

(526) საქართველო, Georgia
(511) 35, 39, 41, 42

(260) AM 2020 104209 A
(210) AM 104209
(220) 2019 07 24
(731) Gia Ghviniashvili
Bogdan Khmelnitkiy St. 3a, ap. 22, Tbilisi,
Georgia

(540)

Beliaani
ბელიაანი
белиаани

(591) Black, white
(511) 29, 30, 33

(260) AM 2020 104216 A
(210) AM 104216
(220) 2019 07 25
(731) Natalia Tatulashvili
Berbuli St. 10/19-21, block III, ap. 22,
Tbilisi, Georgia
(540)



(591) Brown, yellow
(531) 08.01.16; 08.01.25; 26.01.06; 26.01.18;
27.05.01; 28.19; 29.01.13
(511) 43

(260) AM 2020 104217 A
(210) AM 104217
(220) 2019 07 25
(731) LTD "Copper Cablo"
D. Guramishvili St. 78, Batumi, Georgia
(540)



(591) Black, red, green, orange, yellow, sky-blue,
white, blue
(531) 14.01.05; 14.01.06; 26.11.12; 27.05.07;
29.01.15
(511) 9, 11

(260) AM 2020 104307 A
(210) AM 104307
(220) 2019 07 26
(731) NOVARTIS AG
4002 Basel, Switzerland
(740) Pavle Meipariani
(540)

Экзодерил

(591) Black, white
(511) 5

(260) AM 2020 104316 A
(210) AM 104316
(220) 2019 07 31
(731) CILAG GMBH INTERNATIONAL
Gubelstrasse 34, CH-6300, Zug, Switzerland
(740) Giorgi Taktakishvili

(540)



(591) Black, white
(531) 26.11.12; 27.01.12
(511) 3

(260) AM 2020 104331 A
(210) AM 104331
(220) 2019 08 01
(731) LTD "BORAN LIGHT"
Marneuli St. 44, Ponichala, 0165,
Tbilisi, Georgia
(540)



(591) Red
(531) 27.05.17; 29.01.01
(511) 7

(260) AM 2020 104402 A
(210) AM 104402
(220) 2019 08 02
(731) BIOLOGISCHE HEILMITTEL HEEL
GmbH
Dr.-Reckeweg-Strasse 2-4, D-76532 Baden-
Baden, Germany
(740) Tamaz Shilakadze
(540)



(591) Black, white
(511) 5

(260) AM 2020 104403 A
(210) AM 104403
(220) 2019 08 02
(731) Elvin Pashaev
Vill. Sartichala, Gardabani District, 1324,
Georgia
(740) Khatuna Imnadze
(540)



(591) Black, white
(531) 27.05.01
(511) 25

(260) AM 2020 104425 A
(210) AM 104425

(220) 2019 08 05
(731) LTD "IPRODUCTION"
Delisi St. 50, ap. 6a, Tbilisi, Georgia
(540)



(591) Black, white
(511) 12

(260) AM 2020 104426 A
(210) AM 104426
(220) 2019 08 05
(731) LTD "IPRODUCTION"
Delisi St. 50, ap. 6a, Tbilisi, Georgia
(540)



(591) Black, white
(511) 12

(260) AM 2020 104427 A
(210) AM 104427
(220) 2019 08 05
(731) LTD "IPRODUCTION"
Delisi St. 50, ap. 6a, Tbilisi, Georgia
(540)



(591) Black, white
(511) 12

(260) AM 2020 104428 A
(210) AM 104428
(220) 2019 08 05
(731) LTD "IPRODUCTION"
Delisi St. 50, ap. 6a, Tbilisi, Georgia
(540)



(591) Black, white
(511) 12

(260) AM 2020 104429 A
(210) AM 104429
(220) 2019 08 05
(731) LTD "IPRODUCTION"
Delisi St. 50, ap. 6a, Tbilisi, Georgia
(540)



(591) Black, white
(511) 12

(260) AM 2020 104535 A
(210) AM 104535
(220) 2019 08 12
(731) LTD "Georgian Education Group"
P. Melikishvili Av. 8a/Erekle Tatishvili St. 1,
Mtatsminda district, 0179, Tbilisi, Georgia
(740) Levan Dadiani
(540)

მწვანე სკოლა

(591) Black, white
(511) 41, 42

(260) AM 2020 104537 A
(210) AM 104537
(220) 2019 08 12
(731) LTD "Georgian Education Group"
P. Melikishvili Av. 8a/Erekle Tatishvili St. 1,
Mtatsminda district, 0179, Tbilisi, Georgia
(740) Levan Dadiani
(540)



(591) White, Green
(531) 05.01.16; 28.19; 29.01.03
(511) 41,42

REGISTERED TRADEMARKS

(111) M 2020 32396 R
 (151) 2020 03 05
 (181) 2030 03 05
 (260) AM 2019 100084 A
 (220) 2019 04 25
 (732) LTD "BORUN LIGHT"
 Marneuli St. 44, 0165, Tbilisi, Georgia

(111) M 2020 32402 R
 (151) 2020 03 05
 (181) 2030 03 05
 (260) AM 2019 101640 A
 (220) 2019 02 12
 (732) LTD "GLOBAL TSBS"
 Stanislavskiy St. 5, 0119, Tbilisi, Georgia

(111) M 2020 32397 R
 (151) 2020 03 05
 (181) 2030 03 05
 (260) AM 2019 101213 A
 (220) 2019 03 20
 (732) JSC "GREENWAY GEORGIA"
 University St. 6, 0177, Tbilisi, Georgia

(111) M 2020 32403 R
 (151) 2020 03 05
 (181) 2030 03 05
 (260) AM 2019 101645 A
 (220) 2019 02 13
 (732) LTD "GLOBAL TSBS"
 Stanislavskiy St. 5, 0119, Tbilisi, Georgia

(111) M 2020 32398 R
 (151) 2020 03 05
 (181) 2030 03 05
 (260) AM 2019 101214 A
 (220) 2019 03 20
 (732) JSC "GREENWAY GEORGIA"
 University St. 6, 0177, Tbilisi, Georgia

(111) M 2020 32404 R
 (151) 2020 03 05
 (181) 2030 03 05
 (260) AM 2019 101650 A
 (220) 2019 02 14
 (732) GEORGIAN AGRO HOUSE
 Kostava St. 37-39, Sar. 6, Office 501,
 Mtatsminda District, 0179, Tbilisi, Georgia

(111) M 2020 32399 R
 (151) 2020 03 05
 (181) 2030 03 05
 (260) AM 2019 101617 A
 (220) 2019 02 11
 (732) LTD "GLOBAL TSBS"
 Stanislavskiy St. 5, 0119, Tbilisi, Georgia

(111) M 2020 32405 R
 (151) 2020 03 05
 (181) 2030 03 05
 (260) AM 2019 101656 A
 (220) 2019 02 15
 (732) LLC "Romeo 2009"
 University St. 6, Vake-Saburtalo district,
 Tbilisi, Georgia

(111) M 2020 32400 R
 (151) 2020 03 05
 (181) 2030 03 05
 (260) AM 2019 101619 A
 (220) 2019 02 11
 (732) LTD "GLOBAL TSBS"
 Stanislavskiy St. 5, 0119, Tbilisi, Georgia

(111) M 2020 32406 R
 (151) 2020 03 05
 (181) 2030 03 05
 (260) AM 2019 101643 A
 (220) 2019 02 13
 (732) Getz Pharma International FZ LLC
 Office No.1307, 13th Floor, Al-Thuraya Tower
 1, Dubai Media City, Dubai, United Arab
 Emirates

(111) M 2020 32401 R
 (151) 2020 03 05
 (181) 2030 03 05
 (260) AM 2019 101620 A
 (220) 2019 02 11
 (732) LTD "GLOBAL TSBS"
 Stanislavskiy St. 5, 0119, Tbilisi, Georgia

(111) M 2020 32407 R
 (151) 2020 03 05
 (181) 2030 03 05
 (260) AM 2019 102158 A
 (220) 2019 03 13

(732) RICHTER GEDEON NYRT.
1103 Budapesht, Dzomroi Ut 19-21, Hungary

(111) M 2020 32408 R
(151) 2020 03 05
(181) 2030 03 05
(260) AM 2019 102159 A
(220) 2019 03 13

(732) SOCIÉTÉ DES PRODUITS NESTLÉ S.A.
1800 Vevey, Switzerland

(111) M 2020 32409 R
(151) 2020 03 05
(181) 2030 03 05
(260) AM 2019 102247 A
(220) 2019 03 19
(732) Berlin-Chemie AG
Glienicke Weg 125, 12489, Berlin, Germany

(111) M 2020 32410 R
(151) 2020 03 05
(181) 2030 03 05
(260) AM 2019 102359 A
(220) 2019 03 22
(732) LTD "GMP"
Vill. Ponitchala 65, 0165, Tbilisi, Georgia

(111) M 2020 32411 R
(151) 2020 03 05
(181) 2030 03 05
(260) AM 2019 102362 A
(220) 2019 03 24
(732) OBA RETAIL CHAIN MMC
AZ5001, Sumqayit seheri, 9 mkr,
ev 25C, Baku, Azerbaijan

(111) M 2020 32412 R
(151) 2020 03 05
(181) 2030 03 05
(260) AM 2019 102363 A
(220) 2019 03 24
(732) OBA RETAIL CHAIN MMC
AZ5001, Sumqayit seheri, 9 mkr,
ev 25C, Baku, Azerbaijan

(111) M 2020 32413 R
(151) 2020 03 05
(181) 2030 03 05
(260) AM 2019 102374 A
(220) 2019 03 25
(732) LTD "PURI CHVENI ARSOBISA"
Kldekari St. 23, Tbilisi, Georgia

(111) M 2020 32414 R
(151) 2020 03 05
(181) 2030 03 05
(260) AM 2019 102386 A
(220) 2019 03 27
(732) BOTTEGA VENETA S.R.L.
Lokalita Konti Maltraverso 1, 36054
Montebelo Vichentino (VI), Italy

(111) M 2020 32415 R
(151) 2020 03 05
(181) 2030 03 05
(260) AM 2019 102493 A
(220) 2019 03 29
(732) LTD "Bebias"
D. Tavdadebuli st. 4, ap. 13, 0131, Tbilisi,
Georgia

(111) M 2020 32416 R
(151) 2020 03 05
(181) 2030 03 05
(260) AM 2019 102498 A
(220) 2019 03 29
(732) LLC Georgian "AGRO House"
M. Kostava St. 37-39, II fl., Mtatsminda
district, 0179, Tbilisi, Georgia

(111) M 2020 32417 R
(151) 2020 03 05
(181) 2030 03 05
(260) AM 2019 102500 A
(220) 2019 03 30
(732) LTD "GMP"
Vill. Ponitchala 65, 0165, Tbilisi, Georgia

(111) M 2020 32418 R
(151) 2020 03 05
(181) 2030 03 05
(260) AM 2019 102501 A
(220) 2019 03 30
(732) LTD "GMP"
Vill. Ponitchala 65, 0165, Tbilisi, Georgia

(111) M 2020 32419 R
(151) 2020 03 05
(181) 2030 03 05
(260) AM 2019 102502 A
(220) 2019 03 30
(732) LTD "GMP"
Vill. Ponitchala 65, 0165, Tbilisi, Georgia

(111) M 2020 32420 R
(151) 2020 03 05
(181) 2030 03 05
(260) AM 2019 102503 A
(220) 2019 04 01
(732) LLC Georgian "AGRO House"
M. Kostava St. 37-39, II fl., Mtatsminda
district, 0179, Tbilisi, Georgia

(111) M 2020 32421 R
(151) 2020 03 05
(181) 2030 03 05
(260) AM 2019 102522 A
(220) 2019 04 03
(732) SANOFI
54, Rue La Boétie, Paris, 75008, France

(111) M 2020 32422 R
(151) 2020 03 05
(181) 2030 03 05
(260) AM 2019 102539 A
(220) 2019 04 05
(732) BOTTEGA VENETA S.R.L.
Località Conti Maltraverso 1, 36054
Montebello Vicentino (VI), Italy

(111) M 2020 32423 R
(151) 2020 03 05
(181) 2030 03 05
(260) AM 2019 102713 A
(220) 2019 04 15
(732) JSC "GEPHA"
Akaki Beliashvili St. 142, 0159, Tbilisi,
Georgia

(111) M 2020 32424 R
(151) 2020 03 05
(181) 2030 03 05
(260) AM 2019 102714 A
(220) 2019 04 15
(732) JSC "GEPHA"
Akaki Beliashvili St. 142, 0159, Tbilisi,
Georgia

(111) M 2020 32425 R
(151) 2020 03 05
(181) 2030 03 05
(260) AM 2019 102730 A
(220) 2019 04 17
(732) BMJ Industries FZ-LLC
P.O. Box: 31053, Al-Jazeera, Al-Hamra,
Ras AL Khaimah, United Arab Emirates

(111) M 2020 32426 R
(151) 2020 03 05
(181) 2030 03 05
(260) AM 2019 102833 A
(220) 2019 04 25
(732) ALEKSANDR SUPRUNOV
Viktor Jorbenadze St. 15, 0103, Tbilisi

(111) M 2020 32427 R
(151) 2020 03 05
(181) 2030 03 05
(260) AM 2019 102927 A
(220) 2019 04 30
(732) KT & G CORPORATION
71, Beotkkot-gil, Daedeok-gu, Daejeon,
Republic of Korea

(111) M 2020 32428 R
(151) 2020 03 05
(181) 2030 03 05
(260) AM 2019 103093 A
(220) 2019 05 10
(732) LTD "BUFALO"
Khizabavra St. 5, entrance 1, flat 4, 0167,
Tbilisi, Georgia

(111) M 2020 32429 R
(151) 2020 03 05
(181) 2030 03 05
(260) AM 2019 99429 A
(220) 2019 04 02
(732) Givi Tevzadze
Tskneti Highway 16/18, Tbilisi, Georgia

TRADEMARKS REGISTERED ACCORDING TO THE ACCELERATED PROCEDURE

The decision can be appealed at the Chamber of Appeal of Sakpatenti within 3 months from the publication.

(111) M 2020 32388 R
(151) 2020 02 21
(181) 2030 02 21
(210) AM 107066
(220) 2020 02 12
(732) NEXUS GROUP ENTERPRISES N.V.
Heelsumstraat 51, E-Commerce Park, Curaçao
(740) Tamar Kharazishvili
(540)

FortuneJack

(591) Black, white
(511) 9, 41

(111) M 2020 32389 R
(151) 2020 02 24
(181) 2030 02 24
(210) AM 107068
(220) 2020 02 13
(732) LLC "ABG"
I. Javakhishvili St. 80, ap. 58, Batumi,
Georgia
(540)



(591) Green, sky-blue, red, white
(531) 01.15.15; 26.01.02; 26.01.05; 26.01.13;
26.01.20; 26.04.10; 27.05.02; 27.05.23;
29.01.15
(511) 1

(111) M 2020 32390 R
(151) 2020 02 25
(181) 2030 02 25
(210) AM 106933
(220) 2020 02 04
(732) NOBEL ILAC SANAYII VE TICARET
ANONIM SIRKETI Representative in
Georgia
Freedom Square 4, 0105, Tbilisi, Georgia
(740) Tinatin Tskhvediani

(540)

ნექსეტინი Nexetin

(591) Black, white
(511) 5, 35

(111) M 2020 32391 R
(151) 2020 02 26
(181) 2030 02 26
(210) AM 107259
(220) 2020 02 21
(732) Tural Khudaev
Bako St. 2, 3017, Vill. Kizilajalo, Marneuli,
Georgia
(540)

YIYI

(591) Black, white
(511) 25

(111) M 2020 32392 R
(151) 2020 02 27
(181) 2030 02 27
(210) AM 107157
(220) 2020 02 17
(732) LLC "GLDANI 3"
Tianeti Highway 3, Tbilisi, Georgia
(740) Shalva Gvaramadze
(540)

ნართაა HAPTAA NARTAA

(591) Black, white
(511) 43

(111) M 2020 32393 R
(151) 2020 02 28
(181) 2030 02 28
(210) AM 107170
(220) 2020 02 19
(732) Evgeni Davitaia
Arakishvili St. 8a, ap. 15, Tbilisi, Georgia

(540)

სატაცური
SATATSURI

(591) Black, white
(511) 43

(111) M 2020 32394 R

(151) 2020 02 28

(181) 2030 02 28

(210) AM 107265

(220) 2020 02 21

(732) LLC "GN-Invest"

M. Lebanidze St. 8, 0112, Tbilisi, Georgia

(540)

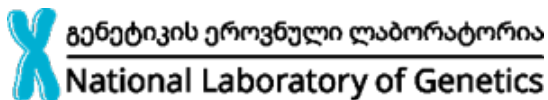

(591) Color of copperas

(531) 26.11.08; 27.05.01; 27.05.11; 27.05.21; 28.19;
29.01.12

(526) National

(511) 44

(111) M 2020 32395 R

(151) 2020 02 28

(181) 2030 02 28

(210) AM 107166

(220) 2020 02 19

(732) LLC "GEOMILL"

Chirnakhuli St. 4, 0151, Tbilisi, Georgia

(740) Giorgi Batlidze

(540)



(591) Red, green

(531) 02.09.01; 26.11.12; 27.05.01; 27.05.19;
29.01.12

(511) 30

(111) M 2020 32430 R

(151) 2020 03 06

(181) 2030 03 06

(210) AM 107298

(220) 2020 02 26

(732) LLC "BIOGRAPHY"

G. Chokheli St. 25, Tbilisi, Georgia

(740) Tornike Maisuradze

(540)

სასტუმრო ბიოგრაფი
Hotel Biography

(591) Black, white

(511) 43

INTERNATIONAL TRADEMARKS FOR WHICH A DECISION ON GRANTING PROTECTIONS IS TAKEN

The decision can be appealed at the Chamber of Appeal of Sakpatenti within 3 months from the publication or at the Mtskheta District Court Administrative Cases Board (Address: №17, Samkhedro str., Mtskheta), within 1 month following the publication.

(260) AM 2020 96791 A

(800) 701861

(151) 1998 10 20

(891) 2018 02 09

(731) MAX ZELLER SÖHNE

AKTIENGESELLSCHAFT

Seeblickstrasse 4, CH-8590 Romanshorn,

Switzerland

(540)

PREFEMIN

(591) Black, white

(511)

5 – Pharmaceutical, veterinary and sanitary preparations; dietetic substances adapted for medical use, food for babies; plasters, materials for dressings; material for stopping teeth and dental wax; disinfectants; preparations for destroying vermin; fungicides, herbicides.

(260) AM 2020 99740 A

(800) 701861

(151) 1998 10 20

(891) 2018 02 09

(731) MAX ZELLER SÖHNE

AKTIENGESELLSCHAFT

Seeblickstrasse 4, CH-8590 Romanshorn,

Switzerland

(540)

PREFEMIN

(591) Black, white

(511)

5 – Pharmaceutical, veterinary and sanitary preparations; dietetic substances adapted for medical use, food for babies; plasters, materials for dressings; material for stopping teeth and dental wax; disinfectants; preparations for destroying vermin; fungicides, herbicides.

(260) AM 2020 100722 A*

(800) 1437884

(151) 2018 06 21

(891) 2018 06 21

(731) HELIOS Tovarna barv, lakov in umetnih smol

Količevo, d.o.o.

Količevo 65, SI-1230 Domžale, Slovenia

(540)

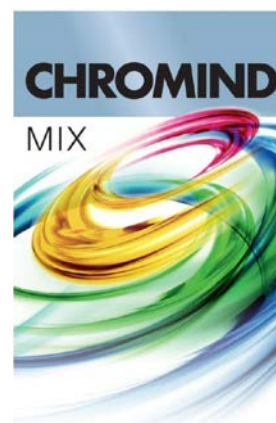

(591) Black, grey, red, violet, green, blue and yellow

(531) 01.15.23; 25.05.02; 26.01.05; 29.01.15

(511)

1 – Chemical products used in industry, namely chemicals used in manufacturing of paints, industrial chemicals, aldehydes, anti-static preparations (except for household purposes), concrete preservatives, except paints and oils; condensationpreventing chemicals; degreasing preparations for use in manufacturing processes; decolorants for industrial processes; emulsifiers; fireproofing preparations; preservatives used in masonry, except paints and oils; enamel staining chemicals; salts for coloring metal; artificial resins, unprocessed; plastics, unprocessed; tanning substances; adhesives for industrial purposes, solvents for varnishes.

2 – Paints, including wood colorings, bactericidal paints, fireproof paints, paints for ceramics; aluminium paints, printing ink and printing paints; painting coatings i.e. coatings, whitening substances, dyes, and binding substances for paints; varnishes for painting; lacquers, including lacquers on the basis of varnish and painting lacquers; anti-rust preparations, especially preservatives against rust; preservatives for metal, minium, red lead, white lead, undercoatings and coatings for chassis of vehicles; mastic, primers; thinners for paints and lacquers; thickeners for paints and lacquers; agglutinants for paints; mordants; enamels; fixatives for watercolors; mordants for leather; wood preservatives, including wood coatings and wood mordants; metals in foil and powder form for painters, decorators, printers and artists, colorants.

17 – Artificial resins (semi-processed), acrylic resins (semi-processed); rubber (raw other semi-processed); seals and rings of rubber; semi-processed plastics; plastic fibres, not for use in textile; adhesive bands and tapes (other than stationery and not for medical purposes); insulating fabrics, insulating oil, insulating paints, insulating varnish, insulating tape and band, substances for insulating buildings against moisture; filtering materials (semi-processed foams or films of plastics); flexible tubes, not of metal.

(260) AM 2020 102447 A

(800) 1458587

(151) 2018 12 19

(891) 2018 12 19

(731) DALAN KİMYA ENDÜSTRİ ANONİM ŞİRKETİ

Kemalpaşa Cad. No. 325, Pınarbaşı-Bornova, İzmir, Turkey

(540)



(591) Black, white

(531) 05.03.15; 26.01.03; 26.01.22; 26.01.24

(511)

3 – Bleaching and cleaning preparations, detergents other than for use in manufacturing operations and for medical purposes, laundry bleach, fabric softeners for laundry use, stain removers, dishwasher detergents; perfumery; non-medicated cosmetics; fragrances; deodorants for personal use and animals; soaps; dental care preparations: dentifrices, denture polishes, tooth whitening preparations, mouth washes, not for medical purposes, abrasive preparations; emery cloth; sandpaper; pumice stone; abrasive pastes; polishing preparations for leather, vinyl, metal and wood, polishes and creams for leather, vinyl, metal and wood, wax for polishing.

(260) AM 2020 102614 A

(800) 1459987

(151) 2018 12 24

(891) 2018 12 24

(731) D.N.S. TEKSTİL SANAYİ VE TİCARET LİMİTED ŞİRKETİ

Akçeşme Mahallesi 2606 Sokak No:10, Merkezefendi, Denizli, Turkey

(540)



(591) Black, white

(531) 27.05.10; 27.05.22

(526) Brandname for quality and fashion.

(511)

24 – Textiles and substitutes for textiles; household linen; adhesive fabric for application by heat, banners, bath mitts; bath linen, except clothing; bed covers of paper, bed clothes, bed linen, bed blankets, bed covers/bedspreads/coverlets [bedspreads]/quilts, billiard cloth, bolting cloth, brocades, buckram, bunting, calico, canvas for tapestry or embroidery, cheese cloth, chenille fabric, cheviots [cloth], cloth, cloths for removing make-up, coasters [table linen], cotton fabrics, covers for cushions, covers [loose] for furniture/loose covers for furniture, crepe [fabric], crepon; curtain holders of textile material, curtains of textile or plastic, damask, diaper changing cloths for babies, diapered linen, door curtains, drugget, eiderdowns [down coverlets], elastic woven material, esparto fabric, fabric; fabric of imitation animal skins; fabric, impervious to gases, for aeronautical balloons; fabric for footwear, fabrics for textile use, face towels of textile, felt; fibreglass fabrics for textile use/fibreglass fabrics, for textile use; filtering materials of textile; flags, not of paper; flannel [fabric], frieze [cloth]; furniture coverings of textile, furniture coverings of plastic/coverings of plastic for furniture, fustian/dimity, gauze [cloth], glass cloths [towels]; gummed cloth, other than for stationery; hemp cloth, haircloth [sackcloth], handkerchiefs of textile; hat linings, of textile, in the piece; hemp fabric, jersey [fabric], jute fabric, knitted fabric, labels of cloth, linen cloth, lingerie fabric, lining fabric for shoes, linings [textile], marabouts [cloth], mattress covers, moleskin [fabric], mosquito nets, net curtains, non-woven textile fabrics, oilcloth for use as tablecloths, peshtemal [traditional Turkish towel]; pillow shams, pillowcases; place mats, not of paper; plastic material [substitute for fabrics], printed calico cloth, printers' blankets of textile, ramie fabric, rayon fabric, sheets [textile], shower curtains of textile or plastic, shrouds, silk [cloth], silk fabrics for printing patterns, sleeping bag liners, sleeping bags for camping, swaddling blankets; table covers, not of paper; table linen, not of paper; table runners, table napkins of textile/serviettes of textile; tablecloths, not of paper; tablemats, not of paper; taffeta [cloth], tenugui [Japanese cotton towels], textile material, tick [linen], ticks [mattress covers], fitted toilet lid covers of fabric, towels of textile, traced cloths for embroidery/traced cloth for embroidery, travelling rugs [lap robes], trellis [cloth], tulle, upholstery fabrics, velvet; wall hangings of textile/tapestry [wall hangings], of textile; woollen cloth/woollen fabric; zephyr [cloth].

25 – Clothing, footwear, headgear, albs, aprons [clothing], ascots, babies' pants [clothing], bandanas [neckerchiefs], bath robes, bath slippers, bath sandals, bathing suits/swimsuits, bathing trunks/bathing

drawers, bathing caps, beach clothes, beach shoes, belts [clothing], berets; bibs, not of paper; boas [necklets], bodices [lingerie], boot uppers, boots for sports, boots, boxer shorts, brassieres, breeches for wear, camisoles, cap peaks, caps [headwear], chasubles, clothing of leather, clothing of imitations of leather, clothing for gymnastics, coats, collars [clothing], combinations [clothing], corselets, corsets [underclothing], cuffs/wristbands [clothing], cyclists' clothing, detachable collars, dress shields, dresses, dressing gowns, ear muffs [clothing], esparto shoes or sandals, fishing vests, fittings of metal for footwear, football shoes/football boots; footmuffs, not electrically heated; footwear uppers, fur stoles, furs [clothing], gabardines [clothing], galoshes/goloshes, garters, girdles, gloves [clothing], gymnastic shoes, half-boots, hat frames [skeletons], hats, headbands [clothing], headgear for wear, heelpieces for stockings, heelpieces for footwear, heels, hoods [clothing], hosiery, jackets [clothing], jerseys [clothing], jumper dresses/pinafore dresses, knickers/panties, knitwear [clothing], lace boots, layettes [clothing], leggings [leg warmers]/leg warmers, leggings [trousers], liveries, maniples, mantillas, masquerade costumes, mitres [hats]/miters [hats], mittens, money belts [clothing], motorists' clothing, muffs [clothing], neck scarves [mufflers]/mufflers [neck scarves]/neck scarfs [mufflers], neckties, non-slipping devices for footwear, outerclothing; overalls/smocks, overcoats/topcoats, paper hats [clothing], paper clothing, parkas, pelerines, pelisses, petticoats, pocket squares, pockets for clothing, ponchos, pyjamas, ready-made clothing, ready-made linings [parts of clothing], sandals, saris, sarongs, sashes for wear, scarves/scarfs, shawls, shirt fronts, shirt yokes, shirts, shoes, short-sleeve shirts, shower caps, ski boots, ski gloves, skirts, skorts; skull caps, sleep masks, slippers, slips [undergarments], sock suspenders, socks, soles for footwear, inner soles, spats/gaiters, sports jerseys, sports shoes, sports singlets, stocking suspenders, stockings, studs for football boots, stuff jackets [clothing], suits, suspenders/braces for clothing [suspenders], sweat-absorbent underclothing/sweat-absorbent underwear, sweat-absorbent stockings, sweaters/jumpers [pullovers]/pullovers, teddies [undergarments], tee-shirts, tights, tips for footwear, togas, top hats, trouser straps/gaiter straps, trousers, turbans, underpants, underwear/underclothing, uniforms, valenki [felted boots]; veils [clothing], visors [headwear], waistcoats/vests, waterproof clothing, welts for footwear, wet suits for water-skiing, wimples, wooden shoes.

35 – Advertising agencies services, marketing and publicity bureau services including commercial or advertisement exhibition and trade fair organization services, provision of an on-line marketplace for buyers and sellers of goods and services; providing office functions; business management of sports people; business administration, advisory services

relating to the operation of franchises, business advice and consultancy relating to franchising; import and export agencies; business investigations, evaluations, expert business appraisals; auctioneering; the bringing together, for the benefit of others, of chemicals used in industry, science and photography, as well as in agriculture, horticulture and forestry, unprocessed artificial resins, unprocessed plastics, manures, fire extinguishing compositions, tempering and soldering preparations, chemical substances for preserving foodstuffs, tanning substances, adhesives used in industry, paints, varnishes, lacquers, preservatives against rust and against deterioration of wood, colorants, mordants, raw natural resins, metals in foil and powder form for painters, decorators, printers and artists, bleaching preparations and other substances for laundry use, cleaning, polishing, scouring and abrasive preparations, soaps, perfumery, essential oils, cosmetics, hair lotions, dentifrices, industrial oils and greases, lubricants, dust absorbing, wetting and binding compositions, fuels (including motor spirit) and illuminants, candles and wicks for lighting, electrical energy, pharmaceutical and veterinary preparations, sanitary preparations for medical purposes, dietetic food and substances adapted for medical or veterinary use, food for babies, dietary supplements for humans and animals, plasters, materials for dressings, material for stopping teeth, dental wax, disinfectants, preparations for destroying vermin, fungicides, herbicides, common metals and their alloys, metal building materials, transportable buildings of metal, materials of metal for railway tracks, non-electric cables and wires of common metal, ironmongery, small items of metal hardware, pipes and tubes of metal, safes, ores, works of art made of common metals or their alloys, ornaments and decorative goods made of common metals or their alloys, ornaments for walls made of common metals or their alloys, figurines [statuettes] of common metal, machines and machine tools, motors and engines, machine coupling and transmission components, agricultural implements other than hand-operated, incubators for eggs, automatic vending machines, hand tools and implements (hand-operated), cutlery, side arms, razors, scientific, nautical, surveying, photographic, cinematographic, optical, weighing, measuring, signalling, checking (supervision), life-saving and teaching apparatus and instruments, apparatus and instruments for conducting, switching, transforming, accumulating, regulating or controlling electricity, apparatus for recording, transmission or reproduction of sound or images, magnetic data carriers, recording discs, compact discs, mechanisms for coin-operated apparatus, clothing for protection against fire/garments for protection against fire, clothing for protection against accidents, irradiation and fire, clothing especially made for laboratories, clothing especially for operating rooms, surgical, medical, dental and veterinary apparatus and

instruments, artificial limbs, eyes and teeth, orthopedic articles, suture materials, apparatus for lighting, healing, steam generating, cooking, refrigerating, drying, ventilating, water supply and sanitary purposes, blankets, electric, for household purposes, vehicles, apparatus for locomotion by land, air or water, firearms, ammunition and projectiles, explosives, fireworks, precious metals and their alloys and goods in precious metals or coated therewith, jewellery, imitation jewellery, works of art of precious metal, precious stones, horological and chronometric instruments, trophies made of precious metal, rosaries, musical instruments, paper, cardboard and goods made from these materials, printed matter, bookbinding material, photographs, posters, stationery, adhesives for stationery or household purposes, artists' materials, paint brushes, typewriters and office requisites, instructional and teaching materials, plastic materials for packaging, printers' type, printing blocks, table napkins of paper, handkerchiefs of paper, toilet paper, towels of paper, face towels of paper, baby bibs of paper, table cloths of paper, table mats of paper, ornaments made of paper, plastic sheets, rubber, gutta-percha, gum, asbestos, mica and goods made from these materials, plastics in extruded form for use in manufacture, packing, stopping and insulating materials, leather and imitations of leather, and goods made of these materials, animal skins, hides, trunks and travelling bags, beach bags, purses, umbrellas and parasols, walking sticks, whips, harness and saddlery, building materials (non-metallic), non-metallic rigid pipes for building, asphalt, pitch and bitumen, non-metallic transportable buildings, monuments, furniture, mattresses, baby mattresses, air mattresses, mattress cushions, pillows, cushions, water beds, bouncing chairs for babies, cradles, infant walkers, non-metallic baskets, fishing baskets, kennels, nesting boxes, beds for household pets, pet cushions, mirrors, picture frames, goods of wood, cork, reed, cane, wicker, horn, bone, ivory, whalebone, shell, amber, mother-of-pearl, meerschaum and substitutes for all these materials, or of plastics, household or kitchen utensils and containers, combs, sponges, brushes, brush-making materials, articles for cleaning purposes, steel-wool, unworked or semi-worked glass, glassware, porcelain and earthenware, ropes, string, nets, tents, awnings, tarpaulins, sails, sacks and bags, padding and stuffing materials, raw fibrous textile materials, yarns for textile use, threads for textile use, woven or non-woven textile fabrics, fabric of imitation animal skins, textiles and textile goods for household use, household linen, curtains, bed covers, sheets (textile), pillowcases, blankets, quilts, towels, peshtemal (traditional Turkish towel), flags, pennants, labels of textile, sleeping bags for camping, swaddling blankets, clothing, footwear, headgear, bath robes, bath slippers, bath sandals, bathing suits, bathing caps, lace and embroidery, ribbons and braid, bu-

ttens, hooks and eyes, pins and needles, artificial flowers, carpets, rugs, mats and matting, linoleum and other materials for covering existing floors, wall hangings, games and playthings, gymnastic and sporting articles, meat, fish, poultry and game, meat extracts, preserved, frozen, dried and cooked fruits and vegetables, jellies, jams, compotes, eggs, milk and milk products, edible oils and fats, coffee, tea, cocoa and artificial coffee, rice, tapioca and sago, flour and preparations made from cereals, bread, pastry and confectionery, edible ices, sugar, honey, treacle, yeast, baking-powder, salt, mustard, vinegar, sauces (condiments), spices, ice, grains and agricultural, horticultural and forestry products, live animals, fresh fruits and vegetables, seeds, natural plants and flowers, foodstuffs for animals, malt, mineral and aerated waters and other non-alcoholic beverages, fruit beverages and fruit juices, syrups and other preparations for making beverages, matches, enabling customers to conveniently view and purchase those goods, such services may be provided by retail stores, wholesale outlets, through vending machines, mail order catalogues or by means of electronic media, for example, through web sites or television shopping programmes.

(260) AM 2020 102852 A

(800) 1462469

(151) 2018 11 01

(891) 2018 11 01

(731) Alca plast, s.r.o.

Biskupský dvůr 2095/8, CZ-110 00 Praha 1,
Nové Město, Czech Republic

(540)



(591) Black, white

(531) 03.07.09; 03.07.16; 27.05.01; 27.05.22

(511)

6 – Metal frames for sanitary installations, metal drains, metal mouldings, metal grids, metal traps, metal locksmith products, metal abutments and supports, metal goods for fixation of sanitary installations.

19 – Non-metallic drains, plastic grids, non-metallic traps, non-metallic building materials and their accessories, non-metallic rigid pipes for liquid pipelines, non-metallic building materials.

(260) AM 2020 102855 A
 (800) 1462565
 (151) 2018 09 12
 (891) 2018 09 12
 (731) V-GUARD INDUSTRIES LTD.
 42/962, vennala high school road, vennala,
 Kochi, Kerala 682028, India

(540)
V-GUARD

(591) Black, white

(531) 27.05.01

(511)

7 – Machines and machine tools; all types of pumps and motors including mono-block, jet, hydraulic, self-priming, rotary, reciprocating, diaphragm, centrifugal, submersible, water, axial pumps and pumping apparatus; electrically powered kitchen appliances for dicing, mincing, slicing and chopping food; mixers, grinders, shredders, slicers, graters, electric knives, milling, mincing, kneading, rasping machines, blenders, juice extractors, juicers, coffee grinders; food processor; parts and fittings of the aforesaid goods.

9 – Electrical and electronic apparatus and instruments (including voltage stabilisers), parts thereof and fittings thereof.

11 – Lighting, heating, steam generating, cooking, refrigerating, drying, ventilating, water supply and sanitary equipments; all type of water heaters and fans; all types of geysers; heating coils, elements and filaments; electrical fans, room fans; table fans; ventilating fans; chimney fans; extractor fans: apparatus for water purification; stoves, installations and apparatus for cooking, hot plates.

(260) AM 2020 102903 A
 (800) 811116
 (151) 2003 05 27
 (891) 2019 04 05
 (731) Glen Dimplex Nordic AS
 Havnegt. 24, N-7500 Stjørdal, Norway

(540)
NOBØ

(591) Black, white

(511)

11 – Apparatus for lighting, heating, cooking, refrigerating, drying and ventilating.

(260) AM 2020 102943 A
 (800) 1463879
 (151) 2019 03 01
 (891) 2019 03 01
 (731) Public Joint Stock Company "KRASNYJ
 OCTYABR"
 ul. Malaya Krasnoselskaya, d. 7, str. 24,
 RU-107140 Moscow, Russian Federation

(540)



(591) Yellow, dark yellow, white, black, orange and blue

(531) 03.07.24; 28.05; 29.01.15

(511)

30 – Aromatic preparations for food; flavorings, other than essential oils, for cakes; flavorings, other than essential oils, for beverages; coffee flavorings; food flavorings, other than essential oils; star aniseed; high-protein cereal bars; pancakes; noodle-based prepared meals; buns; bread rolls; vanillin [vanilla substitute]; waffles; vermicelli [noodles]; natural sweeteners; sausage binding materials; binding agents for ice cream; sea water for cooking; seaweed [condiment]; malt biscuits; cloves [spice]; cake frosting [icing]; mustard; gluten additives for culinary purposes; yeast; thickening agents for cooking foodstuffs; rice-based snack food; cereal-based snack food; artificial coffee; vegetal preparations for use as coffee substitutes; dressings for salad; fruit jellies [confectionery]; confectionery for decorating Christmas trees; cakes; pastries; peanut confectionery; almond confectionery; pasta; ginger [spice]; frozen yogurt [confectionery ices]; cocoa; capers; caramels [candy]; curry [spice]; ketchup [sauce]; quiches; gluten prepared as foodstuff; sweetmeats [candy]; liquorice [confectionery]; peppermint sweets; cinnamon [spice]; coffee; unroasted coffee; starch for food; crackers; custard; groats for human food; hominy grits; semolina; oatmeal; crushed barley; corn, milled; corn, roasted; meat pies; turmeric; couscous [semolina]; noodles; ice for refreshment; ice, natural or artificial; edible ices; rice cakes; mayonnaise; macarons [pastry]; macaroni; maltose; hominy; marinades; marzipan; honey; royal jelly; ice cream; flour; bean meal; tapioca flour; potato flour; corn flour; wheat flour; soya flour; barley meal; dessert mousses [confectionery]; chocolate mousses; muesli; mint for confectionery; cocoa beverages with milk; coffee beverages with milk; coffee-based beverages; tea-based beverages; chocolate beverages with milk; chocolate-based beverages; cocoa-based beverages; infusions, not medicinal; crushed oats; husked oats; nutmegs; stick liquorice [confectionery]; soya bean paste [condiment]; pastilles [confectionery]; molasses for food; pepper; allspice; peppers [seasonings]; pesto [sauce]; cookies; petit-beurre biscuits; pies; pizzas; meat gravies; fondants [confectionery]; popcorn; powders for making ice cream; baking powder; mustard meal; pralines; condiments; meat tenderi-

zers for household purposes; cereal preparations; oat-based food; propolis; gingerbread; spices; petits fours [cakes]; puddings; cake powder; fruit coulis [sauces]; ravioli; chewing gum; relish [condiment]; rice; wheat germ for human consumption; spring rolls; sago; sugar; aniseed; golden syrup; confectionery; baking soda [bicarbonate of soda for cooking purposes]; malt for human consumption; salt for preserving foodstuffs; cooking salt; celery salt; sherbets [ices]; ham glaze; soya sauce; tomato sauce; sauces [condiments]; spaghetti; seasonings; preparations for stiffening whipped cream; rusks; breadcrumbs; sushi; sandwiches; tabbouleh; tacos; tapioca; cream of tartar for culinary purposes; tarts; almond paste; tortillas; garden herbs, preserved [seasonings]; beer vinegar; vinegar; ferments for pastes; halvah; bread; unleavened bread; corn flakes; oat flakes; chicory [coffee substitute]; tea; iced tea; chutneys [condiments]; cheeseburgers [sandwiches]; chow-chow [condiment]; saffron [seasoning]; malt extract for food; essences for foodstuffs, except etheric essences and essential oils; husked barley.

(260) AM 2020 102945 A

(800) 1463887

(151) 2019 03 01

(891) 2019 03 01

(731) Open-Type Joint Stock Company "ROT FRONT"

2-oy Novokuznetskiy pereulok, d. 13/156
RU-115184 Moscow, Russian Federation

(540)



(591) Brown, dark brown and white

(531) 19.03.24; 25.01.25; 25.07.01; 28.05; 29.01.13

(526) Корица в карамели

(511)

30 – Caramels [candy].

(260) AM 2020 102954 A

(800) 1464019

(151) 2019 03 05

(891) 2019 03 05

(731) SPECTRUMLEAF CANNADIPS SP. Z.O.O.
ul. 27 Grudnia, 3, PL-61-737 POZNAN,
Poland

(540)



(591) Black, white

(531) 27.05.01; 27.05.22

(511)

5 – Medicinal herbs; dietary and nutritional supplements; pharmaceuticals; extracts of medicinal herbs; chewing gum for medical purposes; smoking herbs for medical purposes; herbal supplements.

34 – Tobacco substitutes; cigars; tobacco substitutes not for medical purposes; electronic cigarettes; liquid solutions for use in electronic cigarettes; herbs for smoking; cigarettes; snus; cigarillos; chewing tobacco; articles for use with tobacco; tobacco.

(260) AM 2020 102962 A

(800) 1464239

(151) 2019 02 04

(891) 2019 02 04

(731) Toruńskie Zakłady Materiałów
Opatunkowych, Spółka Akcyjna
Żółkiewskiego 20/26, PL-87-100 Toruń,
Poland

(540)

matopat happy

(591) Black, white

(531) 27.05.01

(511)

5 – Adhesive tapes for medical purposes.

(260) AM 2020 102963 A

(800) 1464245

(151) 2019 02 04

(891) 2019 02 04

(731) Toruńskie Zakłady Materiałów
Opatunkowych, Spółka Akcyjna
Żółkiewskiego 20/26, PL-87-100 Toruń,
Poland

(540)

matopat universal

(591) Black, white

(531) 27.05.01

(511)

5 – Adhesive tapes for medical purposes.

(260) AM 2020 102964 A

(800) 1464254

(151) 2019 02 27

(891) 2019 02 27

(731) COMPAGNIE GERVAIS DANONE

17 boulevard Haussmann, F-75009 PARIS,
France

(540)



(591) Blue and pink

(531) 01.03.02; 27.03.15; 27.05.01; 27.05.08;
27.05.09; 29.01.13

(511)

29 – Milk, milk products and substitutes therefor; powdered milk; flavored jellied milks and butter-milk; milk desserts; yogurts; drinking yogurts; white cheese; petit suisse; beverages mainly consisting of milk or dairy products; milk beverages, milk predominating; milk beverages containing fruit; unflavored or flavored fermented dairy products; milk substitutes of vegetable origin; substitutes of dairy products based on plants or nuts; fruit or vegetable beverages consisting mainly of milk products.

30 – Cocoa, chocolate, cocoa-based beverages, chocolate-based beverages, coffee-based beverages, tea-based beverages; custard; chocolate mousses, dessert mousses [confectionery], confectionery, sugar confectionery, sugar, puffed rice, preparations made from cereals, breakfast cereals; biscuits (sweet or savory); cakes; pastries; waffles; cereal-based desserts; rice cakes; semolina cakes; rice pudding, rice-based snack food, cereal-based snack food; edible ices, edible ices consisting primarily of yogurt, ice-cream, sherbet (edible ices), frozen yogurts (edible ices), edible ice-cream made with flavored frozen water; fruit coulis [sauces]; beverages of vegetable origin, excluding dairy substitutes, included in this class.

32 – Still or sparkling waters (mineral or other), fruit or vegetable juices, beverages with fruits or vegetables, lemonades, soda water, sherbets (beverages), preparations for making beverages, syrups for beverages, vegetable or fruit extract without alcohol, non-alcoholic beverages; plant-based beverages.

(260) AM 2020 102966 A

(800) 1464284

(151) 2019 02 04

(891) 2019 02 04

(731) Toruńskie Zakłady Materiałów

Opatrunkowych, Spółka Akcyjna Żółkiewskiego 20/26, PL-87-100 Toruń, Poland

(540)



(591) Black, white

(531) 27.05.01

(511)

5 – Adhesive tapes for medical purposes.

(260) AM 2020 102983 A

(800) 1464776

(151) 2018 10 17

(891) 2018 10 17

(731) MKA TEKSTİL SANAYİ TİCARET

LİMİTED ŞİRKETİ

M.N. Özmen Mh. Keresteciler Sitesi, Fatih

Cd. Kasım S. Fatih Çr. 39/25, Güngören,

İstanbul, Turkey

(540)



(591) Red and blue

(531) 26.04.02; 26.04.22; 27.05.09; 27.05.22;
29.01.12

(511)

25 – Clothing, including underwear and outer-clothing, other than special purpose protective clothing; socks, mufflers [clothing], shawls, bandanas, scarves, belts [clothing]; footwear; headgear.

35 – Advertising, marketing and public relations; organization of exhibitions and trade fairs for commercial or advertising purposes, office functions; secretarial services, arranging newspaper subscriptions for others, compilation of statistics, rental of office machines, systemization of information into computer databases, telephone answering for unavailable subscribers, business management, business administration and business consultancy, accounting, commercial consultancy services, personnel recruitment, personnel placement, employment agencies, import-export agencies, commercial or industrial management assistance, auctioneering, the bringing together, for the benefit of others, of clothing, including underwear and outer-clothing, other than special purpose protective clothing, socks, mufflers [clothing], shawls, bandanas, scarves, belts [clothing], footwear, headgear, enabling customers to conveniently view and purchase those goods, such services may be provided by retail stores, wholesale outlets, by means of electronic media or through mail order catalogues.

(260) AM 2020 102984 A

(800) 1464799

(151) 2018 12 20

(891) 2018 12 20

(731) NOVYI DOM LLC

UL. SALYUTOVSKAYA, D. 31, G.

IZHEVSK, RU-426053 UDMURTSKAYA

RESPUBLIKA, Russian Federation

(540)

KOLERPARK

(591) Black, white

(511)

2 – White lead; dyes; binding preparations for paints; glazes [paints, lacquers]; primers; titanium dioxide [pigment]; indigo [colorant]; alizarine dyes; aniline dyes; ink for leather; shoe dyes; ink for skin-dressing; dyewood; colorants; toner [ink] for photocopiers; aluminium paints; bactericidal paints; wood stains; ceramic paints; marking ink for animals; fire-proof paints; printing ink; engraving ink; enamels for painting; paints; creosote for wood preservation; bitumen varnish; bronzing lacquers; lacquers; oils for the preservation of wood; mastic [natural resin]; zinc oxide [pigment]; pigments; coatings [paints]; wood coatings [paints]; bronze powder for painting; silvering powders; metals in powder form for use in painting, decorating, printing and art; protective preparations for metals; wood mordants; mordants; thinners for paints; thinners for lacquers; whitewash; soot [colorant]; siccatives [drying agents] for paints; natural resins, raw; badigeon; anti-rust greases; anti-rust oils; anti-rust preparations; wood preservatives; fixatives [varnishes]; fixatives for watercolors; dye-wood extracts; enamels [varnishes]; silver emulsions [pigments].

(260) AM 2020 102985 A

(800) 1464839

(151) 2019 02 26

(891) 2019 02 26

(731) Vagabond Skor Varberg AB

Box 521, SE-432 19 VARBERG, Sweden

(540)

VAGABOND

(591) Black, white

(531) 27.05.01

(511)

18 – Bags; attaché-cases; backpacks; card cases; hand bags; hunting bags; briefcases; shopping bags; purses; beach bags; school bags; bands of leather; travelling bags; suitcases; trunks; umbrellas, parasols and walking sticks; leather and leather imitations; saddlery.

25 – Clothing, footwear, headgear; pants; shorts; shirts; t-shirts; pullovers; jerseys; sweat shirts; sweat pants; underwear; sports bras; dresses; skirts; jackets; coats; socks; gloves; belts for clothing; hosiery; tights; vests; hoods; scarves; soles for footwear.

(260) AM 2020 102986 A

(800) 1464929

(151) 2019 02 22

(891) 2019 02 22

(731) CASTER

99 rue du Faubourg Saint-Honoré, F-75008

PARIS, France

(540)

PHYTO NOVATHRIX

(591) Black, white

(511)

3 – Soaps; perfumes; essential oils; non-medical cosmetic preparations for skin care, maintenance and embellishment; make-up and make-up removing products; lipstick; beauty masks; shaving and after shaving products; non-medical preparations for hair care, maintenance and embellishment; shampoos; hair conditioners; creams, gels, masks, balms, mousses and sprays for hair care and styling; lotions for hair care and styling; sunscreen hair preparations; coloring and bleaching products for hair care; hair sprays; hair waving and setting products.

(260) AM 2020 103039 A

(800) 1465171

(151) 2019 02 05

(891) 2019 02 05

(731) BRITISH AMERICAN TOBACCO

(BRANDS) LIMITED

Globe House, 4 Temple Place, London

WC2R 2PG, United Kingdom

(540)

LYFT

(591) Black, white

(511)

34 – Cigarettes; cigarettes containing tobacco substitutes; tobacco, raw or manufactured; tobacco products; tobacco substitutes (not for medical purposes); tobacco free cigarettes (not for medical purposes); snuff with or without tobacco; snus with or without tobacco; cigars, cigarillos; cigarette lighters; matches; smokers' articles; cigarette paper, cigarette tubes, cigarette filters; pocket apparatus for rolling cigarettes; hand held machines for injecting tobacco into paper tubes; electronic cigarettes; liquids for electronic cigarettes; tobacco products for the purpose of being heated; electronic devices and their parts for the purpose of heating cigarettes or tobacco.

(260) AM 2020 103040 A

(800) 1465177

(151) 2019 02 04

(891) 2019 02 04

(731) SUZHOU TOLSEN TOOLS CO., LTD.

No.350, Yangjin Road, Hexing, Jinfeng Town,

Zhangjiagang City, Jiangsu Province, China

(540)

TOLSEN

(591) Black, white
 (531) 27.05.01
 (511)
 6 – Tool chests of metal, empty; soldering wire of metal; nozzles of metal; wire cloth; fittings of metal for furniture; safes [metal or non-metal]; strap-hinges of metal.
 9 – Scales; slide calipers; protective helmets; water level indicators.

(260) AM 2020 103041 A
 (800) 1465183
 (151) 2019 02 18
 (891) 2019 02 18
 (731) SICHUAN YIBIN WULIANGYE GROUP CO., LTD
 #150, Minjiang West Road, Yibin, Sichuan, China
 (540)



(591) Black, white
 (531) 27.01.11; 28.03
 (511)
 33 – Baijiu [Chinese distilled alcoholic beverage]; distilled beverages; cocktails; wine; alcoholic beverages, except beer.

(260) AM 2020 103042 A
 (800) 1465193
 (151) 2019 03 07
 (891) 2019 03 07
 (731) DR. THEISS NATURWAREN GMBH
 Michelinstr. 10, 66424 Homburg, Germany
 (540)



(591) Red, black, blue, grey and brown
 (531) 01.15.21; 26.01.03; 26.01.06; 26.01.16; 26.01.20; 26.15.01; 27.05.09; 27.05.10; 27.05.11; 29.01.14
 (511)
 3 – Bleaching preparations and laundry preparations; cleaning, polishing, scouring and abrasive preparations; perfumery, essential oils, non-medicated cosmetics, including non-medicated skin cleaning and

skin care preparations, and hair care preparations; non-medicated dentifrices.

5 – Pharmaceutical and veterinary preparations; medicines for human purposes; medicines for veterinary purposes; sanitary preparations for medical purposes; dietetic foodstuffs and substances adapted for medical use; nutritional supplements for humans and animals; vitamin preparations.

(260) AM 2020 103055 A
 (800) 1465612
 (151) 2019 03 07
 (891) 2019 03 07
 (731) DR. THEISS NATURWAREN GMBH
 Michelinstr. 10, 66424 Homburg, Germany
 (540)



(591) Yellow, gold, grey
 (531) 01.15.21; 26.01.06; 26.01.13; 26.01.20; 27.05.10; 27.05.11; 29.01.12
 (511)

3 – Bleaching preparations and laundry preparations; Cleaning, polishing, scouring and abrasive preparations; Perfumery, essential oils, non-medicated cosmetics, including non-medicated skin cleaning and skin care preparations, and hair care preparations; Non-medicated dentifrices.

5 – Pharmaceutical and veterinary preparations; Medicines for human purposes; Medicines for veterinary purposes; Sanitary preparations for medical purposes; Dietetic foodstuffs and substances adapted for medical use; Nutritional supplements for humans and animals; Vitamin preparations.

(260) AM 2020 103056 A
 (800) 1465646
 (151) 2019 02 01
 (891) 2019 02 01
 (731) IGNATYEVNA NINO GIYEVNA
 ul.Sheykmana, 119, kv.72, Ekaterinburg, RU-620144 Sverdlovskaya Oblast, Russian Federation
 (540)



(591) Black, white

(531) 27.05.01; 27.05.07; 27.05.08

(511)

18 – Bags; bags for climbers; tool bags, empty; handbags; beach bags; saddlebags; compression cubes adapted for luggage; bags for sports; bags for campers; shopping bags; wheeled shopping bags; school satchels; pouch baby carriers; travelling trunks; mountaineering sticks; slings for carrying infants; luggage tags; pocket wallets; saddlecloths for horses; reins; reins for guiding children; sling bags for carrying infants; harness fittings; parts of rubber for stirrups; chamois leather, other than for cleaning purposes; umbrellas; parasols; saddlery; frames for umbrellas or parasols; handbag frames; card cases [notecases]; cases of leather or leatherboard; valves of leather; whips; imitation leather; leather, unworked or semi-worked; leatherboard; casings, of leather, for springs; umbrella rings; hat boxes of leather; boxes of leather or leatherboard; purses; chain mesh purses; fastenings for saddles; butts [parts of hides]; saddle trees; bags [envelopes, pouches] of leather, for packaging; moleskin [imitation of leather]; travelling sets [leatherware]; knee-pads for horses; muzzles; halters; vanity cases, not fitted; furniture coverings of leather; clothing for pets; covers for animals; trimmings of leather for furniture; collars for animals; hiking sticks; conference folders; music cases; goldbeaters' skin; cat o' nine tails; leather leashes; pads for horse saddles; horseshoes; girths of leather; horse blankets; garment bags for travel; shoulder belts [straps] of leather; briefcases; traces [harness]; fur; randsels [Japanese school satchels]; haversacks; leather straps; straps for soldiers' equipment; harness straps; straps for skates; straps of leather [saddlery]; chin straps, of leather; stirrup leathers; umbrella handles; walking stick handles; suitcase handles; grips for holding shopping bags; rucksacks; travelling bags; riding saddles; net bags for shopping; umbrella or parasol ribs; stirrups; nose bags [feed bags]; bridoons; umbrella sticks; walking stick seats; tefillin [phylacteries]; bits for animals [harness]; bridles [harness]; harness for animals; key cases; horse collars; suitcases; motorized suitcases; suitcases with wheels; valises; attaché cases; covers for horse saddles; umbrella covers; kid; curried skins; animal skins; cattle skins; leather cord; blinkers [harness]; labels of leather; game bags [hunting accessories]; walking sticks; boxes of vulcanized fiber.

25 – Clothing; wimples; bandanas [neckerchiefs]; underwear; sweat-absorbent underwear; berets; overalls; boas [necklets]; teddies [underclothing]; boxer shorts; ankle boots; ski boots; boots for sports; breeches for wear; trousers; football boots; brassieres; valenki [felted boots]; collars [clothing]; detachable collars; shirt yokes; veils [clothing]; gabardines [clothing]; galoshes; neckties; ascots; leggings [leg warmers]; gaiters; boot uppers; corselets; jerseys [clothing];

vests; sports jerseys; hosiery; heels; hoods [clothing]; hat frames [skeletons]; pockets for clothing; neck scarfs [mufflers]; kimonos; sun visors [headwear]; cap peaks; tights; slips [underclothing]; combinations [clothing]; wet suits for water-skiing; bodices [lingerie]; corsets [underclothing]; suits; bathing suits; masquerade costumes; beach clothes; leotards; jackets [clothing]; stuff jackets [clothing]; fishing vests; leggings [trousers]; liveries; camisoles; sports singlets; cuffs; short-sleeve shirts; mantillas; coats; sleep masks; furs [clothing]; hand warmers [fingerless gloves]; miters [hats]; muffs [clothing]; footmuffs, not electrically heated; heelpieces for footwear; bibs, not of paper; bibs, sleeved, not of paper; fur stoles; hairdressing capes; ear muffs [clothing]; socks; sweat-absorbent socks; footwear; beach shoes; sports shoes; paper clothing; outerclothing; ready-made clothing; motorists' clothing; cyclists' clothing; clothing for gymnastics; clothing of imitations of leather; clothing of leather; waterproof clothing; uniforms; fittings of metal for footwear; maniples; overcoats; panties; parkas; pelerines; gloves [clothing]; ski gloves; pajamas; bathing trunks; shirt fronts; scarfs; pocket squares; dresses; headbands [clothing]; garters; sock suspenders; stocking suspenders; ready-made linings [parts of clothing]; dress shields; soles for footwear; braces for clothing [suspenders]; half-boots; lace boots; ponchos; girdles; belts [clothing]; money belts [clothing]; layettes [clothing]; non-slipping devices for footwear; heelpieces for stockings; welts for footwear; chasubles; shirts; wooden shoes; sandals; bath sandals; boots; jumper dresses; saris; sarongs; sweaters; footwear uppers; inner soles; albs; bath slippers; togas; knitwear [clothing]; underpants; shoes; gymnastic shoes; slippers; skull caps; turbans; headwear; aprons [clothing]; judo uniforms; karate uniforms; tee-shirts; dressing gowns; bath robes; top hats; tips for footwear; stockings; sweat-absorbent stockings; shawls; paper hats [clothing]; shower caps; bathing caps; sashes for wear; studs for football boots; hats; babies' pants [underwear]; trouser straps; pelisses; esparto shoes or sandals; skirts; petticoats; skorts.

(260) AM 2020 103064 A

(800) 1465789

(151) 2019 02 07

(891) 2019 02 07

(731) PETER RICKEN

Zeunerstraße 32, 45133 Essen, Germany

(540)

KARA Nutrition

(591) Black, white

(511)

5 – Nutritional supplements; mineral food supplements; zinc dietary supplements; food supplements consisting of amino acids; food supplements consisting of trace elements; dietary supplements consist-

ting of vitamins; dietary supplements for humans; protein powder dietary supplements; mineral dietary supplements for humans; food supplements; mineral nutritional supplements; dietary food supplements for controlling cholesterol; dietary supplements consisting primarily of magnesium; nutritional supplements.

35 – Retail and wholesale services, also provided via the internet, with the following goods: nutritional supplements, mineral food supplements, zinc dietary supplements, food supplements consisting of amino acids, food supplements consisting of trace elements, dietary supplements consisting of vitamins, dietary supplements for humans, protein powder dietary supplements, mineral dietary supplements for humans, food supplements, mineral nutritional supplements, dietary food supplements for controlling cholesterol, dietary supplements consisting primarily of magnesium, nutritional supplements; advertising, marketing and sales promotion, also provided via the internet.

(260) AM 2020 103066 A

(800) 1465823

(151) 2019 02 20

(891) 2019 02 20

(731) FESTİVAL İPLİK VE HALI SANAYİ
TİCARET ANONİM ŞİRKETİ
2. Organize Sanayi Bölgesi, 83228 Nolu
Cadde, No: 19, Şehitkamil – Gaziantep,
Turkey

(540)



(591) Black and white are the feature of the mark

(531) 05.03.13; 05.05.20; 05.05.21; 26.04.05;
26.04.15; 26.04.24; 27.05.09; 27.05.10;
27.05.24

(526) Hali

(511)

27 – Carpets, rugs, mats; prayer rugs; linoleum, artificial turf, linoleum for covering floors; gymnasium mats; wallpaper, wall hangings not of textile.

(260) AM 2020 103074 A

(800) 1465919

(151) 2019 03 04

(891) 2019 03 04

(731) Limited Liability Company "ORIMI"
1-st Microrayon Street, 15/4 plot, Sverdlov
factory settlement, Vsevolozhsk district,
RU-188682 Leningrad oblast, Russian
Federation

(540)



(591) White, black, green, dark green, red, yellow,
beige, brown and dark brown

(531) 02.01.20; 11.03.04; 26.07.05; 26.11.02;
26.11.13; 28.05; 29.01.15

(511)

30 – Coffee; unroasted coffee; artificial coffee; coffee-based beverages; coffee beverages with milk.

(260) AM 2020 103076 A

(800) 1465957

(151) 2019 01 14

(891) 2019 01 14

(731) VIENNA INSURANCE GROUP AG
Wiener Versicherung Gruppe
Schottenring 30, A-1010 Wien, Austria

(540)



VIENNA INSURANCE GROUP

(591) Black, white and red

(531) 01.01.02; 01.01.10; 01.01.12; 26.11.01;
26.11.08; 27.05.09; 27.05.10; 27.05.11;
29.01.12

(511)

36 – Insurance, financial affairs, monetary affairs, real estate affairs.

(260) AM 2020 103077 A

(800) 1466030

(151) 2018 11 05

(891) 2018 11 05

(731) HUAWEI TECHNOLOGIES CO., LTD.
Administration Building Huawei Technologies Co., Ltd. Bantian, Longgang District
Shenzhen, China

(540)



(591) Black, white

(531) 03.07.04; 05.05.20; 10.03.07

(511)

7 – Shoe polishers, electric; electric cordless sweepers; rechargeable sweepers; juice extractors, electric; soybean milk making machines for household purposes; grating machines for vegetables for household purposes; butter machines; washing machines (laundry); dry-cleaning machines; centrifugal mills; ironing machines; sewing machines for household purposes; industrial robots; electric juicers; coffee grinders, other than hand-operated; electric coffee grinders; dishwashers for household purposes; electric blenders for household purposes; hand-held electric grinders; machines and apparatus for cleaning, electric; mixers (machines); crushers for kitchen use, electric; 3D printers; vegetable spiralizers, electric; wringing machines for laundry; washing machines for laundry for household purposes; mixing machines; kitchen machines, electric; meat mincers for household purposes; curtain drawing devices, electrically operated; 3D printing pens; robotic vacuum cleaners; portable rotary steam presses for fabrics.

8 – Electric beard clippers; curling tongs; nail files, electric; manicure sets, electric; razors, electric or non-electric; nail clippers (electric or non-electric); electric hair scissors; electric hair clippers for personal use; electric hair straighteners; electric razors; electric steam irons; peelers (hand tools).

9 – Wearable computers; telecommunication apparatus in the form of jewellery; selfie sticks for mobile phones; cameras (photography); security surveillance robots; electrified fences; sunglasses; sensors; smartphones; computer memories; notebook computers; measuring cups; gas analyzing apparatus; USB data cables; USB data cables for mobile phones; ultrasonic sensors; sound alarms; electric door bells; smoke detectors; theft prevention installations, electric; 3D spectacles; batteries for mobile phones; battery charging devices for motor vehicles; animated cartoons; rearview cameras for vehicles; wearable video display monitors; selfie lenses; laboratory robots; smartwatches; computer software applications, downloadable; computer screen saver software, recorded or downloadable; downloadable graphics for mobile phones; tablet computers; laptop computers; computer operating programs, recorded; smartglasses; wearable activity trackers; earphones; virtual reality headsets; personal digital assistants (PDAs); computer software platforms, recorded or downloadable; thin client computers; hand-held electronic dictionaries; infrared sensors; temperature sensors; automatic focus projectors; portable projectors; mul-

tipoint patch panels; set-top boxes; wireless routers; selfie monopods for smartphones and cameras; audiovisual teaching apparatus; electronic book readers; speed checking apparatus for vehicles; distance recording apparatus; video projectors; temperature indicators; hygrometers; intercoms; pressure sensors; photoelectric sensors; closed circuit television cameras; transfer switches for telecommunication apparatus; humanoid robots with artificial intelligence; acceleration sensors; photo printers; digital video recorder for vehicles; teaching robots; electronic numeric displays; digital door locks; air analysis apparatus; gas testing instruments; electric theft prevention alarms; remote controlling and measuring apparatus; electronic key fobs being remote control apparatus; remote control apparatus; remote controls for household purposes; lie detectors; digital weather stations; computer apparatus for educational purposes; electronic audio apparatus for use with books; talking books; optical lenses; touchscreen sensors; smoke alarms; natural gas alarms; electronic scales for kitchen use; scales with body fat analyzers for household purposes; holders for mobile phones for use in vehicles; USB wireless routers; head-mounted video display monitors; televisions for vehicles; electric and electronic video monitors; smart sockets; projectors with liquid crystal displays (LCD); alarm sensors; electric locks; mobile power source (rechargeable batteries); smart camcorders; battery chargers for vehicles; external hard disk drives for computers; television apparatus; electronic diaries; floppy discs drives (for computers); graphics accelerators; network servers; notebooks; network adapters; recorded computer game programs; touch screen pens; USB card readers; memory expansion cards; disk drives; solid state drives; hard disk drives; data compression software; light pens; fingerprint imagers; digital music downloadable from the Internet; mobile phone software applications for booking taxis; computer terminals for banking purposes; computer chatbot software for simulating conversations; image intensifiers; monitoring apparatus, other than for medical purposes; tyre-pressure measurers; atmospheric oxygen monitors; point-of-sale (POS) terminals; electronic pens (visual display units); electronic teaching machines; chip cards; memory cards; liquid crystal displays (LCD) with large screens; electronic memories; liquid crystal displays (LCD); optical disk drives; flat panel displays; electronic notepad for personal use; memories for use with computers; subscriber identity module (SIM) cards; computer software for operating and controlling audio and video apparatus; pens with conductive point for touch screen devices; automatic cash registers; smartphones in the shape of a watch; high-speed imaging cameras.

10 – Lasers for medical purposes; blood pressure monitors; electric massage apparatus for household use; electroencephalographs; cardiac defibrillation

electrodes; electrically operated hearing aids; surgical robots; electric sphygmomanometers; electric thermometers for medical purposes; body composition monitors; body fat monitors; testing apparatus for medical purposes; massage apparatus for personal use; heart rate monitors; medical apparatus for moxibustion treatment; blood oxygen monitors; electric acupuncture instruments; apparatus and installations for the production of X-rays for medical purposes; physiotherapy apparatus; esthetic massage apparatus; mirrors for surgeons; apparatus for use in medical analysis; defibrillators; medical apparatus for ophthalmic purposes; galvanic belts for medical purposes; heart rate monitoring apparatus; tomographs for medical purposes; digital hearing aids; radiology screens for medical purposes; electrocardiographs; galvanic therapeutic appliances; vibromassage apparatus; soporific pillows for insomnia; abdominal belts; electric knives for surgical purposes; massage apparatus for eyes; vibrating massage apparatus; foot massage apparatus.

11 – Coffee machines, electric; microwave ovens (cooking apparatus); bread baking machines; electric autoclaves for cooking; toilet seats; laundry dryers, electric; fabric steamers; air dryers; portable electric fans; anion generating humidifiers; ceiling fans; air conditioning apparatus; air conditioning fans; air purifiers for automobiles; toilet bowls; electric hot air hand dryers; drinking fountain; kettles, electric; electric stew pans; electrothermal cups; refrigerators; electric fans; electric hair dryers; electric rice cookers; humidifiers for household use; solar furnaces; automatic faucets; toilets (water-closets); electric flashlights; extractor hoods for kitchens; light bulbs; lamps; desk lamps; air purifiers; heaters for baths; air fryers; bath lamps for heating; water filtering apparatus; water ionizers for household purposes; electric heating pads, other than for medical purposes; shoe sterilizers for household purposes; electric baking ovens for household purposes; ceiling lights; night lights; street lamps; induction night lights; deep fryers, electric; food steamers, electric; hot water bottles; electromagnetic ovens; electric coffee pots; electric machines for making coffee; electric cookers for household purposes; electric kitchen ranges for household purposes; oil burners for household purposes; refrigerators for household purposes; electric fans for household purposes; electric kettles for household purposes; electric water purifiers for household purposes.

12 – Automobiles; self-balancing vehicles; electric unicycles; electric one-wheeled self-balancing scooters; electric two-wheeled self-balancing scooters; bicycles; push scooters (vehicles); pushchairs; remote control vehicles, other than toys; electric wheelchairs; electric bicycles; self balancing unicycles; cars; plug-in hybrid electric vehicles; plug-in electric cars; electric scooters; camera drones; pilotless air-

crafts; balance weights for vehicle wheels; electric push scooters (vehicles); electric folding bicycles; ultralight airplanes; civilian drones; side view mirrors for vehicles.

20 – Desks; furniture; wardrobes; beds; shoe cabinets; curtain rails; curtain rods; curtain rollers; bookcases; massage tables; pillows; cupboards; bathroom mirrors; pivot mirrors; dressing table mirrors; cushions; throw pillows; neck pillows; curtain rings; beauty cabinets (furniture); tea tables; mirrors (looking glasses); bolsters.

21 – Toothbrushes, electric; vacuum bottles; shoe polishing mitts; shoe shine sponges and cloths; table plates; stew-pans; services (dishes); beer mugs; teapots; brushes for footwear; coffee services (tableware); itch scratchers; electric combs; electric brushes, except parts of machines; mugs, not of precious metal; bowls (basins); cups; jugs; kitchen utensils; tea services (tableware); electric hair combs; electric make-up removing appliances; insulating flasks; electric devices for attracting and killing insects; plug-in diffusers for mosquito repellents.

28 – Amusement machines, automatic and coin-operated; arcade video game machines; joysticks for video games; electric amusement park rides; toy cameras; golf ball carts; body-building apparatus; hang gliders; drones (toys); toy robots; video game machines for household purposes; amusement apparatus adapted for use with television receivers only; electronic games for the teaching of children; battery-powered computer game machines with liquid crystal displays (LCD); video game machines; portable games with liquid crystal displays; controllers for game consoles; toy watches; toys; building blocks (toys); apparatus for games; scale model vehicles; scale model airplanes; hand-operated toys; electronic action toys; magic cube puzzles; action figure toys; scooters (toys); toy musical boxes (play articles); children's toy bicycles other than for transport; jigsaws and manipulative puzzles; manipulative logic games; automatic mahjong tables; running machines; toy vehicles; smart toys; model airplane kits.

(260) AM 2020 103078 A

(800) 1466052

(151) 2019 01 14

(891) 2019 01 14

(731) VIENNA INSURANCE GROUP AG Wiener
Versicherung Gruppe

Schottenring 30, A-1010 Wien, Austria

(540)



(591) Black, white and red
 (531) 01.01.01; 01.01.02; 01.01.14; 26.11.08; 28.05;
 29.01.13
 (511)
 36 – Insurance, financial affairs, monetary affairs,
 real estate affairs.

(260) AM 2020 103127 A
 (800) 1466210
 (151) 2019 03 14
 (891) 2019 03 14
 (731) Aktsionernoe obschestvo "MAKFA"
 per. Vspol'nyi, d. 5, str. 1, of. 1, RU-123001
 Moskva, Russian Federation

(540)
LIVINGGOOD

(591) Black, white
 (531) 27.05.01; 27.05.17
 (511)
 29 – Oils for food; peanut butter; cocoa butter for
 food; coconut oil for food; coconut butter; corn oil
 for food; sesame oil for food; linseed oil for food;
 extra virgin olive oil for food; olive oil for food;
 palm oil for food; palm kernel oil for food; sunf-
 lower oil for food; colza oil for food; butter; soya
 bean oil for food; potato fritters; tomato paste; potato
 flakes; potato chips; low-fat potato chips.

30 – Cereal bars; high-protein cereal bars; pancakes;
 noodle-based prepared meals; freeze-dried dishes
 with the main ingredient being pasta; freeze-dried
 dishes with the main ingredient being rice; buns;
 bread rolls; vermicelli [noodles]; gluten additives for
 culinary purposes; rice-based snack food; cereal-ba-
 sed snack food; cakes; pastries; peanut confectio-
 nery; almond confectionery; pasta; gimbap [Korean
 rice dish]; gluten prepared as foodstuff; flour-based
 dumplings; crackers; hominy grits; semolina; oat-
 meal; crushed barley; groats for human food; corn,
 milled; corn, roasted; couscous [semolina]; noodles;
 macaroni; bean meal; tapioca flour; potato flour;
 corn flour; nut flours; flour; wheat flour; soya flour;
 barley meal; muesli; crushed oats; husked oats; bis-
 cuits; petit-beurre biscuits; baking powder; cereal
 preparations; oat-based food; gingerbread; rice; ins-
 tant rice; wheat germ for human consumption; batter
 mixes for okonomiyaki [Japanese savoury panca-
 kes]; tomato sauce; pasta sauce; spaghetti; rusks;
 dough; pastry dough; almond paste; rice pulp for cu-
 linary purposes; cake dough; bread; unleavened
 bread; chips [cereal products]; corn flakes; oat fla-
 kes; chicory [coffee substitute]; tea; husked barley.

31 – Beans, fresh; peas, fresh; cereal seeds, unpro-
 cessed; grains [cereals]; chestnuts, fresh; maize;
 bran; wheat; rice, unprocessed; rye; lentils, fresh;
 barley.

(260) AM 2020 103134 A
 (800) 1466347
 (151) 2018 12 10
 (891) 2018 12 10
 (731) PATANJALI AYURVED LIMITED
 d-38 industrial area, Haridwar 249401, India

(540)
The logo for PATANJALI features the brand name in a bold, serif font. A stylized, multi-colored swoosh (green, yellow, and orange) curves under the text from the right side.

(591) Brown, green, orange, white
 (531) 26.11.02; 26.11.12; 27.05.08; 29.01.14
 (511)
 35 – Advertising; business management; business
 administration; office functions.

(260) AM 2020 103136 A
 (800) 1466379
 (151) 2018 12 10
 (891) 2018 12 10
 (731) PATANJALI AYURVED LIMITED
 d-38 industrial area, Haridwar 249401, India

(540)
The logo for PATANJALI features the brand name in a bold, serif font. A stylized, multi-colored swoosh (green, yellow, and orange) curves under the text from the right side.

(591) Brown, green, orange, white
 (531) 26.11.02; 26.11.12; 27.05.08; 29.01.14
 (511)
 24 – Textiles and textile goods, not included in other
 classes; bed and table covers.

(260) AM 2020 103137 A
 (800) 1466404
 (151) 2019 01 24
 (891) 2019 01 24
 (731) GUANGDONG OPPO MOBILE
 TELECOMMUNICATIONS CORP., LTD.
 NO.18, HAIBIN ROAD, WUSHA,
 CHANG'AN TOWN, DONGGUAN, 523860
 GUANGDONG, China

(540)



(591) Black, white
 (531) 04.05.04; 04.05.05
 (511)

9 – Computers; pedometers; apparatus to check franking; ticket dispensers; dictating machines; holograms; hemline markers; voting machines; lottery machines; facial recognition apparatus; phototelegraphy apparatus; weighing machines; measures; blinkers [signalling lights]; cell phones; headsets; cameras [photography]; measuring instruments; connected bracelets [measuring instruments]; optical apparatus and instruments; telephone wires; semi-conductors; electronic chips; semiconductor apparatus; electrical adapters; touch screens; remote control apparatus; power station automation devices; lightning rods; electrolyzers; fire extinguishing apparatus; radiological apparatus for industrial purposes; life saving apparatus and equipment; theft prevention installations, electric; spectacles; rechargeable batteries; animated cartoons; egg-candlers; dog whistles; decorative magnets; electrified fences; electronic collars to train animals; portable remote controlled car stops; humanoid robots with artificial intelligence; smartglasses; smartwatches; smart rings; interactive touch screen terminals; wearable activity trackers; video recorders for automobiles; virtual reality headsets; counterfeit coin detectors; optical fibers [light conducting filaments].

35 – Advertising; presentation of goods on communication media, for retail purposes; import-export agency services; compiling indexes of information for commercial or advertising purposes; accounting; rental of vending machines; sales promotion for others; rental of sales stands; providing business information via a web site; provision of an on-line marketplace for buyers and sellers of goods and services; personnel management consultancy; relocation services for businesses; sponsorship search; retail or wholesale services for pharmaceutical, veterinary and sanitary preparations and medical supplies.

41 – Educational services; arranging and conducting of congresses; providing on-line electronic publications, not downloadable; distribution of videotapes; zoological garden services; providing on-line music, not downloadable; game services provided on-line from a computer network; health club services [health and fitness training]; lending library services; toy rental; games equipment rental; modelling for artists.

(260) AM 2020 103158 A
 (800) 1466972
 (151) 2019 01 10
 (891) 2019 01 10
 (731) Joint-Stock Company "AVTOVAZ"
 Yuzhnoe shosse, 36, RU-445024 Togliatti,
 Samarskaya oblast, Russian Federation

(540)



(591) Black, white
 (531) 18.03.23; 26.01.03; 26.01.16; 27.05.09;
 27.05.10

(526) word combination "NEW HORIZONS"

(511)

12 – Vehicles for locomotion by land, air, water; automobiles; sports cars; motor cars; caravans; shock absorbers for automobiles; suspension shock absorbers for vehicles; luggage carriers for vehicles; vehicle bumpers; brake shoes for vehicles; transmission shafts for land vehicles; valves for vehicle tires; hoods for vehicles; horns for vehicles; doors for vehicles; engines for land vehicles; brake discs for vehicles; adhesive rubber patches for repairing inner tubes; side view mirrors for vehicles; inner tubes for pneumatic tires; hoods for vehicle engines; crankcases for land vehicle components, other than for engines; vehicle wheels; brake pads for automobiles; hub caps; brake linings for vehicles; gear boxes for land vehicles; caps for vehicle fuel tanks; bodies for vehicles; treads for retreading tires; freewheels for land vehicles; clutches for land vehicles; repair outfits for inner tubes; air pumps [vehicle accessories]; upholstery for vehicles; vehicle wheel rims; windows for vehicles; axles for vehicles; headlight wipers; gearing for land vehicles; head-rests for vehicle seats; vehicle running boards; air bags [safety devices for automobiles]; torque converters for land vehicles; cigar lighters for automobiles; anti-dazzle devices for vehicles; anti-theft devices for vehicles; sunblinds adapted for automobiles; non-skid devices for vehicle tires; balance weights for vehicle wheels; shock absorbing springs for vehicles; reduction gears for land vehicles; safety belts for vehicle seats; security harness for vehicle seats; vehicle suspension springs; steering wheels for vehicles; brake segments for vehicles; luggage nets for vehicles; anti-theft alarms for vehicles; safety seats for children, for vehicles; vehicle seats; hydraulic circuits for vehicles; vehicle wheel spokes; spoilers for vehicles; electric vehicles; windcreens; windscreen wipers; vehicle wheel hubs; trailer hitches for vehicles; couplings for land vehicles; wheelbarrows; brakes for vehicles; torsion bars for vehicles; transmissions for land vehicles; trailers [vehicles]; turbines for land vehicles; signal arms for vehicles; vans [vehicles]; undercarriages for vehicles; automobile chains; driving chains for land vehicles; anti-skid chains; transmission chains for land vehicles; spare tire covers; covers for vehicle steering wheels; seat covers for vehicles; vehicle covers [shaped]; vehicle chassis; connecting rods for land vehicles, other than parts of motors and engines; axle journals; automobile tires;

spikes for tires; mudguards; motors, electric, for land vehicles.

16 – Albums; almanacs; posters; forms, printed; announcement cards [stationery]; note books; pads [stationery]; looseleaf binders; pamphlets; booklets; newsletters; magazines [periodicals]; periodicals; printed publications; graphic representations; calendars; catalogues; pictures; books; envelopes [stationery]; printed coupons; flyers; teaching materials [except apparatus]; greeting cards; printed matter; placards of paper or cardboard; writing or drawing books; flags of paper; photographs [printed].

35 – Advertising; rental of advertising space; demonstration of goods; market studies; opinion polling; layout services for advertising purposes; marketing; organization of exhibitions for commercial or advertising purposes; sales promotion for others; production of advertising films; publication of publicity texts; radio advertising; outdoor advertising; on-line advertising on a computer network; distribution of samples; dissemination of advertising matter; direct mail advertising; writing of publicity texts; advertising by mail order; television advertising; administration of consumer loyalty programs; compiling indexes of information for commercial or advertising purposes; presentation of goods on communication media, for retail purposes; provision of an on-line marketplace for buyers and sellers of goods and services.

37 – Repair, installation of vehicle equipment; rebuilding machines that have been worn or partially destroyed; retreading of tires; vulcanization of tires [repair]; repair information; automobiles washing; vehicle washing; rustproofing; anti-rust treatment for vehicles; vehicle maintenance; vehicle polishing; vehicle breakdown repair services; motor vehicle maintenance and repair; upholstery repair; vehicle lubrication; vehicle service stations [refuelling and maintenance]; burglar alarm installation and repair; installation and repair of air-conditioning apparatus; vehicle cleaning.

38 – Electronic bulletin board services [telecommunications services]; providing internet chatrooms; message sending; computer aided transmission of messages and images; providing online forums; videoconferencing services; wireless broadcasting; transmission of electronic mail; communications by computer terminals; teleconferencing services.

(260) AM 2020 103159 A

(800) 1466997

(151) 2019 02 25

(891) 2019 02 25

(731) RAVAGO S.A.

76-78, rue de Merl, L-2146 Luxembourg,
Luxembourg

(540)

RAVASTIK

(591) Black, white

(511)

1 – Chemicals for use in making polyurethanes; unprocessed polyurethane; polyurethane adhesives for industrial purposes; unprocessed polyurethane resins; chemicals for use in the manufacture of polyurethanes; industrial adhesives; glue for industrial purposes; chemical preparations in the nature of glue accelerators; adhesives [sizing]; chemicals for use in the manufacture of adhesives; commercial glues [other than for stationery or household use]; chemical compounds for use in the manufacture of adhesives; adhesives for waterproofing; adhesives for use in the electro-optical industry; adhesives for use in science; adhesives for wallpaper; adhesives for paperhanging; structural adhesives for building use; chemical substances for making adhesives; industrial adhesives for use in building; adhesives, other than for stationery or household purposes; synthetic resins for use in adhesives; adhesives used in industry, in particular in the construction industry; adhesives for use in construction; adhesives for use in building; industrial adhesives for use in coating and sealing; industrial adhesives for use in plumbing; polyurethane adhesives for industrial purposes.

2 – Glue dye; unprocessed natural resins for use in the manufacture of adhesives.

17 – Low-density polyurethane foam for insulation, for packing; polyurethane film, other than for wrapping; insulating materials made of polyurethane foam; polyurethane film for use as building insulation; polyurethane foam sheeting for use as building insulation; polyurethane films for use in sealing and insulating buildings; adhesive tapes for industrial purposes; adhesive sealant compounds; adhesive caulking compounds; adhesive bands for industrial use; elastomeric sealants in the form of extrudable pastes for joints; insulating adhesives.

(260) AM 2020 103162 A

(800) 1467074

(151) 2019 02 15

(891) 2019 02 15

(731) Bolt Technology OÜ

Vana-Lõuna tn 15, EE-10134 Tallinn,
Estonia

(540)

Bolt

(591) Black, white

(531) 27.05.17

(511)

9 – Magnetic data carriers, recording discs; laser discs; DVDs; digital recording media; cash registers; calculators; data processing equipment; computers; software; computer operating programs, recorded; computer programs [downloadable software]; computer software downloaded from the Internet; computer software applications, downloadable; interfaces for computers; downloadable graphics for mobile phones; computer application software for mobile telephones; mobile applications for booking taxis.

35 – Advertising; business management; clerical services; business intermediary and advisory services in the field of selling products and rendering services; price comparison services; tariff information and advisory services; procurement of contracts [for others]; administrative processing of purchase orders; telephone order-taking services for others; ordering services for third parties; data processing; compilation of information into computer databases; systemization of information into computer databases; updating and maintenance of data in computer databases; data search in computer files for others; providing business information, also via Internet, the cable network or other forms of data transfer; business analysis; preparing business reports; economic information services for business purposes; provision of sales analyses; business statistical information services; market studies; market reporting services; arranging of commercial and business contacts; loyalty, incentive and bonus program services; provision of advertising space, time and media.

39 – Transport; packaging and storage of goods; travel arrangement; taxi transport; arrangement of taxi transport; transportation information; computerised reservation services relating to the carriage of passengers; transport brokerage; computerised transport information services; computerised information services relating to the carriage of passengers; computerised information services relating to travel reservations; provision of information relating to travel routes; vehicle rental.

42 – Scientific and technological services; research services; design services; industrial analysis and research services; design and development of computer hardware; software design and development; software as a service [SaaS]; rental of computer software and programs; rental and maintenance of computer software; providing temporary use of on-line non-downloadable software; data warehousing; rental services relating to data processing equipment and computers; providing information, advice and consultancy services in the field of computer software; advisory services relating to man-machine interfaces for computer software; advisory services relating to the rental of computers or computer software.

(260) AM 2020 103164 A

(800) 1467107

(151) 2019 03 28

(891) 2019 03 28

(731) APPLE INC.

One Apple Park Way, MS 169-3IPL,
Cupertino CA 95014, USA

(540)



(591) The color(s) black, white and yellow is/are claimed as a feature of the mark

(531) 17.05.01; 17.05.02; 25.07.20; 25.07.21;
26.04.04; 26.04.10; 26.11.07; 26.11.08;
29.01.13

(511)

9 – Augmented reality software for the detection of size, shape, distance and dimensions of objects; augmented reality software for use in leveling of objects and spatial dimensions; computer software for tracking, viewing and displaying augmented experiences.

(260) AM 2020 103165 A

(800) 1467150

(151) 2019 01 03

(891) 2019 01 03

(731) DEEP.KBB GmbH

Ayhauser Allee 2a, 26160 Bad Zwischenahn,
Germany

(540)



(591) Blue and grey

(531) 26.04.04; 26.04.05; 26.04.10; 26.04.12;
26.04.24; 26.13.25; 29.01.13

(511)

37 – Mining extraction, installation, supervision and maintenance of installations for the production of brine and salt, in particular halite and potassium salt; construction, maintenance and monitoring of underground cavities, in particular caverns and pore storage facilities for the storage of gases or liquids for energy supplying purposes or disposals for waste; carrying out drilling and underground work; brine extraction from rock salt for storage and dumping systems and salt extraction; construction supervision.

39 – Transport services; provision of storage facilities of gases or liquids for energy supplying purposes or disposals for waste in underground cavities, in particular caverns and pore storage facilities; storage of gases and liquids for energy supplying purposes; storage of waste.

42 – Scientific and technological services and research relating to technical planning and monitoring of underground cavities, in particular caverns and pore storage facilities for the storage of gases or liquids for energy supplying purposes and underground disposals for waste; engineering; engineering and scientific consultancy, in particular project planning, software development, technical testing, monitoring and quality control services of installations for the storage of gases and liquids and waste material; drawing up of expert technical opinions in connection with the testing of safety in mines and technical safety; providing of geological and geotechnical expert opinions; research and development in the field of underground storage in salt and rock caverns or pore storage facilities; design and development of geoscientific data for determining storage parameters; scientific and technological services and research relating to technical preparation, conducting and documentation of geological engineering in particular in connection with safety-in-mines and environmental protection; preparation of technical reports of geotechnical work; preparation of technical reports in connection with risk assessments and approval procedures; performance of environmental impact assessments; development of geological projects; preparation and implementation of engineering-geological works; planning and design of underground storage reservoirs in abandoned mines; measuring and analysis of hydrodynamic and gas dynamic tests in pore storage facilities; technical design, planning, development and monitoring of surface and underground landfills; technological consultancy in the field of hydrogeology; technological and scientific investigations of contaminated sites; technical design, development and monitoring of brine stations, brine immersing equipment, filling installations and flooding installations; measuring and testing technology services in the field of underground storage and underground disposal technology; planning and carrying out exploratory drilling for geothermal and balneological applications; technical monitoring of production facilities of brine and salt.

(260) AM 2020 103226 A

(800) 1467283

(151) 2018 11 07

(891) 2018 11 07

(731) HNC Healthy Nutrition Company GmbH
Senefelderstr. 44, 51469 Bergisch Gladbach,
Germany

(540)

maxi  muscle

(591) Black, red and white

(531) 01.01.02; 01.01.10; 26.01.01; 26.01.03;
26.01.13; 29.01.13

(511)

5 – Protein dietary supplements; protein supplements for humans; dietary food supplements in the form of ready-to-eat protein bars, not for medical purposes.

21 – Household or kitchen utensils; household or kitchen containers; shakers; cocktail shakers; drinking bottles; drinking vessels; bottles; flasks; vacuum bottles; sports bottles; water bottles comprising a water filter; insulated water bottles; insulated sports bottles; mugs; insulated drinking mugs; insulated coffee mugs; insulated tea mugs; travel mugs; vacuum mugs; hydration systems, consisting of a drink reservoir, a drinking tube and a mouthpiece; dish containers in the form of rucksacks; mugs to go; fruit cups (dishes).

29 – Processed fruit; dried fruit; prepared fruit; preserved fruit; frozen fruit; cooked fruit; fruit salads; fruit snacks; fruit bars; fruit purée; fruit pulp; fruit chips; fruit pastes; fruit powders; fruit jellies; prepared fruit arrangements; fruit peel; fruit desserts; fruit concentrates; snack bars, consisting wholly or predominantly of fruit, fruit concentrates or dried fruit; processed vegetables; dried vegetables; prepared vegetables; preserved vegetables; frozen vegetables; cooked vegetables; vegetable snacks; vegetable bars; vegetable purée; vegetable pulp; vegetable crisps; vegetable pastes; vegetable powders; vegetable jellies; prepared vegetable arrangements; vegetable concentrates; snack bars, consisting wholly or predominantly of vegetables, vegetable concentrates or dried vegetables; milk and milk products; milk-based, whey, yoghurt-based, buttermilk-based, kefir-based or mixed milk beverages, milk predominating, including with fruit and vegetables, singly or in combination; yoghurt; kefir (milk beverage); fat-containing mixtures for bread slices; vegetable-based spreads; spreads consisting predominantly of eggs; fat-containing spreads; fruit-based spreads; vegetable-based spreads; marmalade; marmalade preparations; albumin and protein milk; eggs, milk and milk products; dietetic food, not adapted for medical use, based on meat, fish, eggs and milk with added proteins, hydrolysates, vital substances, vitamins and minerals, singly or in combination, in particular for sports nutrition, including the aforesaid goods in the form of powders, granulates, tablets, capsules, pastes, bars and in liquid form; prepared nuts; seaweed extracts for food; protein milk powder for nutritional purposes; protein milk in powder form for food purposes containing raising agents; nut-based spreads; dietetic food, in particular for sports people, based on eggs, milk, meat and nuts with added proteins,

carbohydrates, hydrolysates, vital substances, vitamins and minerals, singly or in combination, in liquid form, not for medical purposes; spreads based on nuts; nut-based spreads containing protein.

30 – Porridge; muesli; muesli desserts; muesli and energy bars; cereal-based bars; muesli-based snack food; cereal-based snack food; preparations made from cereals; foodstuffs based on oats, cereals, rice, flour and sugar containing carbohydrates; cereal preparations; dietetic food, not adapted for medical use, based on cereals containing carbohydrates with added hydrolysates, vital substances, vitamins and minerals, singly or in combination, in particular for sports nutrition, including the aforesaid goods in the form of powders, granulates, tablets, capsules, pastes, bars and in liquid form; seaweed (condiment); coffee-containing, tea-containing, cocoa-containing and/or chocolate-containing beverage powders, optionally with added milk, including being packaged in individual portions, in particular in capsule form or pad form; tea; tea mixtures; tea-based beverages; chilled tea-based beverages; iced tea; fruit tea; infusions, not medicinal; fruit coulis (sauces); fructose; fruit bread; ice; ice cream; edible ices; iced sweets; iced confectionery; ice cream preparations; coffee; coffee mixtures; coffee-based beverages; iced coffee; chilled coffee-based beverages; frozen yoghurt; chocolate; chocolate mixtures; chocolate-based beverages; drinking chocolate; cocoa and substitutes therefor; cocoa mixtures; cocoa-based beverages; chilled cocoa-based beverages; sweet spreads (honey); honey; chocolate-based spreads; spreads based on chocolate with added nuts; syrup, in particular syrups for making foodstuffs; treacle; preparations for making coffee-based beverages and tea-based and cocoa-based beverages, in particular chilled coffee-based beverages, iced coffee, tea-based beverages, in particular chilled tea-based beverages, iced tea, fruit tea-based beverages, in particular chilled fruit tea-based beverages, cocoa beverages, in particular chilled cocoa-based beverages, drinking chocolate, caffeinated, tea-containing and cocoa-containing beverages, in particular chilled drinking chocolate, all of the aforesaid in the form of single use beverage capsules; preparations for making coffee-based beverages, and tea-based and cocoa-based beverages, in particular chilled coffee-based beverages, iced coffee, tea-based beverages, in particular chilled tea-based beverages, iced tea, fruit tea-based beverages, in particular chilled fruit tea-based beverages, cocoa-based beverages, in particular chilled cocoa-based beverages, drinking chocolate, caffeinated, tea-containing and cocoa-containing beverages, in particular chilled drinking chocolate, all of the aforesaid in the form of single-use beverage concentrate capsules; spreads based on nougat; chocolate-based and/or nougat-based spreads containing protein; dietetic food, in particular for sports people, based on oats and cereals containing carbohydrate preparati-

ons for food with added proteins, hydrolysates, vital substances, vitamins and minerals, singly or in combination, in liquid form.

32 – Non-alcoholic cocktails; non-alcoholic fruit beverages; non-alcoholic vegetable beverages; juices, in particular fruit juices and vegetable juices; fruit nectars; smoothies; smoothies enriched with cereals; concentrates for making soft drinks; syrups for making beverages; beverages flavoured with herbs and herb preparations; non-alcoholic carbonated beverages; non-alcoholic non-carbonated beverages; soda water; flavoured and unflavoured sparkling water; flavoured and unflavoured still water; bitter non-alcoholic beverages; energy drinks; sports beverages; isotonic beverages; non-alcoholic sparkling fruit juice beverages; beers; beer cocktails; protein-enriched beverages; whey beverages; syrups for beverages; syrups for making beverages; preparations for making non-alcoholic beverages in the form of beverage capsules; preparations for making non-alcoholic carbonated beverages, sodas, flavoured still water, flavoured and unflavoured sparkling water, bitter beverages, energy drinks, sports beverages, isotonic beverages, spritzers, juices, in particular fruit juices, vegetable juices or fruit and vegetable juices, smoothies, fruit nectars, beers, beer cocktails, protein-enriched beverages, whey beverages, all of the aforesaid in the form of beverage capsules; preparations for making non-alcoholic beverages in the form of single-use beverage concentrate capsules; preparations for making non-alcoholic carbonated beverages, sodas, flavoured and unflavoured sparkling water, flavoured and unflavoured still water, bitter beverages, energy drinks, sports beverages, isotonic beverages, spritzers, juices, in particular fruit juices, vegetable juices or fruit and vegetable juices, smoothies, fruit nectars, beers, beer cocktails, protein-enriched beverages, whey beverages, all of the aforesaid in the form of single-use beverage concentrate capsules; powder for making beverages; dietetic beverages, not for medical purposes; isotonic beverage powder for making non-alcoholic beverages, not for medical purposes; powder for making isotonic beverages, beverages and sports beverages containing electrolytes, effervescent pastilles for making beverages with electrolyte content; powder for making non-alcoholic isotonic beverages in the form of carbohydrate-electrolyte solutions; powder for making high-protein beverages containing, sweeteners, vitamins, minerals and creatine, either singly or in a combination of two or more of the aforesaid ingredients; non-alcoholic beverages containing sweeteners, vitamins, minerals and creatine, either singly or in a combination of two or more of the aforesaid ingredients.

(260) AM 2020 103228 A

(800) 1467321

(151) 2018 10 30

(891) 2018 10 30

(731) TOBB UND LOJİSTİK YATIRIM ANONİM
ŞİRKETİ

Eskişehir Yol.Kat-Dumlupınar Blv., No.252

Tobb İkiz Kuleler C Kule K.27, Çankaya

Ankara, Turkey

(540)



(591) Blue, red, yellow

(531) 26.11.11; 26.11.12; 26.11.13; 27.01.01;

27.05.09; 27.05.17; 27.05.22; 29.01.13

(511)

9 – Computer programs and software for land, water, rail and intermodal transportation systems.

35 – Collecting, compiling and management services of information in computerized database which are consisting transit notifications and reports; clerical services for document verification/validation related to customs legislation, administration and management services of customer information and/or business information related to customs legislation with the aid of computer data.

36 – Customs brokerage services; services of transit presenting declaration forms to customs office in electronic media; services of providing assurance for customs tariff and similar customs credits that will originate before customs offices domestically and abroad related to the international transportation activities, particularly the international transportations to be performed in accordance with the common transit provisions of common transit convention and customs regulation.

38 – Radio and television broadcasting services, telecommunication services; providing access to Internet, news agencies.

39 – Consultancy services for land, water, rail and intermodal transportation concerning logistic sector; services for renting land, water and air transportation vehicles and services for land, water and air transportation.

42 – Software services for analysis and verification of the appropriateness of custom transit declarations according to the national/international/supranational regulations of customs procedures for goods and services; software services for customer and business information system services related to customs transit declarations.

(260) AM 2020 103249 A

(800) 1467812

(151) 2018 11 06

(891) 2018 11 06

(731) MCDERMOTT, INC.

757 N. Eldridge Parkway, Houston TX 77079,
USA

(540)

MCDERMOTT

(591) Black, white

(531) 25.01.13; 26.03.23

(511)

35 – Business services, namely, procuring qualified personnel, equipment and materials on behalf of others and business management services in the field of construction, installation and repair of containers, tanks, industrial storage and processing spheres, terminals, towers and tanks, storage vessels and pressure vessels, sea platforms, offshore platforms, power units, refinery units, liquefied natural gas [LNG] processing units, petrochemical units, industrial units, pipelines, drainage systems, dredging systems, mooring systems; business services, namely, procuring qualified personnel, equipment and materials on behalf of others and business management services in the field of equipment for petroleum, petrochemical and natural gas exploration, production, storage, transport and distribution, instrumentation, measuring equipment systems, illuminating units and dredging; procurement of repair and replacement components used in the above items.

37 – Construction, installation and repair services of vessels, namely, containers, industrial storage and processing spheres, terminals, towers and tanks, storage vessels and pressure vessels, sea platforms, offshore platforms, tanks, power plants, refinery units, LNG processing units, petrochemical units, industrial units, pipelines, drainage systems, dredging systems, mooring systems, construction, installation and repair of equipment for the exploration, production, processing, storage, transport and distribution of petroleum products, petrochemicals and natural gas, instrumentation and measuring equipment systems, illuminating units and any of the units constructed or installed above; repair of metallic components used in the above construction, installation and repair services.

42 – Design, engineering, inspection and testing services for others in the fields of vessels, namely, containers, industrial storage and processing spheres, terminals, towers and tanks, storage vessels and pressure vessels, sea platforms, offshore platforms, platforms for sulfur production, tanks, power plants, refinery units, liquefied natural gas [LNG] processing plants and units, petrochemical plants and units, industrial plants, pipelines, drainage systems, dredging systems, mooring systems, oil and gas exploration and production systems, petroleum processing facilities, instrumentation systems, lighting systems.

(260) AM 2020 103251 A
 (800) 1467836
 (151) 2018 10 24
 (891) 2018 10 24
 (731) Grupa LOTOS S.A.
 ul. Elbląska 135; PL-80-718 Gdańsk, Poland



(591) Blue, white, red
 (531) 01.15.05; 01.15.15; 01.15.23; 27.05.01; 29.01; 29.01.12

(511)
 4 – Engine oils, industrial oils for surface lubrication, technological oils included in this class, lubricating, motor oils, grease for machines, combustible oils, fuel oils, compressor, turbine, machine, marine oils, gasoline and diesel oils; mineral, semi-synthetic, synthetic oils.

(260) AM 2020 103255 A
 (800) 1467956
 (151) 2018 12 05
 (891) 2018 12 05
 (731) New Yorker S.H.K. Jeans GmbH & Co. KG
 Russeer Weg 101-103, 24109 Kiel, Germany

(540)



(591) Black, white, red
 (531) 27.01.09; 27.05.19; 29.01.13
 (511)

36 – Financial affairs; issuance of tokens of value; financial services, namely financial management and administration services for bonus schemes (in the form of a customer loyalty system).

38 – Telecommunications; providing access to data networks; providing of access to databases; providing of access to platforms and portals on the Internet, including in the form of an app, in the fields of bonus, promotional, customer loyalty and/or reward schemes; providing of access to information on the Internet in the fields of bonus, promotional, customer loyalty and/or reward schemes.

42 – Technical coordination and support of a bonus scheme (in the form of a customer loyalty system); electronic data storage.

(260) AM 2020 103259 A
 (800) 1468000
 (151) 2018 10 12
 (891) 2018 10 12
 (731) Prénatal Retail Group S.p.A.
 Via Vincenzo Gioberti, 1, I-20123 Milano MI, Italy

(540)



(591) Black, white
 (531) 02.09.01; 27.03.01; 27.03.02

(511)
 3 – Bleaching preparations and other substances for laundry use; polishing preparations; soaps; perfumery, essential oils, cosmetics, hair lotions; dentifrices; cologne; lavender water; toilet water; perfume water; ammonia [volatile alkali] [detergent]; aloe vera preparations for cosmetic purposes; amber [perfume]; starch glaze for laundry purposes; fabric softeners; aromatics; flavourings for beverages [essential oils]; cake flavorings [essential oils]; astringents for cosmetic purposes; balms, other than for medical purposes; bath foam; flower perfumes (bases for -); cotton sticks for cosmetic purposes; javelle water; laundry wax; polishing wax; laundry blue; colorants for toilet purposes; cosmetics; cosmetic creams; barrier creams; polishing creams; skin whitening creams; washing soda, for cleaning; deodorants for human use (perfumery); detergents, other than for use in manufacturing operations and for medical purposes; heliotropine; soap free washing emulsions for the body; badian essence; mint essence [essential oil]; oil of turpentine for degreasing; bergamot oil; ethereal essences; extracts of flowers [perfumes]; massage gels, other than for medical purposes; dental bleaching gels; geraniol; cleaning chalk; greases for cosmetic purposes; incense; ionone [perfumery]; almond milk for cosmetic purposes; cleansing milk for toilet purposes; scented wood; hair lotion; lotions for cosmetic purposes; lip gloss; shoe wax; cosmetic masks; mint for perfumery; transfers (decorative -) for cosmetic purposes; musk [perfumery]; cosmetic kits; oils for toilet purposes; massage oils; essential oils; cedarwood (essential oils of -); essential oils of lemon; oils for perfumes and scents; oils for cleaning purposes; oils for cosmetic purposes; gaultheria oil; jasmine oil; lavender oil; almond oil; rose oil; non-medicated shower oils; non-medicated bath oils; cotton wool for cosmetic purposes; smoothing stones; polishing stones; pumice stone; alum stones [astringents]; pomades for cosmetic purposes; potpourris [fragrances]; tanning preparations; baths (cosmetic preparations for -); douching preparations for perso-

nal sanitary or deodorant purposes [toiletries]; laundry glaze; polishing preparations; sunscreen preparations; color- [colour-] brightening chemicals for household purposes [laundry]; skincare cosmetics; perfumery; laundry preparations; antiperspirants [toiletries]; fumigation preparations [perfumes]; laundry bleach; mouth washes, not for medical purposes; nail care preparations; cleaning preparations; toiletries; smoothing preparations [starching]; laundry soaking preparations; sachets for perfuming linen; degreasers, other than for use in manufacturing processes; make-up removing preparations; paint removers; perfume; air fragrancing preparations; starch for laundry purposes; bath salts, not for medical purposes; bleaching salts; cloths impregnated with a detergent for cleaning; almond soap; bar soap; antiperspirant soap; deodorant soap; soaps in liquid form; shampoo; dry shampoos; destainers; emery; bleaching soda; refurbishing preparations; breath freshening sprays; cloths impregnated with a detergent for cleaning; talcum powder, for toilet use; abrasive cloth; emery cloth; glass cloth [abrasive cloth]; terpenes [essential oils]; dyes (cosmetic -); beard dyes; tissues impregnated with cosmetic lotions; cotton sticks for cleaning the ears; body creams; non-medicated creams, in particular cream for nappy changing; sun creams (cosmetics); detergents for washing machines; cleansing milk for toilet purposes; cold creams, other than for medical use; scented sachets.

5 – Pharmaceuticals; sanitary preparations for medical purposes; dietetic foodstuffs and substances adapted for medical use; infant formula; food supplements for humans; plasters, materials for dressings; disinfectants; preparations for destroying vermin; acaricides; fly catching paper; sea water for medicinal bathing; melissa water for pharmaceutical purposes; goulard water; mineral waters for medical purposes; thermal water; nutritional supplements; dietetic foods adapted for medical use; starch for dietetic or pharmaceutical purposes; amino acids for medical purposes; anaesthetics; antiseptics; dressings, medical; sanitary towels; absorbent articles for personal hygiene; menstruation bandages; post-partum pads; styptic preparations; oxygen baths; bath preparations for medical purposes; balms for medical purposes; stick liquorice for pharmaceutical purposes; sanitary wear; bandages for dressings; medicated dressings; dietetic beverages adapted for medical purposes; bicarbonate of soda for pharmaceutical purposes; medicine cases, portable, filled; wrist bands sold pre-filled with insect repelling preparations; medicated candy; rubber for dental purposes; quinquina for medical purposes; quinine for medical purposes; chinoline for medical purposes; belts for sanitary napkins [towels]; collyrium; compresses; cachets for pharmaceutical purposes; sterile gauze pads; antiseptic cotton; aseptic cotton; cotton for medical use; breast-nursing pads; decoctions for phar-

maceutical purposes; deodorants other than for personal use; air deodorising preparations; deodorants for clothing and textiles; depuratives; detergents for medical purposes; digestives for pharmaceutical purposes; disinfectants for hygiene purposes; disinfectants impregnated into tissues; balsamic preparations for medical purposes; eucalyptus for pharmaceutical purposes; eucalyptol for pharmaceutical purposes; evacuants; lacteal flour for babies; flour for pharmaceutical purposes; first-aid boxes, filled; milk ferments for pharmaceutical purposes; ferments for pharmaceutical purposes; fibre (dietary -); fennel for medical purposes; gauze for dressings; glycerine for medical purposes; adhesive bands for medical purposes; insect repellent incense; medicinal infusions; insecticides; insect repellents; alginate dietary supplements; casein dietary supplements; enzyme dietary supplements; wheat germ dietary supplements; glucose dietary supplements; lecithin dietary supplements; yeast dietary supplements; pollen dietary supplements; propolis dietary supplements; protein dietary supplements; protein supplements for animals; mineral food supplements; iodine for pharmaceutical purposes; almond milk for pharmaceutical purposes; malted milk beverages for medical purposes; milk sugar for pharmaceutical purposes; cedar wood for use as an insect repellent; liquorice for pharmaceutical purposes; lotions for pharmaceutical purposes; eyepatches for medical purposes; bandaging material; haemostatic pencils; medicines for human purposes; medicines for dental purposes; mint for pharmaceutical purposes; menthol; moleskin for medical purposes; fly destroying preparations; pants, absorbent, for incontinents; sanitary pants; adhesive bands for medical purposes; medicinal oils; camphor oil for medical purposes; cod liver oil; castor oil for medical purposes; flaxseed oil dietary supplements; absorbent cotton; wadding for medical purposes; babies' diaper-pants; incontinence diapers; babies' diapers; royal jelly dietary supplements; royal jelly for pharmaceutical purposes; parasiticides; jujube, medicated; pomades for medical purposes; aloe vera preparations for pharmaceutical purposes; preparations for topical treatment of insect bites; preparations of trace elements for human use; teething (preparations to facilitate -); bath (therapeutic preparations for the -); sunburn ointments; biological preparations for medical purposes; chemico-pharmaceutical preparations; sunburn preparations for pharmaceutical purposes; burns (preparations for the treatment of -); pharmaceutical preparations for skin care; organotherapy preparations; fumigation preparations for medical purposes; diagnostic preparations for medical purposes; air purifying preparations; mouthwashes for medical purposes; insect repellents; propolis for pharmaceutical purposes; panty liners; chemical reagents for medical use; tonics [medicines]; constipation (medicines for alleviating -); remedies for perspiration; mineral water salts; potassium salts for

medical purposes; sodium salts for medical purposes; smelling salts; salts for mineral water baths; bath salts for medical purposes; salts for medical purposes; syrups for pharmaceutical purposes; solvents for removing adhesive plasters; dietetic substances adapted for medical use; cooling sprays for medical purposes; vulnerary sponges; surgical dressings; sulfur sticks [disinfectants]; tampons; breast-nursing pads; medicinal tea; tincture of iodine; tinctures for medical purposes; herbal teas for medicinal purposes; tissues impregnated with pharmaceutical lotions; cachou for pharmaceutical purposes; mercurial ointments; ointments for pharmaceutical purposes; medicated creams; anti-bacterial preparations; antibacterial gels; anti-inflammatory gel for the gums; cold cream for medical use; sterile solutions for medical purposes; sterilising solutions; disinfectant soap; medicated soap; anti-bacterial cleaners.

7 – Food processors, electric; electric babies' food processors.

8 – Hand tools and implements (hand-operated); cutlery; silver plate [knives, forks and spoons]; whetstone holders; manicure sets; pedicure sets; knives; table cutlery [knives, forks and spoons]; spoons; ladles [hand tools]; scissors; nail scissors; table forks; rasps [hand tools]; nail files; nail files, electric; hair clippers for personal use, electric and non-electric; nail nippers; cutlery for use by children; plastic cutlery; cutlery of silicon; manicure sets, electric; nail clippers, electric or non-electric; vegetable slicers; penknives; meat choppers [hand tools]; vegetable choppers; insecticide sprayers [hand tools].

9 – Weighing, measuring, signalling, checking (supervision), life-saving and teaching apparatus and instruments; apparatus for recording, transmission or reproduction of sound or images; magnetic data carriers, recording discs; compact discs, DVDs and other digital recording media; data processing equipment, computers; computer software; precision measuring apparatus; projection apparatus; weighing apparatus and instruments; regulating apparatus, electric; measuring devices, electric; monitoring apparatus, electric; amplifiers; audiovisual teaching apparatus; diagnostic apparatus, not for medical purposes; sound recording apparatus; sound reproduction apparatus; sound transmitting apparatus; transparency projection apparatus; security surveillance apparatus; radios; teaching apparatus; spectacle cases; video baby monitors; electric access security apparatus; scales; decorative magnets; integrated circuit cards [smart cards]; video game cartridges; head protection; protective helmets for sports; safety restraints, other than for vehicle seats and sports equipment; discs (compact -) [audio-video]; wearable computers; measuring spoons; plug socket covers; head protection; transparencies [photography]; floppy discs; phonograph records; music CDs; animated cartoons; anti-interference devices [electricity]; igni-

tion (electric apparatus for remote -); safety locking devices [electric]; dosimeters; downloadable image files; downloadable music files; record players; hygrometers; temperature indicating apparatus; speaker phones; compact disc players; disk drives for computers; DVD players; readers [data processing equipment]; portable media players; cassette players; cameras; rules [measuring instruments]; spectacle frames; monitors; voice monitors; intercoms; sunglasses; spectacles [optics]; clocks (time -) [time recording devices]; lactometers; games software; audio- and video-receivers; telephone receivers; life preservers; computer software, recorded; measuring instruments; sound recording carriers; magnetic data media; optical data media; thermometers, not for medical purposes; thermometers for testing water temperature; bath thermometers; encoded magnetic cards; tablet computers.

10 – Medical and dental apparatus and instruments; orthopedic articles; suture materials; teething rings; aerosol dispensers for medical purposes; obstetric apparatus; fumigation apparatus for medical purposes; massage apparatus; nursing appliances; diagnostic apparatus for medical purposes; body cavities (appliances for washing -); esthetic massage apparatus; hot air therapeutic apparatus; ice bag pillows for medical purposes; water bags for medical purposes; feeding bottle receptacles; babies' bottles of polypropylene; elastic stockings for surgical purposes; wheeled trolleys adapted for use as walking aids; feeding bottle valves; umbilical belts; belts for orthopaedic purposes; maternity belts; droppers for medical purposes; abdominal corsets; spoons for administering medicine; thermal packs for first aid purposes; air cushions for medical purposes; cushions for medical purposes; pads (heating -), electric, for medical purposes; covers for baby feeding bottles; cases for dummies for babies; aerosol dispensers for medical purposes; bandages, elastic; slings [supporting bandages]; corsets for medical purposes; gloves for massage; incontinence sheets; mouth guards for medical purposes; feeding bottle receptacles; feeding bottles (babies' bottles); nipple shields for personal use; ear picks; feeding bottle receptacles; containers for use with breast pumps; hypodermic syringes; injection syringes; dummies for babies; orthopedic soles; thermometers for medical purposes; cases for thermometer probes for medical use; feeding bottle teats; feeding bottle teats; breast pumps; breast pumps for use by nursing mothers; draw-sheets for sick beds; humidifying apparatus for medical use; sprayers for medical purposes; nasal aspirators; neonatal pacifiers; bracelets for medical purposes; cups adapted for feeding babies and infants.

11 – Apparatus for lighting, heating, steam generating, cooking, refrigerating, drying, ventilating; hot air apparatus; microwave ovens; deodorising apparatus, not for personal use; ionization apparatus for

the treatment of air; ventilation [air-conditioning] installations and apparatus; air purifying apparatus and machines; lighting apparatus and installations; cooling appliances and installations; cooking apparatus and installations; heating apparatus, electric; kilns; steaming apparatus (electric -) for cooking; fumigation apparatus, not for medical purposes; beverage cooling apparatus; disinfectant apparatus; hair driers [dryers]; electric kettles; germicidal burners; heating cushions [pads], electric, not for medical purposes; light diffusers; driers (air -); evaporators; steam generating installations; chandeliers; street lamps; arc lamps; electric lamps; lamps; lights, electric, for Christmas trees; light bulbs; lamp shades; water heaters [apparatus]; air heating apparatus; heaters, electric, for feeding bottles; baby bottle warmers; food warmers; toilet seats; sterilisers; sterilisers for babies' feeding bottles; humidifiers; humidifiers; room humidifiers; humidifiers [other than for medical use]; electric cooking equipment; bathtubs; electric yoghurt makers.

20 – Furniture, mirrors, picture frames; bed fittings, not of metal; furniture fittings, not of metal; door fittings, not of metal; wardrobe lockers; security cabinets; clothes stands; coatstands; benches [furniture]; chests, not of metal; playpens; expandable safety gates for stairs; infant walkers; chests for toys; chests of drawers; basketry; safety locks [non-metallic, non-electric]; child resistant security closures (non-metallic -) for containers; containers, not of metal [storage, transport]; picture frames; bassinets; safety cots; cushions; support pillows for use in car safety seats for babies and children; nursing pillows; pregnancy cushions; air cushions, not for medical purposes; towel dispensers, fixed, not of metal; divans; display racks; corner cap components of furniture, not of metal; baby changing platforms; figurines [statuettes] of wood, wax, plaster or plastic; hooks, not of metal, for clothes rails; clothes hooks, not of metal; safety hooks, not of metal; infant walkers; clothes hangers and clothes hooks; pillows; air pillows, not for medical purposes; signboards of wood or plastics; beds; mattresses; changing mats; furniture; furniture for children's bedrooms; wind chimes [decoration]; mattress (straw -); screens [furniture]; armchairs for small children; book rests [furniture]; playpens; mattresses; furniture shelves; shelves for storage; racks; filing cabinets; boxes of wood or plastic; babies' bouncing chairs; writing desks; sun loungers; seats; babies' chairs; baby bouncers; high chairs for babies; stools; mirrors (silvered glass); hand-held mirrors [toilet mirrors]; mats for infant playpens; drafting tables; wood bedsteads; interior textile window blinds; vats, not of metal; armchairs; bed rails; wooden chests of drawers; cot bed; seats adapted for babies; security closures, not of metal, in particular: oven guards in the nature of fire guards, cabinet safety locks, wardrobe safety locks, drawer safety locks, door safety locks; crib bumpers; bum-

per pads for cots; crib bumpers; bumper pads for cots; anti mites mattresses; anti mites pillows.

21 – Household or kitchen utensils and containers; combs and sponges; brushes (except paintbrushes); articles for cleaning purposes; deodorising apparatus for personal use; polishing apparatus and machines, for household purposes, non-electric; aerosol dispensers, not for medical purposes; basins [bowls]; beverage glassware; beakers with spouts for children; cups of paper or plastic; bottles; glass flasks [containers]; insulating flasks; refrigerating bottles; insulating flasks; pitchers; straws for drinking; baskets for household purposes; waste paper baskets; heat-insulated containers; thermal containers for babies' bottles (non-electric); portable cool boxes, non-electric; covers for dishes; pot lids; mixing spoons [kitchen utensils]; comb cases; electric devices for attracting and dispersing insects; soap dispensers; water apparatus for cleaning teeth and gums; milk powder dispensers; electric apparatus for killing insects; blenders, non-electric, for household purposes; flasks; whisks, non-electric, for household purposes; portable cool boxes, non-electric; kitchen graters; basting spoons [cooking utensils]; toilet cases; picnic baskets (fitted -), including dishes; cleaning rags; dustbins; combs; comb (electric); combs for the hair (large-toothed -); plates to prevent milk boiling over; plates; serving platters; paper plates; plastic plates; disposable table plates; saucers; cutlery trays; soap dishes; sponge holders; table napkin holders; fruit presses, non-electric, for household purposes; drinking vessels; lunch boxes; containers for household or kitchen use; kitchen containers; thermally insulated containers for food; non-metal coin banks; heaters for feeding bottles, non-electric; metal boxes for dispensing paper towels; cookie jars; soap boxes; baby bottle drying racks; buckets; trivets [table utensils]; brushes; hair for brushes; nail brushes; dishwashing brushes; brushes for cleaning tanks and containers; brushes for cleaning feeding bottles; feeding bottle brushes; toilet brushes; toothbrushes; toothbrushes, electric; nail brushes; toilet sponges; sponges for household purposes; cake moulds; cookery molds [moulds]; cleaning instruments, hand-operated; cups; saucepans (earthenware -); insect traps; kitchen grinders, non-electric; cosmetic utensils; cooking utensils, non-electric; kitchen utensils; household utensils; toilet utensils; perfume vaporizers; baby baths, portable; baby bath tubs; pots; vases; chamber pots; chamber pots; diaper pails; food storage containers; training cups for babies and children.

25 – Clothing, footwear, headgear; clothing of imitations of leather; leather clothing; clothing for gymnastics; gowns; robes; non-slipping devices for footwear; bandanas [neckerchiefs]; plastic baby bibs; bibs, not of paper; caps [headwear]; berets; underwear; maternity underwear; blouses; boas [nec-

klets]; teddies [underclothing]; suspenders; corsets; goloshes; footwear; training shoes; stockings; slippers; socks; breeches; short-sleeve shirts; shirts; hats; hats (paper -) [clothing]; coats; hoods [clothing]; belts [clothing]; belts (money -) [clothing]; tights; shoulder wraps; detachable collars; headgear; neck scarves [mufflers]; ear muffs [clothing]; layettes [clothing]; suits; beachwear; masquerade costumes; neckties; bathing caps; shower caps; headbands [clothing]; pocket squares; gaiters; jackets [clothing]; skirts; pinafore dresses; aprons [clothing]; girdles; gloves [clothing]; ski gloves; mackintoshes; ready-to-wear clothing; paper clothing; knitwear [clothing]; jumpers; leg warmers; leggings [trousers]; jumpers; hosiery; swimsuits; sweaters; muffs [clothing]; pelerines; skorts; maternity underwear; boxer shorts; bathing drawers; babies' pants [clothing]; trousers; mules; parkas; pelisses; pyjamas; ponchos; sweaters; brassieres; nursing bras; sandals; bath sandals; shoes; infants' footwear; children's shoes; bath slippers; gymnastic shoes; beach shoes; training shoes; ski boots; shawls; sashes for wear; briefs; topcoats; outerclothing; knee-high stockings; half-boots; boots; tee-shirts; combinations [clothing]; visors [headwear]; wooden shoes; disposable maternity underwear.

(260) AM 2020 103260 A

(800) 1468010

(151) 2019 03 11

(891) 2019 03 11

(731) Saxo Bank A/S

Philip Heymans Allé 15, DK-2900 Hellerup,
Denmark

(540)

SaxoInvestor

(591) Black, white

(511)

9 – Computer software for use for an electronic trading platform, allowing users to trade securities, currencies and financial instruments online; application software; applications, downloadable, for use with/on computers, tablet computers, laptops, telephones, mobile telephones, smart phones, personal digital assistants (PDA), the Internet and other mobile and wireless apparatus, devices and equipment.

36 – Financial affairs, including financial information, financial management and financial analysis; processing of financial transactions online via a global computer network or via telecommunications, mobile or wireless devices; financial calculations for others, namely financial calculation of investment costs; investment consultancy, namely identifying and providing investment opportunities for investors; financial management, namely capital management; investment and portfolio management services; banking services; investment consultancy; fi-

ancial management, namely financial management; financial asset management and disposition; advisory, information and consultancy services relating to all the aforesaid services, including such services provided on-line from a computer database or via the Internet or extranets.

42 – Scientific and technological services and research and design relating thereto; industrial analysis and research services; design and development of computer hardware and software; updating of computer software; providing temporary use of web-based applications; providing of temporary use of non-downloadable software; hosting of platforms on the Internet; hosting of computerized data, files, applications and information; providing of an electronic trading platform and application software for mobile devices, allowing users to trade securities, currencies and financial instruments online.

(260) AM 2020 103261 A

(800) 1468071

(151) 2019 04 08

(891) 2019 04 08

(731) BRUICHLADDICH DISTILLERY
COMPANY LIMITED

The Bruichladdich Distillery, Islay, Argyll
PA49 7UN, United Kingdom

(540)



(591) Black, white

(531) 19.07.01; 19.08.01

(554) მოცულობითი

(526) "ISLAY SINGLE MALT", "HEBRIDEAN
DISTILLERS"

(511)

33 – Alcoholic beverages, except beers, containing single malt Scotch Whisky and Scotch Whisky based liqueurs produced in the Islay region of Scotland.

(260) AM 2020 103263 A

(800) 1468113

(151) 2018 12 19

(891) 2018 12 19

(731) NATTURA LABORATORIOS, S.A. DE C.V.
Pedro Martínez Rivas #746, Colonia Parque
Industrial Belenes, 45145 Zapopan, Jalisco,
Mexico

(540)

(591) Black, white

(531) 27.05.01; 27.05.19

(511)

3 – Hair bleaches; hair preparations and treatments; shampoos; permanent waving lotion; neutralizers for permanent waving; hair colorants; hair styling gels; hair gels; hair styling waxes; hair strengthening treatment lotions; hydrogen peroxide for cosmetic use; hair spray; conditioners for the hair; creams for the hair.

(260) AM 2020 103264 A

(800) 1468167

(151) 2019 02 07

(891) 2019 02 07

(731) Traxxas, L.P.

6250 Traxxas Way, McKinney TX 75070,
USA

(540)

(591) Black, white

(531) 27.05.01; 27.05.19

(511)

9 – Batteries and battery chargers.

(260) AM 2020 103265 A

(800) 1468180

(151) 2019 03 18

(891) 2019 03 18

(731) JOSÉ EISENBERG

24, Avenue Princesse Grace, Monte-Carlo,
MC-98000 Monaco, Monaco

(540)

EISENBERG YOUTH

(591) Black, white

(511)

3 – Non-medicated cosmetics, non-medicated soaps, soaps for cosmetic use, body soaps, cosmetic bath preparations, hair shampoos, non-medicated shampoos, perfumery products, perfumes, scented water, deodorants for personal cosmetic use, cosmetic products for skin care, lotions for cosmetic use, beauty masks, skin whitening creams, make-up removing products, oils for cosmetic use, cosmetic preparations for slimming purposes, cosmetic preparations for tanning the skin, make-up products, lipsticks, lip

gloss, pencils for cosmetic use, blushes, mascara for eyelashes, nail polish, make-up powders, make-up foundation; non-medicated hair lotions, hair sprays.

(260) AM 2020 103266 A

(800) 1468189

(151) 2019 03 28

(891) 2019 03 28

(731) HERMES INTERNATIONAL

24 rue du Faubourg Saint-Honoré, F-75008
PARIS, France

(540)

HERMES EAU D'ORANGE VERTE

(591) Black, white

(511)

3 – Perfumes, perfumery products, toilet water, eau de parfum, eau de Cologne, essential oils for personal use, cosmetics, make-up products, cosmetic lotions for the body, hair lotions, soaps for cosmetic use, soaps for the body, deodorants for personal use, gels for the bath, gels for the shower, shampoos, beauty creams for the body.

(260) AM 2020 103268 A

(800) 1468229

(151) 2019 04 09

(891) 2019 04 09

(731) CELOTECH CHEMICAL CO., LTD

ROOM 101, COMPLEX BUILDING
NORTH, SECOND FLOOR, NO.48
ZOU MATANG ROAD, MUDU,
WUZHONGQU, SUZHOU, 215000
JIANGSU, China

(540)

CELOPRO

(591) Black, white

(531) 27.05.01

(511)

1 – Starch for industrial purposes; cellulose esters for industrial purposes; cellulose ethers for industrial purposes; agglutinants for concrete; glucosides; cellulose; cellulose derivatives [chemicals]; polyvinyl acetate emulsion; celluloid; chemical additives to drilling muds.

(260) AM 2020 103269 A

(800) 1468241

(151) 2019 04 09

(891) 2019 04 09

(731) ZHEJIANG UNIVERSEFILTER CO., LTD.

AREA B, NORTH INDUSTRIAL PARK,
TANGXIA, RUIAN, ZHEJIANG
PROVINCE, China

(540)



(591) Black, white

(531) 01.05.01; 27.05.08; 27.05.22

(511)

7 – Carburettors; fuel conversion apparatus for internal combustion engines.

(260) AM 2020 103270 A

(800) 1468248

(151) 2019 03 05

(891) 2019 03 05

(731) TOP SEEDS INTERNATIONAL LTD.
1523200 Sharon, Israel

(540)



(591) The colors blue green and black are claimed as a feature of the mark

(531) 26.01.01; 26.01.06; 26.03.01; 26.15.01;
27.05.10; 27.05.15; 29.01.13

(511)

31 – Seeds; plants and seedlings; fresh fruits and vegetables.

(260) AM 2020 103271 A

(800) 1468262

(151) 2019 03 04

(891) 2019 03 04

(731) MEDSPA LABORATOIRES
68 rue du Faubourg Saint-Honoré, F-75008
PARIS, France

(540)

MEDSPA
L A B O R A T O I R E S

(591) Black, white

(531) 27.05.09; 27.05.10

(511)

3 – Cosmetics; cotton wool and absorbent cotton for cosmetic use; cleansing creams; nail polish; beauty masks; lipstick; cosmetic preparations for baths; lip glosses; cosmetics for animals; scented room sprays; all these goods being manufactured under medical supervision; soaps and cakes of soap; hair lotions; cosmetic preparations for slimming; moisturizing hair conditioners; bubble bath; shampoos; essential oils; all these goods are for medical use.

(260) AM 2020 103280 A

(800) 1468402

(151) 2019 03 04

(891) 2019 03 04

(731) JOSE MIGUEL CASANOVA ROSELL
Rambla Celler, 91, entreplanta 4, SAN
CUGAT DEL VALLÉS, Spain

(540)



(591) Turquoise, green, gray, white and dark blue

(531) 26.01.05; 27.05.01; 27.05.09; 29.01.14

(511)

10 – Surgical, medical, dental and veterinary apparatus and instruments; artificial limbs, eyes and teeth; orthopedic articles, suture material.

35 – Advertising, business management, commercial administration, office functions.

44 – Medical services, veterinary services, hygienic and beauty care for human beings or animals; agriculture, horticulture and forestry services.

(260) AM 2020 103287 A

(800) 798072

(151) 2003 01 11

(891) 2019 05 07

(731) MEDI plus TEC Medizinisch-technische
Handelsgesellschaft mbH
Baerler Strasse 100, 47441 Moers,
Germany

(540)

D & J

(591) Black, white

(511)

34 – Cigarettes, tobacco, smokers' articles, matches.

(260) AM 2020 103350 A

(800) 1468620

(151) 2019 03 13

(891) 2019 03 13

(731) Werner Handle GMBH
Am Gutshof 1, A-2171 Herrnbaumgarten,
Austria

(540)



(591) Blue

(531) 01.01.10; 01.03.01; 06.01.04; 26.01.19;
27.05.01; 29.01.04

(511)
32 – Non-alcoholic beverages; preparations for making beverages; beer and brewery products; soft drinks; non-alcoholic beverages.

33 – Alcoholic beverages (except beer); preparations for making alcoholic beverages; cider.

(260) AM 2020 103354 A

(800) 1468657

(151) 2019 03 01

(891) 2019 03 01

(731) Public Joint-Stock Company, "KRASNYJ OCTYABR"

ul. Malaya Krasnoselskaya, d. 7, str. 24,
RU-107140 Moscow, Russian Federation

(540)



(591) Gray, orange, red, white and brown

(531) 19.03.24; 25.07.01; 26.11.13; 27.05.01;
29.01.13

(526) Toffee de luxe

(511)

30 – Sweetmeats [candy].

(260) AM 2020 103357 A

(800) 1468696

(151) 2019 03 21

(891) 2019 03 21

(731) Obschestvo s ogranichennoy
otvetstvennostyu "PETROGLYPH"

per. Lesozavodskoy, 2, Altayskiy rayon,
s. Altayskoe, RU-659653 Altayskiy kray,
Russian Federation

(540)

EPOS

(591) Black, white

(511)

32 – Waters [beverages]; aerated water; mineral water [beverages]; table waters; cocktails, non-alcoholic; lemonades; non-alcoholic beverages; isotonic beverages; non-alcoholic honey-based beverages; protein-enriched sports beverages; non-alcoholic beverages flavored with coffee; non-alcoholic beverages flavored with tea.

(260) AM 2020 103360 A

(800) 1468720

(151) 2018 11 16

(891) 2018 11 16

(731) HUAWEI TECHNOLOGIES CO., LTD.
Administration Building Huawei Technologies Co., Ltd. Bantian, Longgang District
Shenzhen, China

(540)

MATE

(591) Black, white

(511)

9 – Encoded identification bracelets, magnetic; pedometers; electric monitoring apparatus; screens for mobile phones; computer keyboards; mouse (computer peripheral); wearable network communication apparatus with the functions of making calls, monitoring sleeping quality, recording and managing activities; modems; covers for telephones; stands adapted for tablet computers; protective cases for tablet computers; headphones; computer networking gateways; network communication apparatus; cell phone straps; wearable computers with the functions of making calls, monitoring sleeping quality, recording and managing activities; earphones; television apparatus; set-top boxes; portable cabinets for loudspeakers; portable media players; sound transmitting apparatus; camcorders; digital photo frames; routers; smartphones; covers for smartphones; supports for mobile phones; protective cases for mobile phones; electric batteries for mobile phones; tablet computers; covers for tablet computers.

(260) AM 2020 103372 A

(800) 1468864

(151) 2019 03 26

(891) 2019 03 26

(731) HAUTE FRAGRANCE COMPANY, SIA
Kalnupes iela 3, Mārupe, LV-2167 Mārupes
nov., Latvia

(540)

VOODOO CHIC

(591) Black, white

(511)

3 – Perfumery and fragrances (eau de parfum).

(260) AM 2020 103373 A

(800) 1468866

(151) 2019 03 26

(891) 2019 03 26

(731) HAUTE FRAGRANCE COMPANY, SIA
Kalnupes iela 3, Mārupe, LV-2167 Mārupes
nov., Latvia

(540)

WEAR LOVE EVERYWHERE

(591) Black, white

(511)

3 – Perfume and fragrances (eau de parfum).

(260) AM 2020 103377 A

(800) 1468895

(151) 2019 03 15

(891) 2019 03 15

(731) Limited liability company "PIQ-PHARMA"
Oruzheyniy pereulok, d. 25, str. 1, RU-125047
Moscow, Russian Federation

(540)

(591) Black, white

(531) 28.05

(511)

5 – Pharmaceutical preparations; veterinary preparations; hygiene preparations for medical purposes; vitamin preparations; dietetic substances adapted for medical use; medicines for human purposes; food for babies; dietetic foods adapted for medical purposes; dietary supplements.

10 – Analyzers for bacterial identification for medical purposes; blood testing apparatus; testing apparatus for medical purposes; nasal aspirators; vaporizers for medical purposes; containers especially made for medical waste; clips, surgical; acupuncture needles; suture needles; needles for medical purposes; orthopedic articles; inhalers; hydrogen inhalers; injectors for medical purposes; electric acupuncture instruments; droppers for medical purposes; dropper bottles for medical purposes; catheters; respiratory masks for artificial respiration; anaesthetic masks; suture materials; thread, surgical; boots for medical purposes; orthopedic footwear; clothing especially for operating rooms; compression garments; blankets, electric, for medical purposes; condoms; aerosol dispensers for medical purposes; medical apparatus and instruments; brushes for cleaning body cavities; appliances for washing body cavities; receptacles for applying medicines; vaginal syringes; implantable subcutaneous drug delivery devices; contraceptives, non-chemical; orthopedic soles; arch supports for footwear; ear plugs [ear protection devices]; thermal packs for first aid purposes; stockings for varices; splints, surgical; syringes for injections; syringes for medical purposes; hypodermic syringes; uterine syringes; urethral syringes.

35 – Import-export agency services; rental of advertising space; demonstration of goods; market studies; business information; commercial information and advice for consumers in the choice of products and services; business research; professional business consultancy; targeted marketing; updating and maintenance of data in computer databases; organization of exhibitions for commercial or advertising purposes; design of advertising materials; commercial in-

termediation services; providing business information via a web site; provision of commercial and business contact information; provision of an online marketplace for buyers and sellers of goods and services; web indexing for commercial or advertising purposes; presentation of goods on communication media, for retail purposes; sales promotion for others; publication of publicity texts; distribution of samples; dissemination of advertising matter; advertising; online advertising on a computer network; compilation of information into computer databases; systemization of information into computer databases; negotiation of business contracts for others; negotiation and conclusion of commercial transactions for third parties; compiling indexes of information for commercial or advertising purposes; wholesale services for pharmaceutical, veterinary and sanitary preparations and medical supplies; retail services for pharmaceutical, veterinary and sanitary preparations and medical supplies; business management for freelance service providers; commercial administration of the licensing of the goods and services of others; administration of consumer loyalty programs; administrative processing of purchase orders; procurement services for others [purchasing goods and services for other businesses]; all mentioned above services for pharmaceutical, veterinary and sanitary preparations and medical supplies.

39 – Delivery of goods; delivery of goods by mail order; storage information; packaging of goods; wrapping of goods; courier services [messages or merchandise]; physical storage of electronically stored data or documents; storage of goods; storage; freight forwarding; all mentioned above services for pharmaceutical, veterinary and sanitary preparations and medical supplies.

40 – Material treatment information; waste treatment [transformation]; treatment of materials for third parties; grinding; refining services; all mentioned above services for pharmaceutical, veterinary and sanitary preparations and medical supplies.

42 – Water analysis; chemical analysis; clinical trials; bacteriological research; biological research; cosmetic research; chemical research; research and development of new products for others; scientific research; quality control; technical writing; chemistry services; scientific laboratory services; electronic data storage; all mentioned above services for pharmaceutical, veterinary and sanitary preparations and medical supplies.

(260) AM 2020 103381 A

(800) 1468957

(151) 2018 11 08

(891) 2018 11 08

(731) REZNIKOV VLADIMIR ANATOLYEVICH
ul. Orbitalnaya, 68, korp. 2, kv. 88,
RU-344114 g. Rostov-on-Don, Russian
Federation

(540)



(591) Dark-grey, orange and white

(531) 26.04.02; 26.04.05; 26.04.22; 26.04.24;
27.05.01; 27.05.24; 29.01.13

(511)

9 – Electric batteries for vehicles; antennas; remote control apparatus; coaxial cables; fiber optic cables; electric cables; electrical contacts; cabinets for loudspeakers; sheaths for electric cables; remote control transmitters; transmitters of electronic signals; electrical switches; converters, electric; satellite navigational apparatus; telegraph wires; telephone wires; electric wires; electrical conductors; insulated copper wire; players; electrical control panels; voltage surge protectors; horns for loudspeakers; electrical connections; wiring, all of the foregoing for use in automobiles; specifically excluding audio and audiovisual recordings, and none of the foregoing associated with motion picture films or television programs.

(260) AM 2020 103409 A

(800) 1469460

(151) 2019 04 05

(891) 2019 04 05

(731) FERRERO INTERNATIONAL S.A.
Findel Business Center, Complexe B,
Rue de Trèves, L-2632 Findel,
Luxembourg

(540)

WONKA

(591) Black, white

(511)

30 – Pastry and confectionery; biscuits; cakes; chocolate and chocolate based products; sweets [candy]; chewing gum; edible ices.

(260) AM 2020 103410 A

(800) 1469481

(151) 2019 04 05

(891) 2019 04 05

(731) FERRERO INTERNATIONAL S.A.
Findel Business Center, Complexe B,
Rue de Trèves, L-2632 Findel, Luxembourg

(540)

100 GRAND

(591) Black, white

(511)

30 – Pastry and confectionery; biscuits; cakes; chocolate and chocolate based products; sweets [candy]; chewing gum; edible ices.

(260) AM 2020 103411 A

(800) 1469488

(151) 2019 05 09

(891) 2019 05 09

(731) SANONDA (AUSTRALIA) PTY LTD
Suite 822, St Kilda Road Towers, 1 Queens
Rd, MELBOURNE VIC 3004, Australia

(540)

Gleeco

(591) Black, white

(511)

1 – Chemical products for use as fertilizers; natural fertilizers; chlorine-free fertilizers; fertilizers; fertilizers for soil; garden feeds (fertilizers); inorganic fertilizers; land fertilizers; mineral fertilizers; multi-nutrient fertilizers.

(260) AM 2020 103412 A

(800) 1469492

(151) 2019 04 02

(891) 2019 04 02

(731) MERIDIAM

4 place de l'Opéra, F-75002 PARIS, France

(540)

MERIDIAM

(591) Black, white

(511)

36 – Fund investment; fund investment services; portfolio management and investment services; raising or investing capital; management of capital investment funds; arranging of financial investments; asset management; financing of infrastructure and energy projects.

42 – Management, planning and supervision of infrastructure and energy projects; design and development of infrastructure and energy projects; project scheduling; provision of information regarding studies, technical projects and research on the use of natural energy; consulting and information services with respect to infrastructure; assistance in the area of infrastructure; planning, development and management of resources for the optimal use of energy; technical advice and expertise in the field of energies.

(260) AM 2020 103420 A

(800) 850223

(151) 2004 11 24

(891) 2019 05 10

(731) BGSTORE MAĞAZACILIK ANONİM
ŞİRKETİAtatürk Bulvarı Deposite İş Merkezi A1,
Blok Kat:2 No:212 OSB İkitelli,
Başakşehir, İSTANBUL, Turkey

(540)



(591) Blue, grey

(531) 24.17.09; 25.01.09; 27.05.01; 29.01.12

(511)

35 – Exhibition of goods, namely the bringing together, for the benefit of others, of a variety of goods (excluding the transport thereof), enabling customers to conveniently view and purchase those goods; electronic selling service, namely the bringing together in an electronic network for the benefit of others, of a variety of goods enabling customers to place orders and purchase them through electronic means; catalogue retail sales, namely the bringing together, for the benefit of others, of a variety of goods in a catalogue, enabling customers to view, place orders and purchase those goods, retail sales services, namely the bringing together, for the benefit of others, of a variety of goods (excluding the transport thereof), enabling customers to view, place orders and purchase those goods in retail outlets; selling services, namely the bringing together, for the benefit of others, of a variety of goods (excluding the transport thereof), including textiles and ready-made clothes and garment sector goods, enabling customers to conveniently view and purchase those goods.

(260) AM 2020 103421 A

(800) 1326138

(151) 2016 06 30

(891) 2019 04 30

(731) Calzedonia S.p.A.

Via Portici Umberto I, 5, I-37018 Malcesine
(Verona), Italy

(540)

CALZEDONIA

(591) Black, white

(531) 27.05.01; 27.05.17

(511)

3 – Soaps, perfumery, essential oils, cosmetics, shampoos; make-up, make-up removing preparations, toiletries; hair dyes, hair colorants, hair spray, hair waving preparations, hair lotions, hair gel, hair colorants; body lotion, non-medicated body talcum powder, body splash, hand and body cream, non medicated skin care preparations, cleansing milk for toilet purposes; douching preparations for personal sanitary or deodorant purposes [toiletries], shower

gel, bubble bath, non medicated bath preparations, bath salts not for medical purposes; antiperspirants [toiletries], deodorants for personal use; shaving preparations, aftershave lotions, shaving soap, shaving gel, shaving foam; mouthwashes, not for medical purposes, breath freshening sprays, breath freshening strips; sunscreen preparations, sun-tanning preparations [cosmetics], lip glosses, massage gels other than for medical purposes, decorative transfers for cosmetic purposes; nail care preparations, nail polish; shoe cream, shoemakers' wax, shoe polish, shoe wax; air fragrancing preparations, colored toilet bowl detergents, potpourris [fragrances], sachets for perfuming linen, scented wood.

25 – Clothing, footwear, headgear; underwear, underpants, slips, bras, swimwear, beachwear, nightwear, pajamas, babydolls, nightshirts, nightgowns; dresses, skirts, shirts, suits, pants, baby pants, jeans, shorts, tops, vests, dressing gowns; knitwear, knit shirts, knit skirts, knit robes; corsets, lingerie, suspender belts, garters, stockings, leggings, tights, panties; socks, slippers, flip-flops; sports clothing, bath robes, bathing caps, belts [clothing], combinations [clothing], gloves [clothing], mittens, ear muffs [clothing], headbands [clothing], hats, caps, visors [headwear], bandanas [neckerchiefs]; neck scarfs [mufflers], neckties, scarfs, foulards, shawls; ponchos, money belts [clothing].

35 – Mail order, online retail store and retail store services in the field of fashion accessories, soaps, perfumery, essential oils, cosmetics, shampoos, make-up, make-up removing preparations and toiletries; mail order, online retail store and retail store services in the field of hair dyes, hair colorants, hair spray, hair waving preparations, hair lotions, hair gel, hair colorants, body lotion, body talc, body splash, hand and body cream, non medicated skin care preparations, cleansing milk for toilet purposes, douching preparations for personal sanitary or deodorant purposes [toiletries], shower gel, bubble bath, non medicated bath preparations and bath salts not for medical purposes; mail order, online retail store and retail store services in the field of antiperspirants [toiletries], deodorants for personal use, shaving preparations, aftershave lotions, shaving soap, shaving gel, shaving foam, mouthwashes, not for medical purposes, breath freshening sprays and breath freshening strips; mail order, online retail store and retail store services in the field of, sunscreen preparations, sun-tanning preparations [cosmetics], lip glosses, massage gels other than for medical purposes and decorative transfers for cosmetic purposes; mail order, online retail store and retail store services in the field of nail care preparations, nail polish, shoe cream, shoemakers' wax, shoe polish, shoe wax, air fragrancing preparations, colored toilet bowl detergents, potpourris [fragrances], sachets for perfuming linen and scented wood; mail or-

der, online retail store and retail store services in the field of clothing, footwear, headgear, underwear, underpants, slips, bras, swimwear, beachwear, nightwear, pajamas, babydolls, nightshirts and nightgowns; mail order, online retail store and retail store services in the field of dresses, skirts, shirts, suits, pants, babypants, jeans, shorts, tops, vests and dressing gowns; mail order, online retail store and retail store services in the field of knitwear, knit shirts, knit skirts and knit robes; mail order, online retail store and retail store services in the field of corsets, lingerie, suspender belts, garters, stockings, leggings, tights, panties and socks; mail order, online retail store and retail store services in the field of slippers, flip-flops, sports clothing, bath robes, bathing caps, belts [clothing] and combinations [clothing]; mail order, online retail store and retail store services in the field of gloves [clothing], mittens, ear muffs [clothing], headbands [clothing], hats, caps, visors [headwear], bandanas [neckerchiefs], neck scarfs [mufflers], neckties, scarfs, foulards, shawls, ponchos and money belts [clothing].

(260) AM 2020 103423 A

(800) 1451021

(151) 2018 12 10

(891) 2019 05 15

(731) AVOVA GmbH

Blaubeurer Str. 71, 89077 Ulm, Germany

(540)

AVOVA

(591) Black, white

(531) 27.05.01

(511)

12 – Vehicles for locomotion by land, air, water or rail; strollers; stroller covers; stroller hoods; bags adapted for strollers; casters for trolleys [vehicles] [carts (Am)]; safety belts for vehicle seats; safety seats for children, for vehicles; upholstery for vehicles; security harness for vehicle seats; baby carriages; fitted footmuffs for strollers; hand cars; headrests for vehicle seats; anti-theft alarms for vehicles; fitted stroller mosquito nets; fitted footmuffs for baby carriages.

20 – High chairs for babies; infant walkers; Moses baskets; cribs for babies; cradles; cushions; bassinets; pillows; chairs [seats]; playpens for babies; mats for infant playpens; baby changing mats; wall-mounted baby changing platforms.

(260) AM 2020 103424 A

(800) 1457787

(151) 2019 02 18

(891) 2019 05 14

(731) F. Hoffmann-La Roche AG

Grenzacherstrasse 124, CH-4070 Basel,

Switzerland

(540)

ROZLYTREK

(591) Black, white

(511)

5 – Pharmaceutical preparations.

(260) AM 2020 103425 A

(800) 1464725

(151) 2019 01 18

(891) 2019 05 15

(731) CAN DO CO., LTD.

2-21-1, Kitashinjuku, Shinjuku-ku, Tokyo

169-0074, Japan

(540)

Can★Do

(591) Blue, red

(531) 01.01.01; 01.01.02; 01.01.10; 29.01.12

(511)

35 – Advertising and publicity services; promoting goods and services of others through the administration of sales and promotional incentive schemes involving trading stamps; business management analysis or business consultancy; marketing research and analysis; providing information concerning commercial sales; business management of hotels; import-export agency services; office functions, namely filing, in particular documents or magnetic tapes; reception services for visitors in buildings; publicity material rental; retail services or wholesale services for woven fabrics and beddings; retail services or wholesale services for bags and pouches; retail services or wholesale services for personal articles; retail services or wholesale services for liquor; retail services or wholesale services for confectionery, bread and buns; retail services or wholesale services for milk; retail services or wholesale services for carbonated drinks (refreshing beverages) and non-alcoholic fruit juice beverages; retail services or wholesale services for tea, coffee and cocoa; retail services or wholesale services for processed food; retail services or wholesale services for electrical machinery and apparatuses (except dishwashers for household purposes, electric wax-polishing machines for household purposes, electric washing machines for household purposes, electric vacuum cleaners for household purposes, electric food blender for household purposes, electric razors and electric hair clippers, electric flat iron, electric hair curlers, electric buzzers, household electrothermic appliance, electric pencil sharpener, electric tooth brushes); retail services or wholesale services for bladed or pointed hand tools, hand tools and metal hardware;

retail services or wholesale services for kitchen equipment, cleaning tools and washing utensils; retail services or wholesale services for cosmetics, toiletries, dentifrices, soaps and detergents; retail services or wholesale services for flowers (natural) and trees; retail services or wholesale services for paper and stationery; retail services or wholesale services for sports goods; retail services or wholesale services for toys, dolls, game machines and apparatus; retail services or wholesale services for clocks, watches and spectacles (eyeglasses and goggles); retail services or wholesale services for tobaccos and smoking articles.

(260) AM 2020 103488 A

(800) 1469767

(151) 2019 03 26

(891) 2019 03 26

(731) HAUTE FRAGRANCE COMPANY, SIA
Kalnupes iela 3, Mārupe, LV-2167 Mārupes nov., Latvia

(540)

DELICIOUS KISSES

(591) Black, white

(511)

3 – Perfumery and fragrances (eau de parfum).

(260) AM 2020 103497 A

(800) 1469943

(151) 2019 03 08

(891) 2019 03 08

(731) Bewital Holding GmbH & Co KG
Industriestr. 10, 46354 Südlohn, Germany

(540)

ЛЕОНАРДО

(591) Black, white

(531) 28.05

(511)

5 – Dietary supplements for animals; food supplements for veterinary use; mineral food supplements; dietary supplements consisting of vitamins; nutritional supplements for livestock feed; veterinary preparations and substances; nutritional supplements for veterinary use.

31 – Food for animals; foodstuffs (animal-), foodstuffs for dogs; foodstuffs for cats.

44 – Veterinary and agricultural services; hygienic and beauty care for animals.

(260) AM 2020 103498 A

(800) 1469962

(151) 2019 03 26

(891) 2019 03 26

(731) HAUTE FRAGRANCE COMPANY, SIA
Kalnupes iela 3, Mārupe, LV-2167 Mārupes nov., Latvia

(540)

PARTY ON THE MOON

(591) Black, white

(511)

3 – Perfumery and fragrances (eau de parfum).

(260) AM 2020 103509 A

(800) 1470288

(151) 2018 11 21

(891) 2018 11 21

(731) WENZHOU MTYSUN ECONOMIC & TRADE CO., LTD.
Room 1506-1507, Wenzhou Metal Building,
No.1158 Yongzhong West Road, Yongzhong Street, Longwan District, Wenzhou, Zhejiang, China

(540)

OTTOSUN

(591) Black, white

(531) 26.11.12; 27.05.11

(511)

7 – Igniting devices for internal combustion engines; steam/oil separators; bearings [parts of machines]; gears, other than for land vehicles; steam condensers [parts of machines]; cooling radiators for automobile engines; couplings other than for land vehicles; igniting magnetos; filters [parts of machines or engines]; connecting rods for machines, motors and engines.

12 – Clutches for land vehicles; transmission shafts for land vehicles; automobile chassis; brakes for vehicles; torque converters for land vehicles; axles for vehicles; connecting rods for land vehicles, other than parts of motors and engines; shock absorbers for automobiles; direction signals for vehicles.

(260) AM 2020 103510 A

(800) 1470299

(151) 2019 05 06

(891) 2019 05 06

(731) Apple Inc.
One Apple Park Way, MS 169-3IPL,
Cupertino CA 95014, USA

(540)

A12X BIONIC

(591) Black, white

(511)

9 – Computer hardware, namely, integrated circuits; computer chips; computers.

(260) AM 2020 103511 A
 (800) 1470311
 (151) 2019 04 24
 (891) 2019 04 24
 (731) PFD Co., Ltd.
 #2F, 627, Ahasan-ro, Gwangjin-gu,
 Seoul, Republic of Korea

(540)



(591) Black, white
 (531) 26.11.01; 26.11.12; 27.05.01; 27.05.11
 (511)

3 – Cosmetics; cosmetic preparations for skin care; make-up; cosmetic preparations for baths; shampoos; cosmetic soaps; essential oils; perfumes; fabric softeners for laundry use; cosmetics for animals.

(260) AM 2020 103514 A
 (800) 1470460
 (151) 2019 03 21
 (891) 2019 03 21
 (731) K.V.C. CHOOSE CERAMIC PRO, LTD
 Evagora papachristoforou 18, Petoussis
 Building, office 001, t.k., CY-3030
 Limassol, Cyprus

(540)



(591) Black, white and magenta
 (531) 24.15.01; 26.01.03; 26.01.16; 26.01.24;
 27.05.01; 29.01.13

(511)
 2 – Dyes; binding preparations for paints; glazes [paints, lacquers]; primers; paints; lacquers; coatings [paints]; undercoating for vehicle chassis; anti-fouling paints; anti-corrosive preparations; protective preparations for metals; anti-tarnishing preparations for metals; enamels [varnishes].

17 – Plastic film, other than for wrapping; plastic film for protecting paint and glass.

37 – Rebuilding engines that have been worn or partially destroyed; rebuilding machines that have been worn or partially destroyed; vulcanization of tires [repair]; vehicle battery charging; vehicle washing; anti-rust treatment for vehicles; vehicle maintenance; vehicle polishing; vehicle breakdown repair services; motor vehicle maintenance and repair; vehicle greasing; vehicle service stations [refuelling and maintenance]; vehicle cleaning.

(260) AM 2020 103515 A
 (800) 1470484
 (151) 2019 03 21

(891) 2019 03 21
 (731) NEMIROFF INTELLECTUAL PROPERTY
 ESTABLISHMENT
 Städtle 31, FL-9490 Vaduz, Liechtenstein

(540)



(591) Brown, grey, white, black and golden
 (531) 05.03.02; 17.02.02; 24.09.05; 25.01.15;
 26.04.18; 27.05.02; 29.01.15

(511)
 33 – Alcoholic beverages (except beers); distilled beverages; spirits (beverages); vodka.

(260) AM 2020 103526 A
 (800) 1470813
 (151) 2019 03 16
 (891) 2019 03 16
 (731) MUCİZE BATARYA TEKNOLOJİLERİ
 SAN TİC A.Ş.
 Musalla Bağları Mah., Şehit Ahmet Değerli
 Sok. No:11/208, SELÇUKLU/KONYA,
 Turkey

(540)



(591) Black, white
 (531) 26.04.01; 26.04.09; 27.05.01; 27.05.04;
 29.01.03

(511)
 9 – Measurement apparatus and equipment including those for scientific, nautical, topographic, meteorologic, industrial and laboratory purposes, thermometers not for medical purposes, barometers, ammeters, voltmeters, hygrometers, testing apparatus not for medical purposes, telescopes, periscopes, directional compasses, speed indicators, laboratory apparatus, microscopes, magnifying glasses, stills, ovens and furnaces for laboratory experiments; apparatus for recording, transmission or reproduction of sound or images, cameras, photographic cameras, television apparatus, video recorders, CD and DVD players and recorders, MP3 players, computers, desktop computers, tablet computers, microphones, loudspeakers, earphones, telecommunications apparatus, apparatus for the reproduction of sound or images, computer peripheral devices, cell phones, covers for cell phones, telephone apparatus, computer printers, scanners [data processing equipment], photocopiers; magnetic and optic data carriers and computer software and programmes recorded thereto, downloadable and recordable electronic publications, enco-

ded magnetic and optic cards; antennas, satellite antennas, amplifiers for antennas, parts of the aforementioned goods; ticket dispensers, automatic teller machines (ATM); electronic components used in the electronic parts of machines and apparatus, semi-conductors, electronic circuits, integrated circuits, chips [integrated circuits], diodes, transistors [electronic], magnetic heads for electronic apparatus, electronic locks, photocells, remote control apparatus for opening and closing doors, optical sensors; counters and quantity indicators for measuring the quantity of consumption, automatic time switches; clothing for protection against accidents, irradiation and fire, safety vests and life-saving apparatus and equipment; eyeglasses, sunglasses, optical lenses and cases, containers, parts and components thereof; apparatus and instruments for conducting, transforming, accumulating or controlling electricity, electric plugs, junction boxes [electricity], electric switches, circuit breakers, fuses, lighting ballasts, battery starter cables, electrical circuit boards, electric resistances, electric sockets, transformers [electricity], electrical adapters, battery chargers, electric door bells, electric and electronic cables, batteries, electric accumulators; alarms and anti-theft alarms, other than for vehicles, electric bells; signalling apparatus and instruments, luminous or mechanical signs for traffic use; fire extinguishing apparatus, fire engines, fire hose and fire hose nozzles; radar apparatus, sonars, night vision apparatus and instruments; decorative magnets; metronomes.

(260) AM 2020 103527 A

(800) 1470817

(151) 2019 04 04

(891) 2019 04 04

(731) LARKPARK SERVICES INC.

Trident Trust Company (B.V.I.), Trident Chambers, P.O. Box 146, Road Town, Tortola, Virgin Islands (British)

(540)

Tinkoff / Тинькофф

(591) Black, white

(531) 28.05

(511)

9 – Monitors [computer programs]; computer software, recorded; transmitters [telecommunication]; telephone transmitters; transmitters of electronic signals; digital signs; computer game software; computer operating programs, recorded; computer software applications, downloadable; audiovisual teaching apparatus; video recorders; sound reproduction apparatus; identity cards, magnetic; encoded magnetic cards; automated teller machines [ATM]; money counting and sorting machines; mechanisms for coin-operated apparatus; magnetic data media; computer programmes [programs], recorded; computer prog-

rams [downloadable software]; electronic publications, downloadable; integrated circuit cards [smart cards]; invoicing machines; data processing apparatus; couplers [data processing equipment].

(260) AM 2020 103528 A

(800) 1470819

(151) 2018 11 08

(891) 2018 11 08

(731) HAUSBRANDT TRIESTE 1892 S.P.A.

Via Foscarini 52, I-31040 Nervesa della Battaglia (TV), Italy

(540)



TRIESTE 1892

HAUSBRANDT

(591) Black, white

(531) 01.15.11; 04.05.02; 11.03.01; 11.03.14;

25.05.03; 27.05.02

(511)

30 – Coffee, tea, cocoa; sugar and honey; coffee flavorings; artificial coffee; coffee-based beverages; tea-based beverages; cocoa-based beverages; preparations of malted barley for use in making beverages; honey; crushed barley; ground barley; drinking chocolate; waffles; chocolate; vegetal preparations for use as coffee substitutes; biscuits; infusions not medicinal, non-medical herbal teas, fruit-based infusions, aromatic preparations for making non-medicated infusions, fruit flavoured tea, other than medicinal, tisanes.

35 – Advertising; advertising particularly services for the promotion of goods; publicity and sales promotion services; advertising for direct marketing; layout services for advertising purposes; advertising service for the promotion of products in relation to coffee, tea, cocoa, sugar and honey, coffee flavorings, artificial coffee, coffee-based beverages, tea-based beverages, cocoa-based beverages, barley drinks, honey, crushed barley, ground barley, drinking chocolate, waffles, chocolate, vegetal preparations for use as coffee substitutes, biscuits, infusions, not medicinal, non-medical herbal teas, fruit-based infusions, aromatic preparations for making non-medicated infusions, fruit flavoured-tea, other than medicinal, tisanes; dissemination of advertisements; direct mail advertising, namely leaflets, prospectuses, printed material, samples; marketing services; organisation of exhibitions for commercial and advertising purposes; organisation of trade fairs for commercial and advertising purposes; presentation of goods on communication media, for retail purpo-

ses; publication of publicity texts; on-line advertising on a computer network; writing of publicity texts; on-line retail services of products in relation to coffee, tea, cocoa, sugar and honey, coffee flavorings, artificial coffee, coffee-based beverages, tea-based beverages, cocoa-based beverages, barley drinks, honey, crushed barley, ground barley, drinking chocolate, waffles, chocolate, vegetal preparations for use as coffee substitutes, biscuits, infusions, not medicinal, non-medical herbal teas, fruit-based infusions, aromatic preparations for making non-medicated infusions, fruit flavoured tea, other than medicinal, tisanes; retailing or wholesaling of products in relation to coffee, tea, cocoa, sugar and honey, coffee flavorings, artificial coffee, coffee-based beverages, tea-based beverages, cocoa-based beverages, barley drinks, honey, crushed barley, ground barley, drinking chocolate, waffles, chocolate, vegetal preparations for use as coffee substitutes, biscuits, infusions, not medicinal, non-medical herbal teas, fruit-based infusions, aromatic preparations for making non-medicated infusions, fruit flavoured tea, other than medicinal, tisanes; franchising services, namely consultancy and support in the management and organisation of restaurants, bars, cafeterias; retail shop window display arrangement services.

(260) AM 2020 103543 A

(800) 1471090

(151) 2019 01 16

(891) 2019 01 16

(731) PIASTEN GMBH

Piastenstr. 1, 91301 Forchheim, Germany

(540)

GOD MADE THE PEANUT ...BUT HE FORGOT THE CHOCOLATE

(591) Black, white

(511)

30 – Flavourings, other than essential oils, for beverages; baking powder; pastries; cookies; sweetmeats [candy]; fizzy lollipops; buns; bread; hot-cross buns; petit-beurre biscuits; maize flakes; dietetic food not adapted for medical use, based on carbohydrates, dietary fibre, with added vitamins, minerals, trace elements, either singly or in combination, included in this class; ice cream; iced tea; peanut confectionery; fondants; fruit gums; fruit sauces; pastries; fruit jellies [confectionery]; tea-based beverages; groats for human food, spices; honey; frozen yoghurt [confectionery ices]; coffee; cocoa; cocoa-based products; cocoa-based beverages; candy for food; caramels; chewing gum, not for medical purpose; cookies; biscuits; confectionery products; sweetmeats [candy]; crackers; cakes; cake powder; licorice [confectionery]; stick liquorice [confectionery]; gingerbread; lollipops; macarons [pastry]; maltose; al-

mond confectionery; marzipan; chocolate beverages with milk; lozenges [confectionery]; petits fours [cakes]; mint for confectionery; puddings; popcorn; sherbet (confectionery); chocolate; drinking chocolate; sherbets [ices]; edible ices; confectionery; clear gums [confectionery]; glucose for food, both loose and in tablet form; waffles; wine gums; pralines; bonbons made of sugar; confectionery for decorating christmas trees, rusks; chocolate goods; dragées; sugarcoated nuts; sugar-coated almonds; sugar-coated chocolate.

35 – Advertising, business management, business administration, office functions; retailing via the Internet in the field of foodstuffs and beverages, in particular confectionery; wholesaling via the Internet in the field of foodstuffs and beverages, in particular confectionery; retailing in the field of foodstuffs and beverages, in particular confectionery; wholesaling in the field of foodstuffs and beverages, in particular confectionery; advertising; presentation of assorted goods, for others, for retail purposes; the bringing together, for the benefit of others, of a variety of goods for sales purposes, namely in the field of foodstuffs and beverages, in particular confectionery.

(260) AM 2020 103544 A

(800) 1471120

(151) 2019 01 09

(891) 2019 01 09

(731) HUZEMA VALERIJA MYKHAILIVNA

vul. Lomonosova, 52, kv. 139, m. Kyiv 03189, Ukraine

(540)

Guzema

(591) Black, white

(531) 27.05.01; 27.05.17

(511)

14 – Precious metals and their alloys; jewelry; precious stones; watches; agates; anchors (clock- and watchmaking); bracelets (jewelry); straps for wrist-watches; brooches (jewelry); alarm clocks; shoe ornaments of precious metal; works of art of precious metal; badges of precious metal; jet, unwrought or semi-wrought; clocks; clocks and watches, electric; watch chains; clockworks; watch springs, watch crystals; diamonds; precious metals, unwrought or semi-wrought; threads of precious metal (jewelry); cuff links; clasps for jewellery; tie clips; ingots of precious metals; cloisonné jewellery; jewellery of yellow amber; ivory jewellery; gold thread (jewelry); gold, unwrought or beaten; iridium; rings (jewelry); cabochons for making jewellery; hat ornaments of precious metal; trinkets or fobs; jewellery findings; watch cases (part of watches); chains (jewelry); medals; lockets (jewelry); coins; beads for

making jewellery; necklaces (jewelry); pearls made of pressed amber; semi-precious stones; wristwatches; amulets (jewelry); peridot; osmium; palladium; pearls (jewelry); platinum (metal); busts of precious metal; presentation boxes for watches; presentation boxes for jewellery; ornaments (jewelry); ornaments of jet; ornamental pins; spun silver; rhodium; ruthenium; stopwatches; earrings; jewellery boxes; boxes of precious metal; silver, unwrought or beaten; paste jewellery; clock hands; watch hands; statuettes of precious metal; jewellery rolls; charms (jewelry); pins (jewelry); tie pins.

35 – The bringing together, for the benefit of others, of a variety of goods, namely jewelry, precious stones, watches, bracelets, cuff links, rings (jewelry), brooches (jewelry), chains (jewelry), necklaces (jewelry), earrings, jewellery boxes, charms, excluding the transport thereof, enabling customers to conveniently view and purchase those goods, such services may be provided by retail stores, wholesale outlets, by means of electronic media or through mail order catalogues or through web sites or television shopping programmes; business inquiries; administrative processing of purchase orders; administration of consumer loyalty programs; market studies; demonstration of goods; business management assistance; commercial information and advice for consumers; commercial administration of the licensing of the goods and services for others; business management consultancy; business organization consultancy; marketing; marketing research; provision of an on-line marketplace for buyers and sellers of goods and services; organization of exhibitions for commercial or advertising purposes; organization of fashion shows for promotional purposes; organization of trade fairs for commercial or advertising purposes; rental of advertising space; shop window dressing, layout services for advertising purposes; modelling for advertising or sales promotion; publicity agency; public relations; retail or wholesale services for jewelry, articles of precious metals, articles of precious stones; presentation of goods on communication media, for retail purposes, rental of sales stands; direct mail advertising; radio advertising; advertising; pay per click advertising; advertising by mail order; on-line advertising on a computer network; distribution of samples; dissemination of advertising matter; design of advertising materials; sales promotion for others; production of advertising films; television advertising; telemarketing services.

(260) AM 2020 103545 A
(800) 1471121
(151) 2019 01 11
(891) 2019 01 11
(731) LLC KNAUF GIPS

Zentralnaja St., 139, RU-143405 Krasnogorsk,
Moscow region, Russian Federation

(540)

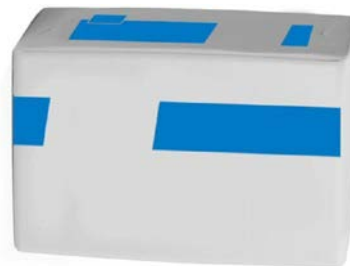

(591) Gray and blue

(531) 19.03.03; 26.15.13; 29.01.12

(554) მოცულობითი

(511)

2 – Primers; paints, including dispersion paints; aluminium paints; asbestos paints; bactericidal paints; wood stains; distempers; fireproof paints; enamels for painting; coatings [paints]; wood coatings [paints]; dyes; binding preparations for paints; colorants; lacquers; cobalt oxide [colorant]; undercoating for vehicle chassis; anti-fouling paints; thinners for paints; thinners for lacquers; whitewash; soot [colorant]; thickeners for paints; anti-rust greases; siccatives [drying agents] for paints; badigeon; anti-tarnishing preparations for metals; anti-rust preparations; wood preservatives; turpentine [thinner for paints]; fixatives [varnishes]; yellowwood [colorant]; enamels [varnishes].

17 – Insulating paints; insulating varnish; lute; liquid rubber; gutta-percha; insulators; insulating materials; insulating refractory materials; sealant compounds for joints; rubber solutions; gum, raw or semi-worked; substances for insulating buildings against moisture; gaffer tape; insulating tapes; masking tape for industrial purposes; duct tapes; adhesive tapes for industrial purposes; adhesive bands, other than stationery and not for medical or household purposes; drywall joint tape; adhesive tape for industrial and commercial use; insulating plaster.

19 – Plaster; gypsum [building material]; clay; lime; tar; pitch; building materials, not of metal; slate powder; coatings [building materials]; wall claddings, not of metal, for building; cladding, not of metal, for building; linings, not of metal, for building; building mix, namely mortar mix, cement mixes, filling cement, patching compounds with a tar base; mortar for building; asbestos mortar; building mortars sprayed by machines; cements, including quick setting; mortars ready for use, including paste-like putty; plaster and spackling compounds, including on the basis of gypsum and gypsum binder, polymer plaster and spackling compounds, adhesive plaster for building purposes and spackling compounds, glued plaster and spackling compounds, structural plaster and spackling compounds, cement plaster and spackling compounds.

35 – Demonstration of goods; information and advice to commercial consumers [consumer informati-

on]; organization of exhibitions for commercial or advertising purposes; organization of trade fairs for commercial or advertising purposes; provision of an on-line marketplace for buyers and sellers of goods and services; presentation of goods on communication media, for retail purposes; sales promotion for others; retail and wholesale services for goods in particular primers, paints, including dispersion paints, aluminium paints, asbestos paints, bactericidal paints, wood stains, distempers, fireproof paints, enamels for painting, coatings [paints], wood coatings [paints], dyes, binding preparations for paints, colorants, lacquers, cobalt oxide [colorant], undercoating for vehicle chassis, anti-fouling paints, thinners for paints, thinners for lacquers, whitewash, soot [colorant], thickeners for paints, anti-rust greases, siccatives [drying agents] for paints, badigeon, anti-tarnishing preparations for metals, anti-rust preparations, wood preservatives, turpentine [thinner for paints], fixatives [varnishes], yellowwood [colorant], enamels [varnishes], insulating paints, insulating varnish, lute, liquid rubber, gutta-percha, insulators, insulating materials, insulating plaster, insulating refractory materials, sealant compounds for joints, rubber solutions, gum, raw or semi-worked, substances for insulating buildings against moisture, gaffer tape, insulating tapes, masking tape for industrial purposes, duct tapes, adhesive tapes for industrial purposes, adhesive bands, other than stationery and not for medical or household purposes, drywall joint tape, adhesive tape for industrial and commercial use, plaster, gypsum [building material], clay, lime, tar, pitch, building materials, not of metal, slate powder, coatings [building materials], wall claddings, not of metal, for building, cladding, not of metal, for building, linings, not of metal, for building, mortar for building, building mix, namely mortar mix, cement mixes, filling cement, patching compounds with a tar base, asbestos mortar, building mortars sprayed by machines, cements, including quick setting, mortars ready for use, including paste-like putty, plaster and spackling compounds, including on the basis of gypsum and gypsum binder, polymer plaster and spackling compounds, adhesive plaster for building purposes and spackling compounds, glued plaster and spackling compounds, structural plaster and spackling compounds, cement plaster and spackling compounds; rental of sales stands; distribution of samples; advertising; pay per click advertising; procurement services for others [purchasing goods and services for other businesses]; outsourcing services [business assistance].

(260) AM 2020 103546 A
 (800) 1471147
 (151) 2019 01 11
 (891) 2019 01 11
 (731) LLC KNAUF GIPS

Zentralnaja St., 139, RU-143405 Krasnogorsk,
 Moscow region, Russian Federation

(540)

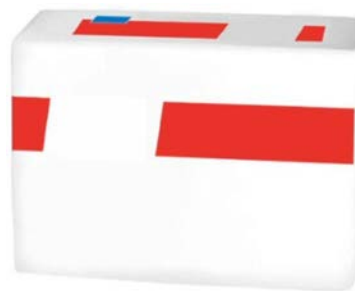

(591) White, red and blue
 (531) 19.03.03; 26.15.13; 29.01.13
 (554) მოცულობითი

(511)

2 – Primers; paints, including dispersion paints; aluminium paints; asbestos paints; bactericidal paints; wood stains; distempers; fireproof paints; enamels for painting; coatings [paints]; wood coatings [paints]; dyes; binding preparations for paints; colorants; lacquers; cobalt oxide [colorant]; undercoating for vehicle chassis; anti-fouling paints; thinners for paints; thinners for lacquers; whitewash; soot [colorant]; thickeners for paints; anti-rust greases; siccatives [drying agents] for paints; badigeon; anti-tarnishing preparations for metals; anti-rust preparations; wood preservatives; turpentine [thinner for paints]; fixatives [varnishes]; yellowwood [colorant]; enamels [varnishes].

17 – Insulating paints; insulating varnish; lute; liquid rubber; gutta-percha; insulators; insulating materials; insulating refractory materials; sealant compounds for joints; rubber solutions; gum, raw or semi-worked; substances for insulating buildings against moisture; gaffer tape; insulating tapes; masking tape for industrial purposes; duct tapes; adhesive tapes for industrial purposes; adhesive bands, other than stationery and not for medical or household purposes; drywall joint tape; adhesive tape for industrial and commercial use; insulating plaster.

19 – Plaster; gypsum [building material]; clay; lime; tar; pitch; building materials, not of metal; slate powder; coatings [building materials]; wall claddings, not of metal, for building; cladding, not of metal, for building; linings, not of metal, for building; building mix, namely mortar mix, cement mixes, filling cement, patching compounds with a tar base; mortar for building; asbestos mortar; building mortars sprayed by machines; cements, including quick setting; mortars ready for use, including paste-like putty; plaster and spackling compounds, including on the basis of gypsum and gypsum binder, polymer plaster and spackling compounds, adhesive plaster for building purposes and spackling compounds, glued plaster and spackling compounds, structural plaster and spackling compounds, cement plaster and spackling compounds.

35 – Demonstration of goods; information and advice to commercial consumers [consumer information]; organization of exhibitions for commercial or advertising purposes; organization of trade fairs for commercial or advertising purposes; provision of an on-line marketplace for buyers and sellers of goods and services; presentation of goods on communication media, for retail purposes; sales promotion for others; retail and wholesale services for goods in particular primers, paints, including dispersion paints, aluminium paints, asbestos paints, bactericidal paints, wood stains, distempers, fireproof paints, enamels for painting, coatings [paints], wood coatings [paints], dyes, binding preparations for paints, colorants, lacquers, cobalt oxide [colorant], undercoating for vehicle chassis, anti-fouling paints, thinners for paints, thinners for lacquers, whitewash, soot [colorant], thickeners for paints, anti-rust greases, siccatives [drying agents] for paints, badigeon, anti-tarnishing preparations for metals, anti-rust preparations, wood preservatives, turpentine [thinner for paints], fixatives [varnishes], yellowwood [colorant], enamels [varnishes], insulating paints, insulating varnish, lute, liquid rubber, gutta-percha, insulators, insulating materials, insulating plaster, insulating refractory materials, sealant compounds for joints, rubber solutions, gum, raw or semi-worked, substances for insulating buildings against moisture, gaffer tape, insulating tapes, masking tape for Industrial purposes, duct tapes, adhesive tapes for Industrial purposes, adhesive bands, other than stationary and not for medical or household purposes, drywall joint tape, adhesive tape for industrial and commercial use, plaster, gypsum [building material], clay, lime, tar, pitch, building materials, not of metal, slate powder, coatings [building materials], wall claddings, not of metal, for building, cladding, not of metal, for building, linings, not of metal, for building, mortar for building, building mix, namely mortar mix, cement mixes, filling cement, patching compounds with a tar base, asbestos mortar, building mortars sprayed by machines, cements, including quick setting, mortars ready for use, including pastelike putty, plaster and spackling compounds, including on the basis of gypsum and gypsum binder, polymer plaster and spackling compounds, adhesive plaster for building purposes and spackling compounds, glued plaster and spackling compounds, structural plaster and spackling compounds, cement plaster and spackling compounds; rental of sales stands; distribution of samples; advertising; pay per click advertising; procurement services for others [purchasing goods and services for other businesses]; outsourcing services [business assistance].

(260) AM 2020 103549 A
(800) 1056893
(151) 2010 06 16

(891) 2019 05 09
(731) PPG Deco Czech a.s.
Břasy 223, CZ-338 24 Břasy, Czech Republic
(540)



(591) Black, white
(531) 26.13.01; 26.15.01; 27.05.01
(511)
2 – Paints, varnishes, coatings (paints), oil colours, lacquers, preservatives against rust and against deterioration of wood; colorants, mordants, raw natural resins; wood primers (internal and external); dyes for wood; metals in foil and powder form for painters and decorators; finishing coats (paints) for the inside and outside of buildings included in this class; exterior wall paints; acrylic paints; anti-corrosives; thinners, thickeners, pigments and binding preparations for paints; binding preparations and thinners for paints.

(260) AM 2020 103598 A
(800) 1471403
(151) 2018 11 21
(891) 2018 11 21
(731) BIO-THERA SOLUTIONS, LTD.
Floor 5, Building A6, Science Enterprise Accelerator, 11 Kaiyuan Avenue, High-tech Industrial Development Zone, Science City, Guangzhou, Guangdong Province, China
(540)

JORPOVI

(591) Black, white
(531) 27.05.17
(511)
5 – Pharmaceutical preparations; chemico-pharmaceutical preparations; drugs for medical purposes; biological preparations for medical purposes; chemical preparations for pharmaceutical purposes; medicines for human purposes; chemical preparations for medical purposes; injectable pharmaceuticals; crude drug; biochemical drug.

(260) AM 2020 103611 A
(800) 1471731
(151) 2019 04 09
(891) 2019 04 09
(731) YIWU WEIXIAO IMPORT AND EXPORT CO., LTD
Room 705, No. 1377, Chouzhou North Road, Futian Street, Yiwu City, Zhejiang Province, China

(540)



(591) Black, white
 (531) 26.04.18; 26.04.24; 27.05.24
 (511)
 21 – Cauldrons; stew-pans; frying pans; cooking pots; iron pans; cooking pot sets; pot lids; kitchen utensils; hot pots, not electrically heated; food steamers, non-electric.

(260) AM 2020 103625 A
 (800) 1472054
 (151) 2019 05 07
 (891) 2019 05 07
 (731) INCYTE HOLDINGS CORPORATION
 1801 Augustine Cut-Off, Wilmington DE
 19803, USA

(540)

VUFYSO

(591) Black, white
 (511)
 5 – Pharmaceutical preparations.

(260) AM 2020 103645 A
 (800) 936262
 (151) 2007 08 31
 (891) 2019 04 11
 (731) Novartis AG
 CH-4002 Basel, Switzerland

(540)

MAYZENT

(591) Black, white
 (511)
 5 – Pharmaceutical preparations, vaccines, pharmaceutical preparations for diagnostic use.

(260) AM 2020 103649 A
 (800) 1340208
 (151) 2016 12 20
 (891) 2019 05 10
 (731) Lemei Chemicals Co., Ltd.
 No.18, Chunlan West Road, Agriculture
 Foreign Comprehensive, Development Area,
 Haining City, 314423 Zhejiang, China

(540)

LEMEI
 乐玫

(591) Black, white
 (531) 27.05.17; 28.03
 (511)
 2 – Pigments; dyes; lacquers; coatings [paints]; whitewash; anti-corrosive preparations; gum resins; agglutinants for paints; food colorants; printing ink.

(260) AM 2020 103744 A
 (800) 1473533
 (151) 2018 11 12
 (891) 2018 11 12
 (731) MEDIESTETIK S.R.O.
 Senovazne namesti 23, CZ-110 00 Prague 1,
 Czech Republic

(540)



(591) Purple
 (531) 26.01.05; 26.04.05; 26.04.16; 26.04.24;
 26.13.25; 29.01.12

(511)
 44 – Public bath services for hygiene purposes; turkish bath services; hospital services; depilatory waxing; rehabilitation for substance abuse patients; health centers; nursing home services; hair implantation; pharmacy advice; cosmetology; aromatherapy services; manicuring; chiropractic; massage; orthodontic services; artificial insemination services; hairdressing; midwife services; veterinary assistance; dentistry services; medical assistance; preparation of prescriptions by pharmacists; medical equipment rental; rental of sanitation facilities; beauty salon services; sanatorium services; blood bank services; health care; health counselling / health counseling; tattooing; health spa services; aquaculture services; visagists' services; rest home services; medical clinic services; opticians' services; in vitro fertilisation services; services of a psychologist; sauna services; solarium services; telemedicine services; therapy services; nursing, medical; physical therapy; physiotherapy; plastic surgery; tree surgery; hospice services.

(260) AM 2020 103793 A
 (800) 1473638
 (151) 2018 10 16
 (891) 2018 10 16
 (731) SKLIAROVA YULIIA YURIIVNA
 vul. Anny Akhmatovoi, 45, kv. 74,
 Kyiv 02095, Ukraine;
 SKLIAROVA OLHA YURIIVNA
 vul. Anny Akhmatovoi, 45, kv.74,
 Kyiv 02095, Ukraine

(540)

Elise Braun

(591) Black, white

(531) 27.05.01; 27.05.13; 27.05.19

(511)

3 – Balms, other than for medical purposes; bergamot oil; whitening; lip glosses; badian essence; cotton wool for cosmetic purposes; cotton sticks for cosmetic purposes; bleaching soda; bleaching preparations [decolorants] for cosmetic purposes; decorative transfers for cosmetic purposes; make-up; lipsticks; deodorant soap; scented water; ionone [perfumery]; adhesives for affixing false eyelashes; adhesives for affixing false hair; adhesives for cosmetic purposes; collagen preparations for cosmetic purposes; hair conditioners; cosmetics; eyebrow cosmetics; cosmetics for children; beauty masks; cosmetic preparations for baths; hair straightening preparations; cosmetic preparations for eyelashes; cosmetic preparations for skin care; cosmetic preparations for slimming purposes; skin whitening creams; cosmetic creams; starch glaze for laundry purposes; cakes of toilet soap; lavender water; lavender oil; hair spray; nail polish; hair lotions; lotions for cosmetic purposes; emery cloth; emery paper; nail art stickers; neutralizers for permanent waving; fumigation preparations [perfumes]; eau de Cologne; eyebrow pencils; cosmetic pencils; oils for toilet purposes; oils for perfumes and scents; oils for cosmetic purposes; oils for cleaning purposes; oil of turpentine for degreasing; mouthwashes, not for medical purposes; bases for flower perfumes; cleansing milk for toilet purposes; cleansers for intimate personal hygiene purposes, non medicated; refurbishing preparations; scouring solutions; perfumery; toiletry preparations; perfumes; polishing wax; polishing paper; polishing rouge; polishing stones; pomades for cosmetic purposes; laundry preparations; air fragrancing preparations; varnish-removing preparations; paint stripping preparations; lacquer-removing preparations; shaving preparations; depilatory preparations; nail care preparations; hair waving preparations; make-up removing preparations; make-up preparations; make-up powder; nail varnish removers; eye-washes, not for medical purposes; tissues impregnated with make-up removing preparations; turpentine for degreasing; teeth whitening strips; breath freshening strips; soda lye; bath salts, not for medical purposes; sun-screen preparations; douching preparations for personal sanitary or deodorant purposes [toilettries]; canned pressurized air for cleaning and dusting purposes; dry shampoos; talcum powder for toilet use; terpenes [essential oils]; tripoli stone for polishing; rose oil; toilet water; mascara; beard dyes; hair dyes; cosmetic dyes; phytocosmetic preparations;

lipstick cases; henna [cosmetic dye]; cobblers' wax; shoemakers' wax; sandpaper; abrasive cloth; smoothing stones; grinding preparations; false eyelashes; false nails.

(260) AM 2020 103794 A

(800) 1473656

(151) 2019 04 11

(891) 2019 04 11

(731) THE GREENERY B.V.

Spoorwegemplacement 1, NL-2991 VT
Barendrecht, Netherlands

(540)



(591) Red, green, purple, dark purple, gold and white

(531) 05.07.08; 05.07.09; 05.07.24; 25.01.15; 26.05.01; 26.05.02; 27.05.09; 27.05.10; 29.01.15

(511)

31 – Fresh fruit.

(260) AM 2020 103795 A

(800) 1473671

(151) 2019 05 07

(891) 2019 05 07

(731) BIOFARMA

50 rue Carnot, F-92284 Suresnes Cedex,
France

(540)

ATORSTILOL

(591) Black, white

(511)

5 – Pharmaceutical products; medical preparations; veterinary preparations; sanitary products for medical purposes; dietetic substances and foodstuffs for medical or veterinary use, food for babies; food supplements for humans and animals; plasters, materials for dressings; material for dental fillings and dental

impressions; disinfectants; products for destroying vermin; fungicides, herbicides.

(260) AM 2020 103796 A

(800) 1473683

(151) 2019 05 06

(891) 2019 05 06

(731) BIOFARMA
50 rue Carnot, F-92284 SURESNES CEDEX,
France

(540)

ATORPRELOL

(591) Black, white

(511)

5 – Pharmaceutical products; medical preparations; veterinary preparations; sanitary products for medical purposes; dietetic substances and foodstuffs for medical or veterinary use, food for babies; food supplements for humans and animals; plasters, materials for dressings; material for dental fillings and dental impressions; disinfectants; products for destroying vermin; fungicides, herbicides.

(260) AM 2020 103814 A

(800) 1473994

(151) 2019 02 13

(891) 2019 02 13

(731) FIVE LAKES CYPRUS LTD

Stasikratous, 16, Fiduciana Business Center,
2nd floor, Flat/Office A, CY-1065 Nicosia,
Cyprus

(540)

ПЯТЬ ОЗЕР

(591) Black, white

(531) 28.05

(511)

33 – Alcoholic beverages [except beer].

(260) AM 2020 103815 A

(800) 1473995

(151) 2018 12 18

(891) 2018 12 18

(731) VALIO LTD

Meijerikatu 6, FI-00370 Helsinki, Finland

(540)

Оддлигуд

(591) Black, white

(531) 28.05

(511)

29 – Preserved, frozen, dried and cooked fruits and vegetables; jellies, jams, compotes; milk and milk products including yogurt, curd, creams, sour creams, whipped creams, milk drinks, milk-based beverages containing mainly milk, sour milks, milk puddings, milk shakes, protein milk, flavoured milk, drinks containing lactobacillus, kephir, koumiss; whey; cottage cheese, cheese, cheese products; milk powder, dried whey products and whey powders; edible oils and fats; butter; margarine; soups; milk and cream based dips; dairy product substitutes; milk substitutes; oat milk [milk substitute]; almond

milk; almond milk-based beverages; coconut milk; coconut milk-based beverages; peanut milk; peanut milk-based beverages; rice milk, rice milk for use as milk substitute; soya milk, yoghurt substitutes; drinking yoghurt substitutes; buttermilk substitutes; sour cream substitutes; cream substitutes; vegetable based cream and creamer; butter substitutes, margarine substitutes; cheese substitutes; vegetable powders; coconut milk powder; compotes, fruit and vegetable spreads; processed fruit; fruit snacks; fruit chips; fruit-based snack foods; fruit juices for cooking; vegetable juices for cooking; vegetable juice concentrates for food; soup powders.

30 – Coffee, tea, cocoa and artificial coffee; rice; tapioca and sago; flour and preparations made from cereals; bread, pastry and confectionery; ice cream; sugar, honey, treacle; baking-powder; salt; mustard; vinegar; sauces (condiments); spices; ice; non-dairy ice cream; custard; fruit coulis; cheese sauce; cereal snacks; high-protein cereal bars; high-protein chocolate bars; frozen yoghurt [confectionery ices]; non-dairy frozen yoghurt; sorbets [ices]; processed grains, starches, and goods made thereof, baking preparations and yeasts; food dressings [sauces]; cooking sauces; prepared foodstuffs in the form of sauces; sugars, natural sweeteners, sweet coatings and fillings, bee products; salts, seasonings, flavourings and condiments; porridge oats; gruel; prepared meals and snacks containing any of the aforesaid goods; milk and cream based sauces.

32 – Preparations for making beverages; syrups and other preparations for making beverages; non-alcoholic beverages; oat-based beverages; fruit beverages and fruit juices; nut and soy based beverages (not being milk substitutes); vegetable-based beverages; coconut-based beverages; sorbets [beverages]; energy drinks; smoothies; mineral and aerated waters and other non-alcoholic drinks; protein-enriched sports beverages.

(260) AM 2020 103921 A

(800) 1475513

(151) 2019 05 16

(891) 2019 05 16

(731) SHEN LI

NO.137 YANGMEI EAST BUILDING 2,
YUENAN VILLAGE, YUECHENG TOWN,
JIEDONG COUNTY, JIEYANG CITY,
GUANGDONG PROVINCE, China

(540)

CRONIER

PROFESSIONAL

(591) Black, white

(531) 27.05.01; 27.05.10; 27.05.11

(526) PROFESSIONAL

(511)

8 – Beard clippers; crimping irons; razors, electric or non-electric; hair clippers for personal use, electric and non-electric; curling tongs; hand tools, hand-operated; hand implements for hair curling; depilation appliances, electric and non-electric; eyelash curlers.

11 – Lava rocks for use in barbecue grills; hair driers; hot water bottles; lighters; disinfectant apparatus; watering installations, automatic; water purification installations.

(260) AM 2020 103922 A

(800) 1475530

(151) 2019 04 17

(891) 2019 04 17

(731) IMAN JAPLAGHY

No:19 Dubai Bazar 15Khardad St, Bazar
Tehran, Islamic Republic of Iran

(540)



(591) Black, white

(531) 27.05.22

(511)

3 – Shampoos; cakes of soap; cleaning preparations; polishing preparations; ethereal oils; cosmetics; perfumes; dentifrices; air fragrancing preparations; facial cleansers.

(260) AM 2020 103989 A

(800) 1475838

(151) 2019 01 17

(891) 2019 01 17

(731) SOK Group, Limited Liability Company

Zemlyanoi Val st., 8, room I, 2 fl., apt. 2B,
RU-105064 Moscow, Russian Federation

(540)



(591) Black, white

(531) 07.03.02; 07.03.20; 26.01.12; 27.03.15;

27.05.01; 27.05.04; 27.05.17

(511)

36 – Insurance; financial affairs; monetary affairs; real estate affairs; accident insurance underwriting; accommodation bureau services [apartments]; actuarial services; antique appraisal; apartment house management; arranging finance for construction projects; art appraisal; bail-bonding; banking; brokerage; brokerage of carbon credits; business liquidation services, financial; capital investment; charitable

fund raising; check verification; clearing, financial; credit bureau services; debt advisory services; debt collection agency services; deposits of valuables; electronic funds transfer; exchanging money; factoring; financial analysis; financial consultancy; financial customs brokerage services; financial evaluation [insurance, banking, real estate]; financial evaluation of standing timber; financial evaluation of wool; financial information; financial management; financial management of reimbursement payments for others; financial sponsorship; financing services; fire insurance underwriting; fiscal valuation; health insurance underwriting; instalment loans; insurance brokerage; insurance consultancy; insurance information; insurance underwriting; investment of funds; issuance of credit cards; issuance of tokens of value; issuance of travelers' checks; jewelry appraisal; lease-purchase financing; lending against security; life insurance underwriting; loans [financing]; marine insurance underwriting; mortgage banking; mutual funds; numismatic appraisal; online banking; organization of collections; pawnbrokerage; processing of credit card payments; processing of debit card payments; provident fund services; providing financial information via a web site; providing rebates at participating establishments of others through use of a membership card; real estate agency services; real estate appraisal; real estate brokerage; real estate management; rental of apartments; rental of farms; rental of offices for co-working; rental of offices [real estate]; rental of real estate; rent collection; repair costs evaluation [financial appraisal]; retirement payment services; safe deposit services; savings bank services; securities brokerage; stamp appraisal; stock brokerage services; stock exchange quotations; stocks and bonds brokerage; surety services; trusteeship.

41 – Education; providing of training; entertainment; sporting and cultural activities; academies [education]; aikido instruction; amusement park services; animal training; arranging and conducting of colloquiums; arranging and conducting of concerts; arranging and conducting of conferences; arranging and conducting of congresses; arranging and conducting of in-person educational forums; arranging and conducting of seminars; arranging and conducting of symposiums; arranging and conducting of workshops [training]; arranging of beauty contests; boarding school education; booking of seats for shows; calligraphy services; cinema presentations; club services [entertainment or education]; coaching [training]; conducting fitness classes; conducting guided tours; correspondence courses; disc jockey services; discotheque services; dubbing; educational examination; educational services provided by schools; education information; electronic desktop publishing; entertainer services; entertainment information; entertainment services; film production, other than advertising films; gambling services; games

equipment rental; game services provided on-line from a computer network; gymnastic instruction; health club services [health and fitness training]; holiday camp services [entertainment]; karaoke services; language interpreter services; layout services, other than for advertising purposes; lending library services; microfilming; mobile library services; modelling for artists; movie studio services; music composition services; news reporters services; nightclub services [entertainment]; nursery schools; on-line publication of electronic books and journals; orchestra services; organization of balls; organization of competitions [education or entertainment]; organization of exhibitions for cultural or educational purposes; organization of fashion shows for entertainment purposes; organization of lotteries; organization of shows [impresario services]; organization of sports competitions; party planning [entertainment]; personal trainer services [fitness training]; photographic reporting; photography; physical education; practical training [demonstration]; presentation of circus performances; presentation of live performances; presentation of variety shows; production of music; production of radio and television programmes; production of shows; providing amusement arcade services; providing casino facilities [gambling]; providing films, not downloadable, via video-on-demand services; providing golf facilities; providing museum facilities [presentation, exhibitions]; providing on-line electronic publications, not downloadable; providing on-line music, not downloadable; providing on-line videos, not downloadable; providing recreation facilities; providing sports facilities; providing television programs, not downloadable, via video-on-demand services; publication of books; publication of texts, other than publicity texts; radio entertainment; recording studio services; recreation information; religious education; rental of artwork; rental of audio equipment; rental of cinematographic apparatus; rental of indoor aquaria; rental of lighting apparatus for theatrical sets or television studios; rental of motion pictures; rental of radio and television sets; rental of show scenery; rental of skin diving equipment; rental of sound recordings; rental of sports equipment, except vehicles; rental of sports grounds; rental of stadium facilities; rental of stage scenery; rental of tennis courts; rental of video cameras; rental of video cassette recorders; rental of videotapes; sado instruction [tea ceremony instruction]; screenplay writing; scriptwriting, other than for advertising purposes; sign language interpretation; song writing; sport camp services; subtitling; teaching; television entertainment; theatre productions; ticket agency services [entertainment]; timing of sports events; toy rental; training services provided via simulators; translation; tutoring; videotape editing; videotaping; vocational guidance [education or training advice]; vocational retraining; writing of texts; zoological garden services.

43 – Services for providing food and drink; temporary accommodation; accommodation bureau services [hotels, boarding houses]; bar services; boarding for animals; boarding house bookings; boarding house services; café services; cafeteria services; canteen services; day-nursery [crèche] services; food and drink catering; food sculpting; holiday camp services [lodging]; hotel reservations; hotel services; motel services; providing campground facilities; reception services for temporary accommodation [management of arrivals and departures]; rental of chairs, tables, table linen, glassware; rental of cooking apparatus; rental of drinking water dispensers; rental of lighting apparatus; rental of meeting rooms; rental of temporary accommodation; rental of tents; rental of transportable buildings; restaurant services; retirement home services; self-service restaurant services; snack-bar services; temporary accommodation reservations; tourist home services; washoku restaurant services.

(260) AM 2020 104004 A

(800) 1476075

(151) 2019 03 05

(891) 2019 03 05

(731) CAUSSADE SEMENCES

Impasse de la Lère, BP 109, F-82303

CAUSSADE CEDEX, France

(540)



(591) Yellow, green

(531) 26.11.13; 27.05.22; 29.01.12

(511)

31 – Agricultural products and seeds not included in other classes; seeds (grains); unprocessed seeds from corn, sunflower, sorghum, cereals, rape, soya, wheat, barley, oats, bere, triticale, rye; unprocessed seeds from high-protein crops and other forage seeds.

42 – Scientific and technological services as well as research and design services relating thereto; research services in the field of biotechnology namely varietal research.

(260) AM 2020 104015 A

(800) 1476357

(151) 2019 05 29

(891) 2019 05 29

(731) ALCON INC.

Rue Louis-d'Affry 6, CH-1701 Fribourg,

Switzerland

(540)

REVALIA

(591) Black, white

(511)

10 – Surgical apparatus for ophthalmic surgery.

(260) AM 2020 104130 A

(800) 1477230

(151) 2019 05 27

(891) 2019 05 27

(731) MASLAKOV IGOR BORISOVICH
Sibirskaya st., 51, ap. 59, RU-630132
Novosibirsk, Russian Federation

(540)



(591) Black, white

(531) 26.01.03; 26.01.18; 27.05.22

(511)

25 – Clothing, footwear.

26 – Brooches [clothing accessories]; decorative articles for the hair; trimmings for clothing.

35 – Retail services for clothing, footwear and accessories; presentation of goods on communication media, for retail purposes.

(260) AM 2020 104136 A

(800) 1477357

(151) 2019 05 27

(891) 2019 05 27

(731) MASLAKOV IGOR BORISOVICH
Sibirskaya st., 51, ap. 59, RU-630132
Novosibirsk, Russian Federation

(540)



(591) Black, white

(531) 01.01.02; 01.01.12; 01.15.09; 27.05.01;
27.05.17

(511)

25 – Clothing; footwear; headwear.

26 – Embroidery; cords for trimming; haberdashery ribbons; buttons; pins, other than jewellery; artificial flowers.

35 – Procurement services for others [purchasing goods and services for other businesses]; retail services for clothing, footwear and accessories.

(260) AM 2020 104232 A

(800) 1478443

(151) 2019 03 28

(891) 2019 03 28

(731) NEMIROFF INTELLECTUAL PROPERTY
ESTABLISHMENT
Städtle 31, FL-9490 Vaduz, Liechtenstein

(540)



(591) Black, white, grey, orange, red, brown, golden and green

(531) 03.11.01; 03.13.04; 03.13.05; 05.07.15;
05.09.15; 11.03.01; 17.02.02; 24.09.05;
25.01.19; 29.01.15

(511)

33 – Alcoholic beverages (except beers); alcoholic beverages containing fruit; bitters; cocktails; digesters [liqueurs and spirits]; distilled beverages; liqueurs; spirits [beverages]; vodka.

(260) AM 2020 104233 A

(800) 1478462

(151) 2019 02 06

(891) 2019 02 06

(731) VetNow LLC
1301 Grandview Ave, Pittsburgh PA 15211,
USA

(540)

VETNOW

(591) Black, white

(511)

9 – Downloadable mobile application for providing veterinary services, namely, computer application software for accessing veterinary consultations, diagnoses, and scheduling appointments; downloadable mobile application for providing veterinary consultations; downloadable mobile application for providing veterinary diagnoses; downloadable mobile application for scheduling veterinary appointments; downloadable mobile application featuring medical information for animals; downloadable mobile application for remote herd monitoring; downloadable mobile application for infectious disease monitoring for animals featuring preventive care information; downloadable mobile application for coordinating medical treatment of animals and monitoring of natural disaster and emergency situations for animals; computer software for providing veterinary services, namely, computer software for providing veterinary

consultations, for providing veterinary diagnoses, and for scheduling veterinary appointments; computer software for providing veterinary consultations; computer software for providing veterinary diagnoses; computer software for scheduling veterinary appointments; computer software featuring medical information for animals; computer software for remote herd monitoring; computer software for infectious disease monitoring for animals featuring preventive care information; computer software for coordinating medical treatment of animals and monitoring of natural disaster and emergency situations for animals.

35 – Veterinary appointment scheduling services provided via an online web site and electronic communications networks.

44 – Veterinary services; veterinary emergency and trauma services; veterinary consultations provided via online web site, e-mail, and text; providing medical information for animals via a web site; veterinary services, namely, infectious disease management programs, consulting services in the field of infectious disease control, and providing health information in the field of infectious disease prevention; veterinary services, namely, coordinating and providing the medical treatment of animals during natural disasters and emergency situations.

(260) AM 2020 104234 A

(800) 1478463

(151) 2019 04 19

(891) 2019 04 19

(731) ILIRIJA, d.o.o.

Tržaška cesta 40, SI-1000 Ljubljana, Slovenia

(540)

HAIRCODE

(591) Black, white

(511)

3 – Laundry bleach; laundry preparations; scouring substances; polishing preparations; abrasives; cleaning preparations for household or cosmetic purposes; soaps; toilet soap; almond soap; deodorant soap; deodorants for personal use; antiperspirants [toiletries]; antiperspirant soap; soap for foot perspiration; douching preparations for personal sanitary or deodorant purposes [toiletries]; bath salts, not for medical purposes; cosmetic preparations for baths; toiletries; talcum powder, for toilet use; make-up removing preparations; cleansing milk for toilet purposes; cloths impregnated with a detergent for cleaning; cloths or tissues impregnated with a skin cleanser; tissues impregnated with cosmetic lotions; pre-moistened cosmetic wipes; oils for toilet purposes; colorants for toilet purposes; massage gels, other than for medical purposes; perfumery; perfume; perfumed tissues; scented water; toilet water; cologne; ethereal essences, essential oils, and oils; rose oil;

cosmetics; skincare cosmetics; cosmetic creams; cosmetic hand creams; beauty masks; exfoliants; lotions for cosmetic purposes; tonics for cosmetic purposes, almond milk for cosmetic purposes; almond oil; oils for cosmetic purposes; greases for cosmetic purposes; eyebrow cosmetics; cosmetic preparations for eyelashes; make-up preparations; make-up preparations; mascara; cosmetic pencils; eyebrow pencils; lipstick; lip gloss; petroleum jelly for cosmetic purposes; pomades for cosmetic purposes; make-up powder; eyelashes (false -); eyelashes (adhesives for affixing false -); dyes (cosmetic -); bleaching preparations [decolorants] for cosmetic purposes; skin whitening creams; nail care preparations; nail polish; nail art stickers; false nails; adhesives for cosmetic purposes; sun-tanning preparations [cosmetics]; cosmetic preparations for slimming purposes; depilatories; wax (depilatory -); depilatory preparations; shaving preparations; shaving soap; after-shave lotions; hair preparations and beauty products, hair styling and straightening preparations, included in this class; shampoos for the hair; dry shampoos; hair lotions; hair dye; hair colorants; colour creams for hair; hair toners; hair balm; conditioning preparations for the hair; oils for hair conditioning; hair creams; hair waxes; hair elixirs; hair tonic; hair spray; hair gel; hair styling mousses; hair masks; hair serums; hair fixatives; hair spray; hair-waving preparations; preparations for the permanent waving of hair; neutralizers for permanent waving; brightening agents for hair; hair colour removers; hydrogen peroxide for cosmetic purposes; non-medical preparations for treating dandruff and hair loss; leave-in conditioners for the hair; preparations for moisturising and protection of hair, included in this class; mouth washes, not for medical purposes; dentifrices; toothpaste; dental bleaching gels; breath freshening sprays; dentures (preparations for cleaning -); cotton wool for cosmetic purposes; cotton sticks for cosmetic purposes; cleaning swabs (toiletries); cosmetic kits.

(260) AM 2020 104235 A

(800) 1478513

(151) 2019 05 09

(891) 2019 05 09

(731) SANOFI

54 rue la Boétie, F-75008 PARIS, France

(540)



(591) Dark blue, red, light blue

(531) 09.01.01; 09.01.15; 26.13.25; 29.01.12

(511)

5 – Pharmaceutical products in the field of oncology.

(260) AM 2020 104236 A

(800) 1478517

(151) 2019 06 03

(891) 2019 06 03

(731) BIOFARMA

50 rue Carnot, F-92284 Suresnes Cedex,
France

(540)

QUILIPREL

(591) Black, white

(511)

5 – Pharmaceutical products; medical preparations; veterinary preparations; sanitary products for medical purposes; dietetic substances and foodstuffs for medical or veterinary use, food for babies; food supplements for humans and animals; plasters, materials for dressings; material for dental fillings and dental impressions; disinfectants; products for destroying vermin; fungicides, herbicides.

(260) AM 2020 104243 A

(800) 1478605

(151) 2019 06 03

(891) 2019 06 03

(731) DENSO EUROPE B.V.

Hogeweyselaan 165, NL-1382 JL WEESP,
Netherlands

(540)

Endurovision

(591) Black, white

(511)

12 – Vehicles; apparatus for locomotion by land, air or water; spare parts for vehicles, namely wiper blades.

(260) AM 2020 104244 A

(800) 1478656

(151) 2019 05 20

(891) 2019 05 20

(731) PAYSEND GROUP LIMITED

Cluny Court, John Smith Business Park,
Kirkcaldy, Fife KY2 6QJ, United Kingdom

(540)

PAYSXDR

(591) Light-violet, deep blue

(531) 24.17.18; 27.05.01; 29.01.12

(511)

9 – Payment terminals, including automatic self-service payment terminals and electronic point-of-sale terminals; automatic teller machines; remote control apparatus for payment terminals network, vending machines and automatic teller machines; identity cards, magnetic; encoded magnetic cards; computer programs for payment terminals network, vending

machines, automatic teller machines, conducting financial transactions, crypto- and digital money and crypto-currency; computer software for payment terminals network, vending machines, automatic teller machines; computer programmes [programs], recorded; magnetic data media; chips [integrated circuits]; computer software applications, downloadable, including applications designed for conducting financial transactions, crypto- and digital money and crypto-currency.

36 – Insurance; financial affairs, including activity relating to the use of crypto- and digital money and crypto-currency; monetary affairs including operations with the use of crypto- and digital money and crypto-currency; real estate affairs; issuance of travelers' checks; issuance of credit cards; issuance of tokens of value; debit card services; credit card services; online banking; banking; electronic funds transfer.

(260) AM 2020 104293 A

(800) 1479581

(151) 2019 05 08

(891) 2019 05 08

(731) C.P.C. Creative Perfume Company Holding SA

Rue du Mont-de-Sion 8, c/o Lenhill Partners
SA, CH-1206 Genève, Switzerland

(540)

THE OUD AFFAIR

(591) Black, white

(511)

3 – Amber [perfume]; aromatics [essential oils]; air fragrancing preparations; cake flavorings [essential oils]; flavorings for beverages [essential oils]; food flavorings [essential oils]; breath freshening sprays; balms, other than for medical purposes; lip glosses; sachets for perfuming linen; scented water; Javelle water; lavender water; toilet water; depilatory wax; mustache wax; massage gels, other than for medical purposes; heliotropine; make-up; deodorants for pets; deodorants for human beings or for animals; depilatory preparations; air fragrance reed diffusers; scented wood; perfumes; perfumery; decorative transfers for cosmetic purposes; ionone [perfumery]; eyebrow pencils; cosmetic pencils; adhesives for affixing false eyelashes; adhesives for affixing false hair; hair conditioners; beard dyes; cosmetic dyes; cosmetic creams; skin whitening creams; incense; hair spray; nail polish; hair lotions; lotions for cosmetic purposes; after-shave lotions; beauty masks; oils for perfumes and scents; oils for cosmetic purposes; oils for toilet purposes; essential oils; essential oils of cedarwood; essential oils of lemon; essential oils of citron; oils for cleaning purposes; bergamot oil; gaultheria oil; jasmine oil; lavender oil; almond oil; rose oil; almond milk for cosmetic purposes; cleansing milk for toilet purposes; musk [perfu-

mery]; deodorant soap; shaving soap; soap for brightening textile; cakes of toilet soap; antiperspirant soap; soap for foot perspiration; soap; almond soap; mint for perfumery; cosmetic kits; eau de Cologne; bases for flower perfumes; joss sticks; dentifrices; lipstick cases; breath freshening strips; teeth whitening strips; lipsticks; pomades for cosmetic purposes; shaving preparations; cosmetic preparations for baths; bath preparations, not for medical purposes; hair straightening preparations; hair waving preparations; color-removing preparations; leather bleaching preparations; mouthwashes, not for medical purposes; cosmetic preparations for slimming purposes; make-up removing preparations; nail care preparations; collagen preparations for cosmetic purposes; aloe vera preparations for cosmetic purposes; sunscreen preparations; breath freshening preparations for personal hygiene; make-up powder; nail varnish removers; vaginal washes for personal sanitary or deodorant purposes; tissues impregnated with cosmetic lotions; tissues impregnated with make-up removing preparations; massage candles for cosmetic purposes; potpourris [fragrances]; bath salts, not for medical purposes; fumigation preparations [perfumes]; astringents for cosmetic purposes; eyebrow cosmetics; make-up preparations; sun-tanning preparations [cosmetics]; hair dyes; neutralizers for permanent waving; cosmetic preparations for eyelashes; cosmetic preparations for skin care; cosmetics; cosmetics for children; cosmetics for animals; mascara; cleansers for intimate personal hygiene purposes, non medicated; douching preparations for personal sanitary or deodorant purposes [toiletries]; bleaching preparations [decolorants] for cosmetic purposes; antiperspirants [toiletries]; toiletry preparations; phyto-cosmetic preparations; talcum powder, for toilet use; terpenes [essential oils]; henna [cosmetic dye]; shampoos for animals [non-medicated grooming preparations]; shampoos for pets [non-medicated grooming preparations]; dry shampoos; shampoos; herbal extracts for cosmetic purposes; extracts of flowers [perfumes]; ethereal essences; badian essence; mint essence [essential oil].

4 – Nightlights [candles]; perfumed candles; Christmas tree candles; candles.

(260) AM 2020 104294 A

(800) 535376

(151) 1989 02 23

(891) 2019 07 09

(731) S.C. DU CHATEAU PETRUS

4-10 avenue de la Grande Armée, F-75017
PARIS, France

(540)

PETRUS

(591) Black, white

(531) 27.05.01; 27.05.17

(511)

33 – Wines.

(260) AM 2020 104295 A

(800) 1132736

(151) 2012 07 24

(891) 2019 07 03

(731) KABUSHIKI KAISHA F.C.C.

7000-36 Nakagawa, Hosoe-cho, Kita-ku,
Hamamatsu-shi, Shizuoka-ken, 431-1304,
Japan

(540)



(591) Black, white

(531) 24.17.01; 24.17.02; 27.01.06; 27.05.17

(526) "CLUTCH" AND "TECHNOLOGY".

(511)

7 – Clutches for machines, and parts and fittings therefor.

12 – Clutches for vehicles.

(260) AM 2020 104296 A

(800) 1134104

(151) 2012 07 20

(891) 2019 07 03

(731) KABUSHIKI KAISHA F.C.C.

7000-36 Nakagawa, Hosoe-cho, Kita-ku,
Hamamatsu-shi, Shizuoka-ken, 431-1304,
Japan

(540)

CLUTCH
F.C.C.
TECHNOLOGY

(591) Black, white

(531) 24.17.01; 24.17.02; 27.05.10

(526) "CLUTCH" AND "TECHNOLOGY".

(511)

7 – Clutches for machines, and parts and fittings therefor.

12 – Clutches for land vehicles, and parts and fittings therefor.

(260) AM 2020 106196 A

(800) 1503679

(151) 2019 07 22

(891) 2019 07 22

(731) HAUSBRANDT TRIESTE 1892 S.P.A.

Via Foscarini 52, I-31040 Nervesa della Battaglia (TV), Italy

(540)



HAUSBRANDT

TRIESTE 1892

(591) Black, white

(531) 01.15.11; 04.05.02; 11.03.01; 11.03.04;
11.03.14; 27.05.10

(511)

30 – Coffee, tea, cocoa; sugar and honey; coffee flavorings; artificial coffee; coffee-based beverages; tea-based beverages; cocoa-based beverages; preparations of malted barley for use in making beverages; honey; crushed barley; ground barley; drinking chocolate; waffles; chocolate; vegetal preparations for use as coffee substitutes; biscuits; infusions not medicinal, non-medical herbal teas, fruit-based infusions, aromatic preparations for making non-medicated infusions, fruit flavoured tea, other than medicinal, tisanes.

35 – Advertising; advertising particularly services for the promotion of goods; publicity and sales promotion services; advertising for direct marketing; layout services for advertising purposes; advertising service for the promotion of products in relation to coffee, tea, cocoa, sugar and honey, coffee flavorings, artificial coffee, coffee-based beverages, tea-based beverages, cocoa-based beverages, barley drinks, honey, crushed barley, ground barley, drinking chocolate, waffles, chocolate, vegetal preparations for use as coffee substitutes, biscuits, infusions, not medicinal, non-medical herbal teas, fruit-based infusions, aromatic preparations for making non-medicated infusions, fruit flavoured tea, other than medicinal, tisanes; dissemination of advertisements; direct mail advertising, namely leaflets, prospectuses, printed material, samples; marketing services; organisation of exhibitions for commercial and advertising purposes; organisation of trade fairs for commercial and advertising purposes; presentation of goods on communication media, for retail purposes; publication of publicity texts; on-line advertising on a computer network; writing of publicity texts; on-line retail services of products in relation to coffee, tea, cocoa, sugar and honey, coffee flavorings, artificial coffee, coffee-based beverages, tea-based beverages, cocoa-based beverages, barley drinks, honey, crushed barley, ground barley, drin-

king chocolate, waffles, chocolate, vegetal preparations for use as coffee substitutes, biscuits, infusions, not medicinal, non-medical herbal teas, fruit-based infusions, aromatic preparations for making non-medicated infusions, fruit flavoured tea, other than medicinal, tisanes; retailing or wholesaling of products in relation to coffee, tea, cocoa, sugar and honey, coffee flavorings, artificial coffee, coffee-based beverages, tea-based beverages, cocoa-based beverages, barley drinks, honey, crushed barley, ground barley, drinking chocolate, waffles, chocolate, vegetal preparations for use as coffee substitutes, biscuits, infusions, not medicinal, non-medical herbal teas, fruit-based infusions, aromatic preparations for making non-medicated infusions, fruit flavoured tea, other than medicinal, tisanes; franchising services, namely consultancy and support in the management and organisation of restaurants, bars, cafeterias; retail shop window display arrangement services.

**INTERNATIONAL TRADEMARKS PROTECTED
IN GEORGIA**

(260) AM 2020 97315 A
(800) 1396944
(151) 2018 02 28
(181) 2028 02 28
(891) 2018 02 28
(511) 05, 05, 10, 44

(260) AM 2020 101166 A
(800) 1443883
(151) 2018 11 07
(181) 2028 11 07
(891) 2018 11 07
(511) 30

(260) AM 2020 97663 A
(800) 1401471
(151) 2018 02 19
(181) 2028 02 19
(891) 2018 02 19
(511) 32

(260) AM 2020 101362 A
(800) 684419
(151) 1997 12 12
(181) 2027 12 12
(891) 2018 12 11
(511) 03

(260) AM 2020 99117 A
(800) 1419622
(151) 2017 09 20
(181) 2027 09 20
(891) 2017 09 20
(511) 09

(260) AM 2020 101363 A
(800) 822485
(151) 2004 02 11
(181) 2024 02 11
(891) 2018 12 11
(511) 03

(260) AM 2020 99606 A
(800) 1425244
(151) 2018 07 11
(181) 2028 07 11
(891) 2018 07 11
(511) 03, 05, 32

(260) AM 2020 101364 A
(800) 1141434
(151) 2012 09 07
(181) 2022 09 07
(891) 2019 01 10
(511) 01, 04

(260) AM 2020 101100 A
(800) 1442726
(151) 2018 07 03
(181) 2028 07 03
(891) 2018 07 03
(511) 35, 36, 38, 44

(260) AM 2020 101365 A
(800) 1162778
(151) 2013 05 22
(181) 2023 05 22
(891) 2018 12 17
(511) 14

(260) AM 2020 101121 A
(800) 1443188
(151) 2018 11 10
(181) 2028 11 10
(891) 2018 11 10
(511) 09, 41, 42

(260) AM 2020 101366 A
(800) 1174570
(151) 2013 07 23
(181) 2023 07 23
(891) 2019 01 08
(511) 03, 25

(260) AM 2020 101147 A
(800) 1443496
(151) 2018 10 18
(181) 2028 10 18
(891) 2018 10 18
(511) 09, 41

(260) AM 2020 101367 A
(800) 1199468
(151) 2014 02 13
(181) 2024 02 13
(891) 2019 01 08
(511) 03, 18, 25

(260) AM 2020 101368 A
(800) 1354891
(151) 2017 04 11
(181) 2027 04 11
(891) 2018 12 03
(511) 09, 42

(260) AM 2020 101429 A
(800) 1446484
(151) 2018 12 13
(181) 2028 12 13
(891) 2018 12 13
(511) 05

(260) AM 2020 101431 A
(800) 1446554
(151) 2018 10 31
(181) 2028 10 31
(891) 2018 10 31
(511) 34

(260) AM 2020 101440 A
(800) 1446848
(151) 2018 10 18
(181) 2028 10 18
(891) 2018 10 18
(511) 05

(260) AM 2020 101446 A
(800) 1446919
(151) 2018 10 24
(181) 2028 10 24
(891) 2018 10 24
(511) 36, 39, 41, 43, 44

(260) AM 2020 101448 A
(800) 1446968
(151) 2018 10 23
(181) 2028 10 23
(891) 2018 10 23
(511) 03, 05, 32

(260) AM 2020 101472 A
(800) 1447668
(151) 2018 11 08
(181) 2028 11 08
(891) 2018 11 08
(511) 30, 35, 43

(260) AM 2020 101482 A
(800) 866366
(151) 2005 04 25
(181) 2025 04 25

(891) 2019 01 14
(511) 11

(260) AM 2020 101530 A
(800) 1447731
(151) 2018 11 17
(181) 2028 11 17
(891) 2018 11 17
(511) 05

(260) AM 2020 101531 A
(800) 1447732
(151) 2018 11 17
(181) 2028 11 17
(891) 2018 11 17
(511) 05

(260) AM 2020 101532 A
(800) 1447757
(151) 2018 10 18
(181) 2028 10 18
(891) 2018 10 18
(511) 13

(260) AM 2020 101534 A
(800) 1447785
(151) 2018 03 09
(181) 2028 03 09
(891) 2018 03 09
(511) 05, 28, 32

(260) AM 2020 101536 A
(800) 1447817
(151) 2018 11 17
(181) 2028 11 17
(891) 2018 11 17
(511) 05

(260) AM 2020 101539 A
(800) 1447964
(151) 2018 12 18
(181) 2028 12 18
(891) 2018 12 18
(511) 03

(260) AM 2020 101540 A
(800) 1447974
(151) 2018 12 18
(181) 2028 12 18
(891) 2018 12 18
(511) 03

(260) AM 2020 101541 A (800) 1447992 (151) 2018 11 23 (181) 2028 11 23 (891) 2018 11 23 (511) 03, 25, 41	(181) 2028 10 20 (891) 2018 10 20 (511) 12
<hr/>	<hr/>
(260) AM 2020 101542 A (800) 1447999 (151) 2018 12 12 (181) 2028 12 12 (891) 2018 12 12 (511) 09	(260) AM 2020 101549 A (800) 1448178 (151) 2018 02 27 (181) 2028 02 27 (891) 2018 02 27 (511) 07, 09, 12, 37
<hr/>	<hr/>
(260) AM 2020 101543 A (800) 1448012 (151) 2018 11 27 (181) 2028 11 27 (891) 2018 11 27 (511) 33	(260) AM 2020 101550 A (800) 1448180 (151) 2018 08 10 (181) 2028 08 10 (891) 2018 08 10 (511) 01, 02, 04, 07, 12, 16, 19, 35, 37, 38, 39, 40, 42
<hr/>	<hr/>
(260) AM 2020 101544 A (800) 1448015 (151) 2018 10 17 (181) 2028 10 17 (891) 2018 10 17 (511) 08	(260) AM 2020 101551 A (800) 1448198 (151) 2018 05 04 (181) 2028 05 04 (891) 2018 05 04 (511) 07, 08, 09, 11, 21, 35
<hr/>	<hr/>
(260) AM 2020 101545 A (800) 1448044 (151) 2018 12 13 (181) 2028 12 13 (891) 2018 12 13 (511) 11	(260) AM 2020 101552 A (800) 1448200 (151) 2018 11 28 (181) 2028 11 28 (891) 2018 11 28 (511) 03, 05
<hr/>	<hr/>
(260) AM 2020 101546 A (800) 1448067 (151) 2018 07 17 (181) 2028 07 17 (891) 2018 07 17 (511) 03, 09, 14, 16, 18, 24, 25, 35, 38, 41	(260) AM 2020 101553 A (800) 1448222 (151) 2018 12 24 (181) 2028 12 24 (891) 2018 12 24 (511) 30
<hr/>	<hr/>
(260) AM 2020 101547 A (800) 1448073 (151) 2018 12 13 (181) 2028 12 13 (891) 2018 12 13 (511) 11	(260) AM 2020 101555 A (800) 1448252 (151) 2018 12 19 (181) 2028 12 19 (891) 2018 12 19 (511) 05
<hr/>	<hr/>
(260) AM 2020 101548 A (800) 1448132 (151) 2018 10 20	(260) AM 2020 101556 A (800) 1448254 (151) 2018 12 19 (181) 2028 12 19 (891) 2018 12 19 (511) 05
<hr/>	<hr/>

(260) AM 2020 101563 A
(800) 1448305
(151) 2017 10 18
(181) 2027 10 18
(891) 2017 10 18
(511) 03, 09, 14, 16, 18, 25, 28, 35, 41, 42

(260) AM 2020 101564 A
(800) 1448366
(151) 2018 07 19
(181) 2028 07 19
(891) 2018 07 19
(511) 35

(260) AM 2020 101566 A
(800) 1448423
(151) 2018 12 07
(181) 2028 12 07
(891) 2018 12 07
(511) 34

(260) AM 2020 101567 A
(800) 1448461
(151) 2018 11 21
(181) 2028 11 21
(891) 2018 11 21
(511) 09

(260) AM 2020 101568 A
(800) 1448500
(151) 2018 10 11
(181) 2028 10 11
(891) 2018 10 11
(511) 11

(260) AM 2020 101569 A
(800) 1448541
(151) 2018 11 30
(181) 2028 11 30
(891) 2018 11 30
(511) 36

(260) AM 2020 101570 A
(800) 1448543
(151) 2018 12 07
(181) 2028 12 07
(891) 2018 12 07
(511) 03

(260) AM 2020 101571 A
(800) 1448583
(151) 2018 11 29
(181) 2028 11 29

(891) 2018 11 29
(511) 09, 41

(260) AM 2020 101573 A
(800) 1448683
(151) 2019 01 04
(181) 2029 01 04
(891) 2019 01 04
(511) 09

(260) AM 2020 101577 A
(800) 1448836
(151) 2018 10 01
(181) 2028 10 01
(891) 2018 10 01
(511) 29, 30

(260) AM 2020 101578 A
(800) 1448862
(151) 2018 12 12
(181) 2028 12 12
(891) 2018 12 12
(511) 09

(260) AM 2020 101579 A
(800) 1448877
(151) 2018 07 23
(181) 2028 07 23
(891) 2018 07 23
(511) 18, 25

(260) AM 2020 101581 A
(800) 1448923
(151) 2018 12 20
(181) 2028 12 20
(891) 2018 12 20
(511) 01

(260) AM 2020 101582 A
(800) 1448940
(151) 2018 09 24
(181) 2028 09 24
(891) 2018 09 24
(511) 30

(260) AM 2020 101583 A
(800) 1448950
(151) 2018 11 16
(181) 2028 11 16
(891) 2018 11 16
(511) 03, 18, 25, 28

(260) AM 2020 101584 A
(800) 1448951
(151) 2018 10 15
(181) 2028 10 15
(891) 2018 10 15
(511) 19

(260) AM 2020 101585 A
(800) 1448964
(151) 2018 11 26
(181) 2028 11 26
(891) 2018 11 26
(511) 29

(260) AM 2020 101596 A
(800) 1421820
(151) 2018 05 24
(181) 2028 05 24
(891) 2018 09 20
(511) 19, 35

(260) AM 2020 101696 A
(800) 1449178
(151) 2018 11 19
(181) 2028 11 19
(891) 2018 11 19
(511) 05

(260) AM 2020 101697 A
(800) 1449181
(151) 2018 11 19
(181) 2028 11 19
(891) 2018 11 19
(511) 05

(260) AM 2020 101698 A
(800) 1449189
(151) 2018 11 19
(181) 2028 11 19
(891) 2018 11 19
(511) 05

(260) AM 2020 101699 A
(800) 1449196
(151) 2018 11 19
(181) 2028 11 19
(891) 2018 11 19
(511) 05

(260) AM 2020 101700 A
(800) 1449197
(151) 2018 11 15
(181) 2028 11 15

(891) 2018 11 15
(511) 12

(260) AM 2020 101701 A
(800) 1449198
(151) 2018 12 13
(181) 2028 12 13
(891) 2018 12 13
(511) 05, 36

(260) AM 2020 101702 A
(800) 1449200
(151) 2018 11 19
(181) 2028 11 19
(891) 2018 11 19
(511) 05

(260) AM 2020 101703 A
(800) 1449207
(151) 2018 11 19
(181) 2028 11 19
(891) 2018 11 19
(511) 05

(260) AM 2020 101705 A
(800) 1449234
(151) 2018 07 23
(181) 2028 07 23
(891) 2018 07 23
(511) 18, 28

(260) AM 2020 101706 A
(800) 1449235
(151) 2018 11 16
(181) 2028 11 27
(891) 2018 11 27
(511) 09

(260) AM 2020 101707 A
(800) 1449244
(151) 2018 11 19
(181) 2028 11 19
(891) 2018 11 19
(511) 05

(260) AM 2020 101709 A
(800) 1449251
(151) 2018 11 19
(181) 2028 11 19
(891) 2018 11 19
(511) 05

(260) AM 2020 101711 A
(800) 1449258
(151) 2018 11 19
(181) 2028 11 19
(891) 2018 11 19
(511) 05

(260) AM 2020 101712 A
(800) 1449272
(151) 2018 11 19
(181) 2028 11 19
(891) 2018 11 19
(511) 05

(260) AM 2020 101713 A
(800) 1449277
(151) 2018 11 19
(181) 2028 11 19
(891) 2018 11 19
(511) 05

(260) AM 2020 101714 A
(800) 1449287
(151) 2016 08 19
(181) 2026 08 19
(891) 2016 08 19
(511) 09

(260) AM 2020 101717 A
(800) 1449340
(151) 2018 07 18
(181) 2028 07 18
(891) 2018 07 18
(511) 05

(260) AM 2020 101718 A
(800) 1449347
(151) 2018 11 19
(181) 2028 11 19
(891) 2018 11 19
(511) 29, 30, 35, 43

(260) AM 2020 101719 A
(800) 1449370
(151) 2018 11 07
(181) 2028 11 07
(891) 2018 11 07
(511) 03

(260) AM 2020 101720 A
(800) 1449376
(151) 2018 09 14
(181) 2028 09 14

(891) 2018 09 14
(511) 30

(260) AM 2020 101721 A
(800) 1449388
(151) 2018 11 19
(181) 2028 11 19
(891) 2018 11 19
(511) 05

(260) AM 2020 101722 A
(800) 1449389
(151) 2019 01 15
(181) 2029 01 15
(891) 2019 01 15
(511) 03

(260) AM 2020 101723 A
(800) 1449394
(151) 2018 11 19
(181) 2028 11 19
(891) 2018 11 19
(511) 05

(260) AM 2020 101724 A
(800) 1449399
(151) 2018 11 19
(181) 2028 11 19
(891) 2018 11 19
(511) 05

(260) AM 2020 101726 A
(800) 1449428
(151) 2018 07 19
(181) 2028 07 19
(891) 2018 07 19
(511) 30

(260) AM 2020 101727 A
(800) 1449469
(151) 2019 01 11
(181) 2029 01 11
(891) 2019 01 11
(511) 10

(260) AM 2020 101728 A
(800) 1449495
(151) 2018 11 23
(181) 2028 11 23
(891) 2018 11 23
(511) 18

(260) AM 2020 101737 A
(800) 1449613
(151) 2018 12 20
(181) 2028 12 20
(891) 2018 12 20
(511) 30

(260) AM 2020 101738 A
(800) 1449632
(151) 2018 08 20
(181) 2028 08 20
(891) 2018 08 20
(511) 09, 35, 41, 42

(260) AM 2020 101739 A
(800) 1449738
(151) 2018 12 14
(181) 2028 12 14
(891) 2018 12 14
(511) 02

(260) AM 2020 101741 A
(800) 1449767
(151) 2018 12 20
(181) 2028 12 20
(891) 2018 12 20
(511) 30

(260) AM 2020 101742 A
(800) 1449772
(151) 2019 01 10
(181) 2029 01 10
(891) 2019 01 10
(511) 07, 11, 35, 42

(260) AM 2020 101743 A
(800) 1449781
(151) 2018 11 12
(181) 2028 11 12
(891) 2018 11 12
(511) 03

(260) AM 2020 101744 A
(800) 1449793
(151) 2018 10 26
(181) 2028 10 26
(891) 2018 10 26
(511) 10

(260) AM 2020 101745 A
(800) 1449799
(151) 2018 12 21
(181) 2028 12 21

(891) 2018 12 21
(511) 09

(260) AM 2020 101750 A
(800) 1449915
(151) 2018 11 15
(181) 2028 11 15
(891) 2018 11 15
(511) 30

(260) AM 2020 101751 A
(800) 1449924
(151) 2018 10 18
(181) 2028 10 18
(891) 2018 10 18
(511) 30

(260) AM 2020 101753 A
(800) 1449975
(151) 2019 01 10
(181) 2029 01 10
(891) 2019 01 10
(511) 34

(260) AM 2020 101755 A
(800) 1450014
(151) 2018 11 15
(181) 2028 11 15
(891) 2018 11 15
(511) 12

(260) AM 2020 101756 A
(800) 1450061
(151) 2018 10 30
(181) 2028 10 30
(891) 2018 10 30
(511) 03

(260) AM 2020 101759 A
(800) 1450096
(151) 2018 08 20
(181) 2028 08 20
(891) 2018 08 20
(511) 01, 07, 09, 16, 39

(260) AM 2020 101760 A
(800) 1450106
(151) 2018 08 31
(181) 2028 08 31
(891) 2018 08 31
(511) 11, 20

(260) AM 2020 101761 A
(800) 1450123
(151) 2018 12 18
(181) 2028 12 18
(891) 2018 12 18
(511) 12

(260) AM 2020 101764 A
(800) 1450177
(151) 2019 01 18
(181) 2029 01 18
(891) 2019 01 18
(511) 05

(260) AM 2020 101765 A
(800) 1450179
(151) 2019 01 18
(181) 2029 01 18
(891) 2019 01 18
(511) 05

(260) AM 2020 101766 A
(800) 1450180
(151) 2019 01 18
(181) 2029 01 18
(891) 2019 01 18
(511) 31

(260) AM 2020 101767 A
(800) 1450192
(151) 2018 12 11
(181) 2028 12 11
(891) 2018 12 11
(511) 05

(260) AM 2020 101768 A
(800) 1450195
(151) 2018 12 07
(181) 2028 12 07
(891) 2018 12 07
(511) 05

(260) AM 2020 101769 A
(800) 1450196
(151) 2018 11 19
(181) 2028 11 19
(891) 2018 11 19
(511) 05

(260) AM 2020 101770 A
(800) 1450197
(151) 2018 12 03
(181) 2028 12 03

(891) 2018 12 03
(511) 05

(260) AM 2020 101771 A
(800) 1450198
(151) 2018 12 03
(181) 2028 12 03
(891) 2018 12 03
(511) 05

(260) AM 2020 101772 A
(800) 1450254
(151) 2018 12 17
(181) 2028 12 17
(891) 2018 12 17
(511) 09

(260) AM 2020 101798 A
(800) 1450507
(151) 2018 10 08
(181) 2028 10 08
(891) 2018 10 08
(511) 19, 35, 36, 37, 40, 44

(260) AM 2020 101800 A
(800) 1450516
(151) 2018 10 16
(181) 2028 10 16
(891) 2018 10 16
(511) 30

(260) AM 2020 101801 A
(800) 1450542
(151) 2018 08 30
(181) 2028 08 30
(891) 2018 08 30
(511) 04, 07, 09, 42

(260) AM 2020 101803 A
(800) 1450667
(151) 2018 07 17
(181) 2028 07 17
(891) 2018 07 17
(511) 09, 28

(260) AM 2020 101830 A
(800) 1451052
(151) 2018 11 19
(181) 2028 11 19
(891) 2018 11 19
(511) 05

(260) AM 2020 101832 A
(800) 1451071
(151) 2018 12 03
(181) 2028 12 03
(891) 2018 12 03
(511) 05

(260) AM 2020 101836 A
(800) 1451086
(151) 2018 11 19
(181) 2028 11 19
(891) 2018 11 19
(511) 05

(260) AM 2020 101837 A
(800) 1451087
(151) 2018 12 03
(181) 2028 12 03
(891) 2018 12 03
(511) 05

(260) AM 2020 101838 A
(800) 1451088
(151) 2018 12 03
(181) 2028 12 03
(891) 2018 12 03
(511) 05

(260) AM 2020 101839 A
(800) 1451093
(151) 2018 12 03
(181) 2028 12 03
(891) 2018 12 03
(511) 05

(260) AM 2020 101840 A
(800) 1451098
(151) 2018 12 03
(181) 2028 12 03
(891) 2018 12 03
(511) 05

(260) AM 2020 101841 A
(800) 1451104
(151) 2018 12 03
(181) 2028 12 03
(891) 2018 12 03
(511) 05

(260) AM 2020 101842 A
(800) 1451106
(151) 2018 12 03
(181) 2028 12 03

(891) 2018 12 03
(511) 05

(260) AM 2020 101843 A
(800) 1451108
(151) 2018 12 03
(181) 2028 12 03
(891) 2018 12 03
(511) 05

(260) AM 2020 101844 A
(800) 1451139
(151) 2018 09 10
(181) 2028 09 10
(891) 2018 09 10
(511) 35, 41, 42

(260) AM 2020 101845 A
(800) 1451181
(151) 2018 10 18
(181) 2028 10 18
(891) 2018 10 18
(511) 41

(260) AM 2020 101847 A
(800) 1451201
(151) 2018 11 06
(181) 2028 11 06
(891) 2018 11 06
(511) 35, 41, 43, 45

(260) AM 2020 101848 A
(800) 1451205
(151) 2018 08 13
(181) 2028 08 13
(891) 2018 08 13
(511) 11

(260) AM 2020 101849 A
(800) 1451206
(151) 2018 12 03
(181) 2028 12 03
(891) 2018 12 03
(511) 03, 05, 10

(260) AM 2020 101850 A
(800) 1451214
(151) 2018 09 28
(181) 2028 09 28
(891) 2018 09 28
(511) 08

(260) AM 2020 101851 A
(800) 1451263
(151) 2018 06 21
(181) 2028 06 21
(891) 2018 06 21
(511) 01, 02, 17

(260) AM 2020 101852 A
(800) 1451343
(151) 2018 11 27
(181) 2028 11 27
(891) 2018 11 27
(511) 05, 10

(260) AM 2020 101853 A
(800) 1451353
(151) 2019 01 25
(181) 2029 01 25
(891) 2019 01 25
(511) 05, 10

(260) AM 2020 101854 A
(800) 1451389
(151) 2019 01 25
(181) 2029 01 25
(891) 2019 01 25
(511) 05

(260) AM 2020 101855 A
(800) 1451449
(151) 2018 10 20
(181) 2028 10 20
(891) 2018 10 20
(511) 10, 35

(260) AM 2020 101856 A
(800) 1451453
(151) 2019 01 09
(181) 2029 01 09
(891) 2019 01 09
(511) 11

(260) AM 2020 101857 A
(800) 1451569
(151) 2018 10 30
(181) 2028 10 30
(891) 2018 10 30
(511) 01, 17, 19

(260) AM 2020 101858 A
(800) 1451589
(151) 2018 12 25
(181) 2028 12 25

(891) 2018 12 25
(511) 12

(260) AM 2020 101859 A
(800) 1451592
(151) 2018 11 19
(181) 2028 11 19
(891) 2018 11 19
(511) 34

(260) AM 2020 101868 A
(800) 1451636
(151) 2018 12 13
(181) 2028 12 13
(891) 2018 12 13
(511) 03, 09, 14, 16, 18, 25, 35

(260) AM 2020 101869 A
(800) 1451645
(151) 2018 12 14
(181) 2028 12 14
(891) 2018 12 14
(511) 32

(260) AM 2020 101870 A
(800) 1451652
(151) 2018 08 24
(181) 2028 08 24
(891) 2018 08 24
(511) 33

(260) AM 2020 101871 A
(800) 1451664
(151) 2019 01 11
(181) 2029 01 11
(891) 2019 01 11
(511) 12

(260) AM 2020 101875 A
(800) 1451770
(151) 2018 12 14
(181) 2028 12 14
(891) 2018 12 14
(511) 29, 30

(260) AM 2020 101876 A
(800) 1451825
(151) 2019 01 02
(181) 2029 01 02
(891) 2019 01 02
(511) 07

(260) AM 2020 101877 A
(800) 1451828
(151) 2018 12 27
(181) 2028 12 27
(891) 2018 12 27
(511) 05

(260) AM 2020 101878 A
(800) 1451844
(151) 2018 12 31
(181) 2028 12 31
(891) 2018 12 31
(511) 09

(260) AM 2020 101879 A
(800) 1451856
(151) 2019 01 02
(181) 2029 01 02
(891) 2019 01 02
(511) 09, 35, 37

(260) AM 2020 101892 A
(800) 1133845
(151) 2012 06 11
(181) 2022 06 11
(891) 2019 01 08
(511) 39

(260) AM 2020 101944 A
(800) 1452231
(151) 2018 10 23
(181) 2028 10 23
(891) 2018 10 23
(511) 19

(260) AM 2020 101947 A
(800) 1452298
(151) 2018 11 19
(181) 2028 11 19
(891) 2018 11 19
(511) 03, 05, 10, 44

(260) AM 2020 101949 A
(800) 1452312
(151) 2018 12 18
(181) 2028 12 18
(891) 2018 12 18
(511) 03

(260) AM 2020 101965 A
(800) 1452501
(151) 2018 11 19
(181) 2028 11 19

(891) 2018 11 19
(511) 05

(260) AM 2020 101966 A
(800) 1452503
(151) 2018 12 03
(181) 2028 12 03
(891) 2018 12 03
(511) 05

(260) AM 2020 101967 A
(800) 1452505
(151) 2018 12 03
(181) 2028 12 03
(891) 2018 12 03
(511) 05

(260) AM 2020 101968 A
(800) 1452510
(151) 2018 07 17
(181) 2028 07 17
(891) 2018 07 17
(511) 09, 12, 16, 25, 35, 36, 39

(260) AM 2020 101969 A
(800) 1452515
(151) 2018 11 19
(181) 2028 11 19
(891) 2018 11 19
(511) 05

(260) AM 2020 101970 A
(800) 1452516
(151) 2018 12 03
(181) 2028 12 03
(891) 2018 12 03
(511) 05

(260) AM 2020 101971 A
(800) 1452533
(151) 2018 08 28
(181) 2028 08 28
(891) 2018 08 28
(511) 10, 16, 18, 20, 24, 25, 28, 35, 36, 39, 41, 43

(260) AM 2020 101972 A
(800) 1452601
(151) 2018 11 23
(181) 2028 11 23
(891) 2018 11 23
(511) 03

(260) AM 2020 101973 A
(800) 1452609
(151) 2018 07 25
(181) 2028 07 25
(891) 2018 07 25
(511) 11

(260) AM 2020 101974 A
(800) 1452628
(151) 2018 11 19
(181) 2028 11 19
(891) 2018 11 19
(511) 05

(260) AM 2020 101975 A
(800) 1452640
(151) 2019 01 29
(181) 2029 01 29
(891) 2019 01 29
(511) 05

(260) AM 2020 101976 A
(800) 1452698
(151) 2018 10 15
(181) 2028 10 15
(891) 2018 10 15
(511) 30

(260) AM 2020 101977 A
(800) 1452730
(151) 2018 08 22
(181) 2028 08 22
(891) 2018 08 22
(511) 06

(260) AM 2020 101979 A
(800) 1452793
(151) 2018 12 18
(181) 2028 12 18
(891) 2018 12 18
(511) 03

(260) AM 2020 101981 A
(800) 1452838
(151) 2018 12 20
(181) 2028 12 20
(891) 2018 12 20
(511) 35, 41, 42

(260) AM 2020 101982 A
(800) 1452856
(151) 2018 12 04
(181) 2028 12 04

(891) 2018 12 04
(511) 34

(260) AM 2020 101983 A
(800) 1452862
(151) 2018 12 25
(181) 2028 12 25
(891) 2018 12 25
(511) 14

(260) AM 2020 101984 A
(800) 1452906
(151) 2018 10 05
(181) 2028 10 05
(891) 2018 10 05
(511) 09, 35

(260) AM 2020 101985 A
(800) 1452932
(151) 2018 09 23
(181) 2028 09 23
(891) 2018 09 23
(511) 38, 42, 44

(260) AM 2020 101997 A
(800) 1453313
(151) 2018 11 23
(181) 2028 11 23
(891) 2018 11 23
(511) 18

(260) AM 2020 101998 A
(800) 1453317
(151) 2018 11 23
(181) 2028 11 23
(891) 2018 11 23
(511) 35, 38, 42

(260) AM 2020 102016 A
(800) 1290944
(151) 2015 12 21
(181) 2025 12 21
(891) 2018 12 21
(511) 43

(260) AM 2020 102017 A
(800) 1291066
(151) 2015 12 21
(181) 2025 12 21
(891) 2018 12 21
(511) 33

(260) AM 2020 102018 A
(800) 1332479
(151) 2016 11 18
(181) 2026 11 18
(891) 2018 09 27
(511) 09, 28, 41

(260) AM 2020 102020 A
(800) 1436330
(151) 2017 11 21
(181) 2027 11 21
(891) 2019 01 21
(511) 07, 08, 11, 21

(260) AM 2020 102084 A
(800) 1453735
(151) 2018 12 03
(181) 2028 12 03
(891) 2018 12 03
(511) 05

(260) AM 2020 102085 A
(800) 1453760
(151) 2018 12 10
(181) 2028 12 10
(891) 2018 12 10
(511) 05

(260) AM 2020 102086 A
(800) 1453782
(151) 2018 11 02
(181) 2028 11 02
(891) 2018 11 02
(511) 03

(260) AM 2020 102087 A
(800) 1453791
(151) 2018 12 07
(181) 2028 12 07
(891) 2018 12 07
(511) 05

(260) AM 2020 102088 A
(800) 1453793
(151) 2018 12 03
(181) 2028 12 03
(891) 2018 12 03
(511) 05

(260) AM 2020 102099 A
(800) 1454099
(151) 2018 12 17
(181) 2028 12 17

(891) 2018 12 17
(511) 21

(260) AM 2020 102100 A
(800) 1454108
(151) 2018 11 30
(181) 2028 11 30
(891) 2018 11 30
(511) 09, 28

(260) AM 2020 102101 A
(800) 1454117
(151) 2018 12 17
(181) 2028 12 17
(891) 2018 12 17
(511) 07

(260) AM 2020 102102 A
(800) 1454128
(151) 2018 09 05
(181) 2028 09 05
(891) 2018 09 05
(511) 29, 30

(260) AM 2020 102103 A
(800) 1454151
(151) 2018 11 28
(181) 2028 11 28
(891) 2018 11 28
(511) 11, 21, 35

(260) AM 2020 102104 A
(800) 1454189
(151) 2018 08 17
(181) 2028 08 17
(891) 2018 08 17
(511) 43

(260) AM 2020 102105 A
(800) 1454194
(151) 2018 09 18
(181) 2028 09 18
(891) 2018 09 18
(511) 39

(260) AM 2020 102106 A
(800) 1454195
(151) 2018 10 18
(181) 2028 10 18
(891) 2018 10 18
(511) 09

(260) AM 2020 102107 A
(800) 1454197
(151) 2018 10 30
(181) 2028 10 30
(891) 2018 10 30
(511) 33

(260) AM 2020 102120 A
(800) 1454585
(151) 2018 06 22
(181) 2028 06 22
(891) 2018 06 22
(511) 01, 05

(260) AM 2020 102123 A
(800) 1454696
(151) 2018 12 03
(181) 2028 12 03
(891) 2018 12 03
(511) 29

(260) AM 2020 102186 A
(800) 1455201
(151) 2018 11 16
(181) 2028 11 16
(891) 2018 11 16
(511) 32

(260) AM 2020 102196 A
(800) 1455436
(151) 2018 12 17
(181) 2028 12 17
(891) 2018 12 17
(511) 19

(260) AM 2020 102206 A
(800) 1455606
(151) 2018 10 24
(181) 2028 10 24
(891) 2018 10 24
(511) 34

(260) AM 2020 102208 A
(800) 1455750
(151) 2018 12 28
(181) 2028 12 28
(891) 2018 12 28
(511) 01

(260) AM 2020 102210 A
(800) 1455771
(151) 2018 10 11
(181) 2028 10 11

(891) 2018 10 11
(511) 03

(260) AM 2020 102219 A
(800) 1455911
(151) 2018 12 29
(181) 2028 12 29
(891) 2018 12 29
(511) 32

(260) AM 2020 102275 A
(800) 1456235
(151) 2019 02 06
(181) 2029 02 06
(891) 2019 02 06
(511) 28

(260) AM 2020 102276 A
(800) 1456262
(151) 2018 12 31
(181) 2028 12 31
(891) 2018 12 31
(511) 07, 08

(260) AM 2020 102277 A
(800) 1456264
(151) 2018 09 28
(181) 2028 09 28
(891) 2018 09 28
(511) 05

(260) AM 2020 102278 A
(800) 1456279
(151) 2018 12 06
(181) 2028 12 06
(891) 2018 12 06
(511) 30

(260) AM 2020 102279 A
(800) 1456291
(151) 2019 02 15
(181) 2029 02 15
(891) 2019 02 15
(511) 01

(260) AM 2020 102280 A
(800) 1456310
(151) 2018 11 26
(181) 2028 11 26
(891) 2018 11 26
(511) 03, 05

(260) AM 2020 102293 A
(800) 1456607
(151) 2018 09 20
(181) 2028 09 20
(891) 2018 09 20
(511) 02, 03

(260) AM 2020 102302 A
(800) 1456768
(151) 2018 11 21
(181) 2028 11 21
(891) 2018 11 21
(511) 29, 30, 41, 43

(260) AM 2020 102303 A
(800) 1456769
(151) 2019 01 10
(181) 2029 01 10
(891) 2019 01 10
(511) 35

(260) AM 2020 102305 A
(800) 1456796
(151) 2018 12 21
(181) 2028 12 21
(891) 2018 12 21
(511) 09, 42

(260) AM 2020 102307 A
(800) 1456897
(151) 2018 12 10
(181) 2028 12 10
(891) 2018 12 10
(511) 34

(260) AM 2020 102308 A
(800) 1456911
(151) 2019 01 18
(181) 2029 01 18
(891) 2019 01 18
(511) 03, 08

(260) AM 2020 102309 A
(800) 1456932
(151) 2019 02 06
(181) 2029 02 06
(891) 2019 02 06
(511) 03

(260) AM 2020 102310 A
(800) 1456961
(151) 2018 09 26
(181) 2028 09 26

(891) 2018 09 26
(511) 09, 28, 41

(260) AM 2020 102337 A
(800) 1266688
(151) 2015 06 08
(181) 2025 06 08
(891) 2019 02 12
(511) 03

(260) AM 2020 102339 A
(800) 1302605
(151) 2016 03 31
(181) 2026 03 31
(891) 2019 02 12
(511) 03

(260) AM 2020 102340 A
(800) 1385126
(151) 2017 11 15
(181) 2027 11 15
(891) 2019 02 12
(511) 03

(260) AM 2020 102414 A
(800) 1457768
(151) 2019 01 30
(181) 2029 01 30
(891) 2019 01 30
(511) 05, 10

(260) AM 2020 102415 A
(800) 1457778
(151) 2018 11 15
(181) 2028 11 15
(891) 2018 11 15
(511) 33

(260) AM 2020 102416 A
(800) 1457804
(151) 2019 01 30
(181) 2029 01 30
(891) 2019 01 30
(511) 05, 10

(260) AM 2020 102417 A
(800) 1457805
(151) 2019 01 28
(181) 2029 01 28
(891) 2019 01 28
(511) 30

(260) AM 2020 102418 A
(800) 1457821
(151) 2019 02 15
(181) 2029 02 15
(891) 2019 02 15
(511) 09

(260) AM 2020 102419 A
(800) 1457822
(151) 2018 09 26
(181) 2028 09 26
(891) 2018 09 26
(511) 09, 28, 41

(260) AM 2020 102420 A
(800) 1457827
(151) 2018 09 28
(181) 2028 09 28
(891) 2018 09 28
(511) 03

(260) AM 2020 102441 A
(800) 1458532
(151) 2018 07 24
(181) 2028 07 24
(891) 2018 07 24
(511) 05, 10, 35, 44

(260) AM 2020 102445 A
(800) 1458556
(151) 2019 01 25
(181) 2029 01 25
(891) 2019 01 25
(511) 12

(260) AM 2020 102467 A
(800) 1458800
(151) 2018 11 15
(181) 2028 11 15
(891) 2018 11 15
(511) 39

(260) AM 2020 102480 A
(800) 207666
(151) 1958 02 24
(181) 2028 02 24
(891) 2019 02 05
(511) 03

(260) AM 2020 102481 A
(800) 882927
(151) 2006 02 10
(181) 2026 02 10

(891) 2019 02 12
(511) 35, 36

(260) AM 2020 102483 A
(800) 1219150
(151) 2014 04 07
(181) 2024 04 07
(891) 2019 02 08
(511) 05, 29, 32, 35, 43

(260) AM 2020 102582 A
(800) 1459178
(151) 2019 02 14
(181) 2029 02 14
(891) 2019 02 14
(511) 30

(260) AM 2020 102584 A
(800) 1459190
(151) 2018 12 04
(181) 2028 12 04
(891) 2018 12 04
(511) 37

(260) AM 2020 102585 A
(800) 1459205
(151) 2018 12 28
(181) 2028 12 28
(891) 2018 12 28
(511) 30, 35

(260) AM 2020 102586 A
(800) 1459208
(151) 2018 11 21
(181) 2028 11 21
(891) 2018 11 21
(511) 09, 16, 21, 35, 36, 38, 42

(260) AM 2020 102587 A
(800) 1459241
(151) 2019 01 22
(181) 2029 01 22
(891) 2019 01 22
(511) 03, 05

(260) AM 2020 102588 A
(800) 1459253
(151) 2018 12 13
(181) 2028 12 13
(891) 2018 12 13
(511) 29, 30

(260) AM 2020 102589 A
(800) 1459305
(151) 2018 11 02
(181) 2028 11 02
(891) 2018 11 02
(511) 30

(260) AM 2020 102590 A
(800) 1459310
(151) 2018 12 13
(181) 2028 12 13
(891) 2018 12 13
(511) 03, 05, 10

(260) AM 2020 102591 A
(800) 1459349
(151) 2018 11 29
(181) 2028 11 29
(891) 2018 11 29
(511) 33

(260) AM 2020 102592 A
(800) 1459407
(151) 2018 11 22
(181) 2028 11 22
(891) 2018 11 22
(511) 29, 30, 32

(260) AM 2020 102671 A
(800) 1460959
(151) 2018 12 21
(181) 2028 12 21
(891) 2018 12 21
(511) 03, 05

(260) AM 2020 102672 A
(800) 1460972
(151) 2018 12 21
(181) 2028 12 21
(891) 2018 12 21
(511) 03, 05

(260) AM 2020 102673 A
(800) 1460981
(151) 2019 02 26
(181) 2029 02 26
(891) 2019 02 26
(511) 09

(260) AM 2020 102674 A
(800) 1461017
(151) 2019 01 18
(181) 2029 01 18

(891) 2019 01 18
(511) 09, 34

(260) AM 2020 102675 A
(800) 203699
(151) 1957 10 01
(181) 2027 10 01
(891) 2019 02 28
(511) 15

(260) AM 2020 102679 A
(800) 984591
(151) 2008 11 04
(181) 2028 11 04
(891) 2019 02 28
(511) 07

(260) AM 2020 102680 A
(800) 1066522
(151) 2010 12 15
(181) 2020 12 15
(891) 2019 03 13
(511) 29

(260) AM 2020 102681 A
(800) 1097048
(151) 2011 09 21
(181) 2021 09 21
(891) 2019 03 21
(511) 05, 16, 42, 44

(260) AM 2020 102773 A
(800) 1461914
(151) 2018 12 20
(181) 2028 12 20
(891) 2018 12 20
(511) 29

(260) AM 2020 102774 A
(800) 1461926
(151) 2019 02 26
(181) 2029 02 26
(891) 2019 02 26
(511) 03, 04

(260) AM 2020 102775 A
(800) 1461945
(151) 2018 12 17
(181) 2028 12 17
(891) 2018 12 17
(511) 29, 30, 35, 43

(260) AM 2020 102776 A
(800) 1461966
(151) 2018 09 14
(181) 2028 09 14
(891) 2018 09 14
(511) 06, 35, 37, 42

(260) AM 2020 102777 A
(800) 1461970
(151) 2019 01 10
(181) 2029 01 10
(891) 2019 01 10
(511) 21

(260) AM 2020 102778 A
(800) 1461992
(151) 2018 11 15
(181) 2028 11 15
(891) 2018 11 15
(511) 09, 14, 16, 18, 20, 21, 24, 25, 28, 30, 34, 35

(260) AM 2020 102779 A
(800) 1461999
(151) 2019 02 22
(181) 2029 02 22
(891) 2019 02 22
(511) 07

(260) AM 2020 102794 A
(800) 1462271
(151) 2018 03 02
(181) 2028 03 02
(891) 2018 03 02
(511) 09, 16, 35, 36, 38, 40, 42, 45

(260) AM 2020 102797 A
(800) 1462341
(151) 2018 11 15
(181) 2028 11 15
(891) 2018 11 15
(511) 09, 14, 16, 18, 20, 21, 24, 25, 28, 30, 34, 35

(260) AM 2020 102800 A
(800) 1141653
(151) 2012 09 27
(181) 2022 09 27
(891) 2019 03 29
(511) 07, 11, 21

(260) AM 2020 102885 A
(800) 1463244
(151) 2018 09 04
(181) 2028 09 04

(891) 2018 09 04
(511) 37, 39, 42

(260) AM 2020 102886 A
(800) 1463317
(151) 2018 12 28
(181) 2028 12 28
(891) 2018 12 28
(511) 05

(260) AM 2020 102888 A
(800) 1463380
(151) 2019 02 18
(181) 2029 02 18
(891) 2019 02 18
(511) 33

(260) AM 2020 102889 A
(800) 1463446
(151) 2019 01 21
(181) 2029 01 21
(891) 2019 01 21
(511) 03

(260) AM 2020 102890 A
(800) 1463494
(151) 2018 12 28
(181) 2028 12 28
(891) 2018 12 28
(511) 12

(260) AM 2020 102891 A
(800) 1463501
(151) 2019 02 28
(181) 2029 02 28
(891) 2019 02 28
(511) 25

(260) AM 2020 102892 A
(800) 1463526
(151) 2018 11 14
(181) 2028 11 14
(891) 2018 11 14
(511) 03, 04, 05, 06, 08, 11, 16, 17, 21, 22

(260) AM 2020 102947 A
(800) 1463920
(151) 2019 02 04
(181) 2029 02 04
(891) 2019 02 04
(511) 09, 28, 35, 41, 42

(260) AM 2020 102948 A
(800) 1463928
(151) 2018 11 21
(181) 2028 11 21
(891) 2018 11 21
(511) 05

(260) AM 2020 102949 A
(800) 1463949
(151) 2019 01 21
(181) 2029 01 21
(891) 2019 01 21
(511) 03

(260) AM 2020 102950 A
(800) 1463957
(151) 2019 03 29
(181) 2029 03 29
(891) 2019 03 29
(511) 28

(260) AM 2020 102951 A
(800) 1463984
(151) 2019 03 29
(181) 2029 03 29
(891) 2019 03 29
(511) 43

(260) AM 2020 103054 A
(800) 1465588
(151) 2019 03 07
(181) 2029 03 07
(891) 2019 03 07
(511) 03, 05

(260) AM 2020 103631 A
(800) 1472194
(151) 2018 11 09
(181) 2028 11 09
(891) 2018 11 09
(511) 12, 35, 36, 38, 39, 42

OFFICIAL NOTIFICATIONS

INVENTIONS

EXPIRATION OF PATENTS RESTORATION

(21) AP 2012 12551

(11) P 2014 6175 B

(73) Iv. Javakishvili Tbilisi State University

(54) **METHOD OF SOLID-STATE SYNTHESIS OF OXIDE CERAMIC MATERIAL**

DATE OF CANCELLATION OF PATENT: 2020 01 27

PATENT RESTRICTION DATE: 2020 03 10

(21) AP 2015 13727

(11) P 2017 6652 B

(73) Bichiko Surguladze;

Nugzar Sivanadze;

Levan Pirkulashvili

(54) **PRELIMINARILY TENSED FRAME CONSTRUCTION**

DATE OF CANCELLATION OF PATENT: 2020 02 06

PATENT RESTRICTION DATE: 2020 03 10

(21) AP 2014 13745

(11) P 2017 6653 B

(73) HYUN ENGINEERING AND CONSTRUCTION CO., LTD

(54) **METHOD FOR REINFORCING PILLAR PART OF ADJACENTLY CONSTRUCTED PARALLEL TUNNELS WITH REINFORCING RODS AND EXCAVATION METHOD**

DATE OF CANCELLATION OF PATENT: 2019 05 08

PATENT RESTRICTION DATE: 2020 03 10

(21) AP 2005 8972

(11) P 2009 4663 B

(73) Giorgi Ioramashvili;

Marine Beroshvili

(54) **METHOD FOR SEPARATION OF FLUID INTRUSION**

DATE OF CANCELLATION OF PATENT: 2019 09 12

PATENT RESTRICTION DATE: 2020 03 10

ABOLITION OF PATENTS WITH THE RIGHT TO RESTORE

(21) AP 2010 11695

(11) P 2011 5360 B

(73) Vazha Khositashvili

(54) **VEGETATIVE GATHERING – ANTIOXIDANT, ANTIRADIATION AND FOR TREATMENT OF CARDIOVASCULAR DISEASES AND MEDICAL MEANS ON ITS BASIS**

DATE OF CANCELLATION OF PATENT: 2020 02 23

THE TERM OF RESTORATION OF PATENT VALIDITY HAS EXPIRED: 2021 02 23

(21) AP 2010 11696

(11) P 2011 5361 B

(73) Vazha Khositashvili;

Levana Khositashvili;

Babri Oren

(54) **PREPARATION - ANTIOXIDANT, ANTIRADIATION, REGULATING LIPIDIC EXCHANGE AND PREPARATION FOR TREATMENT OF CARDIOVASCULAR DISEASES**

DATE OF CANCELLATION OF PATENT: 2020 02 23

THE TERM OF RESTORATION OF PATENT VALIDITY HAS EXPIRED: 2021 02 23

(21) AP 2011 12105

(11) P 2013 5737 B

(73) LES LABORATOIRES SERVIER

(54) **NEW METHOD FOR IVABRADINE AND THEIR ACID-ADDITIVE SALTS SYNTHESIS**

DATE OF CANCELLATION OF PATENT: 2020 02 15

THE TERM OF RESTORATION OF PATENT VALIDITY HAS EXPIRED: 2021 02 15

(21) AP 2011 12110

(11) P 2012 5675 B

(73) Mariam Ionanidze;

Bagrat Basiladze

(54) **METHOD OF SAUCE PREPARATION**

DATE OF CANCELLATION OF PATENT: 2020 02 18

THE TERM OF RESTORATION OF PATENT VALIDITY HAS EXPIRED: 2021 02 18

(21) AP 2010 12446

(11) P 2014 6189 B

(73) Yoav COHEN

(54) **INSTALLATION DESIGNED TO CONVERT ENVIRONMENTAL THERMAL ENERGY INTO USEFUL ENERGY**

DATE OF CANCELLATION OF PATENT: 2020 02 18

THE TERM OF RESTORATION OF PATENT VALIDITY HAS EXPIRED: 2021 02 18

(21) AP 2012 12569

(11) P 2013 5970 B

(73) LES LABORATOIRES SERVIER

(54) **NEW METHOD OF SYNTHESIS OF IVABRADINE AND PHARMACEUTICALLY ACCEPTABLE ACID-ADDITIVE SALTS THEREOF**

DATE OF CANCELLATION OF PATENT: 2020 02 10

THE TERM OF RESTORATION OF PATENT VALIDITY HAS EXPIRED: 2021 02 10

(21) AP 2011 12854

(11) P 2016 6456 B

(73) LES LABORATOIRES SERVIER

(54) **USE OF AGOMELATINE FOR THE PREPARATION OF DRUGS FOR TREATING OBSESSIVE COMPULSIVE DISORDER (OCD)**

DATE OF CANCELLATION OF PATENT: 2020 02 10

THE TERM OF RESTORATION OF PATENT VALIDITY HAS EXPIRED: 2021 02 10

(21) AP 2011 12859

(11) P 2015 6230 B

(73) SALIX PHARMACEUTICALS LTD

(54) **FORMS OF RIFAXIMIN AND USAGE THEREOF**

DATE OF CANCELLATION OF PATENT: 2020 02 16

THE TERM OF RESTORATION OF PATENT VALIDITY HAS EXPIRED: 2021 02 16

(21) AP 2011 13141

(11) P 2017 6745 B

(73) SALIX PHARMACEUTICALS LTD

(54) **FORMS OF RIFAXIMIN AND USAGE THEREOF**

DATE OF CANCELLATION OF PATENT: 2020 02 16

THE TERM OF RESTORATION OF PATENT VALIDITY HAS EXPIRED: 2021 02 16

(21) AP 2013 13560

(11) P 2017 6687 B

(73) MILLENNIUM PHARMACEUTICALS INC.

(54) **PYRAZOLOPYRIMIDINYL INHIBITORS OF UBIQUITIN-ACTIVATING ENZYME**

DATE OF CANCELLATION OF PATENT: 2020 02 14

THE TERM OF RESTORATION OF PATENT VALIDITY HAS EXPIRED: 2021 02 14

(21) AP 2013 13570

(11) P 2017 6643 B

(73) ABLOY OY

(54) **KEY AND DISC TUMBLER CYLINDER LOCK**

DATE OF CANCELLATION OF PATENT: 2020 02 14

THE TERM OF RESTORATION OF PATENT VALIDITY HAS EXPIRED: 2021 02 14

(21) AP 2015 14272

(11) P 2018 6909 B

(73) TAKEDA PHARMACEUTICAL COMPANY LIMITED

(54) **SUBSTITUTED CYCLOPENTANES, TETRAHYDROFURANES AND PYRROLIDINES AS OREXIN RECEPTOR ANTAGONISTS**

DATE OF CANCELLATION OF PATENT: 2020 02 19

THE TERM OF RESTORATION OF PATENT VALIDITY HAS EXPIRED: 2021 02 19

(21) AP 2015 14273

(11) P 2018 6910 B

(73) TAKEDA PHARMACEUTICAL COMPANY LIMITED

(54) **1,2-SUBSTITUTED CYCLOPENTANES AS OREXIN RECEPTOR ANTAGONISTS**

DATE OF CANCELLATION OF PATENT: 2020 02 19

THE TERM OF RESTORATION OF PATENT VALIDITY HAS EXPIRED: 2021 02 19

(21) AP 2017 14428

(11) P 2018 6926 B

(73) Giorgi Lekvinadze

(54) **ELEVATOR**

DATE OF CANCELLATION OF PATENT: 2020 02 17

THE TERM OF RESTORATION OF PATENT VALIDITY HAS EXPIRED: 2021 02 17

(21) AP 2004 8975

(11) P 2008 4436 B

(73) Interdigital Technology Corporation

(54) **WIRELESS COMMUNICATION METHOD AND SYSTEM FOR CONTROLLING DATA BIT RATES TO MAINTAIN THE QUALITY OF RADIO LINKS**

DATE OF CANCELLATION OF PATENT: 2020 02 11

THE TERM OF RESTORATION OF PATENT VALIDITY HAS EXPIRED: 2021 02 11

EXPIRATION OF TERM OF RESTORATION OF PATENTS

(21) AP 2010 12394

(11) P 2013 5933 B

(73) BOEHRINGER INGELHEIM INTERNATIONAL GMBH

(54) **COMPOUNDS AS BRADYKININ B1 ANTAGONISTS**

DATE OF CANCELLATION OF PATENT: 2019 02 23

THE TERM OF RESTORATION OF PATENT VALIDITY HAS EXPIRED: 2020 02 23

(21) AP 2011 12862

(11) P 2014 6070 B

(73) BOEHRINGER INGELHEIM INTERNATIONAL GMBH

(54) **COMPOUNDS AS BRADYKININ B1 ANTAGONISTS**

DATE OF CANCELLATION OF PATENT: 2019 02 21

THE TERM OF RESTORATION OF PATENT VALIDITY HAS EXPIRED: 2020 02 21

(21) AP 2013 13578

(11) P 2018 6824 B

(73) SANTEN SAS

(54) **OIL DISPERSION, HOW IT IS MADE, PACKAGED AND THE USE OF BORIC ACID AS AN OIL DISPERSION CONSERVATION STIMULANT**

DATE OF CANCELLATION OF PATENT: 2019 02 22

THE TERM OF RESTORATION OF PATENT VALIDITY HAS EXPIRED: 2020 02 22

(21) AP 2015 14248

(11) P 2018 6892 B

(73) H. Lundbeck A/S

(54) **2-AMINO-3, 5, 5-TRIFLUORO-3, 4, 5, 6-TETRAHYDROPYRIDINES AS BACE1 INHIBITORS FOR TREATMENT OF ALZHEIMER'S DISEASE**

DATE OF CANCELLATION OF PATENT: 2019 02 17

THE TERM OF RESTORATION OF PATENT VALIDITY HAS EXPIRED: 2020 02 17

(21) AP 2000 6055

(11) P 2003 3067 B

(73) Gesellschaft fuer Biotechnologische Forschung Mbh;
Bristol-Myers Squibb Company (US)

(54) C-21 MODIFIED EPOTHILONES

DATE OF CANCELLATION OF PATENT: 2019 02 17

THE TERM OF RESTORATION OF PATENT VALIDITY HAS EXPIRED: 2020 02 17

(21) AP 2004 8984

(11) P 2010 4908 B

(73) HELSINN HEALTHCARE SA

(54) USE OF PALONOSETRON TREATING POST-OPERATIVE NAUSEA AND VOMITING

DATE OF CANCELLATION OF PATENT: 2019 02 18

THE TERM OF RESTORATION OF PATENT VALIDITY HAS EXPIRED: 2020 02 18

REGISTRATION OF LICENSE AGREEMENT

(11) P 2017 6755 B

(54) METHOD FOR ADMINISTERING HYPNOTIC/SEDATIVE AGENT

(73) PAION UK LIMITED (GB)

Chivers Way, Histon, Cambridge, Cambridgeshire CB24 9ZR (GB)

LICENSEE: JSC "R PHARM"
Berzarin St., korp. 1, ap. 19, 123154, Moscow, Russian Federation

NUMBER OF REGISTRATION: 118 E

DATE OF REGISTRATION: 22 01 2020

VALIDITY: Validity of patent

LICENSE FORM: Exclusive

THIS ATTACHMENT IS IMPARTIBLE FROM PATENT P 2017 6755 B

GROUNDS: Agreement of January 13, 2020

UTILITY MODELS

EXPIRATION OF PATENT RESTORATION

(21) AU 2013 13209

(11) U 2015 1856 Y

(73) Giorgi Ugulava

(54) **DAM**

DATE OF CANCELLATION OF PATENT: 2019 08 30

PATENT RESTRICTION DATE: 2020 03 10

ABOLITION OF PATENT WITH THE RIGHT TO RESTORE

(21) AU 2011 12112

(11) U 2012 1707 Y

(73) Giorgi Bendelava;

Parmen Margvelashvili;

The apple is jelly;

David Loladze

(54) **METHOD OF TEA IODINE ENRICHMENT**

DATE OF CANCELLATION OF PATENT: 2020 02 21

THE TERM OF RESTORATION OF PATENT VALIDITY HAS EXPIRED: 2021 02 21

EXPIRATION OF TERM OF RESTORATION OF PATENTS

(21) AU 2017 14429

(11) U 2018 1985 Y

(73) Maia Grdzeldze;

Avtandil Katamadze

(54) **ECOLOGICAL PLATE INSOLE**

DATE OF CANCELLATION OF PATENT: 2019 02 20

THE TERM OF RESTORATION OF PATENT VALIDITY HAS EXPIRED: 2020 02 20

TRANSFER OF RIGHT

(21) AU 2018 14969

(11) U 2020 2033 Y

(54) BACTERIOPHAGE DRUG PREPARATION METHOD FOR USAGE IN VETERINARY MEDICINE

NEW OWNER AND ADDRESS: Tarasi Gabisonia (GE)
I. Chavchavadze Av. 39b, ap. 23, 0162, Tbilisi, Georgia (GE);
Natela Chakhunashvili (GE)
Bendeliani St. 5, ap. 43, 0102, Tbilisi, Georgia (GE);
Teimuraz Katamadze (GE)
Varketili 3, III mkr., korps. 323, ap. 5, 0163, Tbilisi, Georgia (GE);
Manana Loladze (GE)
Al. Kazbegi Av. 17, ap. 9, 0160, Tbilisi, Georgia (GE);
Natia Tamarashvili (GE)
Varketili, III massivi, 10 kvart., korp. 10, ap. 9, 0182, Tbilisi, Georgia (GE)

FORMER OWNER AND ADDRESS: Tarasi Gabisonia (GE)
I. Chavchavadze Av. 39b, ap. 23, 0162, Tbilisi, Georgia (GE);
Natela Chakhunashvili (GE)
Bendeliani St. 5, ap. 43, 0102, Tbilisi, Georgia (GE);
Teimuraz Katamadze (GE)
Varketili 3, III mkr., korps. 323, ap. 5, 0163, Tbilisi, Georgia (GE);
Manana Loladze (GE)
Al. Kazbegi Av. 17, ap. 9, 0160, Tbilisi, Georgia (GE);
Natia Tamarashvili (GE)
Varketili, III mass., 10 kvart., korp. 10, ap. 9, 0182, Tbilisi, Georgia (GE)

DATE OF REGISTRY: 21 02 2020

DESIGNS

EXTENSION OF REGISTRATION OF DESIGNS

(11) D 2005 252 S

(73) Sony Computer Entertainment Inc. (JP)
2-6-21, Minami-Aoyama, Minato-ku, Tokyo 107-0062, Japan (JP)

(54) ELECTRICAL CONNECTOR

(28) 1
(24) 2005 03 14
(18) 2025 03 14
(58) 2020 03 04

(11) D 2005 253 S

(73) Sony Computer Entertainment Inc. (JP)
2-6-21, Minami-Aoyama, Minato-ku, Tokyo 107-0062, Japan (JP)

(54) BATTERY

(28) 1
(24) 2005 03 14
(18) 2025 03 14
(58) 2020 03 04

(11) D 2005 261 S

(73) Sony Computer Entertainment Inc. (JP)
2-6-21, Minami-Aoyama, Minato-ku, Tokyo 107-0062, Japan (JP)

(54) REMOTE CONTROL DEVICE

(28) 1
(24) 2005 03 14
(18) 2025 03 14
(58) 2020 03 04

CANCELLATION OF DESIGNS REGISTRATION

(11) D 2014 586 S

(73) Gari Chapidze (GE)
Khomleli St., korp. 4, ap. 27, 0182, Tbilisi, Georgia (GE)

(54) SCHOOL DESK WITH SOUND IMAGES

(18) 2019 07 14
(58) 2020 02 19

(11) D 2015 618 S

(73) Omar Kvinikadze (GE)
Dighomi Array, III kvart., korp. 39, ap. 61, 0159, Tbilisi, Georgia (GE)

(54) KEYBOARD FOR MUSICAL INSTRUMENT

(18) 2019 07 23
(58) 2020 02 19

TRANSFER OF RIGHT

(11) D 2015 625 S**(54) GLASS BOTTLE HAVING WOOD APPLIANCE-HOLDER**

NEW OWNER AND ADDRESS: Nino Natsvlshvili (GE)
Dighomi Array, V kvart., korp. 7, ap. 13, 0159, Tbilisi, Georgia (GE)

FORMER OWNER AND ADDRESS: Aleksandre Kvernadze (GE)
Dighomi Array, V kvart., korp. 25a, ap. 48, 0159, Tbilisi, Georgia (GE)

(58) 2020 03 04

EXTENSION OF REGISTRATION OF INTERNATIONAL DESIGNS

(11) DM/66200

(73) SOCIÉTÉ DES PRODUITS NESTLÉ S.A.

Case postale 353, CH-1800 Vevey (CH)

(15) 2004 12 23

(24) 2004 12 23

(18) 2024 12 23

(28) 1

(28') 1

(54) Chocolate

(11) DM/66248

(73) BRAUN GMBH

Frankfurter Strasse 145, 61476 Kronberg (DE)

(15) 2005 01 14

(24) 2005 01 14

(18) 2025 01 14

(28) 1

(28') 1

(54) Toothbrush

(11) DM/66295

(73) VAN CLEEF & ARPELS LOGISTICS S.A

8, route de Chandolan, CH-1752 VILLARS-SUR-GLÂNE (CH)

(15) 2004 12 08

(24) 2004 12 08

(18) 2024 12 08

(28) 2

(28') 2

(54) Jewellery

(11) DM/66503

(73) ELOPAK SYSTEMS AG

Cherstrasse 4, Postfach, CH-8152 GLATTBRUGG (CH)

(15) 2004 12 24

(24) 2004 12 24

(18) 2024 12 24

(28) 2

(28') 2

(54) Packaging containers

(11) DM/66737

(73) DR. MED. ROBERT BÖTTCHER

Ferdinand-Lasalle-Straße 17, 99885 Ohrdruf (DE)

(15) 2004 12 28

(24) 2004 12 28

(18) 2024 12 28

(28) 9

(28') 9

(54) Prosthetic articles

(11) DM/72250

- (73) SOREMARTEC S.A.
Rue Joseph Netzer 5, B-6700 ARLON (BX)
- (15) 2009 09 01
(24) 2009 09 01
(18) 2024 09 01
(28) 4
(28') 4
(54) Displays
-

(11) DM/72733

- (73) ALFRED KÄRCHER GMBH & CO. KG
Alfred-Kärcher-Str. 28-40, 71364 Winnenden (DE)
- (15) 2009 11 26
(24) 2009 11 26
(18) 2024 11 26
(28) 4
(28') 4
(54) High pressure cleaners (parts of), Vacuum cleaners (parts of)
-

(11) DM/72806

- (73) SOREMARTEC S.A.
Rue Joseph Netzer 5, B-6700 ARLON (BX)
- (15) 2009 12 28
(24) 2009 12 28
(18) 2024 12 28
(28) 11
(28') 11
(54) Containers for liquids, Packagings or containers for food products
-

(11) DM/72843

- (73) ADOLF WÜRTH GMBH & CO. KG
Reinhold-Würth-Straße 12-17, 74653 Künzelsau (DE)
- (15) 2009 12 17
(24) 2009 12 17
(18) 2024 12 17
(28) 1
(28') 1
(54) Label
-

(11) DM/73135

- (73) CASTROL LIMITED
Wakefield House, Pipers Way, Swindon, Wiltshire SN3 1RE (EM)
- (15) 2010 02 17
(24) 2010 02 17
(18) 2025 02 17
(28) 2
(28') 2
(54) Containers
-

(11) DM/73197

(73) JOSÉ EISENBERG

24, avenue Princesse Grace, MC-98000 Monaco (EM)

(15) 2010 01 25

(24) 2010 01 25

(18) 2025 01 25

(28) 3

(28') 3

(54) Logos

(11) DM/73933

(73) MAISON ELOGA HORLOGERIE ET BIJOUTERIE SÀRL

Rue du Grenier 18, CH-2302 La Chaux-de-Fonds (CH)

(15) 2010 03 25

(24) 2010 03 25

(18) 2025 03 25

(28) 2

(28') 2

(54) Watches

(11) DM/83661

(73) VİNERO BAĞCILIK SANAYİ VE TİCARET ANONİM ŞİRKETİ

İstinye Mahallesi, Balabandere Caddesi No:14, TR-34460 SARIYER/ISTANBUL (TR)

(15) 2014 01 17

(24) 2014 01 17

(18) 2024 01 17

(28) 1

(28') 1

(54) Wine bottle

(11) DM/84559

(73) SWATCH AG (SWATCH SA) (SWATCH LTD)

Jakob-Stämpfli-Strasse 94, CH-2502 Biel/ Bienne (CH)

(15) 2014 10 03

(24) 2014 10 03

(18) 2024 10 03

(28) 9

(28') 9

(54) Watch hand, Wristwatches

(11) DM/85068

(73) FRIESLAND BRANDS B.V.

Stationsplein 4, NL-3818 LE Amersfoort (BX)

(15) 2014 12 10

(24) 2014 12 10

(18) 2024 12 10

(28) 2

(28') 2

(54) Bottles

(11) DM/85998

(73) SIMKIN OLEXANDR MAKSYMОВYCH, vul. Cheliuskinciv, bud. 140, kv. 187, m. Donetsk 83001 (UA)

SARBASH FEDIR FEDOROVYCH, vul.Dniprodzerzhynska, bud.6, kv.45, m.Donetsk 83016 (UA)

(15) 2014 12 09

(24) 2014 12 09

(18) 2024 12 09

(28) 2

(28') 2

(54) Covers for jars

(11) DM/86513

(73) PROCREDIT HOLDING AG & CO. KGAA

Rohmerplatz 33-37, 60486 Frankfurt (DE)

(15) 2015 03 16

(24) 2015 03 16

(18) 2025 03 16

(28) 2

(28') 2

(54) Logos

TRADEMARKS**RENEWAL OF REGISTRATIONS**

(111) M 2000 13179 R2

(156) 2000 03 07

(186) 2030 03 07

(732) TDK KABUSHIKI KAISHA

(TDK CORPORATION)

2-5-1 Nihonbashi, Chuo-ku, Tokyo, Japan

(111) M 2010 20201 R1

(156) 2010 01 26

(186) 2030 01 26

(732) Hilton Worldwide Holding LLP

Maple Court Central Park, Reeds Crescent,

Watford, WD24 4QQ, United Kingdom

(111) M 2010 20206 R1

(156) 2010 01 26

(186) 2030 01 26

(732) Fertilizers & Chemicals Ltd, An Israeli

Limited Liability Company

P.O.B. 1428, Haifa, 31013, Israel

(111) M 2010 20207 R1

(156) 2010 01 26

(186) 2030 01 26

(732) Fertilizers & Chemicals Ltd, An Israeli

Limited Liability Company

P.O.B. 1428, Haifa, 31013, Israel

(111) M 2010 20401 R1

(156) 2010 04 27

(186) 2030 04 27

(732) MOTİF KUYUMCULUK SANAYİ VE

TİCARET ANONİM ŞİRKETİ

Vezirhan Caddesi, No: 101 Çemberlitaş –

Eminönü – İstanbul, Turkey

(111) M 2010 20261 R1

(156) 2010 02 15

(186) 2030 02 15

(732) JON VARVATOS APPAREL CORP.

(a Delaware corporation)

3411 Silverside Road, Wilmington, Delaware

19810, USA

(111) M 2010 20210 R1

(156) 2010 01 26

(186) 2030 01 26

(732) ARIMA HOLDING CORP.

Suite C-12, Market Place, Providenciales,

Turks and Caicos Islands

(111) M 2010 20404 R1

(156) 2010 04 27

(186) 2030 04 27

(732) Vifor (International) AG, Vifor (International)

Ltd, Vifor (International) Inc.

Rechenstrasse 37, 9014 St. Gall, Switzerland

(111) M 2010 20217 R1

(156) 2010 01 29

(186) 2030 01 29

(732) GMP LLC

Zemo Vedzisi St. 103, 0160, Tbilisi, Georgia

(111) M 2010 20218 R1

(156) 2010 01 29

(186) 2030 01 29

(732) GMP LLC

Zemo Vedzisi St. 103, 0160, Tbilisi, Georgia

(111) M 2010 20219 R1

(156) 2010 01 29

(186) 2030 01 29

(732) GMP LLC

Zemo Vedzisi St. 103, 0160, Tbilisi, Georgia

(111) M 2010 20220 R1

(156) 2010 01 29

(186) 2030 01 29

(732) GMP LLC

Zemo Vedzisi St. 103, 0160, Tbilisi, Georgia

(111) M 2010 20221 R1

(156) 2010 01 29

(186) 2030 01 29

(732) GMP LLC

Zemo Vedzisi St. 103, 0160, Tbilisi, Georgia

(111) M 2010 20222 R1

(156) 2010 01 29

(186) 2030 01 29

(732) GMP LLC

Zemo Vedzisi St. 103, 0160, Tbilisi, Georgia

(111) M 2010 20444 R1
(156) 2010 05 13
(186) 2030 05 13
(732) AbbVie Inc., a corporation of the State
of Delaware
1 N. Waukegan Road, North Chicago,
Illinois 60064, USA

(111) M 2010 20445 R1
(156) 2010 05 13
(186) 2030 05 13
(732) AbbVie Inc., a corporation of the State
of Delaware
1 N. Waukegan Road, North Chicago,
Illinois 60064, USA

(111) M 2010 20378 R1
(156) 2010 04 15
(186) 2030 04 15
(732) INTEL CORPORATION
2200 Mission College Boulevard, Santa
Clara, California 95052-8119, USA

(111) M 2010 20340 R1
(156) 2010 03 25
(186) 2030 03 25
(732) GMP LLC
Zemo Vedzisi St. 103, 0160, Tbilisi, Georgia

(111) M 2010 20341 R1
(156) 2010 03 25
(186) 2030 03 25
(732) GMP LLC
Zemo Vedzisi St. 103, 0160, Tbilisi, Georgia

(111) M 2010 20465 R1
(156) 2010 05 13
(186) 2030 05 13
(732) MARS INCORPORATED
6885 ELM Street, McLean, Virginia
22101-3883, USA

(111) M 2010 20468 R1
(156) 2010 05 13
(186) 2030 05 13
(732) KIA MOTORS CORPORATION
231 Yangjae-dong, Seocho-gu, Seoul 137-938,
Republic of Korea

(111) M 2010 20356 R1
(156) 2010 03 25
(186) 2030 03 25

(732) GMP LLC
Zemo Vedzisi St. 103, 0160, Tbilisi, Georgia

(111) M 2010 20648 R1
(156) 2010 08 16
(186) 2030 08 16
(732) KIA MOTORS CORPORATION
12, Heolleung-ro, Seocho-gu, Seoul,
Republic of Korea

(111) M 2010 20563 R1
(156) 2010 06 11
(186) 2030 06 11
(732) ASTELLAS PHARMA INC.
5-1, Nihonbashi-Honcho 2-Chome, Chuo-ku,
Tokyo 103-8411, Japan

(111) M 2010 20663 R1
(156) 2010 08 16
(186) 2030 08 16
(732) KIA MOTORS CORPORATION
231 Yangjae-dong, Seocho-gu, Seoul 137-938,
Republic of Korea

(111) M 2010 20885 R1
(156) 2010 11 03
(186) 2030 11 03
(732) MARS INCORPORATED
6885 ELM Street, McLean, Virginia
22101-3883, USA

(111) M 2010 20680 R1
(156) 2010 08 16
(186) 2030 08 16
(732) MARS INCORPORATED
6885 Elm Street Mclean, Virginia
22101-3883, USA

(111) M 2010 20618 R1
(156) 2010 07 26
(186) 2030 07 26
(732) MARS INCORPORATED
6885 ELM Street, McLean, Virginia
22101-3883, USA

(111) M 2010 20620 R1
(156) 2010 07 26
(186) 2030 07 26
(732) MARS INCORPORATED
6885 Elm Street Mclean, Virginia
22101-3883, USA

(111) M 2010 20621 R1
(156) 2010 07 26
(186) 2030 07 26
(732) MARS INCORPORATED
6885 Elm Street Mclean, Virginia
22101-3883, USA

(111) M 2010 20763 R1
(156) 2010 09 22
(186) 2030 09 22
(732) MATTEL, INC.
333 Continental Boulevard, El Segundo,
California 90245, USA

(111) M 2010 20888 R1
(156) 2010 11 03
(186) 2030 11 03
(732) ASTELLAS PHARMA INC.
5-1, Nihonbashi-Honcho 2-Chome, Chuo-ku,
Tokyo 103-8411, Japan

(111) M 2010 20891 R1
(156) 2010 11 03
(186) 2030 11 03
(732) MARS INCORPORATED
a Delaware corporation
6885 Elm Street, McLean, Virginia
22101-3883, USA

(111) M 2010 20954 R1
(156) 2010 11 30
(186) 2030 11 30
(732) MARS INCORPORATED
6885 ELM Street, McLean, Virginia
22101-3883, USA

COMPLETE TRANSFER OF RIGHTS

-
- | | |
|---|--|
| <p>(111) M 2006 16982 R
(732) EXELTIS İLAÇ SANAYİİ VE TİCARET ANONİM ŞİRKETİ
Maslak Mahallesi, Sümer Sokak, Ayazaga
Ticaret Merkezi No: 3/9, TR-34398 Sariyer/
İstanbul, Turkey
(770) LTD "ASPHARMA" – Georgian Pharmaceutical Company
Mtskheta St. 8, 0179, Tbilisi Georgia
(580) 13 02 2020</p> | <p>(111) M 2013 23311 R
(732) Asfarma Medikal Dental Ürünler İlaç San. Tic. A.Ş.
Bahçelievler Mah.Ressam Halim Sokak. Kadir Has iş Merkez No.7/32 34189 İstanbul, Turkey
(770) LTD "ASPHARMA" – Georgian Pharmaceutical Company
Mtskheta St. 8, 0179, Tbilisi Georgia
(580) 04 12 2019</p> |
|---|--|
-
- | | |
|--|--|
| <p>(111) M 2006 16984 R
(732) Aspharma Medical Dental Ürünler İlaç San. Tic. A.Ş.
Bahçelievler Mah.Ressam Halim Sokak.
Kadir Has iş Merkez No.7/32 34189 İstanbul, Turkey
(580) 20 02 2020</p> | |
|--|--|
-
- | | |
|--|--|
| <p>(111) M 2011 21301 R
(732) EXELTIS İLAÇ SANAYİİ VE TİCARET ANONİM ŞİRKETİ
Maslak Mahallesi, Sümer Sokak, Ayazaga
Ticaret Merkezi No: 3/9, TR-34398 Sariyer/
İstanbul, Turkey
(770) LTD "ASPHARMA" – Georgian Pharmaceutical Company
Shevchenko St. 12, 0108, Tbilisi Georgia
(580) 13 02 2020</p> | |
|--|--|
-
- | | |
|--|--|
| <p>(111) M 1996 2610 R
(732) ESHMAN TEQNOLOJIS LTD
Eshman House, 15 Peter Road, Lancing,
West Sussex BN15 8TJ, United Kingdom
(770) ESCHMANN HOLDINGS LIMITED
Peter Road, Lancing, West Sussex BN15
8TJ, United Kingdom
(580) 18 02 2020</p> | |
|--|--|
-
- | | |
|--|--|
| <p>(111) M 1997 7308 R
(732) Nouryon Chemicals International B.V.
Velperweg 76, NL-6824 BM Arnhem,
Netherlands
(770) AKZO NOBEL CHEMICALS B.V.
Velperweg 76, NL-6824 BM Arnhem,
Netherlands
(580) 14 02 2020</p> | |
|--|--|
-

CHANGES OF NAMES AND/OR ADDRESS OF OWNERS

- (111) M 2010 20479 R
(732) KMG International N.V.
Strawinskylaan 807, Tower A-8, NL-1077
XX Amsterdam, Netherlands
(770) THE ROMPETROL GROUP NV
Strawinskylaan 807, Tower A-8, 1077
XX Amsterdam, Netherlands
(580) 21 02 2020
-

LICENSE AGREEMENTS

- (111) M 2019 31031 R
(732) LLC "KARTLI ENERGY"
Krtsanisi St. 22-24, Tbilisi, Georgia
(791) LLC "KARTLI GENERATION"
Bagebi, Tskneti Highway 67, Tbilisi, Georgia
(793) 1601
(793) 27 12 2019 – 20-12-2029
(793) Simple
(793) 6, 35, 37, 42
-

- (111) M 2019 30995 R
(732) LLC "KARTLI GENERATION"
Krtsanisi St. 22-24, 0114, Tbilisi, Georgia
(791) LLC "KARTLI ENERGY"
Bagebi, Tskneti Highway 67, Tbilisi, Georgia
(793) 1602
(793) 20 12 2019 – 20 12 2031
(793) Simple
(793) 35, 37, 42
-

CLASSIFICATION INDEXES

INVENTIONS

CONCORDANCE TABLE OF INTERNATIONAL CLASSIFICATION INDEX AND PUBLICATION NUMBERS

INTERNATIONAL CLASSIFICATION INDEXES (51)	NUMBER OF PUBLISHED APPLICATION (10)
A 61 P 25/02; A 61 P 25/04; A 61 K 31/496; A 61 K 45/06; A 61 K 31/195	AP 2020 14778 A
A 61 K 31/506; A 61 P 37/00; A 61 P 9/00; A 61 P 25/30; A 61 P 35/00; A 61 P 25/02; A 61 P 3/10; A 61 P 3/06; A 61 P 7/02; C 07 D 403/14; C 07 D 403/04; C 07 D 401/14	AP 2020 14820 A
A 61 K 31/661; A 61 K 31/519; A 61 P 35/00; C 07 D 495/04; C 07 F 9/6561	AP 2020 14858 A
C 07 D 285/12; C 07 D 285/08; C 07 D 277/26; C 07 D 495/04; C 07 D 271/06; C 07 D 263/32; C 07 D 261/08; C 07 D 249/08; C 07 D 249/06; C 07 D 417/04; C 07 D 413/10; C 07 D 413/06; C 07 D 413/04; C 07 D 233/64; C 07 D 231/12	AP 2020 14908 A

CONCORDANCE TABLE OF PUBLICATION NUMBERS AND INTERNATIONAL CLASSIFICATION INDEX

NUMBER OF PUBLISHED APPLICATION (10)	INTERNATIONAL CLASSIFICATION INDEXES (51)
AP 2020 14778 A	A 61 P 25/02; A 61 P 25/04; A 61 K 31/496; A 61 K 45/06; A 61 K 31/195
AP 2020 14820 A	A 61 K 31/506; A 61 P 37/00; A 61 P 9/00; A 61 P 25/30; A 61 P 35/00; A 61 P 25/02; A 61 P 3/10; A 61 P 3/06; A 61 P 7/02; C 07 D 403/14; C 07 D 403/04; C 07 D 401/14
AP 2020 14858 A	A 61 K 31/661; A 61 K 31/519; A 61 P 35/00; C 07 D 495/04; C 07 F 9/6561
AP 2020 14908 A	C 07 D 285/12; C 07 D 285/08; C 07 D 277/26; C 07 D 495/04; C 07 D 271/06; C 07 D 263/32; C 07 D 261/08; C 07 D 249/08; C 07 D 249/06; C 07 D 417/04; C 07 D 413/10; C 07 D 413/06; C 07 D 413/04; C 07 D 233/64; C 07 D 231/12

CONCORDANCE TABLE OF INTERNATIONAL CLASSIFICATION INDEX, PATENT NUMBERS AND PUBLICATION NUMBERS

INTERNATIONAL CLASSIFICATION INDEX (51)	NUMBER OF PATENT (11)	NUMBER OF PUBLISHED APPLICATION (10)
A 43 B 17/14; C 08 L 9/06	P 2020 7077 B	AP 2019 14777 A
A 61 K 31/519; A 61 P 35/00; A 61 P 37/00; C 07 D 495/04	P 2020 7074 B	AP 2019 14678 A
A 61 P 37/00; A 61 P 35/00; A 61 K 31/519; C 07 D 495/04	P 2020 7076 B	AP 2019 14680 A
A 61 P 37/00; A 61 P 35/00; A 61 K 31/519; C 07 D 495/04	P 2020 7075 B	AP 2019 14679 A
B 22 F 9/08	P 2020 7078 B	AP 2019 15009 A

**CONCORDANCE TABLE OF PATENT NUMBERS,
PUBLICATION NUMBERS AND INTERNATIONAL CLASSIFICATION INDEX**

NUMBER OF PATENT (11)	NUMBER OF PUBLISHED APPLICATION (10)	INTERNATIONAL CLASSIFICATION INDEX (51)
P 2020 7074 B	AP 2019 14678 A	A 61 K 31/519; A 61 P 35/00; A 61 P 37/00; C 07 D 495/04
P 2020 7075 B	AP 2019 14679 A	A 61 P 37/00; A 61 P 35/00; A 61 K 31/519; C 07 D 495/04
P 2020 7076 B	AP 2019 14680 A	A 61 P 37/00; A 61 P 35/00; A 61 K 31/519; C 07 D 495/04
P 2020 7077 B	AP 2019 14777 A	A 43 B 17/14; C 08 L 9/06
P 2020 7078 B	AP 2019 15009 A	B 22 F 9/08

**CONCORDANCE TABLE OF APPLICATION NUMBERS, PUBLICATION NUMBERS
AND PATENTS**

NUMBER OF APPLICATION (21)	NUMBER OF PUBLISHED APPLICATION (10)	NUMBER OF PATENT (11)
AP 2018 14777	AP 2019 14777 A	P 2020 7077 B
AP 2016 14678	AP 2019 14678 A	P 2020 7074 B
AP 2016 14680	AP 2019 14680 A	P 2020 7076 B
AP 2016 14679	AP 2019 14679 A	P 2020 7075 B
AP 2019 15009	AP 2019 15009 A	P 2020 7078 B

UTILITY MODELS

**CONCORDANCE TABLE OF INTERNATIONAL CLASSIFICATION INDEX
AND PUBLICATION NUMBERS**

INTERNATIONAL CLASSIFICATION INDEXES (51)	NUMBER OF PUBLISHED APPLICATION (10)
E 04 C 1/00	AU 2020 15133 U
F 03 D 3/02; F 03 D 3/00	AU 2020 15122 U

**CONCORDANCE TABLE OF PUBLICATION NUMBERS
AND INTERNATIONAL CLASSIFICATION INDEX**

NUMBER OF PUBLISHED APPLICATION (10)	INTERNATIONAL CLASSIFICATION INDEXES (51)
AU 2020 15122 U	F 03 D 3/02; F 03 D 3/00
AU 2020 15133 U	E 04 C 1/00

TRADEMARKS

CONCORDANCE TABLE OF REGISTRATION NUMBERS, APPLICATION NUMBERS, PUBLICATION NUMBERS AND BULLETIN NUMBERS

NUMBER OF REGISTRATION (111)	NUMBER OF APPLICATIONS (210)	NUMBER OF PUBLISHED APPLICATIONS (260)	NUMBER OF BULLETIN
M 2020 32388 R	AM 107066	–	5(537)/2020
M 2020 32389 R	AM 107068	–	5(537)/2020
M 2020 32390 R	AM 106933	–	5(537)/2020
M 2020 32391 R	AM 107259	–	5(537)/2020
M 2020 32392 R	AM 107157	–	5(537)/2020
M 2020 32393 R	AM 107170	–	5(537)/2020
M 2020 32394 R	AM 107265	–	5(537)/2020
M 2020 32395 R	AM 107166	–	5(537)/2020
M 2020 32396 R	AM 100084	AM 2019 100084 A	21(529)/2019
M 2020 32397 R	AM 101213	AM 2019 101213 A	21(529)/2019
M 2020 32398 R	AM 101214	AM 2019 101214 A	21(529)/2019
M 2020 32399 R	AM 101617	AM 2019 101617 A	17(525)/2019
M 2020 32400 R	AM 101619	AM 2019 101619 A	17(525)/2019
M 2020 32401 R	AM 101620	AM 2019 101620 A	17(525)/2019
M 2020 32402 R	AM 101640	AM 2019 101640 A	17(525)/2019
M 2020 32403 R	AM 101645	AM 2019 101645 A	17(525)/2019
M 2020 32404 R	AM 101650	AM 2019 101650 A	18(526)/2019
M 2020 32405 R	AM 101656	AM 2019 101656 A	19(527)/2019
M 2020 32406 R	AM 101643	AM 2019 101643 A	17(525)/2019
M 2020 32407 R	AM 102158	AM 2019 102158 A	21(529)/2019
M 2020 32408 R	AM 102159	AM 2019 102159 A	21(529)/2019
M 2020 32409 R	AM 102247	AM 2019 102247 A	20(528)/2019
M 2020 32410 R	AM 102359	AM 2019 102359 A	21(529)/2019
M 2020 32411 R	AM 102362	AM 2019 102362 A	21(529)/2019
M 2020 32412 R	AM 102363	AM 2019 102363 A	21(529)/2019
M 2020 32413 R	AM 102374	AM 2019 102374 A	21(529)/2019
M 2020 32414 R	AM 102386	AM 2019 102386 A	21(529)/2019
M 2020 32415 R	AM 102493	AM 2019 102493 A	21(529)/2019
M 2020 32416 R	AM 102498	AM 2019 102498 A	21(529)/2019
M 2020 32417 R	AM 102500	AM 2019 102500 A	21(529)/2019
M 2020 32418 R	AM 102501	AM 2019 102501 A	21(529)/2019
M 2020 32419 R	AM 102502	AM 2019 102502 A	21(529)/2019
M 2020 32420 R	AM 102503	AM 2019 102503 A	21(529)/2019
M 2020 32421 R	AM 102522	AM 2019 102522 A	21(529)/2019
M 2020 32422 R	AM 102539	AM 2019 102539 A	21(529)/2019
M 2020 32423 R	AM 102713	AM 2019 102713 A	21(529)/2019
M 2020 32424 R	AM 102714	AM 2019 102714 A	21(529)/2019
M 2020 32425 R	AM 102730	AM 2019 102730 A	21(529)/2019
M 2020 32426 R	AM 102833	AM 2019 102833 A	22(530)/2019
M 2020 32427 R	AM 102927	AM 2019 102927 A	21(529)/2019
M 2020 32428 R	AM 103093	AM 2019 103093 A	22(530)/2019
M 2020 32429 R	AM 99429	AM 2019 99429 A	21(529)/2019
M 2020 32430 R	AM 107298	–	5(537)/2020

CONCORDANCE TABLE OF PUBLICATION NUMBERS
AND APPLICATION NUMBERS

NUMBER OF PUBLISHED APPLICATION (260)	NUMBER OF APPLICATION (210)	1	2
1	2		
AM 2020 103559 A	AM 103559	AM 2020 104106 A	AM 104106
AM 2020 103692 A	AM 103692	AM 2020 104177 A	AM 104177
AM 2020 103780 A	AM 103780	AM 2020 104199 A	AM 104199
AM 2020 103879 A	AM 103879	AM 2020 104207 A	AM 104207
AM 2020 103943 A	AM 103943	AM 2020 104209 A	AM 104209
AM 2020 103952 A	AM 103952	AM 2020 104216 A	AM 104216
AM 2020 103956 A	AM 103956	AM 2020 104217 A	AM 104217
AM 2020 103970 A	AM 103970	AM 2020 104307 A	AM 104307
AM 2020 103974 A	AM 103974	AM 2020 104316 A	AM 104316
AM 2020 103975 A	AM 103975	AM 2020 104331 A	AM 104331
AM 2020 104060 A	AM 104060	AM 2020 104402 A	AM 104402
AM 2020 104073 A	AM 104073	AM 2020 104403 A	AM 104403
AM 2020 104084 A	AM 104084	AM 2020 104425 A	AM 104425
AM 2020 104088 A	AM 104088	AM 2020 104426 A	AM 104426
		AM 2020 104427 A	AM 104427
		AM 2020 104428 A	AM 104428
		AM 2020 104429 A	AM 104429
		AM 2020 104535 A	AM 104535
		AM 2020 104537 A	AM 104537

**CONCORDANCE TABLE OF INDEX OF GOODS AND/OR SERVICES
AND APPLICATION NUMBERS**

INDEX OF GOODS AND/OR SERVICES (511)	NUMBER OF PUBLISHED APPLICATIONS (26)	1	2
1	2		
1	AM 2020 103879 A	33	AM 2020 103692 A
3	AM 2020 103956 A	33	AM 2020 103943 A
3	AM 2020 104316 A	33	AM 2020 103974 A
5	AM 2020 103970 A	33	AM 2020 103975 A
5	AM 2020 104199 A	33	AM 2020 104060 A
5	AM 2020 104307 A	33	AM 2020 104084 A
5	AM 2020 104402 A	33	AM 2020 104209 A
7	AM 2020 104073 A	34	AM 2020 104088 A
7	AM 2020 104331 A	35	AM 2020 103879 A
9	AM 2020 103559 A	35	AM 2020 103943 A
9	AM 2020 104073 A	35	AM 2020 104073 A
9	AM 2020 104217 A	35	AM 2020 104207 A
11	AM 2020 104073 A	37	AM 2020 103559 A
11	AM 2020 104217 A	38	AM 2020 104073 A
12	AM 2020 104177 A	39	AM 2020 104207 A
12	AM 2020 104425 A	40	AM 2020 103559 A
12	AM 2020 104426 A	41	AM 2020 103974 A
12	AM 2020 104427 A	41	AM 2020 103975 A
12	AM 2020 104428 A	41	AM 2020 104207 A
12	AM 2020 104429 A	41	AM 2020 104535 A
14	AM 2020 104073 A	41	AM 2020 104537 A
16	AM 2020 103559 A	42	AM 2020 104073 A
25	AM 2020 104403 A	42	AM 2020 104207 A
29	AM 2020 103879 A	42	AM 2020 104535 A
29	AM 2020 104209 A	42	AM 2020 104537 A
30	AM 2020 103879 A	43	AM 2020 104073 A
30	AM 2020 104106 A	43	AM 2020 104207 A
30	AM 2020 104209 A	43	AM 2020 104535 A
		43	AM 2020 104537 A
		43	AM 2020 104073 A
		43	AM 2020 104207 A
		43	AM 2020 104535 A
		43	AM 2020 104537 A
		43	AM 2020 104073 A
		43	AM 2020 103780 A
		43	AM 2020 103952 A
		43	AM 2020 103974 A
		43	AM 2020 103975 A
		43	AM 2020 104106 A
		43	AM 2020 104216 A
		45	AM 2020 104073 A

**CONCORDANCE TABLE OF INDEX OF GOODS AND/OR SERVICES
AND NUMBERS OF TRADEMARKS REGISTERED ACCORDING
TO THE ACCELERATED PROCEDURE**

INDEX OF GOODS AND/OR SERVICES (511)	NUMBERS OF REGISTERED ACCORDING TO THE ACCELERATED PROCEDURE (111)
1	M 2020 32389 R
5	M 2020 32390 R
9	M 2020 32388 R
25	M 2020 32391 R
30	M 2020 32395 R
35	M 2020 32390 R
41	M 2020 32388 R
43	M 2020 32392 R
43	M 2020 32393 R
43	M 2020 32430 R
44	M 2020 32394 R

OFFICIAL BULLETIN OF THE INDUSTRIAL PROPERTY

**INVENTIONS
UTILITY MODELS
DESIGNS
TRADEMARKS**

5(537)

EDITOR-IN-CHIEF: N. Bebrishvili

EDITOR-TRANSLATOR: E. Gabunia

PROOFREADER: A. Shikhashvili

COMPUTER LAYOUT: M. Ordenidze
K. Svanidze

www.sakpatenti.gov.ge

E-mail: info@sakpatenti.org.ge