



საქართველოს ინტელექტუალური საკუთრების ეროვნული ცენტრი
NATIONAL INTELLECTUAL PROPERTY CENTER OF GEORGIA

საქპატენტი
SAKPATENTI

**OFFICIAL BULLETIN
OF THE INDUSTRIAL PROPERTY**

6(538)

2020
TBILISI

INID CODES FOR IDENTIFICATION OF BIBLIOGRAPHIC DATA

INVENTIONS, UTILITY MODELS

- (10) Number of publication for application, which has been examined
- (11) Number of patent and kind of document
- (21) Serial number of application
- (22) Date of filing of the application
- (23) Date of exhibition or the date of the earlier filing and the number of application, if any
- (24) Date from which patent may have effect
- (31) Number of priority application
- (32) Date of filing of priority application
- (33) Code of the country or regional organization allotting priority application number
- (44) Date of publication of application not granted, but examined and number of bulletin
- (45) Date of publication of registered document
- (51) International Patent Classification Index

- (54) Title of the invention
- (57) Abstract
- (60) Number of examined patent document granted by foreign patent office, date from which patent has effect and country code
- (62) Number of the earlier application and in case of divided application, date of filing an application
- (71) Name, surname and address of applicant (country code)
- (72) Name, surname of inventor (country code)
- (73) Name, surname and address of patent owner (country code)
- (74) Name, surname of representative or patent attorney
- (85) Date of commencement of the national phase of International Application
- (86) Number and date of filing of international application
- (87) Number and date of publication of international application
- (94) Calculated date of expiry of the SPC or the duration of the SPC

DESIGNS

- (10) Number of publication for application
- (11) Number of patent and kind of document or number of registration
- (15) Date of registration/Date of patent renewal
- (18) Expected expiration date of patent or registration
- (21) Serial number of application
- (22) Date of filing of the application
- (23) Date of exhibition or the date of the earlier filing and the number of application, if any
- (24) Date from which patent may have effect
- (28) Number of designs included in the application
- (30) Data relating to priority (number of application, date of filing of application, two-letter code identifying the authority with whom the priority application was made)
- (31) Number of priority application
- (32) Date of filing of priority application
- (33) Code of the country or regional organization allotting priority application number
- (34) Two-letter code according to WIPO St.3 identifying the authority with which the priority application was made
- (44) Date of publication of design and number of bulletin (the first publication)
- (45) Date of publication of design registered by WIPO and number of bulletin

- (51) International Classification for designs (class and subclass of the Locarno Classification)
- (54) Title of the invention
- (55) Reproduction of the design
- (57) Description of characteristic features of the design including indication of colors
- (58) Date of recording of any kind of amendment in the Register
- (62) Number of the earlier application, registration and document number and if available the date of filing an application in case of divided application
- (71) Name, surname and address of applicant (country code)
- (72) Name, surname of creator (country code)
- (73) Name, surname and address of patent owner (country code)
- (74) Name, surname of representative or patent attorney
- (81) Contracting states concerned
 - II designated contracting states according to the 1960 Act
 - III designated contracting states according to the 1999 Act
- (85) Owner's permanent address
- (86) Owner's nationality
- (87) Owner's residence
- (88) State in which the owner has a real and effective industrial or commercial establishment

TRADEMARKS

- (111) - Number of registration
- (151) - Date of registration
- (156) - Date of the renewal
- (181) - Expected expiration date of registration
- (186) - Renewal expiration date of registration
- (141) - Date of cancel of duration of the mark
- (210) - Serial number of application
- (220) - Date of filing of the application
- (230) - Data concerning exhibition
- (260) - Number of application, for which favorable decision of examination about registration has been taken (publication number)
- (310) - Number of the first application
- (320) - Date of filing of the first application
- (330) - Code, identifying national or regional Office where the first application was made
- (511) - International Classification of Goods and Services for the purposes of registration of trade marks and/or list of goods and/or services classified according thereto
- (526) - Disclaimer
- (531) - Description of figurative elements of Trade Marks according to the International Classification of the Figurative Elements of Marks

- (540) - Reproduction of Trade Mark
- (550) - Nature and kind of Trade Mark
- (551) - Indication to the effect that the mark is a collective mark, a certification mark or a guarantee mark
- (554) - Three-dimensional mark
- (580) - Date of recording of any kind changes in respect of applications or registrations
- (591) - Information concerning colors claimed
- (731) - Name and address of the applicant
- (732) - Name and address of the holder of the registration
- (740) - Name and address of the representative
- (750) - Addreses for correspondence
- (770) - Name and address of the previous applicant or holder in case of change in ownership
- (771) - Previous name and address of the applicant or holder in case of change in ownership
- (791) - Name and address of the licensee
- (793) - Indication of conditions and/or restrictions under the license (Type of license, number of license agreement, data of license, data of validity of license)
- (800) - Certain data relating to the international registration of Trade Marks under the Protocol Relating to Madrid Agreement (International registration number
- (852) - Partial cancellation of the list of goods and services
- (891) - Date of subsequent designation

CODES FOR PUBLICATION IN BULLETIN

- (21) AP 0000 000000 - serial number of application for invention
- (10) AP 0000 0000 A - number of published application for invention (first publication)
- (11) P 0000 0000 B - number of patent for invention (second publication)
- (21) API 0000 000000 - number of application for imported patent
- (11) PI 0000 0000 A - number of imported patent (first publication)
- (21) AU 0000 000000 - serial number of application for utility model
- (10) AU 0000 000 U - number of published application for utility model (first publication)
- (11) U 0000 000 Y - number of patent for utility model (second publication)
- (21) AD 0000 000000 - serial number of application for design
- (10) AD 0000 000 S - number of published application for design (first publication)
- (11) D 0000 000 S - registered design

INTERNATIONAL PATENT CLASSIFICATION FOR INVENTIONS AND UTILITY MODELS

- SECTION A - HUMAN NECESSITIES
- SECTION B - PERFORMING OPERATIONS; TRANSPORTING
- SECTION C - CHEMISTRY; METALLURGY
- SECTION D - TEXTILES; PAPER
- SECTION E - FIXED CONSTRUCTIONS
- SECTION F - MECHANICAL ENGINEERING; LIGHTING; HEATING; WEAPONS; BLASTING
- SECTION G - PHYSICS
- SECTION H - ELECTRICITY

-
- M - Trade Mark
 - (210) AM 0000 000000 - Serial number of application;
 - (260) AAM 0000 00000 A - Publication number of application;
 - (111) M 0000 00000 R - Number of registration;
 - (111) MMM0000 00000 Rn - Number of renewals, in which n=1,2,3;
 - (111) M 0000 00000 R(P) - Number of registration under partial assignment of rights
-

**LIST OF CODES, IN ALPHABETIC SEQUENCE, AND THE CORRESPONDING (SHORT) NAMES OF STATES, OTHER ENTITIES AND INTERGOVERNMENTAL ORGANIZATIONS
(WIPO STANDARD ST.3)**

AD	Andorra				
AE	United Arab Emirates	GD	Grenada	NE	Niger
AF	Afghanistan	GG	Guernsey	NG	Nigeria
AG	Antigua and Barbuda	GH	Ghana	NI	Nicaragua
AI	Anguilla	GI	Gibraltar	NL	Netherlands
AL	Albania	GT	Guatemala	NO	Norway
AM	Armenia	GW	Guinea- Bissau	NP	Nepal
AN	Netherlands Antilles	GY	Guyana	NR	Nauru
AO	Angola	HK	The Hong Kong Special Administrative Region of the People's Republic of China	NZ	New Zealand
AP	African Regional Intellectual Property Organization (ARIPO)	HN	Honduras	OA	African Intellectual Property Organization (OAPI)
AR	Argentina	HR	Croatia	OM	Oman
AT	Austria	HT	Haiti	PA	Panama
AU	Australia	HU	Hungary	PE	Peru
AW	Aruba	IB	International Bureau of the World Intellectual Property Organization (WIPO)	PG	Papua New Guinea
AZ	Azerbaijan	ID	Indonesia	PH	Philippines
BA	Bosnia and Herzegovina	IE	Ireland	PK	Pakistan
BB	Barbados	IL	Israel	PL	Poland
BD	Bangladesh	IM	Isle of Man	PT	Portugal
BE	Belgium	IN	India	PW	Palau
BF	Burkina Faso	IQ	Iraq	PY	Paraguay
BG	Bulgaria	IR	Iran (Islamic Republic of)	QA	Qatar
BH	Bahrain	IS	Iceland	QZ	Community Plant Variety Office (European Community) (CPVO)
BI	Burundi	IT	Italy	RO	Romania
BJ	Benin	JE	Jersey	RS	Serbia
BM	Bermuda	JM	Jamaica	RU	Russian Federation
BN	Brunei Darussalam	JO	Jordan	RW	Rwanda
BO	Bolivia	JP	Japan	SA	Saudi Arabia
BR	Brazil	KE	Kenya	SB	Solomon Islands
BS	Bahamas	KG	Kyrgyzstan	SC	Seychelles
BT	Bhutan	KH	Cambodia	SD	Sudan
BV	Bouvet Island	KI	Kiribati	SG	Singapore
BW	Botswana	KM	Saint Kitts and Nevis	SH	Saint Helena
BX	Benelux Office for Intellectual Property (BOIP)	KP	Democratic People's Republic of Korea	SI	Slovenia
BY	Belarus	KR	Republic of Korea	SK	Slovakia
BZ	Belize	KW	Kuwait	SL	Sierra Leone
CA	Canada	KY	Cayman Islands	SM	San Marino
CD	Democratic Republic of the Congo	KZ	Kazakhstan	SN	Senegal
CF	Central African Republic	LA	Lao People's Democratic Republic	SO	Somalia
CG	Congo	LB	Lebanon	SR	Suriname
CH	Switzerland	LC	Saint Lucia	ST	Sao Tome and Principe
CI	Cote d'Ivoire	LI	Liechtenstein	SV	El Salvador
CK	Cook Islands	LK	Sri Lanka	SY	Syrian Arab Republic
CL	Chile	LR	Liberia	SZ	Swaziland
CM	Cameroon	LS	Lesotho	TC	Turks and Caicos Islands
CN	China	LT	Lithuania	TD	Chad
CO	Colombia	LU	Luxembourg	TG	Togo
CR	Costa Rica	LV	Latvia	TH	Thailand
CU	Cuba	LY	Libyan Arab Jamahiriya	TJ	Tajikistan
CV	Cape Verde	MA	Morocco	TL	Timor-Leste
CY	Cyprus	MC	Monaco	TM	Turkmenistan
CZ	Czech Republic	MD	Republic of Moldova	TN	Tunisia
DE	Germany	ME	Montenegro	TO	Tonga
DJ	Djibouti	MG	Madagascar	TR	Turkey
DM	Dominica	MK	The former Yugoslav Republic of Macedonia	SE	Sweden
DO	Dominican Republic	ML	Mali	TT	Trinidad and Tobago
DZ	Algeria	MM	Myanmar	TV	Tuvalu
EA	Eurasian Patent Organization (EAPO)	MN	Mongolia	TW	Taiwan, Province of China
EC	Ecuador	MO	Macao	TZ	United Republic of Tanzania
EE	Estonia	MP	Northern Mariana Islands	UA	Ukraine
EG	Egypt	MR	Mauritania	UG	Uganda
EH	Western Sahara	MS	Montserrat	US	United States of America
EM	Office for Harmonization in the Internal Market (Trademarks and Designs)(OHIM)	MT	Malta	UY	Uruguay
EP	European Patent Office (EPO)	MU	Mauritius	UZ	Uzbekistan
ER	Eritrea	MV	Maldives	VA	Holy See
ES	Spain	MW	Malawi	VC	Saint Vincent and the Grenadines
ET	Ethiopia	MX	Mexico	VE	Venezuela
FI	Finland	MY	Malaysia	VG	Virgin Islands (British)
FJ	Fiji	MZ	Mozambique	VN	Viet Nam
FK	Falkland Islands (Malvinas)	NA	Namibia	VU	Vanuatu
FO	Faroe Islands			WO	World Intellectual Property Organization (WIPO)
FR	France			WS	Samoa
GA	Gabon			XN	Nordic Patent Institute (NPI)
GB	United Kingdom			YE	Yemen
GC	Patent Office of the Cooperation Council for the Arab States of the Gulf (GCC)			ZA	South Africa
				ZM	Zambia
				ZW	Zimbabwe

**OFFICIAL BULLETIN
OF THE INDUSTRIAL PROPERTY**

6(538)

**INVENTIONS
UTILITY MODELS
DESIGNS
TRADEMARKS**

DATE OF PUBLICATION: 2020 03 25

CONTENTS

PUBLISHED TITLES OF PROTECTION	3
INVENTIONS	
▪ APPLICATIONS APPROVED FOR GRANTING PATENTS	4
▪ PATENTED INVENTIONS	6
UTILITY MODELS	
▪ APPLICATIONS APPROVED FOR GRANTING PATENTS	7
▪ PATENTED UTILITY MODELS	9
DESIGNS	
▪ APPLICATIONS APPROVED FOR REGISTRATION	10
▪ DESIGN, WHICH HAVE BEEN REGISTERED WITH THE INTERNATIONAL BUREAU CLAIMING PRIORITY ON THE TERRITORY OF GEORGIA	16
TRADEMARKS	
▪ APPLICATIONS FILED UNDER THE NATIONAL PROCEDURE APPROVED FOR REGISTRATION	28
▪ REGISTERED TRADEMARKS	36
▪ TRADEMARKS REGISTERED ACCORDING TO THE ACCELERATED PROCEDURE	39
▪ INTERNATIONAL TRADEMARKS FOR WHICH A DECISION ON GRANTING PROTECTION IS TAKEN	41
▪ INTERNATIONAL TRADEMARKS PROTECTED IN GEORGIA	119
OFFICIAL NOTIFICATIONS	
INVENTIONS	
▪ ABOLITION OF PATENTS WITH THE RIGHT TO RESTORE	128
▪ EXPIRATION OF TERM OF RESTORATION OF PATENTS	130
UTILITY MODEL	
▪ EXPIRATION OF PATENT RESTORATION	131
DESIGNS	
▪ EXTENSION OF REGISTRATION OF DESIGNS	131
▪ CANCELLATION OF REGISTRATION OF DESIGNS	132
▪ CHANGES OF REPRESENTATIVE DATA	133
▪ CANCELLATION OF REGISTRATION OF INTERNATIONAL DESIGNS	133
TRADEMARKS	
▪ RENEWAL OF REGISTRATIONS	135
▪ COMPLETE TRANSFER OF RIGHTS	141
▪ CHANGES OF NAMES AND/OR ADDRESSES OF OWNERS	142
▪ TERMINATION OF TRADEMARKS REGISTRATION	143
CLASSIFICATION INDEXES	
INVENTIONS	145
UTILITY MODELS	146
DESIGNS	147
TRADEMARKS	148

PUBLISHED TITLES OF PROTECTION

INVENTIONS

- **APPLICATIONS APPROVED FOR GRANTING PATENT:**
14924; 14836; 14662
- **PATENTED INVENTIONS:**
7079-7081

UTILITY MODELS

- **APPLICATIONS APPROVED FOR GRANTING PATENT:**
15093; 15004; 14973; 14804
- **PATENTED UTILITY MODEL:**
2034

DESIGNS

- **APPLICATIONS APPROVED FOR REGISTRATION:**
1114; 1117; 1116; 1112, 1113
- **DESIGN, WHICH HAVE BEEN REGISTERED WITH THE INTERNATIONAL BUREAU CLAIMING PRIORITY ON THE TERRITORY OF GEORGIA:**
202849

TRADEMARKS

- **APPLICATIONS FILED UNDER THE NATIONAL PROCEDURE APPROVED FOR REGISTRATION:**
90029**; 99947*; 99950*; 100771; 100874*; 100880; 102832; 103485; 103942; 103954, 103955; 103979; 104085; 104176; 104196-104198; 104200; 104206; 104313; 104406; 104430; 104432; 104436-104438; 104444; 104447; 104454; 104530; 104532, 104533; 104536; 104555; 104557-104559; 104561; 104752, 104753; 104756; 104758, 104759; 104812
- **REGISTERED TRADEMARKS:**
32436-32468
- **TRADEMARKS REGISTERED ACCORDING TO THE ACCELERATED PROCEDURE:**
32431-32435; 32469-32472
- **INTERNATIONAL TRADEMARKS FOR WHICH A DECISION ON GRANTING PROTECTIONS IS TAKEN:**
99422, 99423; 100341*; 101337; 101432*; 102290; 102429; 102611; 102739; 102873; 102978; 103057-103060; 103146, 103147; 103149; 103163; 103238, 103239; 103281-103283; 103300; 103349, 103366; 103368-103370; 103384-103386; 103388, 103389; 103397-103401; 103492, 103493; 103505-103508; 103529; 103531-103535; 103537; 103539; 103541, 103542; 103548; 103550; 103553; 103595; 103605; 103607; 103613; 103615, 103616; 103618-103620; 103627, 103628; 103633; 103638; 103642; 103647; 103707; 103716; 103718, 103719; 103728; 103732-103734; 103736, 103737; 103745, 103746, 103807; 103811-103813; 103816-103820; 103822; 103827; 103830; 103834; 103905; 103912; 103923; 103925; 104333; 104337; 104343; 104390; 104393; 104519; 104521; 104654; 104657, 104658; 104694; 104733
- **INTERNATIONAL TRADEMARKS PROTECTED IN GEORGIA:**
97101; 101554; 101752; 101762, 101763; 101797; 101799; 101802; 101812-101817; 101820-101829; 101831; 101846; 101860-101867; 101872-101874; 101880-101883; 101937-101943; 101951-101955; 101957-101964; 101986; 101989-101993; 101999-102001; 102003-102005; 102015; 102019; 102090; 102092; 102109-102111; 102113; 102124-102128; 102135-102138; 102184; 102205; 102207, 102211, 102212; 102226-102228; 102296; 102298; 102300, 102301; 102311-102314; 102324; 102435; 102437-102439; 102442; 102444; 102446; 102448; 102583; 102795, 102796; 102798, 102799; 102893-102896

INVENTIONS

APPLICATIONS APPROVED FOR GRANTING PATENTS

The decision can be appealed at the Chamber of Appeal of Sakpatenti within 3 months from the publication or at the Mtskheta District Court Administrative Cases Board (Address: №17, Samkhedro str., Mtskheta), within 1 month following the publication.

PART A

A 61

(10) AP 2020 14924 A (51) Int. Cl. (2006)
A 61 K 31/4178
A 61 P 11/00
C 07 D 417/14
C 07 D 403/14
C 07 D 413/14
C 07 D 403/04

(21) AP 2017 14924 (22) 2017 05 26

(31) 16172196.4

(32) 2016 05 31

(33) EP

(71) CHIESI FARMACEUTICI S.P.A. (IT)
Via Palermo, 26/A, 43122 Parma (IT)

(72) ARMANI, Elisabetta (IT);
CAPALDI, Carmelida (IT);
JENNINGS, Andrew Stephan Robert (IT);
HEALD, Robert Andrew (IT);
SUTTON, Jonathan Mark (IT)

(74) Shalva Gvaramadze

(85) 2018 11 14

(86) PCT/EP2017/062754, 2017 05 26

(54) **IMIDAZOLONE COMPOUNDS AS
HUMAN NEUTROPHIL ELASTASE
INHIBITORS**

(57) Present invention relates to imidazolone derivatives having human neutrophil elastase inhibitory properties.

Claims: 4 independent

8 dependent

PART B

B 01

(10) AP 2020 14836 A (51) Int. Cl. (2006)
B 01 D 53/58
C 05 C 13/00

(21) AP 2016 14836 (22) 2016 12 21

(31) 15201598.8

(32) 2015 12 21

(33) EP

(71) STAMICARBON B.V. (NL)
Mercator, 3 NL-6135 KW Sittard (NL)

(72) PUCI, Giusy Elisa (NL);
DOBREE, Joey (NL)

(74) Liliana Darakhvelidze

(85) 2018 07 19

(86) PCT/NL2016/050902, 2016 12 21

(54) **CARBAMIDE AMMONIUM
NITRATE PRODUCTION**

(57) Present invention relates to a method for carbamide ammonium nitrate production, and system and method for device modification. The method provides produced by ammonium nitrate production the outlet gas containing ammonia treatment with purifying acid liquid in final treating section having gas inlet connected to carbamide producing device bringing down section gas outlet, wherein bringing down section is executed with capability to make solid carbamide liquid, and that, said final treating section is executed with capability to treat outlet gas containing ammonia with purifying acid liquid.

Claims: 3 independent

12 dependent

Fig.: 1

PART G

G 01

(10) AP 2020 14662 A (51) Int. Cl. (2006)
G 01 P 1/07
G 01 P 1/12

(21) AP 2017 14662 (22) 2017 12 28

(71) Valerian Kharitonashvili (GE)
Mitskevich St. 25, app. 35, 0194, Tbilisi (GE);
Nikoloz Titvinidze (GE)
G. Chanturia St. 66, 1400, Gori (GE)

(72) Valerian Kharitonashvili (GE)

Nikoloz Titvinidze (GE)

(54) **VEHICLE SPEEDOMETER**

(57) Vehicle speedometer includes a case 1, motion speed fixing knot at the crash comprising a case 2, electromagnetic relay 3 switched to airbags control unit 4 and gas balloon connecting cables 5 by means semiconductor diodes 6. Speed fixing knot case has

a cavity 7, wherein longitudinally movable stem 8 is placed, which one end is switched to electromagnetic relay 3 core 11 by means of spring 9. Stem 8 another end is passed through a hole executed in state speedometer case creating an aperture nearby speedometer coil 12. Springed fixator 13 connected to a bolt 14 screwed in the case 2 is braced onto the stem 8.

Claims: 1 independent

Fig.: 3

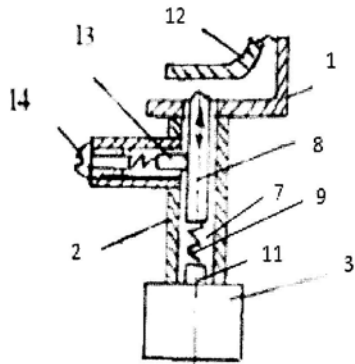

Fig. 2

PATENTED INVENTIONS
PART A**A 61**

- (11) P 2020 7079 B** **(51) Int. Cl. (2006)**
A 61 K 31/4985
A 61 P 25/24
- (10) AP 2019 14339 A (44) 21(529)/2019
(21) AP 2014 14339
(22) 2014 05 09
(24) 2014 05 09
(86) PCT/PT2014/000026, 2014 05 09
(73) Tecnimede Sociedade Tecnico-Medicinal S.A. (PT)
Rua Tapada Grande, Nº2 Abrunheira
P-2710-089 Sintra (PT)
(72) PARDAL FILIPE, Augusto Eugénio (PT);
EUFRÁSIO PEDROSO, Pedro Filipe (PT);
ALMEIDA PECORELLI, Susana
Marques (PT);
CASIMIRO CAIXADO, Carlos Alberto
Eufrásio (PT);
LOPES, Ana Sofia da Conceição (PT);
DAMIL, João Carlos Ramos (PT);
E OLIVEIRA SANTOS, Pedro Paulo
de Lacerda (PT)
(74) Tamaz Shilakadze
(54) **PHARMACEUTICALLY ACCEPTABLE
SALTS OF PIRLINDOLE ENANTIO-
MERS FOR USE IN MEDICINE**
-

A 47

- (11) P 2020 7080 B** **(51) Int. Cl. (2006)**
A 47 L 1/00
- (10) AP 2019 14878 A (44) 22(530)/2019
(21) AP 2018 14878
(22) 2018 09 18
(24) 2018 09 18
(73) LTD "IRNERO" (GE)
Sanapiro St. 2a, 0105, Tbilisi, Georgia (GE)
(72) Luka Patchkoria (GE)
(74) Shalva Gvaramadze
(54) **EQUIPMENT FOR WINDOW
AUTOMATIC CLEANING**
-

PART C**C 07**

- (11) P 2020 7081 B** **(51) Int. Cl. (2006)**
C 07 K 14/47
- (10) AP 2019 14514 A (44) 20(528)/2019
(21) AP 2015 14514
(22) 2015 10 22
(24) 2015 10 22
(31) 14386034.4
(32) 2014 12 19
(33) EP
(86) PCT/EP2015/074482, 2015 10 22
(71) TSETI, Ioulia (GR)
13 Pavlou Mela St., GR-145 61 Kifisia
Attica (GR)
(72) TSETI, Ioulia (GR)
(74) Tamar Kochlamazashvili
(54) **PROCESS FOR PRODUCING IRON
(III) CASEIN N-ACETYL-ASPA-
RTYLATED COMPLEXES AND USE
THEREOF IN PHARMACEUTICAL
COMPOSITIONS**
-

UTILITY MODELS

APPLICATIONS APPROVED FOR GRANTING PATENT

The decision can be appealed at the Chamber of Appeal of Sakpatenti within 3 months from the publication or at the Mtskheta District Court Administrative Cases Board (Address: №17, Samkhedro str., Mtskheta), within 1 month following the publication.

PART B

B 60

(10) AU 2020 15093 U (51) Int. Cl. (2006)
B 60 K 31/00
G 08 G 1/00

(21) AU 2019 15093 (22) 2019 05 23

(71) Vakhtang Iashvili (GE)

Krtsanisi St. 7, 0114, Tbilisi (GE)

(72) Vakhtang Iashvili (GE)

(54) **CAR SPEED LIMITER SYSTEM**

(57) Utility model provides car speed limiter system including throttle pedal position gauge, drive control- and speed limiter modules switched together. Speed limiter module is switched into connecting line with throttle pedal position gauge and drive control module. Additionally the system is equipped with satellite navigation system configured to define geographical area and speed of car motion, and server with communication line switched thereto and configured to define appropriated determined maximum value of speed.

Claims: 1 independent

3 dependent

Fig.: 4

Libani St. 3, ap. 58, 0159, Tbilisi,
Georgia (GE);

Leila Japaridze (GE)

S. Kurdiani St. 1/6, 0101, Tbilisi,
Georgia (GE);

Eter Salukvadze (GE)

Dolidze St. korp. 26, ap. 128, 0161,
Tbilisi, Georgia (GE)

(72) Vladimer Tsitsishvili (GE);

Nana Osipova (GE);

Tamar Kvernadze (GE);

Tsiala Gabelia (GE);

Leila Japaridze (GE);

Eter Salukvadze (GE)

(54) **COMBINED FILTER FOR WASTE
WATERS PURIFICATION**

(57) Utility model relates to ecosystem protection that is actual temporary problem and purification of water waste with toxic heavy metals. Combined filter purifying waters waste with toxic heavy metals (Sr^{+2} , Zn^{+2} , Fe^{+2} , Fe^{+3} , Cu^{+2} , Co^{+2} , Mn^{+2} , Ni^{+2} , Pb^{+2}) by means of sorption includes adsorbent layers; at that, it consists of four layers, wherefrom one is thermochemically treated quartz sand, and three are zeolites, wherefrom one is represented as aluminosilicate limonite.

Claims: 1 independent

Table: 2

PART C

C 02

(10) AU 2020 15004 U (51) Int. Cl. (2006)
C 02 F 1/28
C 02 F 1/58

(21) AU 2019 15004 (22) 2019 02 14

(71) Vladimer Tsitsishvili (GE)

D. Uznadze St. 2, 0102, Tbilisi, Georgia (GE);

Nana Osipova (GE)

Nutsubidze St. 77b, ap. 54, 0177, Tbilisi,
Georgia (GE);

Tamar Kvernadze (GE)

Gazapkhuli St. 11, 0179, Tbilisi,

Georgia (GE);

Tsiala Gabelia (GE)

PART E

E 04

(10) AU 2020 14973 U (51) Int. Cl. (2006)
E 04 H 6/06

(21) AU 2018 14973 (22) 2018 12 25

(71) Sergo Jorbenadze (GE)

R. Tabukashvili St. 46, ap. 8, 0108,

Tbilisi, Georgia (GE);

Malkhaz Tsiskarishvili (GE)

S. Meskhi St.17, 0177, Tbilisi, Georgia (GE);

Nikoloz Melitauri (GE)

Mtskheta St. 28, ap. 6, Tbilisi, Georgia (GE);

Aleksandre Shermazanashvili (GE)

Vazha-Pshavela Av. II kvart., korp. 12,
ap. 42, Tbilisi, Georgia (GE)

(72) Sergo Jorbenadze (GE);

Malkhaz Tsiskarishvili (GE);

Nikoloz Melitauri (GE);

Aleksandre Shermazanashvili (GE)

(54) **AUTOPARKING ELEVATOR**

(57) An elevator includes carrying vertical supporting metallic poles 1 executed as II-like guide, lifting platform 3, hydraulic actuator executed as hydraulic compressor 9 and hydrocylinder 8 connected to lifting flexible componentry 5 engaged to rollers 6; furthermore, the sliders 2 are inserted with capability to slip in each pole, wherein each slider includes rotatable on an axis 13 excentrically fixed and springed, as least, one cam 11, communicated thereto and equipped with accident actuating spring 12 the conic wedge 4 rigid to lifting flexible component 5 engaged to rollers 6 and connected to burton 7 rolling mechanism horisontaly disposed in elevator construction bottom and connected to hydrocylinder.

Claims: 1 independent

Fig.: 2

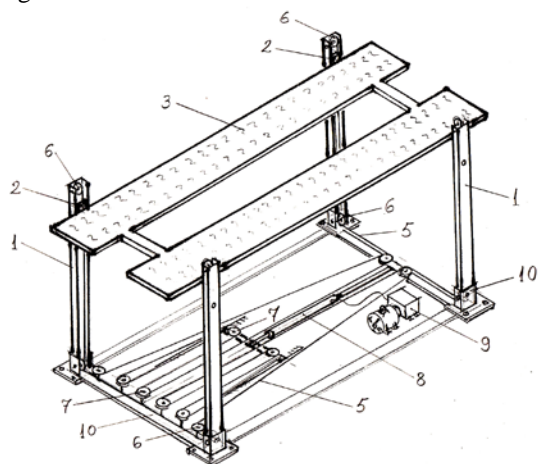

Fig. 1

programm by operator and with mobile application - from consumer side. The method is characterized with this that information about release of one isolated keeping cell is reflected on consumer's smartphone application by means of operator's computer, and in the case of laguage keeping payment, its placement in cell and electromechanical locking by consumer by means of smarhphone application the unique code is created by means of operator's computer, which is transmitted and reflected to consumer's smarhphone application together with cell number and keeping duration, and can be used to open cell electromechanical lock.

Claims: 1 independent

Fig.: 2

E 05

(10) AU 2020 14804 U (51) Int. Cl. (2006)

E 05 B 47/00

(21) AU 2018 14804 (22) 2018 06 10

(71) Levan Chitadze (GE)

Moscow Ave., V kvart., korp. 4, ap. 86,
0145, Tbilisi, Georgia (GE)

(72) Levan Chitadze (GE)

(54) **METHOD FOR MAINTAIN
LAGUAGE KEEPING AUTOMATIC
CHAMBER**

(57) There is represented a method for maintain laguage keeping automatic chamber, wherein laguage keeping chamber cells open-locking operation maintain is executed with computer

PATENTED UTILITY MODEL

PART E

E 04

(11) U 2020 2034 Y (51) Int. Cl. (2006)
E 04 B 1/01

(10) AU 2019 14993 U (44) 22(530)/2019

(21) AU 2019 14993

(22) 2019 02 06

(24) 2019 02 06

(73) Revaz Sikharulidze (GE)

Tkibuli St. 16, 0178, Tbilisi (GE)

(72) Revaz Sikharulidze (GE)

(54) SIKHARULIDZE'S WALL

DESIGNS

APPLICATIONS APPROVED FOR REGISTRATION

The decision can be appealed at the Chamber of Appeal of Sakpatenti within 3 months from the publication or at the Mtskheta District Court Administrative Cases Board (Address: №17, Samkhedro str., Mtskheta), within 1 month following the publication.

(10) AD 2020 1114 S (51) 03-01
(21) AD 2019 1114 (22) 2019 11 06
(28) 1
(71) Giorgi Kalandadze (GE)
Sakhalkho St. 17, 0113, Tbilisi, Georgia (GE)
(72) Giorgi Kalandadze (GE)
(54) **HANDBAG**
(55)



1.1



1.2



1.3



1.4

1.5



1.6



1.7



1.8



1.9



1.10



(10) AD 2020 1117 S (51) 03-01

(21) AD 2019 1117 (22) 2019 11 08

(28) 1

(71) Viktoria Berishvili (GE)

Budapesht St. 10, 0160, Tbilisi, Georgia (GE)

(72) Viktoria Berishvili (GE)

(54) CASKET

(55)

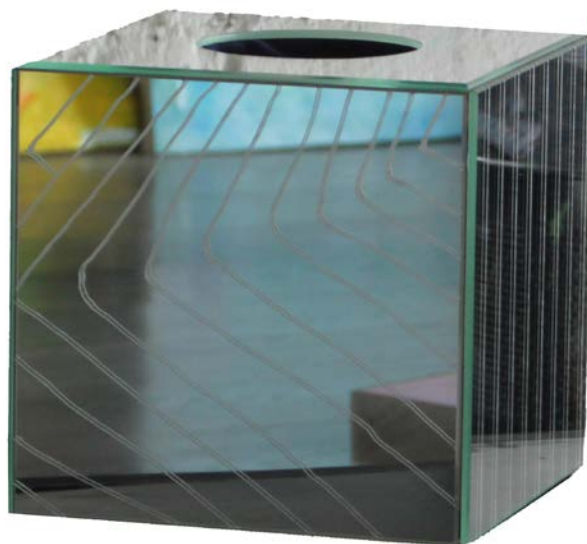

1.1

(10) AD 2020 1116 S (51) 06-03; 06-04
(21) AD 2019 1116 (22) 2019 11 08
(28) 3
(71) Viktoria Berishvili (GE)
Budapesht St. 10, 0160, Tbilisi, Georgia (GE)
(72) Viktoria Berishvili (GE)
(54) FURNITURE
(55)

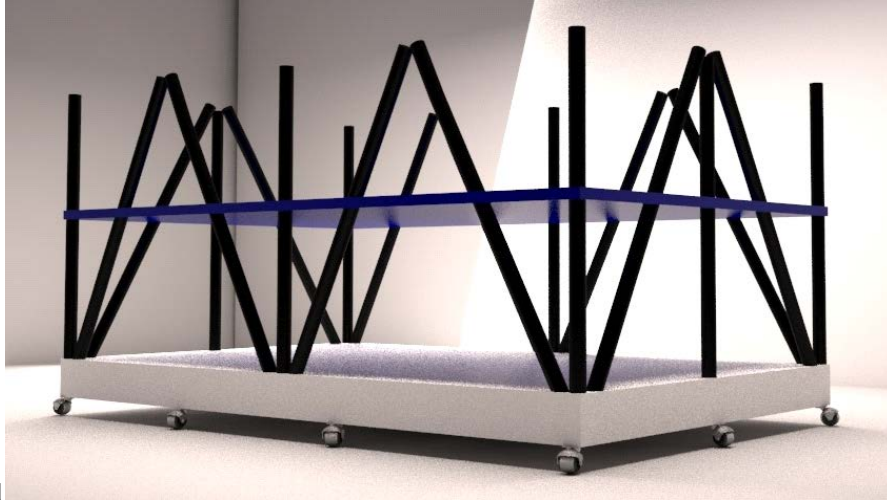

1.1

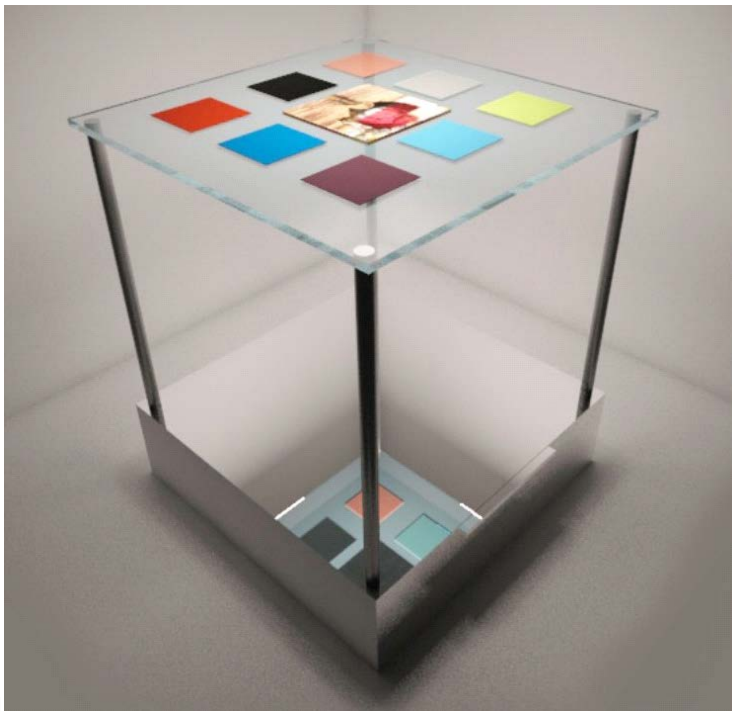

2.1



3.1

(10) AD 2020 1112 S (51) 09-01
(21) AD 2019 1112 (22) 2019 10 29
(28) 2
(71) LLC "ALAZANI WINERY" (GE)
D. Tavdadebuli St. 3, 4800, Kvareli, Georgia (GE)
(72) Giorgi Zautashvili (GE)
(74) Giorgi Kartvelishvili (GE)
(54) BOTTLES
(55)



(10) AD 2020 1113 S (51) 09-01
(21) AD 2019 1113 (22) 2019 10 31
(28) 1
(71) Natalia Berezhnikh (RU)
Ulitsa Sportivnaya, dom 15, Kanevskiy Raion, Kanevskaya Stanitsa, Krasnodarskiy Kray,
Russian Federation (RU)
(72) Natalia Berezhnikh (RU)
(74) Naira Badaliani (GE)
(54) **BOTTLE**
(55)



1.1



1.2

**DESIGN, WHICH HAVE BEEN REGISTERED WITH THE INTERNATIONAL
BUREAU CLAIMING PRIORITY ON THE TERRITORY OF GEORGIA**

The decision can be appealed at the Chamber of Appeal of Sakpatenti within 3 months from the publication or at the Mtskheta District Court Administrative Cases Board (Address: №17, Samkhedro Str., Mtskheta), within 1 month following the publication.

- (11) **DM/202 849** (51) **03-01**
 (15) 2019 07 11 (44) 03/2020 (2020 01 17)
 (22) 2019 07 11
 (28) 9
 (73) Chanel SARL
 Quai Du Général-Guisan 24, 1204 Genève (CH)
 (85) CH
 (86) CH
 (87) CH
 (88) CH
 (89) CH
 (81) II. GR, MA III. TR, GE, TN, AZ, BG, EG
 (72) Marianna NITSCH
 135 Avenue Charles De Gaulle, 92521, Neuilly-sur-Seine (FR)
 (54) 1.-2. Handbag, 3.-8. Waist bag, 9. Strap for a bag
 (55)

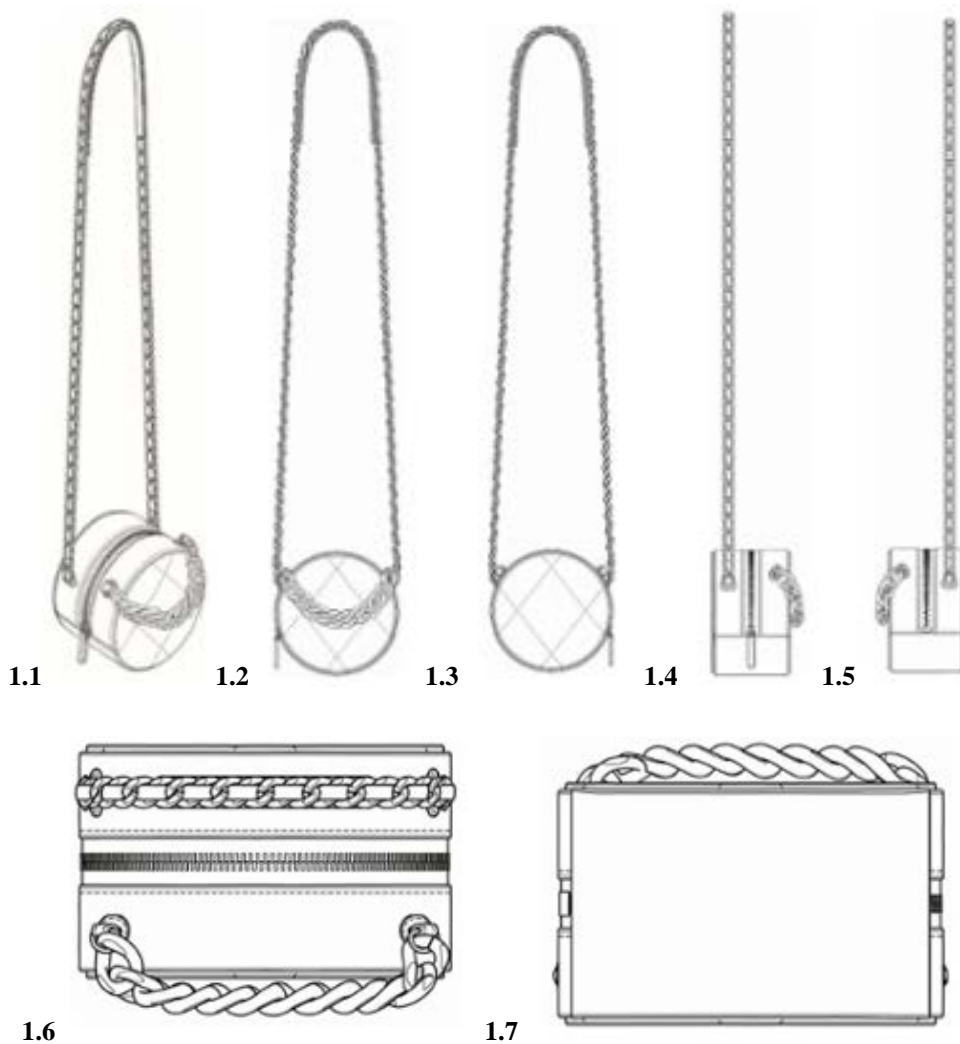

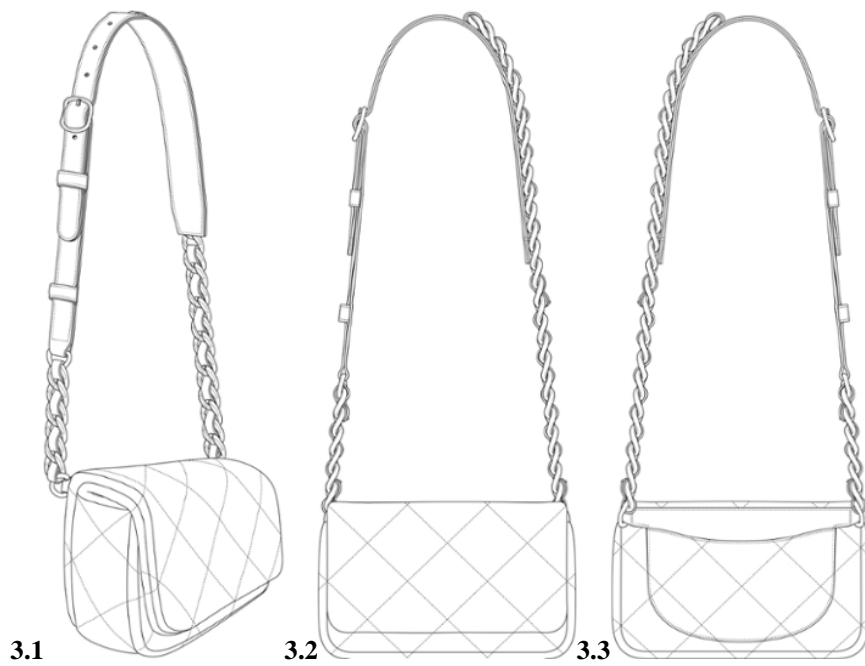
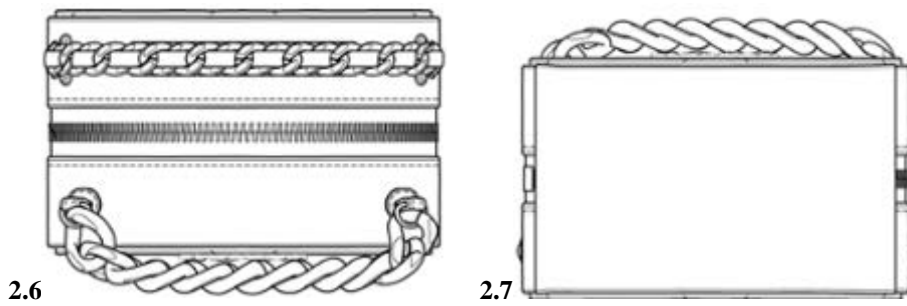
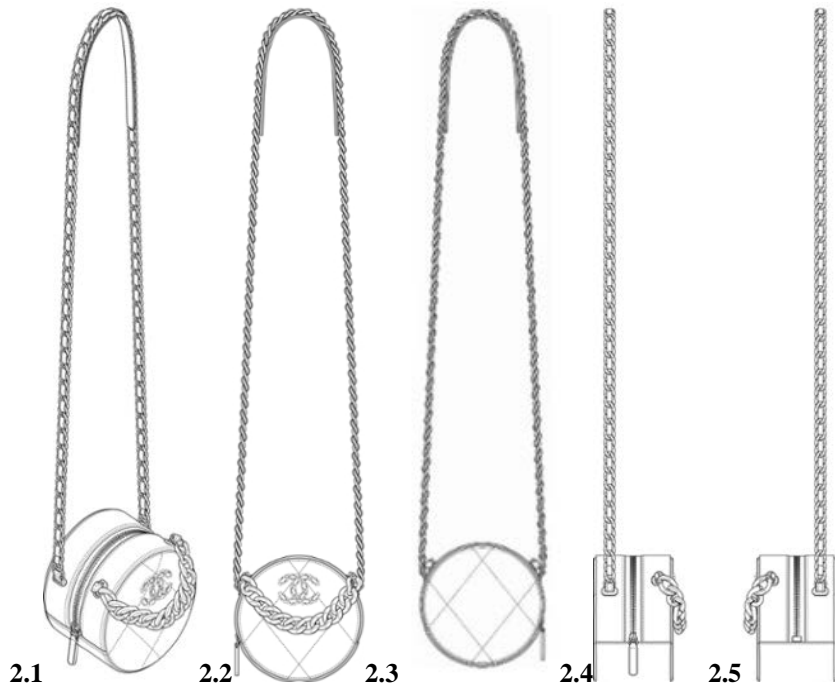

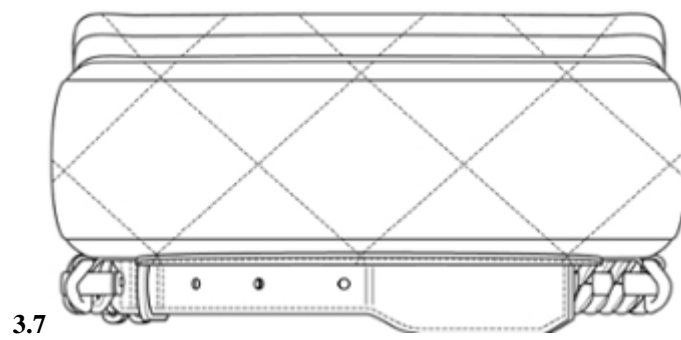
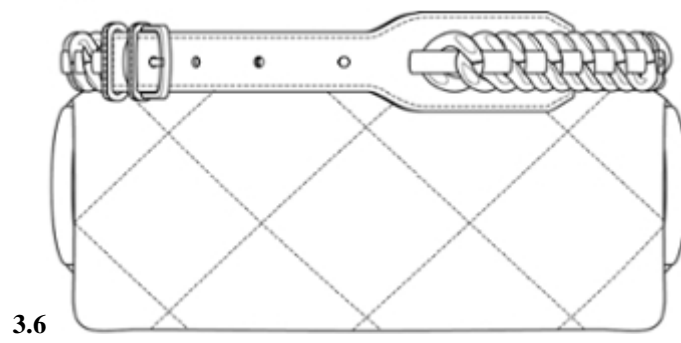
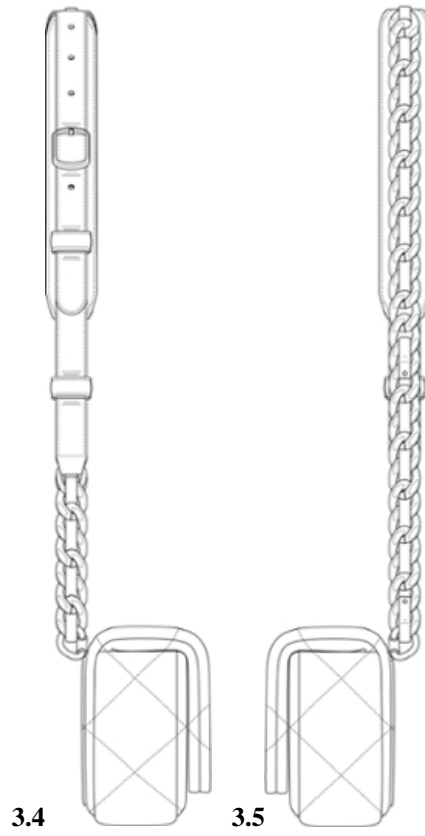

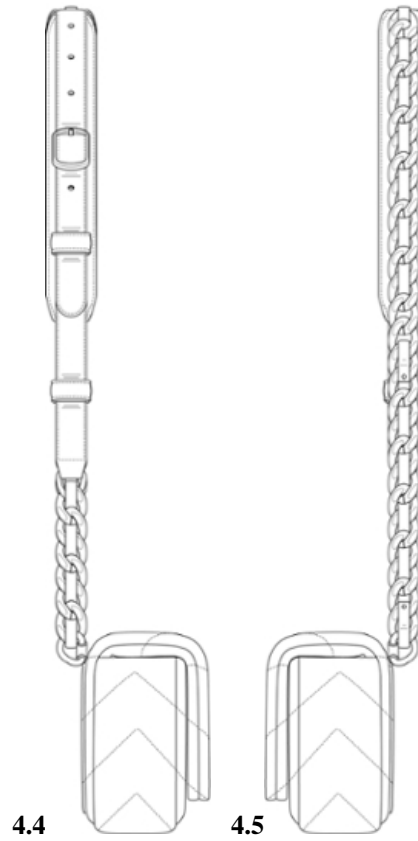
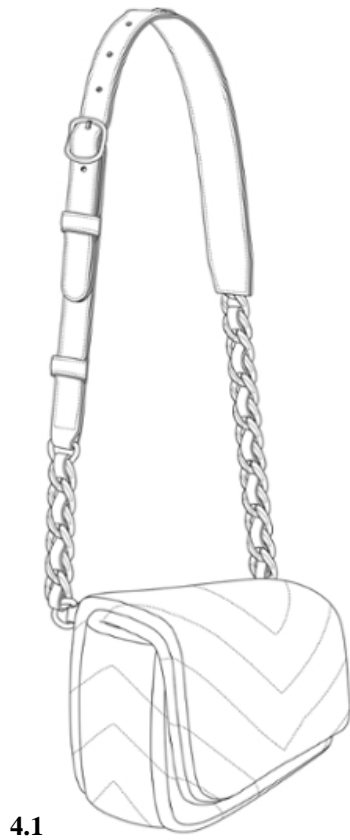

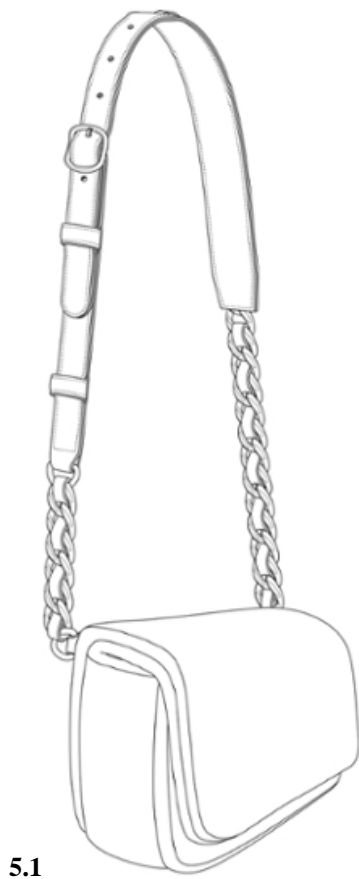
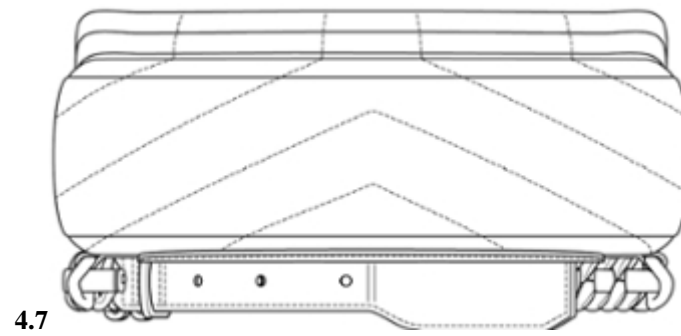
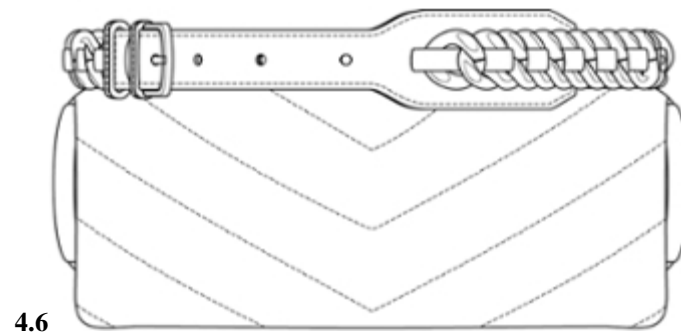

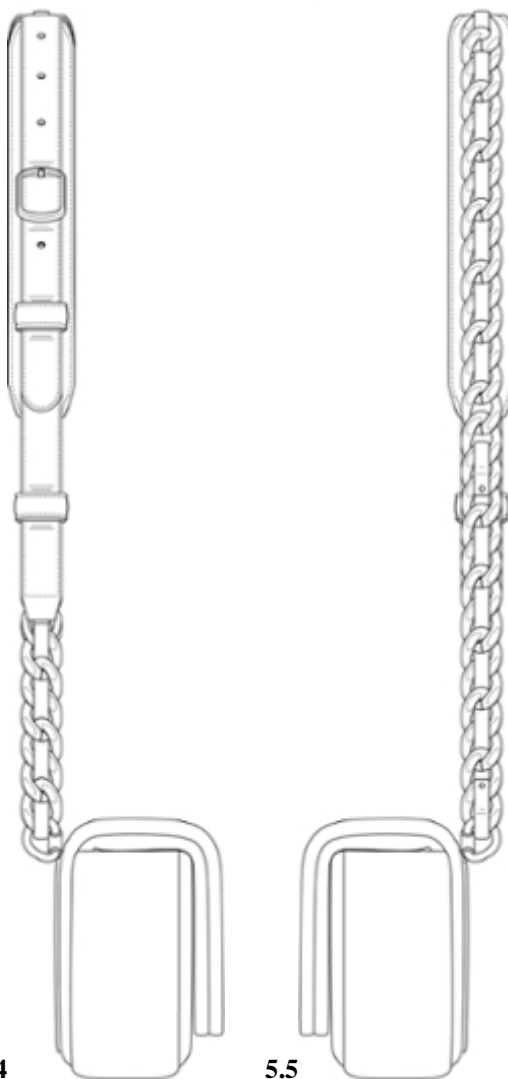

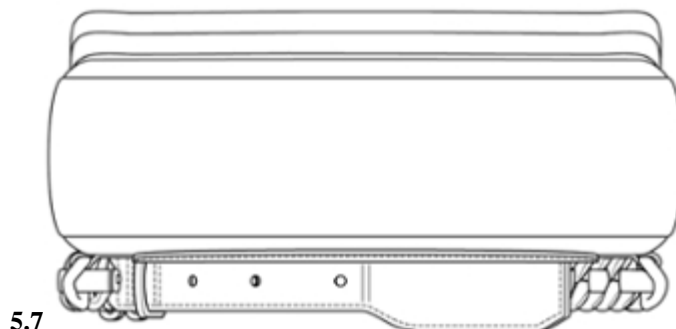
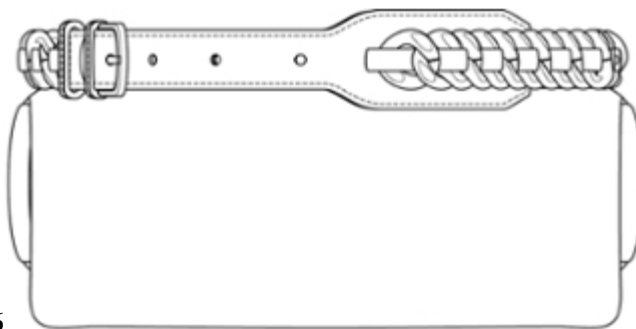

6.1

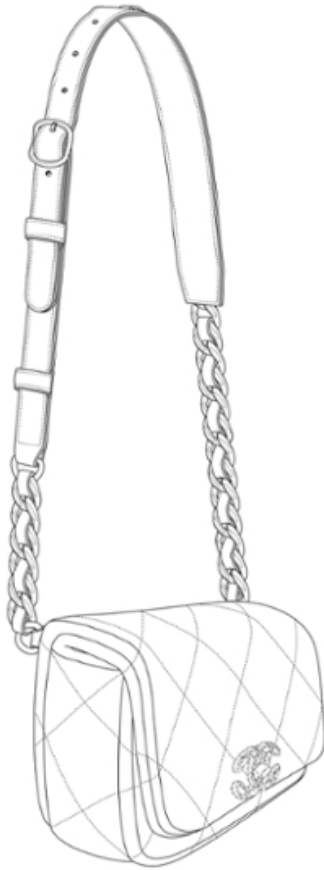

6.2



6.3



6.4

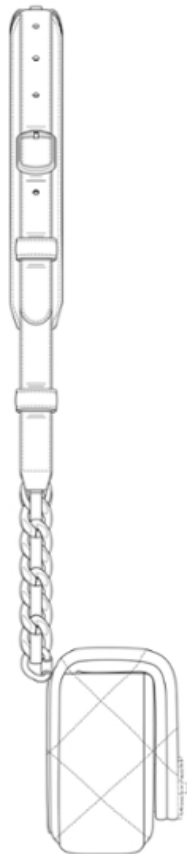

6.5

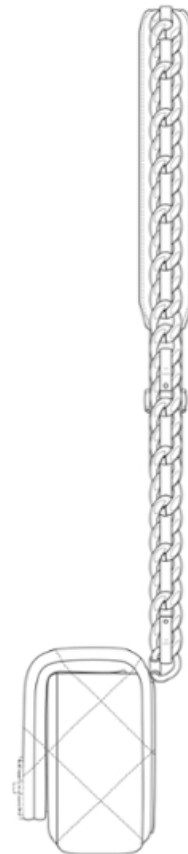

6.6

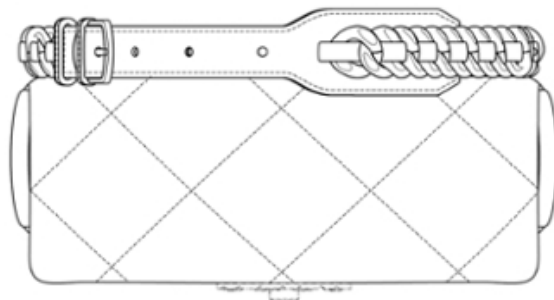

6.7

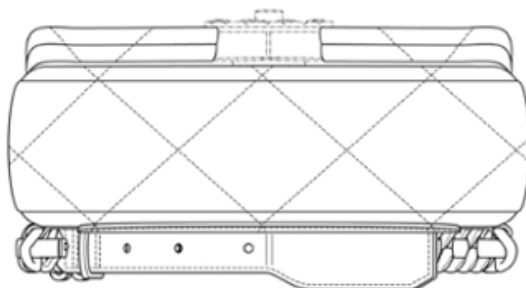

7.1

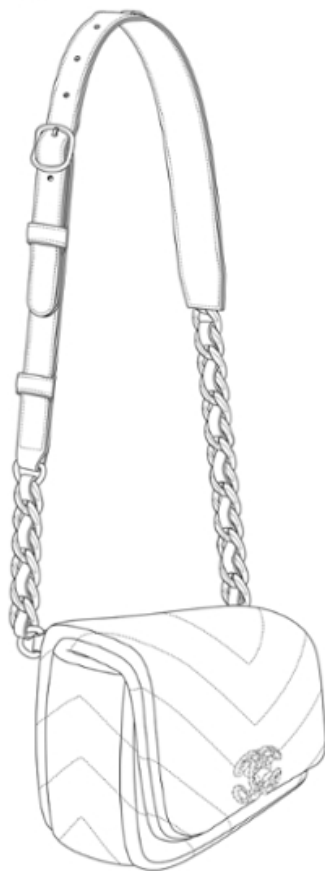

7.2



7.3



7.4

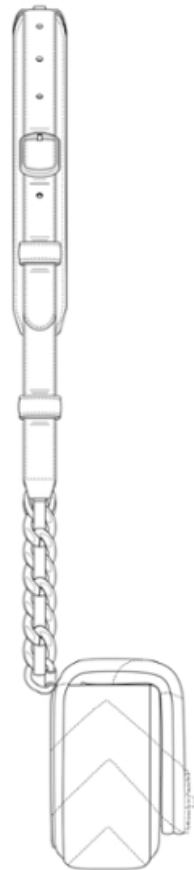

7.5

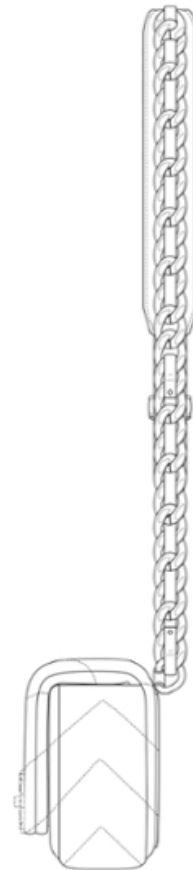

7.6

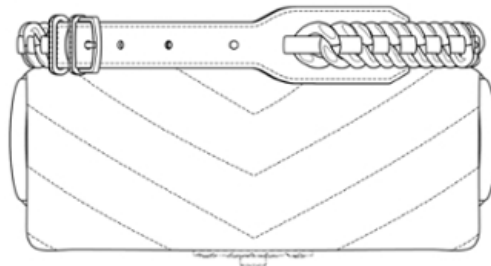

7.7

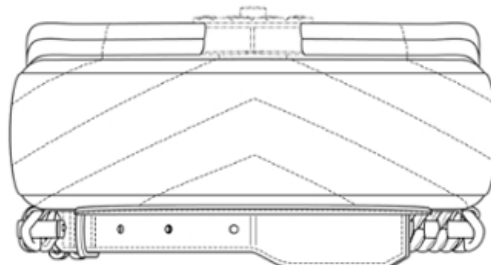

8.1

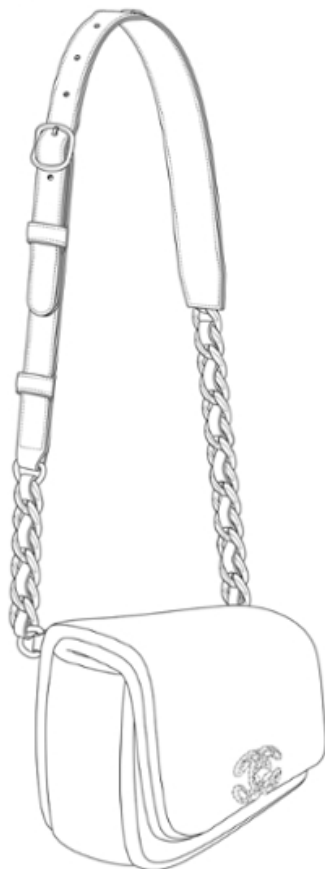

8.2



8.3



8.4

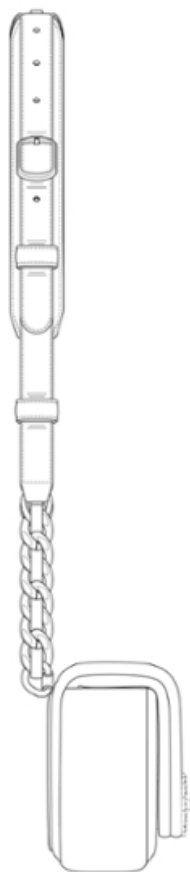

8.5



8.6

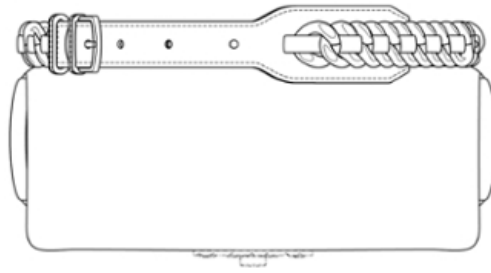

8.7

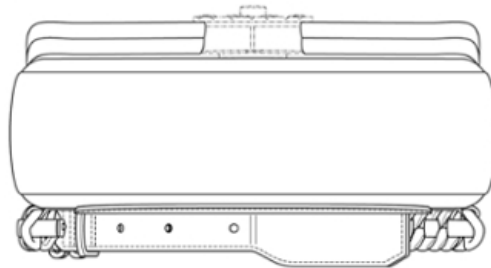

9.1

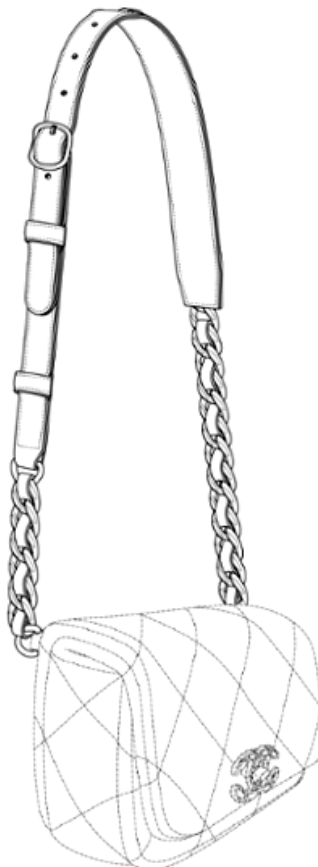

9.2



9.3



9.4

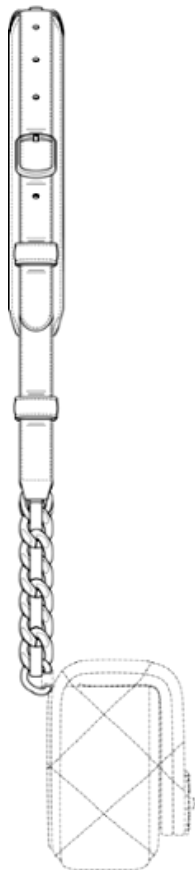

9.5

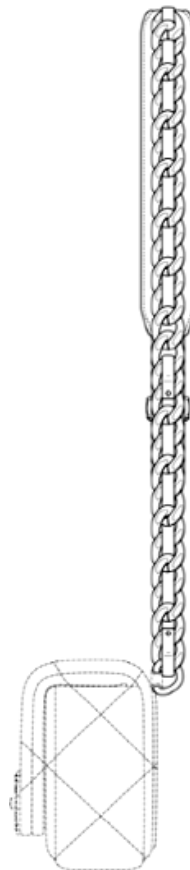

9.6

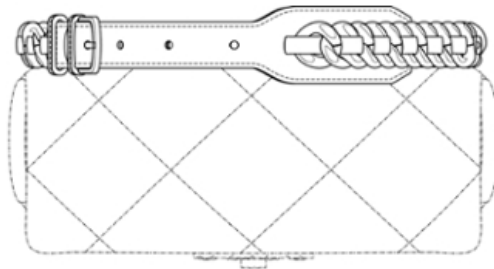

9.7

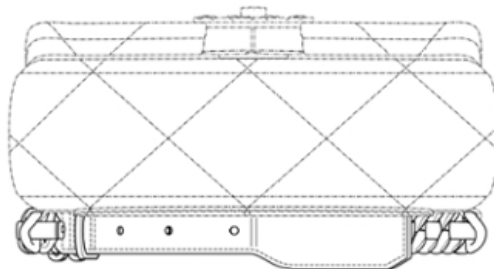

TRADEMARKS

APPLICATIONS FILED UNDER THE NATIONAL PROCEDURE APPROVED FOR REGISTRATION

The decision can be appealed at the Chamber of Appeal of Sakpatenti within 3 months from the publication or at the Mtskheta District Court Administrative Cases Board (Address: №17, Samkhedro St., Mtskheta), within 1 month following the publication.

(260) AM 2020 90029 A**
(210) AM 90029
(220) 2016 12 20
(731) CHINOIN GYOGYSZER ES VEGYESZETI
TERMEKEK GYARA ZRT
To utca 1-5, H-1045 Budapest, Hungary
(740) Shalva Gvaramadze
(540)

ALGOFLEX

(511) 5

(260) AM 2020 99947 A*
(210) AM 99947
(220) 2018 10 22
(731) EMERSON ELECTRIC CO.
A Missouri Corporation
8000 West Florissant Avenue, St. Louis,
Missouri 63136, USA
(740) Tamaz Shilakadze
(540)

EMERSON

(591) Black, white
(511) 7

(260) AM 2020 99950 A*
(210) AM 99950
(220) 2018 10 22
(731) EMERSON ELECTRIC CO.
A Missouri Corporation
8000 West Florissant Avenue, St. Louis,
Missouri 63136, USA
(740) Tamaz Shilakadze
(540)



EMERSON

(591) Black, white
(531) 26.01.05; 26.11.11; 26.11.13; 27.05.01;
27.05.17
(511) 7

(260) AM 2020 100771 A
(210) AM 100771
(220) 2019 09 04
(731) Alexandre Bolkvadze
Z. Paliashvili St. 66, ap. 51, 0179, Tbilisi,
Georgia
(540)



(591) Black, white
(531) 19.07.01; 23.03.02; 27.01.12; 28.19
(511) 33, 35

(260) AM 2020 100874 A*
(210) AM 100874
(220) 2018 12 25
(731) LTD "SHALVINO"
Z. Panaskertel-Tsitsishvili St., korp. 1, ap. 10,
0160, Tbilisi, Georgia
(740) Shalva Gvaramadze
(540)

ანაგურელი
АНАГУРЕЛИ

(591) Black, white
(511) 33

(260) AM 2020 100880 A
(210) AM 100880
(220) 2019 09 02
(731) Ivane Abaiadze
D. Aghmashenebeli St. 25, Gori, 1400,
Georgia
(540)

ამბორი
ambori

(591) Black, white
(511) 32, 33

(260) AM 2020 102832 A
(210) AM 102832
(220) 2019 04 24
(731) LTD "KVARELI CELLAR"
Vill. Chikaani, 4814, Kvareli, Georgia
(740) Khatuna Imnadze
(540)



(591) Black, white, red, gold, silver
(531) 05.03.04; 06.19.07; 25.01.19; 25.01.25;
26.11.07; 27.05.01; 29.01.15
(526) KVARELI, ყვარელი
(511) 33

(260) AM 2020 103485 A
(210) AM 103485
(220) 2019 06 07
(731) SHANDONG WEIFANG RAINBOW
CHEMICAL CO. LTD
Binhais Ekonomikuri Ganvitarebis Zona,
Veifangi, Shandongi, 262737, Shandong,
China
(740) Irma Kartoza
(540)

Rainbow
all about growing

(591) White, light green, dark green
(531) 05.03.13; 05.03.15; 27.05.01; 27.05.07;
27.05.09; 27.05.10; 29.01.03
(511) 5, 35

(260) AM 2020 103942 A
(210) AM 103942
(220) 2019 07 05
(731) LTD "KRINTI"
Madneuli St. 10, Vill. Kazreti, Bolnisi,
Georgia
(540)



(591) Black, white
(531) 24.01.15; 26.05.01; 26.05.22; 26.05.24;
27.05.01; 27.05.17; 27.05.24

(260) AM 2020 103954 A
(210) AM 103954
(220) 2019 07 08
(731) JSC "GEFA"
Ak. Beliashvili St. 142, 0159, Tbilisi, Georgia
(740) Salome Jeladze
(540)

THEBODYSHOP

(591) Black, white
(511) 44

(260) AM 2020 103955 A
(210) AM 103955
(220) 2019 07 08
(731) JSC "GEFA"
Ak. Beliashvili St. 142, 0159, Tbilisi, Georgia
(740) Salome Jeladze
(540)

THEFACESHOP

(511) 44

(260) AM 2020 103979 A
(210) AM 103979
(220) 2019 07 11
(731) LTD "MUSEUM"
Orbeliani St. 8/10, 0105, Tbilisi, Georgia
(740) Tea Svanidze
(540)

სორაჯხანა

(591) Black, white
(511) 43

(260) AM 2020 104085 A
 (210) AM 104085
 (220) 2019 07 15
 (731) LTD "Georgian Wine and Spirits Company"
 Vill. Achinebuli, 2200, Telavi, Georgia
 (740) Irine Pilauri;
 Elene Totibadze
 (540)



(591) Red, green, blue, blue, turquoise, brown,
 yellow
 (531) 06.07.05; 07.01.08; 07.01.12; 25.01.19;
 29.01.15
 (526) Tbilisi
 (511) 33

(260) AM 2020 104176 A
 (210) AM 104176
 (220) 2019 07 19
 (310) 018040104
 (320) 25 03 2019
 (330) EUIPO
 (731) NUFARM EUROPE GMBH
 11 Parsevalshtr. 40468 Diuseldorf, Germany
 (740) Tamaz Shilakadze
 (540)

CHAMPION

(591) Black, white
 (511) 5

(260) AM 2020 104196 A
 (210) AM 104196
 (220) 2019 07 23
 (731) LTD "LADY HEALTHCARE"
 Yuri Gagarin St. 5, Office Space 6, Tbilisi,
 Georgia
 (740) Davit Chikhladze
 (540)

SLIDERON
სლიდერონი
СЛИДЕРОН

(591) Black, white
 (511) 5

(260) AM 2020 104197 A
 (210) AM 104197
 (220) 2019 07 23
 (731) LTD "LADY HEALTHCARE"
 Yuri Gagarin St. 5, Office Space 6, Tbilisi,
 Georgia
 (740) Davit Chikhladze
 (540)

BELACEF
ბელაცეფ
БЕЛАЦЕФ

(591) Black, white
 (511) 5

(260) AM 2020 104198 A
 (210) AM 104198
 (220) 2019 07 23
 (731) LTD "LADY HEALTHCARE"
 Yuri Gagarin St. 5, Office Space 6, Tbilisi,
 Georgia
 (740) Davit Chikhladze
 (540)

KREMAKS
კრემაქს
КРЕМАКС

(591) Black, white
 (511) 5

(260) AM 2020 104200 A
 (210) AM 104200
 (220) 2019 07 23
 (731) LTD "LADY HEALTHCARE"
 Yuri Gagarin St. 5, Office Space 6, Tbilisi,
 Georgia
 (740) Davit Chikhladze
 (540)

AKSIOMIN
აკსიომინი
АКСИОМИН

(591) Black, white
 (511) 5

(260) AM 2020 104206 A
 (210) AM 104206
 (220) 2019 07 24

(731) EXPRESS LUCK INDUSTRIAL
(SHENZHEN) LIMITE
1 St Flor, N1 Feqtori, N88, Baotong Saut
Roud, Sikeng Komuniti, Iuanshan Strit,
Longgang Distriqt, Shenjen Siti, Guandunis
Provincia, Shenzhen City, 518000, China

(740) Khatuna Imnadze
(540)

Caixun

(591) Black, white
(531) 27.05.01
(511) 9

(260) AM 2020 104313 A
(210) AM 104313
(220) 2019 07 30
(731) RAKUTEN, INC.
1-14-1 Tamagawa, Setagaya-ku, Tokyo,
158-0094, Japan
(740) Merab Kvimsadze
(540)

R
POINT

(591) Black, white
(531) 26.03.01; 26.03.24; 27.05.01; 27.05.11;
27.05.17; 27.05.21; 29.01.12
(511) 35, 36

(260) AM 2020 104406 A
(210) AM 104406
(220) 2019 08 02
(731) LTD "HERITAGE managment"
St. Petersburg St. 6, ap. 2, Tbilisi,
Georgia
(540)



(591) Lilac, orange

(531) 25.01.19; 26.01.18; 26.01.24; 26.04.01;
26.04.10; 26.04.22; 26.04.24; 27.05.10;
27.05.11; 27.05.21; 27.05.24; 29.01.12
(511) 43

(260) AM 2020 104430 A
(210) AM 104430
(220) 2019 08 05
(731) LTD "IPRODUCTION"
Delisi St. 50, ap. 6a, Tbilisi, Georgia
(540)

კოდ2
kod2

(591) Black, white
(511) 12

(260) AM 2020 104432 A
(210) AM 104432
(220) 2019 08 05
(731) LTD "IPRODUCTION"
Delisi St. 50, ap. 6a, Tbilisi, Georgia
(540)

kod•ori

(591) Black, white
(511) 12

(260) AM 2020 104436 A
(210) AM 104436
(220) 2019 08 06
(731) LTD "KOREAN ELECTRONICS"
Varketili, III masivi, X kvart., korp. "ZH",
space 2a, Samgori District, 0182, Tbilisi,
Georgia
(540)

BBS

ბი ბი ეს

(591) Black, white
(511) 35

(260) AM 2020 104437 A
(210) AM 104437
(220) 2019 08 06
(731) LTD "KOREAN ELECTRONICS"

Varketili, III masivi, X kvart., korp. "ZH",
space 2a, Samgori District, 0182, Tbilisi,
Georgia

(540)

SET
სებ

(591) Black, white
(511) 35

(260) AM 2020 104438 A

(210) AM 104438

(220) 2019 08 06

(731) LTD "KOREAN ELECTRONICS"

Varketili, III masivi, X kvart., korp. "ZH",
space 2a, Samgori District, 0182, Tbilisi,
Georgia

(540)

NET
ნებ

(591) Black, white
(511) 35

(260) AM 2020 104444 A

(210) AM 104444

(220) 2019 08 07

(731) UNILEVER N.V.

Weena 455, 3013 AL Rotterdam, Netherlands

(740) Shalva Gvaramadze

(540)

SIGNAL WHITE NOW

(591) Black, white
(511) 3

(260) AM 2020 104447 A

(210) AM 104447

(220) 2019 08 07

(731) NOVARTIS AG

4002 Basel, Switzerland

(740) Shalva Gvaramadze

(540)

Кайендра

(591) Black, white

(531) 28.05

(511) 5

(260) AM 2020 104454 A

(210) AM 104454

(220) 2019 08 08

(731) MAJID AL FUTTAIM RETAIL LLC

P.O. Box 124441, Dubai, United Arab

Emirates

(740) Merab Kvimsadze



(591) Black, white

(531) 25.01.25; 26.11.01; 26.11.12; 27.05.01; 28.01

(511) 3, 35

(260) AM 2020 104530 A

(210) AM 104530

(220) 2019 08 09

(731) LTD "VAZIANI COMPANY"

Mshvidoba St. 42, 2200, Telavi, Georgia

(540)

მაყაშვილის ღვინის მარანი

Makashvili Wine Cellar

Винный Погреб Макашвили

(591) Black, white

(511) 33

(260) AM 2020 104532 A

(210) AM 104532

(220) 2019 08 09

(731) LTD "MIRTEK"

Ul. Dovatorcev 33a, Stavropol, 355037,

Russian Federation

(740) Nino Bakhtadze

(540)

MIRTEK®

inventing the future

(591) Black, white

(531) 26.04.02; 26.04.18; 27.05.01; 27.05.10

(511) 9

(260) AM 2020 104533 A
 (210) AM 104533
 (220) 2019 08 12
 (731) THE PROCTER & GAMBLE COMPANY
 One Procter & Gamble Plaza, Cincinnati,
 Ohio, 45202, USA
 (740) Merab Kvimsadze
 (540)



(591) Dark green, light green, white, red
 (531) 01.01.10; 01.15.09; 01.15.21; 24.13.09;
 24.13.22; 24.17.05; 26.01.06; 27.05.01;
 27.05.09; 27.05.10; 27.05.17; 27.05.24;
 29.01.15
 (511) 3

(260) AM 2020 104536 A
 (210) AM 104536
 (220) 2019 08 12
 (731) LTD "Georgian Education Group"
 Petre Melikishvili Av. 8a/ Erekle Tatishvili
 St. 1, Mtatsminda District, 0179, Tbilisi,
 Georgia
 (740) Levan Dadiani
 (540)



(591) Green, white
 (531) 05.01.16; 28.19; 29.01.03
 (511) 41, 42

(260) AM 2020 104555 A
 (210) AM 104555
 (220) 2019 08 19
 (731) LTD "BORAN LIGHT"
 Marneuli St. 44, Ponitchala, 0165, Tbilisi,
 Georgia

(540)

Winger

(511) 11

(260) AM 2020 104557 A
 (210) AM 104557
 (220) 2019 08 20
 (731) JSC "Georgian Beer Company"
 Vill. Saguramo, 3311, Mtskheta, Georgia
 (540)

სოფს
 aida
 айда

(591) Black, white
 (511) 32

(260) AM 2020 104558 A
 (210) AM 104558
 (220) 2019 08 21
 (731) LTD "Nevinnomyskiy Masloekstraktsionniy
 Zavod"
 ul. Matrosova 8, Nevinnomysk, Stavropols-
 kiy kray, 357101, Russian Federation
 (740) Giorgi Taktakishvili
 (540)



(591) Green, blue, brown, purplet, white, black, red,
 yellow
 (531) 05.05.04; 06.07.25; 06.19.11; 06.19.15;
 06.19.16; 07.01.09; 07.01.13; 18.01.08;
 27.03.12; 28.05; 29.01.15
 (511) 29, 35, 39

(260) AM 2020 104559 A
 (210) AM 104559
 (220) 2019 08 21
 (731) Import Foods Company LLC
 47 Electrotecnicheskaya str., Kiev, 02660,
 Ukraine
 (740) Irakli Gvilia

(540)



(591) Black, white
 (531) 02.01.20; 02.01.21; 03.03.01; 18.01.03;
 19.01.01; 19.01.05; 25.01.10; 25.01.19
 (511) 33

(260) AM 2020 104561 A
 (210) AM 104561
 (220) 2019 08 21
 (731) LTD "ITANI"
 Gr. Robakidze Av. 7, Tbilisi, Georgia
 (540)



(591) Golden, black
 (531) 01.15.23; 25.01.10; 26.01.01; 26.01.18;
 26.01.24; 27.05.01; 27.05.10; 27.05.21;
 27.05.24; 29.01.12
 (511) 43

(260) AM 2020 104752 A
 (210) AM 104752
 (220) 2019 09 03
 (731) LTD "Pontos Maritime Consulting"
 Zh. Shartava St. 32, ap. 22, Saburtalo District,
 0160, Tbilisi, Georgia
 (740) Giori Miladze
 (540)



(591) White, red
 (531) 26.01.18; 27.05.01; 28.11; 29.01.12
 (511) 39

(260) AM 2020 104753 A
 (210) AM 104753
 (220) 2019 09 03
 (731) LTD "Pontos Maritime Consulting"
 Zh. Shartava St. 32, ap. 22, Saburtalo District,
 0160, Tbilisi, Georgia
 (740) Giori Miladze



(591) White, red
 (531) 26.01.18; 27.05.01; 28.11; 29.01.12
 (511) 39

(260) AM 2020 104756 A
 (210) AM 104756
 (220) 2019 09 04
 (731) EURODRUG LABORATORIES B.V.
 Regulusweg 11, 2516 AC The Hague,
 Netherlands
 (740) Tamaz Shilakadze
 (540)

Puroxan

(591) Black, white
 (511) 5

(260) AM 2020 104758 A
 (210) AM 104758
 (220) 2019 09 04
 (731) EURODRUG LABORATORIES B.V.
 Regulusweg 11, 2516 AC The Hague,
 Netherlands
 (740) Tamaz Shilakadze
 (540)

Spasmopriv

(591) Black, white
 (511) 5

(260) AM 2020 104759 A
 (210) AM 104759
 (220) 2019 09 04
 (731) KANEKA CORPORATION
 2-3-18, Nakanoshima, Kita-ku, Osaka,
 Japan
 (740) Pavle Meipariani

(540)

ED COIL

(591) Black, white

(511) 10

(260) AM 2020 104812 A

(210) AM 104812

(220) 2019 09 09

(731) F.S. "MALENZI"

Sh. Nutsubidze Plateau, II mkr., I kvart.,
korp. 1a, ap. 24, 0183, Tbilisi, Georgia

(540)

ფ.ს. მაკენზი

(591) Black, white

(511) 39

REGISTERED TRADEMARKS

(111) M 2020 32436 R
(151) 2020 03 11
(181) 2030 03 11
(260) AM 2019 100065 A
(220) 2019 04 23
(732) LTD "TALISMAN"
N. Tskhvedadze St. 28, 0162, Tbilisi, Georgia

(111) M 2020 32437 R
(151) 2020 03 11
(181) 2030 03 11
(260) AM 2019 101295 A
(220) 2019 01 22
(732) LTD "DND GROUP"
Kurkhuli St. 11, Tbilisi, Georgia

(111) M 2020 32438 R
(151) 2020 03 11
(181) 2030 03 11
(260) AM 2019 101504 A
(220) 2019 02 04
(732) CARGOTEK PATENTER AB
c/o Cargotec Sweden AB, Box 1133,
16422 KISTA, Sweden

(111) M 2020 32439 R
(151) 2020 03 11
(181) 2030 03 11
(260) AM 2019 101671 A
(220) 2019 02 19
(732) LLC "Ras Al Khaimah Investment Authority
Georgia"
Nutsbidze Plateau II mkr, Plot 16,
Vake District, 0183, Tbilisi, Georgia

(111) M 2020 32440 R
(151) 2020 03 11
(181) 2030 03 11
(260) AM 2019 101672 A
(220) 2019 02 19
(732) LLC "Ras Al Khaimah Investment Authority
Georgia"
Nutsbidze Plateau II mkr, Plot 16,
Vake District, 0183, Tbilisi, Georgia

(111) M 2020 32441 R
(151) 2020 03 11
(181) 2030 03 11
(260) AM 2019 101673 A
(220) 2019 02 19
(732) LLC "Ras Al Khaimah Investment Authority
Georgia"

Nutsbidze Plateau II mkr, Plot 16,
Vake District, 0183, Tbilisi, Georgia

(111) M 2020 32442 R
(151) 2020 03 11
(181) 2030 03 11
(260) AM 2019 101920 A
(220) 2019 02 27
(732) GRAND CANDY LLC
31 May St., 0061, Yerevan, Armenia

(111) M 2020 32443 R
(151) 2020 03 11
(181) 2030 03 11
(260) AM 2019 102069 A
(220) 2019 03 07
(732) MYLAN INSTITUTIONAL INC
1718 Nortrok Kort, Rockford, Illinois, 61103,
USA

(111) M 2020 32444 R
(151) 2020 03 11
(181) 2030 03 11
(260) AM 2019 102072 A
(220) 2019 03 07
(732) LLC "Ras Al Khaimah Investment Authority
Georgia"
Telavi St. 20, Isani district, 0183, Tbilisi,
Georgia

(111) M 2020 32445 R
(151) 2020 03 11
(181) 2030 03 11
(260) AM 2019 102073 A
(220) 2019 03 07
(732) LLC "Ras Al Khaimah Investment Authority
Georgia"
Telavi St. 20, Isani district, 0183, Tbilisi,
Georgia

(111) M 2020 32446 R
(151) 2020 03 11
(181) 2030 03 11
(260) AM 2019 102074 A
(220) 2019 03 07
(732) LLC "Ras Al Khaimah Investment Authority
Georgia"
Telavi St. 20, Isani district, 0183, Tbilisi,
Georgia

(111) M 2020 32447 R
 (151) 2020 03 11
 (181) 2030 03 11
 (260) AM 2019 102075 A
 (220) 2019 03 07
 (732) LLC "Ras Al Khaimah Investment Authority
 Georgia"
 Telavi St. 20, Isani district, 0183, Tbilisi,
 Georgia

(111) M 2020 32453 R
 (151) 2020 03 11
 (181) 2030 03 11
 (260) AM 2019 102495 A
 (220) 2019 03 29
 (732) LLC Georgian "AGRO House"
 M. Kostava St. 37-39, II fl., Mtatsminda
 district, 0179, Tbilisi, Georgia

(111) M 2020 32448 R
 (151) 2020 03 11
 (181) 2030 03 11
 (260) AM 2019 102233 A
 (220) 2019 03 15
 (732) BASF CORPORATION
 100 Park Avenue, Florham Park
 New Jersey, USA

(111) M 2020 32454 R
 (151) 2020 03 11
 (181) 2030 03 11
 (260) AM 2019 102523 A
 (220) 2019 04 03
 (732) LTD "GMP"
 Village Ponitchala 65, 0165, Tbilisi, Georgia

(111) M 2020 32449 R
 (151) 2020 03 11
 (181) 2030 03 11
 (260) AM 2019 102252 A
 (220) 2019 03 19
 (732) MYLAN INSTITUTIONAL INC.
 1718 Northrock Court, Rockford, Illinois,
 61103, USA

(111) M 2020 32455 R
 (151) 2020 03 11
 (181) 2030 03 11
 (260) AM 2019 102524 A
 (220) 2019 04 03
 (732) LTD "GMP"
 Village Ponitchala 65, 0165, Tbilisi, Georgia

(111) M 2020 32450 R
 (151) 2020 03 11
 (181) 2030 03 11
 (260) AM 2019 102383 A
 (220) 2019 03 26
 (732) LTD "AISI"
 Varketili III, mkr. I, bl. 28, ap. 26, 0163,
 Tbilisi Georgia

(111) M 2020 32456 R
 (151) 2020 03 11
 (181) 2030 03 11
 (260) AM 2019 102525 A
 (220) 2019 04 04
 (732) PAUL International SA
 rue Saint-Leger 2, c/o Paul Suisse SA,
 1205 GENEVE, Switzerland

(111) M 2020 32451 R
 (151) 2020 03 11
 (181) 2030 03 11
 (260) AM 2019 102398 A
 (220) 2019 03 27
 (732) LTD "BIBLUS"
 Iosebidge St. 49, 0160, Tbilisi, Georgia

(111) M 2020 32457 R
 (151) 2020 03 11
 (181) 2030 03 11
 (260) AM 2019 102546 A
 (220) 2019 04 09
 (732) Michael Jerzey Pelchinskiy
 Vakhtang Gorgasali Lane 5, ap. 32, Krtsanisi
 district, 0105, Tbilisi, Georgia

(111) M 2020 32452 R
 (151) 2020 03 11
 (181) 2030 03 11
 (260) AM 2019 102403 A
 (220) 2019 03 28
 (732) LTD "Royal Racha"
 Shartava St. 40, Fl. 7, 0160, Tbilisi,
 Georgia

(111) M 2020 32458 R
 (151) 2020 03 11
 (181) 2030 03 11
 (260) AM 2019 102566 A
 (220) 2019 04 11
 (732) Enrico Beridze
 10 Titsian Tabidze St., Lane 1, Tbilisi, Georgia

(111) M 2020 32459 R
 (151) 2020 03 11
 (181) 2030 03 11

(260) AM 2019 102697 A
(220) 2019 04 12
(732) JSC "GEORGIAN BEER COMPANY"
Vill. Saguramo, 3311, Mtskheta, Georgia

(111) M 2020 32460 R
(151) 2020 03 11
(181) 2030 03 11
(260) AM 2019 102701 A
(220) 2019 04 12
(732) JSC "GEORGIAN BEER COMPANY"
Vill. Saguramo, 3311, Mtskheta, Georgia

(111) M 2020 32461 R
(151) 2020 03 11
(181) 2030 03 11
(260) AM 2019 102706 A
(220) 2019 04 12
(732) JSC "GEORGIAN BEER COMPANY"
Vill. Saguramo, 3311, Mtskheta, Georgia

(111) M 2020 32462 R
(151) 2020 03 11
(181) 2030 03 11
(260) AM 2019 102716 A
(220) 2019 04 15
(732) LLC "Vendoo"
Petre Kavtaradze St. 44, Block B, commercial
space 8, Vake district, 0186, Tbilisi, Georgia

(111) M 2020 32463 R
(151) 2020 03 11
(181) 2030 03 11
(260) AM 2019 102723 A
(220) 2019 04 16
(732) LLC "Vendoo"
Petre Kavtaradze St. 44, Block B, commercial
space 8, Vake district, 0186, Tbilisi, Georgia

(111) M 2020 32464 R
(151) 2020 03 11
(181) 2030 03 11
(260) AM 2019 102731 A
(220) 2019 04 18
(732) GIORGI DALAKISHVILI
Vill. Mukhrani, 3309, Mtskheta, Georgia

(111) M 2020 32465 R
(151) 2020 03 11
(181) 2030 03 11
(260) AM 2019 102826 A
(220) 2019 04 24
(732) LTD "ALFA"

Tevdore Mghvdeli St. 53, 0154, Tbilisi,
Georgia

(111) M 2020 32466 R
(151) 2020 03 11
(181) 2030 03 11
(260) AM 2019 102917 A
(220) 2019 04 30
(732) INPHA LLP Representative office in Georgia
Besiki St. 4 (plot 46/10), 0108, Tbilisi,
Georgia

(111) M 2020 32467 R
(151) 2020 03 11
(181) 2030 03 11
(260) AM 2017 94699 A
(220) 2017 10 18
(732) LTD "BERIKA"
I. Chavchavadze Av., I Lane 6, ap. 80, 0179,
Tbilisi Georgia

(111) M 2020 32468 R
(151) 2020 03 11
(181) 2030 03 11
(260) AM 2018 99773 A
(220) 2018 10 09
(732) "სას გრუპი (SAS GROUP)"
Mashtots Av. 18, Yerevan, Armenia

TRADEMARKS REGISTERED ACCORDING TO THE ACCELERATED PROCEDURE

The decision can be appealed at the Chamber of Appeal of Sakpatenti within 3 months from the publication.

(111) M 2020 32431 R
(151) 2020 03 09
(181) 2030 03 09
(210) AM 107285
(220) 2020 02 24
(732) LTD "AI GHVINO"
Mazniashvili St. 5/7, Tbilisi, Georgia
(540)



(591) Red, black, white
(531) 27.05.01; 28.19; 29.01.13
(511) 32, 33, 43

(111) M 2020 32432 R
(151) 2020 03 10
(181) 2030 03 10
(210) AM 107404
(220) 2020 03 05
(732) LTD "ZEXYBERRY GROUP"
Shatberashvili St., Second lane 2, floor 5,
ap. 11a, Vake District, Tbilisi, Georgia
(540)



(591) White, red, brown
(531) 01.15.15; 27.05.01; 27.05.09; 27.05.10;
29.01.12
(511) 35, 43

(111) M 2020 32433 R
(151) 2020 03 10
(181) 2030 03 10
(210) AM 107284
(220) 2020 02 24
(732) LTD "LUXIN"
Vill. Untsa, Gardens, Adigeni District,
Georgia

(540)

(591) Sky-blue, white, grey
(531) 14.01.05; 14.01.08
(511) 9

(111) M 2020 32434 R
(151) 2020 03 10
(181) 2030 03 10
(210) AM 107291
(220) 2020 02 25
(732) Giorgi Ghambashidze
Mtatsminda St. 27, ap. 30, 0108, Tbilisi,
Georgia
(740) David Dzamukashvili
(540)



(591) Blue, white, light black
(531) 01.15.15; 24.15.02; 24.15.13; 26.04.13;
29.01.13
(511) 33

(111) M 2020 32435 R
(151) 2020 03 10
(181) 2030 03 10
(210) AM 107271
(220) 2020 02 21
(732) LTD "NOVA"
R. Agladze St. 45, 0119, Tbilisi, Georgia
(540)



(591) Red (C-4, M-82, Y-55, K-0) CMYK palette,
blue (C-100, M-75, Y-20, K-17)
CMYK palette
(531) 26.03.23; 26.04.04; 26.04.24; 28.19; 29.01.12
(511) 6, 11, 17, 20, 35

(111) M 2020 32469 R
(151) 2020 03 12
(181) 2030 03 12
(210) AM 107394
(220) 2020 03 02
(732) JAPAN TOBACCO INC.
2-2-1 Toranomom, Minato-ku, Tokyo,
Japan
(740) Shalva Gvaramadze
(540)

WINSTON DEMOSERIES

(591) Black, white
(511) 34

(111) M 2020 32470 R
(151) 2020 03 12
(181) 2030 03 12
(210) AM 107283
(220) 2020 02 24
(732) LTD "ZEARIS"
Richard Holbrook St. 13, Tbilisi, Georgia
(740) Ramaz Krichinashvili
(540)

ორბი
ORBI
ОРБИ

(591) Black, white
(511) 32

(111) M 2020 32471 R
(151) 2020 03 12
(181) 2030 03 12
(210) AM 107456
(220) 2020 03 06
(732) LTD "LAZETI TOBACCO"
Tamar Mepe St. 3, Zugdidi, Georgia
(540)



(591) Blue, white

(531) 26.04.18; 26.04.24; 27.05.22; 29.01.12
(511) 34

(111) M 2020 32472 R
(151) 2020 03 12
(181) 2030 03 12
(210) AM 107483
(220) 2020 03 11
(732) LTD "SLON GROUP"
G. Nishnianidze St. 1, ap. 13 (Kojori St. 1),
Tbilisi, Georgia
(540)



(591) Black, white
(531) 08.05.03; 27.05.01; 27.05.24
(511) 43

INTERNATIONAL TRADEMARKS FOR WHICH A DECISION ON GRANTING PROTECTIONS IS TAKEN

The decision can be appealed at the Chamber of Appeal of Sakpatenti within 3 months from the publication or at the Mtskheta District Court Administrative Cases Board (Address: №17, Samkhedro str., Mtskheta), within 1 month following the publication.

(260) AM 2020 99422 A

(800) 1269336

(151) 2015 06 23

(891) 2018 06 25

(731) Sovmestnoe obchtchestvo s ogranichennoi otvetstvennostiou "MOROZPRODOUKT" k 5, d. 133, oul. Oktiabrskaja, Marina Gorka, Poukhovitchski r-n, 222810 Minskaia obl., Belarus

(540)



(591) Blue, white and dark blue

(531) 26.11.12; 28.05; 29.01.04

(511)

29 – Meat, fish, poultry and game; meat extracts; preserved, frozen, dried and cooked fruits and vegetables; jellies, jams, compotes; eggs; milk and milk products; edible oils and fats; jellies for food; fruit jellies; buttercream; margarine; peanut butter; edible oils; cocoa butter; coconut oil; coconut butter; butter; milk; cranberry sauce [compote]; apple purée; vegetable salads; fruit salads; whipped cream; cheese; processed cheese; tofu; curd; curd snacks; curd mass and other milk products included in this class.

30 – Coffee, tea, cocoa, artificial coffee; sugar, rice, tapioca, sago; flour and preparations made from cereals, bread, pastry and confectionery, edible ices; honey, treacle; yeast, baking-powder; salt, mustard; vinegar, sauces (condiments); spices; Russian ravioli (pelmeni), ice creams including ice cream pies, ice cream cakes, ice cream with sponge cake inclusion, flavored ice cream, filled ice cream, ice cream with various added products, coated ice cream, multi-layered ice cream.

(260) AM 2020 99423 A

(800) 1270613

(151) 2015 06 23

(891) 2018 06 25

(731) Sovmestnoe obchtchestvo s ogranichennoi otvetstvennostiou "MOROZPRODOUKT"

k 5, d. 133, oul. Oktiabrskaja, Marina Gorka, Poukhovitchski r-n, 222810 Minskaia obl., Belarus

(540)



(591) Blue, white and dark blue

(531) 26.11.12; 29.01.04

(511)

29 – Meat, fish, poultry and game; meat extracts; preserved, frozen, dried and cooked fruits and vegetables; jellies, jams, compotes; eggs; milk and milk products; edible oils and fats; jellies for food; fruit jellies; buttercream; margarine; peanut butter; edible oils; cocoa butter; coconut oil; coconut butter; butter; milk; cranberry sauce [compote]; apple purée; vegetable salads; fruit salads; whipped cream; cheese; processed cheese; tofu; curd; curd snacks; curd mass and other milk products included in this class.

30 – Coffee, tea, cocoa, artificial coffee; sugar, rice, tapioca, sago; flour and preparations made from cereals, bread, pastry and confectionery, edible ices; honey, treacle; yeast, baking-powder; salt, mustard; vinegar, sauces (condiments); spices; Russian ravioli (pelmeni), ice creams including ice cream pies, ice cream cakes, ice cream with sponge layer inclusion, flavored ice cream, filled ice cream, ice cream with various added products, coated ice cream, multi-layered ice cream.

(260) AM 2020 100341 A*

(800) 1433032

(151) 2018 06 08

(891) 2018 06 08

(731) NOURYON CHEMICALS

INTERNATIONAL B.V.

Velperweg 76, NL-6824 BM Arnhem,

Netherlands

(540)

NOURYON

(591) Black, white
(511)

1 – Chemicals used in industry, science and photography, as well as in agriculture, horticulture and forestry; unprocessed artificial resins, unprocessed plastics; manures; fire extinguishing compositions; tempering and soldering preparations; chemical substances for preserving foodstuffs; tanning substances; adhesives used in industry; chemical substances used as additives to asphalt and bitumen; chemicals for use in the pharmaceutical industry; chemical substances for water treatment; chemical cleaning agents for use in industrial processes; surfactants for industrial purposes; salt for industrial purposes; salt (chemical products).

(260) AM 2020 101337 A
(800) 1445677

(151) 2018 07 02
(891) 2018 07 02

(731) ZHENG CHUANGHONG
Room 2003, No.2, Tongjingli, Haizhu
District, Guangzhou, China

(540)



(591) White, blue and orange
(531) 26.04.22; 27.05.01; 28.03; 29.01.13
(511)

9 – Cellular phones; sockets, plugs and other contacts [electric connections]; computer peripheral devices; protective films adapted for smartphones; satellite navigational apparatus; headsets; chargers for electric batteries; readers [data processing equipment]; cameras [photography]; materials for electricity mains [wires, cables].

(260) AM 2020 101432 A*
(800) 1446609

(151) 2017 05 19
(891) 2017 05 19

(731) Sky International AG
Stockerhof, Dreikönigstrasse 31A, CH-8002
Zürich, Switzerland

(540)

SKY

(591) Black, white
(511)

9 – Scientific, nautical, surveying, photographic, cinematographic, optical, weighing, measuring, signalling, checking (supervision), life-saving and teaching apparatus and instruments; apparatus and instruments for conducting, switching, transforming, accumulating, regulating or controlling electricity; apparatus for recording, transmission or reproducti-

on of sound or images; magnetic data carriers, recording discs; compact discs, DVDs and other digital recording media; mechanisms for coin-operated apparatus; cash registers, calculating machines, data processing equipment; computers; computer software; fire-extinguishing apparatus; 3D spectacles; abacuses; accumulators, electric; acid hydrometers; acidimeters for batteries; acoustic alarms/sound alarms; acoustic conduits; acoustic couplers; actinometers; adding machines; aerials; aerometers; air analysis apparatus; alarm bells, electric; alarms; alcoholmeters; alidades; altimeters; ammeters; amplifiers; amplifying tubes/amplifying valves; anemometers; animated cartoons; anode batteries / high tension batteries; anodes; answering machines; anti-dazzle shades; anti-glare glasses; anti-glare visors; anti-interference devices [electricity]; anti-theft warning apparatus; anticathodes; apertometers [optics]; apparatus and installations for the production of X-rays, not for medical purposes; apparatus and instruments for astronomy; apparatus and instruments for physics; apparatus for changing record player needles; apparatus for editing cinematographic film; apparatus for fermentation [laboratory apparatus]; apparatus for measuring the thickness of skins; apparatus to check franking; appliances for measuring the thickness of leather; armatures [electricity]; asbestos clothing for protection against fire; asbestos gloves for protection against accidents; asbestos screens for firemen; audio- and video-receivers; audio interfaces; audio mixers; audiovisual teaching apparatus; automated teller machines [ATM]; automatic indicators of low pressure in vehicle tires; azimuth instruments; baby monitors; baby scales; bags adapted for laptops; balances [steelyards]; balancing apparatus; bar code readers; barometers; bathroom scales; batteries, electric; batteries, electric, for vehicles; batteries for lighting; batteries for electronic cigarettes; battery boxes/accumulator jars; battery chargers; battery jars/accumulator jars; beacons, luminous; bells [warning devices]; betatrons; binoculars; biochips; black boxes [data recorders]; blinkers [signalling lights]; blueprint apparatus; boiler control instruments; branch boxes [electricity]; breathing apparatus, except for artificial respiration; breathing apparatus for underwater swimming; bullet-proof waistcoats; bullet-proof clothing; buzzers; cabinets for loudspeakers; cables, electric; calculating disks; calculating machines; calibrating rings; calipers; calorimeters; camcorders; cameras [photography]; capacitors; capillary tubes; carpenters' rules; carriers for dark plates [photography]; cases especially made for photographic apparatus and instruments; cases for smartphones; cases fitted with dissecting instruments [microscopy]; cash registers; cassette players; cathodes; cathodic anti-corrosion apparatus; cell switches [electricity] / reducers [electricity]; cell phone straps; centering apparatus for photographic transparencies; apparatus for changing record player needles; central

processing units [processors]; chargers for electric batteries; chargers for electronic cigarettes; charging stations for electric vehicles; apparatus to check franking / apparatus to check stamping mail; chemistry apparatus and instruments; chips [integrated circuits]; choking coils [impedance]; chromatography apparatus for laboratory use; chronographs [time recording apparatus]; cinematographic cameras; cinematographic film, exposed; circuit breakers; circuit closers; circular slide rules; cleaning apparatus for phonograph records; close-up lenses; clinometers; clothing especially made for laboratories; clothing for protection against accidents, irradiation and fire; clothing for protection against fire; coaxial cables; coils, electric; coin-operated mechanisms for television sets; collectors, electric; commutators; compact disc players; compact discs [audio-video]; compact discs [read-only memory]; comparators; compasses [measuring instruments]; computer game software; computer keyboards; computer memory devices; computer operating programs, recorded; computer peripheral devices; computer programmes [downloadable software]; computer software applications, downloadable; programs [downloadable software]; computer software, recorded; computer hardware; computers; condensers [capacitors] / capacitors; conductors, electric; connected bracelets [measuring instruments]; connections for electric lines; connectors [electricity]; contact lenses; contacts, electric; containers for contact lenses; containers for microscope slides; control panels [electricity]; converters, electric; copper wire, insulated; cordless telephones; correcting lenses [optics]; cosmographic instruments; counterfeit [false] coin detectors / false coin detectors; counters / meters; couplers [data processing equipment]; couplings, electric; covers for electric outlets; covers for smartphones; covers for personal digital assistants [PDAs]; covers for tablet computers; crash test dummies; cupels [laboratory]; current rectifiers; cyclotrons; darkroom lamps [photography]; darkrooms [photography]; data processing apparatus; decompression chambers; decorative magnets; demagnetizing apparatus for magnetic tapes; densimeters; densitometers; detectors; diagnostic apparatus, not for medical purposes; diaphragms [acoustics]; diaphragms for scientific apparatus; diaphragms [photography]; dictating machines; diffraction apparatus [microscopy]; digital photo frames; digital signs; digital weather stations; directional compasses; discharge tubes, electric, other than for lighting; disk drives for computers; disks, magnetic; distance measuring apparatus; distance recording apparatus; distillation apparatus for scientific purposes; distribution boards [electricity]; distribution boxes [electricity]; distribution consoles [electricity]; divers' masks; diving suits; DNA chips; dog whistles; dosimeters; downloadable image files; downloadable music files; downloadable ring tones

for mobile phones; drainers for use in photography; dressmakers' measures; drying apparatus for photographic prints; drying racks [photography]; ducts [electricity]; DVD players; dynamometers; ear plugs for divers; editing appliances for cinematographic films; egg timers; egg-candlers; electricity conduits; electric apparatus for commutation; electric apparatus for remote ignition; electric discharge tubes, other than for lighting; electric door bells; electric installations for the remote control of industrial operations; electric loss indicators; electricity conduits; electrified fences; electrified rails for mounting spot lights; electro-dynamic apparatus for the remote control of railway points; electro-dynamic apparatus for the remote control of signals; electrolyzers; electronic book readers; electromagnetic coils; electronic collars to train animals; electronic access control systems for interlocking doors; electric and electronic effects units for musical instruments; electronic interactive white boards; electronic key fobs being remote control apparatus; electronic sheet music, downloadable; electronic agendas; electronic notice boards; electronic pens [visual display units]; electronic pocket translators; electronic publications, downloadable; electronic tags for goods; encoded identification bracelets, magnetic; encoded magnetic cards; encoded key cards; enlarging apparatus [photography]; epidiascopes; equalizers [audio apparatus]; ergometers; exposure meters [light meters]; eyeglass cases; eyeglass chains; eyeglass cords; eyeglass frames; eyepieces; facsimile machines; false coin detectors; fibre [fiber (Am.)] optic cables; film cutting apparatus; films, exposed; filters for respiratory masks; filters for ultraviolet rays, for photography; filters [photography]; fire alarms; fire beaters; fire blankets; fire boats; fire engines; fire escapes; fire extinguishers; fire extinguishing apparatus; fire hose; fire hose nozzles; fire pumps; flash-bulbs [photography]; flashing lights [luminous signals]; flashlights [photography]; floppy disks; flowmeters; fluorescent screens; fog signals, non-explosive; food analysis apparatus; frames for photographic transparencies; frequency meters; furniture especially made for laboratories; fuse wire; fuses; galena crystals [detectors]; galvanic batteries; galvanic cells; galvanometers; garments for protection against fire; gas testing instruments; gasometers [measuring instruments]; gauges; electrical conductor; glazing apparatus for photographic prints; global positioning system [GPS] apparatus; gloves for divers; gloves for protection against accidents; gloves for protection against X-rays for industrial purposes; goggles for sports; graduated glassware; grids for batteries; hands free kits for phones; head cleaning tapes [recording]; headphones; heat regulating apparatus; heliographic apparatus; hemline markers; high-frequency apparatus; holders for electric coils; holograms; horns for loudspeakers; hourglasses; humanoid robots with artificial intelligence; hydrometers;

hygrometers; identification sheaths for electric wires; identification threads for electric wires; identity cards, magnetic; incubators for bacteria culture; inductors [electricity]; infrared detectors; instruments containing eyepieces; integrated circuit cards [smart cards]; integrated circuits; intercommunication apparatus; interfaces for computers; interactive touch screen terminals; inverters [electricity]; invoicing machines; ionization apparatus not for the treatment of air or water; jigs [measuring instruments]; juke boxes for computers; juke boxes, musical; junction boxes [electricity]; junction sleeves for electric cables; knee-pads for workers; laboratory centrifuges; laboratory trays; lactodensimeters; lactometers; laptop computers; lasers, not for medical purposes; lens hoods; lenses for astrophotography; letter scales; levelling instruments; levels [instruments for determining the horizontal]; life belts; life buoys; life jackets; life nets; life saving apparatus and equipment; life-saving rafts; light conducting filaments [optical fibers [fibres]]; light dimmers [regulators], electric; light-emitting diodes [LED]; light-emitting electronic pointers; lighting ballasts; lightning arresters; limiters [electricity]; locks, electric; logs [measuring instruments]; loudspeakers; magic lanterns; magnetic data media; magnetic encoders; magnetic tape units for computers; magnetic tapes; magnetic wires; magnets; magnifying glasses [optics]; manometers; marine compasses; marine depth finders; marking buoys; marking gauges [joinery]; masts for wireless aerials; material testing instruments and machines; materials for electricity mains [wires, cables]; mathematical instruments; measures; measuring apparatus; measuring devices, electric; measuring instruments; measuring spoons; mechanical signs; mechanisms for coin-operated apparatus; mechanisms for counter-operated apparatus; megaphones; mercury levels; metal detectors for industrial or military purposes; meteorological balloons; meteorological instruments; meters; metronomes; micrometer screws for optical instruments; micrometers; microphones; microprocessors; microscopes; microtomes; milage recorders for vehicles; mirrors for inspecting work; mirrors [optics]; modems; money counting and sorting machines; monitoring apparatus, electric; monitors [computer hardware]; monitors [computer programs]; mouse [data processing equipment]; mouse pads; nautical apparatus and instruments; naval signalling apparatus; navigation apparatus for vehicles [on-board computers]; navigational instruments; needles for surveying compasses; neon signs; nets for protection against accidents; nose clips for divers and swimmers; notebook computers; objectives [lenses] [optics]; observation instruments; octants; ohmmeters; optical apparatus and instruments; optical character readers; optical condensers; optical data media; optical discs; optical glass; optical goods; optical lamps; optical lenses; oscillographs; ovens for labo-

ratory use; oxygen transvasing apparatus; ozonisers [ozonators]; parking meters; particle accelerators; pedometers; peepholes [magnifying lenses] for doors; periscopes; personal stereos; petri dishes; petrol gauges; phonograph records; photocopiers [photographic, electrostatic, thermic]; photographic racks; photometers; phototelegraphy apparatus; photovoltaic cells; pince-nez; pipettes; pitot tubes; plane tables [surveying instruments]; planimeters; plates for batteries; plotters; plugs, sockets and other contacts [electric connections]; plumb bobs; plumb lines; pocket calculators; polarimeters; portable media players; portable telephones; precision balances; precision measuring apparatus; pressure indicator plugs for valves; pressure indicators; pressure measuring apparatus; printed circuit boards; printed circuits; printers for use with computers; prisms [optics]; probes for scientific purposes; projection apparatus; projection screens; protection devices against X-rays, not for medical purposes; protection devices for personal use against accidents; protective films adapted for smartphones; protective helmets; protective helmets for sports; protective masks; protective suits for aviators; protractors [measuring instruments]; punched card machines for offices; push buttons for bells; pyrometers; quantity indicators; radar apparatus; radio pagers; radiological apparatus for industrial purposes; radiology screens for industrial purposes; radios; radiotelegraphy sets; radiotelephony sets; railway traffic safety appliances; readers [data processing equipment]; record players; reducers [electricity]; reflecting discs for wear, for the prevention of traffic accidents; refractometers; refractors; regulating apparatus, electric; relays, electric; remote control apparatus; resistances, electric; respirators for filtering air; respirators, other than for artificial respiration; resuscitation mannequins [teaching apparatus]; retorts; retorts' stands; revolution counters; rheostats; riding helmets; road signs, luminous or mechanical; rods for water diviners; rods [surveying instruments]; rulers [measuring instruments]; rules [measuring instruments]; saccharometers; safety restraints, other than for vehicle seats and sports equipment; safety tarpaulins; Salinometers; satellite navigational apparatus; satellites for scientific purposes; scales; scales with body mass analyzers; scanners [data processing equipment]; screens for photoengraving; screens [photography]; screw-tapping gauges; security tokens [encryption devices]; semi-conductors; sextants; sheaths for electric cables; shoes for protection against accidents, irradiation and fire; shutter releases [photography]; shutters [photography]; sighting telescopes for firearms; signal bells; signal lanterns; signalling buoys; signalling panels, luminous or mechanical; signalling whistles; signals, luminous or mechanical; signs, luminous; simulators for the steering and control of vehicles; sirens; sleeves for laptops; slide calipers; slide projectors; slide-rules; slides [photo-

graphy]; smart rings; smoke detectors; solar batteries; solderers' helmets; solenoid valves [electromagnetic switches]; sonars; sound alarms; sound locating instruments; sound recording apparatus; sound recording carriers; sound recording strips; sound reproduction apparatus; sound transmitting apparatus; sounding apparatus and machines; sounding leads; sounding lines; spark-guards; speaking tubes; spectacle cases; spectacle frames; spectacle lenses; spectacles [optics]; spectrograph apparatus; spectrosopes; speed checking apparatus for vehicles; speed indicators; speed measuring apparatus [photography]; speed regulators for record players; spherometers; spirit levels; spools [photography]; squares for measuring; square rulers for measuring; sprinkler systems for fire protection; stage lighting regulators; stands for photographic apparatus; starter cables for motors; steering apparatus, automatic, for vehicles; step-up transformers; stereoscopes; stereoscopic apparatus; stills for laboratory experiments; stroboscopes; styli for record players; subwoofers; sulphitometers; sunglasses; surveying apparatus and instruments; surveying chains; surveying instruments; surveyors' levels; switchboards; switchboxes [electricity]; switches, electric; t-squares for measuring; tachometers; tape recorders; taximeters; teaching apparatus; teeth protectors; telegraph wires; telegraphs [apparatus]; telemeters; telephone apparatus; telephone receivers; telephone transmitters; telephone wires; teleprinters; teleprompters; telerupters; telescopes; television apparatus; temperature indicator labels, not for medical purposes; temperature indicators; terminals [electricity]; test tubes; testing apparatus not for medical purposes; theft prevention installations, electric; theodolites; thermal imaging cameras; thermionic tubes; thermometers, not for medical purposes; thermo-hygrometers; thermostats; thermostats for vehicles; ticket dispensers; time clocks [time recording devices]; time recording apparatus; time switches, automatic; tone arms for record players; totalizators; traffic cones; traffic-light apparatus [signalling devices]; transformers [electricity]; transistors [electronic]; transmitters of electronic signals; transmitters [telecommunication]; transmitting sets [telecommunication]; transponders; triodes; tripods for cameras; urinometers; USB flash drives; vacuum gauges; vacuum tubes [radio]; variometers; vehicle breakdown warning triangles; vehicle radios; verniers; video cassettes; video game cartridges; video recorders; video screens; video telephones; videotapes; viewfinders, photographic; viscosimeters; voltage regulators for vehicles; voltage surge protectors; voltmeters; voting machines; wafers for integrated circuits; waling glasses; walkie-talkies; washing trays [photography]; water level indicators; wavemeters; weighbridges; weighing apparatus and instruments; weighing machines; weights; whistle alarms; wind socks for indicating wind direction; wire connectors [electricity]; wires, elec-

tric; workmen's protective face-shields; wrist rests for use with computers; X-ray apparatus not for medical purposes; X-ray films, exposed; X-ray photographs, other than for medical purposes; X-ray tubes not for medical purposes; data storage apparatus and instruments, software and data storage software, and software for video-conferencing, radio, television, sound recording, sound reproducing, telecommunications and teaching apparatus and instruments; apparatus for recording television programmes; apparatus for reproduction or reception of sound, images or audio visual content; electrical and electronic apparatus for use in the reception of satellite, terrestrial or cable broadcasts; televisions; LCD and plasma screens; home cinema systems; amplifiers; speakers; radios; wireless audio and/or audio visual devices; portable wireless audio and/or audio visual devices; remote controls; wireless keypads; television receivers including a decoder; set-top boxes; digital set-top boxes; high definition set-top boxes; personal video recorder; set-top boxes for use in decoding and reception of satellite, terrestrial and cable broadcasts; apparatus for decoding encoded signals including set-top boxes for television reception; set-top box apparatus including a decoder and an interactive viewing guide; set-top box apparatus including a decoder and a recorder for recording television and audio programmes; set-top box apparatus including a decoder and a recorder programmable to transfer stored recordings to storage and also to delete the older recordings; satellite dishes; low noise block downconverters; satellite meters; computer software to enable searching of data; encoded programs for computers and for data processing and telecommunications; telephones; mobile telephones; PDAs; telephone and radio modems; television receivers including a decoder; set-top boxes for use in decoding and reception of satellite, terrestrial cable and digital subscriber line (DSL), Internet or other electronic broadcasts; apparatus for decoding encoded signals; recorded television and radio programmes; recorded programmes for broadcasting or other transmission on television, radio, mobile telephones, PDAs and on PCs; video recordings; multimedia apparatus and instruments; portable or hand-held computers; DVD players; computers; computer hardware; firmware; computer firmware; computer hardware, apparatus and instruments all for transmitting, displaying, receiving, storing and searching electronic information; computer programs; computer software; computer software and telecommunications apparatus to enable connection to databases and the Internet; computer software supplied from the Internet; network termination equipment; wired and/or wireless computer network routers, modems, firewalls and/or bridges; computer software and computer programs for distribution to, and for use by, viewers of a digital television channel for the viewing and purchase of goods and ser-

vices; computer games software and computer quiz software; computer programs for interactive television and for interactive games and/or quizzes; interactive video game devices comprised of computer software namely software for operating game controllers; portable and/or hand-held electronic devices for receiving, playing and transmitting music, sounds, images, text, signals, information and code; electronic publications; computer games (computer software); computer video games (computer software); video screens; video projectors; tapes, discs and wires, all being magnetic; cassettes and cartridges, all adapted for use with the aforesaid tapes; blank and pre-recorded audio and video cassettes, tapes and cartridges; compact discs; DVD discs; phonographic records; laser readable discs for recording sound or video; ROM cartridges, CD ROMs, cards and discs, integrated circuit cards, memory carriers, recording media, all pre-recorded with computer video games and/or quizzes; encoded cards; radio and television signal antenna; downloadable music, sounds, videos, images, text and information provided by a telecommunications network, by on-line delivery and by way of the Internet and/or the world-wide web or other communications network; interactive sound and/or audio recordings; music, video, sound and/or audio recordings (downloadable) provided from MP3 Internet websites; MP3 players, MP3 readers; audio and/or video file recorders and/or players; portable audio and/or video file recorders and/or players; telephone ring tones (downloadable); downloadable ring tones for mobile phones; apparatus and instruments for the reception of radio and television broadcasts including the reception of cable, satellite and digital broadcasts; smart cards; credit cards; encoded loyalty cards; acoustic apparatus or instruments, namely acoustic discs, acoustic meters, acoustic sound alarms; adaptors; aerials; antenna; amplifiers; communication apparatus and instruments; encoded or magnetic banking or credit cards; cinematographic film; cinematographic instruments and apparatus; data carriers; data storage apparatus, equipment and instruments; electrical telecommunications and/or communications and/or broadcast and/or transmission and/or decoding and/or image processing and/or audio visual instruments and apparatus; electronic telecommunications and/or communications and/or broadcast and/or transmission and/or decoding and/or image processing and/or audio visual instruments and apparatus; film reproducing instruments and apparatus; hand held electrical telecommunications and/or communications and/or broadcast and/or transmission and/or decoding and/or image processing and/or audio visual instruments and apparatus; hand held electronic telecommunications and/or communications and/or broadcast and/or transmission and/or decoding and/or image processing and/or audio visual instruments and apparatus; mobile telep-

hones; motion pictures; telephone apparatus and equipment; parts and fittings for all the aforesaid goods; sunglasses, leather cases for holding mobile phones; downloadable media content, including video and films, television programmes, computer games, music, images and ring tones provided by internet, telephone line, cable, wireless transmission, satellite or terrestrial broadcast service; cases, containers, protective coverings and parts and fittings therefor, all for use with MP3 players, music storage devices, media storage devices and other audio, visual and computer devices; electrical, electronic and computer equipment for machinery for use in conservation, generation and efficient use of heat, light and water, including thermostatic controls, solar panels for electricity generation, photovoltaic devices, solar cells turbines and motion detectors; electrical and electronic equipment for use in the generation of solar power; electrical, electronic and computer equipment for use in the generation of alternative energy including wind power, hydroelectric power, tidal power, geothermal power, solar power, biomass, and biofuels; control and monitoring equipment for use in the generation of alternative energy including wind power, hydroelectric power, tidal power, geothermal power, solar power, biomass, and biofuels; automated control apparatus for local management of lighting, heating and water supplies; electronic publications (downloadable), including electronic publications, magazines and newsletters regarding environmental protection, energy conservation and ecology, animal welfare and renewable energy projects, including wind power, hydroelectric power, tidal power, geothermal power, solar power, biomass, and biofuels; apparatus and instruments for closed circuit television and surveillance systems; apparatus and instruments for personal security monitoring; apparatus and instruments for home security monitoring and control; home and personal security apparatus; home and personal security devices; home and personal security alarms; electronic protection equipment, including fire detecting and alarm equipment, intruder and burglar alarm equipment and motion detecting equipment; radio, telephonic, television and signalling apparatus and instruments, cameras, sound and video monitoring and recording and sound and video reproducing apparatus and instruments, all for control and telemetry purposes for the home and personal security; closed-circuit television systems (CCTV); monitors; cameras; optical lenses; camera casings; prepackaged cameras; videocassette recorders (VCRs); system controlling software; video monitoring apparatus; detectors; access control apparatus; readers; magnetic or encoded access control cards; monitoring apparatus; electronic panels for alarm management and monitoring; alarm panels; glass breakage detectors; smoke detectors; carbon monoxide detectors; digital audio recorders; digital video recorders;

digital audio servers; digital video servers; electrical communication equipment; message programming equipment; radio paging equipment; electronic locking systems; life-saving apparatus and equipment; electric alarms; electronic devices for opening doors; electronic devices for protection; intruder alarms and anti-theft equipment; intruder detection apparatus; motion detecting equipment; electronic control apparatus; electronic apparatus for controlling operation of machines; remote apparatus for controlling operation of machines; computer apparatus for controlling operation of machines; electronic network equipment; electronic communication equipment; message programming devices; electronic locking apparatus; parts and fittings for all the aforesaid goods; computer software, operating system software, devices, and hardware for transmitting, receiving, synchronizing, displaying, backing-up, monitoring, controlling, sharing, coding, decoding, encrypting, accessing, remotely accessing, creating, collecting, storing, securing, removing, transferring, disseminating, locating, organizing or otherwise utilizing data, voice, multimedia, audio, visual, music, photographs, drawings, images, audiovisual, video, text, graphics or other data, including over a global communications network; computer software, operating system software, devices, and hardware for synchronizing data, files, e-mails, contacts, calendars, task lists, text messages, photos, music, audio, visual, audio visual, video, text, graphics, programs and other information between computers and handheld or other devices, and vice versa; communications platforms for enabling instantaneous, continuous, scheduled and perpetual synchronization of data between computers and hand-held or other devices, and vice versa; multimedia cards, memory cards, flash memory cards, memory chips, data storage media devices, plugs, plug-in cards, magnetic cards, SIM cards, telephone calling cards, headphones, headsets, portable and/or hand held electronic devices for receiving, storing, playing and transmitting data, voice, multimedia, audio, visual, music, photographs, drawings, images, audiovisual, video, text, graphics or other data; online dictionaries, encyclopaedias, and reference texts (downloadable); online publications, including newspapers, magazines (periodicals), comics, journals (publications), books, user manuals, instructional and teaching materials (downloadable); online posters, photographs, pictures, articles, vouchers and tickets (downloadable), online electronic dictionaries, encyclopaedias and reference texts (downloadable); computer software for processing electronic payments and transferring funds to and from others; downloadable authentication software; conversion software and databases, including currency conversion and measurement conversion; computer software for the purpose of monitoring online communications and chat room conversations and alerting third parties to the con-

tents; computer software for monitoring the use of computers and the Internet by children; computer software relating to online protection and online security; protective clothing [against accident or injury] for cycling; locks (electric) for bicycles; parts and fittings for all the aforesaid goods; satellite navigational system for bicycles; global positioning systems for use with bicycles; computers for use with bicycles; ergometers; computer apparatus for remote meter reading; bicycle meters; distance meters; power meters; speed meters; eyewear; sports eyewear; protective eyewear; sunglasses; cases for eyewear; cases for sunglasses; frames for eyewear; lenses for eyewear; straps for sunglasses and eyewear; helmets; cyclists helmets; crash helmets; protective sports helmets; sports bags for protective helmets; sporting articles for protective purposes; protective body and limb pads for cycling; face masks for cycling; protective gloves; visors; radios; communicators; aerials for radios; parts for radios; carrying cases for radios; electronic radio apparatus; mobile radios; mounting fittings for radios; radio receivers and transmitters; radio transceivers; radios for vehicles; solar powered radios; wireless boosters; wireless transmitters; wireless communication apparatus; two way wireless communication systems; digital electronic devices for recording, organizing, transmitting, receiving, manipulating, playing and reviewing text, data, image, audio and video files; computer software for use in organizing, transmitting, receiving, manipulating, playing and reviewing text, data, image, audio, and video files; computer hardware and computer software for the reproduction, processing and streaming of audio, video and multimedia content; computer hardware and software for controlling the operation of audio and video devices and for viewing, searching and/or playing audio, video, television, movies, photographs and other digital images, and other multimedia content; computer software for creating and editing music and sounds; computer hardware, peripherals and devices for portable media storage and digital media streaming; computer hardware for upload, storage, retrieval, download, transmission and delivery of digital content; virtual reality systems; virtual reality glasses or goggle, data gloves, head mounted displays, data-suits, virtual reality clothing, headphones, speakers, joysticks, equipment and apparatus for virtual reality rooms; virtual reality software; virtual reality headsets, helmets and viewers; virtual reality (VR) and augmented reality (AR) products namely goggles, gloves, 3D glasses for smartphones, headsets and head mounted displays adapted for use in watching videos and movies, headphones, head trackers, motion trackers, data gloves, 3D controllers, haptic devices, stereoscopic 3D displays, 2D monoscopic, monocular; virtual reality and augmented reality headsets, helmets, display screens, and sound systems comprised primarily of speakers, all adapted

for use in playing video games, viewing motion pictures, and participating in virtual reality and augmented reality environments in which users can interact for recreational, leisure, or entertainment purposes; electronic and optical communications instruments and components, namely, display screens for virtual reality visualization, manipulation, immersion and integration of audio, video, text, binary, still images, graphics and multimedia files; personal video display devices in the nature of wearable displays for viewing digital content including virtual reality, augmented reality, and mixed reality content; virtual reality motion platforms; cameras for use in virtual reality products (headsets, head mounted displays adapted for use in watching videos and movies, headphones, head trackers, stereoscopic 3D displays; motion tracking sensors; hologram apparatus; holographic apparatus; software for virtual reality immersion and integration of geographic information in interaction with on-line member communities, other applications and the data itself; smart phones; portable virtual reality systems; wearable computers; vision processing unit; holographic processing unit; inertial measurement unit; virtual reality games software; virtual reality hardware and peripheral devices; virtual reality software; augmented reality software; software in the field of virtual reality, motion tracking, location, position, and orientation sensing; software for developing and interfacing with virtual reality/augmented reality software; software, namely, mobile application for setting up, configuring, viewing and running virtual reality/augmented reality software; hardware and software for use in enabling computers, handheld consoles, tablet computers, mobile devices, and smart phones to provide virtual world experiences; virtual reality software for creating, sharing, and viewing virtual reality content over the internet; virtual reality computer platform; earphones for mobile computer terminals; microphones; earphones; smart phones; webcams; head-mounted video displays; micro-displays, namely, head mounted video displays and near eye video displays; parts and accessories for micro-display; video processors; software and firmware for video drivers and video processing; personal video display screens; personal video display devices in the nature of wearable displays for viewing digital content including virtual reality, augmented reality, and mixed reality content; downloadable computer game programs for cellular phones, mobile computer terminals, set-top boxes, DVD players connected to network and television sets connected to network; downloadable computer game programs; downloadable video game programs; game programs for home video game machines; game programs for hand-held games with liquid crystal displays; downloadable or installable computer and video game programs for home video game machines; downloadable or installable additional image data for home

video game machines; downloadable or installable computer and video game programs for hand-held games with liquid crystal displays; downloadable or installable additional image data for hand-held games with liquid crystal displays; downloadable image file containing artwork, text, audio, video, games and Internet Web links relating to sporting and cultural activities; downloadable images for cellular phones and mobile computer terminals; downloadable stand by image for cellular phones; downloadable ring tones for mobile phones; downloadable electronic publications in the nature of books, manuals, magazines, newspapers in the field of video games, game software, music and video movies; earphones for home video game machines; headphones for home video game machines; microphones for home video game machines; webcams exclusively for use with home video game machines; earphones exclusively for use with hand-held games with liquid crystal displays; headphones exclusively for use with hand-held games with liquid crystal displays; microphones exclusively for use with hand-held games with liquid crystal displays; computer software for creating and editing music and sounds, computer hardware, peripherals and devices for portable media storage and digital media streaming, computer hardware for upload, storage, retrieval, download, transmission and delivery of digital content; parts and fittings for all of the above.

35 – Advertising; business management; business administration; office functions; accounting; administrative processing of purchase orders; advertising by mail order; advisory services for business management; arranging newspaper subscriptions for others; arranging subscriptions to telecommunication services for others; auctioneering; bill-posting; business appraisals; business auditing; business efficiency expert services; business information; business inquiries; business investigations; business intermediary services relating to the matching of potential private investors with entrepreneurs needing funding; business management and organization consultancy; business management assistance; business management consultancy; business management of hotels; business management of performing artists; business management of sports people; business organization consultancy; business research; commercial administration of the licensing of the goods and services of others; commercial information agencies; commercial information and advice for consumers [consumer advice shop]; commercial or industrial management assistance; compilation of information into computer databases; compiling indexes of information for commercial or advertising purposes; compilation of statistics; computerized file management; consultancy regarding public relations communications strategy; consultancy regarding advertising communications strategy; cost price ana-

lysis; data search in computer files for others; demonstration of goods; direct mail advertising; dissemination of advertising matter; distribution of samples; document reproduction; drawing up of statements of accounts; economic forecasting; employment agencies; import-export agencies; invoicing; layout services for advertising purposes; marketing; marketing research; marketing studies; modelling for advertising or sales promotion; negotiation of business contracts for others; news clipping services; office machines and equipment rental; on-line advertising on a computer network; opinion polling; organization of exhibitions for commercial or advertising purposes; organization of fashion shows for promotional purposes; organization of trade fairs for commercial or advertising purposes; outsourcing services [business assistance]; payroll preparation; personnel management consultancy; personnel recruitment; photocopying services; presentation of goods on communication media, for retail purposes; price comparison services; procurement services for others [purchasing goods and services for other businesses]; production of advertising films; production of teleshopping programmes; professional business consultancy; psychological testing for the selection of personnel; public relations; publication of publicity texts; publicity; publicity agencies; publicity columns preparation; publicity material rental; radio advertising; registration of written communications and data; relocation services for businesses; rental of advertising space; rental of advertising time on communication media; rental of photocopying machines; rental of vending machines; retail or wholesale services connected with the sale of pharmaceutical, veterinary and sanitary preparations and medical supplies; sales promotion for others; secretarial services; shop window dressing; shorthand; sponsorship search; systemization of information into computer databases; tax preparation; telemarketing services; telephone answering for unavailable subscribers; television advertising; transcription; typing; updating of advertising material; updating and maintenance of information in registries; word processing; writing of publicity texts; promotional services; administration services for businesses; accounting services; customer relationship management; organisation, operation and supervision of sales and promotional incentive schemes; online advertising; provision of product information and advice to prospective purchasers of home entertainment equipment, multi-media apparatus and instruments, television and radio equipment, audio visual equipment, set-top boxes, personal video recorders, video recorders, computer games software, hardware and peripheral devices; demonstration services for advertising, business, commercial & trade purposes; rental of advertising space; production of television advertising commercials; preparation and presentation of audio visual displays for advertising purpo-

ses; dissemination of advertising matter; arranging and conducting of trade shows and exhibitions; arranging and conducting trade show exhibitions in the field of electronic, computer and video games for the computer and video game industry; advertisement and promotion of television services; compilation of business statistics and commercial information; loyalty card services; marketing studies; marketing of radio programmes, television programmes, films, motion pictures, pre-recorded video tapes, audio and/or visual material, pre-recorded video cassettes, DVDs or pre-recorded video discs; monitoring and analysis of call information (office services); business planning, inspection, survey and appraisal services; receipt and provision of computerised business information data; compilation of business statistics and commercial information, all relating to television, radio, satellite broadcasting and video games; magazine and newspaper subscriptions; the bringing together, for the benefit of others of a variety of goods namely bleaching preparations and other substances for laundry use, cleaning, polishing, scouring and abrasive preparations, cleaning, bleaching and abrasive preparations and substances, all for laundry use, anti-perspirants, perfumes, non-medicated toilet preparations, cosmetic preparations, dentifrices, toilet articles, hair preparations, shampoos, soaps, essential oils, beauty products, toiletries, colognes, eau de toilette, deodorants, body sprays, perfumed body sprays, oils, creams and lotions for the skin, preparations for the bath and shower, shampoos and conditioners, hair styling products, shaving gel, foams and cream, pre and post shave balms, aftershaves, razors, razor blades, chamois creams, embrocation creams, depilatory preparations, sunscreen preparations, cosmetics, perfumery, candles including all the aforesaid made from unbleached and/or organic and/or biodegradable ingredients, pharmaceutical and veterinary preparations, industrial oils and greases, lubricants, fuels (including motor spirit) and illuminants, fuel additives and preparations for enhancing combustion of fuels, machine tools, motors and engines, turbines for power generation, control panels for turbines for power generation, machines for household use, building and construction materials (non-metallic), building glass, sheet materials, metal hardware, insulation, cladding, roofing materials, pipes, doors, door furniture, windows, window furniture, joinery materials, ladders, kitchen units, kitchen furniture, bedroom furniture, dining room furniture, flooring, lighting, radiators, soft furnishings, storage, shelving, fireplaces and surrounds, living room furniture, natural materials for use as horticultural fertilizers, horticultural implements, gardening equipment, horticultural frames, garden tools (hand operated), watering cans, garden sprayers, garden lighting, garden furniture, covers for garden furniture, garden ornaments, gardening gloves, seeds, plants, gardening clothing,

gardening footwear, gardening headwear, garden storage boxes, paints and varnishes, hand tools, scientific, nautical, surveying, photographic, cinematographic, optical, weighing, measuring, radio, television, sound recording, sound reproducing, telecommunications, signalling, checking (supervision) and teaching apparatus and instruments, apparatus for recording television programmes, apparatus for recording, transmission, reproduction or reception of sound, images or audio visual content, electrical and electronic apparatus for use in the reception of satellite, terrestrial or cable broadcasts, televisions, LCD and plasma screens, home cinema systems, amplifiers, speakers, radios, wireless audio and/or audio visual devices, portable wireless audio and/or audio visual devices, remote controls, games controllers, wireless gaming controllers, wireless keypads, television receivers including a decoder, set-top boxes, digital set-top boxes, high definition set-top boxes, personal video recorder, set-top boxes for use in decoding and reception of satellite, terrestrial and cable broadcasts, apparatus for decoding encoded signals including set-top boxes for television reception, set-top box apparatus including a decoder and an interactive viewing guide, set-top box apparatus including a decoder and a recorder for recording television and audio programmes, set-top box apparatus including a decoder and a recorder programmable to transfer stored recordings to storage and also to delete the older recordings, satellite dishes, low noise blocks, satellite meters, computer software to enable searching of data, encoded programs for computers and for data processing and telecommunications, telephones, mobile telephones, PDAs, telephone and radio modems, television receivers including a decoder, set-top boxes for use in decoding and reception of satellite, terrestrial cable and digital subscriber line (DSL), Internet or other electronic broadcasts, apparatus for decoding encoded signals, recorded television and radio programmes, recorded programmes for broadcasting or other transmission on television, radio, mobile telephones, PDAs and on PCs, video recordings, multimedia apparatus and instruments, portable or hand-held computers, DVD players, computers, computer hardware and peripheral devices, computer hardware, apparatus and instruments all for transmitting, displaying, receiving, storing and searching electronic information, computer programs, electronic computer games, electronic interactive computer games, computer software, computer software and telecommunications apparatus to enable connection to databases and the Internet, computer software supplied from the Internet, network termination equipment, wired and/or wireless computer network routers, modems, firewalls and/or bridges, computer software and computer programs for distribution to, and for use by, viewers of a digital television channel for the viewing and purchase of goods and services, computer games

software and computer quiz software, computer video games and/or quizzes adapted for use with television receivers and screens or with video monitors or with computer screens, computer programs for interactive television and for interactive games and/or quizzes, electronic apparatus adapted for use with television receivers in playing games, games consoles, interactive video game devices comprised of computer hardware and software and accessories, namely game consoles, game controllers and software for operating game controllers, portable and/or hand-held electronic devices for interactive computer and video games, portable and/or hand-held electronic devices for receiving, playing and transmitting music, sounds, images, text, signals, information and code, portable wireless audio devices, virtual reality systems, home entertainment systems, multi-media equipment, audio visual equipment, video and television equipment, electronic publications, computer games, computer video games, video screens, video projectors, tapes, discs and wires, all being magnetic, cassettes and cartridges, all adapted for use with the aforesaid tapes, blank and pre-recorded audio and video cassettes, tapes and cartridges, compact discs, DVD discs, phonographic records, laser readable discs for recording sound or video, ROM cartridges, CD ROMs, cards and discs, integrated circuit cards, memory carriers, recording media, all pre-recorded with computer video games and/or quizzes, encoded cards, radio and television signal antennae, music, sounds, videos, images, text and information provided by a telecommunications network, by on-line delivery and by way of the Internet and/or the world-wide web or other communications network, interactive sound and/or audio recordings, music, video, sound and/or audio recordings (downloadable) provided from MP3 Internet websites, MP3 players, MP3 readers, audio and/or video file recorders and/or players, portable audio and/or video file recorders and/or players, personal video recorders, telephone ring tones (downloadable), apparatus and instruments for conducting, switching, transforming, accumulating, regulating or controlling electricity, apparatus and instruments for the reception of radio and television broadcasts including the reception of cable, satellite and digital broadcasts, smart cards, credit cards, loyalty cards, acoustic apparatus or instruments, namely acoustic discs, acoustic meters, acoustic sound alarms, adaptors, aerials, antennae, amplifiers, amusement apparatus and instruments adapted for use with an external display screen or monitor, communication apparatus and instruments, encoded or magnetic banking or credit cards, cinematographic film, cinematographic instruments and apparatus, data carriers, data storage apparatus, equipment and instruments, electrical telecommunications and/or communications and/or broadcast and/or transmission and/or decoding and/or image processing and/or audio visual instruments and appa-

ratus, electronic telecommunications and/or communications and/or broadcast and/or transmission and/or decoding and/or image processing and/or audio visual instruments and apparatus, film reproducing instruments and apparatus, hand held electrical telecommunications and/or communications and/or broadcast and/or transmission and/or decoding and/or image processing and/or audio visual instruments and apparatus, hand held electronic telecommunications and/or communications and/or broadcast and/or transmission and/or decoding and/or image processing and/or audio visual instruments and apparatus, interactive educational or entertainment games for use with television receivers and video apparatus, mobile telephones, motion pictures, telephone apparatus and equipment, parts and fittings for all the aforesaid goods, sunglasses, leather cases for holding mobile phones, downloadable media content, including video and films, television programmes, computer games, music, images and ring tones provided by internet, telephone line, cable, wireless transmission, satellite or terrestrial broadcast service, cases, containers, protective coverings and parts and fittings therefor, all for use with MP3 players, music storage devices, media storage devices and other audio, visual and computer devices, electrical, electronic and computer equipment for machinery for use in conservation, generation and efficient use of heat, light and water, including thermostatic controls, solar panels for electricity generation, photovoltaic devices, solar cells, turbines and motion detectors, electrical, electronic and computer equipment for use in the generation of alternative energy including wind power, hydroelectric power, tidal power, geothermal power, solar power, biomass, and biofuels, control and monitoring equipment for use in the generation of alternative energy including wind power, hydroelectric power, tidal power, geothermal power, solar power, biomass, and biofuels, electronic publications (downloadable), including electronic publications, magazines and newsletters regarding environmental protection, energy conservation and ecology, animal welfare and renewable energy projects, including wind power, hydroelectric power, tidal power, geothermal power, solar power, biomass, and biofuels, apparatus and instruments for closed circuit television and surveillance systems, apparatus and instruments for personal security monitoring, apparatus and instruments for home security monitoring and control, home and personal security apparatus, home and personal security devices, home and personal security alarms, electronic protection equipment, including fire detecting and alarm equipment, intruder and burglar alarm equipment and motion detecting equipment, radio, telephonic, television and signalling apparatus and instruments, cameras, sound and video monitoring and recording and sound and video reproducing apparatus and instruments, all for control and telemetry

purposes for the home and personal security, closed-circuit television systems (CCTV), monitors, cameras, optical lenses, camera casings, prepackaged cameras, videocassette recorders (VCRs), system controlling software, video monitoring apparatus, detectors, access control apparatus, readers, magnetic or encoded access control cards, monitoring apparatus, electronic panels for alarm management and monitoring, alarm panels, glass breakage detectors, smoke detectors, carbon monoxide detectors, digital audio recorders, digital video recorders, digital audio servers, digital video servers, electrical communication equipment, message programming equipment, radio paging equipment, electronic locking systems, life-saving apparatus and equipment, electric alarms, electronic devices for opening doors, electronic devices for protection, intruder alarms and anti-theft equipment, intruder detection apparatus, motion detecting equipment, electronic control apparatus, electronic apparatus for controlling operation of machines, remote apparatus for controlling operation of machines, computer apparatus for controlling operation of machines, electronic network equipment, electronic communication equipment, message programming devices, electronic locking apparatus, computer software, operating system software, devices, and hardware for transmitting, receiving, synchronizing, displaying, backing-up, monitoring, controlling, sharing, coding, decoding, encrypting, accessing, remotely accessing, creating, collecting, storing, securing, removing, transferring, disseminating, locating, organizing or otherwise utilizing data, voice, multimedia, audio, visual, music, photographs, drawings, images, audiovisual, video, text, graphics or other data, including over a global communications network, computer software, operating system software, devices, and hardware for synchronizing data, files, e-mails, contacts, calendars, task lists, text messages, photos, music, audio, visual, audio visual, video, text, graphics, programs and other information between computers and hand-held or other devices, and vice versa, communications platforms for enabling instantaneous, continuous, scheduled and perpetual synchronization of data between computers and hand-held or other devices, and vice versa, multimedia cards, memory cards, flash memory cards, memory chips, data storage media devices, plugs, plug-in cards, magnetic cards, SIM cards, telephone calling cards, headphones, headsets, portable and/or hand held electronic devices for receiving, storing, playing and transmitting data, voice, multimedia, audio, visual, music, photographs, drawings, images, audiovisual, video, text, graphics or other data, online dictionaries, encyclopaedias, and reference texts (downloadable), online publications, including newspapers, magazines (periodicals), comics, journals (publications), books, user manuals, instructional and teaching materials (downloadable), online posters, photographs, pictu-

res, articles, tickets (downloadable), online electronic dictionaries, encyclopaedias and reference texts, (downloadable) computer software for processing electronic payments and transferring funds to and from others, online and downloadable authentication software, online conversion software and databases, including currency conversion and measurement conversion, computer software for the purpose of monitoring online communications and chat room conversations and alerting third parties to the contents, computer software for monitoring the use of computers and the Internet by children, computer software relating to online protection and online security, spectacles, contact lenses, musical instruments, medical equipment, domestic electrical and electronic equipment, washing machines, tumble dryers, washer dryers, fridges, freezers, dishwashers, cookers, ovens, hobs, microwaves, jewellery, clocks, watches, stationery, apparatus for controlling temperature including remote and computer apparatus and instruments, apparatus for controlling water supply, apparatus for controlling lighting including remote and computer apparatus and instruments, apparatus for energy efficient lighting, heating and water supply purposes, in particular, light bulbs, apparatus for water conservation and water use minimization, automated control apparatus for local management of lighting, heating and water supplies, vehicles, apparatus for locomotion by land, air or water, vehicles adapted for use with renewable energy sources including wind power, hydroelectric power, tidal power, geothermal power, solar power, biomass, and biofuels, paper, cardboard, paper and cardboard articles namely albums, boxes, archive boxes, tubes, mailing tubes, office paper stationery, pads, notemakers, note pads, jotter, journal, refill pads, notebooks, business book, message pads, graph pad, tracing pads, flipchart pads, business card books, telephone/address books, files, folders, suspension files, pocket files, flap wallets, portfolio wallets, slip file, gusset files, box files, lever arch files, magazine file, ring binders, dividers, paper sorter, repositionable note, page markers, envelopes, labels, string tags, CD/DVD sleeves, raffle tickets, business cards, filing modules, desktop collection tray, recycling bin, year planners, bookmark, cardboard packaging, advertisement boards of paper or cardboard, advertising signs of paper or cardboard, banners of paper or cardboard, placards of paper or cardboard, signboards of paper or cardboard, packaging bags of paper or cardboard, packaging boxes of paper or cardboard, packaging container of paper or cardboard, paper bags, disposable paper products, paper napkins, paper hand towels, drying towels of paper, tissues, handkerchiefs of paper, paper cups, paper plates, dinner mats of paper, coasters, paper place mats, cocktail mats, coffee filters, paper table covers, paper table runners, containers for ice made of paper or cardboard, bibs of paper, fly catching paper,

portable / standing paper lanterns, decorative paper centrepieces, adhesive wall decoration of paper, wrapping paper, gift paper, paper party decorations, paper party bags, cake decorations, drawer liners, dust bags of paper for cleaning apparatus, flags of paper or cardboard, flower-pot covers of paper or cardboard, lining paper, make-up pads of paper, paper badges, name badges, picture mounts, paper shopping bags, paper tissues, works of art and figurines of paper or cardboard, architects models, paper party hats, paper party favours, paper trumpets, paper face masks, wall paper, artificial flowers of paper, paper hats (clothing), paper clothing, bed linen of paper, bed covers of paper, paper toys, absorbent paper, account books, cheque book holders, adhesive paper, almanacs, baking paper, baking parchment, dress-making patterns, hat boxes of cardboard, lithographs, maps, menus, name cards, paper doilies, paper toilet seat covers, toilet tissue, postage stamps, scented paper, sandwich bags, stencils, printed matter, publications, newspapers, magazines (periodicals), comics, journals (publications) and books, publications including strategy guides, user manuals, books and magazines all in the field of computer games, science fiction, games and entertainment, quiz books, shopping guides listing products for purchase, promotional literature relating to the promotion of goods for sale via digital television, the Internet or other telecommunication channels, photographs, instructional and teaching materials (other than apparatus), posters, postcards and greeting cards, calendars, diaries, cards and stickers for collecting and collating in albums, writing requisites, rulers, erasers, writing paper, writing sets, catalogues, adhesive stickers, advertising material, advertisements, bags, credit cards, instructional manuals, newsletters, pens, pencils, writing instruments, pen and pencil holders, programme guides, stationery, user guides or manuals, paper, cardboard, printed matter, bookbinding material, photographs, stationery, adhesives for stationery or household purposes, artists' materials, plastic materials for packaging, publications, magazines, including all the aforesaid made from recycled and/or unbleached materials and/or from organic matter, insulation materials, in particular, for the conservation of heat within residential and commercial buildings, leather and imitations of leather, animal skins, hides, trunks and travelling bags, umbrellas, parasols and walking sticks, whips, harness and saddlery, handbags, backpacks, school bags, beach bags, travelling bags, suitcases, trunks, haversacks, bags for campers, fur-skins, collars for animals, covers for animals, boxes of leather or leather board, attaché cases, pocket wallets, school satchels and briefcases, key cases (leatherwear) attaché cases, backpacks, beach bags, briefcases, canes, card cases, key cases, leather shoulder belts, net bags, parasols, pocket wallets, purses, pouches, rucksacks, school bags, school satchels, sling bags, shopping bags,

suitcases, garment bags, tote bags, travelling trunks, valises, vanity cases, umbrella covers, and wallets, clothing, footwear, headgear, underclothing, clothing for men, women, children and infants, jeans, slacks, trousers, skirts, shorts, wraps, jerseys, sweaters, waistcoats, dresses, jumpers, sleepwear, robes, warm-up suits, rainwear, sweaters, scarves, hats, caps, mittens, snow suits, belts, smocks, swimwear, playsuits, bibs, stockings, socks, waterproof clothing, underwear, footwear for men, women, children, and infants shoes, sneakers, sandals, slippers, boots, headgear for men, women, children, and infants hats, headbands, earmuffs, caps, sweaters, dress shirts, blouses, jackets, ties, suits, bathing suits, belts, skirts, dresses, coats, hats, caps, tuxedos, pants, vests, hosiery, scarves, pyjamas, underwear, kilts, mufflers, shawls, footwear, shoes, boots, slippers, and athletic shoes, blazers, headbands, wristbands, coveralls, overalls, sweat pants, and sleepwear, hair bands, ribbons for hair, hair slides, hair scrunchies, headbands, headwraps, hair elastics, hair combs, lighting, kitchenware, glassware, china, porcelain, ornaments, furniture, kitchens, sanitary ware, art, paintings, posters, postcards, prints, photographs, household containers and utensils, crockery, cutlery, furnishings, carpets, textiles, table linen, bed linen, haberdashery, sewing machines and equipment, toys, games and playthings, electronic games, hand-held devices for playing electronic, computer or video games, video games apparatus, playing cards, card games, sporting articles, games involving gambling, amusement machines, amusement apparatus and instruments, interactive educational or entertainment games, playing cards, sports equipment, fitness equipment, camping equipment, pets goods, namely pet cleaning products, hygienic and beauty implements for animals, pet shampoos and conditioners, pet towels, pet brushes, pet clothing, blankets for animals, pet cushions, rugs for pets, pet collars, ID tags for pets, leads/leashes for pets, beds for pets, nesting boxes, pet carriers, pet feeding dishes, food containers for pets, pet automatic feeders, toys, games and playthings for pets, ropes for use on pet toys, pet scratching furniture, food and drink, massage apparatus, massage chairs and massage cushions, foot spas, deck chairs, aromatherapy apparatus, saunas, hammocks, yoga equipment, pilates equipment, meditation equipment, water features, heat therapy, light therapy, sound therapy software and recordings, motor vehicles and their parts, protective clothing for cycling, locks for bicycles, lights for bicycles, cycling shoes, cycling clothing, cycling headwear including helmets, protective clothing for cycling, cycling products, namely, bike bags, wheel bags, bike box, cycle cameras, bicycles dynamos, bicycle reflectors, bicycle saddle covers, forks, stands for bicycles, bicycle mirrors, bike mounts for phones, gear and brake cables, cassettes, derailleurs, lubricants and cleaners, frame protection kits, chain-

stay protector, map holders, protective gloves, visors, protective body and limb pads for cycling, face masks, cases and/or bags adapted for carrying bicycles, stationary exercise bicycles, nutritional supplements in the form of bars, gels, beverages and preparations for making beverages, vitamin and mineral supplements in the form of bars, gels, beverages and preparations for making beverages, food products for use during exercise, proteinaceous preparations for making beverages, bicycles, bicycle parts, helmets and water bottles, mudguards, bicycle seats, repair kits for cycling, including puncture repair kits, satellite navigational system for bicycles, global positioning systems for use with bicycles, computers for use with bicycles, ergometers, computer apparatus for remote meter reading, bicycle meters, distance meters, power meters, speed meters, eyewear, sports eyewear, sun visors, protective eyewear, sunglasses, cases for eyewear, cases for sunglasses, frames for eyewear, lenses for eyewear, straps for sunglasses and eyewear, helmets, cyclists helmets, crash helmets, protective sports helmets, sports bags for protective helmets, sporting articles for protective purposes, visors, radios, communicators, aerials for radios, parts for radios, carrying cases for radios, electronic radio apparatus, mobile radios, mounting fittings for radios, radio receivers and transmitters, radio transceivers, radios for vehicles, solar powered radios, parts and fittings for all of the above, heart monitors, heart monitors to be worn during exercise, parts and fittings for all of the above, bicycle lights, parts and fittings therefor, bicycles, track bicycles, velodrome bicycles, mountain bicycles, racing bicycles, cross country bicycles, cyclo-cross bicycles, bmx bicycles, indoor bicycles, all terrain bicycles, parts and fittings for all the aforementioned goods, bicycle frames, handlebars and handlebar stems for bicycles, handlebar tape, handlebar grips, saddles, saddle posts, bicycle seat posts, bicycle rims, bicycle gears, group sets of gears, chains for bicycles, bicycle bells, baskets for bicycles, brakes for bicycles, spokes for bicycles, dress guards for bicycles, pedals for bicycles, bicycle pumps, wheels and tyres for bicycles, inner tubes for bicycles, mudguards for bicycles, bicycle stands (supports), bicycle bags, bicycle stabilisers, luggage bags for bicycles, panniers for bicycles, bicycle carriers and racks, auxiliary child seats for bicycles and parts and fittings therefor, covers for bicycles and bicycle saddles, direction indicators and signals for bicycles, fittings for bicycles for carrying beverages and food, bidons, bottle cages for bicycles, fittings for bicycles for carrying luggage and panniers, puncture repair outfits and kits for bicycle tyres, toe straps and toe clips for use on bicycles, twist grips for bicycles, trailers for use with bicycles, roof racks, roof racks for vehicles, roof rack and storage containers for land vehicles, cranks for bicycles, power meters for

bicycles, parts and fittings for all of the above, horological and chronometric instruments, watches, clocks, bands for watches, bracelets for watches, straps for watches of any material, cases for watches and clocks, watch chains, clock and watch hands, dials for watches, faces for watches, electric watches, mechanical and automatic watches, movements for watches and clocks, parts for clocks and watches, pendant watches, sports watches, watch and clock springs, watch clasps, watches for outdoor use, watches for sporting use, watches incorporating a memory function, time keeping devices, stop watches parts and fittings for all of the above, sportswear, sports clothing, sports footwear, sports headwear, caps, hats, sports uniforms, sun visors, parts and fittings for all of the above, rollers for bicycles, trainers for bicycles, turbo trainers for bicycles, rollers for stationary bicycles, computer controlled exercise apparatus, parts and fittings for all of the above, meat, fish, poultry and game, preserved, frozen, dried and cooked fruits and vegetables, jellies, jams, compotes, eggs, milk and milk products, edible oils and edible fats, dairy products, butter, margarine and other butter substitutes, preserves, pickles, edible nuts and seeds and products prepared there from, shellfish, snacks, prepared meals and prepared dishes, soups, gravy and preparations for making gravy or soup, coffee, tea, cocoa, sugar, rice, tapioca, sago, artificial coffee, flour and preparations made from cereals of from flour, bread, pastry and confectionery, ices, honey, treacle, yeast, baking powder, salt, mustard, pepper, vinegar, sauces (condiments), ice, spices, biscuits (other than biscuits for animals), cakes, pasta, pasta products and pastry products, chocolate, chocolates non-medicated confectionery, ice-cream, water ices and frozen confections, coffee substitutes, coffee essences and coffee extracts, beverages and preparations therefor, puddings, desserts, prepared meals and prepared snacks and fillings, fresh fruit and fresh vegetables, shellfish, beers, mineral and aerated waters and other non-alcoholic drinks, fruit drinks and fruit juices, syrups and other preparations for making beverages, alcoholic beverages other than beer, energy drinks, wireless boosters, wireless transmitters, wireless communication apparatus, two way wireless communication systems, digital electronic devices for recording, organizing, transmitting, receiving, manipulating, playing and reviewing text, data, image, audio and video files, computer software for use in organizing, transmitting, receiving, manipulating, playing and reviewing text, data, image, audio, and video files, computer hardware and computer software for the reproduction, processing and streaming of audio, video and multimedia content, computer hardware and software for controlling the operation of audio and video devices and for viewing, searching and/or playing audio, video, television, movies, photographs and other digital images, and other mul-

timedia content, computer software for creating and editing music and sounds, computer hardware, peripherals and devices for portable media storage and digital media streaming, computer hardware for upload, storage, retrieval, download, transmission and delivery of digital content, virtual reality systems, virtual reality glasses or goggle, data gloves, head mounted displays, datasuits, virtual reality clothing, headphones, speakers, joysticks, equipment and apparatus for virtual reality rooms, virtual reality software, virtual reality headsets, helmets and viewers, virtual reality (VR) and augmented reality (AR) products namely goggles, gloves, 3D glasses for smartphones, headsets and head mounted displays adapted for use in watching videos and movies, headphones, head trackers, motion trackers, data gloves, 3D controllers, haptic devices, stereoscopic 3D displays, 2D monoscopic, monocular, virtual reality and augmented reality headsets, helmets, display screens, and sound systems comprised primarily of speakers, all adapted for use in playing video games, viewing motion pictures, and participating in virtual reality and augmented reality environments in which users can interact for recreational, leisure, or entertainment purposes, electronic and optical communications instruments and components, namely, display screens for virtual reality visualization, manipulation, immersion and integration of audio, video, text, binary, still images, graphics and multimedia files, personal video display devices in the nature of wearable displays for viewing digital content including virtual reality, augmented reality, and mixed reality content, virtual reality motion platforms, cameras for use in virtual reality products (headsets, head mounted displays adapted for use in watching videos and movies, headphones, head trackers, stereoscopic 3D displays), motion tracking sensors, hologram apparatus, holographic apparatus, virtual reality immersion and integration of geographic information in interaction with on-line member communities, other applications and the data itself, smart phones, portable virtual reality systems, wearable computers, vision processing unit, holographic processing unit, inertial measurement unit, virtual reality games software, virtual reality hardware and peripheral devices, virtual reality software, augmented reality software, software in the field of virtual reality, motion tracking, location, position, and orientation sensing, software for developing and interfacing with virtual reality/augmented reality software, software, namely, mobile application for setting up, configuring, viewing and running virtual reality/augmented reality software, hardware and software for use in enabling computers, handheld consoles, tablet computers, mobile devices, and smart phones to provide virtual world experiences, virtual reality software for creating, sharing, and viewing virtual reality content over the internet, virtual reality computer platform, earphones for mo-

mobile computer terminals, microphones, earphones, smart phones, webcams, head-mounted video displays, micro-displays, namely, head mounted video displays and near eye video displays, parts and accessories for micro-display, video processors, software and firmware for video drivers and video processing, personal video display screens, personal video display devices in the nature of wearable displays for viewing digital content including virtual reality, augmented reality, and mixed reality content, downloadable computer game programs for cellular phones, mobile computer terminals, set-top boxes, DVD players connected to network and television sets connected to network, downloadable computer game programs, downloadable video game programs, game programs for home video game machines, game programs for hand-held games with liquid crystal displays, downloadable or installable computer and video game programs for home video game machines, downloadable or installable additional image data for home video game machines, downloadable or installable computer and video game programs for hand-held games with liquid crystal displays, downloadable or installable additional image data for hand-held games with liquid crystal displays, downloadable image file containing artwork, text, audio, video, games and Internet Web links relating to sporting and cultural activities, downloadable images for cellular phones and mobile computer terminals, downloadable stand by image for cellular phones, downloadable ring tones for mobile phones, downloadable electronic publications in the nature of books, manuals, magazines, newspapers in the field of video games, game software, music and video movies, earphones for home video game machines, headphones for home video game machines, microphones for home video game machines, keyboards for home video game machines, mouse for home video game machines, webcams exclusively for use with home video game machines, earphones exclusively for use with hand-held games with liquid crystal displays, headphones exclusively for use with hand-held games with liquid crystal displays, microphones exclusively for use with hand-held games with liquid crystal displays, keyboards exclusively for use with hand-held games with liquid crystal displays, mouse exclusively for use with hand-held games with liquid crystal displays, promotional literature, programmes, leaflets, tickets and passes, banners and wall hangings made of paper or cardboard, stickers, temporary tattoos, beer mats and coasters, all made of paper or card, virtual reality games, home video game machines, handset cradles for home video game machines, game controllers for home video game machines, joysticks exclusively for use with home video game machines, parts and accessories for home video game machines, protective carrying cases specially adapted for handheld video games, hand-held games with liquid crystal

displays, support stands exclusively for use with hand-held games with liquid crystal displays, mounts exclusively for hand-held games with liquid crystal displays, dolls, game cards included in this class, trading card games, computer software for creating and editing music and sounds, computer hardware, peripherals and devices for portable media storage and digital media streaming, computer hardware for upload, storage, retrieval, download, transmission and delivery of digital content, programmes, leaflets, tickets and passes, banners and wall hangings made of paper or cardboard, stickers, temporary tattoos, beer mats and coasters, all made of paper or card, enabling customers to conveniently view and purchase those goods including via an Internet website, an interactive television shopping channel, a digital television shopping channel, an Internet walled garden or by means of interactive television and/or telecommunications (including voice, telephony and/or transfer of digital information or data) and/or interactive digital media; business customer information and consultancy services for promotional, advertising and marketing purposes in relation to broadcast reception apparatus and instruments and parts and fittings therefor including cable, satellite and terrestrial, analogue or digital reception; advertising and promotional services in relation to lifestyle, ecological and environmental issues; business management of renewable energy projects, including wind power, hydroelectric power, tidal power, geothermal power, solar power, biomass, and biofuels and projects in connection with other renewable energy sources; collection and processing of operational data in connection with renewable energy projects, including wind power, hydroelectric power, tidal power, geothermal power, solar power, biomass, and biofuels, including compilation of statistics relating to operation and production; The bringing together, for the benefit of others, of a variety of advertising agency services, advertising services, aerial photography services, alarm monitoring services, alternative energy products installation, maintenance and repair services, anti-spamming services, archive library services, arranging and conducting of seminars, conferences, arranging and conducting workshops, audio and video recording services, audio, film, video and television recording facilities, banking services, bar services, beauty salon services, beauty therapy services, betting services and electronic betting services, bicycle rental services, booking of seats for entertainment, sporting and cultural events, bookmaking services, box office services in relation to booking of tickets for entertainment, educational, sporting and cultural activities, box office information services in relation to booking of tickets for entertainment, educational, sporting and cultural activities, brand creation services, brand design services, broadband services, broadcasting services, business consultancy services, business data analysis

services, business management advisory services, business management services, cable and satellite broadcasting and transmission services, call recording services, card services, career advisory services, casino services, catering services, charitable fundraising services, mentoring (personal) services, education and training services, education, training and entertainment services in the form of skills studios for children and young people in the field of media, television and news reporting, education, training, entertainment and sporting activities involving athletes and celebrities in the form of initiatives to promote confidence, sports skills and life skills in children and young people, education, training and entertainment services related to the promotion of creative skills in children and young people, including creative studios, financial services relating to scholarships and bursary schemes for children and young people in the fields of sport, the arts, media and television, promotional services relating to work experience and employment opportunities for young people, promotional services relating to apprenticeships and graduate employment, education, training and entertainment services in the field of initiatives to inspire young people and to provide them with life skills, business skills, opportunities for development and self-confidence, administration services relating to the organising and conducting of volunteer programmes and community service projects, chat room services, cholesterol testing services, cinema services, cloud computing/storage services, coaching services, coffee shops, communication services, computer advisory services, computer and information technology consultancy services, computer firewall services, computer installation, maintenance, repair and updating services, computer programming services, computer services, computer software advisory services, computer support services, computer system analysis services, concert ticket booking services, conference services, consumer advisory services, consumer market information services, educational course services, correspondence course services, sports coaching services, training course services, professional workshop and training course services, commercial, trade and business workshops and training course services, problem solving, think-tank and brainstorming workshops, seminars and training courses services, technical studies course services, credit betting services, credit card services, cycling event services, cycling training services, data broadcasting services, data communication services, data encryption services, data recovery services, data security services, data storage services, data streaming services, data transmission services, database services, debit card services, delicatessen restaurant services, retail delicatessen services connected with the sale of food and drink, design services, scientific development services, technical development services, development services

of new products for others, development services in the field of environmental protection, energy conservation and alternative energy sources, and ecology, development services in relation to computer hardware and software, technology development services, diet advisory services, dietary education services, television programme directing services, radio programme directing services, film, music, plays, theatrical production, musical shows, concerts, exhibitions, sporting events and road show directing services, directory enquiry services, discussion group and chat room services, distance learning services, distribution services, domain name services, editing services, education services, electricity distribution services, electricity generating services, electricity supply services, electronic bulletin board services, electronic conferencing services, e-mail services, employment agency/bureau services, entertainment agency services, entertainment services, environmental conservation services, environmental consultancy services, online market place services in relation to streamable and downloadable media content, including video and films, television programmes, computer games, music, images and ring tones provided by internet, telephone line, cable, wireless transmission, satellite or terrestrial broadcast, exercise class services, fan club services, fast food/takeaway services, financial services, fitness club services, fitness testing services, fixed and mobile telephone services, flower delivery services, food development services, food nutrition services, gambling services, gaming services, gas services, gift selection/delivery services, greeting cards custom manufacture service, delivery services relating to greeting cards, gym services, hairdressing salon services, health advice and information services, health club services, health farm/spa services, hiring, leasing or rental services in relation to radio programmes, television programmes, films, motion pictures, pre-recorded video tapes, audio and/or visual material, pre-recorded video cassettes, dvds or pre-recorded video discs, hiring, rental and leasing service in relation to entertainment, holiday accommodation services, horoscope services, website hosting services, computer hosting services, hotel reservation services, hotel services, instant messaging services, instruction services, insurance services, intellectual property advisory and consultancy services, interactive entertainment services, interactive games services, interactive news services, interactive services, interactive sport services, interactive television services, internet access services, internet portal services, ISP services, IT services, leisure services, lottery services, loyalty, incentive and bonus program services, magazine and newspaper subscription services, maintenance services, gaming apparatus, equipment and instrument installation and repair services, broadcasting apparatus, equipment and instrument installation and repair services, tele-

communication and/or communications apparatus equipment and instrument installation and repair services, domestic electronic equipment installation and repair services, electronic business equipment installation and repair services, alarm, lock and safe installation and repair services, computer software installation and repair services, electric and/or electrical appliance installation and repair services, market analysis studies, market assessment services, market forecasting services, marketing advisory services, marketing agency services, marketing information services, marketing research services, marketing services, music broadcasting services, on demand entertainment services, streaming, downloading and transmission services relating to entertainment, educational, sporting and cultural activities, night club services, nutrition services, online auction services, online distance learning services, online fraud protection services, online gaming services, online internet security services, online magazine and book services, online reward and incentive program services, online security services, pay to play games services, peer to peer interactive gaming services, personal training services, photographic services, photography services, podcasting services, price comparison services, product information services, product launch services, audio, visual and video production services relating to entertainment, education, training, sport and/or culture, business management services relating to cyclists, cycling teams and/or cycling events, sports promotional services, sports financial sponsorship services, administration services relating to the arranging, organising and running and/or conducting of cyclists, cycling teams and/or cycling events, rental services relating to telecommunication facilities and equipment, pub services, real estate services, recreation services, recycling services, scientific research services, technical research services, research services of new products for others, research services in the field of environmental protection, energy conservation and alternative energy sources, ecology, business research services, research services in relation to computer hardware and software, technology research services, reservation services, restaurant reservation services, restaurant services, sales promotion services, satellite services, security services, server hosting services, short message services (sms), slimming club services, social networking services, special events planning services, sponsorship services, sporting services, sporting tuition course services, storage services, taxi services, teaching services, team building services, telecommunication services, telephone marketing services, therapy services, ticket agency services (entertainment), ticket booking services, ticket reservation services, tour reservation services, tourist information services, training services, transport services, travel agency services, travel guide services, travel services, tuition services, university

services, utility distribution services, utility services, utility supply services, video messaging services, video on demand services, video-conferencing services, videotext services, voicemail services, WAP services, warranty services, web portal services, webcasting services, website design/maintenance services enabling customers to conveniently view and purchase those services, including over a global computer network; electronic and online retrieval of data, files, e-mails, contacts, calendars, task lists, text messages, photos, music, audio, visual, audio visual, video, text, graphics, programs and other data or information; online auction services; provision of an online database of advertisements including personal advertisements, employment and placement opportunities advertisements and real estate advertisements; provision of online financial services comparisons; provision of online price comparison services; advertising agency services; brand creation services; business consultancy services; business data analysis services; business management advisory services; business management services; career advisory services (other than education and training advice); consumer market information services; retail and subscription services relating to streamable and downloadable media content, including video and films, television programmes, computer games, music, images and ring tones provided by internet, telephone line, cable, wireless transmission, satellite or terrestrial broadcast; database management services; magazine and newspaper subscription services; market analysis studies; market assessment services; market forecasting services; marketing advisory services; marketing agency services; marketing information services; marketing research services, marketing services; product launch services; business management services relating to cyclists, cycling teams and/or cycling events; sports promotional services; administration services relating to the arranging, organising and running and/or conducting of cyclists, cycling teams and/or cycling events; sales promotion services; telephone marketing services; provision of online word processing, spreadsheet, calendar, presentation and database management services; business management and administration services relating to individual cyclists and or cycling teams; provision of virtual online office support staff services; on-line ordering/purchase of gift items; provision of loyalty rewards information; loyalty, incentive and bonus program services; provision of online reward and incentive programs; provision of business information and advice; business management of amusement parks and theme parks; insurance quotation comparisons; promotional sponsorship of individual cyclists and/or cycling teams and/or cycling events; provision of interactive business calendars from a computer database or over the Internet; provision of online reward and incentive programs relating to fitness tracking, health trac-

king, personal tracking, lifestyle tracking and emotional tracking; advertising, marketing and promotion consultancy; advertising services; advertising services for the promotion of radio programmes, television programmes, films and motion pictures; advertising services relating to radio programmes, television programmes, films and motion pictures; advertising services for the promotion of radio programmes, television programmes, films and motion pictures based on the customers viewing habits/preferences; promotion of radio programmes, television programmes, films and motion pictures; promotion of radio programmes, television programmes, films and motion pictures based on the customers viewing habits/preferences; market research for compiling information on viewers of television; advertising and commercial information services via audio, video, digital, and online media; promotional sponsorship; organization and conducting of exhibitions and special shows for commercial or advertising purposes; business management, particularly in respect of organizing and conducting exhibitions and special shows; arranging of entertainment, sporting or cultural events, concerts, festivals, gigs and live band events for business, commercial and advertising purposes; promoting live entertainment events and ticket sales; promoting musical artists; promotion of venues; accounting and office functions in connection with the reservation, issuing and sales of admission tickets; radio advertising; television advertising; arranging subscriptions to telecommunication services for others; online advertising; online business services for connecting social network users with businesses; providing online music subscription services; providing ad funded music subscription services; rental of advertising time on communication media; commercial administration of the licensing of the goods and services of others; provision of business information and advice; advertising by transmission of on-line publicity for third parties through electronic communications networks; advertising, including promotion relating to the sale of articles and services for third parties by online advertising; electronic commerce services, namely, providing information about products and services via audio, video, digital, and online media for advertising and sales purposes; advertising services in the nature of matching and connecting advertisers and video content publishers for the purpose of advertising, marketing and promotional services; advertising and publicity services, namely, promoting the goods, services, brand identity and commercial information and news of third parties through audio, video, digital, and online media; provision of business information and advice; consultancy, information and advisory services relating to all the aforesaid services; professional consultancy, information and advisory services relating to all the aforesaid services; consultancy, information and advisory services

relating to all the aforesaid services provided on-line from a computer database or via a helpline or the Internet.

38 – Telecommunications; cable television broadcasting; cellular telephone communication; communications by computer terminals; communications by fiber [fibre] optic networks; communications by telegrams; communications by telephone; computer aided transmission of messages and images; electronic bulletin board services [telecommunications services]; electronic mail; facsimile transmission; information about telecommunication; message sending; paging services [radio, telephone or other means of electronic communication]; providing access to databases; providing internet chatrooms; providing online forums; providing telecommunication channels for teleshopping services; providing telecommunication connections to a global computer network; providing user access to global computer networks; radio broadcasting; rental of access time to global computer networks; rental of facsimile apparatus; rental of message sending apparatus; rental of modems; rental of telecommunication equipment; rental of telephones; satellite transmission; telecommunications routing and junction services; teleconferencing services; telegraph services; telephone services; television broadcasting; telex services; transmission of digital files; transmission of greeting cards online; transmission of telegrams; videoconferencing services; voice mail services; wire service; wireless broadcasting; broadcasting of television programs in bars, pubs, clubs, hotels and other public venues; video-conferencing services and sharing of files, images, music, video, photos, drawings, audio-visual, text, documents and data; telegraph communications services; mobile and fixed telecommunications services; communications services; satellite, cellular and radio communication services; television and radio broadcasting; transmission and communication services; broadcasting and/or transmission of radio and/or television programmes and/or films; satellite, DTT, cable, DSL and broadband broadcasting and/or transmission of audio and/or audio visual programming; transmission of audio, video and/or audio visual programming (by any means); transmission of video films; broadcasting and transmission of television programmes and films to personal computers; broadcasting and communications by means of or aided by computer; transmission of audio, video and/or audio visual programming by Internet protocol (IPTV); telecommunications services over the Internet including but not limited to services provided using voice over Internet protocol (VOIP); provision of access and/or connectivity to broadband networks whether fixed, portable or wireless; transmission of text, messages, sound and/or pictures; telecommunication and/or communication and/or broadcast and/or transmission of audio visual content;

communication of information and data (including web pages), for others by radio, telecommunications and by satellite; online managing and filtering of electronic communications; telephone, mobile telephone, message collection and transmission, radio-paging, call diversion, answerphone and directory enquiry services; personal numbering services; television screen based information broadcasting and retrieval services; loan of replacement telecommunications and communications apparatus and instruments in case of breakdown, loss or theft; computer aided transmission of messages and images; messaging services namely, sending, receiving and forwarding messages in the form of text, audio, graphic images or video or a combination of these formats; instant messaging; short message services (SMS); multimedia messaging services (MMS); unified messaging services; voicemail services; video conferencing services; video telephone services; providing access to telecommunications infrastructures for other operators; provision of access to electronic conferencing, discussion groups and chat rooms; provision of chat rooms; hire, leasing or rental of apparatus, instruments, installations or components for use in the provision of the aforementioned services; communications services by satellite, television and/or radio; news agency services; provision of access to news, current affairs and sports information; hiring, rental and leasing of communications apparatus; electronic mail services; telecommunication services relating to the Internet; telecommunication of information (including web pages); provision of location based services for telecommunications and communications apparatus and instruments; provision of wireless application protocol services including those utilising a secure communications channel; provision of information relating to or identifying telecommunications and communications apparatus and instruments; provision of telecommunications links to computer databases and websites on the Internet; telecommunications services dedicated to retailing goods and services through interactive communications with customers; interactive television services being telecommunications and/or communications and/or broadcasting and/or transmission services; interactive services for television viewers including those watching on mobile telephones and PCs being telecommunications and/or communications and/or broadcasting and/or transmission services; television broadcasting services incorporating interactive services for viewing guides and intelligent automated selection for programme recordal; interactive services for television viewers facilitating the recordal of programmes automatically initiated on the basis of customer viewing habits/preferences being telecommunications and/or communications and/or broadcasting and/or transmission services; providing interactive television viewers (including those watching on their mobile telephones or PCs) with access to information,

data, graphics, audio and/or audio-visual content from a restricted group of Internet websites or portals; broadcasting and transmission of interactive television, interactive games, interactive news, interactive sport, interactive entertainment and interactive competitions; video on demand and near on demand telecommunication and/or communication and/or broadcast and/or transmission services; streaming delivery of video on demand streams to viewers; providing access to movies, videos and television programmes to viewers on demand and near on demand; professional consultancy services relating to broadcasting; providing access to a database storing information relating to a variety of goods and services; enabling access to the Internet; provision of a connection between websites and television viewers via an interactive television portal; internet portal services; web portal services; provision of broadband services; interactive television portal services providing access to Internet websites for television viewers via their television receiving equipment including digital television receiving equipment; providing access to Internet websites to mobile telephone users; leasing access time to an information database; telecommunications information; factual information services relating to television broadcasting; audio visual communication services; data communication services; data broadcasting services; electronic delivery of messages; telecommunication and/or communication and/or broadcast and/or transmission of radio programmes, television programmes, films and motion pictures; telecommunication and/or communication and/or broadcast and/or transmission of audio and/or visual material and material from pre-recorded video tapes; transmission of radio programmes, television programmes, films, motion pictures, pre-recorded video tapes, audio and/or visual material, pre-recorded video cassettes, DVDs or pre-recorded video discs; rental, leasing or hire of communications equipment; message sending; telephonic or telephone communications services; wireless communication services; delivery by telecommunication of media content, including video and films, television programmes, computer games, music, images and ring tones provided by internet, telephone line, cable, wireless transmission, satellite or terrestrial broadcast service; organisation of call information; monitoring and analysis of call information; call screening services; call alerting services; provision of communication services for accessing a communications or computer network; provision of communication services for accessing entertainment, education, information and data via telephone, line, cable, wire or fibre, database or computer network; provision of communication services for accessing information, messages, text, sound, images and data via a computer network; provision of communication services for accessing and retrieving radio and television programmes; consultancy,

transfer and transmission of programs, data, files, e-mails, contacts, calendars, task lists, text messages, photos, music, audio, visual, audio visual, video, text, graphics, programs and other information via telecommunications and global communications networks; data synchronization over telecommunications, communications and computer networks; remote data access services; e-mail, email notification and alert services; online instant messaging; provision of online conferencing, discussion groups, message boards and chat rooms; internet portal services; web portal services; online video on demand or near on demand telecommunication and/or communication and/or broadcast and/or transmission services; online telecommunications services to enable the accessing and retrieving of data, files, e-mails, contacts, calendars, task lists, text messages, photos, music, audio, visual, audio visual, video, text, graphics, programs and other information via a computer or computer network or electronic device including services provided over a global communications network; online telecommunications services relating to webcasting and podcasting including services provided over a global communications network; peer to peer network communication services; provision of interactive polling services being telecommunications and/or communications and/or broadcasting services; rental of radio equipment; broadcasting services; cable and satellite broadcasting and transmission services; call recording services; data streaming services; data transmission services; e-mail services; electronic delivery services relating to greeting cards; instant messaging services; internet access services; ISP services; music broadcasting services; podcasting services; video messaging services; videotext services; webcasting services; streaming, downloading and transmission services relating to entertainment, educational, sporting and cultural activities; provision of access to on demand entertainment services; broadcasting and transmission of virtual reality/augmented reality content; providing access to online dictionaries, encyclopaedias, and reference texts; providing access to online publications, including newspapers, magazines (periodicals), comics, journals (publications), books, user manuals, instructional and teaching materials; providing access to online posters, photographs, pictures, articles, vouchers and tickets; streaming of radio programmes and audio material on the Internet; transmitting streamed sound, audio-visual recordings and multimedia content via mobile telephone devices; transmitting audio-visual recordings and multimedia content via the Internet; Internet communication services; data streaming services; streaming of audio, visual and audio visual content; providing community forums for users to post, search, watch, share, critique, rate, and comment on, videos and other multimedia content via the Internet and other communications networks; providing access to a video sharing portal for

entertainment and education purposes; electronic transmission and streaming of digital media content for others via global and local computer networks; podcasting; consultancy, information and advisory services relating to all the aforesaid services; professional consultancy, information and advisory services relating to all the aforesaid services; consultancy, information and advisory services relating to all the aforesaid services provided on-line from a computer database or via a helpline or the Internet.

41 – Education; providing of training; entertainment; sporting and cultural activities; academies [education]; aikido instruction; amusement parks; amusements; animal training; arranging and conducting of colloquiums; arranging and conducting of concerts; arranging and conducting of conferences; arranging and conducting of congresses; arranging and conducting of seminars; arranging and conducting of symposiums; arranging and conducting of workshops [training]; arranging of beauty contests; boarding schools; booking of seats for shows; bookmobile services; calligraphy services; cinema presentations; circuses; club services [entertainment or education]; coaching [training]; conducting fitness classes; correspondence courses; disc jockey services; discotheque services; dubbing; education information; educational examination; electronic desktop publishing; entertainer services; entertainment information; film production, other than advertising films; gambling; game services provided on-line from a computer network; games equipment rental; gymnastic instruction; health club services [health and fitness training]; holiday camp services [entertainment]; language interpreter services; layout services, other than for advertising purposes; lending libraries; microfilming; modelling for artists; movie studios; music composition services; music-halls; news reporters services; night clubs; nursery schools; operating lotteries; orchestra services; organization of balls; organization of competitions [education or entertainment]; organization of exhibitions for cultural or educational purposes; organization of fashion shows for entertainment purposes; organization of shows [impresario services]; organization of sports competitions; party planning [entertainment]; personal trainer services [fitness training]; photographic reporting; photography; physical education; practical training [demonstration]; presentation of live performances; production of music; production of radio and television programmes; production of shows; providing amusement arcade services; providing casino facilities [gambling]; providing films, not downloadable, via video-on-demand transmission services; providing television programmes, not downloadable, via video-on-demand transmission services; providing golf facilities; providing karaoke services; providing museum facilities [presentation, exhibitions]; providing on-line electronic publicati-

ons, not downloadable; providing recreation facilities; providing sports facilities; publication of books; publication of electronic books and journals on-line; publication of texts, other than publicity texts; radio entertainment; recording studio services; recreation information; religious education; rental of artwork; rental of audio equipment; rental of camcorders; rental of cine-films; rental of indoor aquaria; rental of lighting apparatus for theatrical sets or television studios; rental of movie projectors and accessories; rental of radio and television sets; rental of show scenery; rental of skin diving equipment; rental of sound recordings; rental of sports equipment, except vehicles; rental of sports grounds; rental of stadium facilities; rental of stage scenery; rental of tennis courts; rental of video cassette recorders; rental of videotapes; sado instruction [tea ceremony instruction]; scriptwriting services; services of schools [education]; sign language interpretation; sport camp services; subtitling; television entertainment; theatre productions; ticket agency services [entertainment]; timing of sports events; toy rental; training services provided via simulators; translation; tuition; videotape editing; videotape film production; videotaping; vocational guidance [education or training advice]; vocational retraining; writing of texts, other than publicity texts; zoological garden services; provision and production of audio visual content relating to entertainment, education, training, sport and culture; education and entertainment services by means of radio, television, telephony, the internet and on-line databases; hiring, rental and leasing of cine-films, videos, DVDs, sound recordings, sound recording apparatus, sports apparatus, television sets and video recorders, DVD recorders and radio recorders; production of films for television and cinema; providing on-line electronic publications (not downloadable); publication of magazines, books, texts and printed matter; publication of electronic books or journals on-line; provision of electronic publications; provision of online dictionaries, encyclopaedias, and reference texts; provision of online publications, including newspapers, magazines (periodicals), comics, journals (publications), books, user manuals, instructional and teaching materials; provision of online posters, photographs, pictures, articles; issuing of online tickets in relation to entertainment, educational, sporting and cultural activities; provision of recording studio facilities; hire of recording studios; live show production services; organising of sporting activities and competitions; box office services; box office services in relation to booking of tickets for entertainment, educational, sporting and cultural activities, box office information services in relation to booking of tickets for entertainment, educational, sporting and cultural activities; production and presentation of programmes transmitted by television, the Internet or other telecommunication channels for the conduct of the interactive viewing, selection and

purchase of goods; ticket reservation services relating to entertainment; production, presentation and distribution of radio and television programmes, interactive television, interactive games, interactive entertainment and interactive competitions; production, presentation and provision of competitions, contests, games, quizzes, studio entertainment and audience participation events; interactive television programme selection services for viewers; provision and production of interactive entertainment, entertainment and sporting news, cultural activities and sport for television viewers; interactive entertainment, educational, sporting and cultural services for television viewers; viewing guide services; viewing guide services facilitating the recordal and fixed term rental of programmes and movies; television programme recording services automatically initiated on the basis of customer viewing habits/preferences; video on demand and near video on demand entertainment, educational, sporting and cultural services; providing movies, videos and television programmes to viewers on demand and near video on demand; betting, gaming and gambling services; credit betting, gaming, gambling, lottery or bookmaking services; credit card betting, gaming, gambling, lottery or bookmaking services; organising and conducting lotteries; electronic betting, gaming, gambling, lottery or bookmaking services provided by means of the Internet, or via a global computer network, or on-line from a computer network database, or via telephony including to mobile telephones, or via a television channel including a television channel distributed by satellite, terrestrial or cable television broadcast; arranging and conducting competitions for video game players and computer game players; pay to play games services; peer to peer interactive games and gaming services; interactive poker games and gaming including single and multi player gaming formats; presentation and production of poker competitions, tournaments, games and gaming; educational or entertainment games played online; electronic publishing services; publishing services (including electronic publishing services); video taping and filming services; information and advisory services relating to the aforesaid services; provision of news reporting, current affairs information and sports information; news reporting, current affairs and educational information services; information and advisory services relating to television and radio programmes, to education, recreation, entertainment, music and to sport; booking and issuing of tickets for entertainment, sporting and cultural events; information and advisory services relating to television and radio programmes, to education, recreation, entertainment, music and to sport, provided on-line from a computer database or the Internet or to mobile telephones; factual information services relating to television and radio programmes, news reporting and sport; instruction services; training

services; leisure services; demonstration services for cultural, training, educational & entertainment purposes; advisory services relating to entertainment; arranging conferences, seminars, symposiums or workshops; arranging exhibitions or festivals; ticket reservation and booking services for cultural and sporting events; cinema services; cinema studio services; distribution of radio programmes, television programmes, films, motion pictures, pre-recorded video tapes, audio and/or visual material, pre-recorded video cassettes, DVDs or pre-recorded video discs; production of radio programmes, television programmes, films, motion pictures, pre-recorded video tapes, audio and/or visual material, pre-recorded video cassettes, DVDs or pre-recorded video discs; editing of radio programmes, television programmes, films, motion pictures, pre-recorded video tapes, audio and/or visual material, pre-recorded video cassettes, DVDs or pre-recorded video discs; hire, leasing or rental of radio programmes, television programmes, films, motion pictures, pre-recorded video tapes, audio and/or visual material, pre-recorded video cassettes, DVDs or pre-recorded video discs; exhibition of radio programmes, television programmes, films, motion pictures, pre-recorded video tapes, audio and/or visual material, pre-recorded video cassettes, DVDs or pre-recorded video discs for entertainment, educational, sporting or cultural purposes; amusement park services with a theme of films, radio or television productions; organisation of amusement parks and theme parks; organisation of entertainment; preparation and production of radio programmes, television programmes, films, pre-recorded video tapes, DVDs, audio and/or visual material, pre-recorded video cassettes, pre-recorded video discs or motion pictures for distribution for transmission or broadcast by any means; provision of radio programmes, television programmes, films, audio and/or visual material or motion pictures online (not downloadable); publication of printed media and recordings; digital photography services; dubbing; video tape editing; entertainment; film production; rental of motion pictures; movie studios; providing movie theatres facilities; production of shows; video film tape production; rental of audio equipment; rental of lighting apparatus for theatrical sets or television studios; rental of motion pictures; rental of movie projectors and movie projector accessories; rental of televisions and television equipment; rental of sports equipment; rental of video cameras; rental of video tapes; rental of video recorders; theatre productions; movie studio services; organising or hosting awards ceremonies; presentation of films; production of special effects for films; reservation services (included in this class) for sporting, scientific, political and cultural events; recording studio services; provision of video and audio content by rental, whereby the consumer is entitled to single or multiple viewings of the media content

via any form of playback device, all relating to entertainment, education, sports and culture; education and providing of training in connection with environmental protection, energy conservation and ecology and animal welfare; education and providing of training in connection with alternative energy sources, including wind power, hydroelectric power, tidal power, geothermal power, solar power, biomass, and biofuels; publication of instructional material and promotional material relating to environmental protection, energy conservation and ecology and animal welfare; arranging and conducting of seminars and workshops (training); establishing training programmes; preparation and publication of training manuals; organising and conducting safety courses and educational courses; online news reporting services; online provision of information and general encyclopaedic knowledge relating to entertainment, education, training, sports, culture, news, current affairs, satellite, television and radio programmes, music, films, books and other printed matter, video games, computer games, amusement machines, amusement centres or amusement parks; online translation services; online library services including the lending and exchanging of books and other publications and photographs; provision of online classes, seminars, workshops, exhibitions and displays; leasing, booking and providing of diving equipment; online card games; organization of sports and holiday camps; ring tones (not downloadable) provided via the Internet; arranging, organisation and running of individual cyclists and/or cycling teams and/or cycling events; provision of professional cycling services; organisation of cycling events; provision of online fitness tracking; high-definition studios, edit suites, voice-over studios and audio suites; career counselling; aerial photography services; archive library services; audio and video recording services; audio, film, video and television recording facilities; booking of seats for entertainment, sporting and cultural events; career advisory services (education or training); casino services; concert ticket booking services; sports coaching services; professional workshop and training course services; commercial, trade and business workshops and training course services; provision of workshops, seminars and training courses relating to problem solving, think-tank and brainstorming; cycling training services; dietary education services; television programme directing services; radio programme directing services; film, music, plays, theatrical production, musical shows, concerts, exhibitions, sporting events and road show directing services; distance learning services; ticket reservation and booking services for entertainment events; exercise class services; entertainment services provided via fan clubs; fitness club services; gym services; hiring, leasing or rental services in relation to radio programmes, television programmes, films, motion pictures, pre-recorded video tapes,

audio and/or visual material, pre-recorded video cassettes, DVDs or pre-recorded video discs; hiring, rental and leasing service in relation to entertainment; interactive entertainment services, interactive games services, interactive news reporting services, interactive services, interactive sport services, interactive television services; online distance learning services; photography services; photographic services; personal training services; online gaming services; recreation services; special events planning services; sporting services; sporting tuition course services; teaching services; team building (education); university services; organisation of cycling events; leasing, rental and hiring of data rooms for entertainment, sporting and cultural events; high-definition studios, edit suites, voice-over studios and audio suites; circuses; arranging, organisation, promotion, production, management, conducting, presentation and staging of entertainment, events, concerts, festivals, gigs and live band performances including such services provided on-line from a computer database or the Internet; arranging of festivals for entertainment, cultural and recreational purposes; festival services; performance of music, dance, comedy, theatre, poetry and circus entertainment, including such services provided on-line from a computer database or the Internet; arranging of musical events; organisation of events for fund raising; entertainment and cultural events; provision of information relating to festivals; provision of leisure, entertainment and recreation facilities; provision of playrooms and games rooms; organisation of parties; provision of facilities for parties; party and event organisation and planning services; organisation and staging of dance events, music and live music entertainment; provision of live music; provision of live musical performances & shows; arranging of music performances; entertainment in the form of live musical performances; music festival services; music performance services; music entertainment services; nightclub services; organising nightclub events; publication of texts (other than publicity texts); entertainment services, namely, providing podcasts; recording of music onto a variety of media; presentation and distribution of sound and video recordings; hiring disc jockeys; composition of music; music production; music publishing and music recording services; music recording; song publishing; provision of on-line music and on-line videos (not downloadable); production, presentation, distribution, syndication, networking and rental of radio and television programmes and of music, sound and video recordings; non-downloadable radio programmes, television programmes, videos, sound, images or data accessed from the Internet or other communication networks; providing on-line electronic publications; providing downloadable pre-recorded music and video for a fee or pre-paid subscription via the Internet; organisation of competitions, concerts and live shows; club

services [entertainment]; disc jockey services; presentation of live performances; music composition services; providing on-line voting services via the Internet or a wireless communication device for entertainment purposes; production of dance shows, music shows and video award shows; comedy shows, game shows and sports events before live audiences which are broadcast live or taped for later broadcast; organising talent contests and music and television award events; entertainment, namely providing streamed or downloadable music, film, tv-programs, audio books and games to users online via a communication network; creating and publication of playlists; entertainment services, namely, a musical chart service that provides the consumer with updated statistical ranking of songs based on radio airplay, sales of recordings, streaming of music to devices and views of internet videos; virtual reality studios; production, presentation and distribution of virtual reality/augmented reality content; consultancy, information and advisory services relating to all the aforesaid services; professional consultancy, information and advisory services relating to all the aforesaid services; consultancy, information and advisory services relating to all the aforesaid services provided on-line from a computer database or via a helpline or the Internet.

(260) AM 2020 102290 A
 (800) 1456552
 (151) 2019 01 17
 (891) 2019 01 17
 (731) JOHANN BERGMANN GMBH & CO
 Azendorf 63, 95359 Kasendorf,
 Germany
 (540)

ecolor

(591) Black, white
 (511)
 2 – Paints; painting colors; mineral or organic paints, preferably interior paints, exterior paints, solar paints, house paints; primer for all aforementioned paints.

(260) AM 2020 102429 A
 (800) 1458021
 (151) 2019 01 31
 (891) 2019 01 31
 (731) FRIESLANDCAMPINA NEDERLAND B.V.
 Stationsplein 4, NL-3818 LE Amersfoort,
 Netherlands

(540)



(591) Blue, white and gold
 (531) 03.04.02; 07.01.13; 24.17.02; 26.02.01;
 26.04.05; 26.04.22; 29.01.13
 (511)
 29 – Milk powder for pregnant and lactating women.

(260) AM 2020 102611 A
 (800) 1459903
 (151) 2018 11 29
 (891) 2018 11 29
 (731) PUMA SE
 PUMA Way 1, 91074 Herzogenaurach,
 Germany

(540)



(591) Black, white
 (531) 27.05.17
 (511)
 9 – sunglasses; eyeglasses; spectacle lenses and frames; spectacle cases; contact lenses; spectacle chains; clothing for protection against accidents, including footwear; clothing especially made for rescue purposes face-protection shields, protective eyewear and masks; helmets, including protective helmets for motorists and cyclists as well as protective helmets for sports; special containers (cases, sheaths, housings), adapted to the apparatus and instruments included in this class.

14 – Precious metals and their alloys; jewellery, ornaments, precious stones; mechanic or electric watches for horological purposes, also as day counters, stopwatches, divers' watches; clocks; parts and fittings for watches; wristwatches; electronic clocks and watches; bracelets [jewelry]; watchbands; control clocks [master clocks]; their parts and fittings, namely cases and gift containers for watches, stands for clocks, chains for watches and watch straps; cases for watches [presentation].

(260) AM 2020 102739 A
 (800) 1461033
 (151) 2019 02 25
 (891) 2019 02 25
 (731) RAYBO (BEIJING) TECHNOLOGY CO.,
 TD.

ROOM 092, 3RD FLOOR, SUITE D,
 BUILDING 24, YARD 68, BEIQING RD,
 HAIDIAN DISTRICT, 100094 BEIJING,
 China

(540)



(591) Black, white
 (531) 27.05.01
 (511)
 9 – Computers; cash registers; monitoring apparatus, electric; cameras [photography]; cinematographic film, exposed; computer peripheral devices; computer software, recorded; encoded key cards; invoicing machines; electronic agendas; cell phones; data processing apparatus; computer memory devices; computer programs [downloadable software]; computer software applications, downloadable; chips [integrated circuits]; computer hardware; navigational instruments.

36 – Art appraisal; real estate agencies; lending against security; capital investment; guarantees; trusteeship; clearing, financial; charitable fund raising; insurance brokerage; financial evaluation [insurance, banking, real estate]; financial information.

38 – Television broadcasting; communications by computer terminals; providing online forums; message sending; computer aided transmission of messages and images; providing internet chatrooms; electronic mail; electronic bulletin board services [telecommunications services]; providing telecommunications connections to a global computer network.

41 – Arranging and conducting of colloquiums; arranging and conducting of conferences; arranging and conducting of in-person educational forums; game services provided on-line from a computer network; providing on-line music, not downloadable; organization of competitions [education or entertainment]; on-line publication of electronic books and journals; providing on-line electronic publications, not downloadable.

(260) AM 2020 102873 A
 (800) 1462889
 (151) 2018 12 21
 (891) 2018 12 21
 (731) INMOTION ENTERTAINMENT GROUP,
 LLC
 4801 Executive Park Court, Suite 100,
 JACKSONVILLE FL 32216, USA

(540)



(591) Black, white
 (531) 27.01.06; 27.01.12

(511)

35 – Retail store services in the field of consumer electronics, photographic equipment, cellular phones, telecommunications products, video equipment, audio equipment, portable electronic devices and related accessories, personal computers, digital tablets, digital audio visual recording and playing devices, batteries, wearable fitness tracking devices, headsets including headphones and ear buds, noise cancellation devices, accessories for portable electronic devices, digital storage devices, chargers, carrying cases for portable electronic devices, cellular phones, tablets, laptops and cameras, luggage and accessories, travel accessories, prepaid phone cards, and travel comfort accessories; retail store services featuring a wide variety of consumer goods sold by others relating to technology products and their accessories.

(260) AM 2020 102978 A

(800) 1464615

(151) 2019 03 08

(891) 2019 03 08

(731) BEWITAL HOLDING GMBH & Co KG

Industriestr. 10, 46354 Südlohn,
Germany

(540)

БЕЛЬКАНДО

(591) Black, white

(531) 28.05

(511)

31 – Food for animals; foodstuffs (animal-), foodstuffs for dogs; foodstuffs for cats.

44 – Veterinary and agricultural services; hygienic and beauty care for animals.

(260) AM 2020 103057 A

(800) 1465649

(151) 2019 03 07

(891) 2019 03 07

(731) DR. THEISS NATURWAREN GMBH

Michelinstr. 10, 66424 Homburg, Germany

(540)



(591) Grey

(531) 26.01.06; 26.01.20; 26.01.24; 27.05.10;
27.05.11

(511)

3 – Bleaching preparations and laundry preparations; Cleaning, polishing, scouring and abrasive preparations; Perfumery, essential oils, non-medicated cosmetics, including non-medicated skin cleaning and skin care preparations, and hair care preparations; Non-medicated dentifrices.

5 – Pharmaceutical and veterinary preparations; Medicines for human purposes; Medicines for veterinary purposes; Sanitary preparations for medical purposes; Dietetic foodstuffs and substances adapted for medical use; Nutritional supplements for humans and animals; Vitamin preparations.

(260) AM 2020 103058 A

(800) 1465654

(151) 2019 01 08

(891) 2019 01 08

(731) ORIFLAME COSMETICS AG

c/o Oriflame Global Management AG,
Bleicheplatz 3, CH-8200 Schaffhausen,
Switzerland

(540)

ORIFLAME FEEL GOOD

(591) Black, white

(511)

3 – Non-medicated conditioning and care preparations for application to the hair, scalp, skin and nails; shampoos; hair conditioner; soaps; perfumes; perfumery; eau de cologne; toilet waters; essential and herbal oils; cosmetics; make-up; make-up preparations; lipsticks; nail varnishes; nail varnish removers; eyeliner; mascara; non-medicated toilet preparations; hair lotions; hair sprays and hair gels; preparations for use in the bath or shower; bath and shower oils, gels, creams and foams; face and body masks; face and body scrubs; facial washes; skin cleansers and hydrators; skin toners; skin moisturizers; blemish creams and blemish gels; deodorants; antiperspirants; preparations for use before shaving and after shaving; shaving soaps; shaving creams; shaving gels; after-shave preparations; pre-shave preparations; talcum powders; toiletries; dentifrices; toothpastes; foot care preparations (non-medicated).

(260) AM 2020 103059 A

(800) 1465700

(151) 2019 02 26

(891) 2019 02 26

(731) HUAWEI TECHNOLOGIES CO., LTD.

HUAWEI ADMINISTRATION BUILDING,
BANTIAN, LONGGANG DISTRICT,
SHENZHEN, 518129 GUANGDONG, China

(540)

FreeLace

(591) Black, white

(511)

9 – Earphones; cabinets for loudspeakers; headphones; sound transmitting apparatus; sound recording apparatus; microphones; video recorders; camcorders; electrical and electronic video monitoring apparatus; video monitors; portable media players; ultra high definition televisions; liquid crystal display (LCD) televisions; computer software, recorded; computer programs, downloadable; facial recognition apparatus; downloadable image files; smartphone software applications, downloadable; downloadable ring tones for mobile phones; computer software applications, downloadable; downloadable music files; head-mounted video displays; security tokens [encryption devices]; computer programs, recorded; tablet computers; data processing apparatus; smartphones; smartwatches; transmitters of electronic signals; notebook computers; network communication equipment; computer game software, downloadable; electronic publications, downloadable; cameras [photography]; chips [integrated circuits].

(260) AM 2020 103060 A

(800) 1465703

(151) 2018 11 19

(891) 2018 11 19

(731) Closed Joint Stock Company

"STARODVORSKIE KOLBASY"

ul. Poliny Osipenko, 41, of. 210, RU-600009

g. Vladimir, Russian Federation

(540)

СТАРОДВОРЬЕ

(591) Black, white

(531) 28.05

(511)

29 – Meat, fish, poultry and game; meat extracts; preserved, frozen, dried and cooked fruits and vegetables; jellies, jams, compotes; eggs, milk and milk products; oils and fats for food; avocados, processed; quinces, processed; ajvar [preserved peppers]; sweetfish, not live; aloe vera prepared for human consumption; alginates for culinary purposes; anchovies, processed; oranges, processed; canned peanuts; peanuts, prepared; artichokes, processed; fried plantain; albumen for culinary purposes; textured vegetable protein for use as a meat extender; white of eggs; prepared entrées consisting primarily of seafood; vegetable-based entrées; frozen pre-packaged entrées consisting primarily of seafood; frozen meals consisting primarily of meat, fish, poultry or vegetables; packaged meals consisting primarily of meat, fish, poultry or vegetables; prepared meals consisting primarily of meat, fish, poultry or vegetables; beans, preserved; beans, processed; refried beans; soya beans, preserved, for food; dried soya beans; natto [fermented soya beans]; soya beans, processed;

beans, dried; beef stock; veal stock; chicken stock; fish stock; bouillon; prepared stock; ginger jam; ham; fatty substances for the manufacture of edible fats; maraschino cherries; cherries, processed; yakinori [sheets of toasted laver]; dried edible seaweed; processed algae for human consumption; edible seaweed, processed; dried edible algae; ghee; edible birds' nests; beef; dried beef; beef slices; prepared beef; beef stew; peas, preserved; peas, processed; peas, prepared; mushrooms, preserved; mushrooms, processed; mushrooms, prepared; jerky; sea urchins, not live; gelatine; meat jellies; vegetable jellies; jellies for food; fish jellies; fruit jellies; yolk of eggs; beef tallow for food; whale fat for food; coconut fat; bone oil for food; lard; short-necked clams, not live; suet for food; vegetable fats for food; non-dairy creamers; coffee whiteners consisting primarily of dairy products; creamers for beverages; frozen appetizers consisting primarily of chicken; frozen appetizers consisting primarily of seafood; fruit-based snack food; potato-based snack foods; nut-based snack foods; antipasto salads; aspic; margarine substitutes; butter substitutes; meat substitutes; poultry substitutes; vegetable-based meat substitutes; sour cream substitutes; cheese substitutes; egg substitutes; vegetable-based snack foods; shepherd's pie; headcheese; charcuterie; fish sausages; raisins; sea salmon roe for food; sea trout roe for food; fish roe, processed; crème fraîche; turkey; figs, dried; yogurt; drinking yogurts; processed cactus for food; sauerkraut; cabbage, processed; carp, not live; fried potatoes; potatoes, preserved; potatoes, processed; sweet potatoes, processed; French fries; kephir [milk beverage]; kimchi [fermented vegetable dish]; isinglass for food; clams, not live; potato-based dumplings; milk shakes; black pudding; kielbasa; onion rings; compotes; meat, tinned; vegetables, tinned; fish, tinned; fruits, tinned; bouillon concentrates; pickled watermelon rind; processed roots for human consumption; gherkins; crab cakes; beef patties; veggie burger patties; soya burger patties; hamburger patties; uncooked hamburger patties; turkey burger patties; fish cakes; crabs, not live; shrimps, not live; prawns, not live; dried prawns; buttercream; salmon croquettes; fish croquettes; stock cubes; silkworm chrysalis for human consumption; kumys [milk beverage]; chicken, not live; kelp, processed; spiny lobsters, not live; lecithin for culinary purposes; sea bream, not live; salmon, not live; smoked salmon; lemons, processed; onions, preserved; onions, processed; onions, prepared; red snapper, not live; mangos, processed; margarine; marmalade; hydrogenated oils for food; hardened oils for food; vegetable oils for food; spiced oils; peanut butter; peanut oil for food; grape-seed oil for food; cooking oil; cashew nut butter; cocoa butter; whale oil for food; coconut oil for food; coconut butter; corn oil for food; sesame oil for food; extra virgin olive oil for culinary purposes; olive oil for culinary purposes; olive oil for food; palm

oil for food; palm kernel oil for food; sunflower oil for food; colza oil for food; rice bran oil for food; pumpkin seed oil for food; butter; soya bean oil for food; clarified butter; blue mussels, not live; shellfish, not live; almonds, processed; almonds, ground; animal marrow for food; ark shells, not live; shortening; mussels, not live; acidophilus milk; goat's milk; coconut milk for culinary purposes; hemp milk for use as a milk substitute; cow's milk; sheep's milk; condensed milk; soya milk [milk substitute]; albumin milk; powdered milk; rice milk for use as a milk substitute; seafood, canned; seafood, processed; fish meal for human consumption; chicken mousses; meat-based spreads; vegetable mousses; fish mousses; fruit pulp; fried meat; luncheon meat; meat, frozen; meat, preserved; meat, processed; sliced meat; meat, prepared; cooked meat, canned; ground meat; dried meat; beverages made from yogurt; lactic acid drinks; milk-based beverages containing coffee; milk-based beverages flavored with chocolate; milk beverages, milk predominating; milk-based beverages containing fruits; milk-based beverages containing fruit juice; dairy-based beverages; beverages consisting primarily of milk; lactic acid bacteria drinks; mincemeat made from fruits; fruit-based fillings for cakes and pies; chickpeas, processed; pre-packaged dinners consisting primarily of game; pre-packaged dinners consisting primarily of seafood; pre-packaged dinners consisting primarily of meat; pre-packaged dinners consisting primarily of poultry; pre-packaged dinners consisting primarily of fish; grilled vegetables; vegetables preserved in oil; pickled vegetables; cut vegetables; sliced vegetables, canned; vegetables, processed; spicy pickles; sea bass, not live; potato fritters; olives, preserved; olives, processed; processed olives, canned; olives, cooked; olives, prepared; olives stuffed with red peppers; olives stuffed with almonds; olives, stuffed, with sauce; olives, stuffed, with sunflower oil; olives, dried; lobsters, not live; omelets; blanched nuts; walnuts, prepared; roasted nuts; candied nuts; pine nuts, processed; coconut, processed; coconut, prepared; coconut, desiccated; nuts, prepared; seasoned nuts; octopuses, not live; cheese sticks; potato sticks; papayas, processed; anchovy paste; artichoke paste; guava paste; crab roe paste; nut butter; almond butter; olive pastes; tomato purée; fruit paste; soup pastes; vegetable pastes; buttermilk; liver pâté; meat pâté; fruit pectin for culinary purposes; pectin for culinary purposes; peppers, processed; pepperoncinis, processed; peppers, prepared; pimientos, processed; breaded and fried peppers; pickled peppers; peaches, processed; liver; pulses, processed; pulses, dried; jams; lemon curd; powdered coconut milk; powdered eggs; animal kidneys [offal]; fermented milk; processed meat products; food products made from fish; canned fish products; smoked fish products; processed fish products for human consumption; bean sprouts, processed; prostokvasha [soured milk];

poultry, not live; pollen prepared as foodstuff; mashed potatoes; instant mashed potato; cranberry compote; vegetable purées; fruit purées; apple purée; stews; instant stew; pre-cooked stew; crayfish, not live; crustaceans, not live; fish, preserved; smoked fish; pickled fish; fish, not live; fish and chips; salted fish; ryazhenka [fermented baked milk]; coleslaw; vegetable salads; fruit salads; bacon; sardines, not live; beets, processed; pork; pork, canned; canned pork and beans; herrings, not live; seeds, prepared; sunflower seeds, prepared; processed pumpkin seeds; whipped cream; whipping cream; artificial cream [dairy product substitutes]; cream [dairy products]; mixes for making broths; mixes for making soup; fat-containing mixtures for bread slices; snack mixes mainly consisting of processed nuts and dehydrated fruit or raisins with addition of sauce; snack mixes consisting of processed fruits, processed nuts or raisins; snack mixes consisting of dehydrated fruit and processed nuts; blended oil for food; dried fruit mixes; half and half [milk and cream mixture]; smetana [sour cream]; candied fruit snacks; soya-based snack foods; dried fruit-based snacks; vegetable juices for cooking; clam juice; meat juices; tomato juice for cooking; truffle juice; salted meats; corned beef; corned beef hash; sausages; vegetarian sausages; sausages in batter; hot dog sausages; preserved sausages; uncooked sausages; preparations for making bouillon; preparations for making soup; asparagus, processed; hazelnut spreads; dairy-based spreads; meatballs; vegetable-based spreads; fruit-based spreads; garlic-based spreads; fruit spreads; tripe; pre-cooked soup; bisques; matzo ball soup; soups; vegetable soup preparations; dried fruits; whey; goat's milk cheese; sheep's milk cheese; smoked cheese; soft cheese; cheese spreads; fresh unripened cheeses; blended cheese; hard cheese; cheese powder; soft-ripened cheeses; ripened cheeses; mold-ripened cheeses; strained soft white cheeses; tahini [sesame seed paste]; strained cheese; cottage cheese; tofu; veal; chicken croquettes; tomatoes, canned; tomatoes, processed; peeled tomatoes; cod, not live; truffles, preserved; dried truffles [edible fungi]; tuna fish; snails, canned; snails, cooked; snails prepared for human consumption; oysters, not live; abalones, not live; milk ferments for culinary purposes; rennet; chicken breast fillets; fish fillets; dates, processed; dates, dried; pistachios, prepared; meat-based mousses; crystallized fruits; frozen fruits; fruit preserved in alcohol; pickled fruits; cut fruits; sliced fruits, canned; fruit, stewed; potato flakes; flaked coconut; hummus [chickpea paste]; edible flowers, processed; processed edible flowers in crystallized form; fruit peel; chowder; soft-shelled turtles, not live; blueberries, processed; prunes; preserved garlic; lentils, preserved; lentils, dried; banana chips; potato chips; low-fat potato chips; vegetable chips; soya chips; fruit chips; chorizo; bacon rinds; pork rinds; spinach, frozen; spinach, canned;

spinach, cooked; non-alcoholic eggnog; seaweed extracts for food; poultry extracts; tomato extracts; apples, processed; lamb, processed; walnut kernels; nutmeats; frozen eggs; hen's eggs; eggs, processed; quail eggs; snail eggs for consumption; duck eggs; yams, processed.

30 – Coffee, tea, cocoa and artificial coffee; rice; tapioca and sago; flour and preparations made from cereals; bread, pastries and confectionery; ice cream; sugar, honey, treacle; yeast, baking-powder; salt; mustard; vinegar, sauces [condiments]; spices; ice for refreshment; aromatic preparations for food; flavorings, other than essential oils, for cakes; flavorings, other than essential oils, for beverages; coffee flavorings; star aniseed; high-protein cereal bars; muesli bars; flapjacks [oat bars]; chocolate bars; filled chocolate bars; sponge cakes; cheese-flavored corn snacks; pancakes; fruit ice bars; ice milk bars; vanillin [vanilla substitute]; cotton candy; waffles; vermicelli [noodles]; natural sweeteners; sausage binding materials; sea water for cooking; seaweed [condiment]; biscuits for cheese; malt biscuits; clove powder [spice]; cloves [spice]; cake frosting [icing]; honey glazes for ham; frosting; glucose for culinary purposes; croûtons; custards [baked desserts]; floating islands; chocolate desserts; gluten additives for culinary purposes; processed ginseng for use as an herb, spice or flavoring; thickening agents for cooking foodstuffs; leaven; rice-based snack food; cereal-based snack food; chicory-based coffee substitutes; vegetal preparations for use as coffee substitutes; sugar substitutes; tea substitutes; dressings for salad; roasted coffee beans; sugar-coated coffee beans; toasted corn kernels; fruit jellies [confectionery]; confectionery for decorating Christmas trees; frozen confectionery; cakes; pastries; peanut confectionery; almond confectionery; pasta shells; pasta for soups; fresh pasta; preserved ginger [condiment]; pickled ginger [condiment]; ginger [spice]; cocoa-based ingredients for confectionery products; toffees; frozen yogurt [confectionery ices]; prepared cocoa beverages; cocoa powder; cocoa mixes; cream of tartar for culinary purposes; capers; caramels [candy]; sugar-coated hard caramels; curry [spice]; kasha; chervil, preserved; ketchup [sauce]; tomato ketchup; quiches; gluten prepared as foodstuff; rice dumplings; peanut brittle; sweetmeats [candy]; gum sweets; gummy candies; candy made with caramel; liquorice [confectionery]; peppermint sweets; starch-based candies; bonbons made of sugar; candy made with cocoa; chocolate candies; cinnamon powder [spice]; cinnamon [spice]; caffeine-free coffee; ground coffee; instant coffee; iced coffee; unroasted coffee; cornstarch for culinary purposes; starch for food; wheat starch flour; custard; custard powder; crème caramels; chocolate-coated pretzels; pretzels; chocolate chips; croissants; hominy grits; semolina; oatmeal; pearl barley; crushed barley; groats for hu-

man food; ice cubes; corn, milled; maize, processed; corn, roasted; meat pies; couscous [semolina]; dried wheat gluten; noodles; bean-starch noodles; instant noodles; rice noodles; dried noodles; candy; ice milk; ice, natural or artificial; edible ices; flavored ices; fried dough cookies; chalupas [corn tortillas]; millet cakes; rice cakes; poppadums; mayonnaise; almond cookies; macaroni; maltose; hominy; marzipan; molasses syrup for culinary purposes; bean meal; buckwheat flour for food; potato flour; corn flour; flour; wheat flour; soya flour; rice flour; barley meal; barley flour for food; dessert mousses [confectionery]; chocolate mousses; muesli; crumb; mint for confectionery; cocoa beverages with milk; coffee beverages with milk; coffee-based beverages; prepared coffee beverages; coffee-based beverages containing milk; cocoa-based beverages; chocolate-based beverages with milk; tea-based beverages; chocolate-based beverages; custard-based fillings for cakes and pies; bread-based stuffing mixes; chocolate-based fillings for cakes and pies; crushed oats; oats, processed; husked oats; banana fritters; pineapple fritters; apple fritters; nutmegs; pizza crust; stick liquorice [confectionery]; breadsticks; curry paste; soya bean paste [condiment]; chocolate paste; pastilles [confectionery]; non-medicated lozenges [confectionery]; molasses for food; granulated sugar; pesto [sauce]; cookies; onion biscuits; petit-beurre biscuits; salted biscuits; savory biscuits; pies; potpies; poultry and game meat pies; almond cakes; custard tarts; pizzas; fresh pizzas; meat gravies; fondants [confectionery]; doughnuts; popcorn; candy-coated popcorn; glazed popcorn; caramel-coated popcorn; mustard meal; mustard powder [spice]; yeast powder; curry powder [spice]; powdered garlic; chocolate powder; pralines; prepared horseradish [condiment]; meat tenderizers for household purposes; ready-to-eat cereals; breakfast cereals; oat-based food; chocolate products; propolis [bee glue] for human consumption; gingerbread; petits fours [cakes]; puddings; cake powder; powdered sugar; wheat, processed; pounded wheat; crumpets; fruit coulis [sauces]; ravioli; sugar-free chewing gum [confectionery]; relish [condiment]; chewing gum, not for medical purposes; cooked rice; puffed rice; artificial rice; brown rice; steamed rice; enriched rice; wheat germ for human consumption; spring rolls; white sugar; palm sugar; crystal sugar pieces [confectionery]; aniseed; linseed for culinary purposes [seasoning]; pancake syrup; golden syrup; starch syrup for culinary purposes; corn syrup for culinary purposes; table syrup; chocolate syrups; confectionery; sweetmeats made of sesame oil; cream puffs; pancake mixes; instant pancake mixes; instant doughnut mixes; instant pudding mixes; cookie mixes; pastry mixes; seasoned coatings; frosting mixes; cake mixes; mixtures of coffee and chicory; crab boil [seasoning]; spice mixes; curry spice mixes; baking soda [bicarbonate of soda for cooking purposes]; malt for hu-

man consumption; salt for preserving foodstuffs; edible salt; cooking salt; celery salt; table salt; table salt mixed with sesame seeds; sherbets [ices]; ham glaze; curry sauce; soya sauce; tomato sauce; pasta sauce; sauces [condiments]; cocoa spreads; preparations for stiffening whipped cream; confectionery chips for baking; vanilla pods; sushi; tabbouleh; tacos; dough; wafer dough; cookie dough; frozen cookie dough; pizza dough; bread dough; almond paste; chocolate toppings; tortillas; tortilla shells; iced cakes; fruit cakes; processed herbs [seasonings]; garden herbs, preserved [seasonings]; dried herbs for culinary purposes; cinnamon rolls; wine vinegar; beer vinegar; ferments for pastes; halvah; bread; wholemeal bread; unleavened bread; pita bread; bread flavored with spices; bread made with soya beans; fruit bread; crispbread; garlic bread; corn flakes; oat flakes; chips [cereal products]; horseradish; chicory [coffee substitute]; chicory and chicory mixtures for use as substitutes for coffee; herbal teas, other than for medicinal use; fruit teas; theine-free tea; theine-free tea with added sweeteners; white tea; green tea; lime blossom tea; black tea; chutneys [condiments]; noodle-based prepared meals; tortilla chips; corn chips; corn curls [cheese-flavored puffed corn snacks]; grain-based chips; saffron [seasoning]; chocolate; hot chocolate; milk chocolate; filled chocolates; malt extract for food; yeast extracts for human consumption; cocoa extracts for human consumption; coffee extracts; tea extracts; coffee essences; essences for foodstuffs, except etheric essences and essential oils; husked barley; piccalilli; candy-coated apples; sausage rolls; peanut butter chips [confectionery].

35 – Arranging subscriptions to telecommunication services for others; import-export agency services; commercial information agency services; advertising agency services; cost price analysis; rental of advertising space; business auditing; employment agency services; computerized file management; book-keeping; invoicing; demonstration of goods; transcription of communications [office functions]; opinion polling; market studies; business information; business investigations; business research; marketing research; personnel recruitment; business organization consultancy; business management consultancy; personnel management consultancy; professional business consultancy; layout services for advertising purposes; marketing; business management of performing artists; business management of sports people; writing of résumés for others; updating and maintenance of data in computer databases; word processing; organization of exhibitions for commercial or advertising purposes; arranging newspaper subscriptions for others; organization of fashion shows for promotional purposes; organization of trade fairs for commercial or advertising purposes; shop window dressing; design of advertising materials; business

appraisals; payroll preparation; data search in computer files for others; sponsorship search; business management assistance; commercial or industrial management assistance; commercial intermediation services; provision of commercial and business contact information; providing business information via a web site; economic forecasting; auctioneering; sales promotion for others; production of advertising films; office machines and equipment rental; rental of advertising time on communication media; publicity material rental; rental of signs for advertising purposes; rental of vending machines; rental of sales stands; rental of photocopying machines; publication of publicity texts; radio advertising; bill-posting; distribution of samples; dissemination of advertising matter; direct mail advertising; writing of publicity texts; on-line advertising on a computer network; advertising by mail order; television advertising; document reproduction; compilation of statistics; compilation of information into computer databases; business inquiries; systemization of information into computer databases; negotiation and conclusion of commercial transactions for third parties; tax preparation; drawing up of statements of accounts; telemarketing services; psychological testing for the selection of personnel; business management of hotels; business management for freelance service providers; commercial administration of the licensing of the goods and services of others; business project management services for construction projects; administrative processing of purchase orders; public relations; modelling for advertising or sales promotion; typing; relocation services for businesses; tax filing services; web site traffic optimization; price comparison services; secretarial services; procurement services for others [purchasing goods and services for other businesses]; shorthand; outsourcing services [business assistance]; telephone answering for unavailable subscribers; photocopying services; business efficiency expert services; commercial information and advice for consumers in the choice of products and services; business management and organization consultancy; updating of advertising material; news clipping services; provision of an on-line marketplace for buyers and sellers of goods and services; presentation of goods on communication media, for retail purposes; wholesale services for pharmaceutical, veterinary and sanitary preparations and medical supplies; pay per click advertising; search engine optimization for sales promotion; business management and consultancy services; outsourced administrative management for companies; business management of reimbursement programs for others.

43 – Providing temporary housing accommodation; accommodation bureau services [hotels, boarding houses]; rental of temporary accommodation in vacation homes and apartments; rental of temporary

accommodation; rental of temporary accommodation in the nature of villas and bungalows; rental of floor coverings for hotels; rental of meeting rooms; restaurant reservation services; hotel services; temporary accommodation; hotel catering services; retirement home services; take-away food and drink services; snack-bar services; hotel information services; cafeteria services; cafe services; consultancy provided by telephone call centers and hotlines in the field of temporary accommodation; outside catering services; motel services; providing temporary accommodation in vacation homes; providing temporary accommodation in hotels, motels and boarding houses; providing temporary accommodation for guests; providing accommodation in hotels and motels; arranging temporary housing accommodations; arranging and providing temporary accommodation; arranging hotel accommodation; boarding for animals; boarding house services; serving of alcoholic beverages; serving food and drink in bistros; serving food and drink for guests; serving food and drink in Internet cafes; serving food and drink in doughnut shops; serving food and drink in retail and takeaway establishments; serving food and drink for guests in restaurants; serving of tea, coffee, cocoa, carbonated drinks or fruit juice beverages; providing food and drink catering services for convention facilities; supplying meals to the homeless or underprivileged; providing of food and drink for patients and guests; providing food to needy persons [charitable services]; providing temporary lodging at holiday camps; providing information about temporary accommodation services; providing information about crèche services; providing information about temporary accommodation via the Internet; providing information relating to hotels; providing information about wine characteristics; providing conference rooms; providing conference, exhibition and meeting facilities; providing community centers for social gatherings and meetings; providing on-line advice and information services relating to wine and food pairings; providing on-line information relating to vacation accommodation reservations; providing on-line information relating to hotel reservations; providing food and drink; providing food and drink catering services for fair and exhibition facilities; providing food and drink in bistros; providing food and drink in Internet cafés; providing food and drink in doughnut shops; providing food and drink in restaurants and bars; providing food and drink for guests; providing food and drink for guests in restaurants; providing food and drink as part of hospitality services; providing food, drink and temporary accommodation for guests; providing hotel accommodation; advice concerning cooking recipes; providing bar services; providing hotel, motel and boarding house services; providing room reservation and hotel reservation services; providing travel lodging information services and travel lodging booking agency services for

travelers; providing restaurant services; preparation and provision of food and drink for immediate consumption; preparation and provision of food and drink for consumption on and off the premises; preparation and provision of food and drink for consumption in retail establishments; preparation of Japanese food for immediate consumption; preparation of food and beverages; rental of cooking apparatus; rental of chairs, tables, table linen, glassware; rental of lighting apparatus other than for theatrical sets or television studios; rental of tents; rental of transportable buildings; rental of towels for hotels; rental of drinking water dispensers; hotel room reservation services; restaurant, bar and catering services; fast-food restaurants and snack-bars; self-service restaurant services; canteen services; agency services for booking hotel accommodation; agency services for the reservation of temporary accommodation; holiday camp services [lodging]; bar and bistro services; bar and catering services; juice bar services; reservation and booking services for hotels, restaurants and holiday accommodation; hotel reservation services provided via the Internet; buffet services for cocktail lounges; delicatessens [restaurants]; wine bar services; temporary accommodation and catering services for guests; temporary accommodation services provided by holiday camps; serving of food and drink; hotel, motel and boarding house services; hotel accommodation services; snack-bar and cafeteria services; boarding for pets; self-service cafeteria services; cafeteria and restaurant services; providing campground facilities; cocktail lounge services; consultancy services in the field of culinary arts; consultancy services in the field of food and drink catering; catering services for hospitals; catering services for hospitality suites; catering services for nursing homes; catering services for conference centers; catering services for company cafeterias; catering services for the provision of food and drink; catering services for educational establishments; catering services for schools; hotel, bar and restaurant services; hotel, motel and resort services; temporary accommodation provided by dude ranches; pubs; services for the reservation of rooms; hostel services; pet day-care services; services for providing food and drink, and temporary accommodation; catering in fast-food cafeterias; serving food and drink in restaurants and bars; services for providing food and drink; food and drink catering for institutions; food and drink catering; food and drink catering for cocktail parties; food preparation services; take-away fast food services; restaurant, bar and cocktail lounge services; fast food and non-stop restaurant services; restaurants featuring home delivery; take-away food services; travel agency services for reserving temporary accommodation; travel agency services for reserving hotel accommodation; travel agency services for making hotel reservations; travel agency services for

making restaurant reservations; preschooler and infant care at daycare centers; tea room services; personal chef services; day-nursery [crèche] services.

(260) AM 2020 103146 A

(800) 1466686

(151) 2019 02 27

(891) 2019 02 27

(731) DAW SE

Roßdörfer Str. 50, 64372 Ober-Ramstadt,
Germany

(540)

Сарамур

(591) Black, white

(511)

2 – Paints; varnishes; lacquers; glazes; coatings; preservatives against rust; primers; colorants; dyestuffs; dye pastes; mordants; paint thickeners; fixatives, siccatives for paints; raw natural resins; thinning and binding preparations for paints and lacquers; solvents for thinning paints; preparations for preserving wood, wood mordants and wood preserving oils; paints, including structuring paints; bactericidal and/or fungicidal paints; anti-corrosion preparations; protective preparations for metals; metals in foil and powder form for painters, decorators, printers and artists.

19 – Building materials, not of metal or mainly not of metal, in particular profile rails and corner irons, finishing profiles; adjusting and levelling parts, spacers for building, sills, all not of metal or mainly not of metal; natural and artificial stone; mortar (building materials); quartz; plaster [building materials]; coatings (building materials); wall and ceiling panels (not of metal or mainly not of metal, for building); fabric embedding compounds for building; fillers (building materials); fabrics for building, not of metal or mainly not of metal, in particular stabilising fabrics.

(260) AM 2020 103147 A

(800) 1466690

(151) 2019 02 08

(891) 2019 02 08

(731) Obshchestvo s ogranichennoy
otvetstvennostyu "BIOTEHNOS"

pr-kt Andropova, d.18, korp. 6, pom. XI,
kom. 7, RU-115432 Moscow, Russian
Federation

(540)

ЗДОРОВЬЕ СУСТАВОВ В НАДЕЖНЫХ РУКАХ

(591) Black, white

(531) 28.05

(511)

5 – Pharmaceuticals, medical and veterinary preparations.

35 – Advertising; business management; business administration; office functions.

(260) AM 2020 103149 A

(800) 1466768

(151) 2018 11 27

(891) 2018 11 27

(731) LLC YALOGA-NT

ulitsa Salyutovskaya, dom 31, office 224,
gorod Izhevsk, RU-426053 Resp.
Udmurtskaya, Russian Federation

(540)

ЯЛОГА

YALOGA

(591) Black, white

(531) 27.05.01; 28.05

(511)

2 – Annatto [dyestuff]; auramine; Canada balsam; white lead; paper for dyeing Easter eggs; dyes; binding preparations for paints; glazes [paints, lacquers]; litharge; primers; gamboge for painting; gum-lac; titanium dioxide [pigment]; repositionable paint patches; indigo [colorant]; gum resins; colophony; caramel [food colorant]; carbonyl [wood preservative]; cochineal carmine; toner cartridges, filled, for printers and photocopiers; copal; alizarine dyes; aniline dyes; ink for leather; colorants for liqueurs; colorants for beverages; shoe dyes; colorants for beer; colorants for butter; ink for skin-dressing; dyewood; malt colorants; food colorants; colorants; toner [ink] for photocopiers; aluminium paints; asbestos paints; bactericidal paints; wood stains; ceramic paints; marking ink for animals; distempers; fireproof paints; printing ink; engraving ink; enamels for painting; paints; creosote for wood preservation; turmeric [colorant]; black japan; bitumen varnish; bronzing lacquers; copal varnish; lacquers; anti-corrosive bands; anti-rust oils; oils for the preservation of wood; mastic [natural resin]; lime wash; cobalt oxide [colorant]; zinc oxide [pigment]; silver paste; printers' pastes [ink]; pigments; coatings [paints]; coatings for roofing felt [paints]; wood coatings [paints]; undercoating for vehicle chassis; anti-fouling paints; varnishes; aluminium powder for painting; bronze powder for painting; silvering powders; metals in powder form for use in painting, decorating, printing and art; anti-corrosive preparations; protective preparations for metals; wood mordants; mordants for leather; mordants; thinners for paints; thin-

ners for lacquers; whitewash; soot [colorant]; carbon black [pigment]; lamp black [pigment]; sandarac; thickeners for paints; sienna earth; siccatives [drying agents] for paints; anti-rust greases; natural resins, raw; malt caramel [food colorant]; badigeon; anti-tarnishing preparations for metals; anti-rust preparations; wood preservatives; sumac for varnishes; minium; turpentine [thinner for paints]; fixatives [varnishes]; fixatives for watercolors; metal foil for use in painting, decorating, printing and art; yellowwood [colorant]; saffron [colorant]; dyewood extracts; enamels [varnishes]; silver emulsions [pigments].

3 – Abrasives; amber [perfume]; descaling preparations for household purposes; antistatic preparations for household purposes; aromatics [essential oils]; air fragrancing preparations; cake flavorings [essential oils]; flavorings for beverages [essential oils]; breath freshening sprays; canned pressurized air for cleaning and dusting purposes; balms, other than for medical purposes; lip glosses; polishing stones; abrasive paper; emery paper; polishing paper; petroleum jelly for cosmetic purposes; shoe polish; cobblers' wax; cotton wool for cosmetic purposes; sachets for perfuming linen; drying agents for dishwashing machines; adhesives for cosmetic purposes; scented water; Javelle water; lavender water; toilet water; laundry wax; floor wax; non-slipping wax for floors; depilatory wax; mustache wax; tailors' wax; creams for leather; polish for furniture and flooring; shoemakers' wax; polishing wax; massage gels, other than for medical purposes; heliotropine; dental bleaching gels; geraniol; make-up; deodorants for pets; deodorants for human beings; depilatory preparations; scented wood; perfumes; non-slipping liquids for floors; windshield cleaning liquids; greases for cosmetic purposes; volcanic ash for cleaning; toiletry preparations; perfumery; decorative transfers for cosmetic purposes; ionone [perfumery]; shaving stones [astringents]; smoothing stones; eyebrow pencils; cosmetic pencils; silicon carbide [abrasive]; carbides of metal [abrasives]; alum stones [astringents]; tripoli stone for polishing; adhesives for affixing false eyelashes; adhesives for affixing false hair; hair conditioners; quillaia bark for washing; corundum [abrasive]; beard dyes; colorants for toilet purposes; cosmetic dyes; laundry starch; laundry glaze; shoe cream; polishing creams; cosmetic creams; skin whitening creams; polishing rouge; incense; hair spray; nail polish; hair lotions; lotions for cosmetic purposes; after-shave lotions; beauty masks; oils for perfumes and scents; oils for cosmetic purposes; oils for toilet purposes; essential oils; essential oils of cedarwood; essential oils of lemon; essential oils of citron; oils for cleaning purposes; bergamot oil; gaultheria oil; jasmine oil; lavender oil; almond oil; rose oil; oil of turpentine for degreasing; whitening; cleaning chalk; almond milk for cosmetic purposes;

cleansing milk for toilet purposes; musk [perfumery]; soap; deodorant soap; shaving soap; soap for brightening textile; cakes of toilet soap; antiperspirant soap; soap for foot perspiration; almond soap; mint for perfumery; cosmetic kits; emery; nail art stickers; false nails; eau de Cologne; bases for flower perfumes; joss sticks; pastes for razor strops; dentifrices; pumice stone; lipstick cases; hydrogen peroxide for cosmetic purposes; breath freshening strips; abrasive cloth; glass cloth [abrasive cloth]; lipsticks; pomades for cosmetic purposes; shaving preparations; cosmetic preparations for baths; bath preparations, not for medical purposes; hair straightening preparations; hair waving preparations; laundry soaking preparations; grinding preparations; cleansers for intimate personal hygiene purposes, non medicated; personal deodorants; smoothing preparations [starching]; color-removing preparations; leather bleaching preparations; polishing preparations; denture polishes; mouthwashes, not for medical purposes; cosmetic preparations for slimming purposes; starch glaze for laundry purposes; refurbishing preparations; fabric softeners for laundry use; laundry bleach; dry-cleaning preparations; paint stripping preparations; lacquer-removing preparations; make-up removing preparations; floor wax removers [scouring preparations]; varnish-removing preparations; rust removing preparations; nail care preparations; cleaning preparations; preparations for cleaning dentures; wallpaper cleaning preparations; preparations for unblocking drain pipes; laundry preparations; aloe vera preparations for cosmetic purposes; sunscreen preparations; color-brightening chemicals for household purposes [laundry]; shining preparations [polish]; make-up powder; diamantine [abrasive]; stain removers; scouring solutions; false eyelashes; tissues impregnated with cosmetic lotions; tissues impregnated with make-up removing preparations; safrol; laundry blueing; turpentine for degreasing; potpourris [fragrances]; bleaching soda; washing soda, for cleaning; bath salts, not for medical purposes; bleaching salts; fumigation preparations [perfumes]; preservatives for leather [polishes]; ammonia [volatile alkali] [detergent]; astringents for cosmetic purposes; eyebrow cosmetics; make-up preparations; sun-tanning preparations [cosmetics]; hair dyes; neutralizers for permanent waving; preparations to make the leaves of plants shiny; cosmetic preparations for eyelashes; cosmetic preparations for skin care; shoe wax; cosmetics; cosmetics for animals; mascara; detergents, other than for use in manufacturing operations and for medical purposes; degreasers, other than for use in manufacturing processes; bleaching preparations [decolorants] for cosmetic purposes; antiperspirants [toiletries]; talcum powder, for toilet use; terpenes [essential oils]; emery cloth; cloths impregnated with a detergent for cleaning; henna [cosmetic dye]; shampoos; shampoos for pets; dry shampoos; sandpaper; soda lye; extracts

of flowers [perfumes]; ethereal essences; badian essence; mint essence [essential oil].

5 – Acaricides; aconitine; alkaloids for medical purposes; alginates for pharmaceutical purposes; algicides; aldehydes for pharmaceutical purposes; dental amalgams of gold; dental amalgams; amino acids for veterinary purposes; amino acids for medical purposes; analgesics; anaesthetics; antibiotics; antiseptics; medicine cases, portable, filled; first-aid boxes, filled; aluminium acetate for pharmaceutical purposes; acetates for pharmaceutical purposes; germicides; balms for medical purposes; bandages for dressings; diagnostic biomarker reagents for medical purposes; biocides; bromine for pharmaceutical purposes; paper for mustard plasters; fly catching paper; reagent paper for medical or veterinary purposes; moth-proofing paper; petroleum jelly for medical purposes; vaccines; oxygen baths; antiseptic cotton; aseptic cotton; absorbent cotton; wadding for medical purposes; cotton for medical purposes; dietetic substances adapted for medical use; radiological contrast substances for medical purposes; nutritive substances for microorganisms; radioactive substances for medical purposes; bismuth subnitrate for pharmaceutical purposes; melissa water for pharmaceutical purposes; sea water for medicinal bathing; mineral waters for medical purposes; thermal water; dietary fiber; molding wax for dentists; gases for medical purposes; guaiacol for pharmaceutical purposes; hematogen; hemoglobin; hydrastine; hydrastinine; glycerine for medical purposes; glycerophosphates; glucose for medical purposes; gentian for pharmaceutical purposes; hormones for medical purposes; mustard for pharmaceutical purposes; mustard plasters; mud for baths; medicinal mud; gamboge for medical purposes; gurjun balsam for medical purposes; air deodorising preparations; deodorants, other than for human beings or for animals; deodorants for clothing and textiles; diastase for medical purposes; digitalin; mineral food supplements; nutritional supplements; albumin dietary supplements; dietary supplements for animals; yeast dietary supplements; alginate dietary supplements; glucose dietary supplements; casein dietary supplements; lecithin dietary supplements; linseed oil dietary supplements; propolis dietary supplements; protein dietary supplements; protein supplements for animals; royal jelly dietary supplements; pollen dietary supplements; wheat germ dietary supplements; linseed dietary supplements; enzyme dietary supplements; yeast for pharmaceutical purposes; gelatine for medical purposes; cod liver oil; isotopes for medical purposes; insecticides; iodine for pharmaceutical purposes; iodides for pharmaceutical purposes; alkaline iodides for pharmaceutical purposes; iodoform; calomel; cream of tartar for pharmaceutical purposes; camphor for medical

Purposes; capsules for medicines; cachets for pharmaceutical purposes; hemostatic pencils; wart pencils; caustic pencils; headache pencils; carbolineum [parasiticide]; caustics for pharmaceutical purposes; cachou for pharmaceutical purposes; quassia for medical purposes; quebracho for medical purposes; oxygen for medical purposes; gallic acid for pharmaceutical purposes; acids for pharmaceutical purposes; adhesives for dentures; surgical glues; adhesive tapes for medical purposes; stem cells for veterinary purposes; stem cells for medical purposes; cocaine; collodion for pharmaceutical purposes; corn rings for the feet; candy, medicated; angostura bark for medical purposes; barks for pharmaceutical purposes; cedar wood for use as an insect repellent; condurango bark for medical purposes; croton bark; mangrove bark for pharmaceutical purposes; myrobalan bark for pharmaceutical purposes; quinquina for medical purposes; medicated animal feed; medicinal roots; rhubarb roots for pharmaceutical purposes; lint for medical purposes; starch for dietetic or pharmaceutical purposes; creosote for pharmaceutical purposes; blood for medical purposes; biological tissue cultures for veterinary use; biological tissue cultures for medical use; cultures of microorganisms for medical or veterinary use; curare; dental lacquer; liquorice for pharmaceutical purposes; lactose for pharmaceutical purposes; candy for medical purposes; adhesive plasters; medicines for alleviating constipation; lecithin for medical purposes; lotions for veterinary purposes; dog lotions; lotions for pharmaceutical purposes; personal sexual lubricants; lupulin for pharmaceutical purposes; magnesia for pharmaceutical purposes; liniments; ointments for pharmaceutical purposes; sunburn ointments; mercurial ointments; frostbite salve for pharmaceutical purposes; gauze for dressings; medicinal oils; mustard oil for medical purposes; camphor oil for medical purposes; castor oil for medical purposes; oil of turpentine for pharmaceutical purposes; dill oil for medical purposes; dental mastics; dental abrasives; dental impression materials; teeth filling material; dressings, medical; surgical dressings; drugs for medical purposes; medicines for veterinary purposes; serotherapeutic medicines; medicines for human purposes; medicines for dental purposes; menthol; medicinal drinks; moleskin for medical purposes; almond milk for pharmaceutical purposes; royal jelly for pharmaceutical purposes; milk ferments for pharmaceutical purposes; Irish moss for medical purposes; flour for pharmaceutical purposes; linseed meal for pharmaceutical purposes; fish meal for pharmaceutical purposes; fly glue; mint for pharmaceutical purposes; dietetic beverages adapted for medical purposes; malted milk beverages for medical purposes; narcotics; medicinal infusions; tincture of iodine; eucalyptol for pharmaceutical purposes; tinctures for medical purposes; opium; opodeldoc; decoctions for pharmaceutical purposes; anti-

parasitic collars for animals; cotton sticks for medical purposes; stick liquorice for pharmaceutical purposes; sulfur sticks [disinfectants]; pastilles for pharmaceutical purposes; pectin for pharmaceutical purposes; pepsins for pharmaceutical purposes; pепtones for pharmaceutical purposes; hydrogen peroxide for medical purposes; pesticides; food for babies; leeches for medical purposes; blood plasma; eyepatches for medical purposes; poultices; compresses; scapulars for surgical purposes; babies' diapers; diapers for pets; bunion pads; breast-nursing pads; pomades for medical purposes; powder of cantharides; pyrethrum powder; belts for sanitary towels; anti-uric preparations; bacterial preparations for medical and veterinary use; bacteriological preparations for medical and veterinary use; balsamic preparations for medical purposes; albuminous preparations for medical purposes; biological preparations for veterinary purposes; biological preparations for medical purposes; veterinary preparations; bismuth preparations for pharmaceutical purposes; vitamin preparations; diagnostic preparations for veterinary purposes; diagnostic preparations for medical purposes; therapeutic preparations for the bath; hemorrhoid preparations; preparations for callouses; acne treatment preparations; preparations to facilitate teething; preparations for the treatment of burns; fumigation preparations for medical purposes; ootherapy preparations; air purifying preparations; eye-washes; bronchodilating preparations; preparations for reducing sexual activity; sterilising preparations; soil-sterilising preparations; corn remedies; pharmaceutical preparations for treating dandruff; preparations for destroying noxious animals; herbicides; preparations for destroying dry rot fungus; larvae exterminating preparations; fly destroying preparations; preparations for destroying mice; slug exterminating preparations; vermin destroying preparations; pharmaceutical preparations for skin care; contact lens cleaning preparations; lime-based pharmaceutical preparations; bath preparations for medical purposes; medicinal hair growth preparations; opiates; anticryptogamic preparations; aloe vera preparations for pharmaceutical purposes; preparations of trace elements for human and animal use; sulfonamides [medicines]; pharmaceutical preparations; pharmaceutical preparations for treating sunburn; enzyme preparations for veterinary purposes; enzyme preparations for medical purposes; chemico-pharmaceutical preparations; chemical preparations for veterinary purposes; chemical preparations for the diagnosis of pregnancy; chemical preparations for medical purposes; chemical preparations to treat wheat blight; vine disease treating chemicals; chemical preparations to treat mildew; chemical preparations for treating phylloxera; chemical preparations for pharmaceutical purposes; chilblain preparations; moth-proofing preparations; collyrium; lead water; chemical conductors for electrocardiograph electrodes; al-

buminous foodstuffs for medical purposes; dietetic foods adapted for medical purposes; by-products of the processing of cereals for dietetic or medical purposes; sanitary towels; diapers for incontinents; panty liners [sanitary]; propolis for pharmaceutical purposes; pearl powder for medical purposes; radium for medical purposes; hydrated chloral for pharmaceutical purposes; solvents for removing adhesive plasters; vaginal washes; solutions for contact lenses; chemical reagents for medical or veterinary purposes; gum for medical purposes; rubber for dental purposes; chewing gum for medical purposes; insect repellents; insect repellent incense; repellents for dogs; tissues impregnated with pharmaceutical lotions; sarsaparilla for medical purposes; sugar for medical purposes; asthmatic tea; fumigating sticks; suppositories; linseed for pharmaceutical purposes; tobacco-free cigarettes for medical purposes; siccatives [drying agents] for medical purposes; syrups for pharmaceutical purposes; turpentine for pharmaceutical purposes; milking grease; greases for veterinary purposes; greases for medical purposes; lacteal flour for babies; soporifics; bicarbonate of soda for pharmaceutical purposes; bath salts for medical purposes; salts for mineral water baths; salts for medical purposes; potassium salts for medical purposes; sodium salts for medical purposes; smelling salts; mineral water salts; malt for pharmaceutical purposes; semen for artificial insemination; alcohol for pharmaceutical purposes; medicinal alcohol; alloys of precious metals for dental purposes; ergot for pharmaceutical purposes; cooling sprays for medical purposes; adjuvants for medical purposes; styptic preparations; vermifuges; disinfectants; disinfectants for hygiene purposes; disinfectants for chemical toilets; douching preparations for medical purposes; appetite suppressants for medical purposes; medical preparations for slimming purposes; parasiticides; mouthwashes for medical purposes; febrifuges; depuratives; animal washes; detergents for medical purposes; cattle washes; dog washes; vesicants; remedies for headache; purgatives; remedies for perspiration; remedies for foot perspiration; chemical contraceptives; antiparasitic preparations; sedatives; laxatives; tonics [medicines]; digestives for pharmaceutical purposes; nervines; media for bacteriological cultures; steroids; strychnine; serums; tanning pills; appetite suppressant pills; slimming pills; jujube, medicated; antioxidant pills; sanitary tampons; vulnerary sponges; thymol for pharmaceutical purposes; smoking herbs for medical purposes; medicinal herbs; surgical implants comprised of living tissues; pants, absorbent, for incontinents; sanitary panties; babies' diaper-pants; charcoal for pharmaceutical purposes; fennel for medical purposes; porcelain for dental prostheses; phenol for pharmaceutical purposes; enzymes for veterinary purposes; enzymes for medical purposes; ferments for pharmaceutical purposes; formic aldehyde for pharmaceuti-

cal purposes; phosphates for pharmaceutical purposes; fungicides; quinine for medical purposes; chinoline for medical purposes; diabetic bread adapted for medical use; chloroform; flowers of sulfur for pharmaceutical purposes; cement for animal hooves; bone cement for surgical and orthopaedic purposes; dental cements; medicinal tea; herbal teas for medicinal purposes; eucalyptus for pharmaceutical purposes; tobacco extracts [insecticides]; extracts of hops for pharmaceutical purposes; elixirs [pharmaceutical preparations]; ethers for pharmaceutical purposes; esters for pharmaceutical purposes; cellulose esters for pharmaceutical purposes; cellulose ethers for pharmaceutical purposes; rat poison; poisons; bacterial poisons; jalap; disinfectant soaps; medicated soaps.

(260) AM 2020 103163 A

(800) 1467086

(151) 2018 08 03

(891) 2018 08 03

(731) W. L. Gore & Associates, Inc.

555 Paper Mill Road, Newark DE 19711,
USA

(540)

TOGETHER, IMPROVING LIFE

(591) Black, white

(511)

9 – Protective clothing, namely, pants, coats, footwear, coveralls, jackets, gloves, mittens, pants, parkas, vests, jumpsuits, rain suits, head wear, glove liners; electrical connectors; coaxial cables and assemblies, namely, cable connectors; fiber optic cables and assemblies, namely, cable connectors; cable assemblies; electrical interconnect, namely, cable connectors, for use in electronic equipment such as printed circuit boards; transmission line cable assemblies, namely, cable connectors; shielded electrical wires and cables; electrochemical electrodes used as part of fuel cell and other electrochemical cells, namely, cells and batteries; electronic enclosures in the nature of electronic cases; surface mount (SMT) electromagnetic interference (EMI), and radio frequency (RF) grounding pads; electromagnetic interference board level shield; acoustic protective covers; acoustic materials (terms considered too vague by the International Bureau – rule 13 (2) (b) of the Common Regulations); pressure vents and moisture management devices for cameras, sensors, and solar, industrial, and automotive electronic enclosure; capacitors.

10 – Vascular grafts (terms considered too vague by the International Bureau – rule 13 (2) (b) of the Common Regulations); surgical implants, namely, expanded polytetrafluoroethylene in the forms of

sheets, patches, membranes, tubes and fibers for use in the reconstruction and/or repair of body parts; surgical implants composed of artificial materials, namely, synthetic bio-absorbable material for use in the regeneration of soft and hard body tissue; catheters; catheter balloons; strip of polymeric material used to reinforce staples and sutures in a surgical site; surgical instruments, namely, suture passer and introducer sheath; stents; stent-grafts; endoprosthesis; medical device, namely, hernia plug for the repair of hernias; blood filter; ultrasound probe assemblies for medical use.

11 – Filter bags and filter cartridges for use in industrial gas or liquid filtration; air filtering machines for industrial use; air filters for use in electronic equipment, namely, marine applications, military use, audible commercial applications, and appliances; air filters for office automation equipment; filtration membranes consisting of porous sheets and films of various thickness and densities; industrial air and water filter devices, namely, filters, filter cartridges, filter cloths.

12 – Air filters for vents for electronic components in land vehicles.

15 – Strings for musical instruments.

17 – Plastic membrane material in sheet form for use in the further manufacture of chemical separation and electrochemical applications; thermal interface materials made of plastic, namely, low thermal resistance interface pads, tapes, sheets, and films for use as heat transfer interfaces between electronic components and thermal dissipation members; plastics in the form of sheets for use in manufacturing; braided plastic fibers for industrial packings; nonmetal synthetic gaskets and mechanical seals for use in the aerospace industry; plastic gaskets for use in electrical equipment, namely, gasketing in cell phones to prevent electromagnetic interference; expanded PTFE sold in the form of film, tubing, rods and other shapes for use in the industrial arts; plastic tube for chemical fluid transfer; gaskets, seals and packing materials, namely, fluoropolymers; synthetic gaskets in strip form, plastic or pre-cut shapes and sheets for use in the aerospace, telecommunications and electronics industries; sheet gaskets; plastic tape for use in spiral wound gaskets for such uses as preventing leaks of volatile chemicals; gasket tape for use in industrial and chemical applications; nonmetallic packing material for forming seals for pumps and valves; autoclavable jacketing material for use with wires; polymeric filter media for domestic and industrial filtration; polymeric material, namely, fluoropolymer materials in the form of plastic fiber for use in the manufacture of dental floss; polymeric filter media, namely, porous fluoropolymer, used in the manufacture of venting; membranes for use as filters in medical equipment; membranes and filters

for use in process equipment; fluoropolymers, namely, vents for pharmaceutical packaging; insulation, namely, insulating coverings for electronic conductors, namely, wire; electrical insulators in the form of liquid polymer preparations for use in the electronic industry; plastic containers to protect food, pharmaceutical and biological product (terms considered too vague by the International Bureau – rule 13 (2) (b) of the Common Regulations); adhesive tape for industrial use, namely, tape for sealing joined pieces of fabric; fluoropolymer in the form of sheets, patches, membranes, tubes and fibers for use in permanent and temporary implantable and non-implantable medical applications; thermal insulative and conductive materials for consumer electronics, automotive electronics, and industrial electronic enclosures.

22 – Bivy bags, tents, synthetic fibers, camouflage covers, nettings and tarpaulins; synthetic fibers for braiding into industrial packings; plastic filaments and synthetic fibers for use in the manufacture of fabric; non-woven polymeric fiber for use in the manufacture of fabric.

23 – Yarn and thread; sewing thread.

24 – Fabric made of polytetrafluoroethylene and fiberglass for use in the manufacture of industrial or architectural products; covers for facilitating decomposition; textile shoe lining; loosely woven synthetic fiber fabrics, namely, scrim.

25 – Clothing, namely, headwear, footwear, coats, jackets, parkas, vests, pants, shirts, sweaters, skirts, shorts, gloves, mittens, jumpsuits, coveralls, gaiters, rain suits, athletic wear, namely, singlets, shorts, leg warmers, knee warmers, neck gaiters, and headbands, waders, dry suits, and undergarments.

(260) AM 2020 103238 A

(800) 1467527

(151) 2019 04 17

(891) 2019 04 17

(731) EYE PHARMA S.p.A.

Via Borghero 9, I-16148 Genova, Italy

(540)

FRIDOP

(591) Black, white

(511)

5 – Dietetic substances adapted for medical use.

(260) AM 2020 103239 A

(800) 1467586

(151) 2019 04 03

(891) 2019 04 03

(731) BEIJING SHENMO CULTURE
COMMUNICATION CO.,LTD.

Room 1203, Block C1, Wanliuyicheng
Plaza, No.7 Changchunqiao Road,
Haidian District, Beijing City, China

(540)



(591) Black, white

(531) 02.05.01; 09.07.22; 24.03.01; 24.03.07;
24.03.12

(511)

41 – Academies [education]; educational services; teaching; boarding school education; coaching [training]; educational services provided by schools; tutoring; organization of competitions [education or entertainment]; organization of exhibitions for cultural or educational purposes; publication of books.

(260) AM 2020 103281 A

(800) 1468422

(151) 2019 04 01

(891) 2019 04 01

(731) SHANTOU HONGHU PLASTICS CO.,
LIMITED

ROOM 1606, 16TH FLOOR, 2ND.

BUILDING, YIFAYUAN, SOUTH TONGYI
ROAD, CHENGHAI DISTRICT, SHANTOU
CITY, 515800, China

(540)



(591) White, gray, yellow, blue, light blue, green,
light green, pink, red, lilac, light lilac

(531) 21.03.01; 27.03.01; 27.03.15; 29.01.15

(511)

28 – Toy vehicles; dolls' feeding bottles; tricycles for infants [toys]; spinning tops [toys]; dumb-bells; jigsaw puzzles; flying discs [toys]; dolls' houses; chessboards; checkerboards; drones [toys]; kites; toys; stuffed toys; plush toys; toy mobiles; novelty toys for playing jokes; games; parlor games; board games; building games; kaleidoscopes; baby gyms; dolls' rooms; controllers for toys; dolls' beds; building blocks [toys]; dolls; toy models; scale model kits [toys]; scale model vehicles; balls for games; toy pistols; toy air pistols; percussion caps [toys]; caps

for pistols [toys]; rattles [playthings]; portable games with liquid crystal displays; soap bubbles [toys]; toy robots; scooters [toys]; remote-controlled toy vehicles; slides [playthings]; conjuring apparatus; apparatus for games; toy figures; foosball tables; playing balls; play balloons; chess games; checkers [games].

(260) AM 2020 103282 A

(800) 1468451

(151) 2019 03 15

(891) 2019 03 15

(731) Limited liability company "PIQ-PHARMA"
Oruzheyniy pereulok, d. 25, str. 1, RU-125047
Moscow, Russian Federation

(540)

ПИКФАРМА

(591) Black, white

(531) 28.05

(511)

5 – Pharmaceutical preparations; veterinary preparations; hygiene preparations for medical purposes; vitamin preparations; dietetic substances adapted for medical use; medicines for human purposes; food for babies; dietetic foods adapted for medical purposes; dietary supplements.

10 – Analyzers for bacterial identification for medical purposes; blood testing apparatus; testing apparatus for medical purposes; nasal aspirators; vaporizers for medical purposes; containers especially made for medical waste; clips, surgical; acupuncture needles; suture needles; needles for medical purposes; orthopedic articles; inhalers; hydrogen inhalers; injectors for medical purposes; electric acupuncture instruments; droppers for medical purposes; dropper bottles for medical purposes; catheters; respiratory masks for artificial respiration; anaesthetic masks; suture materials; thread, surgical; boots for medical purposes; orthopedic footwear; clothing especially for operating rooms; compression garments; blankets, electric, for medical purposes; condoms; aerosol dispensers for medical purposes; medical apparatus and instruments; brushes for cleaning body cavities; appliances for washing body cavities; receptacles for applying medicines; vaginal syringes; implantable subcutaneous drug delivery devices; contraceptives, non-chemical; orthopedic soles; arch supports for footwear; ear plugs [ear protection devices]; thermal packs for first aid purposes; stockings for varices; splints, surgical; syringes for injections; syringes for medical purposes; hypodermic syringes; uterine syringes; urethral syringes.

35 – Import-export agency services; rental of advertising space; demonstration of goods; market studies; business information; commercial information and advice for consumers in the choice of products and

services; business research; professional business consultancy; targeted marketing; updating and maintenance of data in computer databases; organization of exhibitions for commercial or advertising purposes; design of advertising materials; commercial intermediation services; providing business information via a web site; provision of commercial and business contact information; provision of an online marketplace for buyers and sellers of goods and services; web indexing for commercial or advertising purposes; presentation of goods on communication media, for retail purposes; sales promotion for others; publication of publicity texts; distribution of samples; dissemination of advertising matter; advertising; online advertising on a computer network; compilation of information into computer databases; systemization of information into computer databases; negotiation of business contracts for others; negotiation and conclusion of commercial transactions for third parties; compiling indexes of information for commercial or advertising purposes; wholesale services for pharmaceutical, veterinary and sanitary preparations and medical supplies; retail services for pharmaceutical, veterinary and sanitary preparations and medical supplies; business management for freelance service providers; commercial administration of the licensing of the goods and services of others; administration of consumer loyalty programs; administrative processing of purchase orders; procurement services for others [purchasing goods and services for other businesses]; all mentioned above services for pharmaceutical, veterinary and sanitary preparations and medical supplies.

39 – Delivery of goods; delivery of goods by mail order; storage information; packaging of goods; wrapping of goods; courier services [messages or merchandise]; physical storage of electronically stored data or documents; storage of goods; storage; freight forwarding; all mentioned above services for pharmaceutical, veterinary and sanitary preparations and medical supplies.

40 – Material treatment information; waste treatment [transformation]; treatment of materials for third parties; grinding; refining services; all mentioned above services for pharmaceutical, veterinary and sanitary preparations and medical supplies.

42 – Water analysis; chemical analysis; clinical trials; bacteriological research; biological research; cosmetic research; chemical research; research and development of new products for others; scientific research; quality control; technical writing; chemistry services; scientific laboratory services; electronic data storage; all mentioned above services for pharmaceutical, veterinary and sanitary preparations and medical supplies.

(260) AM 2020 103283 A
 (800) 1468468
 (151) 2019 03 26
 (891) 2019 03 26
 (731) Aktsionernoe obschestvo "MAKFA"
 per. Vspol'nyj, d. 5, str. 1, of. 1, RU-123001
 Moskva, Russian Federation
 (540)



(591) Black, white
 (531) 05.03.13; 05.03.15; 26.01.01; 26.01.04;
 26.01.12; 26.01.15; 26.01.18; 26.01.24; 28.07
 (511)

29 – Oils for food; peanut butter; cocoa butter for food; coconut oil for food; coconut butter; corn oil for food; sesame oil for food; linseed oil for food; extra virgin olive oil for food; olive oil for food; palm oil for food; palm kernel oil for food; sunflower oil for food; colza oil for food; butter; soya bean oil for food; potato fritters; tomato paste; potato flakes; potato chips; low-fat potato chips.

30 – Cereal bars; high-protein cereal bars; pancakes; noodle-based prepared meals; freeze-dried dishes with the main ingredient being pasta; freeze-dried dishes with the main ingredient being rice; buns; bread rolls; vermicelli [noodles]; gluten additives for culinary purposes; rice-based snack food; cereal-based snack food; cakes; pastries; peanut confectionery; almond confectionery; pasta; gimbap [Korean rice dish]; gluten prepared as foodstuff; flour-based dumplings; crackers; hominy grits; semolina; oatmeal; crushed barley; groats for human food; corn, milled; corn, roasted; couscous [semolina]; noodles; macaroni; bean meal; tapioca flour; potato flour; corn flour; nut flours; flour; wheat flour; soya flour; barley meal; muesli; crushed oats; husked oats; biscuits; petit-beurre biscuits; baking powder; cereal preparations; oat-based food; gingerbread; rice; instant rice; wheat germ for human consumption; batter mixes for okonomiyaki [Japanese savoury pancakes]; tomato sauce; pasta sauce; spaghetti; rusks; dough; pastry dough; almond paste; rice pulp for culinary purposes; cake dough; bread; unleavened bread; chips [cereal products]; corn flakes; oat flakes; chicory [coffee substitute]; tea; husked barley.

31 – Beans, fresh; peas, fresh; cereal seeds, unprocessed; grains [cereals]; chestnuts, fresh; maize; bran; wheat; rice, unprocessed; rye; lentils, fresh; barley.

(260) AM 2020 103300 A
 (800) 1443772
 (151) 2018 08 29
 (891) 2019 05 03
 (731) LLC firm "Torgovy Dom Yarmarka"
 Pryazhinskoe shosse, 2km, RU-185013
 Petrozavodsk, Russian Federation
 (540)

Yelli

Йелли

(591) Black, white
 (531) 27.05.17; 28.05
 (511)

29 – Ajvar [preserved peppers]; aloe vera prepared for human consumption; alginates for culinary purposes; anchovy; peanuts, prepared; albumen for culinary purposes; white of eggs; beans, preserved; soya beans, preserved, for food; bouillon; ginger jam; ham; fatty substances for the manufacture of edible fats; toasted laver; edible birds' nests; peas, preserved; mushrooms, preserved; game, not live; gelatine; meat jellies; jellies for food; fruit jellies; yolk of eggs; coconut fat; bone oil, edible; lard; suet for food; edible fats; fruit-based snack food; raisins; caviar; fish roe, prepared; yogurt; sauerkraut; kephir [milk beverage]; kimchi [fermented vegetable dish]; isinglass for food; clams, not live; milk shakes; black pudding [blood sausage]; compotes; meat, tinned [canned (Am.)]; vegetables, tinned [canned (Am.)]; fish, tinned [canned (Am.)]; fruits, tinned [canned (Am.)]; bouillon concentrates; gherkins; shrimps, not live; prawns, not live; buttercream; croquettes; silkworm chrysalis, for human consumption; kumys [kumyss] [milk beverage]; spiny lobsters, not live; lecithin for culinary purposes; salmon, not live; onions, preserved; margarine; marmalade; edible oils; peanut butter; cocoa butter; coconut oil; coconut butter; corn oil; sesame oil; linseed oil for culinary purposes; olive oil for food; palm oil for food; palm kernel oil for food; sunflower oil for food; colza oil for food; butter; shellfish, not live; almonds, ground; animal marrow for food; mussels, not live; milk; condensed milk; soya milk [milk substitute]; albumin milk; fish meal for human consumption; vegetable mousses; fish mousses; fruit pulp; meat; meat, preserved; milk beverages, milk predominating; vegetables, preserved; vegetables, cooked; vegetables, dried; potato fritters; olives, preserved; lobsters, not live; coconut, desiccated; nuts, prepared; tomato purée; liver pâté; pectin for culinary purposes; liver; jams; pickles; powdered eggs; milk products; foods made from fish; curd; prostokvasha [soured milk]; poultry, not live; pollen prepared as

foodstuff; cranberry sauce [compote]; apple purée; crayfish, not live; crustaceans, not live; fish, preserved; fish, not live; salted fish; ryazhenka [fermented baked milk]; vegetable salads; fruit salads; bacon; sardines, not live; pork; herrings, not live; seeds, prepared; sunflower seeds, prepared; whipped cream; cream [dairy products]; fat-containing mixtures for bread slices; smetana [sour cream]; vegetable juices for cooking; tomato juice for cooking; salted meats; sausages; sausages in batter; preparations for making bouillon; preparations for making soup; tripe; soups; vegetable soup preparations; whey; cheese; tahini [sesame seed paste]; tofu; sea-cucumbers, not live; truffles, preserved; tuna, not live; oysters, not live; milk ferments for culinary purposes; rennet; fish fillets; dates; crystallized fruits; frozen fruits; fruit, preserved; fruit preserved in alcohol; fruit, stewed; potato flakes; hummus [chickpea paste]; fruit peel; preserved garlic; lentils, preserved; potato chips; low-fat potato chips; fruit chips; non-alcoholic eggnog; seaweed extracts for food; meat extracts; eggs; snail eggs for consumption.

31 – Algarovilla for animal consumption; oranges, fresh; peanuts, fresh; draff; beans, fresh; locust beans, raw; wreaths of natural flowers; grapes, fresh; algae for human or animal consumption; fruit residue [marc]; dog biscuits; peas, fresh; mushroom spawn for propagation; mushrooms, fresh; trees; palm trees; turf, natural; unsawn timber; undressed timber; yeast for animal consumption; Christmas trees; edible chews for animals; live animals; menagerie animals; peanut cake for animals; maize cake for cattle; oil cake; rape cake for cattle; bagasses of cane [raw material]; cereal seeds, unprocessed; grains [cereals]; grains for animal consumption; lime for animal forage; fish spawn; cocoa beans, raw; potatoes, fresh; chestnuts, fresh; copra; raw barks; animal foodstuffs; rough cork; pet food; stall food for animals; bird food; strengthening animal forage; chicory roots; roots for food; nettles; groats for poultry; maize; edible sesame, unprocessed; shrubs; rose bushes; spiny lobsters, live; lemons, fresh; vine plants; salmon, live; onions, fresh; flower bulbs; leeks, fresh; olives, fresh; products for animal litter; bran mash for animal consumption; shellfish, live; almonds [fruits]; mussels, live; peanut meal for animals; linseed meal for animal consumption; meal for animals; flax meal [fodder]; rice meal for forage; fish meal for animal consumption; straw mulch; beverages for pets; oats; vegetables, fresh; cucumbers, fresh; lobsters, live; coconuts; kola nuts; nuts [fruits]; bran; distillery waste for animal consumption; residue in a still after distillation; palms [leaves of the palm tree]; cuttle bone for birds; peppers [plants]; aromatic sand for pets [litter]; citrus fruit, fresh; mash for fattening livestock; animal fattening preparations; preparations for egg laying poultry; fishing bait, live; by-products of the processing of

cereals, for animal consumption; seed germ for botanical purposes; poultry, live; wheat; pollen [raw material]; crayfish, live; crustaceans, live; seedlings; plants; aloe vera plants; plants, dried, for decoration; rhubarb, fresh; rice, unprocessed; rye; wheat germ for animal consumption; fish, live; lettuce, fresh; beet, fresh; seeds for planting; linseed for animal consumption; hay; coconut shell; bred stock; sanded paper for pets [litter]; malt for brewing and distilling; straw litter; straw [forage]; salt for cattle; trunks of trees; wood chips for the manufacture of wood pulp; litter peat; garden herbs, fresh; sea-cucumbers, live; sugarcane; truffles, fresh; squashes, fresh; oysters, live; fruit, fresh; hazelnuts; fodder; hops; flowers, natural; flowers, dried, for decoration; chicory, fresh; silkworms; lentils, fresh; pine cones; hop cones; spinach, fresh; juniper berries; berries, fresh; eggs for hatching, fertilised; silkworm eggs; barley.

(260) AM 2020 103349 A

(800) 1468603

(151) 2019 02 26

(891) 2019 02 26

(731) HUAWEI TECHNOLOGIES CO., LTD.
ADMINISTRATION BUILDING, HUAWEI
TECHNOLOGIES CO., LTD., BANTIAN,
LONGGANG DISTRICT, SHENZHEN
CITY, GUANGDONG PROVINCE, China

(540)

HUAWEI SuperSound

(591) Black, white

(531) 27.05.01; 27.05.10

(511)

9 – Smartphones; tablet computers; computer programmes, recorded; computer software applications, downloadable; digital signal processors; central processing units for processing information, data, sound or images; computer software for controlling the operation of audio and video devices; computer chatbot software for simulating conversations; computer software for organizing and viewing digital images and photographs; computer software for creating and editing music and sounds; wearable activity trackers; cabinets for loudspeakers; headphones; headsets; virtual reality headsets; loudspeakers; portable media players; sound transmitting apparatus; electronic sheet music, downloadable; wearable computers; telecommunication apparatus in the form of jewelry; selfie sticks for use with smartphones; wearable video display monitors; selfie lenses; sound reproduction apparatus; megaphones; audio interfaces; equalizers [audio apparatus]; electronic sounding device within books, namely, audio devices for audiobooks; audio transmitter units; software to control and improve audio equip-

ment sound quality; computer software for processing digital music files.

(260) AM 2020 103366 A

(800) 1468735

(151) 2019 03 26

(891) 2019 03 26

(731) HAUTE FRAGRANCE COMPANY, SIA

Kalnupes iela 3, Mārupe, LV-2167 Mārupes nov., Latvia

(540)

BLACK ORRIS

(591) Black, white

(511)

3 – Perfumery and fragrances (eau de parfum).

(260) AM 2020 103368 A

(800) 1468753

(151) 2018 12 10

(891) 2018 12 10

(731) AGC Inc.

5-1, Marunouchi 1-chome, Chiyoda-ku, Tokyo 100-8405, Japan

(540)



(591) Blue, red

(531) 27.05.17; 27.05.23; 29.01.12

(511)

1 – Chemicals; chemicals for use in industry; chemical condensation preparations; solvents; detergents for industrial use; surface-active compounds; water repellents; ion-exchange resins [chemical preparations]; waterproofing chemical compositions; silica gel; ungluing preparations; unprocessed plastics [plastics in primary form]; fluorine resins, unprocessed; unprocessed polyurethane resins; unprocessed polyvinyl chloride resins; chemical sorbents; metallic oxides; oil cement [putty]; glue and adhesives for industrial purposes; wallpaper removing preparations; plant growth regulating preparations; fertilizers; ceramic glazings; higher fatty acids; non-ferrous metals as chemical preparations; non-metallic minerals; chemical compositions for use in developing photographs; chemical test papers; artificial sweeteners; flour and starch for industrial purposes; pulp.

2 – Coating compositions in the nature of paint; fluorine based coating materials in the nature of paints; urethane-based coatings in the nature of paints; dyestuffs; pigments; mordants; mastic; wood preservatives; printing inks, colorants; colors for

painting pictures; anti-rust greases; nonferrous metals in foil or powder form for painters, decorators, printers and artists.

3 – Dry-cleaning fluids; refurbishing preparations; grinding preparations; sharpening preparations; abrasive agents; abrasive preparations; abrasive slurry; abrasive agents for semiconductor; anti-static preparations for household purposes; degreasing preparations for household purposes; soaps and detergents; rust removing preparations; abrasive paper [sandpaper]; abrasive cloths; abrasive sands; adhesives for affixing false hair; adhesives for affixing false eyelashes; polishing agents; stain removing benzene; fabric softeners for laundry use; laundry bleach; laundry starch; paint stripping preparations; shoe and boot creams; dentifrices; perfume and flavour materials; incense; polishing papers; false nails; false eyelashes.

7 – Chemical processing machines and apparatus; filtering machines for chemical processing; membrane filtration apparatus for chemical processing; glassware manufacturing machines and apparatus; semiconductor manufacturing machines and systems; 3D printers; painting machines and apparatus; plastic processing machines and apparatus; metalworking machines and tools; electric arc welding apparatus; electric metal cutting machines by arc, gas or plasma; electric welding apparatus; construction machines and apparatus; loading-unloading machines and apparatus; textile machines and apparatus; lumbering, woodworking, or veneer or plywood making machines and apparatus; packaging or wrapping machines and apparatus; machines and apparatus for manufacturing rubber goods; boilers for non-electric prime movers and engines; automatic vending machines; dishwashers; electric washing machines; vacuum cleaners; electric food blenders; curtain drawing devices electrically operated; electric door openers; waste compacting machines and apparatus; waste crushing machines and apparatus.

9 – Electrolysers; electrolytic cells; laboratory apparatus and instruments; glassware for laboratory use; screens [photography]; optical lenses; optical filters; solar batteries; solar cells; Telecommunication machines and apparatus; television receivers [TV sets]; liquid crystal display [LCD] televisions; organic light-emitting diode [OLED] televisions; telephone apparatus; smartphones; protective films adapted for smartphones; electronic machines, apparatus and their parts; computer hardware; laptop computers; tablet computers; printed electronic circuits; digital signages; digital signage monitors; LCD monitors; computer whiteboards; photographic machines and apparatus; cinematographic machines and apparatus; optical apparatus and instruments; batteries and cells; touch panels; computer software applications, downloadable; ozonisers [ozonators]; mathematical

instruments; time and date stamping machines; time clocks [time recording devices]; billing machines; fire alarms; gas alarms; anti-theft warning apparatus; railway signals; luminous or mechanical road signs; measuring or testing machines and instruments; power distribution or control machines and apparatus; rotary converters; phase modifiers; electric or magnetic meters and testers; electric wires and cables; magnetic cores; resistance wires; electrodes; gloves for protection against accidents; dust masks; spectacles [eyeglasses and goggles]; phonograph records; electronic circuits and CD-ROMs recorded with automatic performance programs for electronic musical instruments; exposed cinematographic films; slide film mounts; recorded video discs and video tapes; electronic publications.

11 – Industrial furnaces; solar water heaters; water purifying apparatus; gas purification apparatus; drying apparatus; membrane dryers; waste water treatment tanks for industrial purposes; electric lamps and lighting apparatus; light-emitting diodes [LED] lighting apparatus; kitchen worktops with integrated sinks; kitchen sinks; bath fittings; prefabricated bathrooms sold as a unit; desalination installations; desalination units; water purifying apparatus for household purposes; distillation apparatus; household electrothermic appliances; washers for water taps; washers for water faucets; gas-fired water heaters; electric heaters; lamp chimneys; waste water treatment tanks for household purposes; septic tanks for household purposes; toilet units consisting of toilet bowl and seat; recuperators for chemical processing; steamers for chemical processing; evaporators; heat exchangers, other than parts of machines; forage drying apparatus; boilers, other than parts of machines; air-conditioning apparatus; freezing machines and apparatus; laundry dryers, electric, for industrial purposes; cooking apparatus and installations for commercial use; industrial dish drying machines; dish disinfectant apparatus for industrial purposes; tap water faucets; level controlling valves for tanks; pipe line cocks; septic tanks for industrial purposes; garbage incinerators; ice-cooling refrigerators for household purposes; heating or cooling packs filled with chemical substances ready to react when required.

12 – Railway rolling stock and their parts and fittings; window glass for automobiles; automobiles and their parts and fittings; sunroofs for automobiles; vessels and their parts and fittings; aircraft and their parts and fittings; two-wheeled motor vehicles, bicycles and their parts and fittings; traction engine; nonelectric prime movers for land vehicles, not including their parts; mechanical elements for land vehicles; anti-theft alarms for vehicles; AC motors or DC motors for land vehicles, not including their parts; cigar lighters for automobiles; sleighs and sleds [vehicles]; wheel barrows; carts; carts [Riya-

kah]; adhesive rubber patches for repairing tubes or tires.

17 – Gaskets; joint packings; plastic films for agricultural purposes; plastic semi-worked products; artificial resins in the form of sheets for use in manufacture [semi-finished products]; boards and plates of plastics; fiber-reinforced plastic boards; rubber [raw or semi-worked]; fluoro rubber; washers of rubber or vulcanized fiber; extruded plastics in the form of sponges for use in manufacture or for insulation; valves of rubber or vulcanized fiber, not including machine elements; insulating refractory materials; thermal insulating materials; plastic fibers and carbon fibers, not for textile use; insulating paper; junctions for pipes, not of metal; electrical insulating materials; rock wool; slag wool; rubber thread and covered rubber yarn, not for textile use; elastic yarns and thread, not for textile use; insulating gloves; rubber cords and laces; industrial packaging containers of rubber; rubber stoppers for industrial packaging containers; rubber lids and caps for industrial packaging containers; vulcanized fiber; soundproofing materials of rock wool, not for building purposes.

19 – Ceramic building materials, bricks and refractory products; refractory cement; insulating refractory bricks; plastic building materials; cement and its products; aggregate; building glass; synthetic building materials; asphalt, and asphalt building or construction materials; rubber building or construction materials; plastic security windows allowing communication; building materials made of linoleum for fixing to existing walls or floors; plaster for building purposes; lime building or construction materials; building or construction materials of plaster; road and field marking sheets and strips; building timber; building stone; paint spraying booths, not of metal; moulds for forming cement products, not of metal; water-pipe valves, not of metal or plastics; road signs, not of metal, non-luminous and non-mechanical; beacons, not of metal, non-luminous; storage tanks of masonry; joinery fittings, not of metal; transportable greenhouses, not of metal, for household use; tar and pitch; buildings, not of metal.

20 – Mirrors being items of furniture; valves of plastics, not including machine elements; furniture; storage tanks, not of metal or masonry; metal-substitute plastic fasteners; nails, wedges, nuts, screws, tacks, bolts, rivets and casters, not of metal; washers, not of metal, not of rubber or vulcanized fiber; cushions [furniture]; Japanese floor cushions [Zabuton]; pillows; mattresses; indoor window blinds [shade] [furniture]; loading pallets, not of metal; containers for transport, not of metal; blinds of reed, rattan or bamboo [Sudare]; bead curtains for decoration; oriental single panel standing partition [Tsuitate]; ori-

ental folding partition screens [Byoubu]; benches; upright signboards of wood or plastics.

21 – Unworked or semi-worked glass, not for building; cookware for use in microwave ovens; coffee-makers, non-electric; coffeepots, non-electric; tea pots, non-electric; tableware; food preserving jars of glass; pepper pots, sugar bowls and salt shakers; glass containers for soy source; glass containers for edible oil; hand-operated coffee grinders and pepper mills; industrial packaging containers of glass or porcelain; cooking pots and pans, non-electric; kettles, non-electric; vacuum bottles [insulated flasks]; ice pails; whisks, non-electric; cooking strainers; lemon squeezers; citrus juicers; sugar tongs; nutcrackers; gloves for household purposes; coldboxes, non-electric; kitchen containers for rice; drinking flasks; portable ice chests, non-electric, for household purposes; egg cups; napkin holders and napkin rings; colanders; shakers; Japanese style cooked rice scoops [Shamoji]; bottle openers; cooking graters; tart scoops; waffle irons, non-electric; upright signboards of glass or ceramics; cosmetic and toilet utensils.

37 – Construction; glazing of windows; installation and maintenance of photovoltaic installations; repair or maintenance of automobiles; building caulking services; painting, interior and exterior; joinery; building damp-proofing; bricklaying; renovation of buildings; installation and maintenance of solar thermal installations; advisory services relating to joinery; asphaltting; tile laying, bricklaying or block laying; pipeline construction; installation and repair of air-conditioning apparatus; repair or maintenance of railway rolling stocks; repair or maintenance of vessels; aircraft repair or maintenance; repair or maintenance of two-wheeled motor vehicles.

42 – Architectural design; product design and development services; software design and development; biotechnology research; chemical research; research and development services in the field of antibody technology; testing, inspection and research services in the fields of pharmaceuticals, cosmetics and food-stuffs; design of building interiors and exteriors; design and programming of web sites; computer software consulting; design and development of software for inventory management; research in the field of pharmaceuticals; agrochemical research services; product research services; research relating to building construction; research and development services relating to solar cells and electricity generation; research and development of new products for third parties in the field of plastic materials.

(260) AM 2020 103369 A
(800) 1468778
(151) 2019 03 26

(891) 2019 03 26
(731) Ferring B.V.
Polarisavenue 144, NL-2132 JX Hoofddorp,
Netherlands
(540)

MENOPUR

(591) Black, white
(511)
10 – Surgical and medical apparatus and instruments; syringe devices for injections; syringe devices for medical purposes; orthopaedic articles; suture materials; apparatus, devices and articles for nursing infants; sexual activity apparatus, devices and articles.

(260) AM 2020 103370 A
(800) 1468802
(151) 2019 04 09
(891) 2019 04 09
(731) MOORE STEPHENS INTERNATIONAL
LICENSING LIMITED
5 Market Yard Mews, 194-204 Bermondsey
Street, London SE1 3TQ, United Kingdom
(540)

MOORE

(591) Black, white
(511)
35 – Accountancy services; accounting, auditing and reporting, bookkeeping, and data processing services; business and management consultancy services; business information, research, and analysis services; business risk management services; forensic accountancy investigation services; business support services; economic forecasting and analysis services; remuneration and payroll preparation and consultancy services, advertising, marketing and market research services; tax preparation and consultancy services; personnel planning and consultancy services; recruitment services; arranging exhibitions; data management services; advisory services relating to data processing and data management; company secretarial services.

(260) AM 2020 103384 A
(800) 1468978
(151) 2019 02 28
(891) 2019 02 28
(731) Obshchestvo s ogranichennoy
otvetstvennostyu "Konsortsium-PIK"
Oruzheyniy pereulok, d. 25, str. 1, RU-125047
Moscow, Russian Federation
(540)

ЭТОПИКНОЛ

(591) Black, white

(531) 28.05

(511)

5 – Pharmaceuticals and veterinary preparations; sanitary preparations for medical purposes; dietetic food and substances adapted for medical or veterinary use, food for babies; dietary supplements for human beings and animals; plasters, materials for dressings; material for stopping teeth, dental wax; disinfectants; preparations for destroying vermin; fungicides, herbicides.

(260) AM 2020 103385 A

(800) 1468979

(151) 2019 04 12

(891) 2019 04 12

(731) MUHAMMED BILGE

Okul Sok. No:13/10, Altunizade Uskudar,
Istanbul, Turkey

(540)

Olivera

(591) Black, white

(511)

3 – Bleaching and cleaning preparations, detergents other than for use in manufacturing operations and for medical purposes, laundry bleach, fabric softeners for laundry use, stain removers, dishwasher detergents; perfumery; non-medicated cosmetics; fragrances; deodorants for personal use and animals; soaps; dental care preparations: dentifrices, denture polishes, tooth whitening preparations, mouth washes, not for medical purposes; abrasive preparations; emery cloth; sandpaper; pumice stone; abrasive pastes; polishing preparations for leather, vinyl, metal and wood, polishes and creams for leather, vinyl, metal and wood, wax for polishing.

(260) AM 2020 103386 A

(800) 1469036

(151) 2019 04 15

(891) 2019 04 15

(731) BIOFARMA

50 rue Carnot; F-92284 Suresnes cedex,
France

(540)

ATORPLIXAM

(591) Black, white

(511)

5 – Pharmaceutical products; medical preparations; veterinary preparations; sanitary products for medical purposes; dietetic substances and foodstuffs for medical or veterinary use, food for babies; food supplements for humans and animals; plasters, materials for dressings; material for dental fillings and dental impressions; disinfectants; products for destroying vermin; fungicides, herbicides.

(260) AM 2020 103388 A

(800) 1469088

(151) 2019 03 26

(891) 2019 03 26

(731) HAUTE FRAGRANCE COMPANY, SIA

Kalnupes iela 3, Mārupe, LV-2167 Mārupes
nov., Latvia

(540)

SWEET & SPOILED

(591) Black, white

(511)

3 – Perfumery and fragrances (eau de parfum).

(260) AM 2020 103389 A

(800) 1469090

(151) 2019 03 26

(891) 2019 03 26

(731) HAUTE FRAGRANCE COMPANY, SIA

Kalnupes iela 3, Mārupe, LV-2167 Mārupes
nov., Latvia

(540)

OR NOIR

(591) Black, white

(511)

3 – Perfumery and fragrances (eau de parfum).

(260) AM 2020 103397 A

(800) 1469122

(151) 2019 03 29

(891) 2019 03 29

(731) AUGUST STORCK KG

Waldstraße 27, 13403 Berlin, Germany

(540)



(591) Green, yellow, orange, pink, light blue, red and white

(531) 01.03.09; 05.01.05; 05.01.12; 05.01.16; 27.01.12; 27.03.11; 27.05.03; 28.05; 29.01.15

(511)

30 – Confectionery; chocolate; chocolate products; pastries; ice-cream; preparations for making the aforementioned products, included in class 30.

(260) AM 2020 103398 A

(800) 1469123

(151) 2019 03 28

(891) 2019 03 28

(731) August Storck KG
Waldstraße 27, 13403 Berlin, Germany

(540)

Волшебный твист

(591) Black, white

(531) 28.05

(511)

30 – Confectionery; chocolate; chocolate products; pastries; ice-cream; preparations for making the aforementioned products, included in class 30.

(260) AM 2020 103399 A

(800) 1469129

(151) 2019 02 26

(891) 2019 02 26

(731) CPS Technologies, LLC
1 South Pinckney Street, Madison WI 53703, USA

(540)

CLARIOS

(591) Black, white

(511)

9 – Batteries; galvanic batteries; polymer lithium-ion batteries; fuel cells; rechargeable batteries for electric vehicles; parts and accessories for batteries; battery chargers; voltmeters for electric batteries for land, air and water vehicles; battery monitors for land, air and water vehicles; grids for batteries, namely, conductive grids for batteries; component parts of batteries, namely, internal frames for the purpose of providing structural durability; component parts of batteries, namely, vent caps; industrial batteries; downloadable mobile application software for use with battery monitoring, battery diagnostic, and battery safety devices to monitor the performance of a battery; downloadable mobile application software for education relating to battery technology.

35 – Online retail store services featuring batteries; providing business information in the field of batteries via the internet.

37 – Installation, maintenance, and repair of vehicle batteries; vehicle battery charging.

(260) AM 2020 103400 A

(800) 1469134

(151) 2019 02 28

(891) 2019 02 28

(731) HUAWEI TECHNOLOGIES CO., LTD.
HUAWEI ADMINISTRATION BUILDING,
BANTIAN, LONGGANG DISTRICT,
SHENZHEN, 518129 GUANGDONG,
China

(540)

HUAWEI Mate X

(591) Black, white

(531) 27.05.10

(511)

9 – Notebook computers; laptop computers; wearable computers; computer software for creating and editing music and sounds; personal digital assistants [PDA]; computer memory devices; computer keyboards; interactive touch screen terminals; thin client computers; humanoid robots with artificial intelligence; computer software applications, downloadable; downloadable software applications for mobile phones; tablet computers; downloadable graphics for mobile phones; computer screen saver software, recorded or downloadable; computer software platforms, recorded or downloadable; computer programs, recorded; hand-held electronic dictionaries; smart rings (data processing); smart watches (data processing); smart glasses (data processing); facial recognition apparatus; handprint readers; scales; scales with body mass analyzers; wearable activity trackers; switchboards; selfie sticks used as smartphone accessories; stands adapted for mobile phones; telecommunication apparatus in the form of jewellery; network communication equipment; smartphones; protective films adapted for smartphones; cases for smartphones; covers for smartphones; security surveillance robots; portable media players; wearable video display monitors; television apparatus; headsets; microphones; camcorders; sound transmitting apparatus; video monitors; virtual reality headsets; loudspeakers; cabinets for loudspeakers; cameras [photography]; selfie lenses; teaching robots; gas testing instruments; biochips; laboratory robots; digital weather stations; optical lenses; USB cables; USB cable for mobile phones; plugs, sockets and other contacts [electric connections]; touch screens; electronic chips; integrated circuits; video screens; batteries, electric.

(260) AM 2020 103401 A

(800) 1469248

(151) 2018 12 12

(891) 2018 12 12

(731) UNIFI, INC.

7201 W. Friendly Avenue, Greensboro
NC 27410, USA

(540)



(591) Black, white
 (531) 24.15.02; 24.15.13; 26.01.18; 26.01.24;
 27.05.21; 27.05.24

(511)
 23 – Yarn for use in the manufacture of shirts, t-shirts, pants, shorts, dresses, skirts, sweatshirts, pullovers, jackets, vests, underwear, sleepwear, loungewear, hats and caps, socks, hosiery, and swimwear.

(260) AM 2020 103492 A
 (800) 1469818
 (151) 2019 04 10
 (891) 2019 04 10
 (731) CHENGDU KANGHONG
 PHARMACEUTICALS GROUP CO., LTD.
 NO.36, SHUXI RD., JINNIU DISTRICT,
 CHENGDU, SICHUAN, China

(540)



(591) Black, white
 (531) 26.01.03; 26.11.12; 28.03
 (511)
 5 – Disinfectants; solutions for contact lenses; media for bacteriological cultures; medicine cases, portable, filled; dietetic substances adapted for medical use; depuratives; medicines for veterinary purposes; pesticides; disinfectant wipes; dressings, medical; teeth filling material; medicines for human purposes; medicinal tea; biochemical medicine; gases for medical purposes.

(260) AM 2020 103493 A
 (800) 1469828
 (151) 2019 01 14
 (891) 2019 01 14
 (731) EGIS GYÓGYSZERGYÁR ZRT.
 Keresztúri út 30-38., H-1106 Budapest,
 Hungary

(540)

СУПРАСТИДЕН

(591) Black, white
 (531) 28.05
 (511)
 5 – Pharmaceutical preparations for human use.

(260) AM 2020 103505 A
 (800) 1470214
 (151) 2019 03 07

(891) 2019 03 07
 (731) UTOPIA TABLEWARE LIMITED
 Unit 1, Langham Park, Mansfield Road,
 Corbriggs, Chesterfield S41 0GG, United
 Kingdom

(540)

utopia

(591) Black, white
 (511)
 8 – Cutlery; flatware namely knives, forks and spoons; kitchen knives; steak knives; dessert spoons; soup spoons; tea spoons; coffee spoons; butter knives; dessert knives, forks and spoons; fish forks; fish knives; bread knives; sporks; latte spoons; cake forks; silverware [cutlery, forks and spoons]; children's cutlery; pizza cutters; hand-operated chop-pers; hand-operated slicers; knife sharpeners.

21 – Household or kitchen utensils; tableware; cook-ware and containers; containers for household or kitchen use not of precious metal; containers for household or kitchen use of precious metal; tableware; vitrified tableware; dinnerware; crockery; plates; dinner plates; side plates; bowls; dessert bowls; sugar bowls; dip pots; dishes; mugs; mixing bowls; cups; saucers; bowls; mugs; espresso cups; teapots; jugs; condiments containers, shakers and pots; coffee-pots; latte glasses; table mats; trays for household purposes; cutting boards for the kitchen; household utensils, namely, kitchen tongs, spatulas, strainers, turners, servers; serving scoops; ladles; slotted spoons; pans; skillets; platters; ice pails (not of precious metal); glasses (receptacles); tumblers; decanters; jugs; bottles; glassware; porcelain ware; porcelain products; crystal [glassware]; earthenware products; ceramic products; gravy boats; stoneware products; drinking straws; water bottles; whisks; salt cellars; pepper cellars; salt mills; pepper mills; ramekins; casserole dishes; chargers [serving plates]; glass bottles; vinegar bottles; oil bottles; carafes; tumblers; cocktail strainers; bar scoops; wine buckets; beer glasses; wine glasses; tankards; goblets; flutes; cocktail glasses; conical flasks [barware]; beakers [barware]; cocktail shakers; shot glasses; barware; lemon slice squeezers; pitchers; glass flasks; pots; pans; frying pans; woks; pan lids; pan strainers; covers for dishes; plate covers; squeeze bottles; brushes; baskets; storage baskets; candle holders; night light holders; cloches; butter dishes; cake plates; 3-tier cake plates; footed cake stands; wire baskets [cooking utensils]; wire baskets [ser-vice]; bottle stoppers; pourers; wooden serving boards; melamine serveware; bamboo shot paddles; serving trays; vases; fish bowls; ice cream scoops; egg cups; butter dishes; cup/glass racks; bar cad-dy/tidy; punch barrels; corkscrews.

(260) AM 2020 103506 A
 (800) 1470221
 (151) 2019 04 12
 (891) 2019 04 12
 (731) GUANGDONG WONDERFUL CERAMICS,
 CO., LTD.
 TANGXIA VILLAGE, GAOBU TOWN,
 DONGGUAN CITY, 523121 GUANGDONG
 PROVINCE, China
 (540)



(591) Black, white
 (531) 01.05.02; 25.01.25; 27.05.01
 (511)
 11 – Lamps; bath tubs for sitz baths; bath fittings;
 urinals being sanitary fixtures; hand wash basins
 being parts of sanitary installations; toilets [water-
 closets]; toilet bowls; bath tubs; bath installations.

(260) AM 2020 103507 A
 (800) 1470280
 (151) 2019 03 28
 (891) 2019 03 28
 (731) AUGUST STORCK KG
 Waldstraße 27, 13403 Berlin, Germany
 (540)

Мамба Волшебни

(591) Black, white
 (531) 28.05
 (511)
 30 – Confectionery; chocolate; chocolate products;
 pastries; ice-cream; preparations for making the afo-
 rementioned products, included in class 30.

(260) AM 2020 103508 A
 (800) 1470283
 (151) 2019 03 05
 (891) 2019 03 05
 (731) MAKE UP ARTS PRODUCTION
 19 rue de la Pierre Levée, F-75011 PARIS,
 France
 (540)



(591) Black, white
 (531) 16.03.05
 (511)
 3 – Cosmetics; cosmetic products; cosmetic oils;
 cosmetic masks; cosmetic creams; cosmetic lotions;
 cosmetic soaps; cosmetic kits; cosmetics for eyelas-
 hes; moisturizers [cosmetics]; cosmetic sun creams;
 cosmetic slimming preparations; cosmetic hair-sty-
 ling products; powder compacts [cosmetic products];
 eye-liners [cosmetics]; fluid creams [cosmetics]; pe-
 ncils for cosmetic use; pomades for cosmetic use;
 lacquers for cosmetic use; glitter for cosmetic use;
 serums for cosmetic use; gels for cosmetic use; cot-
 ton wool for cosmetic use; eyebrow cosmetics;
 night creams [cosmetics]; cosmetics for use on the
 skin; cosmetic products for children; after-sun milks
 [cosmetics]; hair cosmetics; nail cosmetics; lip cos-
 metics; wet wipes for cosmetic use; essential oils for
 cosmetic purposes; artificial nails for cosmetic use;
 perfumed powders [for cosmetic use]; repair creams
 for cosmetic use; eye compresses for cosmetic use;
 cosmetic preparations for baths; cosmetic cleansers
 for the face; body oils [cosmetics]; face creams [cos-
 metics]; powder compact refills [cosmetic products];
 skin masks [cosmetics]; cleaning product for cos-
 metical brushes; nail base [cosmetics]; lip colorants
 [cosmetics]; cosmetic pencils for cheeks; solid pow-
 der for powder compacts [cosmetics]; hand creams
 (cosmetics); nail polish for cosmetic use; massage
 candles for cosmetic use; sun stick for the lips [cos-
 metics]; cosmetic lotions for strengthening nails; nail
 polish removers [cosmetics]; nail polish base coats
 [cosmetics]; face powders [for cosmetic use]; facial
 masks for cosmetic use; cosmetics sold in the nature
 of kits; firming creams for the eye contour for cos-
 metical purposes; cosmetic skin-tanning preparations;
 cosmetic products in the nature of eye shadow; cos-
 metical products in the nature of blush; gel eye pat-
 ches for cosmetic use; peeling preparations for the
 face for cosmetic use; concealers (against dark cir-
 cles); make-up foundations in the form of pastes; lip
 glosses; concealer for the face; concealers intended
 for spots and blemishes; lip liner pencils; eyelid
 pencils; eyebrow pencils; eye pencils; eyebrow col-
 ors in the nature of powders and pencils; lipstick
 cases; foundation cream; liquid foundation; eyebrow
 gel; make-up removing gels; make-up removing
 milk; make-up removing lotions; multi functional
 make-up; face and body make-up; mascara; eyebrow
 mascara; beauty masks; lip gloss palettes; eye make-
 up palettes; make-up powder; eyebrow powder;
 make-up removing products; eye-color make-up pro-
 ducts; eye make-up products; blusher for cheeks;
 lipstick; eyebrow dyes; dye for eyelashes; prepara-
 tions for removing gel nails; cosmetic products for the
 shower; facial care preparations; anti-aging skin care
 preparations; lotions for face and body care; exfo-
 liants for the cleansing of the skin; perfumed body

creams; make-up removing creams; creams for cellulite reduction; false eyelashes.

44 – Make-up services [cosmetics]; cosmetic services [beauty care]; cosmetic face care; consultancy with respect to cosmetics; cosmetic treatment services for the face and body; application of cosmetic products on the face (beauty care service); application of cosmetic products on the body [beauty care service]; cosmetic treatment services for the body, face and hair; cosmetic testing; skin care centers; consultation relating to beauty; information regarding beauty; rental of skin care equipment; rental of equipment for human hygiene and beauty care; beauty and hairdressing salon services; consultancy relating to beauty care; consulting relating to skin care; consultancy provided via the Internet in the field of body and beauty care; consultancy services in the field of make-up; manicure services; make-up services; eyebrow shaping services; pedicure services; face care services; beauty care services; nail care services; beauty treatments for the body; eyebrow tattooing services; beauty care; hygienic and beauty care.

(260) AM 2020 103529 A
(800) 1470868
(151) 2019 01 21
(891) 2019 01 21
(731) XIAOMI INC.

Floor 13, Rainbow City Shopping Mall II,
of China Resources, NO. 68, Qinghe Middle
Street, Haidian District, Beijing, China

(540)

Mi Pay

(591) Black, white
(531) 27.05.15
(511)

9 – Computer peripheral devices; Global Positioning System [GPS] apparatus; electronic sounding device within books, namely, audio devices for audiobooks; animated cartoons; cameras [photography]; mouse pads; quantity indicators; measuring instruments; sensors; spectacles; video screens; remote control apparatus; chips [integrated circuits]; theft prevention installations, electric; chargers for electric batteries.

35 – Advertising; commercial intermediation services; marketing; personnel management consultancy; relocation services for businesses; compilation of information into computer databases; accounting; rental of vending machines; sponsorship search; retail services for pharmaceutical, veterinary and sanitary preparations and medical supplies.

36 – Financing services; loans [financing]; installment loans; providing financial information via a web site; insurance information; financial customs brokerage services; surety services; real estate agency services; trusteeship; pawnbrokerage.

(260) AM 2020 103531 A
(800) 1470916
(151) 2019 04 15
(891) 2019 04 15
(731) JAPAN TOBACCO INC.
2-2-1 Toranomom, Minato-ku, Tokyo,
Japan

(540)



(591) Black, white
(531) 14.03.13; 15.07.03; 26.01.03; 26.01.24;
26.11.08; 26.11.12; 26.13.25; 27.05.01

(511)

34 – Tobacco, raw or manufactured; smoking tobacco, pipe tobacco, rolling tobacco, chewing tobacco, snus; cigarettes, electronic cigarettes, cigars, cigarettos; snuff; smokers' articles included in class 34; cigarette paper, cigarette tubes and matches.

(260) AM 2020 103532 A
(800) 1470919
(151) 2019 04 26
(891) 2019 04 26
(731) SEATTLE GENETICS, INC.
21823 30th Drive S.E., Bothell WA 98021,
USA;
AGENSYS, INC.
1800 Stewart Street, Santa Monica CA 90404,
USA

(540)



(591) The color(s) gold and blue is/are claimed as a feature of the mark

(531) 26.03.23; 26.04.03; 29.01.13

(511)

5 – Pharmaceutical preparations and substances for the treatment of cancer; pharmaceutical preparations and substances for use in oncology.

(260) AM 2020 103533 A
 (800) 1470937
 (151) 2018 06 18
 (891) 2018 06 18
 (731) IIC-INTERSPORT International
 Corporation GmbH
 Wölflistrasse 2, CH-3006 Bern, Switzerland
 (540)

The logo for INTERSPORT features a stylized blue and red graphic element on the left, followed by the word "INTERSPORT" in a bold, blue, sans-serif font.

(591) Red and blue
 (531) 26.07.05; 27.05.10; 29.01.12
 (511)

35 – Advertising, including direct marketing and online marketing; advertising by sponsoring; commercial business management; commercial administration; computer file management; collection of data in a central file; systematization of data in a central file; provision of space on web sites, for advertising of goods and services; analysis of statistics and data with respect to market research; order and stock management services; computerized data processing services, especially processing of orders and order vouchers and billing services; business management and organization consultancy; advice on organizing and managing sports shops and sports centers; shop window dressing; demonstration of goods; dissemination of advertisements; dissemination of advertising material; market study; import-export agencies; rental of advertising space; rental of advertising material; organization of exhibitions for commercial or advertising purposes; sales promotion through the sponsoring of cultural and sporting events; promoting the goods and services of others, by means of contractual agreements, in particular sponsoring and licensing agreements, enabling them to gain additional notoriety and/ or enhanced image and/or a surge of sympathy derived from cultural and sporting events; publication of advertising texts; radio advertising; television advertising; retail sale in stores and by means of a global computer network (the Internet); electronic commerce services (e-commerce), namely provision of information on products via telecommunication networks for advertising and sales purposes; electronic commerce services, namely advertising in the form of data, texts, images, sound, individually or in combination, via computer networks, for the sale of clothing, footwear, headgear and sports items; presentation of goods on all communication media, for retail purposes; retail services for clothing, footwear, headgear and sports items; wholesale services for clothing, footwear, headgear and sports items; mail order services with regard to clothing, footwear, headgear and sports items; grouping of wholesale purchases; wholesale services; grouping services for the benefit of others of a variety of goods and services (except for the transport thereof) enabling customers to conveniently

view, find out about and purchase such goods or services; procurement services for others (purchasing goods and services for other businesses); selection and presentation of products and services, in printed form or by electronic means of communication, for the purpose of enabling the purchase by mail order; commercial advisory services relating to the establishment and operation of franchises; commercial administration of the licensing of the goods and services of others; services provided by a license granter and/or franchiser, namely transfer (provision) of commercial knowhow.

(260) AM 2020 103534 A
 (800) 1470938
 (151) 2019 04 15
 (891) 2019 04 15
 (731) JAPAN TOBACCO INC.
 2-2-1 Toranomom, Minato-ku, Tokyo, Japan
 (540)



(591) Black, white
 (531) 26.01.01; 26.01.04; 26.01.11; 26.01.24;
 26.04.01; 26.04.09; 26.11.01; 26.11.08;
 26.13.25

(511)
 34 – Tobacco, raw or manufactured; smoking tobacco, pipe tobacco, rolling tobacco, chewing tobacco, snus; cigarettes, electronic cigarettes, cigars, cigarettos; snuff; smokers' articles included in class 34; cigarette paper, cigarette tubes and matches.

(260) AM 2020 103535 A
 (800) 1470944
 (151) 2019 04 16
 (891) 2019 04 16
 (731) UNITOP Spółka z ograniczoną
 Odpowiedzialnością
 Andrzeja Struga 61, PL-90-959 Łódź,
 Poland
 (540)

AMKI

(591) Black, white
 (511)
 30 – Confectionery.

(260) AM 2020 103537 A
 (800) 1470968
 (151) 2019 04 09
 (891) 2019 04 09

(731) Obschestvo s ogranichennoj otvetstvennost'yu "SISTEMA"
ul. Kujbysheva, d. 44, ofis 910, RU-620026
g. Ekaterinburg, Russian Federation

(540)



(591) Yellow-gold, black and red, bitter-blue, turquoise blue, pine-green, blue-gray, black amber and white

(531) 26.04.17; 26.04.22; 29.01.13

(526) barcode

(511)

41 – Arranging and conducting of workshops [training]; educational services provided by schools; practical training [demonstration].

(260) AM 2020 103539 A

(800) 1471002

(151) 2018 07 10

(891) 2018 07 10

(731) HYPRED

55 boulevard Jules Verger, F-35800 DINARD,
France

(540)

KERSIA

(591) Black, white

(511)

1 – Chemical, biological and enzyme products for use in the agricultural, food, agri-food, pharmaceutical, cosmetic, laundry industries, by the health and veterinary sector, and in the restaurant and hotel industry, especially with respect to disinfection and detergents; chemical and biological products for the treatment of air and water; chemical products and chemical substances for the purification and disinfection of water; water softening chemicals; silage preservatives; biological products for preserving foodstuffs; milk ferments for preserving silage.

3 – Laundry preparations and substances; preparations for cleaning and degreasing materials, equipment, apparatus, installations, vehicles and containers, buildings, floors, surfaces, clothing, instruments for use in the agricultural, food, agri-food, pharmaceutical, cosmetic, health, laundry industry and in catering and hotel services; non-medicated preparations and products for care of animal udders and teats; hand soaps; moisturizing preparations and products for animal udders and teats, hooves, paws of animals, milking equipment; non-medicated pre-

parations and products for cleaning teats and udders of animals and animal hooves and paws.

5 – Sanitary products and preparations and disinfectants for materials, equipment, apparatus, installations, vehicles and containers, buildings, floors, surfaces, clothing, instruments for use in the agricultural, food, agri-food, pharmaceutical, cosmetic, laundry industry, in the health and veterinary sector, and in the restaurant and hotel industry; sanitary products, preparations and disinfecting products for animal udders, teats, shoes and claws and animal milking equipment; hand sanitizer; food supplements for animals; dietetic foodstuffs for animals, nutritional supplements for animals, energy food supplements for animals.

7 – Industrial machines; machine tools, robots and mechanical equipment (machines) for treating, cleaning and purifying water and air; apparatus for and application of cleaning and disinfecting goods.

9 – Apparatus for dosing of cleaning preparations and disinfectants; apparatus and instruments for the diagnosis of contamination of air and water; apparatus and instruments for collecting and controlling air and water.

11 – Apparatus and machines for treating, cleaning and purifying air and water.

21 – Cleaning and washing equipment; brushes; brushmaking materials; utensils and containers for washing, deembedding, disinfecting and cleaning for the food, agri-food, pharmaceutical, cosmetic, agricultural, health, restaurant and laundry industry.

31 – Agricultural products; animal foodstuffs.

(260) AM 2020 103541 A

(800) 1471064

(151) 2019 03 08

(891) 2019 03 08

(731) TOBB UND LOJİSTİK YATIRIM ANONİM
ŞİRKETİ

Eskişehir Yol.Kat-Dumlupınar Blv. No.252
Tobb İkiz Kuleler C Kule K.27, Çankaya
Ankara, Turkey

(540)

(591) Blue, red, yellow, white

(531) 26.11.11; 26.11.13; 27.01.25; 27.05.09;
27.05.10; 27.05.19; 27.05.22; 27.05.25;
29.01.13

(511)

9 – Computer programs and software for land, water, rail and intermodal transportation systems.

35 – Collecting, compiling and management services of information in computerized database which are consisting transit notifications and reports; document verification / validation services related to customs legislation, administration and management services of customer information and / or business information related to customs legislation with the aid of computer data.

36 – Customs brokerage services; services of transit presenting declaration forms to customs office in electronic media; services of providing assurance for customs tariff and similar customs credits that will originate before customs offices domestically and abroad related to the international transportation activities, particularly the international transportations to be performed in accordance with the common transit provisions of common transit convention and customs regulation.

38 – Radio and television broadcasting services, telecommunication services; providing access to Internet, news agencies.

39 – Consultancy services for land, water, rail and intermodal transportation concerning with logistic sector; services for renting land, water and air transportation vehicles and services for land, water and air transportation.

42 – Software services for analysis and verification of the appropriateness of custom transit declarations according to the national/international/supranational regulations of customs procedures for goods and services; software services for customer and business information system services related to customs transit declarations.

(260) AM 2020 103542 A
 (800) 1471079
 (151) 2019 04 26
 (891) 2019 04 26
 (731) SEATTLE GENETICS, INC.
 21823 30th Drive S.E., Bothell WA 98021,
 USA;
 Agensys, Inc.
 1800 Stewart Street, Santa Monica CA 90404,
 USA
 (540)



(591) The color(s) gold, white and blue is/are claimed as a feature of the mark
 (531) 26.03.23; 26.04.03; 26.04.16; 29.01.13

(511)
 5 – Pharmaceutical preparations and substances for the treatment of cancer; pharmaceutical preparations and substances for use in oncology.

(260) AM 2020 103548 A
 (800) 1011340
 (151) 2009 04 21
 (891) 2019 05 22
 (731) CABERG S.P.A.
 Via Emilia, 11, I-24052 AZZANO SAN
 PAOLO (Bergamo), Italy
 (540)

CABERG

(591) Black, white
 (511)
 9 – Protective helmets and helmets for motorcyclists, motorists, cyclists and for sports in general; protective helmets for work and accident prevention; components for helmets.

(260) AM 2020 103550 A
 (800) 1105210
 (151) 2011 10 19
 (891) 2019 05 21
 (731) HG International B.V.
 Damluisweg 70, NL-1332 EJ Almere,
 Netherlands
 (540)

HG

(591) Black, white
 (511)
 1 – Chemicals used in industry, science and photography, as well as in agriculture, horticulture and forestry; chemicals not included in other classes, including detergents, for use in manufacturing processes; products for the removal of scale, not for household purposes; products for the separation of greases and oils; moisture repellent preparations, not included in other classes; products for the removal of wallpaper.

2 – Paints, varnishes, lacquers; preservatives against rust and against deterioration of wood; colorants; mordants; raw natural resins; metals in foil and powder form for painters, decorators, printers and artists; anti-tarnishing preparations for metals; products, including oils, for the conservation of furniture and floors, not included in other classes.

3 – Bleaching preparations and other substances for laundry use; shining preparations; refurbishing preparations; polish for furniture and flooring; stain removers; cleaning, polishing, scouring and abrasive preparations; soaps; perfumery, essential oils, cosmetics, hair lotions; dentifrices; products for cleaning and degreasing furniture and floors; detergents

for the removal of paints, printing ink, grease, soot, rust and verdigris; detergents for the removal of limestone, for household purposes; preparations for cleaning waste pipes; graffiti removers; cleaning preparations for synthetic garden furniture; cleaning products for the removal of scale and other (extreme) contaminations of water-resistant surfaces.

4 – Industrial oils and greases; penetrating oils and other lubricants; dust absorbing, wetting and binding compositions; fuels (including motor spirit) and illuminants; candles and wicks for lighting.

5 – Disinfectants for sanitary use; preparations for destroying vermin; insecticides; fungicides and herbicides; air purifying preparations.

(260) AM 2020 103553 A

(800) 1316265

(151) 2016 06 13

(891) 2019 05 06

(731) FEDIAI VOLODYMYR IVANOVYCH
vul. Naberezhna Peremohy, 134, korp. 3,
kv. 47, Dnipro 49106, Ukraine

(540)



(591) Yellow, blue, crimson and gray

(531) 02.01.30; 02.05.02; 09.07.22; 21.01.25;
27.05.08; 27.05.10; 29.01.15

(511)

41 – Academies [education]; educational services; videotaping; arranging and conducting of congresses; arranging and conducting of colloquiums; arranging and conducting of conferences; arranging and conducting of concerts; arranging and conducting of in-person educational forums; arranging and conducting of workshops [training]; arranging and conducting of seminars; arranging and conducting of symposiums; arranging of beauty contests; gymnastic instruction; electronic desktop publishing; nursery schools; animal training; dubbing; educational examination; providing on-line videos, not downloadable; providing on-line electronic publications, not downloadable; providing on-line music, not downloadable; providing sports facilities; providing recreation facilities; providing golf facilities; providing casino facilities [gambling]; booking of seats for shows; correspondence courses; game services provided on-line from a computer network; recreation information; education information; entertainment information; cinema presentations; microfilming; videotape editing; tutoring; boarding school education; providing museum facilities [presenta-

tion, exhibitions]; screenplay writing; songwriting; scriptwriting, other than for advertising purposes; writing of texts; organization of balls; organization of shows [impresario services]; organization of exhibitions for cultural or educational purposes; organization of competitions [education or entertainment]; organization of lotteries; organization of fashion shows for entertainment purposes; organization of sports competitions; sign language interpretation; party planning [entertainment]; entertainer services; lending library services; disc jockey services; discot- heque services; calligraphy services; layout services, other than for advertising purposes; language interpreter services; providing amusement arcade services; zoological garden services; coaching [training]; ka- raoke services; movie studio services; club services [entertainment or education]; health club services [health and fitness training]; modelling for artists; nightclub services [entertainment]; orchestra ser- vices; amusement park services; translation; bookmo- bile services; personal trainer services [fitness train- ing]; news reporters services; sport camp services; recording studio services; holiday camp services [entertainment]; ticket agency services [entertain- ment]; photographic reporting; services of schools [education]; gambling services; music composition services; practical training [demonstration]; presen- tation of live performances; presentation of variety shows; presentation of circus performances; conduc- ting guided tours; conducting fitness classes; rental of audio equipment; rental of show scenery; rental of camcorders; rental of video cassette recorders; rental of videotapes; rental of sound recordings; toy rental; games equipment rental; rental of cinematographic apparatus; rental of motion pictures; rental of skin diving equipment; rental of lighting apparatus for theatrical sets or television studios; rental of radio and television sets; rental of sports grounds; rental of sports equipment, except vehicles; rental of stage scenery; rental of tennis courts; rental of stadium facilities; vocational retraining; vocational guidance [education or training advice]; on-line publication of electronic books and journals; publication of books; publication of texts, other than publicity texts; radio entertainment; religious education; entertainment services; production of shows; production of music; production of radio and television programmes; film production, other than advertising films; subtitling; theatre productions; television entertainment; physi- cal education; photography; timing of sports events.

(260) AM 2020 103595 A

(800) 1471317

(151) 2019 03 11

(891) 2019 03 11

(731) ALLIED BRANDS S.R.L.

CORSO VENEZIA 36, I-20121 MILANO,
Italy

(540)

XENTA SHARE YOUR EXPERIENCE

(591) Black, white

(511)

33 – Alcoholic beverages.

(260) AM 2020 103605 A

(800) 1471618

(151) 2019 01 08

(891) 2019 01 08

(731) Roeckl Handschuhe & Accessoires GmbH & Co. KG

Isartalstraße 49, 80469 München, Germany

(540)

ROECKL

(591) Black, white

(531) 27.05.01

(511)

3 – Soaps; perfumery; essential oils; cosmetics and beauty care preparations; hair lotions.

9 – Sunglasses; optical glasses; spectacle cases; spectacle frames; safety gloves for protection against accident or injury; protective work gloves; covers and cases for smartphones, touchscreens and tablet computers.

14 – Jewellery; gemstones; semi-precious stones; clocks; time instruments; key rings of leather.

18 – Bags; handbags; leather and imitations of leather and goods made of them, namely bags, handbags, travel bags, suitcases, travel cases; furniture coverings of leather; small leather goods, namely, purses, wallets; cases, namely for cards, credit cards, driving licenses, ties, keys; cosmetic purses; pouches; packaging bags of leather, pouches, of leather, for packaging; briefcases; shopping bags; luggage covers; umbrellas; boxes of leather; animal skins; fur; luggage; carrying bags; rucksacks; trunks and suitcases; straps, shoulder straps and cords for handbags, rucksacks and luggage; umbrellas and parasols; walking sticks; whips; harnesses; collars, leads and covers for animals.

20 – Furniture; mirrors; picture frames; containers, not of metal, for storage and transport; goods of wood, cork, reed, cane, wicker, horn, bone, ivory, fish bone, tortoiseshell, amber, mother-of-pearl, meerschaum and their substitutes or of plastics, namely boxes, identification bracelets, trays, statues, figures, works of art, ornaments, decorations, packaging containers of plastic material, non-metal closures for containers, furniture fittings, not of metal, boxes, of wood or plastic, baskets, non-metallic; wickerwork.

24 – Cloths, insofar as included in class 24; woven fabrics and textile goods, insofar as they are inclu-

ded in class 24; bed linen; bed blankets; table linen; table cloths of textile; blankets, insofar as included in class 24; pillow covers.

25 – Clothing; footwear; headgear; gloves (not being sportswear), in particular all kinds of gloves made of leather, gloves made of textile cloth, gloves made of fur, gloves made of cotton, gloves made of satin, gloves made of lace, gloves made of silk, gloves made of natural fibres, gloves made of artificial fibres; gloves, suitable for operating electronic devices with touch screen technology; headgear made from fur; muffs [clothing]; collars [clothing], in particular fur collars; scarves; stoles; shawls; scarfs; pocket squares; scarves made from textile materials; sashes; mantillas; ponchos; pareos; swimwear and beachwear; belts [clothing].

26 – Lace; embroidery; ribbons; laces; buttons; hooks and eyes; needles; artificial flowers; buckles [clothing accessories]; belt clasps.

35 – Wholesale and retail services also via the internet, retail services via teleshopping and mail order selling, each concerning soaps, perfumery, essential oils, cosmetics and beauty care preparations, hair lotions, sunglasses, optical glasses, spectacle cases, spectacle frames, safety gloves for protection against accident or injury, protective work gloves, covers and cases for smart phones, touchscreens and tablet computers, jewellery, gemstones, semi-precious stones, clocks, time instruments, bags, handbags, leather and imitations of leather and goods made of them, namely bags, handbags, travel bags, suitcases, travel cases, furniture coverings of leather, small leather goods, namely, purses, wallets, cases, namely for cards, credit cards, driving licenses, ties, keys, cosmetic purses, pouches, packaging bags of leather, pouches, of leather, briefcases, shopping bags, luggage covers, umbrellas, boxes of leather, animal skins, fur, luggage, carrying bags, rucksacks, trunks and suitcases, straps, shoulder straps and cords for handbags, rucksacks and luggage, umbrellas and parasols, walking sticks, whips, harnesses, furs, collars, leads and covers for animals, furniture, mirrors, picture frames, containers, not of metal, for storage and transport, goods of wood, cork, reed, cane, wicker, horn, bone, ivory, fish bone, tortoiseshell, amber, mother-of-pearl, meerschaum and their substitutes or of plastics, namely boxes, identification bracelets, trays, statues, figures, works of art, ornaments, decorations, packaging containers of plastic material, non-metal closures for containers, furniture fittings, not of metal, boxes, of wood or plastic, baskets, non-metallic, wickerwork, cloths, woven fabrics and textile goods, bed linen, bed blankets, table linen, table cloths of textile, blankets, pillow covers, clothing, footwear, headgear, gloves (not being sportswear), in particular all kinds of gloves made of leather, gloves made of textile cloth,

gloves made of fur, gloves made of cotton, gloves made of satin, gloves made of lace, gloves made of silk, gloves made of natural fibres, gloves made of artificial fibres, gloves, suitable for operating electronic devices with touch screen technology, headgear made from fur, muffs [clothing], collars [clothing], in particular fur collars, scarves, stoles, shawls, scarfs, pocket squares, scarves made from textile materials, sashes, mantillas, ponchos, pareos, swimwear and beachwear, belts [clothing], lace, embroidery, ribbons, laces, buttons, hooks and eyes, needles, artificial flowers, buckles [clothing accessories], belt clasps.

(260) AM 2020 103607 A
 (800) 1471661
 (151) 2019 05 08
 (891) 2019 05 08
 (731) JIANGSU FOLEE MEDICAL EQUIPMENT CO., LTD.
 NO.16, XINGMAO ROAD, ZHENJIANG CITY, 212009 JIANGSU PROVINCE, China

(540)



(591) Black, white
 (531) 27.05.01
 (511)
 10 – Medical apparatus and instruments; dental apparatus and instruments; physiotherapy apparatus; air mattresses for medical purposes; breast pumps; condoms; artificial limbs; orthopedic articles; suture materials.

(260) AM 2020 103613 A
 (800) 1471757
 (151) 2019 03 18
 (891) 2019 03 18
 (731) ACULIFE HEALTHCARE PRIVATE LIMITED
 commerce house-v, besides vodafone house, prahladnagar corporate road, Ahmedabad 380051, gujarat, India

(540)



(591) Black, white
 (531) 27.05.01
 (511)
 5 – Medicinal and pharmaceuticals preparations.

(260) AM 2020 103615 A
 (800) 1471833
 (151) 2018 10 29

(891) 2018 10 29
 (731) KOLISNYK OLEKSANDR OLEKSIIOVYCH
 prosp. Heroiv Stalinhrada, bud. 12 Zh, kv. 64, m. Kyiv 04210, Ukraine

(540)



(591) Black, white
 (531) 26.04.24; 27.05.10; 27.05.22; 27.05.24
 (511)
 7 – Air brushes for applying colour; glaziers' diamonds [parts of machines]; apparatus for machining; drums [parts of machines]; concrete mixers [machines]; vacuum pumps [machines]; fans for motors and engines; machine tools; die-cutting and tapping machines; threading machines; screwdrivers, electric; vibrators [machines] for industrial use; water heaters [parts of machines]; suction machines for industrial purposes; suction nozzles for vacuum cleaners; lawnmowers [machines]; nut-tapping machines; brake shoes, other than for vehicles; emergency power generators; alternators; dynamos; current generators; hydraulic engines and motors; sharpening machines; sharpening wheels [parts of machines]; tilling machines for agricultural purposes; wood-working machines; mortising machines; chisels for machines; jacks [machines]; pneumatic jacks; electric hand drills; kitchen grinders, electric; electric welding apparatus; electric hammers; generators of electricity; electrodes for welding machines; electric arc welding apparatus; electric arc cutting apparatus; soldering apparatus, gas-operated; welding machines, electric; mixing machines; mixers [machines]; blenders, electric, for household purposes; glue guns, electric; compressors [machines]; cultivators [machines]; food processors, electric; kitchen machines, electric; chain saws; winches; blade sharpening [stropping] machines; stropping machines; blade holders [parts of machines]; corn and grain husking machines; crushing machines; spraying machines; grinding machines; colour-washing machines; machines and apparatus for polishing [electric]; machines and apparatus for wax-polishing, electric; metal-working machines; power hammers; high pressure washers; washing apparatus; hammers [parts of machines]; motorized cultivators; meat choppers [machines]; pumps [machines]; pumps [parts of machines, engines or motors]; scissors, electric; knives for mowing machines; chaff cutter blades; knives, electric; dust exhausting installations for cleaning purposes; soldering irons, gas-operated; soldering irons, electric; soldering lamps; saws [machines]; saw blades [parts of machines]; vacuum cleaners; saw benches [parts of machines]; guns [tools using explo-

sives]; spray guns for paint; ploughs; compressed air guns for the extrusion of mastics; blowing machines; air pumps [garage installations]; crushers for kitchen use, electric; pulverisers [machines]; cutting blow pipes, gas-operated; cutters [machines]; tools [parts of machines]; cutting machines; knives [parts of machines]; hand-held tools, other than hand-operated; drilling machines; drilling heads [parts of machines]; drill chucks [parts of machines]; sparking plugs for internal combustion engines; juice extractors, electric; planing machines; lathes [machine tools]; grindstones [parts of machines]; holding devices for machine tools; milling machines; vacuum cleaner hoses; trueing machines; carbon brushes [electricity]; dynamo brushes; grinding machines, electric; electric perforators; pneumatic hammers, hand-held; electric carving knives; electric tile cutters; electric planes; grinding wheels [parts of machines]; cutting wheels [parts of machines]; punches for punching machines; all the aforesaid goods except machines, machine components and goods for the printing industry, in particular for mailroom technique and the further processing of printed products, devices for collating, sorting, arrangement and storing of printed products; all the aforesaid goods except machines and machine components for the conveying technique, namely conveying installations and conveying equipment, machines and machine components for transporting, commissioning, sorting and handling of conveying technique objects.

8 – Abrading instruments [hand instruments]; glaziers' diamonds [parts of hand tools]; apparatus for destroying plant parasites, hand-operated; borers; screwdrivers, non-electric; agricultural forks [hand tools]; tap wrenches; spanners [hand tools]; wrenches [hand tools]; scythe stones; sharpening stones; sharpening wheels [hand tools]; edge tools [hand tools]; pincers; rakes [hand tools]; sand trap rakes; cutter bars [hand tools]; handles for hand-operated hand tools; punch pliers [hand tools]; lifting jacks, hand-operated; clamps for carpenters or coopers; bits [hand tools]; grafting tools [hand tools]; priming irons [hand tools]; gouges [hand tools]; sharpening instruments; stropping instruments; trowels; centre punches [hand tools]; picks [hand tools]; mallets [hand instruments]; riveters [hand tools]; riveting hammers [hand tools]; pliers; scythes; hainault scythes; squares [hand tools]; emery grinding wheels; sled-gehammers; blades [hand tools]; blades for planes; shear blades; blade sharpening instruments; jigsaws; shovels [hand tools]; lawn clippers [hand instruments]; taps [hand tools]; hammers [hand tools]; bushhammers; needle files; emery files; files [tools]; dies [hand tools]; shears; shearers [hand instruments]; pruning shears; border shears; scissors; paring knives; pruning knives; bill-hooks; penknives; vegetable shredders; vegetable peelers [hand tools]; perforating tools [hand tools]; saws [hand tools];

guns [hand tools]; guns, hand-operated, for the extrusion of mastics; fruit pickers [hand tools]; air pumps, hand-operated; polishing irons [glazing tools]; saw blades [parts of hand tools]; tool belts [holders]; punches [hand tools]; nail punches; numbering punches; pin punches; insecticide vaporizers [hand tools]; rasps [hand tools]; tube cutting instruments; cutting tools [hand tools]; bits [parts of hand tools]; graving tools [hand tools]; cutters; syringes for spraying insecticides; planes; plane irons; hand drills, hand-operated; hand tools, hand-operated; garden tools, hand-operated; hoes [hand tools]; augers [hand tools]; carpenters' augers; gimlets [hand tools]; drill holders [hand tools]; pruning scissors; tree pruners; sickles; choppers [knives]; agricultural implements, hand-operated; axes; holing axes; hatchets; grindstones [hand tools]; saw holders; tube cutters [hand tools]; nail extractors, hand-operated; ladles [hand tools]; awls; spatulas [hand tools]; screwdrivers, hand-operated.

(260) AM 2020 103616 A
 (800) 1471886
 (151) 2019 04 05
 (891) 2019 04 05
 (731) JIANGSU XINRI E-VEHICLE CO., LTD.
 No.501 Xishan Avenue, Xishan District,
 Wuxi City, Jiangsu Province, China
 (540)



(591) Black, white
 (531) 24.11.25; 26.11.02; 26.11.06; 26.11.12;
 26.15.25; 27.05.01
 (511)
 12 – Remote control vehicles, other than toys; strollers; suspension shock absorbers for vehicles; tires for vehicle wheels; cars; electric vehicles; electric bicycle; electric motorcycle; scooter (vehicle); electric tricycle.

(260) AM 2020 103618 A
 (800) 1471918
 (151) 2019 03 10
 (891) 2019 03 10
 (731) ANSHAN HIFICHEM CO., LTD.
 No.8, No.1 Road, Tengao Economic
 Development Zone, Anshan City, 114225
 Liaoning Province, China

(540)

HIFIFAST

(591) Black, white

(511)

2 – Colorants; dyes; pigments; color masterbatch; food dyes; printing ink; paints; lacquers; anti-corrosion preparations; gum resins.

35 – Advertising; business management consultancy; commercial administration of the licensing of the goods and services of others; marketing; import-export agency services; procurement services for others [purchasing goods and services for other businesses]; personnel management consultancy; administrative processing of purchase orders; book-keeping; sponsorship search.

(260) AM 2020 103619 A

(800) 1471989

(151) 2019 05 10

(891) 2019 05 10

(731) GUANGZHOU HAVIT TECHNOLOGY COMPANY LIMITED
RM. 1307, 13F (Building B-C), POLY WORLD TRADE CENTER, PHASE 2, NO.1000 XINGANG DONG ROAD, HAIZHU DISTRICT, GUANGZHOU CITY, China

(540)



(591) Black, white

(531) 27.05.01; 27.05.17

(511)

9 – Notebook computers; computers; computer keyboards; computer peripheral devices; couplers [data processing equipment]; microphones; mouse [computer peripheral]; data processing apparatus; headphones; cabinets for loudspeakers.

(260) AM 2020 103620 A

(800) 1472012

(151) 2019 02 21

(891) 2019 02 21

(731) Obshchestvo s ogranichennoi otvetstvennostyu "SPIKA"
ul. Bakinskaya, 139, kv. 13, RU-115516
Moscow, Russian Federation

(540)



(591) Black, white

(531) 27.05.01

(511)

33 – Aperitifs; arrack [arak]; baijiu [Chinese distilled alcoholic beverage]; brandy; wine; piquette; whisky; vodka; anisette [liqueur]; kirsch; gin; digesters [liqueurs and spirits]; cocktails; curacao; anise [liqueur]; liqueurs; pre-mixed alcoholic beverages, other than beer-based; alcoholic beverages, except beer; alcoholic beverages containing fruit; spirits [beverages]; distilled beverages; mead [hydromell]; peppermint liqueurs; bitters; nira [sugarcane-based alcoholic beverage]; rum; sake; perry; cider; rice alcohol; alcoholic extracts; fruit extracts, alcoholic; alcoholic essences.

(260) AM 2020 103627 A

(800) 1472078

(151) 2019 04 11

(891) 2019 04 11

(731) ALPEN PHARMA AG

Casinoplatz 2, CH-3011 Bern, Switzerland

(540)

ELEFTERIA

(591) Black, white

(511)

5 – Pharmaceutical products, medical and veterinary preparations; sanitary products for medical purposes; dietetic substances and foodstuffs for medical or veterinary use, food for babies; food supplements for humans and animals; plasters, materials for dressings; material for dental fillings and dental impressions; disinfectants; products for destroying vermin; fungicides, herbicides.

10 – Surgical, medical, dental and veterinary apparatus and instruments; artificial limbs, eyes and teeth; orthopedic articles; suture material; therapeutic and assistance devices designed for people with disabilities; massage apparatus; apparatus, devices and articles for child care; apparatus, devices and articles for sexual activities.

(260) AM 2020 103628 A

(800) 1472144

(151) 2019 05 16

(891) 2019 05 16

(731) ZOTOS INTERNATIONAL, INC.

100 Tokeneke Road, Darien CT 06820,
USA

(540)

ALL ABOUT CURLS

(591) Black, white

(526) CURLS

(511)

3 – Hair care products, namely, hair care preparations; hair styling preparations.

(260) AM 2020 103633 A
 (800) 1472224
 (151) 2019 04 30
 (891) 2019 04 30
 (731) SLATE SCIENCE TECHNOLOGY PTY LTD.
 447 Kent Street, Suite 901, Sydney NSW
 2000, Australia
 (540)

MATIFIC

(591) Black, white
 (511)
 41 – Education; provision of training; education services provided via all forms of publication, delivery, dissemination and electronic transmission; educational publishing including on-line; educational services directed to mathematics.

(260) AM 2020 103638 A
 (800) 1472319
 (151) 2018 12 11
 (891) 2018 12 11
 (731) GUANGZHOU VESLEE CHEMICAL SCIENCE AND TECHNOLOGY CO., LTD.
 SI DA XIANG, INDUSTRIAL PARK,
 SANJING, FUHE, ZHONGXIN TOWN,
 ZENGCHENG, GUANGZHOU,
 GUANGDONG, China
 (540)



(591) Black, white
 (531) 26.04.18; 26.04.24
 (511)
 1 – Tensio-active agents; chemical additives to motor fuel; antifreeze; brake fluid; power steering fluid; mould-release preparations; refrigerants; fire extinguishing compositions; leather-dressing chemicals; water glass [soluble glass] for interior and exterior wall use.
 2 – Colorants; pigments; paints; undercoating for vehicle chassis; bitumen varnish; lacquers; thinners for paints; thinner; anti-tarnishing preparations for metals.
 3 – Polishing wax; perfumes; dewaxing liquid; floor wax; washing liquids; grinding preparations; stain removers; air fragrancing preparations; leather preservatives [polishes]; lacquer-removing preparations; polishing creams; rust removing preparations.

4 – Grease for leather; lubricating oil; fuel; dust removing preparations; electrical energy; mineral fuel; non-slipping preparations for belts.

17 – Non-metallic sealing strips; padding materials of rubber or plastics; synthetic rubber; shock-absorbing buffers of rubber; caulking materials; chemical compositions for repairing leaks; plastic fibers, not for use in textiles; connecting hose for vehicle radiators; asbestos packing; insulating materials.

(260) AM 2020 103642 A
 (800) 693322
 (151) 1998 04 17
 (891) 2019 05 24
 (731) ROBERT BOSCH GMBH
 70469 Stuttgart, Germany
 (540)



(591) Black, white
 (531) 14.03.01; 14.03.03; 26.01.01; 26.01.16;
 26.01.18; 26.07.11; 26.07.25; 26.13.25
 (511)
 28 – Games, playthings; gymnastic and sporting articles (as far as included in this class).

(260) AM 2020 103647 A
 (800) 1224965
 (151) 2014 07 16
 (891) 2019 05 21
 (731) PASKÀ S.R.L.
 Via Delle Industrie, 35, I-80147 NAPOLI,
 Italy
 (540)



(591) Grey, green, red and white
 (531) 01.15.11; 11.03.04; 24.07.01; 27.05.10;
 29.01.12
 (511)
 30 – Coffee, tea, cocoa, sugar, artificial coffee, coffee-based beverages, coffee flavourings; preparations made from cereals, pastry and confectionery; ices; honey, treacle, sauces (condiments); spices; ice.

(260) AM 2020 103707 A

(800) 1472601

(151) 2019 04 26

(891) 2019 04 26

(731) APPLE INC.

One Apple Park Way, Cupertino CA 95014,
USA

(540)



(591) Turquoise, green, and black

(531) 26.04.04; 26.04.18; 27.05.21; 29.01.12

(511)

9 – Application development software; computer software used in developing other software applications; computer operating system software; application programming interface software for use in developing applications for execution on graphic processor units.

42 – Computer programming; design and development of computer hardware and software; consulting services relating to the design, development, implementation, and use of computer hardware and software; consultation services related to the design and development of computer systems, databases and applications; providing information online relating to the design, development, implementation, and use of computer hardware and software; providing an online database featuring technical information regarding software development and programming.

(260) AM 2020 103716 A

(800) 1472908

(151) 2019 02 27

(891) 2019 02 27

(731) Obshchestvo s ogranichennoy

otvetstvennostyu "DIMAKS PROF"

Fabrichny proezd, vladenie 15, sooruzheniye

1, g. Shchelkovo, Shchelkovskij r-n,

RU-141101 Moscow region, Russian

Federation

(540)

Т А Й Г А

(591) Black, white

(531) 28.05

(511)

5 – Preparations for destroying noxious animals; fungicides and herbicides.

(260) AM 2020 103718 A

(800) 1473014

(151) 2019 04 05

(891) 2019 04 05

(731) Obshchestvo s ogranichennoy

otvetstvennostyu "ARENA"

ul. Sportivnaya, 5, Chernyahovsk, RU-238151

Kaliningradskaya obl., Russian Federation

(540)

POLAR LINE

(591) Black, white

(531) 27.05.01; 27.05.17

(511)

9 – Scientific, navigation, surveying, photographic, cinematographic, optical, weighing, measuring, signalling, inspecting, life-saving and teaching apparatus and instruments; apparatus and instruments for conducting, switching, transforming, accumulating, regulating or controlling the distribution or use of electricity; apparatus for recording, transmitting or reproducing sound or images; magnetic data media; sound recording discs; mechanisms for coin-operated apparatus; cash registers, calculating devices; computers; fire-extinguishing apparatus.

(260) AM 2020 103719 A

(800) 1473015

(151) 2019 04 05

(891) 2019 04 05

(731) Obshchestvo s ogranichennoy

otvetstvennostyu "ARENA"

ul. Sportivnaya, 5, Chernyahovsk, RU-238151

Kaliningradskaya obl., Russian Federation

(540)

POLAR HOME

(591) Black, white

(531) 27.05.01; 27.05.17

(511)

9 – Scientific, navigation, surveying, photographic, cinematographic, optical, weighing, measuring, signalling, inspecting, life-saving and teaching apparatus and instruments; apparatus and instruments for conducting, switching, transforming, accumulating, regulating or controlling the distribution or use of electricity; apparatus for recording, transmitting or reproducing sound or images; magnetic data media; sound recording discs; mechanisms for coin-operated apparatus; cash registers, calculating devices; computers; fire-extinguishing apparatus.

(260) AM 2020 103728 A

(800) 1473217

(151) 2019 04 08

(891) 2019 04 08

(731) Limited Liability Company "AVALON"

Frunze st., vlad. 9/14, RU-142803 Stupino,

Moskovskaya oblast, Russian Federation

(540)

GREEN LOVE

(591) Black, white

(511)

3 – Descaling preparations for household purposes; antistatic preparations for household purposes; air fragrancing preparations; canned pressurized air for cleaning and dusting purposes; polishing stones; abrasive paper; emery paper; polishing paper; shoe polish; cobblers' wax; cotton wool for cosmetic purposes; sachets for perfuming linen; drying agents for dishwashing machines; wax for parquet floors; floor wax; non-slipping wax for floors; polish for furniture and flooring; shoemakers' wax; polishing wax; non-slipping liquids for floors; windshield cleaning liquids; volcanic ash for cleaning; shaving stones [astringents]; silicon carbide [abrasive]; carbides of metal [abrasives]; alum stones [astringents]; quillaia bark for washing; corundum [abrasive]; colorants for toilet purposes; polishing creams; polishing rouge; cleaning chalk; deodorant soap; shaving soap; soap for brightening textile; cakes of toilet soap; antiperspirant soap; soap for foot perspiration; almond soap; emery; pumice stone; abrasive cloth; glass cloth [abrasive cloth]; laundry soaking preparations; smoothing preparations [starching]; color-removing preparations; leather bleaching preparations; polishing preparations; starch glaze for laundry purposes; refurbishing preparations; fabric softeners for laundry use; laundry bleach; dry-cleaning preparations; paint stripping preparations; lacquer-removing preparations; make-up removing preparations; floor wax removers [scouring preparations]; varnish-removing preparations; rust removing preparations; cleaning preparations; wallpaper cleaning preparations; preparations for unblocking drain pipes; laundry preparations; color-brightening chemicals for household purposes [laundry]; shining preparations [polish]; diamantine [abrasive]; stain removers; scouring solutions; saftrol; laundry blueing; turpentine for degreasing; bleaching soda; bleaching salts; ammonia [volatile alkali] [detergent]; detergents, other than for use in manufacturing operations and for medical purposes; degreasers, other than for use in manufacturing processes; emery cloth; cloths impregnated with a detergent for cleaning; sandpaper; soda lye; abrasives; laundry glaze; soap; washing soda, for cleaning; preparations to make the leaves of plants shiny; shoe cream.

(260) AM 2020 103732 A

(800) 1473287

(151) 2019 04 18

(891) 2019 04 18

(731) HEIDI CHOCOLAT SUISSE SA

Täschmattstrasse 10, CH-6015 Luzern,
Switzerland

(540)



(591) Black, white

(531) 02.05.03; 02.05.27; 05.05.20; 05.05.23;
06.01.02; 06.01.04; 26.11.01; 26.11.08;
27.05.17

(511)

5 – Dietetic substances and foodstuffs, chocolate, chocolate candy, candy, petits fours (pastry) and confectionery for diabetics.

30 – Chocolate; petits fours (cakes); chocolate candy; candy and sugar confectionery; edible ices.

35 – Commercial business management; commercial administration; office functions; retail sale and wholesale of chocolate, chocolate candy, petits fours (pastry), candy, sugar confectionery and edible ices; on-line retail store services for chocolate, chocolate candy, petits fours (pastry), candy, sugar confectionery and edible ices.

(260) AM 2020 103733 A

(800) 1473291

(151) 2019 01 21

(891) 2019 01 21

(731) YANGTZE RIVER PHARMACEUTICAL (GROUP) CO., LTD.

No.1, South Yangtze River Road, Taizhou,
Jiangsu, China

(540)

扬子江

(591) Black, white

(531) 28.03

(511)

5 – Tonics [medicines]; preparations to facilitate teething; radioactivity drug; medicinal ointments; gelatin capsules for pharmaceuticals; air deodorising preparations; pharmaceutical preparations in the form of troche; semen for artificial insemination; medicines for human purposes; pesticides; biochemical drug; medicines for veterinary purposes; pharmaceutical preparations in the form of aqua; disinfectants; impregnated antiseptic wipes; chemical conductors for electrocardiograph electrodes; medicinal drinks; cultures of microorganisms for medical and veterinary use; oxygen for medical purposes; drugs for medical purposes; dietetic substances adapted for medical use; contact lens cleaning preparations; raw material drug; injectable pharma-

ceuticals; Chinese medicine nostrum; Chinese medicine bag; pharmaceutical preparations in the form of tincture.

(260) AM 2020 103734 A

(800) 1473310

(151) 2019 04 17

(891) 2019 04 17

(731) HANGZHOU TECHDERM BIOLOGICAL PRODUCTS CO., LTD.

Floor 2, East Building 6, No.88, Jiangling Road, Binjiang District, Hangzhou, 310051 Zhejiang, China

(540)

Sofiderm

(591) Black, white

(531) 05.05.20; 27.05.07

(511)

3 – Soap; detergents, other than for use in manufacturing operations and for medical purposes; polishing preparations; grinding preparations / sharpening preparations; perfumery; cosmetics; dentifrices; incense; cosmetics for animals; air fragrancing preparations.

5 – Scapulars for surgical purposes; wadding for medical purposes; air purifying preparations; pesticides; babies' diapers / babies' napkins; dressings, medical; adhesive tapes for medical purposes / adhesive bands for medical purposes; teeth filling material; diapers for pets; surgical dressings.

10 – Surgical implants comprised of artificial materials; suture materials; condoms; orthopedic articles / orthopaedic articles; stents; surgical apparatus and instruments; cushions for medical purposes; feeding bottles / babies' bottles.

(260) AM 2020 103736 A

(800) 1473362

(151) 2019 02 26

(891) 2019 02 26

(731) EPIC GAMES, INC.

620 Crossroads Boulevard, Cary NC 27518, USA

(540)

FORTNITE

(591) Black, white

(511)

3 – Toiletries; cleaning and fragrancing preparations; perfumery and fragrances; oral hygiene preparations; laundry preparations; decorative transfers for cosmetic purposes; shampoos; nail art stickers; joss

sticks; fumigation preparations [perfumes]; false nails; household fragrances; essential oils and aromatic extracts; animal grooming preparations; body cleaning and beauty care preparations; hair preparations and treatments; hair removal and shaving preparations; deodorants and antiperspirants; bath preparations; soaps and gels; make-up; skin, eye and nail care preparations; scouring substances; polishing preparations; abrasives; cleaning preparations; temporary tattoos.

6 – Figurines [statuettes] of common metal; artistic castings of common metal; statues and works of art of common metals; molds of metal; common metals and their alloys; structures and transportable buildings of metal; small items of metal hardware; safes [metal or non-metal]; building and construction materials and elements of metal; hooks of metal for clothes rails; metal hardware; locks and keys, of metal; door knockers of metal; door fasteners of metal; iron gates; metal gates; metal signs and boards, non-luminous and non-mechanical, used for route showing or publicity purposes; frameworks of metal; ladders of metal; barrels of metal; towel dispensers of metal.

8 – Hygienic and beauty implements for humans and animals; edged and blunt weapons; hand-operated implements for chopping, dicing or slicing food, kitchen knives and hand-operated cutting tools, cutlery for eating; fire tending implements; hair cutting and removal implements; razors; hand tools and implements [hand-operated]; manicure and pedicure tools; razor cases; hair styling appliances; hand-operated tools and implements for treatment of materials, and for construction, repair and maintenance; fastening and joining tools; hammers, mallets and sledgehammers; lifting tools; cutting, drilling, grinding, sharpening and surface treatment hand tools; scissors; tweezers.

9 – Software programs for video games; downloadable video game programs; programs for arcade video game machines; audiovisual headsets for playing video games; computer peripheral devices; recorded content; downloadable media; computer software; data processing equipment and accessories (electrical and mechanical); photographic apparatus and instruments; cinematographic machines and apparatus; optical apparatus and instruments; weighing apparatus and instruments; nautical apparatus and instruments; surveying apparatus and instruments; measuring apparatus and instruments; checking (supervision) apparatus and instruments; signalling apparatus and instruments; life-saving apparatus and instruments; scientific apparatus and instruments; teaching apparatus and instruments; apparatus and instruments for controlling electricity; apparatus and instruments for accumulating electricity; apparatus and instruments for switching electricity; apparatus

and instruments for transforming electricity; apparatus and instruments for regulating electricity; apparatus and instruments for conducting electricity; sound transmitting apparatus; apparatus for the transmission of images; apparatus for the reproduction of images; sound reproduction apparatus; apparatus for recording images; sound recording apparatus; magnetic data carriers, recording discs; DVDs; compact discs; digital recording media; calculators; talking books; holograms; computer operating systems; USB flash drives; aerials; handheld communication devices; cases for smartphones; cases for tablet computers; protective films adapted for smartphones; communications equipment; data communications apparatus; point-to-point communications equipment; radios; broadcasting equipment; antennas and aerials as communications apparatus; cases adapted for mobile phones; encoded cards; credit cards; ticket dispensers; keyboards; computers and computer hardware; headphones; signal cables for IT, AV and telecommunication; magnets, magnetizers and demagnetizers; batteries; optical goods; signs, luminous; helmets for bicycles; protective and safety equipment; eye protection; navigation, guidance, tracking, targeting and map making devices; wrist rests for use with computers; tripods for cameras; stands for photographic apparatus; spectacle frames; safety restraints, other than for vehicle seats and sports equipment; respiratory masks, other than for artificial respiration; reflecting discs for wear, for the prevention of traffic accidents; mouse pads; mechanical signs; life-saving rafts; safety nets; life buoys; life belts; downloadable electronic publications; downloadable ring tones for mobile phones; downloadable music files; downloadable image files; containers for contact lenses; cell phone straps; animated cartoons; information technology and audiovisual, multimedia and photographic devices; tablet covers; covers for smartphones; optical devices, enhancers and correctors; glasses, sunglasses and contact lenses; eyewear cases.

14 – Alloys of precious metal; chronometric instruments; gemstones, pearls and precious metals, and imitations thereof; pins [jewellery]; tie pins; ornamental pins; badges of precious metal; jewels; necklaces [jewellery]; jewelry stickpins; jewellery, clocks and watches; statues and figurines, made of or coated with precious or semi-precious metals or stones, or imitations thereof; time instruments; figures of precious metal; ornaments, made of or coated with precious or semi-precious metals or stones, or imitations thereof; jewellery boxes and watch boxes; key rings and key chains, and charms therefor; key rings [split rings with trinket or decorative fob]; cases for clock- and watchmaking; clock cases; clock hands; coins; copper tokens; jewel cases; medals; pendulums [clock- and watchmaking]; semi-precious stones; watch bands; watch chains; pendants; de-

corative articles [trinkets or jewellery] for personal use; decorative boxes made of precious metal; commemorative coins.

16 – Paper and cardboard; figurines made from cardboard; graphic representations; graphic prints; printed packaging materials of paper; cardboard containers; decorative wrapping paper; paper gift tags; gift bags; school cones, empty; cling film; carrier bags; writing implements and stamps [seals]; paper stationery; postcards; photo albums and collectors' albums; office machines; books; novels; fiction books; series of fiction books; printed matter; works of art and figurines of paper and cardboard, and architects' models; decoration and art materials and media; stationery and educational supplies; comics; comic books; bookbinding material; photographs [printed]; adhesives for stationery or household purposes; artists' materials; paintbrushes; office requisites; teaching materials [except apparatus]; plastic materials for packaging; arts and crafts paint kits, and modelling materials; filtering materials of paper; bags [envelopes, pouches] of paper or plastics, for packaging; note books; pencils; erasing products; bookmarkers; paperweights; cabinets for stationery [office requisites]; ball pens; correcting and erasing implements; office binders; gift cards; paper identification tags; pencil sharpeners; paint boxes; paper loyalty cards; school supplies [stationery]; pen or pencil holders; envelopes [stationery]; printing sets, portable [office requisites]; bookbinding equipment; calendars; trading cards, other than for games; printed tickets; paper pennants; adhesive wall decorations of paper; placards of paper; transfers [decalcomanias]; stickers; posters; flags of paper; collectable cards; collectable trading cards; sticker books; money holders; place mats of paper; tissues of paper for removing make-up; mats for beer glasses; paper tissues; coasters of cardboard; coasters of paper; handkerchiefs of paper; table napkins of paper; paper lunch bags; paper cocktail parasols; kitchen rolls [paper]; garbage bags of paper or of plastics; holders for cheque books; house painters' rollers; packaging material made of starches; passport holders; photograph stands; wristbands for the retention of writing instruments; computer game instruction manuals; paper cake decorations.

18 – Luggage, bags, wallets and other carriers; umbrellas and parasols; leather and imitations of leather; animal skins, hides; saddlery, whips and apparel for animals; trunks and suitcases; walking sticks; wallets; school bags; gym bags; school knapsacks; trolley duffels; beach bags; girths of leather; reins; attaché cases; backpacks; duffle bags; waist bags; sports bags; shoulder belts [straps] of leather; card cases [notecases]; chain mesh purses; game bags [hunting accessories]; handbags; haversacks; key cases; music cases; luggage label holders; muzzles; net bags for shopping; pouch baby carriers; purses; shopping

bags; sling bags for carrying infants; pouches; umbrella covers; vanity cases, not fitted; cane handles; roller bags; reins for guiding children.

20 – Furniture and furniture parts; statues, figurines, works of art and ornaments and decorations, made of materials such as wood, wax, plaster or plastic, included in the class; animal housing and beds; model vehicles [ornaments] made of plastic; model aeroplanes [ornaments] made of plastic; beds, bedding, mattresses, pillows and cushions; mirrors; picture frames; locks and keys, non-metallic; coat hangers; coathooks, not of metal; magazine racks; newspaper display stands; babies' bouncing chairs; high chairs for babies; barrels and casks, non-metallic; containers and container closures, non-metallic; vats, not of metal; stoppers, not of metal; crates and pallets, non-metallic; cap closures (non-metallic -) for bottles; non-metallic pallets; letter boxes, not of metal or masonry; ladders and movable steps, non-metallic; air cushions, not for medical purposes; air pillows, not for medical purposes; baby changing mats; bead curtains for decoration; bins, not of metal; bolsters; cabinet work; covers for clothing [wardrobe]; dog kennels; fans for personal use, non-electric; flower-pot pedestals; furniture casters, not of metal; garment covers [storage]; infant walkers; inflatable publicity objects; kennels for household pets; knobs, not of metal; mats for infant playpens; mobiles [decoration]; nesting boxes; paper blinds; plaited straw, except matting; sealing caps, not of metal; straw mattresses; straw plaits; wax figures; table tops; wind chimes [decoration].

21 – Tableware, cookware and containers; cleaning articles for clothing and footwear; cosmetic and toilet utensils and bathroom articles; statues, figurines, plaques and works of art, made of materials such as porcelain, terra-cotta or glass, included in the class; glasses, drinking vessels and barware; coin banks (piggy banks); containers for household or kitchen use; household or kitchen utensils; combs; sponges; earthenware; material for brush-making; cleaning articles; brushes; reed diffusers being devices for diffusing perfumes, sold empty; dustbins; cooking pot sets; mugs; insulating flasks; table napkin holders; napkin rings; pepper pots; egg cups; bread boards; glass jars [carboys]; buckets; table plates; lunch boxes; drinking bottles; insulating jars; paper cups; salt cellars; cutting boards; coasters (tableware); dishware; beverage coolers [containers]; straws for drinking; bottle openers, electric and non-electric.

24 – Textiles and substitutes for textiles; table linen; fabrics; pennants of textile; labels of textile; wall hangings; linens; bed clothes and blankets; coasters of textile; towels of textile; bed linen and blankets; bath linen; dish towels for drying; filtering materials of textile; cloth napkins for removing makeup; ba-

nners of textile or plastic; curtains of textile or plastic; flags of textile or plastic; furniture coverings of plastic; plastic material [substitute for fabrics]; sleeping bags; cloth.

25 – Clothing; headgear; footwear; outerwear; underwear; sleepwear; neck scarves [mufflers]; t-shirts; sweaters; hooded sweatshirts; hooded pullovers; jackets [clothing]; socks; stockings; neckties; ascots; bath robes; boxer shorts; overalls; bibs, not of paper; sock suspenders; waist belts; sweatbands; layettes [clothing]; sportswear; knitwear [clothing]; bath shoes; slippers; esparto shoes or sandals; espadrilles; caps; cap peaks; pockets for clothing; soles for footwear; costumes for use in role-playing games; halloween costumes; masquerade costumes; theatrical costumes; belts [clothing].

26 – Buttons, trimmings, borders and edgings for clothing [clothing accessories]; parts of sewing kits and decorative textile articles for the hair; charms, other than for jewellery, key rings or key chains; braids; embroidery; lace; ribbons; needles; hooks and eyes; pins; hook and pile fastening tapes; decorative articles for the hair; hair ornaments, hair rollers, hair fastening articles and false hair; wigs; artificial fruit, flowers and vegetables; patches for clothing; badges for wear, not of precious metal; belt clasps; brassards; brooches [clothing accessories]; buckles [clothing accessories]; competitors' numbers; heat adhesive patches for decoration of textile articles [haberdashery]; fastenings for suspenders; feathers [clothing accessories]; hat trimmings; heat adhesive patches for repairing textile articles; mica spangles; monogram tabs for marking linen; needle cases; needle cushions; ornamental novelty badges [buttons]; sewing boxes; shoe buckles; shoe fasteners; shoe laces; shoe trimmings; shoe ornaments not of precious metal.

28 – Toys, games, playthings and novelties; sporting articles and equipment; playing cards; board games; electronic board games; games; toys; hand-held units for playing electronic games; gaming keypads; portable games with liquid crystal displays; games adapted for use with television receivers; video game apparatus; apparatus for electronic games adapted for use with an external display screen or monitor; gymnastic articles; decorations for Christmas trees; skateboards; snowboards; water wings; flippers for swimming; body-building apparatus; chest expanders [exercisers]; stationary exercise bicycles; appliances for gymnastics; slides [playthings]; gloves made specifically for use in playing sports; stand-up paddle boards; swimming boards; swimming jackets; swimming floats for recreational use; shin guards; gymnastic apparatus; hunting tackles, bows and lures, and fishing equipment; Christmas tree decorations and artificial Christmas trees; fair-ground and playground apparatus; rattles [playt-

hings]; stuffed toys; soap bubbles [toys]; trading cards [card game]; water toys; bathtub toys; balls for games; party favors in the nature of small toys; streamers [party novelties]; balloons; puzzles; party novelties; toy artificial fingernails; action figures [toys or playthings]; toy human characters; clothing for toy figures; toy figures; toy environments for use with action figures; toy vehicles; bobble head dolls; Halloween masks; modeled plastic toy figurines; play figures; swimming pools [play articles]; miniature car models [toys or playthings]; miniatures for use in games; dolls' clothes; toys for animals; dart mats; barrels for darts; holders for darts; bags especially designed for skis and surfboards; pool table cushions; bladders of balls for games; Christmas tree stands; confetti; cricket bags; novelty toys for playing jokes; paper party hats; sole coverings for skis; body protectors for athletic use.

41 – Entertainment services; arranging of entertainment shows; training; sporting and cultural activities; publishing and reporting; teaching; education; gambling services; sports and fitness; library services; provision of training courses; arranging and conducting conferences; exhibition services for entertainment purposes; organizing and arranging exhibitions for entertainment purposes; organisation of games and competitions; arranging and conducting of competitions [education or entertainment]; electronic desktop publishing; games equipment rental; layout services, other than for advertising purposes; providing online electronic publications, not downloadable; publication of books; online publication of electronic books and journals; publication of texts, other than publicity texts; ticket agency services [entertainment]; box office services; toy rental; videotaping; providing museum facilities and services; electronic game services and competitions provided by means of the internet; organization of electronic game competitions; providing electronic publications from a global computer network or the internet, not downloadable; multimedia publishing; publication of printed matter in electronic form on the internet; publication of printed matter; video game entertainment services; provision of online computer games; multimedia publishing of video games; audio, video and multimedia production, and photography.

42 – Development of computer hardware for computer games; design and development of computer game software; website design services; website design consultancy; design, creation, hosting and maintenance of websites for others; hosting of digital content, namely, on-line journals and blogs; providing temporary use of non-downloadable computer software for use in the creation and publication of on-line journals and blogs.

(260) AM 2020 103737 A
 (800) 1473433
 (151) 2019 02 05
 (891) 2019 02 05
 (731) WTM Establishment
 Stadtle 28, FL-9490 Vaduz, Liechtenstein
 (540)



(591) Black, white
 (531) 18.01.08; 26.04.03; 26.04.07; 26.04.16;
 26.04.18; 27.05.10; 28.05
 (526) Водка, Vodka, of the selected grain.
 (511)
 33 – Vodka.

(260) AM 2020 103745 A
 (800) 1125404
 (151) 2012 03 15
 (891) 2019 05 14
 (731) SOFT MEDICAL AESTHETICS
 55 boulevard Pereire, F-75017 PARIS, France
 (540)



(591) White, gray and orange
 (531) 19.13.03; 23.01.01; 29.01.12
 (511)
 10 – Cannulas; needles for medical use; surgical, medical, dental and veterinary apparatus and instruments; suture materials.

(260) AM 2020 103746 A
 (800) 1153968
 (151) 2013 01 16
 (891) 2019 05 29
 (731) SECURETEC DETEKTIONS-SYSTEME AG
 Lilienthalstrasse 7, 85579 Neubiberg,
 Germany
 (540)

DrugWipe

(591) Black, white
(511)

1 – Diagnostic kits, diagnostic preparations and substances, except for medical purposes; diagnostic agents for non-medicated purposes.

5 – Diagnostic preparations for medical purposes, diagnostic preparations and substances for medicinal purposes, test strips for diagnostic purposes.

9 – Scientific apparatuses and instruments, testing and diagnostic equipment and apparatus, other than for medical purposes.

10 – Apparatus and instruments for medical use; diagnostic equipment and apparatus for medical purposes; diagnostic testing materials for medical purposes.

(260) AM 2020 103807 A

(800) 1473847

(151) 2019 05 17

(891) 2019 05 17

(731) LABORATORIOS ERN, S.A.

C. Perú, 228, E-08020 Barcelona, Spain

(540)

apiretal

(591) Blue

(531) 27.05.01; 29.01.04

(511)

3 – Soaps; perfumery products; essential oils; cosmetics; hair lotions; dentifrices.

5 – Pharmaceutical products, preparations for medical and veterinary use; hygiene and sanitary products for medical use; dietetic food and substances for medical or veterinary use, food for babies; food supplements for humans or animals; plasters, material for dressings; teeth filling and dental impression materials; disinfectants; products for destroying vermin; fungicides; herbicides.

10 – Surgical, medical, dental and veterinary apparatus and instruments; orthopedic articles; suture materials; artificial limbs, eyes and teeth.

32 – Isotonic beverages [other than for medical use]; mineral waters and other non-alcoholic beverages; fruit-based beverages and fruit juices; syrups and other preparations for making beverages.

33 – Alcoholic beverages (except beers).

42 – Scientific and technological services, as well as associated research and design services; research and development in the field of pharmacy and biotechnology; research relating to medicine.

44 – Medical services; veterinary services; hygienic and beauty treatments for humans or animals; phar-

macy advice; provision of information relating to medicine.

(260) AM 2020 103811 A

(800) 1473960

(151) 2019 01 25

(891) 2019 01 25

(731) R.B.M. S.p.A.

Via Industriale 23, I-25060 SAN GIOVANNI
POLAVENO (Brescia), Italy

(540)



(591) Blue, light blue and white

(531) 26.03.01; 26.03.02; 27.05.17; 29.01.12

(511)

6 – Collars of metal for fastening pipes; manifolds of metal for pipelines; ducts of metal for ventilating installations; ducts of metal for air conditioning installations; metal pipes for heating; metal expansion joints for floors and walls; metal expansion joints for pipes and channels; elbows of metal for pipes; junctions of metal for pipes, including those from alloy steel and titanium; metal hose fittings; metal pipes and tubes; flexible tubes of metal; valves of metal other than parts of machines, including those from alloy steel and titanium; water pipe valves of metal; valves for zone heating and cooling systems, nuts of metal; screws of metal; metal boxes for containment and inspection.

7 – Mechanical seals (machine parts); pressure reducers (parts of machines); control valves for regulating the flow of gases and liquids (parts of machine); pumps control valves; machine valves; pressure valves (parts of machines); valves (parts of pumps).

9 – Calorimeters; switchboxes (electricity); electrical cables; counters; temperature indicators, level indicators; pressure indicators; electronic indicator boards; control panels (electricity); pressure gauges; thermostats; digital thermostats for climate control; software for the accounting of energy consumption, in particular of heat, water, gas and electricity consumption; infrared remote controls; thermostat controllers; valve operators (electrical controls).

11 – Regulating accessories for water or gas apparatus and pipes; safety accessories for water or gas apparatus and gas; air conditioning installations; heating installations; air conditioning installations and apparatus; water distribution installations; taps for

pipes and pipelines; heating armatures; water filters; air filters for air conditioning units; air filters for industrial use; automatic temperature regulators (thermostatic valves) for central heating radiators; dampers (heating); waste pipes for sanitary installations; flexible hoses as parts of plumbing installations for bathrooms; boiler pipes (tubes) for heating installations; air conditioning units; air purification units; dispensing valves [parts of heating or gas installations]; thermostatic valves (parts of heating installations); thermostatic valves for radiators; valves for heating bodies; valves for plumbing and heating installations; air vent valves; fans (air conditioning); heat pumps; heat exchangers; dehumidifiers; components for radiant heating and cooling installations.

17 – Water-tight rings; water-tight rings for plumbing pipes; non-metallic pipe couplings; non-metal coupling for hoses; non-metal elbows for pipes; waterproof packings; pipe muffers, not of metal; insulation materials for pipes; fittings, not of metal, for pipes; fittings, not of metal for flexible pipes; fittings, not of metal, for rigid pipes; flexible hoses, not of metal; multilayer flexible hoses, not of metal; valves of rubber.

20 – Water pipe valves of plastic, clips, not of metal, for cables and pipes; boxes, not of metal, for containment and inspection.

(260) AM 2020 103812 A

(800) 1473975

(151) 2018 11 12

(891) 2018 11 12

(731) ONISHCHUK HANNA TROKHMYMIVNA
vul. Didrikhsona, 27, kv. 62, m. Odesa 65029,
Ukraine

(540)

Arvitum

(591) Black, white

(531) 27.05.01

(511)

10 – Massage apparatus; body rehabilitation apparatus for medical purposes; traction apparatus for medical purposes; testing apparatus for medical purposes; physical exercise apparatus for medical purposes; supportive bandages; bracelets for medical purposes; cases fitted for medical instruments; orthopaedic footwear; vibromassage apparatus; basins for medical purposes; hypogastric belts; diagnostic apparatus for medical purposes; corsets for medical purposes; beds specially made for medical purposes; gloves for massage; medical apparatus and instruments; instrument cases for use by doctors; cooling patches for medical purposes; finger guards for medical purposes; corn knives; walking frames for disabled persons; orthopedic articles; knee bandages,

orthopaedic; orthopaedic soles; orthopaedic belts; elastic stockings for surgical purposes; stockings for varices; slings [supporting bandages]; invalids' hoists; draw-sheets for sick beds; plaster bandages for orthopaedic purposes; air cushions for medical purposes; anti-rheumatism bracelets; anti-rheumatism rings; toe separators for orthopaedic purposes; arch supports for footwear; walking sticks for medical purposes; quad canes for medical purposes; supports for flat feet; physiotherapy apparatus; wheeled walkers to aid mobility; boots for medical purposes; abdominal corsets; abdominal belts; abdominal pads; splints, surgical.

25 – Ankle boots; football boots; footwear; bath slippers; non-slipping devices for footwear; half-boots; tips for footwear; clothing; hosiery; stockings; sweat-absorbent stockings; footwear uppers; soles for footwear; heelpieces for stockings; welts for footwear; sandals; boots for sports; shoes; sports shoes; inner soles; boot uppers; boots; sweat-absorbent socks.

44 – Health counselling; massage; medical assistance; health care; medical advice for individuals with disabilities; nursing, medical; alternative medicine services; nursing home services; health spa services; hospital services; medical clinic services; health center services; convalescent home services; rest home services; beauty salon services; sanatorium services; sauna services; solarium services; telemedicine services; medical equipment rental; rental of sanitation facilities; therapy services; pharmacy advice; physical therapy.

(260) AM 2020 103813 A

(800) 1473977

(151) 2019 05 06

(891) 2019 05 06

(731) BANK OF AMERICA CORPORATION
100 North Tryon Street, Charlotte NC 28255,
USA

(540)



(591) Black, white

(531) 03.04.04; 03.04.24

(511)

9 – Computer software for financial research, financial information, financial analysis, financial planning, financial management, investment management, banking services, trading of foreign exchange,

providing electronic processing of electronic funds transfer, ACH, electronic check and electronic payments, financial transactions, electronic funds transfers; downloadable computer software for financial research, financial information, financial analysis, financial planning, financial management, investment management, banking services, trading of foreign exchange, providing electronic processing of electronic funds transfer, ACH, electronic check and electronic payments, financial transactions, electronic funds transfers; downloadable software in the nature of a mobile application for financial research, financial information, financial analysis, financial planning, financial management, investment management, banking services, trading of foreign exchange, providing electronic processing of electronic funds transfer, ACH, electronic check and electronic payments, financial transactions, electronic funds transfers.

36 – Financial research; financial information; financial analysis; financial advice; financial planning; financial consultation; financial management; investment brokerage; investment consultation; investment management; investment advice; mutual fund investment; banking services; credit card and debit card services; trading of securities, shares, foreign exchange, commodities, options and other derivative products for others; financial planning for retirement; financial information and services provided online from a computer database or global computer network.

42 – Computer programming; computer software consultancy; computer systems analysis; provision of online computer software; providing online non-downloadable software for financial research, financial information, financial analysis, financial planning, financial management, investment management, banking services, trading of foreign exchange, providing electronic processing of electronic funds transfer, ACH, electronic check and electronic payments, financial transactions, electronic funds transfers; design, maintenance, development and updating of computer software for financial research, financial information, financial analysis, financial planning, financial management, investment management, banking services, trading of foreign exchange, providing electronic processing of electronic funds transfer, ACH, electronic check and electronic payments, financial transactions, electronic funds transfers.

(260) AM 2020 103816 A

(800) 1474017

(151) 2018 12 10

(891) 2018 12 10

(731) ADP GAUSELMANN GMBH

Merkur-Allee 1-15, 32339 Espelkamp,
Germany

(540)

Casino Queen

(591) Black, white

(511)

9 – Computer software; coin-operated mechanisms; computer and video games software; games software in particular for use on any computer platform, including electronic entertainment and games consoles; computer game programs; video games (software); computer games provided through a global computer network or supplied by means of multi-media electronic broadcast or through telecommunications or electronic transmission or via the Internet; computer games, leisure and recreational software, video games and computer software, all being provided in the form of storage media; programs for operating electric and electronic apparatus for games, amusement and/or entertainment purposes; computer software for computer games on the Internet; online games (software), in particular for online betting games, online prize games, online gambling games, online games of skill and online casino games; computer software in the form of an app for mobile devices and computers; calculating apparatus in coin-operated machines and parts for the aforesaid goods; electric, electronic, optical or automatic apparatus, for identifying data earners, identity cards and credit cards, bank notes and coins; software in particular for casino and/or amusement arcade games, for gaming machines and/or slot machines each one with or without prize payouts; gaming software that generates or displays wager outcomes of gaming machines; operational computer games software; computer software for managing of games (game collection); computer programs for video games; computer video game software.

28 – Games; toys; gaming apparatus (including coin-operated apparatus); coin-operated arcade games (machines); games for amusement arcades (included in this class); coin-operated video gaming apparatus; video games apparatus adapted for use with external screens or monitors only; casino fittings, namely roulette tables, roulette wheels; coin-operated automatic gaming machines and gaming machines, in particular for gaming arcades, with or without a prize payout; electronic or electrotechnical gaming apparatus, automatic gaming machines, gaming machines, slot machines operated by coins, tokens, banknotes, tickets or by means of electronic, magnetic or biometric storage media, in particular for commercial use in casinos and amusement arcades, with or without a prize payout; automatic gaming machines and gaming machines, in particular for commercial use in casinos and gaming arcades, with or without a prize payout; coin-operated gaming machines and/or electronic money-based gaming apparatus (machines), with or without prizes; housings adapted for

gaming machines, gaming apparatus and automatic gaming machines, operated by means of coins, tokens, tickets or by means of electronic, magnetic or biometric storage media, in particular for commercial use in casinos and gaming arcades, with or without a prize payout; electronic games; electronic game entertainment apparatus and parts thereof; video output game machines; drawing apparatus for prize games and lotteries, draws or raffles; housings of metal, plastic and/or wood for coin-operated automatic machines; apparatus for games (including video games), other than adapted for use with external screens or monitors only; electropneumatic and electric slot machines with pulling handles (gaming machines); gaming tables, in particular for table football, billiards, sliding games; flying discs (toys) and darts; gaming machines, namely electric, electronic or electromechanical apparatus for bingo games, lotteries or video lottery games and for betting offices, connected or unconnected to a computer network; LCD games consoles; automatic gaming machines; all the aforesaid automatic machines operating in networks; apparatus and devices for accepting and storing money, being fittings for the aforesaid automatic machines, included in this class; automatic lottery machines.

(260) AM 2020 103817 A
 (800) 1474049
 (151) 2018 11 27
 (891) 2018 11 27
 (731) SAHINYAN LEVON
 A. Khachatryan 11-65, Yerevan, Armenia
 (540)



(591) Black, white
 (531) 01.15.05; 26.11.02; 26.11.08; 27.05.01;
 27.05.08; 27.05.11
 (526) R
 (511)
 34 – Tobacco; smokers' articles; matches.

(260) AM 2020 103818 A
 (800) 1474053
 (151) 2019 05 14
 (891) 2019 05 14
 (731) INCYTE HOLDINGS CORPORATION
 1801 Augustine Cut-Off, Wilmington DE
 19803, USA
 (540)



(591) Black, white

(511)
 5 – Pharmaceutical preparations.

(260) AM 2020 103819 A
 (800) 1474087
 (151) 2019 05 23
 (891) 2019 05 23
 (731) CHROME HEARTS LLC
 915 N. Mansfield, Hollywood CA 90038,
 USA
 (540)

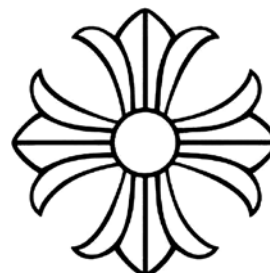

(591) Black, white
 (531) 24.13.25
 (511)
 9 – Eyewear, namely, eyeglasses, sunglasses, eyeglass cases and sunglass cases.

(260) AM 2020 103820 A
 (800) 1474126
 (151) 2019 05 17
 (891) 2019 05 17
 (731) HENAN JINDAN LACTIC ACID
 TECHNOLOGY CO., LTD
 NO.8, JINDAN AVENUE, DANCHENG
 COUNTY, 477150 HENAN PROVINCE,
 China
 (540)



(591) Black, white
 (531) 26.01.03; 26.11.12; 28.03
 (511)
 1 – Lactic acid; calcium lactate; zinc lactate; sodium lactate; ferrous lactate; ethyl lactate; potassium lactate; polylactic acid.

(260) AM 2020 103822 A
 (800) 1474150
 (151) 2018 11 28
 (891) 2018 11 28
 (731) LIBRA HOLDING S.R.L.
 Viale IV Novembre, 82/C, I-31100 TREVISO,
 Italy

(540)



(591) Black, white

(531) 26.04.19; 27.01.01; 27.01.02

(511)

2 – Paints, varnishes, lacquers; preservatives against rust and against deterioration of wood; colorants, dyes; inks for printing, marking and engraving; raw natural resins; metals in foil and powder form for use in painting, decorating, priming and art; paints for walls; paints; varnishes; lacquers; wall coatings [paints]; protective preparations for metals; fire retardant paints; bactericidal paints; antifouling paints; fixatives [varnishes]; dyes; mordants; all of the aforesaid goods being related to the construction industry only.

19 – Building materials [non-metallic]; non-metallic rigid pipes for building; asphalt, pitch and bitumen; non-metallic transportable buildings; monuments, not of metal; lime; slag-lime cement; mortar; plaster; screeds; binding materials for road repair; binding materials for floor repair; binding materials for wall repair; binding agents for making stones; binding agents for making briquettes; cement; cement mixes; cements for building; wall linings, not of metal, for building; cladding (non-metallic -) for facades; facade cladding sheets of mortar coated foamed materials; load-bearing section bars, not of metal; facades (non-metallic-); slabs (cement -); building components (non-metallic -) in the form of slabs; facade construction components of non-metallic materials; tiles; mosaic tiles; stucco tiles; non-metal tiles; plaster boards; non-metallic building materials having acoustic properties; prefabricated non-metal walls; prefabricated building components (non-metallic -); roof coverings, not of metal; stairs, not of metal; stair-treads [steps], not of metal; components for load-bearing walls; modular building units (non-metallic -); foundation material (non-metallic -) for use in building; structures and transportable buildings, not of metal; thermal insulating glass for use in building; sand; gravel; refractory aggregates; concrete; prefabricated elements (non-metallic -) for building; floorings made of cement; walls made of cement.

37 – Building construction; repair of building materials [non-metallic], non-metallic rigid pipes for building, non-metallic transportable buildings, monuments, not of metal, wall linings, not of metal, for building, cladding (non-metallic -) for facades, facade

de cladding sheets of mortar coated foamed materials, facades (non-metallic -), plaster boards, non-metallic building materials having acoustic properties, soundproof hoods [structures], not of metal, prefabricated non-metal walls, prefabricated building components (non-metallic -), attic covers, staircases, components for load-bearing walls, modular building units (non-metallic -), foundation material (non-metallic -) for use in building, structures and transportable buildings, not of metal, thermal insulating glass for use in building, prefabricated elements (non-metallic -) for building; installation services concerning building materials [non-metallic], non-metallic rigid pipes for building, non-metallic transportable buildings, monuments, not of metal, wall linings, not of metal, for building, cladding (non-metallic -) for facades, facade cladding sheets of mortar coated foamed materials, facades (non-metallic -), plaster boards, non-metallic building materials having acoustic properties, sound-proof hoods [structures], not of metal, prefabricated non-metal walls, prefabricated building components (non-metallic-), attic covers, staircases, components for load-bearing walls, modular building units (non-metallic -), foundation material (non-metallic -) for use in building, structures and transportable buildings, not of metal, thermal insulating glass for use in building, prefabricated elements (non-metallic -) for building; construction; rental of building equipment; installation of building materials; rental of materials for construction, selection, extraction of gravel material, ground movement; renovation, restoration and repair of building construction.

(260) AM 2020 103827 A

(800) 1474231

(151) 2019 02 07

(891) 2019 02 07

(731) SQM Europe, naamloze vennootschap

Houtdok-Noordkaai 25 a, B-2030 Antwerpen,
Belgium

(540)

SQM

(591) Black, white

(511)

1 – Chemicals used in industry and science, as well as in fish-breeding, agriculture, horticulture and forestry; fertilizers; fertilizing preparations; boric acid; copper carbonate; copper chemicals; copper phosphate; copper sulphate; industrial minerals; industrial salts and ceramic glazings in the nature of a dry chemical preparation for use in the manufacture of ceramics; iodine for chemical and industrial purposes; lithium; magnesium chloride; manures; alkaline-earth metals; nitrates; potassium; unprocessed resins; salt peter.

42 – Scientific and technological services, as well as industrial analysis and research and information services in the field of chemicals used in industry, science, fish-breeding, agriculture, horticulture and forestry, fertilizers, fertilizing preparations, iodine, lithium and minerals; provision of evaluation, estimation and engineering, scientific, technical and technological reports in the field of the application of chemicals, fertilizers and fertilizing preparations.

44 – Agriculture, horticulture and forestry services; advisory and consultancy services relating to the use of chemicals, fertilizers and fertilizing preparations in fish-breeding, agriculture, horticulture and forestry; spreading of fertilizers and other agricultural chemicals.

(260) AM 2020 103830 A

(800) 1474377

(151) 2019 03 19

(891) 2019 03 19

(731) EGIS GYÓGYSZERGYÁR ZRT.

Keresztúri út 30-38., H-1106 Budapest,
Hungary

(540)



(591) Black, white

(531) 26.11.11; 26.13.25

(511)

5 – Pharmaceutical preparations for human use.

(260) AM 2020 103834 A

(800) 1344789

(151) 2016 08 23

(891) 2018 06 25

(731) Sano – Moderní výživa zvířat spol. s r.o.

Npor. O. Bartoška 15, CZ-344 01 Domažlice,
Czech Republic

(540)

(591) Black, white

(531) 27.05.01; 27.05.17

(511)

31 – Fodders for animals, primarily dry.

44 – Services related to animal nutrition and animal breeding, veterinary services.

(260) AM 2020 103905 A

(800) 1474984

(151) 2019 04 04

(891) 2019 04 04

(731) ADP GAUSELMANN GMBH

Merkur-Allee 1-15, 32339 Espelkamp,
Germany

(540)

Hyper Fruits

(591) Black, white

(511)

9 – Computer software; coin-operated mechanisms; computer and video games software; games software in particular for use on any computer platform, including electronic entertainment and games consoles; computer game programs video games (software); computer games provided through a global computer network or supplied by means of multi-media electronic broadcast or through telecommunications or electronic transmission or via the Internet; computer games, leisure and recreational software, video games and computer software, all being provided in the form of storage media; programs for operating electric and electronic apparatus for games, amusement and/or entertainment purposes; computer software for computer games on the Internet; online games (software), in particular for online betting games, online prize games, online gambling games, online games of skill and online casino games; computer software in the form of an app for mobile devices and computers; calculating apparatus in coin-operated machines and parts for the aforesaid goods; electric, electronic, optical or automatic apparatus, for identifying data carriers, identity cards and credit cards, bank notes and coins; software in particular for casino and/or amusement arcade games, for gaming machines and/or slot machines each one with or without prize payouts; gaming software that generates or displays wager outcomes of gaming machines; operational computer games software; computer software for managing of games (game collection); computer programs for video games; computer video game software.

28 – Games; toys; gaming apparatus (including coin-operated apparatus); coin-operated arcade games (machines); games for amusement arcades (included in this class); coin-operated video gaming apparatus; video games apparatus adapted for use with external screens or monitors only; casino fittings namely roulette tables, roulette wheels; coin-operated automatic gaming machines and gaming machines, in particular for gaming arcades, with or without a prize payout; electronic or electrotechnical gaming apparatus, automatic gaming machines, gaming machines, slot machines operated by coins, tokens, banknotes, tickets or by means of electronic, magnetic or biometric storage media, in particular for commercial use

in casinos and amusement arcades with or without a prize payout; automatic gaming machines and gaming machines, in particular for commercial use in casinos and gaming arcades, with or without a prize payout; coin-operated gaming machines and/or electronic money-based gaming apparatus (machines) with or without prizes; housings adapted for gaming machines, gaming apparatus and automatic gaming machines, operated by means of coins, tokens, tickets or by means of electronic, magnetic or biometric storage media, in particular for commercial use in casinos and gaming arcades, with or without a prize payout; electronic games; electronic game entertainment apparatus and parts thereof; video output game machines; drawing apparatus for prize games and lotteries, draws or raffles; housings of metal, plastic and/or wood adapted for coin-operated automatic amusement machines; apparatus for games (including video games), other than adapted for use with external screens or monitors only; electropneumatic and electric slot machines with pulling handles (gaming machines), gaming tables, in particular for table football, billiards, sliding games; flying discs (toys) and darts; gaming machines, namely electric, electronic or electromechanical apparatus for bingo games, lotteries or video lottery games and for betting offices, connected or unconnected to a computer network; LCD games consoles; automatic gaming machines: all the aforesaid automatic machines operating in networks; apparatus and devices for accepting and storing money, being fittings for the aforesaid automatic machines, included in this class; automatic lottery machines.

(260) AM 2020 103912 A

(800) 1475227

(151) 2019 02 01

(891) 2019 02 01

(731) KOLSAN KOCAELI LASTIK SANAYI ANONIM SIRKETI

Arslanbey Organize Sanayi Bolgesi, Orta Mah. Fabrikalar Sk. No:7, Kartepe, Kocaeli, Turkey

(540)



(591) Gray and light blue

(531) 01.15.05; 26.11.03; 27.05.01; 29.01.12

(511)

12 – Motor land vehicles, motorcycles, mopeds; engines and motors for land vehicles; clutches for land vehicles; transmissions, transmission belts and transmission chains for land vehicles; gearing for land vehicles; brakes, brake discs and brake linings for land vehicles; vehicle chassis, automobile bon-

nets, vehicle suspension springs, shock absorbers for automobiles, gearboxes for land vehicles, steering wheels for vehicles, rims for vehicle wheels; bicycles and their bodies; handlebars and mudguards for bicycles; vehicle bodies; tipping bodies for trucks; trailers for tractors; frigorific bodies for land vehicles; trailer hitches for vehicles; vehicle seats; headrests for vehicle seats; safety seats for children, for vehicles; seat covers for vehicles; vehicle covers (shaped); sun-blinds adapted for vehicles; direction signals and arms for direction signals for vehicles; windscreen wipers and wiper arms for vehicles; inner and outer tires for vehicle wheels; tubeless tires; tire-fixing sets comprised of tire patches and tire valves for vehicles; windows for vehicles, safety windows for vehicles, rearview mirrors and wing mirrors for vehicles; anti-skid chains for vehicles; luggage carriers for vehicles; bicycle and ski carriers for cars; saddles for bicycles or motorcycles; air pumps for vehicles, for inflating tires; anti-theft alarms for vehicles, horns for vehicles; safety belts for vehicle seats, air bags (safety devices for automobiles); baby carriages, wheelchairs, pushchairs; wheelbarrows; shopping carts; single or multi-wheeled wheelbarrows; shopping trolleys; grocery carts; handling carts; rail vehicles, namely, locomotives; trains; trams; waggons; cable cars; chairlifts; vehicles for locomotion by water and their parts, other than their motors and engines; vehicles for locomotion by air and their parts, other than their motors and engines.

(260) AM 2020 103923 A

(800) 1475592

(151) 2019 01 10

(891) 2019 01 10

(731) JUDEAN DESERT HERBS DISTRIBUTION AND MARKETING LTD

36 Gruner Street, 5121206 Bnei Brak, Israel

(540)

ONmacabim

(591) Black, white

(511)

3 – Cosmetics and cosmetic preparations; non-medicated cleansing preparations for the skin; cleansing and moisturizing creams, oils, lotions and preparations; cosmetic lotions; cosmetic facial care preparations; anti-ageing skincare preparations; cosmetic gels; massage creams, other than for medical purposes; cosmetic nourishing creams; nonmedicated skin serums; cosmetic masks; cosmetic lotions and creams for reducing the appearance of age spots and freckles; eye creams and gels for cosmetic use; skin exfoliants; non-medicated exfoliating preparations for the face; massage oils and lotions; oils for cosmetic purposes; sun-tanning and sun protection preparations; after-sun creams; facial peel preparations

for cosmetic purposes; skin care preparations, namely, skin peels; hand cream; non-medicated foot creams; hair care preparations; beauty serums; body sprays for cosmetic use; cosmetics for eyelashes and eyebrows; ampoules containing cosmetic preparations; creams for cellulite reduction for cosmetic purposes; cosmetic pads and wipes; nail care preparations; cosmetic soaps; bath soaps in liquid, solid or gel form; bath salts, not for medical purposes; cosmetic preparations containing alginates; seaweed for use in cosmetology.

(260) AM 2020 103925 A

(800) 1475649

(151) 2019 03 11

(891) 2019 03 11

(731) HyperSat LLC

1354 Lewinsville Mews Court, McLean

VA 22102, USA

(540)

HYPERSAT

(591) Black, white

(511)

35 – Business advisory services, namely, providing satellite hyperspectral data to assist and enable critical business decision making; commercial advisory services, namely, providing business management advice in the field of satellite hyperspectral data.

36 – Government advisory services, namely, advice about government financial assistance programs and financial grants in the field of satellite hyperspectral data; operation and management of satellite services, namely, financial management of satellite operations.

38 – Leasing of satellites for earth observation and scientific purposes, namely, the leasing of satellite transmission capacity for data acquisition; satellite communication services; transmission of sound, data and vision via satellite or interactive multimedia networks; operation of satellite services, namely, satellite transmission services for data acquisition.

42 – Providing hyperspectral analysis of ground and atmosphere operating satellite with hyperspectral sensors; computer software consultation, namely, analysis of computer software and proprietary algorithms for visualization in the nature of graphical representation and analysis of hyperspectral data provided by satellite; scientific analysis of earth photographs and electronic images taken from satellite; operation of satellite services, namely, remote monitoring of the data acquisition functioning of satellites.

45 – Business services, namely advising government and commercial enterprises about utilizing the analysis of hyperspectral images for compliance with

various laws and regulations relating to environmental standards, treaties, and contractual obligations, all of the foregoing services expressly excluding legal services (term considered too vague by the International Bureau – rule 13 (2) (b) of the Common Regulations).

(260) AM 2020 104333 A

(800) 1479609

(151) 2019 05 08

(891) 2019 05 08

(731) C.P.C. Creative Perfume Company, Holding SA

Rue du Mont-de-Sion 8, c/o Lenhill Partners SA, CH-1206 Genève, Switzerland

(540)



(591) Black, white

(531) 05.05.20; 26.01.15

(511)

3 – Amber [perfume]; aromatics [essential oils]; air fragranting preparations; cake flavorings [essential oils]; flavorings for beverages [essential oils]; food flavorings [essential oils]; breath freshening sprays; balms, other than for medical purposes; lip glosses; sachets for perfuming linen; scented water; Javelle water; lavender water; toilet water; depilatory wax; mustache wax; massage gels, other than for medical purposes; heliotropine; make-up; deodorants for pets; deodorants for human beings or for animals; depilatory preparations; air fragrance reed diffusers; scented wood; perfumes; perfumery; decorative transfers for cosmetic purposes; ionone [perfumery]; eyebrow pencils; cosmetic pencils; adhesives for affixing false eyelashes; adhesives for affixing false hair; hair conditioners; beard dyes; cosmetic dyes; cosmetic creams; skin whitening creams; incense; hair spray; nail polish; hair lotions; lotions for cosmetic purposes; after-shave lotions; beauty masks; oils for perfumes and scents; oils for cosmetic purposes; oils for toilet purposes; essential oils; essential oils of cedarwood; essential oils of lemon; essential oils of citron; oils for cleaning purposes; bergamot oil; gaultheria oil; jasmine oil; lavender oil; almond oil; rose oil; almond milk for cosmetic purposes; cleansing milk for toilet purposes; musk [perfumery]; deodorant soap; shaving soap; soap for brightening textile; cakes of toilet soap; antiperspirant soap; soap for foot perspiration; soap; almond soap; mint for perfumery; cosmetic kits; eau de Cologne; bases for flower perfumes; joss sticks; dentifrices;

lipstick cases; breath freshening strips; teeth whitening strips; lipsticks; pomades for cosmetic purposes; shaving preparations; cosmetic preparations for baths; bath preparations, not for medical purposes; hair straightening preparations; hair waving preparations; color-removing preparations; leather bleaching preparations; mouthwashes, not for medical purposes; cosmetic preparations for slimming purposes; make-up removing preparations; nail care preparations; collagen preparations for cosmetic purposes; aloe vera preparations for cosmetic purposes; sunscreen preparations; breath freshening preparations for personal hygiene; make-up powder; nail varnish removers; vaginal washes for personal sanitary or deodorant purposes; tissues impregnated with cosmetic lotions; tissues impregnated with make-up removing preparations; massage candles for cosmetic purposes; potpourris [fragrances]; bath salts, not for medical purposes; fumigation preparations [perfumes]; astringents for cosmetic purposes; eyebrow cosmetics; make-up preparations; sun-tanning preparations [cosmetics]; hair dyes; neutralizers for permanent waving; cosmetic preparations for eyelashes; cosmetic preparations for skin care; cosmetics; cosmetics for children; cosmetics for animals; mascara; cleansers for intimate personal hygiene purposes, non medicated; douching preparations for personal sanitary or deodorant purposes [toiletries]; bleaching preparations [decolorants] for cosmetic purposes; antiperspirants [toiletries]; toiletry preparations; phytocosmetic preparations; talcum powder, for toilet use; terpenes [essential oils]; henna [cosmetic dye]; shampoos for animals [non-medicated grooming preparations]; shampoos for pets [non-medicated grooming preparations]; dry shampoos; shampoos; herbal extracts for cosmetic purposes; extracts of flowers [perfumes]; ethereal essences; badian essence; mint essence [essential oil].

4 – Nightlights [candles]; perfumed candles; Christmas tree candles; candles.

(260) AM 2020 104337 A

(800) 1479714

(151) 2019 05 08

(891) 2019 05 08

(731) C.P.C. Creative Perfume Company Holding SA

Rue du Mont-de-Sion 8, c/o Lenhill Partners SA, CH-1206 Genève, Switzerland

(540)

MORNING CHESS

(591) Black, white

(511)

3 – Amber [perfume]; aromatics [essential oils]; air fragrancing preparations; cake flavorings [essential oils]; flavorings for beverages [essential oils]; food

flavorings [essential oils]; breath freshening sprays; balms, other than for medical purposes; lip glosses; sachets for perfuming linen; scented water; Javelle water; lavender water; toilet water; depilatory wax; mustache wax; massage gels, other than for medical purposes; heliotropine; make-up; deodorants for pets; deodorants for human beings or for animals; depilatory preparations; air fragrance reed diffusers; scented wood; perfumes; perfumery; decorative transfers for cosmetic purposes; ionone [perfumery]; eyebrow pencils; cosmetic pencils; adhesives for affixing false eyelashes; adhesives for affixing false hair; hair conditioners; beard dyes; cosmetic dyes; cosmetic creams; skin whitening creams; incense; hair spray; nail polish; hair lotions; lotions for cosmetic purposes; after-shave lotions; beauty masks; oils for perfumes and scents; oils for cosmetic purposes; oils for toilet purposes; essential oils; essential oils of cedarwood; essential oils of lemon; essential oils of citron; oils for cleaning purposes; bergamot oil; gaultheria oil; jasmine oil; lavender oil; almond oil; rose oil; almond milk for cosmetic purposes; cleansing milk for toilet purposes; musk [perfumery]; deodorant soap; shaving soap; soap for brightening textile; cakes of toilet soap; antiperspirant soap; soap for foot perspiration; soap; almond soap; mint for perfumery; cosmetic kits; eau de Cologne; bases for flower perfumes; joss sticks; dentifrices; lipstick cases; breath freshening strips; teeth whitening strips; lipsticks; pomades for cosmetic purposes; shaving preparations; cosmetic preparations for baths; bath preparations, not for medical purposes; hair straightening preparations; hair waving preparations; color-removing preparations; leather bleaching preparations; mouthwashes, not for medical purposes; cosmetic preparations for slimming purposes; make-up removing preparations; nail care preparations; collagen preparations for cosmetic purposes; aloe vera preparations for cosmetic purposes; sunscreen preparations; breath freshening preparations for personal hygiene; make-up powder; nail varnish removers; vaginal washes for personal sanitary or deodorant purposes; tissues impregnated with cosmetic lotions; tissues impregnated with make-up removing preparations; massage candles for cosmetic purposes; potpourris [fragrances]; bath salts, not for medical purposes; fumigation preparations [perfumes]; astringents for cosmetic purposes; eyebrow cosmetics; make-up preparations; sun-tanning preparations [cosmetics]; hair dyes; neutralizers for permanent waving; cosmetic preparations for eyelashes; cosmetic preparations for skin care; cosmetics; cosmetics for children; cosmetics for animals; mascara; cleansers for intimate personal hygiene purposes, non medicated; douching preparations for personal sanitary or deodorant purposes [toiletries]; bleaching preparations [decolorants] for cosmetic purposes; antiperspirants [toiletries]; toiletry preparations; phytocosmetic preparations; talcum powder, for toilet

use; terpenes [essential oils]; henna [cosmetic dye]; shampoos for animals [non-medicated grooming preparations]; shampoos for pets [non-medicated grooming preparations]; dry shampoos; shampoos; herbal extracts for cosmetic purposes; extracts of flowers [perfumes]; ethereal essences; badian essence; mint essence [essential oil].

4 – Nightlights [candles]; perfumed candles; Christmas tree candles; candles.

(260) AM 2020 104343 A

(800) 1479777

(151) 2019 06 19

(891) 2019 06 19

(731) CHROME HEARTS LLC

915 N. Mansfield, Hollywood CA 90038, USA

(540)

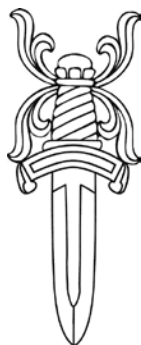

(591) Black, white

(531) 23.01.01

(511)

9 – Eyewear, namely, eyeglasses, sunglasses, eyeglass cases and sunglass cases.

(260) AM 2020 104390 A

(800) 1480643

(151) 2019 06 17

(891) 2019 06 17

(731) HAIER GROUP CORPORATION

Haier Industrial Park, Haier Road, Qingdao Hi-Tech Industrial Park, 266101 Shandong Province, China

(540)

Casarte

(591) Black, white

(531) 27.05.01

(511)

7 – Dishwashers; blenders, electric, for household purposes; electric kitchen machines; food processors, electric; household bean juice maker; washing machines [laundry]; wringing machines for laundry; vacuum cleaners; machines and apparatus for cleaning, electric; agricultural machines; food prepara-

tion machines, electromechanical; beverage preparation machines, electromechanical; ironing machines; hand-held tools, other than hand-operated; valves [parts of machines]; blowing machines for the compression, exhaustion and transport of gases; drums [parts of machines]; shoe polishers, electric; door openers, electric.

9 – Computers; facsimile machines; neon signs; mobile phones; television apparatus; cameras [photography]; MP3 players; DVD players; computer software, recorded; pedometers; electronic tags for goods; measuring instruments; optical apparatus and instruments; semi-conductors; integrated circuits; fluorescent screens; fire-extinguishing apparatus; life saving apparatus and equipment; batteries, electric; animated cartoons.

11 – Lighting apparatus and installations; cooking apparatus and installations; refrigerators; air conditioning apparatus; heating apparatus, electric; sanitary apparatus and installations; radiators, electric; friction lighters for igniting gas; heaters for baths; microwave ovens [cooking apparatus]; extractor hoods for kitchens; gas burners; refrigerating appliances and installations; freezers; coffee machines, electric; laundry dryers, electric; central heating radiators; gas lamps; hair driers; socks, electrically heated.

(260) AM 2020 104393 A

(800) 1480749

(151) 2019 02 15

(891) 2019 02 15

(731) MOROZOV VICTOR ALEKSANDROVICH

Kosmonavtov street, 5, building G, apartment 40, RU-344092 Rostov-on-Don, Russian Federation

(540)



(591) Blue, violet, pink, beige, light brown, brown, dark brown, orange, blue, white, gray, black and red

(531) 05.03.13; 11.03.04; 11.03.14; 26.01.02; 26.01.15; 26.01.16; 26.01.18; 26.04.08;

26.04.10; 26.04.18; 26.04.24; 28.05; 29.01.15

(511)

30 – Vanilla flavorings for culinary purposes; flavorings, other than essential oils, for cakes; flavorings, other than essential oils, for beverages; coffee flavorings; food flavorings, other than essential oils; star

aniseed; baozi [stuffed buns]; cereal bars; high-protein cereal bars; pancakes; noodle-based prepared meals; freeze-dried dishes with the main ingredient being pasta; freeze-dried dishes with the main ingredient being rice; buns; bulgur; bread rolls; edible rice paper; edible paper; burritos; vanillin [vanilla substitute]; vareniki [stuffed dumplings]; waffles; vermicelli [noodles]; natural sweeteners; sausage binding materials; binding agents for ice cream; sea water for cooking; seaweed [condiment]; malt biscuits; cloves [spice]; mirror icing [mirror glaze]; cake frosting [icing]; glucose for culinary purposes; mustard; croûtons; buckwheat, processed; gluten additives for culinary purposes; yeast; thickening agents for cooking foodstuffs; leaven; rice-based snack food; cereal-based snack food; artificial coffee; vegetal preparations for use as coffee substitutes; dressings for salad; zephyr [confectionery]; fruit jellies [confectionery]; candy decorations for cakes; confectionery for decorating Christmas trees; cakes; pastries; peanut confectionery; almond confectionery; pasta; ginger [spice]; frozen yogurt [confectionery ices]; cocoa; cream of tartar for culinary purposes; capers; caramels [candy]; curry [spice]; ketchup [sauce]; gimbap [Korean rice dish]; kimchi-jeon [fermented vegetable pancakes]; quinoa, processed; quiches; gluten prepared as foodstuff; flour-based dumplings; sweetmeats [candy]; liquorice [confectionery]; peppermint sweets; mints for breath freshening; dulce de leche; cinnamon [spice]; coffee; unroasted coffee; starch for food; crackers; custard; hominy grits; semolina; oatmeal; crushed barley; groats for human food; ice cubes; corn, milled; corn, roasted; meat pies; turmeric; couscous [semolina]; noodles; soba noodles; udon noodles; ice for refreshment; ice, natural or artificial; edible ices; candy; rice cakes; lomper [potato-based flatbread]; mayonnaise; macaroons [pastry]; macaroni; maltose; hominy; piccalilli; marinades; marzipan; honey; royal jelly; ice cream; bean meal; buckwheat flour; tapioca flour; potato flour; corn flour; nut flours; flour; wheat flour; soya flour; barley meal; dessert mousses [confectionery]; chocolate mousses; muesli; mint for confectionery; cocoa beverages with milk; coffee beverages with milk; coffee-based beverages; cocoa-based beverages; chamomile-based beverages; tea-based beverages; chocolate beverages with milk; chocolate-based beverages; infusions, not medicinal; crushed oats; husked oats; okonomiyaki [Japanese savory pancakes]; onigiri [rice balls]; nutmegs; chocolate-coated nuts; stick liquorice [confectionery]; soya bean paste [condiment]; pastila [confectionery]; pastilles [confectionery]; molasses for food; pâtés en croûte; pelmeni [dumplings stuffed with meat]; pepper; allspice; peppers [seasonings]; pesto [sauce]; cookies; petit-beurre biscuits; bibimbap [rice mixed with vegetables and beef]; pies; pizzas; meat gravies; fondants [confectionery]; popcorn; powders for making ice cream; baking powder; mustard meal;

pralines; condiments; meat tenderizers for household purposes; cereal preparations; oat-based food; propolis; gingerbread; spices; petits fours [cakes]; rice pudding; puddings; cake powder; fruit coulis [sauces]; ravioli; ramen [Japanese noodle-based dish]; chewing gum; chewing gum for breath freshening; relish [condiment]; rice; instant rice; wheat germ for human consumption; spring rolls; sago; sugar; palm sugar; sesame seeds [seasonings]; linseed for culinary purposes [seasoning]; processed seeds for use as a seasoning; aniseed; agave syrup [natural sweetener]; golden syrup; confectionery; batter mixes for okonomiyaki [Japanese savory pancakes]; baking soda [bicarbonate of soda for cooking purposes]; malt for human consumption; salt for preserving foodstuffs; cooking salt; celery salt; sherbets [ices]; ham glaze; cranberry sauce [condiment]; soya sauce; tomato sauce; apple sauce [condiment]; sauces [condiments]; pasta sauce; spaghetti; seasonings; chocolate-based spreads; chocolate spreads containing nuts; preparations for stiffening whipped cream; shaved ice with sweetened red beans; rusks; breadcrumbs; sushi; senbei [rice crackers]; sandwiches; tabbouleh; tacos; tapioca; tarts; dough; pastry dough; almond paste; rice pulp for culinary purposes; cake dough; tortillas; garden herbs, preserved [seasonings]; chocolate decorations for cakes; vinegar; beer vinegar; ferments for pastes; halvah; bread; unleavened bread; chips [cereal products]; corn flakes; oat flakes; hot dog sandwiches; flowers or leaves for use as tea substitutes; jiaozi [stuffed dumplings]; chicory [coffee substitute]; tea; iced tea; chutneys [condiments]; minced garlic [condiment]; cheeseburgers [sandwiches]; chow-chow [condiment]; saffron [seasoning]; chocolate; malt extract for food; essences for foodstuffs, except etheric essences and essential oils; husked barley.

35 – Arranging subscriptions to telecommunication services for others; import-export agency services; commercial information agency services; advertising agency services; cost price analysis; rental of advertising space; business auditing; financial auditing; business intermediary services relating to the matching of potential private investors with entrepreneurs needing funding; employment agency services; computerized file management; book-keeping; invoicing; demonstration of goods; transcription of communications [office functions]; opinion polling; market studies; business information; commercial information and advice for consumers in the choice of products and services; business investigations; business research; marketing research; personnel recruitment; business management and organization consultancy; business organization consultancy; business management consultancy; personnel management consultancy; professional business consultancy; consultancy regarding advertising communication strategies; consultancy regarding public rela-

tions communication strategies; layout services for advertising purposes; marketing; marketing in the framework of software publishing; targeted marketing; business management of performing artists; business management of sports people; writing of résumés for others; scriptwriting for advertising purposes; news clipping services; updating and maintenance of information in registries; updating and maintenance of data in computer databases; updating of advertising material; word processing; online retail services for downloadable and pre-recorded music and movies; online retail services for downloadable ring tones; online retail services for downloadable digital music; organization of exhibitions for commercial or advertising purposes; arranging newspaper subscriptions for others; organization of fashion shows for promotional purposes; organization of trade fairs for commercial or advertising purposes; shop window dressing; design of advertising materials; business appraisals; payroll preparation; data search in computer files for others; sponsorship search; administrative assistance in responding to calls for tenders; business management assistance; commercial or industrial management assistance; commercial intermediation services; providing business information via a web site; provision of commercial and business contact information; web indexing for commercial or advertising purposes; economic forecasting; auctioneering; retail services for works of art provided by art galleries; sales promotion for others; promotion of goods and services through sponsorship of sports events; production of teleshopping programmes; production of advertising films; office machines and equipment rental; rental of advertising time on communication media; publicity material rental; rental of signs for advertising purposes; rental of vending machines; rental of sales stands; rental of photocopying machines; publication of publicity texts; radio advertising; bill-posting; distribution of samples; dissemination of advertising matter; direct mail advertising; registration of written communications and data; writing of publicity texts; advertising; online advertising on a computer network; advertising by mail order; television advertising; document reproduction; compilation of statistics; compilation of information into computer databases; business inquiries; systemization of information into computer databases; advisory services for business management; negotiation of business contracts for others; negotiation and conclusion of commercial transactions for third parties; compiling indexes of information for commercial or advertising purposes; tax preparation; drawing up of statements of accounts; telemarketing services; psychological testing for the selection of personnel; wholesale services for pharmaceutical, veterinary and sanitary preparations and medical supplies; retail services for pharmaceutical, veterinary and sanitary preparations and medical supplies; interim business management;

business management of hotels; business management for freelance service providers; business project management services for construction projects; commercial administration of the licensing of the goods and services of others; business management of reimbursement programs for others; administration of consumer loyalty programs; administration of frequent flyer programs; administrative processing of purchase orders; public relations; competitive intelligence services; modelling for advertising or sales promotion; typing; market intelligence services; appointment reminder services [office functions]; relocation services for businesses; tax filing services; search engine optimization for sales promotion; appointment scheduling services [office functions]; gift registry services; price comparison services; pay per click advertising; secretarial services; procurement services for others [purchasing goods and services for other businesses]; shorthand; outsourcing services [business assistance]; telephone answering for unavailable subscribers; photocopying services; business efficiency expert services; promoting the goods and services of others; services of shops selling goods of the 30th class, namely, vanilla flavorings for culinary purposes, flavorings, other than essential oils, for cake, cakes, flavorings, other than essential oils, for beverages, coffee flavorings, food flavorings, other than essential oils, star aniseed, baozi [stuffed buns], cereal bars, high-protein cereal bars, pancakes, noodle-based prepared meals, freeze-dried dishes with the main ingredient being pasta, freeze-dried dishes with the main ingredient being rice, buns, bulgur, bread rolls, edible rice paper, edible paper, burritos, vanillin [vanilla substitute], vareniki [stuffed dumplings], waffles, vermicelli [noodles], natural sweeteners, sausage binding materials, binding agents for ice cream, sea water for cooking, seaweed [condiment], malt biscuits, cloves [spice], mirror icing [mirror glaze], cake frosting [icing], glucose for culinary purposes, mustard, crotons, buckwheat, processed, gluten additives for culinary purposes, yeast, thickening agents for cooking foodstuffs, leaven, rice-based snack food, cereal-based snack food, artificial coffee, vegetal preparations for use as coffee substitutes, dressings for salad, zephyr [confectionery], fruit jellies [confectionery], candy decorations for cakes, confectionery for decorating Christmas trees, cakes, pastries, peanut confectionery, almond confectionery, pasta, ginger [spice], frozen yogurt [confectionery ices], cocoa, cream of tartar for culinary purposes, capers, caramels [candy], curry [spice], ketchup [sauce], gimbap [Korean rice dish], kimchijeon [fermented vegetable pancakes], quinoa, processed, quiches, gluten prepared as foodstuff, flour-based dumplings, sweetmeats [candy], liquorice [confectionery], peppermint sweets, mints for breath freshening, dulce de leche, cinnamon [spice], coffee, unroasted coffee, starch for food, crackers, custard, hominy grits, se-

molina, oatmeal, crushed barley, groats for human food, ice cubes, milled corn, roasted corn, meat pies, turmeric, couscous [semolina], noodles, soba noodles, udon noodles, ice for refreshment, natural or artificial ice, edible ices, candy, rice cakes, lomper [potato-based flatbread], mayonnaise, macarons [pastry], macaroni, maltose, hominy, piccalilli, marinades, marzipan, honey, royal jelly, ice cream, bean meal, buckwheat flour, tapioca flour, potato flour, corn flour, nut flours, flour, wheat flour, soya flour, barley meal, dessert mousses [confectionery], chocolate mousses, muesli, mint for confectionery, cocoa beverages with milk, coffee beverages with milk, coffee-based beverages, cocoa-based beverages, chamomile-based beverages, tea-based beverages, chocolate beverages with milk, chocolate-based beverages, not medicinal infusions, crushed oats, husked oats, okonomiyaki [Japanese savory pancakes], onigiri [rice balls], nutmegs, chocolate-coated nuts, stick liquorice [confectionery], soya bean paste [condiment], pastila [confectionery], pastilles [confectionery], molasses for food, pâtés en croûte, pelmeni [dumplings stuffed with meat], pepper, allspice, peppers [seasonings], pesto [sauce], cookies, petit-beurre biscuits, bibimbap [rice mixed with vegetables and beef], pies, pizzas, meat gravies, fondants [confectionery], popcorn, powders for making ice cream, baking powder, mustard meal, pralines, condiments, meat tenderizers for household purposes, cereal preparations, oat-based food, propolis, gingerbread, spices, petits fours [cakes], rice pudding, puddings, cake powder, fruit coulis [sauces], ravioli, ramen [Japanese noodle-based dish], chewing gum, chewing gum for breath freshening, relish [condiment], rice, instant rice, wheat germ for human consumption, spring rolls, sago, sugar, palm sugar, sesame seeds [seasonings], linseed for culinary purposes [seasoning], processed seeds for use as a seasoning, aniseed, agave syrup [natural sweetener], golden syrup, confectionery, batter mixes for okonomiyaki [Japanese savory pancakes], baking soda [bicarbonate of soda for cooking purposes], malt for human consumption, salt for preserving foodstuffs, cooking salt, celery salt, sherbets [ices], ham glaze, cranberry sauce [condiment], soya sauce, tomato sauce, apple sauce [condiment], sauces [condiments], pasta sauce, spaghetti, seasonings, chocolate-based spreads, chocolate spreads containing nuts, preparations for stiffening whipped cream, shaved ice with sweetened red beans, rusks, breadcrumbs, sushi, senbei [rice crackers], sandwiches, tabbouleh, tacos, tapioca, tarts, dough, pastry dough, almond paste, rice pulp for culinary purposes, cake dough, tortillas, preserved garden herbs [seasonings], chocolate decorations for cakes, vinegar, beer vinegar, ferments for pastes, halvah, bread, unleavened bread, chips [cereal products], corn flakes, oat flakes, hot dog sandwiches, flowers or leaves for use as tea substitutes, jiaozi [stuffed dumplings], chicory [coffee substitute], tea,

iced tea, chutneys [condiments], minced garlic [condiment], cheeseburgers [sandwiches], chow-chow [condiment], saffron [seasoning], chocolate, malt extract for food, essences for foodstuffs (except etheric essences and essential oils), husked barley; provision of an online marketplace for buyers and sellers of goods and services; presentation of goods on communication media, for retail purposes; outsourced administrative management for companies; web site traffic optimization.

(260) AM 2020 104519 A

(800) 1482034

(151) 2019 03 25

(891) 2019 03 25

(731) ORIFLAME COSMETICS AG

c/o Oriflame Global Management AG,
Bleicheplatz 3, CH-8200 Schaffhausen,
Switzerland

(540)

BEAUTANICALS

(591) Black, white

(511)

3 – Non-medicated conditioning and care preparations for application to the hair, scalp, skin and nails; shampoos; hair conditioner; soaps; perfumes; perfumery; eau de cologne; toilet waters; essential and herbal oils; cosmetics; make-up; make-up preparations; lipsticks; nail varnishes; nail varnish removers; eyeliner; mascara; non-medicated toilet preparations; hair lotions; hair sprays and hair gels; preparations for use in the bath or shower; bath and shower oils, gels, creams and foams; face and body masks; face and body scrubs; facial washes; skin cleansers and hydrators; skin toners; skin moisturizers; non-medicated blemish creams and blemish gels; deodorants; antiperspirants; preparations for use before shaving and after shaving; shaving soaps; shaving creams; shaving gels; after-shave preparations; pre-shave preparations; talcum powders; toiletries; dentifrices; toothpastes; foot care preparations (non-medicated).

(260) AM 2020 104521 A

(800) 737102

(151) 2000 07 03

(891) 2019 07 25

(731) REINEMAILLE

234 Rue du Général de Gaulle, Zone
Industrielle Sud, LES RONZIERES, F-69530
BRIGNAIS, France

(540)

ORCIVAL

(591) Black, white

(511)

25 – Clothing, underclothing; footwear (excluding orthopaedic footwear); headwear.

(260) AM 2020 104654 A
 (800) 1484068
 (151) 2019 04 25
 (891) 2019 04 25
 (731) TRELLEBORG BOHEMIA, A.S.
 Akademia Bedrny 531/8a, CZ-500 03
 Hradec Králové, Věkoše, Czech Republic
 (540)



(591) Black, white
 (531) 26.01.18; 26.04.22; 27.05.01; 27.05.02;
 27.05.07
 (511)
 12 – Bicycle tyres, bicycle tubes; V-belts, cogged
 belts, flat belts for land vehicles.

(260) AM 2020 104657 A
 (800) 1484163
 (151) 2019 06 28
 (891) 2019 06 28
 (731) TOYOTA JIDOSHA KABUSHIKI KAISHA,
 (also trading as TOYOTA MOTOR
 CORPORATION)
 1, Toyota-cho, Toyota-shi, Aichi-ken
 471-8571, Japan

(540)
**Lexus Self Charging
 Hybrid**

(591) Black, white
 (511)
 12 – Driving motors for land vehicles; engine mo-
 unts for land vehicles; engines for land vehicles; jet
 engines for land vehicles; motors for land vehicles;
 propulsion mechanisms for land vehicles; turbines
 for land vehicles; automobile chains; connecting
 rods for land vehicles, other than parts of motors and
 engines; gear boxes for land vehicles; gearing for
 land vehicles; hydraulic circuits for vehicles; reduc-
 tion gears for land vehicles; torque converters for
 land vehicles; transmission chains for land vehicles;
 transmission shafts for land vehicles; transmissions
 for land vehicles; power transmission belts for land
 vehicles; brake discs for vehicles; brake linings for
 vehicles; brake pads for automobiles; brake seg-
 ments for vehicles; brake shoes for vehicles; brakes
 for vehicles; ac motors for land vehicles, not inclu-
 ding their parts; dc motors for land vehicles not
 including their parts; motors, electric, for land
 vehicles; electrically powered motor vehicles; hybrid
 cars; electric tricycles; buses; trucks; ambulances;
 racing cars; amphibious vehicles; snowmobiles; ar-
 mored vehicles; fork lift trucks; camping cars; trac-
 tors; trailers; trolley buses; hearses; automobiles and

structural parts thereof; structural parts for buses;
 structural parts for trucks; automobile bodies; auto-
 mobile bonnets; automobile bumpers; automobile
 chassis; automobile dashboards; automobile doors;
 automobile door handles; automobile hoods; auto-
 mobile horns; automobile seats; automobile seat co-
 vers; automobile sunroofs; automobile tires; auto-
 mobile wheels; spokes for automobile wheels; inner
 tubes for automobile tires; automobile wheel rims;
 rearview mirrors for automobiles; automobile win-
 dows; automobile windscreens; automobile winds-
 hields; automobile convertible tops; safety belts for
 automobile seats; safety harnesses for automobile
 racing; safety harnesses for automobile seats; secu-
 rity harness for automobile seats; steering wheels for
 automobiles; steering wheel covers for automobiles;
 air bags for automobiles, buses and trucks; seat belt
 pre-tensioners for automobiles; brake pedals for land
 vehicles; direction signals for automobiles; leather
 upholstery for automobile seats; leather upholstery
 for automobiles; cigar lighters for automobiles; sha-
 ped automobile covers; mudguards for automobiles;
 luggage carriers for automobiles; spare wheel hol-
 ders for automobiles; automobile roof racks; head-
 light wipers; windscreen wipers; windscreen wiper
 blades; motor vehicle brake control systems for app-
 lying emergency braking at low vehicle speeds; elec-
 tronic brake control apparatus for automobiles; two-
 wheeled motor vehicles; structural parts for two-
 wheeled motor vehicles; bicycles; structural parts for
 bicycles; motorcycles; structural parts for motor-
 cycles.

(260) AM 2020 104658 A
 (800) 1484166
 (151) 2019 07 12
 (891) 2019 07 12
 (731) Colgate-Palmolive Company
 300 Park Avenue, New York NY 10022,
 USA

(540)



(591) The color(s) red and blue is/are claimed as a
 feature of the mark
 (531) 25.05.01; 25.12.03; 29.01.12
 (511)
 3 – Dentifrices; toothpaste; tooth gel.

(260) AM 2020 104694 A
 (800) 1484597
 (151) 2019 04 24
 (891) 2019 04 24

(731) Hipp & Co
Brünigstr. 141, CH-6072 Sachseln,
Switzerland

(540)



(591) Magenta, cyan, orange and violet

(531) 02.09.01; 27.05.04; 27.05.10; 27.05.17;
29.01.14

(511)

5 – Food for babies and baby food; beverages for infants; dietetic substances for children and invalids, adapted for medical use; dietetic foods adapted for medical use; dietetic beverages for babies adapted for medical purposes; foodstuffs for special medical purposes; pharmaceuticals; dietetic substances for infants, babies, toddlers and children; milk powders [foodstuff for babies]; powdered milk foods for infants; dietary supplements for human consumption; nutritional supplements; powder, lotions, creams and bath preparations for medical purposes, and intended in particular for babies and toddlers; pharmaceuticals and natural remedies; breast-nursing pads; absorbent articles for personal hygiene; nappies for babies and incontinents; disposable diapers; cloth diapers; teething (preparations to facilitate -); moist wipes impregnated with a pharmaceutical lotion.

29 – Meat, fish, poultry, game and meat products; meat extracts; meat, fish, fruit and vegetable jellies; jams; freeze-dried fruit and vegetables; compotes; eggs, milk and milk products, in particular butter, cheese, cream, yoghurt, quark, dried milk, powdered milk; fruit bars, consisting primarily of fruit and/or nuts, including with added cereals, muesli, grains, pseudocereals, preparations made from cereals, preparations made from pseudocereals and/or sugar; vegetable pulp; fruit pulp; vegetable purees; fruit purées; purees and pulps consisting primarily of meat, fish, poultry, game, fruit and/or vegetables, either singly or in combination; snacks made from fruits and/or vegetables; snacks based on fruits and/or vegetables; desserts and puddings, predominantly of milk, milk products and/or fruit; prepared and semi-prepared meals, consisting primarily of meat, poultry, game, fish, fruit, vegetables, eggs, milk products, pulses and/or potatoes; soups; meat, fish, poultry, game, vegetable, fruit and milk preserves; edible oils and fats; dietetic food, not adapted for medical use, based on proteins, fats and/or fatty acids, all also including added vitamins, minerals, trace elements, either singly or in combination.

30 – Tea; tea drinks; infusions, not medicinal; cocoa; grape sugar; rice; tapioca; sago; flour; semolina; chips (cereal products) and pseudocereal flakes and other preparations made from cereals and prepa-

rations made from pseudocereals (other than animal fodder); bread; cookies; cakes; pastries; long-life cakes and pastries; snack products, namely the aforesaid consisting predominantly of chips (cereal products), substitutes for chips (cereal products), corn flakes, oat flakes, cereal preparations, substitutes for cereal preparations, biscuits, cakes, pastries, confectionery, chocolate, sugar confectionery, muesli, cereals, either singly or in combination, including the aforesaid with added fruits and/or nuts; confectionery products; farinaceous food pastes; chocolate; bonbons made of sugar; glucose preparations; bee glue [propolis] for human consumption; desserts and puddings with a base of carbohydrates; prepared meals and semi-prepared meals, consisting primarily of cereals, pseudocereals, preparations made from cereals, preparations made from pseudocereals, rice and/or pasta; spices; dressings for food; prepared foodstuffs in the form of sauces; muesli, consisting primarily of fruit, grains, cereals, pseudocereals, preparations made from cereals and/or preparations made from pseudocereals, also including added nuts and/or sugar; cereal and pseudocereal bars, consisting primarily of grains, muesli, preparations made from cereals, preparations made from pseudocereals, cereals and/or pseudocereals, all also including added fruit, nuts and/or sugar; muesli bars, consisting primarily of fruit, grains, preparations made from cereals, preparations made from pseudocereals, cereals and/or pseudocereals, all also including added fruit, nuts and/or sugar; ready-to-eat cereal and/or pseudocereal foods; dietetic food, not adapted for medical use, in particular based on carbohydrates and/or roughage, all including added vitamins, fatty acids, minerals, trace elements, either singly or in combination.

32 – Waters and other non-alcoholic beverages, in particular fruit juices, fruit juice beverages, fruit spritzers; fruit syrups and other non-alcoholic fruit preparations for making non-alcoholic beverages.

(260) AM 2020 104733 A

(800) 1165543

(151) 2013 04 12

(891) 2019 07 22

(731) Provalliance Salons Luxembourg S.C.A.
18, Avenue de la Liberté, L-1930
Luxembourg, Luxembourg

(540)

Jean Louis David

(591) Black, white

(531) 27.05.01

(511)

3 – Bleaching preparations and other substances for laundry use; cleaning, polishing, scouring and ab-

rasive preparations; soaps; perfumery, essential oils, cosmetics, hair lotions; dentifrices; hair care products (not for medical purposes), hair colorants, hair dyes, shampoos.

44 – Hygienic and beauty care for human beings or animals; beauty salons and hairdressing salons.

**INTERNATIONAL TRADEMARKS PROTECTED
IN GEORGIA**

(260) AM 2020 97101 A
(800) 1395043
(151) 2017 10 26
(181) 2027 10 26
(891) 2017 10 26
(511) 29

(260) AM 2020 101802 A
(800) 1450623
(151) 2018 09 04
(181) 2028 09 04
(891) 2018 09 04
(511) 20, 21, 31

(260) AM 2020 101554 A
(800) 1448232
(151) 2018 09 14
(181) 2028 09 14
(891) 2018 09 14
(511) 30

(260) AM 2020 101812 A
(800) 1450802
(151) 2018 12 03
(181) 2028 12 03
(891) 2018 12 03
(511) 05

(260) AM 2020 101752 A
(800) 1449961
(151) 2018 11 15
(181) 2028 11 15
(891) 2018 11 15
(511) 09, 10, 16, 25, 26, 28, 35, 38, 42

(260) AM 2020 101813 A
(800) 1450814
(151) 2018 12 17
(181) 2028 12 17
(891) 2018 12 17
(511) 32

(260) AM 2020 101762 A
(800) 1450159
(151) 2019 01 10
(181) 2029 01 10
(891) 2019 01 10
(511) 34

(260) AM 2020 101814 A
(800) 1450823
(151) 2018 11 19
(181) 2028 11 19
(891) 2018 11 19
(511) 05

(260) AM 2020 101763 A
(800) 1450176
(151) 2019 01 18
(181) 2029 01 18
(891) 2019 01 18
(511) 05

(260) AM 2020 101815 A
(800) 1450834
(151) 2018 11 19
(181) 2028 11 19
(891) 2018 11 19
(511) 05

(260) AM 2020 101797 A
(800) 1450494
(151) 2018 10 16
(181) 2028 10 16
(891) 2018 10 16
(511) 29, 30

(260) AM 2020 101816 A
(800) 1450835
(151) 2018 11 19
(181) 2028 11 19
(891) 2018 11 19
(511) 05

(260) AM 2020 101799 A
(800) 1450514
(151) 2018 10 04
(181) 2028 10 04
(891) 2018 10 04
(511) 12, 39, 42

(260) AM 2020 101817 A
(800) 1450865
(151) 2018 11 19
(181) 2028 11 19
(891) 2018 11 19
(511) 05

(260) AM 2020 101820 A
(800) 1450889
(151) 2018 12 03
(181) 2028 12 03
(891) 2018 12 03
(511) 05

(260) AM 2020 101821 A
(800) 1450890
(151) 2018 12 03
(181) 2028 12 03
(891) 2018 12 03
(511) 05

(260) AM 2020 101822 A
(800) 1450898
(151) 2018 12 03
(181) 2028 12 03
(891) 2018 12 03
(511) 05

(260) AM 2020 101823 A
(800) 1450941
(151) 2018 07 17
(181) 2028 07 17
(891) 2018 07 17
(511) 09, 28

(260) AM 2020 101824 A
(800) 1450962
(151) 2019 01 14
(181) 2029 01 14
(891) 2019 01 14
(511) 05

(260) AM 2020 101825 A
(800) 1451020
(151) 2018 12 10
(181) 2028 12 10
(891) 2018 12 10
(511) 03, 05

(260) AM 2020 101826 A
(800) 1451022
(151) 2018 08 03
(181) 2028 08 03
(891) 2018 08 03
(511) 06, 19, 37

(260) AM 2020 101827 A
(800) 1451037
(151) 2018 07 17
(181) 2028 07 17

(891) 2018 07 17
(511) 09, 28, 41

(260) AM 2020 101828 A
(800) 1451041
(151) 2018 12 14
(181) 2028 12 14
(891) 2018 12 14
(511) 09

(260) AM 2020 101829 A
(800) 1451046
(151) 2018 11 23
(181) 2028 11 23
(891) 2018 11 23
(511) 07, 08, 09

(260) AM 2020 101831 A
(800) 1451064
(151) 2018 12 03
(181) 2028 12 03
(891) 2018 12 03
(511) 05

(260) AM 2020 101846 A
(800) 1451185
(151) 2018 07 17
(181) 2028 07 17
(891) 2018 07 17
(511) 09

(260) AM 2020 101860 A
(800) 1451594
(151) 2019 01 09
(181) 2029 01 09
(891) 2019 01 09
(511) 09, 42

(260) AM 2020 101861 A
(800) 1451606
(151) 2018 11 26
(181) 2028 11 26
(891) 2018 11 26
(511) 29

(260) AM 2020 101862 A
(800) 1451618
(151) 2018 11 02
(181) 2028 11 02
(891) 2018 11 02
(511) 16, 17

(260) AM 2020 101863 A (800) 1451622 (151) 2018 10 09 (181) 2028 10 09 (891) 2018 10 09 (511) 30	(891) 2018 10 12 (511) 12, 35
<hr/>	
(260) AM 2020 101864 A (800) 1451623 (151) 2019 01 09 (181) 2029 01 09 (891) 2019 01 09 (511) 09, 42	(260) AM 2020 101880 A (800) 1451859 (151) 2018 08 06 (181) 2028 08 06 (891) 2018 08 06 (511) 30, 32
<hr/>	
(260) AM 2020 101865 A (800) 1451626 (151) 2019 01 09 (181) 2029 01 09 (891) 2019 01 09 (511) 09, 42	(260) AM 2020 101881 A (800) 1451887 (151) 2018 12 31 (181) 2028 12 31 (891) 2018 12 31 (511) 09
<hr/>	
(260) AM 2020 101866 A (800) 1451627 (151) 2018 07 25 (181) 2028 07 25 (891) 2018 07 25 (511) 09, 43	(260) AM 2020 101882 A (800) 1451938 (151) 2018 12 05 (181) 2028 12 05 (891) 2018 12 05 (511) 09, 36, 37, 38, 41, 42
<hr/>	
(260) AM 2020 101867 A (800) 1451634 (151) 2018 10 31 (181) 2028 10 31 (891) 2018 10 31 (511) 11	(260) AM 2020 101883 A (800) 1451965 (151) 2018 10 04 (181) 2028 10 04 (891) 2018 10 04 (511) 36
<hr/>	
(260) AM 2020 101872 A (800) 1451665 (151) 2019 01 09 (181) 2029 01 09 (891) 2019 01 09 (511) 09, 42	(260) AM 2020 101937 A (800) 1452075 (151) 2019 01 21 (181) 2029 01 21 (891) 2019 01 21 (511) 30
<hr/>	
(260) AM 2020 101873 A (800) 1451700 (151) 2018 11 12 (181) 2028 11 12 (891) 2018 11 12 (511) 25, 35	(260) AM 2020 101938 A (800) 1452116 (151) 2018 06 12 (181) 2028 06 12 (891) 2018 06 12 (511) 04, 09, 12, 14, 16, 18, 21, 25, 28, 32, 35, 36, 37, 38, 39, 41, 42, 43
<hr/>	
(260) AM 2020 101874 A (800) 1451715 (151) 2018 10 12 (181) 2028 10 12	(260) AM 2020 101939 A (800) 1452168 (151) 2018 10 31 (181) 2028 10 31 (891) 2018 10 31 (511) 07
<hr/>	

(260) AM 2020 101940 A
(800) 1452194
(151) 2018 06 11
(181) 2028 06 11
(891) 2018 06 11
(511) 01, 02, 17

(260) AM 2020 101941 A
(800) 1452205
(151) 2018 10 11
(181) 2028 10 11
(891) 2018 10 11
(511) 01, 02, 03, 04, 05, 11, 16, 21, 25, 26

(260) AM 2020 101942 A
(800) 1452219
(151) 2018 12 13
(181) 2028 12 13
(891) 2018 12 13
(511) 03, 05

(260) AM 2020 101943 A
(800) 1452230
(151) 2018 10 11
(181) 2028 10 11
(891) 2018 10 11
(511) 01, 02, 03, 04, 05, 11, 16, 21, 25, 26

(260) AM 2020 101951 A
(800) 1452317
(151) 2018 11 19
(181) 2028 11 19
(891) 2018 11 19
(511) 05

(260) AM 2020 101952 A
(800) 1452318
(151) 2018 11 19
(181) 2028 11 19
(891) 2018 11 19
(511) 05

(260) AM 2020 101953 A
(800) 1452321
(151) 2018 11 19
(181) 2028 11 19
(891) 2018 11 19
(511) 05

(260) AM 2020 101954 A
(800) 1452332
(151) 2018 12 03
(181) 2028 12 03

(891) 2018 12 03
(511) 05

(260) AM 2020 101955 A
(800) 1452333
(151) 2018 12 03
(181) 2028 12 03
(891) 2018 12 03
(511) 05

(260) AM 2020 101957 A
(800) 1452362
(151) 2018 11 19
(181) 2028 11 19
(891) 2018 11 19
(511) 05

(260) AM 2020 101958 A
(800) 1452368
(151) 2018 12 20
(181) 2028 12 20
(891) 2018 12 20
(511) 02, 03, 04, 17, 40

(260) AM 2020 101959 A
(800) 1452412
(151) 2018 12 14
(181) 2028 12 14
(891) 2018 12 14
(511) 32

(260) AM 2020 101960 A
(800) 1452415
(151) 2019 01 22
(181) 2029 01 22
(891) 2019 01 22
(511) 30

(260) AM 2020 101961 A
(800) 1452426
(151) 2018 12 14
(181) 2028 12 14
(891) 2018 12 14
(511) 32

(260) AM 2020 101962 A
(800) 1452462
(151) 2018 12 03
(181) 2028 12 03
(891) 2018 12 03
(511) 05

(260) AM 2020 101963 A
(800) 1452467
(151) 2018 05 03
(181) 2028 05 03
(891) 2018 05 03
(511) 03, 09, 16, 18, 35

(260) AM 2020 101964 A
(800) 1452473
(151) 2018 12 03
(181) 2028 12 03
(891) 2018 12 03
(511) 05

(260) AM 2020 101986 A
(800) 1452938
(151) 2018 11 13
(181) 2028 11 13
(891) 2018 11 13
(511) 09

(260) AM 2020 101989 A
(800) 1453065
(151) 2018 12 21
(181) 2028 12 21
(891) 2018 12 21
(511) 30

(260) AM 2020 101990 A
(800) 1453096
(151) 2018 12 12
(181) 2028 12 12
(891) 2018 12 12
(511) 12

(260) AM 2020 101991 A
(800) 1453152
(151) 2018 10 17
(181) 2028 10 17
(891) 2018 10 17
(511) 25, 35

(260) AM 2020 101992 A
(800) 1453193
(151) 2018 10 31
(181) 2028 10 31
(891) 2018 10 31
(511) 06, 21, 24, 27

(260) AM 2020 101993 A
(800) 1453231
(151) 2018 10 16
(181) 2028 10 16

(891) 2018 10 16
(511) 37

(260) AM 2020 101999 A
(800) 1453322
(151) 2018 12 04
(181) 2028 12 04
(891) 2018 12 04
(511) 01, 03, 05

(260) AM 2020 102000 A
(800) 1453330
(151) 2019 01 22
(181) 2029 01 22
(891) 2019 01 22
(511) 03, 05

(260) AM 2020 102001 A
(800) 1453340
(151) 2018 11 07
(181) 2028 11 07
(891) 2018 11 07
(511) 19, 37, 42

(260) AM 2020 102003 A
(800) 1453385
(151) 2018 10 23
(181) 2028 10 23
(891) 2018 10 23
(511) 09, 10, 25

(260) AM 2020 102004 A
(800) 1453433
(151) 2018 11 09
(181) 2028 11 09
(891) 2018 11 09
(511) 24

(260) AM 2020 102005 A
(800) 1453450
(151) 2018 12 19
(181) 2028 12 19
(891) 2018 12 19
(511) 39

(260) AM 2020 102015 A
(800) 1166408
(151) 2013 05 30
(181) 2023 05 30
(891) 2019 02 01
(511) 34

(260) AM 2020 102019 A
(800) 1400799
(151) 2018 02 27
(181) 2028 02 27
(891) 2019 02 11
(511) 03

(260) AM 2020 102090 A
(800) 1453995
(151) 2018 09 04
(181) 2028 09 04
(891) 2018 09 04
(511) 09, 18, 28

(260) AM 2020 102092 A
(800) 1454030
(151) 2018 11 28
(181) 2028 11 28
(891) 2018 11 28
(511) 11, 21, 35

(260) AM 2020 102109 A
(800) 1454264
(151) 2018 11 23
(181) 2028 11 23
(891) 2018 11 23
(511) 09

(260) AM 2020 102110 A
(800) 1454265
(151) 2018 11 06
(181) 2028 11 06
(891) 2018 11 06
(511) 09, 42

(260) AM 2020 102111 A
(800) 1454365
(151) 2018 12 29
(181) 2028 12 29
(891) 2018 12 29
(511) 30

(260) AM 2020 102113 A
(800) 1454404
(151) 2018 11 23
(181) 2028 11 23
(891) 2018 11 23
(511) 09, 14

(260) AM 2020 102124 A
(800) 413942
(151) 1975 02 22
(181) 2025 02 22

(891) 2019 02 06
(511) 03

(260) AM 2020 102125 A
(800) 618598
(151) 1994 05 12
(181) 2024 05 12
(891) 2019 02 06
(511) 03

(260) AM 2020 102126 A
(800) 940409
(151) 2007 05 23
(181) 2027 05 23
(891) 2019 02 01
(511) 03, 05, 29, 30

(260) AM 2020 102127 A
(800) 957465
(151) 2006 06 29
(181) 2026 06 29
(891) 2019 01 03
(511) 15

(260) AM 2020 102128 A
(800) 957487
(151) 2008 01 04
(181) 2028 01 04
(891) 2019 02 01
(511) 03, 05, 29, 30, 44

(260) AM 2020 102135 A
(800) 1360828
(151) 2017 04 11
(181) 2027 04 11
(891) 2019 02 06
(511) 03

(260) AM 2020 102136 A
(800) 1430671
(151) 2018 08 20
(181) 2028 08 20
(891) 2019 02 14
(511) 30, 32

(260) AM 2020 102137 A
(800) 1442163
(151) 2018 08 21
(181) 2028 08 21
(891) 2019 02 06
(511) 10

(260) AM 2020 102138 A
(800) 1450002
(151) 2018 11 06
(181) 2028 11 06
(891) 2019 02 18
(511) 09, 20, 35

(260) AM 2020 102184 A
(800) 1454986
(151) 2018 12 12
(181) 2028 12 12
(891) 2018 12 12
(511) 30

(260) AM 2020 102205 A
(800) 1455568
(151) 2018 09 13
(181) 2028 09 13
(891) 2018 09 13
(511) 09

(260) AM 2020 102207 A
(800) 1455607
(151) 2018 10 24
(181) 2028 10 24
(891) 2018 10 24
(511) 34

(260) AM 2020 102211 A
(800) 1455772
(151) 2019 02 07
(181) 2029 02 07
(891) 2019 02 07
(511) 05

(260) AM 2020 102212 A
(800) 1455802
(151) 2018 09 10
(181) 2028 09 10
(891) 2018 09 10
(511) 05, 35, 44

(260) AM 2020 102226 A
(800) 1307915
(151) 2016 03 29
(181) 2026 03 29
(891) 2019 02 26
(511) 09, 10

(260) AM 2020 102227 A
(800) 1339994
(151) 2017 01 11
(181) 2027 01 11

(891) 2019 02 08
(511) 18, 25, 35

(260) AM 2020 102228 A
(800) 1404015
(151) 2017 10 12
(181) 2027 10 12
(891) 2019 02 13
(511) 14, 35

(260) AM 2020 102296 A
(800) 1456659
(151) 2018 12 17
(181) 2028 12 17
(891) 2018 12 17
(511) 19

(260) AM 2020 102298 A
(800) 1456699
(151) 2018 12 26
(181) 2028 12 26
(891) 2018 12 26
(511) 11

(260) AM 2020 102300 A
(800) 1456745
(151) 2019 01 10
(181) 2029 01 10
(891) 2019 01 10
(511) 05, 35

(260) AM 2020 102301 A
(800) 1456760
(151) 2019 01 10
(181) 2029 01 10
(891) 2019 01 10
(511) 05, 35

(260) AM 2020 102311 A
(800) 1456977
(151) 2018 09 27
(181) 2028 09 27
(891) 2018 09 27
(511) 05

(260) AM 2020 102312 A
(800) 1457052
(151) 2018 09 26
(181) 2028 09 26
(891) 2018 09 26
(511) 09, 28, 41

(260) AM 2020 102313 A
(800) 1457096
(151) 2018 09 27
(181) 2028 09 27
(891) 2018 09 27
(511) 05

(260) AM 2020 102314 A
(800) 1457110
(151) 2019 02 12
(181) 2029 02 12
(891) 2019 02 12
(511) 05

(260) AM 2020 102324 A
(800) 1457406
(151) 2018 12 06
(181) 2028 12 06
(891) 2018 12 06
(511) 09, 35, 42

(260) AM 2020 102435 A
(800) 1458286
(151) 2018 12 04
(181) 2028 12 04
(891) 2018 12 04
(511) 03, 07

(260) AM 2020 102437 A
(800) 1458327
(151) 2018 09 13
(181) 2028 09 13
(891) 2018 09 13
(511) 09, 14, 16, 25, 28, 41, 42

(260) AM 2020 102438 A
(800) 1458340
(151) 2018 10 31
(181) 2028 10 31
(891) 2018 10 31
(511) 09

(260) AM 2020 102439 A
(800) 1458349
(151) 2019 01 24
(181) 2029 01 24
(891) 2019 01 24
(511) 29, 30, 32

(260) AM 2020 102442 A
(800) 1458535
(151) 2018 10 22
(181) 2028 10 22

(891) 2018 10 22
(511) 05, 09, 29, 30, 31, 32, 33, 34, 35, 36, 42

(260) AM 2020 102444 A
(800) 1458540
(151) 2019 01 04
(181) 2029 01 04
(891) 2019 01 04
(511) 03

(260) AM 2020 102446 A
(800) 1458561
(151) 2018 09 25
(181) 2028 09 25
(891) 2018 09 25
(511) 11, 21

(260) AM 2020 102448 A
(800) 1458593
(151) 2019 01 09
(181) 2029 01 09
(891) 2019 01 09
(511) 30

(260) AM 2020 102583 A
(800) 1459184
(151) 2019 02 08
(181) 2029 02 08
(891) 2019 02 08
(511) 03, 09, 14, 18, 24, 25, 35

(260) AM 2020 102795 A
(800) 1462280
(151) 2019 03 05
(181) 2029 03 05
(891) 2019 03 05
(511) 35

(260) AM 2020 102796 A
(800) 1462305
(151) 2018 12 21
(181) 2028 12 21
(891) 2018 12 21
(511) 30, 35

(260) AM 2020 102798 A
(800) 1462346
(151) 2018 09 06
(181) 2028 09 06
(891) 2018 09 06
(511) 03

(260) AM 2020 102799 A
(800) 526413
(151) 1988 03 10
(181) 2028 03 10
(891) 2019 03 19
(511) 07, 08, 21

(260) AM 2020 102893 A
(800) 1463527
(151) 2019 01 21
(181) 2029 01 21
(891) 2019 01 21
(511) 29

(260) AM 2020 102894 A
(800) 1463587
(151) 2018 12 06
(181) 2028 12 06
(891) 2018 12 06
(511) 30

(260) AM 2020 102895 A
(800) 1463595
(151) 2019 03 22
(181) 2029 03 22
(891) 2019 03 22
(511) 06

(260) AM 2020 102896 A
(800) 1463606
(151) 2018 11 21
(181) 2028 11 21
(891) 2018 11 21
(511) 09, 16, 21, 35, 36, 38, 42

OFFICIAL NOTIFICATIONS

INVENTIONS

ABOLITION OF PATENTS WITH THE RIGHT TO RESTORE

(21) AP 2009 11948

(11) P 2013 5898 B

(73) SALIX PHARMACEUTICALS LTD

(54) **RIFAXIMIN FORMS AND USAGE**

DATE OF CANCELLATION OF PATENT: 2020 02 25

THE TERM OF RESTORATION OF PATENT VALIDITY HAS EXPIRED: 2021 02 25

(21) AP 2009 11952

(11) P 2012 5664 B

(73) TAKEDA PHARMACEUTICAL COMPANY LIMITED

(54) **CONDENSED HETEROCYCLIC DERIVATIVES AND APPLICATION THEREOF**

DATE OF CANCELLATION OF PATENT: 2020 02 25

THE TERM OF RESTORATION OF PATENT VALIDITY HAS EXPIRED: 2021 02 25

(21) AP 2011 12127

(11) P 2014 6143 B

(73) Iuza Nachkebia

(54) **HEAT ENGINE HAVING ROTOR**

DATE OF CANCELLATION OF PATENT: 2020 03 07

THE TERM OF RESTORATION OF PATENT VALIDITY HAS EXPIRED: 2021 03 07

(21) AP 2012 12607

(11) P 2015 6240 B

(73) Besarion Partsvania;

Gia Petriashvili

(54) **DEVICE FOR BIOLOGICAL TISSUE HETEROGENEITY DETERMINATION**

DATE OF CANCELLATION OF PATENT: 2020 03 01

THE TERM OF RESTORATION OF PATENT VALIDITY HAS EXPIRED: 2021 03 01

(21) AP 2014 13399

(11) P 2016 6578 B

(73) LES LABORATOIRES SERVIER

(54) **METHOD FOR (7S)-3,4-DIMETHYL BICYCLO[4.2.0]OCTA-1,3,5-TRIEN-7-CARBON ACID ENZYMATIC SYNTHESIS AND USAGE THEREFOR SYNTHESIS OF IVABRADINE AND SALTS THEREOF**

DATE OF CANCELLATION OF PATENT: 2020 02 26

THE TERM OF RESTORATION OF PATENT VALIDITY HAS EXPIRED: 2021 02 26

(21) AP 2013 13601

(11) P 2016 6547 B

(73) OFFICINE MACCAFERRI S.P.A.

(54) **GABION**

DATE OF CANCELLATION OF PATENT: 2020 03 07

THE TERM OF RESTORATION OF PATENT VALIDITY HAS EXPIRED: 2021 03 07

(21) AP 2013 13646

(11) P 2016 6582 B

(73) KHARLAMPOV Vladimir Vladimirovich

(54) **"DOLG M3" TACTICAL GUN BELT**

DATE OF CANCELLATION OF PATENT: 2020 02 12

THE TERM OF RESTORATION OF PATENT VALIDITY HAS EXPIRED: 2021 02 12

(21) AP 2013 13836

(11) P 2017 6646 B

(73) Arif Mirjalal Ogli Pashaev;

Abdolbar Reza Ogli Gozal;

Telman Inayat Ogli Nizamov;

Akif Asker Ogli Askerov;

Enver Isa Ogli Isaev;

Akper Alinazar Ogli Aliyev;

Anar Telman Ogli Nizamov

(54) **TEA FERMENTATION METHOD**

DATE OF CANCELLATION OF PATENT: 2020 03 01

THE TERM OF RESTORATION OF PATENT VALIDITY HAS EXPIRED: 2021 03 01

(21) AP 2016 14073

(11) P 2017 6664 B

(73) Irine Berdzenishvili

(54) **FRIT FOR DIRECT-ON ENAMELING**

DATE OF CANCELLATION OF PATENT: 2020 02 28

THE TERM OF RESTORATION OF PATENT VALIDITY HAS EXPIRED: 2021 02 28

(21) AP 2015 14268

(11) P 2018 6864 B

(73) PFIZER INC.

(54) **DIACYLGLYCEROL ACYLTRANSFERASE 2 INHIBITORS FOR USE IN THE TREATMENT OF METABOLIC AND RELATED DISORDERS**

DATE OF CANCELLATION OF PATENT: 2020 03 03

THE TERM OF RESTORATION OF PATENT VALIDITY HAS EXPIRED: 2021 03 03

(21) AP 2015 14284

(11) P 2019 6984 B

(73) TAKEDA PHARMACEUTICAL COMPANY LIMITED

(54) **PYRIDAZINE DERIVATIVES FOR USE IN THE PREVENTION OR TREATMENT OF AN ATAXIC DISORDER**

DATE OF CANCELLATION OF PATENT: 2020 03 06

THE TERM OF RESTORATION OF PATENT VALIDITY HAS EXPIRED: 2021 03 06

(21) AP 2015 14292

(11) P 2019 6977 B

(73) SANovel ILAC SANAYI VE TICARET A.S.

(54) **PHARMACEUTICAL FORMULATIONS OF VILDAGLIPTIN**

DATE OF CANCELLATION OF PATENT: 2020 03 05

THE TERM OF RESTORATION OF PATENT VALIDITY HAS EXPIRED: 2021 03 05

EXPIRATION OF TERM OF RESTORATION OF PATENTS

(21) AP 2006 10143

(11) P 2009 4726 B

(73) JUPITER OXYGEN CORPORATION

(54) **MODULE-BASED OXY-FUEL BOILER**

DATE OF CANCELLATION OF PATENT: 2019 03 01

THE TERM OF RESTORATION OF PATENT VALIDITY HAS EXPIRED: 2020 03 01

(21) AP 2009 11962

(11) P 2013 5844 B

(73) TAKEDA PHARMACEUTICAL COMPANY LIMITED

(54) **HETEROCYCLIC COMPOUND**

DATE OF CANCELLATION OF PATENT: 2019 03 04

THE TERM OF RESTORATION OF PATENT VALIDITY HAS EXPIRED: 2020 03 04

(21) AP 2009 11964

(11) P 2013 5927 B

(73) Aziende Chimiche Riunite Angelini Francesco A.C.R.A.F. S.p.A.

(54) **1-BENZYL-3-HYDROXYMETHYLINDAZOLE DERIVATIVES AND USAGE THEREAT
TREATMENT OF DISEASES BASED ON MCP-1, CX3CR1 AND P40 EXPRESSION**

DATE OF CANCELLATION OF PATENT: 2019 03 05

THE TERM OF RESTORATION OF PATENT VALIDITY HAS EXPIRED: 2020 03 05

(21) AP 2010 12396

(11) P 2015 6407 B

(73) Antal Zombor

(54) **ARRANGEMENT FOR STORAGE, WAREHOUSE RACK AND HANDLING MACHINE
PARTICULARLY FOR SUCH ARRANGEMENT**

DATE OF CANCELLATION OF PATENT: 2019 03 02

THE TERM OF RESTORATION OF PATENT VALIDITY HAS EXPIRED: 2020 03 02

(21) AP 2013 13584

(11) P 2018 6899 B

(73) BOEHRINGER INGELHEIM INTERNATIONAL GMBH

(54) **6-ALKYNYL PYRIDINES AS SMAC MIMETICS**

DATE OF CANCELLATION OF PATENT: 2019 02 25

THE TERM OF RESTORATION OF PATENT VALIDITY HAS EXPIRED: 2020 02 25

(21) AP 2015 13742

(11) P 2016 6491 B

(73) LEPL AGRICULTURE SCIENTIFIC-RESEARCH CENTER

(54) **COMBINED AGGREGATE FOR TEA GARDENS RESTORATION**

DATE OF CANCELLATION OF PATENT: 2019 02 24

THE TERM OF RESTORATION OF PATENT VALIDITY HAS EXPIRED: 2020 02 24

(21) AP 2015 13743

(11) P 2016 6492 B

(73) LEPL AGRICULTURE SCIENTIFIC-RESEARCH CENTER

(54) **FRUIT HARVESTING MACHINE**

DATE OF CANCELLATION OF PATENT: 2019 02 24

THE TERM OF RESTORATION OF PATENT VALIDITY HAS EXPIRED: 2020 02 24

(21) AP 2005 9660

(11) P 2009 4736 B

(73) BRISTOL-MYERS SQUIBB COMPANY

(54) **PRODRUGS OF PIPERAZINE AND SUBSTITUTED PIPERIDINE ANTIVIRAL AGENTS**

DATE OF CANCELLATION OF PATENT: 2019 03 03

THE TERM OF RESTORATION OF PATENT VALIDITY HAS EXPIRED: 2020 03 03

(21) AP 2005 9667

(11) P 2010 4925 B

(73) BRISTOL-MYERS SQUIBB COMPANY

(54) **COMBINATIONS FOR TREATING HIV INFECTION**

DATE OF CANCELLATION OF PATENT: 2019 03 01

THE TERM OF RESTORATION OF PATENT VALIDITY HAS EXPIRED: 2020 03 01

UTILITY MODEL

EXPIRATION OF TERM OF RESTORATION OF PATENT

(21) AU 2014 13398

(11) **U 2015 1844 Y**

(73) Merab Baghaturia

(54) **PASTE TUBE "SATSEBELI"**

DATE OF CANCELLATION OF PATENT: 2019 02 25

THE TERM OF RESTORATION OF PATENT VALIDITY HAS EXPIRED: 2020 02 25

DESIGNS

EXTENSION OF REGISTRATION OF DESIGNS

(11) D 2014 602 S

(73) Gia Baazov (GE)

Chikobava St. 42/5, 0102, Tbilisi, Georgia (GE)

(54) **BOTTLE**

(28) 1

(24) 2014 11 17

(18) 2024 11 17

(58) 2020 03 11

(11) D 2015 643 S

(73) Tamar Zasukhina (GE)

Marijani St. 4, 0186, Tbilisi, Georgia (GE)

(54) **LOGO**

(28) 2

(24) 2015 02 20

(18) 2025 02 20

(58) 2020 03 09

(11) D 2015 642 S

(73) Tamar Zasukhina (GE)
Marijani St. 4, 0186, Tbilisi, Georgia (GE)

(54) Wine bottle label

(28) 2
(24) 2015 02 20
(18) 2025 02 20
(58) 2020 03 09

(11) D 2015 650 S

(73) Nikoloz Nutsubidze (GE)
Z. Panaskertel-Tsitsishvili St. 11, ap. 68, 0194, Tbilisi, Georgia (GE)

(54) GEORGIAN FEAST

(28) 2
(24) 2015 03 12
(18) 2025 03 12
(58) 2020 03 11

(11) D 2015 625 S

(73) Nino Natsvlishvili (GE)
Digomi Massive, korp. 7, ap. 13, 0159, Tbilisi, Georgia (GE)

(54) GLASS BOTTLE HAVING WOOD APPLIANCE-HOLDER

(28) 2
(24) 2015 04 07
(18) 2025 04 07
(58) 2020 03 06

(11) D 2015 629 S

(73) JSC "GEFA" (GE)
Ak. Beliashvili St. 142, 0159, Tbilisi, Georgia (GE)

(54) SOCIAL PHARMACY DISCOUNT CARD

(28) 1
(24) 2015 04 27
(18) 2025 04 27
(58) 2020 03 19

CANCELLATION OF REGISTRATION OF DESIGNS

(11) D 2014 588 S

(73) LTD GEORGIA "EURO CONCERT" (GE)
Gldani II mkr., korp. 28, ap. 24, 0167, Tbilisi, Georgia (GE)

(54) GRAPHIC SYMBOL

(18) 2019 08 05
(58) 2020 03 16

(11) D 2015 628 S

(73) Lali Chumburidze (GE)
Didi Dighomi, near the TV factory, korp. I, ap. 2, 0131, Tbilisi, Georgia (GE)

(54) GRAPHIC SYMBOL

(18) 2019 08 26
(58) 2020 03 16

(11) D 2015 644 S

(73) MOTOSEL INDUSTRIAL GROUP INC. (CA)
108-5910 No 6 Road, Richmond, BC V6V 1Z1, Canada (CA)

(54) DOUBLE BOTTLE

(18) 2019 09 08
(58) 2020 03 16

CHANGES OF REPRESENTATIVE DATA

(11) D 2015 629 S

New Representative Name and/or Address: JSC "GEFA" (GE)
Ak. Beliashvili St. 142, 0159, Tbilisi, Georgia (GE)

Former representative's name and / or address: LTD "A-B-C PHARMACY" (GE)
Sanapiro St. 10, 0108, Tbilisi, Georgia (GE)

(58) 2020 03 19

CANCELLATION OF REGISTRATION OF INTERNATIONAL DESIGNS

(11) DM/65604

(73) SWATCH AG (SWATCH SA) (SWATCH LTD.)

94, Rue Jakob Stämpfli, CH-2502 BIENNE (CH)

DATE OF CANCELLATION OF REGISTRATION: 2019 07 20

(58) 2020 03 05

(11) DM/71165

(73) THE SWATCH GROUP MANAGEMENT SERVICES AG (THE SWATCH GROUP MANAGEMENT SERVICES SA) (THE SWATCH GROUP MANAGEMENT SERVICES LTD.),

Seevorstadt 6, CH-2501 BIEL/BIENNE (CH)

DATE OF CANCELLATION OF REGISTRATION: 2018 12 31

(58) 2020 03 05

(11) DM/71173

(73) SWATCH AG (SWATCH SA)(SWATCH LTD)

Jakob-Stämpfli-Strasse 94, CH-2502 BIEL/BIENNE (CH)

DATE OF CANCELLATION OF REGISTRATION: 2019 01 12

(58) 2020 03 05

(11) DM/71606

(73) ZAKLAD MECHANIKI I ELEKTRONIKI ZAMEL SP. JAWNA J.W. DZIDA,

K. LODZINSKA

ul. Zielona 27, PL-43-200 Pszczyna (EM)

DATE OF CANCELLATION OF REGISTRATION: 2018 11 28

(58) 2020 03 05

(11) DM/71607

(73) ZAKLAD MECHANIKI I ELOKTRONIKI ZAMEL SP. JAWNA J.W. DZIDA,
K. LODZINSKA
ul. Zielona 27, PL-43-200 Pszczyna (EM)
DATE OF CANCELLATION OF REGISTRATION: 2018 12 05
(58) 2020 03 04

(11) DM/71608

(73) ZAKLAD MECHANIKI I ELOKTRONIKI ZAMEL SP. JAWNA J.W. DZIDA,
K. LODZINSKA
ul. Zielona 27, PL-43-200 Pszczyna (EM)
DATE OF CANCELLATION OF REGISTRATION: 2018 12 05
(58) 2020 03 05

(11) DM/71664

(73) NOKIA CORPORATION
Keilalahdentie 4, FI-02150 Espoo (EM)
DATE OF CANCELLATION OF REGISTRATION: 2019 01 19
(58) 2020 03 05

(11) DM/71893

(73) SWATCH AG (SWATCH SA) (SWATCH LTD.)
Jakob-Stämpfli-Strasse 94, CH-2502 Biel/Bienne (CH)
DATE OF CANCELLATION OF REGISTRATION: 2019 06 22
(58) 2020 03 05

(11) DM/72597

(73) EASIGRASS GARDENS LIMITED
37 Felsham Road, Putney, London SW15 1AY (EM)
DATE OF CANCELLATION OF REGISTRATION: 2019 06 08
(58) 2020 03 05

(11) DM/84534

(73) STRETENTSEV PAVLO
Boulevard Lesi Ukrainki 8, Ap. 44, Kiev 01133 (UA)
DATE OF CANCELLATION OF REGISTRATION: 2019 07 22
(58) 2020 03 05

TRADEMARKS

RENEWAL OF REGISTRATIONS

(111) M 2000 13230 R2
 (156) 2000 04 14
 (186) 2030 04 14
 (732) NOVO NORDISK A/S
 Novo Alle, DK-2880 Bagsvaerd, Denmark

(111) M 2000 13389 R2
 (156) 2000 06 30
 (186) 2030 06 30
 (732) UNILEVER N.V.
 Weena 455, NL-3013 AL Rotterdam,
 Netherlands

(111) M 1999 13060 R2
 (156) 1999 12 15
 (186) 2029 12 15
 (732) Schaeffler Technologies AG & Co. KG
 Industriestraße 1-3, 91074 Herzogenaurach,
 Germany

(111) M 1999 13064 R2
 (156) 1999 12 15
 (186) 2029 12 15
 (732) Schaeffler Technologies AG & Co. KG
 Industriestraße 1-3, 91074 Herzogenaurach,
 Germany

(111) M 2000 13208 R2
 (156) 2000 03 29
 (186) 2030 03 29
 (732) PARAMOUNT PICTURES
 CORPORATION, a Delaware Corporation
 555 Melrose Avenue, Los Angeles, California
 90038-3197, USA

(111) M 2000 13096 R2
 (156) 2000 01 28
 (186) 2030 01 28
 (732) Sony Interactive Entertainment inc.
 1-7-1 Konan, Minato-ku, Tokyo, Japan

(111) M 2000 13278 R2
 (156) 2000 04 26
 (186) 2030 04 26
 (732) The Absolut Company Aktiebolag
 11797 Stockholm, Sweden

(111) M 2000 13436 R2
 (156) 2000 07 26
 (186) 2030 07 26
 (732) JSC "INSURANCE COMPANY ALDAGI"
 Pushkini St. 3, Old Tbilisi District, Tbilisi,
 Georgia

(111) M 2000 13437 R2
 (156) 2000 07 26
 (186) 2030 07 26
 (732) JSC "INSURANCE COMPANY ALDAGI"
 Pushkini St. 3, Old Tbilisi District, Tbilisi,
 Georgia

(111) M 2000 13383 R2
 (156) 2000 06 09
 (186) 2030 06 09
 (732) KIA MOTORS CORPORATION
 231, Yangjae-dong, Seocho-gu, Seoul,
 Republic of Korea

(111) M 2000 13375 R2
 (156) 2000 06 09
 (186) 2030 06 09
 (732) MCDONALD'S INTERNATIONAL
 PROPERTY COMPANY LTD
 110 North Carpenter Street, Chicago, Illinois
 60607, USA

(111) M 2000 13376 R2
 (156) 2000 06 09
 (186) 2030 06 09
 (732) MCDONALD'S INTERNATIONAL
 PROPERTY COMPANY LTD
 110 North Carpenter Street, Chicago, Illinois
 60607, USA

(111) M 2000 13377 R2
 (156) 2000 06 09
 (186) 2030 06 09
 (732) MCDONALD'S INTERNATIONAL
 PROPERTY COMPANY LTD
 110 North Carpenter Street, Chicago, Illinois
 60607, USA

(111) M 2000 13378 R2
 (156) 2000 06 09
 (186) 2030 06 09

(732) MCDONALD'S INTERNATIONAL
PROPERTY COMPANY LTD
110 North Carpenter Street, Chicago, Illinois
60607, USA

(111) M 2000 13438 R2
(156) 2000 07 26
(186) 2030 07 26

(732) JSC "INSURANCE COMPANY ALDAGI"
Pushkini St. 3, Old Tbilisi District, Tbilisi,
Georgia

(111) M 2000 13439 R2
(156) 2000 07 26
(186) 2030 07 26

(732) JSC "INSURANCE COMPANY ALDAGI"
Pushkini St. 3, Old Tbilisi District, Tbilisi,
Georgia

(111) M 2000 13442 R2
(156) 2000 07 26
(186) 2030 07 26

(732) MCDONALD'S INTERNATIONAL
PROPERTY COMPANY LTD
110 North Carpenter Street, Chicago, Illinois
60607, USA

(111) M 2000 13443 R2
(156) 2000 07 26
(186) 2030 07 26

(732) MCDONALD'S INTERNATIONAL
PROPERTY COMPANY LTD
110 North Carpenter Street, Chicago, Illinois
60607, USA

(111) M 2000 13433 R2
(156) 2000 07 12
(186) 2030 07 12

(732) MCDONALD'S INTERNATIONAL
PROPERTY COMPANY LTD
110 North Carpenter Street, Chicago, Illinois
60607, USA

(111) M 2000 13434 R2
(156) 2000 07 12
(186) 2030 07 12

(732) MCDONALD'S INTERNATIONAL
PROPERTY COMPANY LTD
110 North Carpenter Street, Chicago, Illinois
60607, USA

(111) M 2000 13444 R2
(156) 2000 07 26
(186) 2030 07 26

(732) MCDONALD'S INTERNATIONAL
PROPERTY COMPANY LTD
110 North Carpenter Street, Chicago, Illinois
60607, USA

(111) M 2000 13427 R2
(156) 2000 07 12
(186) 2030 07 12

(732) EBEWE PHARMA GES.M.B.H. NFG. KG
Mondseestrasse 11, A-4866 Unterach, Austria

(111) M 2009 19183 R1
(156) 2009 03 30
(186) 2029 03 30

(732) SOSO CHKHAPELIA
Panaskertel-Tsitsishvili St. 16/61, 0194,
Tbilisi, Georgia

(111) M 2010 20156 R1
(156) 2010 01 26
(186) 2030 01 26

(732) JSC "BADAGONI"
Vill. Zemo Khodasheni, 0910, Akhmeta
District, Georgia

(111) M 2010 20270 R1
(156) 2010 02 26
(186) 2030 02 26

(732) JSC "BADAGONI"
Vill. Zemo Khodasheni, 0910, Akhmeta
District, Georgia

(111) M 2009 19878 R1
(156) 2009 10 16
(186) 2029 10 16

(732) KUNHI PARAMBATH BASHEER
Naif Market, P.O. Box 3843, Deira, Dubai,
United Arab Emirates

(111) M 2010 20233 R1
(156) 2010 02 15
(186) 2030 02 15

(732) LTD "KTRW Group"
Ksani St. 12, 0141, Tbilisi, Georgia

(111) M 2010 20234 R1
(156) 2010 02 15
(186) 2030 02 15

(732) LTD "Kakhetian Traditional Vinemaking"
Ksani St. 12, 0141, Tbilisi, Georgia

(111) M 2009 19905 R1
(156) 2009 10 16
(186) 2029 10 16
(732) JSC "LOMIST"
Vill. Natakhtari, 3308, Mtskheta District,
Georgia

(111) M 2010 20165 R1
(156) 2010 01 26
(186) 2030 01 26
(732) LTD "GLOBALPHARM"
Tamar Mepe Av. 7/13, 0112, Tbilisi, Georgia

(111) M 2010 20166 R1
(156) 2010 01 26
(186) 2030 01 26
(732) LTD "GLOBALPHARM"
Tamar Mepe Av. 7/13, 0112, Tbilisi, Georgia

(111) M 2010 20168 R1
(156) 2010 01 26
(186) 2030 01 26
(732) LTD "GLOBALPHARM"
Tamar Mepe Av. 7/13, 0112, Tbilisi, Georgia

(111) M 2010 20169 R1
(156) 2010 01 26
(186) 2030 01 26
(732) LTD "GLOBALPHARM"
Tamar Mepe Av. 7/13, 0112, Tbilisi, Georgia

(111) M 2010 20170 R1
(156) 2010 01 26
(186) 2030 01 26
(732) LTD "GLOBALPHARM"
Tamar Mepe Av. 7/13, 0112, Tbilisi,
Georgia

(111) M 2010 20173 R1
(156) 2010 01 26
(186) 2030 01 26
(732) LTD "GLOBALPHARM"
Tamar Mepe Av. 7/13, 0112, Tbilisi,
Georgia

(111) M 2010 20174 R1
(156) 2010 01 26
(186) 2030 01 26

(732) LTD "GLOBALPHARM"
Tamar Mepe Av. 7/13, 0112, Tbilisi, Georgia

(111) M 2010 20175 R1
(156) 2010 01 26
(186) 2030 01 26
(732) LTD "GLOBALPHARM"
Tamar Mepe Av. 7/13, 0112, Tbilisi, Georgia

(111) M 2010 20176 R1
(156) 2010 01 26
(186) 2030 01 26
(732) LTD "GLOBALPHARM"
Tamar Mepe Av. 7/13, 0112, Tbilisi, Georgia

(111) M 2010 20177 R1
(156) 2010 01 26
(186) 2030 01 26
(732) LTD "GLOBALPHARM"
Tamar Mepe Av. 7/13, 0112, Tbilisi, Georgia

(111) M 2010 20178 R1
(156) 2010 01 26
(186) 2030 01 26
(732) LTD "GLOBALPHARM"
Tamar Mepe Av. 7/13, 0112, Tbilisi, Georgia

(111) M 2010 20179 R1
(156) 2010 01 26
(186) 2030 01 26
(732) LTD "GLOBALPHARM"
Tamar Mepe Av. 7/13, 0112, Tbilisi, Georgia

(111) M 2010 20180 R1
(156) 2010 01 26
(186) 2030 01 26
(732) LTD "GLOBALPHARM"
Tamar Mepe Av. 7/13, 0112, Tbilisi, Georgia

(111) M 2010 20181 R1
(156) 2010 01 26
(186) 2030 01 26
(732) LTD "GLOBALPHARM"
Tamar Mepe Av. 7/13, 0112, Tbilisi, Georgia

(111) M 2010 20182 R1
(156) 2010 01 26
(186) 2030 01 26
(732) LTD "GLOBALPHARM"
Tamar Mepe Av. 7/13, 0112, Tbilisi, Georgia

(111) M 2010 20188 R1
 (156) 2010 01 26
 (186) 2030 01 26
 (732) LTD "GLOBALPHARM"
 Tamar Mepe Av. 7/13, 0112, Tbilisi, Georgia

(111) M 2010 20190 R1
 (156) 2010 01 26
 (186) 2030 01 26
 (732) LTD "GLOBALPHARM"
 Tamar Mepe Av. 7/13, 0112, Tbilisi, Georgia

(111) M 2010 20192 R1
 (156) 2010 01 26
 (186) 2030 01 26
 (732) LTD "GLOBALPHARM"
 Tamar Mepe Av. 7/13, 0112, Tbilisi, Georgia

(111) M 2010 20193 R1
 (156) 2010 01 26
 (186) 2030 01 26
 (732) LTD "GLOBALPHARM"
 Tamar Mepe Av. 7/13, 0112, Tbilisi, Georgia

(111) M 2010 20195 R1
 (156) 2010 01 26
 (186) 2030 01 26
 (732) LTD "GLOBALPHARM"
 Tamar Mepe Av. 7/13, 0112, Tbilisi, Georgia

(111) M 2010 20291 R1
 (156) 2010 02 26
 (186) 2030 02 26
 (732) BPI HOLDINGS INTERNATIONAL, INC.
 4400 Prime Parkway, McHenry, Illinois
 60050, USA

(111) M 2010 20306 R1
 (156) 2010 03 15
 (186) 2030 03 15
 (732) Whirlpool EMEA S.p.A.
 Via C. Pisacane 1, 20016 Pero (MI),
 Italy

(111) M 2010 20333 R1
 (156) 2010 03 25
 (186) 2030 03 25
 (732) MHCS
 9, avenue de Champagne, 51200 Epernay,
 France

(111) M 2010 20375 R1
 (156) 2010 04 15
 (186) 2030 04 15
 (732) SYSMEX CORPORATION
 1-5-1, Wakinohama-Kaigandori, Chuo-ku,
 Kobe, Hyogo, Japan

(111) M 2010 20489 R1
 (156) 2010 05 17
 (186) 2030 05 17
 (732) TARAS GAGNIDZE
 Kiphshidze St. 8, ap. 24, 0162, Tbilisi,
 Georgia

(111) M 2010 20328 R1
 (156) 2010 03 15
 (186) 2030 03 15
 (732) LTD "AVERSI-PHARMA"
 Davit Agmashenebeli Av. 148/2, 0112,
 Tbilisi, Georgia

(111) M 2010 20363 R1
 (156) 2010 03 26
 (186) 2030 03 26
 (732) LTD "AVERSI-PHARMA"
 Davit Agmashenebeli Av. 148/2, 0112,
 Tbilisi, Georgia

(111) M 2010 20490 R1
 (156) 2010 05 17
 (186) 2030 05 17
 (732) Taras Gagnidze
 Kiphshidze St. 8, ap. 24, 0162, Tbilisi,
 Georgia

(111) M 2010 20572 R1
 (156) 2010 06 28
 (186) 2030 06 28
 (732) JSC "LOMISI"
 Ksnis Sanapiro St. 1, 0600, Akhlagori,
 Georgia

(111) M 2010 20426 R1
 (156) 2010 04 27
 (186) 2030 04 27
 (732) THE COCA-COLA COMPANY
 One Coca-Cola Plaza, Atlanta, Georgia
 30313, USA

(111) M 2010 20474 R1
 (156) 2010 05 13
 (186) 2030 05 13

(732) KMG International N.V.
Strawinskyiaan 807, Tower A-8,
1077XX Amsterdam, Netherlands

(111) M 2010 20476 R1
(156) 2010 05 13
(186) 2030 05 13

(732) KMG International N.V.
Strawinskyiaan 807, Tower A-8,
1077XX Amsterdam, Netherlands

(111) M 2010 20477 R1
(156) 2010 05 13
(186) 2030 05 13

(732) KMG International N.V.
Strawinskyiaan 807, Tower A-8,
1077XX Amsterdam, Netherlands

(111) M 2010 20480 R1
(156) 2010 05 13
(186) 2030 05 13

(732) Mary Kay Inc. (a Delaware corporation)
16251 Dallas Parkway, Addison, Texas
75001, USA

(111) M 2010 20483 R1
(156) 2010 05 13
(186) 2030 05 13

(732) Mary Kay Inc. (a Delaware corporation)
16251 Dallas Parkway, Addison, Texas
75001, USA

(111) M 2010 20433 R1
(156) 2010 04 27
(186) 2030 04 27

(732) GLAXOSMITHKLINE BIOLOGICALS S.A.
Rue de l'Institut 89, B-1330 Rixensart,
Belgium

(111) M 2010 20505 R1
(156) 2010 05 27
(186) 2030 05 27

(732) LTD "GLOBAL CBS"
Stanislavskiy St. 5, 0119, Tbilisi, Georgia

(111) M 2010 20510 R1
(156) 2010 05 27
(186) 2030 05 27

(732) GLAXOSMITHKLINE BIOLOGICALS S.A.
Rue de l'Institut 89, B-1330 Rixensart,
Belgium

(111) M 2010 20649 R1
(156) 2010 08 16
(186) 2030 08 16

(732) Faes Farma S.A.
c/Maximo Aguire 14, 48940 LAMIACO-
LEIOA (Bizkaia), Spain

(111) M 2010 20512 R1
(156) 2010 05 27
(186) 2030 05 27

(732) SUN PHARMACEUTICALS INDUSTRIES
LIMITED
SPARC, Tandalja, Vadodara - 390 020,
Gujarat, India

(111) M 2010 20594 R1
(156) 2010 07 16
(186) 2030 07 16

(732) YILDIZ HOLDING A.S.
Kisikli Mahallesi Çeşme Çikmazi, Sokak
No:6/1, Üsküdar İstanbul, Turkey

(111) M 2010 20934 R1
(156) 2010 11 25
(186) 2030 11 25

(732) STAATLICHES HOFBRAUHAUS IN
MUNCHEN
Hofbrauallee 1, D-81829 Munchen, Germany

(111) M 2010 20669 R1
(156) 2010 08 16
(186) 2030 08 16

(732) MAY CHEONG TOY PRODUCTS
FACTORY LIMITED
7/F., East Wing, Tsim Sha Tsui Centre,
66 Mody Road, Tsimshatsui East, Kowloon,
Hong Kong

(111) M 2010 20745 R1
(156) 2010 09 15
(186) 2030 09 15

(732) SHARP AUTO GROUP LIMITED
P.O. Box 957, Offshore Inkorporations Centre,
Road Town, Tortola, Virgin Islands (British)

(111) M 2010 20688 R1
(156) 2010 08 20
(186) 2030 08 20

(732) VAKHTANG KANDELAKI
Irakli Abashidze St. 14, ap. 20, 0179, Tbilisi,
Georgia

(111) M 2010 20960 R1

(156) 2010 11 30

(186) 2030 11 30

(732) DUNHILL TOBACO OF LONDON
LIMITED

Globe House, 4 Temple Place, London
WC2R 2PG, United Kingdom

COMPLETE TRANSFER OF RIGHTS

(111) M 1997 4986 R
(732) SANOFI MATURE IP
54 rue La Boétie F-75008 Paris, France
(770) AVENTIS PHARMA S.A.
20, avenue Raymond Aron, 92160 Antony,
France
(580) 17 02 2020

(111) M 1997 4987 R
(732) SANOFI MATURE IP
54 rue La Boétie F-75008 Paris, France
(770) AVENTIS PHARMA S.A.
20, avenue Raymond Aron, 92160 Antony,
France
(580) 17 02 2020

(111) M 2006 16880 R
(732) LTD "TM-SERVISE"
Ul. 2 Brestskaya, dom 8, 125047, Moscow,
Russian Federation
(770) LTD "TIFLISSKIY VINNI POGREB"
Iumashev St. 27, 0198, Tbilisi Georgia
(580) 24 02 2020

(111) M 1996 3258 R
(732) SMITH & WESSON INC.
2100 Roosevelt Avenue, Springfield,
MA 01104, USA
(770) AMERICAN OUTDOOR BRANDS SALES
COMPANY
1800 North Route Z, Columbia, MO 65202,
USA
(580) 21 02 2020

(111) M 1996 3239 R
(732) SMITH & WESSON Inc.
2100 Roosevelt Avenue, Springfield,
MA 01104, USA
(770) AMERICAN OUTDOOR BRANDS SALES
COMPANY
1800 North Route Z, Columbia, MO
65202, USA
(580) 21 02 2020

(111) M 1996 3240 R
(732) SMITH & WESSON INC.
2100 Roosevelt Avenue, Springfield, MA
01104, USA
(770) American Outdoor Brands Sales
Company

1800 North Route Z, Columbia,
MO 65202, USA
(580) 21 02 2020

(111) M 2017 28133 R
(732) LTD "TM-SERVISE"
Ul. 2 Brestskaya, dom 8, 125047, Moscow,
Russian Federation
(770) LTD "TIFLISSKIY VINNI POGREB"
Iumashev St. 27, 0198, Tbilisi Georgia
(580) 24 02 2020

(111) M 2016 27709 R
(732) LTD "GEO ALKO"
Sarajishvilis Gamz. 4, 0153, Tbilisi, Georgia
(770) JSC "SARAJISHVILI"
Sarajishvili Av. 4, 0153, Tbilisi, Georgia
(580) 05 02 2020

(111) M 2019 31383 R
(732) BEST BUILDER INTERNATIONAL
COMPANY
Asureti St. 31, Gldani-Nadzaladevi District,
Tbilisi, Georgia
(770) KUROSH ABDOLLAHZADEH
Mikheil Berdzenishvili St.10, ap. 9, 0179,
Tbilisi, Georgia
(580) 25 02 2020

CHANGES OF NAMES AND/OR ADDRESS OF OWNERS

(111) M 1996 1366 R
(732) INGERSOLL-RAND COMPANY
800-E Beaty Street, Davidson, North
Carolina 28036, USA
(770) INGERSOLL-RAND COMPANY
800-D Beaty Street, Davidson, North
Carolina 28036, USA
(580) 21 02 2020

(111) M 1996 1977 R
(732) INGERSOLL-RAND COMPANY
800-E Beaty Street, Davidson, North
Carolina 28036, USA
(770) INGERSOLL-RAND COMPANY
800-D Beaty Street, Davidson, North
Carolina 28036, USA
(580) 21 02 2020

(111) M 2010 20156 R
(732) JSC "BADAGONI"
Vill. Zemo Khodasheni, 0910, Akhmeta
District, Georgia
(770) LTD "BADAGONI"
Freedom Square 4, 0105, Tbilisi, Georgia
(580) 25 02 2020

(111) M 2010 20629 R
(732) JSC "BADAGONI"
Vill. Zemo Khodasheni, 0910, Akhmeta
District, Georgia
(770) LTD "BADAGONI"
Freedom Square 4, 0105, Tbilisi, Georgia
(580) 25 02 2020

(111) M 2010 20270 R
(732) JSC "BADAGONI"
Vill. Zemo Khodasheni, 0910, Akhmeta
District, Georgia
(770) LTD "BADAGONI"
Freedom Square 4, 0105, Tbilisi, Georgia
(580) 25 02 2020

(111) M 2010 20594 R
(732) YILDIZ HOLDING A.S.
Kisikli Mahallesi Çeşme Çikmazi, Sokak
No:6/1, Üsküdar İstanbul, Turkey
(770) YILDIZ HOLDING A.S.
Kisikli mah. Ferah Cad. Kisikli Cesme Sk.
No:2/4 B. Camlica, Uskudar/ISTANBUL,
Turkey
(580) 19 02 2020

(111) M 2010 20627 R
(732) JSC "BADAGONI"
Vill. Zemo Khodasheni, 0910, Akhmeta
District, Georgia
(770) LTD "BADAGONI"
Freedom Square 4, 0105, Tbilisi, Georgia
(580) 25 02 2020

(111) M 2011 21503 R
(732) AUXILIUM INTERNATIONAL
HOLDINGS, LLC
1209 Orange Street, Wilmington, Delaware
19801, USA
(770) AUXILIUM INTERNATIONAL
HOLDINGS, INC.
1105 North Market Street, Suite 1300,
Wilmington, Delaware 19801, USA
(580) 11 03 2020

(111) M 2010 20628 R
(732) JSC "BADAGONI"
Vill. Zemo Khodasheni, 0910, Akhmeta
District, Georgia
(770) LTD "BADAGONI"
Freedom Square 4, 0105, Tbilisi, Georgia
(580) 25 02 2020

(111) M 2011 21510 R
(732) AUXILIUM INTERNATIONAL
HOLDINGS, LLC
1209 Orange Street, Wilmington, Delaware
19801, USA
(770) AUXILIUM INTERNATIONAL
HOLDINGS, INC.
1105 North Market Street, Suite 1300,
Wilmington, Delaware 19801, USA
(580) 11 03 2020

(111) M 1996 1978 R
(732) INGERSOLL-RAND COMPANY
800-E Beaty Street, Davidson, North
Carolina 28036, USA
(770) INGERSOLL-RAND COMPANY
800-D Beaty Street, Davidson, North
Carolina 28036, USA
(580) 21 02 2020

TERMINATION OF TRADEMARKS REGISTRATIONS

(111) M 2019 30799 R
 (151) 2019 02 08
 (732) NARKOM ILIAZOVI
 Vill. Muganlo Me-19 q. 5, Gardabani, Georgia
 (141) 2020 03 12

(111) M 1999 12667 R
 (151) 1999 08 24
 (732) INBEV BELGIUM SPRL
 Boulevard Industriel 21, 1070 Brussels,
 Belgium
 (141) 2020 03 10

(111) M 1999 12586 R
 (151) 1999 08 23
 (732) BERNARD MATTHEWS PLC
 Great Witchingham Hall, Great
 Witchingham Norwich, Norfolk NR9
 5QD, United Kingdom
 (141) 2020 03 10

(111) M 1999 12669 R
 (151) 1999 08 24
 (732) FCA US LLC
 1000 Chrysler Drive, City of Auburn Hills,
 State of Michigan 48326, USA
 (141) 2020 03 10

(111) M 1999 12641 R
 (151) 1999 08 24
 (732) PFIZER INC., a Delaware corporation
 235 EAST 42nd Street, New York, State
 of New York, 10017, USA
 (141) 2020 03 10

(111) M 1999 12671 R
 (151) 1999 08 24
 (732) INLINGUA INTERNATIONALE AG
 Belpstrasse 11, CH-3007 Bern, Switzerland
 (141) 2020 03 10

(111) M 1999 12649 R
 (151) 1999 08 24
 (732) TAKEDA AS
 Drammensveien 852, 1383 Asker, Norway
 (141) 2020 03 10

(111) M 1999 12722 R
 (151) 1999 08 31
 (732) MEDA AB
 Pipers Väg 2A, Box 906 SE-170 09 Solna,
 Sweden
 (141) 2020 03 16

(111) M 1999 12653 R
 (151) 1999 08 24
 (732) THE DRAMBUIE LIQUEUR
 COMPANY LIMITED
 Hillwood House, Corstrophine Edinburgh
 EH12 6UX Scotland, United Kingdom
 (141) 2020 03 10

(111) M 1999 12694 R
 (151) 1999 08 24
 (732) BIOFARMA
 50, rue Carnot, 92284 Suresnes cedex, France
 (141) 2020 03 10

(111) M 1999 12663 R
 (151) 1999 08 24
 (732) OBSHCHESTVO S OGRANICHENNOI
 OTVESTVENNOSTYOU "PETRO"
 198206, SANKT-PETERBURG,
 PETERGOFOSKOE SHOSSE D.71, Russian
 Federation
 (141) 2020 03 10

(111) M 1999 12674 R
 (151) 1999 08 24
 (732) OPEL AUTOMOBILE GMBH
 Bahnhofplatz, 65423 Rüsselsheim, Germany
 (141) 2020 03 10

(111) M 1999 12666 R
 (151) 1999 08 24
 (732) ANHEUSER-BUSCH INBEV S.A.
 Grand-Pace 1, 1000 Brussels, Belgium
 (141) 2020 03 10

(111) M 1999 12677 R
 (151) 1999 08 24
 (732) OPEL AUTOMOBILE GMBH
 Bahnhofplatz, 65423 Rüsselsheim, Germany
 (141) 2020 03 10

(111) M 1999 12620 R
 (151) 1999 08 24
 (732) MERCK SHARP & DOHME CORP.

One Merck Drive, Whitehouse Station,
New Jersey 08889, USA
(141) 2020 03 10

(111) M 1999 12727 R
(151) 1999 08 31
(732) MERCK & CO., INC.
a New Jersey Corporation
One Merck Drive, P.O. Box 100,
Whitehouse Station, New Jersey
08889-0100, USA
(141) 2020 03 16

(111) M 1999 12624 R
(151) 1999 08 24
(732) L'OREAL
14, rue Royale, F-75008 Paris, France
(141) 2020 03 10

(111) M 1999 12628 R
(151) 1999 08 24
(732) TOYOTA JIDOSHA KABUSHIKI KAISHA
(also trading as TOYOTA MOTOR
CORPORATION)
1, Toyota-cho, Toyota-shi, Aichi-ken, Japan
(141) 2020 03 10

(111) M 1999 12633 R
(151) 1999 08 24
(732) PFIZER PRODUCTS INC.
a Connecticut Corporation
Eastern Point Road, Groton, Connecticut
06340, USA
(141) 2020 03 10

(111) M 1999 12634 R
(151) 1999 08 24
(732) PFIZER PRODUCTS INC.
a Connecticut Corporation
Eastern Point Road, Groton, Connecticut
06340, USA
(141) 2020 03 10

(111) M 1999 12635 R
(151) 1999 08 24
(732) PFIZER PRODUCTS INC.
a Connecticut Corporation
Eastern Point Road, Groton, Connecticut
06340, USA
(141) 2020 03 10

(111) M 1999 12692 R
(151) 1999 08 24
(732) KLASSIKA INTERNATIONAL LIMITED
Office 203, 2nd Floor, Liliana Building,
10 Kyriakou Matsi avenue, Agious
Omologites, PC 1082, Nicosia, Cyprus
(141) 2020 03 10

(111) M 1999 12681 R
(151) 1999 08 24
(732) Société des Produits Nestlé S.A.
1800 Vevey, Switzerland
(141) 2020 03 10

(111) M 1999 12683 R
(151) 1999 08 24
(732) Société des Produits Nestlé S.A.
1800 Vevey, Switzerland
(141) 2020 03 10

(111) M 1999 12689 R
(151) 1999 08 24
(732) Société des Produits Nestlé S.A.
1800 Vevey, Switzerland
(141) 2020 03 10

(111) M 1999 12717 R
(151) 1999 08 31
(732) DANISCO A/S
Langenbrogade 1, P.O. Box 17, DK-1001
Copenhagen K, Denmark
(141) 2020 03 16

(111) M 1999 12719 R
(151) 1999 08 31
(732) UNILEVER N.V.
Weena 455, NL-3013 AL Rotterdam,
Netherlands
(141) 2020 03 16

CLASSIFICATION INDEXES

INVENTIONS

CONCORDANCE TABLE OF INTERNATIONAL CLASSIFICATION INDEX AND PUBLICATION NUMBERS

INTERNATIONAL CLASSIFICATION INDEXES (51)	NUMBER OF PUBLISHED APPLICATION (10)
A 61 K 31/4178; A 61 P 11/00; C 07 D 417/14; C 07 D 403/14; C 07 D 413/14; C 07 D 403/04	AP 2020 14924 A
B 01 D 53/58; C 05 C 13/00	AP 2020 14836 A
G 01 P 1/07; G 01 P 1/12	AP 2020 14662 A

CONCORDANCE TABLE OF PUBLICATION NUMBERS AND INTERNATIONAL CLASSIFICATION INDEX

NUMBER OF PUBLISHED APPLICATION (10)	INTERNATIONAL CLASSIFICATION INDEXES (51)
AP 2020 14662 A	G 01 P 1/07; G 01 P 1/12
AP 2020 14836 A	B 01 D 53/58; C 05 C 13/00
AP 2020 14924 A	A 61 K 31/4178; A 61 P 11/00; C 07 D 417/14; C 07 D 403/14; C 07 D 413/14; C 07 D 403/04

CONCORDANCE TABLE OF INTERNATIONAL CLASSIFICATION INDEX, PATENT NUMBERS AND PUBLICATION NUMBERS

INTERNATIONAL CLASSIFICATION INDEX (51)	NUMBER OF PATENT (11)	NUMBER OF PUBLISHED APPLICATION (10)
A 61 K 31/4985; A 61 P 25/24	P 2020 7079 B	AP 2019 14339 A
A 47 L 1/00	P 2020 7080 B	AP 2019 14878 A
C 07 K 14/47	P 2020 7081 B	AP 2019 14514 A

CONCORDANCE TABLE OF PATENT NUMBERS, PUBLICATION NUMBERS AND INTERNATIONAL CLASSIFICATION INDEX

NUMBER OF PATENT (11)	NUMBER OF PUBLISHED APPLICATION (10)	INTERNATIONAL CLASSIFICATION INDEX (51)
P 2020 7079 B	AP 2019 14339 A	A 61 K 31/4985; A 61 P 25/24
P 2020 7080 B	AP 2019 14878 A	A 47 L 1/00
P 2020 7081 B	AP 2019 14514 A	C 07 K 14/47

**CONCORDANCE TABLE OF APPLICATION NUMBERS, PUBLICATION NUMBERS
AND PATENTS**

NUMBER OF APPLICATION (21)	NUMBER OF PUBLISHED APPLICATION (10)	NUMBER OF PATENT (11)
AP 2014 14339	AP 2019 14339 A	P 2020 7079 B
AP 2015 14514	AP 2019 14514 A	P 2020 7081 B
AP 2018 14878	AP 2019 14878 A	P 2020 7080 B

UTILITY MODELS

**CONCORDANCE TABLE OF INTERNATIONAL CLASSIFICATION INDEX
AND PUBLICATION NUMBERS**

INTERNATIONAL CLASSIFICATION INDEXES (51)	NUMBER OF PUBLISHED APPLICATION (10)
B 60 K 31/00; G 08 G 1/00	AU 2020 15093 U
C 02 F 1/28, C 02 F 1/58	AU 2020 15004 U
E 04 H 6/06	AU 2020 14973 U
E 05 B 47/00	AU 2020 14804 U

**CONCORDANCE TABLE OF PUBLICATION NUMBERS
AND INTERNATIONAL CLASSIFICATION INDEX**

NUMBER OF PUBLISHED APPLICATION (10)	INTERNATIONAL CLASSIFICATION INDEXES (51)
AU 2020 14804 U	E 05 B 47/00
AU 2020 14973 U	E 04 H 6/06
AU 2020 15004 U	C 02 F 1/28, C 02 F 1/58
AU 2020 15093 U	B 60 K 31/00; G 08 G 1/00

**CONCORDANCE TABLE OF INTERNATIONAL CLASSIFICATION INDEX,
PATENT NUMBERS AND PUBLICATION NUMBERS**

INTERNATIONAL CLASSIFICATION INDEX (51)	NUMBER OF PATENT (11)	NUMBER OF PUBLISHED APPLICATION (10)
E 04 B 1/01	U 2020 2034 Y	AU 2019 14993 U

**CONCORDANCE TABLE OF PATENT NUMBERS,
PUBLICATION NUMBERS AND INTERNATIONAL CLASSIFICATION INDEX**

NUMBER OF PATENT (11)	NUMBER OF PUBLISHED APPLICATION (10)	INTERNATIONAL CLASSIFICATION INDEX (51)
U 2020 2034 Y	AU 2019 14993 U	E 04 B 1/01

**CONCORDANCE TABLE OF APPLICATION NUMBERS, PUBLICATION NUMBERS
AND PATENTS**

NUMBER OF APPLICATION (21)	NUMBER OF PUBLISHED APPLICATION (10)	NUMBER OF PATENT (11)
AU 2019 14993	AU 2019 14993 U	U 2020 2034 Y

DESIGNS

**CONCORDANCE TABLE OF INTERNATIONAL CLASSIFICATION INDEX
AND PUBLICATION NUMBERS**

INTERNATIONAL CLASSIFICATION INDEXES (51)	NUMBER OF PUBLISHED APPLICATION (10)
03-01	AD 2020 1114 S
03-01	AD 2020 1117 S
06-03; 06-04	AD 2020 1116 S
09-01	AD 2020 1112 S
09-01	AD 2020 1113 S

**CONCORDANCE TABLE OF PUBLICATION NUMBERS
AND INTERNATIONAL CLASSIFICATION INDEX**

NUMBER OF PUBLISHED APPLICATION (10)	INTERNATIONAL CLASSIFICATION INDEXES (51)
AD 2020 1112 S	09-01
AD 2020 1113 S	09-01
AD 2020 1114 S	03-01
AD 2020 1116 S	06-03; 06-04
AD 2020 1117 S	03-01

TRADEMARKS

CONCORDANCE TABLE OF REGISTRATION NUMBERS, APPLICATION NUMBERS, PUBLICATION NUMBERS AND BULLETIN NUMBERS

NUMBER OF REGISTRATION (111)	NUMBER OF APPLICATIONS (210)	NUMBER OF PUBLISHED APPLICATIONS (260)	NUMBER OF BULLETIN
M 2020 32431 R	AM 107285	–	6(538)2020
M 2020 32432 R	AM 107404	–	6(538)2020
M 2020 32433 R	AM 107284	–	6(538)2020
M 2020 32434 R	AM 107291	–	6(538)2020
M 2020 32435 R	AM 107271	–	6(538)2020
M 2020 32436 R	AM 100065	AM 2019 100065 A	22(530)2019
M 2020 32437 R	AM 101295	AM 2019 101295 A	17(525)2019
M 2020 32438 R	AM 101504	AM 2019 101504 A	17(525)2019
M 2020 32439 R	AM 101671	AM 2019 101671 A	21(529)2019
M 2020 32440 R	AM 101672	AM 2019 101672 A	21(529)2019
M 2020 32441 R	AM 101673	AM 2019 101673 A	21(529)2019
M 2020 32442 R	AM 101920	AM 2019 101920 A	17(525)2019
M 2020 32443 R	AM 102069	AM 2019 102069 A	21(529)2019
M 2020 32444 R	AM 102072	AM 2019 102072 A	21(529)2019
M 2020 32445 R	AM 102073	AM 2019 102073 A	21(529)2019
M 2020 32446 R	AM 102074	AM 2019 102074 A	21(529)2019
M 2020 32447 R	AM 102075	AM 2019 102075 A	21(529)2019
M 2020 32448 R	AM 102233	AM 2019 102233 A	21(529)2019
M 2020 32449 R	AM 102252	AM 2019 102252 A	21(529)2019
M 2020 32450 R	AM 102383	AM 2019 102383 A	22(530)2019
M 2020 32451 R	AM 102398	AM 2019 102398 A	21(529)2019
M 2020 32452 R	AM 102403	AM 2019 102403 A	22(530)2019
M 2020 32453 R	AM 102495	AM 2019 102495 A	21(529)2019
M 2020 32454 R	AM 102523	AM 2019 102523 A	22(530)2019
M 2020 32455 R	AM 102524	AM 2019 102524 A	22(530)2019
M 2020 32456 R	AM 102525	AM 2019 102525 A	21(529)2019
M 2020 32457 R	AM 102546	AM 2019 102546 A	21(529)2019
M 2020 32458 R	AM 102566	AM 2019 102566 A	21(529)2019
M 2020 32459 R	AM 102697	AM 2019 102697 A	22(530)2019
M 2020 32460 R	AM 102701	AM 2019 102701 A	22(530)2019
M 2020 32461 R	AM 102706	AM 2019 102706 A	22(530)2019
M 2020 32462 R	AM 102716	AM 2019 102716 A	22(530)2019
M 2020 32463 R	AM 102723	AM 2019 102723 A	22(530)2019
M 2020 32464 R	AM 102731	AM 2019 102731 A	22(530)2019
M 2020 32465 R	AM 102826	AM 2019 102826 A	22(530)2019
M 2020 32466 R	AM 102917	AM 2019 102917 A	22(530)2019
M 2020 32467 R	AM 94699	AM 2019 94699 A	17(525)2019
M 2020 32468 R	AM 99773	AM 2019 99773 A	17(525)2019
M 2020 32469 R	AM 107394	–	6(538)2020
M 2020 32470 R	AM 107283	–	6(538)2020
M 2020 32471 R	AM 107456	–	6(538)2020
M 2020 32472 R	AM 107483	–	6(538)2020

CONCORDANCE TABLE OF PUBLICATION NUMBERS
AND APPLICATION NUMBERS

NUMBER OF PUBLISHED APPLICATION (260)	NUMBER OF APPLICATION (210)	1	2
1	2		
AM 2020 90029 A**	AM 90029	AM 2020 104406 A	AM 104406
AM 2020 99947 A*	AM 99947	AM 2020 104430 A	AM 104430
AM 2020 99950 A*	AM 99950	AM 2020 104432 A	AM 104432
AM 2020 100771 A	AM 100771	AM 2020 104436 A	AM 104436
AM 2020 100874 A*	AM 100874	AM 2020 104437 A	AM 104437
AM 2020 100880 A	AM 100880	AM 2020 104438 A	AM 104438
AM 2020 102832 A	AM 102832	AM 2020 104444 A	AM 104444
AM 2020 103485 A	AM 103485	AM 2020 104447 A	AM 104447
AM 2020 103942 A	AM 103942	AM 2020 104454 A	AM 104454
AM 2020 103954 A	AM 103954	AM 2020 104530 A	AM 104530
AM 2020 103955 A	AM 103955	AM 2020 104532 A	AM 104532
AM 2020 103979 A	AM 103979	AM 2020 104533 A	AM 104533
AM 2020 104085 A	AM 104085	AM 2020 104536 A	AM 104536
AM 2020 104176 A	AM 104176	AM 2020 104555 A	AM 104555
AM 2020 104196 A	AM 104196	AM 2020 104557 A	AM 104557
AM 2020 104197 A	AM 104197	AM 2020 104558 A	AM 104558
AM 2020 104198 A	AM 104198	AM 2020 104559 A	AM 104559
AM 2020 104200 A	AM 104200	AM 2020 104561 A	AM 104561
AM 2020 104206 A	AM 104206	AM 2020 104752 A	AM 104752
AM 2020 104313 A	AM 104313	AM 2020 104753 A	AM 104753
		AM 2020 104756 A	AM 104756
		AM 2020 104758 A	AM 104758
		AM 2020 104759 A	AM 104759
		AM 2020 104812 A	AM 104812

**CONCORDANCE TABLE OF INDEX OF GOODS AND/OR SERVICES
AND APPLICATION NUMBERS**

INDEX OF GOODS AND/OR SERVICES (511)	NUMBER OF PUBLISHED APPLICATIONS (26)	1	2
1	2	32	AM 2020 100880 A
1	AM 2020 103942 A	32	AM 2020 104557 A
2	AM 2020 103942 A	33	AM 2020 100771 A
3	AM 2020 104444 A	33	AM 2020 100874 A*
3	AM 2020 104454 A	33	AM 2020 100880 A
3	AM 2020 104533 A	33	AM 2020 102832 A
5	AM 2020 103485 A	33	AM 2020 104085 A
5	AM 2020 104176 A	33	AM 2020 104530 A
5	AM 2020 104196 A	33	AM 2020 104559 A
5	AM 2020 104197 A	35	AM 2020 100771 A
5	AM 2020 104198 A	35	AM 2020 103485 A
5	AM 2020 104200 A	35	AM 2020 104313 A
5	AM 2020 104447 A	35	AM 2020 104436 A
5	AM 2020 104756 A	35	AM 2020 104437 A
5	AM 2020 104758 A	35	AM 2020 104438 A
5	AM 2020 90029 A**	35	AM 2020 104454 A
7	AM 2020 99947 A*	35	AM 2020 104558 A
7	AM 2020 99950 A*	36	AM 2020 104313 A
9	AM 2020 104206 A	39	AM 2020 104558 A
9	AM 2020 104532 A	39	AM 2020 104752 A
10	AM 2020 104759 A	39	AM 2020 104753 A
11	AM 2020 104555 A	39	AM 2020 104812 A
12	AM 2020 104430 A	41	AM 2020 104536 A
12	AM 2020 104432 A	42	AM 2020 104536 A
29	AM 2020 104558 A	43	AM 2020 103979 A
		43	AM 2020 104406 A
		43	AM 2020 104561 A
		44	AM 2020 103954 A
		44	AM 2020 103955 A

CONCORDANCE TABLE OF INDEX OF GOODS AND/OR SERVICES
AND NUMBERS OF TRADEMARKS REGISTERED ACCORDING
TO THE ACCELERATED PROCEDURE

INDEX OF GOODS AND/OR SERVICES (511)	NUMBERS OF REGISTERED ACCORDING TO THE ACCELERATED PROCEDURE (111)
6	M 2020 32435 R
9	M 2020 32433 R
11	M 2020 32435 R
17	M 2020 32435 R
20	M 2020 32435 R
32	M 2020 32431 R
32	M 2020 32470 R
33	M 2020 32431 R
33	M 2020 32434 R
34	M 2020 32469 R
34	M 2020 32471 R
35	M 2020 32432 R
35	M 2020 32435 R
43	M 2020 32431 R
43	M 2020 32432 R
43	M 2020 32472 R

OFFICIAL BULLETIN OF THE INDUSTRIAL PROPERTY

INVENTIONS
UTILITY MODELS
DESIGNS
TRADEMARKS

6(538)

EDITOR-IN-CHIEF: N. Bebrishvili

EDITOR-TRANSLATOR: E. Gabunia

PROOFREADER: A. Shikhashvili

COMPUTER LAYOUT: M. Ordenidze
K. Svanidze

www.sakpatenti.gov.ge

E-mail: info@sakpatenti.org.ge