

Official Bulletin of the Industrial Property

Inventions

Utility Models

Designs

Trademarks



საქართველოს ინტელექტუალური
საკუთრების ეროვნული ცენტრი

საქპატენტი

SAKPATENTI

NATIONAL INTELLECTUAL PROPERTY
CENTER OF GEORGIA

www.sakpatenti.gov.ge

Date of Publication – 2023 03 27

(609)9

INID CODES FOR IDENTIFICATION OF BIBLIOGRAPHIC DATA

INVENTIONS, UTILITY MODELS

- (10) Number of publication for application, which has been examined
- (11) Number of patent and kind of document
- (21) Serial number of application
- (22) Date of filing of the application
- (23) Date of exhibition or the date of the earlier filing and the number of application, if any
- (24) Date from which patent may have effect
- (31) Number of priority application
- (32) Date of filing of priority application
- (33) Code of the country or regional organization allotting priority application number
- (44) Date of publication of application not granted, but examined and number of bulletin
- (45) Date of publication of registered document
- (51) International Patent Classification Index

- (54) Title of the invention
- (57) Abstract
- (60) Number of examined patent document granted by foreign patent office, date from which patent has effect and country code
- (62) Number of the earlier application and in case of divided application, date of filing an application
- (71) Name, surname and address of applicant (country code)
- (72) Name, surname of inventor (country code)
- (73) Name, surname and address of patent owner (country code)
- (74) Name, surname of representative or patent attorney
- (85) Date of commencement of the national phase of International Application
- (86) Number and date of filing of international application
- (87) Number and date of publication of international application
- (94) Calculated date of expiry of the SPC or the duration of the SPC

DESIGNS

- (10) Number of publication for application
- (11) Number of patent and kind of document or number of registration
- (15) Date of registration/Date of patent renewal
- (18) Expected expiration date of patent or registration
- (21) Serial number of application
- (22) Date of filing of the application
- (23) Date of exhibition or the date of the earlier filing and the number of application, if any
- (24) Date from which patent may have effect
- (28) Number of designs included in the application
- (30) Data relating to priority (number of application, date of filing of application, two-letter code identifying the authority with whom the priority application was made)
- (31) Number of priority application
- (32) Date of filing of priority application
- (33) Code of the country or regional organization allotting priority application number
- (34) Two-letter code according to WIPO St.3 identifying the authority with which the priority application was made
- (44) Date of publication of design and number of bulletin (the first publication)
- (45) Date of publication of design registered by WIPO and number of bulletin

- (51) International Classification for designs (class and subclass of the Locarno Classification)
- (54) Title of the invention
- (55) Reproduction of the design
- (57) Description of characteristic features of the design including indication of colors
- (58) Date of recording of any kind of amendment in the Register
- (62) Number of the earlier application, registration and document number and if available the date of filing an application in case of divided application
- (71) Name, surname and address of applicant (country code)
- (72) Name, surname of creator (country code)
- (73) Name, surname and address of patent owner (country code)
- (74) Name, surname of representative or patent attorney
- (81) Contracting states concerned
 - II designated contracting states according to the 1960 Act
 - III designated contracting states according to the 1999 Act
- (85) Owner's permanent address
- (86) Owner's nationality
- (87) Owner's residence
- (88) State in which the owner has a real and effective industrial or commercial establishment

TRADEMARKS

- (111) - Number of registration
- (151) - Date of registration
- (156) - Date of the renewal
- (181) - Expected expiration date of registration
- (186) - Renewal expiration date of registration
- (141) - Date of cancel of duration of the mark
- (210) - Serial number of application
- (220) - Date of filing of the application
- (230) - Data concerning exhibition
- (260) - Number of application, for which favorable decision of examination about registration has been taken (publication number)
- (310) - Number of the first application
- (320) - Date of filing of the first application
- (330) - Code, identifying national or regional Office where the first application was made
- (511) - International Classification of Goods and Services for the purposes of registration of trade marks and/or list of goods and/or services classified according thereto
- (526) - Disclaimer
- (531) - Description of figurative elements of Trade Marks according to the International Classification of the Figurative Elements of Marks

- (540) - Reproduction of Trade Mark
- (550) - Nature and kind of Trade Mark
- (551) - Indication to the effect that the mark is a collective mark, a certification mark or a guarantee mark
- (554) - Three-dimensional mark
- (580) - Date of recording of any kind changes in respect of applications or registrations
- (591) - Information concerning colors claimed
- (731) - Name and address of the applicant
- (732) - Name and address of the holder of the registration
- (740) - Name and address of the representative
- (750) - Addreses for correspondence
- (770) - Name and address of the previous applicant or holder in case of change in ownership
- (771) - Previous name and address of the applicant or holder in case of change in ownership
- (791) - Name and address of the licensee
- (793) - Indication of conditions and/or restrictions under the license (Type of license, number of license agreement, data of license, data of validity of license)
- (800) - Certain data relating to the international registration of Trade Marks under the Protocol Relating to Madrid Agreement (International registration number
- (852) - Partial cancellation of the list of goods and services
- (891) - Date of subsequent designation

CODES FOR PUBLICATION IN BULLETIN

- (21) AP 0000 000000 - serial number of application for invention
- (10) AP 0000 0000 A - number of published application for invention (first publication)
- (11) P 0000 0000 B - number of patent for invention (second publication)
- (21) API 0000 000000 - number of application for imported patent
- (11) PI 0000 0000 A - number of imported patent (first publication)
- (21) AU 0000 000000 - serial number of application for utility model
- (10) AU 0000 000 U - number of published application for utility model (first publication)
- (11) U 0000 000 Y - number of patent for utility model (second publication)
- (21) AD 0000 000000 - serial number of application for design
- (10) AD 0000 000 S - number of published application for design (first publication)
- (11) D 0000 000 S - registered design

INTERNATIONAL PATENT CLASSIFICATION FOR INVENTIONS AND UTILITY MODELS

- SECTION A - HUMAN NECESSITIES
- SECTION B - PERFORMING OPERATIONS; TRANSPORTING
- SECTION C - CHEMISTRY; METALLURGY
- SECTION D - TEXTILES; PAPER
- SECTION E - FIXED CONSTRUCTIONS
- SECTION F - MECHANICAL ENGINEERING; LIGHTING; HEATING; WEAPONS; BLASTING
- SECTION G - PHYSICS
- SECTION H - ELECTRICITY

-
- M - Trade Mark
 - (210) AM 0000 000000 - Serial number of application;
 - (260) AAM 0000 00000 A - Publication number of application;
 - (111) M 0000 00000 R - Number of registration;
 - (111) MMM0000 00000 Rn - Number of renewals, in which n=1,2,3;
 - (111) M 0000 00000 R(P) - Number of registration under partial assignment of rights
-

Official Bulletin of the Industrial Property

Inventions

Utility Models

Designs

Trademarks

CONTENT

PUBLISHED TITLES OF PROTECTION	3
INVENTIONS	
▪ APPLICATIONS APPROVED FOR GRANTING PATENT	4
▪ PATENTED INVENTIONS	7
UTILITY MODELS	
▪ APPLICATION APPROVED FOR GRANTING PATENT	11
▪ PATENTED UTILITY MODELS	12
DESIGNS	
▪ DESIGNS, WHICH HAVE BEEN REGISTERED WITH THE INTERNATIONAL BUREAU CLAIMING PRIORITY ON THE TERRITORY OF GEORGIA	13
TRADEMARKS	
▪ APPLICATIONS FILED UNDER THE NATIONAL PROCEDURE APPROVED FOR REGISTRATION	20
▪ REGISTERED TRADEMARKS	24
▪ TRADEMARKS REGISTERED ACCORDING TO THE ACCELERATED PROCEDURE	31
▪ INTERNATIONAL TRADEMARKS FOR WHICH A DECISION ON GRANTING PROTECTION IS TAKEN	34
▪ INTERNATIONAL TRADEMARKS PROTECTED IN GEORGIA	63
OFFICIAL NOTIFICATIONS	
INVENTIONS	
▪ RESTORATION OF PATENTS	76
▪ ABOLITION OF PATENTS WITH THE RIGHT TO RESTORE	77
▪ DATE OF PATENTS RESTORATION EXPIRATION	78
▪ EXPIRATION OF TERMS OF PATENT	79
UTILITY MODELS	
▪ RESTORATION OF PATENTS	79
▪ DATE OF PATENTS RESTORATION EXPIRATION	80
DESIGNS	
▪ EXTENSION OF TERMS OF DESIGN REGISTRATION	80
▪ CANCELLATION OF DESIGNS REGISTRATION	80
▪ EXTENSION OF TERMS OF INTERNATIONAL DESIGNS REGISTRATION	81
TRADEMARKS	
▪ EXTENSION OF TERMS OF TRADEMARKS REGISTRATION	82
▪ COMPLETE TRANSFER OF RIGHTS	88
▪ CHANGES OF NAMES AND/OR ADDRESSES OF TRADEMARKS OWNERS	89
▪ CANCELLATION OF TRADEMARKS REGISTRATION	90
CLASSIFICATION INDEXES	
INVENTIONS	92
UTILITY MODELS	94
TRADEMARKS	95

PUBLISHED TITLES OF PROTECTION

INVENTIONS

- **APPLICATIONS APPROVED FOR GRANTING PATENT:**
16008; 15801; 15606; 15737
- **PATENTED INVENTIONS:**
7476-7488

UTILITY MODELS

- **APPLICATION APPROVED FOR GRANTING PATENT:**
16017
- **PATENTED UTILITY MODELS:**
2146, 2147

DESIGNS

DESIGNS, WHICH HAVE BEEN REGISTERED WITH THE INTERNATIONAL BUREAU CLAIMING PRIORITY ON THE TERRITORY OF GEORGIA:
225959; 225958; 225924; 225928; 220602; 226091

TRADEMARKS

- **APPLICATIONS FILED UNDER THE NATIONAL PROCEDURE APPROVED FOR REGISTRATION:**
117550; 118540; 118838; 118927, 118928; 119004; 119014-119018; 119084; 119092; 119099; 119111; 119119; 119122; 119125; 119127; 119176; 119178; 119194; 119200, 119208-19211
- **REGISTERED TRADEMARKS:**
36548-36579; 36581; 36592-36639
- **TRADEMARKS REGISTERED ACCORDING TO THE ACCELERATED PROCEDURE:**
36580; 36582-36591
- **INTERNATIONAL TRADEMARKS FOR WHICH A DECISION ON GRANTING PROTECTIONS IS TAKEN:**
113086*; 114834*; 114870*; 115270*; 117001; 117798; 118037; 118041; 118248; 118250-118253; 118255, 118256; 118258-118267; 118271; 118273, 118274; 118283; 118318; 118323; 118360; 118363-118365; 118568, 118569; 118574; 118584; 118588-118590; 118592; 118595-118597; 118599-118601; 118674; 118709; 118713; 118715; 118718; 118874-118880
- **INTERNATIONAL TRADEMARKS PROTECTED IN GEORGIA:**
113962; 115447; 116345; 116437; 116450; 116468; 116477; 116503, 116504; 116554, 116555; 116558-116561; 116563; 116571; 116574; 116580; 116586; 116591; 116594, 116595; 116597; 116615-116618; 116674-116676; 116687, 116688; 116707; 116709, 116710; 116714, 116715; 116717-116720; 116722, 116723; 116725-116727; 116768; 116777; 116779-116782; 116785-116788; 116790; 116795; 116798; 116800-116803; 116805; 116807-116811; 116813-116825; 116869; 116875; 116887-116890; 116895-116897; 116903-116909; 116943-11949; 116997, 116998; 117033-117046; 117048-117050; 117120; 117225, 117226; 117235; 117237-117239; 117241-117243; 117397-117412; 117458; 117460, 117461; 117496; 117499-117502; 117516; 117518, 117519; 117563, 117564; 117567-117571; 117628-117632; 117686-117688; 117777-117781

INVENTIONS

APPLICATIONS APPROVED FOR GRANTING PATENT

The decision can be appealed at the Chamber of Appeal of Sakpatenti within 3 months from the publication or at the Mtskheta District Court Administrative Cases Board (Address: №17, Samkhedro St., Mtskheta), within 1 month following the publication.

PART A

A 23

- (10) AP 2023 16008 A (51) Int. Cl. (2006)
A 23 C 23/00
- (21) AP 2022 16008 (22) 2022 07 18
- (71) Maria Silagadze (GE)
26 May Str. 45, 4600, Kutaisi, Georgia (GE);
Nato Burjaliani (GE)
Z. Chavchavadze Str. 48/27, 4600, Kutaisi,
Georgia (GE);
Giorgi Pkhakadze (GE)
26 May Str. 45, 4600, Kutaisi, Georgia (GE);
Gulnara Khetsuriani (GE)
Rustaveli Ave. 120a, ap. 42, 4600, Kutaisi,
Georgia (GE);
Andria Ghvinepadze (GE)
Kazbegi Str. 28, 4600, Kutaisi, Georgia (GE);
Khatia Khvadagiani (GE)
Rezo Tabukashvili Str. 183/76, 4600, Kutaisi,
Georgia (GE)
- (72) Maria Silagadze (GE);
Nato Burjaliani (GE);
Giorgi Pkhakadze (GE);
Gulnara Khetsuriani (GE);
Andria Ghvinepadze (GE);
Khatia Khvadagiani (GE)

(54) PROPHYLACTIC CHEESE PRODUCT FOR ANTIANEMIC DIET

(57) A product includes fat free cottage cheese, germinated and grinded lentil crops, vegetable milk pressed therefrom, roasted and grinded pumpkin seeds, extruded wheat bran, crushed nuts and dark chocolate chips, finely chopped dried quince and apple, and raisins.

Claims: 1 independent

A 61

- (10) AP 2023 15801 A (51) Int. Cl. (2006)
A 61 K 31/498
A 61 K 31/506
A 61 K 31/538
A 61 K 31/4439
A 61 P 31/04
C 07 D 413/14
C 07 D 403/14
C 07 D 401/14
C 07 D 401/04
- (21) AP 2018 15801 (22) 2018 11 02
- (62) AP 2018 15681 2018 11 02
- (31) 1718285.8
- (32) 2017 11 03
- (33) GB
- (71) DISCUVA LTD. (GB)
136A Eastern Avenue Milton Park, Abingdon,
OX14 4SB, UK (GB)
- (72) MEO, Paul (GB);
KHAN, Mohamed Nawaz (GB);
CHARRIER, Cedric (GB)
- (74) Tamar Kochlamazashvili
- (85) 2021 11 18
- (86) PCT/GB2018/053183, 2018 11 02
- (54) ANTIBACTERIAL COMPOUNDS
- (57) Compound of common formula (V),

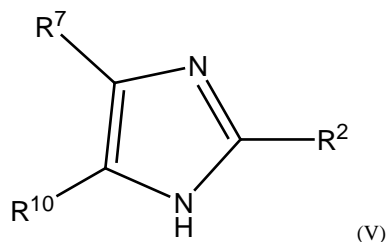

wherein R² is NH² and values of R⁷, R¹⁰ substitutes are provided in the claims or pharmaceutically acceptable salt, hydrate or ether thereof, pharmaceutical composition on the basis thereof, and their usage for remedies production at the treatment of infection or diseases caused by Enterobacteriaceae.

Claims: 7 independents

13 dependents

Table: 21

PART B**B 22**

- (10) AP 2023 15606 A (51) Int. Cl. (2006)
B 22 F 3/23
C 22 B 5/04
C 22 C 33/00
- (21) AP 2021 15606 (22) 2021 04 15
- (71) Garegin Zakharov (GE)
Ertso Str. 11, ap. 9, 0192, Tbilisi, Georgia (GE);
Zurabi Aslamazashvili (GE)
D. Tavkhelidze Str. 1, ap. 58, 0186, Tbilisi,
Georgia (GE);
Davit Kvashkvadze (GE)
II Lane 6a, Vill. Tsikhisdziri, Kobuleti, Georgia
(GE);
Giorgi Mikaberidze (GE)
Gamsakhurdia Ave. 14, ap. 34, 0171, Tbilisi,
Georgia (GE);
Mikheil Chikhradze (GE)
Al. Lazbegi Ave., 24g, ap. 130, 0186, Tbilisi,
Georgia (GE);
Tamaz Batsikadze (GE)
Nutsbidze Str. 179, bld. 2, ap. 16, 0186, Tbilisi,
Georgia (GE);
Levan Antashvili (GE)
Tashkenti Str. 7, ap. 5, 3700, Rustavi, Georgia
(GE);
Daviti Shonia (GE)
Batumi Str. 14, b. 19, Rustavi, Georgia (GE);
Irakli Maisuradze (GE)
Queen Tamara Ave. 17, Tbilisi, Georgia (GE);
Akaki Peikrishvili (GE)
Zhiuli Shartava Str. 16, ap. 32, 0160, Tbilisi,
Georgia (GE);
Gulnara Urushadze (GE)
Petre Kavtaradze Str. 43, ap. 18, 0186, Tbilisi,
Georgia (GE);
Ramin Abesadze (GE)
Vill. Ghvitori, 5518, Chiatura, Georgia (GE)
- (72) Garegin Zakharov (GE);
Zurabi Aslamazashvili (GE);
Davit Kvashkvadze (GE);
Giorgi Mikaberidze (GE);
Mikheil Chikhradze (GE);
Tamaz Batsikadze (GE);
Levan Antashvili (GE);
Daviti Shonia (GE);
Irakli Maisuradze (GE);
Akaki Peikrishvili (GE);
Gulnara Urushadze (GE);
Ramin Abesadze (GE)
- (54) METHOD FOR FERROBORON PREPARATION
- (57) A method for ferroboration preparation provides preparation of crucible from initial powder componentry, placing therein refractory mold coated with functional protective layer made of inorganic

refractory compounds, from inside, then placing therein a centrifuge, that is four-by-four TMC hermetic reactors arranged on at least two different horizontal levels on shafts rotating around vertical axis, initiating synthesis process, and synthesis in combustion mode, under the influence of centrifugal forces – by overloading achieved by changing rotation number, and the distance-lever from reactor rotation axis, as well, removal of cast alloys from synthesized product. At that, the TMC reactors are hanged in vertical position at initial cast loading and terminal product reloading, and during the influence of centrifugal forces, they move and maintain horizontal position by means of special joint, while the overloading under the influence of centrifugal forces amount is 1100-1200g. As one of the componentry of reaction mixture, metallurgical or any other production waste containing iron slag with a content of no less than 85% by mass of iron oxides with any ratio of viustite FeO, magnetite Fe₃O₄, and hematite Fe₂O₃, is used. Energetic supplement as calcium peroxide CaO₂ is used as second component, and boric anhydride B₂O₃ – as third, and aluminum – as metal-restoring, with a certain ratio of components in mass%:

Waste Containing Iron Slag – 44.7-48.4;
Boric Anhydride B₂O₃ – 6.6-17.9;
Energetic Supplement – Calcium Peroxide
CaO₂ – 3.0-8.8; and
Metal-Restoring – Aluminum – 29.9-30.7.

Claims: 1 independent

Table: 1

Fig.: 1

B 66

- (10) AP 2023 15737 A (51) Int. Cl. (2006)
B 66 C 1/10
- (21) AP 2019 15737 (22) 2019 04 10
- (71) NOSIREV, Sergey Vasilievich (RU)
Chudnovsky Str. 8, bld. 1, ap. 523, 193312, Saint
Petersburg, Russian Federation (RU)
- (72) NOSIREV, Sergey Vasilievich (RU)
- (74) Nikoloz Gogilidze
- (85) 2021 09 16
- (86) PCT/RU2019/000234, 2019 04 10
- (54) DEVICE FOR CONTROLLING CONTAINER,
PARTICULARLY BOTTOM-DUMP CONTAINER
- (57) A device, particularly a spreader 1 includes a frame 2 with twistlocks 3 mounted thereon, power drive 4, movable engagement mechanism 5, and force transmission means connecting the power drive 4 to movable engagement mechanism 5. Power drive 4 and force transmission means are placed along long sides of frame 2, and movable engagement mechanism 5 is placed on short sides of frame 2. Power drive 4 provides reciprocating movement of movable

engagement mechanism 5 mainly in the direction perpendicular to the plane of frame 2.

Claims: 1 independent

8 dependents

Fig.: 5

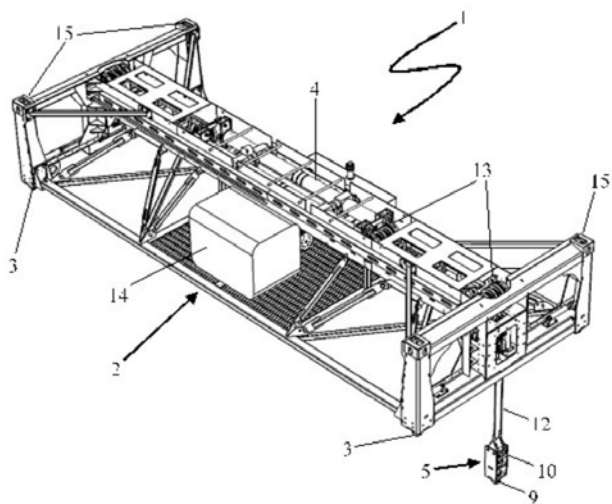

Fig. 2

PATENTED IVENTIONS

PART A

A 47

- (11) P 2023 7482 B (51) Int. Cl. (2006)
A 47 J 31/40
- (10) AP 2022 15817 A (44) 22(601)/2022
- (21) AP 2021 15817
- (22) 2021 12 02
- (24) 2021 12 02
- (73) LTD "Aquix" (GE)
Dimitri Uznadze Str. 111, bld. 2, ap. 11,
Didube District, Tbilisi, Georgia (GE)
- (72) CHENTSOV, Andrey Vladimirovich (RU);
KOLOMITSEV, Aleksandr Viktorovich (RU);
BALIANKO, Artem Arturovich (RU);
KALACHEV, Andrey Urevich (RU)
- (74) Shalva Gvaramadze
- (54) BEVERAGE (DRINK) PREPARATION
MODULE

A 61

- (11) P 2023 7478 B (51) Int. Cl. (2006)
A 61 G 7/05
- (10) AP 2022 15899 A (44) 22(601)/2022
- (21) AP 2022 15899
- (22) 2022 03 10
- (24) 2022 03 10
- (73) Mikheil Kotishadze (GE)
Ana Politkovskaya Str. 41/60, 0171, Tbilisi,
Georgia (GE);
University of Georgia (GE)
Merab Kostava Str. 77a, 0171, Tbilisi,
Georgia (GE)
- (72) Mikheil Kotishadze (GE)
- (54) BED AGAINST OF BEDSORES
APPEARANCE

- (11) P 2023 7486 B (51) Int. Cl. (2006)
A 61 K 9/19
A 61 K 9/08
A 61 K 47/02
A 61 K 47/26
- (10) AP 2022 15306 A (44) 20(599)/2022
- (21) AP 2018 15306
- (22) 2018 09 06
- (24) 2018 09 06
- (31) 17190117.6; 17207771.1
- (32) 2017 09 08; 2017 12 15
- (33) EP; EP
- (86) PCT/EP2018/073965, 2018 09 06

- (73) Bayer Pharma Aktiengesellschaft (DE)
Müllerstraße 178, Berlin, 13353,
Germany (DE);
Bayer Consumer Care AG (CH)
Peter-Merian-Str. 84 4002, Basel,
Switzerland (CH)
- (72) JACOBS, Nia (DE);
FREUNDLIEB, Julia (DE)
- (74) Tamar Kochlamazashvili
- (54) FORMULATIONS OF COPANLISIB

- (11) P 2023 7476 B (51) Int. Cl. (2006)
A 61 K 31/435
A 61 P 37/00
C 07 D 413/08
C 07 D 405/14
C 07 D 401/08
C 07 D 413/14
C 07 D 417/08
- (10) AP 2022 15588 A (44) 21(600)/2022
- (21) AP 2019 15588
- (22) 2019 09 18
- (24) 2019 09 18
- (31) 62/734,486
- (32) 2018 09 21
- (33) US
- (86) PCT/IB2019/057856, 2019 09 18
- (73) Pfizer Inc. (US)
235 East 42nd Street, New York, NY 10017,
USA (US)
- (72) GERSTENBERGER, Brian Stephen (US);
FLICK, Andrew Christopher (US);
NUHANT, Philippe Marcel (US);
MOUSSEAU, James John (US);
THORARENSEN, Atli (US);
ROBINSON, JR., Ralph Pelton (US);
SCHMITT, Daniel Copley (US);
SCHNUTE, Mark Edward (US);
LOMBARDO, Vincent Michael (US);
TRUJILLO, John Isidro (US);
UNWALLA, Rayomand Jal (US);
WU, Huixian (US);
KUNG, Daniel Wei-Shung (US)
- (74) Tamar Kochlamazashvili
- (54) N-SUBSTITUTED-DIOXOCYCLO-
BUTENYLAMINO-3-HYDROXY-
PICOLINAMIDES USEFUL AS
CCR6 INHIBITORS

(11) P 2023 7483 B (51) Int. Cl. (2006)
A 61 K 31/495
A 61 K 31/4985
A 61 P 35/00
A 61 P 25/28
C 07 D 487/04

(10) AP 2022 15327 A (44) 19(598)/2022

(21) AP 2018 15327

(22) 2018 10 17

(24) 2018 10 17

(31) 62/574,057; 62/608,897; 62/727,316

(32) 2017 10 18; 2017 12 21; 2018 09 05

(33) US; US; US

(86) PCT/US2018/056311, 2018 10 17

(73) Incyte Corporation (US)

1801 Augustine Cut-Off Wilmington,
DE 19803, USA (US)

(72) DOUTY, Brent (US);

BUESKING, Andrew W. (US);

BURNS, David M. (US);

COMBS, Andrew P. (US);

FALAHATPISHEH, Nikoo (US);

JALLURI, Ravi Kumar (US);

LEVY, Daniel (US);

POLAM, Padmaja (US);

SHAO, Lixin (US);

SHEPARD, Stacey (US);

SHVARTSBART, Artem (US);

SPARKS, Richard B. (US);

YUE, Eddy W. (US)

(74) Tamaz Shilakadze

(54) CONDENSED IMIDAZOLE DERIVATIVES
SUBSTITUTED BY TERTIARY HYDROXY
GROUPS AS PI3K-GAMMA INHIBITORS

(11) P 2023 7480 B (51) Int. Cl. (2006)
A 61 K 39/395
A 61 P 29/00
A 61 P 35/00
A 61 P 37/06

(10) AP 2022 15050 A (44) 21(600)/2022

(21) AP 2017 15050

(22) 2017 09 20

(24) 2017 09 20

(31) 62/397,752; 62/515,480

(32) 2016 09 21; 2017 06 05

(33) US; US

(86) PCT/US2017/052592, 2017 09 20

(73) ALX Oncology Inc. (US)

866 Malcolm Rd., Suite 100, Burlingame,
CA 94010, USA (US)

(72) PONS, Jaime (US);

WAN, Hong (US);

SIM, Bang Janet (US);

HARRIMAN, William Don (US);

KUO, Tracy Chia-Chien (US);

IZQUIERDO, Shelley (US);

KAUDER, Steven Elliot (US);

(74) Tamar Kochlamazashvili

(54) ANTIBODIES AGAINST SIGNAL-REGU-
LATORY PROTEIN ALPHA AND
METHODS OF USE

PART B

B 28

(11) P 2023 7485 B (51) Int. Cl. (2006)
B 28 B 1/00
C 04 B 7/02

(10) AP 2022 15412 A (44) 19(598)/2022

(21) AP 2020 15412

(22) 2020 08 20

(24) 2020 08 20

(73) Aleksey Nefedov (GE)

Avshani Str. 20, 0178, Tbilisi, Georgia (GE)

(72) Aleksey Nefedov (GE);

(74) Tamaz Shilakadze

(54) METHOD OF NANO CEMENT
PRODUCTION

PART C

C 02

(11) P 2023 7481 B (51) Int. Cl. (2006)
C 02 F 9/00
C 02 F 1/42
C 02 F 1/28
C 02 F 1/44
C 02 F 1/461

(10) AP 2022 15814 A (44) 22(601)/2022

(21) AP 2021 15814

(22) 2021 11 29

(24) 2021 11 29

(73) LTD "Aquix" (GE)

Dimitri Uznadze Str. 111, bld. 2, ap. 11

Didube District, Tbilisi, Georgia (GE)

(72) CHENTSOV, Andrey Vladimirovich (RU);

KOLOMITSEV, Alexander Viktorovich (RU);

BALYAKNO, Artyom Arturovich (RU);

KALACHEV, Andrey Urevich

(74) Shalva Gvaramadze

(54) WATER TREATMENT METHOD AND
SYSTEM

C 07

- (11) P 2023 7479 B (51) Int. Cl. (2006)
C 07 B 59/00
C 07 D 295/145
- (10) AP 2022 15377 A (44) 21(600)/2022
(21) AP 2014 15377
(22) 2014 10 17
(24) 2014 10 17
(62) AP 2014 14132 2014 10 17
(31) 13004991.9; 14175612.2
(32) 2013 10 18; 2014 07 03
(33) EP; EP
(86) PCT/EP2014/002808, 2014 10 17
(73) Deutsches Krebsforschungszentrum (DE)
Im Neuenheimer Feld 280, 69120 Heidelberg,
Germany (DE);
Ruprecht-Karls-Universität Heidelberg (DE)
Grabengasse 1, 69117 Heidelberg,
Germany (DE)
- (72) EDER, Matthias (DE);
KOPKA, Klaus (DE);
SCHÄFER, Martin (DE);
BAUDER-WÜST, Ulrike (DE);
HABERKORN, Uwe (DE);
EISENHUT, Michael (DE);
MIER, Walter (DE);
BENESOVA, Martina (DE);
KRATOCHWIL Clemens (DE)
- (74) Shalva Gvaramadze
- (54) LABELED INHIBITORS OF PROSTATE
SPECIFIC MEMBRANE ANTIGEN
(PSMA), THEIR USE AS IMAGING
AGENTS AND PHARMACEUTICAL
AGENTS FOR THE TREATMENT
OF PROSTATE CANCER

- (11) P 2023 7477 B (51) Int. Cl. (2006)
C 07 D 403/12
C 07 D 413/12
C 07 D 249/08
- (10) AP 2023 13653 A (44) 17(596)/2022
(21) AP 2013 13653
(22) 2013 05 09
(24) 2013 05 09
(31) 61/798,188; 61/644,802
(32) 2013 03 15; 2012 05 09
(33) US; US
(86) PCT/US2013/040404, 2013 05 09
(73) Biogen Ma Inc. (US)
225 Binney Street, Cambridge, 02142 MA,
USA (US)
- (72) SANDANAYAKA, Vincent, P. (US);
SHECHTER, Sharon (IL);
SHACHAM, Sharon (IL);
MCCAULEY, Dilara (US);
BALOGLU, Erkan (US)
- (74) Tamaz Shilakadze

**(54) NUCLEAR TRANSPORT MODULATORS
AND USES THEREOF**

- (11) P 2023 7484 B (51) Int. Cl. (2006)
C 07 K 16/24
- (10) AP 2022 15316 A (44) 20(599)/2022
(21) AP 2018 15316
(22) 2018 09 11
(24) 2018 09 11
(31) 17191989.7
(32) 2017 09 19
(33) EP
(86) PCT/EP2018/074522, 2018 09 11
(73) Tillotts Pharma AG (CH)
15, Baslerstrasse, 4310 Rheinfelden, Switzer-
land (CH)
- (72) FURRER, Esther Maria (CH)
- (74) Tamar Kochlamazashvili
- (54) ANTIBODY VARIANTS

PART G**G 07**

- (11) P 2023 7487 B (51) Int. Cl. (2006)
G 07 F 17/32
- (10) AP 2022 15665 A (44) 21(600)/2022
(21) AP 2019 15665
(22) 2019 10 09
(24) 2019 10 09
(31) 112840
(32) 2018 11 21
(33) BG
(86) PCT/BG2019/000023, 2019 10 09
(73) LLC "Euro Games Technology" (BG)
4, "Maritsa" Str., "Vranya-LOzen-
Triugulnika BG-1151 Sofia, Bulgaria (BG)
- (72) MIHALEVA, Ivelina Petrova (BG)
- (74) Larisa Amirkhanyan
- (54) ELECTRONIC GAMING MACHINE AND
METHOD FOR IMPLEMENTING THE
GAME PROCESS

PART H

H 04

- (11) P 2023 7488 B (51) Int. Cl. (2006)
H 04 L 9/32
- (10) AP 2022 15656 A (44) 21(600)/2022
- (21) AP 2019 15656
- (22) 2019 11 19
- (24) 2019 11 19
- (31) 2018/07754
- (32) 2018 11 19
- (33) ZA
- (86) PCT/IB2019/059924, 2019 11 19
- (73) Capitec Bank Limited (ZA)
5 Neutron Rd., Techno Park Stellenbosch
Western Cape 7600, Stellenbosch 7600,
RSA (ZA)
- (72) STEYN, Louis Johannes (ZA);
DE WET, Riaan (ZA);
CLAUSEN, Zsa-Jacques (ZA);
SMITH, Arno (ZA)
- (74) Nikoloz Gogilidze
- (54) METHOD AND SYSTEM FOR PROVIDING A TAMPER PROOF RECORD CHAIN
-

UTILITY MODELS

APPLICATION APPROVED FOR GRANTING PATENT

The decision can be appealed at the Chamber of Appeal of Sakpatenti within 3 months from the publication or at the Mtskheta District Court Administrative Cases Board (Address: №17, Samkhedro St., Mtskheta), within 1 month following the publication.

PART A

A 23

(10) AU 2023 16017 U (51) Int. Cl. (2006)

A 23 L 1/236

(21) AU 2022 16017 (22) 2022 08 03

(71) Konstantine Maghradze (GE)

Davari Str. 22, ap. 55, Tbilisi, Georgia (GE);

Nugzari Joglidze (GE)

Miminoshvili Str. 6, Tbilisi, Georgia (GE)

(72) Konstantine Maghradze (GE);

Nugzari Joglidze (GE)

(54) PRODUCT HAVING INTENSIVE
SWEETENING FEATURES

(57) A product contains a sugar, succinic acid, citric acid and/or table salt, and at least one sweetener selected from the following ingredients: stevia, acesulfame K, sucrose, neotame, advantame, erythritol, trehalose, as a sweetener.

Claims: 1 independent

1 dependent

PATENTED UTILITY MODELS
PART A**A 01**

- (11) U 2023 2147 Y (51) Int. Cl. (2006)
A 01 G 7/04
- (10) AU 2022 15752 U (44) 22(601)/2022
- (21) AU 2021 15752
- (22) 2021 10 08
- (24) 2021 10 08
- (73) Jamlet Monaselidze (GE)
Vazha-Pshavela Ave., IV qu., bld. 18, ap. 33,
0186, Tbilisi, Georgia (GE);
Eteri Ghelaghutashvili (GE)
Vazha-Pshavela Ave. 73, III qu., bld. 1b,
ap. 39, 0186, Tbilisi, Georgia (GE);
Nanuli Baghdavadze (GE)
Vazha-Pshavela Ave., IV qu., bld. 21, ap. 1,
0186, Tbilisi, Georgia (GE);
Aleksandre Ghonghadze (GE)
Irakli Abashidze St. 68, ap. 24, 0162, Tbilisi,
Georgia (GE);
Mikheil Gogebashvili (GE)
Nutsubidze St. 58, bld. 16, entr. 2, ap. 21, 0177,
Tbilisi, Georgia (GE)
- (72) Jamlet Monaselidze (GE);
Eteri Ghelaghutashvili (GE);
Nanuli Baghdavadze (GE);
Aleksandre Ghonghadze (GE);
Mikheil Gogebashvili (GE)
- (54) METHOD FOR RESISTANCE MAINTAINING AND GROWTH STIMULATING OF SPIRULINA PLATENSIS BY USAGE OF CS137 GAMMA RADIATION
-

PART C**C 13**

- (11) U 2023 2146 Y (51) Int. Cl. (2006)
C 13 K 1/00
- (10) AU 2022 15869 U (44) 21(600)/2022
- (21) AU 2022 15869
- (22) 2022 01 29
- (24) 2022 01 29
- (73) Tamar Japaridze (GE)
Chaikovsky-Chonkadze St. 9/19, Tbilisi,
Georgia (GE)
- (72) Tamar Japaridze (GE)
- (54) METHOD FOR SYRUP PREPARATION
-

DESIGNS

DESIGNS, WHICH HAVE BEEN REGISTERED WITH THE INTERNATIONAL BUREAU CLAIMING PRIORITY ON THE TERRITORY OF GEORGIA

The decision can be appealed at the Chamber of Appeal of Sakpatenti within 3 months from the publication or at the Mtskheta District Court Administrative Cases Board (Address: №17, Samkhedro St., Mtskheta), within 1 month following the publication.

- (11) DM/225 959 (51) 02-04
(15) 2022 12 19 (44) 03/2023 (2023 01 20)
(22) 2022 12 19
(28) 1
(73) Valentino S.p.A.
Via Turati 16/18, 20121 Milano (EM)
(85) –
(86) EM, IT
(87) EM, IT
(88) EM, IT
(89) EM
(81) III. AZ, EM, GB, GE, JP, KG, KR, RU, TJ, TR, UA, US
(72) Pierpaolo PICCIOLI
C/o Valentino S.p.A., Via Turati, 16/18, 20121, Milano (IT)
(74) Jacobacci & Partners S.p.A./ Matteo Mozzi
Via Senato, 8, 20121 Milano (IT)
(46) 2023 01 20
(54) 1. SHOE
(55)

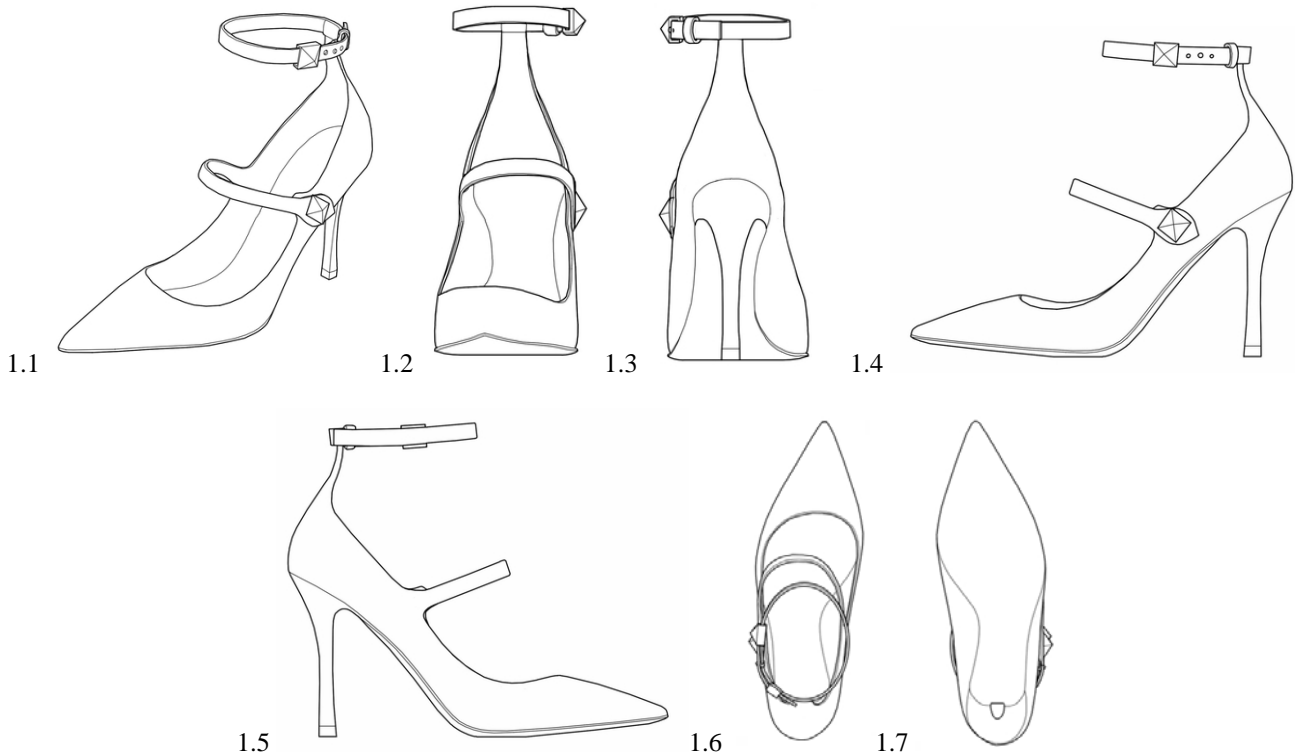

- (11) DM/225 958 (51) 03-01
(15) 2022 12 19 (44) 03/2023 (2023 01 20)
(22) 2022 12 19
(28) 1
(73) Valentino S.p.A.
Via Turati, 16/18, 20121 Milano (EM)
(85) –
(86) EM, IT
(87) EM, IT
(88) EM, IT
(89) EM
(81) III. AZ, EM, GB, GE, JP, KG, KR, RU, TJ, TR, UA, US
(72) Pierpaolo PICCIOLI
C/o Valentino S.p.A., Via Turati, 16/18, 20121, Milano (IT)
(74) Jacobacci & Partners S.p.A./ Matteo Mozzi
Via Senato, 8, 20121 Milano (IT)
(46) 2023 01 20
(54) 1. BAG
(55)

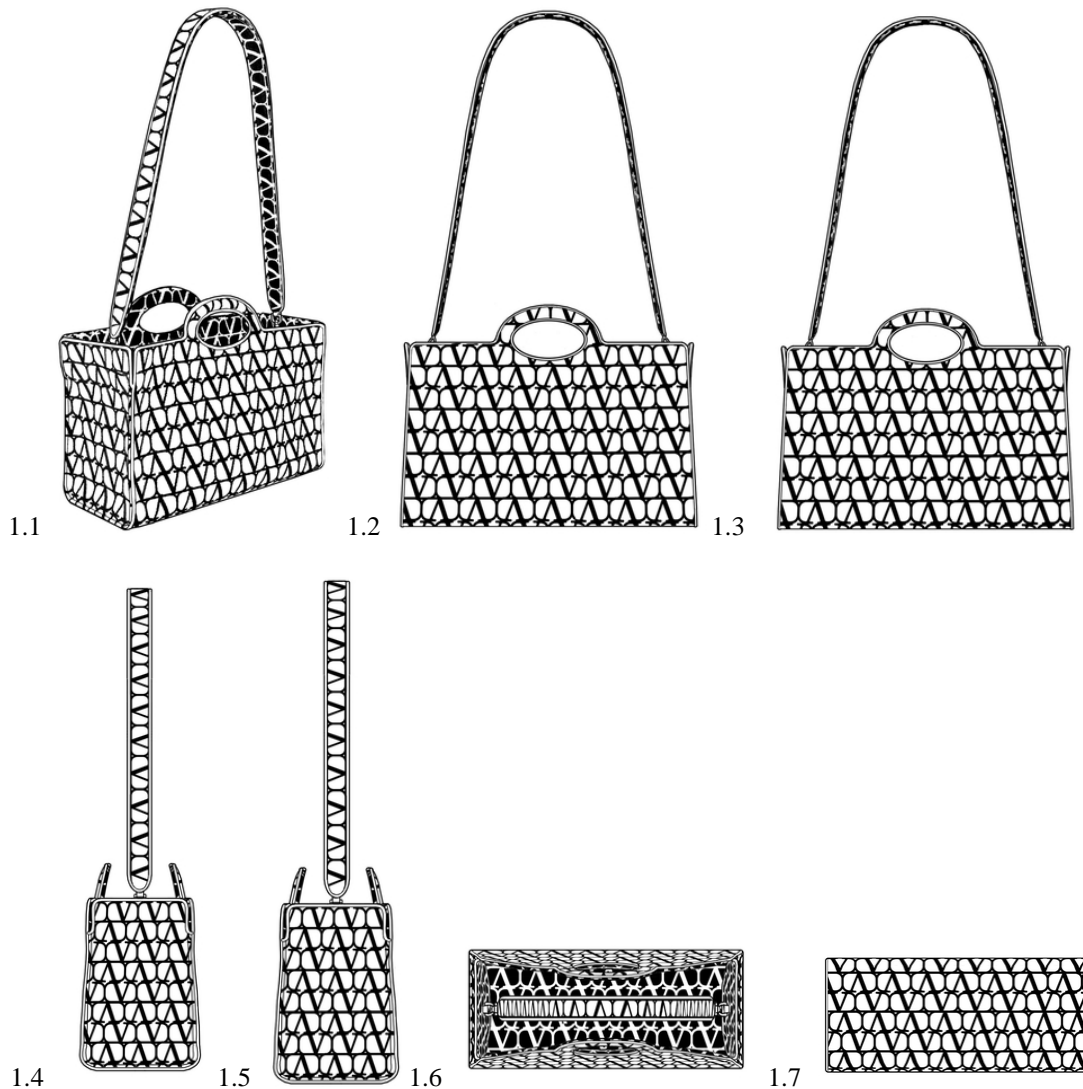

- (11) DM/225 924 (51) 21-01
 (15) 2022 12 21 (44) 03/2023 (2023 01 20)
 (22) 2022 12 21
 (28) 1
 (30) No1: 16.11.2022; 015003472-0001; EM
 (73) GUANGDONG LOONGON ANIMATION & CULTURE CO., LTD.
 East of Ning Chuan Bei Road, North of Deng Feng Road Xin Shi District Shantou, Guangdong (CN)
 (85)
 (86) CN
 (87) CN
 (88) CN
 (89) CN
 (81) III. AL, AM, AZ, BA, BN, BW, BY, BZ, CA, CH, CN, EG, GB, GE, GH, IL, IS, JM, JP, KG, KH, KP, KR, LI, MA, MC, MD, ME, MK, MN, MX, NA, NO, OA, OM, RS, RU, RW, SG, SM, SR, ST, SY, TJ, TM, TN, TR, UA, US, VN, WS
 (72) Chen Zhen Kai
 East of Ning Chuan Bei Road, North of Deng Feng Road Xin Shi District, Shantou, Guangdong (CN)
 (74) Fert, Jakubiak vel Wojtczak, Wróblewski - rzecznicy patentowi sp.p.
 Wieniawskiego 5/9/211A, 61-712 Poznań, Wielkopolskie (PL)
 (46) 2023 01 20
 (54) 1. FIGURINE [TOY]
 (55)

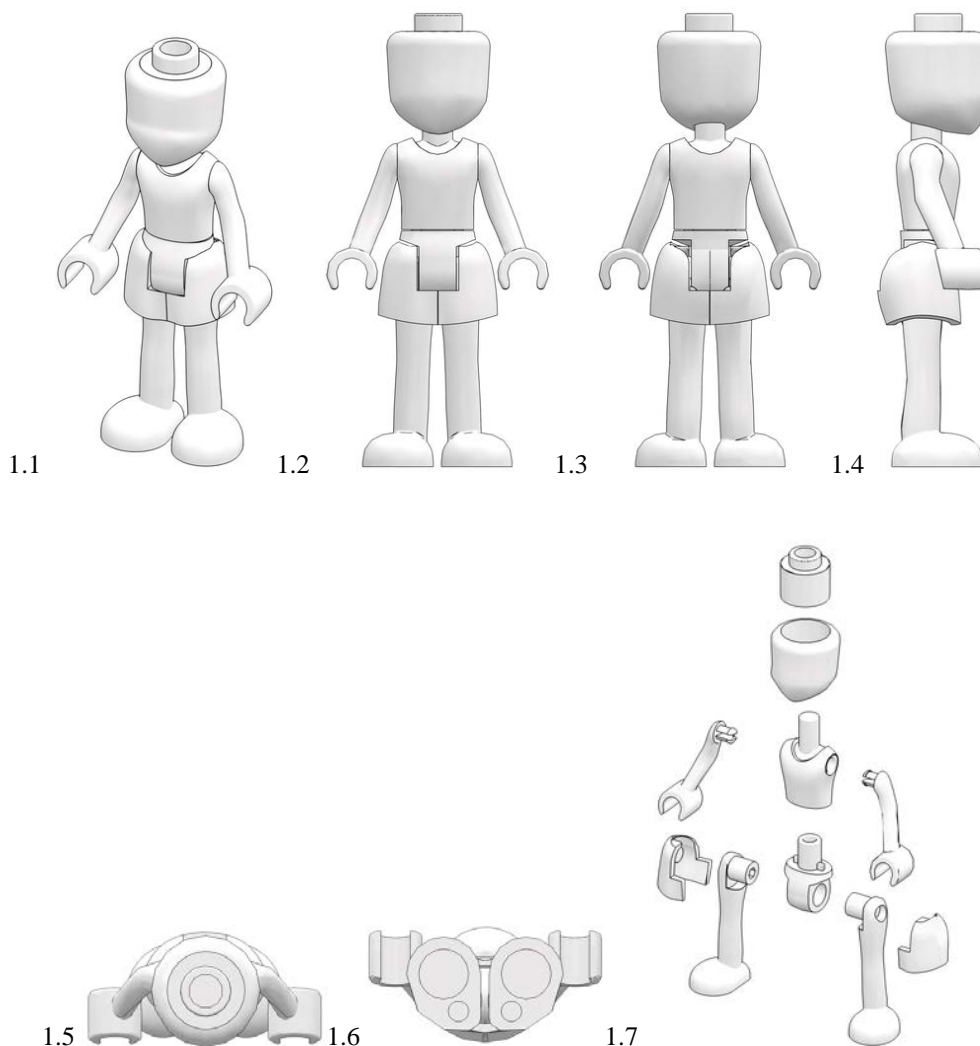

- (11) DM/225 928 (51) 21-01
- (15) 2022 12 21 (44) 03/2023 (2023 01 20)
- (22) 2022 12 21
- (28) 1
- (30) No1: 03.11.2022; 015002292-0001; EM
- (73) GUANGDONG LOONGON ANIMATION & CULTURE CO., LTD.
East of Ning Chuan Bei Road, North of Deng Feng Road Xin Shi District Shantou, Guangdong (CN)
- (85) –
- (86) CN
- (87) CN
- (88) CN
- (89) CN
- (81) III. AL, AM, AZ, BA, BN, BW, BY, BZ, CA, CH, CN, EG, GB, GE, GH, IL, IS, JM, JP, KG, KH, KP, KR, LI, MA, MC, MD, ME, MK, MN, MX, NA, NO, OA, OM, RS, RU, RW, SG, SM, SR, ST, SY, TJ, TM, TN, TR, UA, US, VN, WS
- (72) Chen Zhen Kai
East of Ning Chuan Bei Road, North of Deng Feng Road Xin Shi District, Shantou, Guangdong (CN)
- (74) Fert, Jakubiak vel Wojtczak, Wróblewski - rzecznicy patentowi sp.p.
Wieniawskiego 5/9/211A, 61-712 Poznań, Wielkopolskie (PL)
- (46) 2023 01 20
- (54) 1. FIGURINE [TOY]
- (55)

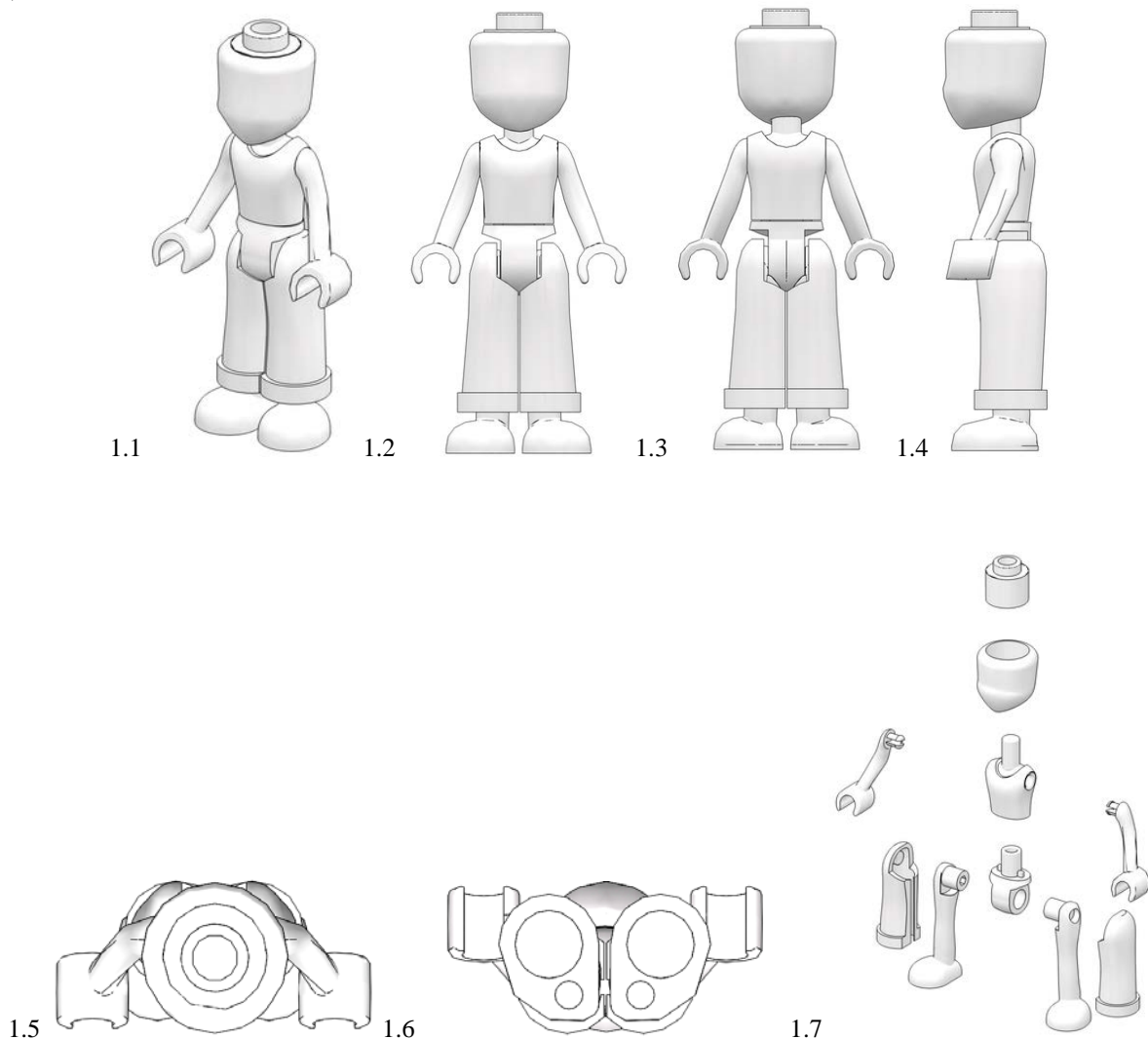

- (11) DM/220 602 (51) 09-03
(15) 2022 01 21 (44) 04/2023 (2023 01 27)
(22) 2022 01 21
(28) 2
(73) NUH'UN ANKARA MAKARNASI SANAYI VE TICARET ANONIM ŞİRKETİ
Organize Sanayi Bölgesi, Altınordu Caddesi No:1, 06935 Ankara (TR)
(85) TR
(86) TR
(87) TR
(88) –
(89) TR
(81) III. GE, US, NO, RU, IL, JP, SY, KR, UA, SG, MD, VN, TM
(72) Nihat UYSALLI
Umit Mahallesi 2437 Sokak, No: 4/3 Umitkoy Cankaya, 06810, Ankara (TR)
(74) GÖK-SEL DANIŞMANLIK VE TICARET LIMITED ŞİRKETİ
Incek, Kızılcasar Mahallesi 1209.Cadde No:3A/24, 06830 Ankara (TR)
(46) 2023 01 27
(54) 1.-2. ORNAMENTATION FOR PACKAGING
(55)

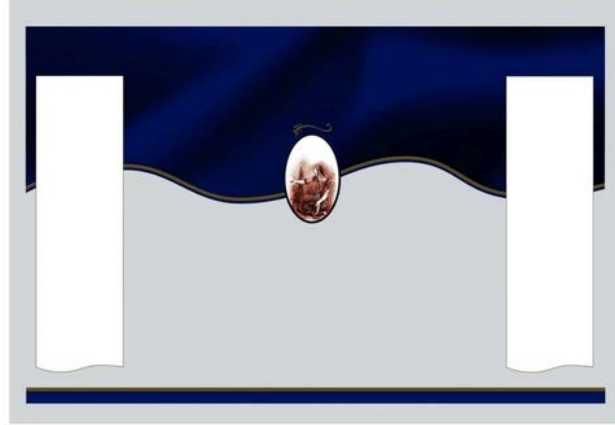

1.1



2.1

(11) DM/226 091 (51) 28-03
 (15) 2022 09 30 (44) 04/2023 (2023 01 27)
 (22) 2022 09 30
 (28) 1

(73) Beurer (Shanghai) Healthcare Product Co.,Ltd.
 Unit 2905, Baokuang Intercontinental Business Center, 100 Yutong Road, Jing'an District,
 200000 Shanghai (CN)

(85) CN
 (86) CN
 (87) CN
 (88) CN
 (89) CN

(81) III. RO, CA, OM, GE, EE, RS, NO, BG, RW, SY, DK, EM, AM, BW, TJ, MD, VN, TN, PL, SR, MN, JP,
 KR, LT, CN, UA, OA, MA, SI, BX, ME, AZ, SM, KG, WS, LI, MK, US, BA, DE, EG, FI, RU, JM, IS,
 HU, ES, BY, GB, KH, TR, ST, GH, IL, KP, CH, LV, HR, MX, AL, FR, BN, NA, SG, MC, BZ, TM

(72) Weifeng MA
 Unit 2905 Of Intercontinental Business Center, 100 Baokuang, Yutong Road, Jing'an District, 200000,
 Shanghai (CN)

(74) Yuanhe United Intellectual Property Partners
 Level 58, Fortune Financial Center, No.5 Dong SanHuan Zhong Road, Chaoyang District, 100020
 Beijing (CN)

(46) 2023 01 27
 (54) I. MASSAGE APPLIANCE
 (55)

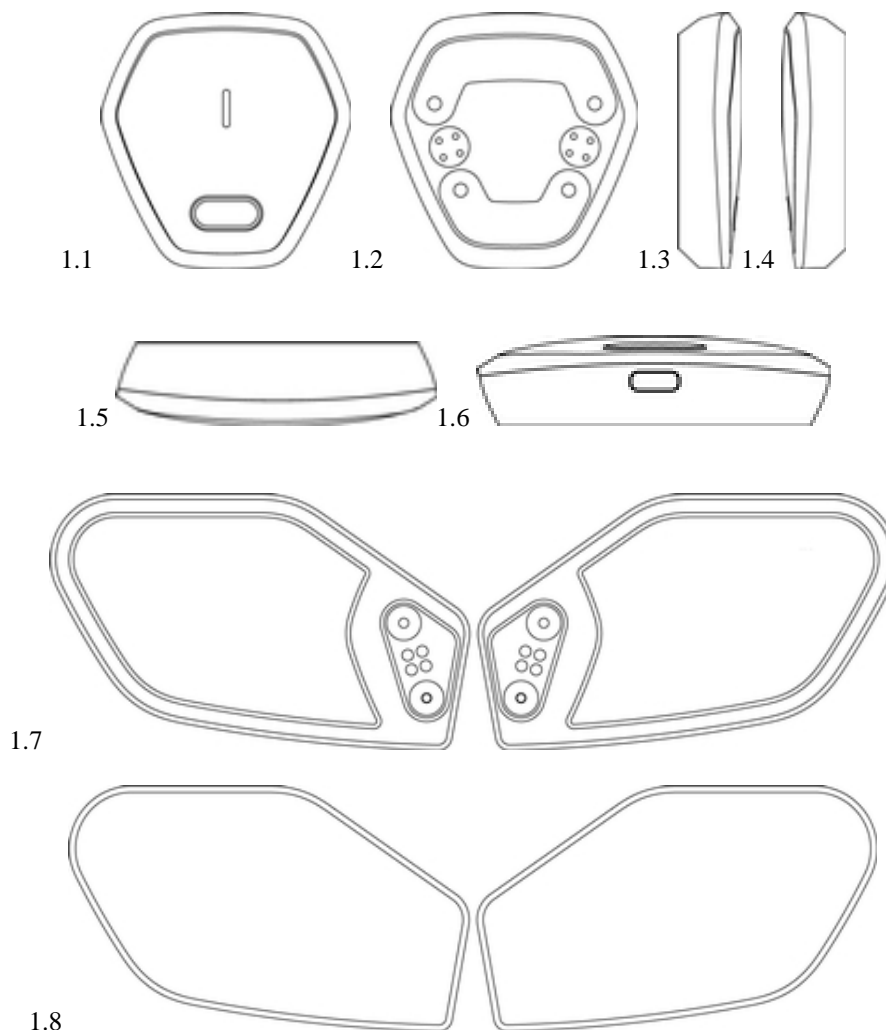

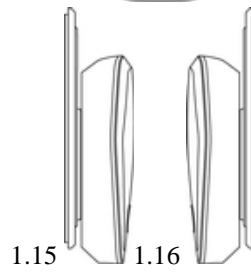
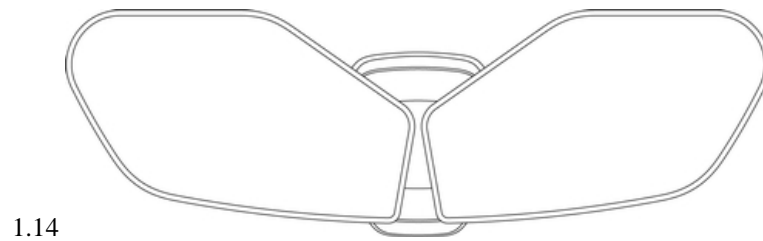
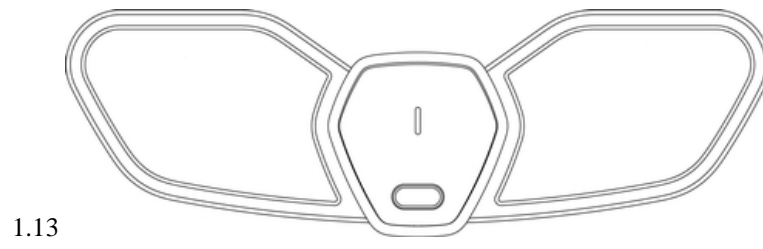
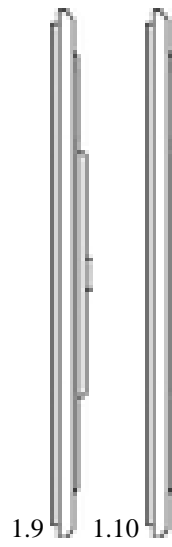

TRADEMARKS

APPLICATIONS FILED UNDER THE NATIONAL PROCEDURE APPROVED FOR REGISTRATION

The decision can be appealed at the Chamber of Appeal of Sakpatenti within 3 months from the publication or at the Mtskheta District Court Administrative Cases Board (Address: №17, Samkhedro St., Mtskheta), within 1 month following the publication.

(260) AM 2023 117550 A
(210) AM 117550
(220) 2022 04 21
(731) JSC "Kotekhi - Winery of Gurjaani"
K. Koroghlishvili Str. 38, 1500, Gurjaani,
Georgia
(740) Dimitri Dzamukashvili
(540)

საქართველოს რეზერვები
Reserves of Georgia
Резервы Грузии

(591) Black-white
(526) საქართველო Georgia Грузия
(511) 33

(260) AM 2023 118540 A
(210) AM 118540
(220) 2022 07 12
(731) Reckitt & Colman (Overseas) Hygiene Home
Limited
103-105 Bath Road, Slough, Berkshire,
SL1 3UH, United Kingdom
(740) Liliana Darakhvelidze
(540)

MORTEIN

(591) Black-white
(511) 5

(260) AM 2023 118838 A
(210) AM 118838
(220) 2022 08 01
(731) LTD "Skynet Distribution"
Vill. Akhasheni, 2th Str. 75, Gurjaani
Region, Georgia
(540)



(591) Black, red, white
(531) 26.01.18; 27.05.01; 29.01.13
(511) 9

(260) AM 2023 118927 A
(210) AM 118927
(220) 2022 08 09
(731) LTD "City Development"
Vazha-Pshavela Ave. 70. Vake District,
Tbilisi, Georgia
(540)

Cityzen
სიტიზენ
СИТИЗЕН

(591) Black-white
(511) 19, 36, 37, 42

(260) AM 2023 118928 A
(210) AM 118928
(220) 2022 08 10
(731) Obshchestvo s Ogranichennoy Otvetstven-
nostyu "Merkuriy"
ul. Komsomolskaya, 109, Mtsensk,
Orlovskaya obl., 303030, Russian Federation
(740) Giorgi Taktakishvili
(540)



(591) Yellow, orange, white, grey, black
(531) 02.09.04; 26.04.02; 26.04.14; 26.04.22;
26.04.24; 27.05.01; 27.05.24; 29.01.14
(511) 32, 33

(260) AM 2023 119004 A
 (210) AM 119004
 (220) 2022 08 16
 (731) Costa Limited
 Costa House, Houghton Hall Business Park,
 Porz Avenue, Houghton Regis, Dunstable,
 Bedfordshire, LU5 5YG, United Kingdom
 (740) Shalva Gvaramadze
 (540)

კოსტა კოფი

(591) Black-white
 (511) 7, 29, 30, 32, 43

(260) AM 2023 119014 A
 (210) AM 119014
 (220) 2022 08 17
 (731) Alkaloid AD Skopje
 Blvd. Aleksandar Makedonski 12, 1000
 Skopje, The Republic of North Macedonia
 (740) Shalva Gvaramadze
 (540)

AXSOZIL

(591) Black-white
 (511) 5

(260) AM 2023 119015 A
 (210) AM 119015
 (220) 2022 08 17
 (731) Alkaloid AD Skopje
 Blvd. Aleksandar Makedonski 12, 1000
 Skopje, The Republic of North Macedonia
 (740) Shalva Gvaramadze
 (540)

NEQLOFOL

(591) Black-white
 (511) 5

(260) AM 2023 119016 A
 (210) AM 119016
 (220) 2022 08 17
 (731) Alkaloid AD Skopje
 Blvd. Aleksandar Makedonski 12, 1000
 Skopje, The Republic of North Macedonia
 (740) Shalva Gvaramadze
 (540)

WRODIONA

(591) Black-white
 (511) 5

(260) AM 2023 119017 A
 (210) AM 119017
 (220) 2022 08 17
 (731) Alkaloid AD Skopje
 Blvd. Aleksandar Makedonski 12, 1000
 Skopje, The Republic of North Macedonia
 (740) Shalva Gvaramadze
 (540)

RISEFTIM

(591) Black-white
 (511) 5

(260) AM 2023 119018 A
 (210) AM 119018
 (220) 2022 08 17
 (731) Alkaloid AD Skopje
 Blvd. Aleksandar Makedonski 12, 1000
 Skopje, The Republic of North Macedonia
 (740) Shalva Gvaramadze
 (540)

SIFOXINA

(591) Black-white
 (511) 5

(260) AM 2023 119084 A
 (210) AM 119084
 (220) 2022 08 23
 (731) Tarasi Gagnidze
 N. Kipshidze Str. 8/24, 0162, Vake District,
 Tbilisi, Georgia
 (540)



(591) Red, white, blue, black
 (531) 01.05.02; 01.05.06; 28.19; 29.01.14
 (511) 16, 38

(260) AM 2023 119092 A
 (210) AM 119092
 (220) 2022 08 24
 (731) LLC "Fitness One"
 Vazha-Pshavela Ave. 71, Valr District,
 Tbilisi, Georgia
 (540)

**ფიტნეს ვან
 Fitness One**

(591) Black-white
 (511) 28, 41

(260) AM 2023 119099 A
 (210) AM 119099
 (220) 2022 08 24
 (731) LLC "Fitness One"
 Vazha-Pshavela Ave. 71, Valr District,
 Tbilisi, Georgia
 (540)



(591) Grey, blue, azure
 (531) 24.17.02; 26.11.08; 27.05.01; 28.19;
 29.01.12
 (511) 28, 41

(260) AM 2023 119111 A
 (210) AM 119111
 (220) 2022 08 25
 (731) Alexander Sukiashvili
 Varketili III m/r, bld. 34, ap. 27, 0182,
 Tbilisi, Georgia
 (540)



(591) Grey, dark blue
 (531) 27.01.03; 27.05.01; 27.05.22; 28.19;
 29.01.12
 (511) 14, 25, 36, 37

(260) AM 2023 119119 A
 (210) AM 119119
 (220) 2022 08 25
 (731) LLC "International Masis Tabak"
 10 Hrant Vardanyan Str., 0802, Masis,
 Ararat region, Armenia
 (740) Giorgi Taktakishvili
 (540)

ნიუ ბლექი

(591) Black-white
 (511) 34

(260) AM 2023 119122 A
 (210) AM 119122
 (220) 2022 08 25
 (731) LLC "Grand Tobacco LLC"
 22 Hrant Vardanyan Street, 0061, Yerevan,
 Armenia
 (740) Giorgi Taktakishvili
 (540)

გტ გრანდი

(591) Black-white
 (511) 34

(260) AM 2023 119125 A
 (210) AM 119125
 (220) 2022 08 25
 (731) LLC "Grand Tobacco"
 22 Hrant Vardanyan Str., 0061, Yerevan,
 Armenia
 (740) Giorgi Taktakishvili
 (540)

გარნი

(591) Black-white
 (511) 34

(260) AM 2023 119127 A
 (210) AM 119127
 (220) 2022 08 25
 (731) LLC "International Masis Tabak"
 10 Hrant Vardanyan Str., 0802, Masis,
 Ararat Region, Armenia
 (740) Giorgi Taktakishvili
 (540)

ბლექ ტიპი

(591) Black-white
 (511) 34

(260) AM 2023 119176 A
 (210) AM 119176
 (220) 2022 08 26
 (731) Vasili Babluani
 Ghrmaghele I Lane, 55, 0192, Tbilisi,
 Georgia
 (540)



(591) ED3215 red
 (531) 05.05.20; 27.05.01; 29.01.01
 (511) 29

(260) AM 2023 119178 A
 (210) AM 119178
 (220) 2022 08 26
 (731) Ana Adeishvili
 6th Street 18, Krtsanisi, Tbilisi, Georgia
 (540)



(591) FBB040 orange, 36548A blue, red, lilac,
 black, white

(531) 04.05.02; 04.05.03; 04.05.13; 26.04.03;
27.05.01; 28.19; 29.01.15
(511) 16, 18, 21, 24, 28, 35

(260) AM 2023 119194 A
(210) AM 119194
(220) 2022 08 29
(731) LTD "Nuki"
A, Razmadze Str. 52, ap. 21, 0179, Vake
District, Tbilisi, Georgia
(540)



(591) Black, white, red
(531) 26.13.01; 27.05.01; 27.05.10; 27.05.24;
29.01.13
(511) 3, 35

(260) AM 2023 119200 A
(210) AM 119200
(220) 2022 08 31
(731) Intersun Holding FZCO
Jebal Ali Free Zone, Dubai, 61051, United
Arab Emirates
(740) Mariam Gogitidze
(540)

charisma

(591) Black-white
(511) 30, 35

(260) AM 2023 119208 A
(210) AM 119208
(220) 2022 09 01
(731) LLC "Law Firm Business Legal Bureau"
Merab Kostava Str. 71a, ap. 33, 0171,
Saburtalo district, Tbilisi, Georgia
(540)



(591) EDDBA4B orange, 9B199E lilac, white
(531) 27.05.01; 27.05.10; 27.05.17; 27.05.17;
27.05.22; 27.05.23; 29.01.12
(511) 36, 45

(260) AM 2023 119209 A
(210) AM 119209
(220) 2022 09 01
(731) LLC "The Seafood Company"
Gldani, VII mcr., bld. 23, ap. 86, Tbilisi,
Georgia
(540)



(591) Emerald green, white
(531) 03.09.01; 03.09.24; 27.05.01; 27.05.09;
27.05.10; 29.01.03
(511) 43

(260) AM 2023 119210 A
(210) AM 119210
(220) 2022 09 01
(731) LLC "Law Firm Business Legal Bureau"
Merab Kostava Str. 71a, ap. 33, 0171,
Saburtalo District, Tbilisi, Georgia
(540)



(591) D8BC61 orange, white
(531) 27.05.01; 27.05.10; 27.05.19; 27.05.22;
29.01.01
(511) 45

(260) AM 2023 119211 A
(210) AM 119211
(220) 2022 09 01
(731) LTD "LB Capital"
Ilia Chavchavadze Ave. 34, shop 12A,
0107, Tbilisi, Georgia
(740) Lia Shikhiashvili;
Zurab Bezhashvili;
Ioane Iarajuli
(540)

Capri+

(591) Black-white
(511) 3

REGISTERED TRADEMARKS

(111) M 2023 36548 R
(151) 2023 03 10
(181) 2033 03 10
(260) AM 2022 117269 A
(220) 2022 03 28
(732) LTD "Kvareli Cellar"
Vill. Chikaani, 4814, Kvareli, Georgia

(111) M 2023 36549 R
(151) 2023 03 10
(181) 2033 03 10
(260) AM 2022 116420 A
(220) 2022 02 02
(732) Colgate-Palmolive Company
Delaware Corporation
300 Park Avenue, New York, NY 10022, USA

(111) M 2023 36550 R
(151) 2023 03 10
(181) 2033 03 10
(260) AM 2022 117444 A
(220) 2022 04 12
(732) Alkaloid AD Skopje
Blvd. Aleksandar Makedonski 12, Skopje,
1000, The Republic of North Macedonia

(111) M 2023 36551 R
(151) 2023 03 10
(181) 2033 03 10
(260) AM 2022 117268 A
(220) 2022 03 28
(732) LTD "Kvareli Cellar"
Vill. Chikaani, 4814, Kvareli, Georgia

(111) M 2023 36552 R
(151) 2023 03 10
(181) 2033 03 10
(260) AM 2022 117270 A
(220) 2022 03 28
(732) LTD "Kvareli Cellar"
Vill. Chikaani, 4814, Kvareli, Georgia

(111) M 2023 36553 R
(151) 2023 03 10
(181) 2033 03 10
(260) AM 2022 117271 A
(220) 2022 03 28
(732) LTD "Kvareli Cellar"
Vill. Chikaani, 4814, Kvareli, Georgia

(111) M 2023 36554 R
(151) 2023 03 10
(181) 2033 03 10
(260) AM 2022 117443 A
(220) 2022 04 12
(732) Monoprix
14-16 rue Marc Bloch, 92110 CLICHY, France

(111) M 2023 36555 R
(151) 2023 03 10
(181) 2033 03 10
(260) AM 2022 116848 A
(220) 2022 03 01
(732) LTD "Ashtel"
Frij Murari, Sadazgevo Korporacia Alain
Ahlia, Luqsi 103, Dubai, 89599, United Arab
Emirates

(111) M 2023 36556 R
(151) 2023 03 10
(181) 2033 03 10
(260) AM 2022 117179 A
(220) 2022 03 21
(732) LTD "Rich Group"
Vill. Mughanlo, Marneuli Municipality, Georgia

(111) M 2023 36557 R
(151) 2023 03 10
(181) 2033 03 10
(260) AM 2021 115593 A
(220) 2021 11 29
(732) LTD "Ninana"
Sulkhan Tsintsadze Str. 11, ap. 43, 0171,
Tbilisi, Georgia

(111) M 2023 36558 R
(151) 2023 03 10
(181) 2033 03 10
(260) AM 2022 116419 A
(220) 2022 02 02
(732) LTD "Dariani"
Vill. Tchrebalo, 0418, Ambrolauri Region,
Georgia

(111) M 2023 36559 R
(151) 2023 03 10
(181) 2033 03 10
(260) AM 2022 117320 A
(220) 2022 04 08
(732)) LTD "Agrospace"

Kalistrate Kutateladze Str. 5, ap. 45, 0179,
Tbilisi, Georgia

(111) M 2023 36560 R
(151) 2023 03 10
(181) 2033 03 10
(260) AM 2022 116986 A
(220) 2022 03 09

(732) Ape Foundation
Whitehall Chambers, 2nd Floor Whitehall
House, 238 North Church Street, P.O. Box
31489, KY1-1206, George Town, Grand
Cayman, Cayman Islands

(111) M 2023 36561 R
(151) 2023 03 10
(181) 2033 03 10
(260) AM 2022 116238 A
(220) 2022 01 18

(732) Duck Global Licensing AG (Duck Global
Licensing SA) (Duck Global Licensing Ltd)
c/o Fischer & Partner, Sonnenbergstrasse 9,
6052 Hergiswil, Switzerland

(111) M 2023 36562 R
(151) 2023 03 10
(181) 2033 03 10
(260) AM 2022 116988 A
(220) 2022 03 10

(732) Fonterra Brands (Singapore) PTE Limited
182 Cecil Street, #15-01 Frasers Tower,
Singapore 069547, Singapore

(111) M 2023 36563 R
(151) 2023 03 10
(181) 2033 03 10
(260) AM 2022 116327 A
(220) 2022 01 26

(732) S. C. Johnson & Son Inc.
1525 Howe Street, Racine, WI 53403-2236,
USA

(111) M 2023 36564 R
(151) 2023 03 10
(181) 2033 03 10
(260) AM 2022 116236 A
(220) 2022 01 18

(732) Duck Global Licensing AG (Duck Global
Licensing SA) (Duck Global Licensing Ltd)
c/o Fischer & Partner, Sonnenbergstrasse 9,
6052 Hergiswil, Switzerland

(111) M 2023 36565 R
(151) 2023 03 10
(181) 2033 03 10
(260) AM 2022 116306 A
(220) 2022 01 21

(732) LTD "Aspharma – Georgian Pharmaceutical
Company"
Mtskheta Str. 8, 0179, Tbilisi, Georgia

(111) M 2023 36566 R
(151) 2023 03 10
(181) 2033 03 10
(260) AM 2022 117281 A
(220) 2022 03 30

(732) INPHA LLP Representative office in Georgia
Nearby Besiki Str. 4, plot 46/10, 0108, Tbilisi,
Georgia

(111) M 2023 36567 R
(151) 2023 03 10
(181) 2033 03 10
(260) AM 2022 117078 A
(220) 2022 03 15

(732) Groupe Adeo
135 rue Sadi Carnot CS 00001, 59790 Ronchin,
France

(111) M 2023 36568 R
(151) 2023 03 10
(181) 2033 03 10
(260) AM 2022 116225 A
(220) 2022 01 14

(732) Levan Zhvania
Nutsbidze Plateau, III mcr., III qu., bld. 6,
ap. 15, 0183, Tbilisi, Georgia

(111) M 2023 36569 R
(151) 2023 03 10
(181) 2033 03 10
(260) AM 2022 117547 A
(220) 2022 04 20

(732) Basf SE
Carl-Bosch-Strasse 38, Ludwigshafen am
Rhein, Germany

(111) M 2023 36570 R
(151) 2023 03 10
(181) 2033 03 10
(260) AM 2022 117280 A
(220) 2022 03 30

(732) INPHA LLP Representative office in Georgia
Nearby Besiki Str. 4, plot 46/10, 0108, Tbilisi,
Georgia

(111) M 2023 36571 R
(151) 2023 03 10
(181) 2033 03 10
(260) AM 2022 116305 A
(220) 2022 01 21
(732) LTD "Aspharma – Georgian Pharmaceutical Company"
Mtskheta Str. 8, 0179, Tbilisi, Georgia

(111) M 2023 36577 R
(151) 2023 03 10
(181) 2033 03 10
(260) AM 2022 117290 A
(220) 2022 03 30
(732) LTD "Impexpharm"
Giorgi Saakadze Str., II Exit 17, 0160, Tbilisi, Georgia

(111) M 2023 36572 R
(151) 2023 03 10
(181) 2033 03 10
(260) AM 2022 116950 A
(220) 2022 03 04
(732) Nissan Jidosha Kabushiki Kaisha
(Also Trading As Nissan Motor Co., LTD.)
No.2, Takara-cho, Kanagawa-ku, Yokohama-shi, Kanagawa-ken, Japan

(111) M 2023 36578 R
(151) 2023 03 10
(181) 2033 03 10
(260) AM 2022 117174 A
(220) 2022 03 19
(732) Ne-Saç Tekstil Sanayi Ve Ticaret Limited Şirketi
Atatürk Mahallesi, G531 Sokak No:24
Esenyurt – İstanbul, Türkiye

(111) M 2023 36573 R
(151) 2023 03 10
(181) 2033 03 10
(260) AM 2022 117439 A
(220) 2022 04 12
(732) LLC "The Khachapuri Company"
Lalioni Lane 4a, Tbilisi, Georgia

(111) M 2023 36579 R
(151) 2023 03 10
(181) 2033 03 10
(260) AM 2022 117163 A
(220) 2022 03 18
(732) LTD "Nido"
Kavsadze Str. 4, ap. 19, 0168, Tbilisi, Georgia

(111) M 2023 36574 R
(151) 2023 03 10
(181) 2033 03 10
(260) AM 2022 117199 A
(220) 2022 03 24
(732) H. Lundbeck A/S
Ottiliavej 9, Valby, 2500, Denmark

(111) M 2023 36581 R
(151) 2023 03 10
(181) 2033 03 10
(260) AM 2022 117294 A
(220) 2022 04 03
(732) Meta Platforms Inc.
1601 Willow Road, Menlo Park, California, 94025, USA

(111) M 2023 36575 R
(151) 2023 03 10
(181) 2033 03 10
(260) AM 2022 117187 A
(220) 2022 03 22
(732) LTD "Hungry"
Dighomi, IV qu., bld. 18, ap. 52, 0159, Didube District, Tbilisi, Georgia

(111) M 2023 36592 R
(151) 2023 03 16
(181) 2033 03 16
(260) AM 2022 116252 A
(220) 2022 01 20
(732) Chongqing Qiulong Technology Co., LTD
No.259 Shimiancun, Qiezixi Residential District, Dadukou District, 400000, Chongqing, People Republic of China

(111) M 2023 36576 R
(151) 2023 03 10
(181) 2033 03 10
(260) AM 2022 117265 A
(220) 2022 03 28
(732) LTD "Impexpharm"
Giorgi Saakadze Str., II Exit 17, 0160, Tbilisi, Georgia

(111) M 2023 36593 R
(151) 2023 03 16
(181) 2033 03 16
(260) AM 2022 116408 A
(220) 2022 01 31
(732) JSC "Progress Energy Group"
M. Tamarashvili Str. 13o, ap. 227, 0177, Tbilisi, Georgia

(111) M 2023 36594 R
(151) 2023 03 16
(181) 2033 03 16
(260) AM 2022 116521 A
(220) 2022 02 04
(732) JSC "Gefa"
Akaki Beliashvili Str. 142, 0159, Tbilisi,
Georgia

(111) M 2023 36595 R
(151) 2023 03 16
(181) 2033 03 16
(260) AM 2022 117302 A
(220) 2022 04 04
(732) Anri Chanchibadze
Mukha Str. 1, ap. 4, Tbilisi, Georgia

(111) M 2023 36596 R
(151) 2023 03 16
(181) 2033 03 16
(260) AM 2022 117273 A
(220) 2022 03 29
(732) JSC "Kotekhi-Gurjaani Winery"
K. Koroghlishvili Str. 38, 1500, Gurjaani,
Georgia

(111) M 2023 36597 R
(151) 2023 03 16
(181) 2033 03 16
(260) AM 2021 115883 A
(220) 2021 12 22
(732) LTD "Mandarin Club House"
Parnavaz Mepe Str. 74, floor 2, ap. 10, Batumi
Georgia

(111) M 2023 36598 R
(151) 2023 03 16
(181) 2033 03 16
(260) AM 2022 116407 A
(220) 2022 01 31
(732) LLC "Multiverse"
Merab Kostava Str. 59, Tbilisi, Georgia

(111) M 2023 36599 R
(151) 2023 03 16
(181) 2033 03 16
(260) AM 2022 116250 A
(220) 2022 01 20
(732) RK "Winery Bakhtrioni"
Vill. Atskuri, Akhmeta, Georgia

(111) M 2023 36600 R
(151) 2023 03 16
(181) 2033 03 16
(260) AM 2022 116669 A
(220) 2022 02 17
(732) Foshan Dingzhineng Technology Co., LTD
No.3,4F, Yitai Industrial Building, Lianfeng
Industrial Area, Zhoucun, Lishui Town, Nanhai
District, Foshan City, Guangdong, 528244,
People Republic of China

(111) M 2023 36601 R
(151) 2023 03 16
(181) 2033 03 16
(260) AM 2022 116147 A
(220) 2022 01 10
(732) Riot Games Inc.
12333 W. Olympic Blvd., Los Angeles,
CA 90064, USA

(111) M 2023 36602 R
(151) 2023 03 16
(181) 2033 03 16
(260) AM 2022 117557 A
(220) 2022 04 21
(732) Vivo Mobile Communication Co., LTD
N1 Vivo Road, Chang'an, Dongguan,
Guangdong, 0100, People Republic of China

(111) M 2023 36603 R
(151) 2023 03 16
(181) 2033 03 16
(260) AM 2022 117559 A
(220) 2022 04 21
(732) Sopharma AD
16, Iliensko shose str., Sofia, BG-1220, Bulgaria

(111) M 2023 36604 R
(151) 2023 03 16
(181) 2033 03 16
(260) AM 2022 117166 A
(220) 2022 03 18
(732) LTD "Arcon"
Vakhtang Gorgasali Str. 51-53, 0114, Krtsanisi
District, Tbilisi, Georgia

(111) M 2023 36605 R
(151) 2023 03 16
(181) 2033 03 16
(260) AM 2022 117314 A
(220) 2022 04 05
(732) TD "Impost"
N. Kipshidze Str. 7g, ap. 12b, 0162, Vake
District, Tbilisi, Georgia

(111) M 2023 36606 R
 (151) 2023 03 16
 (181) 2033 03 16
 (260) AM 2022 117823 A
 (220) 2022 05 17
 (732) Beijing Masking Technology
 Development Co., Ltd.
 No.1, 3F, Building 9 No.14 Maliandao Road
 Xicheng District, Beijing, 100056, People's
 Republic of China

(111) M 2023 36607 R
 (151) 2023 03 16
 (181) 2033 03 16
 (260) AM 2022 116851 A
 (220) 2022 03 02
 (732) Bagi Professional Cleaning Products LTD
 194 Akko Road, Kiriat Bialik 27232, Israel

(111) M 2023 36608 R
 (151) 2023 03 16
 (181) 2033 03 16
 (260) AM 2022 116855 A
 (220) 2022 03 02
 (732) Bagi Professional Cleaning Products LTD
 194 Akko Road, Kiriat Bialik 27232, Israel

(111) M 2023 36609 R
 (151) 2023 03 16
 (181) 2033 03 16
 (260) AM 2022 116856 A
 (220) 2022 03 02
 (732) Bagi Professional Cleaning Products LTD
 194 Akko Road, Kiriat Bialik 27232, Israel

(111) M 2023 36610 R
 (151) 2023 03 16
 (181) 2033 03 16
 (260) AM 2022 116858 A
 (220) 2022 03 02
 (732) Bagi Professional Cleaning Products LTD
 194 Akko Road, Kiriat Bialik 27232, Israel

(111) M 2023 36611 R
 (151) 2023 03 16
 (181) 2033 03 16
 (260) AM 2022 116860 A
 (220) 2022 03 02
 (732) Bagi Professional Cleaning Products LTD
 194 Akko Road, Kiriat Bialik 27232, Israel

(111) M 2023 36612 R
 (151) 2023 03 16
 (181) 2033 03 16
 (260) AM 2022 117102 A
 (220) 2022 03 17
 (732) Bagi Professional Cleaning Products LTD
 194 Akko Road, Kiriat Bialik 27232, Israel

(111) M 2023 36613 R
 (151) 2023 03 16
 (181) 2033 03 16
 (260) AM 2022 117418 A
 (220) 2022 04 11
 (732) Tsitadeli
 Didi Dighomi, Demetre Tavidadbuli Str. 16,
 ap. 50, 0131, Saburtalo District, Tbilisi, Georgia

(111) M 2023 36614 R
 (151) 2023 03 16
 (181) 2033 03 16
 (260) AM 2022 117457 A
 (220) 2022 04 14
 (732) Paata Aroshidze
 Vill. Tskhemliskhidi, Ozurgeti, Georgia

(111) M 2023 36615 R
 (151) 2023 03 16
 (181) 2033 03 16
 (260) AM 2022 117530 A
 (220) 2022 04 18
 (732) LLC "Royal Home Luxury"
 Rustavi Highway 19, bld. 3, Storeroom,
 Floor 1, Tbilisi, Georgia

(111) M 2023 36616 R
 (151) 2023 03 16
 (181) 2033 03 16
 (260) AM 2022 117536 A
 (220) 2022 04 19
 (732) LLC "LB Group"
 Ilia Chavchavadze Ave. 34, 0108, Vake District,
 Tbilisi, Georgia

(111) M 2023 36617 R
 (151) 2023 03 16
 (181) 2033 03 16
 (260) AM 2022 117617 A
 (220) 2022 04 27
 (732) LTD "Multitest"
 Vill. Dighomi, Davit Aghmashenebeli Str. 35,
 Tbilisi, Georgia

(111) M 2023 36618 R
(151) 2023 03 16
(181) 2033 03 16
(260) AM 2022 117307 A
(220) 2022 04 04
(732) Bilim İlaç Sanayi Ve Ticaret Anonim Şirketi
Kaptanpasa Mahallesi, Zincirlikuyu Caddesi,
No:184 Beyoglu, Istanbul, Türkiye

(111) M 2023 36624 R
(151) 2023 03 16
(181) 2033 03 16
(260) AM 2022 117452 A
(220) 2022 04 13
(732) LLC "Rosali Sambar"
Osip Mandelstam Str. 2a, Shopping Area 6,
floor 2, Tbilisi, Georgia

(111) M 2023 36619 R
(151) 2023 03 16
(181) 2033 03 16
(260) AM 2022 117534 A
(220) 2022 04 19
(732) LTD "Rich Group"
Vill. Mughanlo, Marneuli Region, Georgia

(111) M 2023 36625 R
(151) 2023 03 16
(181) 2033 03 16
(260) AM 2022 117714 A
(220) 2022 05 06
(732) LLC "Global Assistance Georgia"
Merab Kostava Str. 67, 0171, Tbilisi, Georgia

(111) M 2023 36620 R
(151) 2023 03 16
(181) 2033 03 16
(260) AM 2022 117535 A
(220) 2022 04 19
(732) LTD "Rich Group"
Vill. Mughanlo, Marneuli Region, Georgia

(111) M 2023 36626 R
(151) 2023 03 16
(181) 2033 03 16
(260) AM 2021 114977 A
(220) 2021 10 15
(732) British American Tobacco (Brands) Inc.
(a Delaware Corporation)
251 Little Falls Drive, Suite 100, Wilmington,
Delaware, 19808-1674, USA

(111) M 2023 36621 R
(151) 2023 03 16
(181) 2033 03 16
(260) AM 2022 117546 A
(220) 2022 04 20
(732) Chung Pak Investment Limited
Unit B, 2/F., Wah Shun Industrial Building,
4 Cho Yuen Street, Yau Tong, Kowloon,
Hong Kong

(111) M 2023 36627 R
(151) 2023 03 16
(181) 2033 03 16
(260) AM 2021 114804 A
(220) 2021 10 05
(732) British American Tobacco (Brands) Limited
Globe House, 4 Temple Place, London,
WC2R 2PG, United Kingdom

(111) M 2023 36622 R
(151) 2023 03 16
(181) 2033 03 16
(260) AM 2022 117446 A
(220) 2022 04 12
(732) LLC "Chateau Kingstown"
Gr. Peradze Str. 22a, Tbilisi, Georgia

(111) M 2023 36628 R
(151) 2023 03 16
(181) 2033 03 16
(260) AM 2022 116514 A
(220) 2022 02 04
(732) Duck Global Licensing AG
(Duck Global Licensing SA)
(Duck Global Licensing LTD)
c/o Fischer & Partner, Sonnenbergstrasse 9,
6052 Hergiswil, Switzerland

(111) M 2023 36623 R
(151) 2023 03 16
(181) 2033 03 16
(260) AM 2022 117447 A
(220) 2022 04 12
(732) LLC "Chateau Kingstown"
Gr. Peradze Str. 22a, Tbilisi, Georgia

(111) M 2023 36629 R
(151) 2023 03 16
(181) 2033 03 16
(260) AM 2022 116513 A
(220) 2022 02 04
(732) (Duck Global Licensing SA)
(Duck Global Licensing LTD)

c/o Fischer & Partner, Sonnenbergstrasse 9, 6052 Hergiswil, Switzerland	(111) M 2023 36636 R (151) 2023 03 16 (181) 2033 03 16 (260) AM 2022 117066 A (220) 2022 03 14 (732) LTD "IDS Borjomi Beverages Co.N.V." Pareraweg 45, Curaçao
(111) M 2023 36630 R (151) 2023 03 16 (181) 2033 03 16 (260) AM 2022 117427 A (220) 2022 04 11 (732) LTD "Mermisi" Davit Aghmashenebeli Ave. 142, Tbilisi, Georgia	(111) M 2023 36637 R (151) 2023 03 16 (181) 2033 03 16 (260) AM 2022 116415 A (220) 2022 02 02 (732) Melory Tsipouria 1642 Myra Ct, Chula Vista, CA 91911, USA
(111) M 2023 36631 R (151) 2023 03 16 (181) 2033 03 16 (260) AM 2022 117426 A (220) 2022 04 11 (732) LTD "Mermisi" Davit Aghmashenebeli Ave. 142, Tbilisi, Georgia	(111) M 2023 36638 R (151) 2023 03 16 (181) 2033 03 16 (260) AM 2022 116640 A (220) 2022 02 14 (732) PPG Industries Ohio Inc. 3800 West 143rd Street, Cleveland, State of Ohio 44111, USA
(111) M 2023 36632 R (151) 2023 03 16 (181) 2033 03 16 (260) AM 2022 117425 A (220) 2022 04 11 (732) LTD "Mermisi" Davit Aghmashenebeli Ave. 142, Tbilisi, Georgia	(111) M 2023 36639 R (151) 2023 03 16 (181) 2033 03 16 (260) AM 2022 117423 A (220) 2022 04 11 (732) LTD "Mermisi" Davit Aghmashenebeli Ave. 142, Tbilisi, Georgia
(111) M 2023 36633 R (151) 2023 03 16 (181) 2033 03 16 (260) AM 2022 117424 A (220) 2022 04 11 (732) LTD "Mermisi" Davit Aghmashenebeli Ave. 142, Tbilisi, Georgia	
(111) M 2023 36634 R (151) 2023 03 16 (181) 2033 03 16 (260) AM 2022 117533 A (220) 2022 04 19 (732) LLC "Wings" Iliia Chavchavadze Ave. 37m, floor 19, ap. 56, Tbilisi, Georgia	
(111) M 2023 36635 R (151) 2023 03 16 (181) 2033 03 16 (260) AM 2022 116416 A (220) 2022 02 02 (732) General Motors LLC 300 Renaissance Center, City of Detroit, State of Michigan 48265-3000, USA	

TRADEMARKS REGISTERED ACCORDING TO THE ACCELERATED PROCEDURE

The decision can be appealed at the Chamber of Appeal of Sakpatenti within 3 months from the publication.

(111) M 2023 36580 R

(151) 2023 03 10

(181) 2033 03 10

(210) AM 121719

(220) 2023 02 17

(732) LTD "Geo Designers"

Davit Agmashenebeli Alley 3, ap. 52, Tbilisi,
Georgia

(740) Giorgi Taktakishvili

(540)

GEORGIAN DESIGNERS  ქართული დიზაინერები

(591) Black-white

(531) 26.04.02; 26.04.22; 26.04.24; 27.05.01;
27.05.22; 27.05.24

(511) 35

(111) M 2023 36582 R

(151) 2023 03 13

(181) 2033 03 13

(210) AM 121727

(220) 2023 02 20

(732) LLC "Geo Telemedicine"

Gamrekeli Str. 19, Commercial Space,
floor 2, 0160, Tbilisi, Georgia

(540)



(591) White, black, 02B8A2 green

(531) 04.05.04; 16.01.04; 16.01.05; 16.01.11;
16.03.13; 19.13.22; 28.19; 29.01.13

(511) 44

(111) M 2023 36583 R

(151) 2023 03 13

(181) 2033 03 13

(210) AM 121664

(220) 2023 02 16

(732) LLC "UG Lubricants"

Avtomshenebeli Str. 88 (Free Industrial
Zone), Kutaisi, Georgia

(540)



LUBRICANTS

(591) White, turquoise, black

(531) 15.07.01; 15.07.03; 15.07.04; 27.03.15;
27.05.01; 29.01.12

(511) 4

(111) M 2023 36584 R

(151) 2023 03 13

(181) 2033 03 13

(210) AM 121726

(220) 2023 02 20

(732) LTD "Bolero & Company"

Kuchishvili Str. 12-14-16, Tbilisi, Georgia

(540)

კნეინა

KNEINA

КНЕИНА

(591) Black-white

(511) 33

(111) M 2023 36585 R

(151) 2023 03 16

(181) 2033 03 16

(210) AM 121534

(220) 2023 02 09

(732) LTD "Bum Group"

Tengiz Chantladze Str., I Lane 14, Samgori
District, Tbilisi, Georgia

(540)

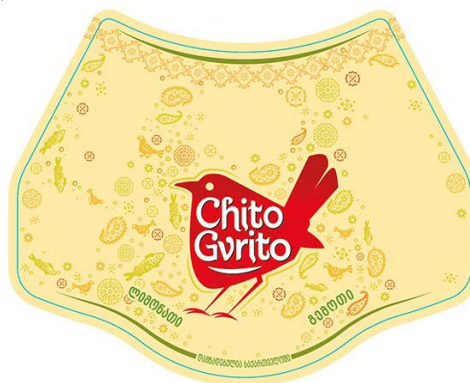

(591) Dark red, light red, white, black, yellow, dark green, light green, light brown
 (531) 03.07.03; 03.07.13; 25.01.09; 25.01.10; 25.01.15; 25.07.25; 29.01.15
 (511) 32

(111) M 2023 36586 R
 (151) 2023 03 16
 (181) 2033 03 16
 (210) AM 121751
 (220) 2023 02 21
 (732) LTD "Elite Group"
 Kakheti Lane, Tbilisi, Georgia
 (540)

Artizan
არტიზანი

(591) Black-white
 (511) 43

(111) M 2023 36587 R
 (151) 2023 03 16
 (181) 2033 03 16
 (210) AM 121755
 (220) 2023 02 21
 (732) LLC "Green Town Development"
 Gr. Robakidze Ave. 7, bld. 5, ap. 23, Didube District, Tbilisi, Georgia
 (540)



(591) White, green
 (531) 26.04.02; 26.04.09; 26.15.11; 26.15.13; 27.05.01; 27.05.10; 27.05.11; 28.19; 29.01.12
 (511) 37

(111) M 2023 36588 R
 (151) 2023 03 16
 (181) 2033 03 16
 (210) AM 121743
 (220) 2023 02 21
 (732) Nunu Mchedlishvili

Agaraki Str. 14, Vill. Agaraki, Vake District, Tbilisi, Georgia
 (740) Giorgi Taktakishvili
 (540)



(591) Black-white
 (531) 01.01.02; 01.01.09; 26.02.03; 27.05.01; 27.05.10
 (511) 29, 30, 35

(111) M 2023 36589 R
 (151) 2023 03 16
 (181) 2033 03 16
 (210) AM 121750
 (220) 2023 02 21
 (732) LTD "GeoCrown"
 Rapael Agladze Str. 32, Tbilisi, Georgia
 (540)



(591) Red, black, white, blue, purple, yellow, green, orange
 (531) 01.15.05; 07.01.09; 20.01.05; 25.01.15; 25.01.18; 27.05.01; 27.05.10; 27.05.11; 27.05.24; 29.01.15
 (511) 2

(111) M 2023 36590 R
 (151) 2023 03 16
 (181) 2033 03 16
 (210) AM 121765
 (220) 2023 02 22
 (732) Nino Macharashvili
 Ilia Chavchavadze Ave. 49E, 0179, Tbilisi Georgia;
 Gvantsa Macharashvili
 Kavtiskhevi Str. 11a, 0180, Tbilisi, Georgia
 (540)

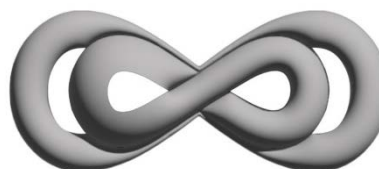

(591) Black-white
 (531) 09.01.10; 09.03.13; 24.17.08
 (511) 14, 16, 18, 20, 21, 24, 25, 26, 35, 44

(111) M 2023 36591 R

(151) 2023 03 16

(181) 2033 03 16

(210) AM 121649

(220) 2023 02 14

(732) LTD "Eco Clean Service"

Gldani, II mcr., bld. 29a, ap. 72a, 0167,

Tbilisi, Georgia

(540)



(591) Transitional tones of green and blue

(531) 24.17.02; 26.15.01; 28.19; 29.01.12

(511) 37

INTERNATIONAL TRADEMARKS FOR WHICH A DECISION ON GRANTING PROTECTIONS IS TAKEN

The decision can be appealed at the Chamber of Appeal of Sakpatenti within 3 months from the publication or at the Mtskheta District Court Administrative Cases Board (Address: №17, Samkhedro St., Mtskheta), within 1 month following the publication.

(260) AM 2023 113086 A*
 (800) 1592700
 (151) 2021 04 09
 (891) 2021 04 09
 (731) PHILOSYS CO., LTD.
 28-5, Gwangwol-gil, Okgu-eup, Gunsan-si,
 Jeollabuk-do, Republic of Korea
 (540)

Gmate

(591) Black, white
 (511)
 10 – Electric massage apparatus for household use; medical instruments for application on animal bodies; lancets; medical apparatus and instruments; medical clothing; sanitary masks for medical purposes; gloves for medical purposes; support bandages for medical purposes; diagnostic apparatus for medical purposes; apparatus for blood tests [for medical use]; insulin pens; insulin pen needle; dental apparatus and instruments; contraceptive apparatus; blood glucose testing apparatus; devices for measuring blood sugar; capillary tubes for blood; apparatus for taking blood; blood ketone measuring instruments; blood cholesterol measuring instruments.

(260) AM 2023 114834 A*
 (800) 1616766
 (151) 2021 05 03
 (891) 2021 05 03
 (731) Harry Winston SA
 Chemin du Tourbillon 8, CH-1228 Plan-les-
 Ouates, Switzerland
 (540)

JEWELS THAT TELL TIME

(591) Black, white
 (511)
 14 – Jewelry, namely bracelets; parts and accessories, namely hands, anchors, pendulums, barrels, watch cases, watch bracelets, watch dials, clockworks, watch chains, movements for timepieces, watch springs, watch glasses, presentation cases for timepieces, cases for timepieces.

(260) AM 2023 114870 A*
 (800) 1617939
 (151) 2021 03 31
 (891) 2021 03 31
 (731) Stropus Ltd.
 7-9 Riga Fereou, Lizantia Court, office 310,
 Agioi Omologites, CY-1087 Nicosia, Cyprus
 (540)



WINFINITY

(591) Black, white
 (531) 09.01.10; 16.03.13; 24.17.08; 26.04.03;
 26.04.09; 27.05.01
 (511)
 41 – language interpreter services.

(260) AM 2023 115270 A*
 (800) 1624046
 (151) 2021 05 20
 (891) 2021 05 20
 (731) Wolt Enterprises Oy
 Arkadiankatu 6, FI-00100 Helsinki, Finland
 (540)



(591) Blue and white
 (531) 26.01.03; 26.01.18; 27.05.24; 29.01.12
 (511)
 9 – Application software; web application software; software and applications for mobile devices; downloadable applications for mobile devices; ordering and delivery software; software for courier services; payment software; e-commerce and e-payment software; online payment software; retail software; downloadable software in the nature of a mobile application for product delivery and ordering; software for ordering of transport services; downloadable computer softwa-

re application for engaging and coordinating transportation, delivery and courier services.

42 – Design and development of computer hardware and software; software development, programming and implementation; software engineering; maintenance of computer software; development of computer software application solutions; development and design of mobile applications; software as a service [SaaS]; software as a service [SaaS] featuring a software for online ordering services; software as a service [SaaS] featuring a software for delivery services; software as a service [SaaS] featuring a software for food delivery services; platform as a service [PaaS]; platform as a service [PaaS] featuring a software for online ordering services; platform as a service [PaaS] featuring a software for delivery services; platform as a service [PaaS] featuring a software for food delivery services; all aforementioned services relating to food, retail products, groceries, restaurants, grocery stores, online ordering services, online marketplaces, retail services, and delivery and transport services.

(260) AM 2023 117001 A

(800) 1648736

(151) 2021 10 07

(891) 2021 10 07

(731) Euro Games Technology Ltd.

4, "Maritsa" Str., "Vranya-Lozen-Triugulnika",
BG-1151 Sofia, Bulgaria

(540)



(591) Purple, yellow, orange, brown and red

(531) 24.05.01; 27.05.02; 28.03; 29.01.15

(511)

9 – Software; computer gaming software; computer software packages; computer operating system software; computer software, recorded; software drivers; virtual reality software; games software; entertainment software for computer games; computer programs for network management; operating computer software for main frame computers; monitors (computer hardware); computer hardware; apparatus for recording images; monitors (computer programs); computer game programs; computer programs for recorded games; apparatus for recording, transmission or reproduction of sound or images; communications servers [computer hardware]; electronic components for gambling machines; computer application software featuring games and gaming; computer software for the administration of on-line games and gaming; computer hardware for games and gaming; hardware and software for gambling, gambling machines, gambling

games on the Internet and via telecommunication network.

28 – Gaming machines for gambling; chips for gambling; mah-jong; arcade games; gambling machines operating with coins, notes and cards; games; electronic games; parlor games; gaming chips; gaming tables; slot machines [gaming machines]; LCD game machines; slot machines and gaming devices; coin-operated amusement machines; roulette chips; poker chips; chips and dice [gaming equipment]; equipment for casinos; roulette tables; gaming roulette wheels; casino games; automats and gambling machines; coin-operated machines and/or electronic coin-operated machines with or without the possibility of gain; boxes for coin-operated machines, slot machines and gaming machines; electronic or electrotechnical gaming devices, automats and machines, coin-operated machines; housings for coin-operated machines, gaming equipment, gaming machines, machines for gambling; electropneumatic and electrical gambling machines (slot machines).

41 – Gambling; services related to gambling; gaming services for entertainment purposes; casino, gaming and gambling services; training in the development of software systems; provision of gaming equipment for gambling halls; providing casino equipment [gambling]; gaming machine entertainment services; providing casino facilities [gambling]; halls with gaming machines; amusement arcade services; games equipment rental; rental of gaming machines; providing amusement arcade services; rental of gaming machines with images of fruits; editing or recording of sounds and images; sound recording and video entertainment services; hire of sound reproducing apparatus; provision of gaming equipment for casinos; providing of casino facilities; online gambling services; casino management services; operation of gaming establishments, gaming halls, internet casinos, online gambling sites.

(260) AM 2023 117798 A

(800) 1635903

(151) 2021 07 12

(891) 2022 01 13

(731) SOS-Kinderdorf

Stafflerstraße 10a, A-6020 Innsbruck, Austria

(540)

SOS CHILDREN'S VILLAGES

(591) Black, white

(511)

36 – Collecting donations, including donations in kind and monetary donations; fundraising and financial sponsorship; arranging charitable collections [for others]; management of collected funds; financial affairs, in particular financial sponsorship.

41 – Organising and conducting lotteries; entertainment services; sporting and cultural activities; education, providing of training and tuition, in particular of children and young adults; provision of educational and entertainment services for children and young adults in after school centers; providing establishments for the care of children and young adults; operating family-type accommodation units [education]; education and training of foster mothers and foster fathers in connection with the operation and supervision of communal accommodation; arranging information meetings in the field of education; arranging and conducting meetings, seminars and exhibitions for cultural and educational purposes.

43 – Providing food and drink and temporary accommodation for guests; providing food and drink and temporary accommodation for needy persons [charitable services]; operating family-type accommodation units in the form of homes for children, young adults and adults, communal residences and multi-generational homes.

44 – Medical assistance consultancy provided by doctors and other specialized medical personnel; services of psychologists and therapists, in particular ergotherapists and speech therapists; hospital services; medical, psychological and therapeutic counseling.

(260) AM 2023 118037 A

(800) 1664089

(151) 2021 11 04

(891) 2021 11 04

(731) MARGIELA

2 Place des Etats Unis, F-75116 Paris, France

(540)

0 1 2 3 4 5 6 7 8 9
10 11 12 13 14 15 16
17 18 19 20 21 22 23

(591) Black, white

(531) 27.07.01

(511)

4 – Candles; Christmas tree candles; aromatherapy fragrance candles; scented candles.

35 – Retail and wholesale services in connection with: bleaching preparations and other substances for laundry use, cleaning, polishing, degreasing and abrasive preparations, perfumery products, perfumes, eau de toilet, cosmetic products, soaps, toiletry soaps, lotions, salts, oils and gels (not for medical use) for the bath, shaving and toiletry purposes, essential oils, make-up powder, make-up, nail polish, lipstick, talcum powder for toiletry use, hair lotions (not for medical use), hair spray, shampoos, toothpastes; retail and wholesale services in connection with: ethereal essences and oils, incense sticks, scented sachet,

scented linen water, scented room sprays, fragrances for automobiles, household fragrances, air fragrance reed diffusers, fragrance refills for non-electric room fragrance dispensers, potpourris (fragrances), room fragrances, room fresheners (fragrance preparations), body deodorants; retail and wholesale services in connection with: spectacles, spectacles cases, spectacle chains, optical frames, contact lenses, protective helmets, headphone-microphone combinations, smart watches, earbuds, wearable activity trackers, mobile phones, cases and carrying cases, sacks, and bags, all for use with computers and portable and handheld digital electric and electronic devices, covers for use with computers and portable and handheld digital electric and electronic devices; retail and wholesale services in connection with: docking stations for computers and mobile phones, loudspeakers, computers, computer mice, battery pack, power adapters for computers, earphones, downloadable mobile applications and software for computers and mobile devices, headphones and earphones; retail and wholesale services in connection with: lighting apparatus, linear air diffusers, electric dispensers for air fresheners, air freshener plug-ins, supply air diffusers, electric candles; retail and wholesale services in connection with: jewelry and costume jewelry, namely rings, bracelets, necklaces, tie-bars, scarf rings, pendants, ear clips, tie clips cufflinks, earrings, key holders made of precious metals, brooches, pins being jewelry, clocks, watches, chronographs for use as watches, chronometers; retail and wholesale services in connection with: bags, handbags, purses, clutches, bumbags, travel baggage, valises, pocket wallets, leather purses, umbrellas, key cases, grocery tote bags, net-bags for shopping, vanity cases, not fitted, duffel bags, haversacks, attaché cases, credit-card holders, business card cases, school book bags, rucksacks, small bags for men, suitcases, shopping bags, satchels; retail and wholesale services in connection with: furniture, mirrors, picture frames, plaster, mattresses; retail and wholesale services in connection with: household utensils and containers, kitchen utensils and containers, combs and sponges, glassware for household purposes, knife holders for the table, dishes, plates, carafes, drinking glasses, candle holders, incense burners, flowerpots not made of paper, trays for domestic purposes, vases, glasses (containers), perfume sprays, pomanders [containers], aromatic oil diffusers, other than reed diffusers, scent sprays [atomizers]; retail and wholesale services in connection with: fabrics, bed and table covers, bath linen (except clothing), household linen, curtains of textile; retail and wholesale services in connection with: clothing, coats, mantles, raincoats, dusters, furs, dresses, suits, skirts, jackets, knitwear, trousers, shorts sets, bermuda jeans, waistcoats, shirts, t-shirts, tops, blouses, jerseys, sweaters, blazers, cardigans, stockings, socks, underwear, corsets, brassiere, underpants, dressing gowns, night-gowns, nightwear, shifts, pajamas, bathrobes, bathing suits, beach-wraps, sun

suits, sport jackets, waterproof clothing, wind-resistant jackets, anoraks, sweat suits; retail and wholesale services in connection with: ties, neckties, scarves, shawls, mufflers, foulards being clothing articles, gloves being clothing, headgear, caps, hats, hoods, sashes, belts, footwear, boots, shoes, slippers, hoodies, leggings, parkas, sweatpants, sneakers, ankle boots, mittens, headbands, headwear, face mask [clothing]; retail and wholesale services in connection with: carpets, cutlery, printed matter, stationery.

35 – Retail and wholesale services in connection with: candles, Christmas tree candles, aromatherapy fragrance candles, scented candles.

(260) AM 2023 118041 A

(800) 1664247

(151) 2022 02 18

(891) 2022 02 18

(731) UNDERDOG PRO Limited Liability Partnership

apt. 29, Akbulak microdistrict, 127, Alatau district, 050038 Almaty city, Kazakhstan

(540)



(591) Black, red and white

(531) 26.05.01; 26.07.25; 27.05.24; 29.01.13

(511)

35 – Business management of sports people; promotion of goods and services through sponsorship of sports events; wholesale services relating to sporting goods; retail or wholesale services for sports goods; retail services provided by sporting goods stores; promotion of goods and services through sponsorship of international sports events; advertising.

(260) AM 2023 118248 A

(800) 1667456

(151) 2021 11 30

(891) 2021 11 30

(731) ekaterra Group IP Holdings B.V.

Weena 455, NL-3013 AL Rotterdam, Netherlands

(540)



(591) Green

(531) 05.03.11; 05.03.13; 26.01.01; 26.01.03; 26.01.18; 26.01.24; 27.05.04; 27.05.08; 27.05.17; 27.05.25; 29.01.12

(511)

5 – Dietetic substances for medical use; herbal preparations for medical purposes; medicated herbal supplements and medicated herbal extracts; herbal tea for medicinal use; medicated herbal beverages; vitamins; mineral supplements for human consumption; food supplements; nutritional supplements for human consumption.

30 – Coffee; artificial coffee; tea; tea products; tea extracts; iced tea; carbonated and non-carbonated iced tea; iced tea mix powders; non medicinal herbal tea and infusions; cocoa; flour and preparations made from cereals; pastries; confectionery; chocolate; biscuits; ice cream; water ices; frozen confectionery; preserved herbs.

32 – Non-alcoholic beverages; soft drinks; sport drinks; energy drinks; mineral and aerated waters; flavoured water; carbonated and non-carbonated beverages; fruit beverages and fruit juices; vegetable juices; syrups and other non-alcoholic preparations for making beverages.

35 – Advertising; dissemination of advertising; publicity services; promotion services; market research; business management; accounts and bookkeeping services; business administration; office functions; clerical services; telephone answering services; retail, wholesale, online sale services relating to food and beverages; loyalty, incentive and bonus program services; consultancy services in the field of the aforementioned services.

41 – Educational advice in relation to food, refreshment and home consumer products; organisation of activities for entertaining and recreational purposes, all in relation to food, refreshment and home consumer products and consultancy in this field; educational advice in relation to food, beverages and wellbeing; organisation of activities for entertaining and recreational purposes, all in relation to food, beverages and wellbeing and consultancy in this field; arranging and conducting of seminars, workshops and discussion groups; sporting and cultural activities; publication of texts; organisation of exhibitions for cultural or educational purposes; presentation of works of visual art and literature to the public for cultural or educational purposes; entertainment services; entertainment information services; providing online electronic publications, not downloadable.

43 – Services for providing food and drink; catering; restaurants; information, advice and reservation services for the provision of food and drink.

(260) AM 2023 118250 A
 (800) 1667534
 (151) 2022 02 08
 (891) 2022 02 08
 (731) Obschestvo s ogranichennoy otvetstvennostyu
 "EVRA"
 Solnechnogorskaya ul. 4, str. 6, RU-125413
 Moscow, Russian Federation

(540)

SWEET POPS

(591) Black, white

(511)

30 – Coffee, tea, cocoa and coffee substitutes; tapioca and sago; flour and preparations made from cereals; bakery products; confectionery; molasses syrup; yeast, baking-powder; salt; vanilla flavorings for culinary purposes; flavorings, other than essential oils, for cakes; flavorings, other than essential oils, for beverages; coffee flavourings; food flavorings, other than essential oils; star anise; baozi; cereal bars; high-protein cereal bars; pancakes; noodle-based prepared meals; freeze-dried dishes with the main ingredient being pasta; freeze-dried dishes with the main ingredient being rice; buns; bulgur; bread rolls; edible rice paper; edible paper; burritos; vanillin [vanilla substitute]; vareniki [stuffed dumplings]; waffles; vermicelli; natural sweeteners; sausage binding materials; binding agents for ice cream; sea water for cooking; seaweed [condiment]; malt biscuits; cloves [spice]; mirror icing [mirror glaze]; cake frosting [icing]; glucose for culinary purposes; mustard; toast; processed buckwheat; gluten additives for culinary purposes; thickening agents for cooking foodstuffs; leaven; rice-based snack food; cereal-based snack food; vegetal preparations for use as coffee substitutes; salad dressings; zephyr being confectionery; fruit jellies [confectionery]; candy decorations for cakes; confectionery for decorating christmas trees; cakes; pastries; peanut confectionery; almond confectionery; pasta; ginger [spice]; frozen yogurt [confectionery ices]; cream of tartar for culinary purposes; capers; caramels [sweets]; curry [seasoning]; ketchup [sauce]; prepared rice rolled in seaweed; kimchijeon [fermented vegetable pancakes]; quinoa, processed; quiche; gluten prepared as foodstuff; flour-based dumplings; candy; liquorice [confectionery]; peppermint sweets; mints for breath freshening; dulce de leche; cinnamon [spice]; unroasted coffee; food starch; crackers; custard; hominy grits; semolina; oatmeal; crushed barley; groats for human food; ice cubes; corn, milled; fried corn; meat pies; turmeric; couscous; noodles; soba noodles; udon noodles; ice for refreshment; ice, natural or artificial; edible ices; lollipops; rice cakes; lomper [potato-based flatbread]; mayonnaise; macaroons [pastries]; maltose; hominy; piccalilli; marinades; marzipan; honey; miso [seasoning]; royal jelly; ice cream; bean meal; buckwheat flour; tapioca flour; potato flour; corn flour; nut flours; flour; wheat flour; soy flour; barley flour; dessert mousses [confectionery]; chocolate mo-

usses; muesli; mint for confectionery; cocoa beverages with milk; coffee beverages with milk; coffee drinks; cocoa-based drinks; chamomile-based beverages; tea beverages; chocolate beverages with milk; chocolate-based beverages; non-medicinal infusions; husked oats; okonomiyaki [Japanese savory pancakes]; onigiri [rice balls]; nutmeg; chocolate-coated nuts; stick liquorice [confectionery]; soybean paste [seasoning]; lozenges [confectionery]; molasses for food; pâtés en croûte; pelmeni; pepper; allspice; peppers [seasonings]; pesto [sauce]; cookies; petit-beurre biscuits; bibimbap [rice mixed with vegetables and beef]; pies; Pizza; meat gravies; fondants [confectionery]; popcorn; powders for making ice cream; mustard powder; pralines; aromatic preparations for food; seasonings; meat tenderizers for household purposes; oat-based food; propolis; gingerbread; spices; petits fours; rice pudding; puddings; cake powder; fruit colulis [sauces]; ravioli; ramen [Japanese noodle-based dish]; chewing gum; chewing gum for breath freshening; relish [condiment]; rice; instant rice; wheat germ for human consumption; spring rolls; sugar; palm sugar; sesame seeds [seasonings]; linseed for culinary purposes [seasoning]; processed seeds for use as a seasoning; aniseed; agave syrup [natural sweetener]; golden syrup; sweets; batter mixes for okonomiyaki [Japanese savory pancakes]; baking soda [bicarbonate of soda for cooking purposes]; malt for human consumption; salt for preserving foodstuffs; table salt; celery salt; sorbets [ices]; ham glaze; cranberry sauce [condiment]; soy sauce; tomato sauce; apple sauce [condiment]; sauces [condiments]; sauces for pasta; spaghetti; chocolate-based spreads; chocolate spreads containing nuts; preparations for stiffening whipped cream; shaved ice with sweetened red beans; breadcrumbs; sushi; senbei [rice crackers]; sandwiches; tabbouleh; tacos; tarts; dough; pastry dough; almond paste; rice pulp for culinary purposes; cake batter; tortillas; garden herbs, preserved [seasonings]; chocolate decorations for cakes; vinegar; beer vinegar; ferments for pastes; halva; bread; unleavened bread; chips [cereal products]; cornflakes; oat flakes; hot dogs; flowers or leaves for use as tea substitutes; jiaozi; chicory [coffee substitute]; tea; iced tea; chutneys [condiments]; minced garlic [condiment]; cheeseburgers [sandwiches]; chow-chow [condiment]; saffron [seasoning]; chocolate; malt extract for food; essences for foodstuffs, except etheric essences and essential oils; husked barley.

(260) AM 2023 118251 A

(800) 1667567

(151) 2022 04 27

(891) 2022 04 27

(731) BioNTech SE

An der Goldgrube 12, 55131 Mainz, Germany

(540)

BioNTainer

(591) Black, white

(511)

6 – Transportable buildings of metal; transportable buildings of metal for the manufacture and filling of pharmaceuticals, medical and veterinary preparations and vaccines; metal containers; metal containers for storage or transport.

(260) AM 2023 118252 A

(800) 1667616

(151) 2022 01 19

(891) 2022 01 19

(731) GUANGBO GROUP STOCK CO., LTD.

Chehe, Shiqi Street, Haishu District,

Ningbo City, Zhejiang Province, China

(540)

 The logo for GuangBo features a stylized 'G' symbol on the left, composed of three curved lines. To the right of the symbol, the word 'GuangBo' is written in a bold, sans-serif font. The 'G' is significantly larger than the other letters.

(591) Black, white

(531) 27.05.01; 27.05.09

(511)

9 – Calculating machines; computer keyboards; electronic pens [visual display units]; mouse [computer peripheral]; scanners [data processing equipment]; electronic pocket translators; pocket calculators; mouse pads; USB flash drives; toner cartridges, unfilled, for printers and photocopiers.

16 – Paper; copying paper [stationery]; toilet paper; towels of paper; paper and fibre nappy [disposable]; paper and fibre diapers [disposable]; albums; note books; paper clasps; envelopes [stationery]; ledgers; printed matter; bookmarks; greeting cards; notepads; pads; calendars; exercise books; geographical maps; photograph stands; bags [envelopes, pouches] of paper or plastics, for packaging; paper boxes; staples; stapling presses [office requisites]; office perforators; paper cutter [office supplies]; pencil sharpeners; office requisites, except furniture; folders for papers; correcting fluids [office requisites]; writing cases [sets]; stationery; ink; hand labelling appliances; writing instruments; adhesive bands for stationery or household purposes; adhesives [glues] for stationery or household purposes; drawing squares; drawing materials; teaching materials [except apparatus]; clip [stationery]; desktop cabinets for stationery [office requisites]; paper clips.

(260) AM 2023 118253 A

(800) 1667635

(151) 2021 11 09

(891) 2021 11 09

(731) ASBISC Enterprises PLC

Iapetou 1, CY-4101 Limassol, Cyprus

(540)

 The logo consists of the letters 'A', 'E', 'N', and 'O' in a bold, sans-serif font, spaced evenly across the line.

(591) Black, white

(531) 27.05.01

(511)

3 – Non-medicated cosmetics and toiletry preparations; toothpastes other than for medical purposes; perfumery, essential oils; bleaching preparations and other substances for laundry use; cleaning, polishing, scouring and abrasive preparations; non-medicated soaps; perfumery.

7 – Steam mops; vacuum packaging machines; vacuum cleaners; cordless vacuum cleaners; vacuum cleaners, electric, hand-operated; grinders for household use, electric; food blenders, electric, for household purposes; coffee grinders, other than hand-operated; window cleaning robots; planetary mixers; fruit presses, electric, for household purposes; food processors, electric, for household purposes; meat cutters, electric, for household purposes; dust filters for vacuum cleaners; blenders, electric, for household purposes; bar ice crushers, electric; hand-held milk frothers [whisks], electric.

8 – Hand tools and implements, hand-operated; cutlery; razors; flat irons; flat irons for household purposes, electric; razors, electric or non-electric; laser hair removal apparatus, other than for medical purposes; hair straightening tongs, electric, hand-operated; food processors, hand-operated; manicure sets; manicure sets, electric; mincing knives [hand tools]; ladles [hand tools]; wine bottle foil cutters, hand-operated; knives; electric hair curling irons, hand-operated.

9 – Scales; kitchen scales; electronic scales; personal weighing scales; accumulators for electric toothbrushes; thermometers, not for medical purposes; radiation measuring apparatus; nitrate testers for food; spirit measures; measuring cups.

10 – Thermometers for medical purposes; tonometers; heart rate monitors; pulse oximeters; pulse tachometers for medical purposes; inhalers; nebulizers for household use; glucometers; body massage apparatus; microcurrent face massagers; face and body lifting massagers.

11 – Kettles, electric; multicookers; air purifying apparatus and machines; humidifiers; household air cleaners; roasting apparatus; electric cookers; kitchen ranges [ovens]; induction cookers; microwave ovens [cooking apparatus]; food steamers, electric; garment steamers; coffee machines, electric; coffee roasters; coffee percolators, electric; electric frying pans; heaters for heating irons; hair dryers; air grills; bread toasters; ice-cream making machines; electric appliances for making yogurt; sous-vide cookers, electric; sterilizers; heating apparatus, electric, including convector heating apparatus, oil heating apparatus, infrared glass and ceramic heating apparatus; fan heaters;

electric fans for personal use; hair dryers; thermopots, electric; water coolers; electric hot water dispensers; removable panels being part of electric grills and removable panels being part of sandwich makers; removable bowls being part of multicookers; water purification apparatus, automated; cartridge filters for water purification; filters for air cleaners; hydromassage foot baths; steam facial apparatus [saunas].

21 – Household or kitchen utensils and containers; cookware and tableware, except forks, knives and spoons; combs and sponges; brushes, except paintbrushes; articles for cleaning purposes; glassware, porcelain and earthenware; dishes; bottles; vases; mugs; cutting boards for the kitchen; containers for household or kitchen use; table plates; saucers; bowls [basins]; salad bowls; jugs; decanters; strainers for household purposes; stew-pans; saute pans; frying pans; flower pots; ladles for serving wine; toothbrushes, electric; apparatus for cleaning teeth and gums using high-pressure water for home use; food steamers, non-electric; gloves for household purposes; fruit presses, non-electric, for household purposes; pet feeding bowls, automatic; drinking troughs; litter boxes for pets; cosmetic facial cleansing devices, including vacuum facial cleansing devices, ultrasound facial cleansing devices, electric brushes for facial cleansing; bath tubs for cleaning cosmetic brushes and sponges; lint removers, electric or non-electric; moulds [kitchen utensils]; cake moulds; whisks, non-electric, for household purposes; sugar bowls; ice-cream bowls; butter dishes; salt cellars; pepper pots; serving ladles; potato mashers; sieves [household utensils]; nutcrackers; ice tongs; salad tongs; sugar tongs; kettles, non-electric; food blenders, non-electric; insulating flasks; electric hair brushes; reusable silicone food covers; potholders; substance dispensing elements of bottles; mixing cups [shakers]; bar bottles; corkscrews, electric and non-electric; bottle openers, electric and non-electric; pestles and muddlers for bar use; lemon presses, non-electric, for household purposes; straws for drinking; cocktail mixing spoons [bar utensils]; strainers [bar utensils]; place mats, not of paper or textile; trivets [table utensils].

25 – Aprons [clothing].

(260) AM 2023 118255 A
(800) 1667737
(151) 2022 05 04
(891) 2022 05 04
(731) COMPTOIR NOUVEAU DE LA
PARFUMERIE
23 rue Boissy d'Anglas, F-75008 PARIS,
France

(540)

UN JARDIN A CYTHERE

(591) Black, white

(511)

3 – Perfumes, parfumery products, eau de parfum, toilet water, eau de Cologne, beauty care products other than for medical use, cosmetic products and cosmetic preparations, cosmetic creams, skin cleansers (cosmetic), cosmetic lotions for the hair and body, soaps, shower gels, cosmetic preparations for the bath, deodorants for personal use, essential oils for personal use.

(260) AM 2023 118256 A

(800) 1667748

(151) 2022 04 26

(891) 2022 04 26

(731) SAVENCIA SA

42 rue Rieussec, F-78220 VIROFLAY, France

(540)



(591) Black, white

(531) 18.03.14; 24.07.01; 25.07.08; 26.04.02;
26.04.06; 26.04.07; 26.04.09; 26.04.16;
26.04.18; 26.04.24; 27.05.24

(511)

29 – Cheeses being of French origin or made in France.

(260) AM 2023 118258 A

(800) 1667961

(151) 2022 01 26

(891) 2022 01 26

(731) Obschestvo s ogranichennoi otvetstvennostju
"Set data-tsentrov "Selektel"
Tsvetochnaya Street, 21, liter A, RU-196084
Saint Petersburg, Russian Federation

(540)



(591) Black and blue

(531) 26.05.01; 27.05.01; 29.01.12

(511)

9 – 3D spectacles; aerials; holograms; floppy disks; phonograph records; disks, magnetic; optical discs; electronic notice boards; interfaces for computers; coaxial cables; fibre optic cables; cables, electric; calculating machines; pocket calculators; identity cards, magnetic; video game cartridges; memory cards for video game machines; encoded magnetic cards; electronic book readers; electronic agendas; mouse pads;

compact discs [audio-video]; compact discs [read-only memory]; computers; laptop computers; tablet computers; notebook computers; decorative magnets; monitors [computer hardware]; monitors [computer programs]; headphones; magnetic data media; optical data media; electronic sheet music, downloadable; computer software, recorded; computer hardware; sunglasses; goggles for sports; radio pagers; computer software applications, downloadable; computer programs, recorded; computer game software, downloadable; computer operating programs, recorded; electronic publications, downloadable; integrated circuit cards [smart cards]; smart glasses; smartphones; smartwatches; bags adapted for laptops; downloadable ring tones for mobile phones; downloadable image files; downloadable music files; animated cartoons; USB flash drives; covers for tablet computers; covers for smartphones; cell phone straps.

16 – Fountain pens; albums; almanacs; posters; banners of paper; tickets; forms, printed; announcement cards [stationery]; note books; pads [stationery]; drawing pads; loose-leaf paper; pamphlets; booklets; wrapping paper; paper; newsletters; signboards of paper or cardboard; bunting of paper; newspapers; magazines [periodicals]; bookmarks; periodicals; printed publications; graphic representations; calendars; pencils; pencil lead holders; pictures; transfers [decalcomanias]; catalogues; books; comic books; envelopes [stationery]; boxes of paper or cardboard; printed coupons; flyers; bags [envelopes, pouches] of paper or plastics, for packaging; stickers [stationery]; passport holders; musical greeting cards; greeting cards; postcards; conical paper bags; folders for papers; desk mats; writing cases [sets]; office requisites, except furniture; writing materials; writing instruments; printed matter; prospectuses; writing or drawing books; bottle wrappers of paper or cardboard; manuals [handbooks]; flags of paper; stencils; stamps [seals]; shields [paper seals]; labels of paper or cardboard.

28 – Playing cards.

38 – Wireless broadcasting; electronic bulletin board services [telecommunications services]; providing information about wireless communication; providing user access to global computer networks; providing access to databases; providing internet chatrooms; providing telecommunications connections to a global computer network; message sending; computer aided transmission of messages and images; transmission of digital files; providing online forums; rental of access time to global computer networks; rental of telecommunication equipment; communications by fibre optic networks; communications by computer terminals; telecommunications routing and junction services; streaming of data.

41 – Academies [education]; publication of books; layout services, other than for advertising purposes; virtual reality game services provided on-line from a

computer network; on-line publication of electronic newspapers; practical training [demonstration]; providing recreation facilities; arranging and conducting of conferences; arranging and conducting of workshops [training]; arranging and conducting of seminars; organization of competitions [education or entertainment]; organization of lotteries; vocational guidance [education or training advice]; providing online videos, not downloadable; providing online music, not downloadable; educational examination; electronic desktop publishing; online publication of electronic books and journals; publication of texts, other than publicity texts; entertainment services; tutoring.

42 – Computer system analysis; recovery of computer data; computer virus protection services; installation of computer software; computer security consultancy; information technology [IT] consultancy; consultancy in the design and development of computer hardware; computer software consultancy; data security consultancy; updating of computer software; monitoring of computer systems to detect breakdowns; monitoring of computer systems for detecting unauthorized access or data breach; monitoring of computer systems by remote access; software as a service [SaaS]; maintenance of computer software; providing information relating to computer technology and programming via a website; providing search engines for the internet; conversion of computer programs and data, other than physical conversion; computer system design; rental of web servers; computer rental; rental of computer software; hosting computer sites [web sites]; design and development of operating software for computer networks and servers; creating and maintaining websites for others; computer programming; technical writing; copying of computer programs; IT programming services; off-site data backup; consultancy services in the fields of science, engineering and information technology; telecommunications technology consultancy; data encryption services; electronic data storage.

(260) AM 2023 118259 A

(800) 1668056

(151) 2021 10 08

(891) 2021 10 08

(731) Berner Omnichannel Trading Holding SE
Bernerstraße 6, 74653 Künzelsau, Germany
(540)



(591) Black, white

(531) 26.03.23; 27.05.01

(511)

1 – Chemical preparations for use in industry; growing media, fertilizers and chemicals for use in agri-

culture, horticulture and forestry; chemical compositions and materials for use in science; chemical preparations and materials for film, photography and printing; chemical and organic compositions and substances for treatment of leather and textile; chemical and organic compositions for use in the manufacture of food and beverages; adhesives for use in industry; fire extinguishing compositions; fire prevention compositions; tempering and soldering preparations; unprocessed plastics; brake fluid; fluids for hydraulic circuits; putties, and fillers and pastes for use in industry; chemical substances, chemical materials and chemical preparations.

2 – Paints, varnishes, lacquers; anti-rust preparations; wood preservatives; dyes; mordants; preservatives; raw natural resins; thinners and thickeners for coatings, dyes and inks; metal in foil and powder form for use in painting, decorating, printing and art; metals in aerosol form.

3 – Cleaning, polishing, scouring and abrasive preparations; toiletries; beauty care cosmetics; essential oils and aromatic extracts; cleaning and fragancing preparations.

4 – Industrial oils and greases; lubricants and industrial greases, waxes and fluids; dust controlling compositions; fuels and illuminants; candles and wicks for lighting.

5 – Medical and veterinary preparations and articles, namely, articles in the form of substances that prevent, detect, monitor or mitigate diseases; sanitary preparations and articles; disinfectants and antiseptics; pest control preparations and articles; medical dressings and plasters.

6 – Metal hardware; containers of metal for storage and transport; building and construction materials and elements of metal; welding and soldering materials; non-electric cables and wires of common metal; containers of metal for storage, transport and packaging.

7 – Machines and machine tools for treatment of materials and for manufacturing; mechanical hand tools; parts of all the aforesaid goods, included in this class.

8 – Hand-operated tools and implements for treatment of materials, and for construction, repair and maintenance; cutlery; parts of all the aforesaid goods, included in this class; tool bags [filled].

9 – Software for the automation, control and optimisation of processes, products and service; mobile apps; measuring, detecting, monitoring and controlling devices; apparatus, instruments and cables for electricity; safety, security, protection and signalling devices.

10 – Hearing protection devices; receptacles for applying medicines.

11 – Lighting and lighting reflectors; sterilization, disinfection and decontamination equipment; heating,

ventilating, and air conditioning and purification equipment (ambient); burners, boilers and heaters.

12 – Parts and fittings for vehicles.

16 – Disposable paper napkins, paper towels, toilet paper, tissue paper and towels of paper for cleaning purposes.

17 – Semi-worked plastic substances; seals, sealants and fillers; packing and insulating materials; insulation and barrier articles and materials; flexible hoses, not of metal; adhesive tapes, adhesive plastic sealing strips, adhesive bands and adhesive polymer films for industrial or commercial use.

19 – Building and construction materials and elements, not of metal; bitumen.

20 – Containers, and closures and holders therefor, non-metallic; fasteners, not of metal, for pipes and cables; structural joint connectors, not of metal; workshop furniture; office furniture.

21 – Cleaning articles; cosmetic, hygiene and beauty care utensils (as far as included in this class); household utensils for cleaning, brushes and brush-making materials.

22 – Slings, not of metal, for handling loads; bands, not of metal, for wrapping or binding; tarpaulins, awnings, tents, and unfitted coverings.

25 – Clothing; footwear; headgear.

27 – Carpets, rugs and mats.

35 – Wholesale services and retail services relating to chemical preparations for use in industry, growing media, fertilizers and chemicals for use in agriculture, horticulture and forestry, chemical compositions and materials for use in science, chemical preparations and materials for film, photography and printing, chemical and organic compositions and substances for treatment of leather and textile, chemical and organic compositions for use in the manufacture of food and beverages, adhesives for use in industry, fire extinguishing compositions, fire prevention compositions, tempering and soldering preparations, unprocessed plastics, brake fluid, fluids for hydraulic circuits, putties, and fillers and pastes for use in industry, chemical substances, chemical materials and chemical preparations, paints, varnishes, lacquers, anti-rust preparations, wood preservatives, dyes, mordants, preservatives, raw natural resins, thinners and thickeners for coatings, dyes and inks, metal in foil and powder form for use in painting, decorating, printing and art, metals in aerosol form, cleaning, polishing, scouring and abrasive preparations, toiletries, beauty care cosmetics, essential oils and aromatic extracts, cleaning and fragancing preparations, industrial oils and greases, lubricants and industrial greases, waxes and fluids, dust controlling compositions, fuels and illuminants, candles and wicks for lighting, medical and veterinary pre-

parations and articles, sanitary preparations and articles, disinfectants and antiseptics, pest control preparations and articles, medical dressings, coverings and applicators, metal hardware, containers of metal for storage and transport, building and construction materials and elements of metal, welding and soldering materials, non-electric cables and wires of common metal, containers, and transportation and packaging articles, of metal, machines and machine tools for treatment of materials and for manufacturing, mechanical hand tools, hand-operated tools and implements for treatment of materials, and for construction, repair and maintenance, cutlery, tool bags [filled], software for the automation, control and optimisation of processes, products and service, mobile apps, measuring, detecting, monitoring and controlling devices, apparatus, instruments and cables for electricity, safety, security, protection and signalling devices, hearing protection devices, lighting and lighting reflectors, sterilization, disinfection and decontamination equipment, heating, ventilating, and air conditioning and purification equipment (ambient), burners, boilers and heaters, parts and fittings for vehicles, disposable paper products, semi-worked plastic substances, seals, sealants and fillers, packing materials, insulation and barrier articles and materials, flexible hoses, not of metal, adhesive tapes, strips, bands and films, building and construction materials and elements, not of metal, bitumen, containers, and closures and holders therefor, non-metallic, fasteners, non-metallic, cable fasteners, connectors and holders, non-metallic, workshop furniture, office furniture, cleaning articles, cosmetic, hygiene and beauty care utensils, household utensils for cleaning, brushes and brush-making materials, slings and bands, tarpaulins, awnings, tents, and unfitted coverings, clothing, footwear, headgear, carpets, rugs and mats; business assistance, management and administrative services; rental of vending machines.

36 – Loan and credit, and lease-finance services.

37 – Installation, cleaning, repair and maintenance in relation to the goods referred to herein in classes 06, 07, 08, 09, 10, 11, 12, 19, 20, 21, 22, 25 and 27; building, construction and demolition; rental of hand-operated equipment and tools for material processing; rental of machines and machine tools for material processing and customized manufacturing.

39 – Transport; rental services related to transportation and storage.

40 – Recycling and waste treatment.

41 – Education; training; continuous training.

42 – Scientific and technological services; scientific research and analysis; industrial analysis and research services; research and development of new products for others.

(260) AM 2023 118260 A

(800) 1668106

(151) 2022 04 04

(891) 2022 04 04

(731) LIMITED LIABILITY MANUFACTURING AND TRADING COMPANY "ACME"
5 Promyslova Str., Ukrainka, Obukhivsky r-n,
Kyivska obl. 08720, Ukraine

(540)

FORTESSE
PROFESSIONAL

(591) Black, white

(531) 26.11.02; 26.11.08; 27.05.09; 27.05.11

(511)

3 – Toiletry preparations; balms, other than for medical purposes; cosmetic hair balms; hair conditioners; hair care cosmetics; hair lotions; dry shampoos; shampoos.

5 – Pharmaceutical preparations; hygienic preparations for medical purposes.

(260) AM 2023 118261 A

(800) 1668150

(151) 2022 04 08

(891) 2022 04 08

(731) Teslenko Nailya Sabitovna
ul. Leningradskaya, d. 3, kv. 1269, mkr.
Noviy Okkervil, g. Kudrovo, Vsevolozhskiy
rayon, RU-188691 Leningradskaya oblast,
Russian Federation

(540)



(591) Black, white

(531) 26.04.05; 26.04.18; 26.04.24; 27.05.01;
27.05.09; 27.05.10; 27.05.24

(526) PROFESSIONAL

(511)

3 – Nail glitter; nail polish; nail art stickers; nail care preparations; cosmetic nail care preparations.

5 – Nail care preparations for medical purposes.

8 – Nail clippers, electric or non-electric; nail nippers; manicure sets; manicure sets, electric; pedicure sets; emery boards; nail files; nail files, electric; fingernail polishers, electric or non-electric; nail cutters; cuticle nippers.

11 – Nail lamps.

(260) AM 2023 118262 A

(800) 1668192

(151) 2022 04 24

(891) 2022 04 24

(731) Guangzhou Aoking Leather Co., Ltd
No. 6, Zebin Road, Yangguang Avenue,
Shiling Town, Huadu District, Guangzhou
City, Guangdong Province, China

(540)

**AOKING
BACK
PACK**

(591) Black, white

(531) 27.05.01; 27.05.09

(511)

18 – Rucksacks; travelling bags; travelling sets [leatherware]; garment bags for travel; pocket wallets; handbags; shopping handbags; school bags; trunks [luggage]; bags for sports.

(260) AM 2023 118263 A

(800) 1668197

(151) 2022 05 04

(891) 2022 05 04

(731) Huons Bio Pharma Co., Ltd.
7F, A-dong, 17, Changeop-ro, Sujeong-gu,
Seongnam-si, Gyeonggi-do, Republic of Korea

(540)

HUTOX

(591) Black, white

(511)

5 – Pharmaceutical preparations for the treatment of dystonia; pharmaceuticals containing botulinum toxin; antiseptic cotton; antiseptic preparations; pharmaceutical preparations for skin care; pharmaceutical preparations for the treatment of neurological disorder; chemical preparations for pharmaceutical purposes; food for babies; diagnostic preparations for medical or veterinary purposes; preparations of microorganisms for medical or veterinary use; pharmaceutical syringes prefilled with medical botulinum toxin as the main ingredient; dietetic substances adapted for medical use; drugs for medical purposes; adhesive skin patches for medical use; materials for artificial teeth; pharmaceutical preparations for the treatment of wrinkles; injectable dermal fillers; pharmaceutical preparations for the treatment of pain; dermatological pharmaceutical products; skin grafts.

(260) AM 2023 118264 A

(800) 1668231

(151) 2022 04 01

(891) 2022 04 01

(731) DURANTE ADESIVI S.p.A.
Via Giuseppe Garibaldi, 23, I-33080 PRATA
DI PORDENONE, Frazione Ghirano (PN),
Italy

(540)

 **DuranteAdesivi**

(591) Black and red

(531) 27.05.01; 29.01.12

(511)

1 – Adhesives for use in industry; gums [adhesives] for industrial purposes; thermofusible adhesives; glue for industrial purposes; fabric glues for industrial use; woodworking adhesives for industrial use; paper converting glues for industrial use; industrial adhesives for use in coating and sealing; synthetic resins; chemical substances for making adhesives; detergents for cleaning use [part of manufacturing operations]; liquids for use in cleansing during manufacturing processes.

16 – Adhesives for stationery or household purposes.

(260) AM 2023 118265 A

(800) 1668232

(151) 2022 05 19

(891) 2022 05 19

(731) Janssen Pharmaceutica NV
Turnhoutseweg 30, B-2340 Beerse, Belgium

(540)



(591) Crimson, white, blue

(531) 01.15.11; 25.01.10; 26.04.02; 26.04.18;
27.05.04; 27.05.08; 27.05.24; 29.01.12

(511)

5 – Feminine sanitary protection products.

(260) AM 2023 118266 A

(800) 1668235

(151) 2022 04 01

(891) 2022 04 01

(731) DURANTE ADESIVI S.p.A.
Via Giuseppe Garibaldi, 23, I-33080 PRATA
DI PORDENONE, Frazione Ghirano (PN),
Italy

(540)



(591) Black and red.

(531) 27.05.01; 27.05.23; 29.01.12

(511)

1 – Adhesives for use in industry; gums [adhesives] for industrial purposes; thermofusible adhesives; glue for industrial purposes; fabric glues for industrial use; woodworking adhesives for industrial use; paper converting glues for industrial use; industrial adhesives for use in coating and sealing; synthetic resins; chemical substances for making adhesives; detergents for cleaning use [part of manufacturing operations]; liquids for use in cleansing during manufacturing processes.

16 – Adhesives for stationery or household purposes.

(260) AM 2023 118267 A

(800) 1668236

(151) 2022 04 01

(891) 2022 04 01

(731) DURANTE ADESIVI S.p.A.

Via Giuseppe Garibaldi, 23, I-33080 PRATA DI PORDENONE, Frazione Ghirano (PN), Italy

(540)

DURANTEADESIVI

(591) Black, white

(511)

1 – Adhesives for use in industry; gums [adhesives] for industrial purposes; thermofusible adhesives; glue for industrial purposes; fabric glues for industrial use; woodworking adhesives for industrial use; paper converting glues for industrial use; industrial adhesives for use in coating and sealing; synthetic resins; chemical substances for making adhesives; detergents for cleaning use [part of manufacturing operations]; liquids for use in cleansing during manufacturing processes.

16 – Adhesives for stationery or household purposes.

(260) AM 2023 118271 A

(800) 1668325

(151) 2022 04 29

(891) 2022 04 29

(731) Scientific Technological Pharmaceutical Firm "POLYSAN" Ltd.

Salova Street, 72, Bldg. 2, Liter A, RU-192102 Saint Petersburg, Russian Federation

(540)

Allergostin

(591) Black, white

(511)

5 – Drugs for medical purposes; medicines for veterinary purposes; medicines for human purposes; veterinary preparations; vitamin preparations; opotherapy preparations; pharmaceutical preparations; chemico-pharmaceutical preparations; chemical preparations for veterinary purposes; chemical preparations for medical purposes; tonics [medicines].

(260) AM 2023 118273 A

(800) 1668363

(151) 2022 05 06

(891) 2022 05 06

(731) Beijing Jingheng Tengwei Kejian Trade Co., Ltd.

Room 306, Third Floor, 28-09 Nanhuan Road, Chengbei Street, Changping District, 102200 Beijing, China

(540)

Royal Kludge

(591) Black, white

(531) 27.05.01

(511)

9 – Calculating machines; computer peripheral devices; wrist rests for use with computers; mouse pads; computer game software, downloadable; computer keyboards; computer; mouse [computer peripheral]; battery chargers.

(260) AM 2023 118274 A

(800) 1668387

(151) 2022 01 07

(891) 2022 01 07

(731) Salesforce, Inc.

Salesforce Tower, 415 Mission Street, 3rd Floor, San Francisco, CA 94105, USA

(540)

SALESFORCE

(591) Black, white

(511)

41 – Business education services, namely, conducting classes, seminars, workshops and training in the fields of business, marketing, advertising, brand development, sales, customer service, cloud computing, data analytics, customer information, customer relationship management, employee efficiency, and software development; publication of printed matter, books, newspapers and periodicals, other than for advertising purposes; publication of newspapers, periodicals and books, and of instructional and information materials in the nature of pamphlets, brochures, manuals, infor-

mational flyers, informational sheets and newsletters in the fields of business, marketing, advertising, brand development, sales, customer service, cloud computing, data analytics, customer information, customer relationship management, employee efficiency, and software development, other than for advertising purposes, all in electronic form and on the Internet; electronic desktop publishing; publication of texts, other than publicity texts; rental of printed publications; publication of online blogs, magazines, books, newspapers, periodicals, pamphlets, brochures, manuals, informational flyers, informational sheets and newsletters, other than for advertising purposes; production of television, mobile phone television and radio programs; film production, other than advertising films; conducting entertainment, cultural events, and live cultural events, namely, presentation of live dance and musical performances, live show performances and concerts, organizing arts events, planning and conducting parties and award shows for people and organizations, arranging and conducting nightclub entertainment events, arranging of contests, organizing and hosting social entertainment events, organizing cultural and arts festivals and fairs not for commercial purposes; educational services, namely, organizing and conducting training events in the nature of expositions, retreats, classes, lectures, seminars, conferences, tutorial sessions and symposia in the fields of business, marketing, advertising, brand development, sales, customer service, cloud computing, data analytics, customer information, customer relationship management, employee efficiency, and software development; night club services; professional coaching services in the fields of automated business processes and business development tools, business, marketing, advertising, brand development, sales, customer service, cloud computing, data analytics, customer information, customer relationship management, and employee efficiency; education in the fields of business, marketing, advertising, brand development, sales, customer service, cloud computing, data analytics, customer information, customer relationship management, employee efficiency, and software development rendered through correspondence courses; providing information about education; educational examination services; providing practical training in the fields of business, marketing, advertising, brand development, sales, customer service, cloud computing, data analytics, customer information, customer relationship management, employee efficiency, and software development; providing vocational retraining in the fields of business, marketing, advertising, brand development, sales, customer service, cloud computing, data analytics, customer information, customer relationship management, employee efficiency, and software development; arranging and conducting of conferences, congresses, concerts and symposiums, seminars, training courses, instructional and lecture events, all for cultural or educational purposes in the fields of business, marketing,

advertising, brand development, sales, customer service, cloud computing, data analytics, customer information, customer relationship management, employee efficiency, and software development; arranging of entertainment shows; providing online computer and electronic games; entertainment services, namely, conducting computer and electronic games on the Internet and on the mobile Internet; providing information on the entertainment services of others via online computer networks.

(260) AM 2023 118283 A

(800) 1540159

(151) 2020 04 30

(891) 2022 06 08

(731) Costa Limited

Costa House, Houghton Hall Business Park,
Porz Avenue, Houghton Regis, Dunstable,
Bedfordshire LU5 5YG, United Kingdom

(540)



(591) Black, white

(531) 01.03.17; 05.07.27

(511)

7 – Vending machines; beverage vending machines; beverage making machines; beverage processing machines; electric vending machines for beverages or foods; machines for dispensing hot beverages; parts and fittings for the aforesaid goods.

29 – Prepared salads; soup; milk; yoghurts; milk based beverages; yoghurt based beverages; almond based milk beverages; cocoa flavoured milk beverages; yoghurt drinks; milk based drinks containing fruit juice; milkshakes; none of the aforesaid goods including pastes made of dry fruits, dairy cream, cream for cooking, sour cream or bechamel sauce.

30 – Coffee, tea, cocoa, hot chocolate, namely, drinking chocolate, coffee substitutes, sugar, cakes, cheesecake, muffins, brownies, shortbread biscuits, tea cakes, cookies, biscuits, brioche, fruit tarts, custard tarts, wafers, flapjacks, biscotti, gingerbread, popcorn, chocolate, chocolate bars, meringues, panettone, fruit jellies, candy, pastilles, chewing gum, milk chocolate covered raisins, sandwiches, sandwich wraps, toasted sandwiches, panini, croissants, pastries, ice, fruit ices, bread, sandwiches, toast, sandwich wraps, prepared meals consisting primarily of pasta, rice, noodles or quinoa, porridge, coffee flavourings in the nature of syrup for flavouring beverages, flavour enhancers used in beverage products, flavourings for beverages

other than essential oils, frozen yoghurt; confectionery ices, namely, frozen yoghurt, ice cream; ice cream powders and food flavourings for ice cream, not being essential oils; sorbets; wafers and cornets in the nature of cones for ice cream.

32 – Non-alcoholic fruit juice and water based beverages; ice based fruit drinks; mineral water, carbonated waters; flavoured aqueous drinks namely, squashes, flavoured mineral water, soft drinks, soft drinks flavoured with tea, carbonated soft drinks, cola, sports drinks, energy drinks; unflavoured aqueous drinks namely, water, soda water, tonic water, coconut water, sparkling water; fruit drinks and fruit juices; fruit drinks and fruit juices; beverages based on fruit and/or fruit juices; powders for the preparation of beverages; liquid drinks mixers namely, syrups for making flavoured drinks, essences for making flavoured water (not in the nature of essential oils); syrups for making beverages; ingredients for preparing drinks, namely, cordials, essences for making beverages, concentrates for making fruit juices and fruit drinks; none of the aforesaid goods including vegetable juices or tiger nut beverages, namely, horchata.

43 – Cafes; cafeterias; restaurants; snack bars; bars; catering services; coffee shops; coffee shop concessions; coffee shop kiosks; self-serve coffee bars; self-serve hot beverage bar; coffee bars; coffee supply services (term considered too vague by the International Bureau – rule 13 (2) (b) of the Common Regulations); hot beverage supply services (term considered too vague by the International Bureau – rule 13 (2) (b) of the Common Regulations); coffee bar services; contract beverage services (term considered too vague by the International Bureau – rule 13 (2) (b) of the Common Regulations).

(260) AM 2023 118318 A

(800) 1668796

(151) 2022 03 21

(891) 2022 03 21

(731) HELIER FASHION FZE

Office No LB15224 Jebel Ali Free Zone,
Dubai, United Arab Emirates

(540)



(591) Black, white

(531) 03.11.01; 03.11.24; 26.13.25; 27.03.03

(511)

14 – Precious metals and their alloys and goods in precious metals or coated therewith; precious stones and their imitations; jewelry cases; boxes of precious

metal; jewelry and imitation of jewelry; earrings; bracelets; trinkets; brooches; tie clips; pins; necklaces; rings; cuff links; key rings; shoe ornaments of precious metal; clocks and watches; chronometers; alarm clocks; wrist watches; table clocks; pocket watches; cases for watches; watch chains; watch bands and straps.

(260) AM 2023 118323 A

(800) 1668991

(151) 2022 01 13

(891) 2022 01 13

(731) CORDIER

1 rue de la Seiglière, F-33800 Bordeaux, France

(540)

CORDIER

(591) Black, white

(511)

33 – Wines and alcoholic beverages (excluding beers).

35 – Advertising; dissemination, distribution of advertising material (leaflets, prospectuses, printed matter, samples); organization and conducting of trade fairs for advertising and/or commercial purposes; organization and conducting of professional or public exhibitions, fairs, for commercial and/or advertising purposes; administrative and commercial management of exhibition sites; good and service presentation and demonstration services for promotional purposes; organization of promotional activities; organization of regional and national promotional campaigns; inventory management services; commercial business management; commercial administration; hosting of events at outlet stores; import-export agencies; assistance and support to industrial or commercial companies in their business operation; computer file management; compilation of commercial or advertising data in a database; services provided by a franchiser, namely assistance in running or managing commercial businesses within a network of shops; consulting and support services relating to business management and organization in the context of a franchise network and concessions; management consulting; advertising strategy consulting; conducting of commercial events within a commercial network; services for retailing or wholesaling, mail-order, retailing or wholesaling via the Internet or via any electronic means for remote ordering of wines and alcoholic beverages (with the exception of beers), wine-related articles, particularly wine glasses, tasting glasses, liqueur glasses, corkscrews, pourers, stoppers, decanters, ice-cube bags; sales promotion services via a customer loyalty service using loyalty cards, discount card, services related to promotional commercial activity in all forms, namely, recommendation services, sponsorship, patronage, commercial partnership operations and promotional information campaigns with regard to products and services in

the field of wines and alcoholic beverages, wine-related articles; public relations.

(260) AM 2023 118360 A

(800) 1499205

(151) 2019 03 27

(891) 2022 06 10

(731) "AGRODRIP – I.G. Gropalis – Irrigation Systems – Water Supply Systems – Industrial Societe Anonyme", with distinctive title "AGRODRIP S.A."
Industrial area of Sindos, Block 35/ Entrance C, P.O. Box 1147, GR-570 22 Sindos, Thessaloniki, Greece

(540)



(591) Black, blue and green

(531) 05.01.16; 07.05.15; 27.03.11; 27.05.10; 28.07; 29.01.13

(511)

11 – Apparatus and installations for water supply; irrigation systems; appliances for water distribution; watering machines for agricultural purposes; water conduit installations; drip irrigation emitters [irrigation fittings]; hot water bottles; whirlpool-jet apparatus; watering installations, automatic; water filtering apparatus; filters for drinking water.

17 – Unprocessed and semi processed rubber, gutta-percha, gum, asbestos, mica and substitutes for all these materials; plastic and resins in extruded form for use in manufacture; packing, stopping and insulating materials; flexible pipes, tubes, hoses, non-metallic; fittings, not of metal, for compressed air lines; fittings, not of metal, for rigid pipes; fittings, not of metal, for flexible pipes; flexible hoses not of metal; plastic substances, semi-processed; garden hoses; irrigation hoses.

37 – Irrigation devices installation and repair; construction consultancy.

(260) AM 2023 118363 A

(800) 1648038

(151) 2021 12 14

(891) 2022 05 27

(731) LRC Products Limited
103-105 Bath Road, Slough, Berkshire
SL13UH, United Kingdom

(540)



(591) Black, white

(531) 26.11.09; 27.05.01

(511)

3 – Non-medicated cosmetic wipes; non-medicated wipes impregnated with a soap or a cleaning preparation, not for personal use; non-medicated wipes impregnated with a soap or a cleaning preparation for personal use; non-medicated cleansers for intimate personal hygiene; toiletries, soaps, for personal use; cleaning preparations for personal use; non-medicated preparations for the bath in the form of salts (oils and soaks); moisturising preparations; essential oils; massage oils; massage creams; massage gels; body wash; shower gels; non-medicated preparations for the care of intimate parts of the body.

5 – Contraceptive preparations and substances; chemical contraceptives; chemical contraceptives that can be used by women following unprotected intercourse to prevent pregnancy; medicated products for feminine use, including pre-moistened feminine wipes; spermicidal gels, liquids and creams; hygienic lubricants and disinfectants for use in the area of the vagina, penis and anus; personal lubricants; vaginal moisturizers; topical preparations, namely, sprays, gels, liquids and creams for sexual health and/or enhancing sexual arousal; sexual stimulant gels; pharmaceutical preparations and substances, namely supplements for sexual health and/or enhancing sexual arousal; diagnostic preparations and substances all for gynaecological testing purposes or for the diagnosis of sexually transmitted diseases.

10 – Condoms; contraceptive, hygienic or prophylactic devices; massage apparatus, instruments and appliances; electric and electronic massage apparatus, instruments and appliances; body massagers; personal massagers; vibrators; vibrating rings; marital aids; sex toys; sex aids; parts and fittings for all the aforesaid goods.

(260) AM 2023 118364 A

(800) 1652166

(151) 2021 08 17

(891) 2022 06 03

(731) KOSAN KOZMETİK SANAYİ VE TİCARET ANONİM ŞİRKETİ

Acibadem Mah, Cecen Sok, Akasya Etabi
A Blok N: 25 K: 1, Uskudar, Türkiye

(540)

HAPPINESS IS YOUR COLOR

(591) Black, white

(511)

3 – Bleaching and cleaning preparations, detergents other than for use in manufacturing operations and for medical purposes, laundry bleach, fabric softeners for laundry use, stain removers, dishwasher detergents; perfumery; non-medicated cosmetics; fragrances; deodorants for personal use and animals; soaps; dental care preparations: dentifrices, denture polishes, tooth whitening preparations, mouth washes, not for medical purposes; abrasive preparations; emery cloth; sandpaper; pumice stone; abrasive pastes; polishing preparations for leather, vinyl, metal and wood, polishes and creams for leather, vinyl, metal and wood, wax for polishing.

35 – The bringing together, for the benefit of others, of a variety of goods, namely, bleaching and cleaning preparations, detergents other than for use in manufacturing operations and for medical purposes, laundry bleach, fabric softeners for laundry use, stain removers, dishwasher detergents, perfumery, non-medicated cosmetics, fragrances, deodorants for personal use and animals, soaps, dental care preparations, dentifrices, denture polishes, tooth whitening preparations, mouth washes, not for medical purposes, abrasive preparations, emery cloth, sandpaper, pumice stone, abrasive pastes, polishing preparations for leather, vinyl, metal and wood, polishes and creams for leather, vinyl, metal and wood, wax for polishing, enabling customers to conveniently view and purchase those goods, such services may be provided by retail stores, wholesale outlets, by means of electronic media or through mail order catalogues.

(260) AM 2023 118365 A

(800) 1652810

(151) 2022 01 13

(891) 2022 06 14

(731) LES LABORATOIRES SERVIER

50 rue Carnot, F-92284 Suresnes cedex, France

(540)



(591) Orange and midnight blue

(531) 01.01.02; 01.01.10; 26.11.01; 26.11.06;
26.11.12; 29.01.12

(511)

5 – Pharmaceutical products, medical and veterinary preparations; sanitary products for medicine; dietetic substances and foodstuffs for medical or veterinary use, food for babies; food supplements for humans and animals; plasters, materials for dressings; material for dental fillings and dental impressions; disinfectants; products for destroying vermin; fungicides, herbicides.

44 – Medical services; veterinary services; hygiene and beauty care for human beings or animals; health advice; pharmacy consultation; health services; telemedicine services; therapeutic services; medical diagnostic services; home care services; individualized medical prescription services; online medical prescription services; providing support in the follow-up of patients receiving medical treatment; advice with respect to home medical treatment; advice on self-medication; provision of medical information to patients; remote medical examination services; advice concerning personal well-being [health]; medical monitoring of patients including remote monitoring.

(260) AM 2023 118568 A

(800) 1671285

(151) 2022 05 05

(891) 2022 05 05

(731) ILLVA SARONNO S.p.A.

Via Archimede 243, I-21047 SARONO (VA),
Italy

(540)

TIA MARIA

(591) Black, white

(511)

33 – Spirits [beverages]; liqueurs; cocktails.

(260) AM 2023 118569 A

(800) 1671301

(151) 2022 05 31

(891) 2022 05 31

(731) LLC TorgCity

Tatarskaya str., 1, lit. L, of. 303, RU-690039
Vladivostok, Russian Federation

(540)

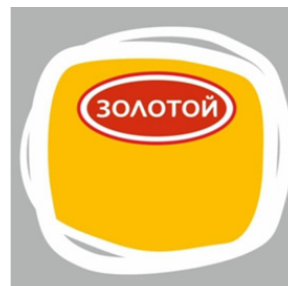

(591) Red, white, yellow and grey

(531) 26.04.06; 28.05; 29.01.14

(511)

29 – Edible fats; whipped cream; fat-containing mixtures for bread slices; milk substitutes; yogurt; kephir; margarine; oils for food; olive oil for food; sunflower oil for food; butter; milk products; milk; condensed milk; powdered milk; milk beverages, milk predominating; prostokvasha being soured milk; vegetable oils for food; ryazhenka being fermented baked milk; cream [dairy products]; smetana; cheese; tofu; cottage cheese; strained soft white cheeses; pickles.

30 – Aniseed; star aniseed; cloves [spice]; mustard; ginger [spice]; curry [spice]; cinnamon [spice]; turmeric; pepper; peppers [seasonings]; condiments; spices; relish [condiment]; celery salt; salt for preserving foodstuffs; cooking salt; salt; seasonings; saffron [seasoning]; allspice; essences for foodstuffs, except etheric essences and essential oils.

(260) AM 2023 118574 A

(800) 1671481

(151) 2022 06 09

(891) 2022 06 09

(731) AMB SARL

1 Rue Jean Jaurès, F-74000 Annecy, France

(540)

Mont Blanc

(591) Black, white

(531) 27.05.01

(511)

33 – Vodka; vodka-based alcoholic beverages.

(260) AM 2023 118584 A

(800) 1671902

(151) 2022 01 19

(891) 2022 01 19

(731) Vingroup Joint Stock Company

No. 7, Bang Lang 1 Street, Vinhomes Riverside
Ecological Urban Area, Viet Hung Ward, Long
Bien District, Hanoi City, Viet Nam

(540)

VINFAST VF 7

(591) Black, white

(531) 27.05.01; 27.05.01; 27.07.01; 27.07.01;
27.07.21

(511)

12 – Automobiles; electric cars; off road light sports utility vehicles; motorcycles; electric motorcycles; motor scooters; mopeds; bicycles; electric bicycles; electrically assisted bicycles, with pedals; all-terrain vehicles; golf cars; engines for land vehicles; sports cars; electrically-powered motor vehicles; side cars; structural parts and component parts for land vehicles, namely air bags [safety devices for automobiles], anti-glare devices, anti-skid chains, automobile bodies, drive chains for land vehicles, vehicle chassis, hoods

for vehicles, brakes for vehicles, axles for vehicles, torsion bars for vehicles, bicycle frames, motorcycle frames, bicycle pedals, bicycle saddles, vehicle bumpers, clutches for land vehicles, doors for vehicles, driving motors for land vehicles, rearview mirrors, side view mirror, reduction gears for land vehicles, vehicle wheels, rims for vehicle wheels, safety belts for vehicle seats, vehicle seats, shock absorbers for vehicles, tires for vehicle wheels, windows for vehicles, windscreen wipers, windscreen.

(260) AM 2023 118588 A

(800) 1672105

(151) 2022 01 19

(891) 2022 01 19

(731) Vingroup Joint Stock Company

No. 7, Bang Lang 1 Street, Vinhomes Riverside
Ecological Urban Area, Viet Hung Ward, Long
Bien District, Hanoi City, Viet Nam

(540)

VINFAST VF 8

(591) Black, white

(531) 27.05.01; 27.07.01

(511)

12 – Automobiles; electric cars; off road light sports utility vehicles; motorcycles; electric motorcycles; motor scooters; mopeds; bicycles; electric bicycles; electrically assisted bicycles, with pedals; all-terrain vehicles; golf cars; engines for land vehicles; sports cars; electrically-powered motor vehicles; side cars; structural parts and component parts for land vehicles, namely air bags [safety devices for automobiles], anti-glare devices, anti-skid chains, automobile bodies, drive chains for land vehicles, vehicle chassis, hoods for vehicles, brakes for vehicles, axles for vehicles, torsion bars for vehicles, bicycle frames, motorcycle frames, bicycle pedals, bicycle saddles, vehicle bumpers, clutches for land vehicles, doors for vehicles, driving motors for land vehicles, rearview mirrors, side view mirror, reduction gears for land vehicles, vehicle wheels, rims for vehicle wheels, safety belts for vehicle seats, vehicle seats, shock absorbers for vehicles, tires for vehicle wheels, windows for vehicles, windscreen wipers, windscreen.

(260) AM 2023 118589 A

(800) 1672108

(151) 2022 01 19

(891) 2022 01 19

(731) Vingroup Joint Stock Company

No. 7, Bang Lang 1 Street, Vinhomes Riverside
Ecological Urban Area, Viet Hung Ward, Long
Bien District, Hanoi City, Viet Nam

(540)

VINFAST VF 9

(591) Black, white
(531) 27.05.01; 27.07.01; 27.07.21
(511)

12 – Automobiles; electric cars; off road light sports utility vehicles; motorcycles; electric motorcycles; motor scooters; mopeds; bicycles; electric bicycles; electrically assisted bicycles, with pedals; all-terrain vehicles; golf cars; engines for land vehicles; sports cars; electrically-powered motor vehicles; side cars; structural parts and component parts for land vehicles, namely air bags [safety devices for automobiles], anti-glare devices, anti-skid chains, automobile bodies, drive chains for land vehicles, vehicle chassis, hoods for vehicles, brakes for vehicles, axles for vehicles, torsion bars for vehicles, bicycle frames, motorcycle frames, bicycle pedals, bicycle saddles, vehicle bumpers, clutches for land vehicles, doors for vehicles, driving motors for land vehicles, rearview mirrors, side view mirror, reduction gears for land vehicles, vehicle wheels, rims for vehicle wheels, safety belts for vehicle seats, vehicle seats, shock absorbers for vehicles, tires for vehicle wheels, windows for vehicles, windscreen wipers, windscreen.

(260) AM 2023 118590 A
(800) 1672109
(151) 2022 01 19
(891) 2022 01 19

(731) Vingroup Joint Stock Company
No. 7, Bang Lang 1 Street, Vinhomes Riverside
Ecological Urban Area, Viet Hung Ward, Long
Bien District, Hanoi City, Viet Nam

(540)

VINFAST VF 6

(591) Black, white
(531) 27.05.01; 27.07.01
(511)

12 – Automobiles; electric cars; off road light sports utility vehicles; motorcycles; electric motorcycles; motor scooters; mopeds; bicycles; electric bicycles; electrically assisted bicycles, with pedals; all-terrain vehicles; golf cars; engines for land vehicles; sports cars; electrically-powered motor vehicles; side cars; structural parts and component parts for land vehicles, namely air bags [safety devices for automobiles], anti-glare devices, anti-skid chains, automobile bodies, drive chains for land vehicles, vehicle chassis, hoods for vehicles, brakes for vehicles, axles for vehicles, torsion bars for vehicles, bicycle frames, motorcycle frames, bicycle pedals, bicycle saddles, vehicle bumpers, clutches for land vehicles, doors for vehicles, driving motors for land vehicles, rearview mirrors, side view mirror, reduction gears for land vehicles, vehicle wheels, rims for vehicle wheels, safety belts for vehicle seats, vehicle seats, shock absorbers for vehicles, tires for vehicle wheels, windows for vehicles, windscreen wipers, windscreen.

(260) AM 2023 118592 A
(800) 1672175
(151) 2022 05 18
(891) 2022 05 18

(731) Azar Foolad Amin
In front of Municipality district 5, Tehran
gate, Tabriz, Islamic Republic of Iran

(54)



AFA STEEL

(591) Red and black
(531) 27.05.01; 27.05.09; 29.01.12
(526) The applicant has no exclusive right to use the word STEEL alone.

(511)

6 – Steel alloys; beams of common metal for building, drywall corner beads of metal (building materials).

35 – Import-export agencies; goods import-export agencies, goods import-export agency services, import-export business services, export goods.

40 – Custom assembling of materials.

42 – Industrial design.

(260) AM 2023 118595 A
(800) 1672291
(151) 2022 04 22
(891) 2022 04 22

(731) GUANGZHOU HUIHUANG ELECTRONICS
CO., LTD.

No. 28 Yongxing Middle Street, Taihe Town,
Baiyun District, Guangzhou City, Guangdong
Province, China

(540)

JOKADE

(591) Black, white
(531) 27.05.17
(511)

9 – Data processing apparatus; readers [data processing equipment]; computer peripheral devices; couplers [data processing equipment]; headphones; telephone wires; fibre optic cables / fiber optic cables; accumulators, electric; battery chargers; batteries, electric.

(260) AM 2023 118596 A
(800) 1672370
(151) 2022 06 14
(891) 2022 06 14

(731) Tidel Engineering, L.P.
#114, 2025 W. Belt Line Road, Carrollton
TX 75006, USA

(540)



(591) Color is not claimed as a feature of the mark

(531) 26.01.03; 26.01.19; 27.05.01; 29.01.12

(511)

9 – Electronic devices capable of receiving cash and negotiable instruments, and dispensing of cash for retail establishments and financial institution; devices capable of accepting, counting, storing, safekeeping, restricting access through timed access and other programmed policies, and reporting of all device transactions, including currency and negotiable instruments which are deposited into, and cash dispensed from, the device.

(260) AM 2023 118597 A

(800) 1672404

(151) 2022 01 13

(891) 2022 01 13

(731) Euro Games Technology Ltd.

4, "Maritsa" Str., "Vranya-Lozen-Triugulnika",
BG-1151 Sofia, Bulgaria

(540)

X-NAVE

(591) Black, white

(511)

9 – Software; computer gaming software; computer software packages; computer operating system software; computer software, recorded; software drivers; virtual reality software; games software; entertainment software for computer games; computer programs for network management; operating computer software for main frame computers; monitors (computer hardware); computer hardware; apparatus for recording images; monitors (computer programs); computer game programs; computer programs for recorded games; apparatus for recording, transmission or reproduction of sound or images; communications servers [computer hardware]; electronic components for gambling machines; computer application software featuring games and gaming; computer software for the administration of on-line games and gaming; computer hardware for games and gaming; hardware and software for gambling, gambling machines, gambling games on the internet and via telecommunication network; digital telephone platforms and software; collaboration software platforms [software]; computer software platforms for social networking; collaboration management software platforms; computer software platforms for gaming; computer software platforms for gambling.

28 – Gaming machines for gambling; chips for gambling; mah-jong; arcade games; gambling machines

operating with coins, notes and cards; games; electronic games; parlor games; gaming chips; gaming tables; slot machines [gaming machines]; LCD game machines; slot machines and gaming devices; coin-operated amusement machines; roulette chips; poker chips; chips and dice [gaming equipment]; gaming equipment for casinos; roulette tables; gaming roulette wheels; casino games; gambling machines and amusement machines, automatic coin-operated; coin-operated amusement machines and / or electronic coin-operated amusement machines with or without the possibility of gain; boxes for coin-operated machines, slot machines and gaming machines; electronic or electro-technical amusement machines and apparatus, gaming machines, coin-operated entertainment machines; housings for coin-operated machines, gaming equipment, gaming machines, machines for gambling; electropneumatic and electrical gambling machines (slot machines).

38 – Providing access to platforms on the internet; providing access to gaming websites on the internet; providing access to gambling websites on the internet; telecommunication services; computer communication and internet access; broadcasting services; automatic transfer of digital data using telecommunication channels; audiovisual communication services; video communication services; video transmission via digital networks; remote transmission of audio signals by means of telecommunications; remote transmission of data by means of telecommunications; delivery of messages by electronic media; electronic communications services; communication services for the electronic transmission of data; electronic transmission and retransmission of sounds, images, documents, messages and data; message sending, receiving and forwarding; interactive communication services; interactive telecommunications services; interactive transmission of video over digital networks; cable transmission of sounds, images, signals and data; communication by electronic means; communications via multinational telecommunication networks; communications services; communications services for the exchange of data in electronic form; communication services provided electronically; advisory services relating to communications equipment; mobile media services in the nature of electronic transmission of entertainment media content; network transmission of sounds, images, signals and data; virtual chatrooms established via text messaging; providing electronic telecommunication connections; transmission of data, messages and information; transmission of sound and vision via satellite or interactive multimedia networks; computer-aided transmission of sound; transmission of sound via interactive multimedia networks; transmission of sound or visual recordings over networks; transmission of vision via interactive multimedia networks; transmission of information through video communication systems; transmission of information in the audiovisual field; provision of communications facilities

for the interchange of digital data; telecommunication services between computer networks; telecommunication services relating to electronic commerce; telecommunication of information (including web pages); electronic transmission of information (services for the -); secured data, sound and image transmission services; inter-active video text services; video uploading services; photo uploading services; delivery of messages by audiovisual media; telematic data transmission and file transfer; digital transmission services for audio and video data; rental of telecommunication devices and equipment enabling connection to networks; rental of telecommunication equipment; provision of access to content, websites and portals; provision of access to data or documents stored electronically in central files for remote consultation; provision of access to electronic sites; providing access to multimedia content online; providing access to gambling and gaming websites on the internet; providing access to websites on the internet or any other communications network; providing user access to portals on the internet; providing user access to platforms on the internet; provision of telecommunication access to video and audio content provided via an online video-on-demand service; provision of telecommunication access to video content provided via the internet; electrical data transmission over a global remote data processing network, including the internet; video-on-demand transmission services; sending and receiving of electronic messages; message sending via a website; computerised communication services; communications by computer terminals; computer intercommunication; communication by computer; on-line communication services; on-line transmission of electronic publications; transmission and distribution of data or audiovisual images via a global computer network or the internet; transmission of data, audio, video and multimedia files; transmission of data, audio, video and multimedia files, including downloadable files and files streamed over a global computer network; data transmission and data broadcasting; transmission of data or audio visual images via a global computer network or the internet; transmission of data and information by computer and electronic communication means; transmission of information on-line; transmission of multimedia content via the internet; transmission of sound, picture and data signals; computer-aided transmission of messages and images; exchange of messages via computer transmission; distribution of data or audio visual images via a global computer network or the internet; streaming audio and video material on the internet; streaming of audio, visual and audiovisual material via a global computer network; streaming of data; internet based telecommunication services; web conferencing services; video, audio and television streaming services; access to content, websites and portals; online messaging services; broadcasting of audiovisual and multimedia content via the internet.

41 – Gambling; entertainment services related to gambling; gaming services for entertainment purposes; casino, gaming and gambling services; training in the development of software systems; provision of gaming equipment for gambling halls; providing casino equipment [gambling]; gaming machine entertainment services; providing casino facilities [gambling]; gaming hall services; amusement arcade services; games equipment rental; rental of gaming machines; providing amusement arcade services; rental of gaming machines with images of fruits; editing or recording of sounds and images; sound recording and video entertainment services; hire of sound reproducing apparatus; provision of gaming equipment for casinos; providing of casino facilities; online gambling services; casino, gaming and gambling services; provision of gaming facilities, gaming hall facilities, internet casinos and online gambling services.

42 – Platform as a service [PaaS] featuring software platforms for transmission of images, audio-visual content, video content and messages; platform as a service [PaaS]; platforms for gaming as software as a service [SaaS]; platforms for online gaming as software as a service [SaaS]; platforms for online gambling as software as a service [SaaS]; platforms for gambling as software as a service [SaaS]; development of computer platforms; development of computer platforms for gambling; hosting platforms on the internet; programming of software for internet platforms; computer software technical support services; troubleshooting of computer software problems; provision of technical support in the supervision of computing networks; provision of technical support in the operation of computing networks; technical support services relating to computer software and applications; technical inspection services; monitoring of computer systems by remote access; machine condition monitoring; installation, repair and maintenance of computer software; design, maintenance and updating of computer software; installation, setting up and maintenance of computer software; design, maintenance, development and updating of computer software; installation and customisation of computer applications software; technical consultancy relating to the installation and maintenance of computer software; computer system monitoring services; design of graphic software systems; development of interactive multimedia software; design and development of computer hardware; advice relating to the design of computer hardware; advisory and information services relating to the design and development of computer hardware.

(260) AM 2023 118599 A
 (800) 1672468
 (151) 2022 06 17
 (891) 2022 06 17
 (731) GOODWE TECHNOLOGIES CO., LTD.
 No, 90 Zijin Rd., 215000 Suzhou, China

(540)

GOODWE

(591) Black, white

(531) 27.05.01

(511)

9 – Photovoltaic inverters; inverters [electricity]; inverters for power supply; transformers; current rectifiers; solar batteries; electro-dynamic apparatus for the remote control of signals; computer software, recorded; electric apparatus for commutation; automation system for power plants.

(260) AM 2023 118600 A

(800) 1672496

(151) 2022 01 24

(891) 2022 01 24

(731) Honor Device Co., Ltd.

Suite 3401, Unit A, Building 6, Shum Yip Sky Park, No. 8089, Hongli West Road, Xiangmihu Street, Futian District, Shenzhen, 518040 Guangdong, China

(540)



(591) Black, white

(531) 02.09.14; 26.04.04; 26.04.07; 26.04.09; 26.04.24; 26.13.25

(511)

9 – Computer programs, downloadable; computer programs, recorded; downloadable computer software programs; smartwatches; tablet computers; operating system programs; data processing apparatus; smartphones; video telephones; television apparatus; computer programs for connecting to remote computers and computer networks; computer programs for enabling access or entrance control; computer utility programs for computer maintenance; downloadable software for remotely accessing and controlling a computer.

37 – Providing information relating to repairs; installation of electronic and digital connections to call centers; installation, maintenance and repair of computers and computer peripherals; repair of telecommunication machines and apparatus; repair or maintenance of amusement machines and apparatus; electric appliance installation and repair; installation of hardware for computer systems; repair or maintenance of telephone apparatus; burglar alarm installation and repair; repair of telephones.

42 – Computer software design; computer programming; maintenance of computer software; providing search engines for the internet; cloud computing; consultancy in the design and development of computer hardware; computer software consultancy; computer security consultancy; recovery of computer data; updating of computer software.

(260) AM 2023 118601 A

(800) 1672497

(151) 2022 01 16

(891) 2022 01 16

(731) Honor Device Co., Ltd.

Suite 3401, Unit A, Building 6, Shum Yip Sky Park, No. 8089, Hongli West Road, Xiangmihu Street, Futian District, Shenzhen, 518040 Guangdong, China

(540)

HONOR Smart Space

(591) Black, white

(511)

9 – TV and computer all-in-one; personal digital assistants [PDAs]; interactive touch screen terminals; laptop computers; smartphone software applications, downloadable; computer software applications, downloadable; computer programs, downloadable; large-screen liquid crystal displays [LCDs]; computer software platforms, recorded or downloadable; computer programs, recorded; tablet computers; stands adapted for tablet computers; hand-held electronic dictionaries; smart rings (data processing apparatus); smartwatches (data processing apparatus); smartglasses (data processing apparatus); liquid crystal display [LCD] screens; wearable computers; notebook computers; video printers; digital color printers; flexible flat panel displays for computers; integrated circuit cards [smart cards]; holders for cell phones; selfie sticks for mobile phones; smartphones; protective films adapted for smartphones; cases for smartphones; wearable activity trackers; network communication devices; network routers; wrist-mounted smartphones; telecommunication apparatus in the form of jewellery; portable media players; headphones; virtual reality headsets; security surveillance robots; cabinets for loudspeakers; camcorders; digital photo frames; set-top boxes; liquid crystal display (LCD) televisions; television apparatus; wearable video display monitors; earphones; dashboard cameras; video surveillance apparatus; car televisions; microphones; cameras [photography]; selfie lenses; USB cables; USB cables for mobile phones; materials for electricity mains [wires, cables]; electronic chips; video screens; touch screens; integrated circuits; humanoid robots with artificial intelligence for use in scientific research.

(260) AM 2023 118674 A
 (800) 1673071
 (151) 2022 06 29
 (891) 2022 06 29
 (731) Federal Treasury Enterprise,
 "Sojuzplodoimport"
 Orlikov per., 1/11, RU-107139 Moscow,
 Russian Federation
 (540)

SEVER

(591) Black, white
 (511)
 33 – Alcoholic beverages (except beer); aperitifs; arak [arrack]; brandy; wine; piquette; whisky; vodka; gin; digestifs [liqueurs and spirits]; cocktails; liqueurs; alcoholic beverages containing fruit; spirits [beverages]; distilled beverages; hydromel [mead]; peppermint liqueurs; bitters; rum; sake; cider; rice alcohol; alcoholic extracts; fruit extracts, alcoholic; alcoholic essences.

(260) AM 2023 118709 A
 (800) 1674106
 (151) 2022 05 18
 (891) 2022 05 18
 (731) Obshchestvo s ogranichennoy otvetstvennostyu
 "Novastok TD"
 ul. Zajceva, 31, pomeshchenie P2, of. 409,
 RU-603158 g. Nizhnij Novgorod,
 Nizhegorodskaya obl., Russian Federation
 (540)



(591) Red, white, blue, purple, rose red, green and light gray
 (531) 02.09.01; 25.12.03; 27.05.07; 29.01.15
 (511)
 3 – Non-medicated cosmetics and toiletry preparations; non-medicated dentifrices; perfumery; cosmetic kits; mouthwashes, not for medical purposes; fabric softeners for laundry use; preparations for washing; dry-cleaning preparations; aloe vera preparations for cosmetic purposes; sunscreen preparations; colour-brightening chemicals for household purposes [laundry]; baby wipes impregnated with cleaning preparations; bath salts, not for medical purposes; douching preparations for personal sanitary or deodorant purposes [toiletries]; detergents, other than for use in manufacturing operations and for medical purposes; shampoos; laundry glaze; bleaching and laundry preparations; laundry bleach.
 5 – Dietetic food and substances adapted for medical or veterinary use; nutritional supplements for human beings; antiseptics; seawater for medicinal bathing;

thermal water; dietary fibre; massage gels for medical purposes; haematogen; mud for baths; medicinal mud; mineral dietary supplements; dietary supplements; albumin dietary supplements; cod liver oil; food for babies; swim diapers, reusable, for babies; swim diapers, disposable, for babies; diapers for incontinence; diaper changing mats, disposable, for babies; breast-nursing pads; pomades for medical purposes; dietetic foods adapted for medical purposes; by-products of the processing of cereals for dietetic or medical purposes; homogenized food adapted for medical purposes; freeze-dried food adapted for medical purposes; lacteal flour for babies; infant formula; bath salts for medical purposes; salts for mineral water baths; salts for medical purposes; medicinal herbs; pants, absorbent, for incontinence; babies' diaper-pants; medicated shampoos; plasters, materials for dressings; fennel for medical purposes.

10 – Clips for dummies; teething rings; feeding bottle valves; gum massagers for babies; orthopaedic footwear; incontinence sheets; dummies for babies; feeding bottle teats; baby feeding dummies; thermometers for medical purposes; thermal packs for first aid purposes.

16 – Paper; toilet paper; plastic bubble packs for wrapping or packaging; steel letters; towels of paper; paper wipes for cleaning; tablemats of paper; sheets of reclaimed cellulose for wrapping; printed matter.

(260) AM 2023 118713 A
 (800) 1350712
 (151) 2016 09 20
 (891) 2022 07 01
 (731) HABITA INTERNATIONAL ESTATES OY
 LTD
 Elimäenkatu 17-19, FI-00510 Helsinki, Finland
 (540)

Habita

(591) Black, white
 (511)
 36 – Real estate brokerage.

(260) AM 2023 118715 A
 (800) 1487296
 (151) 2019 07 15
 (891) 2022 06 07
 (731) BTL Industries
 8 Tzar Kaloyan str; BG-1000 Sofia, Bulgaria
 (540)

EMTONE

(591) Black, white
 (511)
 10 – Medical and aesthetic apparatus and instruments, in particular apparatus and instruments generating electrical, magnetic, electromagnetic, mechanical or

thermal therapeutic energy; medical and aesthetic apparatus and instruments, in particular apparatus and instruments for body shaping, fat removal, circumference reduction, skin tightening, cellulite reduction, skin rejuvenation, wrinkle reduction, scar reduction, stretch mark reduction; aesthetic massage apparatus, in particular apparatus for lymphatic drainage and increasing the circulation of bodily fluids; physical therapy apparatus, in particular apparatus for treating pain and preventing muscle cramps; aesthetic massage apparatus; gynaecological and urological apparatus and instruments; dental equipment; rehabilitation apparatus (body -) for medical purposes; physical therapy equipment; physiotherapy and rehabilitation equipment; beds specially made for medical purposes; contraceptive devices; artificial limbs; orthopedic articles; suture materials.

(260) AM 2023 118718 A
 (800) 1611194
 (151) 2021 04 20
 (891) 2022 05 26
 (731) FUJIAN TIME AND TIANHE INDUSTRIAL, CO., LTD.
 Honggongshan Development Zone, Honglai Town, Nanan City, Fujian, China
 (540)

YourSun

(591) Black, white
 (531) 27.01.12; 27.05.01; 27.05.17
 (511)
 5 – Pesticides; disinfectants impregnated into tissues; sanitary napkins; babies' diaper-pants; compresses; depuratives; medicines for veterinary purposes.

(260) AM 2023 118874 A
 (800) 1675731
 (151) 2022 01 30
 (891) 2022 01 30
 (731) Hebei Fengxuan Heating Equipment Manufacturing Co., Ltd.
 Tongda Road, Jinzhou City, Hebei Province, China
 (540)



(591) Black, white
 (531) 01.15.05; 28.03
 (511)
 11 – Stoves [heating apparatus]; boilers, other than parts of machines; heat exchangers, other than parts of machines; heating units; boiler pipes [tubes] for heating installations; solar thermal collectors [heating]; air conditioning apparatus; lamps; water heating installations; water purification installations.

(260) AM 2023 118875 A
 (800) 1675733
 (151) 2022 04 28
 (891) 2022 04 28
 (731) Obshestvo s ogranichennoy otvetstvennostyu "DAD SWEETS PARTNERS"
 284A, Qorasaroy street, Olmazor district, Tashkent, Uzbekistan
 (540)



(591) Dark blue and gold
 (531) 24.17.02; 26.01.01; 26.01.05; 26.01.06; 26.01.12; 26.01.20; 27.05.01; 29.01.12
 (511)
 30 – Pastries and confectionery.

(260) AM 2023 118876 A
 (800) 1675751
 (151) 2022 06 21
 (891) 2022 06 21
 (731) Khmelevskaya Olga Mikhailovna
 str. 40-letiya Pobedy, h. 16, fl. 272, Ul'yanskovsk, RU-432017 Ul'yanskovskaya obl., Russian Federation
 (540)

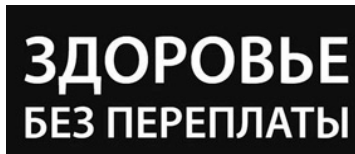

(591) Black, white
 (531) 26.04.05; 26.04.22; 26.04.24; 28.05
 (511)
 3 – Balms, other than for medical purposes; cosmetics, including gels for cosmetic use, cosmetic creams, beauty lotions, beauty masks, oils for cosmetic purposes, beauty milk; cosmetics for use on the skin; cosmetics for personal use; cosmetics and toiletries; massage balms, gels, oils, lotions other than for medical purposes; cosmetic preparations for slimming purposes; essential oils for toilet purposes; cosmetic kits;

non-medicated dentifrices; deodorants for human beings; sanitary preparations being non-medicated toiletries; sunscreen preparations; pre-moistened cosmetic wipes; cleaning pads impregnated with cosmetics; bath salts for cosmetic purposes; cosmetic preparations for baths; antiperspirants [toiletries]; shampoos.

5 – Dietary fibre; balms for medical purposes; vitamin preparations; topical gels for medical and therapeutic purposes; sanitary preparations for medical purposes; vitamin and mineral supplements; nutritional supplements; dietary supplements for human consumption; dietetic food supplements; dietetic substances consisting of vitamins, minerals and trace elements, either individually or in combination; medicinal creams, gels, ointments, balms for medical purposes; massage oil, medicated; corn and callus creams; medicated body lotions; anti-inflammatory ointments; dietetic beverages adapted for medical purposes; nutritionally fortified beverages for medical purposes; medicinal infusions; tinctures for medical purposes; therapeutic preparations for the bath; dietetic and nutritionally fortified food and substances adapted for medical use; enzyme preparations for medical purposes; syrups for pharmaceutical purposes; dietary supplement drink mixes; medicated skin care preparations; tonics [medicines]; pharmaceutical preparations; medical preparations for slimming purposes.

(260) AM 2023 118877 A

(800) 1675783

(151) 2022 02 04

(891) 2022 02 04

(731) Hak B.V.

Hendrik Cornelis Hakstraat 1, NL-4283 KA
Giessen, Netherlands

(540)



(591) Red, dark green, white

(531) 26.02.01; 26.02.24; 27.05.17; 27.05.23;
29.01.12

(511)

29 – Preserved, dried and cooked fruits and vegetables; pickles; beans; salads; canned fruit and vegetables; fruit and vegetable preserves; pickles; legumes, processed; soups; soup preparations; snacks based on vegetables; ready-to-eat meals consisting primarily of vegetables and preserved vegetables and legumes; ready-to-eat meals, mainly consisting of meat substitutes; veggie burger patties; soy steaks for hamburgers;

tofu steaks for hamburgers; burgers based on vegetables [patties]; beet burgers [patties]; bean burgers [patties]; corn burgers [patties]; vegetable extracts for cooking; vegetable, preserved; processed fruit, mushrooms and vegetables (including nuts and legumes); pie or pastry filling of canned fruit, frozen fresh fruits; jellies, jams, compotes and fruit and vegetable spreads; apple, pear and rhubarb, processed; broth based on vegetables; vegetable chips; vegetable jellies; vegetable mousse; vegetable juices for cooking; ready-to-eat vegetable products; processed fruits and vegetables flavoured with sauces, spices and herbs; vegetable salads; vegetable soups; pickled vegetables; frozen vegetables; canned peas and beans; canned pickles; broth; instant soup; soup in packages; canned soups; packaged soups; dried preparations for use in soup preparation; soup mixes; vegetable-based snacks, fruit-based snack food, nut-based snack food, seed-based snack food, prepared meals and meat substitutes; pre-packed lunch dishes, mainly consisting of vegetables; fruit and vegetable salads, pre-cut vegetable salads.

30 – Ready-to-eat meals, mainly consisting of pasta or rice; salts, seasonings, flavourings and condiments; savory sauces, chutneys and pastas; pies stuffed with vegetables; pastry stuffed with vegetables; pasta; dishes based on flour; bread; sandwiches.

31 – Fresh fruit; fresh vegetables; agricultural, horticultural and forestry products and seeds not included in other classes; seeds, live plants and flowers; food for animals, malt.

(260) AM 2023 118878 A

(800) 1675812

(151) 2022 04 27

(891) 2022 04 27

(731) Yazara Payment Solutions Inc.

230 Park Avenue, Suite 413, New York
NY 10169, USA

(540)

YAZARA

(591) Black, white

(511)

9 – Downloadable software for use in connection with mobile, digital and wireless payment processing, acceptance, and verification; downloadable software for use in connection with financial and commercial transactions; downloadable software for use in connection with mobile, digital, and wireless payment processing, acceptance and verification through the use of near-field communication (NFC), QR codes, pay links, biometrics, e-commerce, SoftPOS, and MPOS; downloadable software for use in connection with contactless mobile, digital, and wireless payment processing, acceptance, and verification.

36 – Mobile, digital, wireless, and contactless payment acceptance services; mobile, wireless, and contactless payment processing services; mobile, digital, wireless, and contactless payment verification services; mobile, digital, wireless, and contactless payment processing, acceptance, and verification services providing via use of near-field communications (NFC), QR codes, pay links, biometrics, e-commerce, SoftPOS, and MPOS; mobile, digital, wireless, and contactless financial management of reimbursement payments for others; mobile, digital, wireless, and contactless charge card and credit card payment processing services; mobile, digital, and wireless payment and funds verification services; financial transaction services, namely, providing secure commercial transactions and payment options through mobile, digital, wireless, and contactless methods; processing electronic payments made through prepaid cards via mobile, digital, wireless, and contactless methods; providing electronic processing of electronic funds transfer, ACH, credit card, debit card, electronic check and electronic payments via mobile, digital, wireless and contactless methods; providing electronic processing of credit card transactions and electronic payments via a global computer network, all provided in connection with mobile, digital, wireless, and contactless payments; electronic debit card transaction processing provided in connection with mobile, digital, wireless, and contactless payments.

42 – Software as a service (SAAS) services featuring software for use in connection with mobile, digital, wireless, and contactless payment processing, acceptance, and verification; software as a service (SAAS) services featuring software for use in connection with financial and commercial transactions; software as a service (SAAS) services featuring software for use in connection with mobile, digital, wireless, and contactless payment processing, acceptance, and verification via the use of near-field communications (NFC), QR codes, pay links, biometrics, e-commerce, SoftPOS, and MPOS; software as a service (SAAS) services featuring software for use in connection with electronic monitoring of credit card activity to detect fraud via the internet; platform as a service (PAAS) services featuring computer software platforms for use in connection with mobile, digital, wireless, and contactless payment processing, acceptance, and verification; platform as a service (PAAS) services featuring computer software platforms for use in connection with financial and commercial transactions; platform as a service (PAAS) services featuring computer software platforms for use in connection with mobile, digital, wireless, and contactless payment processing, acceptance, and verification via the use of near-field communications (NFC), QR codes, pay links, biometrics, e-commerce, SoftPOS, and MPOS; platform as a service (PAAS) services featuring computer software platforms for use in connection with electronic mo-

itoring of credit card activity to detect fraud via the internet.

(260) AM 2023 118879 A

(800) 1675813

(151) 2022 04 27

(891) 2022 04 27

(731) Yazara Payment Solutions Inc.

230 Park Avenue, Suite 413, New York

NY 10169, USA

(540)

GLASSPAY

(591) Black, white

(511)

9 – Downloadable software for use in connection with mobile, digital and wireless payment processing, acceptance, and verification; downloadable software for use in connection with financial and commercial transactions; downloadable software for use in connection with mobile, digital, and wireless payment processing, acceptance and verification through the use of near-field communication (NFC), QR codes, pay links, biometrics, e-commerce, SoftPOS, and MPOS; downloadable software for use in connection with contactless mobile, digital, and wireless payment processing, acceptance, and verification.

36 – Mobile, digital, wireless, and contactless payment acceptance services; mobile, wireless, and contactless payment processing services; mobile, digital, wireless, and contactless payment verification services; mobile, digital, wireless, and contactless payment processing, acceptance, and verification services providing via use of near-field communications (NFC), QR codes, pay links, biometrics, e-commerce, SoftPOS, and MPOS; mobile, digital, wireless, and contactless financial management of reimbursement payments for others; mobile, digital, wireless, and contactless charge card and credit card payment processing services; mobile, digital, and wireless payment and funds verification services; financial transaction services, namely, providing secure commercial transactions and payment options through mobile, digital, wireless, and contactless methods; processing electronic payments made through prepaid cards via mobile, digital, wireless, and contactless methods; providing electronic processing of electronic funds transfer, ACH, credit card, debit card, electronic check and electronic payments via mobile, digital, wireless and contactless methods; providing electronic processing of credit card transactions and electronic payments via a global computer network, all provided in connection with mobile, digital, wireless, and contactless payments; electronic debit card transaction processing provided in connection with mobile, digital, wireless, and contactless payments.

42 – Software as a service (SAAS) services featuring software for use in connection with mobile, digital,

wireless, and contactless payment processing, acceptance, and verification; software as a service (SAAS) services featuring software for use in connection with financial and commercial transactions; software as a service (SAAS) services featuring software for use in connection with mobile, digital, wireless, and contactless payment processing, acceptance, and verification via the use of near-field communications (NFC), QR codes, pay links, biometrics, e-commerce, SoftPOS, and MPOS; software as a service (SAAS) services featuring software for use in connection with electronic monitoring of credit card activity to detect fraud via the internet; platform as a service (PAAS) services featuring computer software platforms for use in connection with mobile, digital, wireless, and contactless payment processing, acceptance, and verification; platform as a service (PAAS) services featuring computer software platforms for use in connection with financial and commercial transactions; platform as a service (PAAS) services featuring computer software platforms for use in connection with mobile, digital, wireless, and contactless payment processing, acceptance, and verification via the use of near-field communications (NFC), QR codes, pay links, biometrics, e-commerce, SoftPOS, and MPOS; platform as a service (PAAS) services featuring computer software platforms for use in connection with electronic monitoring of credit card activity to detect fraud via the internet.

(260) AM 2023 118880 A

(800) 1675907

(151) 2022 03 01

(891) 2022 03 01

(731) Kinopoisk LLC

Ulitsa Sadovnicheskaya 82, Building 2,
Office 9A01, RU-115035 Moscow,
Russian Federation

(540)



(591) Dark orange, orange, yellow and green-yellow

(531) 28.05; 29.01.13

(511)

9 – 3D spectacles; DVD players; ticket dispensers; juke boxes, musical; accumulators, electric; high-frequency apparatus; remote control apparatus; sound recording apparatus; Global Positioning System [GPS] apparatus; sound transmitting apparatus; projection apparatus; telephone apparatus; electronic tags for goods; encoded identification bracelets, magnetic; electronic key fobs being remote control apparatus; camcorders; video baby monitors; video cassettes; video telephones; video screens; mechanical signs; hands-free kits for telephones; dictating machines; floppy disks; phonograph records; disks, magnetic; optical discs; electronic interactive whiteboards; electronic

notice boards; signal bells; audio interfaces; signs, luminous; downloadable emoticons for mobile phones; interfaces for computers; cinematographic cameras; identity cards, magnetic; video game cartridges; memory cards for video game machines; encoded magnetic cards; cinematographic film, exposed; electronic book readers; electronic agendas; compact discs [audio-video]; computers; laptop computers; tablet computers; notebook computers; wearable computers; portable media players; diaphragms [acoustics]; mechanisms for coin-operated apparatus; coin-operated mechanisms for television sets; monitors [computer hardware]; monitors [computer programs]; ear pads for headphones; headphones; sound recording carriers; magnetic data media; optical data media; electronic sheet music, downloadable; computer hardware; signalling panels, luminous or mechanical; telephone transmitters; transmitters of electronic signals; data gloves; computer software platforms, recorded or downloadable; wafers for integrated circuits; printed circuit boards; compact disc players; cassette players; sound recording strips; personal digital assistants [PDAs]; distance recording apparatus; teaching apparatus; audio- and video-receivers; computer software applications, downloadable; computer game software, downloadable; computer programs, downloadable; computer screen saver software, recorded or downloadable; record players; processors [central processing units]; electronic publications, downloadable; baby monitors; transmitting sets [telecommunication]; radios; vehicle radios; walkie-talkies; teaching robots; telepresence robots; humanoid robots with artificial intelligence for use in scientific research; hand-held electronic dictionaries; integrated circuit cards [smart cards]; smartglasses; smartphones; smartwatches; audiovisual teaching apparatus; radiotelephony sets; cordless telephones; mobile telephones; video recorders; sound reproduction apparatus; data processing apparatus; devices for the projection of virtual keyboards; apparatus for editing cinematographic film; couplers [data processing equipment]; computer peripheral devices; electric and electronic effects units for musical instruments; bar code readers; downloadable image files; downloadable music files; animated cartoons; filters for use in photography; USB flash drives; virtual reality headsets; equalizers [audio apparatus]; downloadable graphics for mobile phones; epidiscopes; compact discs [read-only memory]; computer software, recorded; computer programs, recorded; computer operating programs, recorded; scanners [data processing equipment]; readers [data processing equipment]; downloadable ring tones for mobile phones.

16 – Fountain pens; albums; banners of paper; tickets; note books; pamphlets; booklets; newsletters; magazines [periodicals]; periodicals; printed publications; graphic representations; calendars; pictures; catalogues; books; graphic prints; conical paper bags; printed matter; labels of paper or cardboard.

18 – Pocket wallets; business card cases; umbrellas; parasols; frames for umbrellas or parasols; card cases [notecases]; umbrella rings; purses; bags [envelopes, pouches] of leather, for packaging; conference folders; briefcases; haversacks; umbrella handles; rucksacks; travelling bags; net bags for shopping; umbrella or parasol ribs; bags; garment bags for travel; handbags; beach bags; bags for sports; bags for campers; reusable shopping bags; wheeled shopping bags; school bags; umbrella sticks; key cases; suitcases; suitcases with wheels; umbrella covers; credit card cases [wallets].

25 – Bandanas [neckerchiefs]; galoshes; waistcoats; caps being headwear; visors being headwear; combinations [clothing]; suits; jackets [clothing]; socks; footwear; clothing; outerclothing; waterproof clothing; parkas; gloves [clothing]; fingerless gloves; headscarves; scarves; non-slipping devices for footwear; boots; headwear; tee-shirts; hats; blazers; suit jackets; trench coats; tube tops; sweatshirts; heavy coats; hoodies; sleep masks.

35 – Import-export agency services; commercial information agency services; advertising agency services; cost price analysis; rental of advertising space; computerized file management; demonstration of goods; opinion polling; market studies; business investigations; business research; marketing research; consultancy regarding advertising communication strategies; layout services for advertising purposes; marketing; targeted marketing; business management of performing artists; scriptwriting for advertising purposes; news clipping services; updating and maintenance of information in registries; updating and maintenance of data in computer databases; updating of advertising material; word processing; online retail services for downloadable and pre-recorded music and movies; online retail services for downloadable ring tones; online retail services for downloadable digital music; organization of exhibitions for commercial or advertising purposes; arranging newspaper subscriptions for others; organization of fashion shows for promotional purposes; organization of trade fairs for commercial or advertising purposes; shop window dressing; data search in computer files for others; commercial intermediation services; providing business information via a website; providing commercial and business contact information; provision of an online marketplace for buyers and sellers of goods and services; web indexing for commercial or advertising purposes; media relations services; economic forecasting; sales promotion for others; promotion of goods and services through sponsorship of sports events; production of teleshopping programmes; production of advertising films; rental of advertising time on communication media; publicity material rental; rental of billboards [advertising boards]; rental of vending machines; rental of sales stands; publication of publicity texts; radio advertising; bill-posting; distribution of

samples; dissemination of advertising matter; direct mail advertising; registration of written communications and data; editing of publicity texts; advertising; online advertising on a computer network; outdoor advertising; advertising by mail order; television advertising; compilation of statistics; compilation of information into computer databases; business inquiries; systemization of information into computer databases; negotiation of business contracts for others; negotiation and conclusion of commercial transactions for third parties; compiling indexes of information for commercial or advertising purposes; telemarketing services; commercial administration of the licensing of the goods and services of others; business management of reimbursement programmes for others; administration of consumer loyalty programs; administration of frequent flyer programs; administrative processing of purchase orders; public relations; commercial lobbying services; modelling for advertising or sales promotion; market intelligence services; website traffic optimization; search engine optimization for sales promotion; gift registry services; price comparison services; pay per click advertising; procurement services for others [purchasing goods and services for other businesses]; outsourcing services [business assistance]; arranging subscriptions to services for the transmission, broadcasting and downloading of video and audiovisual content for others; providing business information; providing commercial information and advice for consumers in the choice of products and services; consultancy regarding public relations communication strategies; marketing in the framework of software publishing; presentation of goods on communication media, for retail purposes; auctioneering; retail or wholesale services for goods, including via the Internet; the aforementioned services can be ordered and provided including through a mobile or online application.

38 – Wireless broadcasting; television broadcasting; cable television broadcasting; electronic bulletin board services [telecommunications services]; providing user access to global computer networks; providing access to databases; providing telecommunications connections to a global computer network; providing telecommunication channels for teleshopping services; video-on-demand transmission; message sending; computer aided transmission of messages and images; transmission of telegrams; transmission of digital files; providing online forums; videoconferencing services; rental of message sending apparatus; rental of access time to global computer networks; rental of telecommunication equipment; radio broadcasting; radio communications; transmission of electronic mail; communications by fibre optic networks; communications by cellular phones; communications by computer terminals; satellite transmission; communications by telegrams; communications by telephone; facsimile transmission; teleconferencing services; voice mail services; streaming of data; telephone services; pro-

viding internet chatrooms; transmission of greeting cards online; telecommunications routing and junction services; the aforementioned services can be ordered and provided including through a mobile or online application.

41 – Academies [education]; rental of artwork; lending library services; booking of seats for shows; videotaping; production of music; discotheque services; dubbing; publication of books; film distribution; movie studio services; layout services, other than for advertising purposes; microfilming; videotape editing; production of radio and television programmes; screenplay writing; correspondence courses; practical training [demonstration]; training services provided via simulators; organization of exhibitions for cultural and educational purposes; providing recreation facilities; arranging and conducting of colloquiums; arranging and conducting of congresses; arranging and conducting of conferences; arranging and conducting of concerts; arranging and conducting of workshops [training]; arranging and conducting of seminars; arranging and conducting of symposiums; organization of competitions [education or entertainment]; organization of cosplay entertainment events; organization of lotteries; organization of sports competitions; vocational guidance [education or training advice]; television entertainment; providing online videos, not downloadable; providing online music, not downloadable; providing television programmes, not downloadable, via video-on-demand services; providing films, not downloadable, via video-on-demand services; cinema presentations; providing online electronic publications, not downloadable; presentation of circus performances; presentation of variety shows; presentation of live performances; theatre productions; rental of audio equipment; rental of video cameras; rental of video cassette recorders; rental of videotapes; rental of sound recordings; rental of cinematographic apparatus; rental of motion pictures; rental of radio and television sets; electronic desktop publishing; online publication of electronic books and journals; publication of texts, other than publicity texts; radio entertainment; entertainment services; writing of texts; news reporters services; film directing, other than advertising films; party planning [entertainment]; music composition services; subtitling; video editing services for events; disc jockey services; sound engineering services for events; game services provided online from a computer network; karaoke services; club services; songwriting; cultural, educational or entertainment services provided by art galleries; providing museum facilities; teaching; orchestra services; scriptwriting, other than for advertising purposes; ticket agency services [entertainment]; recording studio services; photography; photographic reporting; timing of sports events; production of shows; ordering and distributing tickets for film screenings in cinemas and at events; recording, production and distribution of films, video and audio recordings, radio and television

programs; movie schedule information services; organization and presentation of film screenings, competitions, games, concerts and entertainment events; presentation of films; providing non-downloadable films and television programs via pay television; distribution of motion pictures; cinema services, including the demonstration of films and videos; consulting services in the field of the film industry; entertainment in the form of development, creation, production/editing, distribution/rental of motion pictures, television shows, special events and multimedia entertainment content; providing entertainment through a global communication network in the form of online games and websites with a wide variety of entertainment information of general interest in relation to movies, television shows, music videos related to movies, photographs and other multimedia materials; providing online non-downloadable video clips and other multimedia digital content containing audio, video, illustrations and / or text from current television series or related to current television series; providing entertainment information via a website; fan club services [entertainment]; providing information, reviews and recommendations regarding films and television shows through websites and video-on-demand services; providing information, news and comments, reviews in the field of entertainment; providing information in the field of education; providing information relating to recreational activities; providing information in the field of entertainment; arranging and conducting of in-person educational forums; film production, other than advertising films; the aforementioned services can be ordered and provided including through a mobile or online application.

42 – Computer system analysis; graphic design of promotional materials; computer virus protection services; installation of computer software; research and development of new products for others; website design consultancy; computer security consultancy; information technology [IT] consultancy; consultancy in the design and development of computer hardware; computer software consultancy; data security consultancy; updating of computer software; monitoring of computer systems to detect breakdowns; monitoring of computer systems for detecting unauthorized access or data breach; monitoring of computer systems by remote access; software as a service [SaaS]; maintenance of computer software; conversion of data or documents from physical to electronic media; providing search engines for the internet; conversion of computer programs and data, other than physical conversion; computer system design; rental of web servers; computer rental; rental of computer software; hosting computer websites; development of computer platforms; computer software design; software development in the framework of software publishing; server hosting; creating and maintaining websites for others; computer programming; technical writing; copying of computer programs; providing virtual computer

systems through cloud computing; off-site data backup; data encryption services; electronic data storage; providing information relating to computer technology and programming via a website; platform as a service [PaaS]; electronic monitoring of credit card activity to detect fraud via the internet; the aforementioned services can be ordered and provided including through a mobile or online application.

45 – Licensing [legal services] in the framework of software publishing; licensing of intellectual property; licensing of computer software [legal services]; personal background investigations; legal document preparation services; online social networking services; legal services in relation to the negotiation of contracts for others; personal and social services rendered by others to meet the needs of individuals; the aforementioned services can be ordered and provided including through a mobile or online application.

INTERNATIONAL TRADEMARKS PROTECTED IN GEORGIA

(260) AM 2023 113962 A
(800) 1267107
(151) 2015 05 25
(181) 2025 05 25
(891) 2021 04 13
(511) 09, 15

(260) AM 2023 115447 A
(800) 1626015
(151) 2021 09 15
(181) 2031 09 15
(891) 2021 09 15
(511) 03

(260) AM 2023 116345 A
(800) 1640319
(151) 2021 12 17
(181) 2031 12 17
(891) 2021 12 17
(511) 05

(260) AM 2023 116437 A
(800) 1641093
(151) 2021 12 16
(181) 2031 12 16
(891) 2021 12 16
(511) 11, 16, 32, 41

(260) AM 2023 116450 A
(800) 1641432
(151) 2021 11 23
(181) 2031 11 23
(891) 2021 11 23
(511) 01, 04, 06, 14, 16, 18, 19, 24, 25, 35, 37, 38, 39,
40, 42, 45

(260) AM 2023 116468 A
(800) 1641611
(151) 2021 09 10
(181) 2031 09 10
(891) 2021 09 10
(511) 05, 09, 10, 42, 44

(260) AM 2023 116477 A
(800) 1641970
(151) 2021 08 17
(181) 2031 08 17
(891) 2021 08 17

(511) 05, 29, 30

(260) AM 2023 116503 A
(800) 1642644
(151) 2021 12 15
(181) 2031 12 15
(891) 2021 12 15
(511) 09, 28, 41

(260) AM 2023 116504 A
(800) 1642656
(151) 2021 11 10
(181) 2031 11 10
(891) 2021 11 10
(511) 20, 21

(260) AM 2023 116554 A
(800) 1642766
(151) 2021 12 13
(181) 2031 12 13
(891) 2021 12 13
(511) 12

(260) AM 2023 116555 A
(800) 1642769
(151) 2021 11 11
(181) 2031 11 11
(891) 2021 11 11
(511) 35, 39, 43

(260) AM 2023 116558 A
(800) 1642794
(151) 2021 09 28
(181) 2031 09 28
(891) 2021 09 28
(511) 41

(260) AM 2023 116559 A
(800) 1642795
(151) 2021 09 28
(181) 2031 09 28
(891) 2021 09 28
(511) 16, 41

(260) AM 2023 116560 A
(800) 1642810
(151) 2021 12 08
(181) 2031 12 08

(891) 2021 12 08
(511) 28, 31

(260) AM 2023 116561 A
(800) 1642816
(151) 2021 12 10
(181) 2031 12 10
(891) 2021 12 10
(511) 13

(260) AM 2023 116563 A
(800) 1642843
(151) 2021 12 15
(181) 2031 12 15
(891) 2021 12 15
(511) 33

(260) AM 2023 116571 A
(800) 1642946
(151) 2021 12 17
(181) 2031 12 17
(891) 2021 12 17
(511) 05

(260) AM 2023 116574 A
(800) 1642996
(151) 2021 12 17
(181) 2031 12 17
(891) 2021 12 17
(511) 05

(260) AM 2023 116580 A
(800) 1643235
(151) 2021 11 25
(181) 2031 11 25
(891) 2021 11 25
(511) 03, 09, 18, 20, 21, 24, 30

(260) AM 2023 116586 A
(800) 1643466
(151) 2021 08 19
(181) 2031 08 19
(891) 2021 08 19
(511) 03, 35

(260) AM 2023 116591 A
(800) 1643530
(151) 2021 11 05
(181) 2031 11 05
(891) 2021 11 05
(511) 07, 09, 11, 21, 28

(260) AM 2023 116594 A
(800) 1643655
(151) 2021 12 15
(181) 2031 12 15
(891) 2021 12 15
(511) 09, 28, 41

(260) AM 2023 116595 A
(800) 1643656
(151) 2021 12 15
(181) 2031 12 15
(891) 2021 12 15
(511) 09, 28, 41

(260) AM 2023 116597 A
(800) 1643773
(151) 2021 12 15
(181) 2031 12 15
(891) 2021 12 15
(511) 09, 28, 41

(260) AM 2023 116615 A
(800) 1519518
(151) 2020 01 27
(181) 2030 01 27
(891) 2022 01 26
(511) 29, 31, 44

(260) AM 2023 116616 A
(800) 1525004
(151) 2019 11 11
(181) 2029 11 11
(891) 2021 12 06
(511) 07, 12

(260) AM 2023 116617 A
(800) 1576513
(151) 2020 10 13
(181) 2030 10 13
(891) 2022 01 11
(511) 05

(260) AM 2023 116618 A
(800) 1585178
(151) 2021 02 24
(181) 2031 02 24
(891) 2022 01 13
(511) 09

(260) AM 2023 116674 A
(800) 1644445
(151) 2021 05 31
(181) 2031 05 31

(891) 2021 05 31
(511) 16, 39, 43

(260) AM 2023 116675 A
(800) 1644450
(151) 2021 02 07
(181) 2031 02 07
(891) 2021 02 07
(511) 03, 05, 21, 28, 30

(260) AM 2023 116676 A
(800) 1644453
(151) 2021 10 26
(181) 2031 10 26
(891) 2021 10 26
(511) 05, 10

(260) AM 2023 116687 A
(800) 1644561
(151) 2021 12 01
(181) 2031 12 01
(891) 2021 12 01
(511) 03, 05

(260) AM 2023 116688 A
(800) 1644572
(151) 2021 12 15
(181) 2031 12 15
(891) 2021 12 15
(511) 05, 44

(260) AM 2023 116707 A
(800) 1645337
(151) 2021 12 09
(181) 2031 12 09
(891) 2021 12 09
(511) 37

(260) AM 2023 116709 A
(800) 1645435
(151) 2021 06 24
(181) 2031 06 24
(891) 2021 06 24
(511) 09, 18, 25, 28, 35

(260) AM 2023 116710 A
(800) 1645486
(151) 2021 01 15
(181) 2031 01 15
(891) 2021 01 15
(511) 39, 42

(260) AM 2023 116714 A
(800) 1645581
(151) 2021 09 14
(181) 2031 09 14
(891) 2021 09 14
(511) 05, 35

(260) AM 2023 116715 A
(800) 1645585
(151) 2021 09 30
(181) 2031 09 30
(891) 2021 09 30
(511) 09, 38, 41

(260) AM 2023 116717 A
(800) 1645653
(151) 2021 12 01
(181) 2031 12 01
(891) 2021 12 01
(511) 20

(260) AM 2023 116718 A
(800) 1645686
(151) 2021 12 02
(181) 2031 12 02
(891) 2021 12 02
(511) 10, 40, 44

(260) AM 2023 116719 A
(800) 1645758
(151) 2022 01 04
(181) 2032 01 04
(891) 2022 01 04
(511) 25

(260) AM 2023 116720 A
(800) 1645797
(151) 2021 12 20
(181) 2031 12 20
(891) 2021 12 20
(511) 01

(260) AM 2023 116722 A
(800) 1108094
(151) 2011 12 30
(181) 2031 12 30
(891) 2022 01 21
(511) 01

(260) AM 2023 116723 A
(800) 1136470
(151) 2012 10 08
(181) 2022 10 08

(891) 2022 02 03
(511) 18, 25, 35

(260) AM 2023 116725 A
(800) 1499332
(151) 2019 06 07
(181) 2029 06 07
(891) 2021 10 05
(511) 03, 05, 35

(260) AM 2023 116726 A
(800) 1541527
(151) 2020 06 16
(181) 2030 06 16
(891) 2022 02 03
(511) 03

(260) AM 2023 116727 A
(800) 1593069
(151) 2021 02 17
(181) 2031 02 17
(891) 2022 01 31
(511) 35, 41

(260) AM 2023 116768 A
(800) 1645832
(151) 2021 08 05
(181) 2031 08 05
(891) 2021 08 05
(511) 03, 05, 35

(260) AM 2023 116777 A
(800) 1646137
(151) 2022 01 15
(181) 2032 01 15
(891) 2022 01 15
(511) 03

(260) AM 2023 116779 A
(800) 1646190
(151) 2022 01 21
(181) 2032 01 21
(891) 2022 01 21
(511) 01, 05

(260) AM 2023 116780 A
(800) 1646248
(151) 2021 10 18
(181) 2031 10 18
(891) 2021 10 18
(511) 09, 28, 41

(260) AM 2023 116781 A
(800) 1646379
(151) 2021 11 18
(181) 2031 11 18
(891) 2021 11 18
(511) 05

(260) AM 2023 116782 A
(800) 1646435
(151) 2021 12 24
(181) 2031 12 24
(891) 2021 12 24
(511) 30

(260) AM 2023 116785 A
(800) 1646467
(151) 2021 08 31
(181) 2031 08 31
(891) 2021 08 31
(511) 33

(260) AM 2023 116786 A
(800) 1646468
(151) 2021 08 31
(181) 2031 08 31
(891) 2021 08 31
(511) 33

(260) AM 2023 116787 A
(800) 1646470
(151) 2021 09 28
(181) 2031 09 28
(891) 2021 09 28
(511) 41

(260) AM 2023 116788 A
(800) 1646481
(151) 2021 12 02
(181) 2031 12 02
(891) 2021 12 02
(511) 19, 35

(260) AM 2023 116790 A
(800) 1646509
(151) 2021 12 15
(181) 2031 12 15
(891) 2021 12 15
(511) 32, 33

(260) AM 2023 116795 A
(800) 1646668
(151) 2022 01 20
(181) 2032 01 20
(891) 2022 01 20
(511) 10

(260) AM 2023 116798 A
(800) 1646694
(151) 2022 01 20
(181) 2032 01 20
(891) 2022 01 20
(511) 03

(260) AM 2023 116800 A
(800) 1646788
(151) 2021 12 16
(181) 2031 12 16
(891) 2021 12 16
(511) 35

(260) AM 2023 116801 A
(800) 1646833
(151) 2021 12 13
(181) 2031 12 13
(891) 2021 12 13
(511) 34

(260) AM 2023 116802 A
(800) 1646845
(151) 2021 10 18
(181) 2031 10 18
(891) 2021 10 18
(511) 09, 28, 41

(260) AM 2023 116803 A
(800) 1646855
(151) 2020 11 16
(181) 2030 11 16
(891) 2020 11 16
(511) 09

(260) AM 2023 116805 A
(800) 1646883
(151) 2021 07 30
(181) 2031 07 30
(891) 2021 07 30
(511) 01, 34, 35

(260) AM 2023 116807 A
(800) 1646899
(151) 2021 09 14
(181) 2031 09 14

(891) 2021 09 14
(511) 07, 09, 11, 12, 14, 18, 25, 28, 40, 42

(260) AM 2023 116808 A
(800) 1646948
(151) 2021 09 15
(181) 2031 09 15
(891) 2021 09 15
(511) 35

(260) AM 2023 116809 A
(800) 1647003
(151) 2021 11 17
(181) 2031 11 17
(891) 2021 11 17
(511) 09, 36, 38, 42

(260) AM 2023 116810 A
(800) 1647007
(151) 2021 10 22
(181) 2031 10 22
(891) 2021 10 22
(511) 09, 10, 44

(260) AM 2023 116811 A
(800) 1647017
(151) 2021 11 02
(181) 2031 11 02
(891) 2021 11 02
(511) 05

(260) AM 2023 116813 A
(800) 1647063
(151) 2022 01 12
(181) 2032 01 12
(891) 2022 01 12
(511) 35, 36, 39, 41, 45

(260) AM 2023 116814 A
(800) 1647099
(151) 2021 11 29
(181) 2031 11 29
(891) 2021 11 29
(511) 35

(260) AM 2023 116815 A
(800) 733013
(151) 2000 04 26
(181) 2030 04 26
(891) 2022 02 04
(511) 33

(260) AM 2023 116816 A
(800) 899419
(151) 2006 01 23
(181) 2026 01 23
(891) 2022 02 04
(511) 01, 02, 04

(260) AM 2023 116817 A
(800) 1105867
(151) 2011 12 19
(181) 2031 12 19
(891) 2022 01 28
(511) 35, 42

(260) AM 2023 116818 A
(800) 1216739
(151) 2014 01 10
(181) 2024 01 10
(891) 2022 02 04
(511) 01, 02, 04

(260) AM 2023 116819 A
(800) 1263742
(151) 2015 04 21
(181) 2025 04 21
(891) 2022 02 01
(511) 18, 25, 35

(260) AM 2023 116820 A
(800) 1375390
(151) 2017 09 20
(181) 2027 09 20
(891) 2022 02 04
(511) 33

(260) AM 2023 116821 A
(800) 1553700
(151) 2020 06 19
(181) 2030 06 19
(891) 2021 12 02
(511) 05

(260) AM 2023 116822 A
(800) 1561426
(151) 2020 10 07
(181) 2030 10 07
(891) 2022 01 27
(511) 09, 45

(260) AM 2023 116823 A
(800) 1561448
(151) 2020 10 07
(181) 2030 10 07

(891) 2022 01 27
(511) 09, 45

(260) AM 2023 116824 A
(800) 1584574
(151) 2021 02 19
(181) 2031 02 19
(891) 2022 02 09
(511) 11, 30, 35

(260) AM 2023 116825 A
(800) 1608382
(151) 2021 07 15
(181) 2031 07 15
(891) 2022 02 09
(511) 30, 35, 43

(260) AM 2023 116869 A
(800) 1647168
(151) 2021 02 09
(181) 2031 02 09
(891) 2021 02 09
(511) 03, 05, 21

(260) AM 2023 116875 A
(800) 1647346
(151) 2021 08 27
(181) 2031 08 27
(891) 2021 08 27
(511) 09

(260) AM 2023 116887 A
(800) 1647624
(151) 2021 10 20
(181) 2031 10 20
(891) 2021 10 20
(511) 16, 21, 28

(260) AM 2023 116888 A
(800) 1647646
(151) 2021 12 22
(181) 2031 12 22
(891) 2021 12 22
(511) 35

(260) AM 2023 116889 A
(800) 1647691
(151) 2021 10 07
(181) 2031 10 07
(891) 2021 10 07
(511) 09, 28, 41

(260) AM 2023 116890 A
(800) 1647721
(151) 2021 12 20
(181) 2031 12 20
(891) 2021 12 20
(511) 07

(260) AM 2023 116895 A
(800) 1647863
(151) 2022 01 14
(181) 2032 01 14
(891) 2022 01 14
(511) 35

(260) AM 2023 116896 A
(800) 1647915
(151) 2021 10 07
(181) 2031 10 07
(891) 2021 10 07
(511) 09, 28, 41

(260) AM 2023 116897 A
(800) 1647918
(151) 2021 12 20
(181) 2031 12 20
(891) 2021 12 20
(511) 07

(260) AM 2023 116903 A
(800) 1647965
(151) 2022 01 19
(181) 2032 01 19
(891) 2022 01 19
(511) 10

(260) AM 2023 116904 A
(800) 1647995
(151) 2021 12 03
(181) 2031 12 03
(891) 2021 12 03
(511) 25

(260) AM 2023 116905 A
(800) 1648007
(151) 2022 01 28
(181) 2032 01 28
(891) 2022 01 28
(511) 09

(260) AM 2023 116906 A
(800) 1648011
(151) 2021 12 29
(181) 2031 12 29

(891) 2021 12 29
(511) 11, 34

(260) AM 2023 116907 A
(800) 1648028
(151) 2021 12 03
(181) 2031 12 03
(891) 2021 12 03
(511) 28

(260) AM 2023 116908 A
(800) 1648129
(151) 2021 07 02
(181) 2031 07 02
(891) 2021 07 02
(511) 06

(260) AM 2023 116909 A
(800) 1648148
(151) 2021 01 15
(181) 2031 01 15
(891) 2021 01 15
(511) 39, 42

(260) AM 2023 116943 A
(800) 1265213
(151) 2014 12 19
(181) 2024 12 19
(891) 2022 02 15
(511) 05

(260) AM 2023 116944 A
(800) 1518747
(151) 2020 01 17
(181) 2030 01 17
(891) 2022 01 25
(511) 39, 43

(260) AM 2023 116945 A
(800) 1568208
(151) 2020 09 07
(181) 2030 09 07
(891) 2022 02 07
(511) 07

(260) AM 2023 116946 A
(800) 1588961
(151) 2021 03 05
(181) 2031 03 05
(891) 2022 02 15
(511) 05

(260) AM 2023 116947 A
 (800) 1590116
 (151) 2021 03 05
 (181) 2031 03 05
 (891) 2022 02 15
 (511) 05

(260) AM 2023 117035 A
 (800) 1649394
 (151) 2021 09 24
 (181) 2031 09 24
 (891) 2021 09 24
 (511) 07, 08, 09

(260) AM 2023 116948 A
 (800) 1607169
 (151) 2021 03 05
 (181) 2031 03 05
 (891) 2022 02 15
 (511) 05

(260) AM 2023 117036 A
 (800) 1649400
 (151) 2021 11 23
 (181) 2031 11 23
 (891) 2021 11 23
 (511) 09, 12, 42

(260) AM 2023 116949 A
 (800) 1642780
 (151) 2021 06 08
 (181) 2031 06 08
 (891) 2022 01 28
 (511) 05, 29, 30, 32

(260) AM 2023 117037 A
 (800) 1649432
 (151) 2022 02 10
 (181) 2032 02 10
 (891) 2022 02 10
 (511) 20

(260) AM 2023 116997 A
 (800) 1648663
 (151) 2021 12 10
 (181) 2031 12 10
 (891) 2021 12 10
 (511) 03

(260) AM 2023 117038 A
 (800) 1649457
 (151) 2021 11 16
 (181) 2031 11 16
 (891) 2021 11 16
 (511) 03

(260) AM 2023 116998 A
 (800) 1648667
 (151) 2021 12 23
 (181) 2031 12 23
 (891) 2021 12 23
 (511) 01, 05, 09, 35, 37, 39, 42

(260) AM 2023 117039 A
 (800) 1649469
 (151) 2021 09 29
 (181) 2031 09 29
 (891) 2021 09 29
 (511) 18, 24, 25

(260) AM 2023 117033 A
 (800) 1649381
 (151) 2021 12 24
 (181) 2031 12 24
 (891) 2021 12 24
 (511) 03, 09, 12, 14, 16, 18, 20, 21, 24, 25, 26, 27, 28,
 33, 35, 36, 39, 40, 41, 42, 43, 45

(260) AM 2023 117040 A
 (800) 1649471
 (151) 2021 09 02
 (181) 2031 09 02
 (891) 2021 09 02
 (511) 07, 09, 16, 35, 38, 40, 41

(260) AM 2023 117034 A
 (800) 1649393
 (151) 2021 09 21
 (181) 2031 09 21
 (891) 2021 09 21
 (511) 09, 28, 41

(260) AM 2023 117041 A
 (800) 1649495
 (151) 2021 12 08
 (181) 2031 12 08
 (891) 2021 12 08
 (511) 02, 07, 19

(260) AM 2023 117042 A
(800) 1649508
(151) 2021 11 24
(181) 2031 11 24
(891) 2021 11 24
(511) 05

(260) AM 2023 117043 A
(800) 1649531
(151) 2022 01 04
(181) 2032 01 04
(891) 2022 01 04
(511) 20, 24, 25, 35

(260) AM 2023 117044 A
(800) 1649537
(151) 2022 01 27
(181) 2032 01 27
(891) 2022 01 27
(511) 41, 42

(260) AM 2023 117045 A
(800) 1649600
(151) 2021 11 02
(181) 2031 11 02
(891) 2021 11 02
(511) 03

(260) AM 2023 117046 A
(800) 1649635
(151) 2021 07 27
(181) 2031 07 27
(891) 2021 07 27
(511) 03, 05, 30, 31

(260) AM 2023 117048 A
(800) 1649715
(151) 2022 01 25
(181) 2032 01 25
(891) 2022 01 25
(511) 09, 35

(260) AM 2023 117049 A
(800) 1649760
(151) 2022 01 19
(181) 2032 01 19
(891) 2022 01 19
(511) 01, 06

(260) AM 2023 117050 A
(800) 1649802
(151) 2021 11 01
(181) 2031 11 01

(891) 2021 11 01
(511) 03

(260) AM 2023 117120 A
(800) 1650140
(151) 2022 02 03
(181) 2032 02 03
(891) 2022 02 03
(511) 05

(260) AM 2023 117225 A
(800) 1651917
(151) 2021 10 01
(181) 2031 10 01
(891) 2021 10 01
(511) 03, 05

(260) AM 2023 117226 A
(800) 1651918
(151) 2021 10 01
(181) 2031 10 01
(891) 2021 10 01
(511) 03, 05

(260) AM 2023 117235 A
(800) 1652108
(151) 2021 11 03
(181) 2031 11 03
(891) 2021 11 03
(511) 12

(260) AM 2023 117237 A
(800) 1652144
(151) 2020 09 29
(181) 2030 09 29
(891) 2020 09 29
(511) 41

(260) AM 2023 117238 A
(800) 1652150
(151) 2021 08 24
(181) 2031 08 24
(891) 2021 08 24
(511) 03

(260) AM 2023 117239 A
(800) 1652153
(151) 2021 07 09
(181) 2031 07 09
(891) 2021 07 09
(511) 19, 20, 35

(260) AM 2023 117241 A
 (800) 1652185
 (151) 2021 10 26
 (181) 2031 10 26
 (891) 2021 10 26
 (511) 05, 10

(260) AM 2023 117401 A
 (800) 1654838
 (151) 2021 12 02
 (181) 2031 12 02
 (891) 2021 12 02
 (511) 10, 40, 44

(260) AM 2023 117242 A
 (800) 1652292
 (151) 2022 01 13
 (181) 2032 01 13
 (891) 2022 01 13
 (511) 30

(260) AM 2023 117402 A
 (800) 1654870
 (151) 2022 01 11
 (181) 2032 01 11
 (891) 2022 01 11
 (511) 35

(260) AM 2023 117243 A
 (800) 1652327
 (151) 2022 02 10
 (181) 2032 02 10
 (891) 2022 02 10
 (511) 01

(260) AM 2023 117403 A
 (800) 1654880
 (151) 2021 12 24
 (181) 2031 12 24
 (891) 2021 12 24
 (511) 30, 32, 35, 43

(260) AM 2023 117397 A
 (800) 1654724
 (151) 2021 12 13
 (181) 2031 12 13
 (891) 2021 12 13
 (511) 35, 36, 45

(260) AM 2023 117404 A
 (800) 1654980
 (151) 2022 02 25
 (181) 2032 02 25
 (891) 2022 02 25
 (511) 29

(260) AM 2023 117398 A
 (800) 1654784
 (151) 2022 02 25
 (181) 2032 02 25
 (891) 2022 02 25
 (511) 29

(260) AM 2023 117405 A
 (800) 1654989
 (151) 2021 08 12
 (181) 2031 08 12
 (891) 2021 08 12
 (511) 25, 28, 41

(260) AM 2023 117399 A
 (800) 1654816
 (151) 2021 08 27
 (181) 2031 08 27
 (891) 2021 08 27
 (511) 25, 35

(260) AM 2023 117406 A
 (800) 1655085
 (151) 2021 12 03
 (181) 2031 12 03
 (891) 2021 12 03
 (511) 03, 05

(260) AM 2023 117400 A
 (800) 1654820
 (151) 2021 09 03
 (181) 2031 09 03
 (891) 2021 09 03
 (511) 09

(260) AM 2023 117407 A
 (800) 614557
 (151) 1994 01 25
 (181) 2024 01 25
 (891) 2022 02 18
 (511) 06

(260) AM 2023 117408 A
(800) 1125984
(151) 2011 12 06
(181) 2031 12 06
(891) 2022 03 11
(511) 05

(260) AM 2023 117461 A
(800) 1655272
(151) 2022 03 09
(181) 2032 03 09
(891) 2022 03 09
(511) 38

(260) AM 2023 117409 A
(800) 1208979
(151) 2014 02 25
(181) 2024 02 25
(891) 2022 02 10
(511) 18, 25, 35

(260) AM 2023 117496 A
(800) 1656056
(151) 2021 12 07
(181) 2031 12 07
(891) 2021 12 07
(511) 29, 30

(260) AM 2023 117410 A
(800) 1549962
(151) 2020 07 17
(181) 2030 07 17
(891) 2022 03 18
(511) 09, 42

(260) AM 2023 117499 A
(800) 1656226
(151) 2021 12 14
(181) 2031 12 14
(891) 2021 12 14
(511) 09, 41, 42

(260) AM 2023 117411 A
(800) 1568915
(151) 2020 12 01
(181) 2030 12 01
(891) 2022 03 18
(511) 30

(260) AM 2023 117500 A
(800) 1656228
(151) 2021 12 14
(181) 2031 12 14
(891) 2021 12 14
(511) 42, 44

(260) AM 2023 117412 A
(800) 1615249
(151) 2021 05 28
(181) 2031 05 28
(891) 2022 02 15
(511) 42

(260) AM 2023 117501 A
(800) 1656256
(151) 2021 11 11
(181) 2031 11 11
(891) 2021 11 11
(511) 12, 35, 37, 42

(260) AM 2023 117458 A
(800) 1655151
(151) 2022 03 04
(181) 2032 03 04
(891) 2022 03 04
(511) 30

(260) AM 2023 117502 A
(800) 1656281
(151) 2022 01 21
(181) 2032 01 21
(891) 2022 01 21
(511) 07

(260) AM 2023 117460 A
(800) 1655254
(151) 2021 10 25
(181) 2031 10 25
(891) 2021 10 25
(511) 19

(260) AM 2023 117516 A
(800) 1166645
(151) 2013 05 24
(181) 2023 05 24
(891) 2022 03 02
(511) 05, 10

(260) AM 2023 117518 A
(800) 1270198
(151) 2015 06 24
(181) 2025 06 24
(891) 2021 12 20
(511) 17, 19

(260) AM 2023 117519 A
(800) 1270199
(151) 2015 06 24
(181) 2025 06 24
(891) 2021 12 20
(511) 17, 19

(260) AM 2023 117563 A
(800) 1656638
(151) 2022 02 28
(181) 2032 02 28
(891) 2022 02 28
(511) 09, 28

(260) AM 2023 117564 A
(800) 1656639
(151) 2022 02 28
(181) 2032 02 28
(891) 2022 02 28
(511) 09, 28, 41

(260) AM 2023 117567 A
(800) 1656701
(151) 2021 12 29
(181) 2031 12 29
(891) 2021 12 29
(511) 06, 17, 19

(260) AM 2023 117568 A
(800) 1656750
(151) 2022 03 18
(181) 2032 03 18
(891) 2022 03 18
(511) 41

(260) AM 2023 117569 A
(800) 1656764
(151) 2021 12 21
(181) 2031 12 21
(891) 2021 12 21
(511) 35

(260) AM 2023 117570 A
(800) 1656767
(151) 2022 03 18
(181) 2032 03 18
(891) 2022 03 18
(511) 35, 41

(260) AM 2023 117571 A
(800) 1656771
(151) 2022 03 02
(181) 2032 03 02
(891) 2022 03 02
(511) 05

(260) AM 2023 117628 A
(800) 1657891
(151) 2022 03 01
(181) 2032 03 01
(891) 2022 03 01
(511) 08

(260) AM 2023 117629 A
(800) 1657905
(151) 2022 03 14
(181) 2032 03 14
(891) 2022 03 14
(511) 07, 11

(260) AM 2023 117630 A
(800) 1657918
(151) 2021 12 06
(181) 2031 12 06
(891) 2021 12 06
(511) 35, 41

(260) AM 2023 117631 A
(800) 1657932
(151) 2022 03 22
(181) 2032 03 22
(891) 2022 03 22
(511) 05, 16, 44

(260) AM 2023 117632 A
(800) 1657990
(151) 2021 12 22
(181) 2031 12 22
(891) 2021 12 22
(511) 05, 29, 32

(260) AM 2023 117686 A
(800) 1659384
(151) 2021 12 15
(181) 2031 12 15
(891) 2021 12 15
(511) 09, 28, 41

(260) AM 2023 117781 A
(800) 1661042
(151) 2022 01 17
(181) 2032 01 17
(891) 2022 01 17
(511) 01, 02, 17

(260) AM 2023 117687 A
(800) 1659385
(151) 2021 12 16
(181) 2031 12 16
(891) 2021 12 16
(511) 09, 28, 41

(260) AM 2023 117688 A
(800) 1659424
(151) 2022 04 04
(181) 2032 04 04
(891) 2022 04 04
(511) 30, 43

(260) AM 2023 117777 A
(800) 1660976
(151) 2022 01 25
(181) 2032 01 25
(891) 2022 01 25
(511) 09, 12, 14, 25, 28, 32, 35, 38, 41, 42

(260) AM 2023 117778 A
(800) 1660978
(151) 2022 01 25
(181) 2032 01 25
(891) 2022 01 25
(511) 09, 12, 14, 25, 28, 32, 35, 38, 41, 42

(260) AM 2023 117779 A
(800) 1661020
(151) 2022 03 29
(181) 2032 03 29
(891) 2022 03 29
(511) 34

(260) AM 2023 117780 A
(800) 1661027
(151) 2021 10 05
(181) 2031 10 05
(891) 2021 10 05
(511) 29, 35

**OFFICIAL NOTIFICATIONS
INVENTIONS
RESTORATION OF PATENTS**

(21) AP 2011 13092
(11) P 2015 6303 B
(73) Reforcetech LTD
(54) REINFORCEMENT BAR AND METHOD FOR MANUFACTURING SAME
DATE OF PATENT CANCELLATION: 2022 10 21
DATE OF PATENT RESTORATION: 2023 03 27

(21) AP 2017 14588
(11) P 2021 7250 B
(73) DaW SE
(54) SOLVENT-CONTAINING COATING COMPOSITION
DATE OF PATENT CANCELLATION: 2022 09 18
DATE OF PATENT RESTORATION: 2023 03 27

(21) AP 2019 15002
(11) P 2020 7150 B
(73) Giorgi Nozadze;
 Aleksandre Kartvelishvili;
 Davit Pataraiia;
 Rusudan Maisuradze;
 LEPL "Grigol Tsulukidze Mining Institute"
(54) SUSPENSION ROPE-WAY WITH SELF-PROPELLED CARRIAGE
DATE OF PATENT CANCELLATION: 2023 02 13
DATE OF PATENT RESTORATION: 2023 03 27

(21) AP 2005 8972
(11) P 2009 4663 B
(73) Giorgi Ioramashvili;
 Marine Beroshvili
(54) METHOD FOR SEPARATION OF FLUID INTRUSION
DATE OF PATENT CANCELLATION: 2022 09 12
DATE OF PATENT RESTORATION: 2023 03 27

ABOLITION OF PATENTS WITH THE RIGHT TO RESTORE

(21) AP 2010 11695
(11) P 2011 5360 B
(73) Vazha Khositashvili
(54) VEGETATIVE GATHERING – ANTIOXIDANT, ANTIRADIATION AND FOR TREATMENT OF
CARDIOVASCULAR DISEASES AND MEDICAL MEANS ON ITS BASIS
DATE OF PATENT CANCELLATION: 2023 02 23
LIMITED DATE OF PATENT RESTORATION: 2024 02 23

(21) AP 2010 11696
(11) P 2011 5361 B
(73) Vazha Khositashvili;
Levan Khositashvili
Babri Oreni
(54) PREPARATION-ANTIOXIDANT, ANTIRADIATION, REGULATING LIPIDIC EXCHANGE
AND PREPARATION FOR TREATMENT OF CARDIOVASCULAR DISEASES
DATE OF PATENT CANCELLATION: 2023 02 23
LIMITED DATE OF PATENT RESTORATION: 2024 02 23

(21) AP 2012 12581
(11) P 2013 5895 B
(73) Eter Kemertelidze;
Aleksandre Skhirtladze;
Tsisana Sulakvelidze
(54) METHOD OF OBTAINING DIGITONIN
DATE OF PATENT CANCELLATION: 2023 02 20
LIMITED DATE OF PATENT RESTORATION: 2024 02 20

(21) AP 2015 13750
(11) P 2016 6541 B
(73) LEPL "Ferdinand Tavadze Institute of Metallurgy and Materials Science"
(54) METHOD FOR INORGANIC MATERIALS ARTICLES PRODUCTION WITH POWDERED
EXOTHERMAL MIXES
DATE OF PATENT CANCELLATION: 2023 03 04
LIMITED DATE OF PATENT RESTORATION: 2024 03 04

(21) AP 2015 14284
(11) P 2019 6984 B
(73) Takeda Pharmaceutical Company Limited
(54) PYRIDAZINE DERIVATIVES FOR USE IN THE PREVENTION OR TREATMENT OF AN ATAXIC
DISORDER
DATE OF PATENT CANCELLATION: 2023 03 06
LIMITED DATE OF PATENT RESTORATION: 2024 03 06

(21) AP 2016 14600
(11) P 2021 7282 B
(73) Atea Pharmaceuticals Inc.
(54) β -D-2'-DEOXY-2' α -FLUORO-2'- β -C-SUBSTITUTED-2-MODIFIED-N6-SUBSTITUTED PURINE
NUCLEOTIDES FOR HCV TREATMENT
DATE OF PATENT CANCELLATION: 2023 03 07
LIMITED DATE OF PATENT RESTORATION: 2024 03 07

(21) AP 2018 14718
(11) P 2020 7061 B
(73) Tamaz Jaliashvili;
Omar Mikadze;
Vasil Kopaleishvili;
Otar Barbakadze
(54) METALLIC PLATE CONTINUES CASTING DEVICE
DATE OF PATENT CANCELLATION: 2023 03 01
LIMITED DATE OF PATENT RESTORATION: 2024 03 01

DATE OF PATENTS RESTORATION EXPIRATION

(21) AP 2012 12584
(11) P 2014 6199 B
(73) Eter Kemertelidze;
Meri Alania;
Nana Kavtaradze
(54) HYPOAZOTEMICAL DRUG MADE OF PLANT PUERARIA HIRSUTE MATSUM
DATE OF PATENT CANCELLATION: 2022 02 20
DATE OF PATENT RESTORATION EXPIRATION: 2023 02 20

(21) AP 2012 12603
(11) P 2013 5971 B
(73) Eter Kemertelidze;
Mariam Benidze;
Aleksandre Skhirtladze;
Petre Naskidashvili;
Ivane Zedgenidze
(54) METHOD OF OBTAINING PLANT GROW STIMULATOR "ALEXIN"
DATE OF PATENT CANCELLATION: 2022 02 28
DATE OF PATENT RESTORATION EXPIRATION: 2023 02 28

(21) AP 2016 14074
(11) P 2017 6732 B
(73) Andro Maisuradze;
Lasha Maisuradze
(54) THREE-FLOW TURBOJET ENGINE
DATE OF PATENT CANCELLATION: 2022 02 28
DATE OF PATENT RESTORATION EXPIRATION: 2023 02 28

(21) AP 2015 14278
(11) P 2018 6829 B
(73) Synthetics S.A..
(54) PROCESS FOR PRODUCING A STABLE LOW CONCENTRATION, INJECTABLE SOLUTION
OF NORADRENALINE
DATE OF PATENT CANCELLATION: 2022 02 26
DATE OF PATENT EXPIRATION: 2023 02 26

(21) AP 2020 15295
(11) P 2021 7233 B
(73) Zurab Vashalomidze
(54) BOTTLES SET CLAMP
DATE OF PATENT CANCELLATION: 2022 03 02
DATE OF PATENT EXPIRATION: 2023 03 02

EXPIRATION OF TERMS OF PATENT

(21) AP 2003 8391
(11) P 2006 3986 B
(73) Chiesi Farmaceutici S.P.A.
(54) FORMOTEROL SUPERFINE FORMULATION
DATE OF PATENT EXPIRATION: 2023 02 26

(21) AP 2003 8501
(11) P 2007 4211 B
(73) Les Laboratoires Servier
(54) NOVEL PERINDOPRIL SALT AND PHARMACEUTICAL COMPOSITIONS CONTAINING SAME
DATE OF PATENT EXPIRATION: 2023 02 17

UTILITY MODELS RESTORATION OF PATENTS

(21) AU 2016 14064
(11) U 2016 1915 Y
(73) LTD "Maltisoft"
(54) PAYMENT SYSTEM FOR SERVICE BY ABONENT USING TELENET
DATE OF PATENT CANCELLATION: 2023 02 22
LIMITED DATE OF PATENT RESTORATION: 2024 02 22

(21) AU 2020 15285
(11) U 2021 2091 Y
(73) Astrata AG
(54) TEAPOT LID
DATE OF PATENT CANCELLATION: 2023 02 19
LIMITED DATE OF PATENT RESTORATION: 2024 02 19

(21) AU 2020 15288
(11) U 2021 2088 Y
(73) Astrata AG
(54) TEAPOT LID
DATE OF PATENT CANCELLATION: 2023 02 19
LIMITED DATE OF PATENT RESTORATION: 2024 02 19

DATE OF PATENTS RESTORATION EXPIRATION

(21) AU 2016 14085
(11) U 2017 1926 Y
(73) Guram Makharadze;
Arkadi Rikrikadze
(54) DOUBLE-WINDING THREE-PHASE ELECTRIC MACHINE
DATE OF PATENT CANCELLATION: 2022 03 09
DATE OF PATENT RESTORATION EXPIRATION: 2023 03 09

(21) AU 2020 15290
(11) U 2021 2076 Y
(73) Goga Chalhaia;;
Levani Tsulukidze
(54) ANTILANDSLIDE CONSTRUCTION
DATE OF PATENT CANCELLATION: 2022 02 21
DATE OF PATENT RESTORATION EXPIRATION: 2023 02 21

DESIGNS

EXTENTION OF TERMS OF DESIGN REGISTRATION

(11) D 2018 790 S
(73) Tamaz Bochorishvili (GE)
Ilia Chavchavadze Ave. 62, ap. 17, 4600, Kutaisi, Georgia (GE)
(54) CUP
(28) 1
(24) 2018 03 06
(18) 2028 03 06
(58) 2023 03 09

CANCELLATION OF DESIGNS REGISTRATION

(11) D 2017 723 S
(73) JSC "Argo" (GE)
Lilo, Lochini Khevi (plot. 05/001), 0151, Tbilisi, Georgia (GE)
(54) 1.-6. GRAPHIC IMAGE
(18) 2022 08 25
(58) 2023 03 14

(11) D 2018 765 S
(73) Levan Khmiadashvili (GE)
Kavtiskhevi Str. 16, 0180, Tbilisi, Georgia (GE)
(54) BOOK CASE
(18) 2022 09 06
(58) 2023 03 16

(11) D 2018 761 S
(73) Natia Abramishvili (GE)
Ch. Bendeliani Zemo Dasakhleba 15, 0180, Tbilisi, Georgia (GE)
(54) MAP OF GEORGIA SHAPED GLASS AND BOTTLE STAND
(18) 2022 09 07
(58) 2023 03 16

(11) D 2018 757 S
(73) Solar Eco Systems (AE)
Sharja Saif Zoun Osoriti, Sharja, United Arab Emirates (AE)
(54) SUNSHINE DEVICE FOR CIRCLE LIGHTENING
(18) 2022 09 08
(58) 2023 03 16

(11) D 2018 758 S
(73) Solar Eco Systems (AE)
Sharja Saif Zoun Osoriti, Sharja, United Arab Emirates (AE)
(54) SUNSHINE DEVICE FOR LINEAR LIGHTENING
(18) 2022 09 08
(58) 2023 03 16

EXTENTION OF TERMS OF INTERNATIONAL DESIGNS REGISTRATION

(11) DM/69806
(73) SWATCH AG (SWATCH SA)(SWATCH LTD)
Jakob-Stämpfli-Strasse 94, CH-2502 BIEL/BIENNE (CH)
(15) 2008 02 29
(24) 2008 02 29
(18) 2028 02 28
(28) 6
(28') 6
(54) WRISTWATCHES

(11) DM/80857
(73) GUNSAN ELEKTRIK MALZEMELERI SANAYI VE TICARET ANONIM SIRKETI
Osmangazi Mahallesi Yildirim Beyazit Caddesi No:29, Sancaktepe/Istanbul (TR)
(15) 2013 04 29
(24) 2013 04 29
(18) 2028 04 29
(28) 4
(28') 4
(54) COMMUTATOR, ELECTRIC SWITCH, ELECTRIC SWITCH FRAME, GROUNDED SOCKET

TRADEMARKS

EXTENSION OF TERMS OF TRADEMARKS REGISTRATION

(111) M 2003 14988 R2

(151) 2003 02 12

(186) 2033 02 12

(732) Teva Pharma EAD

ul. Lyuba Velichkova 9, 1407 Sofia,
Bulgaria

One Johnson & Johnson Plaza,
New Brunswick, New Jersey 08933, USA

(111) M 2003 15016 R2

(151) 2003 03 12

(186) 2033 03 12

(732) The Procter & Gamble Company

One Procter & Gamble Plaza, Cincinnati,
Ohio, USA

(111) M 2003 15006 R2

(151) 2003 03 04

(186) 2033 03 04

(732) Johnson & Johnson

One Johnson & Johnson Plaza, New
Brunswick, New Jersey 08933, USA

(111) M 2003 14991 R2

(151) 2003 02 12

(186) 2033 02 12

(732) LLC "Tiflissky Winni Pogreb"

Yumashev Str. 27, 0198, Tbilisi, Georgia

(111) M 2003 14967 R2

(151) 2003 02 12

(186) 2033 02 12

(732) Teva Pharma EAD

ul. Lyuba Velichkova 9, 1407 Sofia, Bulgaria

(111) M 2003 14909 R2

(151) 2003 01 30

(186) 2033 01 30

(732) Obshchestvo s Ogranichenoi Otvetstvenostiu
"Obiedinennie Pivovarni Heineken"

Ul. Telmana, Dom 24, Liter "A", Saint
Petersburg, 193230, Russian Federation

(111) M 2003 15002 R2

(151) 2003 03 04

(186) 2033 03 04

(732) Ppg Industries Ohio

(A Delaware Corporation)
3800 West 143rd St., Cleveland, 44111,
Ohio, 3800, USA

(111) M 2003 14910 R2

(151) 2003 01 30

(186) 2033 01 30

(732) Obshchestvo s Ogranichenoi Otvetstvenostiu
"Obiedinennie Pivovarni Heineken"

Ul. Telmana, Dom 24, Liter "A", Saint
Petersburg, 193230, Russian Federation

(111) M 2003 14984 R2

(151) 2003 02 12

(186) 2033 02 12

(732) Johnson & Johnson Surgical Vision Inc.

1700 E. St. Andrew Place, Santa Ana,
CA 92705, USA

(111) M 2003 14927 R2

(151) 2003 01 30

(186) 2033 01 30

(732) Faurecia Clarion Electronics Co. Ltd.

7-2, Shintoshin- Chuo-Ku, Saitama-Shi,
Saitama, Japan

(111) M 2003 15108 R2

(151) 2003 04 30

(186) 2033 04 30

(732) NR Class 3 LLC

300 West 23rd Street, PH-B New York,
New York 10011, USA

(111) M 2003 15005 R2

(151) 2003 03 04

(186) 2033 03 04

(732) Johnson & Johnson

(111) M 2003 15109 R2

(151) 2003 04 30

(186) 2033 04 30

(732) YKK Corporation

1, Kanda Izumi-Cho, Chiyoda-Ku, Tokyo,
Japan

(111) M 2003 15048 R2
(151) 2003 03 28
(186) 2033 03 28
(732) Egis Gyógyszergyár Zrt.
30-38 Kereszturi ut, Budapest 1106, Hungary

(111) M 2003 15110 R2
(151) 2003 04 30
(186) 2033 04 30
(732) Johnson & Johnson
One Johnson & Johnson Plaza, New
Brunswick, New Jersey 08933, USA

(111) M 2003 15111 R2
(151) 2003 04 30
(186) 2033 04 30
(732) Johnson & Johnson
One Johnson & Johnson Plaza, New
Brunswick, New Jersey 08933, USA

(111) M 2003 15117 R2
(151) 2003 04 30
(186) 2033 04 30
(732) International Foodstuffs Co.
Al-Wahda Street, Industrial Area N1,
P.O. BOX 4115, Sharjah, United Arab
Emirates

(111) M 2003 15157 R2
(151) 2003 06 11
(186) 2033 06 11
(732) LLC "Tiflissky Winni Pogreb"
Yumashev Str. 27, 0198, Tbilisi, Georgia

(111) M 2003 15158 R2
(151) 2003 06 11
(186) 2033 06 11
(732) LLC "Tiflissky Winni Pogreb"
Yumashev Str. 27, 0198, Tbilisi, Georgia

(111) M 2003 15159 R2
(151) 2003 06 11
(186) 2033 06 11
(732) LLC "Tiflissky Winni Pogreb"
Yumashev Str. 27, 0198, Tbilisi, Georgia

(111) M 2003 15057 R2
(151) 2003 03 28
(186) 2033 03 28
(732) N.V. Organon
Kloosterstraat 6, 5349 AB Oss, Netherlands

(111) M 2003 15046 R2
(151) 2003 03 28
(186) 2033 03 28
(732) JSC "Bank of Georgia"
Gagarin Str. 29A, 0160, Tbilisi, Georgia

(111) M 2003 15047 R2
(151) 2003 03 28
(186) 2033 03 28
(732) JSC "Bank of Georgia"
Gagarin Str. 29A, 0160, Tbilisi, Georgia

(111) M 2003 15081 R2
(151) 2003 04 29
(186) 2033 04 29
(732) LLC "G M Pharmaceuticals"
Rustavi Highway 52, 0114, Tbilisi, Georgia

(111) M 2003 15082 R2
(151) 2003 04 29
(186) 2033 04 29
(732) LLC "G M Pharmaceuticals"
Rustavi Highway 52, 0114, Tbilisi, Georgia

(111) M 2003 15083 R2
(151) 2003 04 29
(186) 2033 04 29
(732) LLC "G M Pharmaceuticals"
Rustavi Highway 52, 0114, Tbilisi, Georgia

(111) M 2003 15084 R2
(151) 2003 04 30
(186) 2033 04 30
(732) LLC "G M Pharmaceuticals"
Rustavi Highway 52, 0114, Tbilisi, Georgia

(111) M 2003 15105 R2
(151) 2003 04 30
(186) 2033 04 30
(732) LLC "G M Pharmaceuticals"
Rustavi Highway 52, 0114, Tbilisi, Georgia

(111) M 2003 15106 R2
(151) 2003 04 30
(186) 2033 04 30
(732) LLC "G M Pharmaceuticals"
Rustavi Highway 52, 0114, Tbilisi, Georgia

(111) M 2003 15085 R2
(151) 2003 04 30
(186) 2033 04 30
(732) LLC "G M Pharmaceuticals"
Rustavi Highway 52, 0114, Tbilisi, Georgia

(111) M 2003 15086 R2
(151) 2003 04 30
(186) 2033 04 30
(732) LLC "G M Pharmaceuticals"
Rustavi Highway 52, 0114, Tbilisi, Georgia

(111) M 2003 15087 R2
(151) 2003 04 30
(186) 2033 04 30
(732) LLC "G M Pharmaceuticals"
Rustavi Highway 52, 0114, Tbilisi, Georgia

(111) M 2003 15088 R2
(151) 2003 04 30
(186) 2033 04 30
(732) LLC "G M Pharmaceuticals"
Rustavi Highway 52, 0114, Tbilisi, Georgia

(111) M 2003 15099 R2
(151) 2003 04 30
(186) 2033 04 30
(732) LLC "G M Pharmaceuticals"
Rustavi Highway 52, 0114, Tbilisi, Georgia

(111) M 2003 15089 R2
(151) 2003 04 30
(186) 2033 04 30
(732) LLC "G M Pharmaceuticals"
Rustavi Highway 52, 0114, Tbilisi, Georgia

(111) M 2003 15090 R2
(151) 2003 04 30
(186) 2033 04 30
(732) LLC "G M Pharmaceuticals"
Rustavi Highway 52, 0114, Tbilisi, Georgia

(111) M 2003 15091 R2
(151) 2003 04 30
(186) 2033 04 30
(732) LLC "G M Pharmaceuticals"
Rustavi Highway 52, 0114, Tbilisi, Georgia

(111) M 2003 15092 R2
(151) 2003 04 30
(186) 2033 04 30
(732) LLC "G M Pharmaceuticals"
Rustavi Highway 52, 0114, Tbilisi, Georgia

(111) M 2003 15093 R2
(151) 2003 04 30
(186) 2033 04 30
(732) LLC "G M Pharmaceuticals"
Rustavi Highway 52, 0114, Tbilisi, Georgia

(111) M 2003 15094 R2
(151) 2003 04 30
(186) 2033 04 30
(732) LLC "G M Pharmaceuticals"
Rustavi Highway 52, 0114, Tbilisi, Georgia

(111) M 2003 15095 R2
(151) 2003 04 30
(186) 2033 04 30
(732) LLC "G M Pharmaceuticals"
Rustavi Highway 52, 0114, Tbilisi, Georgia

(111) M 2003 15096 R2
(151) 2003 04 30
(186) 2033 04 30
(732) LLC "G M Pharmaceuticals"
Rustavi Highway 52, 0114, Tbilisi, Georgia

(111) M 2003 15097 R2
(151) 2003 04 30
(186) 2033 04 30
(732) LLC "G M Pharmaceuticals"
Rustavi Highway 52, 0114, Tbilisi, Georgia

(111) M 2003 15098 R2
(151) 2003 04 30
(186) 2033 04 30
(732) LLC "G M Pharmaceuticals"
Rustavi Highway 52, 0114, Tbilisi, Georgia

(111) M 2003 15100 R2
(151) 2003 04 30
(186) 2033 04 30
(732) LLC "PSP"
Zemo Vedzisi Str. 103, 0160, Tbilisi, Georgia

(111) M 2003 15101 R2
(151) 2003 04 30
(186) 2033 04 30
(732) LLC "PSP"
Zemo Vedzisi Str. 103, 0160, Tbilisi, Georgia

(111) M 2003 15102 R2
(151) 2003 04 30
(186) 2033 04 30
(732) LLC "PSP"
Zemo Vedzisi Str. 103, 0160, Tbilisi, Georgia

(111) M 2003 15103 R2
(151) 2003 04 30
(186) 2033 04 30
(732) LLC "PSP"
Zemo Vedzisi Str. 103, 0160, Tbilisi, Georgia

(111) M 2003 15104 R2
(151) 2003 04 30
(186) 2033 04 30
(732) LLC "PSP"
Zemo Vedzisi Str. 103, 0160, Tbilisi, Georgia

(111) M 2003 15153 R2
(151) 2003 05 28
(186) 2033 05 28
(732) LLC "G M Pharmaceuticals"
Rustavi Highway 52, 0114, Tbilisi, Georgia

(111) M 2003 15154 R2
(151) 2003 05 28
(186) 2033 05 28
(732) LLC "G M Pharmaceuticals"
Rustavi Highway 52, 0114, Tbilisi, Georgia

(111) M 2003 15251 R2
(151) 2003 09 29
(186) 2033 09 29
(732) Philip Morris Brands SARL
Quai Jeanrenaud 3, 2000 Neuchâtel,
Switzerland

(111) M 2003 15252 R2
(151) 2003 09 29
(186) 2033 09 29
(732) Philip Morris Brands SARL
Quai Jeanrenaud 3, 2000 Neuchâtel,
Switzerland

(111) M 2012 22755 R1
(151) 2012 07 13
(186) 2032 07 13
(732) Beiben Trucks Group Co., Ltd
N9 Binggong East Road, Equipment
Manufacturing Industry Park, Baotou City,
Inner Mongolia Autonomous Region, China

(111) M 2013 23607 R1
(151) 2013 04 26
(186) 2033 04 26
(732) World Medicine Limited
Commonwealth Trust Limited, Drake
Chambers, Tortola, Virgin Islands (British)

(111) M 2012 22959 R1
(151) 2012 09 24
(186) 2032 09 24
(732) World Medicine Limited
Commonwealth Trust Limited, Drake
Chambers, Tortola, Virgin Islands (British)

(111) M 2013 23365 R1
(151) 2013 02 27
(186) 2033 02 27
(732) JSC "Georgian Beer Company"
Vill. Saguramo, 3311, Mtskheta, Georgia

(111) M 2012 23042 R1
(151) 2012 11 02
(186) 2032 11 02
(732) The Hercules Tire & Rubber Company,
a Connecticut corporation
12200 Herbert Wayne Court, Suite 150,
Huntersville, North Carolina 28078, USA

(111) M 2013 23331 R1
(151) 2013 02 12
(186) 2033 02 12
(732) Yiğit Akü Malzemeleri Nakliyat
Turizm İnşaat Sanayi ve Ticaret
Anonim Şirketi
Organize Sanayi Bölgesi, Türkmenistan
Caddesi No. 27, Sincan - Ankara, Türkiye

(111) M 2013 23372 R1
(151) 2013 02 27
(186) 2033 02 27
(732) "Foodservice" LLC (406286674)
T. Chantladze Str. 40/Didi Lilo, Tetri Khevi
Settlement, Tbilisi, Georgia

(111) M 2013 23373 R1 (151) 2013 02 27 (186) 2033 02 27 (732) "Foodservice" LLC (406286674) T. Chantladze Str. 40/Didi Lilo, Tetri Khevi Settlement, Tbilisi, Georgia	2-4, Nakanoshima 3-chome, Kita-ku, Osak, Japan
(111) M 2013 23374 R1 (151) 2013 02 27 (186) 2033 02 27 (732) JSC "Georgian Beer Company" village Saguramo, 3311, Mtskheta, Georgia	(111) M 2013 23587 R1 (151) 2013 04 12 (186) 2033 04 12 (732) Teijin Limited 2-4, Nakanoshima 3-chome, Kita-ku, Osak, Japan
(111) M 2013 23249 R1 (151) 2013 01 09 (186) 2033 01 09 (732) Solutia Singapore PTE. Ltd. 9 Nort Buona Vista Draivi, #05-01, Ze Metropolis, 138588, Singapore	(111) M 2013 23791 R1 (151) 2013 06 25 (186) 2033 06 25 (732) LLC "Tiflissky Winni Pogreb" Yumashev Str. 27, 0198, Tbilisi, Georgia
(111) M 2013 23565 R1 (151) 2013 04 12 (186) 2033 04 12 (732) Solutia Singapore PTE. Ltd. 12 Jalan Kilang Barat #06-01, Singapore 159354, Singapore	(111) M 2013 23792 R1 (151) 2013 06 25 (186) 2033 06 25 (732) LLC "Tiflissky Winni Pogreb" Yumashev Str. 27, 0198, Tbilisi, Georgia
(111) M 2013 23461 R1 (151) 2013 03 13 (186) 2033 03 13 (732) "IPKLI" LLC Kharadze str. 2a, 0153, Tbilisi, Georgia	(111) M 2013 23793 R1 (151) 2013 06 25 (186) 2033 06 25 (732) LLC "Tiflissky Winni Pogreb" Yumashev Str. 27, 0198, Tbilisi, Georgia
(111) M 2013 23516 R1 (151) 2013 03 27 (186) 2033 03 27 (732) Edgewell Personal Care Brands, LLC 6 Research Drive, Shelton, Connecticut 06484, USA	(111) M 2013 23794 R1 (151) 2013 06 25 (186) 2033 06 25 (732) LLC "Tiflissky Winni Pogreb" Yumashev Str. 27, 0198, Tbilisi, Georgia
(111) M 2013 23529 R1 (151) 2013 03 27 (186) 2033 03 27 (732) Petroleo Brasileiro S.A. – Petrobras Avenida Republica do Chile, 65, Centro, CEP 20.031-912, Rio de Janeiro, RJ, Brazil	(111) M 2013 23795 R1 (151) 2013 06 25 (186) 2033 06 25 (732) LLC "Tiflissky Winni Pogreb" Yumashev Str. 27, 0198, Tbilisi, Georgia
(111) M 2013 23586 R1 (151) 2013 04 12 (186) 2033 04 12 (732) Teijin Limited	(111) M 2013 23594 R1 (151) 2013 04 12 (186) 2033 04 12 (732) Merck Sharp & Dohme LLC 126 East Lincoln Ave., P.O. Box 2000, Rahway New Jersey 07065, USA
(111) M 2013 23586 R1 (151) 2013 04 12 (186) 2033 04 12 (732) Teijin Limited	(111) M 2013 23887 R1 (151) 2013 08 14 (186) 2033 08 14 (732) "Aqua Geo" LLC

Village Misakseyeli, 3308, Mtskheta Region, Georgia	(111) M 2014 24419 R1 (151) 2014 01 21 (186) 2034 01 21 (732) odeon Turizm Isletmeciliği A.Ş. Cumhuriyet Cad. No: 181 Harbiye Şişli, İstanbul, Türkiye
(111) M 2013 23857 R1 (151) 2013 07 19 (186) 2033 07 19 (732) Toyota Jidosha Kabushiki Kaisha (also trading as Toyota Motor Corporation) 1, Toyota-Cho, Toyota-Shi, Aichi-Ken, Japan	(111) M 2013 23358 R1 (151) 2013 02 20 (186) 2033 02 20 (732) JSC "Georgian Beer Company" Vill. Saguramo, 3311, Mtskheta, Georgia
(111) M 2013 23906 R1 (151) 2013 08 14 (186) 2033 08 14 (732) Philip Morris Brands SàRL. Quai Jeanrenaud 3, 2000 Neuchâtel, Switzerland	(111) M 2013 23418 R1 (151) 2013 03 12 (186) 2033 03 12 (732) LTD "Cherry" Didi Lilo, plot 726, 0198, Tbilisi, Georgia
(111) M 2013 23911 R1 (151) 2013 08 14 (186) 2033 08 14 (732) Toyota Jidosha Kabushiki Kaisha (also trading as Toyota Motor Corporation) 1, Toyota-Cho, Toyota-Shi, Aichi-Ken, Japan	(111) M 2013 23472 R1 (151) 2013 03 18 (186) 2033 03 18 (732) JSC "Georgian Beer Company" Vill. Saguramo, 3311, Mtskheta, Georgia
(111) M 2013 23940 R1 (151) 2013 08 14 (186) 2033 08 14 (732) China Resources Snow Breweries Company Ltd. Room 306 China Resources Building, No.8 Jianguomen North Avenue, Dongcheng District, Beijing 100005, China	(111) M 2013 23601 R1 (151) 2013 04 18 (186) 2033 04 18 (732) JSC "Georgian Beer Company" Vill. Saguramo, 3311, Mtskheta, Georgia
(111) M 2013 24234 R1 (151) 2013 11 04 (186) 2033 11 04 (732) British American Tobacco (Brands) Inc. (a Delaware corporation) 251 Little Falls Drive, Suite 100, Wilmington, DE 19808-1674, USA	(111) M 2013 23661 R1 (151) 2013 05 16 (186) 2033 05 16 (732) LTD "Zadeni" Plot 19/38 between Vakhtang Gorgasali Str. Lane and Krtsanisi Str., 0105, Tbilisi, Georgia
(111) M 2013 24238 R1 (151) 2013 11 04 (186) 2033 11 04 (732) British American Tobacco (Brands) Inc. (a Delaware corporation) 251 Little Falls Drive, Suite 100, Wilmington, DE 19808-1674, USA	

COMPLETE TRANSFER OF RIGHTS

(111) M 2020 33367 R
(732) Vadim Sukhanov
Ul. Turchinskogo 85, ap. 9, Urban Taip
Settlement Krasnaya Polyana, Adlerskiy
District, Sochi, Krasnodarskiy Kray, Russian
Federation
(770) Obshestvo S Ogranichennoi Otvetstvennostiu
"Stratford Global"
Ul. Belkinskaya, Dom 25, Entr. 5,
Pomeshchenie 1, Obninsk, Kaluzhskaya
Oblast, RU-249034, Russian Federation
(580) 2022 11 24

(111) M 1998 8144 R
(732) Ekaterina Group IP Holdings B.V.
Weena 455, 3013 AL Rotterdam, Netherlands
(770) Unilever IP Holdings B.V.
Weena 455, 3013 AL Rotterdam, Netherlands
(580) 2022 06 07

(111) M 2003 14959 R
(732) DRiV Automotive Inc.
27300 West Eleven Mile Road, Southfield,
Michigan 48034, USA
(770) Tenneco Automotive Operating
Company Inc.
500 North Field Drive, Lake Forest,
IL 60045, USA
(580) 2023 01 18

(111) M 2015 25606 R
(111) M 2017 29005 R
(732) Grand Candy LLC
31 Masis Str., 0061, Yerevan, Armenia
(770) Karen Vardanyan
Barnov Str. 3, ap. 36, Yerevan, Armenia
(580) 2022 12 28

(111) M 2015 25941 R
(732) Grand Candy LLC
31 Masis Str., 0061, Yerevan, Armenia
(770) Karen Vardanyan
Barnov Str. 3, ap. 36, Yerevan, Armenia
(580) 2022 12 28

(111) M 2016 27330 R
(732) Grand Candy LLC
31 Masis Str., 0061, Yerevan, Armenia
(770) Karen Vardanyan
Barnov Str. 3, ap. 36, Yerevan, Armenia
(580) 2022 12 28

(111) M 2017 29005 R
(732) Grand Candy LLC
31 Masis Str., 0061, Yerevan, Armenia
(770) Karen Vardanyan
Barnov Str. 3, ap. 36, Yerevan, Armenia
(580) 2022 12 28

CHANGES OF NAMES AND/OR ADDRESSES OF TRADEMARKS OWNERS

(111) M 1999 11868 R
(732) Yahoo Inc.
11955 Democracy Dr., 14th Floor, Reston,
VA 20190, USA
(770) Yahoo Inc.
22000 Aol Way, Dulles VA 20166, USA
(580) 2023 02 27

(111) M 1995 688 R
(732) Nestle Waters (Societe par actions
simplifíee)
34-40 rue Guynemer, 92130 Issy-les-
Moulineaux, France
(770) Nestle Waters (Societe par actions
simplifíee)
12, Boulevard Garibaldi, F-92130 ISSY-LES-
Moulineaux, France
(580) 2023 01 27

(111) M 2007 17633 R
(732) SmithKline Beecham (Cork) Limited
12 Riverwalk, Sitywest Bussiness Campus,
Dublin 24, Ireland
(770) SmithKline Beecham (Cork) Limited
Currabinny, Carrigaline, County Cork,
Ireland
(580) 2023 01 26

(111) M 2010 20778 R
(732) PJSC "Gazprom"
2/3 Lakhtinsky Avenue, Bldg. 1,
St. Petersburg, 197229, Russian Federation
(770) PJSC "Gazprom"
Nametkina Str. 16, Moskow 117997, Russian
Federation
(580) 2023 01 19

(111) M 2010 20779 R
(732) PJSC "Gazprom"
2/3 Lakhtinsky Avenue, Bldg. 1,
St. Petersburg, 197229, Russian Federation
(770) PJSC "Gazprom"
Nametkina Str. 16, Moskow 117997, Russian
Federation
(580) 2023 01 19

(111) M 2010 20780 R
(732) PJSC "Gazprom"
2/3 Lakhtinsky Avenue, Bldg. 1, St. Peters-
burg, 197229, Russian Federation
(770) PJSC "Gazprom"
Nametkina Str. 16, 117997, Moskow, Russian
Federation
(580) 2023 01 19

(111) M 2010 20781 R
(732) PJSC "Gazprom"
2/3 Lakhtinsky Avenue, Bldg. 1, St. Peters-
burg, 197229, Russian Federation
(770) PJSC "Gazprom"
Nametkina Str. 16, 117997, Moskow, Russian
Federation
(580) 2023 01 19

(111) M 1996 1939 R
(732) Thermo King LLC
314 West 90th Street, Minneapolis, Minnesota
55420, USA
(770) Thermo King Corporation
314 West 90th Street, Minneapolis, Minnesota
55420, USA
(580) 2022 11 02

(111) M 1996 1940 R
(732) Thermo King LLC
314 West 90th Street, Minneapolis, Minnesota
55420, USA
(770) Thermo King Corporation
314 West 90th Street, Minneapolis, Minnesota
55420, USA
(580) 2022 11 02

(111) M 2016 27881 R
(732) Meta Platforms Technologies LLC
1601 Willow Road, Menlo Park, California
94025, USA
(770) Facebook Technologies LLC
1601 Willow Road, Menlo Park, California
94025, USA
(580) 2023 01 26

CANCELLATION OF TRADEMARKS REGISTRATION

(111) M 2022 36199 R
(151) 2022 11 11
(732) LLC "Elfbar"
Alexi Machavariani Str. 2, ap. 16, 0179,
Mtatsminda District, Tbilisi, Georgia
(141) 2023 03 15
Grounds: "Law of Georgia on Trademarks, Article
15.1.8 and 15.1.9"

(111) M 2012 22864 R
(151) 2012 08 30
(732) JSC "Nobel Ilac Sanayii Ve Ticaret Anonim
Sirketi" Representative in Georgia
Freedom Square 4, 0105, Tbilisi, Georgia
(141) 2023 03 10

(111) M 2012 22865 R
(151) 2012 08 30
(732) Ashtarak Kat CJSC
Village Agarak, Aragatsotn province, Armenia
(141) 2023 03 10

(111) M 2012 22867 R
(151) 2012 08 30
(732) Garage International Lux Sarl
1 Allée Scheffer, Suite 2.05.1, L-2520
Luxembourg, Luxembourg
(141) 2023 03 10

(111) M 2012 22868 R
(151) 2012 08 30
(732) Garage International Lux Sarl
1 Allée Scheffer, Suite 2.05.1, L-2520
Luxembourg, Luxembourg
(141) 2023 03 10

(111) M 2012 22869 R
(151) 2012 08 30
(732) Garage International Lux Sarl
1 Allée Scheffer, Suite 2.05.1, L-2520
Luxembourg, Luxembourg
(141) 2023 03 10

(111) M 2012 22870 R
(151) 2012 08 30
(732) LLC "Vaziani Cognac and Winery Factory"
Tamar Mepe Ave. 6, 0112, Tbilisi, Georgia
(141) 2023 03 10

(111) M 2012 22871 R
(151) 2012 08 30
(732) Omer Babur
Ilia Chavchavadze Ave. 37, 0179, Tbilisi,
Georgia
(141) 2023 03 10

(111) M 2012 22872 R
(151) 2012 08 30
(732) JSC "Imani Georgia"
Ilia Chavchavadze Ave. 74, Vake-Saburtalo
District, Tbilisi, Georgia
(141) 2023 03 10

(111) M 2012 22873 R
(151) 2012 08 30
(732) Chongqing Sokon Industry Group Stock Co.,
Ltd.
61-1, Jinqiao Road, Shapingba District,
Chongqing, China
(141) 2023 03 10

(111) M 2012 22874 R
(151) 2012 08 30
(732) Abdi İbrahim İlaç Sanayi ve Ticaret Anonim
Şirketi
Reşitpaşa Mahallesi Eski Büyükdere Caddesi
No: 4, 34467 Maslak-Sarıyer-İstanbul, Türkiye
(141) 2023 03 10

(111) M 2012 22875 R
(151) 2012 08 30
(732) Abdi İbrahim İlaç Sanayi ve Ticaret Anonim
Şirketi
Reşitpaşa Mahallesi Eski Büyükdere Caddesi
No: 4, 34467 Maslak-Sarıyer-İstanbul, Türkiye
(141) 2023 03 10

(111) M 2012 22885 R
(151) 2012 08 30
(732) British American Tobacco (Brands) Inc.
(a Delaware corporation)
251 Little Falls Drive, Suite 100, Delaware,
19808-1674, Wilmington, USA
(141) 2023 03 10

(111) M 2012 22886 R
(151) 2012 08 30
(732) Obshchestvo s Ogranichennoy Otvetstven-
nostiu "Fast Food Systems"

Altufevskoe shosse, d.2 a, 127273 q. Moskovi,
Russian Federation
(141) 2023 03 10

(111) M 2012 22892 R
(151) 2012 08 30
(732) British American Tobacco (Brands) Inc.
(a Delaware corporation)
2711 Centerville Road, Suite 300, Wilmington,
Delaware 19808, USA
(141) 2023 03 10

(111) M 2012 22893 R
(151) 2012 08 30
(732) LTD "Foodservice"
Marshall Gelovani Ave. 2, 0159, Tbilisi,
Georgia
(141) 2023 03 10

(111) M 2012 22894 R
(151) 2012 08 30
(732) LTD "Foodservice"
Marshall Gelovani Ave. 2, 0159, Tbilisi,
Georgia
(141) 2023 03 10

(111) M 2012 22897 R
(151) 2012 08 30
(732) Aschland Licensing and Intellectual Property
LLC
5200 Blazer Parkway, Dublin, Ohio 43017,
USA
(141) 2023 03 10

(111) M 2012 22898 R
(151) 2012 08 30
(732) Philip Morris Brands SÀRL.
Quai Jeanrenaud 3, 2000 Neuchâtel,
Switzerland
(141) 2023 03 10

(111) M 2012 22899 R
(151) 2012 08 30
(732) Tong Mo Ching
6/F.,-Yan Hing Centre, 9-13 Wong Chuk
Yeung Street, Fo Tan, New Territories,
Hong Kong
(141) 2023 03 10

(111) M 2012 22901 R
(151) 2012 08 30
(732) Fischer Pharmaceuticals LTD
9 Bar Yochai Street, Bnei Brak 51553, Israel
(141) 2023 03 10

(111) M 2012 22862 R
(151) 2012 08 29
(732) LTD "Georgian Baker"
Beliashvili Str. 2, 0159, Tbilisi, Georgia
(141) 2023 03 10

(111) M 2012 22924 R
(151) 2012 09 05
(732) Zaur Gabaidze
Vill. Angisa Settlement 13, 6500, Batumi,
Georgia
(141) 2023 03 13

(111) M 2012 22921 R
(151) 2012 08 31
(732) Gocha Chkhaidze
Shpaliernaya Str. 34, ap. 13, St. Petersburg,
Russian Federation
(141) 2023 03 10

(111) M 2012 22923 R
(151) 2012 09 03
(732) SK "Dizon Limited" Representation in Georgia
Ateni Str. 6/8, ap. 75, 0179, Tbilisi, Georgia
(141) 2023 03 13

(111) M 2012 22857 R
(151) 2012 08 23
(732) LLC "Info 9"
Pekin Ave. 8, ap. 25, 0171, Tbilisi, Georgia
(141) 2023 03 10

(111) M 2012 22861 R
(151) 2012 08 23
(732) LTD "Grand Electronics"
Tevdore Mghvdeli Str. 44, Didube-Chugureti
District, 0154, Tbilisi, Georgia
(141) 2023 03 10

(111) M 2012 22860 R
(151) 2012 08 23
(732) I/E "Giorgi Altunashvili"
Varketili, IV mcr., IInd row, bld. 6, ap. 144,
0177, Tbilisi, Georgia
(141) 2023 03 10

CLASSIFICATION INDEXES

INVENTIONS

CONCORDANCE TABLE OF INTERNATIONAL CLASSIFICATION INDEX AND PUBLICATION NUMBERS

INTERNATIONAL CLASSIFICATION INDEXES (51)	NUMBER OF PUBLISHED APPLICATION (10)
A 23 C 23/00	AP 2023 16008 A
A 61 K 31/498; A 61 K 31/506; A 61 K 31/538; A 61 K 31/4439; A 61 P 31/04; C 07 D 413/14; C 07 D 403/14; C 07 D 401/14; C 07 D 401/04	AP 2023 15801 A
B 22 F 3/23; C 22 B 5/04; C 22 C 33/00	AP 2023 15606 A
B 66 C 1/10	AP 2023 15737 A

CONCORDANCE TABLE OF PUBLICATION NUMBERS AND INTERNATIONAL CLASSIFICATION INDEX

NUMBER OF PUBLISHED APPLICATION (10)	INTERNATIONAL CLASSIFICATION INDEXES (51)
AP 2023 15606 A	B 22 F 3/23; C 22 B 5/04; C 22 C 33/00
AP 2023 15737 A	B 66 C 1/10
AP 2023 15801 A	A 61 K 31/498; A 61 K 31/506; A 61 K 31/538; A 61 K 31/4439; A 61 P 31/04; C 07 D 413/14; C 07 D 403/14; C 07 D 401/14; C 07 D 401/04
AP 2023 16008 A	A 23 C 23/00

CONCORDANCE TABLE OF INTERNATIONAL CLASSIFICATION INDEX, PATENT NUMBERS AND PUBLICATION NUMBERS

INTERNATIONAL CLASSIFICATION INDEX (51)	NUMBER OF PATENT (11)	NUMBER OF PUBLISHED APPLICATION (10)
A 47 J 31/40	P 2023 7482 B	AP 2022 15817 A
A 61 G 7/05	P 2023 7478 B	AP 2022 15899 A
A 61 K 9/19; A 61 K 9/08; A 61 K 47/02 A 61 K 47/26	P 2023 7486 B	AP 2022 15306 A
A 61 K 31/435; A 61 P 37/00; C 07 D 413/08; C 07 D 405/14; C 07 D 401/08; C 07 D 413/14; C 07 D 417/08	P 2023 7476 B	AP 2022 15588 A
A 61 K 39/395; A 61 P 29/00; A 61 P 35/00; A 61 P 37/06	P 2023 7480 B	AP 2022 15050 A
B 28 B 1/00; C 04 B 7/02	P 2023 7485 B	AP 2022 15412 A
C 02 F 9/00; C 02 F 1/42; C 02 F 1/28; C 02 F 1/44; C 02 F 1/461	P 2023 7481 B	AP 2022 15814 A
C 07 B 59/00; C 07 D 295/145	P 2023 7479 B	AP 2022 15377 A
C 07 D 403/12; C 07 D 413/12; C 07 D 249/08	P 2023 7477 B	AP 2023 13653 A
C 07 K 16/24	P 2023 7484 B	AP 2022 15316 A
G 07 F 17/32	P 2023 7487 B	AP 2022 15665 A
H 04 L 9/32	P 2023 7488 B	AP 2022 15656 A

**CONCORDANCE TABLE OF PATENT NUMBERS,
PUBLICATION NUMBERS AND INTERNATIONAL CLASSIFICATION INDEX**

NUMBER OF PATENT (11)	NUMBER OF PUBLISHED APPLICATION (10)	INTERNATIONAL CLASSIFICATION INDEX (51)
P 2023 7476 B	AP 2022 15588 A	A 61 K 31/435; A 61 P 37/00; C 07 D 413/08; C 07 D 405/14; C 07 D 401/08; C 07 D 413/14; C 07 D 417/08
P 2023 7477 B	AP 2023 13653 A	C 07 D 403/12; C 07 D 413/12; C 07 D 249/08
P 2023 7478 B	AP 2022 15899 A	A 61 G 7/05
P 2023 7479 B	AP 2022 15377 A	C 07 B 59/00; C 07 D 295/145
P 2023 7480 B	AP 2022 15050 A	A 61 K 39/395; A 61 P 29/00; A 61 P 35/00; A 61 P 37/06
P 2023 7481 B	AP 2022 15814 A	C 02 F 9/00; C 02 F 1/42; C 02 F 1/28; C 02 F 1/44; C 02 F 1/461
P 2023 7482 B	AP 2022 15817 A	A 47 J 31/40
P 2023 7483 B	AP 2022 15327 A	A 61 K 31/495; A 61 K 31/4985; A 61 P 35/00; A 61 P 25/28; C 07 D 487/04
P 2023 7484 B	AP 2022 15316 A	C 07 K 16/24
P 2023 7485 B	AP 2022 15412 A	B 28 B 1/00; C 04 B 7/02
P 2023 7486 B	AP 2022 15306 A	A 61 K 9/19; A 61 K 9/08; A 61 K 47/02 A 61 K 47/26
P 2023 7487 B	AP 2022 15665 A	G 07 F 17/32
P 2023 7488 B	AP 2022 15656 A	H 04 L 9/32

**CONCORDANCE TABLE OF APPLICATION NUMBERS,
PUBLICATION NUMBERS AND PATENTS**

NUMBER OF APPLICATION (21)	NUMBER OF PUBLISHED APPLICATION (10)	NUMBER OF PATENT (11)
AP 2013 13653	AP 2023 13653 A	P 2023 7477 B
AP 2017 15050	AP 2022 15050 A	P 2023 7480 B
AP 2018 15306	AP 2022 15306 A	P 2023 7486 B
AP 2018 15316	AP 2022 15316 A	P 2023 7484 B
AP 2018 15327	AP 2022 15327 A	P 2023 7483 B
AP 2014 15377	AP 2022 15377 A	P 2023 7479 B
AP 2020 15412	AP 2022 15412 A	P 2023 7485 B
AP 2019 15588	AP 2022 15588 A	P 2023 7476 B
AP 2019 15656	AP 2022 15656 A	P 2023 7488 B
AP 2019 15665	AP 2022 15665 A	P 2023 7487 B
AP 2021 15814	AP 2022 15814 A	P 2023 7481 B
AP 2021 15817	AP 2022 15817 A	P 2023 7482 B
AP 2022 15899	AP 2022 15899 A	P 2023 7478 B

UTILITY MODELS

CONCORDANCE TABLE OF INTERNATIONAL CLASSIFICATION INDEX AND PUBLICATION NUMBERS

INTERNATIONAL CLASSIFICATION INDEXES (51)	NUMBER OF PUBLISHED APPLICATION (10)
A 23 L 1/236	AU 2023 16017 U

CONCORDANCE TABLE OF PUBLICATION NUMBERS AND INTERNATIONAL CLASSIFICATION INDEX

NUMBER OF PUBLISHED APPLICATION (10)	INTERNATIONAL CLASSIFICATION INDEXES (51)
AU 2023 16017 U	A 23 L 1/236

CONCORDANCE TABLE OF INTERNATIONAL CLASSIFICATION INDEX, PATENT NUMBERS AND PUBLICATION NUMBERS

INTERNATIONAL CLASSIFICATION INDEX (51)	NUMBER OF PATENT (11)	NUMBER OF PUBLISHED APPLICATION (10)
A 01 G 7/04	U 2023 2147 Y	AU 2022 15752 U
C 13 K 1/00	U 2023 2146 Y	AU 2022 15869 U

CONCORDANCE TABLE OF PATENT NUMBERS, PUBLICATION NUMBERS AND INTERNATIONAL CLASSIFICATION INDEX

NUMBER OF PATENT (11)	NUMBER OF PUBLISHED APPLICATION (10)	INTERNATIONAL CLASSIFICATION INDEX (51)
U 2023 2146 Y	AU 2022 15869 U	C 13 K 1/00
U 2023 2147 Y	AU 2022 15752 U	A 01 G 7/04

CONCORDANCE TABLE OF APPLICATION NUMBERS, PUBLICATION NUMBERS AND PATENTS

NUMBER OF APPLICATION (21)	NUMBER OF PUBLISHED APPLICATION (10)	NUMBER OF PATENT (11)
AU 2021 15752	AU 2022 15752 U	U 2023 2147 Y
AU 2022 15869	AU 2022 15869 U	U 2023 2146 Y

TRADEMARKS

CONCORDANCE TABLE OF REGISTRATION NUMBERS, APPLICATION NUMBERS, PUBLICATION NUMBERS AND BULLETIN NUMBERS

NUMBER OF REGISTRATION (111)	NUMBER OF APPLICATIONS (210)	NUMBER OF PUBLISHED APPLICATIONS (260)	NUMBER OF BULLETIN
1	2	3	4
M 2023 36548 R	AM 117269	AM 2022 117269 A	20(599)2022
M 2023 36549 R	AM 116420	AM 2022 116420 A	15(594)2022
M 2023 36550 R	AM 117444	AM 2022 117444 A	20(599)2022
M 2023 36551 R	AM 117268	AM 2022 117268 A	20(599)2022
M 2023 36552 R	AM 117270	AM 2022 117270 A	20(599)2022
M 2023 36553 R	AM 117271	AM 2022 117271 A	20(599)2022
M 2023 36554 R	AM 117443	AM 2022 117443 A	20(599)2022
M 2023 36555 R	AM 116848	AM 2022 116848 A	18(597)2022
M 2023 36556 R	AM 117179	AM 2022 117179 A	19(598)2022
M 2023 36557 R	AM 115593	AM 2022 115593 A	16(595)2022
M 2023 36558 R	AM 116419	AM 2022 116419 A	15(594)2022
M 2023 36559 R	AM 117320	AM 2022 117320 A	20(599)2022
M 2023 36560 R	AM 116986	AM 2022 116986 A	20(599)2022
M 2023 36561 R	AM 116238	AM 2022 116238 A	15(594)2022
M 2023 36562 R	AM 116988	AM 2022 116988 A	20(599)2022
M 2023 36563 R	AM 116327	AM 2022 116327 A	15(594)2022
M 2023 36564 R	AM 116236	AM 2022 116236 A	15(594)2022
M 2023 36565 R	AM 116306	AM 2022 116306 A	16(595)2022
M 2023 36566 R	AM 117281	AM 2022 117281 A	21(600)2022
M 2023 36567 R	AM 117078	AM 2022 117078 A	19(598)2022
M 2023 36568 R	AM 116225	AM 2022 116225 A	20(599)2022
M 2023 36569 R	AM 117547	AM 2022 117547 A	21(600)2022
M 2023 36570 R	AM 117280	AM 2022 117280 A	21(600)2022
M 2023 36571 R	AM 116305	AM 2022 116305 A	16(595)2022
M 2023 36572 R	AM 116950	AM 2022 116950 A	20(599)2022
M 2023 36573 R	AM 117439	AM 2022 117439 A	21(600)2022
M 2023 36574 R	AM 117199	AM 2022 117199 A	21(600)2022
M 2023 36575 R	AM 117187	AM 2022 117187 A	19(598)2022
M 2023 36576 R	AM 117265	AM 2022 117265 A	21(600)2022
M 2023 36577 R	AM 117290	AM 2022 117290 A	21(600)2022
M 2023 36578 R	AM 117174	AM 2022 117174 A	21(600)2022
M 2023 36579 R	AM 117163	AM 2022 117163 A	21(600)2022
M 2023 36580 R	AM 121719	-	6(609)2023
M 2023 36581 R	AM 117294	AM 2022 117294 A	21(600)2022
M 2023 36582 R	AM 121727	-	6(609)2023
M 2023 36583 R	AM 121664	-	6(609)2023
M 2023 36584 R	AM 121726	-	6(609)2023
M 2023 36585 R	AM 121534	-	6(609)2023
M 2023 36586 R	AM 121751	-	6(609)2023
M 2023 36587 R	AM 121755	-	6(609)2023
M 2023 36588 R	AM 121743	-	6(609)2023
M 2023 36589 R	AM 121750	-	6(609)2023
M 2023 36590 R	AM 121765	-	6(609)2023
M 2023 36591 R	AM 121649	-	6(609)2023
M 2023 36592 R	AM 116252	AM 2022 116252 A	17(596)2022
M 2023 36593 R	AM 116408	AM 2022 116408 A	16(595)2022

1	2	3	4
M 2023 36594 R	AM 116521	AM 2022 116521 A	21(600)2022
M 2023 36595 R	AM 117302	AM 2022 117302 A	21(600)2022
M 2023 36596 R	AM 117273	AM 2022 117273 A	21(600)2022
M 2023 36597 R	AM 115883	AM 2023 115883 A	5(608) 2023
M 2023 36598 R	AM 116407	AM 2022 116407 A	16(595)2022
M 2023 36599 R	AM 116250	AM 2022 116250 A	17(596)2022
M 2023 36600 R	AM 116669	AM 2022 116669 A	17(596)2022
M 2023 36601 R	AM 116147	AM 2022 116147 A	16(595)2022
M 2023 36602 R	AM 117557	AM 2022 117557 A	22(601)2022
M 2023 36603 R	AM 117559	AM 2022 117559 A	22(601)2022
M 2023 36604 R	AM 117166	AM 2022 117166 A	21(600)2022
M 2023 36605 R	AM 117314	AM 2022 117314 A	22(601)2022
M 2023 36606 R	AM 117823	AM 2022 117823 A	22(601)2022
M 2023 36607 R	AM 116851	AM 2022 116851 A	21(600)2022
M 2023 36608 R	AM 116855	AM 2022 116855 A	21(600)2022
M 2023 36609 R	AM 116856	AM 2022 116856 A	21(600)2022
M 2023 36610 R	AM 116858	AM 2022 116858 A	21(600)2022
M 2023 36611 R	AM 116860	AM 2022 116860 A	21(600)2022
M 2023 36612 R	AM 117102	AM 2022 117102 A	21(600)2022
M 2023 36613 R	AM 117418	AM 2022 117418 A	22(601)2022
M 2023 36614 R	AM 117457	AM 2022 117457 A	22(601)2022
M 2023 36615 R	AM 117530	AM 2022 117530 A	22(601)2022
M 2023 36616 R	AM 117536	AM 2022 117536 A	22(601)2022
M 2023 36617 R	AM 117617	AM 2022 117617 A	22(601)2022
M 2023 36618 R	AM 117307	AM 2022 117307 A	22(601)2022
M 2023 36619 R	AM 117534	AM 2022 117534 A	22(601)2022
M 2023 36620 R	AM 117535	AM 2022 117535 A	22(601)2022
M 2023 36621 R	AM 117546	AM 2022 117546 A	21(600)2022
M 2023 36622 R	AM 117446	AM 2022 117446 A	22(601)2022
M 2023 36623 R	AM 117447	AM 2022 117447 A	22(601)2022
M 2023 36624 R	AM 117452	AM 2022 117452 A	22(601)2022
M 2023 36625 R	AM 117714	AM 2022 117714 A	22(601)2022
M 2023 36626 R	AM 114977	AM 2022 114977 A	19(598)2022
M 2023 36627 R	AM 114804	AM 2022 114804 A	19(598)2022
M 2023 36628 R	AM 116514	AM 2022 116514 A	17(596)2022
M 2023 36629 R	AM 116513	AM 2022 116513 A	17(596)2022
M 2023 36630 R	AM 117427	AM 2022 117427 A	22(601)2022
M 2023 36631 R	AM 117426	AM 2022 117426 A	22(601)2022
M 2023 36632 R	AM 117425	AM 2022 117425 A	22(601)2022
M 2023 36633 R	AM 117424	AM 2022 117424 A	22(601)2022
M 2023 36634 R	AM 117533	AM 2022 117533 A	22(601)2022
M 2023 36635 R	AM 116416	AM 2022 116416 A	18(597)2022
M 2023 36636 R	AM 117066	AM 2022 117066 A	22(601)2022
M 2023 36637 R	AM 116415	AM 2022 116415 A	17(596)2022
M 2023 36638 R	AM 116640	AM 2022 116640 A	18(597)2022
M 2023 36639 R	AM 117423	AM 2022 117423 A	22(601)2022

**CONCORDANCE TABLE OF PUBLICATION NUMBERS
AND APPLICATION NUMBERS**

NUMBER OF PUBLISHED APPLICATION (260)	NUMBER OF APPLICATION (210)
1	2
AM 2023 117550 A	AM 117550
AM 2023 118540 A	AM 118540
AM 2023 118838 A	AM 118838
AM 2023 118927 A	AM 118927
AM 2023 118928 A	AM 118928
AM 2023 119004 A	AM 119004
AM 2023 119014 A	AM 119014
AM 2023 119015 A	AM 119015
AM 2023 119016 A	AM 119016
AM 2023 119017 A	AM 119017
AM 2023 119018 A	AM 119018
AM 2023 119084 A	AM 119084

1	2
AM 2023 119092 A	AM 119092
AM 2023 119099 A	AM 119099
AM 2023 119111 A	AM 119111
AM 2023 119119 A	AM 119119
AM 2023 119122 A	AM 119122
AM 2023 119125 A	AM 119125
AM 2023 119127 A	AM 119127
AM 2023 119176 A	AM 119176
AM 2023 119178 A	AM 119178
AM 2023 119194 A	AM 119194
AM 2023 119200 A	AM 119200
AM 2023 119208 A	AM 119208
AM 2023 119209 A	AM 119209
AM 2023 119210 A	AM 119210
AM 2023 119211 A	AM 119211

**CONCORDANCE TABLE OF INDEX OF GOODS AND/OR SERVICES
AND APPLICATION NUMBERS**

INDEX OF GOODS AND/OR SERVICES (511)	NUMBER OF PUBLISHED APPLICATIONS (260)
1	2
3	AM 2023 119194 A
3	AM 2023 119211 A
5	AM 2023 118540 A
5	AM 2023 119014 A
5	AM 2023 119015 A
5	AM 2023 119016 A
5	AM 2023 119017 A
5	AM 2023 119018 A
7	AM 2023 119004 A
9	AM 2023 118838 A
14	AM 2023 119111 A
16	AM 2023 119084 A
16	AM 2023 119178 A
18	AM 2023 119178 A
19	AM 2023 118927 A
21	AM 2023 119178 A
24	AM 2023 119178 A
25	AM 2023 119111 A
28	AM 2023 119092 A
28	AM 2023 119099 A
28	AM 2023 119178 A
29	AM 2023 119004 A
29	AM 2023 119176 A

1	2
30	AM 2023 119004 A
30	AM 2023 119200 A
32	AM 2023 118928 A
32	AM 2023 119004 A
33	AM 2023 117550 A
33	AM 2023 118928 A
34	AM 2023 119119 A
34	AM 2023 119122 A
34	AM 2023 119125 A
34	AM 2023 119127 A
35	AM 2023 119178 A
35	AM 2023 119194 A
35	AM 2023 119200 A
36	AM 2023 118927 A
36	AM 2023 119111 A
36	AM 2023 119208 A
37	AM 2023 118927 A
37	AM 2023 119111 A
38	AM 2023 119084 A
41	AM 2023 119092 A
41	AM 2023 119099 A
42	AM 2023 118927 A
43	AM 2023 119004 A
43	AM 2023 119209 A
45	AM 2023 119208 A
45	AM 2023 119210 A

CONCORDANCE TABLE OF INDEX OF GOODS AND/OR SERVICES
AND NUMBERS OF TRADEMARKS REGISTERED ACCORDING
TO THE ACCELERATED PROCEDURE

INDEX OF GOODS AND/OR SERVICES (511)	NUMBERS OF REGISTERED ACCORDING TO THE ACCELERATED PROCEDURE (111)
2	M 2023 36589 R
4	M 2023 36583 R
14	M 2023 36590 R
16	M 2023 36590 R
18	M 2023 36590 R
20	M 2023 36590 R
21	M 2023 36590 R
24	M 2023 36590 R
25	M 2023 36590 R
26	M 2023 36590 R
29	M 2023 36588 R
30	M 2023 36588 R
32	M 2023 36585 R
33	M 2023 36584 R
35	M 2023 36580 R
35	M 2023 36588 R
35	M 2023 36590 R
37	M 2023 36587 R
37	M 2023 36591 R
43	M 2023 36586 R
44	M 2023 36582 R
44	M 2023 36590 R

OFFICIAL BULLETIN OF THE INDUSTRIAL PROPERTY

INVENTIONS
UTILITY MODELS
DESIGNS
TRADEMARKS

6(609)

EDITOR-IN-CHIEF: N. Bebrishvili

EDITOR-TRANSLATOR: E. Gabunia

PROOFREADER: A. Shixashvili

COMPUTER LAYOUT: M. Ordenidze
K. Svanidze

ISSN 2720-8486

info@sakpatenti.gov.ge
www.sakpatenti.gov.ge