



საქართველოს ინტელექტუალური საკუთრების ეროვნული ცენტრი
NATIONAL INTELLECTUAL PROPERTY CENTER OF GEORGIA

საქპატენტი
SAKPATENTI

**OFFICIAL BULLETIN
OF THE INDUSTRIAL PROPERTY**

7(515)

**2019
TBILISI**

INID CODES FOR IDENTIFICATION OF BIBLIOGRAPHIC DATA

INVENTIONS, UTILITY MODELS

- (10) Number of publication for application, which has been examined
- (11) Number of patent and kind of document
- (21) Serial number of application
- (22) Date of filing of the application
- (23) Date of exhibition or the date of the earlier filing and the number of application, if any
- (24) Date from which patent may have effect
- (31) Number of priority application
- (32) Date of filing of priority application
- (33) Code of the country or regional organization allotting priority application number
- (44) Date of publication of application not granted, but examined and number of bulletin
- (45) Date of publication of registered document
- (51) International Patent Classification Index
- (54) Title of the invention
- (57) Abstract
- (60) Number of examined patent document granted by foreign patent office, date from which patent has effect and country code
- (62) Number of the earlier application and in case of divided application, date of filing an application
- (71) Name, surname and address of applicant (country code)
- (72) Name, surname of inventor (country code)
- (73) Name, surname and address of patent owner (country code)
- (74) Name, surname of representative or patent attorney
- (85) Date of commencement of the national phase of International Application
- (86) Number and date of filing of international application
- (87) Number and date of publication of international application

DESIGNS

- (10) Number of publication for application
- (11) Number of patent and kind of document or number of registration
- (15) Date of registration/Date of patent renewal
- (18) Expected expiration date of patent or registration
- (21) Serial number of application
- (22) Date of filing of the application
- (23) Date of exhibition or the date of the earlier filing and the number of application, if any
- (24) Date from which patent may have effect
- (28) Number of designs included in the application
- (30) Data relating to priority (number of application, date of filing of application, two-letter code identifying the authority with whom the priority application was made)
- (31) Number of priority application
- (32) Date of filing of priority application
- (33) Code of the country or regional organization allotting priority application number
- (34) Two-letter code according to WIPO St.3 identifying the authority with which the priority application was made
- (44) Date of publication of design and number of bulletin (the first publication)
- (45) Date of publication of design registered by WIPO and number of bulletin
- (51) International Classification for designs (class and subclass of the Locarno Classification)
- (54) Title of the invention
- (55) Reproduction of the design
- (57) Description of characteristic features of the design including indication of colors
- (58) Date of recording of any kind of amendment in the Register
- (62) Number of the earlier application, registration and document number and if available the date of filing an application in case of divided application
- (71) Name, surname and address of applicant (country code)
- (72) Name, surname of creator (country code)
- (73) Name, surname and address of patent owner (country code)
- (74) Name, surname of representative or patent attorney
- (81) Contracting states concerned
 - II designated contracting states according to the 1960 Act
 - III designated contracting states according to the 1999 Act
- (85) Owner's permanent address
- (86) Owner's nationality
- (87) Owner's residence
- (88) State in which the owner has a real and effective industrial or commercial establishment

TRADEMARKS

- (111) – Number of registration
- (151) – Date of registration
- (156) – Date of the renewal
- (181) – Expected expiration date of registration
- (186) – Renewal expiration date of registration
- (141) – Date of cancel of duration of the mark
- (210) – Serial number of application
- (220) – Date of filing of the application
- (230) – Date concerning exhibition
- (260) – Number of application, for which favorable decision of examination about registration has been taken (publication number)
- (310) – Number of the first application
- (320) – Date of filing of the first application
- (330) – Code, identifying national or regional Office where the first application was made
- (511) – International Classification of Goods and Services for the purposes of registration of trade marks and/or list of goods and/or services classified according thereto
- (531) – Description of figurative elements of Trade Marks according to the International Classification of the Figurative Elements of Marks
- (540) – Reproduction of Trade Mark
- (550) – Nature and kind of Trade Mark
- (580) – Date of recording of any kind changes in respect of applications or registrations
- (591) – Information concerning colors claimed
- (731) – Name and address of the applicant
- (732) – Name and address of the holder of the registration
- (740) – Name and address of the representative
- (750) – Address for correspondence
- (770) – Name and address of the previous applicant or holder in case of change in ownership
- (771) – Previous name and address of the applicant or holder in case of change in ownership
- (791) – Name and address of the licensee
- (793) – Indication of conditions and/or restrictions under the license (Type of license, number of license agreement, data of license, data of validity of license)
- (800) – Certain data relating to the international registration of Trade Marks under the Protocol Relating to Madrid Agreement (International registration number)

CODES FOR PUBLICATION IN BULLETIN

- (21) AP 0000 000000 – serial number of application for invention
- (10) AP 0000 0000 A – number of published application for invention (first publication)
- (11) P 0000 0000 B – number of patent for invention (second publication)
- (21) API 0000 000000 – number of application for imported patent
- (11) PI 0000 0000 A – number of imported patent (first publication)
- (21) AU 0000 000000 – serial number of application for utility model
- (10) AU 0000 000 U – number of published application for utility model (first publication)
- (11) U 0000 000 Y – number of patent for utility model (second publication)
- (21) AD 0000 000000 – serial number of application for design
- (10) AD 0000 000 S – number of published application for design (first publication)
- (11) D 0000 000 S – number of patent for design (second publication)

INTERNATIONAL PATENT CLASSIFICATION FOR INVENTIONS AND UTILITY MODELS

- SECTION A – HUMAN NECESSITIES
- SECTION B – PERFORMING OPERATIONS; TRANSPORTING
- SECTION C – CHEMISTRY; METALLURGY
- SECTION D – TEXTILES; PAPER
- SECTION E – FIXED CONSTRUCTIONS
- SECTION F – MECHANICAL ENGINEERING; LIGHTING; HEATING; WEAPONS; BLASTING
- SECTION G – PHYSICS
- SECTION H – ELECTRICITY

-
- M – Trade Mark
 - (210) AM 0000 000000 – Serial number of application;
 - (260) AAM 0000 00000 A – Publication number of application;
 - (111) M 0000 00000 R – Number of registration;
 - (111) MMM0000 00000 Rn – Number of renewals, in which n=1,2,3;
 - (111) M 0000 00000 R(P) – Number of registration under partial assignment of rights
-

LIST OF CODES, IN ALPHABETIC SEQUENCE, AND THE CORRESPONDING (SHORT) NAMES OF STATES, OTHER ENTITIES AND INTERGOVERNMENTAL ORGANIZATIONS
(WIPO STANDARD ST.3)

AD	Andorra				
AE	United Arab Emirates				
AF	Afghanistan				
AG	Antigua and Barbuda				
AI	Anguilla				
AL	Albania				
AM	Armenia				
AN	Netherlands Antilles				
AO	Angola				
AP	African Regional Intellectual Property Organization (ARIPO)				
AR	Argentina				
AT	Austria				
AU	Australia				
AW	Aruba				
AZ	Azerbaijan				
BA	Bosnia and Herzegovina				
BB	Barbados				
BD	Bangladesh				
BE	Belgium				
BF	Burkina Faso				
BG	Bulgaria				
BH	Bahrain				
BI	Burundi				
BJ	Benin				
BM	Bermuda				
BN	Brunei Darussalam				
BO	Bolivia				
BR	Brazil				
BS	Bahamas				
BT	Bhutan				
BV	Bouvet Island				
BW	Botswana				
BX	Benelux Office for Intellectual Property (BOIP)				
BY	Belarus				
BZ	Belize				
CA	Canada				
CD	Democratic Republic of the Congo				
CF	Central African Republic				
CG	Congo				
CH	Switzerland				
CI	Cote d'Ivoire				
CK	Cook Islands				
CL	Chile				
CM	Cameroon				
CN	China				
CO	Colombia				
CR	Costa Rica				
CU	Cuba				
CV	Cape Verde				
CY	Cyprus				
CZ	Czech Republic				
DE	Germany				
DJ	Djibouti				
DM	Dominica				
DO	Dominican Republic				
DZ	Algeria				
EA	Eurasian Patent Organization (EAPO)				
EC	Ecuador				
EE	Estonia				
EG	Egypt				
EH	Western Sahara				
EM	Office for Harmonization in the Internal Market (Trademarks and Designs)(OHIM)				
EP	European Patent Office (EPO)				
ER	Eritrea				
ES	Spain				
ET	Ethiopia				
FI	Finland				
FJ	Fiji				
FK	Falkland Islands (Malvinas)				
FO	Faroe Islands				
FR	France				
GA	Gabon				
GB	United Kingdom				
GC	Patent Office of the Cooperation Council for the Arab States of the Gulf (GCC)				
GD	Grenada				
GG	Guernsey				
GH	Ghana				
GI	Gibraltar				
GT	Guatemala				
GW	Guinea- Bissau				
GY	Guyana				
HK	The Hong Kong Special Administrative Region of the People's Republic of China				
HN	Honduras				
HR	Croatia				
HT	Haiti				
HU	Hungary				
IB	International Bureau of the World Intellectual Property Organization (WIPO)				
ID	Indonesia				
IE	Ireland				
IL	Israel				
IM	Isle of Man				
IN	India				
IQ	Iraq				
ID	Indonesia				
IE	Ireland				
IL	Israel				
IM	Isle of Man				
IN	India				
IQ	Iraq				
IR	Iran (Islamic Republic of)				
IS	Iceland				
IT	Italy				
JE	Jersey				
JM	Jamaica				
JO	Jordan				
JP	Japan				
KE	Kenya				
KG	Kyrgyzstan				
KH	Cambodia				
KI	Kiribati				
KM	Saint Kitts and Nevis				
KP	Democratic People's Republic of Korea				
KR	Republic of Korea				
KW	Kuwait				
KY	Cayman Islands				
KZ	Kazakhstan				
LA	Lao People's Democratic Republic				
LB	Lebanon				
LC	Saint Lucia				
LI	Liechtenstein				
LK	Sri Lanka				
LR	Liberia				
LS	Lesotho				
LT	Lithuania				
LU	Luxembourg				
LV	Latvia				
LY	Libyan Arab Jamahiriya				
MA	Morocco				
MC	Monaco				
MD	Republic of Moldova				
ME	Montenegro				
MG	Madagascar				
MK	The former Yugoslav Republic of Macedonia				
ML	Mali				
MM	Myanmar				
MN	Mongolia				
MO	Macao				
MP	Northern Mariana Islands				
MR	Mauritania				
MS	Montserrat				
MT	Malta				
MU	Mauritius				
MV	Maldives				
MW	Malawi				
MX	Mexico				
MY	Malaysia				
MZ	Mozambique				
NA	Namibia				
NE	Niger				
NG	Nigeria				
NI	Nicaragua				
NL	Netherlands				
NO	Norway				
NP	Nepal				
NR	Nauru				
NZ	New Zealand				
OA	African Intellectual Property Organization (OAPI)				
OM	Oman				
PA	Panama				
PE	Peru				
PG	Papua New Guinea				
PH	Philippines				
PK	Pakistan				
PL	Poland				
PT	Portugal				
PW	Palau				
PY	Paraguay				
QA	Qatar				
QZ	Community Plant Variety Office (European Community) (CPVO)				
RO	Romania				
RS	Serbia				
RU	Russian Federation				
RW	Rwanda				
SA	Saudi Arabia				
SB	Solomon Islands				
SC	Seychelles				
SD	Sudan				
SG	Singapore				
SH	Saint Helena				
SI	Slovenia				
SK	Slovakia				
SL	Sierra Leone				
SM	San Marino				
SN	Senegal				
SO	Somalia				
SR	Suriname				
ST	Sao Tome and Principe				
SV	El Salvador				
SY	Syrian Arab Republic				
SZ	Swaziland				
TC	Turks and Caicos Islands				
TD	Chad				
TG	Togo				
TH	Thailand				
TJ	Tajikistan				
TL	Timor-Leste				
TM	Turkmenistan				
TN	Tunisia				
TO	Tonga				
TR	Turkey				
SE	Sweden				
TT	Trinidad and Tobago				
TV	Tuvalu				
TW	Taiwan, Province of China				
TZ	United Republic of Tanzania				
UA	Ukraine				
UG	Uganda				
US	United States of America				
UY	Uruguay				
UZ	Uzbekistan				
VA	Holy See				
VC	Saint Vincent and the Grenadines				
VE	Venezuela				
VG	Virgin Islands (British)				
VN	Viet Nam				
VU	Vanuatu				
WO	World Intellectual Property Organization (WIPO)				
WS	Samoa				
XN	Nordic Patent Institute (NPI)				
YE	Yemen				
ZA	South Africa				
ZM	Zambia				
ZW	Zimbabwe				

**OFFICIAL BULLETIN
OF THE INDUSTRIAL PROPERTY**

7(515)

**INVENTIONS
UTILITY MODELS
DESIGNS
TRADEMARKS**

DATE OF PUBLICATION
2019 04 10

CONTENTS

PUBLISHED TITLES OF PROTECTION	3
INVENTIONS	
▪ APPLICATIONS APPROVED FOR GRANTING PATENTS	4
▪ PATENTED INVENTIONS	11
UTILITY MODELS	
▪ APPLICATIONS APPROVED FOR GRANTING PATENT	13
▪ PATENTED UTILITY MODELS	14
DESIGNS	
▪ APPLICATION APPROVED FOR REGISTRATION	15
▪ REGISTERED DESIGN	17
▪ DESIGNS, WHICH HAVE BEEN REGISTERED WITH THE INTERNATIONAL BUREAU CLAIMING PRIORITY ON THE TERRITORY OF GEORGIA	18
TRADEMARKS	
▪ APPLICATIONS FILED UNDER THE NATIONAL PROCEDURE APPROVED FOR REGISTRATION	30
▪ REGISTERED TRADEMARKS	40
▪ TRADEMARKS REGISTERED ACCORDING TO THE ACCELERATED PROCEDURE	43
▪ INTERNATIONAL TRADEMARKS FOR WHICH A DECISION ON GRANTING PROTECTION IS TAKEN	48
▪ INTERNATIONAL TRADEMARKS PROTECTED IN GEORGIA	135
OFFICIAL NOTIFICATIONS	
INVENTIONS	
▪ EXPIRATION OF PATENTS RESTORATION	142
▪ ABOLITION OF PATENTS WITH THE RIGHT TO RESTORE	142
▪ EXPIRATION OF TERM OF RESTORATION OF PATENTS	144
▪ CHANGES OF NAMES AND/OR ADDRESSES OF PATENTOWNER	146
UTILITY MODELS	
▪ EXPIRATION OF PATENTS RESTORATION	146
▪ ABOLITION OF PATENTS WITH THE RIGHT TO RESTORE	146
▪ EXPIRATION OF TERM OF RESTORATION OF PATENTS	147
▪ TRANSFER OF RIGHTS	148
DESIGNS	
▪ RENEWAL OF REGISTRATIONS	149
TRADEMARKS	
▪ RENEWAL OF REGISTRATIONS	150
▪ COMPLETE TRANSFER OF RIGHTS	157
▪ CHANGES OF NAMES AND/OR ADDRESSES OF OWNERS	158
▪ TERMINATION OF TRADEMARKS REGISTRATION	162
CLASSIFICATION INDEXES	
INVENTIONS	164
UTILITY MODELS	166
DESIGNS	167
TRADEMARKS	168

PUBLISHED TITLES OF PROTECTION

INVENTIONS

- **APPLICATIONS APPROVED FOR GRANTING PATENT:**
14375; 14169; 14626; 14562; 14478; 14538; 14362; 14558; 13960; 14430; 14379; 14114; 14307; 14384; 14386; 13247
- **PATENTED INVENTIONS:**
6962-6968

UTILITY MODELS

- **APPLICATIONS APPROVED FOR GRANTING PATENT:**
14723; 14779
- **PATENTED UTILITY MODELS:**
2005, 2006

DESIGNS

- **APPLICATION APPROVED FOR REGISTRATION:**
1066
- **REGISTERED DESIGN:**
802
- **DESIGNS WHICH HAVE BEEN REGISTERED WITH THE INTERNATIONAL BUREAU CLAIMING PRIORITY ON THE TERRITORY OF GEORGIA:**
200011; 102450; 200021; 099867

TRADEMARKS

- **APPLICATIONS FILED UNDER THE NATIONAL PROCEDURE APPROVED FOR REGISTRATION:**
94562*; 96572; 97167*-97169*, 97171*; 98206; 98554; 98573; 98586; 98663; 98667; 98672; 98693; 98758; 98765; 98773; 98785; 98798, 98799; 98802, 98803; 98898; 98909, 98910; 98964; 98973; 99054; 99060; 99065; 99067; 99164; 99166; 99182; 99188; 99196; 99304; 99312, 99314, 99315; 99330, 99331; 99457, 99458; 99471-99476; 99479-99483, 99645
- **REGISTERED TRADEMARKS:**
30984; 30996-31029; 31033
- **TRADEMARKS REGISTERED ACCORDING TO THE ACCELERATED PROCEDURE:**
30973-30983; 30985-30995; 31030-31032
- **INTERNATIONAL TRADEMARKS FOR WHICH A DECISION ON GRANTING PROTECTIONS IS TAKEN:**
93381*; 93383*, 93384*; 94946; 95102, 95103; 95496; 95894*; 96873; 97505; 97719-97722; 97730; 97733; 97868; 97917-97925; 98020, 98021; 98037; 98040-98050; 98052-98058; 98065; 98069; 98071-98077; 98081-98083; 98088; 98092-98098; 98101; 98103; 98106; 98109-98111; 98115-98117; 98131; 98136, 98137; 98142; 98251-98260; 98275-98314; 98317, 98318; 98323; 98325; 98336, 98337; 98341; 98343; 98347-98352; 98354, 98355; 98364; 98453-98455; 98473; 98477, 98478; 98482, 98483; 98487; 98544- 98546; 98587-98590; 98592, 98593; 98595, 98596; 98599, 98600; 98613; 98638-98640; 98643; 98645, 98647; 98649; 98658; 98698; 98701-98703; 98735, 98736; 98741-98743
- **INTERNATIONAL TRADEMARKS PROTECTED IN GEORGIA:**
91912; 92971; 93645; 94736; 94738; 95269; 95495; 95691; 95915, 95916; 96059; 96231; 96233; 96318; 96322-96327; 96351; 96354; 96360; 96364; 96371-96373; 96387, 96388; 96390-96393; 96400; 96403, 96404; 96426; 96428-96435; 96444; 96477; 96511-96513; 96515, 96516; 96519-96521; 96526; 96596, 96597; 96599; 96602-96604; 96610; 96652; 96664; 96677; 96681-96685; 96687, 96688; 96794, 96795; 96822, 96823; 96829; 96874; 96953; 96957, 96958; 96961-96963; 96965; 96968-96970; 97132; 97150; 97162

INVENTIONS

APPLICATIONS APPROVED FOR GRANTING PATENTS

The decision can be appealed at the Chamber of Appeal of Sakpatenti within 3 months from the publication or at the Mtskheta District Court Administrative Cases Board (Address: №17, Samkhedro str., Mtskheta), within 1 month following the publication.

PART A

A 43

(10) AP 2019 14375 A (51) Int. Cl. (2006)

A 43 B 7/12

A 43 B 23/02

A 43 B 23/07

A 43 B 7/08

(21) AP 2015 14375 (22) 2015 06 17

(31) PD2014A000148

(32) 2014 06 17

(33) IT

(71) GEOX S.P.A. (IT)

Via Feltrina Centro 16 I-31044 Montebelluna,
Frazione Biadene (IT)

(72) POLEGATO MORETTI, Mario (IT);

POLONI, Livio (IT)

(74) Aleksandre Gegechkori

(85) 2017 01 06

(86) PCT/EP2015/063623, 2015 06 17

(54) **VENTILATED SHOE**

(57) Ventilated shoe comprises a sole (11) and upper assembly (12) associated therewith in upward region. Upper assembly comprises: – external upper (13), with which inner lining (14) is associated which is constituted at least partly by first element (16a) that defines at least one interspace (17a) that separates the foot of user from external upper (13) and is provided with preferential passages for the sweat that moves away from the foot of user toward upper external edge (20) of shoe, – breathable insole (15), joined perimetrically at least to inner lining (14).

Claims: 1 independent

13 dependent

Fig.: 6

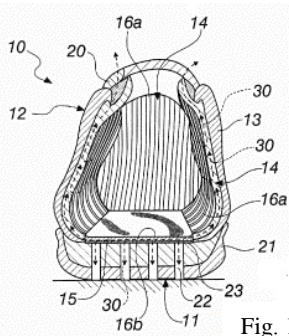

Fig. 1

A 47

(10) AP 2019 14169 A (51) Int. Cl. (2006)
A 47 K 10/38

(21) AP 2014 14169 (22) 2014 11 17

(31) 2013/13358

(32) 2013 11 18

(33) TR

(71) IPEK KAĞIT SANAYI VE TICARET

ANONİM ŞİRKETİ (TR)

Tokmak Köyü Kavak Mevkii 77700

Karamürsel/Yalova (TR)

(72) BOĞAÇ, Şimşir (TR)

(74) Larisa Amirkhanyan

(85) 2016 06 06

(86) PCT/TR2014/000434, 2014 11 17

(54) **A DISPENSER COMPRISING
A SYSTEM FACILITATING THE
PLACEMENT OF THE PRODUCT MADE
OF PAPER INTO THE DISPENSER**

(57) Present invention relates to a dispenser designed for use of products made of paper such as paper towels, toilet papers and the like and comprising a system enabling the product to be easily placed into the dispenser for use. The dispenser according to the present invention comprises the following: main body 8, inner receptacle 9 for placing the product made of paper, dispenser cover 1, a slot/receptacle 3 connected with the dispenser cover, a product outlet 10 positioned on the slot/receptacle, a joint 4, stopper surface 5 positioned on the slot/receptacle, and ribs 7 positioned on the dispenser cover.

Claims: 2 independent

2 dependent

Fig.: 6

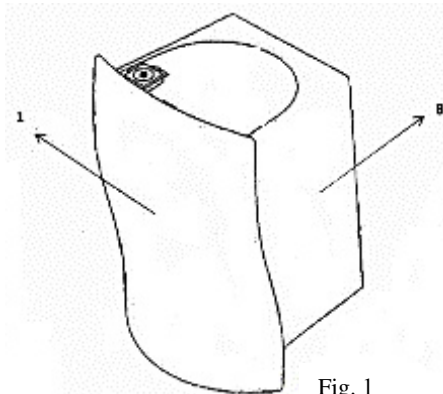
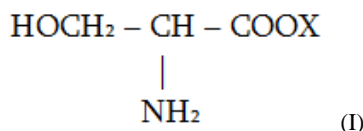

Fig. 1

A 61

- (10) AP 2019 14626 A (51) Int. Cl. (2006)
A 61 K 31/47
C 01 D 17/00
C 07 C 51/41
C 07 F 1/00
- (21) AP 2017 14626 (22) 2017 11 17
(71) Irakli Nadiradze (GE)
Bakos q. 12, 0112, Tbilisi (GE);
Nodar Chigogidze (GE)
Al. Kazbegis gamz. 4a, b. 47, 0160,
Tbilisi (GE)
(72) Irakli Nadiradze (GE);
Nodar Chigogidze (GE)
(54) **PREPARATION OF NOVEL
METASTASIS INHIBITORS FOR
ONCOLOGICAL DISORDERS
CHEMOTHERAPY**
(57) An invention relates to compound of formula (I)



of metastasis tumour having inhibitory activity, wherein (X is cesium or rubidium) and containing these compounds of pharmaceutical compositions.
Claims: 2 independent
1 dependent

- (10) AP 2019 14562 A (51) Int. Cl. (2006)
A 61 K 31/265
A 61 K 9/16
- (21) AP 2015 14562 (22) 2015 12 23
(31) TO2015A000086
(32) 2015 02 09
(33) IT
(71) RIVOPHARM SA (CH)
Centro Insema 6928 Manno, LUGANO (CH)
(72) PIAZZOLLA, Tommaso Roberto (CH);
POLI, Piero (CH);
FIORINO, Alessandro (CH)
(74) Aleksandre Gegechkori
(85) 2017 08 08
(86) PCT/EP2015/081187, 2015 12 23
(54) **PHARMACEUTICAL FORMULATION
OF RACECADOTRIL**
(57) For the manufacture of the drug racecadotril used a method of dry granulating, providing compaction strength of 4-30 kN, grinding and screening of slugs. At the same time, no more than 50% of obtained granulate has a particle size of less than 90 micron.
Claims: 1 independent
12 dependent
Fig.: 3

- (10) AP 2019 14478 A (51) Int. Cl. (2006)
A 61 K 31/295
A 61 K 31/7004

- (21) AP 2015 14478 (22) 2015 07 28
(31) 14386023.7
(32) 2014 09 22
(33) EP
(71) TSETI, Ioulia (GR)
13 Pavlou Mela St., 145 61 Kifisia
Attikis (GR)
(72) TSETI, Ioulia (GR)
(74) Tamar Kochlamazashvili
(85) 2017 04 20
(86) PCT/EP2015/067216, 2015 07 28
(54) **IRON (III) HYDROXIDE COMPLEXES
WITH ACTIVATED GLUCOSE SYRUPS
AND PROCESS FOR PREPARING SAME**
(57) Glucose syrup into a complex with iron (III) hydroxide, pharmaceutical composition on the basis thereof, and method for complex preparation; usage of pharmaceutical composition in the therapy of iron deficiency.
Claims: 5 independent
3 dependent
Table: 5
Fig.: 6

PART B**B 61**

- (10) AP 2019 14538 A (51) Int. Cl. (2006)
B 61 L 23/16
- (21) AP 2017 14538 (22) 2017 06 30
(71) Nino Mukhigulashvili (GE)
Tsitsamuris q. 16, 0180, Tbilisi (GE);
Giorgi Keshelava (GE)
Chubinashvilis q. 75, 0112, Tbilisi (GE);
Merab Chaladze (GE)
Javakhetis q., II shes., korp. 10, b. 30,
0182, Tbilisi (GE);
Murtaz Papaskiri (GE)
Dimitri Kipianis q. 6, 0108, Tbilisi (GE);
Vakhtang Kupradze (GE)
Dighmis mas., III kv., korp. 5, b. 83,
0159, Tbilisi (GE)
(72) Nino Mukhigulashvili (GE);
Giorgi Keshelava (GE);
Merab Chaladze (GE);
Murtaz Papaskiri (GE);
Vakhtang Kupradze (GE)
(54) **METHOD FOR ISOLATING JOINTS
CORRECTION CONTROL**
(57) A method for rail track circuit isolating joints correction control provides choke transformer inclusion onto rail section till insulating joint,

placing of magnetic field indicator and analog-to-digital converter switched to the indicator by rail base, and providing central server with communication channel and a concentrator.

Claims: 1 independent

Fig.: 1

B 62

(10) AP 2019 14362 A (51) Int. Cl. (2006)

B 62 D 23/00

B 62 D 27/02

B 62 D 29/00

(21) AP 2015 14362 (22) 2015 06 25

(31) 1411454.0

(32) 2014 06 27

(33) GB

(71) GORDON MURRAY DESIGN

LIMITED (GB)

Wharfside Broadford Park Shalford Surrey

GU4 8EP (GB)

(72) MURRAY, Ian Gordon (GB);

COPPUCK, Frank (GB)

(74) Shalva Gvaramadze

(85) 2016 12 23

(86) PCT/EP2015/064370, 2015 06 25

(54) **VEHICLE CHASSIS STRUCTURES**

(57) A chassis comprising a framework of interconnected tubular-section metallic members and a plurality of composite panels, each panel being adhesively bonded to a plurality of metallic members, wherein at least one bond between composite panel and metallic member is formed by arcuate formation integral with and extending from an edge of planar section of composite panel and fitting around an exterior of metallic member, and a layer of adhesive along the gap there between extending substantially from the edge of planar section across a part of but less than the complete angular extent of arcuate section.

Claims: 3 independent

10 dependent

Fig.: 8

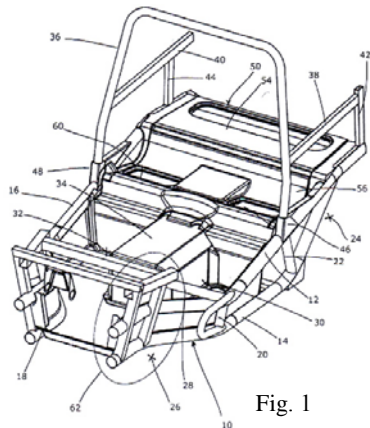

Fig. 1

B 67

(10) AP 2019 14558 A (51) Int. Cl. (2006)

B 67 D 7/04

G 06 Q 50/28

G 06 Q 10/08

(21) AP 2015 14558 (22) 2015 12 31

(31) 2015/00108

(32) 2015 01 06

(33) TR

(71) MEGA INDUSTRI KONTROL

SISTEMLERI TIC. LTD STI. (TR)

Yasamkent Mah. 3207 Cad. 3204 Sok. No: 8

Cayyolu Ankara (TR)

(72) SAHINER, Bulent (TR)

(74) Khatuna Imnadze

(85) 2017 08 04

(86) PCT/TR2015/000396, 2015 12 31

(54) **ELECTRONIC SYSTEM FOR PRODUCT IDENTIFICATION AND FILLING MANAGEMENT**

(57) The invention is related to an electronic system for product identification and filling management, which eliminates mixing of the products with the haulage media of fluid hauling vehicles such as tankers, wagons, vessels and similar, and mistakes experienced during filling and unloading operations. The invention is particularly suitable for filling and unloading of different fluid products in more than one tank compartments.

Claims: 2 independent

4 dependent

PART C

C 07

(10) AP 2019 13960 A (51) Int. Cl. (2006)

C 07 D 215/22

C 07 C 305/24

C 07 C 233/60

A 61 K 31/47

A 61 P 35/00

(21) AP 2014 13960 (22) 2014 03 17

(31) 61/792,413

(32) 2013 03 15

(33) US

(71) EXELIXIS, INC. (US)

210 East Grand Avenue South San Francisco,
CA 94080 (US)

(72) AFTAB, Dana, T. (US);

NAGANATHAN, Sriram (US);

XU, Wei (US);

LACY, Steven (US);

NGUYEN, Linh (US)

(74) Tamar Kochlamazashvili

(85) 2015 10 13

(86) PCT/US2014/030524, 2014 03 17

(54) **METABOLITES OF N-(4-[[6,7-BIS (METHYLOXY)QUINOLIN-4-YL] OXY}PHENYL)-N'-(4-FLUOROPHENYL) CYCLOPROPANE-1,1-DICARBOXAMIDE**

(57) The invention relates to metabolites of cabozantinibs and pharmaceutical composition containing them.

Claims: 3 independent
10 dependent**(10) AP 2019 14430 A (51) Int. Cl. (2006)****C 07 D 401/14****C 07 D 405/14****C 07 D 403/14****C 07 D 487/08****C 07 D 519/00****A 61 K 31/506****A 61 P 35/00****A 61 P 37/00**

(21) AP 2015 14430 (22) 2015 08 07

(31) 62/039,969

(32) 2014 08 21

(33) US

(71) PFIZER INC. (US)

235 East 42nd Street, New York,
NY 10017 (US)

(72) FENSOME, Andrew (US);

GOPALSAMY, Ariamala (US);

GERSTENBERGER, Brian S. (US);

EFREMOV, Ivan Viktorovich (US);

WAN, Zhao-Kui (US);

PIERCE, Betsy (US);

TELLIEZ, Jean-Baptiste (US);

TRUJILLO, John I (US);

ZHANG, Liying (US);

XING, Li (US);

SAIAH, Eddine (US)

(74) Tamar Kochlamazashvili

(85) 2017 02 21

(86) PCT/IB2015/056021, 2015 08 07

(54) **AMINOPYRIMIDINYL COMPOUNDS AS JAK INHIBITORS**

(57) Compound structure whereof is provided bellow,

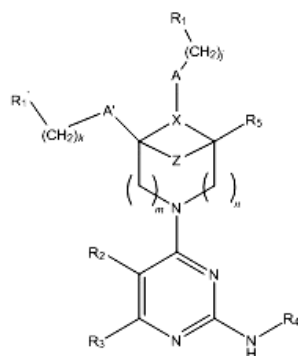
and values of R₁, R_{1'}, R₂, R₃, R₄, R₅, A, A' X, Z substitutes and k, j, m, n derivatives are provided in the claims or pharmaceutically acceptable salt thereof and pharmaceutical anti-veterinary composition on the basis thereof.

Claims: 3 independent

12 dependent

Table: 13

(10) AP 2019 14379 A (51) Int. Cl. (2006)**C 07 D 403/14****C 07 D 473/16**

(21) AP 2015 14379

(22) 2015 05 13

(31) 62/014,500

(32) 2014 06 19

(33) US

(71) ARIAD PHARMACEUTICALS, INC. (US)

26 Landsdowne Street Cambridge,
MA 02139 (US)

(72) HUANG, Wei-Sheng (US);

GONG, Yongjin (CN);

LI, Feng (CN);

BENCIVENGA, Nicholas, E. (US);

DALGARNO, David, C. (US);

KOHLMANN, Anna (US);

SHAKESPEARE, William, C. (US);

THOMAS, Ranny, M. (IN);

ZHU, Xiaotian (US);

WEST, Angela, V. (CA);

YOUNGSAYE, Willmen (US);

ZHANG, Yun (CN);

ZHOU, Tianjun (US)

(74) Shalva Gvaramadze

(85) 2017 01 12

(86) PCT/US2015/030576, 2015 05 13

(54) **HETEROARYL COMPOUNDS FOR KINASE INHIBITION**

(57) Heteroaryl compounds structure whereof if provided bellow,

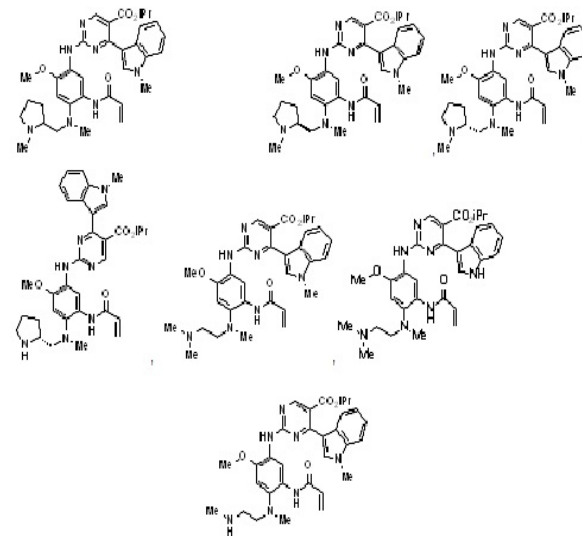

or pharmaceutically acceptable salts thereof, pharmaceutical compositions on the basis thereof and usage thereof cancer treatment.

Claims: 3 independent
9 dependent

Table: 30

(10) AP 2019 14114 A (51) **Int. Cl. (2006)**
C 07 D 487/04
A 61 K 31/4985
A 61 P 31/14
A 61 P 31/16

(21) AP 2014 14114 (22) 2014 09 10
(31) 62/031,673; 61/011,784; 61/877,151
(32) 2014 07 31; 2014 06 13; 2013 09 12
(33) US; US; US
(71) ALIOS BIOPHARMA, INC. (US)
260 E. Grand Avenue, 2nd Floor South
San Francisco, CA 94080 (US)
(72) BEIGELMAN, Leonid (US);
SMITH, David, Bernard (US);
STOYCHEVA, Antitsa, Dimitrova (US);
HENDRICKS, Robert, Than (US)

(74) Aleksandre Gegechkori
(85) 2016 04 11
(86) PCT/US2014/055012, 2014 09 10
(54) **AZA-PYRIDONE COMPOUNDS
AND USES THEREOF**

(57) Compound of formula (I),

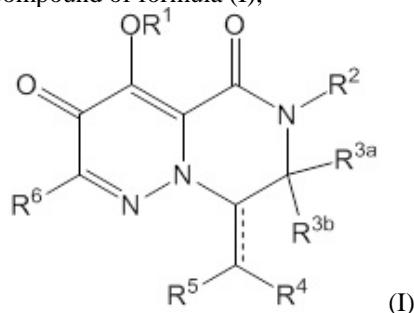

wherein values of R^1 , R^2 , R^{3a} , R^{3b} , R^4 , R^5 , R^6 substituents are provided in the claims, pharmaceutical composition on the basis thereof and usage thereof condition improvement or treatment at orthomyxovirus infection or replication inhibition.

Claims: 5 independent
78 dependent

Table: 6
Fig.: 4

(10) AP 2019 14307 A (51) **Int. Cl. (2006)**
C 07 D 487/04
C 07 H 19/06
C 07 H 19/14
A 61 K 31/7064
A 61 K 31/7076
A 61 P 1/16

(21) AP 2015 014307 (22) 2015 03 26
(31) PCT/CN2014/074294
(32) 2014 03 28
(33) CN
(71) MERCK SHARP & DOHME CORP. (US)
126 East Lincoln Avenue Rahway, New Jersey
07065-0907 (US)
(72) GIRIJAVALLABHAN, Vinay, M. (US);
OLSEN, David, B. (US);
ZHANG, Zhibo (CN);
FU, Jianmin (CA);
TANG, Bing-Yu (CN)
(74) Shalva Gvaramadze
(85) 2016 10 25
(86) PCT/US2015/022621, 2015 03 26
(54) **4'-SUBSTITUTED NUCLEOSIDE-
DERIVATIVES AS HIV REVERSE
TRANSCRIPTASE INHIBITORS**
(57) Compound of formula (I),

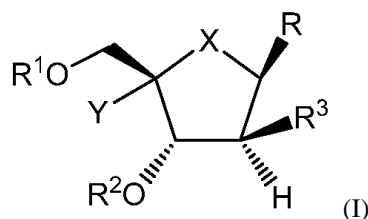

wherein values of R , R^1 , R^2 , R^3 , X and Y substituents are provided in the claims or pharmaceutically acceptable salt thereof, pharmaceutical composition on the basis thereof and usage thereof HIV infection or AIDS prevention or treatment.

Claims: 10 independent
31 dependent

Table: 7

PART E

E 01

(10) AP 2019 14384 A (51) **Int. Cl. (2006)**
E 01 H 5/06

(21) AP 2017 14384 (22) 2017 01 18
(31) 1650405
(32) 2001 01 19
(33) FR
(71) SOVIAR (FR)
503 Ave de Marlioz 74190 Passy (FR)
(72) BENEDETTI, Michel (FR);
BOUZI, Frédéric (FR);
DUCERF, Ludovic (FR)
(74) Tamar Kochlamazashvili
(54) **SNOW TRAILER**
(57) Snow removal trailer (1) intended to be towed by a vehicle with towing hitch, said snow removal trailer comprising a frame (3) extending in a first

direction (1-1) and having a snow plow (4, 5), and comprising at least one selectively steerable wheel (6a-6d) carrying the frame (3). The drawbar (8) of the trailer is pivotally articulated to the chassis (3) of the trailer, and pivoting means (10) selectively move pivotally the frame (3) of the trailer with respect to the drawbar (8) and to fix the relative angular position of the chassis (3) of trailer and the drawbar (8) between a position of transport and at least one snow clearing position.

Claims: 2 independent
14 dependent

Fig.: 10

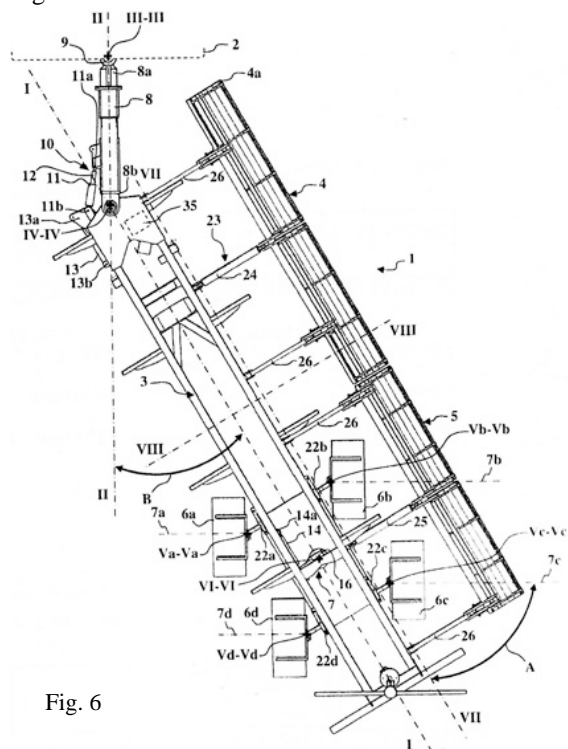

Fig. 6

PART F

F 03

(10) AP 2019 14386 A (51) Int. Cl. (2006)

F 03 B 3/12

F 03 B 3/02

(21) AP 2015 14386 (22) 2015 04 30

(31) 62/027,910

(32) 2014 07 23

(33) US

(71) ANDRITZ HYDRO LTD. (CA)
6100 Trans-Canada Hwy. Pointe-Claire,
Québec H9R 1B9 (CA)

(72) VON FELLEBERG, Sven (CA)

(74) Tamar Kochlamazashvili

(85) 2017 01 20

(86) PCT/CA2015/050367, 2015 04 30

(54) FRANCIS TURBINE WITH SHORT BLADE AND SHORT BAND

(57) An impeller 48 of radial-axial hydraulic turbine contains short rim 62 and short blades 50, continuing from a hub 65 to a rim, the connection between impeller blade front edge 52 and the rim, preceding the connection of front edge with the hub into rotation direction and impeller blade rear edge 54, having a curvature between the rim and the hub, curved to impeller blade front edge, thereby further reducing the length of blade.

Claims: 3 independent
10 dependent

Fig.: 15

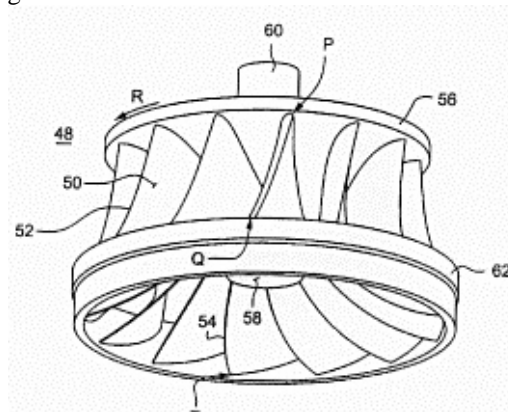

Fig. 11

F 04

(10) AP 2019 13247 A (51) Int. Cl. (2006)

F 04 B 25/00

(21) AP 2013 13247 (22) 2013 09 27

(71) Ivane Beroshvili (GE)

Dighmis mas., V kv., korp. 20, b. 73, 0159,
Tbilisi (GE);

Abesalom Beroshvili (GE)

Dighmis mas., V kv., korp. 20, b. 73, 0159,
Tbilisi (GE);

Teimuraz Kechiani (UA)

Prospekt Lenina 132, Ap. 5, Enakievo,
Donetskaya Oblast (UA)

(72) Ivane Beroshvili (GE);

Abesalom Beroshvili (GE);

Teimuraz Kechiani (UA)

(54) METHOD FOR GAS INJECTION

(57) A method provides gas compression step-by-step by means of pistons 2, 3 and 4 reciprocal motions and, accordingly, gas pressure rising step-by-step at the injection process; from one step injected gas is brought into the block-crankcase 7, in lower part of pistons, and gas pressure is risen to injected pressure on that step, for compensation of acting pressure forces on the piston from compressing chamber.

Claims: 1 independent

Fig.: 1

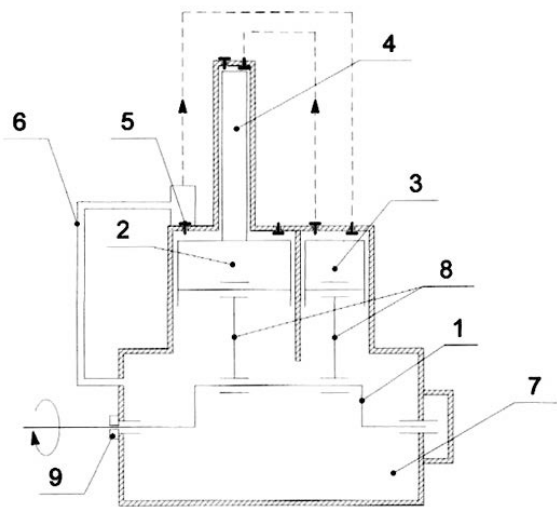

Fig. 11

PATENTED INVENTIONS

PART A

A 01

- (11) P 2019 6964 B** **(51) Int. Cl. (2006)**
A 01 N 43/40
C 07 D 401/06
C 07 D 213/46
A 01 P 7/00
A 01 N 51/00
A 01 N 43/42
A 01 N 43/56
A 01 N 43/80
A 01 N 47/02
A 01 N 43/76
A 01 N 43/22
A 01 N 47/40
A 01 N 43/707
A 01 N 43/82
A 01 N 37/50
- (10) AP 2018 13585 A (44) 24(508)/2018
(21) AP 2013 13585
(22) 2013 02 27
(24) 2013 02 27
(31) 2012-044514
(32) 2012 02 29
(33) JP
(86) PCT/JP2013/056051, 2013 02 27
(73) MEIJI SEIKA PHARMA CO., LTD. (JP)
4-16, Kyobashi 2-chome, Chuo-ku, Tokyo
1048002 (JP)
(72) HORIKOSHI, Ryo (JP);
ONozAKI, Yasumichi (JP);
NAKAMURA, Satoshi (JP);
NOMURA, Masahiro (JP);
MATSUMURA, Makoto (JP);
MITOMI, Masaaki (JP)
(74) Tamar Kochlamazashvili
(54) **PEST CONTROL COMPOSITION
INCLUDING NOVEL IMINOPYRIDINE
DERIVATIVE**

A 47

- (11) P 2019 6966 B** **(51) Int. Cl. (2006)**
A 47 K 10/38
A 47 K 10/32
- (10) AP 2018 14167 A (44) 24(508)/2018
(21) AP 2014 14167
(22) 2014 11 17
(24) 2014 11 17
(31) 2013/13364
(32) 2013 11 18

- (33) TR
(86) PCT/TR2014/000433, 2014 11 17
(73) ECZACIBAŞI TÜKETİM ÜRÜNLERİ
SANAYİ VE TİCARET A.Ş (TR)
Kavacık Ofis. Rüzgarlı Bahçe Mahallesi,
Kavak Sokak No: 20. Beykoz 34805,
İstanbul (TR)
(72) ŞİMŞİR, Boğaç (TR)
(74) Larisa Amirkhanyan
(54) **DISPENSER COMPRISING PRODUCT
LEVEL INDICATOR**

A 61

- (11) P 2019 6962 B** **(51) Int. Cl. (2006)**
A 61 K 31/416
A 61 K 31/4174
A 61 K 45/06
A 61 P 31/10
- (10) AP 2018 14557 A (44) 21(505)/2018
(21) AP 2016 14557
(22) 2016 01 08
(24) 2016 01 08
(31) 15150904.9
(32) 2015 01 13
(33) EP
(86) PCT/EP2016/050272, 2016 01 08
(73) AZIENDE CHIMICHE RIUNITE
ANGELINI FRANCESCO A.C.R.A.F.
S.P.A. (IT)
Viale Amelia 70, I-00181 Roma (IT)
(72) MILANESE, Claudio (IT);
CAPEZZONE DE JOANNON,
Alessandra (IT);
TONGIANI, Serena (IT);
DONATI, Luca (IT)
(74) Liliana Darakhvelidze
(54) **PHARMACEUTICAL COMPOSITI-
ON FOR THE TREATMENT OF
MYCOSIS**

- (11) P 2019 6963 B** **(51) Int. Cl. (2006)**
A 61 K 39/395
C 07 K 16/22
- (10) AP 2018 11194 A (44) 19(503)/2018
(21) AP 2004 11194
(22) 2004 07 15
(24) 2004 07 15
(62) 60/487,431 2003 07 15 (US)
(31) 60/487,431
(32) 2003 07 15
(33) US
(86) PCT/US2004/022876, 2004 07 15

- (73) AMGEN INC. (US)
One Amgen Center Drive, Thousand Oaks,
CA 91320-1799 (US);
MEDAREX LLC (US)
Route 206 And Province Line Rd Princeton,
NJ 08540 (US)
- (72) WILD, Kenneth, D., Jr. (US);
TREANOR, James, J., S. (GB);
HUANG, Haichun (US);
INOUE, Heather (US);
ZHANG, Tie, J. (US);
MARTIN, Frank (US)
- (74) Shalva Gvaramadze
- (54) **HUMAN ANTI-NGF NEUTRALIZING
ANTIBODIES AS SELECTIVE NGF
PATHWAY INHIBITORS**

PART C

C 02

- (11) P 2019 6967 B (51) Int. Cl. (2006)
C 02 F 1/00
C 02 F 1/32
C 02 F 1/34
C 02 F 1/36
C 02 F 1/48
C 02 F 1/78
- (10) AP 2018 14472 A (44) 22(506)/2018
(21) AP 2017 14472
(22) 2017 04 11
(24) 2017 04 11
- (73) Tatiana Gegechkori (GE)
Vazha-Pshavelas gamz. VI kv.,
korp. 38, b.3, 0186, Tbilisi (GE);
Grigor Mamniashvili (GE)
Vazha-Pshavelas gamz. VI kv.,
korp. 38, b.3, 0186, Tbilisi (GE);
Sarkis Markaryan (GE)
Ts. Dadianis q. 34, korp. 12, b. 41, 0180,
Tbilisi (GE);
Tsisana Gavasheli (GE)
Toidzis q. 43, 0102, Tbilisi (GE)
- (72) Tatiana Gegechkori (GE);
Grigor Mamniashvili (GE);
Sarkis Markaryan (GE);
Tsisana Gavasheli (GE)
- (54) **SYNERGETIC DEVICE AND METHOD
FOR WATER PURIFICATION**

C 22

- (11) P 2019 6965 B (51) Int. Cl. (2006)
C 22 B 47/00
C 22 B 1/02
C 22 B 1/08
C 22 B 3/04
- (10) AP 2018 13978 A (44) 11(495)/2018
(21) AP 2015 13978
(22) 2015 10 28
(24) 2015 10 28
- (73) GEORGIAN TECHNICAL
UNIVERSITY (GE)
M. Kostavas q. 77, 0175, Tbilisi (GE)
- (72) Lali Ghurtchumelia (GE);
Akaki Gigineishvili (GE);
Zakaria Buachidze (GE);
Archil Tchirakadze (GE);
Giorgi Oniashvili (GE);
Garegin Zakharov (GE);
Zurab Aslamazashvili (GE)
- (74) Givi Sibashvili
- (54) **METHOD FOR GETTING METALLIC
MANGANESE FROM LOW-GRADE
MANGANESE ORES**

PART E

E 02

- (11) P 2019 6968 B (51) Int. Cl. (2006)
E 02 B 5/02
E 02 B 3/16
- (10) AP 2018 14433 A (44) 21(505)/2018
(21) AP 2015 14433
(22) 2015 07 30
(24) 2015 07 30
(31) MI2014A001393
(32) 2014 07 31
(33) IT
(86) PCT/EP2015/067505, 2015 07 30
(73) CARPI TECH B.V. (NL)
Sporhaven 88, NL-2651 AV Berkel
en Rodenrijs (NL)
- (72) SCUERO, Alberto, Maria (NL)
- (74) Liliana Darakhvelidze
- (54) **METHOD, WATERPROOF LINER
AND WATERPROOF PANELS FOR
INSTALLATION IN BASINS AND
CANALS**

UTILITY MODELS

APPLICATIONS APPROVED FOR GRANTING PATENT

The decision can be appealed at the Chamber of Appeal of Sakpatenti within 3 months from the publication or at the Mtskheta District Court Administrative Cases Board (Address: №17, Samkhedro str., Mtskheta), within 1 month following the publication.

PART B

B 65

(10) AU 2019 14723 U (51) Int. Cl. (2006)
B 65 D 5/40

(21) AU 2018 14723 (22) 2018 03 07

(71) Gaga Lomouri (GE)

Lermontovis q. 67, 6000, Batumi (GE)

(72) Gaga Lomouri (GE)

(54) FAT- AND WATERPROOF CARDBOARD BOX FOR FOODSTUFF

(57) A box contains a base 4, side walls 5, the covers 6, the handles 7; at that, at least one ventilation hole 8 provided with valves are made of the same or different sizes on side walls and the covers.

Claims: 1 independent

1 dependent

Fig.: 6

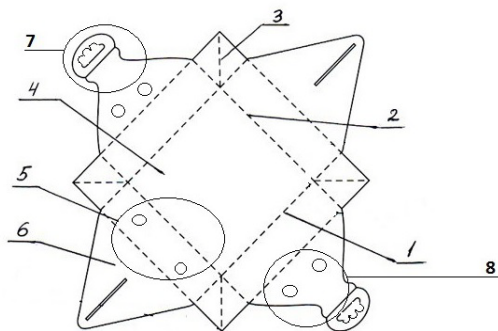

Fig. 3

PART E

E 04

(10) AU 2019 14779 U (51) Int. Cl. (2006)
E 04 B 5/43

(21) AU 2018 14779 (22) 2018 05 11

(71) Revaz Sikharulidze (GE)

Tkibulis q.16, 0178, Tbilisi (GE)

(72) Revaz Sikharulidze (GE)

(54) ARMATURE FRAMEWORK FOR HEAT-INSULATING CEILING PLATE

(57) Spatial armature framework, made in the form of bar farm is equipped with suspension system, first part 5 whereof is made capable to place heat-insulating blocks inside the framework, between flat componentry, and second part 6 – to hold additional reinforcing rods 7 passing through space central part, parallel to these flat componentry, between their upper belts. The support is upper belt of bar farm and each specified part runs in rows, transversely to flat componentry for each part of suspension system.

Claims: 1 independent

Fig.: 3

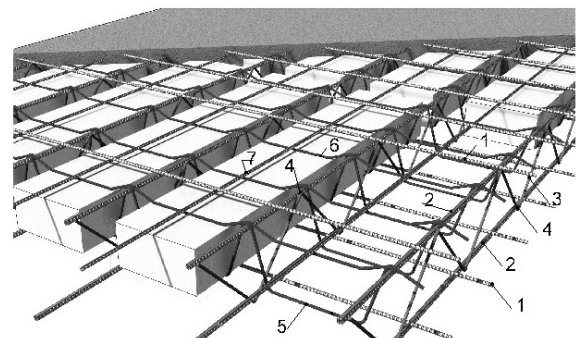

Fig. 1

PATENTED UTILITY MODELS
PART C**C 04**

- (11) U 2019 2005 Y (51) Int. Cl. (2006)
C 04 B 35/45
H 01 L 39/00
- (10) AU 2018 14630 U (44) 22(506)/2018
(21) AU 2017 14630
(22) 2017 11 22
(24) 2017 11 22
(73) Nikoloz Margiani (GE)
Vazha-Pshavelas gamz., V kv., korp. 4, b.
49, 0186, Tbilisi (GE);
Nodar Kekelidze (GE)
Kekelidzis q. 25, b. 188, 0179, Tbilisi (GE);
Giorgi Mumladze (GE)
Politkovskayas q. 47, 0186, Tbilisi (GE);
Zurab Adamia (GE)
Saburtalos q. 57, b. 5, 0177, Tbilisi (GE);
Iamze Kvartskhava (GE)
D. Tavdadebulis q. 7, b. 27, 4400, Poti (GE);
Natela Papunashvili (GE)
Dolidzis q., korp. 15, b. 19, 0171,
Tbilisi (GE);
Vakhtang Zhghamadze (GE)
Varketili 3, I mkr., korp. 3, b. 108,
0163, Tbilisi (GE);
Maia Balakhashvili (GE)
V. Bochorishvilis q. 28, 0171, Tbilisi (GE)
- (72) Nikoloz Margiani (GE);
Vakhtang Zhghamadze (GE);
Natela Papunashvili (GE);
Iamze Kvartskhava (GE);
Zurab Adamia (GE);
Maia Balakhashvili (GE);
Giorgi Mumladze (GE);
Nodar Kekelidze (GE)
- (54) **SUPERCONDUCTING HIGH-TEMP-
PERATURE CERAMICS WITH HIGH
CRITICAL CURRENT**
-

PART E**E 02**

- (11) U 2019 2006 Y (51) Int. Cl. (2006)
E 02 B 9/04
E 03 B 3/00
- (10) AU 2018 14299 U (44) 20(504)/2018
(21) AU 2016 14299
(22) 2016 10 12
(24) 2016 10 12
(73) Teimuraz Katamadze (GE)
Rustavelis q. 292, 6200, Kobuleti (GE)
(72) Teimuraz Katamadze (GE)
(74) Vakhtang Torotadze
(54) **METHOD FOR INTAKE
CONSTRUCTION IN MOUNTAIN
RIVER**
-

DESIGNS

APPLICATION APPROVED FOR REGISTRATION

The decision can be appealed at the Chamber of Appeal of Sakpatenti within 3 months from the publication or at the Mtskheta District Court Administrative Cases Board (Address: №17, Samkhedro str., Mtskheta), within 1 month following the publication.

(10) AD 2019 1066 S (51) 11-02
(21) AD 2018 1066 (22) 2018 11 22
(28) 4
(71) Zviad Tsikolia (GE)
A. Kurdianis q. 6, b. 73, 0112, Tbilisi (GE)
(72) Zviad Tsikolia (GE)
(74) Shalva Gvaramadze (GE)
(54) 1.-4. ORNAMENTAL METAL FABRICATIONS
(55)



1.1



1.2



1.3



2.1



2.2



2.3



2.4



2.5

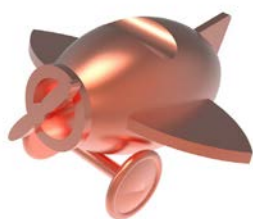

3.1

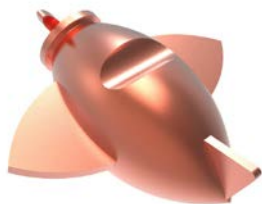

3.2



3.3

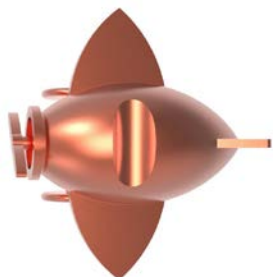

3.4

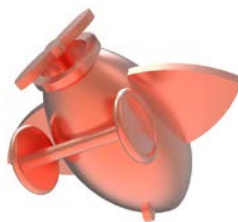

3.5

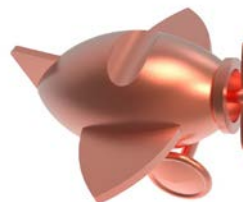

3.6



4.1

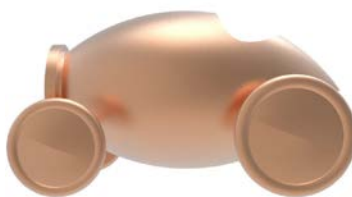

4.2



4.3



4.4

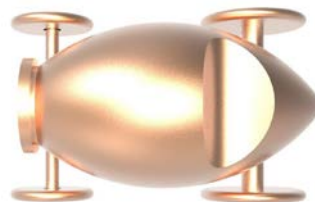

4.5

REGISTERED DESIGN

- (11) **D 2019 802 S** (51) **09-01**
(10) AD 2018 1050 S (44) 24(508)/2018
(21) AD 2018 1050
(22) 2018 08 16
(24) 2018 08 16
(28) 1
(18) 2023 08 16
(73) Tamaz Kakhidze (GE)
Didacharis q. 17, 6000, Batumi,
Khelvachauri (GE);
Mirian Kakhidze (GE)
Didacharis q. 17, 6000, Batumi,
Khelvachauri (GE)
(72) Tamaz Kakhidze (GE);
Mirian Kakhidze (GE)
(54) **GLASS CAN**
-

DESIGNS, WHICH HAVE BEEN REGISTERED WITH THE INTERNATIONAL BUREAU CLAIMING PRIORITY ON THE TERRITORY OF GEORGIA

The decision can be appealed at the Chamber of Appeal of Sakpatenti within 3 months from the publication or at the Mtskheta District Court Administrative Cases Board (Address: №17, Samkhedro Str., Mtskheta), within 1 month following the publication.

- (11) **DM/200 011** (51) **03-01**
(15) 2018 11 22 (44) 04/2019 (2019 01 25)
(22) 2018 11 22
(28) 1
(73) Valentino S.p.A.
 Via Turati, 16/18, I-20121 Milan (IT)
(85) –
(86) IT, EM
(87) IT, EM
(88) IT, EM
(89) EM
(81) III. TR, US, GE, UA, KG, AZ, EM, KR, JP, TJ, RU
(72) Stefano Sassi
 c/o Valentino S.p.A., Via Turati, 16/18, I-20121 Milan (IT)
(74) Matteo Mozzi
 C/o Jacobacci & Partners S.p.A., Via Senato, 8, I-20121 Milan (IT)
(54) Bag
(55)



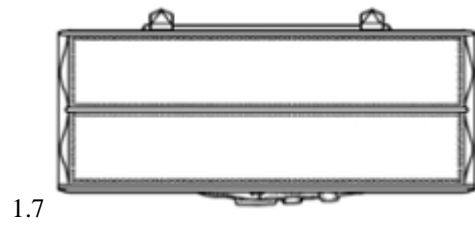
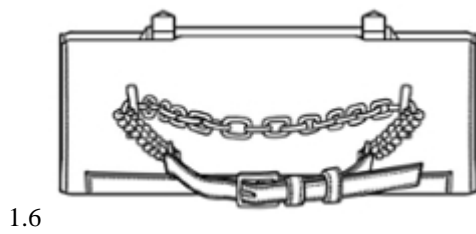
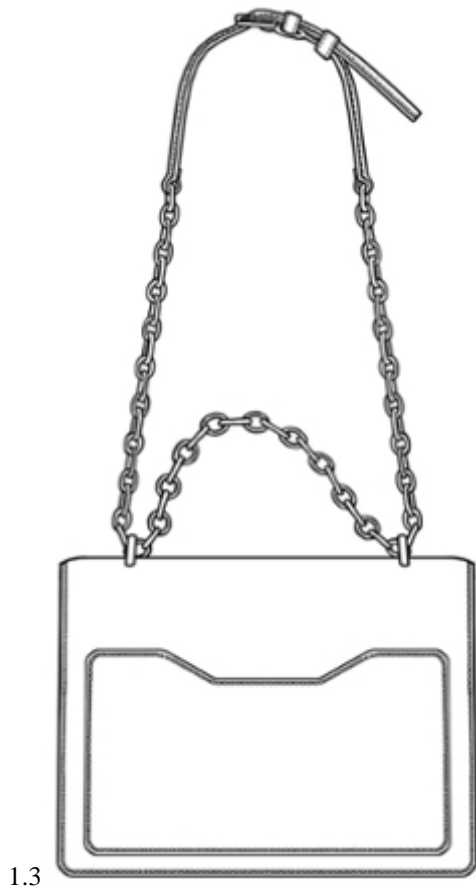

(11) DM/102 450

(15) 2018 07 30

(22) 2018 07 30

(28) 1

(73) ROLEX SA

3-5-7, Rue François-Dussaud, CH-1211 GENEVE 26 (CH)

(85) CH

(86) CH

(87) CH

(88) CH

(89) CH

(81) II. BZ, MA, SR III. AL, AM, AZ, BA, BN, BW, EG, EM, GB, GE, GH, IS, JP, KG, KH, KP, KR, LI, MC, MD, ME, MK, MN, NA, NO, OA, OM, RS, RU, RW, SG, ST, SY, TJ, TM, TN, TR, UA

(72) CALVANI Maria

Chemin David Munier 12, 1223 COLOGNY (CH)

(74) Bugnion S.A.

Route De Florissant 10, Case Postale 375, CH-1211 Genève 12 (CH)

(54) 1. Watch dial

(55)

(51) 10-07

(44) 05/2019 (2019 02 01)

1.1



1.2



1.3



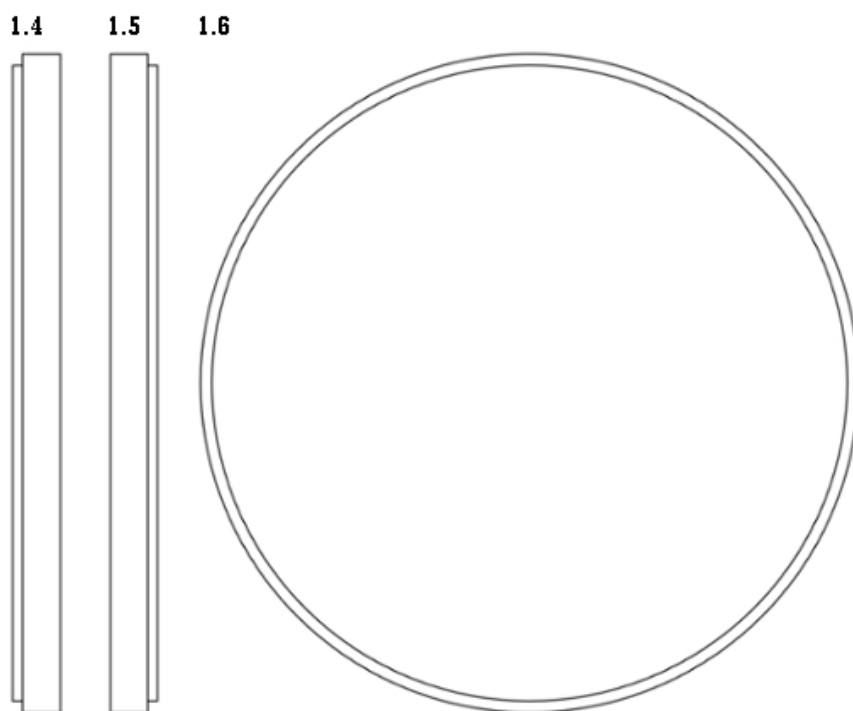

(11) DM/200 021

(15) 2018 11 16

(22) 2018 11 16

(28) 1

(73) Valentino S.p.A.

Via Turati, 16/18, I-20121 Milano (IT)

(85) –

(86) IT, EM

(87) IT, EM

(88) IT, EM

(89) EM

(81) III. TR, US, GE, KG, UA, AZ, EM, KR, TJ, JP, RU

(72) Stefano SASSI

c/o VALENTINO S.p.A., Via Turati, 16/18, I-20121 Milano (IT)

(74) Salvatore Giovanni PENNACCHIO

C/o Jacobacci & Partners S.p.A., Via Senato, 8, I-20121 MILANO (IT)

(54) 1. Shoe

(55)

(51) 02-04

(44) 05/2019 (2019 02 01)

1.1



1.2



1.3

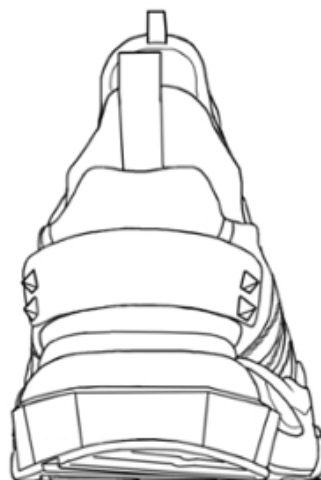

1.4



1.5

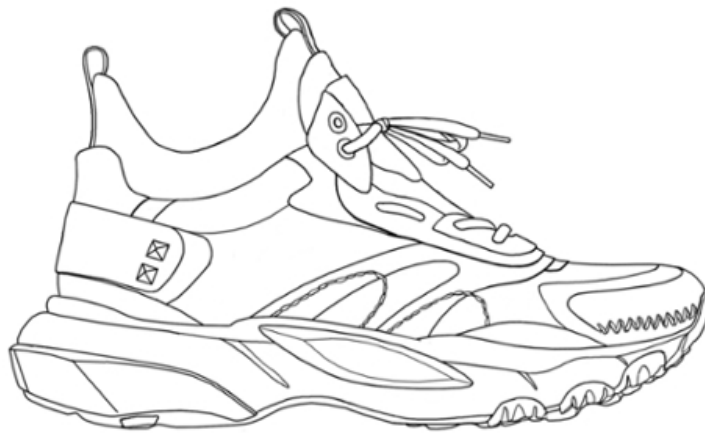

1.6

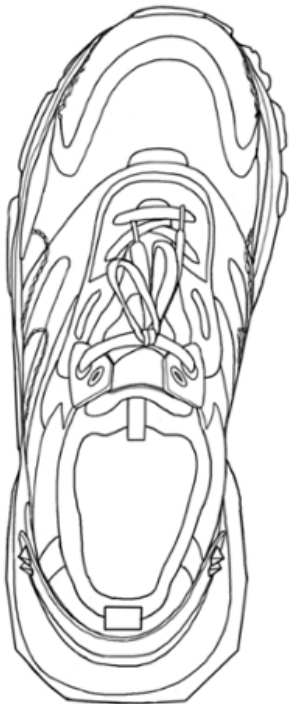

1.7



1.8



(11) DM/099 867

(51) 10-07

(15) 2018 02 15

(44) 07/2019 (2019 02 15)

(22) 2018 02 15

(28) 6

(73) Glashütter Uhrenbetrieb GmbH

Altenberger Straße 1 Glashütte, 01768 (DE)

(85) DE, EM

(86) DE, EM

(87) DE, EM

(88) DE, EM

(89) DE

(81) II. MA, BZ III. AM, AL, AZ, ME, MD, SG, MN, BA, OM, TR, MK, GE, LI, KG, TN, EM, CH

(72) 2, 4 Sebastien EINHORN

Friedenstrasse 11, 01097 Dresden (DE);

1, 3, 5-6 Katharina STEGMANN

Am Mühlfeld 84, 01744 Dippoldiswalde/Paulsdorf (DE)

(74) The Swatch Group AG (The Swatch Group SA) (The Swatch Group Ltd.)

Faubourg Du Lac 6 Biel/Bienne, CH-2501 (CH)

(46) 2019 02 15

(54) 1. Watch dial, 2. Watch case, 3. Watch dial, 4. Watch case, 5. Watch hands, 6. Watch hands

(55)

1.1



1.2

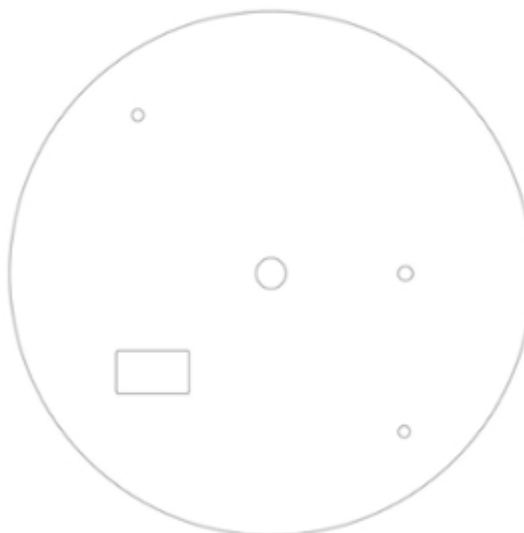

1.3



1.4



1.5



1.6



1.7

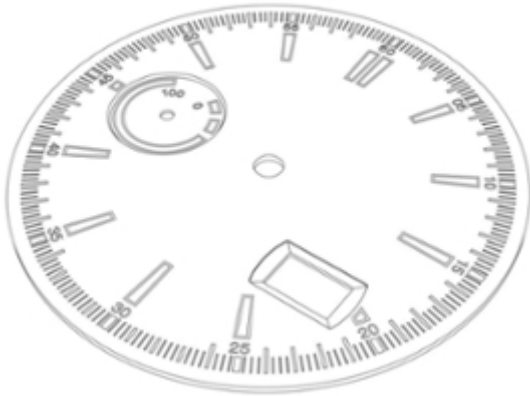

2.1

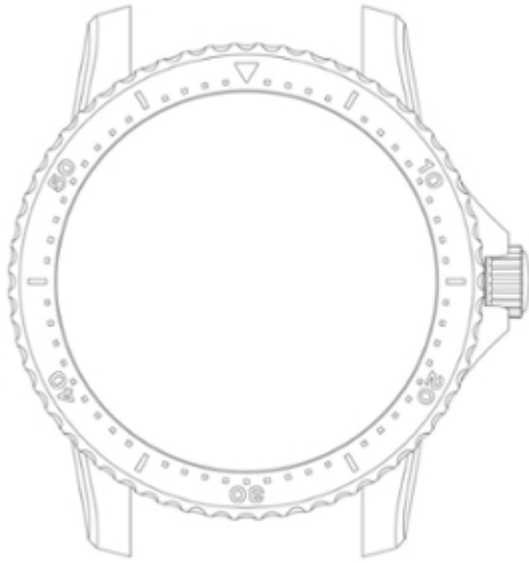

2.2

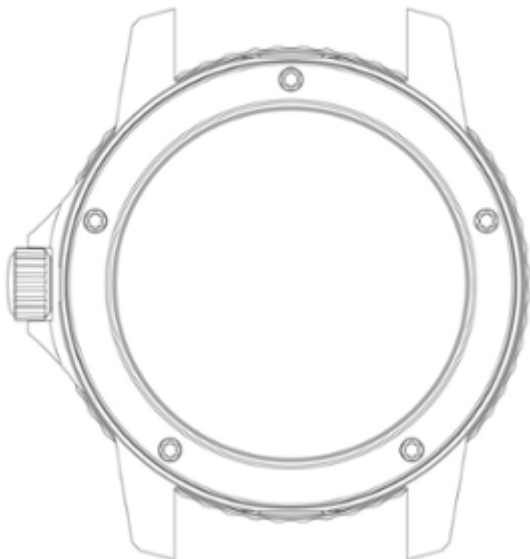

2.3

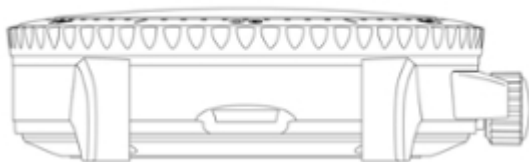

2.4

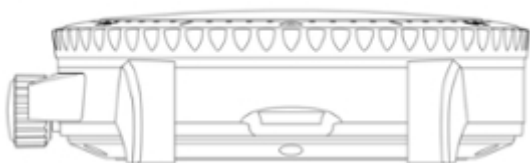

2.5

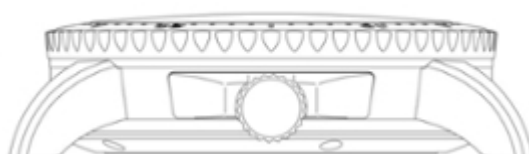

2.7



2.6

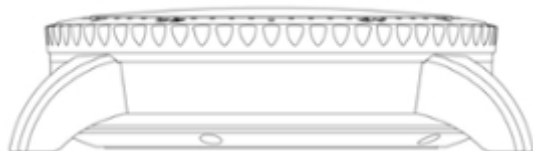

3.1



3.2



3.3



3.4



3.5



3.6



3.7



4.1

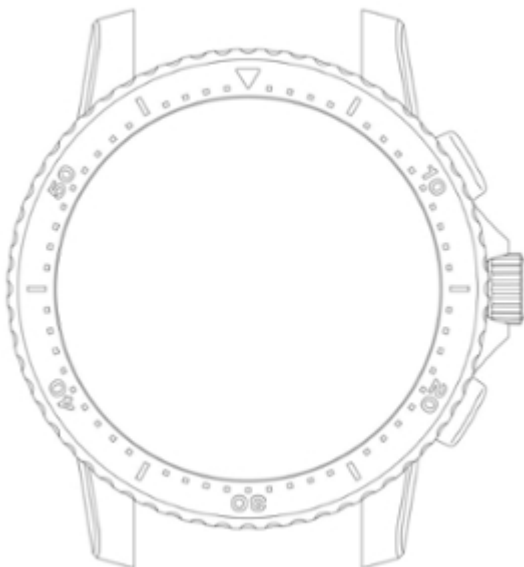

4.2

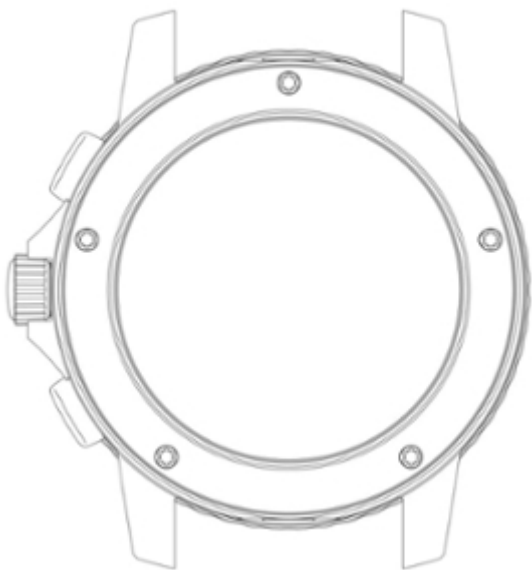

4.3

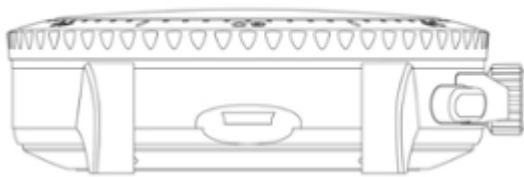

4.4

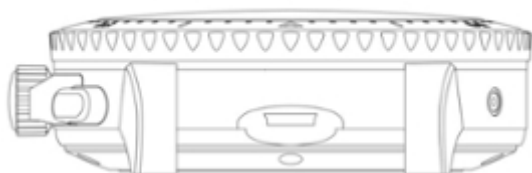

4.5

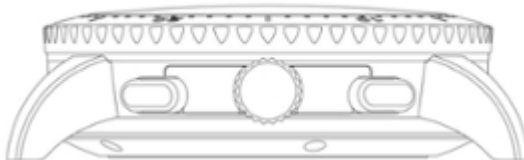

4.6

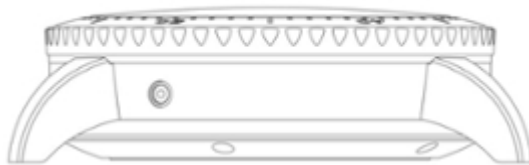

4.7

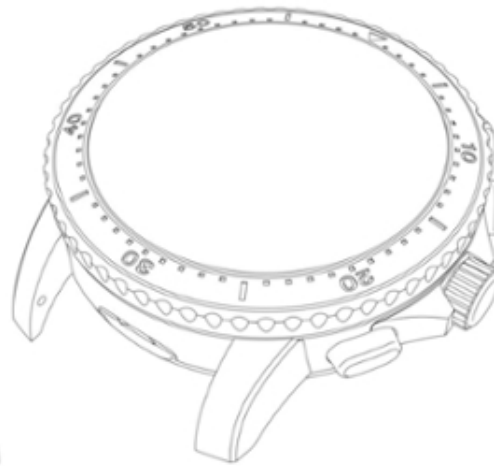

5.1

5.2

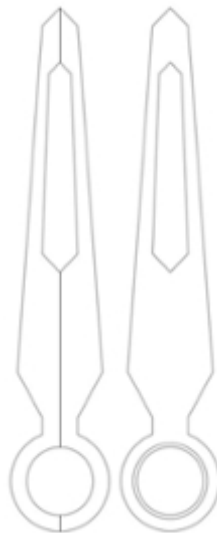

5.3

5.4



5.5

5.6



5.7



6.1 6.2

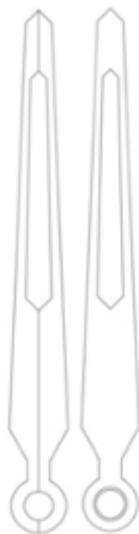

6.3



6.4



6.5 6.6



6.7



TRADEMARKS

APPLICATIONS FILED UNDER THE NATIONAL PROCEDURE APPROVED FOR REGISTRATION

The decision can be appealed at the Chamber of Appeal of Sakpatenti within 3 months from the publication or at the Mtskheta District Court Administrative Cases Board (Address: №17, Samkhedro St., Mtskheta), within 1 month following the publication.

(260) AM 2019 94562 A*
(210) AM 94562
(220) 11 10 2017
(731) Kraft Foods Group Brands LLC
200 Ist Rendolf Strit, Chikago, Ilinoisi 60601,
USA
(740) Natela Otardidze
(540)

KRAFT

(591) Black, white
(511) 29, 30

(260) AM 2019 96572 A
(210) AM 96572
(220) 07 09 2018
(731) LTD "FIRINI"
Dighomi Training Trial, "Khosi Gora", 0159,
Tbilisi, Georgia
(540)



(591) Black, golden
(531) 05.07.02; 26.04.01; 26.04.15; 26.04.22;
26.04.24; 27.05.01; 27.05.24; 29.01.12
(511) 30, 35, 43

260) AM 2019 97167 A*
(210) AM 97167
(220) 30 03 2018
(731) Benihana Holdings Pte. Ltd
10 Anson Road, 33-07/08 International
Plaza, 079903, Singapore
(740) Shalva Gvaramadze
(540)

BENIHANA

(591) Black, white
(531) 27.05.01
(511) 29, 33, 43

(260) AM 2019 97168 A*
(210) AM 97168
(220) 30 03 2018
(731) Benihana Holdings Pte. Ltd
10 Anson Road, 33-07/08 International
Plaza, 079903, Singapore
(740) Shalva Gvaramadze
(540)

БЕНИХАНА

(591) Black, white
(531) 28.05
(511) 29, 33, 43

(260) AM 2019 97169 A*
(210) AM 97169
(220) 30 03 2018
(731) Benihana Holdings Pte. Ltd
10 Anson Road, 33-07/08 International
Plaza, 079903, Singapore
(740) Shalva Gvaramadze
(540)



(591) Black, white
(531) 05.05.20; 05.05.23; 26.04.15; 26.04.16
(511) 29, 33, 43

(260) AM 2019 97171 A*
(210) AM 97171
(220) 30 03 2018
(731) Benihana Holdings Pte. Ltd
10 Anson Road, 33-07/08 International
Plaza, 079903, Singapore
(740) Shalva Gvaramadze
(540)

 **BENIHANA**

(591) Black, white
 (531) 05.05.20; 05.05.23; 26.04.15; 26.04.16;
 27.05.17
 (511) 43

(260) AM 2019 98206 A
 (210) AM 98206
 (220) 25 06 2018
 (731) Cainiao Smart Logistics Holding Limited
 Fourth Floor, One Capital Place,
 P.O. Box 847, Grand Cayman, KY1-1103,
 Cayman Islands
 (740) Tamaz Shilakadze
 (540)

菜鸟

(591) Black, white
 (531) 28.03
 (511) 9, 16, 35, 36, 38, 39, 41, 42

(260) AM 2019 98554 A
 (210) AM 98554
 (220) 17 07 2018
 (731) Natela Sheklashvili
 P. Iashvili Str., Deadlock 3, Sachkhere,
 Georgia
 (740) Vakhtang Torotadze
 (540)

ლიჩელი

(591) Black, white
 (511) 32

(260) AM 2019 98573 A
 (210) AM 98573
 (220) 19 07 2018
 (731) Scottish & Newcastle Limited
 3-4 Broadway Park, South Gyle Broadway,
 Edinburgh, EH12 9JZ, United Kingdom
 (740) Tamaz Shilakadze
 (540)



(591) Black, white, dark yellow, red
 (531) 01.01.01; 01.01.02; 01.01.10; 24.05.07;
 25.01.19; 26.01.02; 26.01.04; 26.01.21;
 27.01.12; 29.01.15
 (511) 32

(260) AM 2019 98586 A
 (210) AM 98586
 (220) 20 07 2018
 (731) LTD "KRIALA"
 Kiziki Str. 12, (Plot N2 / 21), Samgori
 district, 0182, Tbilisi, Georgia
 (540)



(591) Yellow, green, light green, red, white
 (531) 05.03.16; 05.05.20; 28.19; 29.01.14
 (511) 16

(260) AM 2019 98663 A
 (210) AM 98663
 (220) 23 07 2018
 (731) LTD "FIRM "DISNA"
 Druzhba Narodov Boulevard, house
 14-16, room 500, 01103, Kiev, Ukraine
 (740) Giorgi Kankava
 (540)



(591) Black and yellow
 (531) 25.01.10; 25.01.19; 26.01.11; 26.01.12;
 27.05.01; 29.01.12
 (511) 32, 35

(260) AM 2019 98667 A
 (210) AM 98667
 (220) 24 07 2018
 (731) LTD "N-M-G GROUP"
 Ts. Dadiani Str. 319, 0192, Tbilisi, Georgia
 (740) Nino Gazdeliani

(540)



(591) Peach, black, white
 (531) 02.09.19; 27.05.01; 27.05.10; 29.01.12
 (511) 10, 12, 20, 35

(260) AM 2019 98672 A
 (210) AM 98672
 (220) 24 07 2018
 (731) LTD "Digital Development of Product"
 III Massiv, z/p 5, ap.. 43, 0182, Tbilisi,
 Georgia

(540)



(591) Sky-blue, white, black
 (531) 26.01.01; 26.01.03; 28.19; 29.01.13
 (511) 42

(260) AM 2019 98693 A
 (210) AM 98693
 (220) 26 07 2018
 (731) LLC "Gas Consulting"
 Bolshaya Gruzinskaya Str., house. 30A,
 build. 1, Pom. 217, Moscow, 123056,
 Russian Federation

(740) Vakhtang Torotadze
 (540)



(591) Blue, sky-blue, white
 (531) 26.04.02; 26.04.05; 26.04.07; 26.04.22;
 26.04.24; 27.05.10; 27.05.24; 29.01.12
 (511) 9

(260) AM 2019 98758 A
 (210) AM 98758
 (220) 30 07 2018
 (731) Mylan Pharma Group Limited
 Inverin County, Galway, Ireland
 (740) Tamar Kochlamazashvili

(540)

СУПЛАЗИН

(591) Black, white
 (511) 5, 10

(260) AM 2019 98765 A
 (210) AM 98765
 (220) 01 08 2018
 (731) Biocon Limited
 20th K.M., Hosur Road, Electronic City P.O.,
 Bangalore - 560100, India
 (740) Merab Kvimsadze
 (540)

INSU+

(591) Black, white
 (531) 24.13.01; 24.13.14; 24.17.05; 24.17.07;
 27.05.01
 (511) 5, 10

(260) AM 2019 98773 A
 (210) AM 98773
 (220) 01 08 2018
 (731) Nika Goletiani
 Bakhtrioni Str. 60, 2200, Telavi, Georgia
 (540)

Bioland**ბომბოფა****Биоземля**

(591) Black, white
 (511) 29, 31

(260) AM 2019 98785 A
 (210) AM 98785
 (220) 03 08 2018
 (731) LTD "AVERSI-PHARMA"
 D. Aghmashenebeli Ave. 148/2, 0112,
 Tbilisi, Georgia
 (540)

სუნბლონი**Сунилон****Sunilon**

(591) Black, white
 (511) 5

(260) AM 2019 98798 A
 (210) AM 98798
 (220) 03 08 2018
 (731) Super 8 Worldwide Inc.
 22 Sylvan Way, Parsippany, New Jersey
 07054, USA

(740) Tamaz Shilakadze
(540)

SUPER 8

(591) Black, white
(511) 43

(260) AM 2019 98799 A
(210) AM 98799
(220) 03 08 2018
(731) Super 8 Worldwide Inc.
22 Sylvan Way, Parsippany, New Jersey
07054, USA
(740) Tamaz Shilakadze
(540)



(591) Black, white
(531) 25.03.03; 26.04.02; 26.04.06; 26.04.17;
26.04.22; 27.05.01; 27.07.03; 27.07.17
(511) 43

(260) AM 2019 98802 A
(210) AM 98802
(220) 03 08 2018
(731) JSC "Georgian Beer Company"
Village Saguramo, 3311, Mtskheta, Georgia
(540)

დოზა
доза
doza

(591) Black, white
(511) 32, 33

(260) AM 2019 98803 A
(210) AM 98803
(220) 03 08 2018
(731) JSC "Georgian Beer Company"
Village Saguramo, 3311, Mtskheta, Georgia
(540)

დოზა
dose

(591) Black, white
(511) 32, 33

(260) AM 2019 98898 A
(210) AM 98898
(220) 07 08 2018
(731) LTD "BATONO"
L. Gotua Str. 8, 0160, Tbilisi, Georgia
(740) Giorgi Imnadze
(540)

ფესვი
PESVI
ПЕСВИ

(591) Black, white
(511) 33

(260) AM 2019 98909 A
(210) AM 98909
(220) 09 08 2018
(731) LTD "Bolero & Company"
Marshal Gelovani Ave. 13, fl. 9, 0159, Tbilisi,
Georgia
(540)

კომბლე
Компле
Comme blé Comble

(591) Black, white
(511) 33

(260) AM 2019 98910 A
(210) AM 98910
(220) 09 08 2018
(731) LTD "Bolero & Company"
Marshal Gelovani Ave. 13, fl. 9, 0159, Tbilisi,
Georgia
(540)

გემო კეთილი
Гемо Кетили
Gemo Ketili
Вкус добрый

(591) Black, white
(511) 33

(260) AM 2019 98964 A
(210) AM 98964
(220) 10 08 2018

(731) LTD "TBC PAY"
K. Marjanishvili Str. 7, 0102, Tbilisi, Georgia
(540)

ფეი ბოტი

(591) Black, white
(511) 42

(260) AM 2019 98973 A
(210) AM 98973
(220) 14 08 2018
(731) Qualcomm Incorporated
5775 Morehous Drive, San Diego, CA 92121-1714, USA
(740) Tamaz Shilakadze
(540)

QUALCOMM

(591) Black, white
(511) 9, 38, 42

(260) AM 2019 99054 A
(210) AM 99054
(220) 20 08 2018
(731) LTD "GEM"
I. Chavchavadze Ave. 56, ap. 22,
Vake District, 0162, Tbilisi, Georgia
(540)



(591) Black, white
(531) 26.04.01; 26.04.05; 26.04.24; 27.05.24
(511) 14, 18, 25

(260) AM 2019 99060 A
(210) AM 99060
(220) 21 08 2018
(731) LTD "INO-LABI"
M Brose Str. 2, 0108, Tbilisi, Georgia
(540)



(591) White, sky-blue
(531) 01.15.15; 01.15.24; 29.01.12
(511) 1, 5

(260) AM 2019 99065 A
(210) AM 99065
(220) 22 08 2018
(731) Ramada International Inc.
22 Silvan Vei, Parsipani, Niu-Jersey
07054, USA
(740) Tamaz Shilakadze
(540)



(591) Red, purple, blue, green, yellow
(531) 26.11.12; 27.01.12; 27.05.01; 27.05.21;
29.01.15
(511) 43

(260) AM 2019 99067 A
(210) AM 99067
(220) 22 08 2018
(731) "Mechanization -2005"
Khornabuji St. 21, Dedoplistskaro,
Georgia
(540)



(591) Green, blue, black, white, brown, orange,
yellow
(531) 03.04.02; 03.04.12; 03.04.24; 06.19.13; 08.03;
25.01.15; 25.01.18; 28.19; 29.01.15
(511) 29, 35

(260) AM 2019 99164 A
(210) AM 99164
(220) 29 08 2018
(731) ZTE CORPORATION
ZTE Plaza, Keji Road South, Hi-Tech
Industrial Park, Nanshan District, Shenzhen,
China
(740) Shalva Gvaramadze

(540)

ZENIC

(591) Black, white
 (531) 27.05.01; 27.05.17
 (511) 42

(260) AM 2019 99166 A
 (210) AM 99166
 (220) 29 08 2018
 (731) Hilton Worldwide Manage Limited
 Maple Court Central Park, Reeds Crescent,
 Watford WD24 4QQ, United Kingdom
 (740) Tamaz Shilakadze
 (540)

CANOPY

(591) Black, white
 (511) 35, 41, 43, 44

(260) AM 2019 99182 A
 (210) AM 99182
 (220) 03 09 2018
 (731) Techtronic Power Tools Technology Limited
 Trident Chambers, P.O. Box 146, Road Town,
 Tortola, Virgin Islands (British)
 (740) Merab Kvimsadze
 (540)

FUEL

(591) Black, white
 (531) 27.05.01
 (511) 7

(260) AM 2019 99188 A
 (210) AM 99188
 (220) 05 09 2018
 (731) LTD "KARTVELI"
 Kakheti highway, 110a, Isani-Samgori
 District, 0151, Tbilisi, Georgia
 (740) Davit Dzamukashvili
 (540)

GVARIANI

(591) Black, white
 (531) 27.05.01
 (511) 32, 33

(260) AM 2019 99196 A
 (210) AM 99196
 (220) 06 09 2018
 (731) Philip Morris Brands Sàrl
 Ke Janreno 3, 2000 Nevshateli,
 Quai Jeanrenaud 3, 2000 Neuchâtel,
 Switzerland

(740) Shalva Gvaramadze
 (540)

ATELIER

(511) 34

(260) AM 2019 99304 A
 (210) AM 99304
 (220) 07 09 2018
 (731) LTD "Publishing House Palitra L"
 Iosebidge Str. 49, 0160, Tbilisi, Georgia
 (540)



(591) Black, grey
 (531) 24.17.10; 24.17.14; 28.19
 (511) 9, 16, 35, 41

(260) AM 2019 99312 A
 (210) AM 99312
 (220) 10 09 2018
 (731) LTD "ROST-BREND"
 Leningradski Ave., Bld. 37/9, room 806,
 Moskow, 125167, Russian Federation
 (740) Giorgi Taktakishvili
 (540)



(591) Black, white, greenish-blue, light beige,
 red, yellow
 (531) 07.01.03; 24.13.01; 25.01.19; 25.01.25;
 29.01.15
 (511) 32, 33

(260) AM 2019 99314 A
 (210) AM 99314
 (220) 11 09 2018
 (731) "Mechanization -2005"
 Khornabuji St. 21, Dedoplistskaro,
 Georgia

(540)



(591) Golden, black, white
 (531) 02.05.17; 05.01.19; 19.09.02; 27.05.01;
 27.05.19; 28.19; 29.01.13
 (511) 33, 35

(260) AM 2019 99315 A
 (210) AM 99315
 (220) 11 09 2018
 (731) LTD "ფეშენტვ ჯორჯია-FASHIONTV
 GEORGIA"
 Grishashvili Str. 4, 4600, Kutaisi, Georgia
 (740) Nino Gazdeliani
 (540)



(591) Silver, brown
 (531) 05.13.01; 05.13.25; 25.01.25; 27.05.01;
 27.05.08; 27.05.10; 27.05.17; 27.05.23;
 29.01.12
 (511) 25, 35

(260) AM 2019 99330 A
 (210) AM 99330
 (220) 12 09 2018
 (731) LTD "ALPEN MILK"
 D. Aghmashenebeli Str. 28/1, Akhalkalaki,
 Georgia
 (740) Shalva Gvaramadze

(540)

ფილამუკ
Fillamook
 Филамук

(591) Black, white
 (511) 29

(260) AM 2019 99331 A
 (210) AM 99331
 (220) 12 09 2018
 (731) LTD "ALPEN MILK"
 D. Aghmashenebeli Str. 28/1, Akhalkalaki,
 Georgia
 (740) Shalva Gvaramadze
 (540)

პოლა
ПОЛА

(591) Black, white
 (511) 29

(260) AM 2019 99457 A
 (210) AM 99457
 (220) 20 09 2018
 (731) Sundaram-Clayton Limited
 'Jaialakshmi Estates' No. 29 (old No.8),
 Hedouz Roudi, Chennai, 600 006, India
 (740) Tamaz Shilakadze
 (540)



(591) Black, white
 (531) 27.05.01; 27.05.09; 27.05.23
 (511) 12

(260) AM 2019 99458 A
 (210) AM 99458
 (220) 20 09 2018
 (731) Sundaram-Clayton Limited
 'Jaialakshmi Estates' No. 29 (old No.8),
 Hedouz Roudi, Chennai, 600 006, India
 (740) Tamaz Shilakadze
 (540)



(591) Black, white
 (531) 27.05.01; 27.05.09; 27.05.10; 27.05.19
 (511) 12

(260) AM 2019 99471 A
 (210) AM 99471
 (220) 24 09 2018
 (731) LTD "Lithuanian Bakery +"
 T. Eristavi Str. 1, 0192, Tbilisi, Georgia
 (540)



(591) Red, yellow, white, purple
 (531) 02.01.20; 05.07.02; 25.01.01; 26.11.12;
 26.11.13; 28.19; 29.01.14
 (511) 30

(260) AM 2019 99472 A
 (210) AM 99472
 (220) 24 09 2018
 (731) LTD "Lithuanian Bakery +"
 T. Eristavi Str. 1, 0192, Tbilisi, Georgia
 (540)



(591) Red, yellow, white, purple, brown, gray
 (531) 02.01.20; 05.07.02; 25.01.01; 28.19; 29.01.15
 (511) 30

(260) AM 2019 99473 A
 (210) AM 99473
 (220) 24 09 2018
 (731) LTD "Lithuanian Bakery +"
 T. Eristavi Str. 1, 0192, Tbilisi, Georgia

(540)



(591) White, yellow, green, purple, gray
 (531) 02.01.01; 02.01.20; 05.07.02; 25.01.01;
 26.11.13; 28.19; 29.01.14
 (511) 30

(260) AM 2019 99474 A
 (210) AM 99474
 (220) 24 09 2018
 (731) LTD "Lithuanian Bakery +"
 T. Eristavi Str. 1, 0192, Tbilisi, Georgia
 (540)



(591) White, red, yellow, purple, brown
 (531) 02.01.20; 05.07.02; 25.01.01; 25.01.05; 28.19;
 29.01.15
 (511) 30

(260) AM 2019 99475 A
 (210) AM 99475
 (220) 24 09 2018
 (731) LTD "Lithuanian Bakery +"
 T. Eristavi Str. 1, 0192, Tbilisi, Georgia
 (540)



(591) Red, yellow, brown, black, orange, white
 (531) 02.01.20; 05.05.04; 05.07.02; 25.01.01;
 27.05.24; 28.19; 29.01.15
 (511) 30

(260) AM 2019 99476 A
 (210) AM 99476
 (220) 24 09 2018
 (731) LTD "Lithuanian Bakery +"
 T. Eristavi Str. 1, 0192, Tbilisi, Georgia
 (540)



(591) White, red, yellow, orange, purple
 (531) 02.01.20; 05.05.04; 05.07.02; 25.01.01; 28.19;
 29.01.15
 (511) 30

(260) AM 2019 99479 A
 (210) AM 99479
 (220) 24 09 2018
 (731) Kentuki Fraid Chiken Interneshenel
 Holdingz Llk
 7100 Corporate Drive, TX, Plano,
 75024, USA
 (740) Tamar Kochlamazashvili
 (540)

KFC BATTLE

(591) Black, white
 (511) 41

(260) AM 2019 99480 A
 (210) AM 99480
 (220) 24 09 2018
 (731) Kentuki Fraid Chiken Interneshenel
 Holdingz Llk
 7100 Corporate Drive, TX, Plano,
 75024, USA

(740) Tamar Kochlamazashvili
 (540)

KFC Батл

(591) Black, white
 (511) 41

(260) AM 2019 99481 A
 (210) AM 99481
 (220) 24 09 2018
 (731) Kentuki Fraid Chiken Interneshenel
 Holdingz Llk
 7100 Corporate Drive, TX, Plano, 75024,
 USA

(740) Tamar Kochlamazashvili
 (540)

TAKE YOURS!

(591) Black, white
 (511) 41

(260) AM 2019 99482 A
 (210) AM 99482
 (220) 24 09 2018
 (731) Kentuki Fraid Chiken Interneshenel
 Holdingz Llk
 7100 Corporate Drive, TX, Plano,
 75024, USA

(740) Tamar Kochlamazashvili
 (540)

БЕРИ СВОЁ!

(591) Black, white
 (511) 41

(260) AM 2019 99483 A
 (210) AM 99483
 (220) 24 09 2018
 (731) JSC "LIBERTY BANK"
 I. Chavchavadze Ave. 74, 0162, Tbilisi,
 Georgia

(740) Mikheil Kvaraia
 (540)

LIBERTY PRIME

(591) Red, white, black
 (531) 27.05.01; 27.05.25; 29.01.13
 (511) 36

(260) AM 2019 99645 A
 (210) AM 99645
 (220) 28 09 2018
 (310) SD2018/0023530

(320) 28 03 2018

(330) BM

(731) The Concentrate Manufacturing Company
of Ireland
Swan Building, 3rd Floor, 26 Victoria Street,
Hamilton, HM12, Bermuda

(740) Tamar Kochlamazashvili

(540)



(591) Brown, white

(531) 26.01.21; 26.01.24; 26.11.03; 26.11.08;
27.05.01; 27.05.24; 29.01.12

(511) 29, 30

REGISTERED TRADEMARKS

(111) M 2019 30984 R (151) 21 03 2019 (181) 21 03 2029 (260) AM 2018 97189 A (220) 05 04 2018 (732) LTD "CONCORD TRAVEL" Janashvilis q. 3a, 0179, Tbilisi, Georgia	Vazha-Pshavelas kvart. VII, korp. 15, b. 24, 0186, Tbilisi, Georgia
(111) M 2019 30996 R (151) 02 04 2019 (181) 02 04 2029 (260) AM 2017 91645 A (220) 11 04 2017 (732) LTD "ASPHARMA GEORGIA PHARMACEUTICAL COMPANY" Mtskhethis q. 8, 0179, Tbilisi, Georgia	(111) M 2019 31001 R (151) 02 04 2019 (181) 02 04 2029 (260) AM 2018 95946 A (220) 11 01 2018 (732) AGIO PHARMACEUTICALS LTD A-38, Nandjyot, Ind. Estate, Kurla-Andheri Road, Safedpool, Mumbai, 400 072, India
(111) M 2019 30997 R (151) 02 04 2019 (181) 02 04 2029 (260) AM 2017 92380 A (220) 25 05 2017 (732) INPHA LLP Representative Office in Georgia Besikis q. 4 (nakveti 46/10), 0108, Tbilisi, Georgia	(111) M 2019 31002 R (151) 02 04 2019 (181) 02 04 2029 (260) AM 2018 95998 A (220) 16 01 2018 (732) LTD "KAISER GROUP" Ikalto Mountain I, b. 67, 0171, Tbilisi, Georgia
(111) M 2019 30998 R (151) 02 04 2019 (181) 02 04 2029 (260) AM 2017 94832 A (220) 31 10 2017 (732) LTD "S.V.G" Moskovis gamz. 37, b. 2, 0137, Tbilisi, Georgia	(111) M 2019 31003 R (151) 02 04 2019 (181) 02 04 2029 (260) AM 2018 96524 A (220) 23 02 2018 (732) MARUSSIA BEVERAGES B.V. Siriusdreef 22, 2132 WT Hoofddorp, Netherlands
(111) M 2019 30999 R (151) 02 04 2019 (181) 02 04 2029 (260) AM 2017 94833 A (220) 31 10 2017 (732) LTD "S.V.G" Moskovis gamz. 37, b. 2, 0137, Tbilisi, Georgia	(111) M 2019 31004 R (151) 02 04 2019 (181) 02 04 2029 (260) AM 2018 96525 A (220) 23 02 2018 (732) MARUSSIA BEVERAGES B.V. Siriusdreef 22, 2132 WT Hoofddorp, Netherlands
(111) M 2019 31000 R (151) 02 04 2019 (181) 02 04 2029 (260) AM 2017 95203 A (220) 27 11 2017 (732) LTD "ISTYLE"	(111) M 2019 31005 R (151) 02 04 2019 (181) 02 04 2029 (260) AM 2018 96859 A (220) 15 03 2018 (732) INPHA LLP Representative Office in Georgia Besikis q. 4 (nakveti 46/10), 0108, Tbilisi, Georgia
	(111) M 2019 31006 R (151) 02 04 2019 (181) 02 04 2029

(260) AM 2018 96861 A
 (220) 15 03 2018
 (732) INPHA LLP Representative Office in Georgia
 Besikis q. 4 (nakveti 46/10), 0108, Tbilisi,
 Georgia

(111) M 2019 31007 R
 (151) 02 04 2019
 (181) 02 04 2029
 (260) AM 2018 96919 A
 (220) 20 03 2018
 (732) GULBAHAR TOBACCO INTERNATIONAL
 FZE
 P.O. Box 61401, Jebel Ali Free Zone, Dubai,
 United Arab Emirates

(111) M 2019 31008 R
 (151) 02 04 2019
 (181) 02 04 2029
 (260) AM 2018 96973 A
 (220) 21 03 2018
 (732) LTD "KHIRSA"
 Debi Ishkhnelebis q. 2, 4600, Kutaisi, Georgia

(111) M 2019 31009 R
 (151) 02 04 2019
 (181) 02 04 2029
 (260) AM 2018 96993 A
 (220) 23 03 2018
 (732) LTD "MZAMZAREULI"
 Zakaria Paliashvilis q. 2, b.18, 0179, Tbilisi,
 Georgia

(111) M 2019 31010 R
 (151) 02 04 2019
 (181) 02 04 2029
 (260) AM 2018 97009 A
 (220) 26 03 2018
 (732) DUBAI AVIATION CORPORATION
 (trading as fly Dubai)
 FlyDubai Headquarters Terminal 2, P.O. Box
 353, Dubai, United Arab Emirates

(111) M 2019 31011 R
 (151) 02 04 2019
 (181) 02 04 2029
 (260) AM 2018 97063 A
 (220) 29 03 2018
 (732) LTD "BIOPOLUS"
 Noneshvilis q. 65, 6000, Batumi, Georgia

(111) M 2019 31012 R
 (151) 02 04 2019
 (181) 02 04 2029

(260) AM 2018 97070 A
 (220) 29 03 2018
 (732) LTD "BIOPOLUS"
 Noneshvilis q. 65, 6000, Batumi, Georgia

(111) M 2019 31013 R
 (151) 02 04 2019
 (181) 02 04 2029
 (260) AM 2018 97074 A
 (220) 29 03 2018
 (732) LTD "BIOPOLUS"
 Noneshvilis q. 65, 6000, Batumi, Georgia

(111) M 2019 31014 R
 (151) 02 04 2019
 (181) 02 04 2029
 (260) AM 2018 97181 A
 (220) 03 04 2018
 (732) PHARMACEUTICAL CHEMICALCOSME-
 TIC INDUSTRY ALKALOID AD SKOPJE
 Bul. Aleksandar Makedonski, 12, Skopje, 1000,
 Macedonia (the former Yugoslav Republic of)

(111) M 2019 31015 R
 (151) 02 04 2019
 (181) 02 04 2029
 (260) AM 2018 97182 A
 (220) 03 04 2018
 (732) PHARMACEUTICAL CHEMICALCOSME-
 TIC INDUSTRY ALKALOID AD SKOPJE
 Bul. Aleksandar Makedonski, 12, Skopje, 1000,
 Macedonia (the former Yugoslav Republic of)

(111) M 2019 31016 R
 (151) 02 04 2019
 (181) 02 04 2029
 (260) AM 2018 97207 A
 (220) 10 04 2018
 (732) PHILIP MORRIS PRODUCTS S.A.
 Quai Jeanrenaud 3, 2000 Neuchâtel, Switzerland

(111) M 2019 31017 R
 (151) 02 04 2019
 (181) 02 04 2029
 (260) AM 2018 97210 A
 (220) 10 04 2018
 (732) PFIZER IRELAND PHARMACEUTICALS
 (2011 PIP)
 Operations Support Group, Ringaskiddy,
 Co. Cork, Ireland

(111) M 2019 31018 R
 (151) 02 04 2019
 (181) 02 04 2029

(260) AM 2018 97229 A
(220) 15 04 2018
(732) LTD "GMP"
Sop. Ponitchala 65, 0165, Tbilisi, Georgia

(111) M 2019 31019 R
(151) 02 04 2019
(181) 02 04 2029
(260) AM 2018 97230 A
(220) 15 04 2018
(732) LTD "GMP"
Sop. Ponitchala 65, 0165, Tbilisi, Georgia

(111) M 2019 31020 R
(151) 02 04 2019
(181) 02 04 2029
(260) AM 2018 97233 A
(220) 16 04 2018
(732) BIOCON LIMITED
20 K.m., Hosur Roud, Elektronik Siti P.o.,
Bangalori, 560100, India

(111) M 2019 31021 R
(151) 02 04 2019
(181) 02 04 2029
(260) AM 2018 97418 A
(220) 27 04 2018
(732) GVANCA MGALOBLSHVILI
Barnovis q. I chikhi 8, 0108, Tbilisi, Georgia

(111) M 2019 31022 R
(151) 02 04 2019
(181) 02 04 2029
(260) AM 2018 97438 A
(220) 02 05 2018
(732) LTD "SOTO"
Z. Paliashvili-Kavsadzis q. 70/7, b. 11, Tbilisi,
Georgia

(111) M 2019 31023 R
(151) 02 04 2019
(181) 02 04 2029
(260) AM 2018 97442 A
(220) 03 05 2018
(732) JSC "RAKHAT"
Zenkovis q. 2a, Almati, Kazakhstan

(111) M 2019 31024 R
(151) 02 04 2019
(181) 02 04 2029
(260) AM 2018 97453 A
(220) 04 05 2018
(732) JSC "RAKHAT"
Zenkovis q. 2a, Almati, Kazakhstan

(111) M 2019 31025 R
(151) 02 04 2019
(181) 02 04 2029
(260) AM 2018 97459 A
(220) 04 05 2018
(732) INPHA LLP Representative Lobbyist Office
in Georgia
Besikis q. 4-is Mimdebared (nakveti 46/10),
0108, Tbilisi, Georgia

(111) M 2019 31026 R
(151) 02 04 2019
(181) 02 04 2029
(260) AM 2018 97707 A
(220) 17 05 2018
(732) PHILIP MORRIS BRANDS SÀRL
Quai Jeanrenaud 3, 2000 Neuchâtel,
Switzerland

(111) M 2019 31027 R
(151) 02 04 2019
(181) 02 04 2029
(260) AM 2018 97709 A
(220) 17 05 2018
(732) PHILIP MORRIS BRANDS SÀRL
Quai Jeanrenaud 3, 2000 Neuchâtel,
Switzerland

(111) M 2019 31028 R
(151) 02 04 2019
(181) 02 04 2029
(260) AM 2018 97900 A
(220) 31 05 2018
(732) LTD "GLOBALPHARMI"
Almasianis q. 13a / Berbutis q. 8, 0171, Tbilisi,
Georgia

(111) M 2019 31029 R
(151) 02 04 2019
(181) 02 04 2029
(260) AM 2018 97901 A
(220) 31 05 2018
(732) LTD "GLOBALPHARMI"
Almasianis q. 13a / Berbutis q. 8, 0171, Tbilisi,
Georgia

(111) M 2019 31033 R
(151) 03 04 2019
(181) 03 04 2029
(260) AM 2018 97025 A
(220) 28 03 2018
(732) RUBIK'S BRAND LIMITED
7 Lambton Place, London W112SH, England,
United Kingdom

TRADEMARKS REGISTERED ACCORDING TO THE ACCELERATED PROCEDURE

The decision can be appealed at the Chamber of Appeal of Sakpatenti within 3 months from the publication.

(111) M 2019 30973 R
 (151) 20 03 2019
 (181) 20 03 2029
 (210) AM 102076
 (220) 07 03 2019
 (732) JSC "DONSKOY TABAK"
 I Lugovaya 17, 344002, Rostov-On-Don,
 Russian Federation
 (740) Shalva Gvaramadze
 (540)

DONTABAK

(591) Black, white
 (511) 34

(111) M 2019 30974 R
 (151) 20 03 2019
 (181) 20 03 2029
 (210) AM 102067
 (220) 07 03 2019
 (732) JSC "DONSKOY TABAK"
 I Lugovaya 17, 344002, Rostov-On-Don,
 Russian Federation
 (740) Shalva Gvaramadze
 (540)

RICHMOND

(591) Black, white
 (511) 34

(111) M 2019 30975 R
 (151) 20 03 2019
 (181) 20 03 2029
 (210) AM 102165
 (220) 14 03 2019
 (732) JAPAN TOBACCO INC.
 -1 Toranomom Minato-Ku, Tokyo, Japan
 (740) Shalva Gvaramadze
 (540)

WINSTON SUMMER MIX

(591) Black, white
 (511) 34

(111) M 2019 30976 R
 (151) 20 03 2019
 (181) 20 03 2029

(210) AM 101301
 (220) 23 01 2019
 (732) LTD "Royal Khvanchkara"
 M. Kostava Str. 13, 0400, Ambrolauri,
 Georgia
 (540)



ROYAL KHVANCHKARA

(591) Black, golden, white
 (531) 24.05.20; 24.05.25; 24.09.01; 27.05.01;
 29.01.13
 (526) Khvanchkara
 (511) 33

(111) M 2019 30977 R
 (151) 20 03 2019
 (181) 20 03 2029
 (210) AM 102175
 (220) 15 03 2019
 (732) I/E Evgeniya Grigorieva
 M. Chakhava Str. 4, ap. 1, Tbilisi, Georgia
 (540)

 Kapistoni



*Handcrafted Limited edition
Vintage*

(591) Black, white, red, grey
 (531) 07.01.09; 19.09.02; 27.05.01; 27.05.09;
 27.05.13; 27.05.19; 29.01.14
 (511) 33

(111) M 2019 30978 R
 (151) 21 03 2019
 (181) 21 03 2029
 (210) AM 101655
 (220) 15 02 2019
 (732) JSC "Georgian Beer Company"
 Village Saguramo, 3311, Mtskheta,
 Georgia
 (540)

ჰარლინგი
Harling
Харлинг

(591) Black, white
 (511) 32

(111) M 2019 30979 R
 (151) 21 03 2019
 (181) 21 03 2029
 (210) AM 102027
 (220) 01 03 2019
 (732) JSC "Georgian Beer Company"
 Village Saguramo, 3311, Mtskheta,
 Georgia
 (540)

ლიმონა
Лимона
Limona

(591) Black, white
 (511) 32

(111) M 2019 30980 R
 (151) 21 03 2019
 (181) 21 03 2029
 (210) AM 102042
 (220) 04 03 2019
 (732) JSC "Georgian Beer Company"
 Village Saguramo, 3311, Mtskheta,
 Georgia
 (540)

დინო
Дино
Dino

(591) Black, white
 (511) 32, 35

(111) M 2019 30981 R
 (151) 21 03 2019
 (181) 21 03 2029
 (210) AM 102146
 (220) 11 03 2019
 (732) LTD "GEO ALCO"
 Sarajishvili Ave.. 4, Tbilisi, Georgia
 (540)



KARTLIS VAZI

(591) Black, white
 (531) 05.07.10; 26.01.05; 26.01.15; 27.05.01
 (511) 33

(111) M 2019 30982 R
 (151) 21 03 2019
 (181) 21 03 2029
 (210) AM 102147
 (220) 11 03 2019
 (732) LTD "GEO ALCO"
 Sarajishvili Ave.. 4, Tbilisi, Georgia
 (540)



KARTLULI VAZI

(591) Black, white
 (531) 05.01.19; 26.01.15; 27.05.01
 (511) 33

(111) M 2019 30983 R
 (151) 21 03 2019
 (181) 21 03 2029
 (210) AM 102148
 (220) 11 03 2019
 (732) LTD "GEO ALCO"
 Sarajishvili Ave.. 4, Tbilisi, Georgia
 (540)



(591) Black, white
 (531) 01.01.01; 01.01.10; 01.01.20; 01.03.02;
 01.03.07; 25.01.09; 25.01.10; 26.01.14
 (511) 33

(111) M 2019 30985 R
 (151) 25 03 2019
 (181) 25 03 2029
 (210) AM 102031
 (220) 04 03 2019
 (732) JSC "GLOBAL BEER GEORGIA"
 Village Tsilkani, 3319 Mtskheta,
 Georgia
 (540)

ინდი
Indie

(591) Black, white
 (511) 32

(111) M 2019 30986 R
 (151) 25 03 2019
 (181) 25 03 2029
 (210) AM 102070
 (220) 07 03 2019
 (732) JSC "Georgian Beer Company"
 Village Saguramo, 3311, Mtskheta,
 Georgia
 (540)

სოლე
Solle
солé

(591) Black, white
 (511) 32

(111) M 2019 30987 R
 (151) 25 03 2019
 (181) 25 03 2029
 (210) AM 102144
 (220) 11 03 2019
 (732) JSC "Georgian Beer Company"
 Village Saguramo, 3311, Mtskheta,
 Georgia
 (540)

ზორო
Zorro

(591) Black, white
 (511) 32

(111) M 2019 30988 R
 (151) 26 03 2019
 (181) 26 03 2029
 (210) AM 102142
 (220) 11 03 2019
 (732) JSC "Georgian Beer Company"
 Village Saguramo, 3311, Mtskheta,
 Georgia
 (540)

აქვაზენი
Aquazen

(591) Black, white
 (511) 32

(111) M 2019 30989 R
 (151) 27 03 2019
 (181) 27 03 2029
 (210) AM 102248
 (220) 19 03 2019
 (732) Beka Beglarishvili
 Ilori Str. 6, 0153, Tbilisi, Georgia
 (540)

ინდიგო
Indigo

(591) Black, white
 (511) 32, 35

(111) M 2019 30990 R
 (151) 27 03 2019
 (181) 27 03 2029
 (210) AM 101613
 (220) 11 02 2019
 (732) JSC "Georgian Beer Company"
 Village Saguramo, 3311, Mtskheta,
 Georgia
 (540)

ბრავია
Бравия
Bravia

(591) Black, white
 (511) 32, 33, 35, 43

(111) M 2019 30991 R
 (151) 27 03 2019
 (181) 27 03 2029
 (210) AM 102160
 (220) 13 03 2019
 (732) JSC "Georgian Beer Company"
 Village Saguramo, 3311, Mtskheta,
 Georgia

(540)

**გენერალი
Generali**

(591) Black, white
(511) 32

(111) M 2019 30992 R

(151) 27 03 2019

(181) 27 03 2029

(210) AM 102162

(220) 13 03 2019

(732) JSC "Georgian Beer Company"

Village Saguramo, 3311, Mtskheta,
Georgia

(540)

**დიპლომატი
Diplomat**

(591) Black, white
(511) 32

(111) M 2019 30993 R

(151) 28 03 2019

(181) 28 03 2029

(210) AM 102156

(220) 13 03 2019

(732) JSC "Georgian Beer Company"

Village Saguramo, 3311, Mtskheta,
Georgia

(540)

**ქართული სამეფო
Грузинское царство
Georgian Kingdom**

(591) Black, white
(511) 32

(111) M 2019 30994 R

(151) 02 04 2019

(181) 02 04 2029

(210) AM 102260

(220) 21 03 2019

(732) LTD LLC "EUROLEX"

A. Tsereteli Ave. 118, 0119,
Tbilisi, Georgia

(540)

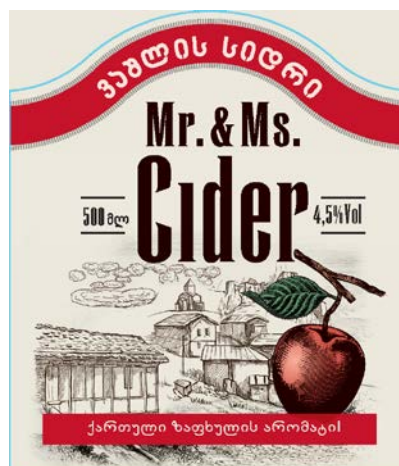

(591) Red, white, black, purple, brown, blue,
green

(531) 05.07.13; 06.07.01; 06.07.04; 06.07.07;
06.07.08; 06.07.11; 28.19; 29.01.15

(511) 33

(111) M 2019 30995 R

(151) 02 04 2019

(181) 02 04 2029

(210) AM 102382

(220) 26 03 2019

(732) LTD "GEORGIAN GENERATION"

Krtsanisi Str. 22-24, Tbilisi, Georgia

(540)



(591) White, green

(531) 16.01.01; 26.04.12; 26.13.25; 27.05.01;
29.01.12

(511) 35, 37, 42

(111) M 2019 31030 R

(151) 02 04 2019

(181) 02 04 2029

(210) AM 102243

(220) 18 03 2019

(732) JSC "Georgian Beer Company"

Village Saguramo, 3311, Mtskheta,
Georgia

(540)

**ჩელი
Cheli**

(591) Black, white
(511) 32

(111) M 2019 31031 R
(151) 03 04 2019
(181) 03 04 2029
(210) AM 102384
(220) 26 03 2019
(732) JSC "KARTLI ENERGY"
Krtsanisi Str. 22-24, Tbilisi, Georgia
(540)



(591) White, green
(531) 16.01.01; 26.04.12; 26.13.25; 27.05.01;
29.01.12
(511) 6, 35, 37, 42

(111) M 2019 31032 R
(151) 03 04 2019
(181) 03 04 2029
(210) AM 102385
(220) 26 03 2019
(732) LTD "KRAFT & DRAFT"
Village Tsilkani, Territory of Tsilkani,
Mtskheta District, Georgia
(540)

სანაპირო
Sanapiro
Санapiro

(591) Black, white
(511) 35, 43

INTERNATIONAL TRADEMARKS FOR WHICH A DECISION ON GRANTING PROTECTIONS IS TAKEN

The decision can be appealed at the Chamber of Appeal of Sakpatenti within 3 months from the publication or at the Mtskheta District Court Administrative Cases Board (Address: №17, Samkhedro str., Mtskheta), within 1 month following the publication.

(260) AM 2019 93381 A*

(800) 1354956

(151) 2017 04 20

(891) 2017 04 20

(731) PHILIP MORRIS PRODUCTS S.A.

Quai Jeanrenaud 3 CH-2000 Neuchâtel,
Switzerland

(540)

CRIMPED

(591) Black and white

(511)

34 – wired vaporizer for electronic cigarettes and electronic smoking devices; tobacco sticks; electronic devices and their parts for the purpose of heating cigarettes or tobacco in order to release nicotine-containing aerosol for inhalation; liquid nicotine solutions for use in electronic cigarettes; electronic smoking devices; electronic cigarettes; electronic cigarettes as substitute for traditional cigarettes; electronic devices for the inhalation of nicotine containing aerosol; oral vaporising devices for smokers; smokers' articles for electronic cigarettes; extinguishers for heated cigarettes and cigars as well as heated tobacco sticks; electronic rechargeable cigarette cases.

(260) AM 2019 93383 A*

(800) 1354957

(151) 2017 04 21

(891) 2017 04 21

(731) PHILIP MORRIS PRODUCTS S.A.

Quai Jeanrenaud 3 CH-2000 Neuchâtel,
Switzerland

(540)

CRIMPED TOBACCO

(591) Black and white

(511)

34 – wired vaporizer for electronic cigarettes and electronic smoking devices; tobacco sticks; electronic devices and their parts for the purpose of heating cigarettes or tobacco in order to release nicotine-containing aerosol for inhalation; liquid nicotine solutions for use in electronic cigarettes; electronic smoking devices; electronic cigarettes; electronic cigarettes as substitute for traditional cigarettes; electronic devices for the inhalation of nicotine containing aerosol; oral vaporising devices for smokers; smokers' articles for electronic cigarettes; extinguish-

ers for heated cigarettes and cigars as well as heated tobacco sticks; electronic rechargeable cigarette cases.

(260) AM 2019 93384 A*

(800) 1355014

(151) 2017 04 20

(891) 2017 04 20

(731) PHILIP MORRIS PRODUCTS S.A.

Quai Jeanrenaud 3 CH-2000 Neuchâtel,
Switzerland

(540)

CRIMPING

(591) Black and white

(511)

34 – wired vaporizer for electronic cigarettes and electronic smoking devices; tobacco sticks; electronic devices and their parts for the purpose of heating cigarettes or tobacco in order to release nicotine-containing aerosol for inhalation; liquid nicotine solutions for use in electronic cigarettes; electronic smoking devices; electronic cigarettes; electronic cigarettes as substitute for traditional cigarettes; electronic devices for the inhalation of nicotine containing aerosol; oral vaporising devices for smokers; smokers' articles for electronic cigarettes; extinguishers for heated cigarettes and cigars as well as heated tobacco sticks; electronic rechargeable cigarette cases.

(260) AM 2019 94946 A

(800) 1373509

(151) 2016 08 19

(891) 2016 08 19

(731) JOSEPH VÖGELE AG

Joseph-Vögele-Str. 1 67067 Ludwigshafen,
Germany

(540)

VÖGELE

(591) Black and white

(511)

1 – Chemicals for purifying exhaust gases in chemical processes; chemicals for reducing emissions of harmful substances in exhaust gases from internal combustion engines; chemical additives for fuels, lubricants and industrial oils; filtering materials ma-

de from chemical and non-chemical substances; urea (organic compound); fluids for hydraulic circuits; urea (organic compound) and urease (enzyme) in the form of additives in connection with the aforesaid goods, included in this class.

4 – Filling and lubricating accessories; gearbox oil; hydraulic oil; engine oil; lubricants; lubricants; industrial oils and greases; additives in connection with the aforesaid goods, included in this class.

6 – Joining pieces; joists; hinges; fixing materials; containers; sheets and plates of metal; bolts; expansion sleeves; wall plugs; grilles; handles; straps; hooks; non-electric cables and wires of common metal; caps; wedges; chains; ball bearings; ducts; structures of metal; goods of metal, in particular construction elements, building materials, receptacles, containers, storage articles, ducts, pipes, hoses, silos, tanks, transport articles, packaging articles, cylinders; model vehicles and machines; nuts; rivets; pallets; slabs; bolts; rings; reels; hinges; discs; neck rings; metal rails; signals and signalling panels; ironmongery, small items of metal hardware; locks, keys, key-rings; screws; screw connections; protective screens, roofs and strips; circlips; security pins; bungs; stoppers; stays, not of metal; telescopic pipes; connectors; fastening devices; walls; tool chests, empty; parts, replacement parts and accessories for the aforesaid goods; all of the aforesaid goods consisting of metal, not for electric purposes.

7 – Mechanically operated construction apparatus; construction machines; dispensing machines; asphalt finishers; asphalt paving machines; loaders; feeders; feed vehicles; concrete construction machines; earth-moving machinery; conveyors and conveying installations; abrading machines; loading ramps; machines for treatment, application, finishing, manufacturing, post-treatment, structuring, fastening and/or distribution of road surfaces; landfill construction machines; machines for manufacturing and processing polymers, bitumen, concrete and asphalt; road repairing machines; machines for treatment of materials and for manufacturing; mixing installations and machines; levellers; levelling systems; oscillating and vibrating drives and systems; shakers; spraying and atomisation machines; tamping rams; road making machines; road finishers; spreading machines; compacting apparatus and machines; vibrators; jacks; feeding machines and devices; rubber covering and sealing strips; copings; impression rollers; separators; shoring; axles; starters for motors and engines; drive aids, chains, wheels, rollers and/or shafts; exhausts; belt coverings; controls; dustpans; floor panels; beams, extending screeds, screeds; beam attachment parts; bolts; brakes; brake segments; brake linings; brake callipers; brushes; gaskets; pressure intensifiers; pressure converters; pressure transformers; nozzles; emulsion spray installations; driver cabs; travelling gears; crawler tracks; spring ste-

el strips; springs; spring assemblies; wheel rims; filters (oil filters, fuel filters, air filters, pneumatic filters, hydraulic filters and/or water filters); filter housings; pulleys; belts for conveyors, conveying apparatus and conveyor chains; guide rails and rollers; joints; generators; gears; screed plates; sliding blocks; girths; hand-held tools, other than hand-operated; hydraulic pumps; hydraulic engines and motors; hydraulic hoses; hydraulic valves; oil hydraulic cylinders; hydro installations; hydro valves; hydro hoses; hydro cylinders; limiting plates; body parts; v-belts; grooved pulleys; chains; cam sprockets; clack valves; pistons [parts of machines or engines]; piston rods; compressors; power bands; scraper belt coverings; scraper belt chains; scraper belt controllers; scraper chains; scraper bars; cooling radiators; closure caps for radiators; clutches; bearings; bearing blocks; track chains and/or rollers; rubbers for material hoppers; flow dividers; motors and engines (except for land vehicles); oil mist apparatus; fitted awnings for machines; discs; pressure bars; pumps [machines]; gear pump distributors; wheels; wheelworks; regulators; tyres; belting; belt pulleys; guttering; pipes; rollers; roller chains; gratings; rotors; exhaust silencers; slide valves; installations for lubricating purposes; snails; auger blades; worm gears; auger controllers; screw shafts; fly wheels; sensors; sifters; clamping sleeves; tensioners; mirrors (looking glass); spraying booms; control stands; control blocks; hydraulic, mechanical or pneumatic control devices; shock absorber; bumpers; tampers; tamper bearings; tamper bars; tanks; telescopic pipes; heat sealers; load-bearing rollers; hoppers; tumblers; idling pulleys; casings for parts of machines; cooling fans; valves (in particular directional valves), stop valves, pressure valves, pressure reducer valves; flow control valves, servo-valves; compacting assemblies; distributors; spreading augers; vibrators; transmission components; walls; heat-exchangers; shafts; tools; wheelwork; sparking-plugs; cyclone separators; cylinders; power operated tools; generators; hydraulic tools; pistons [parts of machines or engines]; piston rods; hydraulic motors; bearings; pumps (in particular lubricant and hydro pumps); alternators; direct current generators; pressure sprayers, grease guns and funnel tubes (machines); parts, replacement parts and accessories for the aforesaid goods.

8 – Hand-operated apparatus, pumps and tools; pocket knives; cases for tools; parts, replacement parts and fittings for all of the aforesaid goods.

9 – Scientific, surveying, photographic, cinematographic, optical, weighing, measuring, signalling, checking (supervision), control and regulating apparatus and instruments; apparatus, equipment and instruments for the conducting, switching, converting, storage, regulating and controlling of electricity; apparatus and instruments for capturing, recording, trans-

mission, reception or reproduction of sound, images and data; impression rollers; push beams; analysis and diagnostic apparatus; connection units; antennas; aerial installations; indication panels; audio devices and radio receivers; suspension apparatus; batteries; battery chargers; command panels; control apparatus; control desks; frame sensors; can modules; computers; peripherals adapted for use with computers; data carriers for recording images, sound and data; detectors; displays; metering installations; dosimeters; wires; pressure switches; pressure sensors; electric and electronic apparatus, devices and equipment for telematics, telecommunications and/or data processing purposes; electric and electronic apparatus, devices and equipment for operation and error analysis; electric switchboxes, switch cabinets and distribution boards; electrical circuits and circuit boards; electric and electronic equipment for lifting or lowering machines or parts of machines; electrical amplifiers; electronic modules; electrostatic precipitators; detection instruments, apparatus, regulators and devices; electric tools; receiving apparatus; remote control apparatus; fire-extinguishing apparatus; films for educational purposes; filters; filter components; radiocommunication apparatus; generators; graphic equalizers; hardware; height sensors; horns; hydraulic tools; hydraulic motors; hydro cylinders; pulse generators; information technology and audiovisual apparatus; joy sticks; cables; cable harnesses; cable contacts; cable loops; clips; pistons; piston rods; communications equipment; bearings; lasers; laser, infrared and ultrasound apparatus, devices and instruments; loudspeakers; light diodes; luminous signs; magnets; magnetising and demagnetising apparatus; rubbers for material hoppers; navigation, orientation, positioning, location tracking, target tracking and mapping apparatus and instruments; gradient sensors; levelling apparatus, devices and instruments; levelling systems; oil level indicators; boards; proportional amplifiers; testing and quality control apparatus and instruments; pumps (in particular lubricant and hydro pumps); calculators; reflectors; regulators; relay; image scanning apparatus; commutators; keys; keycards; protective apparatus and equipment; transmitters; sensors, in particular level sensors and overflow sensors; safety apparatus and equipment; safety apparatus and equipment; fuses; signals and signalling panels; instrumentation simulators; ski sensors; software; mirrors; steel cores; control apparatus, instruments, regulators and devices; control units, apparatus and systems; components for electric circuits; buzzers; tanks; keyboards; ultrasound sensors; monitoring instruments, apparatus, regulators and devices; USB flash drives; valves; scales; gear pumps; central processing units; parts, spare parts and fittings for the aforesaid goods.

11 – Lighting apparatus and installations; alternators; DC generators; electric screed heaters; gas filters; power generators; heating components; heating

apparatus and installations; heating rods; insulating material; refrigerating apparatus and installations; luminaires; light reflectors; air filters; air, gas and water purifying apparatus and installations; ventilation apparatus and installations; pumps; radiators; vehicle headlamps; pocket searchlights; ventilating and air conditioning apparatus and installations; water filters; water supply apparatus and installations; parts, replacement parts and fittings for all of the aforesaid goods.

12 – Vehicles; transport means; towing trucks; parts, replacement parts and fittings for the aforesaid goods, in particular strippers, drive units, floor boards, braking installations, brakes, brake segments, brake linings, brake calipers, rims, couplings, wheels, tyres, crawler tracks, chains, drives, motors and engines, windscreen wipers, mirrors, machine transmission components.

16 – Pencils; color pencils; fountain pens; ball pens; office requisites (except furniture); printed matter; disposable paper products; cases for business cards and for storing stationery; graphic representations; calendars; cards; instructional and teaching material (except apparatus); note pad boxes; writing sets; stationery; bags, pouches and goods for packaging, wrapping and storage purposes; plastic materials for packaging (not included in other classes); parts, replacement parts and fittings for all of the aforesaid goods.

17 – Packing, stopping and insulating materials; ducts, pipes, connectors and connections; hoses, hosepipes and hose connections, not of metal; cables; finished or semi-finished products designed for a specific use, included in this class, namely coverings and sleeves, clutch linings and brake linings; seals; parts, replacement parts and fittings for all of the aforesaid goods.

20 – Tags; containers, and closures and holders therefor; containers (not of metal); displays, stands and signage; overhead rail systems; pots; crates and pallets, non-metallic; stairs and escalators; model vehicles and machines, not of metal; lubricant and hydraulic reservoirs of plastic; seats; tension reel; statues, figures, works of art; tanks, not made of metal nor of masonry; telescopic tubes of plastic; goods, not of metal, namely support devices, armrests, fasteners, bolts, staves, dowels, shelves, joints, handles, hooks, holders, chain links, clack valves, clips, masts, nuts, nails, rivets, poles, protectors, bolts, rings, suction cups, clamps, rails, locks, keys, key rings, screws, spiral springs, coils, bungs, rods, stackable adapters, washers, valves, stiffening materials, pennant holders; connectors and connections; non-metallic tool chests [empty]; tent parts; parts, replacement parts and accessories for the aforesaid goods.

21 – Household or kitchen utensils and containers; glass ware, porcelain and earthenware; model vehic-

les and machines (ornaments) of stone, glass or porcelain; statues, figurines, signs and works of art, included in this class; plates; containers; bottles; loudspeakers; cups; tins; pots; funnels; parts, replacement parts and accessories for the aforesaid goods.

28 – Model vehicles and machines (miniatures); model vehicles and machines (playthings); toys; games; playthings and curiosities; sporting articles and equipment; parts, accessories and spare parts for all the aforesaid goods.

35 – Wholesaling, retailing and international trade, including by means of mail order catalogues or with the aid of electronic media, namely of the following goods; chemicals for purifying exhaust gases in chemical processes, chemicals for reducing emissions of harmful substances in exhaust gases from internal combustion engines, chemical additives for fuels, lubricants and industrial oils, filtering materials consisting of chemical and non-chemical substances, urea (organic compound), fluids for hydraulic circuits, filling and lubricating accessories, gearbox oil, hydraulic oil, motor oil, lubricants, pressure sprayers (lubricant requisites), grease guns (lubricant requisites), filling cans (lubricant requisites), funnel tubes (lubricant requisites), lubricants, industrial oils and greases, connectors, beams, bands, fasteners, containers, sheets and plates of metal, bolts, expansion sleeves, dowels, grilles, handles, belts, hook, non-electric cables and wires of metal, caps, wedges, chains, ball-bearings, ducts, structures of metal, goods of metal, in particular construction elements, building materials, receptacles, containers, storage articles, ducts, pipes, hoses, silos, tanks, transport articles, packaging articles, cylinders, model vehicles and machines, nuts, rivets, pallets, panels, bolts, rings, rollers, hinges, washers, clamps, rails, signals and signalling panels, ironmongery and small items of metal hardware, locks, keys, key rings, screws, screw connections, protective screens, roofs and strips, circlips, locking pins, bungs, stoppers, props, telescopic tubes, couplings, closures, walls, tool chests, mechanically operated building equipment, construction equipment, dispensing machines, asphalt pavers, asphaltting machines, loaders, feeders, feed vehicles, concrete construction machines, earth-moving machines, conveyors and conveying installations, smoothing machines, loading ramps, machines for treatment, application, finishing, manufacturing, post-treatment, structuring, fastening and/or distribution of road surfaces, landfill construction machines, machines for processing and manufacturing asphalt, concrete, bitumen and polymers, road repairing machines, machines for treatment of materials and production, mixing installations and machines, levellers, levelling systems, oscillating and vibrating drives and systems, shakers, spraying and atomisation machines, crushing machines, road making machines, road pavers, spreading machines, compac-

ting apparatus and machines, vibrators, lifting jacks, feeding machines and devices, rubber covering and sealing strips, coverings, impression rollers, separators, supports, axles, starters, drive aids, chains, wheels, rollers and/or shafts, exhaust systems, belt coverings, operating elements, base plates, floor boards, beams, extending screeds, paving screeds, beam attachment parts, bolts, brakes, brake segments, brake linings, brake calipers, brushes, gaskets, pressure intensifiers, pressure converters, pressure transducers, nozzles, emulsion spray installations, drivers' cabs, chassis, crawler tracks, spring steel strips, springs, spring assemblies, rims, filters (oil filters, fuel filters, air filters, pneumatic filters, hydro filters and/or water filters); filter housings; pulleys; belts for conveyors, conveying apparatus and conveyor chains, guide rails and rollers, joints, generators, gears, screed plates, sliding blocks, belts, hand-held tools, other than hand-operated, hydraulic pumps, hydraulic engines and motors, hydraulic hoses, hydraulic valves, hydraulic cylinders, hydro installations, hydro valves, hydro hoses, hydro cylinders, limiting plates, bodywork parts, V-belts, V-belt pulleys, chains, chain wheels, clack valves, pistons, piston rods, compressors, power belts, scraper belt coverings, scraper belt chains, scraper belt controllers, scraper chains, scraper bars, radiators, closure caps for radiators, couplings, bearings, bearing blocks, track chains and/or rollers, rubbers for material hoppers, flow dividers, engines, other than for land vehicles, oil mist apparatus, fitted covers for machines, panels, pressure bars, pumps, gear pump distributors, wheels, wheelworks, regulators, tyres, straps, pulleys, channels, pipes, rollers, roller chains, grids, rotors, mufflers, valves, lubricating installations, augers, auger blades, worm gears, auger controllers, screw shafts, fly-wheels, sensors, screens, adapter sleeves, tensioning devices, mirrors, spray bars, control stands, control blocks, hydraulic, mechanical or pneumatic control devices, shock absorbers, bumpers, tampers, tamper bearings, tamper bars, tanks, telescopic tubes, thermal elements, load-bearing rollers, funnels, tumblers, deflection rollers, casings for parts of machines, fans, valves (in particular directional valves, stop valves, pressure valves, pressure reducer valves, flow control valves, servo valves), compacting assemblies, distributors, spreading augers, vibrators, machine transmission components, walls, heat exchangers, shafts, tools, toothed wheels, spark plugs, cyclone separators, cylinders, electric tools, generators, hydraulic tools, pistons, piston rods, hydraulic motors, bearings, pumps (in particular lubricating and hydro pumps), alternators, direct current generators, hand-operated apparatus, pumps and tools, pocket knives, scientific, surveying, photographic, cinematographic, optical, weighing, measuring, signalling, checking (supervision), control and regulating apparatus and instruments, devices, apparatus and instruments for conducting, switching,

transforming, accumulating, regulating or controlling electricity, apparatus and instruments for capturing, recording, transmission, receiving or reproduction of sound, images or data, impression rollers, push beams, analysis and diagnostic apparatus, connecting parts, aerials, aerial installations, notice boards, audio equipment and radio receivers, mounts, batteries, battery chargers, operating consoles, operating apparatus, control panels, frame sensors, CAN modules, computers, computer peripherals, data carriers for recording images, sound and data, detectors, gaskets, displays, dosing installations, dosing dispensers, wires, pressure switches, pressure sensors, electric and electronic apparatus, devices and equipment for telematics, telecommunications and/or data processing purposes, electric and electronic apparatus, devices and equipment for operation and error analysis, electric switchboxes, switch cabinets and distribution boards, electric circuits and circuit boards, electric and electronic apparatus for lifting or lowering machines and parts of machines, electric amplifiers, electronic modules, electrostatic precipitators, detection instruments, apparatus, regulators and devices, receivers, remote control devices, fire-extinguishing apparatus, films for educational purposes, filters, filter components, radio communications apparatus, graphic equalisers, hardware, height sensors, horns, hydro motors, hydro cylinders, pulse generators, information technology and audiovisual apparatus, joysticks, cables, cable harnesses, cable contacts, cable loops, clips, communications equipment, lasers, laser, infrared and ultrasound apparatus, devices and instruments, loudspeakers, light-emitting diodes, signalling lights, magnets, magnetisers and demagnetisers, rubbers for material hoppers, navigation, orientation, positioning, location tracking, target tracking and mapping apparatus and instruments, gradient sensors, levelling apparatus, devices and instruments, levelling systems, oil level indicators, circuit boards, proportional amplifiers, testing and quality control apparatus and instruments, calculating machines, reflectors, regulators, relays, scanners, switches, keys, key cards, protective apparatus and equipment, transmitters, sensors (in particular level sensors and overflow sensors), security apparatus and equipment, safety apparatus and equipment, fuses, signals and signalling panels, simulators, ski sensors, software, mirrors, steel cores, control apparatus, instruments, regulators and devices, control units, apparatus and systems, circuit elements, buzzers, keyboards, ultrasound sensors, monitoring instruments, apparatus, regulators and devices, USB flash drives, valves, scales, gear pumps, central processing units, lighting apparatus and installations, electric screed heaters, gas filters, heating elements, heating apparatus and installations, heating rods, refrigerating apparatus and installations, lights, light reflectors, air filters, air, gas and water purifying apparatus and installations; venti-

ating apparatus and installations, radiators, headlights, electric pocket torches, ventilating and air conditioning apparatus and installations, water filters, water supply apparatus and installations, vehicles, conveyances, tractors, strippers, drive units, floor boards, braking installations, brakes, brake segments, brake linings, brake calipers, rims, couplings, wheels, tyres, crawler tracks, chains, drives, motors and engines, windscreen wipers, mirrors, machine transmission components, pencils, coloured pencils, fountain pens, ball-point pens, office requisites (except furniture), printed matter, disposable paper articles, cases for business cards and for storing stationery, graphic representations, calendars, cards, instructional and teaching material (except apparatus), note pad boxes, stationery sets, stationery, bags, pouches and goods for packaging, wrapping and storage purposes, plastic materials for packaging, packing, stopping and insulating materials, ducts, pipes, connectors and connections, hoses, hosepipes and hose connections, not of metal, cables, finished or semi-finished products designed for a specific use, namely coverings and sleeves, clutch linings and brake linings, fitted tool chests, not of metal, trailers, containers, and closures and holders therefor; containers (not of metal), displays, stands and signage, overhead rail systems, cans, boxes and pallets (not of metal), ladders and mobile steps, model vehicles and machines, not of metal, lubricants and hydraulic containers of plastic, seats, tension rollers, statues, figurines, works of art, tanks, not of metal nor of masonry, telescopic tubes of plastic, goods, not of metal, namely support devices, armrests, fasteners, bolts, staves, dowels, shelves, joints, handles, hooks, holders, chain links, clack valves, clips, masts, nuts, nails, rivets, poles, protectors, bolts, rings, suction cups, clamps, rails, locks, keys, key rings, screws, spiral springs, coils, bungs, rods, stackable adapters, washers, valves, stiffening materials, pennant holders, connectors and connecting parts, empty tool chests, not of metal, tent parts, household or kitchen utensils and containers, glassware, porcelain and earthenware, model vehicles and machines (ornaments) of stone, glass or porcelain, statues, figurines, signboards and works of art, dishes, containers, bottles, boxes, cups, cases, cans, funnels, scale model vehicles and machines, model vehicles and machines (toys), toys, games, playthings and novelties, sporting articles and equipment, and parts, replacement parts and fittings therefor; agency business; procurement services, for others; ordering services; operation of a hotline for information, complaints and emergencies; professional business analysis, information and research; professional business consulting; data processing; electronic retrieval and storage of data; preparation of cost-benefit analyses, cost-price analyses and professional business workload studies; compilation of statistics; business management; import and export services; business

information; commercial services; marketing and promotion services; arranging business contacts; organisational planning of operating times and locations for mechanical engineering and electrical engineering goods, structural engineering, civil engineering and mining goods, industrial installations, vehicles, equipment and machines; organizational project management; organisational management of vehicle and machine fleets and consultancy relating thereto; product demonstrations and product display services; quality management, namely process optimisation; business management and organisation consultancy; business administration; arranging and organising of trade fairs for trade and advertising purposes; negotiation and mediation services; advertising; compilation and systemisation of data and information into electronic databases.

37 – Building construction; installation, cleaning, repair and maintenance of building equipment, construction equipment, dispensing machines, asphalt pavers, asphalt machines, loaders, feeders, feed vehicles, concrete construction machines, earth-moving machines, conveyors and conveying installations, smoothing machines, loading ramps, machines for treatment, application, finishing, manufacturing, post-treatment, structuring, fastening and/or distribution of road surfaces, landfill construction machines, machines for processing and manufacturing asphalt, concrete, bitumen and polymers, road repairing machines, machines for treatment of materials and production, mixing installations and machines, levellers, levelling systems, oscillating and vibrating drives and systems, shakers, spraying and atomisation machines, crushing machines, road making machines, road pavers, spreading machines, compacting apparatus and machines, vibrators, lifting jacks, feeding machines and devices, beams, rubber covering and sealing strips, coverings, impression rollers, separators, supports, axles, starters, drive aids, chains, wheels, rollers and/or shafts, exhaust systems, belt coverings, operating elements, base plates, floor boards, beams, extending screeds, paving screeds, beam attachment parts, bolts, brakes, brake segments, brake linings, brake calipers, brushes, gaskets, pressure intensifiers, pressure converters, pressure transducers, nozzles, emulsion spray installations, drivers' cabs, chassis, crawler tracks, spring steel strips, springs, spring assemblies, rims, filters (oil filters, fuel filters, air filters, pneumatic filters, hydro filters and/or water filters); filter housings; pulleys; belts for conveyors, conveying apparatus and conveyor chains, guide rails and rollers, joints, generators, gears, screed plates, sliding blocks, belts, hand-held tools, other than hand-operated, hydraulic pumps, hydraulic engines and motors, hydraulic hoses, hydraulic valves, hydraulic cylinders, hydro installations, hydro valves, hydro hoses, hydro cylinders, limiting plates, bodywork parts, V-belts, V-belt pulleys, chains, chain wheels, clack valves, pistons,

piston rods, compressors, power belts, scraper belt coverings, scraper belt chains, scraper belt controllers, scraper chains, scraper bars, radiators, closure caps for radiators, couplings, bearings, bearing blocks, track chains and/or rollers, rubbers for material hoppers, flow dividers, engines, other than for land vehicles, oil mist apparatus, fitted covers for machines, panels, pressure bars, pumps, gear pump distributors, wheels, wheelworks, regulators, tyres, straps, pulleys, channels, pipes, rollers, roller chains, grids, rotors, mufflers, valves, lubricating installations, augers, auger blades, worm gears, auger controllers, screw shafts, fly-wheels, sensors, screens, adapter sleeves, tensioning devices, mirrors, spray bars, control stands, control blocks, hydraulic, mechanical or pneumatic control devices, shock absorbers, bumpers, tampers, tamper bearings, tamper bars, tanks, telescopic tubes, thermal elements, load-bearing rollers, funnels, tumblers, deflection rollers, casings for parts of machines, fans, valves (in particular directional valves, stop valves, pressure valves, pressure reducer valves, flow control valves, servo valves), compacting assemblies, distributors, spreading augers, vibrators, machine transmission components, walls, heat exchangers, shafts, tools, toothed wheels, spark plugs, cyclone separators, cylinders, electric tools, generators, hydraulic tools, pistons, piston rods, hydraulic motors, bearings, pumps (in particular lubricating and hydro pumps), alternators, direct current generators, hand-operated apparatus, pumps and tools, pocket knives, scientific, surveying, photographic, cinematographic, optical, weighing, measuring, signalling, checking (supervision), control and regulating apparatus and instruments, devices, apparatus and instruments for conducting, switching, transforming, accumulating, regulating or controlling electricity, apparatus and instruments for capturing, recording, transmission, receiving or reproduction of sound, images or data, impression rollers, push beams, analysis and diagnostic apparatus, connecting parts, aerials, aerial installations, notice boards, audio equipment and radio receivers, mounts, batteries, battery chargers, operating consoles, operating apparatus, control panels, frame sensors, CAN modules, computers, computer peripherals, data carriers for recording images, sound and data, detectors, gaskets, displays, dosing installations, dosing dispensers, wires, pressure switches, pressure sensors, electric and electronic apparatus, devices and equipment for telematics, telecommunications and/or data processing purposes, electric and electronic apparatus, devices and equipment for operation and error analysis, electric switchboxes, switch cabinets and distribution boards, electric circuits and circuit boards, electric and electronic apparatus for lifting or lowering machines and parts of machines, electric amplifiers, electronic modules, electrostatic precipitators, detection instruments, apparatus, regulators and devices, receivers, remote control devices,

fire-extinguishing apparatus, films for educational purposes, filters, filter components, radio communications apparatus, graphic equalisers, hardware, height sensors, horns, hydro motors, hydro cylinders, pulse generators, information technology and audiovisual apparatus, joysticks, cables, cable harnesses, cable contacts, cable loops, clips, communications equipment, lasers, laser, infrared and ultrasound apparatus, devices and instruments, loudspeakers, light-emitting diodes, signalling lights, magnets, magnetisers and demagnetisers, rubbers for material hoppers, navigation, orientation, positioning, location tracking, target tracking and mapping apparatus and instruments, gradient sensors, levelling apparatus, devices and instruments, levelling systems, oil level indicators, circuit boards, proportional amplifiers, testing and quality control apparatus and instruments, calculating machines, reflectors, regulators, relays, scanners, switches, keys, key cards, protective apparatus and equipment, transmitters, sensors (in particular level sensors and overflow sensors), security apparatus and equipment, safety apparatus and equipment, fuses, signals and signalling panels, simulators, ski sensors, software, mirrors, steel cores, control apparatus, instruments, regulators and devices, control units, apparatus and systems, circuit elements, buzzers, keyboards, ultrasound sensors, monitoring instruments, apparatus, regulators and devices, USB flash drives, valves, scales, gear pumps, central processing units, lighting apparatus and installations, electric screeed heaters, gas filters, heating elements, heating apparatus and installations, heating rods, refrigerating apparatus and installations, lights, light reflectors, air filters, air, gas and water purifying apparatus and installations; ventilating apparatus and installations, radiators, headlights, electric pocket torches, ventilating and air conditioning apparatus and installations, water filters, water supply apparatus and installations, vehicles, conveyances, tractors, strippers, drive units, floor boards, braking installations, brakes, brake segments, brake linings, brake calipers, rims, couplings, wheels, tyres, crawler tracks, chains, drives, motors and engines, windscreen wipers, mirrors, machine transmission components, packing, stopping and insulating materials, ducts, pipes, connectors and connections, hoses, hosepipes and hose connections, not of metal, cables, finished or semi-finished products designed for a specific use, namely coverings and sleeves, clutch linings and brake linings, fitted tool chests, not of metal, trailers, containers, and closures and holders therefor; containers (not of metal), displays, stands and signage, overhead rail systems, cans, boxes and pallets (not of metal), ladders and mobile steps, model vehicles and machines, not of metal, lubricants and hydraulic containers of plastic, seats, tension rollers, statues, figurines, works of art, tanks, not of metal nor of masonry, telescopic tubes of plastic, goods, not of metal, namely support devi-

ces, armrests, fasteners, bolts, staves, dowels, shelves, joints, handles, hooks, holders, chain links, clack valves, clips, masts, nuts, nails, rivets, poles, protectors, bolts, rings, suction cups, clamps, rails, locks, keys, key rings, screws, spiral springs, coils, bungs, rods, stackable adapters, washers, valves, stiffening materials, pennant holders, connectors and connecting parts, empty tool chests, not of metal, tent parts, and parts, replacement parts and fittings therefor; application of surface coatings; building consultancy; construction management; building, construction and demolition; construction of tips; frost-proofing; manufacturing, installation, cleaning, repair and maintenance of structures of metal; construction and civil engineering; installation, cleaning, repair and maintenance in relation to structures and roads, computer hardware, mechanical and electrical engineering products, structural and civil engineering and mining products, industrial installations, vehicles, machines and apparatus, and parts therefor; sewer construction; street construction; rental, hiring and leasing of construction equipment; rental and leasing of objects in connection with providing the aforesaid services; advisory, consultancy and information services relating to all the aforesaid services.

38 – Providing of access to electronic databases and communications networks; services in the field of telematics, included in class 38; communications services for the exchange of data in electronic form; communications by means of radio, computer, the Internet, satellite, telematics, cables and digital transmission; telecommunication services; rental of access time to electronic databases and communications networks; rental and leasing of objects in connection with providing the aforesaid services; rental of access times for enabling the use of non-downloadable online software; advisory, consultancy and information services relating to the aforesaid services.

41 – Providing of training; education; education; organisation, arranging and conducting of courses, workshops and seminars; courses, in particular relating to occupational safety and the operation, use, repair and maintenance of vehicles, equipment and machines, and parts therefor; driving instruction; rental and leasing of objects in connection with providing the aforesaid services; advisory, information and consultancy services relating to any of the aforesaid services.

42 – Application technology consultancy and technical support; building design services; consultancy relating to the operation of vehicles, equipment and machines, and parts therefor; design services; design and development of computer hardware and software; product research and development; development of industrial processes, new products and technologies, mechanical and electrical engineering products, structural and civil engineering and mining products,

industrial installations, vehicles, apparatus and machines, and parts therefor; surveying; troubleshooting and fault diagnosis relating to computer hardware, computer software, mechanical engineering and electrical engineering products, structural engineering, civil engineering and mining products, industrial installations, vehicles, equipment and machines, and parts therefor; remote control, remote monitoring, remote maintenance, electronic location tracking; research in the fields of mechanical engineering, electrical engineering and construction; industrial analysis and research services; engineering services; IT services; construction drafting and design; measurement services; testing, safety testing, technical testing, authentication and quality control; technical consultancy in the field of telematics; engineering design and consultancy; technical development of models and concepts to be implemented for the operation, production and logistics of commercial enterprises; technical development of usage concepts; engineering project management services; technical testing services; technological services, namely obtaining and analysing data in relation to construction processes; technical evaluation of data in relation to construction processes; weather forecasting; scientific and technological services and research and design relating thereto; rental and leasing of objects in connection with providing the aforesaid services; consultancy and information relating to the aforesaid services.

(260) AM 2019 95102 A

(800) 1374091

(151) 2017 08 24

(891) 2017 08 24

(731) THE CONCENTRATE MANUFACTURING COMPANY OF IRELAND

Swan Building, 3th Floor, 26 Victoria Street,
Hamilton HM12, Bermuda

(540)



(591) White, red and green

(531) 26.01.18; 27.07.02; 29.01.13

(511)

3 – Amber [perfume]; antistatic preparations for household purposes; air fragrancing preparations; cake flavorings [essential oils]; flavorings for beverages [essential oils]; food flavorings [essential oils]; aromatics [essential oils]; breath freshening

sprays; balms, other than for medical purposes; lip glosses; petroleum jelly for cosmetic purposes; shoe polish; cotton wool for cosmetic purposes; sachets for perfuming linen; adhesives for cosmetic purposes; scented water; toilet water; depilatory wax; mustache wax; creams for leather; shoemakers' wax; massage gels, other than for medical purposes; dental bleaching gels; make-up; deodorants for human beings or for animals; perfumes; greases for cosmetic purposes; perfumery; cosmetic pencils; hair conditioners; cosmetic dyes; shoe cream; cosmetic creams; hair spray; nail polish; hair lotions; lotions for cosmetic purposes; beauty masks; oils for perfumes and scents; oils for cosmetic purposes; essential oils; cleansing milk for toilet purposes; soap; cosmetic kits; dentifrices; breath freshening strips; lipsticks; pomades for cosmetic purposes; shaving preparations; cosmetic preparations for baths; bath preparations, not for medical purposes; douching preparations for personal sanitary or deodorant purposes [toiletries]; cosmetic preparations for slimming purposes; make-up removing preparations; nail care preparations; cleaning preparations; laundry preparations; sunscreen preparations; make-up powder; stain removers; scouring solutions; tissues impregnated with cosmetic lotions; potpourris [fragrances]; bath salts, not for medical purposes; fumigation preparations [perfumes]; eyebrow cosmetics; make-up preparations; sun-tanning preparations [cosmetics]; hair dyes; cosmetic preparations for eyelashes; cosmetic preparations for skin care; cosmetics; mascara; cotton sticks for cosmetic purposes; shampoos; extracts of flowers [perfumes]; ethereal essences.

9 – DVD players; accumulators [batteries]; rechargeable batteries; batteries for cellular phones; batteries, electric; binoculars; scales; camcorders; video cassettes; hands-free kits for telephones; wireless headsets for use with cellular phones; holders for mobile telephones; dictating machines; floppy disks; sound recording discs; disks, magnetic; electronic notice boards; memory cards for video game machines; universal serial bus [USB] cables; Ethernet cables; modem cables; computer cables; microphone cables; cables, electric; battery cables; encoded magnetic cards; keyboards for cellular phones; computer keyboards; multifunction computer keyboards; computer keypads; mouse pads; compact discs [audio-video]; tablet computers; notebook computers; magnets; decorative magnets; ski goggles; goggles for motorcyclists; divers' masks; portable media players; headphones; headsets for cellular phones; sound recording carriers; sunglasses; goggles for sports; eyeglasses; transmitters [telecommunication]; MP3 players; audio- and video-receivers; lanyards [straps] for cellular phones; audiovisual teaching apparatus; mobile telecommunications handsets; cellular phones; sound reproduction apparatus; mains chargers; battery chargers; battery chargers for cellular phones; cellular phone battery chargers for use in

vehicles; battery chargers for use with telephones; downloadable ring tones for mobile phones; protective cases for cellular phones; leather cases for cellular phones; cases adapted for cellular phones; screens [photography]; covers for cellular phones; cell phone straps; projection screens.

14 – Key fobs; alarm clocks; ornamental pins; tie pins; tie clips; cuff links; medals; presentation boxes for watches; watches.

16 – Fountain pens; albums; scrapbook albums; almanacs; atlases; posters; tickets; forms, printed; announcement cards [stationery]; filler paper; scratch pads; note books; pads [stationery]; pamphlets; booklets; paper; paper sheets [stationery]; toilet paper; wrapping paper; newsletters; signboards of paper or cardboard; newspapers; terrestrial globes; diagrams; writing slates; diaries; blackboards; advertisement boards of paper or cardboard; day planners; magazines [periodicals]; periodicals; printed publications; graphic representations; calendars; pencils; pencil lead holders; pictures; transfers [decalcomanias]; paintings [pictures], framed or unframed; cards; geographical maps; catalogues; books; envelopes [stationery]; boxes of paper or cardboard; adhesive bands for stationery or household purposes; gummed tape [stationery]; adhesive tapes for stationery or household purposes; self-adhesive tapes for stationery or household purposes; flyers; graphic prints; teaching materials [except apparatus]; bags [envelopes, pouches] of paper or plastics, for packaging; printing sets, portable [office requisites]; stickers [stationery]; paper knives [cutters] [office requisites]; bottle envelopes of paper or cardboard; covers [stationery]; musical greeting cards; greeting cards; postcards; conical paper bags; folders for papers; pen cases; seals [stamps]; writing materials; school supplies [stationery]; printed matter; prospectuses; printed timetables; graphic reproductions; paper clasps; staples for offices; writing or drawing books; stationery; bottle wrappers of paper or cardboard; flags of paper; shields [paper seals].

18 – Pocket wallets; business card cases; umbrellas; parasols; frames for umbrellas or parasols; cases of leather or leatherboard; umbrella rings; purses; bags [envelopes, pouches] of leather, for packaging; travelling sets [leatherware]; briefcases; haversacks; leather straps; straps of leather [saddlery]; umbrella handles; suitcase handles; rucksacks; travelling bags; bags; portmanteaux; beach bags; bags for sports; bags for campers; shopping bags; school satchels; travelling trunks; umbrella sticks; key cases; trunks [luggage]; valises; attaché cases; umbrella covers; leather laces.

24 – Household linen; bath linen, except clothing; bed linen; table linen, not of paper; table runners of textile; shower curtains of textile or plastic; curtains of textile or plastic; net curtains; cloth banners; can-

vas for tapestry or embroidery; bolting cloth; fabrics for textile use; wall hangings of textile; non-woven textile fabrics; plastic material [substitute for fabrics]; textile material; pillowcases; mattress covers; bed blankets; handkerchiefs of textile; travelling rugs [lap robes]; linings [textile]; bed covers; bed covers of paper; towels of textile; cloth; door curtains; sheets [textile]; eiderdowns [down coverlets]; bath mitts; face towels of textile; table napkins of textile; tablecloths, not of paper; oilcloth for use as tablecloths; fabric; lingerie fabric; tulle; flags of textile or plastic; covers [loose] for furniture; labels of textile.

25 – Bandanas [neckerchiefs]; underwear; overalls; boxer shorts; ankle boots; boots for sports; breeches for wear; trousers; football boots; neckties; sports jerseys; hosiery; tights; combinations [clothing]; suits; bathing suits; masquerade costumes; beach clothes; stuff jackets [clothing]; jackets [clothing]; leggings [trousers]; sports singlets; socks; footwear; sports shoes; clothing; outerclothing; ready-made clothing; motorists' clothing; cyclists' clothing; clothing for gymnastics; clothing of imitations of leather; clothing of leather; waterproof clothing; uniforms; gloves [clothing]; bathing trunks; scarfs; headbands [clothing]; belts [clothing]; shirts; sweaters; inner soles; knitwear [clothing]; shoes; headgear for wear; tee-shirts; dressing gowns; caps [headwear].

(260) AM 2019 95103 A

(800) 1374092

(151) 2017 08 24

(891) 2017 08 24

(731) THE CONCENTRATE MANUFACTURING COMPANY OF IRELAND

Swan Building, 3th Floor, 26 Victoria Street
Hamilton HM12, Bermuda

(540)



(591) Black, white

(531) 26.01.18; 26.01.24; 27.07.02

(511)

3 – Amber [perfume]; antistatic preparations for household purposes; air fragrancing preparations; cake flavorings [essential oils]; flavorings for beverages [essential oils]; food flavorings [essential oils]; aromatics [essential oils]; breath freshening sprays; balms, other than for medical purposes; lip glosses;

petroleum jelly for cosmetic purposes; shoe polish; cotton wool for cosmetic purposes; sachets for perfuming linen; adhesives for cosmetic purposes; scented water; toilet water; depilatory wax; mustache wax; creams for leather; shoemakers' wax; massage gels, other than for medical purposes; dental bleaching gels; make-up; deodorants for human beings or for animals; perfumes; greases for cosmetic purposes; perfumery; cosmetic pencils; hair conditioners; cosmetic dyes; shoe cream; cosmetic creams; hair spray; nail polish; hair lotions; lotions for cosmetic purposes; beauty masks; oils for perfumes and scents; oils for cosmetic purposes; essential oils; cleansing milk for toilet purposes; soap; cosmetic kits; dentifrices; breath freshening strips; lipsticks; pomades for cosmetic purposes; shaving preparations; cosmetic preparations for baths; bath preparations, not for medical purposes; douching preparations for personal sanitary or deodorant purposes [toiletries]; cosmetic preparations for slimming purposes; make-up removing preparations; nail care preparations; cleaning preparations; laundry preparations; sunscreen preparations; make-up powder; stain removers; scouring solutions; tissues impregnated with cosmetic lotions; potpourris [fragrances]; bath salts, not for medical purposes; fumigation preparations [perfumes]; eyebrow cosmetics; make-up preparations; sun-tanning preparations [cosmetics]; hair dyes; cosmetic preparations for eyelashes; cosmetic preparations for skin care; cosmetics; mascara; cotton sticks for cosmetic purposes; shampoos; extracts of flowers [perfumes]; ethereal essences.

9 – DVD players; accumulators [batteries]; rechargeable batteries; batteries for cellular phones; batteries, electric; binoculars; scales; camcorders; video cassettes; hands-free kits for telephones; wireless headsets for use with cellular phones; holders for mobile telephones; dictating machines; floppy disks; sound recording discs; disks, magnetic; electronic notice boards; memory cards for video game machines; universal serial bus [USB] cables; Ethernet cables; modem cables; computer cables; microphone cables; cables, electric; battery cables; encoded magnetic cards; keyboards for cellular phones; computer keyboards; multifunction computer keyboards; computer keypads; mouse pads; compact discs [audio-video]; tablet computers; notebook computers; magnets; decorative magnets; ski goggles; goggles for motorcyclists; divers' masks; portable media players; headphones; headsets for cellular phones; sound recording carriers; sunglasses; goggles for sports; eyeglasses; transmitters [telecommunication]; MP3 players; audio- and video-receivers; lanyards [straps] for cellular phones; audiovisual teaching apparatus; mobile telecommunications handsets; cellular phones; sound reproduction apparatus; mains chargers; battery chargers; battery chargers for cellular phones; cellular phone battery chargers for use in vehicles; battery chargers for use with telephones; down-

loadable ring tones for mobile phones; protective cases for cellular phones; leather cases for cellular phones; cases adapted for cellular phones; screens [photography]; covers for cellular phones; cell phone straps; projection screens.

14 – Key fobs; alarm clocks; ornamental pins; tie pins; tie clips; cuff links; medals; presentation boxes for watches; watches.

16 – Fountain pens; albums; scrapbook albums; almanacs; atlases; posters; tickets; forms, printed; announcement cards [stationery]; filler paper; scratch pads; note books; pads [stationery]; pamphlets; booklets; paper; paper sheets [stationery]; toilet paper; wrapping paper; newsletters; signboards of paper or cardboard; newspapers; terrestrial globes; diagrams; writing slates; diaries; blackboards; advertisement boards of paper or cardboard; day planners; magazines [periodicals]; periodicals; printed publications; graphic representations; calendars; pencils; pencil lead holders; pictures; transfers [decalcomanias]; paintings [pictures], framed or unframed; cards; geographical maps; catalogues; books; envelopes [stationery]; boxes of paper or cardboard; adhesive bands for stationery or household purposes; gummed tape [stationery]; adhesive tapes for stationery or household purposes; self-adhesive tapes for stationery or household purposes; flyers; graphic prints; teaching materials [except apparatus]; bags [envelopes, pouches] of paper or plastics, for packaging; printing sets, portable [office requisites]; stickers [stationery]; paper knives [cutters] [office requisites]; bottle envelopes of paper or cardboard; covers [stationery]; musical greeting cards; greeting cards; postcards; conical paper bags; folders for papers; pen cases; seals [stamps]; writing materials; school supplies [stationery]; printed matter; prospectuses; printed timetables; graphic reproductions; paper clasps; staples for offices; writing or drawing books; stationery; bottle wrappers of paper or cardboard; flags of paper; shields [paper seals].

18 – Pocket wallets; business card cases; umbrellas; parasols; frames for umbrellas or parasols; cases of leather or leatherboard; umbrella rings; purses; bags [envelopes, pouches] of leather, for packaging; travelling sets [leatherware]; briefcases; haversacks; leather straps; straps of leather [saddlery]; umbrella handles; suitcase handles; rucksacks; travelling bags; bags; portmanteaux; beach bags; bags for sports; bags for campers; shopping bags; school satchels; travelling trunks; umbrella sticks; key cases; trunks [luggage]; valises; attaché cases; umbrella covers; leather laces.

24 – Household linen; bath linen, except clothing; bed linen; table linen, not of paper; table runners of textile; shower curtains of textile or plastic; curtains of textile or plastic; net curtains; cloth banners; canvas for tapestry or embroidery; bolting cloth; fab-

rics for textile use; wall hangings of textile; non-woven textile fabrics; plastic material [substitute for fabrics]; textile material; pillowcases; mattress covers; bed blankets; handkerchiefs of textile; travelling rugs [lap robes]; linings [textile]; bed covers; bed covers of paper; towels of textile; cloth; door curtains; sheets [textile]; eiderdowns [down coverlets]; bath mitts; face towels of textile; table napkins of textile; tablecloths, not of paper; oilcloth for use as tablecloths; fabric; lingerie fabric; tulle; flags of textile or plastic; covers [loose] for furniture; labels of textile.

25 – Bandanas [neckerchiefs]; underwear; overalls; boxer shorts; ankle boots; boots for sports; breeches for wear; trousers; football boots; neckties; sports jerseys; hosiery; tights; combinations [clothing]; suits; bathing suits; masquerade costumes; beach clothes; stuff jackets [clothing]; jackets [clothing]; leggings [trousers]; sports singlets; socks; footwear; sports shoes; clothing; outerclothing; ready-made clothing; motorists' clothing; cyclists' clothing; clothing for gymnastics; clothing of imitations of leather; clothing of leather; waterproof clothing; uniforms; gloves [clothing]; bathing trunks; scarfs; headbands [clothing]; belts [clothing]; shirts; sweaters; inner soles; knitwear [clothing]; shoes; headgear for wear; tee-shirts; dressing gowns; caps [headwear].

(260) AM 2019 95496 A

(800) 1379244

(151) 2017 09 21

(891) 2017 09 21

(731) Tovarishchestvo s ogranichennoi otvetstvennostyu "ALMOL"
Krasnogvardeiskii trakt, 497 050030 gorod
Almaty, Kazakhstan

(540)



(591) Blue, black, white and red

(531) 01.15.17; 01.15.19; 01.15.25; 03.01.14;
19.03.24; 28.05; 29.01.14

(511)

29 – Ajvar [preserved peppers]; aloe vera prepared for human consumption; alginates for culinary purposes; anchovy, not live; peanuts, prepared; albumen for culinary purposes; white of eggs; beans, preserved; soya beans, preserved, for food; bouillon; ginger jam, ham; fatty substances for the manufacture of edible fats; toasted laver; edible birds' nests; peas,

preserved; mushrooms, preserved; game, not live; gelatine; meat jellies; jellies for food; fruit jellies; yolk of eggs; coconut fat; bone oil, edible; lard; suet for food; edible fats; fruit-based snack food; charcuterie; raisins; caviar; fish roe, processed; yogurt; sauerkraut; kephir [milk beverage]; isinglass for food; clams, not live; milk shakes; black pudding [blood sausage]; compotes; meat, tinned [canned (Am.)]; vegetables, tinned [canned (Am.)]; fish, tinned [canned (Am.)]; fruits, tinned [canned (Am.)]; bouillon concentrates; gherkins; shrimps, not live; prawns, not live; buttercream; croquettes; silkworm chrysalis for human consumption; kumys [kumyss] [milk beverage]; spiny lobsters, not live; lecithin for culinary purposes; salmon, not live; onions, preserved; margarine; marmalade; oils for food; peanut butter, cocoa butter for food; coconut oil for food; coconut butter; corn oil for food; sesame oil for food, linseed oil for culinary purposes; olive oil for food, palm oil for food, sunflower oil for food; colza oil for food, butter; shellfish, not live; almonds, ground; animal marrow for food; mussels, not live; milk; condensed milk; albumin milk; soya milk; soya-based beverages used as milk substitutes; fish meal for human consumption; vegetable mousses; fish mousses; fruit pulp; meat; meat, preserved; milk beverages, milk predominating; vegetables, preserved; vegetables, dried; vegetables, cooked; potato fritters; olives, preserved; lobsters, not live; coconut, desiccated; nuts, prepared; tomato puree; liver pate; pectin for culinary purposes; liver; pickles; jams; powdered eggs; milk products; kimchi [fermented vegetable dish]; food products made from fish; curd; prostokvasha [soured milk]; poultry, not live; pollen prepared as foodstuff, cranberry sauce [compote]; apple puree; crayfish, not live; crustaceans, not live; fish, preserved; fish, not live; salted fish; ryazhenka [fermented baked milk]; vegetable salads; fruit salads; bacon; sardines, not live; pork; herrings, not live; seeds, prepared; sunflower seeds, prepared; cream [dairy products]; whipped cream; fat-containing mixtures for bread slices; smetana [sour cream]; tomato juice for cooking; vegetable juices for cooking; salted meats; sausages, sausages in batter; preparations for making bouillon; preparations for making soup; tripe; soups, vegetable soup preparations; whey; cheese; tahini [sesame seed paste]; tofu; sea-cucumbers, not live; truffles, preserved; tuna, not live; oysters, not live; milk ferments for culinary purposes, rennet; fish fillets; dates; crystallized fruits; frozen fruits; fruit, preserved; fruit preserved in alcohol; fruit, stewed; potato flakes; hummus [chickpea paste]; fruit peel; preserved garlic; lentils, preserved; potato chips; low-fat potato chips; fruit chips; non-alcoholic eggnog; seaweed extracts for food; meat extracts, snail eggs for consumption; eggs.

(260) AM 2019 95894 A*

(800) 1382315

(151) 2017 09 08

(891) 2017 09 08

(731) HUAWEI TECHNOLOGIES CO., LTD.

Administration Building Huawei Technologies Co., Ltd., Bantian, Longgang District Shenzhen, China

(540)

Selfie Toning Flash

(591) Black, white

(511)

9 – battery chargers; electric batteries; mobile power source (rechargeable batteries); galvanic cells; covers for tablet computers; covers for personal digital assistants; computer keyboards; headphones; earphones; virtual reality headsets; covers for smartphones; microphones; computer memories; audio and video receivers; modems; loudspeakers; sound transmitting apparatus.

(260) AM 2019 96873 A

(800) 1392432

(151) 2017 09 12

(891) 2017 09 12

(731) EGIS GYÓGYSZERGYÁR ZRT.

Keresztúri út 30-38, H-1106 Budapest, Hungary

(540)

СИЛУФОРТЕ

(591) Black, white

(511)

5 – Pharmaceutical preparations for human use; herbal medicines; nasal cleaning preparations for medical purposes; nasal sprays for medical purposes.

(260) AM 2019 97505 A

(800) 1398078

(151) 2017 12 07

(891) 2017 12 07

(731) TOVARYSTVO Z OBMEZHENOYU

VIDPOVIDALNISTYU "SANDORA"

s. Mykolajvske, Vitovskiyi rgn., Mykolajvska obl. 57262, Ukraine

(540)



(591) Green, dark green, light green, blue,

white, red, pink, beige, brown, grey and black

(531) 03.05.09; 03.05.25; 05.07.14; 05.07.22;

21.03.11; 28.05; 29.01.15

(511)

32 – Aperitifs, non-alcoholic; aerated water; waters (beverages); table waters; cocktails, non-alcoholic; lemonades; non-alcoholic beverages; whey beverages; soft drinks; non-alcoholic fruit juice beverages; fruit nectars, non-alcoholic; syrups for lemonade; syrups for beverages; smoothies; fruit juices; cider, non-alcoholic; preparations for making aerated water; preparations for making beverages; non-alcoholic fruit extracts; essences for making beverages.

(260) AM 2019 97719 A

(800) 1401692

(151) 2018 03 29

(891) 2018 03 29

(731) BEWITAL HOLDING GMBH & CO KG

Industriestr. 10, 46354 Südlohn, Germany

(540)

Mastercraft

(591) Black, white

(511)

5 – Dietary supplements for animals; food supplements for veterinary use; mineral food supplements; dietary supplements consisting of vitamins; nutritional supplements for livestock feed; veterinary preparations and substances; nutritional supplements for veterinary use.

31 – Foodstuffs (animal -); foodstuffs (animal-).

44 – Veterinary and agricultural services; hygienic and beauty care for animals.

(260) AM 2019 97720 A

(800) 1401714

(151) 2018 03 16

(891) 2018 03 16

(731) MOBILITY INTERNATIONAL AG

Suurstoffi 16, CH-6343 Rotkreuz, Switzerland

(540)

INTEGRIDE

(591) Black, white

(511)

39 – Transport; packaging and storage of merchandise; travel organization.

(260) AM 2019 97721 A

(800) 1401737

(151) 2017 12 01

(891) 2017 12 01

(731) Obschestvo s ogranichennoy otvetstvennostyu "MAY"

Ozernaya, dom 1 a, Fryazino, RU-141191
Moskovskoy obl., Russian Federation
(540)



(591) White, red, dark red, yellow, blue, light blue, greyish blue, grey, light yellow, lime, green, pink
(531) 02.03.04; 02.03.17; 02.03.18; 02.07.18; 06.01.02; 06.19.01; 06.19.13; 24.01.15; 24.09.01; 24.09.05; 25.01.19; 28.05; 29.01.15
(526) The Cyrillic characters indicated in the mark which transliterate into "VISOKOGORNY" and "Chernyy chay".
(511)
30 – Tea.

(260) AM 2019 97722 A
(800) 1401781
(151) 2018 02 07
(891) 2018 02 07
(731) ROCHE DIAGNOSTICS GMBH
Sandhofer Strasse 116, 68305 Mannheim,
Germany
(540)

COBAS PRO

(591) Black, white
(511)
9 – Scientific instruments and apparatus; laboratory devices for use in research, science and industry; laboratory instruments for research and diagnostic purposes; computer hardware and software for medical and diagnostic purposes; computer software for the provision of automated diagnostic laboratory processes; computer software and hardware for use with laboratory instruments, namely, for use in providing remote automated control, data analysis, and data management.
10 – Medical apparatus and instruments; analyzers for in-vitro diagnostic testing for medical purposes; laboratory apparatus for medical diagnostic purposes.

(260) AM 2019 97730 A
(800) 1402097
(151) 2018 01 31

(891) 2018 01 31
(731) ANNICK GOUTAL
14 rue de Castiglione, F-75001 PARIS, France
(540)

CHAT PERCHE

(591) Black, white
(511)
3 – perfumery; essential oils; aromatic extracts for cosmetic use; cosmetics; hair lotions; toiletries; perfuming and cleaning preparations.

(260) AM 2019 97733 A
(800) 1402248
(151) 2017 12 27
(891) 2017 12 27
(731) MENGHAI TEA FACTORY (General Partnership)
No.1, New Tea Road, Menghai Town, Menghai County, Xishuangbanna Dai Autonomous Prefecture, Yunnan Province, China

(540)



(591) Black, white
(531) 28.03
(511)
21 – Utensils for household purposes, not of precious metal; glassware for everyday use, including cups, plates, kettles, and jars; porcelain for everyday use, including basins, bowls, plates, kettles, tableware, jars, jugs and pots; works of art, of porcelain, terra-cotta or glass; tea services, not of precious metal; toilet utensils; brushes; cosmetic utensils; heat-insulated containers; cleaning utensils.
30 – Coffee; tea; starch for food; tea substitutes; tea-based beverages; noodles; condiments.
32 – Non-alcoholic fruit juice beverages; waters [beverages]; mineral water; non-alcoholic fruit nectars; plant beverages; grape juice; non-alcoholic fruit beverages; vegetable juices [beverages].
43 – Accommodation bureau services [hotels, boarding houses]; restaurant services; teahouse; retirement home services; rental of meeting rooms; day-nursery [crèche] services; boarding for animals; rental of chairs, tables, table linen, glassware; rental of cooking apparatus; rental of drinking water dispensers.

(260) AM 2019 97868 A
 (800) 1403932
 (151) 2018 01 29
 (891) 2018 01 29
 (731) 101CAFFE' S.R.L.
 VIA DEI LAVORATORI, 8/10, I-20090
 BUCCINASCO (MI), Italy
 (540)

101CAFFE'

(591) Black, white
 (511)
 35 – Retail services in relation to preparations for making beverages; wholesale services in relation to preparations for making beverages.
 43 – Cafeteria services; self-service restaurants; services for providing drink; provision of information relating to the preparation of food and drink; office catering services for the provision of coffee; providing food and drink in restaurants and bars; snack-bar services; food and drink preparation services; preparation and provision of food and drink for immediate consumption; café services.

(260) AM 2019 97917 A
 (800) 1404119
 (151) 2018 04 09
 (891) 2018 04 09
 (731) JANSSEN PHARMACEUTICA NV
 Turnhoutseweg 30, B-2340 Beerse, Belgium
 (540)

IPTIMYZE

(591) Black, white
 (511)
 5 – Human pharmaceutical preparations for the prevention and treatment of viral diseases, auto-immune and inflammatory diseases, cardiovascular and pulmonary diseases, central nervous system diseases, peripheral neurological system diseases, pain, dermatologic diseases, gastro-intestinal diseases, infectious-related diseases, metabolic diseases, oncologic diseases, ophthalmic diseases, respiratory diseases, digital ulcers, and cerebrovascular diseases; vaccines; anxiolytics; antiallergics; anti-infectives.

(260) AM 2019 97918 A
 (800) 1404120
 (151) 2018 04 09
 (891) 2018 04 09
 (731) JANSSEN PHARMACEUTICA NV
 Turnhoutseweg 30, B-2340 Beerse,
 Belgium
 (540)

KAPLYENT

(591) Black, white

(511)
 5 – Human pharmaceutical preparations for the prevention and treatment of viral diseases, auto-immune and inflammatory diseases, cardiovascular and pulmonary diseases, central nervous system diseases, peripheral neurological system diseases, pain, dermatologic diseases, gastro-intestinal diseases, infectious-related diseases, metabolic diseases, oncologic diseases, ophthalmic diseases, respiratory diseases, digital ulcers, and cerebrovascular diseases; vaccines; anxiolytics; antiallergics; anti-infectives.

(260) AM 2019 97919 A
 (800) 1404136
 (151) 2018 02 12
 (891) 2018 02 12
 (731) S.C. JOHNSON & SON, INC.
 1525 Howe Street, Racine, WI 53403, USA
 (540)



(591) Black, white
 (531) 26.01.18; 27.01.06; 27.05.21
 (511)
 3 – Air-fragrancing preparations or room fragrances; essential oils for perfuming the atmosphere; air fragrancing preparations; potpourris [fragrances]; incense.
 4 – Candles (lighting); perfumed candles.
 5 – Air purifying preparations; preparations for air cleaning; odor neutralizing preparations; deodorants not for personal use; air room or atmosphere deodorizers; carpet and rug deodorizers; deodorizers for textiles.

(260) AM 2019 97920 A
 (800) 1404218
 (151) 2018 01 19
 (891) 2018 01 19
 (731) SOPHARMA AD
 Iliensko shose Str. 16, BG-1220 SOFIA,
 Bulgaria
 (540)

VICETIN ВИЦЕТИН

(591) Black, white
 (531) 28.05
 (511)
 5 – Pharmaceutical, veterinary and sanitary products.

(260) AM 2019 97921 A
 (800) 1404230
 (151) 2018 01 24
 (891) 2018 01 24
 (731) GEONEXT – PRODUTOS ELÉCTRICOS,
 S.A.
 RUA ANTÓNIO SILVA MARINHO,
 No.197, P-4100-064 PORTO, Portugal

(540)



GLOWING LIFE

(591) Black, white
 (531) 26.04.02; 26.04.05; 26.04.22; 26.04.24;
 27.05.09; 27.05.10; 27.05.24

(511)

7 – Machine tools; motors, electric, other than for land vehicles; motors, other than for land vehicles; current generators; ejectors; current generators; control mechanisms for machines, engines or motors; soldering lamps.

9 – Electrical and electronic control apparatus for use with apparatus or installations for heating; electrical and electronic control apparatus and instruments; remote control apparatus; connectors [electricity]; distribution boxes [electricity]; cables, electric; junction boxes [electricity]; branch boxes [electricity]; switchboxes [electricity]; distribution consoles [electricity]; sleeved rails, electric; connections for electric lines; electric breakers [switches]; switches, electric; batteries and cells; materials for electricity mains [wires, cables]; transformers [electricity]; lighting ballasts; projectors; electrical adapters; light dimmers [regulators], electric; batteries, electric; optical lamps; flashlights [photography]; limiters [electricity]; distribution boards [electricity]; accumulators, electric; locks, electric; automatic controllers for security barriers.

11 – Lighting apparatus and installations; lighting and lighting reflectors; lamps; electric lamps; lights, electric, for christmas trees; projector lamps; safety lamps; laboratory lamps; lanterns for lighting; lights for track mounting; floodlights; lighting tracks [lighting apparatus]; ceiling lights; floor lamps; electrical lamps for outdoor lighting; wall lights; luminaires; lighting armatures; light-emitting diodes [led] lighting apparatus; light diffusers; magnesium filaments for lighting; filaments for electric lamps; sockets for electric lights; heating apparatus, electric; cooling appliances and installations; steam generating installations; water distribution installations; pipes [parts of sanitary installations]; cooking apparatus and installations.

(260) AM 2019 97922 A
 (800) 1404343
 (151) 2017 12 25
 (891) 2017 12 25
 (731) LAW FIRM "GORODISSKY &
 PARTNERS" LTD.
 B. Spasskaya Str., 25, bldg. 3, RU-129090
 Moscow, Russian Federation

(540)

Patadmin

(591) Black, white

(531) 27.05.17

(511)

9 – Computer software for database management; computer software, recorded; computer programs [downloadable software]; electronic databases recorded on computer media; computer software for application and database integration; computer software for creating searchable databases; computer software and telecommunications apparatus, including modems, to enable connection to databases, computer networks, global computer networks and the Internet; magnetic, optical, digital data media; computer programs for data processing; computer software to enable searching of data; computer programmes [programs], recorded; software; software for searching and retrieving information from a computer network; computer software for use in automating and managing business processes; computer program for data and document capture, transmission, storage and indexing.

35 – Computerized file management; compilation of information into computer databases; systemization of information into computer databases; updating and maintenance of data in computer databases; business information; business management and organization consultancy; professional business consultancy.

36 – Financial analysis; financial information; financial consultancy.

41 – Providing on-line electronic publications, not downloadable; education.

42 – Design and development of computer databases; rental of computer database software; hosting computer databases; creating and designing website-based indexes of information for others [information technology services]; installation of computer software; information technology [IT] consultancy; consultancy in the design and development of computer hardware; computer software consultancy; updating of computer software; monitoring of computer systems by remote access; software as a service [SaaS]; maintenance of computer software; conversion of data or documents from physical to electronic media; providing information on computer technology and programming via a web site; providing search engines for the Internet; conversion of computer

programs and data, other than physical conversion; computer system design; computer software design; computer programming; copying of computer programs; off-site data backup; cloud computing; electronic data storage.

45 – Licensing of databases [legal services]; providing legal information from an on-line interactive database; legal services; legal search.

(260) AM 2019 97923 A

(800) 1404406

(151) 2017 12 12

(891) 2017 12 12

(731) W. L. GORE & ASSOCIATES, INC.

555 Paper Mill Road, Newark DE

19711, USA

(540)

GORE-TEX INFINIUM

(591) Black, white

(511)

9 – Protective clothing, namely, pants, coats, footwear, coveralls, jackets, gloves, mittens, parkas, vests, jumpsuits, rain suits, head wear, glove liners.

22 – Bivy bags, tents, synthetic fibers for textile use, camouflage covers, nettings and tarpaulins.

24 – Fabric for the manufacture of outerwear, fabric for the manufacture of protective clothing; fabric for the manufacture of sleeping bags; fabric for the manufacture of bullet proof vests; fabric for the manufacture of clothing; fabric for the manufacture of footwear; fabric for the manufacture of headwear; fabric for the manufacture of tents; sleeping bags.

25 – Clothing, namely, shirts, singlets, crop tops, jerseys, pants, tights, shorts, knickers, bibs, coats, parkas, vests, footwear, head wear, gloves, mittens, glove inserts, coveralls, jumpsuits, rain suits, arm warmers, leg warmers, knee warmers, neck gaiters, fishing waders, athletic base layers, gaiters, balaclavas, scarfs, jackets, dresses, skirts, shorts, suits, socks, shoe covers, helmet covers, pullovers, uniforms.

(260) AM 2019 97924 A

(800) 1404426

(151) 2017 12 08

(891) 2017 12 08

(731) BEIJING HOLILAND ENTERPRISE

INVESTMENT MANAGEMENT CO., LTD

Unit 2308, 20/F, Building 1, Wanda Plaza, 93

Jianguo Street, Chaoyang District, Beijing,

China

(540)

好利来 Holiland

(591) Black, white

(531) 02.09.01; 27.05.07; 28.03

(511)

30 – Cereal preparations; bakery products; candy; rice crust; farinaceous foods; pastries; ice cream; coffee based beverages; soya flour; seasonings.

(260) AM 2019 97925 A

(800) 1404443

(151) 2018 02 14

(891) 2018 02 14

(731) Limited Liability Company "KAVZ"

Avtozavodskaya St., 5, Kurgan, RU-640008

Kurgan region, Russian Federation

(540)



(591) Black, white

(531) 26.01.10; 26.07.25

(511)

12 – Motor buses; motor coaches.

(260) AM 2019 98020 A

(800) 1405229

(151) 2018 02 22

(891) 2018 02 22

(731) GÜRAY METAL PLASTİK SANAYİ

TİCARET LİMİTED ŞİRKETİ

Kışla Caddesi Incirlik Sok. No:16/A,

Topçular Eyüp, İstanbul, Turkey

(540)



(591) Red, white, grey

(531) 26.02.01; 26.02.07; 26.02.08; 27.05.02;

27.05.05; 27.05.10; 29.01.13

(511)

19 – Sand, gravel, crushed stone, asphalt, bitumen, cement, gypsum, plaster, concrete, marble blocks for construction, included in this class; building materials (as finished products) made of concrete, gypsum, clay, potters' clay, stone, marble, wood, plastics and synthetic materials for building, construction, road construction purposes, included in this class; non-metallic buildings, non-metallic building materials, poles not of metal for power lines, barriers not of metal; natural and synthetic coatings in the form

of panels and sheets, being building materials; bitumen cardboard coatings for roofing; bitumen coating for roofing; doors and windows of wood and synthetic materials; traffic signs not of metal, non-luminous and non-mechanical, for roads; monuments and statuettes of stone, concrete and marble; building glass; prefabricated swimming pools not of metal (structures); aquarium sand.

(260) AM 2019 98021 A
 (800) 1405243
 (151) 2018 02 28
 (891) 2018 02 28
 (731) STADA Arzneimittel AG
 Stadastr. 2-18, 61118 Bad Vilbel, Germany
 (540)

TUXXALIB

(591) Black, white
 (511)
 5 – Pharmaceutical preparations; veterinary preparations; medicine; sanitary preparations for medical purposes; dietary supplements and dietetic preparations; dietary supplements for humans; dietary supplements for animals; medical and veterinary preparations and articles; infant formula; diagnostic preparations; plasters, materials for dressings; dressings, medical; teeth filling material; dental impression materials; disinfectants; preparations for destroying vermin; fungicides; herbicides.

10 – Surgical instruments; medical and veterinary apparatus and instruments; dental apparatus and instruments; medical instruments for application on animal bodies; applicators for medications; medical apparatus for introducing pharmaceutical preparations into the human body; diagnostic apparatus for medical purposes; artificial limbs; artificial eyes; artificial teeth; orthopedic articles.

44 – Medical services; providing of medical information relating to diseases and health problems, including online and on the internet; providing medical information from a interactive web site.

(260) AM 2019 98037 A
 (800) 1405631
 (151) 2018 03 02
 (891) 2018 03 02
 (731) SKY GROUP SLOVAKIA, S. R. O.
 Nálepková 7122/28, SK-921 01 Piešťany,
 Slovakia
 (540)

Silver Eagle

(591) Black, white
 (511)
 33 – Distilled beverages; wines; liqueurs; mead [hydromel]; spirits; eaux-de-vie (brandy); piquette;

perry; whisky; alcoholic beverages, except beer; rum; vodka.

(260) AM 2019 98040 A
 (800) 1405683
 (151) 2017 12 05
 (891) 2017 12 05
 (731) H & M HENNES & MAURITZ AB
 SE-106 38 Stockholm, Sweden
 (540)

PLEAT

(591) Black, white
 (511)
 29 – Meat, fish, poultry and game; meat extracts; preserved, frozen, dried and cooked fruits and vegetables; jellies, jams, compotes; eggs; milk and milk products; edible oils and fats; prepared soups; prepared salads; milk shakes.

30 – Coffee, tea, cocoa and artificial coffee; rice; tapioca and sago; flour and preparations made from cereals; bread, pastry and confectionery; edible ices; sugar, honey, treacle; yeast, baking-powder; salt; mustard; vinegar; sauce (condiments); spices; ice; sandwiches; pies; pasties; chocolate; cakes; tarts; biscuits (cookies); candy; pralines; muesli bars; chocolate bars; muesli; pasta; ready-made dishes containing pasta, relishes (condiments); chutneys [condiments].

31 – Raw and unprocessed agricultural, horticultural and forestry products; live animals; fresh fruits and vegetables, herbs (fresh); natural plants and flowers; foodstuffs and beverages for animals; malt; unprocessed seeds and seed grains; bulbs; seedlings and seeds for planting; nuts being fresh.

32 – Beers; mineral and aerated waters and other non-alcoholic beverages; fruit drinks and fruit juices; syrups and other preparations for making beverages; soft drinks; juices; smoothies.

33 – Alcoholic beverages (except beers); wine.

35 – Advertising; business management; business administration; clerical services; retailing relating to preserved, frozen, dried and cooked fruits and vegetables, jellies, jams, compotes, eggs, milk and milk products, edible oils and fats, prepared soups, prepared salads, milkshakes; retailing relating to coffee, tea, cocoa and artificial coffee, rice, flour and preparations made from cereals, bread, pastries and confectionery, edible ices, sugar, honey, treacle, salt, mustard, vinegar, sauces (condiments), spices, ice, sandwiches, pies, baked goods, chocolate, biscuits, cakes, tarts, candy, pralines, muesli bars, chocolate bars, muesli, pasta, prepared pasta dishes, relish (condiment), chutneys; retailing relating to fresh fruits and vegetables and fresh herbs, natural plants and flowers, foodstuffs and beverages for animals,

bulbs, seedlings and seeds for planting, fresh nuts; retailing relating to beers, mineral and aerated waters and other non-alcoholic beverages, fruit beverages and fruit juices, syrups and other preparations for making beverages, soft drinks, juices, smoothies; retail services in relation to alcoholic beverages (except beer), wine.

43 – Services for providing food and drink; temporary accommodation; cafés; restaurants; catering for the provision of food and beverages.

(260) AM 2019 98041 A

(800) 1405717

(151) 2018 02 15

(891) 2018 02 15

(731) RELLA GIDA SANAYİ VE TİCARET ANONİM ŞİRKETİ

Tuzla Kimya San. Org. San. Böl., Melek Aras Bulv. Organik Cad. No:3, Tuzla, İstanbul, Turkey

(540)



(591) Green, dark green, red and purple.

(531) 02.03.17; 05.03.02; 05.03.18; 25.01.25; 27.05.10; 29.01.13

(511)

29 – Meat, fish, poultry and game; processed meat products; dried pulses; soups, bouillon; processed olives, olive paste; milk and milk products, butter; edible oils; dried, preserved, frozen, cooked, smoked or salted fruits and vegetables; tomato paste; prepared nuts and dried fruits as snacks; hazelnut spreads and peanut butter; tahini (sesame seed paste); eggs and powdered eggs; potato chips.

30 – Coffee, cocoa; coffee or cocoa based beverages, chocolate based beverages; pasta, stuffed dumplings, noodles; pastries and bakery products based on flour; desserts based on flour and chocolate; bread, simit [Turkish ring-shaped bagel covered with sesame seeds], poğaç [Turkish bagel], pita, sandwiches, katter [Turkish pastry], pies, cakes, baklava [Turkish dessert based on dough coated with syrup], kadayif [Turkish dessert based on dough]; desserts based on dough coated with syrup; puddings, custard, kazandibi [Turkish pudding], rice pudding, keşkül [Turkish pudding]; honey, bee glue for human consumption, propolis for food purposes; condiments for foodstuff, vanilla (flavoring), spices, sauces (condiments), tomato sauce; yeast, baking powder; flour, semolina, starch for food; sugar, cube sugar, powde-

red sugar; tea, ice tea; confectionery, chocolate, biscuits, crackers, wafers; chewing gums; ice-cream, edible ices; salt; cereal-based snack food, popcorn, crushed oats, corn chips, breakfast cereals, processed wheat for human consumption, crushed barley for human consumption, processed oats for human consumption, processed rye for human consumption, rice; molasses for food.

(260) AM 2019 98042 A

(800) 1405718

(151) 2018 01 24

(891) 2018 01 24

(731) SEVEN FOLD S.R.L.

Via Atto Vannucci, 7, I-50134 FIRENZE, Italy

(540)



(591) Ocra yellow, black, gray and white

(531) 25.01.09; 25.03.25; 27.05.10; 29.01.14

(511)

25 – Clothing; headgear; waterproof clothing; dresses; suits; bandanas [neckerchiefs]; underwear; braces for clothing [suspenders]; stockings; socks; shirts; hats; coats; belts [clothing]; bathing suits; neckties; bolo ties; ascots; silk neckties; bow tie; plastrons; pocket squares; kerchiefs [clothing]; neckerchiefs; silk neckerchiefs; pocket kerchiefs; scarfs; foulards [clothing articles]; jackets [clothing]; gloves [clothing]; jerseys [clothing]; hosiery; sweaters; vests; trousers; shoes; gymnastic shoes; footwear; shawls; fur stoles; sashes for wear; silk shawls; overcoats; tee-shirts.

(260) AM 2019 98043 A

(800) 1405753

(151) 2018 02 27

(891) 2018 02 27

(731) OLYMPUS CORPORATION

2951 Ishikawa-machi, Hachioji-shi, Tokyo 192-8507, Japan

(540)

OLYMPUS

(591) Black, white

(511)

9 – Wearable computers; personal digital assistants; computer application software for personal digital assistants; cloud computing software; computer programs.

35 – Consultancy services in the field of systemization of information into computer databases.

37 – Repair or maintenance of medical apparatus and instruments and providing information relating

thereto; sterilization of medical apparatus and instruments and providing information relating thereto; repair or maintenance of optical machines and apparatus and providing information relating thereto; repair or maintenance of photographic machines and apparatus and providing information relating thereto; repair or maintenance of electronic machines and apparatus and providing information relating thereto; repair or maintenance of telecommunication machines and apparatus and providing information relating thereto; repair or maintenance of laboratory apparatus and instruments and providing information relating thereto; repair or maintenance of measuring and testing machines and providing information relating thereto.

41 – Provision of training via a global computer network; medical training and teaching; educational and training services relating to diagnostic imaging apparatus for medical purposes; consultancy services relating to training; arranging and conducting of training courses.

42 – Hosting web portals; providing computer programs for portals via the Internet or mobile phone; software as a service; online data storage; providing computer programs for image analysis for medical purposes; computer-aided scientific research, testing and analysis services; scientific and medical research and development.

44 – Medical diagnostic services using image data; intermediary services relating to medical diagnosis using image data; providing medical information via the Internet and other communication networks.

(260) AM 2019 98044 A

(800) 1405780

(151) 2018 02 09

(891) 2018 02 09

(731) SWATCH AG (SWATCH SA) (SWATCH LTD)

Jakob-Stämpfli-Strasse 94, CH-2502
Biel/Bienne, Switzerland

(540)

SWATCH PAY

(591) Black, white

(511)

9 – Apparatus for recording, transmission and reproduction of sound or images; electronic payment processing apparatus, apparatus for processing cashless payment transactions; magnetic recording media, sound recording disks; compact disks, DVDs and other digital recording media; apparatus used for playing compressed sound files (MP3 files); calculating machines and data processing equipment, software; games for mobile telephones, for computers and for digital personal stereos; electronic game software for mobile telephones, for computers and for digital per-

sonal stereos; computers, portable computers, handheld computers, mobile computers, personal computers, wrist computers, smartwatches, electronic tablets and computerized and mobile devices, digital personal stereos, mobile telephones and new-generation mobile telephones with greater functionality (smartphones); telecommunication apparatus and instruments; apparatus for recording, transmission, reproduction of sound or images, particularly mobile telephones and new-generation mobile telephones with greater functionality (smartphones); handheld electronic apparatus for accessing the Internet and sending, receiving, recording and storing short messages, electronic messages, telephone calls, faxes, video-conferences, images, sounds, music, text and other digital data; handheld electronic apparatus for wireless reception, storage and transmission of data or messages; handheld electronic apparatus for monitoring or organizing personal information; handheld electronic apparatus for global positioning [GPS] and displaying maps and transport information; handheld electronic devices for detection, storage, monitoring, surveillance and transmission of data relating to user activity, namely position, itinerary, distance traveled, heart rate; covers for computers, portable and mobile telephones; optical apparatus and instruments, particularly spectacles, sunglasses, magnifying glasses; cases for spectacles, sunglasses and magnifying glasses; batteries for electronic apparatus and computers, batteries for timepieces and chronometric instruments.

14 – Precious metals and their alloys and goods made of these materials or coated therewith included in this class, namely figurines, trophies; jewelry, namely rings, earrings, cuff links, bracelets, charms, brooches, chains, necklaces, tie pins, tie clips, jewelry boxes, jewelry cases, cases for watches, cases of precious metals, precious stones, semi-precious stones; timepieces and chronometric instruments, namely chronometers, chronographs, clocks, watches, wristwatches, wall clocks, alarm clocks as well as parts and accessories for the aforesaid goods, namely hands, anchors, pendulums, barrels, watch cases, watch straps, watch dials, clockworks, watch chains, movements for timepieces, watch springs, watch glasses, presentation cases for timepieces, cases for timepieces.

35 – Data processing services in the financial field, computer database management services in the financial field; promotion of the goods and services of others by means of discounts, advertising, electronic offers, loyalty points and value added offers and advertising competitions produced in connection with the use of payment cards and other means of payment; promotion of the use of payment cards and other means of payment via promotional incentives provided by means of recording programs and post or electronic communications; commercial informa-

tion via websites; compilation and systematization of information into computer databases.

36 – Financial services; financial services, namely, providing, processing, checking and authentication of mobile payments and credit and debit card transactions, including payments with or without cash using debit cards, credit cards and loyalty cards, particularly contact-less smart cards and cards with contact and near-field communication devices, also with money back, also via mobile devices; electronic payment services; scriptural currency payment services for third parties and other financial services, particularly for retail trading and service companies; carrying out cashless payment transactions; financial consultancy for others in the context of carrying out payments by means of scriptural currency and loyalty cards; broadcasting of financial information via a global computer network, wireless network or mobile communication device.

(260) AM 2019 98045 A

(800) 1405784

(151) 2018 02 22

(891) 2018 02 22

(731) AZOTER Trading s. r. o.

Dúbravská 2, SK-841 04 Bratislava – mestská časť Karlova Ves, Slovakia

(540)

AZOTER

(591) Black, white

(511)

1 – Fertilizers; phosphates (fertilizers); salts (fertilizers); fertilizers of animal origin; compost activators; non-organic fertilizers; chemical fertilizers; natural fertilizers; organic fertilizers; lawn fertilizers; biological fertilizers; compositions of fertilizers; liquid manure substitutes; manure for herbs and pastures; soil fertilizers; fertilizing preparations; mixtures of chemical products and natural materials as fertilizers for use in agriculture; mixtures of chemical products and natural materials as fertilizers for use in horticulture; bacterial preparations for use in agriculture; bacteriological preparations for use in agriculture; bacterial preparations for use in horticulture; bacterial preparations for use in forestry; bacteriological preparations for use in horticulture; bacteriological preparations for use in forestry; bacteriological preparations other than for medical or veterinary use; chemical preparations for soil treatment; chemical additives for fungicides; chemical additives to insecticides; chemical products for soil enrichment; chemical products for use in agriculture, horticulture and forestry; guano; loam; agricultural chemicals except fungicides, herbicides, insecticides and parasiticides; humus; plant growth stimulating substances; reproductive material (culture environment); soil improving preparations; manure; compost; soil con-

ditioning preparations; preparations for feeding plants; nutritive substances for plants; mineral preparations for use as nutritional additives for plants; nutritive substances (fertilizers) in liquid form for use in agriculture; landscaping (humus) for lawns; prepared soils (preparations for); soil fertilizers; compositions of fertilizers; nutritive substances for plants; artificial fertilizers; lime for use in agriculture; nutritive substances for plants; unprocessed resins; unprocessed synthetic resins; chemical additives for preventing sedimentation; enzyme preparations for decomposing waste; chemical preparations for oil dispersion; degreasing substances for use in manufacturing processes; chemical products for use in industry, science, photography, as well as in agriculture, horticulture and forestry; unprocessed artificial resins, unprocessed plastics; soil fertilizers; fire-extinguishing compositions; tempering and soldering preparations; chemical substances for preserving foodstuffs; tan; adhesives for use in industry.

5 – Biocides; fungicides; herbicides; insecticides; poisons; vermin destroying products; insect repellent incense; acaricides for industrial use; algicides for agricultural use; vermin destroying products; pesticides for agricultural use; mildewcides; antimoss products; products for destroying herbs; synthetic biocides; preparations for repelling vermin; preparations for repelling animals; natural biocides; products against rodents.

35 – Retail or wholesale services for chemical products used in agriculture, horticulture and forestry, manure, bacterial preparations for agriculture, horticulture and forestry, preparations for feeding plants, soil improving preparations, chemical products for the decomposition of oil sediments, biocides, fungicides, herbicides, insecticides and preparations for destroying vermin; administration of consumer loyalty programs; distribution of advertising material (leaflets, prospectuses, printed matter, samples); demonstration of goods; word processing; data search in computer files for others; commercial information and advice for consumers (consumer advice shop); professional business consultancy; computerized file management services; administrative processing of purchase orders; company audits (commercial analyses); invoicing; compilation of statistics; procurement services for others (purchasing goods and services for other businesses); advertising by mail order; outsourcing services (business assistance); compilation of information into computer databases; systematization of information in computer databases; updating and maintenance of data in computer databases; commercial information via websites; sales promotion for others; price comparison services; marketing; advertising; publication of advertising texts; rental of advertising time on all communication media; television advertising; radio advertising; layout services for advertising purposes; market stu-

dies; sales promotion for others; presentation of goods on all communication media, for retail sale; online advertising on a computer network; web site traffic optimization; search engine optimization for sales promotion purposes; postpaid per click advertising services; dissemination of advertisements; updating of advertising material; organization of exhibitions for commercial or advertising purposes; organization of trade fairs for commercial or advertising purposes; outdoor advertising; rental of advertising space; rental of advertising material; import-export agency services; provision of advice and information concerning the aforesaid services by means of communication media, electronic messaging, SMS messages, computer networks and the Internet or by word of mouth.

(260) AM 2019 98046 A

(800) 1405809

(151) 2018 04 05

(891) 2018 04 05

(731) GEVORKYAN ARUTYUN MARTIKOVICH
Rossiyskaya St., h. 138 , of. 120, RU-350000
Krasnodar, Russian Federation

(540)

AMG

(591) Black, white

(531) 27.05.17; 27.05.23

(511)

32 – Aperitifs, non-alcoholic; waters [beverages]; cocktails, non-alcoholic; lemonades; non-alcoholic beverages; non-alcoholic fruit juice beverages; fruit nectars, non-alcoholic; beer; cider, non-alcoholic; vegetable juices [beverages]; fruit juices; preparations for making liqueurs; must; grape must, unfermented; beer wort; malt wort; non-alcoholic fruit extracts; extracts of hops for making beer; essences for making beverages.

33 – Alcoholic beverages, except beer; arrack [arak]; brandy; wine; piquette; whisky; vodka; gin; digesters [liqueurs and spirits]; cocktails; liqueurs; alcoholic beverages containing fruit; spirits [beverages]; distilled beverages; mead [hydromel]; peppermint liqueurs; bitters; rum; sake; cider; rice alcohol; alcoholic extracts; fruit extracts, alcoholic; alcoholic essences.

(260) AM 2019 98047 A

(800) 1405816

(151) 2018 01 25

(891) 2018 01 25

(731) ZER ZEYTINCILIK TARIM URUNLERI
GIDA SANAYI VE TICARET ANONIM
SIRKETI

Incili Pinar Mah. Gazimuhtarpassa Bulvari,
Doktorlar Sitesi C Blok Kat:3 D:306,
Sehitkamil Gaziantep, Turkey

(540)

GOLDINA

(591) Black, white

(531) 01.15.11; 11.03.04; 27.03.15

(511)

30 – Coffee, cocoa; coffee or cocoa based beverages, chocolate based beverages.

(260) AM 2019 98048 A

(800) 1405879

(151) 2017 10 25

(891) 2017 10 25

(731) BEIJING QIHOO TECHNOLOGY
COMPANY LIMITED

Room 112, Area D (Desheng Park), No.28

Xinjiekouwai Street, Xicheng District, 100088

Beijing, China

(540)



(591) Black, white

(531) 24.13.01; 24.17.05; 26.15.01; 27.07.17

(511)

9 – Computer memory devices; data processing apparatus; computer peripheral devices; computer software, recorded; couplers [data processing equipment]; electronic pens [visual display units]; interfaces for computers; computer programs [downloadable software]; optical character readers; laptop computers; computer software applications, downloadable; tablet computers; smartglasses; smartwatches; computer hardware; joysticks for use with computers, other than for video games; pedometers; counters; time recording apparatus; quantity indicators; counterfeit [false] coin detectors; mechanisms for coin-operated apparatus; electronic terminals for generating lottery tickets; punched card machines for offices; weighing apparatus and instruments; measures; signs, luminous; transmitters of electronic signals; network communication devices; optical communications devices; navigational instruments; smartphones; wearable activity trackers; cases for smartphones; covers for smartphones; cabinets for loudspeakers; monitoring apparatus, electric; sound transmitting apparatus; sound recording apparatus; camcorders; headphones; portable media players; learning machines; cameras [photography]; projection apparatus; speed measuring apparatus [photography]; selfie sticks [hand-held monopods]; stands for photographic apparatus; surveying apparatus and instruments; air analysis apparatus; observation instruments; speed checking apparatus for vehicles; food analysis apparatus; testing apparatus not for medical purposes; gas testing instruments; pressure measuring apparatus; diagnostic apparatus, not for me-

dical purposes; audiovisual teaching apparatus; measuring devices, electric; probes for scientific purposes; optical apparatus and instruments; materials for electricity mains [wires, cables]; semi-conductors; electronic chips; semiconductor devices; plugs, sockets and other contacts [electric connections]; video screens; remote control apparatus; electric installations for the remote control of industrial operations; lightning arresters; electrolyzers; fire extinguishing apparatus; apparatus and installations for the production of X-rays, not for medical purposes; protection devices for personal use against accidents; life saving apparatus and equipment; alarms; theft prevention installations, electric; electric door bells; locks, electric; smoke detectors; spectacles; batteries, electric; chargers for electric batteries; animated cartoons; electrified fences; portable remote-controlled arresters for vehicles.

42 – Research and development of new products for others; computer programming; computer software design; maintenance of computer software; computer system design; installation of computer software; conversion of data or documents from physical to electronic media; computer software consultancy; computer virus protection services; providing search engines for the Internet.

(260) AM 2019 98049 A

(800) 1405968

(151) 2018 03 12

(891) 2018 03 12

(731) AB HOLDING MANAGEMENT

119 rue Michel Aulas, Parc Millesime,
F-69400 Limas, France

(540)

E-MOKE

(591) Black, white

(511)

12 – Vehicles and means of transport.

(260) AM 2019 98050 A

(800) 1406010

(151) 2018 01 26

(891) 2018 01 26

(731) MOON LIGHT D.SH.D. OOD

Professor Ivan Georgov str. 2, residence
area Voenna rampa, BG-1220 Sofia, Bulgaria

(540)



(591) Yellow, orange, rose, blue, violet, green, white

(531) 26.01.19; 27.05.02; 29.01.15

(511)

28 – Games, toys and playthings; video game apparatus; gymnastic and sporting articles; decorations for Christmas trees; play balloons; dolls' feeding bottles; Christmas crackers [party novelties]; rattles [playthings]; toy figures; playing cards; skittles [games]; toy vehicles; confetti; dolls; flying discs [toys]; toy models; teddy bears; stuffed toys; toy pistols; plush toys; spinning tops [toys]; jigsaw puzzles; scale model kits [toys]; playing balls; marbles for games; scale model vehicles; novelty toys for playing jokes.

30 – Coffee, tea, cocoa and artificial coffee; rice; tapioca and sago; flour and preparations made from cereals; bread, pastries and confectionery; edible ices; sugar, honey, treacle; yeast, baking-powder; salt; mustard; vinegar, sauces (condiments); spices; ice (frozen water); sweetmeats [candy]; high-protein cereal bars; dessert mousses [confectionery]; chewing gum, not for medical purposes; oat and maize flakes; extruded cereal food products (snacks); sugar confectionery; cereal bars; cereal-based snack food; corn flakes; cereal preparations; cocoa-based beverages; crackers; muesli; petits fours [cakes]; fruit jellies [confectionery]; pralines; puddings; popcorn; sandwiches; cakes; chips [cereal products]; chocolate and chocolate confectionery; chocolate-based spreads; chocolate mousses; chocolate-based beverages; chocolate eggs.

(260) AM 2019 98052 A

(800) 1406013

(151) 2017 12 27

(891) 2017 12 27

(731) Tovarystvo z obmezhenoiu vidpovidalnistiu
"POLIKOLOR"

Vul. Skhidna, 2 A, m. Dniprodzerzhynsk,
Dnipropetrovska obl. 51909, Ukraine

(540)



(591) Black, white

(531) 26.04.18; 26.04.24; 27.05.02; 27.05.03;
27.05.24

(511)

2 – Asbestos paints; alizarine dyes; aluminium powder for painting; aluminium paints; aniline dyes; anotto [dyestuff]; auramine; bactericidal paints; toner cartridges, filled, for printers and photocopiers; shoe dyes; ink for leather; wood stains; colorants for liquors; ink for skin-dressing; colorants for butter; colorants for beverages; colorants for beer; dye-wood;

dyes; bitumen varnish; bronze powder for painting; lime wash; fireproof paints; orange lead; primers; gamboge for painting; titanium dioxide [pigment]; printers' pastes [ink]; printing ink; engraving ink; dyewood extracts; enamels for painting; enamels [varnishes]; silver emulsions [pigments]; colorants; thickeners for paints; undercoating for vehicle chassis; protective preparations for metals; indigo [colorant]; gum resins; Canada balsam; colophony; caramel [food colorant]; carbonyl [wood preservative]; ceramic paints; binding preparations for paints; badi-geon; copal; copal varnish; cochineal carmine; creosote for wood preservation; turmeric [colorant]; varnishes; bronzing lacquers; marking ink for animals; mastic [natural resin]; metals in powder form for use in painting, decorating, printing and art; metal foil for use in painting, decorating, printing and art; cobalt oxide [colorant]; zinc oxide [pigment]; oils for the preservation of wood; paper for dyeing Easter eggs; pigments; coatings [paints]; wood coatings [paints]; lacquers; silvering powders; anti-rust preparations; anti-corrosive preparations; anti-corrosive bands; anti-tarnishing preparations for metals; mordants; stains for leather; wood mordants; thinners for paints; thinners for lacquers; whitewash; soot [colorant]; carbon black [pigment]; lamp black [pigment]; sandarac; white lead; red lead; siccatives [drying agents] for paints; sienna earth; turpentine [thinner for paints]; natural resins, raw; malt caramel [food colorant]; malt colorants; silver paste; sumac for varnishes; distempers; toners [ink] for photocopiers; coatings for roofing felt [paints]; repositionable paint patches; paints; fixatives [varnishes]; fixatives for watercolors [watercolours]; yellowwood [colorant]; food dyes; saffron [colorant]; black Japan.

(260) AM 2019 98053 A
(800) 1406050
(151) 2018 02 28
(891) 2018 02 28
(731) BAYER AKTIENGESELLSCHAFT
Kaiser-Wilhelm-Allee; 51373 Leverkusen,
Germany
(540)



(591) Black, white
(531) 26.03.04; 26.03.06; 26.03.24
(511)
5 – Pharmaceutical preparations.

(260) AM 2019 98054 A
(800) 1406061
(151) 2018 03 09
(891) 2018 03 09
(731) APPLE INC.
One Apple Park Way, Cupertino CA 95014, USA
(540)

APPLECARE

(591) Black, white
(511)
41 – Education services, namely, providing classes, and online educational programs and tutorials in the field of computer hardware, computer peripherals and computer software, and distribution of course material in connection therewith; training services in the field of computer hardware, computer peripherals and computer software.

(260) AM 2019 98055 A
(800) 1406086
(151) 2018 03 22
(891) 2018 03 22
(731) "SUNFOOD" LLC
Zovuni village, Kotayq, Armenia
(540)

Империя вкуса

(591) Black, white
(531) 28.05
(511)
29 – Oils for food and edible fats, namely fatty substances for the manufacture of edible fats; peanut butter; coconut oil for food; corn oil for food; linseed oil for culinary purposes; olive oil for food; sunflower oil for food; butter; margarine; fat-containing mixtures for bread slices; melted vegetable oil mixtures.

(260) AM 2019 98056 A
(800) 1406088
(151) 2018 04 12
(891) 2018 04 12
(731) ORCAN ENERGY AG
Rupert-Mayer-Straße 44, 81379 München,
Germany
(540)

ORCAN

(591) Black, white
(511)
7 – Motors, engines, machines and parts of machines for generating, converting and recovering current or mechanical energy from heat, and accessories; internal combustion engines with coupled heat exchangers for generating current and heat, being complete units in the form of energy recovery modules.

11 – Small power stations, including block-unit power stations, in the form of modules for generating heat, converting heat and recovering heat.

42 – Scientific and technological services and research and development relating thereto, in particular in the field of energy generation and energy conversion; scientific and technological consultancy and services in the field of energy technology, energy generation, energy saving and environmental protection and research into environmental protection.

(260) AM 2019 98057 A

(800) 1406124

(151) 2018 02 27

(891) 2018 02 27

(731) BUNGE SA

13, route de Florissant, CH-1206 Genève,
Switzerland

(540)

BUNGE
PROCUISINE

(591) Black, white

(531) 26.11.02; 26.11.08; 27.05.10; 27.05.11

(511)

29 – Edible oils and fats, fatty substances for the manufacture of edible fats, oils and fats for food, margarine, butter, butter cream, peanut butter, cocoa butter, coconut butter, coconut fat, coconut oil, edible rape oil, palm kernel oil [for food], edible bone oil, sesame oil, edible sunflower oil, fat-containing mixtures for bread slices, gelatin for food, prepared peanuts, preserved soybeans for food, fruit-based preparations for filling bakery and pastry products, preserved, dried and cooked fruit and vegetables; jellies, jams, compotes; eggs, milk and dairy products, milk beverages with predominantly milk.

30 – Coffee, tea, cocoa, sugar, rice, tapioca, sago, artificial coffee; flours and preparations made from cereals, soy flour, vegetable protein fibers for food, pasta, noodles, starch for food, bread, bread dough, flour-based preparations for baking, yeast, baking powder; pastry and confectionery, edible ices, honey, golden syrup; fruit-based sauces, vegetable-based sauces, caramel-based sauces, ice for refreshment, mayonnaise, sauces [condiments], spices; mustard, vinegar and other condiments, salad dressing, spicy soy sauce, flavorings other than essential oils, aromatic preparations for food, seasonings, peanut-based confectionery.

(260) AM 2019 98058 A

(800) 1406141

(151) 2018 05 10

(891) 2018 05 10

(731) BELLES MARKS LTD

4 Arch. Makariou & Kalograion,
NICOLAIDES SEA VIEW CITY, BLOCK A-
B, Floor:9th, Flat: 903 – 904, CY-6016
Larnaca, Cyprus

(540)

**Elyzia Saber EST 1789 in
Bucovina**

(591) Black, white

(511)

33 – Alcoholic beverages (except beer).

(260) AM 2019 98065 A

(800) 1406292

(151) 2017 12 29

(891) 2017 12 29

(731) ZABOLOTSKYI OLEKSANDR
OLEKSANDROVYCH

Leninskyi prospekt, bud. 146, kv. 34,
m. Donetsk 83080, Ukraine

(540)



(591) Black, white

(531) 08.01.23; 26.13.25; 27.05.24

(511)

29 – Meat, fish, poultry and game; meat extracts; preserved, frozen, dried and cooked fruits and vegetables; jellies, jams, compotes; eggs; milk and milk products; edible oils and fats; ajvar [preserved peppers]; aloe vera prepared for human consumption; albumin milk; alginates for culinary purposes; anchovy, not live; peanuts, prepared; peanut butter; peanut milk; peanut milk for culinary purposes; artichokes, preserved; bacon; albumen for culinary purposes; white of eggs; beans, preserved; bulgogi [Korean beef dish]; bouillon; bouillon concentrates; cream [dairy products]; potato-based dumplings; oat milk; toasted laver; sea-cucumbers, not live; flavored nuts; nuts, prepared; peas, preserved; mushrooms, preserved; guacamole [mashed avocado]; potato fritters; jams; game, not live; non-alcoholic egg-nog; seaweed extracts for food; escamoles [edible ant larvae, prepared]; gelatine; meat jellies; jellies for food; bone oil, edible; lard; suet for food; fatty substances for the manufacture of edible fats; yolk of eggs; cranberry sauce [compote]; fruit-based snack food; milk substitutes; frozen fruits; salted fish; candied nuts; whipped cream; condensed milk; eggplant paste; vegetable marrow paste; fish roe, prepared; ginger jam; edible insects, not live; yogurt; galbi [grilled meat dish]; sauerkraut; potato flakes; potato

chips; kefir [milk beverage]; curd; onion rings; kimchi [fermented vegetable dish]; clams, not live; charcuterie; coconut oil for food; coconut butter; coconut milk; coconut milk for culinary purposes; coconut fat; coconut, desiccated; milk shakes; arrangements of processed fruit; compotes; corn dogs; gherkins; shrimps, not live; prawns, not live; vegetable-based cream; black pudding [blood sausage]; croquettes; sweet corn, processed; maize oil for food; koumiss [kumiss] [milk beverage]; sesame oil for food; spiny lobsters, not live; lecithin for culinary purposes; lemon juice for culinary purposes; silkworm chrysalis for human consumption; margarine; butter; cocoa butter for food; buttercream; almond milk; almond milk for culinary purposes; almonds, ground; mussels, not live; milk; powdered milk; milk beverages, milk predominating; milk products; vegetable mousses; fish mousses; meat extracts; meat, tinned [canned (Am.)]; meat; meat, preserved; peanut milk-based beverages; coconut milk-based beverages; almond milk-based beverages; seeds, prepared; sunflower seeds, prepared; sausage casings, natural or artificial; vegetables, tinned [canned (Am.)]; vegetable salads; vegetable juices for cooking; vegetables, preserved; vegetables, cooked; vegetables, dried; olives, preserved; olive oil for food; extra virgin olive oil; linseed oil for culinary purposes; lobsters, not live; herrings, not live; palm oil for food; palm kernel oil for food; liver pastes; pectin for culinary purposes; liver; pollen prepared as foodstuff; marmalade; vegetable soup preparations; prostokvasha [soured milk]; poultry, not live; crayfish, not live; crustaceans, not live; fish, preserved; fish, not live; salmon, not live; fish meal for human consumption; fish fillets; fish, tinned [canned (Am.)]; isinglass for food; rice milk; rice milk for culinary purposes; rape oil for food; raisins; ryazhenka [fermented baked milk]; sardines, not live; pork; cheese; whey; rennet; preparations for making bouillon; smetana [sour cream]; soya bean oil for food; soya milk; soya beans, preserved, for food; pickles; salted meats; sunflower oil for food; sausages; hot dog sausages; sausages in batter; lentils, preserved; nut-based spreads; lyophilised meat; lyophilised vegetables; preparations for making soup; fat-containing mixtures for bread slices; soups; tahini [sesame seed paste]; animal marrow for food; tripe; tomato paste; tomato purée; tomato juice for cooking; tofu; truffles, preserved; tuna, not live; oysters, not live; falafel; milk ferments for culinary purposes; dates; fruit, preserved; crystallized fruits; fruit, stewed; fruit preserved in alcohol; fruit peel; fruit pulp; fruit jellies; fruits, tinned [canned (Am.)]; fruit salads; fruit chips; hazelnuts, prepared; edible fats; oils for food; fish-based foodstuffs; edible birds' nests; hummus [chickpea paste]; onions, preserved; preserved garlic; shellfish, not live; low-fat potato chips; caviar; ham; apple purée; berries, preserved; powdered eggs; snail eggs for consumption; eggs; yakitori.

30 – Coffee, tea, cocoa and artificial coffee; rice; tapioca and sago; flour and preparations made from cereals; bread, pastries and confectionery; edible ices; sugar, honey, treacle; yeast, baking-powder; salt; mustard; vinegar, sauces (condiments); spices; ice; peanut confectionery; flavourings, other than essential oils, for beverages; flavorings, other than essential oils, for cakes; food flavorings, other than essential oils; aromatic preparations for food; baozi [stuffed buns]; cereal bars; high-protein cereal bars; royal jelly; bibimbap [rice mixed with vegetables and beef]; bean meal; nut flours; tapioca flour; flour; pastries; bread rolls; buns; burritos; vanillin [vanilla substitute]; vanilla flavorings for culinary purposes; vareniki [stuffed dumplings]; waffles; vermicelli [noodles]; flour-based dumplings; oatmeal; oat flakes; sausage binding materials; binding agents for ice cream; biscuits; cloves [spice]; mustard; mustard meal; cake frosting [icing]; glucose for culinary purposes; chocolate-coated nuts; garden herbs, preserved [seasonings]; mirror icing [mirror glaze]; gluten additives for culinary purposes; yeast; dulce de leche; essences for foodstuffs, except etheric essences and essential oils; chewing gum; custard; thickening agents for cooking foodstuffs; leaven; ferments for pastes; cereal-based snack food; rice-based snack food; artificial coffee; frozen yoghurt [confectionery ices]; dressings for salad; wheat germ for human consumption; cereal preparations; ginger [spice]; edible paper; edible rice paper; coffee; unroasted coffee; coffee flavorings; coffee beverages with milk; cocoa; cocoa beverages with milk; capers; caramels [candy]; curry [spice]; potato flour; flowers or leaves for use as tea substitutes; ketchup [sauce]; gimbap [Korean rice dish]; quiches; gluten prepared as foodstuff; confectionery; confectionery for decorating Christmas trees; cinnamon [spice]; crackers; cream of tartar for culinary purposes; starch for food; hominy grits; groats for human food; ice cubes; maize, milled; maize, roasted; maize flour; maize flakes; turmeric; couscous [semolina]; cooking salt; ice for refreshment; ice, natural or artificial; liquorice [confectionery]; ribbon vermicelli; mayonnaise; macaroni; pasta; macarons [pastry]; maltose; hominy; semolina; marinades; marzipan; honey; molasses for food; almond paste; almond confectionery; miso [condiment]; pancakes; ice cream; sea water for cooking; seaweed [condiment]; dessert mousses [confectionery]; chocolate mousses; nutmegs; muesli; meat gravies; mint for confectionery; peppermint sweets; coffee-based beverages; cocoa-based beverages; chamomile-based beverages; tea-based beverages; chocolate-based beverages; aniseed; star aniseed; sesame seeds [seasonings]; flaxseed for culinary purposes [seasoning]; infusions, not medicinal; processed seeds for use as a seasoning; crushed oats; okonomiyaki [Japanese savory pancakes]; onigiri [rice balls]; vinegar; husked oats; husked barley; stick liquorice [confectionery]; palm sugar; pastilles

[confectionery]; baking powder; pelmeni [dumplings stuffed with meat]; pepper; allspice; peppers [seasonings]; pesto [sauce]; petits fours [cakes]; beer vinegar; pies; meat pies; pizzas; chips [cereal products]; piccalilli; fondants [confectionery]; popcorn; powders for making ice cream; pralines; candy decorations for cakes; chocolate decorations for cakes; condiments; natural sweeteners; seasonings; unleavened bread; oat-based food; propolis; gingerbread; spices; puddings; cake powder; wheat flour; ravioli; ramen [Japanese noodle-based dish]; relish [condiment]; meat tenderizers for household purposes; preparations for stiffening whipped cream; rice; instant rice; rice pulp for culinary purposes; rice pudding; rice cakes; vegetal preparations for use as coffee substitutes; sago; sandwiches; hot dog sandwiches; celery salt; agave syrup [natural sweetener]; golden syrup; salt for preserving foodstuffs; soya flour; soya sauce; malt for human consumption; malt biscuits; malt extract for food; sweetmeats [candy]; sorbets [ices]; sauces [condiments]; pasta sauce; spaghetti; chocolate-based spreads; spring rolls; noodle-based prepared meals; lyophilised dishes with main ingredient being pasta; lyophilised dishes with main ingredient being rice; ham glaze; batter mixes for okonomiyaki [Japanese savory pancakes]; rusks; breadcrumbs; petit-beurre biscuits; sushi; tabbouleh; tacos; tapioca; tarts; cakes; dough; cake dough; pastry dough; tomato sauce; tortillas; French pie with paste; fruit jellies [confectionery]; fruit coulis [sauces]; halvah; bicarbonate of soda for cooking purposes [baking soda]; edible ices; bread; jiaozi [stuffed dumplings]; chicory [coffee substitute]; candy; sugar; iced tea; tea; minced garlic [condiment]; chutneys [condiments]; cheeseburgers [sandwiches]; chow-chow [condiment]; saffron [seasoning]; chocolate; chocolate beverages with milk; chocolate spreads containing nuts; barley meal; crushed barley.

(260) AM 2019 98069 A
(800) 836919
(151) 2004 08 27
(891) 2018 05 18
(731) MACDONALD & MUIR LIMITED
The Cube, 45 Leith Street, Edinburgh
EH1 3AT, United Kingdom

(540)

ARDBEG

(591) Black, white
(511)
33 – Scotch whisky.

(260) AM 2019 98071 A
(800) 1209164
(151) 2014 03 28
(891) 2018 05 23
(731) GRANAROLO S.P.A.
Via Cadriano 27/2, I-40127 BOLOGNA, Italy

(540)

GRANAROLO

(591) Black, white

(511)

5 – Pharmaceutical and veterinary preparations; dietetic substances adapted for medical use, food for babies; milk ferments for pharmaceutical purposes; nutritional supplements.

29 – Meat, fish, poultry and game; meat extracts; preserved, dried and cooked fruits and vegetables; jellies, jams, eggs, milk and milk products; edible oils and fats.

30 – Coffee, tea, cocoa, sugar, rice, tapioca, sago, artificial coffee; flour and preparations made from cereals, bread, pastry and confectionery, ices; honey, treacle; yeast, baking-powder; salt, mustard; vinegar, sauces (condiments); spices; ice; fruit sauces.

32 – Beers; mineral and aerated waters and other non-alcoholic drinks; fruit drinks and fruit juices; syrups and other preparations for making beverages (except powders for making beverages).

(260) AM 2019 98072 A

(800) 1272218

(151) 2015 10 07

(891) 2018 05 17

(731) PORTOLA PHARMACEUTICALS, INC.
270 East Grand Avenue, South San Francisco
CA 94080, USA

(540)

ANDEXXA

(591) Black, white

(511)

5 – Pharmaceutical preparations for use in oncology and hematology; pharmaceutical preparations for the treatment of coagulation disorders, thrombosis, hematologic cancers, and inflammation.

(260) AM 2019 98073 A

(800) 1294757

(151) 2015 09 17

(891) 2017 12 26

(731) GULYAEVA, Nataliya Ivanivna
14 S. Esenina Str., ap. 6, Kharkiv 61072, Ukraine

(540)



(591) Black, white

(531) 08.01.23; 27.03.15

(511)

30 – Peanut confectionery; flour; farinaceous foods; pastries; bread rolls; buns; sandwiches; binding agents for edible ices; sausage binding materials; vanillin [vanilla substitute]; vanilla [flavoring] [flavoring]; waffles; vermicelli [noodles]; oatmeal; oat flakes; oat-based food; weeds [condiment] (terms too vague in the opinion of the International Bureau – Rule 13(2)(b) of the Common Regulation); biscuits; glucose for culinary purposes; relish [condiment]; essences for foodstuffs, except etheric essences and essential oils; fruit jellies [confectionery]; chewing gum; custard; leaven; frozen yoghurt [confectionery ices]; frozen yoghurt [confectionery ices]; flavorings, other than essential oils, for beverages; flavorings, other than essential oils, for cakes; aromatic preparations for food; flavorings, other than essential oils; preparations for stiffening whipped cream; thickening agents for cooking foodstuffs; cereal preparations; ginger [spice]; coffee; unroasted coffee; coffee flavorings [flavourings]; coffee-based beverages; coffee beverages with milk; vegetal preparations for use as coffee substitutes; cocoa; cocoa beverages with milk; cocoa-based beverages; cocoa products (terms too vague in the opinion of the International Bureau – Rule 13(2)(b) of the Common Regulation); capers; caramels [candy]; pastilles [confectionery]; curry [spice]; ketchup [sauce]; sugar confectionery; tortillas; cinnamon [spice]; groats for human food; corn, milled; corn, roasted; corn flour; popcorn; corn flakes; confectionery for decorating christmas trees; liquorice [confectionery]; noodles; candy; mint for confectionery; peppermint sweets; mayonnaise; macaroni; farinaceous food pastes; maltose; chow-chow [condiment]; marzipan; royal jelly; honey; molasses for food; macaroons [pastry]; almond paste; almond confectionery; flour-milling products (terms too vague in the opinion of the International Bureau – Rule 13(2)(b) of the Common Regulation); pancakes; spring rolls; gruel, with a milk base, for food; ice cream; nutmegs; muesli; tea-based beverages; chocolate-based beverages; infusions, not medicinal; ravioli; pepper; cookies; meat pies; quiches; natural sweeteners; pizzas; chips [cereal products]; pies; fondants [confectionery]; powders for ice cream; edible decorations for cakes, pastries; seasonings; unleavened bread; gingerbread; spices; puddings; cake powder; rice cakes; ferments for pastes; golden syrup; malt extract for food; spaghetti; rusks; breadcrumbs; petit-beurre biscuits; cakes; tarts; sherbets [ices]; halvah; sweetmeats [candy]; sugar; chocolate; chocolate beverages with milk.

(260) AM 2019 98074 A

(800) 1365180

(151) 2017 03 13

(891) 2018 05 23

(731) GRANAROLO S.P.A.

Via Cadriano, 27/2, I-40127 BOLOGNA, Italy

(540)



(591) Black, white

(531) 01.15.15; 11.03.02; 11.03.20; 26.11.08; 27.03.01; 27.05.11

(511)

5 – Dietetic food and substances adapted for medical use, food for babies; powdered milk for babies; lacteal flour for babies; food supplements for humans; nutritional supplements for medical use; dietetic beverages adapted for medical purposes; milk ferments for pharmaceutical purposes; ferments for pharmaceutical purposes; alginate dietary supplements; casein dietary supplements; enzyme dietary supplements; wheat germ dietary supplements; glucose dietary supplements; lecithin dietary supplements; yeast dietary supplements; pollen dietary supplements; propolis dietary supplements; protein dietary supplements; protein supplements for animals; mineral food supplements; milk sugar for pharmaceutical purposes; royal jelly dietary supplements.

29 – Meat, fish, poultry and game; meat extracts; preserved, frozen, dried and cooked fruits and vegetables; jellies, jams, compotes; eggs; edible oils and fats; milk-based drinks; milk beverages, milk predominating; beverages made from or containing milk; drinks made from dairy products; drinks-based on yogurt; flavoured milk beverages; milk drinks containing fruits; yogurt drinks; beverages consisting principally of milk; butter; garlic butter; butter with herbs; double cream; buttercream; smetana [sour cream]; dairy spreads; low fat dairy spreads; cheese spreads; dulce de leche [condensed milk]; ferments (milk -) for culinary purposes; cheese fondue; cheese; cream cheese; soft white cheese; fresh unripened cheeses; cheese mixtures; low fat cheese; soft cheese; cheese containing herbs; cheese containing spices; cottage cheese; soya cheese; blue cheese; ready grated cheese; cheese powder; processed cheese; cheese dips; milk shakes; dairy-based whipped topping; milk; curd; protein milk; milk (albumin); flavoured milk; organic milk; cows' milk; buttermilk; condensed milk; soya milk [milk substitute]; dried milk; fermented milk; goat milk; flavoured milk powder for making drinks; powdered milk for food purposes; skimmed milk; milk products; margarine; blended butter; sour cream; whipped cream; coffee cream in the form of powder; cream [dairy products]; preparations for making yoghurt; butter substitutes; cottage cheese preparations; quark; ricotta cheese; margarine substitutes; tofu; yoghurt; soya

yoghurt; low fat yoghurts; flavoured yoghurts; fruit flavoured yoghurts; drinking yogurts; yoghurt made from goats milk; custard style yoghurts; quail eggs; savory butters; clarified butter; concentrated butter; butter for use in cooking; coconut butter; dairy puddings; canned fruits; fruit chips; preserved fruits; fruit, stewed; prepared fruits; fruit jellies; jellies, jams, compotes, fruit and vegetable spreads; fruit salads; fruit desserts; desserts made from milk products; yoghurt desserts; sweets, milk-based; artificial milk-based desserts; dairy-based dips; fruit-based snack food; soy-based snack foods; fruit preserved in alcohol; crystallized fruits; substitutes for milk and cheese products; lecithin for culinary use; marmalade; fruit pulp; fruit-based snack food; ginger jam; soya bean oil for food; soya beans, preserved, for food; soya (prepared); preserved soya beans; soy-based snack foods; soya yoghurt; vegetable yoghurt; dried soya beans; hamburgers, meatballs and cutlets made with vegetables; hamburgers, meatballs and cutlets made with soy; vegetable cream; vegetable bechamel sauce; soy crisps; dried fruit; dried fruit mixes; dried fruit products; vegetable puree; soy-based creams; soya bean foods; soy-based extruded foods; flaxseed for human consumption; fruit jams; almond milk.

30 – Coffee, tea, cocoa and artificial coffee; rice; tapioca and sago; flour and preparations made from cereals; bread, pastry and confectionery; ices; sugar, honey, treacle; yeast, baking-powder; salt; mustard; vinegar, sauces (condiments); flavourings; ice; spices; coffee flavorings [flavourings]; flavourings (other than essential oils); flavourings, other than essential oils, for beverages; flavourings, other than essential oils, for cakes; beverages (cocoa-based); beverages (coffee-based); beverages (chocolate-based); tea-based beverages; biscuits; malt biscuits; petit-beurre biscuits; bonbons; brioches; puddings; cocoa; cocoa beverages with milk; coffee; coffee beverages with milk; coffee (unroasted -); candies; peppermint candy; waffles; chocolate; chocolate beverages with milk; aromatic preparations for food; condiments; confectionery; peanut confectionery; almond confectionery; sugar coated almond; com flakes; fruit sauces; crackers; almond brittle; desserts; sweeteners (natural -); confectionery for decorating Christmas trees; essences for foodstuffs, except etheric essences and essential oils; malt extract for food; oat flakes; chips [cereal products]; fondants; ice creams; fruit jellies [confectionery]; edible ice; ice, natural or artificial; maize, milled; maize, roasted; popcorn; liquorice [confectionery]; mint for confectionery; mousses (chocolate -); mousse (dessert); muesli; barley (crushed -); husked barley; rusks; royal jelly, not for medical use; almond paste; farinaceous food pastes; pastries; pastry making confectionery; lozenges [confectionery]; petits fours [cakes]; cereals; vegetal preparations for use as coffee substitutes; cocoa products; propolis; seasonings; treacles syrup; oat-

meal; semolina; grits; cereal-based snack food; rice-based snack food; sherbets [ices]; artificial coffee; tea; iced tea; cakes; rice cakes; vanilla [flavoring] [flavouring]; vanillin [vanilla substitute]; yoghurt (frozen -) [confectionery ices]; ginger [spice]; sugar; sweetmeats [candy]; oat-based food for human consumption; vegetable puddings; soy-based puddings; bread with soy bean; soy-based condiments; soya based ice cream products; rice biscuits; rice crackers; soy-based biscuits; soya bean paste (condiments); soya flour for food; snack food products made from soya flour; soy-based ice cream substitute; soya sauce; processed cereals; food mixtures consisting of cereal flakes and dried fruits; extruded snacks containing maize; extruded food products made of maize; extruded food products made of wheat; snack foods consisting principally of extruded cereals; ready to eat savory snack foods made from maize meal formed by extrusion; cereal flour; cereal bars; ready-to-eat cereals; dried chips [cereal products]; foodstuffs made from cereals; cereal-based snack food; grain-based chips; breakfast cereals; crisps made of cereals; muesli consisting predominantly of cereals; cereal-based food bars; cereal bars and energy bars; cereal products in bar form; snack food products made from cereal flour; high-protein cereal bars; breakfast cereals made of rice; cereal preparations consisting of oatbran; grain-based coffee substitutes; snack bars containing a mixture of cereals, nuts and dried fruit; flour of oats; oat flakes; oat biscuits for human consumption; bran preparations for human consumption; tortilla chips; maize flakes; snack foods prepared from maize; foodstuffs made from maize; snack foods made from corn; rice crisps; rice sweet snacks; rice-based dishes; rice-based snacks; dry and liquid ready-to-serve meals, mainly consisting of rice; brown sugar; sweeteners (natural -); filled brioches; crackers filled with cheese; crackers made of prepared cereals; savory pastries; snack food products; sesame snacks; cereal-based snack food; rice-based snack food; flavourings for cheeses; flavourings for butter; puddings with sponge cakes; rice puddings containing sultanas and nutmeg; ready-to-eat puddings; rice-based pudding dessert; semolina pudding; crackers; savory biscuits; crackers flavoured with fruit; custard; cocoa-based creams in the form of spreads; chocolate creams; spreads made from chocolate and nuts; chocolate spreads for use on bread; sandwich spread made from chocolate and nuts; chilled desserts; sweetmeats [candy]; frozen desserts; prepared desserts [chocolate-based]; fruit jellies [confectionery]; mousses (chocolate -); mousse (dessert); mousse confections; pastries, cakes, tarts and biscuits (cookies); preparations for making puddings; chocolate topping; sweet spreads [honey]; ice cream stick bars; ice cream drinks; ice beverages with a coffee base; ice beverages with a chocolate base; ice beverages with a cocoa base; sweets-based on frozen yoghurt; frozen custards; ice

cream desserts; ice confectionery; ice-cream cakes; dairy ice cream; soy-based ice cream products; ice creams containing chocolate; ice cream with fruit; sorbets [water ices]; ice creams flavoured with chocolate; ices; edible fruit ices; ice cream with fruit; ices; ice cream mixes; non-dairy ice cream; yoghurt-based ice cream [ice cream predominating]; ice cream sticks; ice lollies; flavored ices; fruit ices; ice lollies being milk flavoured; ice lollies containing milk; water ice; ice milk [ice cream]; frozen lollipops; parfaits; fruit flavoured water ices in the form of lollipops; sherbets [ices]; sorbets; ice cream substitute; soy-based ice cream substitute; ice cream cakes; yoghurt (frozen -) [confectionery ices]; frozen yoghurt; drinking chocolate; frappes; pasta; pasta containing stuffings; fresh pasta; ravioli; tortellini; dumplings; pasta dishes; couscous [semolina]; fruit sauces; soy sauces.

31 – Grains and agricultural, horticultural and forestry products not included in other classes; live animals; fresh fruits and vegetables; seeds; natural plants and flowers; foodstuffs for animals; malt; mushrooms; maize; fresh soya beans; grains germ; soya sprouts; bran.

32 – Beers; mineral and aerated waters and other non-alcoholic beverages; fruit beverages and fruit juices; syrups and other preparations for making beverages; rice-based beverages (rice milk); oat-based beverages (oat milk); non-dairy milk; fruit-based beverages; vegetable drinks; fruit juices; soy-based beverages, other than milk substitutes.

(260) AM 2019 98075 A

(800) 1388778

(151) 2017 07 10

(891) 2018 04 27

(731) MARSHALL AMPLIFICATION PLC
Denbigh Road, Bletchley, Milton Keynes
MK1 1DQ, United Kingdom

(540)



(591) Black, white

(531) 27.05.01; 27.05.19

(511)

9 – Electrical and electronic audio apparatus and instruments; receivers (audio- and video-); juke boxes [musical]; sound recording, manipulating, amplifying, reproducing and transmitting apparatus; record players; sound transmitting apparatus; sound recording apparatus; sound reproduction apparatus; megaphones; electrical and electronic apparatus and instruments, all for audio amplification, for the graphic equalisation of sound signal frequencies, for mixing sound tones, altering sound tones, or effecting

echo, delay and other effects; sound recording carriers; audio speakers for automobiles; mobile phone speakers; sound amplifiers; microphones, headphones; loudspeakers; horn-type speakers, loudspeaker cabinets; cases for loudspeakers; amplifiers for sound reproducing equipment and for use with musical instruments; amplifiers complete with loudspeakers and cabinets; valve and digital guitar amplifiers; sound reverberation units; sound mixing, processing and synthesizing apparatus; sound mixers; sound-mixer units; cabinets for loudspeakers; megaphones; acoustic pickup; loudspeakers; amplifiers; microphones; time delay reverberator; radios; wireless transmitters; transmitters of electronic signals; transmitters [telecommunications]; MP3 players; record players; portable media players; portable and hand-held digital electronic devices for recording, organizing, transmitting and processing audio, data and video files and electronic accessories therefore; personal stereos; docking stations; stands for MP3 players; stereo amplifier and speaker base stations; stereos; car stereos; vehicle stereos; DVD players; CD, DVD and MP3 cases; computer games; interactive DVD games; computer game programs; computer software for recording sound; computer software, recorded; electronic tuners; amplifier tuners; apparatus for controlling amplifiers; regulating apparatus, electric; remote control apparatus; computer software; computer software for tuning instruments; computer software for controlling amplifiers; computer software for sound recording, manipulating, amplifying, reproducing and transmitting apparatus; interactive computer software; audio playback software; application software; application software for sound recording, manipulating, amplifying, reproducing and transmitting apparatus; computer programs [downloadable software]; computer software applications, downloadable; computer programmes [programs], recorded; audio processing apparatus; data processing apparatus; speakers; speakers [audio equipment]; audio speakers; loud speakers; monitor speakers; audio speakers for home; speakers for record players; speaker enclosures; audio speaker enclosures; cabinets for loudspeakers; speaker switches; switches, electric; record players; software to control and improve audio equipment and sound quality; firmware; computer firmware; computer hardware; apparatus for the processing of sounds; downloadable musical sound recordings; sound data file; downloadable music files; data transmitting apparatus; software for remote diagnostics; diagnostic apparatus, not for medical purposes; telecommunications devices; transmitting sets [telecommunication]; hand-held computers; laptop computers; computer cases; bags adapted for laptops; mobile phones; mobile telephones; mobile phone cases; telephone sheath; mobile phone accessories; computer software for communicating with users of hand-held computers; sunglasses; eyeglasses; eyeglass frames; eyeg-

lass cases; sunglass cases; spectacle cases; spectacles [optics]; glasses; mouse mats; mouse pad; magnets, refrigerator magnets; magnets; calculators; pocket calculators; wireless telephones; wireless communication apparatus; wireless telephony apparatus; wireless headsets for smartphones; wireless transmitters and receivers; two-way wireless communication systems; wireless high frequency transmission instruments; cordless telephones; radiotelephony sets; radios; radios (vehicle-); software to control and improve audio equipment and sound quality; audio playback software; interactive computer software; computer software for communication with users of hand-held computers; foot pedals and foot switches for processing, amplifying or distorting sound; foot pedals and foot switches for processing, amplifying or distorting sound for use with musical instruments; music cassettes; music tapes; music recordings; musical recordings; downloadable digital music; prerecorded music videos; portable music players; music-composition software; digital music players; downloadable music files; musical video recordings; musical sound recordings; prerecorded music audio tapes; prerecorded music compact discs; optical discs featuring music; compact discs featuring music; audio tapes featuring music; phonograph records featuring music; prerecorded non-musical videotapes; downloadable musical sound recordings; covers for music storage devices; cases for music storage devices; prerecorded audio tapes featuring music; downloadable video recordings featuring music; prerecorded video cassettes featuring music; pre-recorded DVDs featuring music; prerecorded video tapes featuring music; series of musical sound recordings; prerecorded non-musical audio tapes; carrying cases for digital music players; carrying cases for portable music players; digital music downloadable from the Internet; docking stations for digital music players; digital music downloadable provided from the internet; computer programs for processing digital music files; laser discs for use in storing music; computer software for processing digital music files; musical recordings in the form of discs; digital music downloadable provided from MP3 internet websites; computer software for creating and editing music and sounds; digital music downloadable provided from MP3 internet web sites; downloadable digital music provided from MP3 Internet web sites; digital music [downloadable] provided from mp3 web sites on the internet; digital music downloadable provided from a computer database or the internet; machine readable computer programs for use in the reproduction of music; integrated circuit memory cards for use in playing electronic musical instruments; electronic publications; downloadable publications; electronic publications recorded on computer media; audio apparatus; audio books; audio compact discs; binders for CDs; cases adapted for CD players; cases adapted for DVD players; cases adapted for mobile

phones; cases for compact discs; cases for MP3 players; cases for spectacles; cases for smartphones; cases for mobile phones; cases for sunglasses; cases for telephones; CD storage wallets; cleaning apparatus for sound recording discs; compact discs; compact discs [audio-video]; computer software for mobile phones; covers for MP3 players; downloadable image files; downloadable movies; DVD cases; portable media players; recording apparatus; recording discs; tape recorders; tape players; computer software for use with any of the aforesaid goods; parts and fittings for the aforesaid goods.

15 – Instruments (musical -); musical accessories; musical instruments; acoustic bass guitars; acoustic basses; acoustic guitars; bass guitars; bass drums-ticks; bass drum sticks; bass drums; basses [musical instruments]; brass instruments; carrying cases for musical instruments; cases adapted for musical instruments; cases for musical instruments; computer controlled musical instruments; devices for tuning musical instruments; drum machines; drum pedals; drum pedals [musical instruments]; drum sticks; drum practice pads; drumheads; drums; drums [musical instrument]; drums [musical instruments]; drumsticks; electric and electronic musical instruments; electric bass guitars; electric basses; electric guitars; electric keyboards [musical instruments]; electric musical instruments; electric pianos; electrical musical instruments; electronic apparatus for synthesising music [musical instrument]; electronic automatically controlled rhythm machines; electronic background music machines; electronic drums; electronic keyboards [musical instruments]; electronic musical synthesizers; electronic musical instruments; electronic musical instrument tuners; electronic musical apparatus for practice; electronic musical apparatus and instruments; electronic musical apparatus for accompaniment; electronic musical apparatus for instruction; guitar armrests; guitar picks; guitar saddles; guitar shoulder straps; guitar straps; guitar strings incorporating steel; guitar strings; guitar strings made from steel; guitar toggle switch tips; guitar tuning cranks; guitars; keyboard instruments; music boxes; music stands; music synthesizers; music stands adapted for use with musical instruments; musical boxes; musical instrument cases; musical instrument stands; musical instruments controlled by computer; musical instruments in the nature of steel drums; musical instruments incorporating apparatus for modifying audio signals; musical instruments incorporating arrangements for modifying audio signals; musical instruments incorporating apparatus for producing audio signals; musical instruments incorporating arrangements for producing audio signals; percussion instruments; picks for stringed instruments; picks for stringed musical instruments; string instruments; stands (music -); woodwind instruments; foot switches and effects pedals for use with electrical musical instruments; foot

switches and effects pedals for use with musical instruments, sustain pedals, expression pedals, delay pedals, all being electronic effects pedals for use with musical instruments; sustain pedals, expression pedals, delay pedals, all being electronic effects pedals for use with musical instruments.

(260) AM 2019 98076 A

(800) 1406357

(151) 2018 01 31

(891) 2018 01 31

(731) ALPAYA DOĞAL VE KOZMETİK
URUNLERI, SANAYİ VE TİCARET
ANONİM ŞİRKETİ

Sanayi Mah, 1655, Sok, Akbatı Residence,
Yesil C, Blok, 2, Kat, Daire No.201, Esenyurt,
Istanbul, Turkey

(540)

FORSCAR

(591) Black, white

(531) 27.05.01

(511)

3 – Non-medicated cosmetics and toiletry preparations; non-medicated dentifrices; perfumery, essential oils.

5 – Pharmaceuticals, medical preparations; sanitary preparations for medical purposes; plasters, materials for dressings; disinfectants.

(260) AM 2019 98077 A

(800) 1406374

(151) 2018 01 31

(891) 2018 01 31

(731) BOBKOV GLEB VIKTOROVICH

Trofimova ul, d.10, kv. 179, RU-115432
Moscow, Russian Federation

(540)



(591) Black, white

(531) 24.09.02; 24.09.05; 24.09.07; 25.03.01; 28.05

(526) ®

(511)

3 – Make-up preparations; make-up removing preparations; mascara; massage gels, other than for medical purposes; mint essence [essential oil]; mint for perfumery; mouthwashes, not for medical purposes; musk [perfumery]; mustache wax; nail art stickers; nail care preparations; nail polish; nail varnish removers; neutralizers for permanent waving; non-slipping liquids for floors; non-slipping wax for floors; oil of turpentine for degreasing; oils for cleaning purposes; oils for cosmetic purposes; oils for perfume

and scents; oils for toilet purposes; paint stripping preparations; pastes for razor strops; perfumery; perfumes; petroleum jelly for cosmetic purposes; polish for furniture and flooring; polishing creams; polishing paper; polishing preparations; polishing rouge; polishing stones; polishing wax; pomades for cosmetic purposes; potpourris [fragrances]; preparations for cleaning dentures; preparations for unblocking drain pipes; preparations to make the leaves of plants shiny; preservatives for leather [polishes]; pumice stone; quillaia bark for washing; rose oil; rust removing preparations; sachets for perfuming linen; safrol; sandpaper; scented water; scented wood; scouring solutions; shampoos; shampoos for pets [non-medicated grooming preparations]; shaving preparations; shaving soap; shaving stones [astringents]; shining preparations [polish]; shoe cream; shoemakers' wax; shoe polish; shoe wax; silicon carbide [abrasive]; skin whitening creams; smoothing preparations [starching]; smoothing stones; soap; soap for brightening textile; soap for foot perspiration; soda lye; stain removers; starch glaze for laundry purposes; sunscreen preparations; sun-tanning preparations [cosmetics]; tailors' wax; talcum powder, for toilet use; terpenes [essential oils]; tissues impregnated with cosmetic lotions; tissues impregnated with make-up removing preparations; toiletry preparations; toilet water; tripoli stone for polishing; turpentine for degreasing; varnish-removing preparations; volcanic ash for cleaning; wallpaper cleaning preparations; washing soda, for cleaning; whitening; windshield cleaning liquids.

(260) AM 2019 98081 A

(800) 1406469

(151) 2018 02 21

(891) 2018 02 21

(731) Limited liability company, Firm "BIOKOR"
str. Lermontova, h. 3, RU-440026 Penza,
Russian Federation

(540)



(591) Black, white

(531) 01.03.01; 26.04.05; 26.04.13; 26.04.18;
26.04.24; 28.05

(511)

5 – Balms for medical purposes; dietetic substances adapted for medical use; dietetic beverages adapted for medical purposes; dietetic foods adapted for medical purposes; nutritional supplements adapted for

medical purposes; mineral food supplements; vitamins; dietary supplements, including in the nature of syrups, in the nature of a powdered drink mix, pill, in tablet form; herbal teas for medicinal purposes; syrups for pharmaceutical purposes; medical preparations for slimming purposes.

(260) AM 2019 98082 A
 (800) 1406470
 (151) 2018 02 15
 (891) 2018 02 15
 (731) PEPSICO, INC. (a North Carolina corporation)
 700 Anderson Hill Road, Purchase,
 New York 10577, USA
 (540)



(591) White, black, red, brown, light brown, dark brown, reddish-brown, yellow, green
 (531) 05.09.15; 05.09.25; 08.01.06; 08.03.08;
 19.03.01; 19.03.05; 24.03.01; 24.15.21;
 25.05.02; 27.05.01; 28.05; 29.01; 29.01.15
 (526) GRENKI
 (511)
 30 – Cereal-based snack food; rusks; toast.

(260) AM 2019 98083 A
 (800) 1406471
 (151) 2018 02 15
 (891) 2018 02 15
 (731) PEPSICO, INC. (a North Carolina corporation)
 700 Anderson Hill Road, Purchase,
 New York 10577, USA
 (540)



(591) White, black, red, brown, light brown, dark brown, reddish-brown, pink, yellow, green.

(531) 08.01.06; 08.05.15; 19.03.01; 19.03.05;
 24.03.01; 24.15.21; 25.05.02; 27.05.01; 28.05;
 29.01.15
 (526) GRENKI
 (511)
 30 – Cereal-based snack food; rusks; toast.

(260) AM 2019 98088 A
 (800) 1406636
 (151) 2018 05 14
 (891) 2018 05 14
 (731) JANSSEN PHARMACEUTICA NV
 Turnhoutseweg 30, Beerse; B-2340, Belgium
 (540)

SPRYLANA

(591) Black, white
 (511)
 5 – Human pharmaceutical preparations for the prevention and treatment of central nervous system disorders.

(260) AM 2019 98092 A
 (800) 1406691
 (151) 2018 02 15
 (891) 2018 02 15
 (731) Limited Liability Company, "WIMM-BILL-DANN FOODS"
 Dmitrovskoe avenue, 108, RU-127591
 Moscow, Russian Federation
 (540)



(591) Blue, white.
 (531) 27.05.04; 27.05.17; 27.05.24; 28.05; 29.01.12
 (511)
 5 – Food for babies; lacteal flour for babies.

29 – Bouillon; fruit-based snack food; yogurt; kephir [milk beverage]; milk shakes; compotes; vegetables, tinned [canned (Am.)]; fruits, tinned [canned (Am.)]; butter; milk; condensed milk; soya milk [milk substitute]; fruit pulp; milk beverages, milk predominating; vegetables, preserved; vegetables, cooked; vegetables, dried; milk products; curd; cranberry sauce [compote]; apple purée; ryazhenka [fermented baked milk]; cream [dairy products]; smetana [sour cream]; soups; vegetable soup preparations; cheese; crystallized fruits; frozen fruits; fruit, preserved; fruit, stewed.

32 – Mineral water [beverages]; waters [beverages]; table waters; cocktails, non-alcoholic; lemonades; non-alcoholic beverages; whey beverages; non-alcoholic fruit juice beverages; fruit nectars, non-alcohol-

lic; powders for effervescent beverages; syrups for lemonade; syrups for beverages; smoothies; vegetable juices [beverages]; fruit juices; tomato juice [beverage]; cider, non-alcoholic.

(260) AM 2019 98093 A

(800) 1406723

(151) 2018 02 19

(891) 2018 02 19

(731) RICHTER GEDEON NYRT.

Gyömrői út 19-21, H-1103 Budapest, Hungary

(540)



ГЕДЕОН РИХТЕР

(591) Blue, white

(531) 26.01.18; 27.05.22; 28.05; 29.01.12

(511)

5 – Pharmaceutical preparations.

41 – Education, providing of training; conducting conferences, symposiums, congresses and awards ceremonies as well as presenting them via traditional and electronic means.

(260) AM 2019 98094 A

(800) 1406724

(151) 2018 02 19

(891) 2018 02 19

(731) RICHTER GEDEON NYRT.

Gyömrői út 19-21, H-1103 Budapest, Hungary

(540)



GEDEON RICHTER

(591) Blue, white

(531) 26.01.18; 27.05.10; 29.01.12

(511)

5 – Pharmaceutical preparations.

41 – Education, providing of training; conducting conferences, symposiums, congresses and awards ceremonies as well as presenting them via traditional and electronic means.

(260) AM 2019 98095 A

(800) 1406725

(151) 2018 02 19

(891) 2018 02 19

(731) RICHTER GEDEON NYRT.

Gyömrői út 19-21, H-1103 Budapest, Hungary

(540)



(591) Black, white

(531) 26.01.18; 27.05.19; 27.05.22

(511)

5 – Pharmaceutical preparations.

41 – Education, providing of training; conducting conferences, symposiums, congresses and awards ceremonies as well as presenting them via traditional and electronic means.

(260) AM 2019 98096 A

(800) 1406750

(151) 2018 03 14

(891) 2018 03 14

(731) ONE BEAUTY ITALIA S.r.l.

Via G. Meoni, 9, I-59100 PRATO, Italy

(540)

Kezy

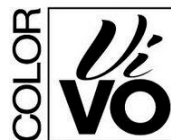

(591) Black, white

(531) 26.04.05; 26.04.18; 26.04.22; 27.05.01;

27.05.09; 27.05.10; 27.05.10

(511)

3 – Cosmetics; hair care and hair treatment preparations; hair creams; hair conditioners; hair spray; hair waxes; hair dyes; tints for the hair; hair lotions; hair waving and hair-setting preparations; preparations for setting hair; hair straightening preparations; bleaching preparations for the hair; hair sprays and hair gels; hair foam; shampoo; soaps and cleansers for the scalp.

(260) AM 2019 98097 A

(800) 1406800

(151) 2018 01 15

(891) 2018 01 15

(731) Obshchestvo s ogranichennoy

otvetstvennost'yu, "Koordinirovushchy

raspredelitel'ny tsentr, "EFKO-Kaskad"

ul. Frunze, 4, g. Alekseevka, RU-309850

Belgorodskaya obl., Russian Federation

(540)

Виват Россия

(591) Black, white

(531) 28.05

(511)

29 – Edible oils and fats, other than milk fat and its substitutes; tomato purée.

30 – Mustard, vinegar, condiments in particular dressings for salad based on tomato, sauces [condiments], including mayonnaise, ketchup.

(260) AM 2019 98098 A

(800) 1406801

(151) 2018 01 17

(891) 2018 01 17

(731) Limited Liability Company, "WIMM-BILL-DANN FOODS"

d. 108, Dmitrovskoe shosse, RU-127591
Moscow, Russian Federation

(540)



(591) Lilac, light grey, grey

(531) 01.01.02; 01.15.21; 27.05.03; 27.05.08; 28.05; 29.01.12

(511)

5 – Thermal water; hematogen; food for babies; babies' diapers; lacteal flour for babies.

29 – Bouillon; meat jellies; jellies for food; fruit jellies; fruit-based snack food; yogurt; kephir [milk beverage]; milk shakes; compotes; vegetables, tinned; fruits, tinned; buttercream; kumys [milk beverage]; margarine; marmalade; butter; milk; condensed milk; soya milk; albumin milk; vegetable mousses; fruit pulp; milk beverages, milk predominating; jams; milk products; curd; cranberry compote; apple purée; ryazhenka [fermented baked milk]; whipped cream; cream [dairy products]; fat-containing mixtures for bread slices; smetana [sour cream]; soups; vegetable soup preparations; whey; cheese; tofu; crystallized fruits; frozen fruits; fruit, preserved; fruit, stewed; potato flakes; potato chips; low-fat potato chips; fruit chips.

30 – Cereal bars; high-protein cereal bars; leaven; rice-based snack food; cereal-based snack food; frozen yogurt [confectionery ices]; candy; edible ices; ice cream; dessert mousses [confectionery]; chocolate mousses; muesli; cocoa beverages with milk; coffee beverages with milk; chocolate beverages with milk; cookies; petit-beurre biscuits; powders for making ice cream; puddings; fruit coulis [sauces]; sherbets [ices].

32 – Aerated water; mineral water [beverages]; waters [beverages]; cocktails, non-alcoholic; lemonades; non-alcoholic beverages; whey beverages; non-alcoholic fruit juice beverages; fruit nectars, non-alcoholic; smoothies; vegetable juices [beverages]; fruit juices.

(260) AM 2019 98101 A

(800) 1406862

(151) 2017 12 25

(891) 2017 12 25

(731) "REGULUS" Joint-stock company
ul. Electrodnaya, 2, RU-111524 Moscow,
Russian Federation

(540)



(591) Black, white

(531) 02.09.01; 27.05.07; 27.05.11

(511)

30 – Allspice; almond confectionery; almond paste; aniseed; aromatic preparations for food; artificial coffee; baking powder; baking soda [bicarbonate of soda for cooking purposes]; barley meal; bean meal; beer vinegar; binding agents for ice cream; bread; bread rolls; breadcrumbs; buns; cake dough; cake frosting [icing]; cake powder; cakes; candy; capers; caramels [candy]; celery salt; cereal bars; cereal preparations; cereal-based snack food; cheeseburgers [sandwiches]; chewing gum; chicory [coffee substitute]; chips [cereal products]; chocolate; chocolate beverages with milk; chocolate mousses; chocolate-based beverages; chow-chow [condiment]; chutneys [condiments]; cinnamon [spice]; cloves [spice]; cocoa; cocoa beverages with milk; cocoa-based beverages; coffee; coffee beverages with milk; coffee flavorings; coffee-based beverages; condiments; confectionery; confectionery for decorating Christmas trees; cookies; cooking salt; corn flakes; corn flour; corn, milled; corn, roasted; couscous [semolina]; crackers; cream of tartar for culinary purposes; crushed barley; crushed oats; curry [spice]; custard; dessert mousses [confectionery]; dough; dressings for salad; edible ices; essences for foodstuffs, except etheric essences and essential oils; ferments for pastes; flavorings, other than essential oils, for beverages; flavorings, other than essential oils, for cakes; flour; fondants [confectionery]; food flavorings, other than essential oils; frozen yogurt [confectionery ices]; fruit coulis [sauces]; fruit jellies [confectionery]; garden herbs, preserved [seasonings]; ginger [spice]; gingerbread; glucose for culinary purposes; gluten additives for culinary purposes; gluten prepared as foodstuff; golden syrup; groats for human food; gruel, with a milk base, for food; halvah; ham

glaze; high-protein cereal bars; hominy; hominy grits; honey; husked barley; husked oats; ice cream; ice for refreshment; ice, natural or artificial; iced tea; infusions, not medicinal; ketchup [sauce]; leaven; linseed for culinary purposes [seasoning]; liquorice [confectionery]; macaroni; macaroons [pastry]; malt biscuits; malt extract for food; malt for human consumption; maltose; marinades; marzipan; mayonnaise; meat gravies; meat pies; meat tenderizers for household purposes; mint for confectionery; molasses for food; muesli; mustard; mustard meal; natural sweeteners; noodle-based prepared meals; noodles; nutmegs; oat flakes; oat-based food; oatmeal; palm sugar; pancakes; pasta; pasta sauce; pastilles [confectionery]; pastries; peanut confectionery; pepper; peppermint sweets; peppers [seasonings]; pesto [sauce]; petit-beurre biscuits; petits fours [cakes]; pies; pizzas; popcorn; potato flour; powders for making ice cream; pralines; preparations for stiffening whipped cream; propolis; puddings; quiches; ravioli; relish [condiment]; rice; rice cakes; rice-based snack food; royal jelly; rusks; saffron [seasoning]; sago; salt for preserving foodstuffs; sandwiches; sauces [condiments]; sausage binding materials; sea water for cooking; seasonings; seaweed [condiment]; semolina; sherbets [ices]; soya bean paste [condiment]; soya flour; soya sauce; spaghetti; spices; spring rolls; star aniseed; starch for food; stick liquorice [confectionery]; sugar; sushi; sweetmeats [candy]; tabbouleh; tacos; tapioca; tapioca flour; tarts; tea; tea-based beverages; thickening agents for cooking foodstuffs; tomato sauce; tortillas; turmeric; unleavened bread; unroasted coffee; vanillin [vanilla substitute]; vegetal preparations for use as coffee substitutes; vermicelli [noodles]; vinegar; waffles; wheat flour; wheat germ for human consumption; yeast.

35 – Administrative processing of purchase orders; advertising; advertising agency services; advertising by mail order; advisory services for business management; arranging newspaper subscriptions for others; arranging subscriptions to telecommunication services for others; auctioneering; bill-posting; book-keeping; business appraisals; business auditing; business efficiency expert services; business information; business inquiries; business investigations; business management and organization consultancy; business management assistance; business management consultancy; business management of hotels; business management of performing artists; business management of sports people; business organization consultancy; business research; commercial administration of the licensing of the goods and services of others; commercial information agency services; commercial information and advice for consumers [consumer advice shop]; commercial or industrial management assistance; compilation of information into computer databases; compilation of statistics; computerized file management; copywriting; cost price analysis; data search in computer files for

others; demonstration of goods; direct mail advertising; dissemination of advertising matter; distribution of samples; document reproduction; drawing up of statements of accounts; economic forecasting; employment agency services; import-export agency services; invoicing; layout services for advertising purposes; market studies; marketing; marketing research; modelling for advertising or sales promotion; news clipping services; office machines and equipment rental; on-line advertising on a computer network; opinion polling; organization of exhibitions for commercial or advertising purposes; organization of fashion shows for promotional purposes; organization of trade fairs for commercial or advertising purposes; outsourcing services [business assistance]; payroll preparation; personnel management consultancy; personnel recruitment; photocopying services; presentation of goods on communication media, for retail purposes; price comparison services; procurement services for others [purchasing goods and services for other businesses]; production of advertising films; professional business consultancy; psychological testing for the selection of personnel; public relations; publication of publicity texts; publicity material rental; radio advertising; relocation services for businesses; rental of advertising space; rental of advertising time on communication media; rental of photocopying machines; rental of vending machines; retail or wholesale services for pharmaceutical, veterinary and sanitary preparations and medical supplies; sales promotion for others; secretarial services; shop window dressing; shorthand; sponsorship search; systemization of information into computer databases; tax preparation; telemarketing services; telephone answering for unavailable subscribers; television advertising; transcription of communications [office functions]; typing; updating of advertising material; word processing; writing of publicity texts.

(260) AM 2019 98103 A

(800) 1406864

(151) 2018 03 02

(891) 2018 03 02

(731) AKTSIONERNOE OBSHCHESTVO,
"KOSMETICHESKOE OBYEDINENIE
"SVOBODA"
ul. Vyatskaya, d. 47, RU-127015 MOSCOW,
Russian Federation

(540)

АЛІСА

(591) Black, white

(531) 28.05

(511)

3 – Bleaching preparations and other substances for laundry use; cleaning preparations; cleaning, scouring and abrasive preparations; soap; perfumery;

essential oils; cosmetics; hair lotions; non-medicated dentifrices.

(260) AM 2019 98106 A

(800) 1406900

(151) 2018 01 24

(891) 2018 01 24

(731) PROMETEON TYRE GROUP S.R.L.

Viale Sarca, 222, I-20126 Milano (MI), Italy

(540)

ANTEO

(591) Black, white

(511)

12 – Pneumatic tyres; pneumatic, semi-pneumatic and/or solid tyres; inner tubes and mousse for vehicle tyres; treads for vehicles tire; adhesive rubber patches for repairing inner tubes; tyres for motor vehicles; non-skid devices for vehicle tires; repair outfits for inner tubes; valves for vehicle tires.

(260) AM 2019 98109 A

(800) 1406985

(151) 2017 09 19

(891) 2017 09 19

(731) ELMAS KİMYA, SANAYİ VE TİCARET LİMİTED ŞİRKETİ

Topçu Çeşme Sokak No:1, Topçular,

Eyüp, İstanbul, Turkey

(540)



(591) Blue

(531) 17.02.01; 17.02.02; 29.01.04

(511)

7 – Machines, machine tools and industrial robots for processing and shaping wood, metals, glass, plastics and minerals, 3D printers; construction machines and robotic mechanisms (machines) for use in construction, bulldozers, diggers (machines), excavators, road construction and road paving machines, drilling machines, rock drilling machines, road sweeping machines; lifting, loading and transmission machines and robotic mechanisms (machines) for lifting, loading and transmission purposes: elevators, escalators and cranes; machines and robotic mechanisms (machines) for use in agriculture and animal breeding, machines and robotic mechanisms (machines) for processing cereals, fruits, vegetables and food; beverage preparation machines, electromechanical; beverage processing machines; engines and

motors, other than for land vehicles, parts and fittings therefor, hydraulic and pneumatic controls for engines and motors, brakes other than for vehicles, brake linings for engines, crankshafts, transmission gears for machines, cylinders for engines, pistons for engines, turbines, not for land vehicles, filters for engines and motors, oil, air and fuel filters for land vehicle engines, exhausts for land vehicle engines, exhaust manifolds for land vehicle engines, engine cylinders for land vehicles, engine cylinder heads for land vehicles, pistons for land vehicle engines, carburetors for land vehicles, fuel conversion apparatus for land vehicle engines, injectors for land vehicle engines, fuel economisers for land vehicle engines, pumps for land vehicle engines, valves for land vehicle engines, starters for motors and engines, dynamos for land vehicle engines, sparking plugs for land vehicle engines; bearings (parts of machines), roller or ball bearings; machines for mounting and detaching tires; alternators, current generators, electric generators, current generators operated with solar energy; painting machines, automatic spray guns for paint, electric, hydraulic and pneumatic punching machines and guns, electric adhesive tape dispensers (machines), electric guns for compressed gas or liquid spraying machines, electric hand drills, electric hand saws, electric jigsaw machines, spiral machines, compressed air machines, compressors (machines), vehicle washing installations, robotic mechanisms (machines) with the abovementioned functions; printing machines; packaging machines, filling, plugging and sealing machines, labellers (machines), sorting machines, industrial robots (machines) with the abovementioned functions, machines for textile processing, sewing machines, industrial robots (machines) with the abovementioned functions; pumps [machines], self-regulating fuel pumps; electric kitchen machines for chopping, grinding, crushing, mixing and mincing foodstuff, washing machines, laundry washing machines, dishwashers, spin driers (not heated), electric cleaning machines for cleaning floors, carpets or floorings, vacuum cleaners and parts thereof; automatic vending machines; galvanizing and electroplating machines; electric door openers and closers; joints (parts of engines); abrasive belts for power-operated sanders; flap discs for power-operated grinders; wire wheels for power-operated grinders; grinders [hand-held power driven]; abrasive wheels for power-operated grinders; machine parts, namely, grindstones; honing machines for metalworking; polishing machines for use in grinding and polishing metal, wood, ceramics and plastics; abrasive disks for power-operated sanders; machines and machine tools for the cutting and forming of materials; machine tools, namely, powered machines for cutting or shaping or finishing metals or other materials; electric sander; discs for cutting for use with power tools; abrasive discs [machine tools]; drilling bits [parts of machines]; reamers [parts of

machines]; machines and apparatus for polishing [electric]; milling machines; shaping machines.

(260) AM 2019 98110 A

(800) 1406990

(151) 2017 11 27

(891) 2017 11 27

(731) ALI DAĞDELEN

Yenidoğan Mah. 41 Sk., No.5 D:1

Zeytinburnu, İstanbul, Turkey

(540)

LOVEFREE

(591) Black, white

(531) 27.05.01; 27.05.17

(511)

25 – Clothing, including underwear and outerclot-
hing, other than special purpose protective clothing;
socks, footwear, headgear.

35 – Advertising, marketing and public relations; or-
ganization of exhibitions and trade fairs for commer-
cial or advertising purposes, office functions; secre-
tarial services; arranging newspaper subscriptions
for others; compilation of statistics; rental of office
machines; systemization of information into compu-
ter databases; telephone answering for unavailable
subscribers, business management, business admin-
istration and business consultancy; accounting; com-
mercial consultancy services; personnel recruit-
ment, personnel placement, employment agencies,
import-export agencies, commercial or industrial
management assistance, auctioneering; the bringing
together, for the benefit of others, of clothing, inclu-
ding underwear and outerclothing, other than special
purpose protective clothing, socks, footwear, head-
gear; enabling customers to conveniently view and
purchase those goods, such services may be provi-
ded by retail stores, wholesale outlets, by means of
electronic media or through mail order catalogues.

(260) AM 2019 98111 A

(800) 1406992

(151) 2017 11 30

(891) 2017 11 30

(731) LLP "Kainar-AKB"

Medeu, 1, 040006 Taldykorgan, Kazakhstan

(540)

NOMAD

(591) Black, white

(511)

1 – Sulfuric acid; battery electrolytes.

9 – Accumulators, electric; accumulators, electric,
for vehicles; flashing lights [luminous signals]; acid-
imeters for batteries; battery jars; batteries for lig-
hting; batteries, electric; simulators for the steering
and control of vehicles; cables, electric; wire con-

nectors [electricity]; collectors, electric; commuta-
tors; condensers [capacitors]; battery boxes; vehicle
radios; voltage regulators for vehicles; grids for bat-
teries; vehicle breakdown warning triangles; battery
chargers; chargers for electric batteries.

35 – Import-export agency services; demonstration
of goods; market studies; business information;
commercial information and advice for consumers
[consumer advice shop]; business management and
organization consultancy; business organization con-
sultancy; business management consultancy; profes-
sional business consultancy; marketing; organization
of trade fairs for commercial or advertising purpo-
ses; business management assistance; commercial or
industrial management assistance; presentation of
goods on communication media, for retail purposes;
sales promotions at point of purchase or sale, for
others; advisory services for business management;
commercial administration of the licensing of the
goods and services of others; administrative proces-
sing of purchase orders; procurement services for
others [purchasing goods and services for other busi-
nesses]; retail services relating to engineering goods;
retail services relating to accumulators, electric, for
vehicles; business intermediary and advisory servi-
ces in the field of product sales; arranging of con-
tracts, for others, for the purchase and sale of goods
and services; retail services provided by means of
mail order catalogs; promoting the goods and ser-
vices of others through advertisements on Internet
web sites; retail services provided by television stor-
es; computerized on-line retail store services.

(260) AM 2019 98115 A

(800) 1407022

(151) 2018 02 16

(891) 2018 02 16

(731) Open-Type Joint Stock Company

"CONFECTIONARY CONCERN

BABAYEVSKY"

ul. Malaya Krasnoselskaya, d. 7, RU-107140

Moscow, Russian Federation

(540)



(591) Brown and light yellow

(531) 07.01.01; 07.01.24; 25.01.05; 26.01.02; 28.05;
29.01.13

(526) 1804

(511)

35 – Import-export agency services; sales promotion
for others; procurement services for others [pur-
chasing goods and services for other businesses].

43 – Snack-bar services; café services; cafeteria services; restaurant services; self-service restaurant services.

(260) AM 2019 98116 A

(800) 1407045

(151) 2018 03 13

(891) 2018 03 13

(731) Sunecho Limited

Julia House, 3 Themistokli Dervi Street, P.C,
CY-1066 Nicosia, Cyprus

(540)



(591) Golden, yellow, light yellow, white, light brown, dark brown, brown and black.

(531) 02.09.01; 27.05.03; 27.05.09; 27.05.10;
29.01.12

(526) ®

(511)

29 – Meat, fish, poultry and game; meat extracts; preserved, frozen, dried and cooked fruits and vegetables; jellies, jams, compotes; eggs; milk and milk products; edible oils and fats; ajvar [preserved peppers]; aloe vera prepared for human consumption; alginates for culinary purposes; anchovy; peanuts, prepared; albumen for culinary purposes; white of eggs; beans, preserved; soya beans, preserved, for food; bouillon, including instant bouillon; ginger jam; ham; fatty substances for the manufacture of edible fats; toasted laver; edible birds' nests; peas, preserved; mushrooms, preserved; gelatine; meat jellies; jellies for food; fruit jellies; yolk of eggs; coconut fat; bone oil, edible; lard; suet for food; fruit-based snack food; charcuterie; raisins; caviar; fish roe, prepared; yogurt; sauerkraut; kephir [milk beverage]; isinglass for food; clams, not live; milk shakes; black pudding [blood sausage]; meat, tinned; vegetables, tinned; fish, tinned; fruits, tinned; bouillon concentrates; gherkins; shrimps, not live; prawns, not live; buttercream; croquettes; silkworm chrysalis, for human consumption; kumys [kumyss] [milk beverage]; spiny lobsters, not live; lecithin for culinary purposes; salmon, not live; onions, preserved; margarine; marmalade; peanut butter; cocoa butter; colza oil for food; coconut butter; corn oil; sesame oil; linseed oil for culinary purposes; olive oil for food; palm oil for food; palm kernel oil for food; sunflower oil for food; coconut oil; butter; shellfish, not live; almonds, ground; animal marrow for food; mussels, not live; condensed milk; protein milk; soya milk [milk substitute]; fish meal for human consumption; vegetable mousses; fish mousses; fruit pulp;

meat, preserved; milk beverages, milk predominating; potato fritters; olives, preserved; lobsters, not live; coconut, desiccated; nuts, prepared; tomato paste; liver pastes; pectin for culinary purposes; liver; pickles; jams; powdered eggs; kimchi [fermented vegetable dish]; foods made from fish; curd; prosoptokvasha [soured milk]; poultry, not live; pollen prepared as foodstuff; cranberry sauce [compote]; apple purée; crayfish, not live; crustaceans, not live; fish, preserved; fish, not live; salted fish; ryazhenka [fermented baked milk]; vegetable salads; fruit salads; bacon; sardines; pork; herrings, not live; seeds, prepared; sunflower seeds, prepared; cream [dairy products]; whipped cream; fat-containing mixtures for bread slices; smetana [sour cream]; tomato juice for cooking; vegetable juices for cooking; salted meats; sausages; sausages in batter; preparations for making bouillon including preparations for making instant bouillon; preparations for making soup including preparations for making instant soup; soups, including instant soups; tripe; vegetable soup preparations including instant vegetable soup preparations; whey; cheese; tahini [sesame seed paste]; tofu; sea-cucumbers, not live; truffles, preserved; tuna fish, not live; oysters, not live; milk ferments for culinary purposes; rennet; fish fillets; dates; crystallized fruits; fruit preserved in alcohol; potato flakes; hummus [chickpea paste]; fruit peel; preserved garlic; lentils, preserved; potato chips; low-fat potato chips; fruit chips; non-alcoholic eggnog; seaweed extracts for food; snail eggs for consumption.

30 – Coffee, tea, cocoa and artificial coffee; tapioca and sago; flour and preparations made from cereals; bread, pastry and confectionery; edible ices; sugar, honey, treacle; yeast, baking-powder; salt; mustard; vinegar, sauces (condiments); spices; ice for refreshment; aromatic preparations for food; flavorings [flavourings], other than essential oils, for cakes; flavorings [flavourings], other than essential oils, for beverages; coffee flavorings [flavourings]; food flavorings, other than essential oils; star aniseed; cereal bars; high-protein cereal bars; pancakes; noodle-based prepared meals; buns; bread rolls; vanillin [vanilla substitute]; vanilla [flavoring]; vareniki [stuffed dumplings]; waffles; vermicelli [noodles], including instant noodles; natural sweeteners; sausage binding materials; binding agents for ice cream [edible ices]; sea water for cooking; seaweed [condiment]; malt biscuits; cloves [spice]; cake frosting [icing]; glucose for culinary purposes; gluten additives for culinary purposes; thickening agents for cooking foodstuffs; leaven; rice-based snack food; cereal-based snack food; vegetal preparations for use as coffee substitutes; dressings for salad; fruit jellies [confectionery]; candy decorations for cakes; confectionery for decorating christmas trees; cakes; pastries; peanut confectionery; almond confectionery; pasta including instant pasta; ginger [spice]; frozen yogurt [confectionery ices]; capers; caramels [can-

dy]; curry [spice]; ketchup [sauce]; quiches; gluten prepared as foodstuff; sweetmeats [candy]; liquorice [confectionery]; peppermint sweets; cinnamon [spice]; unroasted coffee; starch for food; crackers; custard; hominy grits; semolina; oatmeal; crushed barley; pepper; allspice; peppers [seasonings]; pesto [sauce]; biscuits; petit-beurre biscuits; pies; pizzas; meat gravies; fondants [confectionery]; piccalilli; popcorn; powders for ice cream; mustard meal; pralines; meat tenderizers, for household purposes; oat-based food; propolis; gingerbread; petits fours [cakes]; rice pudding; puddings; cake powder; fruit coulis [sauces]; ravioli; chewing gum; relish [condiment]; rice including instant rice; wheat germ for human consumption; spring rolls; palm sugar; aniseed; linseed for culinary purposes [seasoning]; golden syrup; cake dough; baking soda [bicarbonate of soda for cooking purposes]; malt for human consumption; salt for preserving foodstuffs; cooking salt; celery salt; sorbets [ices]; ham glaze; soya sauce; tomato sauce; pasta sauce; spaghetti including instant spaghetti; seasonings; preparations for stiffening whipped cream; rusks; breadcrumbs; sandwiches; tabbouleh; tacos; cream of tartar for culinary purposes; tarts; dough; pastry dough; almond paste; tortillas; garden herbs, preserved [seasonings]; beer vinegar; ferments for pastes; halvah; unleavened bread; chips [cereal products]; corn flakes; oat flakes; chicory [coffee substitute]; iced tea; chutneys [condiments]; cheeseburgers [sandwiches]; chow-chow [condiment]; saffron [seasoning]; chocolate; malt extract for food; essences for foodstuffs, except ethereal essences and essential oils; husked barley.

(260) AM 2019 98117 A
(800) 1407059
(151) 2018 03 29
(891) 2018 03 29
(731) ACINO PHARMA AG
Birsweg 2, CH-4253 Liesberg, Switzerland
(540)

Sedistress

(591) Black, white
(511)
5 – Drugs for medical purposes, pharmaceutical preparations, pharmaceuticals.

(260) AM 2019 98131 A
(800) 1407525
(151) 2018 01 15
(891) 2018 01 15
(731) Obshchestvo s ogranichennoy
otvetstvennost'yu, "Koordiniruyushchy
raspredelitel'ny tsentr, "EFKO-Kaskad"
ul. Frunze, 4, g. Alekseevka, RU-309850
Belgorodskaya obl., Russian Federation

(540)

Vivat

(591) Black, white
(531) 27.05.17
(511)
29 – Edible oils and fats, other than milk fat and its substitutes, tomato purée.
30 – Mustard, vinegar, condiments in particular dressings for salad based on tomato, sauces [condiments], including mayonnaise, ketchup.

(260) AM 2019 98136 A
(800) 890509
(151) 2006 04 26
(891) 2018 05 30
(731) MCE
7 rue de Tilsitt, F-75017 PARIS, France
(540)

GLAM COLOR

(591) Black, white
(511)
3 – Cosmetics, namely products for hair care, hair colouring, and hair care with colour refreshing effect.

(260) AM 2019 98137 A
(800) 1117327
(151) 2011 11 04
(891) 2018 04 05
(731) PIUSI S.P.A.
Via Pacinotti, 16/A, Zona Industriale
Rangavino, I-46029 SUZZARA
(MANTOVA), Italy
(540)

PIUSI

(591) Black, white
(531) 27.05.17
(511)
7 – Pumps [machines]; pumps [parts of machines, engines or motors]; centrifugal pumps; electric pumps; hydraulic pumps; lubricating pumps; pneumatic pumps; centrifugal metering pumps; metered gasoline pumps; pump dispensing nozzles for fuel and lubricants; pumps for lubricants, fuel transfer and fuel in service station use; grease guns; pneumatic grease guns; fueling nozzles; metering nozzles; fuel filters; fuel injectors; automatic fueling nozzles; non-automatic fueling nozzles; fuel pumps for engines; fuel dispensers and nozzles for service stations; self-regulating fuel pumps; petrol pumps for service stations; fuel dispensing pumps for service stations; filtering machines; valves being parts of pumps; machines for filling containers with liquid; control valves for regulating the flow of gases and liquids [parts of machines]; oil filters for engines and motors; oil drain pumps; self-service fuel dispenser;

control mechanisms for machines, engines or motors; fluid couplings being parts of machines; reels, mechanical, for flexible hoses; reels [parts of machines]; automatic hose reels for fuel; automatic hose reels for air and water; high flow rate portable fuel dispenser unit; portable oil transfer unit; filters [parts of machines or engines]; water pumps for water filtering units; cartridges for filtering machines; oil changers; couplings, other than for land vehicles.

8 – Hand-operated pumps; oil filter wrenches; oil cans for lubricating machinery [hand implements]; manual fueling nozzles; hand pumps for drums; hand pumps for oil and greases; hand pumps for liquids and fluid.

9 – Counters for liquids; electronic apparatus for fluid distribution control; rulers [measuring instruments]; measuring apparatus; liquid meters; electronic equipment and instruments to control the distribution of fluids; meters; level indicators; quantity indicators; pressure indicators; electro-mechanical controls for use in controlling the distribution of fuel for use in the fuel and lubricant transfer industry; fuel level indicators; fuel gauges; air/fuel ratio gauges; oil level sensors; remote control apparatus for vacuum pumps; flow meters; digital panel meters; electric apparatus for remote ignition; remote control apparatus; remote control receivers; computer programs [downloadable software]; downloadable computer software for remote monitoring and analysis; regulating apparatus, electric; software for management and monitoring of refueling; fluid monitoring systems; LAN operating software; electrical and electronic control apparatus and instruments; local area network operating software; network access server operating software; computer software for wireless network communications; measuring devices, electric; software to monitor fuel distribution; magnetically encoded key cards; electronic keys; encoded key cards; computer software for controlling self-service terminals; control panels [electricity]; electronic indicator panels; transfer stations for flammable liquids; continuous tank level monitoring; tank level indicators.

(260) AM 2019 98142 A

(800) 1264487

(151) 2015 04 28

(891) 2017 11 30

(731) Obshchestvo s ogranichennoy,
otvetstvennostiu, "BIOLIT"
prospect Akademicheskiiy, 3, RU-634055
Tomsk, Russian Federation

(540)



(591) White, green, pale green

(531) 05.03.14; 26.05.01; 26.05.15; 27.05.10;
29.01.03

(511)

3 – Breath freshening sprays; petroleum jelly for cosmetic purposes; cotton wool for cosmetic purposes; toilet water; make-up; perfumes; greases for cosmetic purposes; perfumery; decorative transfers for cosmetic purposes; eyebrow pencils; cosmetic pencils; colorants for toilet purposes; cosmetic dyes; cosmetic creams; skin whitening creams; hair spray; nail polish; hair lotions; lotions for cosmetic purposes; beauty masks; oils for cosmetic purposes; oils for toilet purposes; cleansing milk for toilet purposes; soap; mint for perfumery; cosmetic kits; false nails; eau de Cologne; dentifrices; lipsticks; shaving preparations; cosmetic preparations for baths; hair waving preparations; leather bleaching preparations; mouthwashes, not for medical purposes; cosmetic preparations for slimming purposes; make-up removing preparations; nail care preparations; potpourris [fragrances]; bath salts, not for medical purposes; cosmetics; cosmetics for animals; degreasers other than for use in manufacturing processes; shampoos; extracts of flowers [perfumes]; ethereal essences.

5 – Germicides; balms for medical purposes; biologically active nutritional supplements; biocides; bracelets for medical purposes; vaccines; oxygen baths; wadding for medical purposes; dietetic substances adapted for medical use; nutritive substances for microorganisms; melissa water for pharmaceutical purposes; mineral waters for medical purposes; hematogen; gamboge for medical purposes; deodorants, other than for human beings or for animals; food for babies; diastase for medical purposes; mineral food supplements; nutritional supplements; hemostatic pencils; medicinal roots; starch for dietetic or pharmaceutical purposes; cultures of microorganisms for medical and veterinary use; adhesive plasters; lotions for pharmaceutical purposes; liniments; medicinal oils; drugs for medical purposes; dietetic beverages adapted for medical purposes; pomades for medical purposes; preparations of trace elements for human and animal use; pharmaceutical preparations; chemico-pharmaceutical preparations; chemical preparations for veterinary purposes; dietetic foods adapted for medical purposes; tissues impregnated with pharmaceutical lotions; suppositories; tobacco-free cigarettes for medical purposes; syrups for pharmaceutical purposes; medical preparations for slimming purposes; medicinal herbs; diabetic bread adapted for medical use; elixirs [pharmaceutical preparations].

32 – Waters [beverages]; cocktails, non-alcoholic; non-alcoholic beverages; isotonic beverages; powders for effervescent beverages; syrups for beverages; preparations for making mineral water; pastilles for effervescent beverages; non-alcoholic fruit extracts; essences for making beverages.

(260) AM 2019 98251 A

(800) 1407670

(151) 2018 04 30

(891) 2018 04 30

(731) TOMORROW LONDON HOLDINGS LIMITED

Biscuit Building, 10 Redchurch Street,
London E2 7DD, United Kingdom

(540)

ATHLETICS FTWR

(591) Black, white

(511)

25 – Sports footwear; sports headgear [other than helmets]; sportswear.

(260) AM 2019 98252 A

(800) 1407679

(151) 2018 04 10

(891) 2018 04 10

(731) ROCHE DIAGNOSTICS GMBH

Sandhofer Strasse 116, 68305 Mannheim,
Germany

(540)

COBAS ULTRA

(591) Black, white

(511)

9 – Scientific instruments and apparatus; laboratory devices for use in research, science and industry; laboratory instruments for scientific and diagnostic purposes; computer hardware and software for medical and diagnostic purposes; computer software for the provision of automated diagnostic laboratory processes; computer software and hardware for use with laboratory instruments, namely, for use in providing remote automated control of diagnostic laboratory instruments, data analysis, and data management.

10 – Medical apparatus and instruments; analyzers for in-vitro diagnostic testing for medical purposes; laboratory apparatus for medical diagnostic purposes.

(260) AM 2019 98253 A

(800) 1407690

(151) 2017 12 14

(891) 2017 12 14

(731) BALENCIAGA

40 rue de Sèvres, F-75007 Paris, France

(540)



(591) Black, white

(531) 27.05.14; 27.05.17; 27.05.21

(511)

3 – Perfumery products; perfumes, eau de parfum, toilet water, eau de Cologne, mascara, blush, make-up powder; cosmetic pencils, eye shadows, make-up foundation, face masks and beauty masks, lipsticks, nail polishes and nail polish removers; make-up removing lotions, creams and preparations; toiletries, shampoos, bath salts, bath and shower gels, bubble baths, toilet soaps, essential oils; cosmetics, shaving creams and foams, after-shave lotions and balms, moisturizing lotions and creams, body milk, body deodorants for personal use.

9 – Spectacle frames, spectacles, sunglasses, tinted or anti-glare spectacles, protective goggles, pince-nez, opera glasses, magnifying glasses, spectacle cases and containers for contact lenses; optical apparatus and instruments, correcting lenses (optics), spectacle lenses, contact lenses, tinted or filtering glasses, protective goggles, magnifying glasses, optical lenses, contact lenses; apparatus for the recording, transmission, reproduction of data, sound or images; telephones, mobile telephones, smartphones, videophones, tablets, PDAs (personal digital assistants) and MP3 players; accessories for telephones, portable telephones, smartphones, videophones, tablets, PDAs (personal digital assistants) and MP3 players, namely, hands-free kits for telephones, batteries, covers, cases, casings, facings, chargers, straps for portable telephone, wrist straps or neck straps; electronic devices for the wireless transmission of data and/or voice signals; accessories for electronic devices for wireless transmission of data and/or voice signals, namely, batteries, car kits, chargers and charging stands, head sets, headphones, adapters, adapter cases, docking stations, computer cables, cases and covers for portable computers, sleeves, covers for batteries; magnetic recording media, sound recording discs, compact discs, DVDs and other digital recording media; data processing equipment, computers; calculating machines; photographic and cinematographic apparatus and instruments; cases especially made for photographic and cinematographic apparatus and instruments; portable communication devices in the form of wristwatches; smartwatches; smartphones in the form of watches.

14 – Precious metals and their alloys; works of art (made of precious metal); jewelry articles (including fashion jewelry) of precious metals, alloy and coated therewith, namely, rings, finger rings, earrings, cuff links, bracelets, brooches, pendants, trinkets, chains and watch chains, necklaces, medals, medallions; semi-precious and precious stones; timepieces and chronometric instruments, watches, watch straps and watch cases; key rings of precious metals, alloys thereof or or plated therewith; boxes and cases for timepieces; jewelry cases and boxes.

18 – Leather and imitation leather, animal skins and imitation animal skins; handbags, shoulder bags,

shopping bags, luggage, wallets, change purses, purses, card holders (wallets), briefcases, briefcases for documents, attache cases, school bags, satchels, beach bags, sports bags, belt bags, travel sets and bags, trunks, suitcases, traveling bags, backpacks, shopping bags, pouches (leather goods), clutch bags (evening handbags), hand pockets, namely, bags (leather goods), boxes intended for toiletry articles, toiletry bags (empty), garment bags for travel, travel sets, namely, luggage sets coordinated for travel, key cases (leather goods); umbrellas, parasols, walking sticks; harness for animals, whips, saddlery.

25 – Clothing; footwear; headgear; shirts; belts (clothing); furs (clothing); gloves (clothing); scarves; neckties; hosiery; socks; bedroom slippers; pajamas; footwear for sports; underwear; bathing suits; tracksuits; sports clothing; rainwear; clothing for children; disguises; footwear for children; headgear for children; layettes [clothing].

35 – Advertising; shop window dressing; presentation of products on all communication media for the retail sale thereof; organization of events for commercial and advertising purposes; retail services relating to the following goods: perfumes, cosmetics, perfumery products, toilet water, spectacle frames, spectacles, sunglasses, precious metals and their alloys, jewelry, precious stones, timepieces and chronometric instruments, printed materials, photographs, stationery, artists' material, plastic materials for packaging, paper and cardboard for packaging, writing instruments, leather and imitations of leather, animal skins, bags, luggage, small leather goods, trunks and traveling bags, umbrellas and parasols, walking sticks, textiles, bed linen, table linen, household linen, bathroom linen, clothing, scarves, gloves, underwear, footwear, headgear, gymnastic and sports articles and equipment, bicycles, games, toys.

(260) AM 2019 98254 A

(800) 1407767

(151) 2018 02 07

(891) 2018 02 07

(731) MABI INTERNATIONAL S.p.A.

Via J. Pirona, 2-4, Zona Industriale, I-33038
SAN DANIELE DEL FRIULI (UD), Italy

(540)

MABI ANI

(591) Black, white

(531) 27.05.01; 27.05.25

(511)

18 – Bags; handbags; clutches [purses]; purses; toiletry bags; satchels; tie cases; umbrellas; keycases; vanity cases, not fitted; trunks [luggage]; traveling trunks; sport bags; chain mesh purses; travelling sets [leatherware]; leather leashes; imitation leather; walking stick handles; umbrella handles; suitcase handles; pouch baby carriers; curried skins; skins of cha-

mois, other than for cleaning purposes; fur; card cases [notecases]; music cases; wallets; reins; haversacks; bags [envelopes, pouches] of leather, for packaging; travelling bags; boxes of leather or leatherboard; handbag frames; valises; attaché cases; garment bags for travel; backpacks.

25 – Clothing; shoes; headgear; pumps [footwear]; footwear for women; footwear for men; leisure shoes; deck shoes; slippers; wooden shoes; sandals; flat shoes; high-heeled shoes; dress shoes; half-boots; lace boots; boots; waterproof boots; winter boots; ankle boots; waist belts; belts [clothing]; belts made from imitation leather; leather belts [clothing].

(260) AM 2019 98255 A

(800) 1407770

(151) 2017 03 30

(891) 2017 03 30

(731) VERNITES S.r.l.

Via delle Roggette, 11, I-21010 CARDANO
AL CAMPO (VA), Italy

(540)

VERNITES

(591) Black, white

(531) 27.05.17

(511)

2 – Paints, varnishes, lacquers; preservatives against rust and against deterioration of wood; dyestuffs; mordants; raw natural resins; metal foil for use in painting, decorating, printing and art; pigments; wood stains; dyes; anti-corrosive preparations; binding preparations and thinners for paints; printing ink; paints for use in the printing industry; coatings (paint); thinners and thickeners for coatings, dyes and inks.

(260) AM 2019 98256 A

(800) 1407781

(151) 2018 01 17

(891) 2018 01 17

(731) Obshchestvo s ogranichennoy

otvetstvennostyu "SUSHI MARKA"

ul. Bely Kuna, d. 6, korp. 1, lit. A, pom.

21N, RU-192242 Saint-Petersburg,

Russian Federation

(540)



СУШИ ШОП

(591) Orange-red, white and black
 (531) 03.09.01; 03.09.24; 24.09.03; 26.01.03;
 26.01.15; 26.01.24; 29.01.13

(511)
 16 – Playbills; posters; forms, printed; pamphlets; booklets; wrapping paper; newsletters; signboards of paper or cardboard; cardboard articles; graphic representations; calendars; pictures; paintings [pictures], framed or unframed; envelopes [stationery]; boxes of cardboard or paper; bags [envelopes, pouches] of paper or plastics, for packaging; greeting cards; conical paper bags; folders for papers; mats for beer glasses; printed matter; place mats of paper; tablemats of paper; stamps [seals]; labels, not of textile.

29 – Toasted laver; caviar; fish roe, prepared; shrimps, not live; prawns, not live; salmon, not live; sesame oil for food; shellfish, not live; fish, preserved; fish, not live; salted fish; soups; cheese; tuna fish; fish fillets.

30 – Seaweed [condiment]; ginger [spice]; soya bean paste [condiment]; condiments; soya sauce; tomato sauce; sushi.

(260) AM 2019 98257 A
 (800) 1407782
 (151) 2018 01 10
 (891) 2018 01 10
 (731) IP SHPILEVSKIY OLEG EDUARDOVICH
 Universitetskii prospect, 6, fl. 27, RU-119333
 Moscow, Russian Federation
 (540)



(591) Black, white
 (531) 26.01.01; 26.01.03; 26.01.20; 26.01.24;
 27.05.10; 27.05.24

(526) PRINTING

(511)
 2 – Toner [ink] for photocopiers; toner cartridges, filled, for photocopiers and printers.

37 – Refilling of toner cartridges.

(260) AM 2019 98258 A
 (800) 1407792
 (151) 2018 03 16
 (891) 2018 03 16
 (731) Limited liability company "5D"
 687-y Proektiruemy proezd, d. 15, of. 8,

g. Zelenograd, RU-124365 Moscow,
 Russian Federation

(540)



(591) Brown, light brown, black, white, gray
 (531) 24.03.07; 24.03.18; 26.01.01; 26.01.04;
 26.01.19; 26.01.21; 27.05.03; 27.05.17;
 27.05.24; 27.07.03; 27.07.11; 27.07.17;
 27.07.24; 29.01.14

(511)
 29 – Peanuts, prepared; raisins; vegetables, dried; potato fritters; flavored nuts; candied nuts; coconut, desiccated; nuts, prepared; jams; sunflower seeds, prepared; dates; crystallized fruits; hazelnuts, prepared; potato flakes; fruit peel; potato chips; low-fat potato chips; fruit chips.

30 – Cereal bars; high-protein cereal bars; candy decorations for cakes; confectionery for decorating Christmas trees; cakes; pastries; peanut confectionery; almond confectionery; pasta; caramels [candy]; sweetmeats [candy]; crackers; chocolate-coated nuts; nutmegs; cookies; petit-beurre biscuits; popcorn; gingerbread; confectionery; rusks; breadcrumbs; corn flakes; chips [cereal products]; oat flakes.

(260) AM 2019 98259 A
 (800) 1407793
 (151) 2018 02 01
 (891) 2018 02 01
 (731) Aktsionernoe obschestvo "MAKFA"
 per. Vspol'nyj, d. 5, str. 1, of. 1, RU-123001
 Moskva, Russian Federation

(540)



(591) White, yellow, brown, green, red, black
 (531) 01.03.01; 04.05.11; 04.05.12; 05.07.02;
 07.01.13; 19.01.11; 24.01.15; 29.01.15

(511)
 30 – Semolina; oatmeal; crushed barley; groats for human food; cereal preparations; rice.

(260) AM 2019 98260 A

(800) 1407845

(151) 2017 07 18

(891) 2017 07 18

(731) GORENJE gospodinjski aparati, d.d.
Partizanska cesta 12, SI-3320 Velenje,
Slovenia

(540)



(591) White, grey and turquoise.

(531) 26.01.05; 26.04.04; 26.04.06; 26.04.22;
26.11.22; 29.01.13

(511)

7 – Electric appliances for preparing food, electric household cleaning appliances; white goods included in this class, namely washing machines, dishwashers; electric household and kitchen machines and apparatus belonging to this class; mixing machines; electric kitchen mixers; electric blenders; cutters (machines); bread cutting machines; electric kitchen knives; electric food choppers; meat choppers (machines); meat mincing machines; electric food processors; grating machines for vegetables; electric crushers for kitchen use; electric tin openers; electric fruit presses for household purposes; juicers; electric citrus juice presses; electric blenders and liquidizers for household purposes; electric fruit squeezers; mills (machines); coffee grinders, other than hand-operated; pepper mills, other than hand-operated; flour mill machines; millstones for milling flour; machines for making pasta; peeling machines; sifting machines; kitchen robots; robots (machines); electric beaters; electric whisks for household purposes; beating machines; kneading machines (electric kitchen machines); electromechanical food preparation machines; electromechanical beverage preparation machines; electrical apparatus for sealing plastics; vacuum packing machines; electrical apparatus for sealing plastics (packaging); washing and drying machines; washing machines; laundry washing machines; drying machines; washer-driers, combined washing machines and tumble driers; spin driers; centrifugal machines; wringing machines for laundry; dishwashers; electric machines and apparatus for cleaning; drums (parts of machines); cleaners, namely vacuum cleaners, wet-dry vacuum cleaners; electric vacuum cleaners; vacuum cleaning machines for use in households; vacuum cleaners for industrial purposes; cordless vacuum cleaners; robotic vacuum cleaners; vacuum cleaners; vacuum cleaner bags; central vacuum cleaning installations; installations for vacuum dust extraction for cleaning purposes;

dust exhausting installations for cleaning purposes; vacuum cleaner hoses; vacuum cleaner attachments for disseminating perfumes and disinfectants; steam cleaners; multi-purpose steam cleaners; electric machines and apparatus for carpet shampooing; electric clothing pressing machines; ironing machines; clothes pressing machines; electric machines and apparatus for wax-polishing; machines and apparatus for polishing (electric); sewing machines; parts and fittings of the afore-mentioned goods belonging to this class.

11 – Apparatus for lighting, heating, steam generating, cooking, refrigerating, drying, ventilating, water supply and sanitary purposes; white goods belonging to this class, namely electric household appliances for cooling, refrigerating, freezing, drying, cooking, roasting, grilling, electric laundry driers; cooling and refrigerating appliances belonging to this class; refrigerating apparatus and machines; refrigerators; refrigerating cabinets; refrigerating display cabinets (display cases); chillers for wine and drinks, wine coolers; freezers; chest freezers; freezer cabinets, upright freezers; fridge-freezers, combination refrigerator-freezers; ice makers; ice chests; electric cool boxes; cooking apparatus and installations; cooking stoves, cookers, household stoves; multi-cookers; hot plates; kitchen ranges; kitchen ranges (ovens); electric, gas and combined cookers; ovens; built-in ovens; hot air ovens; steam ovens; structural plates for ovens, framework of metal for ovens; cooking rings, hobs, cooking plates; induction, glass ceramic and combined cooking hobs; portable induction hobs; steam cookers; warming drawers for kitchens; microwave ovens (cooking apparatus); egg cookers; extractor hoods for kitchens; range hoods; ventilation hoods; rotisseries; griddle plates; barbecues; grills (cooking appliances), griddles (cooking appliances); contact grills; toasters, bread toasters; bread baking apparatus, bread-making machines; roasting apparatus; electric waffle irons; pressure cooking saucepans, electric; electric deep fryers; roasters; coffee machines; electric coffee brewers; electric coffee percolators; food driers; electric oil presses; electric appliances for making yogurt; electric laundry driers, tumble driers (heat driers); drying apparatus; desiccating apparatus; hair driers; hand drying apparatus for washrooms; electric boilers; electric kettles; water heaters (apparatus); electric water heaters; gas fired water heaters; gas boilers; boilers; boilers for hot water supply installations; hot water tanks; boilers other than parts of machines; pellet boilers; log boilers; heat pumps; air conditioning apparatus; ventilating fans; ventilators (parts of air-conditioning installations); fans (air-conditioning); air purifying apparatus and machines; air sterilisers; water purifying apparatus and machines; water sterilizers; air humidifying installations; air humidifiers (ionizers); dehumidifiers; solar collectors (heating), solar heating panels; radiators (hea-

ting); electric radiators; bathroom tubular radiators; fan heaters; toilets (water closets); toilet bowls; toilet seats; urinals (sanitary fixtures); wash-hand basins (parts of sanitary installations), wash-hand bowls (parts of sanitary installations); bidets; bath tubs; bath tub panels; massage bath installations, spa baths (vessels); bath screens, bathtub enclosures; showers; shower bases; shower enclosures, shower cubicles; massage shower cabins, massage showers (massage shower panels); taps (faucets); bath fittings; bath linings; parts and fittings of all the afore-mentioned goods belonging to this class.

(260) AM 2019 98275 A

(800) 1408320

(151) 2018 01 29

(891) 2018 01 29

(731) 101CAFFE' S.R.L.

VIA DEI LAVORATORI, 8/10 I-20090

BUCCINASCO(MI), Italy

(540)



(591) Black, white

(531) 05.07.27; 25.07.07; 26.13.25

(511)

30 – Coffee capsules; tea-based beverages; prepared tea-based beverages; tea; artificial coffee; aromatic teas [other than for medicinal use]; coffee; mixtures of coffee; coffee extracts; coffee flavourings; decaffeinated coffee; prepared coffee and coffee-based beverages; chicory [coffee substitute]; prepared coffee beverages; coffee extracts for use as substitutes for coffee; coffee essences and coffee extracts; coffee-based iced beverages; prepared coffee-based beverages; filters in the form of paper bags filled with coffee; roasted barley and malt for use as substitute for coffee; tea flavorings for food or beverages; tea essences (non-medicated -); tea extracts (non-medicated); tea for infusions; instant tea; tea-based beverages with fruit flavoring; theine-free tea; chocolate-based drinks; imitation chocolate; chocolate extracts (chocolate essences) for the preparation of beverages; chocolate extracts for the preparation of beverages; infusions, not medicinal.

35 – Retail services in relation to preparations for making beverages; wholesale services in relation to preparations for making beverages; rental of vending machines; business advice and consultancy relating to franchising; business advisory services relating to the establishment of franchises.

43 – Cafeteria services; self-service restaurants; services for providing drink; provision of information relating to the preparation of food and drink; office catering services for the provision of coffee; providing food and drink in restaurants and bars; snack-bar services; food and drink preparation services; preparation and provision of food and drink for immediate consumption; café services.

(260) AM 2019 98276 A

(800) 1408341

(151) 2017 09 14

(891) 2017 09 14

(731) DSM GRUP DANISMANLIK ILETISIM VE SATIS TICARET A.S.

Büyükdere Cad. Noramin Plaza, No:237

K: B-1 Maslak, Istanbul, Turkey

(540)

trendyol

(591) Black, white

(531) 27.05.01

(511)

14 – Jewellery; imitation jewellery; gold; precious stones and jewellery made thereof; cufflinks; tie pins; statuettes and figurines of precious metal; clocks, watches and chronometrical instruments; chronometers and their parts; watch straps; trophies made of precious metal; rosaries.

18 – Unworked or semi-worked leather and animal skins, imitations of leather, stout leather, leather used for linings goods made of leather, imitations of leather or other materials, designed for carrying items, included in this class; bags, wallets, boxes and trunks made of leather or stout leather; keycases, trunks [luggage], suitcases; umbrellas; parasols; sun umbrellas; walking sticks; whips; harness; saddlery; stirrups; straps of leather (saddlery).

24 – Woven or non-woven textile fabrics; textile goods for household use, not included in other classes; curtains, bed covers, sheets (textile), pillowcases, blankets, quilts, towels; flags, pennants, labels of textile; swaddling blankets; sleeping bags for camping.

25 – Clothing, including underwear and outer-clothing, other than special purpose protective clothing; socks, mufflers [clothing], shawls, bandanas, scarves, belts [clothing]; footwear, shoes, slippers, sandals; headgear, hats, caps with visors, berets, caps [headwear], skull caps.

35 – The bringing together, for the benefit of others, of a variety of goods, namely, soaps, dental care preparations: dentifrices, denture polishes, tooth whitening preparations, mouth washes, not for medical purposes, perfumery, non-medicated cosmetics, fragrances, deodorants for personal use and animals,

tools and apparatus for personal beauty care use: tools and apparatus for shaving, epilation, manicure and pedicure, electric hand implements for straightening and curling hair, scissors, eyeglasses, sunglasses, apparatus for recording, transmission or reproduction of sound or images, cameras, photographic cameras, television apparatus, video recorders, CD and DVD players and recorders, MP3 players, computers, desktop computers, tablet computers, wearable technological devices (smart watches, wristbands, head-mounted devices); microphones, loudspeakers, earphones, telecommunications apparatus, apparatus for the reproduction of sound or images, computer peripheral devices, cell phones, covers for cell phones, telephone apparatus, computer printers, scanners [data processing equipment], photocopiers, magnetic and optic data carriers and computer software and programmes recorded thereto, downloadable and recordable electronic publications, encoded magnetic and optic cards, movies, tv series and video music clips recorded on magnetic, optical and electronic media, medical orthopaedic articles: corsets for medical purposes, orthopaedic shoes, elastic bandages and supportive bandages, babies' bottles, babies' pacifiers, teats, teethingers for babies, baby carriages, wheelchairs, pushchairs, clocks, watches and chronometrical instruments, chronometers and their parts, watch straps, jewellery, imitation jewellery, gold, precious stones and jewellery made thereof, cufflinks, tie pins, statuettes and figurines of precious metal, clocks, watches and chronometrical instruments, chronometers and their parts, watch straps, trophies made of precious metal, rosaries, unworked or semi-worked leather and animal skins, imitations of leather, stout leather, leather used for linings, goods made of leather, imitations of leather or other materials, designed for carrying items, bags, wallets, boxes and trunks made of leather or stout leather, keycases, trunks [luggage], suitcases, umbrellas, parasols, sun umbrellas, walking slicks, whips, harness, saddlery, stirrups, straps of leather (saddlery), ornaments and decorative goods of wood, cork, reed, cane, wicker, horn, bone, ivory, whalebone, shell, amber, mother-of-pearl, meerschaum, beeswax, plastic or plaster namely figurines, holiday ornaments for walls, sculptures, trophies, bamboo curtains, roller indoor blinds [for interiors], slatted indoor blinds, strip curtains, bead curtains for decoration, curtain hooks, curtain rings, curtain tie-backs, curtain rods, furniture, made of any kind of material, ornaments and decorative goods of glass, porcelain, earthenware or clay namely statues, figurines, vases and trophies, ropes, strings, rope ladders, hammocks, fishing nets, tents, awnings, tarpaulins, sails, vehicle covers, not fitted, bags of textile, for packaging, yarns and threads for textile use, threads and yarns for sewing, embroidery and knitting, thread, elastic yarns and threads for textile use, woven or non-woven textile fabrics, textile goods for household use,

curtains, bed covers, sheets (textile), pillowcases, blankets, quilts, towels, flags, pennants, labels of textile, swaddling blankets, sleeping bags for camping, clothing, including underwear and outer clothing, other than special purpose protective clothing, socks, mufflers [clothing], shawls, bandanas, scarves, belts [clothing], footwear, shoes, slippers, sandals, headgear, hats, caps with visors, berets, caps [headwear], skull caps, carpets, rugs, mats, games and toys, enabling customers to conveniently view and purchase those goods, such services may be provided by retail stores, wholesale outlets, by means of electronic media or through mail order catalogues.

(260) AM 2019 98277 A

(800) 1408362

(151) 2018 02 22

(891) 2018 02 22

(731) WIKOLIA INVESTMENTS LIMITED

Arch.Makariou III & Vyronos, P. Lordos
Center, Block B, 1st floor Flat/Office 103,
Neapoli, CY-3105 Limassol, Cyprus

(540)



(591) Dark blue, bright green, white

(531) 26.01.06; 26.01.24; 27.05.09; 27.05.10;
29.01.13

(511)

35 – Sales promotion for others; wholesale and retail store services.

(260) AM 2019 98278 A

(800) 1408411

(151) 2017 12 26

(891) 2017 12 26

(731) BONDUELLE

La Woestyne, F-59173 RENESCURE,
France

(540)



(591) Yellow, green, brown, white

(531) 01.03.02; 01.15.09; 01.15.15; 05.03.16;
26.02.01; 26.02.03; 26.02.07; 26.11.12;
27.05.08; 28.05; 29.01.14

(511)

29 – Meat; meat extracts; fish; seafood (not live); crustaceans (not live); snails (not live); poultry; game; preserved, frozen, deep-frozen, dried and coo-

ked fruit and vegetables; jams; fruit jelly; compotes; eggs; milk and dairy products; cheeses; cream; yogurts; edible oils and fats; preserved mushrooms; charcuterie; canned meat, fish, fruits and vegetables; canned steamed vegetables, salad vegetables and cooked vegetables; canned mushrooms, corn, beans, peas, carrots, lentils, mixed vegetables, flageolet beans, broad beans, potatoes, fruits; preserves based on vegetables, mushrooms, corn, beans, peas, carrots, lentils, mixed vegetables, flageolet beans, broad beans, potatoes, fruits; canned mixed vegetables and fruits; vegetables, fruits, mixtures of vegetables and fruits being deep-frozen; deep-frozen cooked vegetables; deep-frozen mushrooms, corn, beans, peas, carrots, lentils, mixed vegetables, flageolet beans, broad beans, potatoes, puree; preserved olives; puree; mashed potatoes; vegetable or vegetable-based purees; deep-frozen potatoes and vegetable puree; soups; potages (soups); bouillons; vegetable soups; canned or deep-frozen vegetable soups; fresh, canned or deep-frozen prepared or cooked dishes, preparations and meals based on vegetables, starches (potatoes), sweet potatoes, meat, poultry, game, fish, cheese; deep-frozen French fries; tomato purée; fruit salads, vegetable salads; preserved olives; salads based on vegetables, fruits, meat, fish, charcuterie, cheese; raw vegetable salad; mixed green vegetable salads; salads, mixed salads in bags.

30 – Rice; flour and preparations made from cereals; salt; mustard; vinegar; sauces (condiments); vegetable-based sauces; pastry and confectionery; bread; edible ices; ice for refreshment; ice cream; frozen yogurts; spices; preserved garden herbs; flavorings (other than essential oils); aromatic preparations for food; seasonings; salad dressing; rusks; biscuits, cookies; cakes; tarts; pies; pizzas; buns; snacks based on cereals and rice; dishes, preparations based on cereals; noodle-based prepared meals; chocolate; condiments; couscous semolina; tabbouleh; salad dressings; sushi; cooked corn; roasted corn; popcorn; salads, dishes, meals, preparations based on wheat, rice, pasta, corn, semolina; quinoa; biscuits and cookies for aperitifs; bread-based aperitif products; aromatic herbs; deep-frozen aromatic herbs.

31 – Agricultural, horticultural and forestry products (neither prepared nor processed); grains (seeds); natural plants and flowers; fresh fruits and vegetables; corn; fresh garden herbs; fresh mushrooms; fresh olives.

(260) AM 2019 98279 A
(800) 1408420
(151) 2018 03 16
(891) 2018 03 16
(731) KARELIA TOBACCO COMPANY INC.
Athinon Street, GR-241 00 Kalamata,
Greece

(540)



(591) Blue, white, red, grey
(531) 26.01.06; 26.01.10; 29.01.13

(511)

34 – Tobacco, cigars, cigarettes, electronic cigarettes, cigarillos, smokers' articles, ashtrays, cigarette cases, cigarette lighters, cigarette papers, matches, liquid solutions for use in electronic cigarettes.

(260) AM 2019 98280 A

(800) 1408424

(151) 2018 05 16

(891) 2018 05 16

(731) RIGO TRADING S.A.

Route de Trèves 6 EBBC, Building E,
L-2633 Senningerberg, Luxembourg

(540)



(591) White

(531) 03.01.14; 03.01.24

(554) Three-dimensional

(511)

30 – Confectionery.

(260) AM 2019 98281 A

(800) 1408435

(151) 2018 05 23

(891) 2018 05 23

(731) FANTINI S.R.L.

Via Brigoni, 2-4-6, I-46046 Medole (MN),
Italy

(540)

FANTINI

(591) Black, white

(511)

7 – Agricultural machines; reapers; agricultural machines; robotic mechanisms used in agriculture; agricultural implements, other than hand-operated; har-

vesting heads, parts and fittings therefor; threshers [agricultural implements].

(260) AM 2019 98282 A

(800) 1408457

(151) 2017 12 26

(891) 2017 12 26

(731) ADP GAUSELMANN GMBH

Merkur-Allee 1-15, 32339 Espelkamp,

Germany

(540)

Princess of the Dead

(591) Black, white

(511)

9 – Computer software; computer and video games software; games software in particular for use on any computer platform, including electronic entertainment and games consoles; computer game programs; video games (software); computer games provided through a global computer network or supplied by means of multi-media electronic broadcast or through telecommunications or electronic transmission or via the internet; computer games, leisure and recreational software, video games and computer software, all being provided in the form of storage media; programs for operating electric and electronic apparatus for games, amusement and/or entertainment purposes; computer software for computer games on the internet; online games (software), in particular for online betting games, online prize games, online gambling games, online games of skill and online casino games; computer software in the form of an app for mobile devices and computers; operational computer games software; computer software for managing of games (game collection); computer programs for video games.

(260) AM 2019 98283 A

(800) 1408461

(151) 2017 10 13

(891) 2017 10 13

(731) SOPRO BAUCHEMIE GMBH

Biebricher Str. 74, 65203 Wiesbaden,

Germany

(540)

Sopro

(591) Black, white

(511)

2 – Corrosion inhibitors, preservatives against rust and against deterioration of wood; paints; thinners for colours; mordants; primers; bitumen varnishes; preparations for intensifying and reviving colour, for applying to and coating ceramic, natural stone and concrete; dyes, colorants and pigments; thinners and thickeners for coatings, dyes and inks; coatings;

dyestuffs; varnishes; lacquers; colorants for mortars; colour pigments for mortar; colouring matter for admixture in mortar.

3 – Cleaning, polishing, scouring and abrasive preparations; cleaning and care preparations for a mineral substrate, metal, plastic and wood; cleaning preparations being aids for washing off jointing compounds, included in class 3; cleaning agents for the hands; cleaning preparations for tools; scouring solutions; paint-removing preparations; polishing wax; paint removing compositions; rust removers; lacquer-removing preparations; color-removing preparations; grease-removing preparations; stain removers; spray polish; solvents for removing paints; solvents for removing varnishes; cleaning fluids; oils for cleaning purposes; refurbishing preparations; mould removing preparations.

19 – Building materials (non-metallic), namely hydraulic binding agents, including cement, lime, plaster, and being additives for binding and hardening concrete, mortar and stone-type building materials; building materials (non-metallic), namely hydraulic binding agents and mixtures composed thereof containing aggregates, pozzolanic materials (concrete admixtures) and/or chemical materials (concrete admixtures); mortar (building material), render (coatings), screed compounds (building materials); reinforcing fabrics, not of metal, for building; contact slurry (building materials, non-metallic); building materials (non-metallic), in the form of filling materials for building, for constructing surfaces of concrete, mortar and other stone-type building materials; glass sand for building; bitumen; bituminous products for building; non-metallic rigid pipes for building; concrete and concrete building elements; roof coverings, non-metallic; bituminous coatings for roofing (other than for packing and insulating purposes); non-metal windows; felt for building; gravel; sand for use in construction; non-metal prefabricated swimming pools; chimneys, not of metal; tile coverings (non-metallic), tiles, not of metal; binding agents and materials for road building, road coating materials; building and construction materials and elements, not of metal; mortar; mortar mix; levelling preparations [cement or mortar]; dry mortar; spackling compound; bituminous emulsions; bitumen based compositions; building sections (non-metallic -); constructional components of reinforced cement mortar; roofing fabrics; bituminous sealing membranes; bituminous products in the form of membranes for damp-proofing; flooring screeds; floor tiles, not of metal; epoxy grout; screed; fiberboards [building materials]; prepared dry mortar mix; ready mixed mortar; refractory mortar; skirting boards (non-metallic); floors, not of metal; tempered glass for use in building; insulating glass [building]; fireplace surrounds; fireplace mantles, not of metal; coatings [building materials]; gutters, not of metal; building mate-

rials (non-metallic), in particular including with insulating properties.

(260) AM 2019 98284 A

(800) 1408487

(151) 2017 12 20

(891) 2017 12 20

(731) SWEET BRANDS SPÓŁKA Z
 OGRANICZONĄ, ODPOWIEDZIALNOŚCIĄ
 Runa Leśnego 7, Łąki, PL-05-250 Radzymin,
 Poland

(540)

(591) Black, white

(531) 24.17.09; 24.17.25; 27.05.01

(511)

30 – Confectionery products, chocolate, bakery deserts, chocolate bars, cereal based snacks.

(260) AM 2019 98285 A

(800) 1408661

(151) 2018 02 22

(891) 2018 02 22

(731) TWINSET S.P.A.
 Via del Commercio, 32, I-41012 CARPI
 (MODENA), Italy

(540)

Twinset Milano

(591) Black, white

(511)

3 – Perfumes; potpourris (fragrances); fragrances other than for personal use; cosmetics.

9 – Spectacles [optics]; notebook computers; tablet computers; telephones; mobile phones; protective covers for telephones and tablet computers; bags for carrying computers and tablets.

14 – Costume jewellery; jewellery; precious stones; rings (jewellery), rings (costume jewellery), necklaces, bracelets, brooches all in precious metals or coated therewith; watches; key rings in precious metals or coated therewith.

18 – Bags; handbags; rucksacks; trunks and travelling bags; key cases; wallets; purses made in leather and imitation of leather; make-up bags sold empty; umbrellas.

24 – Wall hanging textile; tapestry (wall hangings) of textile; covers for cushions; pillow shams; pillow

cases; fabrics for textile use; foulard (fabric); table covers; bed covers; towels, namely beach towels and bath towels.

25 – Skirts; trousers; shorts; jeans; shirts; blouses; jerseys; sweaters; T-shirts; vests; suits; tracksuits; cloaks; coats; overcoats; bomber jackets; tunics; jackets; anoraks; raincoats; stockings; socks; hats; headgear; scarves; gloves; neckties; swimsuits; belts; shoes; beach shoes; slippers; boots; bath robes; tights; underwear; sportswear; silk scarves, dresses.

(260) AM 2019 98286 A

(800) 1408665

(151) 2018 05 18

(891) 2018 05 18

(731) RIGO TRADING S.A.
 Route de Trèves 6 EBBC, Building E,
 L-2633 Senningerberg, Luxembourg

(540)

GOAL FOR GOLD

(591) Black, white

(511)

30 – Confectionery.

(260) AM 2019 98287 A

(800) 1408700

(151) 2017 11 14

(891) 2017 11 14

(731) MERAN OTO İNŞ. MOBİLYA KIRT.
 ELEKTRONİK MADEN PETROL ENERJİ
 HİZM. SAN VE TİC. A.Ş.
 Merkez Mah. Prof. Dr. Nurettin, Mazhar Öktem
 Cad. No:8/6, Şişli, İstanbul, Turkey

(540)



(591) Black, white

(531) 26.04.18; 27.01.03; 27.05.24

(511)

20 – Furniture, made of any kind of material, mattresses; pillows; air mattresses and cushions, not for medical purposes, water beds, mirrors, beehives, artificial honeycombs and sections of wood for honeycombs, bouncing chairs for babies, playpens for babies, cradles, infant walkers, display boards, frames for pictures and paintings, identification plates, identification tags, nameplates, identification labels made of wood or synthetic materials, packaging containers of wood or plastics, casks for use in transportation or storage, barrels, storage drums, tanks, boxes, storage containers, transportation containers,

chests, loading pallets and closures for the aforementioned goods, of wood or plastics, small hardware goods of wood or synthetic materials included in this class, furniture fittings, of wood or synthetic materials, opening and closing mechanisms of wood or synthetic materials, ornaments and decorative goods of wood, cork, reed, cane, wicker, horn, bone, ivory, whalebone, shell, amber, mother-of-pearl, meerschaum, beeswax, plastic or plaster namely figurines, holiday ornaments for walls, sculptures, trophies, baskets, fishing baskets, kennels, nesting boxes and beds for household pets, portable ladders and mobile boarding stairs of wood or synthetic materials, bamboo curtains, roller indoor blinds [for interiors], slatted indoor blinds, trip curtains, bead curtains for decoration, curtain hooks, curtain rings, curtain tie-backs, curtain rods, non-metal wheel chocks.

35 – Advertising, marketing and public relations; organization of exhibitions and trade fairs for commercial or advertising purposes; design of advertising material; provision of an online marketplace for buyers and sellers of goods and services, office functions; secretarial services; arranging newspaper subscriptions for others; compilation of statistics; rental of office machines; systemization of information into computer databases; telephone answering for unavailable subscribers, business management, business administration and business consultancy; accounting; commercial consultancy services; personnel recruitment, personnel placement, employment agencies, import-export agencies; temporary personnel placement services, auctioneering, the bringing together, for the benefit of others, of furniture, made of any kind of material, mattresses, pillows, air mattresses and cushions, not for medical purposes, water beds, mirrors, beehives, artificial honeycombs and sections of wood for honeycombs, bouncing chairs for babies, playpens for babies, cradles, infant walkers, display boards, frames for pictures and paintings, identification plates, identification tags, nameplates, identification labels made of wood or synthetic materials, packaging containers of wood or plastics, casks for use in transportation or storage, barrels, storage drums, tanks, boxes, storage containers, transportation containers, chests, loading pallets and closures for the aforementioned goods, of wood or plastics, small hardware goods of wood or synthetic materials, furniture fittings, of wood or synthetic materials, opening and closing mechanisms of wood or synthetic materials, ornaments and decorative goods of wood, cork, reed, cane, wicker, horn, bone, ivory, whalebone, shell, amber, mother-of-pearl, meerschaum, beeswax, plastic or plaster namely figurines, holiday ornaments for walls, sculptures, trophies, baskets, fishing baskets, kennels, nesting boxes and beds for household pets, portable ladders and mobile boarding stairs of wood or synthetic materials, bamboo curtains, roller indoor blinds [for interiors], slatted indoor blinds, trip curtains,

bead curtains for decoration, curtain hooks, curtain rings, curtain tie-backs, curtain rods, non-metal wheel chocks enabling customers to conveniently view and purchase those goods, such services may be provided by retail stores, wholesale outlets, by means of electronic media or through mail order catalogues.

(260) AM 2019 98288 A

(800) 1408780

(151) 2017 12 27

(891) 2017 12 27

(731) Limited Liability Company "ORIMI"

1-st Microrayon Street, 15/4 plot, Sverdlov factory settlement, Vsevolozhsk district, RU-188682 Leningrad oblast, Russian Federation

(540)

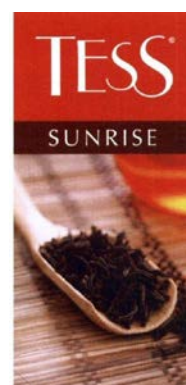

(591) Red, brown, dark brown, white, yellow, orange and beige

(531) 05.03.11; 07.15.08; 11.01.01; 11.01.02; 27.05.24; 29.01.15

(511)

30 – Tea, including instant tea, flavored tea, tea with fruits, garden herbs, preserved [seasonings] and herbal flavorings not for medicinal use, tea-based beverages; iced tea.

(260) AM 2019 98289 A

(800) 1408784

(151) 2018 04 10

(891) 2018 04 10

(731) ROCHE DIAGNOSTICS GmbH

Sandhofer Strasse 116, 68305 Mannheim, Germany

(540)

COBAS MAX

(591) Black, white

(511)

9 – Scientific instruments and apparatus; laboratory devices for use in research, science and industry; laboratory instruments for scientific and diagnostic purposes; computer hardware and software for medical and diagnostic purposes; computer software for the provision of automated diagnostic laboratory

processes; computer software and hardware for use with laboratory instruments, namely, for use in providing remote automated control of diagnostic laboratory instruments, data analysis, and data management.

10 – Medical apparatus and instruments; analyzers for in-vitro diagnostic testing for medical purposes; laboratory apparatus for medical diagnostic purposes.

(260) AM 2019 98290 A

(800) 1408867

(151) 2018 04 10

(891) 2018 04 10

(731) ROCHE DIAGNOSTICS GmbH
Sandhofer Strasse 116, 68305 Mannheim,
Germany

(540)

COBAS ULTIMATE

(591) Black, white

(511)

9 – Scientific instruments and apparatus; laboratory devices for use in research, science and industry; laboratory instruments for scientific and diagnostic purposes; computer hardware and software for medical and diagnostic purposes; computer software for the provision of automated diagnostic laboratory processes; computer software and hardware for use with laboratory instruments, namely, for use in providing remote automated control of diagnostic laboratory instruments, data analysis, and data management.

10 – Medical apparatus and instruments; analyzers for in-vitro diagnostic testing for medical purposes; laboratory apparatus for medical diagnostic purposes.

(260) AM 2019 98291 A

(800) 1408873

(151) 2018 03 19

(891) 2018 03 19

(731) "MOZZART" DOO
Zrenjaninski put 84/c, 11000 Beograd, Serbia

(540)



(591) Blue and light yellow

(531) 24.17.05; 26.01.18; 26.02.08; 27.05.01;
27.05.21; 29.01.12

(511)

9 – Scientific, nautical, surveying, photographic, cinematographic, optical, weighing, measuring, signaling, checking (supervision), emergency (life-saving) and teaching apparatus and instruments; apparatus and instruments for conducting, switching, transforming, accumulating, regulating or controlling electricity; apparatus for recording, transmission or reproduction of sound or images; magnetic recording media, sound recording disks; compact disks, DVDs and other digital recording media; mechanisms for coin-operated apparatus; cash registers; calculating machines; data processing equipment; computers; software; fire extinguishers.

35 – Advertising; commercial business management; commercial administration; office functions.

41 – Education; training; entertainment; sporting and cultural activities.

(260) AM 2019 98292 A

(800) 869856

(151) 2005 06 21

(891) 2018 05 15

(731) VI.BE.MAC. S.p.A.
Via Monte Pastello, 7/I, I-37057 SAN
GIOVANNI LUPATOTO (Verona), Italy

(540)



(591) Red and gray

(531) 24.17.01; 24.17.02; 26.04.01; 26.04.11;
26.04.12; 27.05.01; 29.01.01; 29.01.06

(511)

7 – Stitching machines; hemming machines; ironing machines; cutting machines; darning machines; motors, other than for land vehicles; engines, other than for land vehicles; agricultural implements other than hand-operated; incubators for eggs; sewing machines; pedal drives for sewing machines.

(260) AM 2019 98293 A

(800) 1006229

(151) 2009 05 12

(891) 2018 04 09

(731) SUMITOMO RUBBER INDUSTRIES, LTD.
6-9, Wakinohamacho 3-chome, Chuo-ku,
Kobe-shi, Hyogo 651-0072, Japan

(540)

ENASAVE

(591) Black, white

(511)

12 – Tires for motor vehicles; tires for motor bicycles; tires for automobiles; tires for trucks; tires for buses; tires for two-heeled motor vehicles.

(260) AM 2019 98294 A

(800) 1040888

(151) 2010 05 12

(891) 2018 06 01

(731) SPECIALES GILLARDEAU

Baie de Sinche, F-17560 BOURCEFRANC-
LE-CHAPUS, France

(540)

GILLARDEAU

(591) Black, white

(511)

29 – Fish, canned fish, preserved fish, fish in brine, shellfish, not live, crustaceans (not live), oysters, not live, fishmeal for human consumption, meals made from fish, seaweed extracts for food.

31 – Live fish, shellfish (live), live crustaceans, live oysters, fish spawn, algae for consumption.

43 – Services for providing food and drink, catering services, self-service restaurants, fast-food restaurants and snackbars, cafeterias, coffee shops, cocktail lounge services, tea rooms, preparing take-away meals and dishes; hotel services; temporary accommodation.

(260) AM 2019 98295 A

(800) 1130815

(151) 2012 05 24

(891) 2018 04 23

(731) Zakrytoe aktsionerhoe obshchestvo

"PHARMFIRMA "SOTEX"

d. 11, pos. Belikovo, Selskoe poselenie

Bereznjakovskoe, Sergievo-Posadsky

municipalny rayon, RU-141345 Moscovskaya

obl., Russian Federation

(540)

БЛОККОС

BloccoC

(591) Black, white

(531) 28.05

(511)

5 – Pharmaceutical preparations; veterinary preparations; dietetic substances adapted for medical use; plasters for medical purposes; amino acids for veterinary purposes; amino acids for medical purposes; antibiotics; germicides; balms for medical purposes; biocides; vaccines; dietetic substances adapted for medical use; radioactive substances for medical purposes; mineral water for medical purposes; haematogen; haemoglobin; glucose for medical purposes; hormones for medical purposes; mustard for pharmaceutical purposes; mustard plasters; mud for baths; medicinal mud; diastase for medical purposes; additives to fodder for medical purposes (terms too vague in the opinion of the International Bureau –

Rule 13(2)(b) of the Common Regulations); mineral food-supplements; nutritional additives for medical purposes; yeast for pharmaceutical purposes; gelatin(e) for medical purposes; cod liver oil; camphor for medical purposes; capsules for medicines; cachets for pharmaceutical purposes; candy for medical purposes; acids for pharmaceutical purposes; adhesive bands for medical purposes; candy, medicated; medicinal roots; blood for medical purposes; cultures of microorganisms for medical and veterinary use; adhesive plaster; medicines for alleviating constipation; lecithin for medical purposes; lotions for veterinary purposes; lotions for pharmaceutical purposes; liniments; ointments for pharmaceutical purposes; medicinal oils; drugs for medical purposes; medicines for veterinary purposes; medicines for human purposes; medicines for dental purposes; medicinal drinks; flour for pharmaceutical purposes; fishmeal for pharmaceutical purposes; first-aid boxes, filled; dietetic beverages adapted for medical purposes; medicinal infusions; tinctures for medical purposes; decoctions for pharmaceutical purposes; pills for pharmaceutical purposes; eyepatches for medical purposes; bunion pads; pomades for medical purposes; anti-uric preparations; bacterial preparations for medical and veterinary use; balsamic preparations for medical purposes; vitamin preparations; therapeutic preparations for the bath; pharmaceutical preparations for skin care; contact lens cleaning preparations; bath preparations, medicated; albuminous foodstuffs for medical purposes; dietetic foods adapted for medical purposes; by-products of the processing of cereals for medical purposes; solvents for removing adhesive plasters; vaginal washes; solutions for use with contact lenses; chewing gum for medical purposes; tissues impregnated with pharmaceutical lotions; suppositories; tobacco-free cigarettes for medical purposes; syrups for pharmaceutical purposes; soporifics; anaesthetics; antiseptics; analgesics; adjuvants for medical purposes; styptic preparations; anthelmintics; disinfectants for hygiene purposes; appetite suppressants for medical purposes; medical preparations for slimming purposes; febrifuges; depuratives; articles for headache; remedies for perspiration; remedies for foot perspiration; tonics [medicines]; nervines; digestives for pharmaceutical purposes; serums; medicinal herbs; sedatives; diabetic bread; herbal teas for medicinal purposes; slimming tea for medical purposes; poisons.

(260) AM 2019 98296 A

(800) 1252787

(151) 2015 03 24

(891) 2018 06 07

(731) EUSA PHARMA (UK) LIMITED

Breakspear Park, Breakspear Way, Hemel
Hempstead, Hertfordshire HP2 4TZ, United
Kingdom

(540)

QARZIBA

(591) Black, white

(511)

5 – Pharmaceutical and veterinary preparations; diagnostic preparations for medical purposes; sanitary preparations for medical purposes; dietetic substances adapted for medical use.

(260) AM 2019 98297 A

(800) 1252856

(151) 2014 11 19

(891) 2018 05 16

(731) ANGSTREM TRADING COMPANY LTD.

Shotlandskaya ulitsa, 6, RU-198035

Saint-Petersburg, Russian Federation

(540)

НАЦИОНАЛЬ

(591) Black, white

(531) 28.05

(511)

29 – Anchovy; peanuts, prepared; albumen for culinary purposes; white of eggs; beans, preserved; bouillon; ginger jam; fatty substances for the manufacture of edible fats; peas, preserved; mushrooms, preserved; game, not live; gelatine; meat jellies; jellies for food; fruit jellies; edible fats; fruit-based snack food; charcuterie; raisins; caviar; sauerkraut; isinglass for food; black pudding [blood sausage]; meat, tinned [canned (Am.)]; vegetables, tinned [canned (Am.)]; fish, tinned [canned (Am.)]; fruits, tinned [canned (Am.)]; bouillon concentrates; gherkins; shrimps, not live; buttercream; croquettes; toasted laver; spiny lobsters, not live; salmon; onions, preserved; margarine; piccalilli; marmalade; edible oils; peanut butter; cocoa butter; coconut oil; butter; shellfish, not live; almonds, ground; mussels, not live; milk; soya milk [milk substitute]; fish meal for human consumption; fruit pulp; meat; meat, preserved; vegetables, preserved; vegetables, dried; vegetables, cooked; potato fritters; olives, preserved; lobsters, not live; coconut, desiccated; nuts, prepared; tomato purée; liver pâté; pectin for culinary purposes; liver; pickles; jams; powdered eggs; ham; milk products; kimchi [fermented vegetable dish]; foods made from fish; curd; poultry, not live; cranberry sauce [compote]; apple purée; crustaceans, not live; fish, preserved; fish, not live; vegetable salads; fruit salads; bacon; pork; herrings; whipped cream; fat-containing mixtures for bread slices; vegetable juices for cooking; salted meats; sausages in batter; preparations for making bouillon; preparations for making soup; tripe; soups; cheese; tahini [sesame seed paste]; tofu; sea-cucumbers, not live; truffles, preserved; tuna fish; oysters, not live; rennet; fish fillets;

dates; crystallized fruits; frozen fruits; fruit, preserved; fruit, stewed; potato flakes; hummus [chickpea paste]; fruit peel; lentils, preserved; potato chips; fruit chips; seaweed extracts for food; meat extracts; eggs.

30 – Aromatic preparations for food; star aniseed; cookies; pancakes; buns; bread rolls; vanillin [vanilla substitute]; vanilla [flavoring] [flavouring]; waffles; vermicelli [noodles]; coffee flavorings [flavourings]; natural sweeteners; sausage binding materials; sea water for cooking; glucose for culinary purposes; mustard; yeast; thickening agents for cooking foodstuffs; rice-based snack food; cereal-based snack food; artificial coffee; pastries; confectionery for decorating Christmas trees; cakes; fruit jellies [confectionery]; peanut confectionery; almond confectionery; pasta; pasties; cocoa; cocoa-based ingredients for confectionery products; gruel, with a milk base, for food; capers; caramels [candy]; quiches; gluten prepared as foodstuff; sweetmeats [candy]; coffee; unroasted coffee; starch for food; crackers; groats for human food; corn, milled; corn, roasted; meat pies; turmeric; couscous [semolina]; farinaceous foods; noodles; candy; rice cakes; maltose; hominy; marzipan; custard; honey; royal jelly; flour; muesli; mint for confectionery; cocoa beverages with milk; coffee beverages with milk; coffee based beverages; tea-based beverages; chocolate beverages with milk; chocolate-based beverages; cocoa-based beverages; infusions, not medicinal; crushed oats; husked oats; nutmegs; pastilles [confectionery]; molasses for food; pepper; pies; pizzas; fondants [confectionery]; popcorn; pralines; condiments; meat tenderizers, for household purposes; cereal preparations; flour and cereal preparations; oat-based food; propolis; gingerbread; spices; petits fours [cakes]; puddings; cake powder; ravioli; chewing gum; rice; spring rolls; sugar; aniseed; cake dough; confectionery; baking soda [bicarbonate of soda for cooking purposes]; malt for human consumption; salt for preserving foodstuffs; cooking salt; celery salt; spaghetti; seasonings; preparations for stiffening whipped cream; rusks; breadcrumbs; sushi; sandwiches; yeast extracts for human consumption; tabbouleh; tacos; tapioca; soya bean paste [condiment]; almond paste; tortillas; tarts; garden herbs, preserved [seasonings]; candy decorations for cakes; vinegar; ferments for pastes; halvah; bread; unleavened bread; chips [cereal products]; chicory [coffee substitute]; tea; iced tea; chocolate; malt extract for food; essences for foodstuffs, except etheric essences and essential oils.

31 – Oranges, fresh; peanuts, fresh; beans, fresh; grapes, fresh; algae for human or animal consumption; fruit residue [marc]; mushrooms, fresh; cereal seeds, unprocessed; grains [cereals]; fish spawn; cocoa beans, raw; potatoes, fresh; chestnuts, fresh; animal foodstuffs; bird food; roots for food; maize;

sesame; lemons, fresh; onions, fresh vegetables; leeks, fresh; olives, fresh; almonds [fruits]; oats; vegetables, fresh; cucumbers, fresh; nuts [fruits]; peppers [plants]; fruit, fresh; wheat; crustaceans, live; rhubarb, fresh; rice, unprocessed; rye; lettuce, fresh; beet, fresh; grains [seeds]; malt for brewing and distilling; garden herbs, fresh; truffles, fresh; squashes, fresh; hazelnuts; hops; flowers, natural; chicory, fresh; lentils, fresh; berries, fresh fruits; barley.

(260) AM 2019 98298 A

(800) 1255020

(151) 2014 11 12

(891) 2018 05 16

(731) ANGSTREM Trading Company Ltd.
Shotlandskaya ulitsa, 6, RU-198035
Saint-Petersburg, Russian Federation

(540)

PROSTO

(591) Black, white

(511)

29 – Anchovy; peanuts, prepared; beans, preserved; soya beans, preserved, for food; bouillon; ginger jam; fatty substances for the manufacture of edible fats; peas, preserved; mushrooms, preserved; game, not live; gelatine for food; meat jellies; jellies for food; fruit jellies; suet for food; edible fats; charcuterie, including sausages; raisins; caviar; sauerkraut; isinglass for food; black pudding [blood sausage]; meat, tinned; vegetables, tinned; fish, tinned; fruits, tinned; bouillon concentrates; gherkins; shrimps, not live; buttercream; croquettes; spiny lobsters, not live; salmon; onions, preserved; margarine; piccalilli; marmalade; vegetable oils for food; peanut butter; cocoa butter; coconut butter; butter; cabbage oil for food; shellfish, not live; almonds, ground; mussels, not live; milk; fish meal for human consumption; fruit pulp; meat, including patties, beef steaks, rump steaks; meat, preserved; vegetables, preserved; vegetables, dried; vegetables, cooked, including frozen vegetables; potato fritters; olives, preserved; lobsters, not live; coconut, desiccated; nuts, prepared; tomato purée; liver pâté; pickles; jams; powdered eggs; ham; milk products; foods made from fish; poultry, not live; pollen prepared as foodstuff; cranberry sauce [compote]; apple purée; crustaceans, not live; fish, not live; fish, preserved; vegetable salads; fruit salads; bacon; sardines; pork; herrings; whipped cream; fat-containing mixtures for bread slices; tomato juice for cooking; vegetable juices for cooking; salted meats; sausages in batter; preparations for making bouillon; preparations for making soup; tripe; soups; vegetable soup preparations; cheese; tahini [sesame seed paste]; tofu; sea-cucumbers, not live; truffles, preserved; tuna fish; oysters, not live; fish fillets; dates; crystallized fruits; frozen fruits; fruit, preserved; fruit preserved in alcohol; fruit, stewed;

potato flakes; hummus [chickpea paste]; fruit peel; lentils, preserved; potato chips; fruit chips; seaweed extracts for food; meat extracts; vacuum-packed vegetables; vacuum-packed fruits.

30 – Aromatic preparations for food; star aniseed; sponge cakes; pancakes, including frozen pancakes; buns; bread rolls; vanillin [vanilla substitute]; vanilla [flavoring]; waffles; vermicelli [noodles]; coffee flavorings [flavourings]; natural sweeteners; mustard; thickening agents for cooking foodstuffs; artificial coffee; vegetal preparations for use as coffee substitutes; cakes; pastries, including frozen pastries; peanut confectionery; almond confectionery; pasta; pasties; frozen yogurt [confectionery ices]; cocoa; capers; boiled sweets; gruel, with a milk base, for food; quiches; sweetmeats [candy]; coffee; unroasted coffee; starch for food; crackers; groats for human food; corn, milled; corn, roasted; meat pies; turmeric; couscous [semolina]; farinaceous foods; noodles; ice for refreshment; ice, natural or artificial; edible ices; candy; rice cakes; maltose; marzipan; custard; honey; ice cream; flour; muesli; mint for confectionery; cocoa beverages with milk; coffee beverages with milk; coffee-based beverages; tea-based beverages; chocolate beverages with milk; chocolate-based beverages; cocoa-based beverages; infusions, not medicinal; crushed oats; husked oats; nutmegs; pastilles [confectionery]; molasses for food; pepper; petits fours [cakes]; cookies; pies; pizzas; fondants [confectionery]; popcorn; powder for edible ices; pralines; condiments, including ketchup, mayonnaise, sauces; meat tenderizers, for household purposes; cereal preparations; flour-milling products including frozen flour-milling products; oat-based food; propolis; gingerbread; spices; puddings; cake powder; ravioli, namely pelmeni [dumplings stuffed with meat], manty [dumplings], khinkali [oriental dumplings]; chewing gum, not for medical purposes; rice; spring rolls; sugar; aniseed; cake dough; confectionery; salt for preserving foodstuffs; cooking salt; celery salt; spaghetti; seasonings; preparations for stiffening whipped cream; rusks; breadcrumbs; sushi; sandwiches; tabbouleh; tacos; tapioca; almond paste; tortillas; tarts; candy decorations for cakes; vinegar; ferments for pastes; halvah; bread; unleavened bread; chips [cereal products]; chicory [coffee substitute]; tea; iced tea; chocolate; malt extract for food; essences for foodstuffs, except etheric essences and essential oils; garden herbs, preserved [seasonings].

31 – Oranges, fresh; peanuts, fresh; beans, fresh; grapes, fresh; algae for human or animal consumption; fruit residue [marc]; peas, fresh; mushroom spawn for propagation; mushrooms, fresh; yeast for animal consumption; oil cake; cereal seeds, unprocessed; grains [cereals]; grains for animal consumption; fish spawn; cocoa beans, raw; potatoes, fresh; chestnuts, fresh; animal foodstuffs; bird food; chico-

ry roots; roots for food; groats for poultry; maize; sesame; spiny lobsters, live; lemons, fresh; onions, fresh vegetables; flower bulbs; olives, fresh; shellfish, live; almonds [fruits]; mussels, live; meal for animals; oats; cucumbers, fresh; lobsters, live; nuts [fruits]; coconuts; kola nuts; bran; bran mash for animal consumption; peppers [plants]; fresh fruits; locust beans; by-products of the processing of cereals, for animal consumption; seed germ for botanical purposes; wheat; pollen [raw material]; crustaceans, live; rhubarb, fresh; rice, unprocessed; rye; fish, live; lettuce, fresh; beet, fresh; grains [seeds]; garden herbs, fresh; sea-cucumbers, live; truffles, fresh; squashes, fresh; oysters, live; hazelnuts; hops; chicory, fresh; lentils, fresh; berries; barley.

(260) AM 2019 98299 A

(800) 1275200

(151) 2015 04 09

(891) 2018 05 17

(731) TOSÇELİK PROFİL VE SAÇ ENDÜSTRİSİ ANONİM ŞİRKETİ

Organize Sanayi Bölgesi 2. Cad. Sariseki
İskenderum, Turkey

(540)

TOSÇELİK

(591) Black, white

(531) 27.05.01

(511)

6 – Ores of non-precious metal; common metal and their alloys and semi-finished products made of these materials; metal building materials; goods and materials of common metal used for storage, wrapping, packaging and sheltering purposes, containers of metal, storage, transport, including ladders of metal; metal products manufactured for sifting, filtering and similar purposes, namely, metal window screens, drain traps [valves] of metal; doors, windows, shutters, jalousies and their cases and fittings of metal excluding locks; non-electric cables and wires of metal; ironmongery, small hardware of metal; ventilation ducts, vents, vent covers, pipes, chimney caps, manhole covers, grilles of metal for ventilation, heating, sewage, telephone, underground electricity and air conditioning installations; metal panels or boards, non-luminous and non-mechanical, used for signalling, route showing or publicity purposes, signboards of metal, advertisement columns of metal, signaling panels of metal, non-luminous and non-mechanical traffic signs of metal; pipes of metal for transportation of liquids and gas, drilling pipes of metal and their metal fittings; strong boxes of metal; metal railway materials; bollards of metal, floating docks of metal, mooring buoys of metal, anchors; metal moulds for casting, other than machine parts; works of art made of common metals or their alloys; metal closures, bottle caps of metal; metal poles;

metal pallets and metal ropes for lifting, loading and transportation purposes; metal hangers, ties, straps, tapes and bands used for load-lifting and load-carrying.

35 – Advertising, marketing and public relations; organization of exhibitions and trade fairs for commercial or advertising purposes; office functions; business management, business administration and business consultancy including accountancy services; import-export agencies; commercial or industrial management assistance; auctioneering; the bringing together, for the benefit of others, of a variety of goods, enabling customers to conveniently view and purchase those goods, such services may be provided by retail stores, wholesale outlets, by means of electronic media or through mail order catalogues.

40 – Treatment of common metals; treatment of precious metals; processing of photographic and cinematographic films; photocomposing, photographic printing, photogravure; processing of foodstuffs for use in manufacture; slaughtering of animals; leather working and fur conditioning; saddlery working; textile treating, wool treating; tailoring, embroidery; woodworking and timber processing; framing of works of art; treatment of liquids, chemicals, gas and air for industrial use; grinding of glass and optical glass, custom assembling of materials for others; services of a dental technician; pottery firing; production of energy; rental of generators; paper treating; printing, bookbinding; treatment of plastics.

(260) AM 2019 98300 A

(800) 1281974

(151) 2015 05 08

(891) 2018 05 17

(731) TOSYALI HOLDİNG A.Ş.

Organize Sanayi Bölgesi, Sariseki İskenderun,
Turkey

(540)

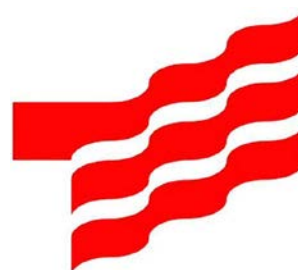

(591) Red

(531) 24.07.23; 26.11.03; 26.11.13; 29.01.01

(511)

6 – Ores of non-precious metal; common metals and their alloys and semi-finished products made of these materials; goods and materials of common metal used for storage, wrapping, packaging and sheltering purposes, containers of metal, storage, transport, including ladders of metal; goods of common metal for filtering and sifting purposes, namely ducts

and grilles; doors, windows, shutters, jalousies and their cases and fittings of metal; non-electric cables and wires of metal; ironmongery, small hardware of metal; ventilation ducts, vents, vent covers, pipes, metal chimneys, chimney caps, manhole covers, grilles of metal for ventilation, heating, sewage, telephone, underground electricity and air conditioning installations; metal panels or boards, non-luminous and non-mechanical, used for signalling, route showing, publicity purposes, signboards of metal, advertisement columns of metal, signaling panels of metal, non-luminous and non-mechanical traffic signs of metal; pipes of metal for transportation of liquids and gas, including drilling pipes of metal and metal valves for water pipes; strong boxes of metal; metal railway materials; bollards of metal, floating docks of metal, mooring buoys of metal, anchors; metal moulds for casting, other than machine parts; works of art made of common metals or their alloys; metal closures, bottle caps of metal; metal poles; metal pallets and metal ropes for lifting, loading and transportation purposes; metal hangers, ties, straps, tapes and bands used for load-lifting and load-carrying, wheel chocks made primarily of metal.

35 – Advertising, marketing and public relations; organization of exhibitions and trade fairs for commercial or advertising purposes; office functions; secretarial services; arranging newspaper subscriptions for others; compilation of statistics; rental of office machines; systemization of information into computer databases; telephone answering for unavailable subscribers; business management, business administration and business consultancy; accounting; commercial consultancy services; personnel placement; employment agencies; personnel recruitment; import-export agencies; temporary personnel placement services; business appraisal services for commercial or industrial products; auctioneering; the bringing together, for the benefit of others, of a variety of goods, namely, ores of non-precious metal, common metals and their alloys and semi-finished products made of these materials, goods and materials of common metal used for storage, wrapping, packaging and sheltering purposes, containers of metal, storage, transport, including ladders of metal, goods of common metal for filtering and sifting purposes, windows, shutters, jalousies and their cases and fittings of metal, non-electric cables and wires of metal, ironmongery, small hardware of metal, ventilation ducts, vents, vent covers, pipes, metal chimneys, chimney caps, manhole covers, grilles of metal for ventilation, heating, sewage, telephone, underground electricity and air conditioning installations, metal panels or boards, non-luminous and non-mechanical, used for signalling, route showing, publicity purposes, signboards of metal, advertisement columns of metal, signaling panels of metal, non-luminous and non-mechanical traffic signs of metal, pipes of metal for transportation of liquids

and gas, including drilling pipes of metal and metal valves for water pipes, strong boxes of metal, metal railway materials, bollards of metal, floating docks of metal, mooring buoys of metal, anchors, metal moulds for casting, other than machine parts, works of art made of common metals or their alloys, metal closures, bottle caps of metal, metal poles, metal pallets and metal ropes for lifting, loading and transportation purposes, metal hangers, ties, straps, tapes and bands used for load-lifting and load-carrying, wheel chocks made primarily of metal, enabling customers to conveniently view and purchase those goods, such services may be provided by retail stores, wholesale order catalogues.

40 – Treatment of common metals; treatment of precious metals; development of photographic and cinematographic films; photocomposing, photographic printing, photogravure; processing of foodstuffs for use in manufacture; slaughtering of animals; leather working and fur conditioning; saddlery working; textile treating, wool treating; tailoring, embroidery; woodworking and timber processing; framing of works of art; treatment of liquids, chemicals, gas and air for industrial use; grinding of glass and optical glass; custom assembling of materials for others, services of a dental technician; pottery firing; production of energy; rental of generators; paper treating; printing, bookbinding; treatment of plastics.

(260) AM 2019 98301 A
 (800) 1292888
 (151) 2016 01 29
 (891) 2018 05 23
 (731) SEXY HAIR CONCEPTS, LLC
 21551 Prairie Street, Chatsworth CA 91311,
 USA

(540)



(591) Black, white
 (531) 01.01.02; 01.01.10
 (511)

3 – Hair care products, namely, hair shampoos, hair colors, hair conditioners, hair mousses, hair sprays, hair gels, hair cremes, hair waxes, hair rinses, hair detanglers, hair balms, hair glosses, hair pomades and hair tonics.

(260) AM 2019 98302 A
 (800) 1347011
 (151) 2017 02 03
 (891) 2018 06 06
 (731) EPOCA 1932 Sàrl
 7 Route de Meinier, CH-1253 Vandoeuvres,
 Switzerland

(540)



(591) Black, white

(531) 11.01.19; 27.03.15; 27.05.10

(511)

30 – Coffee, coffee extracts, coffee-based beverages and preparations; iced coffee.

35 – Retail sale of coffee, coffee machines and products accompanying coffee, including via computer networks.

43 – Restaurant, coffee-shop, bar and tea room services.

(260) AM 2019 98303 A

(800) 1373313

(151) 2017 07 05

(891) 2018 04 09

(731) TWINSET S.P.A.

Via del Commercio, 32, I-41012 CARPI
(MODENA), Italy

(540)



(591) Black, white

(511)

3 – Perfumes; potpourris (fragrances); cosmetics.

9 – Spectacles [optics]; notebook computers; tablet computers; telephones; mobile phones; protective covers for telephones and tablet computers; bags for carrying computers and tablets.

(260) AM 2019 98304 A

(800) 1379398

(151) 2017 08 09

(891) 2018 05 09

(731) BRU TEXTILES NAAMLOZE

VENNOOTSCHAP

Satenrozen 2a, B-2550 Kontich, Belgium

(540)



(591) Shades of blue, black and white

(531) 26.01.01; 26.01.03; 26.01.24; 26.11.01;
26.11.06; 26.11.12; 29.01.12

(511)

23 – Yarns and threads for textile use.

24 – Textile tissues and textile products not included in other classes; blankets, covers for furniture and down comforters, curtains, lining fabrics and sheets

as well as textile fabrics for the manufacture of these materials.

27 – Carpets, floor mats, mats, linoleum and other floor coverings; wall covering, not textile material, wallpaper, wallpaper coated with textile.

35 – Advertising mediation and advertising; distribution of promotional items, advertisements and promotional material; management of commercial matters; business administration; administrative services; business intermediation in sale, wholesale and retail services, import and export in respect of products included in classes 23, 24 and 27; business intermediation in the sale of interior fittings, home accessories, decorative items and art objects; window display arrangement services; organization of exhibitions for publicity and/or commercial purposes; to provide all of the aforementioned services via electronic networks such as the internet, social media and/or via webshops.

42 – Scientific and technological services, as well as associated research and design services; industrial analysis and industrial research services; providing scientific and technological information and advice, quality assurance, certification, color measurement, material testing, research, testing and development services, also via electronic networks such as the internet; to provide all of the aforesaid services in particular with regard to textile products, textile fabrics and their applications such as covers and curtains.

(260) AM 2019 98305 A

(800) 1408903

(151) 2018 03 19

(891) 2018 03 19

(731) SWISS PHARMA INTERNATIONAL AG

Waldmannstrasse 8, CH-8001 Zürich, Switzerland

(540)



(591) Blue (Pantone 287)

(531) 26.15.15; 29.01.04

(511)

5 – Pharmaceutical products.

(260) AM 2019 98306 A

(800) 1408904

(151) 2018 03 19

(891) 2018 03 19

(731) SWISS PHARMA INTERNATIONAL AG

Waldmannstrasse 8, CH-8001 Zürich,
Switzerland

(540)

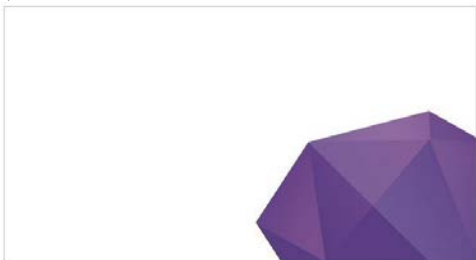

(591) Violet (Pantone 266)

(531) 26.15.15; 29.01.05

(511)

5 – Pharmaceutical products.

(260) AM 2019 98307 A

(800) 1408905

(151) 2018 03 19

(891) 2018 03 19

(731) SWISS PHARMA INTERNATIONAL AG
Waldmannstrasse 8, CH-8001 Zürich,
Switzerland

(540)

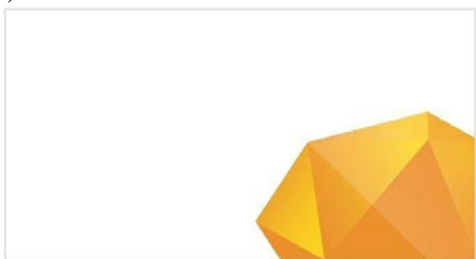

(591) Orange (Pantone 151)

(531) 26.15.15; 29.01.01

(511)

5 – Pharmaceutical products.

(260) AM 2019 98308 A

(800) 1408906

(151) 2018 03 19

(891) 2018 03 19

(731) SWISS PHARMA INTERNATIONAL AG
Waldmannstrasse 8, CH-8001 Zürich,
Switzerland

(540)



(591) Gray (Pantone 7543)

(531) 26.15.15

(511)

5 – Pharmaceutical products.

(260) AM 2019 98309 A

(800) 1408913

(151) 2018 04 17

(891) 2018 04 17

(731) Closed Joint Stock Company

"SOTEX "PHARMFIRM"

pos. Belikovo, d. 11, selskoe poselenie

Berezhnyakovskoe, Sergievo-Posadsky

municipal district, RU-141345 Moscow

Region, Russian Federation

(540)

NEIPILEPT

(591) Black, white

(511)

5 – Analgesics; antibiotics; first-aid boxes, filled; vaccines; dietetic substances adapted for medical use; nutritional supplements; capsules for medicines; cachets for pharmaceutical purposes; candy, medicated; adhesive plasters; liniments; ointments for pharmaceutical purposes; medicinal oils; drugs for medical purposes; medicines for veterinary purposes; dietetic beverages adapted for medical purposes; vitamin preparations; pharmaceutical preparations; chemico-pharmaceutical preparations; dietetic foods adapted for medical purposes; balms for medical purposes; hematogen; mustard plasters; dietary supplements for animals; candy for medical purposes; anaesthetics; antiseptics.

(260) AM 2019 98310 A

(800) 1408914

(151) 2018 04 17

(891) 2018 04 17

(731) Closed Joint Stock Company,

"SOTEX "PHARMFIRM"

pos. Belikovo, d. 11, selskoe poselenie

Berezhnyakovskoe, Sergievo-Posadsky

municipal district, RU-141345 Moscow

Region, Russian Federation

(540)

Ketoaminol

(591) Black, white

(511)

5 – Analgesics; anaesthetics; antibiotics; antiseptics; first-aid boxes, filled; vaccines; dietetic substances adapted for medical use; nutritional supplements; capsules for medicines; cachets for pharmaceutical purposes; candy, medicated; adhesive plasters; liniments; ointments for pharmaceutical purposes; medicinal oils; drugs for medical purposes; medicines for human purposes; medicines for veterinary purposes; dietetic beverages adapted for medical purposes; veterinary preparations; vitamin preparations; pharmaceutical preparations; chemico-pharmaceutical preparations; dietetic foods adapted for medical purposes; chewing gum for medical purposes; tissues impregnated with pharmaceutical lotions; prepa-

rations of trace elements for human and animal use; amino acids for veterinary purposes; balms for medical purposes; hematogen; mustard plasters; dietary supplements for animals; candy for medical purposes; food for babies.

(260) AM 2019 98311 A
 (800) 1408969
 (151) 2018 03 19
 (891) 2018 03 19
 (731) SWISS PHARMA INTERNATIONAL AG
 Waldmannstrasse 8, CH-8001 Zürich,
 Switzerland

(540)



(591) Blue (Pantone 299)
 (531) 26.15.15; 29.01.04
 (511)
 5 – Pharmaceutical products.

(260) AM 2019 98312 A
 (800) 1408974
 (151) 2018 03 19
 (891) 2018 03 19
 (731) SWISS PHARMA INTERNATIONAL AG
 Waldmannstrasse 8, CH-8001 Zürich,
 Switzerland

(540)



(591) Orange (Pantone 172)
 (531) 26.15.15; 29.01.01
 (511)
 5 – Pharmaceutical products.

(260) AM 2019 98313 A
 (800) 1408978
 (151) 2018 03 19
 (891) 2018 03 19
 (731) SWISS PHARMA INTERNATIONAL AG
 Waldmannstrasse 8, CH-8001 Zürich,
 Switzerland

(540)

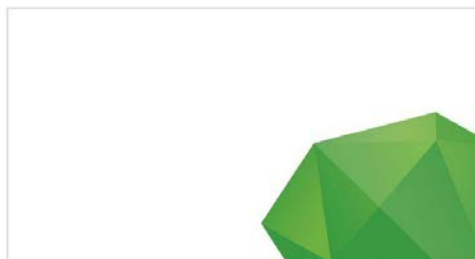

(591) Green (Pantone 362)
 (531) 26.15.15; 29.01.03
 (511)
 5 – Pharmaceutical products.

(260) AM 2019 98314 A
 (800) 1408989
 (151) 2018 03 19
 (891) 2018 03 19
 (731) SWISS PHARMA INTERNATIONAL AG
 Waldmannstrasse 8, CH-8001 Zürich,
 Switzerland

(540)



(591) Turquoise (Pantone 326)
 (531) 26.15.15; 29.01.04
 (511)
 5 – Pharmaceutical products.

(260) AM 2019 98317 A
 (800) 1409058
 (151) 2018 03 20
 (891) 2018 03 20
 (731) "BELUGA MARKET", LLC
 Proletarskaya street, 40A, Zvenigorog,
 RU-143180 Moscow region, Russian
 Federation

(540)

Cigar's Barrel

(591) Black, white
 (511)
 33 – Alcoholic beverages, except beer; aperitifs; ar-rack; brandy; wine; piquette; whiskey; vodka; gin; digesters [liqueurs and spirits]; cocktails; liqueurs; alcoholic beverages containing fruit; spirits [beve-rages]; distilled beverages; mead (hydromel); pep-permint liqueurs; bitters; rum; sake; cider; rice alco-hol; alcoholic extracts; alcoholic fruit extracts; alco-holic essences.

(260) AM 2019 98318 A
 (800) 1409074
 (151) 2018 03 22
 (891) 2018 03 22
 (731) SOCIÉTÉ DES PRODUITS NESTLÉ S.A.
 CH-1800 Vevey, Switzerland
 (540)

Нежный дуэт

(591) Black, white
 (531) 28.05
 (511)
 30 – Chocolate, chocolate products, chocolate paste, chocolate spread, chocolate-based preparations and beverages; confectionery, sugar confectionery, candy; sugar-based confectionery; biscuits, cakes, cookies, wafers, caramels.

(260) AM 2019 98323 A
 (800) 1409416
 (151) 2018 04 12
 (891) 2018 04 12
 (731) MAHINDRA VEHICLE SALES &
 SERVICE, INC.
 1055 W. Square Lake Road, Troy MI 48098,
 USA
 (540)

ROXOR

(591) Black, white
 (511)
 12 – Utility terrain vehicles (UTVs).

(260) AM 2019 98325 A
 (800) 1409455
 (151) 2017 12 27
 (891) 2017 12 27
 (731) SHANGHAI NAR INDUSTRIAL CO., LTD.
 No.26, Xinhua Road, Xinchang Town,
 Pudong New District, 201214 Shanghai,
 China
 (540)

NAR

(591) Black, white
 (531) 27.05.01; 27.05.17; 27.05.23
 (511)
 17 – Plastic film other than for wrapping; anti-dazzle films for windows (tinted films); insulating plastic films; viscose plastic film other than for packing; tinted plastic films for use on windows.

(260) AM 2019 98336 A
 (800) 1409730
 (151) 2017 10 05

(891) 2017 10 05
 (731) KLAUS FABER AG
 Lebacher Straße 152 – 156B 66113
 Saarbrücken, Germany
 (540)



(591) Black, white
 (531) 26.01.01; 26.01.03; 26.04.02; 26.04.09;
 26.04.24; 26.11.03; 26.11.07; 26.11.09;
 26.13.25; 27.05.01

(511)
 6 – Unprocessed and semi-processed materials of metal; pipes, tubes and hoses, and fittings therefor, including valves, of metal; downpoles of metal for the accessing of cables; downpoles of metal for the distribution of cables; trunking [channels] of metal for electric cables; cable ducts made of metal [other than electricity]; clips of metal for cables and pipes; cables, wires and chains, of metal; reels of metal [non-mechanical] for storing cables; cable stretchers; cable supports made of metal; binding screws of metal for cables; cable straps of metal; metal hardware; ducts of metal for ventilating and air conditioning installations; ducts made of metal for trunking conduits for gases.

9 – Cable harnesses; cable modems; cable connectors; cable adapters; cable detectors; cables for transmitting and receiving cable television signals; electric cables for the transmission of sounds and images; cable television converters; usb cables; luminous usb cables; telecommunications cables; data transmission cables; usb cables for cellphones; data synchronization cables; electric cables and wires; mobile high-definition link (mhl) cables; threaded electrical cable connectors; electric wiring harnesses; conductor bars; ducting for electric cables; cable channels (electric-); cable covers [conduits]; wire connectors [electricity]; electrical connecting cables; insulated electrical cables; heat resistant electric wires; thermocouple cables; cable junctions for electric cables; insulated cable for electrical installations; male connectors for electrical cables; connections for electric cables; threaded cable connectors of metal; identification threads for electric wires; cables for electrical signal transmission; joint boxes for housing cable joints; materials for electricity mains [wires, cables]; cable locators; power wires; current plugs; electricity conduits; power adapters; power distributors [electrical]; current-meters; apparatus and instruments for accumulating electricity; power line conditioners; power line protectors; apparatus and instruments for conducting electricity; ducts [el-

electricity]; line drivers; electromagnetic conduits; ducts [electricity]; conduit couplings [electric]; metal ducts [electric]; cables, electric; wires, electric; interface cables [electric]; electrical power extension cords; mounting cords [electrical]; insulated electrical cables; rubber covered electrical wires; heat resistant electric wires; connections for electric cables; junction boxes for electric wires; sheaths for electrical wires; circuits for heavy current; aerial cables for heavy currents.

35 – Retail and wholesale services relating to cables, wires and other electrical goods, in particular copper ropes, including via the internet; information on commercial matters, including via the internet, cable network or other forms of data transmission; electronic processing of orders.

39 – Electricity distribution via cables; supply of electricity; leasing the use of power lines to third parties for the transmission of electricity; electricity distribution via cables; storage of electrical plant; packaging and storage of goods; transportation and storage; storage and delivery of goods; parcel receipt services; storage of packages; storage of cargo; distribution by pipeline and cable.

40 – Metal fabrication and finishing services; custom manufacture of metal hardware; custom manufacture of elastomeric components; custom manufacture of thermoplastic components; custom manufacture of semiconductor components, devices and circuits; coppersmithing; rental of assembly machine equipment; custom assembling of materials for others; heat treatment of pipes and tubes made of metal; exterior and interior plating of pipes and tubes made of metal; photogravure printing; making of rubber stamps; processing of rubber.

(260) AM 2019 98337 A

(800) 1409736

(151) 2018 01 26

(891) 2018 01 26

(731) AKAL TİCARET VE TEKSTİL SANAYİ LİMİTED ŞİRKETİ

Merve Mahallesi, Akabe Caddesi, No:16

Yenidoğan – Sancaktepe, İstanbul, Turkey

(540)



(591) Red

(531) 27.05.17; 29.01.01

(511)

25 – Clothing, including underwear and outer clothing, other than special purpose protective clothing; socks, mufflers [clothing], shawls, bandanas, scar-

ves, belts [clothing]; footwear, shoes, slippers, sandals; headgear, hats, caps with visors, berets, caps [headwear], skull caps.

(260) AM 2019 98341 A

(800) 1409852

(151) 2017 10 16

(891) 2017 10 16

(731) E-SPORTS MEDIA RIGHTS, SL

Avenida Baix Llobregat, 3-5, E-08970 SANT JOAN DESPI (BARCELONA), Spain

(540)



(591) Black, white

(531) 26.13.25; 27.05.10

(511)

38 – Telecommunications; dissemination of audiovisual and multimedia content via the Internet; satellite dissemination services relating to sporting events.

41 – Entertainment services; video game entertainment services; organization of events for cultural, entertainment and sports purposes.

(260) AM 2019 98343 A

(800) 1409877

(151) 2018 05 10

(891) 2018 05 10

(731) EGIS GYOGYSZERGYAR ZRT.

Kereszturi ut 30-38, H-1106 Budapest, Hungary

(540)

LIPEGIS

(591) Black, white

(511)

5 – Pharmaceutical preparations for human use.

(260) AM 2019 98347 A

(800) 1409953

(151) 2018 01 23

(891) 2018 01 23

(731) Limited Liability Company

"FITOKOSMETIK"

1-y Magistralnyy tup., 11, building 1, office 1,

RU-123290 Moscow, Russian Federation

(540)



(591) White and pink.

(531) 02.09.01; 26.11.02; 26.11.12; 28.05; 29.01.12

(511)

3 – Amber [perfume]; aromatics [essential oils]; balms, other than for medical purposes; lip glosses; petroleum jelly for cosmetic purposes; cotton wool for cosmetic purposes; scented water; javelle water; lavender water; toilet water; depilatory wax; waxes for leather; creams for leather; massage gels, other than for medical purposes; deodorants for human beings or for animals; depilatories; perfumes; greases for cosmetic purposes; douching preparations for personal sanitary or deodorant purposes [toiletries]; perfumery; ionone [perfumery]; eyebrow pencils; cosmetic pencils; hair conditioners; beard dyes; cosmetic dyes; cosmetic creams; hair spray; nail polish; hair lotions; lotions for cosmetic purposes; aftershave lotions; beauty masks; oils for perfumes and scents; oils for cosmetic purposes; oils for toilet purposes; essential oils; essential oils of cedarwood; essential oils of lemon; essential oils of citron; oils for cleaning purposes; bergamot oil; gaultheria oil; jasmine oil; lavender oil; almond oil; rose oil; oil of turpentine for degreasing; almond milk for cosmetic purposes; cleansing milk for toilet purposes; musk [perfumery]; soap; deodorant soap; shaving soap; cakes of toilet soap; almond soap; cosmetic kits; eau de Cologne; bases for flower perfumes; cotton sticks for cosmetic purposes; lipsticks; pomades for cosmetic purposes; shaving preparations; cosmetic preparations for baths; bath preparations, not for medical purposes; hair straightening preparations; waving preparations for the hair; color-removing preparations; make-up removing preparations; nail care preparations; aloe vera preparations for cosmetic purposes; sunscreen preparations; make-up powder; potpourris [fragrances]; bath salts, not for medical purposes; fumigation preparations [perfumes]; eyebrow cosmetics; sun-tanning preparations [cosmetics]; hair colorants; neutralizers for permanent waving; cosmetic preparations for eyelashes; cosmetic preparations for skin care; cosmetics; mascara; bleaching preparations [decolorants] for cosmetic purposes; antiperspirants [toiletries]; talcum powder, for toilet use; terpenes [essential oils]; henna [cosmetic dye]; shampoos; dry shampoos; extracts of flowers [perfumes]; ethereal essences; badian essence; mint essence [essential oil].

(260) AM 2019 98348 A

(800) 1409957

(151) 2018 04 16

(891) 2018 04 16

(731) BEMA Pharma GmbH

Porschestraße 22/24, 12107 Berlin, Germany

(540)

NovoFOL

(591) Black, white

(511)

5 – Dietary supplements for humans; nutritional supplements; medicated food supplements; mineral food supplements; food supplements; dietary food supplements; herbal supplements; preparations and products for use as dietary supplement; dietary supplement drink mix; food supplements for veterinary use; food supplements consisting of amino acids, vitamins, minerals, microelements; food supplements for non-medical purposes; calcium tablets as a food supplement; nutritional supplements; dietary supplements and dietetic preparations; vitamin preparations in the nature of food supplements; health food supplements for persons with special dietary requirements.

35 – Import-export agency services; retail or wholesale services in the field of dietary and nutritional supplements.

(260) AM 2019 98349 A

(800) 1409970

(151) 2018 02 08

(891) 2018 02 08

(731) LIFE SCIENCES INTELLECT LIMITED

st. Gorkogo, 4, Obninsk, RU-249033 Kaluga region, Russian Federation

(540)

**КОЛИ
КРОКОДИЛ**

(591) Black, white

(531) 28.05

(511)

5 – Pharmaceuticals, medical and veterinary preparations; sanitary preparations for medical purposes; dietetic food and substances adapted for medical or veterinary use, food for babies; dietary supplements for humans and animals; plasters, materials for dressings; material for stopping teeth, dental wax; disinfectants; preparations for destroying vermin; fungicides, herbicides, acaricides; aconitine; alkaloids for medical purposes; alginates for pharmaceutical purposes; algicides; aldehydes for pharmaceutical purposes; dental amalgams of gold; dental amalgams; amino acids for veterinary purposes; amino acids for medical purposes; analgesics; anaesthetics; antibiotics; antiseptics; medicine cases, portable, filled; first-aid boxes, filled; aluminium acetate for pharmaceutical purposes; acetates for pharmaceutical purposes; germicides; balms for medical purposes; bandages for dressings; biocides; bromine for pharmaceutical purposes; paper for mustard plasters; fly catching paper; mothproofing paper; petroleum jelly for medical purposes; vaccines; oxygen baths; antiseptic cotton; aseptic cotton; absorbent cotton; wadding for medical purposes; cotton for medical purposes; dietetic substances adapted for

medical use; radiological contrast substances for medical purposes; nutritive substances for microorganisms; radioactive substances for medical purposes; bismuth subnitrate for pharmaceutical purposes; melissa water for pharmaceutical purposes; sea water for medicinal bathing; mineral waters for medical purposes; thermal water; dietary fiber; molding wax for dentists; gases for medical purposes; guaiacol for pharmaceutical purposes; hematogen; hemoglobin; hydrastine; hydrastinine; glycerine for medical purposes; glycerophosphates; glucose for medical purposes; gentian for pharmaceutical purposes; hormones for medical purposes; mustard for pharmaceutical purposes; mustard plasters; mud for baths; medicinal mud; gamboge for medical purposes; gurjun [gurjon, gurjan] balsam for medical purposes; air deodorising preparations; deodorants, other than for human beings or for animals; deodorants for clothing and textiles; diastase for medical purposes; digitalin; mineral food supplements; nutritional supplements; albumin dietary supplements; dietary supplements for animals; yeast dietary supplements; alginate dietary supplements; glucose dietary supplements; casein dietary supplements; lecithin dietary supplements; linseed oil dietary supplements; propolis dietary supplements; protein dietary supplements; protein supplements for animals; royal jelly dietary supplements; pollen dietary supplements; wheat germ dietary supplements; linseed dietary supplements; enzyme dietary supplements; yeast for pharmaceutical purposes; gelatine for medical purposes; cod liver oil; isotopes for medical purposes; insecticides; iodine for pharmaceutical purposes; iodides for pharmaceutical purposes; alkaline iodides for pharmaceutical purposes; iodoform; calomel [fungicide]; cream of tartar for pharmaceutical purposes; tartar for pharmaceutical purposes; camphor for medical purposes; capsules for medicines; cachets for pharmaceutical purposes; hemostatic pencils; wart pencils; caustic pencils; carbolineum [parasiticide]; caustics for pharmaceutical purposes; cachou for pharmaceutical purposes; quassia for medical purposes; quebracho for medical purposes; oxygen for medical purposes; gallic acid for pharmaceutical purposes; acids for pharmaceutical purposes; adhesives for dentures; stem cells for veterinary purposes; stem cells for medical purposes; cocaine; collodion for pharmaceutical purposes; corn rings for the feet; candy, medicated; angostura bark for medical purposes; barks for pharmaceutical purposes; cedar wood for use as an insect repellent; condurango bark for medical purposes; croton bark; mangrove bark for pharmaceutical purposes; myrobalan bark for pharmaceutical purposes; quinquina for medical purposes; medicinal roots; rhubarb roots for pharmaceutical purposes; lint for medical purposes; starch for dietetic or pharmaceutical purposes; creosote for pharmaceutical purposes; blood for medical purposes; cultures of microorganisms for medical or vete-

inary use; curare; dental lacquer; liquorice for pharmaceutical purposes; lactose for pharmaceutical purposes; candy for medical purposes; adhesive plasters; medicines for alleviating constipation; adhesive tapes for medical purposes; lecithin for medical purposes; lotions for veterinary purposes; medicated hair lotions; lotions for pharmaceutical purposes; personal sexual lubricants; lupulin for pharmaceutical purposes; magnesia for pharmaceutical purposes; liniments; ointments for pharmaceutical purposes; sunburn ointments; mercurial ointments; frostbite salve for pharmaceutical purposes; gauze for dressings; medicinal oils; mustard oil for medical purposes; camphor oil for medical purposes; castor oil for medical purposes; oil of turpentine for pharmaceutical purposes; dill oil for medical purposes; dental mastics; dental abrasives; dental impression materials; teeth filling material; dressings, medical; surgical dressings; drugs for medical purposes; medicines for veterinary purposes; serotherapeutic medicines; medicines for human purposes; medicines for dental purposes; menthol; medicinal drinks; moleskin for medical purposes; almond milk for pharmaceutical purposes; royal jelly for pharmaceutical purposes; milk ferments for pharmaceutical purposes; Irish moss for medical purposes; flour for pharmaceutical purposes; linseed meal for pharmaceutical purposes; fish meal for pharmaceutical purposes; fly glue; mint for pharmaceutical purposes; dietetic beverages adapted for medical purposes; malted milk beverages for medical purposes; narcotics; medicinal infusions; tincture of iodine; eucalyptol for pharmaceutical purposes; tinctures for medical purposes; opium; opodeldoc; decoctions for pharmaceutical purposes; antiparasitic collars for animals; stick liquorice for pharmaceutical purposes; sulfur sticks [disinfectants]; pastilles for pharmaceutical purposes; pectin for pharmaceutical purposes; pepsins for pharmaceutical purposes; peptones for pharmaceutical purposes; hydrogen peroxide for medical purposes; food for babies; leeches for medical purposes; blood plasma; eyepatches for medical purposes; poultices; compresses; scapulars for surgical purposes; babies' diapers [napkins]; diapers for pets; napkins for incontinents; bunion pads; breast-nursing pads; pomades for medical purposes; powder of cantharides; pyrethrum powder; belts for sanitary napkins [towels]; anti-uric preparations; bacterial preparations for medical and veterinary use; bacteriological preparations for medical and veterinary use; balsamic preparations for medical purposes; albuminous preparations for medical purposes; biological preparations for veterinary purposes; biological preparations for medical purposes; veterinary preparations; bismuth preparations for pharmaceutical purposes; vitamin preparations; diagnostic preparations for medical purposes; bath preparations for medical purposes; therapeutic preparations for the bath; hemorrhoid preparations; preparations for callouses; prepa-

rations to facilitate teething; preparations for the treatment of burns; fumigation preparations for medical purposes; ootherapy preparations; air purifying preparations; bronchodilating preparations; preparations for reducing sexual activity; sterilising preparations; soil-sterilizing preparations; corn remedies; pharmaceutical preparations for treating dandruff; preparations for destroying noxious animals; herbicides; preparations for destroying dry rot fungus; larvae exterminating preparations; fly destroying preparations; preparations for destroying mice; slug exterminating preparations; vermin destroying preparations; pharmaceutical preparations for skin care; contact lens cleaning preparations; preparations of microorganisms for medical or veterinary use; lime-based pharmaceutical preparations; styptic preparations; medicated eye-washes; medicinal hair growth preparations; opiates; anticryptogamic preparations; aloe vera preparations for pharmaceutical purposes; preparations of trace elements for human and animal use; sulfonamides [medicines]; pharmaceutical preparations; pharmaceutical preparations for treating sunburn; enzyme preparations for veterinary purposes; enzyme preparations for medical purposes; chemico-pharmaceutical preparations; chemical preparations for veterinary purposes; chemical preparations for the diagnosis of pregnancy; chemical preparations for medical purposes; chemical preparations to treat wheat blight [smut]; vine disease treating chemicals; chemical preparations to treat mildew; chemical preparations for treating phylloxera; chemical preparations for pharmaceutical purposes; chilblain preparations; mothproofing preparations; collyrium; lead water; chemical conductors for electrocardiograph electrodes; albuminous foodstuffs for medical purposes; dietetic foods adapted for medical purposes; by-products of the processing of cereals for dietetic or medical purposes; sanitary towels; panty liners [sanitary]; propolis for pharmaceutical purposes; pearl powder for medical purposes; radium for medical purposes; hydrated chloral for pharmaceutical purposes; solvents for removing adhesive plasters; vaginal washes for medical purposes; solutions for contact lenses; chemical reagents for medical or veterinary purposes; gum for medical purposes; rubber for dental purposes; chewing gum for medical purposes; insect repellents; insect repellent incense; repellents for dogs; tissues impregnated with pharmaceutical lotions; sarsaparilla for medical purposes; sugar for medical purposes; asthmatic tea; fumigating sticks; suppositories; linseed for pharmaceutical purposes; tobacco-free cigarettes for medical purposes; siccatives [drying agents] for medical purposes; syrups for pharmaceutical purposes; turpentine for pharmaceutical purposes; milking grease; greases for veterinary purposes; greases for medical purposes; lacteal flour for babies; soporifics; bicarbonate of soda for pharmaceutical purposes; bath

salts for medical purposes; salts for mineral water baths; salts for medical purposes; potassium salts for medical purposes; sodium salts for medical purposes; smelling salts; mineral water salts; malt for pharmaceutical purposes; semen for artificial insemination; medicinal alcohol; alloys of precious metals for dental purposes; ergot for pharmaceutical purposes; cooling sprays for medical purposes; adjuvants for medical purposes; astringents for medical purposes; vermifuges; disinfectants for hygiene purposes; disinfectants for chemical toilets; douching preparations for medical purposes; appetite suppressants for medical purposes; medical preparations for slimming purposes; parasiticides; mouthwashes for medical purposes; febrifuges; depuratives; animal washes [insecticides]; detergents for medical purposes; cattle washes [insecticides]; dog washes [insecticides]; vesicants; purgatives; remedies for perspiration; remedies for foot perspiration; chemical contraceptives; antiparasitic preparations; sedatives; tranquillizers; laxatives; tonics [medicines]; digestives for pharmaceutical purposes; nervines; media for bacteriological cultures; steroids; strychnine; serums; tanning pills; appetite suppressant pills; slimming pills; jujube, medicated; antioxidant pills; sanitary tampons; vulnerary sponges; thymol for pharmaceutical purposes; biological tissue cultures for veterinary purposes; biological tissue cultures for medical purposes; smoking herbs for medical purposes; medicinal herbs; transplants [living tissues]; surgical implants comprised of living tissues; pants, absorbent, for incontinents; sanitary panties; babies' diaper-pants; charcoal for pharmaceutical purposes; fennel for medical purposes; porcelain for dental prostheses; phenol for pharmaceutical purposes; enzymes for veterinary purposes; enzymes for medical purposes; ferments for pharmaceutical purposes; formic aldehyde for pharmaceutical purposes; phosphates for pharmaceutical purposes; fungicides; quinine for medical purposes; chinoline for medical purposes; diabetic bread adapted for medical use; chloroform; flowers of sulfur for pharmaceutical purposes; cement for animal hooves; bone cement for surgical and orthopaedic purposes; dental cements; medicinal tea; herbal teas for medicinal purposes; eucalyptus for pharmaceutical purposes; tobacco extracts [insecticides]; extracts of hops for pharmaceutical purposes; elixirs [pharmaceutical preparations]; ethers for pharmaceutical purposes; esters for pharmaceutical purposes; cellulose esters for pharmaceutical purposes; cellulose ethers for pharmaceutical purposes; rat poison; poisons; bacterial poisons; jalap.

35 – Advertising; business management; business administration; office functions; arranging subscriptions to telecommunication services for others; import-export agency services; commercial information agency services; advertising agencies; cost price analysis; rental of advertising space; financial audi-

ting; employment agency services; computerized file management; book-keeping; invoicing; business efficiency expert services; demonstration of goods; transcription of communications [office functions]; opinion polling; market studies; business information; commercial information and advice for consumers in the choice of products and services; business investigations; business research; marketing research; personnel recruitment; business management and organization consultancy; business organization consultancy; business management consultancy; personnel management consultancy; professional business consultancy; layout services for advertising purposes; marketing; business management of performing artists; business management of sports people; news clipping services; updating of advertising material; word processing; organization of exhibitions for commercial or advertising purposes; arranging newspaper subscriptions for others; organization of fashion shows for promotional purposes; organization of trade fairs for commercial or advertising purposes; shop window dressing; business appraisals; payroll preparation; data search in computer files for others; sponsorship search; business management assistance; commercial or industrial management assistance; presentation of goods on communication media, for retail purposes; economic forecasting; auctioneering; sales promotion for others; production of advertising films; office machines and equipment rental; rental of advertising time on communication media; publicity material rental; rental of vending machines; rental of photocopying machines; publication of publicity texts; radio advertising; billposting; outdoor advertising; distribution of samples; dissemination of advertising matter; direct mail advertising; writing of publicity texts; on-line advertising on a computer network; advertising by mail order; television advertising; document reproduction; compilation of statistics; compilation of information into computer databases; business inquiries; systemization of information into computer databases; advisory services for business management; tax preparation; drawing up of statements of accounts; copywriting; telemarketing services; psychological testing for the selection of personnel; business management of hotels; commercial administration of the licensing of the goods and services of others; administrative processing of purchase orders; retail and wholesale services including of goods of 03 class; retail and wholesale store services including of goods of 03 class; retail and wholesale services via the Internet including of goods of 03 class; retail and wholesale store services including of goods of 05 class; retail and wholesale services via the Internet including of goods of 05 class; public relations; modelling for advertising or sales promotion; typing; relocation services for businesses; price comparison services; secretarial services; procurement services for others [purchasing goods and services for other

businesses]; shorthand; outsourcing services [business assistance]; telephone answering for unavailable subscribers; photocopying services.

(260) AM 2019 98350 A
 (800) 1409994
 (151) 2018 02 28
 (891) 2018 02 28
 (731) Obshchestvo s ogranichennoy
 otvetstvennostyu "LUX-VISAGE"
 ul.Dzerzhinskaya 28, Zaslavl, Minskiy
 rayon, 223036 Minskaya obl., Belarus

(540)



The logo for LUXVISAGE features the word "LUXVISAGE" in a bold, black, sans-serif font. The letters "LUX" are slightly larger and more prominent than "VISAGE". The text is set against a white background with a thin black horizontal line underneath.

(591) Black, white
 (531) 27.05.11
 (511)
 3 – Decorative cosmetics.

44 – Hygienic and beauty care for human beings.

(260) AM 2019 98351 A
 (800) 1410012
 (151) 2017 12 05
 (891) 2017 12 05
 (731) GUIZHOU KEWEI PAPER CO. LTD.
 No.6,11/F, Unit 1, Building 2, Western R&D
 Base, Guiyang Hi-Tech Industrial Development
 Area, Guiyang City, Guizhou Province,
 China

(540)



The logo for Capable features the word "Capable" in a large, black, serif font. The letters are bold and well-spaced, with a classic, elegant appearance.

(591) Black, white
 (531) 27.05.01
 (511)
 5 – Breast-nursing pads; babies' diapers [napkins];
 belts for sanitary napkins [towels]; sanitary towels;
 babies' napkin-pants [diaper-pants]; panty liners [sa-
 nitary]; disinfectant wipes; diapers for incontinents;
 pants, absorbent, for incontinents; incontinence gar-
 ments.

(260) AM 2019 98352 A
 (800) 1410051
 (151) 2017 12 11
 (891) 2017 12 11
 (731) ASSAN GIDA SANAYİ VE TİCARET
 ANONİM ŞİRKETİ
 Nispetiye Caddesi, Akmerkez Alışveriş
 Merkezi, B Blok Kat. 5, Etiler Beşiktaş /
 İstanbul, Turkey

(540)

ASSAN FOODS

(591) White and red

(531) 25.05.01; 26.04.07; 26.04.09; 26.04.18;
29.01.12

(526) Foods

(511)

29 – Soups, bouillon; dried, preserved, frozen, cooked, smoked or salted fruits and vegetables; tomato paste; hazelnut spreads and peanut butter; tahini (sesame seed paste).

30 – Condiments for foodstuff, vanilla (flavoring), spices, sauces (condiments), tomato sauce; flour, semolina, starch for food.

32 – Fruit and vegetable juices, fruit juice concentrates, extracts for making beverages, non-alcoholic soft drinks; vegetable-based beverages.

(260) AM 2019 98354 A

(800) 1410083

(151) 2018 04 16

(891) 2018 04 16

(731) BEMA Pharma GmbH

Porschestraße 22/24, 12107 Berlin, Germany

(540)

NovoVISION

(591) Black, white

(511)

5 – Dietary supplements for humans; nutritional supplements; medicated food supplements; mineral food supplements; food supplements; dietary food supplements; herbal supplements; preparations and products for use as dietary supplement; dietary supplement drink mix; food supplements for veterinary use; food supplements consisting of amino acids, vitamins, minerals, microelements; food supplements for non-medical purposes; calcium tablets as a food supplement; nutritional supplements; dietary supplements and dietetic preparations; vitamin preparations in the nature of food supplements; health food supplements for persons with special dietary requirements.

35 – Import-export agency services; retail or wholesale services in the field of dietary and nutritional supplements.

(260) AM 2019 98355 A

(800) 1410111

(151) 2018 03 12

(891) 2018 03 12

(731) SOCIETE COOPERATIVE AGRICOLE
LIMAGRAINRue Henri Mondor, Biopôle Clermont
Limagne, F-63360 SAINT-BEAUZIRE,
France

(540)



(591) Black, white

(531) 01.15.21; 02.01.23; 04.05.05; 26.01.02;
26.01.06; 26.01.16; 26.01.24

(511)

30 – Flours and preparations made from such flours and potentially food additives; cereal preparations; flour mixture; mixture based on cereal raw materials in powder form for food use, concentrates and enhancers based on cereal raw materials in powder form for food use and food additives; meals made with flours; corn semolina; fine flour; flour-milling products; bread, bread products, buns, biscuits, rusks, Viennese pastries, cakes, pastry and confectionery; yeast, baking powders.

31 – Agricultural, horticultural and forestry products (neither prepared, nor processed) and seeds in particular of vegetables, legumes, cereals and more particularly corn and straw cereals, sunflower, soybean, rape, peas, forage and grass; plants and natural flowers, plant seedlings, grains (cereals); animal foodstuffs; bran.

44 – Agriculture, horticulture and forestry services in particular treatment of seeds, agronomy services, advice in farming practices, advice for the treatment of soils and for the protection of the environment, plant growth, parasite and pest control in agriculture, horticulture and forestry, weed killing.

(260) AM 2019 98364 A

(800) 1204815

(151) 2014 02 19

(891) 2018 06 01

(731) Belorussko-rossiyskoe sovместnoe
predpriyatie "AZSINDUSTRIYA"
Obshchestvo s ogranichennoy
otvetstvennostyu
kom. 2, d. 9, 4-y per. Montazhnikov, 220019
Minsk, Belarus

(540)



(591) Orange

(531) 27.05.19; 27.05.23; 29.01.01

(511)

9 – Cash registers; mechanisms for coin-operated car parking gates; mechanical signs; electronic notice boards; road signs, luminous or mechanical; signs, luminous; signalling panels, luminous or mechanical; automatic devices for turnstiles.

11 – Apparatus for lighting; lighting apparatus and installations; lamps including lamps for refueling stations.

35 – Sales promotion for others; retail or wholesale services related to trade in the above-mentioned goods.

37 – Construction; repair; installation of equipment including refueling station equipment; construction consultation.

42 – Research and development of new products for others; technical research; urban planning; construction drafting including drafting for the construction of refueling stations.

(260) AM 2019 98453 A

(800) 1410187

(151) 2018 04 19

(891) 2018 04 19

(731) DEEP DIVE LLC

Corporation Trust Center, 1209 Orange
Street, Wilmington DE 19801, USA

(540)

DEEP SCREEN

(591) Black, white

(511)

9 – Computers; computer hardware; electronic mobile devices; computer software.

(260) AM 2019 98454 A

(800) 1410199

(151) 2018 02 14

(891) 2018 02 14

(731) MAZZA GRAZIANO

Lungomare Gramsci, 19, I-63822 PORTO
SAN GIORGIO (FM), Italy

(540)



(591) Black, white

(531) 24.13.25; 26.04.09; 26.13.25

(511)

25 – Clothing; clothing for men, women and children; clothing of leather; clothing of imitations of leather; clothing for sports; sweaters; dresses; coats; combinations [clothing]; skirts; sashes for wear; nec-

kerchiefs; pocket squares; kerchiefs [clothing]; waistbands [parts of clothing]; money belts [clothing]; neckties; gloves [clothing]; ski gloves; stockings; socks; hats; headgear for wear; visor caps; shoes; shoes for men, women and children; bath slippers; beach shoes; esparto shoes or sandals; gymnastic shoes; footwear; footwear for men, women and children; boots for sports; slippers; sandals; wooden shoes; boots; boot uppers; half-boots; lace boots; ski boots; fittings of metal for footwear; football boots; heelpieces for footwear; galoshes; non-slipping devices for footwear; tips for footwear; welts for footwear; heels; soles for footwear; inner soles; footwear uppers.

(260) AM 2019 98455 A

(800) 1410200

(151) 2018 03 01

(891) 2018 03 01

(731) VALENTINO S.P.A.

Via Turati, 16/18, I-20121 MILANO, Italy

(540)

CANDYSTUD

(591) Black, white

(531) 27.05.01

(511)

18 – Leather and imitations of leather; purses; school bags; school satchels; card cases; travelling trunks; duffel bags for travel; rucksacks; wallets; shopping bags; attaché cases; beach bags; bags; handbags; travelling bags; handbag frames; pouches; briefcases; cases of leather; vanity cases, not fitted; leather key cases; suitcases; bags for sports; hat boxes of leather; garment bags for travel; leather shoulder belts; leather straps; fur; raw skins; dog collars; clothing for pets; umbrellas; umbrella sticks; walking sticks; whips, saddlery, harness fittings.

25 – Clothing; overalls; underwear; sweaters; shirts; jumpers; suits; ready-made clothing; trousers; outer clothing; knitwear; coats; skirts; petticoats; pullovers; overcoats; jackets; stuff jackets; ski jackets; ski pants; parkas; clothing of leather; T-shirts; blouses; pants; dressing gowns; formal dresses; vests; jerseys; pajamas; bathrobes; brassieres; camisoles; corselets; slips; children's clothing; layettes; bathing caps; bathing suits; clothing for gymnastics; waterproof clothing; raincoats; masquerade costumes; footwear; slippers; bath slippers; boots; sport boots; horse-riding boots; galoshes; shoes; beach shoes; sandals; sport shoes; gymnastic shoes; overshoes; headgear; hats; caps; cap peaks; socks; sock suspenders; stockings; garters; gloves; mittens; muffs; shawls; ties; neckties; scarves and foulards (clothing article); veils; bandanas; furs (clothing); fur stoles; belts; wedding dresses.

(260) AM 2019 98473 A

(800) 1410756

(151) 2018 04 02

(891) 2018 04 02

(731) FEBEST GMBH

Am Flugplatz, Gebaude 860, 55483

Lautzenhausen, Germany

(540)



(591) Red and white

(531) 26.04.04; 26.04.22; 26.04.24; 27.05.10;
27.05.24; 29.01.12

(526) AUTO PARTS

(511)

12 – Driverless cars [autonomous cars]; concrete mixing vehicles; motor racing cars; cars; refrigerated vehicles; robotic cars; sports cars; caravans; shock absorbers for automobiles; suspension shock absorbers for vehicles; ski carriers for cars; luggage carriers for vehicles; bumpers for automobiles; vehicle bumpers; tires for vehicle wheels; barges; brake shoes for vehicles; tailboard lifts [parts of land vehicles]; automobile hoods; hoods for vehicles; lug nuts for vehicle wheels; horns for vehicles; treads for vehicles [tractor type]; doors for vehicles; engines for land vehicles; jet engines for land vehicles; driving motors for land vehicles; brake discs for vehicles; clips adapted for fastening automobile parts to automobile bodies; adhesive rubber patches for repairing inner tubes; rearview mirrors; side view mirrors for vehicles; hoods for vehicle engines; crankcases for land vehicle components, other than for engines; vehicle wheels; brake pads for automobiles; hub caps; brake linings for vehicles; gear boxes for land vehicles; caps for vehicle fuel tanks; automobile bodies; tipping bodies for trucks; bodies for vehicles; treads for retreading tires; propulsion mechanisms for land vehicles; mopeds; motor scooters; motorcycles; tyre mousse inserts; freewheels for land vehicles; clutches for land vehicles; repair outfits for inner tubes; air pumps [vehicle accessories]; upholstery for vehicles; rims for vehicle wheels; windows for vehicles; engine mounts for land vehicles; axles for vehicles; headlight wipers; ashtrays for automobiles; gearing for land vehicles; head-rests for vehicle seats; vehicle running boards; air bags [safety devices for automobiles]; casings for pneumatic tires [tyres]; sleeping berths for vehicles; torque converters for land vehicles; cigar lighters for automobiles; non-skid devices for vehicle tires; anti-glare devices for vehicles; anti-theft devices for vehicles; sunblinds adapted for automobiles; balance weights for vehicle wheels; shock absorbing springs for vehicles; reduction gears for land vehicles; safety belts for vehicle seats; security harness for vehicle seats; vehicle suspension springs; steering wheels for vehi-

les; rudders; vehicle joysticks; brake segments for vehicles; bicycle saddles; luggage nets for vehicles; anti-theft alarms for vehicles; reversing alarms for vehicles; safety seats for children, for vehicles; vehicle seats; hydraulic circuits for vehicles; vehicle wheel spokes; spoilers for vehicles; hubs for vehicle wheels; couplings for land vehicles; brakes for vehicles; transmissions for land vehicles; turbines for land vehicles; signal arms for vehicles; vans [vehicles]; automobile chains; driving chains for land vehicles; transmission chains for land vehicles; undercarriages for vehicles; spare wheel covers; covers for vehicle steering wheels; seat covers for vehicles; vehicle covers [shaped]; automobile chassis; vehicle chassis; connecting rods for land vehicles, other than parts of motors and engines; automobile tires; pneumatic tires; solid tires for vehicle wheels; spikes for tires; motors, electric, for land vehicles.

17 – Shock-absorbing buffers of rubber; asbestos; asbestos paper; asbestos felt; asbestos fibers; asbestos millboards; liquid rubber; synthetic rubber; rubber, raw or semi-worked; valves of india-rubber or vulcanized fiber; clack valves of rubber; rings of rubber; water-tight rings; insulating paints; insulating varnish; latex [rubber]; duct tapes; insulating tapes; adhesive bands, other than stationery and not for medical or household purposes; self-adhesive tapes, other than stationery and not for medical or household purposes; asbestos sheets; viscose sheets, other than for wrapping; sheets of regenerated cellulose, other than for wrapping; insulating oils; insulating oil for transformers; weatherstripping compositions; brake lining materials, partly processed; compositions to prevent the radiation of heat; soundproofing materials; insulating materials; insulating refractory materials; padding materials of rubber or plastics; rubber material for recapping tires; non-conducting materials for retaining heat; packing [cushioning, stuffing] materials of rubber or plastics; sealant compounds for joints; filtering materials [semi-processed foams or films of plastic]; sleeves of rubber for protecting parts of machines; asbestos packing; clutch linings; stops of rubber; anti-dazzle films for windows [tinted films]; asbestos coverings; asbestos cloth; rubber stoppers; gaskets; washers of rubber or vulcanized fiber; rubber solutions; gum, raw or semi-worked; chemical compositions for repairing leaks; connecting hose for vehicle radiators.

35 – Import-export agency services; commercial information agency services; advertising agency services; computerized file management; book-keeping; outsourced administrative management for companies; demonstration of goods; opinion polling; market studies; business information; commercial information and advice for consumers in the choice of products and services; business management and organization consultancy; business organization consultancy; business management consultancy; person-

nel management consultancy; professional business consultancy; marketing; organization of exhibitions for commercial or advertising purposes; organization of trade fairs for commercial or advertising purposes; shop window dressing; design of advertising materials; payroll preparation; business management assistance; commercial or industrial management assistance; providing business information via a web site; provision of commercial and business contact information; provision of an on-line marketplace for buyers and sellers of goods and services; web indexing for commercial or advertising purposes; presentation of goods on communication media, for retail purposes; economic forecasting; auctioneering; sales promotion for others; publicity material rental; publication of publicity texts; radio advertising; distribution of samples; dissemination of advertising matter; direct mail advertising; on-line advertising on a computer network; advertising by mail order; television advertising; negotiation of business contracts for others; negotiation and conclusion of commercial transactions for third parties; telemarketing services; commercial administration of the licensing of the goods and services of others; search engine optimization for sales promotion; pay per click advertising; procurement services for others [purchasing goods and services for other businesses].

(260) AM 2019 98477 A
(800) 1410837
(151) 2017 12 06
(891) 2017 12 06
(731) SHENZHEN KTC TECHNOLOGY CO., LTD.

1 Floor A District, 2 Floor B District,
Workshop 1, Northern Wuhe Road, Gangtou
Village, Buji Town, Longgang District,
Shenzhen, Guangdong, China

(540)

Horion

(591) Black, white
(531) 27.05.01; 27.05.17
(511)

9 – Mathematical instruments; eyeglasses; animated cartoons; high-frequency apparatus; probes for scientific purposes; optical lenses; remote control apparatus; scales; pressure measuring apparatus; wires, electric; computer peripheral devices; transducer; video screens; pedometers; detectors; laser direction instrument; water meter; integrated circuits; semiconductors; electronic tags for goods; facsimile machines; measures; mobile telephones; switches, electric; transistors [electronic]; television apparatus; batteries, electric; ticket dispensers; lamp boxes for use as signalling devices; cameras [photography].

(260) AM 2019 98478 A
(800) 1410859
(151) 2018 03 06
(891) 2018 03 06
(731) INFINITYQS INTERNATIONAL, INC.
12601 Fair Lakes Circle, Suite 250, Fairfax
VA 22033, USA

(540)

ENACT

(591) Black, white
(511)
42 – Hosting a website featuring non-downloadable software for monitoring the quality of manufacturing and service industry processes using statistical process control methods and quality control applications, namely, software used in the field of product and process quality control; hosting a website featuring resources, namely, non-downloadable software for monitoring the quality of manufacturing and service industry processes using statistical process control methods and quality control applications, namely, software used in the field of product and process quality control; providing on-line non-downloadable software for monitoring the quality of manufacturing and service industry processes using statistical process control methods and quality control applications, namely, software used in the field of product and process quality control; software as a service (SAAS) services, namely, hosting software for use by others for use in monitoring the quality of manufacturing and service industry processes using statistical process control methods and quality control applications, namely, software used in the field of product and process quality control.

(260) AM 2019 98482 A
(800) 1411000
(151) 2018 03 29
(891) 2018 03 29
(731) SHENZHEN ZHIZHI BRAND
INCUBATION, CO., LTD.
Rm. 3001, Vanke's Day Central Plaza, Dragon
Avenue, Longgang, Shenzhen, China

(540)

U

(591) Black, white
(531) 02.09.01; 26.13.25
(511)
35 – Sales promotion for others; procurement services for others [purchasing goods and services for

other businesses]; import-export agency services; television advertising; on-line advertising on a computer network; commercial administration of the licensing of the goods and services of others; marketing; provision of an on-line marketplace for buyers and sellers of goods and services; personnel management consultancy; outsourcing services [business assistance].

(260) AM 2019 98483 A

(800) 1411062

(151) 2018 05 01

(891) 2018 05 01

(731) ARROWHEAD PHARMACEUTICALS, INC.

225 SOUTH LAKE AVE., SUITE 1050,
PASADENA CA 91101, USA

(540)

TRiM

(591) Black, white

(511)

5 – Pharmaceutical and medicinal preparations to treat intractable diseases in humans.

42 – Development of pharmaceutical preparations and medicines; pharmaceutical products development; pharmaceutical research and development.

(260) AM 2019 98487 A

(800) 1411122

(151) 2018 01 18

(891) 2018 01 18

(731) AKTSIONERNO DROUJESTVO "START" AD

32, VH. A, ET. 4, BOULEVARD "TCHERNI VRAH", RAYON "LOZENETS", BG-1000 SOFIA, Bulgaria

(540)

START

(591) Dark blue, red and white

(531) 27.05.01; 29.01.13

(511)

9 – Electric accumulators; electric accumulators for vehicles; lead acid batteries for starting motor vehicles for loading and for loading heavy equipment, as well as for machines intended for road construction; batteries for buses and coaches; batteries for automobile taxis and for vehicles for special use; batteries for farming equipment; batteries for railway-engine equipment; batteries for starting tourist cars; stationary batteries intended for telecommunications for emergency power for telephone exchanges, for equipment for the transmission of messages and voice data, for mobile and fixed communication systems, for radio and television systems and for transmitters and relay stations; UPS system batteries

intended for electrical power stations, industrial sites, production companies, data storage centers, hospitals, banks and shopping centers, signaling and navigation systems; stationary batteries intended for working in harsh conditions with high working temperatures, for hybrid and cyclic applications in remote sites and in areas of frequent power cuts; batteries for storing energy from renewable energy sources; cyclic application batteries intended for use in AGM technology; semi-traction batteries intended for sites requiring a constant and sustainable electricity supply; special batteries intended for tanks and armored machines, compliant with NATO standards; batteries intended for motor boats, river boats, camping vans, pleasure boats and caravans; accumulator boxes; battery jars; anode batteries; acidimeters for batteries; high-voltage batteries; batteries for lighting; batteries for pocket lamps; electric accumulators for vehicles; electric cells (batteries); batteries for electronic cigarettes; galvanic batteries; plates for batteries, including, grids for batteries; solar batteries; solar panels for electricity production; charging stations for electric vehicles; battery chargers; apparatus for charging electric accumulators; chargers for electronic cigarettes.

(260) AM 2019 98544 A

(800) 1384566

(151) 2017 11 10

(891) 2018 06 26

(731) REGATTA LTD

Risol House, Mercury Way, Dumplington,
Urmston Manchester M41 7RR, United Kingdom

(540)

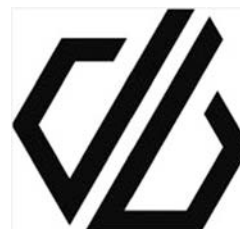

(591) Black, white

(531) 26.13.25

(511)

25 – Clothing, footwear, headgear; articles of clothing, footwear and headgear for use in sporting and outdoor pursuits; gloves [clothing]; mittens; scarves; gaiters, namely, neck gaiters, leg gaiters and ankle gaiters; socks; leggings [leg warmers]; leggings [trousers]; tights; underclothing; sweat-absorbent underclothing [underwear]; underwear; thermal underwear; vests; sleepwear; jackets [clothing]; jacket hoods; jerseys [clothing]; sports jerseys; jumpers; pullovers; body warmers; gilets; fleeces; knitwear; shirts; short-sleeve shirts; sweaters; t-shirts; polo-shirts; tank-tops; leisurewear; tracksuits; skirts; trousers; pants; shorts; skorts; dresses; swimwear; outerwear, namely, shells, rain jackets, rain pants; waterproof clot-

hing; waterproof jackets; overtrousers; coats; overcoats; raincoats; anoraks; parkas; ponchos; windcheaters; ski wear namely, ski suits, ski vests, ski jackets, ski bibs, bib overalls, bib pants, ski pants, ski hats, ski gloves; snowboard wear namely, snowboard jackets, snowboard trousers, snow suits; clothing for cyclists namely, cycle jerseys, cycle t-shirts, cycle jackets, cycle shorts, cycle bibs, cycle trousers, cycle leggings [trousers], waterproof clothing for cyclists, windproof clothing for cyclists, cycle gloves, cycle mitts; athletic clothing; athletic uniforms; sportswear; casualwear; yoga shirts; yoga bottoms; yoga pants; belts [clothing]; money belts (not of precious metal); leisure footwear; shoes; sandals; flip flops; athletic shoes; sneakers; trail shoes; boots; snow boots; ski and snowboard boots and shoes and parts thereof; cycle shoes; lace boots; galoshes; hiking shoes and boots; climbing shoes and boots; athletic shoes; sports footwear; yoga shoes; wellingtons; inner soles; hats; caps [headwear]; headbands [clothing]; earbands; bandanas; ear muffs [clothing]; balaclavas; mufflers; beanies; knitted caps.

(260) AM 2019 98545 A

(800) 1390649

(151) 2017 11 17

(891) 2018 06 13

(731) "BELUGA MARKET", LLC

Proletarskaya street, 40A, Zvenigorog,
RU-143180 Moscow region, Russian
Federation

(540)

TIGROFF

(591) Black, white

(511)

33 – Alcoholic beverages (except beers).

(260) AM 2019 98546 A

(800) 1407487

(151) 2018 03 15

(891) 2018 06 09

(731) Obshchestvo s ogranichennoy

otvetstvennostyu "PARAFARM"

ul. Sverdlova, d. 4, g. Penza, 440026, Russian
Federation

(540)



(591) white, grey, black, blue, red, yellow

(531) 26.04.02; 26.04.09; 26.04.10; 26.04.12;
26.04.18; 26.04.24; 27.05.03; 27.05.10;
27.05.24; 29.01.15

(511)

5 – Amino acids for medical purposes; medicine cases, portable, filled; first-aid boxes, filled; mineral food supplements; nutritional supplements; albumin dietary supplements; yeast dietary supplements; alginate dietary supplements; glucose dietary supplements; casein dietary supplements; lecithin dietary supplements; linseed oil dietary supplements; propolis dietary supplements; protein dietary supplements; royal jelly dietary supplements; pollen dietary supplements; wheat germ dietary supplements; linseed dietary supplements; enzyme dietary supplements; yeast for pharmaceutical purposes; gelatine for medical purposes; cod liver oil; medicinal roots; starch for dietetic or pharmaceutical purposes; blood for medical purposes; cultures of microorganisms for medical or veterinary use; liquorice for pharmaceutical purposes; lactose for pharmaceutical purposes; candy for medical purposes; drugs for medical purposes; medicines for human purposes; powdered milk for babies; royal jelly for pharmaceutical purposes; milk ferments for pharmaceutical purposes; Irish moss for medical purposes; flour for pharmaceutical purposes; linseed meal for pharmaceutical purposes; mint for pharmaceutical purposes; dietetic beverages adapted for medical purposes; medicinal infusions; tinctures for medical purposes; decoctions for pharmaceutical purposes; pectin for pharmaceutical purposes; pepsins for pharmaceutical purposes; peptones for pharmaceutical purposes; food for babies; biological preparations for medical purposes; pharmaceutical preparations; chemico-pharmaceutical preparations; chemical preparations for pharmaceutical purposes; albuminous foodstuffs for medical purposes; dietetic foods adapted for medical purposes; by-products of the processing of cereals for dietetic or medical purposes; pharmaceuticals; sedatives; laxatives; digestives for pharmaceutical purposes; tonics [medicines]; nervines; media for bacteriological cultures; serums; antioxidant pills; appetite suppressant pills; slimming pills; jujube, medicated; medicinal tea; herbal teas for medicinal purposes; eucalyptus for pharmaceutical purposes; plant extracts for pharmaceutical purposes; elixirs [pharmaceutical preparations]; ethers for pharmaceutical purposes; esters for pharmaceutical purposes; cellulose esters for pharmaceutical purposes; cellulose ethers for pharmaceutical purposes.

(260) AM 2019 98587 A

(800) 1412677

(151) 2018 01 31

(891) 2018 01 31

(731) Obshchestvo s ogranichennoj otvetstvennostju

BONTEMPIREST

B. Znamenskiy per., d. 2, str. 3, RU-119019
Moscow, Russian Federation

(540)



(591) Orange, yellow, white

(531) 08.07.04; 26.13.25; 27.05.10; 29.01.01

(511)

29 – Meat, fish, poultry and game; meat extracts; preserved, frozen, dried and cooked fruits and vegetables; jellies, jams, compotes; eggs; milk and milk products; edible oils and fats.

30 – Coffee, tea, cocoa and artificial coffee; rice; tapioca and sago; flour and preparations made from cereals; bread, pastries and confectionery; edible ices; sugar, honey, treacle; yeast, baking-powder; salt; mustard; vinegar, sauces [condiments]; spices; ice.

32 – Mineral and aerated waters and other non-alcoholic beverages; fruit beverages and fruit juices; syrups and other preparations for making beverages.

43 – Services for providing food and drink; temporary accommodation; bar and restaurant services; self-service restaurants.

(260) AM 2019 98588 A

(800) 1412737

(151) 2018 03 22

(891) 2018 03 22

(731) VTB Bank (public joint-stock company)
ul. Bolshaya Morskaya, 29, RU-190000
St.-Petersburg, Russian Federation

(540)



(591) White, blue and dark blue.

(531) 26.03.23; 26.04.05; 26.04.12; 26.04.24;
26.11.03; 26.11.08; 27.05.24; 29.01.12

(511)

36 – Credit bureau services; debt collection agency services; real estate agency services; financial analysis; rental of apartments; rental of real estate; rental of offices [real estate]; lease-purchase financing; savings bank services; accommodation bureau services [apartments]; rent collection; issuance of travelers' checks; issuance of credit cards; issuance of tokens of value; capital investment; insurance information; financial information; clearing, financial; insurance consultancy; financial consultancy; debt advisory services; stock exchange quotations; lending against security; business liquidation services, financial;

brokerage, included in this class; financial management; exchanging money; online banking; processing of debit card payments; processing of credit card payments; factoring; real estate affairs; organization of collections; arranging finance for construction projects; antique appraisal; jewelry appraisal; financial evaluation of standing timber; stamp appraisal; real estate appraisal; numismatic appraisal; art appraisal; financial evaluation of wool; financial evaluation [insurance, banking, real estate]; repair costs evaluation [financial appraisal]; electronic funds transfer; surety services; securities brokerage; financial brokerage; real estate brokerage; brokerage of carbon credits; insurance brokerage; pensions brokerage; providing information relating to securities trading; advisory services relating to pensions; providing rebates at participating establishments of others through use of a membership card; loans [financing]; pawnbrokerage; providing financial information via a web site; check verification; investment of funds, including pension funds; charitable fund raising; stocks and bonds brokerage; financial sponsorship; mortgage banking; instalment loans; insurance underwriting; life insurance underwriting; health insurance underwriting; accident insurance underwriting; marine insurance underwriting; fire insurance underwriting; apartment house management; real estate management; pension fund management; financial management of reimbursement payments for others; actuarial services; banking; stock brokerage services; retirement payment services; bail-bonding; trusteeship; provident fund services, including pension funds; financial customs brokerage services; financial services, including services related to pension funds; financial services, including factoring; financial services of depositories and specialized depositories; mutual funds; financing services; safe deposit services; deposits of valuables; securities deposit services; fiscal valuation; rental of offices for co-working; rental of farms; equity research; investment management; asset and portfolio management; real estate lease surrender services; provident fund services.

(260) AM 2019 98589 A

(800) 1412779

(151) 2018 06 05

(891) 2018 06 05

(731) PHARMATONICA SP. Z O.O.

ul. F. Klimczaka 17/80, PL-02-797 Warszawa,
Poland

(540)

LIPOCIALE

(591) Black, white

(511)

5 – Health food supplements made principally of vitamins; dietary supplements for humans.

(260) AM 2019 98590 A

(800) 1412802

(151) 2018 03 20

(891) 2018 03 20

(731) Limited Liability Company "S8 TRADE"

Volgogradsky Prospekt, 43, building 3,
floor 6, place XXI, room 9B, RU-109316
Moscow, Russian Federation

(540)



(591) Blue, dark blue, white, silver gray, light gray,
gray

(531) 24.17.02; 26.04.04; 26.04.05; 26.04.18;
26.04.24; 27.05.24; 29.01.13

(511)

12 – Motor buses; motor coaches; motor homes; driverless cars (autonomous cars); motor racing cars; cars; sports cars; caravans; shock absorbers for automobiles; suspension shock absorbers for vehicles; ski carriers for cars; luggage carriers for vehicles; bumpers for automobiles; vehicle bumpers; tires for vehicle wheels; brake shoes for vehicles; valves for vehicle tires; automobile hoods; hoods for vehicles; horns for vehicles; doors for vehicles; engines for land vehicles; brake discs for vehicles; side view mirrors for vehicles; inner tubes for pneumatic tires; hoods for vehicle engines; crankcases for land vehicle components, other than for engines; vehicle wheels; mine cart wheels; brake pads for automobiles; hub caps; brake linings for vehicles; gear boxes for land vehicles; caps for vehicle fuel tanks; automobile bodies; bodies for vehicles; treads for retreading tires; mopeds; motor scooters; motorcycles; freewheels for land vehicles; clutches for land vehicles; repair outfits for inner tubes; air pumps (vehicle accessories); upholstery for vehicles; rims for vehicle wheels; windows for vehicles; engine mounts for land vehicles; axles for vehicles; headlight wipers; ashtrays for automobiles; gearing for land vehicles; head-rests for vehicle seats; vehicle running boards; air bags (safety devices for automobiles); casings for pneumatic tires (tyres); cigar lighters for automobiles; non-skid devices for vehicle tires; anti-glare devices for vehicles; anti-theft devices for vehicles; sun-blinds adapted for automobiles; balance weights for vehicle wheels; shock absorbing springs for vehicles; reduction gears for land vehicles; safety belts for vehicle seats; security harness for vehicle seats; vehicle suspension springs; vehicle joysticks; brake segments for vehicles; luggage nets for vehicles; anti-theft alarms for vehicles; reversing alarms for vehicles; safety seats for children, for vehicles; vehicle seats; hydraulic circuits for vehicles; electric vehicles; hubs for vehicle wheels; trailer hitches for vehicles; couplings for land vehicles; brakes for vehicles; torsion bars for vehicles; transmissions for land vehicles; automobile chains; driving chains for land vehicles; anti-skid chains; transmission chains for

land vehicles; undercarriages for vehicles; spare wheel covers; covers for vehicle steering wheels; seat covers for vehicles; vehicle covers (shaped); automobile chassis; vehicle chassis; automobile tires; solid tires for vehicle wheels; spikes for tires; mudguards; motors, electric, for land vehicles; steering wheels for vehicles; connecting rods for land vehicles, other than parts of motors and engines.

35 – Computerized file management; demonstration of goods; business information; updating and maintenance of data in computer databases; providing business information via a web site; provision of commercial and business contact information; provision of an on-line marketplace for buyers and sellers of goods and services; sales promotion for others; on-line advertising on a computer network; compilation of statistics; compilation of information into computer databases; business inquiries; systemization of information into computer databases; public relations; search engine optimization for sales promotion; outsourcing services (business assistance); business efficiency expert services; commercial information and advice for consumers in the choice of products and services; presentation of goods on communication media, for retail purposes; commercial intermediation services; procurement services for others (purchasing goods and services for other businesses).

36 – Credit bureau services; financial analysis; lease-purchase financing; savings bank services; issuance of travelers' checks; issuance of credit cards; issuance of tokens of value; capital investment; insurance information; financial information; clearing, financial; insurance consultancy; financial consultancy; debt advisory services; stock exchange quotations; lending against security; business liquidation services, financial; brokerage; financial management; exchanging money; online banking; processing of debit card payments; processing of credit card payments; factoring; organization of collections; arranging finance for construction projects; antique appraisal; financial evaluation (insurance, banking, real estate); repair costs evaluation (financial appraisal); electronic funds transfer; surety services; insurance brokerage; providing rebates at participating establishments of others through use of a membership card; loans (financing); pawnbrokerage; providing financial information via a web site; check verification; investment of funds; charitable fund raising; stocks and bonds brokerage; financial sponsorship; mortgage banking; instalment loans; insurance underwriting; life insurance underwriting; accident insurance underwriting; fire insurance underwriting; financial management of reimbursement payments for others; actuarial services; banking; stock brokerage services; trusteeship; provident fund services; financial customs brokerage services; mutual funds; automobile lease financing.

37 – Rebuilding engines that have been worn or partially destroyed; retreading of tires; vulcanization of tires (repair); vehicle battery charging; varnishing; vehicle washing; anti-rust treatment for vehicles; vehicle maintenance; vehicle polishing; vehicle breakdown repair services; motor vehicle maintenance and repair; vehicle greasing; vehicle service stations (refuelling and maintenance); tire balancing; installation and repair of air-conditioning apparatus; electric appliance installation and repair; vehicle cleaning.

38 – News agency services; wireless broadcasting; television broadcasting; cable television broadcasting; electronic bulletin board services (telecommunications services); information about telecommunication; providing user access to global computer networks; providing access to databases; providing telecommunications connections to a global computer network; providing telecommunication channels for teleshopping services; video-on-demand transmission; message sending; computer aided transmission of messages and images; transmission of telegrams; transmission of digital files; providing online forums; videoconferencing services; rental of message sending apparatus; rental of access time to global computer networks; rental of modems; rental of telecommunication equipment; rental of telephones; rental of facsimile apparatus; radio broadcasting; radio communications; transmission of electronic mail; communications by fiber optic networks; communications by cellular phones; communications by computer terminals; satellite transmission; communications by telegrams; communications by telephone; facsimile transmission; paging services (radio, telephone or other means of electronic communication); teleconferencing services; telex services; voice mail services; streaming of data; telegraph services; telephone services; providing internet chatrooms; transmission of greeting cards online; telecommunications routing and junction services; electronic mail forwarding services.

39 – Vehicle transport; vehicle transport and rental services; car rental, garage and parking space rental; rental of trucks; truck and trailer rental; parking place rental; rental of vehicles for events; booking of transportation via a web site; transport reservation; freight transportation by truck; booking of transport; information services relating to methods of transport; transportation information; leasing of automobiles; vehicle routing by computer on data networks; providing information relating to vehicle parking services; providing information relating to tariffs, timetables and methods of transport; providing information about transport services; providing on-line information relating to travel; on-line information and booking services in the field of business travel; tracking of automobile fleets using electronic navigation and locating devices (transport information);

transport brokerage; providing transportation information via a web site; providing information via the Internet relating to the leasing of automobiles; chauffeur-driven car hire services; reservation services for vehicle rental; car parking; chauffeur services; transportation services provided to individuals; transport; vehicle rental; consultancy relating to transportation and storage services provided via telephone call centers and hotlines; providing information relating to automobile rental services.

(260) AM 2019 98592 A

(800) 1412844

(151) 2018 02 02

(891) 2018 02 02

(731) PANTAINORASINGH MANUFACTURER CO., LTD

99 Moo2, Tambol Galoong, Maung, Samut, 74000 Sakhon, Thailand

(540)



(591) Red, Blue, Black, Yellow, Green

(531) 02.01.02; 02.01.04; 02.01.12; 18.03.01; 26.01.14; 26.01.15; 26.01.16; 27.05.09; 27.05.11; 28.03; 29.01.14

(526) The blue Thai characters that transliterate to "Krueng Mhai Garn Kha"

(511)

30 – Sauces [condiments]; Fish sauce; Coffee; Tea; Seasonings; Soy sauces; Soya bean curd sauce; Chili paste.

(260) AM 2019 98593 A

(800) 1412861

(151) 2018 02 15

(891) 2018 02 15

(731) ECZACIBASI HOLDING ANONIM SIRKETI
Kanyon Ofis Buyukdere Cad. No:185, Levent,
ISTANBUL, Turkey

(540)



(591) Black, yellow

(531) 26.04.02; 26.04.24; 27.05.17; 27.05.24;
29.01.12

(511)

5 – Pharmaceutical and veterinary preparations for medical purposes; chemical preparations for medical and veterinary purposes, chemical reagents for pharmaceutical and veterinary purposes; medicated cosmetics; dietary supplements for pharmaceutical and veterinary purposes; dietary supplements; nutritional supplements; medical preparations for slimming purposes; food for babies; herbs and herbal beverages adapted for medicinal purposes; dental preparations and articles: teeth filling material, dental impression material, dental adhesives and material for repairing teeth; sanitary preparations for medical use; hygienic pads; hygienic tampons; plasters; materials for dressings; diapers made of paper and textiles for babies, adults and pets; preparations for destroying vermin; herbicides, fungicides, preparations for destroying rodents; deodorants, other than for human beings or for animals; air purifying preparations; air deodorising preparations; disinfectants; antiseptics; detergents for medical purposes; medicated soaps; disinfectant soaps; antibacterial hand lotions.

9 – Measurement apparatus and equipment including those for scientific, nautical, topographic, meteorologic, industrial and laboratory purposes, thermometers, not for medical purposes, barometers, ammeters, voltmeters, hygrometers, testing apparatus not for medical purposes, telescopes, periscopes, directional compasses, speed indicators, laboratory apparatus, microscopes, magnifying glasses, stills, binoculars, ovens and furnaces for laboratory experiments; apparatus for recording, transmission or reproduction of sound or images, cameras, photographic cameras, television apparatus, video recorders, CD and DVD players and recorders, MP3 players, computers, desktop computers, tablet computers, wearable technological devices (smart watches, wristbands, head-mounted devices) microphones, loudspeakers, earphones, telecommunications apparatus, apparatus for the reproduction of sound or images, computer peripheral devices, cell phones, covers for cell phones, telephone apparatus, computer printers, scanners [data processing equipment], photocopiers; magnetic and optic data carriers and computer software and programmes recorded thereto, downloadable and recordable electronic publications, encoded magnetic and optic cards, movies, tv series and video music clips recorded on magnetic, optical and electronic media; antennas, satellite antennas, amplifiers for antennas, parts of the aforementioned goods; ticket dispensers, automatic teller machines (ATM); electronic components used in the electronic parts of machines and apparatus, semi-conductors, electronic circuits, integrated circuits, chips [integrated circuits], diodes, transistors [electronic], magnetic heads for electronic apparatus, electronic locks,

photocells, remote control apparatus for opening and closing doors, optical sensors; counters and quantity indicators for measuring the quantity of consumption, automatic time switches; clothing for protection against accidents, irradiation and fire, safety vests and life-saving apparatus and equipment; eyeglasses, sunglasses, optical lenses and cases, containers, parts and components thereof; apparatus and instruments for conducting, transforming, accumulating or controlling electricity, electric plugs, junction boxes [electricity], electric switches, circuit breakers, fuses, lighting ballasts, battery starter cables, electrical circuit boards, electric resistances, electric sockets, transformers [electricity], electrical adapters, battery chargers, electric and electronic cables, batteries, electric accumulators, solar panels for production of electricity; alarms and anti-theft alarms, other than for vehicles, electric bells; signalling apparatus and instruments, luminous or mechanical signs for traffic use; fire extinguishing apparatus, fire engines, fire hose and fire hose nozzles; radar apparatus, sonars, night vision apparatus and instruments; decorative magnets; metronomes.

21 – Hand-operated non-electric cleaning instruments and appliances, brushes, other than paintbrushes, steel chips for cleaning, sponges for cleaning, steel wool for cleaning, cloths of textile for cleaning, gloves for dishwashing, non-electric polishing machines for household purposes, brooms for carpets, mops; toothbrushes, electric toothbrushes, dental floss, shaving brushes, hair brushes, combs; non-electric household or kitchen utensils, included in this class, [other than forks, knives, spoons], services [dishes], pots and pans, bottle openers, flower pots, drinking straws, non-electric cooking utensils; ironing boards and shaped covers therefor, drying racks for washing, clothes drying hangers; cages for household pets, indoor aquariums, vivariums and indoor terrariums for animals and plant cultivation; ornaments and decorative goods of glass, porcelain, earthenware or clay namely statues, figurines, vases, and trophies; mouse traps, insect traps, electric devices for attracting and killing flies and insects, fly catchers, fly swatters; perfume burners, perfume sprayers, perfume vaporizers, electric or non-electric make-up removing appliances, powder puffs, toilet cases; nozzles for sprinkler hose, nozzles for watering cans, watering devices, garden watering cans; unworked or semi-worked glass, except building glass, mosaics of glass and powdered glass for decoration, except for building, glass wool other than for insulation or textile use.

35 – Advertising, marketing and public relations; organization of exhibitions and trade fairs for commercial or advertising purposes; design for advertising; provision of an online marketplace for buyers and sellers of goods and services; office functions; secretarial services; arranging newspaper subscriptions

for others; compilation of statistics; rental of office machines; systemization of information into computer databases; telephone answering for unavailable subscribers; business management, business administration and business consultancy; accounting; commercial consultancy services; personnel recruitment, personnel placement, employment agencies, import-export agencies; temporary personnel placement services; auctioneering; the bringing together, for the benefit of others, of a variety of goods, namely, bleaching and cleaning preparations, detergents other than for use in manufacturing operations and for medical purposes, laundry bleach, fabric softeners for laundry use, stain removers, dishwasher detergents, perfumery, non-medicated cosmetics, fragrances, deodorants for personal use and animals, soaps, dental care preparations: dentifrices, denture polishes, tooth whitening preparations, mouth washes, not for medical purposes, abrasive preparations, emery cloth, sandpaper, pumice stone, abrasive pastes, polishing preparations for leather, vinyl, metal and wood, polishes and creams for leather, vinyl, metal and wood, wax for polishing, pharmaceutical and veterinary preparations for medical purposes, chemical preparations for medical and veterinary purposes, chemical reagents for pharmaceutical and veterinary purposes, medicated cosmetics, dietary supplements for pharmaceutical and veterinary purposes, dietary supplements, nutritional supplements, medical preparations for slimming purposes, food for babies, herbs and herbal beverages adapted for medicinal purposes, dental preparations and articles: teeth filling material, dental impression material, dental adhesives and material for repairing teeth, sanitary preparations for medical use, hygienic pads, hygienic tampons, plasters, materials for dressings, diapers made of paper and textiles for babies, adults and pets, preparations for destroying vermin, herbicides, fungicides, preparations for destroying rodents, deodorants, other than for human beings or for animals, air purifying preparations, air deodorising preparations, disinfectants, antiseptics, detergents for medical purposes, medicated soaps, disinfectant soaps, antibacterial hand lotions, measurement apparatus and equipment including those for scientific, nautical, topographic, meteorologic, industrial and laboratory purposes, thermometers, not for medical purposes, barometers, ammeters, voltmeters, hygrometers, testing apparatus not for medical purposes, telescopes, periscopes, directional compasses, speed indicators, laboratory apparatus, microscopes, magnifying glasses, stills, binoculars, ovens and furnaces for laboratory experiments, apparatus for recording, transmission or reproduction of sound or images, cameras, photographic cameras, television apparatus, video recorders, CD and DVD players and recorders, MP3 players, computers, desktop computers, tablet computers, wearable technological devices (smart watches, wristbands, head-mounted devices)

ces) microphones, loudspeakers, earphones, telecommunications apparatus, apparatus for the reproduction of sound or images, computer peripheral devices, cell phones, covers for cell phones, telephone apparatus, computer printers, scanners [data processing equipment], photocopiers, magnetic and optic data carriers and computer software and programmes recorded thereto, downloadable and recordable electronic publications, encoded magnetic and optic cards, movies, tv series and video music clips recorded on magnetic, optical and electronic media, antennas, satellite antennas, amplifiers for antennas, parts of the aforementioned goods, ticket dispensers, automatic teller machines (ATM), electronic components used in the electronic parts of machines and apparatus, semi-conductors, electronic circuits, integrated circuits, chips [integrated circuits], diodes, transistors [electronic], magnetic heads for electronic apparatus, electronic locks, photocells, remote control apparatus for opening and closing doors, optical sensors, counters and quantity indicators for measuring the quantity of consumption, automatic time switches, clothing for protection against accidents, irradiation and fire, safety vests and life-saving apparatus and equipment, eyeglasses, sunglasses, optical lenses and cases, containers, parts and components thereof, apparatus and instruments for conducting, transforming, accumulating or controlling electricity, electric plugs, junction boxes [electricity], electric switches, circuit breakers, fuses, lighting ballasts, battery starter cables, electrical circuit boards, electric resistances, electric sockets, transformers [electricity], electrical adapters, battery chargers, electric and electronic cables, batteries, electric accumulators, solar panels for production of electricity, alarms and anti-theft alarms, other than for vehicles, electric bells, signalling apparatus and instruments, luminous or mechanical signs for traffic use, fire extinguishing apparatus, fire engines, fire hose and fire hose nozzles, radar apparatus, sonars, night vision apparatus and instruments, decorative magnets, metronomes, hand-operated non-electric cleaning instalments and appliances, brushes, other than paintbrushes, steel chips for cleaning, sponges for cleaning, steel wool for cleaning, cloths of textile for cleaning, gloves for dishwashing, non-electric polishing machines for household purposes, brooms for carpets, mops, toothbrushes, electric toothbrushes, dental floss, shaving brushes, hair brushes, combs, non-electric household or kitchen utensils, [other than forks, knives, spoons], services [dishes], pots and pans, bottle openers, flower pots, drinking straws, non-electric cooking utensils, ironing boards and shaped covers therefor, drying racks for washing, clothes drying hangers, cages for household pets, indoor aquariums, vivariums and indoor terrariums for animals and plant cultivation, ornaments and decorative goods of glass, porcelain, earthenware or clay namely statues, figurines, vases, and

trophies, mouse traps, insect traps, electric devices for attracting and killing flies and insects, fly catchers, fly swatters, perfume burners, perfume sprayers, perfume vaporizers, electric or non-electric make-up removing appliances, powder puffs, toilet cases, nozzles for sprinkler hose, nozzles for watering cans, watering devices, garden watering cans, unworked or semi-worked glass, except building glass, mosaics of glass and powdered glass for decoration, except for building, glass wool other than for insulation or textile use, enabling customers to conveniently view and purchase those goods, such services may be provided by retail stores, wholesale outlets, by means of electronic media or through mail order catalogues.

(260) AM 2019 98595 A

(800) 1412911

(151) 2018 03 30

(891) 2018 03 30

(731) VTB Bank (public joint-stock company)

ul. Bolshaya Morskaya, 29, RU-190000

St.-Petersburg, Russian Federation

(540)



(591) White, blue and dark blue

(531) 26.11.03; 26.11.08; 27.05.17; 29.01.04

(511)

36 – Credit bureau services; debt collection agency services; real estate agency services; financial analysis; rental of apartments; rental of real estate; rental of offices [real estate]; lease-purchase financing; savings bank services; accommodation bureau services [apartments]; rent collection; issuance of travelers' checks; issuance of credit cards; issuance of tokens of value; capital investment; insurance information; financial information; clearing, financial; insurance consultancy; financial consultancy; debt advisory services; stock exchange quotations; lending against security; business liquidation services, financial; brokerage, included in this class; financial management; exchanging money; online banking; processing of debit card payments; processing of credit card payments; factoring; real estate affairs; organization of collections; arranging finance for construction projects; antique appraisal; jewelry appraisal; financial evaluation of standing timber; stamp appraisal; real estate appraisal; numismatic appraisal; art appraisal; financial evaluation of wool; financial evaluation [insurance, banking, real estate]; repair costs evaluation [financial appraisal]; electronic funds transfer; surety services; securities brokerage; financial brokerage; real estate brokerage; brokerage of carbon credits; insurance brokerage; pensions brokerage; providing information relating to

securities trading; advisory services relating to pensions; providing rebates at participating establishments of others through use of a membership card; loans [financing]; pawnbrokerage; providing financial information via a web site; check verification; investment of funds, including pension funds; charitable fund raising; stocks and bonds brokerage; financial sponsorship; mortgage banking; instalment loans; insurance underwriting; life insurance underwriting; health insurance underwriting; accident insurance underwriting; marine insurance underwriting; fire insurance underwriting; apartment house management; real estate management; pension fund management; financial management of reimbursement payments for others; actuarial services; banking; stock brokerage services; retirement payment services; bail-bonding; trusteeship; provident fund services, including pension funds; financial customs brokerage services; financial services, including services related to pension funds; financial services, including factoring; financial services of depositories and specialized depositories; mutual funds; financing services; safe deposit services; deposits of valuables; securities deposit services; fiscal valuation; rental of offices for co-working; rental of farms; equity research; investment management; asset and portfolio management; real estate lease surrender services; provident fund services.

(260) AM 2019 98596 A

(800) 1412951

(151) 2018 05 30

(891) 2018 05 30

(731) Limited Liability Company

"TOSOL-SINTEZ"

Vatutin Street, 31A Dzerzhinsk, RU-606000

Nizhny Novgorod Region, Russian Federation

(540)

ROSDOT

(591) Black, white

(511)

1 – Industrial chemicals; oil-purifying chemicals; oil-separating chemicals; fluids for hydraulic circuits; antifreeze; brake fluid; anti-tarnishing chemicals for windows; acid proof chemical compositions; condensation-preventing chemicals; anti-boil preparations for engine coolants; radiator flushing chemicals; soldering chemicals; chimney cleaners, chemical; welding chemicals.

4 – Industrial oil; lubricating oil; motor oil; fuel oil; lubricating grease; cutting fluids; lubricants.

12 – Brakes for vehicles; headlight wipers; brake segments for vehicles; treads for retreading tires; brake discs for vehicles; brake shoes for vehicles; brake pads for automobiles; undercarriages for vehicles; brake linings for vehicles.

(260) AM 2019 98599 A

(800) 1412969

(151) 2018 02 23

(891) 2018 02 23

(731) HUAWEI TECHNOLOGIES CO., LTD.

Administration Building, Huawei
Technologies Co., Ltd., Bantian, Longgang
District, Shenzhen, China

(540)

Honor View

(591) Black, white

(531) 27.05.01

(511)

9 – Smartphones; protective films adapted for smartphones; cases for smartphones; covers for smartphones; chargers for electric batteries; earphones; interactive touch screen terminals; laptop computers; tablet computers; covers for tablet computers; batteries, electric; power banks (rechargeable batteries); notebook computers; humanoid robots with artificial intelligence; computer programs, recorded; covers for personal digital assistants [PDAs]; electronic interactive whiteboards; computer keyboards; smart rings; smartglasses; smart watches; cameras [photography]; wearable activity trackers; computer hardware; computer software, recorded; mouse [computer peripheral]; data processing apparatus; digital photo frames; selfie sticks [hand-held monopods]; computer memory devices; audio- and video-receivers; microphones; virtual reality headsets; portable media players; sound transmitting apparatus; scales with body mass analysers; loudspeakers; camcorders; scales; network communication apparatus; modems.

(260) AM 2019 98600 A

(800) 1412975

(151) 2017 12 11

(891) 2017 12 11

(731) GD MIDEA AIR-CONDITIONING
EQUIPMENT CO., LTD.

Lingang Road, Beijiao, Shunde, Foshan,
Guangdong, China

(540)

air magic

(591) Black, white

(531) 27.05.01; 27.05.17

(511)

11 – Cooking apparatus and machines; gas stoves; exhaust fans for kitchen; electric coffee machines; electric cast-iron skillets; induction cookers; rotisseries; water heater for shower; solar water heaters; heating installations; fluorescent tubes; air conditioners; ice machines and apparatus; water purifying apparatus and machines; electric kettles; electric rice

cookers; pressure cookers [autoclaves], electric; bread baking machines; kitchen ranges [ovens]; hearths; tableware disinfection cabinets; water filtering apparatus; electric laundry dryers; fabric steamers; electric appliances for making yogurt; gas or electric water heaters; pocket warmers; drinking water dispensers; dehumidifiers; electric hair drier; microwave ovens [cooking apparatus]; extractor hoods for kitchen; disinfectant apparatus; parts of sanitary installations, namely, pipes; electric heaters for beverages; bed-warmers; electric lamps; heat pump; heating apparatus, electric; refrigerators; air purifying apparatus and machines; humidifiers; electric fans; central air conditioners.

(260) AM 2019 98613 A

(800) 1413214

(151) 2018 04 13

(891) 2018 04 13

(731) KAYALAR KIMYA SANAYI VE TICARET
ANONIM SIRKETI

Kimya San. Organize Sanayi Bolgesi, Tem
Yan Yol Caddesi, No: 4, Melek Aras Blv.
N:48, Tepeoren, Tuzla, Istanbul, Turkey

(540)

WOODSOL

(591) Black, white

(531) 27.05.01; 27.05.17

(511)

2 – Paints; varnishes; lacquers; rust preventatives in the nature of a coating; anti-rust preparations; wood preservatives; preservatives against rust and against deterioration of wood; dyes for wood; thinners for paints; color pigments; protective preparations for metals; printing ink; colorants; toners; raw natural resins; oil colors.

(260) AM 2019 98638 A

(800) 1413847

(151) 2018 04 24

(891) 2018 04 24

(731) HUAWEI TECHNOLOGIES CO., LTD.

Administration Building, Huawei Technolo
gies Co., Ltd., Bantian, Longgang District,
Shenzhen, China

(540)

HUAWEI P30

(591) Black, white

(511)

9 – Smartphones; covers for smartphones; cases for smartphones; electric batteries for mobile phones; tablet computers; protective covers for tablet computers; stands for tablet computers; protective cases for tablet computers; headphones; earphones; television apparatus; set-top boxes; portable cabinets for loud-

speakers; sound transmitting apparatus; camcorders; digital photo frames; routers; network communication apparatus; cell phone straps; screens for mobile phones; computer keyboards; mouse (computer peripheral); modems; covers for mobile phones; portable media players; magnetic encoded identification bracelets; pedometers; electric monitoring apparatus.

(260) AM 2019 98639 A

(800) 1413853

(151) 2018 04 12

(891) 2018 04 12

(731) HUAWEI TECHNOLOGIES CO., LTD.

Administration Building, Huawei Technologies Co., Ltd., Bantian, Longgang District, Shenzhen, China

(540)

honor 

(591) Black, white

(531) 26.01.01; 26.01.04; 26.01.06; 27.05.01

(511)

9 – Electronic chips; plugs, sockets and other contacts [electric connections]; video screens; locks, electric; smartphones; covers for smartphones; cases for smartphones; protective films adapted for smartphones; battery chargers; batteries, electric; mobile power source (rechargeable batteries); galvanic cells; notebook computers; laptop computers; tablet computers; covers for tablet computers; interactive touch screen terminals; electronic interactive whiteboards; humanoid robots with artificial intelligence; covers for personal digital assistants [PDAs]; computer keyboards; computer operating programs, recorded; computer software, recorded; mouse [computer peripheral]; computer hardware; smartglasses; smartwatches; smart rings; wearable activity trackers; earphones; cameras [photography]; virtual reality headsets; selfie sticks [hand-held monopods]; digital photo frames; computer programs, recorded; microphones; audio and video receivers; modems; loudspeakers; portable media players; sound transmitting apparatus; camcorders; network routers; wireless routers; computer software applications, downloadable; wearable computers; telecommunication apparatus in the form of jewelry; selfie sticks used together with mobile phones; selfie lenses; security surveillance robots; wearable video display monitors; pedometers; electronic identification apparatus for fingerprints; electronic numeric displays; thin client computers; computer screen saver software, recorded or downloadable; downloadable graphics for mobile phones; human face recognition devices; scales with body mass analyzers; bathroom scales; headphones; digital video recorders; set-top boxes; air analysis apparatus; digital weather sta-

tions; gas testing instruments; biochips; USB cables; USB cables for mobile phones.

(260) AM 2019 98640 A

(800) 1413861

(151) 2018 04 13

(891) 2018 04 13

(731) SACCO SRL

Via Manzoni, 29/A, I-22071 Cadorago, Como (CO), Italy

(540)

SACCO
system

(591) Grey

(531) 27.05.03

(511)

1 – Cultures of microorganisms, other than for medical and veterinary use; enzymes for the food industry; milk ferments for the food industry; milk ferments for industrial purposes; enzyme preparations for the food industry; preparations of microorganisms, other than for medical and veterinary use; bactericidal preparations [other than for medical and veterinary use]; chemical substances for analyses in laboratories, other than for medical or veterinary purposes.

5 – Nutritional supplements; cultures of microorganisms for medical or veterinary use; milk ferments for pharmaceutical purposes; ferments for pharmaceutical purposes; enzyme dietary supplements; preparations of microorganisms for medical or veterinary use.

29 – Milk ferments for culinary purposes; rennet.

35 – Commercial management; advertising; dissemination of advertisements; distribution of advertising material; marketing; organization of exhibitions for commercial or advertising purposes; organization of trade fairs for commercial or advertising purposes; design of advertising materials; sales promotion for others; publication of publicity texts; on-line advertising on a computer network; advertising by mail order; radio and television advertising.

(260) AM 2019 98643 A

(800) 1413971

(151) 2018 03 08

(891) 2018 03 08

(731) ISHIDA CO., LTD.

44, Sanno-cho, Shogoin, Sakyo-ku, Kyoto-shi, Kyoto 606-8392, Japan

(540)



(591) Red and blue

(531) 04.05.03; 26.03.01; 26.03.05; 26.03.23;
26.03.24; 26.07.25; 27.05.01; 29.01.12

(511)

7 – Product handling machines and apparatus; food or beverage processing machines and apparatus; packaging or wrapping machines and apparatus; adhesive tape dispensing machines; automatic stamping machines; vending machines; carton sealing machines; binding machines; filling machines; automatic packaging or wrapping machines; automatic weighing, bagging and packaging machines; bagging and packaging machines; plastic bag making machines; cartoning machines; carton forming machines; conveying apparatus for product handling; lifts, other than ski-lifts; conveyors; machines and apparatus for packaging food; labellers or label affixing machines; labellers or label affixing machines with weighing machines; packaging or wrapping and label affixing machines and apparatus; vending machines for drinking waters; cereal processing machines and apparatus; automatic conveyors; sorting machines; movable label issuing machines; dry ice making machines; label printers or label printing machines or printing machines.

9 – Cash registers; coin counting or sorting machines; job recording devices; laboratory machines and apparatus; optical machines and apparatus; measuring or testing machines and apparatus; product inspection device and apparatus using electromagnetic wave or radiation; telecommunication machines and apparatus; electronic machines, apparatus and their parts; weighing machines; tablet counting machines; detectors, namely, electric or magnetic meters and testers; detectors; metal detectors for industrial purposes; computer software for use in data management; computer programs for use in systems for enhancing productivity in the field of manufacturing industries; computer programs for inventory management; POS (point-of-sale information management) system, namely, computers, computer software, and computer peripherals; computer programs, recorded; computer software for creation support of advertisement and promotional materials; computer software for designing labels; computer programs for logistics system; computer programs for use in support systems for label issuing; computer programs for use in support systems for food processing; network servers; operation system software; computer operating systems; electronic numeric displays; standard-unit measuring machines and apparatus; weighing scales for medical purposes; quantity indicators; scales; weighing machines and apparatus; processors, namely, central processing units; radio

communication machines and apparatus; indicators of weighing apparatus; electrolysis tank equipped with automatic generation function for electrolysis water; computers for managing information with respect to sorting goods in warehouses.

(260) AM 2019 98645 A

(800) 1414086

(151) 2018 04 13

(891) 2018 04 13

(731) BILZ WERKZEUGFABRIK GMBH & CO.
KG
Vogelsangstraße 8, 73760 Ostfildern,
Germany

(540)



(591) Black, white

(531) 26.04.22; 26.04.24; 27.05.24

(511)

7 – Machine-driven tools and power-driven tools and parts thereof, in particular clamping devices, adjusting devices and changing devices, clamping sleeves, clamping chucks, extensions for clamping chucks, shrink-fit clamping chucks, collet chucks, setting sleeves, drill chucks, thread-cutting chucks, bolt screw-in chucks, chuck inserts, quick-change inserts, devices for clamping and releasing of tools in clamping chucks, in particular shrink-fit machines for thermal shrink-fit clamping of tools, thread-cutting devices configured as machine parts, auxiliary devices for machine-driven tools and power-driven tools, machine-driven balancing devices, machine-driven assembly ratchets, compressed air pistols and compressed air couplings.

8 – Hand-driven tools; clamping and adjusting devices; hand-driven assembly ratchets.

9 – Measuring, recognition, and monitoring instruments, devices and controllers for monitoring of tools and tool holders, in particular electric, mechanical and pneumatic test probes, signal transmitters, signal receivers and signal evaluation devices; software stored on data carriers of any kind for controlling, monitoring and evaluating afore-mentioned goods in classes 7 and 9.

(260) AM 2019 98647 A

(800) 801789

(151) 2003 03 12

(891) 2018 05 07

(731) AGF88 HOLDING Srl

Via del Palù, 7D, I-35018 San Martino di
Lupari (PD), Italy

(540)

ECHOS

(591) Black, white

(531) 27.05.01

(511)

3 – Cosmetics, hair creams, hair oils, essential oils,
soaps, perfumes, hair lotions, hair dyes, hair gels,
hair sprays, shampoos.

(260) AM 2019 98649 A

(800) 1237302

(151) 2014 11 05

(891) 2018 06 06

(731) QUIMI ROMAR, S.L.

Ctra. Moncada-Náquera, Km 11,2,
E-46119 NAQUERA, Spain

(540)

SAIRO

(591) Black, white

(511)

3 – Deodorants and antiperspirants for personal use;
soaps for personal use; perfumery; cosmetics; toilet-
ry preparations; hair care preparations, sprayable
hair care preparations, hair smoothing products, hair
lotions, hair waving preparations, hair sprays.

(260) AM 2019 98658 A

(800) 1411224

(151) 2018 02 09

(891) 2018 06 22

(731) H. LUNDBECK A/S

Ottiliavej 9, DK-2500 Valby, Denmark

(540)

ITRUSDI

(591) Black, white

(511)

5 – Pharmaceuticals and medical preparations and
substances; vaccines; pharmaceutical preparations
and substances for the prevention and treatment of
disorders and diseases in, generated by or acting on
the central nervous system; pharmaceutical prepara-
tions and substances acting on the central nervous
system; central nervous system stimulants; pharma-
ceutical preparations and substances for the preven-
tion and treatment of psychiatric and neurological
disorders and diseases; pharmaceutical preparations
and substances for the prevention and treatment of
dementia, Alzheimer's disorder and disease, dizzi-
ness, seizures, stroke, depression, cognitive impair-
ment, cognitive disorders and diseases, mood disor-ders, psychosis, anxiety, apathy, epilepsy; pharma-
ceutical preparations and substances for the preven-
tion and treatment of Lennox-Gastaut syndrome
(LGS), sclerosis, porphyria, Huntington's disorder
and disease, insomnia, Parkinson's disorder and dis-
ease, falls, movement disorders and diseases, tremor,
schizophrenia, bipolar disorder and disease, mania,
ADHD, PTSD, agitation, aggression, autism, melan-
choly, OCD, Tourette's syndrome, progressive sup-
ranuclear palsy (PSP), restlessness, akathisia, fati-
gue, somnolence, nausea, cancer, migraine, pain, al-
coholism and dependency; preparations, substances,
reagents and agents for diagnostic and medical pur-
poses.

(260) AM 2019 98698 A

(800) 1414181

(151) 2017 12 14

(891) 2017 12 14

(731) SENKEN GROUP CO., LTD.

No.160, West Yuele Street, Wenzhou City,
Zhejiang Province, China

(540)

SENKEN

(591) Black, gray

(531) 27.05.01

(511)

9 – Loudspeakers; microphones; traffic-light appara-
tus [signalling devices]; warning lights; mechanical
signs; remote control apparatus; alarms; sirens; m-
egaphones.

(260) AM 2019 98701 A

(800) 1414235

(151) 2018 03 23

(891) 2018 03 23

(731) Limited Liability Company "DIAMED-farma"

Sovetskaya street, 31, Pervomayskiy,
community, Korolev city, RU-141069
Moscow region, Russian Federation

(540)

MUCOSAT

(591) Black, white

(511)

5 – Pharmaceuticals, medical and veterinary prepa-
rations; sanitary preparations for medical purposes;
dietetic food and substances adapted for medical or
veterinary use, food for babies; dietary supplements
for humans and animals; plasters, materials for dres-
sings; material for dental fillings and dental impres-
sions; disinfectants; preparations for destroying no-
xious animals; fungicides, herbicides; acaricides;
aconitine; alkaloids for medical purposes; alginates

for pharmaceutical purposes; algicides; aldehydes for pharmaceutical purposes; dental amalgams of gold; dental amalgams; amino acids for veterinary purposes; amino acids for medical purposes; analgesics; anaesthetics; antibiotics; antiseptics; medicine cases, portable, filled; first-aid boxes, filled; aluminium acetate for pharmaceutical purposes; acetates for pharmaceutical purposes; germicides; balms for medical purposes; bandages for dressings; diagnostic biomarker reagents for medical purposes; biocides; bromine for pharmaceutical purposes; paper for mustard plasters; fly catching paper; reagent paper for veterinary purposes; reagent paper for medical purposes; mothproofing paper; petroleum jelly for medical purposes; vaccines; oxygen baths; antiseptic cotton; aseptic cotton; absorbent cotton; wadding for medical purposes; cotton for medical purposes; dietetic substances adapted for medical use; radiological contrast substances for medical purposes; nutritive substances for microorganisms; melissa water for pharmaceutical purposes; sea water for medicinal bathing; mineral waters for medical purposes; thermal water; dietary fiber; molding wax for dentists; gases for medical purposes; guaiacol for pharmaceutical purposes; sexual stimulant gels; hematogen; hemoglobin; hydrastine; hydrastinine; glycerine for medical purposes; glycerophosphates; glucose for medical purposes; gentian for pharmaceutical purposes; hormones for medical purposes; mustard for pharmaceutical purposes; mustard plasters; mud for baths; medicinal mud; gamboge for medical purposes; gurjun [gurjon, gurjan] balsam for medical purposes; air deodorising preparations; deodorants, other than for human beings or for animals; deodorants for clothing and textiles; diastase for medical purposes; digitalin; dietary supplements; mineral food supplements; nutritional supplements; albumin dietary supplements; dietary supplements for animals; yeast dietary supplements; alginate dietary supplements; glucose dietary supplements; casein dietary supplements; lecithin dietary supplements; linseed oil dietary supplements; propolis dietary supplements; protein dietary supplements; protein supplements for animals; royal jelly dietary supplements; pollen dietary supplements; wheat germ dietary supplements; linseed dietary supplements; enzyme dietary supplements; yeast for pharmaceutical purposes; gelatine for medical purposes; cod liver oil; isotopes for medical purposes; immunostimulants; insecticides; iodine for pharmaceutical purposes; iodides for pharmaceutical purposes; alkaline iodides for pharmaceutical purposes; iodoform; calomel [fungicide]; tartar for pharmaceutical purposes; camphor for medical purposes; capsules for medicines; cachets for pharmaceutical purposes; hemostatic pencils; wart pencils; caustic pencils; carbolineum [parasiticide]; caustics for pharmaceutical purposes; cachou for pharmaceutical purposes; quassia for medical purposes; quebracho for medical purposes; oxygen for me-

dical purposes; gallic acid for pharmaceutical purposes; acids for pharmaceutical purposes; adhesives for dentures; surgical glues; stem cells for veterinary purposes; stem cells for medical purposes; cocaine; collagen for medical purposes; collodion for pharmaceutical purposes; corn rings for the feet; candy, medicated; angostura bark for medical purposes; barks for pharmaceutical purposes; cedar wood for use as an insect repellent; condurango bark for medical purposes; croton bark; mangrove bark for pharmaceutical purposes; myrobalan bark for pharmaceutical purposes; quinquina for medical purposes; medicated animal feed; medicinal roots; rhubarb roots for pharmaceutical purposes; lint for medical purposes; starch for dietetic or pharmaceutical purposes; creosote for pharmaceutical purposes; blood for medical purposes; cultures of microorganisms for medical or veterinary use; curare; dental lacquer; liquorice for pharmaceutical purposes; lactose for pharmaceutical purposes; candy for medical purposes; adhesive plasters; medicines for alleviating constipation; lecithin for medical purposes; lotions for veterinary purposes; medicated hair lotions; lotions for pharmaceutical purposes; medicated after-shave lotions; personal sexual lubricants; lupulin for pharmaceutical purposes; magnesia for pharmaceutical purposes; liniments; ointments for pharmaceutical purposes; sunburn ointments; mercurial ointments; frostbite salve for pharmaceutical purposes; gauze for dressings; medicinal oils; mustard oil for medical purposes; camphor oil for medical purposes; castor oil for medical purposes; oil of turpentine for pharmaceutical purposes; dill oil for medical purposes; dental mastics; dental abrasives; dental impression materials; teeth filling material; dressings, medical; surgical dressings; drugs for medical purposes; medicines for veterinary purposes; serotherapeutic medicines; medicines for human purposes; medicines for dental purposes; menthol; medicinal drinks; moleskin for medical purposes; almond milk for pharmaceutical purposes; powdered milk for babies; royal jelly for pharmaceutical purposes; milk ferments for pharmaceutical purposes; Irish moss for medical purposes; flour for pharmaceutical purposes; linseed meal for pharmaceutical purposes; fish meal for pharmaceutical purposes; fly glue; antibacterial soap; disinfectant soap; medicated soap; freeze-dried meat adapted for medical purposes; mint for pharmaceutical purposes; dietetic beverages adapted for medical purposes; malted milk beverages for medical purposes; narcotics; medicinal infusions; tincture of iodine; eucalyptol for pharmaceutical purposes; tinctures for medical purposes; opium; opodeldoc; decoctions for pharmaceutical purposes; antiparasitic collars for animals; stick liquorice for pharmaceutical purposes; sulfur sticks [disinfectants]; medicated dentifrices; pectin for pharmaceutical purposes; pepsins for pharmaceutical purposes; peptones for pharmaceutical purposes; hydrogen peroxide for medical

purposes; pesticides; food for babies; leeches for medical purposes; blood plasma; eyepatches for medical purposes; poultices; compresses; scapulars for surgical purposes; diapers for incontinents; bunion pads; breast-nursing pads; pomades for medical purposes; powder of cantharides; pyrethrum powder; belts for sanitary napkins [towels]; anti-uric preparations; bacterial preparations for medical and veterinary use; bacteriological preparations for medical and veterinary use; balsamic preparations for medical purposes; albuminous preparations for medical purposes; biological preparations for veterinary purposes; biological preparations for medical purposes; veterinary preparations; bismuth preparations for pharmaceutical purposes; vitamin preparations; diagnostic preparations for medical purposes; bath preparations for medical purposes; therapeutic preparations for the bath; hemorrhoid preparations; preparations for callouses; lice treatment preparations [pediculicides]; acne treatment preparations; preparations to facilitate teething; preparations for the treatment of burns; fumigation preparations for medical purposes; ootherapy preparations; air purifying preparations; bronchodilating preparations; preparations for reducing sexual activity; sterilizing preparations; soil-sterilising preparations; corn remedies; pharmaceutical preparations for treating dandruff; herbicides; preparations for destroying dry rot fungus; larvae exterminating preparations; fly destroying preparations; preparations for destroying mice; pharmaceutical preparations for skin care; contact lens cleaning preparations; preparations of microorganisms for medical or veterinary use; lime-based pharmaceutical preparations; medicated eye-washes; medicinal hair growth preparations; nutraceutical preparations for therapeutic or medical purposes; opiates; anticryptogamic preparations; aloe vera preparations for pharmaceutical purposes; preparations of trace elements for human and animal use; sulfonamides [medicines]; pharmaceutical preparations; pharmaceutical preparations for treating sunburn; enzyme preparations for veterinary purposes; enzyme preparations for medical purposes; phytotherapy preparations for medical purposes; chemico-pharmaceutical preparations; chemical preparations for veterinary purposes; chemical preparations for the diagnosis of pregnancy; chemical preparations for medical purposes; chemical preparations to treat wheat blight [smut]; vine disease treating chemicals; chemical preparations to treat mildew; chemical preparations for treating phylloxera; chemical preparations for pharmaceutical purposes; chilblain preparations; mothproofing preparations; collyrium; lead water; chemical conductors for electrocardiograph electrodes; albuminous foodstuffs for medical purposes; dietetic foods adapted for medical purposes; by-products of the processing of cereals for dietetic or medical purposes; homogenized food adapted for medical purposes; freeze-dried food adapted for medi-

cal purposes; pharmaceuticals; sanitary towels; sanitary pads; panty liners [sanitary]; propolis for pharmaceutical purposes; pearl powder for medical purposes; radium for medical purposes; hydrated chloral for pharmaceutical purposes; solvents for removing adhesive plasters; vaginal washes for medical purposes; gum for medical purposes; rubber for dental purposes; chewing gum for medical purposes; insect repellents; insect repellent incense; repellents for dogs; tissues impregnated with pharmaceutical lotions; sarsaparilla for medical purposes; sugar for medical purposes; asthmatic tea; fumigating sticks; linseed for pharmaceutical purposes; tobacco-free cigarettes for medical purposes; siccatives [drying agents] for medical purposes; syrups for pharmaceutical purposes; turpentine for pharmaceutical purposes; greases for veterinary purposes; greases for medical purposes; lacteal flour for babies; infant formula; soporifics; bicarbonate of soda for pharmaceutical purposes; bath salts for medical purposes; salts for mineral water baths; salts for medical purposes; potassium salts for medical purposes; sodium salts for medical purposes; smelling salts; mineral water salts; malt for pharmaceutical purposes; semen for artificial insemination; alcohol for pharmaceutical purposes; medicinal alcohol; alloys of precious metals for dental purposes; ergot for pharmaceutical purposes; cooling sprays for medical purposes; antibacterial handwashes; adjuvants for medical purposes; astringents for medical purposes; vermifuges; disinfectants for hygiene purposes; disinfectants for chemical toilets; douching preparations for medical purposes; appetite suppressants for medical purposes; medical preparations for slimming purposes; parasiticides; mouthwashes for medical purposes; febrifuges; depuratives; animal washes [insecticides]; detergents for medical purposes; cattle washes [insecticides]; dog washes [insecticides]; insecticidal veterinary washes; vesicants; purgatives; remedies for perspiration; remedies for foot perspiration; chemical contraceptives; antiparasitic preparations; laxatives; tonics [medicines]; medicated toiletry preparations; digestives for pharmaceutical purposes; nervines; media for bacteriological cultures; steroids; strychnine; serums; tanning pills; appetite suppressant pills; slimming pills; antioxidant pills; sanitary tampons; vulnerary sponges; thymol for pharmaceutical purposes; biological tissue cultures for veterinary purposes; biological tissue cultures for medical purposes; smoking herbs for medical purposes; medicinal herbs; surgical implants comprised of living tissues; pants, absorbent, for incontinents; sanitary panties; babies' napkin-pants [diaper-pants]; charcoal for pharmaceutical purposes; porcelain for dental prostheses; phenol for pharmaceutical purposes; enzymes for veterinary purposes; enzymes for medical purposes; ferments for pharmaceutical purposes; formic aldehyde for pharmaceutical purposes; phosphates for pharmaceutical purposes; fungici-

des;quinine for medical purposes; chinoline for medical purposes; diabetic bread adapted for medical use; chloroform; flowers of sulfur for pharmaceutical purposes; cement for animal hooves; bone cement for surgical and orthopaedic purposes; dental cements; medicinal tea; herbal teas for medicinal purposes; insecticidal animal shampoo; medicated shampoos; medicated shampoos for pets; pediculicidal shampoos; medicated dry shampoos; pre-filled syringes for medical purposes; eucalyptus for pharmaceutical purposes; herbal extracts for medical purposes; plant extracts for pharmaceutical purposes; tobacco extracts [insecticides]; extracts of hops for pharmaceutical purposes; elixirs [pharmaceutical preparations]; ethers for pharmaceutical purposes; esters for pharmaceutical purposes; cellulose esters for pharmaceutical purposes; cellulose ethers for pharmaceutical purposes; rat poison; poisons; bacterial poisons; jalap; cream of tartar for pharmaceutical purposes; adhesive tapes for medical purposes; cotton sticks for medical purposes; slug exterminating preparations; vermin destroying preparations; bismuth subnitrate for pharmaceutical purposes; radioactive substances for medical purposes; pastilles for pharmaceutical purposes; babies' diapers [napkins]; diapers for pets; suppositories; milking grease; sedatives; jujube, medicated; transplants [living tissues]; fennel for medical purposes; diagnostic preparations for veterinary purposes.

10 – Surgical, medical, dental and veterinary apparatus and instruments; artificial limbs, eyes and teeth; suture materials; therapeutic and assistive devices adapted for the disabled; massage apparatus; apparatus, devices and articles for nursing infants; sexual activity apparatus, devices and articles; blood testing apparatus; anaesthetic apparatus; galvanic therapeutic appliances; apparatus for artificial respiration; apparatus for the treatment of deafness; physical exercise apparatus for medical purposes; body rehabilitation apparatus for medical purposes; dental apparatus and instruments; surgical apparatus and instruments; resuscitation apparatus; dental apparatus, electric; physiotherapy apparatus; bed vibrators; hot air therapeutic apparatus; radiotherapy apparatus; microdermabrasion apparatus; fumigation apparatus for medical purposes; apparatus for the regeneration of stem cells for medical purposes; apparatus for DNA and RNA exams for medical purposes; apparatus and installations for the production of X-rays, for medical purposes; radiological apparatus for medical purposes; X-ray apparatus for medical purposes; hearing aids; nasal aspirators; trusses; maternity belts; bandages, elastic; cupping glasses; dental burs; bracelets for medical purposes; anti-rheumatism bracelets; feeding bottles; vaporizers for medical purposes; hot air vibrators for medical purposes; vibromassage apparatus; gastroscopes; hemocytometers; lice combs; surgical sponges; defibrillators; dialyzers; containers especially made for medi-

cal waste; clips, surgical; mirrors for dentists; mirrors for surgeons; probes for medical purposes; urethral probes; surgical implants comprised of artificial materials; inhalers; injectors for medical purposes; incubators for medical purposes; incubators for babies; obstetric apparatus; obstetric apparatus for cattle; electric acupuncture instruments; surgical cutlery; insufflators; endoscopy cameras for medical purposes; cannulae; droppers for medical purposes; dropper bottles for medical purposes; heart pacemakers; heart rate monitoring apparatus; catheters; catgut; draw-sheets for sick beds; enema apparatus for medical purposes; artificial skin for surgical purposes; menstrual cups; teething rings; anti-rheumatism rings; compressors [surgical]; thermo-electric compresses [surgery]; abdominal corsets; corsets for medical purposes; crutches; dentists' armchairs; armchairs for medical or dental purposes; beds specially made for medical purposes; feeding bottle valves; love dolls [sex dolls]; lasers for medical purposes; lamps for medical purposes; quartz lamps for medical purposes; ultraviolet ray lamps for medical purposes; lancets; lenses [intraocular prostheses] for surgical implantation; spoons for administering medicine; masks for use by medical personnel; respiratory masks for artificial respiration; anaesthetic masks; childbirth mattresses; air mattresses for medical purposes; hydrostatic [water] beds for medical purposes; furniture especially made for medical purposes; water bags for medical purposes; douche bags; breast pumps; body fat monitors; body composition monitors; urinals [vessels]; teeth protectors for dental purposes; temperature indicator labels for medical purposes; knee bandages, orthopaedic; tips for crutches; finger guards for medical purposes; medical guidewires; pumps for medical purposes; thread, surgical; knives for surgical purposes; scissors for surgery; ambulance stretchers; stretchers, wheeled; boots for medical purposes; orthopaedic footwear; clothing especially for operating rooms; compression garments; blankets, electric, for medical purposes; supports for flat feet; ophthalmometers; ophthalmoscopes; slings [supporting bandages]; gloves for massage; gloves for medical purposes; pessaries; saws for surgical purposes; ear picks; spittoons for medical purposes; plaster bandages for orthopaedic purposes; supportive bandages; suspensory bandages; abdominal pads; cushions for medical purposes; pads [pouches] for preventing pressure sores on patient bodies; air pillows for medical purposes; soporific pillows for insomnia; heating cushions [pads], electric, for medical purposes; abdominal belts; galvanic belts for medical purposes; hypogastric belts; belts for medical purposes; orthopaedic belts; umbilical belts; belts, electric, for medical purposes; condoms; aerosol dispensers for medical purposes; sphygmomanometers; pulse meters; esthetic massage apparatus; veterinary apparatus and instruments; medical apparatus and instruments; urologi-

cal apparatus and instruments; orthodontic appliances; nursing appliances; brushes for cleaning body cavities; invalids' hoists; appliances for washing body cavities; corn knives; incontinence sheets; sterile sheets, surgical; surgical drapes; hair prostheses; artificial eyes; artificial breasts; dentures; artificial limbs; artificial jaws; ice bags for medical purposes; toe separators for orthopaedic purposes; orthodontic rubber bands; X-ray photographs for medical purposes; respirators for artificial respiration; strait jackets; sex toys; scalpels; tongue scrapers; babies' pacifiers [teats]; feeding bottle teats; receptacles for applying medicines; spirometers [medical apparatus]; vaginal syringes; implantable subcutaneous drug delivery devices; hearing protectors; contraceptives, non-chemical; orthopaedic soles; stents; stethoscopes; operating tables; commode chairs; basins for medical purposes; bed pans; instrument cases for use by doctors; arch supports for footwear; ear plugs [ear protection devices]; thermometers for medical purposes; tomographs for medical purposes; trocars; drainage tubes for medical purposes; X-ray tubes for medical purposes; radium tubes for medical purposes; balling guns; protection devices against X-rays, for medical purposes; apparatus for acne treatment; filters for ultraviolet rays, for medical purposes; walking frames for disabled persons; cases fitted for medical instruments; elastic stockings for surgical purposes; stockings for varices; splints, surgical; tongue depressors for medical purposes; syringes for injections; syringes for medical purposes; hypodermic syringes; uterine syringes; urethral syringes; pins for artificial teeth; forceps; castrating pincers; radiology screens for medical purposes; electrodes for medical use; electrocardiographs; brain pacemakers; analysers for bacterial identification for medical purposes; testing apparatus for medical purposes; traction apparatus for medical purposes; diagnostic apparatus for medical purposes; air cushions for medical purposes; biodegradable bone fixation implants; surgical bougies; ear trumpets; thermal packs for first aid purposes; quad canes for medical purposes.

44 – Medical services; veterinary services; hygienic and beauty care for human beings or animals; agriculture, horticulture and forestry services; public bath services for hygiene purposes; Turkish bath services; hospital services; reforestation services; landscape design; nursing home services; wreath making; hair implantation; medical advice for individuals with disabilities; pharmacy advice; manicuring; chiropractic; massage; horticulture; artificial insemination services; palliative care; hairdressing; body piercing; midwife services; veterinary assistance; medical assistance; tree planting for carbon offsetting purposes; preparation of prescriptions by pharmacists; medical equipment rental; rental of sanitation facilities; farming equipment rental; animal breeding; gardening; landscape gardening; beauty salon services; sanatorium services; blood bank ser-

vices; health care; health counselling; flower arranging; tattooing; weed killing; health spa services; human tissue bank services; aquaculture services; visagists' services; convalescent home services; rest home services; medical clinic services; alternative medicine services; opticians' services; plant nursery services; pest control services for agriculture, aquaculture, horticulture and forestry; services of a psychologist; sauna services; solarium services; telemedicine services; therapy services; nursing, medical; lawn care; animal grooming; pet grooming; physical therapy; plastic surgery; tree surgery; hospice services; depilatory waxing; rehabilitation for substance abuse patients; health center services; aromatherapy services; speech therapy; orthodontic services; dentistry services; vermin exterminating for agriculture, aquaculture, horticulture and forestry; in vitro fertilization services.

(260) AM 2019 98702 A

(800) 1414250

(151) 2017 12 29

(891) 2017 12 29

(731) MİLANGAZ LPG DAĞITIM TİCARET VE SANAYİ ANONİM ŞİRKETİ
Şişhane Yokuşu Demirören, Han No:2
Azapkapı, İstanbul, Turkey

(540)



**DEMİRÖREN
PETROL**

(591) Orange and black.

(531) 14.01.18; 14.01.23; 26.11.02; 27.05.08;
27.05.21; 29.01.13

(526) Petrol

(511)

4 – Industrial oils and greases; cutting fluids; dust absorbing, wetting and binding compositions; solid fuels, coal, firewood; liquid and gas fuels; petrol, diesel oil, liquefied petroleum gas, natural gas, fuel oil and their non-chemical additives; candles; wicks; semi-finished wax; wax and paraffin for lighting purposes.

37 – Vehicles service stations for land vehicles, maintenance, repair and refueling of land vehicles; vehicles service stations for marine vehicles, maintenance, repair and refueling of marine vehicles; repair and maintenance of air vehicles; installation, maintenance and repair of heating, cooling and sanitary installations; installation, maintenance and repair of industrial machines and equipment, office machines and equipment, communication apparatus, electric

and electronic appliances; mining services and mining extraction.

(260) AM 2019 98703 A

(800) 1414271

(151) 2018 05 17

(891) 2018 05 17

(731) CYBEX GmbH

Riedinger Strasse 18, 95448 Bayreuth,
Germany

(540)



(591) Black, white

(531) 01.15.15; 26.01.03; 26.01.12; 26.01.16;
27.05.01

(511)

25 – Baby and juvenile clothing, footgear and headgear.

(260) AM 2019 98735 A

(800) 1415006

(151) 2018 06 28

(891) 2018 06 28

(731) BIRDIE BH 43 LLC

141 PARKWAY ROAD, SUITE 13C,
BRONXVILLE NY 10708, USA

(540)



(591) Black, white

(511)

33 – Vodka.

(260) AM 2019 98736 A

(800) 1415041

(151) 2018 05 17

(891) 2018 05 17

(731) BAYER INTELLECTUAL PROPERTY
GMBH

Alfred-Nobel-Str. 1, 40789 Monheim am
Rhein, Germany

(540)



(591) Black, white

(531) 28.05

(511)

5 – Pharmaceutical preparations.

(260) AM 2019 98741 A

(800) 1415181

(151) 2018 04 13

(891) 2018 04 13

(731) Limited Liability Company "VERTICAL"

station Ovrazhki, vlad. 2, Kraskovo

Village, Luberetskiy District, RU-140050

Moscow, Russian Federation

(540)



(591) Red, yellow, black and white

(531) 29.01.14

(511)

16 – Paper; cardboard; printed matter; newspapers; books; magazines [periodicals]; envelopes [stationery]; photographs [printed]; stationery; plastic packaging materials, not related to other classes; adhesive bands for stationery or household purposes; boxes of paper or cardboard; bags [envelopes, pouches] of paper or plastics, for packaging.

29 – Meat; meat, preserved; meat, tinned; charcuterie; sausages; albumen for culinary purposes; fish, not live; fish-based foodstuffs; fish, tinned; caviar; mussels, not live; poultry, not live; game, not live; bouillon concentrates; fruit, preserved; candied fruits; vegetables, cooked; jellies for food; meat jellies; fruit jellies; jams; compotes; potato chips; fruit chips; mushrooms, preserved; buttercream; eggs; powdered eggs; oils for food; edible fats; butter; margarine.

30 – Coffee; tea; cocoa; sugar; rice; tapioca; sago; artificial coffee; flour; cereal preparations; ice cream; honey; yeast; baking powder; cooking salt; mustard; vinegar; sauces [condiments]; ketchup [sauce]; spices; bread; sandwiches; bread rolls; pancakes; chewing gum; milk porridges; sweetmeats [candy]; starch for food; groats for human food; popcorn; corn flakes; noodles; macaroni; pasta; mayonnaise; pastries; pelmeni [dumplings stuffed with meat]; pepper; cookies; pies; cakes; pizzas; spaghetti; chocolate; chocolate-based beverages.

32 – Beer.

35 – Television advertising; business management; business administration; office functions; distribution of samples; demonstration of goods; market studies; commercial or industrial management assistance; public relations; opinion polling; publication of publicity texts; professional business consultancy; shop window dressing; business appraisals; commercial information agency services; business information.

43 – Restaurant services; cafe services; hotel reservations.

(260) AM 2019 98742 A

(800) 1415182

(151) 2018 04 24

(891) 2018 04 24

(731) SHENZHEN KENXINDA TECHNOLOGY
CO., LTD

18th Floor, Fuchun Orient Building,

Shennan Av 7006, Shenzhen, China

(540)

EL 意龍

(591) Black, white

(531) 27.05.01; 28.03

(511)

9 – Cell phones; intercommunication apparatus; radiotelephony sets; video telephones; cell phone straps; mobile phones; smartphones; cordless telephones; telephone apparatus; telephone wires.

(260) AM 2019 98743 A

(800) 1415184

(151) 2018 05 22

(891) 2018 05 22

(731) XIAMEN GOLDENHOME CO., LTD.

No.190 Jihe Rd, Tongan Industrial District,

Xiamen, China

(540)

GoldenHome

(591) Black, white

(531) 27.05.01

(511)

20 – Sideboards; furniture; chests of drawers; tables; furniture of metal; sofas; plate racks; showcases [furniture]; bookcases; wardrobes; furniture fittings, not of metal; doors for furniture; indoor window shades [furniture].

INTERNATIONAL TRADEMARKS PROTECTED IN GEORGIA

(260) AM 2019 91912 A
(800) 1340015
(151) 2016 11 14
(181) 2026 11 14
(891) 2016 11 14
(511) 07, 09, 11, 42

(260) AM 2019 95691 A
(800) 1380683
(151) 2017 10 10
(181) 2027 10 10
(891) 2017 10 10
(511) 03

(260) AM 2019 92971 A
(800) 1349626
(151) 2017 03 20
(181) 2027 03 20
(891) 2017 03 20
(511) 05

(260) AM 2019 95915 A
(800) 1382800
(151) 2017 11 04
(181) 2027 11 04
(891) 2017 11 04
(511) 05

(260) AM 2019 93645 A
(800) 1224231
(151) 2014 02 25
(181) 2024 02 25
(891) 2017 06 02
(511) 25, 35

(260) AM 2019 95916 A
(800) 1382801
(151) 2017 11 04
(181) 2027 11 04
(891) 2017 11 04
(511) 05

(260) AM 2019 94736 A
(800) 1371263
(151) 2017 08 08
(181) 2027 08 08
(891) 2017 08 08
(511) 44

(260) AM 2019 96059 A
(800) 1384706
(151) 2017 11 29
(181) 2027 11 29
(891) 2017 11 29
(511) 18, 25, 35

(260) AM 2019 94738 A
(800) 1371310
(151) 2017 04 11
(181) 2027 04 11
(891) 2017 04 11
(511) 30, 43

(260) AM 2019 96231 A
(800) 1385569
(151) 2017 11 09
(181) 2027 11 09
(891) 2017 11 09
(511) 09

(260) AM 2019 95269 A
(800) 1375864
(151) 2017 01 13
(181) 2027 01 13
(891) 2017 01 13
(511) 06, 07, 09, 12, 17, 19, 37, 41

(260) AM 2019 96233 A
(800) 1385577
(151) 2017 09 19
(181) 2027 09 19
(891) 2017 09 19
(511) 09, 28

(260) AM 2019 95495 A
(800) 1379221
(151) 2017 06 21
(181) 2027 06 21
(891) 2017 06 21
(511) 35, 37

(260) AM 2019 96318 A
(800) 1386806
(151) 2017 11 14
(181) 2027 11 14
(891) 2017 11 14
(511) 05

(260) AM 2019 96322 A
(800) 1386807
(151) 2017 11 14
(181) 2027 11 14
(891) 2017 11 14
(511) 05

(260) AM 2019 96323 A
(800) 1386808
(151) 2017 11 14
(181) 2027 11 14
(891) 2017 11 14
(511) 05

(260) AM 2019 96324 A
(800) 1386809
(151) 2017 11 14
(181) 2027 11 14
(891) 2017 11 14
(511) 05

(260) AM 2019 96325 A
(800) 1386810
(151) 2017 11 14
(181) 2027 11 14
(891) 2017 11 14
(511) 05

(260) AM 2019 96326 A
(800) 1386811
(151) 2017 11 14
(181) 2027 11 14
(891) 2017 11 14
(511) 05

(260) AM 2019 96327 A
(800) 1386813
(151) 2017 11 14
(181) 2027 11 14
(891) 2017 11 14
(511) 05

(260) AM 2019 96351 A
(800) 1386140
(151) 2017 11 22
(181) 2027 11 22
(891) 2017 11 22
(511) 03, 05, 16, 21, 24

(260) AM 2019 96354 A
(800) 1386836
(151) 2017 09 20

(181) 2027 09 20
(891) 2017 09 20
(511) 03

(260) AM 2019 96360 A
(800) 1386876
(151) 2017 10 05
(181) 2027 10 05
(891) 2017 10 05
(511) 09

(260) AM 2019 96364 A
(800) 1387059
(151) 2016 10 12
(181) 2026 10 12
(891) 2016 10 12
(511) 03, 05, 10

(260) AM 2019 96371 A
(800) 1386405
(151) 2017 11 14
(181) 2027 11 14
(891) 2017 11 14
(511) 05

(260) AM 2019 96372 A
(800) 1386406
(151) 2017 11 14
(181) 2027 11 14
(891) 2017 11 14
(511) 05

(260) AM 2019 96373 A
(800) 1387103
(151) 2017 07 07
(181) 2027 07 07
(891) 2017 07 07
(511) 03

(260) AM 2019 96387 A
(800) 1387370
(151) 2017 10 10
(181) 2027 10 10
(891) 2017 10 10
(511) 03, 35

(260) AM 2019 96388 A
(800) 1386413
(151) 2017 11 07
(181) 2027 11 07
(891) 2017 11 07
(511) 05

(260) AM 2019 96390 A
(800) 1386426
(151) 2017 10 10
(181) 2027 10 10
(891) 2017 10 04
(511) 06, 09, 35

(260) AM 2019 96391 A
(800) 1387373
(151) 2017 10 20
(181) 2027 10 20
(891) 2017 10 20
(511) 03, 09, 14, 18, 25, 35

(260) AM 2019 96392 A
(800) 1386442
(151) 2017 09 29
(181) 2027 09 29
(891) 2017 09 29
(511) 29, 30

(260) AM 2019 96393 A
(800) 1386445
(151) 2017 11 07
(181) 2027 11 07
(891) 2018 11 07
(511) 03, 09, 14, 16, 25, 41

(260) AM 2019 96400 A
(800) 1386585
(151) 2017 09 18
(181) 2027 09 18
(891) 2017 09 18
(511) 09

(260) AM 2019 96403 A
(800) 1386604
(151) 2017 04 28
(181) 2027 04 28
(891) 2017 04 28
(511) 09, 14, 28, 41

(260) AM 2019 96404 A
(800) 1386704A
(151) 2017 09 27
(181) 2027 09 27
(891) 2017 09 27
(511) 09, 16, 35, 38, 39, 41, 42

(260) AM 2019 96426 A
(800) 1387986
(151) 2017 11 14

(181) 2027 11 14
(891) 2017 11 14
(511) 05

(260) AM 2019 96428 A
(800) 1387988
(151) 2017 11 14
(181) 2027 11 17
(891) 2017 11 14
(511) 05

(260) AM 2019 96429 A
(800) 1387989
(151) 2017 11 14
(181) 2027 11 14
(891) 2017 11 14
(511) 05

(260) AM 2019 96430 A
(800) 1387992
(151) 2017 11 30
(181) 2027 11 30
(891) 2017 11 30
(511) 29, 30

(260) AM 2019 96431 A
(800) 1387999
(151) 2017 12 06
(181) 2027 12 06
(891) 2017 12 06
(511) 03

(260) AM 2019 96432 A
(800) 1388006
(151) 2017 11 10
(181) 2027 11 10
(891) 2017 11 10
(511) 02

(260) AM 2019 96433 A
(800) 1388049
(151) 2017 12 01
(181) 2027 12 01
(891) 2017 12 01
(511) 19

(260) AM 2019 96434 A
(800) 1388061
(151) 2017 07 21
(181) 2027 07 21
(891) 2017 07 21
(511) 06, 12

(260) AM 2019 96435 A
(800) 1387499
(151) 2017 11 07
(181) 2027 11 07
(891) 2017 11 07
(511) 05

(260) AM 2019 96444 A
(800) 1387561
(151) 2017 11 30
(181) 2027 11 30
(891) 2017 11 30
(511) 20

(260) AM 2019 96477 A
(800) 1181983
(151) 2013 06 19
(181) 2023 06 19
(891) 2017 12 12
(511) 09

(260) AM 2019 96511 A
(800) 1387787
(151) 2017 12 05
(181) 2027 12 05
(891) 2017 12 05
(511) 12

(260) AM 2019 96512 A
(800) 1387795
(151) 2017 09 28
(181) 2027 09 28
(891) 2017 09 28
(511) 35, 36, 45

(260) AM 2019 96513 A
(800) 1387803
(151) 2017 12 14
(181) 2027 12 14
(891) 2017 12 14
(511) 14

(260) AM 2019 96515 A
(800) 1387878
(151) 2017 11 27
(181) 2027 11 27
(891) 2017 11 27
(511) 25

(260) AM 2019 96516 A
(800) 1387910
(151) 2017 11 09

(181) 2027 11 09
(891) 2017 11 09
(511) 33

(260) AM 2019 96519 A
(800) 1387916
(151) 2017 12 05
(181) 2027 12 05
(891) 2017 12 05
(511) 03, 35

(260) AM 2019 96520 A
(800) 1387948
(151) 2017 09 21
(181) 2027 09 21
(891) 2017 09 21
(511) 30

(260) AM 2019 96521 A
(800) 1387958
(151) 2018 11 27
(181) 2027 11 27
(891) 2017 11 27
(511) 09

(260) AM 2019 96526 A
(800) 1387970
(151) 2017 10 31
(181) 2027 10 31
(891) 2017 10 31
(511) 03

(260) AM 2019 96596 A
(800) 1389545
(151) 2017 07 27
(181) 2027 07 27
(891) 2017 07 27
(511) 29, 30, 32, 33

(260) AM 2019 96597 A
(800) 1389609
(151) 2017 10 13
(181) 2027 10 13
(891) 2017 10 13
(511) 29, 30, 31

(260) AM 2019 96599 A
(800) 1389618
(151) 2017 09 08
(181) 2027 09 08
(891) 2017 09 08
(511) 05

(260) AM 2019 96602 A
(800) 1389647
(151) 2017 11 27
(181) 2027 11 27
(891) 2017 11 27
(511) 09

(260) AM 2019 96603 A
(800) 1389652
(151) 2017 11 30
(181) 2027 11 30
(891) 2017 11 30
(511) 25, 41

(260) AM 2019 96604 A
(800) 1389705
(151) 2017 12 29
(181) 2027 12 29
(891) 2017 12 29
(511) 34

(260) AM 2019 96610 A
(800) 1388677
(151) 2017 06 23
(181) 2027 06 23
(891) 2017 06 23
(511) 09

(260) AM 2019 96652 A
(800) 1390160
(151) 2017 11 29
(181) 2027 11 29
(891) 2017 11 29
(511) 07

(260) AM 2019 96664 A
(800) 1390383
(151) 2017 11 29
(181) 2027 11 29
(891) 2017 11 29
(511) 16

(260) AM 2019 96677 A
(800) 1390727
(151) 2017 11 14
(181) 2027 11 14
(891) 2017 11 14
(511) 12, 21, 37

(260) AM 2019 96681 A
(800) 726176
(151) 1999 12 09

(181) 2019 12 09
(891) 2018 01 19
(511) 07, 16

(260) AM 2019 96682 A
(800) 761257
(151) 2001 06 28
(181) 2021 06 28
(891) 2018 02 05
(511) 05

(260) AM 2019 96683 A
(800) 903358
(151) 2006 08 16
(181) 2026 08 16
(891) 2018 01 16
(511) 07, 09, 11

(260) AM 2019 96684 A
(800) 985322
(151) 2008 10 17
(181) 2018 10 17
(891) 2017 12 11
(511) 04

(260) AM 2019 96685 A
(800) 1076165
(151) 2010 12 03
(181) 2020 12 03
(891) 2017 10 31
(511) 34

(260) AM 2019 96687 A
(800) 1182147
(151) 2013 08 05
(181) 2025 08 05
(891) 2017 12 20
(511) 03

(260) AM 2019 96688 A
(800) 1203331
(151) 2014 01 16
(181) 2024 01 16
(891) 2017 10 09
(511) 11

(260) AM 2019 96794 A
(800) 1298811
(151) 2015 11 30
(181) 2025 11 30
(891) 2018 01 22
(511) 09, 17

(260) AM 2019 96795 A
(800) 1325706
(151) 2015 10 21
(181) 2025 10 21
(891) 2018 02 15
(511) 03, 05, 16

(260) AM 2019 96822 A
(800) 1391363
(151) 2017 07 25
(181) 2027 07 25
(891) 2017 07 25
(511) 09, 42

(260) AM 2019 96823 A
(800) 1391364
(151) 2017 09 12
(181) 2027 09 12
(891) 2017 09 12
(511) 35, 42

(260) AM 2019 96829 A
(800) 1391995
(151) 2017 11 10
(181) 2027 11 10
(891) 2017 11 10
(511) 32, 33

(260) AM 2019 96874 A
(800) 1392475
(151) 2017 02 08
(181) 2027 02 06
(891) 2017 02 06
(511) 29

(260) AM 2019 96953 A
(800) 1393311
(151) 2017 12 21
(181) 2027 12 21
(891) 2017 12 21
(511) 09, 10, 28

(260) AM 2019 96957 A
(800) 1393412
(151) 2017 10 31
(181) 2027 10 31
(891) 2017 10 31
(511) 30

(260) AM 2019 96958 A
(800) 1393420
(151) 2017 11 24

(181) 2027 11 24
(891) 2017 11 24
(511) 11

(260) AM 2019 96961 A
(800) 1393616
(151) 2017 09 22
(181) 2027 09 22
(891) 2017 09 22
(511) 03

(260) AM 2019 96962 A
(800) 1393500
(151) 2017 12 15
(181) 2027 12 15
(891) 2017 12 15
(511) 05

(260) AM 2019 96963 A
(800) 1393641
(151) 2017 12 27
(181) 2027 12 27
(891) 2017 12 27
(511) 25

(260) AM 2019 96965 A
(800) 1393643
(151) 2017 12 05
(181) 2027 12 05
(891) 2017 12 05
(511) 03, 05

(260) AM 2019 96968 A
(800) 1393644
(151) 2017 12 05
(181) 2027 12 05
(891) 2017 12 05
(511) 03, 05

(260) AM 2019 96969 A
(800) 1393539
(151) 2017 08 22
(181) 2027 08 22
(891) 2017 08 22
(511) 06, 17, 19

(260) AM 2019 96970 A
(800) 1393652
(151) 2017 08 22
(181) 2027 08 22
(891) 2017 08 22
(511) 06, 17, 19

(260) AM 2019 97132 A
(800) 1395624
(151) 2018 01 12
(181) 2028 01 12
(891) 2018 01 12
(511) 03

(260) AM 2019 97150 A
(800) 1140438
(151) 2012 10 11
(181) 2022 10 11
(891) 2018 03 15
(511) 18, 25, 35

(260) AM 2019 97162 A
(800) 1354203
(151) 2016 09 09
(181) 2026 09 09
(891) 2018 03 02
(511) 30

OFFICIAL NOTIFICATION

INVENTIONS

EXPIRATION OF PATENTS RESTORATION

(21) AP 2009 11992

(11) P 2012 5666 B

(73) MERCK SHARP & DOHME CORP.

(54) **HYDROXYMETHYL PYRROLIDINES AS β 3 ADRENERGIC RECEPTOR AGONISTS**

DATE OF CANCELLATION OF PATENT: 2018 04 02

DATE OF RESTORATION OF PATENT: 2019 04 10

(21) AP 2011 12110

(11) P 2012 5675 B

(73) Mariam Ionanidze;

Bagrat Basiladze

(54) **DRUG FOR BURN TREATMENT**

DATE OF CANCELLATION OF PATENT: 2019 02 18

DATE OF RESTORATION OF PATENT: 2019 04 10

(21) AP 2011 12129

(11) P 2013 5745 B

(73) Mariam Ionanidze;

Bagrat Basiladze

(54) **DRUG FOR PYODERMIA TREATMENT**

DATE OF CANCELLATION OF PATENT: 2019 03 09

DATE OF RESTORATION OF PATENT: 2019 04 10

ABOLITION OF PATENTS WITH THE RIGHT TO RESTORE

(21) AP 2008 11006

(11) P 2010 5094 B

(73) Vladimer Tarasashvili

(54) **POLARIZATION-HOLOGRAPHIC METHOD OF AMPLIFICATION AND CORRECTION OF OPTICAL SIGNAL**

DATE OF CANCELLATION OF PATENT: 2018 12 10

PATENT RESTORATION IS AVAILABLE: 2019 12 10

(21) AP 2009 11600

(11) P 2011 5273 B

(73) Tengiz Gelashvili

(54) **CLINKER-FREE CEMENT**

DATE OF CANCELLATION OF PATENT: 2018 12 14

PATENT RESTORATION IS AVAILABLE: 2019 12 14

(21) AP 2009 11601
(11) P 2011 5274 B
(73) Tengiz Gelashvili
(54) **LOW-CLINKER CEMENT**
DATE OF CANCELLATION OF PATENT: 2018 12 14
PATENT RESTORATION IS AVAILABLE: 2019 12 14

(21) AP 2011 12129
(11) P 2013 5745 B
(73) Mariam Ionanidze;
Bagrat Basiladze
(54) **DRUG FOR PYODERMIA TREATMENT**
DATE OF CANCELLATION OF PATENT: 2019 03 09
PATENT RESTORATION IS AVAILABLE: 2021 03 09

(21) AP 2010 12412
(11) P 2016 6471 B
(73) GREEN SOURCE ENERGY LLC
(54) **INHIBITING CORROSION AND SCALING OF SURFACES CONTACTED BY SULFUR-CONTAINING MATERIALS**
DATE OF CANCELLATION OF PATENT: 2019 03 10
PATENT RESTORATION IS AVAILABLE: 2020 03 10

(21) AP 2009 12413
(11) P 2017 6603 B
(73) GREEN SOURCE ENERGY LLC
(54) **EXTRACTION OF HYDROCARBONS FROM HYDROCARBON-CONTAINING MATERIALS AND/OR PROCESSING OF HYDROCARBON-CONTAINING MATERIALS**
DATE OF CANCELLATION OF PATENT: 2019 03 13
PATENT RESTORATION IS AVAILABLE: 2020 03 13

(21) AP 2015 13758
(11) P 2017 6801 B
(73) Shota Tserodze;
Julian Bernard Sabtiago Provaldi;
Jovani-Lorenzo Shalino;
Elguja Medzmariashvili;
Nodar Tsignadze;
Malkhaz Nikoladze
(54) **COSMIC REFLECTOR MECHANICAL HUST AND UNFOLDING METHOD THEREOF**
DATE OF CANCELLATION OF PATENT: 2019 03 11
PATENT RESTORATION IS AVAILABLE: 2020 03 11

(21) AP 2007 9927
(11) P 2008 4574 B
(73) Marina Shaduri
(54) **DEVICE FOR GAS-DISCHARGE SURVEY FOR DETECTION OF MALIGNANT PROCESSES IN LIVING ORGANISMS**
DATE OF CANCELLATION OF PATENT: 2019 03 16
PATENT RESTORATION IS AVAILABLE: 2020 03 16

(21) AP 2014 13974
(11) P 2017 6798 B
(73) CONSORT MEDICAL PLC
(54) **IMPROVED MIXING SYRINGE ASSEMBLY**
DATE OF CANCELLATION OF PATENT: 2019 03 26
PATENT RESTORATION IS AVAILABLE: 2020 03 26

EXPIRATION OF TERM OF RESTORATION OF PATENTS

(21) AP 2004 10196
(11) P 2012 5503 B
(73) Interdigital Technology Corporation
(54) **METHOD AND DEVICE FOR WIRELESS MULTI-CELL COMMUNICATION SYSTEM FOR MANAGING RESOURCE POWER TO PROVIDE HIGH SPEED DOWNLINK PACKET ACCESS SERVICES**
DATE OF CANCELLATION OF PATENT: 2018 03 23
THE TERM OF RESTORATION OF PATENT VALIDITY HAS EXPIRED: 2019 03 23

(21) AP 2006 10321
(11) P 2012 5473 B
(73) Interdigital Technology Corporation
(54) **WIRELESS COMMUNICATION METHOD AND SYSTEM FOR CONVEYING MEDIA INDEPENDENT HANDOVER CAPABILITY INFORMATION**
DATE OF CANCELLATION OF PATENT: 2018 03 14
THE TERM OF RESTORATION OF PATENT VALIDITY HAS EXPIRED: 2019 03 14

(21) AP 2009 11969
(11) P 2013 5845 B
(73) TAKEDA PHARMACEUTICAL COMPANY LIMITED
(54) **ORALLY-DISINTEGRATING SOLID FORMULATION**
DATE OF CANCELLATION OF PATENT: 2018 03 10
THE TERM OF RESTORATION OF PATENT VALIDITY HAS EXPIRED: 2019 03 10

(21) AP 2010 12415
(11) P 2014 6212 B
(73) DREDGING INTERNATIONAL N.V.
(54) **METHOD AND DEVICE FOR TREATING DREDGED MATERIAL EXTRACTED BY MEANS OF DREDGING VESSEL**
DATE OF CANCELLATION OF PATENT: 2018 03 15
THE TERM OF RESTORATION OF PATENT VALIDITY HAS EXPIRED: 2019 03 15

(21) AP 2014 13933
(11) P 2017 6692 B
(73) NOVARTIS AG
(54) **BIARYL AMIDE COMPOUNDS AS KINASE INHIBITORS**
DATE OF CANCELLATION OF PATENT: 2018 03 13
THE TERM OF RESTORATION OF PATENT VALIDITY HAS EXPIRED: 2019 03 13

(21) AP 2014 13934
(11) P 2017 6699 B
(73) NOVARTIS AG
(54) **3-PYRIMIDIN-4-YL-OXAZOLIDIN-2-ONES AS INHIBITORS OF MUTANT IDH**
DATE OF CANCELLATION OF PATENT: 2018 03 12
THE TERM OF RESTORATION OF PATENT VALIDITY HAS EXPIRED: 2019 03 12

(21) AP 2014 13959
(11) P 2017 6780 B
(73) Boehringer Ingelheim International GMBH
(54) **SUBSTITUTED 2-AZA-BICYCLO [2.2.1]HEPTANE-3-CARBOXYLIC ACID (BENZYL-CYANO-METHYL)-AMIDES INHIBITORS OF CATHEPSIN C**
DATE OF CANCELLATION OF PATENT: 2018 03 12
THE TERM OF RESTORATION OF PATENT VALIDITY HAS EXPIRED: 2019 03 12

(21) AP 2013 13967
(11) P 2017 6626 B
(73) POLICHEM S.A.
(54) **SYNTHESIS OF (S)-NIFURATEL**
DATE OF CANCELLATION OF PATENT: 2018 03 13
THE TERM OF RESTORATION OF PATENT VALIDITY HAS EXPIRED: 2019 03 13

(21) AP 1999 5600
(11) P 2003 2966 B
(73) Aziende Chimiche Riunite Angelini Francesco A.C.R.A.F. S.p.A.
(54) **OPHTHALMIC SOLUTION COMPRISING GLYCOGEN**
DATE OF CANCELLATION OF PATENT: 2018 03 11
THE TERM OF RESTORATION OF PATENT VALIDITY HAS EXPIRED: 2019 03 11

(21) AP 2003 8440
(11) P 2008 4474 B
(73) WYETH;
Janssen Alzheimer Immunotherapy
(54) **HUMANIZED ANTIBODIES THAT RECOGNIZE BETA AMYLOID PEPTIDE**
DATE OF CANCELLATION OF PATENT: 2018 03 12
THE TERM OF RESTORATION OF PATENT VALIDITY HAS EXPIRED: 2019 03 12

(21) AP 2004 9031
(11) P 2009 4593 B
(73) Interdigital Technology Corporation
(54) **WIRELESS MULTI-CELL COMMUNICATION SYSTEM FOR MANAGING RESOURCE POWER TO PROVIDE HIGH SPEED DOWNLINK PACKET ACCESS SERVICES**
DATE OF CANCELLATION OF PATENT: 2018 03 23
THE TERM OF RESTORATION OF PATENT VALIDITY HAS EXPIRED: 2019 03 23

(21) AP 2007 9923
(11) P 2009 4716 B
(73) Nugzar Abzhandadze
(54) **CONTROL UNIT FOR COLOR MUSIC FOUNTAIN**
DATE OF CANCELLATION OF PATENT: 2018 03 12
THE TERM OF RESTORATION OF PATENT VALIDITY HAS EXPIRED: 2019 03 12

CHANGES OF NAMES AND/OR ADDRESSES OF PATENTOWNER

(21) AP 2017 14632

(11) P 2018 6912 B

(54) **CONSTRUCTIVELY COMBINED NODE FOR NONPRESSURE SANDY FILTERS AND SAID FILTERS EQUIPPED THEREWITH**

LAST NAME AND ADDRESSES: Avtandil Rokhvadze (GE)
Al. Kazbegis gamz. 10a, b. 66, 0177, Tbilisi (GE)
NEW NAME AND ADDRESSES: HUBER SE (DE)
Industripark Erasbach A1 92334 Berching, Germany (DE)
DATE OF REGISTRY: 2019 03 22

UTILITY MODELS

EXPIRATION OF PATENTS RESTORATION

(21) AU 2017 14421

(11) U 2018 1969 Y

(73) Davit Giorgadze;
Temur Giorgadze;
Vladimer Ughrelidze

(54) **TRAILER FOR MOTOR CAR AND MOTOR CULTIVATOR**

DATE OF CANCELLATION OF PATENT: 2019 02 10

DATE OF RESTORATION OF PATENT: 2019 04 10

ABOLITION OF PATENTS WITH THE RIGHT TO RESTORE

(21) AU 2010 11720

(11) U 2011 1662 Y

(73) LTD "AVRSI-RATIONAL"

(54) **THERAPEUTIC COMBINATION "ULTSERONI" FOR TREATMENT OF GASTROINTESTINAL DISEASES CAUSED BY HELICOBACTER PYLORI**

DATE OF CANCELLATION OF PATENT: 2019 03 11

MODEL RESTORATION IS AVAILABLE: 2020 03 11

(21) AU 2011 12134

(11) U 2012 1727 Y

(73) Vili Pachkoria

(54) **DISPOSABLE HYGIENIC BEDDING FOR WC SCAT**

DATE OF CANCELLATION OF PATENT: 2019 03 10

MODEL RESTORATION IS AVAILABLE: 2020 03 10

(21) AU 2013 12969
(11) U 2014 1812 Y
(73) Meri Alania;
Eter Kemertelidze
(54) **METHOD FOR OBTAINING ROBININ**
DATE OF CANCELLATION OF PATENT: 2019 01 17
MODEL RESTORATION IS AVAILABLE: 2020 01 17

(21) AU 2015 13768
(11) U 2016 1908 Y
(73) Razhden Kirvalidze
(54) **METHOD FOR PRODUCTION OF SOAP PREVENTING FALLING HAIR, DANDRUFF AND ACNE**
DATE OF CANCELLATION OF PATENT: 2019 03 24
MODEL RESTORATION IS AVAILABLE: 2020 03 24

(21) AU 2016 14085
(11) U 2017 1926 Y
(73) Guram Makharadze;
Arkadi rikrikadze
(54) **DOUBLE-WINDING THREE-PHASE ELECTRIC MACHINE**
DATE OF CANCELLATION OF PATENT: 2019 03 09
MODEL RESTORATION IS AVAILABLE: 2020 03 09

(21) AU 2017 14451
(11) U 2018 1965 Y
(73) Konstantine Mchedlishvili;
Davit Gegeshidze
(54) **FACILITY FOR RECEIVING COINS WITH PROTECTING MEANS FROM KNAVISH ACTIONS**
DATE OF CANCELLATION OF PATENT: 2019 03 15
MODEL RESTORATION IS AVAILABLE: 2020 03 15

EXPIRATION OF TERM OF RESTORATION OF PATENTS

(21) AU 2009 11170
(11) U 2009 1573 Y
(73) LTD "AVERSI-RATIONAL"
(54) **CAPSULES "NERMO PLUSI"**
DATE OF CANCELLATION OF PATENT: 2018 03 18
THE TERM OF RESTORATION OF PATENT VALIDITY HAS EXPIRED: 2019 03 18

(21) AU 2010 11721
(11) U 2011 1663 Y
(73) LTD "AVERSI-RATIONAL"
(54) **SIORAL RETARD TABLET**
DATE OF CANCELLATION OF PATENT: 2018 03 11
THE TERM OF RESTORATION OF PATENT VALIDITY HAS EXPIRED: 2019 03 11

(21) AU 2014 13416

(11) U 2015 1858 Y

(73) Mamuka Tsintsadze;
Gia Shainidze

(54) FACILITY FOR BRAIDING WIRECLOTHS WITH HEXAGONAL BAYS

DATE OF CANCELLATION OF PATENT: 2018 03 11

THE TERM OF RESTORATION OF PATENT VALIDITY HAS EXPIRED: 2019 03 11

(21) AU 2014 13417

(11) U 2015 1874 Y

(73) Mamuka Tsintsadze

(54) TOOL FOR WIRES MUTUAL CURL AT WEAVING LATTICE PANELS THEREFROM

DATE OF CANCELLATION OF PATENT: 2018 03 11

THE TERM OF RESTORATION OF PATENT VALIDITY HAS EXPIRED: 2019 03 11

TRANSFER OF RIGHTS

(21) AU 2015 13918

(11) U 2017 1934 Y

(54) MEDICINAL PREPARATION FOR ORAL INTAKE

NEW NAME AND ADDRESSES: LTD "Scientific-Technological Pharmaceutical Firm Polisan" (RU)
Ul. Salova, d. 72, korp. 2, Lit. A, 192102, Saint-Petersburg, Russian
Federation (RU)

NEW NAME AND ADDRESSES: EcoPharm Patent Management AG
Haldenstrasse 5, Baar, CH-6342 (CH)

DATE OF REGISTRY: 2019 03 29

(21) AU 2015 13995

(11) U 2018 1960 Y

(54) DRUG FOR PARENTERAL USAGE

NEW NAME AND ADDRESSES: LTD "Scientific-Technological Pharmaceutical Firm Polisan" (RU)
Ul. Salova, d. 72, korp. 2, Lit. A, 192102, Saint-Petersburg, Russian
Federation (RU)

NEW NAME AND ADDRESSES: EcoPharm Patent Management AG
Haldenstrasse 5, Baar, CH-6342 (CH)

DATE OF REGISTRY: 2019 03 29

DESIGNS

RENEWAL OF REGISTRATIONS

(11) D 2003 188 S

(73) Emzar ebralidze (GE)

Panaskertli Str., korp. 11, ap. 4, 0194, Tbilisi, Georgia (GE)

(54) **JAR FOR COFFEE OR OTHER FOOD PRODUCTS**

(18) 2018 09 03

(58) 2019 04 04

(11) D 2009 377 S

(73) Nariko Ohara (JP)

538-18, Ayameikeminami 7-chome, Nara-shi, Nara 631-0033, Japan (JP);

Kuniaki Takamatsu (JP)

34-22, Oaza, Shinchaya, Meiwa-cho, Taki-gun, Mie 515-0314, Japan (JP)

(54) **BRACELET**

(18) 2018 08 20

(58) 2019 04 03

(11) D 2014 573 S

(73) Simon Begheladze (GE)

Sop. Gamoghma Argveti, 4000, bSachkhere, Georgia (GE)

(54) **CONFECTIONERY**

(18) 2018 09 20

(58) 2019 04 04

TRADEMARKS**RENEWAL OF REGISTRATIONS**

(111) M 1999 11868 R2
(156) 20 04 1999
(186) 20 04 2029
(732) OATH INC.
22000 AOL Way, Dulles VA 20166, USA

(111) M 1999 11371 R2
(156) 26 01 1999
(186) 26 01 2029
(732) JOHNSON & JOHNSON
One Johnson & Johnson Plaza, New
Brunswick, New Jersey 08933, USA

(111) M 1999 11683 R2
(156) 15 03 1999
(186) 15 03 2029
(732) PUBLIC JOINT STOCK COMPANY "OIL
COMPANY "LUKOIL"
Sretensky boulevard 11, Moskow 101000,
Russian Federation

(111) M 1999 11684 R2
(156) 15 03 1999
(186) 15 03 2029
(732) PUBLIC JOINT STOCK COMPANY "OIL
COMPANY "LUKOIL"
Sretensky boulevard 11, Moskow 101000,
Russian Federation

(111) M 1999 11685 R2
(156) 15 03 1999
(186) 15 03 2029
(732) PUBLIC JOINT STOCK COMPANY "OIL
COMPANY "LUKOIL"
Sretensky boulevard 11, Moskow 101000,
Russian Federation

(111) M 1999 11401 R2
(156) 26 01 1999
(186) 26 01 2029
(732) YARA INTERNATIONAL ASA
0202 Oslo, Norway

(111) M 1999 11402 R2
(156) 26 01 1999
(186) 26 01 2029
(732) YARA INTERNATIONAL ASA
0202 Oslo, Norway

(111) M 1999 11403 R2
(156) 26 01 1999
(186) 26 01 2029
(732) YARA NEDERLAND B.V.
Industrieweg 10, 4541 HJ Sluiskil, Netherlands

(111) M 1999 11404 R2
(156) 26 01 1999
(186) 26 01 2029
(732) YARA NEDERLAND B.V.
Industrieweg 10, 4541 HJ Sluiskil, Netherlands

(111) M 1999 11405 R2
(156) 26 01 1999
(186) 26 01 2029
(732) YARA NEDERLAND B.V.
Industrieweg 10, 4541 HJ Sluiskil, Netherlands

(111) M 1999 11406 R2
(156) 26 01 1999
(186) 26 01 2029
(732) YARA NEDERLAND B.V.
Industrieweg 10, 4541 HJ Sluiskil, Netherlands

(111) M 1999 11408 R2
(156) 26 01 1999
(186) 26 01 2029
(732) YARA NEDERLAND B.V.
Industrieweg 10, 4541 HJ Sluiskil, Netherlands

(111) M 1999 11501 R2
(156) 11 02 1999
(186) 11 02 2029
(732) YARA INTERNATIONAL ASA
0202 Oslo, Norway

(111) M 1999 11502 R2
(156) 11 02 1999
(186) 11 02 2029
(732) YARA INTERNATIONAL ASA
0202 Oslo, Norway

(111) M 1999 11409 R2
(156) 26 01 1999
(186) 26 01 2029
(732) YARA INTERNATIONAL ASA
0202 Oslo, Norway

(111) M 1999 11410 R2
(156) 26 01 1999
(186) 26 01 2029
(732) YARA INTERNATIONAL ASA
0202 Oslo, Norway

(111) M 1999 11411 R2
(156) 26 01 1999
(186) 26 01 2029
(732) YARA INTERNATIONAL ASA
0202 Oslo, Norway

(111) M 1999 11412 R2
(156) 26 01 1999
(186) 26 01 2029
(732) YARA INTERNATIONAL ASA
0202 Oslo, Norway

(111) M 1999 11413 R2
(156) 26 01 1999
(186) 26 01 2029
(732) YARA NEDERLAND B.V.
Industrieweg 10, 4541 HJ Sluiskil, Netherlands

(111) M 1999 11414 R2
(156) 26 01 1999
(186) 26 01 2029
(732) YARA NEDERLAND B.V.
Industrieweg 10, 4541 HJ Sluiskil, Netherlands

(111) M 1999 11679 R2
(156) 15 03 1999
(186) 15 03 2029
(732) BRITISH AMERICAN TOBACCO
(BRANDS) LIMITED
Globe House, 4 Temple Place, London,
WC2R 2PG, United Kingdom

(111) M 1999 11851 R2
(156) 20 04 1999
(186) 20 04 2029
(732) BERLIN-CHEMIE AG
Glienicke Weg 125, D-12489, Berlin,
Germany

(111) M 1999 11853 R2
(156) 20 04 1999
(186) 20 04 2029
(732) BERLIN-CHEMIE AG
Glienicke Weg 125, D-12489, Berlin,
Germany

(111) M 1999 11884 R2
(156) 20 04 1999
(186) 20 04 2029
(732) SOCIETE DES PRODUITS NESTLE S.A.
Vevey, Switzerland

(111) M 1999 11919 R2
(156) 30 04 1999
(186) 30 04 2029
(732) CARLSBERG A/S
Ny Carlsbergvej 100, DK-1760 Copenhagen
V, Denmark

(111) M 1999 11920 R2
(156) 30 04 1999
(186) 30 04 2029
(732) ABBOTT PRODUCTS OPERATIONS AG
Hegenheimermattweg 127, 4123 Allschwil,
Switzerland

(111) M 1999 11923 R2
(156) 30 04 1999
(186) 30 04 2029
(732) BRITISH AMERICAN TOBACCO
(BRANDS) INC.
251 Little Falls Drive, Suite 100, Wilmington,
DE 19808-1674, USA

(111) M 1999 11925 R2
(156) 30 04 1999
(186) 30 04 2029
(732) SOCIÉTÉ DES PRODUITS NESTLÉ S.A.
CH-1800 Vevey, Switzerland

(111) M 1999 12394 R2
(156) 15 06 1999
(186) 15 06 2029
(732) SANOFI
54, rue La Boétie, 75008 Paris, France

(111) M 1999 12442 R2
(156) 02 07 1999
(186) 02 07 2029
(732) FLEUROP-INTERFLORA
Gemsenstrasse 3, 8006 Zurich, Switzerland

(111) M 1999 12762 R2
(156) 23 09 1999
(186) 23 09 2029
(732) UBS Group AG
Bahnhofstrasse 45, CH-8001 Zurich,
Switzerland

(111) M 1999 12490 R2
 (156) 12 07 1999
 (186) 12 07 2029
 (732) PEPSICO, INC., a North Carolina Corporation
 700 Anderson Hill Road, Purchase, New York
 10577, USA

(111) M 1999 13063 R2
 (156) 15 12 1999
 (186) 15 12 2029
 (732) ABBOTT PRODUCTS OPERATIONS AG
 Hegenheimerweg 127, 4123 Allschwil,
 Switzerland

(111) M 2009 19156 R1
 (156) 30 03 2009
 (186) 30 03 2029
 (732) BRITISH AMERICAN TOBACCO
 WESTERN EUROPE COMMERCIAL
 TRADING LIMITED
 Globe House, 1 Water Street, London, WC2R
 3LA, United Kingdom

(111) M 2009 19736 R1
 (156) 11 09 2009
 (186) 11 09 2029
 (732) BRITISH AMERICAN TOBACCO
 WESTERN EUROPE COMMERCIAL
 TRADING LIMITED
 Globe House, 1 Water Street, London, WC2R
 3LA, United Kingdom

(111) M 2009 19737 R1
 (156) 11 09 2009
 (186) 11 09 2029
 (732) BRITISH AMERICAN TOBACCO
 WESTERN EUROPE COMMERCIAL
 TRADING LIMITED
 Globe House, 1 Water Street, London, WC2R
 3LA, United Kingdom

(111) M 1999 12341 R2
 (156) 15 06 1999
 (186) 15 06 2029
 (732) SABIC Global Technologies B.V.
 Plasticslaan 1, 4612 PX Bergen op Zoom,
 Netherlands

(111) M 2008 18485 R1
 (156) 27 05 2008
 (186) 27 05 2028

(732) PJSC "VIMPEL-COMMUNICATION"
 8th March 10th Street, Building 14, Moscow
 127083, Russian Federation

(111) M 2008 18486 R1
 (156) 27 05 2008
 (186) 27 05 2028
 (732) PJSC "VIMPEL-COMMUNICATION"
 8th March 10th Street, Building 14, Moscow
 127083, Russian Federation

(111) M 2009 19198 R1
 (156) 21 04 2009
 (186) 21 04 2029
 (732) JSC Commercial Bank "TBC BANK"
 Rustavelis q. 121, Borjomi, 1200, Georgia

(111) M 2009 19199 R1
 (156) 21 04 2009
 (186) 21 04 2029
 (732) JSC Commercial Bank "TBC BANK"
 Rustavelis q. 121, Borjomi, 1200, Georgia

(111) M 2009 19200 R1
 (156) 21 04 2009
 (186) 21 04 2029
 (732) JSC Commercial Bank "TBC BANK"
 Rustavelis q. 121, Borjomi, 1200, Georgia

(111) M 2009 19201 R1
 (156) 21 04 2009
 (186) 21 04 2029
 (732) JSC Commercial Bank "TBC BANK"
 Rustavelis q. 121, Borjomi, 1200, Georgia

(111) M 2009 19099 R1
 (156) 02 03 2009
 (186) 02 03 2029
 (732) BERLIN-CHEMIE AG
 Glienicker Weg 125, 12489 Berlin,
 Germany

(111) M 2009 19157 R1
 (156) 30 03 2009
 (186) 30 03 2029
 (732) BERLIN-CHEMIE AG
 Glienicker Weg 125, 12489 Berlin,
 Germany

(111) M 2009 19117 R1
 (156) 16 03 2009
 (186) 16 03 2029

(732) BERLIN-CHEMIE AG
Glienicke Weg 125, 12489 Berlin, Germany

(111) M 2009 19167 R1
(156) 30 03 2009
(186) 30 03 2029
(732) BERLIN-CHEMIE AG
Glienicke Weg 125, 12489 Berlin, Germany

(111) M 2009 19310 R1
(156) 15 05 2009
(186) 15 05 2029
(732) BAYER CONSUMER CARE AG
Peter Merian-Str. 84, 4052 Basel, Switzerland

(111) M 2009 19311 R1
(156) 15 05 2009
(186) 15 05 2029
(732) BAYER CONSUMER CARE AG
Peter Merian-Str. 84, 4052 Basel, Switzerland

(111) M 2009 19312 R1
(156) 15 05 2009
(186) 15 05 2029
(732) BAYER CONSUMER CARE AG
Peter Merian-Str. 84, 4052 Basel, Switzerland

(111) M 2009 19243 R1
(156) 21 04 2009
(186) 21 04 2029
(732) JSC. "LOMISI"
Sanapiros q. 1, Daba Akhlagori, 0600,
Georgia

(111) M 2009 19314 R1
(156) 15 05 2009
(186) 15 05 2029
(732) BAYER CONSUMER CARE AG
Peter Merian-Str. 84, 4052 Basel,
Switzerland

(111) M 2009 19315 R1
(156) 15 05 2009
(186) 15 05 2029
(732) BAYER CONSUMER CARE AG
Peter Merian-Str. 84, 4052 Basel,
Switzerland

(111) M 2009 19316 R1
(156) 15 05 2009
(186) 15 05 2029

(732) BAYER CONSUMER CARE AG
Peter Merian-Str. 84, 4052 Basel,
Switzerland

(111) M 2009 19317 R1
(156) 15 05 2009
(186) 15 05 2029
(732) BAYER CONSUMER CARE AG
Peter Merian-Str. 84, 4052 Basel,
Switzerland

(111) M 2009 19228 R1
(156) 21 04 2009
(186) 21 04 2029
(732) SUNOCO OVERSEAS, INC.
a Delaware Corporation
3801 West Chester Pike, NW-131,
Newtown Square, Pennsylvania 19073, USA

(111) M 2009 19178 R1
(156) 30 03 2009
(186) 30 03 2029
(732) HYUNDAI MOTOR COMPANY
(a Korean limited liability company
Incorporated under the laws of Republic of
Korea)
231, Yangjae-Dong, Seocho-Gu, Seoul,
137-938, Republic of Korea

(111) M 2009 19233 R1
(156) 21 04 2009
(186) 21 04 2029
(732) GRUPPO LEPETIT S.r.l.
Viale Luigi Bodio 37/b, 20158 Milano, Italy

(111) M 2009 19611 R1
(156) 31 07 2009
(186) 31 07 2029
(732) PEPSICO, INC., a North Carolina corporation
700 Anderson Hill Road, Purchase,
NY 10577, USA

(111) M 2009 19612 R1
(156) 31 07 2009
(186) 31 07 2029
(732) PEPSICO, INC.
a North Carolina corporation
700 Anderson Hill Road, Purchase,
NY 10577, USA

(111) M 2009 19189 R1
(156) 30 03 2009
(186) 30 03 2029

(732) LTD "GLOBALPHARMI"
Almasianis q. 13a/ Berbutis q. 8, Tbilisi, 0171,
Georgia

(111) M 2009 19194 R1
(156) 14 04 2009
(186) 14 04 2029

(732) JSC "LOMISI"
Sop. Natakhtari, Mtskhmetis raioni, 3308,
Georgia

(111) M 2009 19285 R1
(156) 29 04 2009
(186) 29 04 2029

(732) QUIZER FARMA GMBH & CO. KG
Schleswiger Straße 74, 24941 Flensburg,
Germany

(111) M 2009 19393 R1
(156) 10 06 2009
(186) 10 06 2029

(732) LTD I. Zhordania named Clinic
Lublianas q.5, Tbilisi, 0159, Georgia

(111) M 2009 19392 R1
(156) 10 06 2009
(186) 10 06 2029

(732) LTD I. Zhordania named Clinic
Lublianas q.5, Tbilisi, 0159, Georgia

(111) M 2009 19287 R1
(156) 29 04 2009
(186) 29 04 2029

(732) HYUNDAI MOTOR COMPANY
(a Korean limited liability company
incorporated under the laws of Republic
of Korea)
231, Yangjae-Dong, Seocho-Gu, Seoul,
137-938, Republic of Korea

(111) M 2009 19288 R1
(156) 29 04 2009
(186) 29 04 2029

(732) HYUNDAI MOTOR COMPANY
(a Korean limited liability company
incorporated under the laws of Republic
of Korea)
231, Yangjae-Dong, Seocho-Gu, Seoul,
137-938, Republic of Korea

(111) M 2009 19289 R1
(156) 29 04 2009
(186) 29 04 2029

(732) HYUNDAI MOTOR COMPANY
(a Korean limited liability company
incorporated under the laws of Republic
of Korea)
231, Yangjae-Dong, Seocho-Gu, Seoul,
137-938, Republic of Korea

(111) M 2009 19429 R1
(156) 16 06 2009
(186) 16 06 2029

(732) NOVARTIS AG
Basel 4002, Switzerland

(111) M 2009 19477 R1
(156) 29 06 2009
(186) 29 06 2029

(732) LTD "DRUG HOUSE"
Tashkentis q. 22, 0160, Tbilisi, Georgia

(111) M 2009 19435 R1
(156) 16 06 2009
(186) 16 06 2029

(732) NOVARTIS AG
4002 Basel, Switzerland

(111) M 2009 19547 R1
(156) 13 07 2009
(186) 13 07 2029

(732) PEPSICO, INC. a North Carolina
A North Carolina Corporation
700 Anderson Hill Road, Purchase, New York
10577, USA

(111) M 2009 19548 R1
(156) 13 07 2009
(186) 13 07 2029

(732) PEPSICO, INC. a North Carolina
A North Carolina Corporation
700 Anderson Hill Road, Purchase, New York
10577, USA

(111) M 2009 19798 R1
(156) 11 09 2009
(186) 11 09 2029

(732) BRITISH AMERICAN TOBACCO
WESTERN EUROPE COMMERCIAL
TRADING LIMITED
Globe House, 1 Water Street, London, WC2R
3LA, United Kingdom

(111) M 2009 19982 R1
(156) 18 11 2009
(186) 18 11 2029
(732) PEPSICO, INC. a North Carolina
A North Carolina Corporation
700 Anderson Hill Road, Purchase, New York
10577, USA

(111) M 2009 19983 R1
(156) 18 11 2009
(186) 18 11 2029
(732) PEPSICO, INC. a North Carolina
A North Carolina Corporation
700 Anderson Hill Road, Purchase, New York
10577, USA

(111) M 2009 19986 R1
(156) 18 11 2009
(186) 18 11 2029
(732) PEPSICO, INC. a North Carolina
A North Carolina Corporation
700 Anderson Hill Road, Purchase, New York
10577, USA

(111) M 1999 12184 R2
(156) 13 05 1999
(186) 13 05 2029
(732) B.S.A.
33, Avenue du Maine Tour Maine
Montparnasse 75015 Paris, France

(111) M 1999 12185 R2
(156) 13 05 1999
(186) 13 05 2029
(732) B.S.A.
33, Avenue du Maine Tour Maine
Montparnasse 75015 Paris, France

(111) M 1999 12105 R2
(156) 10 05 1999
(186) 10 05 2029
(732) BAYER S.A.S.
16, rue Jean-Marie Leclair, 69009 Lyon,
France

(111) M 1999 12141 R2
(156) 12 05 1999
(186) 12 05 2029
(732) RS COMPONENTS LIMITED
P.O. BOX 99, Corby, Northamptonshire
NN17 9RS, United Kingdom

(111) M 1999 11523 R2
(156) 16 02 1999
(186) 16 02 2029
(732) IVECO S.p.A.
Via Puglia 35, Turin, P/C 10156, Italy

(111) M 1999 12007 R2
(156) 10 05 1999
(186) 10 05 2029
(732) COMPAGNIE GENERALE DES
STABLISSEMENTS MICHELIN
23, Place des Carmes-dechaux, 63000
Klermont-Ferrand, France

(111) M 1999 12008 R2
(156) 10 05 1999
(186) 10 05 2029
(732) COMPAGNIE GENERALE DES
ESTABLISSEMENTS MICHELIN
23, Place des Carmes-dechaux, 63000
Klermont-Ferrand, France

(111) M 1999 12317 R2
(156) 27 05 1999
(186) 27 05 2029
(732) SPIESS-URANIA CHEMICALS GMBH
Frankenstrasse 18b, 20097 Hamburg,
Germany

(111) M 1999 12186 R2
(156) 13 05 1999
(186) 13 05 2029
(732) FIAT GROUP MARKETING &
CORPORATE COMMUNICATION S.P.A.
Via Nizza 250, 10126 Torino, Italy

(111) M 1999 12187 R2
(156) 13 05 1999
(186) 13 05 2029
(732) FIAT GROUP MARKETING &
CORPORATE COMMUNICATION S.P.A.
Via Nizza 250, 10126 Torino, Italy

(111) M 1999 11957 R2
(156) 06 05 1999
(186) 06 05 2029
(732) AFTON CHEMICAL LIMITED
London Road, Bracknell, Berkshire RG
12 2UW, United Kingdom

(111) M 1999 12116 R2
(156) 10 05 1999
(186) 10 05 2029

(732) GULF INTERNATIONAL LUBRICANTS,
LTD
Canon's Court, 22 Victoria Street, Hamilton
HM 12, Bermuda

Areál Tatry 1450/1, 742 21 Kopřivnice,
Czech Republic

(111) M 1999 12117 R2
(156) 10 05 1999
(186) 10 05 2029
(732) GULF INTERNATIONAL LUBRICANTS,
LTD
Canon's Court, 22 Victoria Street, Hamilton
HM 12, Bermuda

(111) M 1999 12015 R2
(156) 10 05 1999
(186) 10 05 2029
(732) SONY CORPORATION
1-7-1 Konan, Minato-ku, Tokyo, Japan

(111) M 1999 11985 R2
(156) 10 05 1999
(186) 10 05 2029
(732) VIBRAM S.P.A.
5, Via C. Colombo, I-21041 Albizzate,
Varese, Italy

(111) M 1999 12023 R2
(156) 10 05 1999
(186) 10 05 2029
(732) VIBRAM S.P.A.
5, Via C. Colombo, I-21041 Albizzate,
Varese, Italy

(111) M 1999 12153 R2
(156) 12 05 1999
(186) 12 05 2029
(732) AIR LIQUIDE GLOBAL E&S SOLUTIONS
GERMANY GMBH
Olof-Palme-Straße 35, 60439 Frankfurt
am Main, Germany

(111) M 1999 11816 R2
(156) 19 04 1999
(186) 19 04 2029
(732) SANOFI
54, rue La Boétie, 75008 Paris, France

(111) M 1998 8611 R2
(156) 10 03 1998
(186) 10 03 2028
(732) TATRA TRUCKS A.S.

COMPLETE TRANSFER OF RIGHTS

(111) M 2011 21862 R
(732) THE ABSOLUT COMPANY AKTIEBOLAG
SE-117 97 Stockholm, Sweden
(770) Kahlua AG
c/o Testatoris AG, Topferstrasse 5, CH-6004
Lucerne, Switzerland
(580) 12 03 2019

(111) M 1998 10493 R
(732) THE ABSOLUT COMPANY
AKTIEBOLAG
SE-117 97 Stockholm, Sweden
(770) KAHLUA AG
c/o Testatoris AG, Topferstrasse 5, CH-6004
Lucerne, Switzerland
(580) 12 03 2019

(111) M 2014 24932 R
(732) THE ABSOLUT COMPANY
AKTIEBOLAG
SE-117 97 Stockholm, Sweden
(770) KAHLUA AG
c/o Testatoris AG, Topferstrasse 5, 6004
LUCERNE, Switzerland
(580) 12 03 2019

(111) M 1999 11523 R
(732) NUOVE INIZIATIVE FINANZIARE 5
S.P.A.
Via Puglia 35, Turin, P/C 10156, Italy
(770) IVECO S.p.A.
Via Puglia 35, Turin, Italy
(580) 07 02 2019

(111) M 2015 26535 R
(732) ZEBRA TECHNOLOGIES CORPORATION
3 Overlook Point, Lincolnshire, Illinois
60069, USA
(770) ZIH CORP.
Suite 500, 475 Half Day Road, Lincolnshire,
Illinois 60069, USA
(580) 25 03 2019

(111) M 2016 27075 R
(732) ZEBRA TECHNOLOGIES
CORPORATION
3 Overlook Point, Lincolnshire, Illinois 60069,
USA
(770) ZIH CORP.
Suite 500, 475 Half Day Road, Lincolnshire,
Illinois 60069, USA
(580) 25 03 2019

(111) M 1998 8611 R
(732) TATRA TRUCKS A.S.
Areál Tatry 1450/1, 742 21 Koprivnice,
Czech Republic
(770) TATRA A.S.
Koprivnice, Czech Republic
(580) 04 03 2019

CHANGES OF NAMES AND/OR ADDRESS OF OWNERS

(111) M 1998 9237 R
(732) SEGA GAMES CO., LTD.
Sumitomo Fudosan Osaki Garden Tower,
1-1-1 Nishi-Shinagawa, Shinagawa-ku,
Tokyo, Japan
(770) SEGA GAMES CO., LTD.
2-12, Haneda 1-chome, Ohta-ku, Tokyo
144, Japan
(580) 14 03 2019

(111) M 1998 9238 R
(732) SEGA GAMES CO., LTD.
Sumitomo Fudosan Osaki Garden Tower,
1-1-1 Nishi-Shinagawa, Shinagawa-ku,
Tokyo, Japan
(770) SEGA GAMES CO., LTD.
2-12, Haneda 1-chome, Ohta-ku, Tokyo
144, Japan
(580) 14 03 2019

(111) M 1998 9240 R
(732) SEGA GAMES CO., LTD.
Sumitomo Fudosan Osaki Garden Tower,
1-1-1 Nishi-Shinagawa, Shinagawa-ku,
Tokyo, Japan
(770) SEGA GAMES CO., LTD.
2-12, Haneda 1-chome, Ohta-ku, Tokyo
144, Japan
(580) 14 03 2019

(111) M 1998 9242 R
(732) SEGA GAMES CO., LTD.
Sumitomo Fudosan Osaki Garden Tower,
1-1-1 Nishi-Shinagawa, Shinagawa-ku,
Tokyo, Japan
(770) SEGA GAMES CO., LTD.
2-12, Haneda 1-chome, Ohta-ku, Tokyo
144, Japan
(580) 14 03 2019

(111) M 1998 9244 R
(732) SEGA GAMES CO., LTD.
Sumitomo Fudosan Osaki Garden Tower,
1-1-1 Nishi-Shinagawa, Shinagawa-ku,
Tokyo, Japan
(770) SEGA GAMES CO., LTD.
2-12, Haneda 1-chome, Ohta-ku, Tokyo
144, Japan
(580) 14 03 2019

(111) M 1999 11389 R
(732) ALEXANDER DUCKHAM & CO., LIMITED
69/70 Batley Business Park, Technology
Drive, Batley West Yorkshire, WF17 6ER,
United Kingdom
(770) ALEXANDER DUCKHAM & CO.,
LIMITED
Chertsey Road, Sunbury on Thames,
Middlesex, TW16 7BP, United Kingdom
(580) 13 03 2019

(111) M 1999 11683 R
(732) PUBLIC JOINT STOCK COMPANY "OIL
COMPANY "LUKOIL"
Sretensky boulevard 11, Moskow 101000,
Russian Federation
(770) OPEN JOINT STOCK COMPANY "OIL
COMPANY "LUKOIL"
Sretensky boulevard 11, Moskow 101000,
Russian Federation
(580) 05 03 2019

(111) M 1999 11684 R
(732) PUBLIC JOINT STOCK COMPANY "OIL
COMPANY "LUKOIL"
Sretensky boulevard 11, Moskow 101000,
Russian Federation
(770) OPEN JOINT STOCK COMPANY "OIL
COMPANY "LUKOIL"
Sretensky boulevard 11, Moskow 101000,
Russian Federation
(580) 05 03 2019

(111) M 1999 11685 R
(732) PUBLIC JOINT STOCK COMPANY "OIL
COMPANY "LUKOIL"
Sretensky boulevard 11, Moskow 101000,
Russian Federation
(770) OPEN JOINT STOCK COMPANY "OIL
COMPANY "LUKOIL"
Sretensky boulevard 11, Moskow 101000,
Russian Federation
(580) 05 03 2019

(111) M 1999 12574 R
(732) SEGA GAMES CO., LTD.
Sumitomo Fudosan Osaki Garden Tower,
1-1-1 Nishi-Shinagawa, Shinagawa-ku,
Tokyo, Japan
(770) SEGA GAMES CO., LTD.

2-12, Haneda 1-chome, Ohta-ku, Tokyo
144, Japan
(580) 14 03 2019

(111) M 2000 13189 R
(732) SEGA GAMES CO., LTD.
Sumitomo Fudosan Osaki Garden Tower,
1-1-1 Nishi-Shinagawa, Shinagawa-ku,
Tokyo, Japan
(770) SEGA GAMES CO., LTD.
2-12, Haneda 1-chome, Ohta-ku, Tokyo
144, Japan
(580) 14 03 2019

(111) M 2000 13190 R
(732) SEGA GAMES CO., LTD.
Sumitomo Fudosan Osaki Garden Tower,
1-1-1 Nishi-Shinagawa, Shinagawa-ku,
Tokyo, Japan
(770) SEGA GAMES CO., LTD.
2-12, Haneda 1-chome, Ohta-ku, Tokyo
144, Japan
(580) 14 03 2019

(111) M 1998 8273 R
(732) BRITISH AMERICAN TOBACCO
(BRANDS) INC.
251 Little Falls Drive, Suite 100, Wilmington,
DE 19808-1674, USA
(770) BRITISH AMERICAN TOBACCO
(BRANDS) INC.
2711 Centerville Road, Suite 300,
Wilmington, Delaware 19808, USA
(580) 13 08 2018

(111) M 1995 816 R
(732) PIZZA HUT INTERNATIONAL, LLC
7100 Corporate Drive, Plano, Texas 75024,
USA
(770) PIZZA HUT INTERNATIONAL, LLC
7100 Corporate Drive, Plano, Texas 75024,
USA
(580) 13 03 2018

(111) M 2008 18485 R
(732) PJSC "VIMPEL-COMMUNICATION"
8th March 10th Street, Building 14, Moscow
127083, Russian Federation,
(770)) PJSC "VIMPEL-COMMUNICATION"
8th March 10th Street, Building 14, Moscow
127083, Russian Federation
(580) 13 03 2019

(111) M 2008 18486 R
(732) PJSC "VIMPEL-COMMUNICATION"
8th March 10th Street, Building 14, Moscow
127083, Russian Federation,
(770)) PJSC "VIMPEL-COMMUNICATION"
8th March 10th Street, Building 14, Moscow
127083, Russian Federation
(580) 13 03 2019

(111) M 1999 11523 R
(732) IVECO S.p.A.
Via Puglia 35, Turin, P/C 10156, Italy
(770) NUOVE INIZIATIVE FINANZIARE 5
S.P.A.
Via Puglia 35, Turin, P/C 10156, Italy
(580) 07 02 2019

(111) M 1999 12007 R
(732) COMPAGNE GENERALE DES
ESTABLISSEMENTS MICHELIN
23, Place des Carmes-dechaux, 63000
Klermont-Ferrand, France
(770) COMPAGNE GENERALE DES
ESTABLISSEMENTS MICHELIN
12, cours Sablon, 63000, Clermont-Ferrand,
France
(580) 13 03 2019

(111) M 1999 12008 R
(732) COMPAGNE GENERALE DES
ESTABLISSEMENTS MICHELIN
23, Place des Carmes-dechaux, 63000
Klermont-Ferrand, France
(770) COMPAGNE GENERALE DES
ESTABLISSEMENTS MICHELIN
12, cours Sablon, 63000, Clermont-Ferrand,
France
(580) 13 03 2019

(111) M 1999 12076 R
(732) ASPEN GLOBAL INCORPORATED
GBS Plaza, Cnr. La Salette & Royal Roads,
Grand Bay, Mauritius
(770) ASPEN GLOBAL INCORPORATED
c/o Kross Border Trust Services Ltd,
St. Louis Business Centre, Cnr Desroches
& St. Louis Streets, Port Louis, Mauritius
(580) 25 03 2019

(111) M 1999 12082 R
(732) ASPEN GLOBAL INCORPORATED
GBS Plaza, Cnr. La Salette & Royal Roads,
Grand Bay, Mauritius

(770) ASPEN GLOBAL INCORPORATED
 c/o Kross Border Trust Services Ltd,
 St. Louis Business Centre, Cnr Desroches
 & St. Louis Streets, Port Louis, Mauritius
 (580) 25 03 2019

(111) M 1999 12083 R
 (732) ASPEN GLOBAL INCORPORATED
 GBS Plaza, Cnr. La Salette & Royal Roads,
 Grand Bay, Mauritius
 (770) ASPEN GLOBAL INCORPORATED
 c/o Kross Border Trust Services Ltd,
 St. Louis Business Centre, Cnr Desroches
 & St. Louis Streets, Port Louis, Mauritius
 (580) 25 03 2019

(111) M 1999 11949 R
 (732) ASPEN GLOBAL INCORPORATED
 GBS Plaza, Cnr. La Salette & Royal Roads,
 Grand Bay, Mauritius
 (770) ASPEN GLOBAL INCORPORATED
 c/o Kross Border Trust Services Ltd,
 St. Louis Business Centre, Cnr Desroches
 & St. Louis Streets, Port Louis, Mauritius
 (580) 25 03 2019

(111) M 1999 11951 R
 (732) ASPEN GLOBAL INCORPORATED
 GBS Plaza, Cnr. La Salette & Royal Roads,
 Grand Bay, Mauritius
 (770) ASPEN GLOBAL INCORPORATED
 c/o Kross Border Trust Services Ltd,
 St. Louis Business Centre, Cnr Desroches
 & St. Louis Streets, Port Louis, Mauritius
 (580) 25 03 2019

(111) M 1999 12089 R
 (732) ASPEN GLOBAL INCORPORATED
 GBS Plaza, Cnr. La Salette & Royal Roads,
 Grand Bay, Mauritius
 (770) ASPEN GLOBAL INCORPORATED
 c/o Kross Border Trust Services Ltd,
 St. Louis Business Centre, Cnr Desroches
 & St. Louis Streets, Port Louis, Mauritius
 (580) 25 03 2019

(111) M 1999 12090 R
 (732) ASPEN GLOBAL INCORPORATED
 GBS Plaza, Cnr. La Salette & Royal Roads,
 Grand Bay, Mauritius
 (770) ASPEN GLOBAL INCORPORATED
 c/o Kross Border Trust Services Ltd,

St. Louis Business Centre, Cnr Desroches
 & St. Louis Streets, Port Louis, Mauritius
 (580) 25 03 2019

(111) M 1999 12091 R
 (732) ASPEN GLOBAL INCORPORATED
 GBS Plaza, Cnr. La Salette & Royal Roads,
 Grand Bay, Mauritius
 (770) ASPEN GLOBAL INCORPORATED
 c/o Kross Border Trust Services Ltd,
 St. Louis Business Centre, Cnr Desroches
 & St. Louis Streets, Port Louis, Mauritius
 (580) 25 03 2019

(111) M 1999 12153 R
 (732) AIR LIQUIDE GLOBAL E&S SOLUTIONS
 GERMANY GMBH
 Olof-Palme-Straße 35, 60439 Frankfurt am
 Main, Germany
 (770) LURGI GMBH
 Lurgiallee 5, D-60295 Frankfurt am Main,
 Germany
 (580) 25 03 2019

(111) M 1997 7427 R
 (732) APPLE INC.
 One Apple Park Way, Cupertino, California
 95014, USA
 (770) APPLE INC.
 One Apple Park Way, Cupertino, California
 95014, USA
 (580) 25 10 2018

(111) M 2014 25249 R
 (732) MARUSSIA BEVERAGES B.V.
 Siriusdreef 41, 2132 Vt Hoofddorp,
 Netherlands
 (770) MARUSSIA BEVERAGES B.V.
 Siriusdreef 22, 2132 WT Hoofddorp,
 Netherlands
 (580) 14 01 2019

(111) M 2016 27655 R
 (732) APPLE INC.
 One Apple Park Way, Cupertino, California
 95014, USA
 (770) APPLE INC.
 1 Infinite Loop, Cupertino, California 95014,
 USA
 (580) 25 10 2018

(111) M 2016 27310 R
(732) APPLE INC.
One Apple Park Way, Cupertino, California
95014, USA
(770) APPLE INC.
1, Infinite Loop, Cupertino, California 95014,
USA
(580) 25 10 2018

(111) M 2016 26876 R
(732) MARUSSIA BEVERAGES B.V.
Siriusdreef 41, 2132 Vt Hoofddorp,
Netherlands
(770) MARUSSIA BEVERAGES B.V.
Siriusdreef 22, 2132 WT Hoofddorp,
Netherlands
(580) 14 01 2019

(111) M 2016 27452 R
(732) MARUSSIA BEVERAGES B.V.
Siriusdreef 41, 2132 Vt Hoofddorp,
Netherlands
(770) MARUSSIA BEVERAGES B.V.
Siriusdreef 22, 2132 WT Hoofddorp,
Netherlands
(580) 14 01 2019

(111) M 2016 27453 R
(732) MARUSSIA BEVERAGES B.V.
Siriusdreef 41, 2132 Vt Hoofddorp,
Netherlands
(770) MARUSSIA BEVERAGES B.V.
Siriusdreef 22, 2132 WT Hoofddorp,
Netherlands
(580) 14 01 2019

(111) M 2016 27704 R
(732) LTD "MEAMA"
Givi Amilakhvaris q. 2, Samgoris raioni,
Tbilisi, Georgia
(770) LTD "CAPSULO"
Delisis q. 9/7, 0177, Tbilisi, Georgia
(580) 29 03 2019

(111) M 2017 28547 R
(732) MARUSSIA BEVERAGES B.V.
Siriusdreef 41, 2132 Vt Hoofddorp,
Netherlands
(770) MARUSSIA BEVERAGES B.V.
Sirisdreef 22, 2132 Vt Hoofddorf, Netherlands
(580) 14 01 2019

(111) M 2017 29206 R
(732) LTD "MEAMA"
Givi Amilakhvaris q. 2, Samgoris Raioni,
Tbilisi, Georgia
(770) LTD "CAPSULO"
Delisis q. 9/7, Tbilisi, 0177, Georgia
(580) 29 03 2019

(111) M 2018 29565 R
(732) LTD "MEAMA"
Givi Amilakhvaris q.2, Samgoris Raioni,
Tbilisi, Georgia
(770) LLC "CAPSULO"
Delisis q. 9/7, Tbilisi, 0177, Georgia
(580) 29 03 2019

TERMINATION OF TRADEMARKS REGISTRATION

(111) M 1998 10389 R
(151) 20 08 1998
(732) GlaxoSmithKline Consumer Healthcare (UK)
IP Limited
980 Great West Road, Brentford, Middlesex
TW8 9GS, United Kingdom

(111) M 1998 10393 R
(151) 20 08 1998
(732) TATA MOTORS LIMITED
Bombay House, 24 Homi Mody
Street, HUTATMA-CHOWK, BOMBAY-
400001, India

(111) M 1998 10787 R
(151) 15 09 1998
(732) ONYX S.R.L.
Via degli Alberini, 29, Roma, Italy

(111) M 1998 10789 R
(151) 15 09 1998
(732) American-Cigarette Company (Overseas)
Limited
Zählerweg 4, CH-6300 Zug, Switzerland

(111) M 1998 10795 R
(151) 15 09 1998
(732) GlaxoSmithKline Consumer Healthcare (UK)
IP Limited
980 Great West Road, Brentford, Middlesex
TW8 9GS, United Kingdom

(111) M 1998 10455 R
(151) 20 08 1998
(732) MARS, INCORPORATED
6885, Elm Street, McLean, Virginia, USA

(111) M 1998 10464 R
(151) 20 08 1998
(732) MARS, INCORPORATED
6885, Elm Street, McLean, Virginia, USA

(111) M 1998 10717 R
(151) 10 09 1998
(732) UNILEVER N.V.
Weena 455, NL-3013 AL Rotterdam,
Netherlands

(111) M 1998 10816 R
(151) 15 09 1998
(732) THE PROCTER & GAMBLE
COMPANY
One Procter & Gamble Plaza, Cincinnati,
Ohio, USA

(111) M 1998 10820 R
(151) 15 09 1998
(732) OMEGA PHARMA INNOVATION &
DEVELOPMENT NV
Venecoweg 26, 9810 Nazareth, Belgium

(111) M 1998 10737 R
(151) 11 09 1998
(732) Philip Morris Brands SARL
Quai Jeanrenaud 3, 2000 Neuchâtel,
Switzerland

(111) M 1998 10739 R
(151) 11 09 1998
(732) OSRAM GESELLSCHAFT MIT
BESCHRANKTER HAFTUNG
Marcel-Breuer-Straße 6, 80809 MUNCHEN,
Germany

(111) M 1998 10740 R
(151) 11 09 1998
(732) OSRAM GESELLSCHAFT MIT
BESCHRANKTER HAFTUNG
Marcel-Breuer-Straße 6, 80809 MUNCHEN,
Germany

(111) M 1998 10741 R
(151) 11 09 1998
(732) UNILEVER N.V.
Weena 455, NL-3013 AL Rotterdam,
Netherlands

(111) M 1998 10701 R
(151) 10 09 1998
(732) Omnicom International Holdings Inc.
720 California Street, San Francisco,
California 94108, USA

(111) M 1998 10747 R
(151) 11 09 1998
(732) PMPI LLC

Hunton & Williams, 951 East Byrd Street,
Richmond, VA 23219, USA

(111) M 1998 10748 R

(151) 11 09 1998

(732) UNILEVER N.V.

Weena 455, NL-3013 AL Rotterdam,
Netherlands

(111) M 2008 18669 R

(151) 29 08 2008

(732) International Business Company "Nutritek
International, Corp."

P.O. Box 3321, Road Town, Tortola, Virgin
Islands (British)

(111) M 2008 18675 R

(151) 29 08 2008

(732) LLC "RANOLDS"

Ul. Dzeguzhu 1/2, LV-1007 Riga, Latvia

(111) M 2008 18704 R

(151) 17 09 2008

(732) ROTAPHARM LIMITED

48 Queen Anne Street, London W1G9JJ,
United Kingdom

(111) M 2008 18709 R

(151) 17 09 2008

(732) ROTAPHARM LIMITED

48 Queen Anne Street, London W1G9JJ,
United Kingdom

(111) M 2008 18711 R

(151) 17 09 2008

(732) ROTAPHARM LIMITED

48 Queen Anne Street, London W1G9JJ,
United Kingdom

(111) M 1998 10303 R

(151) 19 08 1998

(732) YVES SAINT LAURENT PARFUMS

284 Boulevard du Parc, 92521 Neuilly
Cedex, France

(111) M 1998 10756 R

(151) 15 09 1998

(732) TRIUMPH INTERNATIONAL AG

80335 Munchen, DE , 80335, Germany

(111) M 1998 10755 R

(151) 15 09 1998

(732) SMITHS HEIMANN GmbH

Carl-Von-Linde-Str. 14, Wiesbaden, Germany

(111) M 1998 10363 R

(151) 19 08 1998

(732) OMV AKTIENGESELLSCHAFT

5, Otto Wagner Platz, A-1090 Wien, Austria

(111) M 1998 10143 R

(151) 05 08 1998

(732) GTBAT International Co. Limited

29 th Floor Oxford House, Taikoo Place,
979 King's Road, Island East, Hong Kong

(111) M 1998 10776 R

(151) 15 09 1998

(732) PFIZER INC.

235, East 42nd Street, New York 10017, USA

(111) M 1998 10784 R

(151) 15 09 1998

(732) MARS, INCORPORATED

6885, Elm Street, McLean, Virginia, USA

(111) M 1998 10295 R

(151) 19 08 1998

(732) MERCK SHARP & DOHME CORP.

One Merck Drive, Whitehouse Station,
New Jersey 08889, USA

(111) M 1998 10369 R

(151) 19 08 1998

(732) BAYER CONSUMER CARE AG

Peter Merian-Str. 84, 4052 Basel, Switzerland

(111) M 1998 10786 R

(151) 15 09 1998

(732) KRKA, tovarna zdravil, d.d., Novo mesto

(abbreviated name: KRKA, d.d., Novo mesto),
Smarjeska cesta 6, 8501 Novo mesto, Slovenia

CLASSIFICATION INDEXES

INVENTIONS

CONCORDANCE TABLE OF INTERNATIONAL CLASSIFICATION INDEX AND PUBLICATION NUMBERS

INTERNATIONAL CLASSIFICATION INDEXES (51)	NUMBER OF PUBLISHED APPLICATION (10)
A 43 B 7/12; A 43 B 23/02; A 43 B 23/07; A 43 B 7/08	AP 2019 14375 A
A 47 K 10/38	AP 2019 14169 A
A 61 K 31/47; C 01 D 17/00; C 07 C 51/41; C 07 F 1/00	AP 2019 14626 A
A 61 K 31/265; A 61 K 9/16	AP 2019 14562 A
A 61 K 31/295; A 61 K 31/7004	AP 2019 14478 A
B 61 L 23/16	AP 2019 14538 A
B 62 D 23/00; B 62 D 27/02; B 62 D 29/00	AP 2019 14362 A
B 67 D 7/04; G 06 Q 50/28; G 06 Q 10/08	AP 2019 14558 A
C 07 D 215/22; C 07 C 305/24; C 07 C 233/60; A 61 K 31/47; A 61 P 35/00	AP 2019 13960 A
C 07 D 401/14; C 07 D 405/14; C 07 D 403/14; C 07 D 487/08; C 07 D 519/00; A 61 K 31/506; A 61 P 35/00; A 61 P 37/00	AP 2019 14430 A
C 07 D 403/14; C 07 D 473/16	AP 2019 14379 A
C 07 D 487/04; A 61 K 31/4985; A 61 P 31/14; A 61 P 31/16	AP 2019 14114 A
C 07 D 487/04; C 07 H 19/06; C 07 H 19/14; A 61 K 31/7064; A 61 K 31/7076; A 61 P 1/16;	AP 2019 14307 A
E 01 H 5/06	AP 2019 14384 A
F 03 B 3/12; F 03 B 3/02	AP 2019 14386 A
F 04 B 25/00	AP 2019 13247 A

CONCORDANCE TABLE OF PUBLICATION NUMBERS AND INTERNATIONAL CLASSIFICATION INDEX

NUMBER OF PUBLISHED APPLICATION (10)	INTERNATIONAL CLASSIFICATION INDEXES (51)
AP 2019 13247 A	F 04 B 25/00
AP 2019 13960 A	C 07 D 215/22; C 07 C 305/24; C 07 C 233/60; A 61 K 31/47; A 61 P 35/00
AP 2019 14114 A	C 07 D 487/04; A 61 K 31/4985; A 61 P 31/14; A 61 P 31/16
AP 2019 14169 A	A 47 K 10/38
AP 2019 14307 A	C 07 D 487/04; C 07 H 19/06; C 07 H 19/14; A 61 K 31/7064; A 61 K 31/7076; A 61 P 1/16;
AP 2019 14362 A	B 62 D 23/00; B 62 D 27/02; B 62 D 29/00
AP 2019 14375 A	A 43 B 7/12; A 43 B 23/02; A 43 B 23/07; A 43 B 7/08
AP 2019 14379 A	C 07 D 403/14; C 07 D 473/16
AP 2019 14384 A	E 01 H 5/06
AP 2019 14386 A	F 03 B 3/12; F 03 B 3/02
AP 2019 14430 A	C 07 D 401/14; C 07 D 405/14; C 07 D 403/14; C 07 D 487/08; C 07 D 519/00; A 61 K 31/506; A 61 P 35/00; A 61 P 37/00
AP 2019 14478 A	A 61 K 31/295; A 61 K 31/7004
AP 2019 14538 A	B 61 L 23/16
AP 2019 14558 A	B 67 D 7/04; G 06 Q 50/28; G 06 Q 10/08
AP 2019 14562 A	A 61 K 31/265; A 61 K 9/16
AP 2019 14626 A	A 61 K 31/47; C 01 D 17/00; C 07 C 51/41; C 07 F 1/00

**CONCORDANCE TABLE OF INTERNATIONAL CLASSIFICATION INDEX,
PATENT NUMBERS AND PUBLICATION NUMBERS**

INTERNATIONAL CLASSIFICATION INDEX (51)	NUMBER OF PATENT (11)	NUMBER OF PUBLISHED APPLICATION (10)
A 01 N 43/40; C 07 D 401/06; C 07 D 213/46; A 01 P 7/00; A 01 N 51/00; A 01 N 43/42; A 01 N 43/56; A 01 N 43/80; A 01 N 47/02; A 01 N 43/76; A 01 N 43/22; A 01 N 47/40; A 01 N 43/707; A 01 N 43/82; A 01 N 37/50	P 2019 6964 B	AP 2018 13585 A
A 47 K 10/38; A 47 K 10/32	P 2019 6966 B	AP 2018 14167 A
A 61 K 31/416; A 61 K 31/4174; A 61 K 45/06; A 61 P 31/10	P 2019 6962 B	AP 2018 14557 A
A 61 K 39/395; C 07 K 16/22	P 2019 6963 B	AP 2018 11194 A
C 02 F 1/00, 1/32, 1/34, 1/36, 1/48, 1/78	P 2019 6967 B	AP 2018 14472 A
C 22 B 47/00, 1/02, 1/08, 3/04	P 2019 6965 B	AP 2018 13978 A
E 02 B 5/02; E 02 B 3/16	P 2019 6968 B	AP 2018 14433 A

**CONCORDANCE TABLE OF PATENT NUMBERS,
PUBLICATION NUMBERS AND INTERNATIONAL CLASSIFICATION INDEX**

NUMBER OF PATENT (11)	NUMBER OF PUBLISHED APPLICATION (10)	INTERNATIONAL CLASSIFICATION INDEX (51)
P 2019 6962 B	AP 2018 14557 A	A 61 K 31/416; A 61 K 31/4174; A 61 K 45/06; A 61 P 31/10
P 2019 6963 B	AP 2018 11194 A	A 61 K 39/395; C 07 K 16/22
P 2019 6964 B	AP 2018 13585 A	A 01 N 43/40; C 07 D 401/06; C 07 D 213/46; A 01 P 7/00; A 01 N 51/00; A 01 N 43/42; A 01 N 43/56; A 01 N 43/80; A 01 N 47/02; A 01 N 43/76; A 01 N 43/22; A 01 N 47/40; A 01 N 43/707; A 01 N 43/82; A 01 N 37/50
P 2019 6965 B	AP 2018 13978 A	C 22 B 47/00, 1/02, 1/08, 3/04
P 2019 6966 B	AP 2018 14167 A	A 47 K 10/38; A 47 K 10/32
P 2019 6967 B	AP 2018 14472 A	C 02 F 1/00, 1/32, 1/34, 1/36, 1/48, 1/78
P 2019 6968 B	AP 2018 14433 A	E 02 B 5/02; E 02 B 3/16

**CONCORDANCE TABLE OF APPLICATION NUMBERS, PUBLICATION NUMBERS
AND PATENTS**

NUMBER OF APPLICATION (21)	NUMBER OF PUBLISHED APPLICATION (10)	NUMBER OF PATENT (11)
AP 2004 11194	AP 2018 11194 A	P 2019 6963 B
AP 2013 13585	AP 2018 13585 A	P 2019 6964 B
AP 2015 13978	AP 2018 13978 A	P 2019 6965 B
AP 2014 14167	AP 2018 14167 A	P 2019 6966 B
AP 2015 14433	AP 2018 14433 A	P 2019 6968 B
AP 2017 14472	AP 2018 14472 A	P 2019 6967 B
AP 2016 14557	AP 2018 14557 A	P 2019 6962 B

UTILITY MODELS

CONCORDANCE TABLE OF INTERNATIONAL CLASSIFICATION INDEX AND PUBLICATION NUMBERS

INTERNATIONAL CLASSIFICATION INDEXES (51)	NUMBER OF PUBLISHED APPLICATION (10)
B 65 D 5/40	AU 2019 14723 U
E 04 B 5/43	AU 2019 14779 U

CONCORDANCE TABLE OF PUBLICATION NUMBERS AND INTERNATIONAL CLASSIFICATION INDEX

NUMBER OF PUBLISHED APPLICATION (10)	INTERNATIONAL CLASSIFICATION INDEXES (51)
AU 2019 14723 U	B 65 D 5/40
AU 2019 14779 U	E 04 B 5/43

CONCORDANCE TABLE OF INTERNATIONAL CLASSIFICATION INDEX, PATENT NUMBERS AND PUBLICATION NUMBERS

INTERNATIONAL CLASSIFICATION INDEX (51)	NUMBER OF PATENT (11)	NUMBER OF PUBLISHED APPLICATION (10)
C 04 B 35/45; H 01 L 39/00	U 2019 2005 Y	AU 2018 14630 U
E 02 B 9/04; E 03 B 3/00	U 2019 2006 Y	AU 2018 14299 U

CONCORDANCE TABLE OF PATENT NUMBERS, PUBLICATION NUMBERS AND INTERNATIONAL CLASSIFICATION INDEX

NUMBER OF PATENT (11)	NUMBER OF PUBLISHED APPLICATION (10)	INTERNATIONAL CLASSIFICATION INDEX (51)
U 2019 2005 Y	AU 2018 14630 U	C 04 B 35/45; H 01 L 39/00
U 2019 2006 Y	AU 2018 14299 U	E 02 B 9/04; E 03 B 3/00

CONCORDANCE TABLE OF APPLICATION NUMBERS, PUBLICATION NUMBERS AND PATENTS

NUMBER OF APPLICATION (21)	NUMBER OF PUBLISHED APPLICATION (10)	NUMBER OF PATENT (11)
AU 2016 14299 U	AU 2018 14299 U	U 2019 2006 Y
AU 2017 14630 U	AU 2018 14630 U	U 2019 2005 Y

DESIGNS**CONCORDANCE TABLE OF INTERNATIONAL CLASSIFICATION INDEX
AND PUBLICATION NUMBERS**

INTERNATIONAL CLASSIFICATION INDEXES (51)	NUMBER OF PUBLISHED APPLICATION (10)
11-02	AD 2019 1066 S

**CONCORDANCE TABLE OF PUBLICATION NUMBERS
AND INTERNATIONAL CLASSIFICATION INDEX**

NUMBER OF PUBLISHED APPLICATION (10)	INTERNATIONAL CLASSIFICATION INDEXES (51)
AD 2019 1066 S	11-02

**CONCORDANCE TABLE OF INTERNATIONAL CLASSIFICATION INDEX,
REGISTRATION NUMBERS AND PUBLICATION NUMBERS**

INTERNATIONAL CLASSIFICATION INDEX (51)	NUMBER OF REGISTRATION (11)	NUMBER OF PUBLISHED APPLICATION (10)
09-01	D 2019 802	AD 2018 1050 S

**CONCORDANCE TABLE OF REGISTRATION NUMBERS,
PUBLICATION NUMBERS AND INTERNATIONAL CLASSIFICATION INDEX**

NUMBER OF REGISTRATION (11)	NUMBER OF PUBLISHED APPLICATION (10)	INTERNATIONAL CLASSIFICATION INDEX (51)
D 2019 802	AD 2018 1050 S	09-01

**CONCORDANCE TABLE OF APPLICATION NUMBERS, PUBLICATION NUMBERS
AND REGISTRATION NUMBERS**

NUMBER OF APPLICATION (21)	NUMBER OF PUBLISHED APPLICATION (10)	NUMBER OF REGISTRATION (11)
AD 2018 1050	AD 2018 1050 S	D 2019 802

TRADEMARKS

CONCORDANCE TABLE OF REGISTRATION NUMBERS, APPLICATION NUMBERS, PUBLICATION NUMBERS AND BULLETIN NUMBERS

NUMBER OF REGISTRATION (111)	NUMBER OF APPLICATIONS (210)	NUMBER OF PUBLISHED APPLICATIONS (260)	NUMBER OF BULLETIN
M 2019 30973 R	AM 102076	-	7(515)2019
M 2019 30974 R	AM 102067	-	7(515)2019
M 2019 30975 R	AM 102165	-	7(515)2019
M 2019 30976 R	AM 101301	-	7(515)2019
M 2019 30977 R	AM 102175	-	7(515)2019
M 2019 30978 R	AM 101655	-	7(515)2019
M 2019 30979 R	AM 102027	-	7(515)2019
M 2019 30980 R	AM 102042	-	7(515)2019
M 2019 30981 R	AM 102146	-	7(515)2019
M 2019 30982 R	AM 102147	-	7(515)2019
M 2019 30983 R	AM 102148	-	7(515)2019
M 2019 30984 R	AM 97189	AM 2018 97189 A	20(504)2018
M 2019 30985 R	AM 102031	-	7(515)2019
M 2019 30986 R	AM 102070	-	7(515)2019
M 2019 30987 R	AM 102144	-	7(515)2019
M 2019 30988 R	AM 102142	-	7(515)2019
M 2019 30989 R	AM 102248	-	7(515)2019
M 2019 30990 R	AM 101613	-	7(515)2019
M 2019 30991 R	AM 102160	-	7(515)2019
M 2019 30992 R	AM 102162	-	7(515)2019
M 2019 30993 R	AM 102156	-	7(515)2019
M 2019 30994 R	AM 102260	-	7(515)2019
M 2019 30995 R	AM 102382	-	7(515)2019
M 2019 30996 R	AM 91645	AM 2018 91645 A	24(508)2018
M 2019 30997 R	AM 92380	AM 2018 92380 A	21(505)2018
M 2019 30998 R	AM 94832	AM 2018 94832 A	14(498)2018
M 2019 30999 R	AM 94833	AM 2018 94833 A	13(497)2018
M 2019 31000 R	AM 95203	AM 2018 95203 A	20(504)2018
M 2019 31001 R	AM 95946	AM 2018 95946 A	16(500)2018
M 2019 31002 R	AM 95998	AM 2018 95998 A	16(500)2018
M 2019 31003 R	AM 96524	AM 2018 96524 A	19(503)2018
M 2019 31004 R	AM 96525	AM 2018 96525 A	19(503)2018
M 2019 31005 R	AM 96859	AM 2018 96859 A	22(506)2018
M 2019 31006 R	AM 96861	AM 2018 96861 A	20(504)2018
M 2019 31007 R	AM 96919	AM 2018 96919 A	21(505)2018
M 2019 31008 R	AM 96973	AM 2018 96973 A	23(507)2018
M 2019 31009 R	AM 96993	AM 2018 96993 A	22(506)2018
M 2019 31010 R	AM 97009	AM 2018 97009 A	20(504)2018
M 2019 31011 R	AM 97063	AM 2018 97063 A	21(505)2018
M 2019 31012 R	AM 97070	AM 2018 97070 A	21(505)2018
M 2019 31013 R	AM 97074	AM 2018 97074 A	21(505)2018
M 2019 31014 R	AM 97181	AM 2018 97181 A	23(507)2018
M 2019 31015 R	AM 97182	AM 2018 97182 A	23(507)2018
M 2019 31016 R	AM 97207	AM 2018 97207 A	23(507)2018
M 2019 31017 R	AM 97210	AM 2018 97210 A	23(507)2018
M 2019 31018 R	AM 97229	AM 2018 97229 A	23(507)2018
M 2019 31019 R	AM 97230	AM 2018 97230 A	23(507)2018

1	2	3	4
M 2019 31020 R	AM 97233	AM 2018 97233 A	21(505)2018
M 2019 31021 R	AM 97418	AM 2018 97418 A	22(506)2018
M 2019 31022 R	AM 97438	AM 2018 97438 A	23(507)2018
M 2019 31023 R	AM 97442	AM 2018 97442 A	24(508)2018
M 2019 31024 R	AM 97453	AM 2018 97453 A	24(508)2018
M 2019 31025 R	AM 97459	AM 2018 97459 A	23(507)2018
M 2019 31026 R	AM 97707	AM 2018 97707 A	24(508)2018
M 2019 31027 R	AM 97709	AM 2018 97709 A	24(508)2018
M 2019 31028 R	AM 97900	AM 2018 97900 A	23(507)2018
M 2019 31029 R	AM 97901	AM 2018 97901 A	23(507)2018
M 2019 31030 R	AM 102243	-	7(515)2019
M 2019 31031 R	AM 102384	-	7(515)2019
M 2019 31032 R	AM 102385	-	7(515)2019
M 2019 31033 R	AM 97025	AM 2018 97025 A	23(507)2018

**CONCORDANCE TABLE OF PUBLICATION NUMBERS
AND APPLICATION NUMBERS**

NUMBER OF PUBLISHED APPLICATION (260)	NUMBER OF APPLICATION (210)	1	2
		1	2
AM 2019 94562 A*	AM 94562	AM 2019 98973 A	AM 98973
AM 2019 96572 A	AM 96572	AM 2019 99054 A	AM 99054
AM 2019 97167 A*	AM 97167	AM 2019 99060 A	AM 99060
AM 2019 97168 A*	AM 97168	AM 2019 99065 A	AM 99065
AM 2019 97169 A*	AM 97169	AM 2019 99067 A	AM 99067
AM 2019 97171 A*	AM 97171	AM 2019 99164 A	AM 99164
AM 2019 98206 A	AM 98206	AM 2019 99166 A	AM 99166
AM 2019 98554 A	AM 98554	AM 2019 99182 A	AM 99182
AM 2019 98573 A	AM 98573	AM 2019 99188 A	AM 99188
AM 2019 98586 A	AM 98586	AM 2019 99196 A	AM 99196
AM 2019 98663 A	AM 98663	AM 2019 99304 A	AM 99304
AM 2019 98667 A	AM 98667	AM 2019 99312 A	AM 99312
AM 2019 98672 A	AM 98672	AM 2019 99314 A	AM 99314
AM 2019 98693 A	AM 98693	AM 2019 99315 A	AM 99315
AM 2019 98758 A	AM 98758	AM 2019 99330 A	AM 99330
AM 2019 98765 A	AM 98765	AM 2019 99331 A	AM 99331
AM 2019 98773 A	AM 98773	AM 2019 99457 A	AM 99457
AM 2019 98785 A	AM 98785	AM 2019 99458 A	AM 99458
AM 2019 98798 A	AM 98798	AM 2019 99471 A	AM 99471
AM 2019 98799 A	AM 98799	AM 2019 99472 A	AM 99472
AM 2019 98802 A	AM 98802	AM 2019 99473 A	AM 99473
AM 2019 98803 A	AM 98803	AM 2019 99474 A	AM 99474
AM 2019 98898 A	AM 98898	AM 2019 99475 A	AM 99475
AM 2019 98909 A	AM 98909	AM 2019 99476 A	AM 99476
AM 2019 98910 A	AM 98910	AM 2019 99479 A	AM 99479
AM 2019 98964 A	AM 98964	AM 2019 99480 A	AM 99480
		AM 2019 99481 A	AM 99481
		AM 2019 99482 A	AM 99482
		AM 2019 99483 A	AM 99483
		AM 2019 99645 A	AM 99645

CONCORDANCE TABLE OF INDEX OF GOODS AND/OR SERVICES
AND APPLICATION NUMBERS

INDEX OF GOODS AND/OR SERVICES (511)	NUMBER OF PUBLISHED APPLICATIONS (26)	1	2
1	2		
1	AM 2019 99060 A	32	AM 2019 98803 A
5	AM 2019 98758 A	32	AM 2019 99188 A
5	AM 2019 98765 A	32	AM 2019 99312 A
5	AM 2019 98785 A	33	AM 2019 97167 A*
5	AM 2019 99060 A	33	AM 2019 97168 A*
7	AM 2019 99182 A	33	AM 2019 97169 A*
9	AM 2019 98206 A	33	AM 2019 98802 A
9	AM 2019 98693 A	33	AM 2019 98803 A
9	AM 2019 98973 A	33	AM 2019 98898 A
9	AM 2019 99304 A	33	AM 2019 98909 A
10	AM 2019 98667 A	33	AM 2019 98910 A
10	AM 2019 98758 A	33	AM 2019 99188 A
10	AM 2019 98765 A	33	AM 2019 99312 A
12	AM 2019 98667 A	33	AM 2019 99314 A
12	AM 2019 99457 A	34	AM 2019 99196 A
12	AM 2019 99458 A	35	AM 2019 96572 A
14	AM 2019 99054 A	35	AM 2019 98206 A
16	AM 2019 98206 A	35	AM 2019 98663 A
16	AM 2019 98586 A	35	AM 2019 98667 A
16	AM 2019 99304 A	35	AM 2019 99067 A
18	AM 2019 99054 A	35	AM 2019 99166 A
20	AM 2019 98667 A	35	AM 2019 99304 A
25	AM 2019 99054 A	35	AM 2019 99314 A
25	AM 2019 99315 A	35	AM 2019 99315 A
29	AM 2019 94562 A*	36	AM 2019 98206 A
29	AM 2019 97167 A*	36	AM 2019 99483 A
29	AM 2019 97168 A*	38	AM 2019 98206 A
29	AM 2019 97169 A*	38	AM 2019 98973 A
29	AM 2019 98773 A	38	AM 2019 99304 A
29	AM 2019 99067 A	39	AM 2019 98206 A
29	AM 2019 99330 A	41	AM 2019 98206 A
29	AM 2019 99331 A	41	AM 2019 99166 A
29	AM 2019 99645 A	41	AM 2019 99304 A
30	AM 2019 94562 A*	41	AM 2019 99479 A
30	AM 2019 96572 A	41	AM 2019 99480 A
30	AM 2019 99471 A	41	AM 2019 99481 A
30	AM 2019 99472 A	41	AM 2019 99482 A
30	AM 2019 99473 A	42	AM 2019 98206 A
30	AM 2019 99474 A	42	AM 2019 98672 A
30	AM 2019 99475 A	42	AM 2019 98964 A
30	AM 2019 99476 A	42	AM 2019 98973 A
30	AM 2019 99645 A	42	AM 2019 99164 A
31	AM 2019 98773 A	43	AM 2019 96572 A
32	AM 2019 98554 A	43	AM 2019 97167 A*
32	AM 2019 98573 A	43	AM 2019 97168 A*
32	AM 2019 98663 A	43	AM 2019 97169 A*
32	AM 2019 98802 A	43	AM 2019 97171 A*
		43	AM 2019 98798 A
		43	AM 2019 98799 A
		43	AM 2019 99065 A
		43	AM 2019 99166 A
		44	AM 2019 99166 A

**CONCORDANCE TABLE OF INDEX OF GOODS AND/OR SERVICES
AND NUMBERS OF TRADEMARKS REGISTERED ACCORDING
TO THE ACCELERATED PROCEDURE**

INDEX OF GOODS AND/OR SERVICES (511)	NUMBERS OF REGISTERED ACCORDING TO THE ACCELERATED PROCEDURE (111)
6	M 2019 31031 R
32	M 2019 30978 R
32	M 2019 30979 R
32	M 2019 30980 R
32	M 2019 30985 R
32	M 2019 30986 R
32	M 2019 30987 R
32	M 2019 30988 R
32	M 2019 30989 R
32	M 2019 30990 R
32	M 2019 30991 R
32	M 2019 30992 R
32	M 2019 30993 R
32	M 2019 31030 R
33	M 2019 30976 R
33	M 2019 30977 R
33	M 2019 30981 R
33	M 2019 30982 R
33	M 2019 30983 R
33	M 2019 30990 R
33	M 2019 30994 R
34	M 2019 30973 R
34	M 2019 30974 R
34	M 2019 30975 R
35	M 2019 30980 R
35	M 2019 30989 R
35	M 2019 30990 R
35	M 2019 30995 R
35	M 2019 31031 R
35	M 2019 31032 R
37	M 2019 30995 R
37	M 2019 31031 R
42	M 2019 30995 R
42	M 2019 31031 R
43	M 2019 30990 R
43	M 2019 31032 R

OFFICIAL BULLETIN OF THE INDUSTRIAL PROPERTY

INVENTIONS
UTILITY MODELS
DESIGNS
TRADEMARKS

7(515)

EDITOR-IN-CHIEF: N. Bebrishvili

EDITOR-TRANSLATOR: E. Gabunia

PROOFREADER: A. Shikhashvili

COMPUTER LAYOUT: M. Ordenidze
K. Svanidze

www.sakpatenti.gov.ge

E-mail: info@sakpatenti.org.ge