

# Official Bulletin of the Industrial Property

Inventions

Utility Models

Designs

Trademarks



საქართველოს ინტელექტუალური  
საკუთრების ეროვნული ცენტრი

**საქპატენტი**

**SAKPATENTI**

NATIONAL INTELLECTUAL PROPERTY  
CENTER OF GEORGIA

[www.sakpatenti.gov.ge](http://www.sakpatenti.gov.ge)

Date of Publication – 2023 04 10

7(610)

# INID CODES FOR IDENTIFICATION OF BIBLIOGRAPHIC DATA

## INVENTIONS, UTILITY MODELS

- (10) Number of publication for application, which has been examined
- (11) Number of patent and kind of document
- (21) Serial number of application
- (22) Date of filing of the application
- (23) Date of exhibition or the date of the earlier filing and the number of application, if any
- (24) Date from which patent may have effect
- (31) Number of priority application
- (32) Date of filing of priority application
- (33) Code of the country or regional organization allotting priority application number
- (44) Date of publication of application not granted, but examined and number of bulletin
- (45) Date of publication of registered document
- (51) International Patent Classification Index

- (54) Title of the invention
- (57) Abstract
- (60) Number of examined patent document granted by foreign patent office, date from which patent has effect and country code
- (62) Number of the earlier application and in case of divided application, date of filing an application
- (71) Name, surname and address of applicant (country code)
- (72) Name, surname of inventor (country code)
- (73) Name, surname and address of patent owner (country code)
- (74) Name, surname of representative or patent attorney
- (85) Date of commencement of the national phase of International Application
- (86) Number and date of filing of international application
- (87) Number and date of publication of international application
- (94) Calculated date of expiry of the SPC or the duration of the SPC

## DESIGNS

- (10) Number of publication for application
- (11) Number of patent and kind of document or number of registration
- (15) Date of registration/Date of patent renewal
- (18) Expected expiration date of patent or registration
- (21) Serial number of application
- (22) Date of filing of the application
- (23) Date of exhibition or the date of the earlier filing and the number of application, if any
- (24) Date from which patent may have effect
- (28) Number of designs included in the application
- (30) Data relating to priority (number of application, date of filing of application, two-letter code identifying the authority with whom the priority application was made)
- (31) Number of priority application
- (32) Date of filing of priority application
- (33) Code of the country or regional organization allotting priority application number
- (34) Two-letter code according to WIPO St.3 identifying the authority with which the priority application was made
- (44) Date of publication of design and number of bulletin (the first publication)
- (45) Date of publication of design registered by WIPO and number of bulletin

- (51) International Classification for designs (class and subclass of the Locarno Classification)
- (54) Title of the invention
- (55) Reproduction of the design
- (57) Description of characteristic features of the design including indication of colors
- (58) Date of recording of any kind of amendment in the Register
- (62) Number of the earlier application, registration and document number and if available the date of filing an application in case of divided application
- (71) Name, surname and address of applicant (country code)
- (72) Name, surname of creator (country code)
- (73) Name, surname and address of patent owner (country code)
- (74) Name, surname of representative or patent attorney
- (81) Contracting states concerned
  - II designated contracting states according to the 1960 Act
  - III designated contracting states according to the 1999 Act
- (85) Owner's permanent address
- (86) Owner's nationality
- (87) Owner's residence
- (88) State in which the owner has a real and effective industrial or commercial establishment

## TRADEMARKS

- (111) - Number of registration
- (151) - Date of registration
- (156) - Date of the renewal
- (181) - Expected expiration date of registration
- (186) - Renewal expiration date of registration
- (141) - Date of cancel of duration of the mark
- (210) - Serial number of application
- (220) - Date of filing of the application
- (230) - Data concerning exhibition
- (260) - Number of application, for which favorable decision of examination about registration has been taken (publication number)
- (310) - Number of the first application
- (320) - Date of filing of the first application
- (330) - Code, identifying national or regional Office where the first application was made
- (511) - International Classification of Goods and Services for the purposes of registration of trade marks and/or list of goods and/or services classified according thereto
- (526) - Disclaimer
- (531) - Description of figurative elements of Trade Marks according to the International Classification of the Figurative Elements of Marks

- (540) - Reproduction of Trade Mark
- (550) - Nature and kind of Trade Mark
- (551) - Indication to the effect that the mark is a collective mark, a certification mark or a guarantee mark
- (554) - Three-dimensional mark
- (580) - Date of recording of any kind changes in respect of applications or registrations
- (591) - Information concerning colors claimed
- (731) - Name and address of the applicant
- (732) - Name and address of the holder of the registration
- (740) - Name and address of the representative
- (750) - Addreses for correspondence
- (770) - Name and address of the previous applicant or holder in case of change in ownership
- (771) - Previous name and address of the applicant or holder in case of change in ownership
- (791) - Name and address of the licensee
- (793) - Indication of conditions and/or restrictions under the license (Type of license, number of license agreement, data of license, data of validity of license)
- (800) - Certain data relating to the international registration of Trade Marks under the Protocol Relating to Madrid Agreement (International registration number
- (852) - Partial cancellation of the list of goods and services
- (891) - Date of subsequent designation

## CODES FOR PUBLICATION IN BULLETIN

- (21) AP 0000 000000 - serial number of application for invention
- (10) AP 0000 0000 A - number of published application for invention (first publication)
- (11) P 0000 0000 B - number of patent for invention (second publication)
- (21) API 0000 000000 - number of application for imported patent
- (11) PI 0000 0000 A - number of imported patent (first publication)
- (21) AU 0000 000000 - serial number of application for utility model
- (10) AU 0000 000 U - number of published application for utility model (first publication)
- (11) U 0000 000 Y - number of patent for utility model (second publication)
- (21) AD 0000 000000 - serial number of application for design
- (10) AD 0000 000 S - number of published application for design (first publication)
- (11) D 0000 000 S - registered design

## INTERNATIONAL PATENT CLASSIFICATION FOR INVENTIONS AND UTILITY MODELS

- SECTION A - HUMAN NECESSITIES
- SECTION B - PERFORMING OPERATIONS; TRANSPORTING
- SECTION C - CHEMISTRY; METALLURGY
- SECTION D - TEXTILES; PAPER
- SECTION E - FIXED CONSTRUCTIONS
- SECTION F - MECHANICAL ENGINEERING; LIGHTING; HEATING; WEAPONS; BLASTING
- SECTION G - PHYSICS
- SECTION H - ELECTRICITY

- 
- M - Trade Mark
  - (210) AM 0000 000000 - Serial number of application;
  - (260) AAM 0000 00000 A - Publication number of application;
  - (111) M 0000 00000 R - Number of registration;
  - (111) MMM0000 00000 Rn - Number of renewals, in which n=1,2,3;
  - (111) M 0000 00000 R(P) - Number of registration under partial assignment of rights
-

# Official Bulletin of the Industrial Property

Inventions

Utility Models

Designs

Trademarks

# CONTENT

<b>PUBLISHED TITLES OF PROTECTION</b> .....	3
<b>INVENTIONS</b>	
▪ APPLICATIONS APPROVED FOR GRANTING PATENT .....	4
▪ PATENTED INVENTION .....	6
<b>UTILITY MODELS</b>	
▪ APPLICATION APPROVED FOR GRANTING PATENTS .....	9
▪ PATENTED UTILITY MODEL .....	10
<b>DESIGNS</b>	
▪ APPLICATION APPROVED FOR REGISTRATION .....	11
▪ DESIGN REGISTERED ACCORDING TO THE ACCELERATED PROCEDURE .....	17
▪ DESIGNS, WICH HAVE BEEN REGISTERED WITH THE INTERNATIONAL BUREAU CLAIMING PRIORITY ON THE TERRITORY OF GEORGIA .....	19
<b>TRADEMARKS</b>	
▪ APPLICATIONS FILED UNDER THE NATIONAL PROCEDURE APPROVED FOR REGISTRATION .....	24
▪ REGISTERED TRADEMARKS .....	34
▪ TRADEMARKS REGISTERED ACCORDING TO THE ACCELERATED PROCEDURE .....	36
▪ INTERNATIONAL TRADEMARKS FOR WHICH A DECISION ON GRANTING PROTECTION IS TAKEN .....	41
▪ INTERNATIONAL TRADEMARKS PROTECTED IN GEORGIA .....	102
<b>OFFICIAL NOTIFICATIONS</b>	
<b>INVENTIONS</b>	
▪ RESTORATION OF PATENTS .....	116
▪ ABOLITION OF PATENTS WITH THE RIGHT TO RESTORE .....	116
▪ DATE OF PATENTS RESTORATION EXPIRATION .....	118
<b>UTILITY MODELS</b>	
▪ RESTORATION OF PATENT .....	119
▪ ABOLITION OF PATENT WITH THE RIGHT TO RESTORE .....	119
▪ DATE OF PATENT RESTORATION EXPIRATION .....	119
<b>DESIGNS</b>	
▪ EXTENSION OF TERMS OF DESIGN REGISTRATION .....	120
▪ CANCELLATION OF DESIGN REGISTRATION .....	120
▪ EXTENSION OF TERMS OF INTERNATIONAL DESIGNS REGISTRATION .....	120
▪ CANCELLATION OF INTERNATIONAL DESIGNS REGISTRATION .....	128
<b>TRADEMARKS</b>	
▪ EXTENSION OF TERMS OF TRADEMARKS REGISTRATION .....	129
▪ COMPLETE TRANSFER OF RIGHTS .....	133
▪ CHANGES OF NAMES AND/OR ADDRESSES OF TRADEMARKS OWNERS .....	135
▪ CANCELLATION OF TRADEMARKS REGISTRATION .....	138
▪ REGISTRATION OF LICENSE AGREEMENTS .....	141
▪ INTERNATIONAL LICENSE AGREEMENTS .....	143
<b>CLASSIFICATION INDEXES</b>	
INVENTIONS .....	144
UTILITY MODELS .....	146
DESIGNS .....	147
TRADEMARKS .....	148

## **PUBLISHED TITLES OF PROTECTION**

### **INVENTIONS**

- **APPLICATIONS APPROVED FOR GRANTING PATENT:**  
15661; 15303; 15542
- **PATENTED INVENTIONS:**  
7489-7498

### **UTILITY MODELS**

- **APPLICATIONS APPROVED FOR GRANTING PATENT:**  
16056; 16007
- **PATENTED UTILITY MODEL:**  
2148

### **DESIGNS**

- **APPLICATION APPROVED FOR REGISTRATION:**  
1284
- **DESIGN REGISTERED ACCORDING TO THE ACCELERATED PROCEDURE:**  
968
- **DESIGNS, WHICH HAVE BEEN REGISTERED WITH THE INTERNATIONAL BUREAU CLAIMING PRIORITY ON THE TERRITORY OF GEORGIA:**  
226215; 222474; 222532; 226420

### **TRADEMARKS**

- **APPLICATIONS FILED UNDER THE NATIONAL PROCEDURE APPROVED FOR REGISTRATION:**  
103095\*; 117558; 118077; 118410; 118561; 118651, 118652; 118761; 118763, 118764; 118832; 118941; 118993; 118996-118999; 119003; 119008, 119009; 119026; 119074; 119077; 119103; 119105; 119179, 119180; 119185-119188; 119190; 119192, 119193; 119196; 119212; 119267; 119269-119271; 119273, 119274; 119276; 119278; 119280; 119283; 119287; 119343; 119345; 119347, 119348; 119351, 119352; 119364; 119368; 119372; 119374; 119483; 119489; 119492, 119493; 119581; 119596; 119675
- **REGISTERED TRADEMARKS:**  
36640, 36641; 36646-36648; 36651-36663
- **TRADEMARKS REGISTERED ACCORDING TO THE ACCELERATED PROCEDURE:**  
36642-36645; 36649, 36650; 36664-36681
- **INTERNATIONAL TRADEMARKS FOR WHICH A DECISION ON GRANTING PROTECTIONS IS TAKEN:**  
116797; 117636; 117962; 118042; 118257; 118272; 118445-118453; 118455-118458; 118460; 118463, 118464; 118567; 118572, 118573; 118575-118583; 118585-118587; 118593, 118594; 118622-118628; 118666-118668; 118675-118678; 118699-118701; 118703-118705; 118711; 118714; 118717; 118768; 118770, 118771; 118774-118780; 118782-118786; 118804; 118818-118821; 118823; 118825, 118826; 118865; 118881, 118882; 118894-118900; 118909-118915; 118943; 119035; 119037-119042; 119060
- **INTERNATIONAL TRADEMARKS PROTECTED IN GEORGIA:**  
116344; 116460; 116576; 116690-116693; 116695-116697; 116699-116703; 116705, 116706; 116708; 116713; 116724; 116772-116776; 116783; 116789; 116796; 116799; 116804; 116812; 116826; 116870; 116873, 116874; 116876; 116879-116886; 116891-116894; 116898-116902; 116910-116912; 116923-116932; 116934-116942; 117003-117012; 117014-117031; 117052; 117061; 117110; 117112, 117113; 117117; 117148-117154; 117156, 117157; 117161; 117206-117210; 117213-117224; 117227; 117229, 117230; 117240; 117322-117326; 117338; 117345; 117347-117349; 117351; 117367; 117376; 117378, 117379; 117381-117383; 117385, 117386; 117473-117475; 117493; 117498; 117594, 117595; 117633-117635; 117637; 117671-117673; 117697-117701; 117793; 117796; 117874-117876; 117878-117883; 117969, 117970; 117974, 117975

---

# INVENTIONS

## APPLICATIONS APPROVED FOR GRANTING PATENT

The decision can be appealed at the Chamber of Appeal of Sakpatenti within 3 months from the publication or at the Mtskheta District Court Administrative Cases Board (Address: №17, Samkhedro St., Mtskheta), within 1 month following the publication.

### PART A

#### A 21

- (10) AP 2023 15661 A (51) Int. Cl. (2006)  
A 21 D 13/11  
A 21 D 13/13  
A 21 D 13/41
- (21) AP 2019 15661 (22) 2019 11 27  
(31) 62/773,843  
(32) 2018 11 30  
(33) US  
(71) IAE LLC (US)  
2 Alhambra Plaza, Penthouse 1B, Coral Gables,  
FL 33134, USA (US)
- (72) FISCHMANN, Fernando, Benjamin (US)
- (74) Shalva Gvaramadze
- (85) 2021 06 14  
(86) PCT/IB2019/001274, 2019 11 27
- (54) PIZZA PRODUCT, PACKAGING FOR PIZZA  
PRODUCT, AND METHOD OF COOKING  
AND DISTRIBUTION FOR PIZZA PRODUCT
- (57) A method for pizza product preparation provides  
formation therefrom two separate componentry:  
previously baked crispy component A, and porous  
dough B. Said componentry are heated in various  
humidity conditions, and then are joint together.  
Porous dough is heated together with humid product  
and additional ingredients to receive pie-like product.  
Furthermore, there are represented pizza packing  
container consisting of lower part, wherein crispy  
component A is heated, upper part, wherein the  
porous dough is heated together with humid product  
and additional ingredients, and middle part – a  
divider, separating lower and upper parts from each  
other.
- Claims 2 independents  
13 dependent
- Fig.: 8
- 

### A 61

- (10) AP 2023 15302 A (51) Int. Cl. (2006)  
A 61 K 39/00  
A 61 K 47/18  
A 61 K 47/26  
A 61 K 9/00  
C 07 K 16/24
- (21) AP 2018 15302 (22) 2018 08 29  
(31) 10-2017 0110426; 10-2017 0144521;  
10-2018-0017449  
(32) 2017 08 30; 2017 11 01; 2018 02 13  
(33) KR; KR; KR
- (71) Celltrion INC. (KR)  
23, Academy-ro, Yeonsu-gu Incheon 22014,  
Republic of Korea (KR)
- (72) LEE, Sung Young (KR);  
AN, Hyun Chul (KR);  
SUH, Jee Hye (KR);  
KIM, Sun Jung (KR)
- (74) Larisa Amirkhanyan  
(85) 2020 03 20  
(86) PCT/KR2018/009998, 2018 08 29
- (54) METHOD FOR TREATING TNF $\alpha$ -RELATED  
DISEASE
- (57) Present invention relates to usage of infliximab  
for the treatment of TNF $\alpha$ -related diseases, by  
providing the subcutaneous injections, wherein the  
TNF $\alpha$ -related diseases are: rheumatoid arthritis,  
ulcerative colitis, Crohn's disease, etc.
- Claims: 3 independents  
6 dependents
- Fig.: 2
-

## PART B

## B 01

(10) AP 2023 15542 A (51) Int. Cl. (2006)

B 01 F 13/10

B 08 B 7/00

B 44 D 3/08

(21) AP 2021 15542 (22) 2021 01 22

(31) 20153505.1

(32) 2020 01 24

(33) EP

(71) DAW SE (DE)

Baustraße 29, 4372 Ober-Ramstadt,  
German (DE)

(72) WEBER, Eno (DE);

CARNER, Carl (DE)

(74) Liliana Darakhvelidze g

(54) KIT-OF-PARTS TINTING DEVICE FOR  
TINTING SYSTEM, METHOD FOR  
PRODUCING TINTED PAINT OR  
PLASTER SYSTEM, AND USAGE  
OF TINTING DEVICE

(57) A device 1 includes at least one collecting capacity 6 for dye or filler 4, and at least one collecting capacity for dye base composition, at least one source 20 of ultraviolet radiation, as well, intended for at least one collecting capacity 6. Ultraviolet radiation source 20, 22, 24 is executed capable to 26 irradiate with violet radiation, the inner walls of case 14, and, if necessary, the dye or filler existed in collecting capacity. The device includes closure lid 96 for collecting capacity 6 having an edge with inner and outer sides, and preferably a side wall adjacent to side edge, and having inner and outer sides, and sealing surface joined to the edge or side wall inner and outer sides. Sealing edge inner side includes at least one source 20 of ultraviolet radiation, executed capable to irradiate at least case 14 inner wall parts.

Claims: 4 independents

27 dependents

Fig.: 5

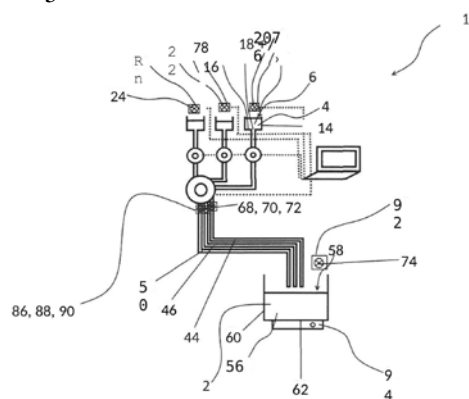

Fig. 2

## PATENTED IVENTIONS

### PART A

#### A 01

- (11) P 2023 7490 B (51) Int. Cl. (2006)  
A 01 N 43/80  
C 07 D 261/04
- (10) AP 2022 15389 A (44) 23(602)/2022  
(21) AP 2018 15389  
(22) 2018 12 14  
(24) 2018 12 14  
(31) 1721235.8  
(32) 2017 12 19  
(33) GB  
(86) PCT/EP2018/084957, 2018 12 14  
(73) Syngenta Participations AG (CH)  
Rosentalstrasse 67, Basel, 4058,  
Switzerland (CH)
- (72) HONE, John (GB);  
JONES, Ian, Kevin (GB);  
GEORGE, Neil (GB)
- (74) Tamar Kochlamazashvili
- (54) POLYMORPHS

#### A 23

- (11) P 2023 7489 B (51) Int. Cl. (2006)  
A 23 F 3/34
- (10) AP 2022 15589 A (44) 22(601)/2022  
(21) AP 2021 15589  
(22) 2021 03 20  
(24) 2021 03 20  
(73) Lepl "Shota Rustaveli National Science  
Foundation of Georgia" (GE)  
M. Aleksidze Str. 1, 0183, Tbilisi, Georgia (GE)
- (72) Vitali Ghvachliani (GE)
- (54) METHOD FOR RECEIVING PARAGUAY  
MATE TYPE TEA FROM GEORGIAN  
SNOW ROSE (CAUCASIAN RHODO-  
DENDRON) FOLIAGE

#### A 61

- (11) P 2023 7492 B (51) Int. Cl. (2006)  
A 61 K 9/08  
A 61 K 31/437  
A 61 K 9/00  
A 61 P 25/20
- (10) AP 2022 15600 A (44) 20(599)/2022  
(21) AP 2019 15600  
(22) 2019 10 04

- (24) 2019 10 04  
(31) 201821038060  
(32) 2018 10 08  
(33) IN  
(86) PCT/IN2019/050734, 2019 10 04  
(73) Troikaa Pharmaceuticals Limited (IN)  
Commerce House – 1, Satya Marg, Bodakdev,  
Ahmedabad, 380054, India (IN)
- (72) PATEL, Nisheel K. (IN);  
PATEL, Ketan R. (IN);  
PATEL, Milan R. (IN);  
PATEL, Kush M. (IN);  
PATEL, Asheel K. (IN)
- (74) Nikoloz Gogilidze
- (54) OROMUCOSAL SOLUTIONS OF ZOLPI-  
DEM OR PHARMACEUTICALLY ACCE-  
PTABLE SALTS THEREOF

- (11) P 2023 7493 B (51) Int. Cl. (2006)  
A 61 K 31/4178  
A 61 P 11/00  
A 61 P 37/00  
C 07 D 403/12
- (10) AP 2022 15523 A (44) 20(599)/2022  
(21) AP 2019 15523  
(22) 2019 05 22  
(24) 2019 05 22  
(31) 2018119193  
(32) 2018 05 24  
(33) RU  
(86) PCT/RU2019/050066, 2019 05 22  
(73) Obshestvo s Organichenoi Otvestvennostiu  
"Valenta-Intellect" (RU)  
Ul. Ryabinovaya, Dom 26, Stroeny 10,  
Cabinet 6-26, 121471, Moscow, Russian  
Federation (RU);  
Ip Nebolsin Vladimir Evgenievich (RU)  
Ul. Golitsinskaya 457, Der. borzier,  
Pavlo-Slobodskoye s/pos., Istrinsky  
District, 143581, Moskovskaya Oblast,  
Russian Federation (RU)
- (72) Vladimir Evgenievich Nebolsin (RU)
- (74) Shalva Gvaramadze
- (54) USE OF MALONIC ACID BISAMIDE  
DERIVATIVE FOR TREATING ALLE-  
RGIC AND OTHER DISEASES IN  
HUMANS AND ANIMALS

- (11) P 2023 7494 B (51) Int. Cl. (2006)  
A 61 P 35/00  
C 07 D 401/14
- (10) AP 2022 15620 A (44) 21(600)/2022  
(21) AP 2019 15620



- (22) 2019 10 30  
 (24) 2019 10 30  
 (31) 18306430.2  
 (32) 2018 10 31  
 (33) EP  
 (86) PCT/EP2019/079621, 2019 10 30  
 (73) Les Laboratoires Servier (FR)  
 35, rue de Verdun, 92284 Suresnes Cedex,  
 France (FR);  
 Vernalis (R&D) Limited (GB)  
 Greanta Park, Cambridge CB21 6GB, United  
 Kingdom (GB)  
 (72) LYNCH, Michael (FR);  
 VILLARD, Frédéric (FR);  
 MOUCHET, Patrick (FR);  
 TAULELLE, Pascal (FR);  
 MASSON, Ludovic (FR)  
 (74) Tamaz Shilakadze  
 (54) NOVEL SALT OF BCL-2 INHIBITOR,  
 RELATED CRYSTALLINE FORM,  
 METHOD FOR PREPARING THE  
 SAME AND PHARMACEUTICAL  
 COMPOSITIONS CONTAINING  
 THE SAME

---

## PART C

### C 04

- (11) P 2023 7495 B (51) Int. Cl. (2006)  
 C 04 B 28/14  
 C 04 B 11/00  
 (10) AP 2022 15261 A (44) 24(603)/2022  
 (21) AP 2017 15261  
 (22) 2017 08 04  
 (24) 2017 08 04  
 (86) PCT/EP2017/000946, 2017 08 04  
 (73) Knauf Gips KG (DE)  
 Am Bahnhof 7, 97346 Iphofen, Germany (DE)  
 (72) DIETZ, Stephan (DE);  
 HARTMANN, Alexander (DE);  
 FRASER, Thomas (AU);  
 BAIER, Manfred (DE);  
 FÖRTHNER, Sebastian (DE);  
 KARAKOUSSIS, Stergios (DE);  
 PARASKOV, Georgi (DE);  
 SCHNEIDERBANGER, Reiner (DE)  
 (74) Larisa Amirkhanyan  
 (54) IMPROVEMENT OF STUCCO PROPERTIES  
 THROUGH AGING AT ELEVATED TEMPE-  
 RATURES AND HIGH HUMIDITY LEVEL

### C 07

- (11) P 2023 7496 B (51) Int. Cl. (2006)  
 C 07 B 59/00  
 C 07 D 295/145  
 (10) AP 2022 15719 A (44) 24(603)/2022  
 (21) AP 2014 15719  
 (22) 2014 10 17  
 (24) 2014 10 17  
 (62) AP 2014 15377 2014 10 17  
 (31) 13004991.9; 14175612.2  
 (32) 2013 10 18; 2014 07 03  
 (33) EP; EP  
 (86) PCT/EP2014/002808, 2014 10 17  
 (73) Deutsches Krebsforschungszentrum (DE)  
 Im Neuenheimer Feld 280, 69120 Heidelberg,  
 Germany (DE);  
 Ruprecht-Karls-Universität Heidelberg (DE)  
 Grabengasse 1, 69117 Heidelberg,  
 Germany (DE)  
 (72) EDER, Matthias (DE);  
 KOPKA, Klaus (DE);  
 SCHÄFER, Martin (DE);  
 BAUDER-WÜST, Ulrike (DE);  
 HABERKORN, Uwe (DE);  
 EISENHUT, Michael (DE);  
 MIER, Walter (DE);  
 BENESOVA, Martina (DE);  
 KRATOCHWIL, Clemens (DE)  
 (74) Shalva Gvaramadze  
 (54) LABELED INHIBITORS OF PROSTATE  
 SPECIFIC MEMBRANE ANTIGEN (PSMA),  
 THEIR USE AS IMAGING AGENTS AND  
 PHARMACEUTICAL AGENTS FOR THE  
 TREATMENT OF PROSTATE CANCER
- 
- (11) P 2023 7497 B (51) Int. Cl. (2006)  
 C 07 B 59/00  
 C 07 D 295/145  
 (10) AP 2022 15720 A (44) 24(603)/2022  
 (21) AP 2014 15720  
 (22) 2014 10 17  
 (24) 2014 10 17  
 (62) AP 2014 15377 2014 10 17  
 (31) 13004991.9; 14175612.2  
 (32) 2013 10 18; 2014 07 03  
 (33) EP; EP  
 (86) PCT/EP2014/002808, 2014 10 17  
 (73) Deutsches Krebsforschungszentrum (DE)  
 Im Neuenheimer Feld 280, 69120 Heidelberg,  
 Germany (DE);  
 Ruprecht-Karls-Universität Heidelberg (DE)  
 Grabengasse 1, 69117 Heidelberg,  
 Germany (DE)  
 (72) EDER, Matthias (DE);  
 KOPKA, Klaus (DE);  
 SCHÄFER, Martin (DE);  
 BAUDER-WÜST, Ulrike (DE);



---

# UTILITY MODELS

## APPLICATIONS APPROVED FOR GRANTING PATENT

The decision can be appealed at the Chamber of Appeal of Sakpatenti within 3 months from the publication or at the Mtskheta District Court Administrative Cases Board (Address: №17, Samkhedro St., Mtskheta), within 1 month following the publication.

### PART A

#### A 61

(10) AU 2023 16056 U (51) Int. Cl. (2006)

A 61 G 10/00

(21) AU 2022 16056 (22) 2022 10 11

(71) Nikoloz Konstantinidi (GE)

Nutsubidze Plateau III m/r, III qu., bld. 6, ap.

11, 0183, Tbilisi, Georgia (GE)

(72) Nikoloz Konstantinidi (GE)

(54) OXYGEN BAY

(57) Oxygen bay – resting, healing and refreshing complex containing hermetic body, a means for receiving oxygen and nitrogen, located outside of hermetic body, a means for supplying oxygen and nitrogen in the hermetic body connected to a means for obtaining oxygen and nitrogen, a means for controlling and regulating air composition of hermetic building, and a means for controlling and regulating the humidity of air of hermetic building, is disclosed; at that, the plants are placed in hermetic building.

Claims: 1 independent

Fig.: 1

---

### PART F

#### F 41

(10) AU 2023 16007 U (51) Int. Cl. (2006)

F 41 F 3/00

F 41 F 7/00

(21) AU 2021 16007 (22) 2021 01 26

(31) u 2020 00490

(32) 2020 01 28

(33) UA

(71) PUGACH, Eugen Olegovich (UA)

Blvd. Lesi Ukrainky, bld. 9V, ap. 79, 01133,

Kyiv, Ukraine (UA)

(72) PUGACH, Eugen Olegovich (UA)

(74) Shalva Gvaramadze

(85) 2022 07 15

(86) PCT/UA2021/000006, 2021 01 26

(54) CONTROLLED CLOSED TYPE STARTER

(57) A starter includes a case 1, wherein the case includes at least one type start module 2, control panel 3, at least one feeding component, at least one component indicating 5 conditions of start module and feeding component. Furthermore, closed type start module consists of casing 8, wherein propellant body 9 is placed, cutting piston 10, a propellant, and initiating component 11 and 12; at that, at least one closed type start module, control panel, at least one feeding component, at least one component for start module, and feeding component indicator are executed with wire connection and/or radio channel control capability.

Claims: 1 independent

2 dependent

Fig.: 2

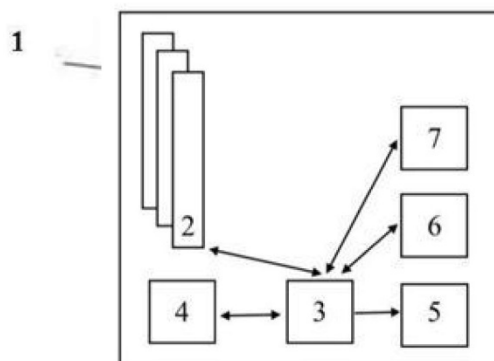

Fig. 1



---

# DESIGNS

## APPLICATION APPROVED FOR REGISTRATION

The decision can be appealed at the Chamber of Appeal of Sakpatenti within 3 months from the publication or at the Mtskheta District Court Administrative Cases Board (Address: №17, Samkhedro str., Mtskheta), within 1 month following the publication.

(10) AD 2023 1284 S (51) 11-01

(21) AD 2022 1284 (22) 2022 11 21

(28) 44

(71) LTD "Zarapkhana" (GE)

Lubiana St. 15, 0162, Tbilisi, Georgia (GE)

(72) Tea Tetradze (GE)

(54) 10. CROSS; 11.-2. RING; 13.-14. EARRING; 15. BRACELET; 16.-17. RING; 18. BRACELET;  
19.-20. CUFFLINK; 1. BRACELET; 21. RING; 22.-24. BRACELET; 25. EARRING; 26.-27. RING;  
28. NECKLACE; 29. EARRING; 2 EARRING; 30. RING; 31. EARRING; 32. CUFFLINK; 33. RING;  
34.-44. BROACH; 3. NECKLACE; 4.-5. RING; 6. NECKLACE; 7. BRACELET; 8.-9. EARRING

(55)





5.2



6.1



7.1



7.2



8.1



9.1



10.1



11.1



11.2



12.1



12.2



13.1





14.1



15.1



15.2



16.1



16.2



17.1



17.2



18.1



18.2



19.1



20.1





21.1



21.2



22.1



22.2



23.1



23.2



24.1



25.1



26.1



26.2



27.1



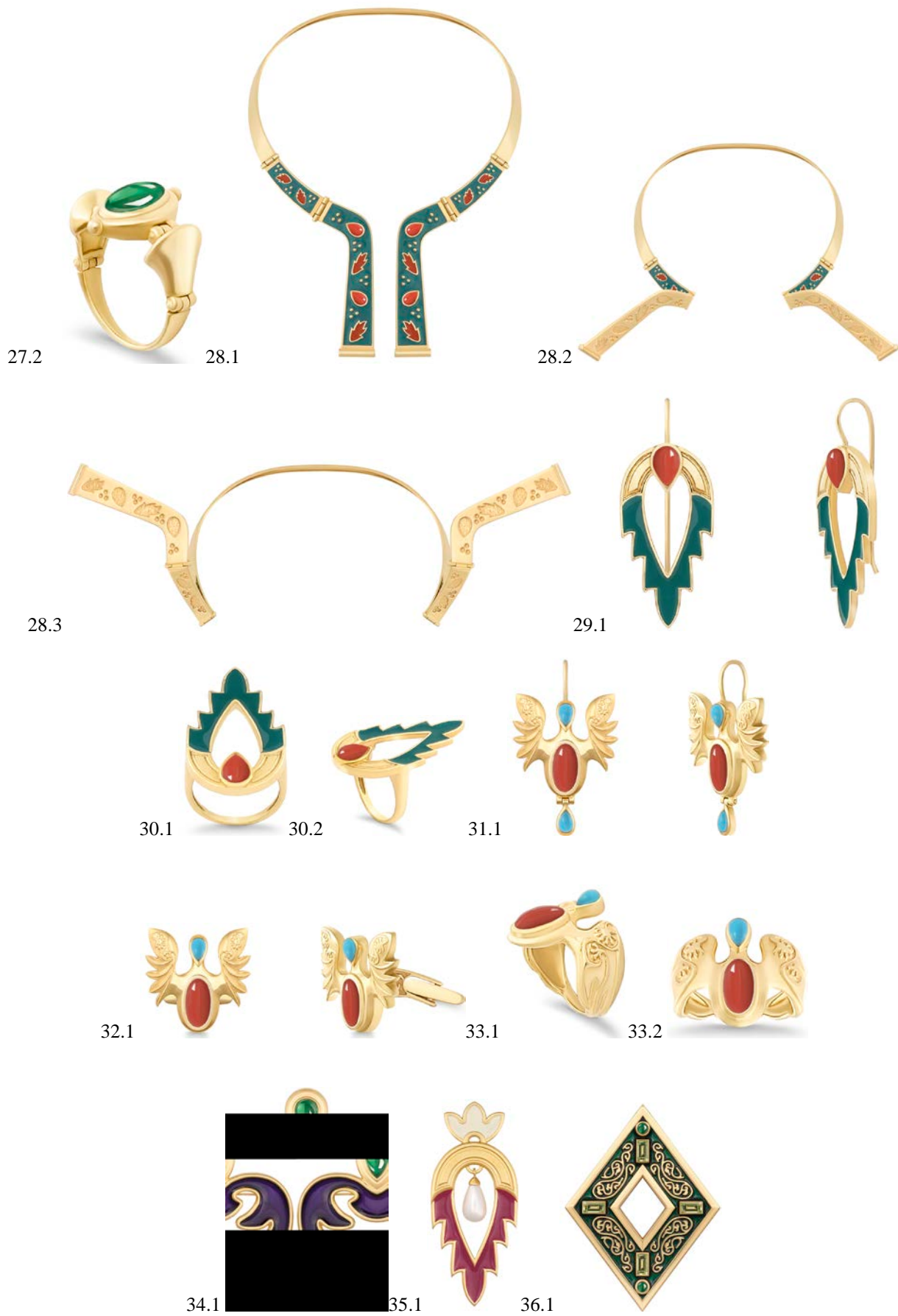



37.1



38.1



39.1

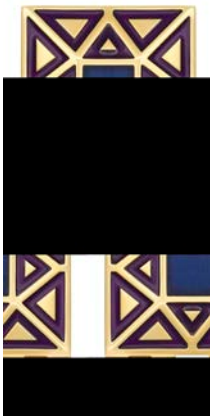

40.1



41.1

42.1



43.1

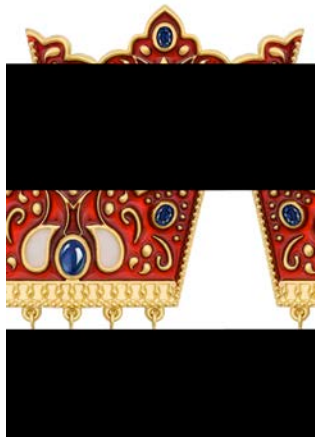

44.1



## DESIGN REGISTERED ACCORDING TO THE ACCELERATED PROCEDURE

The decision can be appealed at the Chamber of Appeal of Sakpatenti within 3 months from the publication.

- (11) D 2023 968 S (51) 19-08  
(21) AD 2023 1301 (22) 2023 03 20  
(24) 2023 03 20  
(28) 7  
(18) 2028 03 20  
(73) JSC "Middle Seas Capital" (GE)  
Guramishvili St. 3, Fl. 1, ap. 3-2, 3700, Rustavi, Georgia (GE)  
(72) Irma Todria (GE)  
(54) LABEL  
(55)

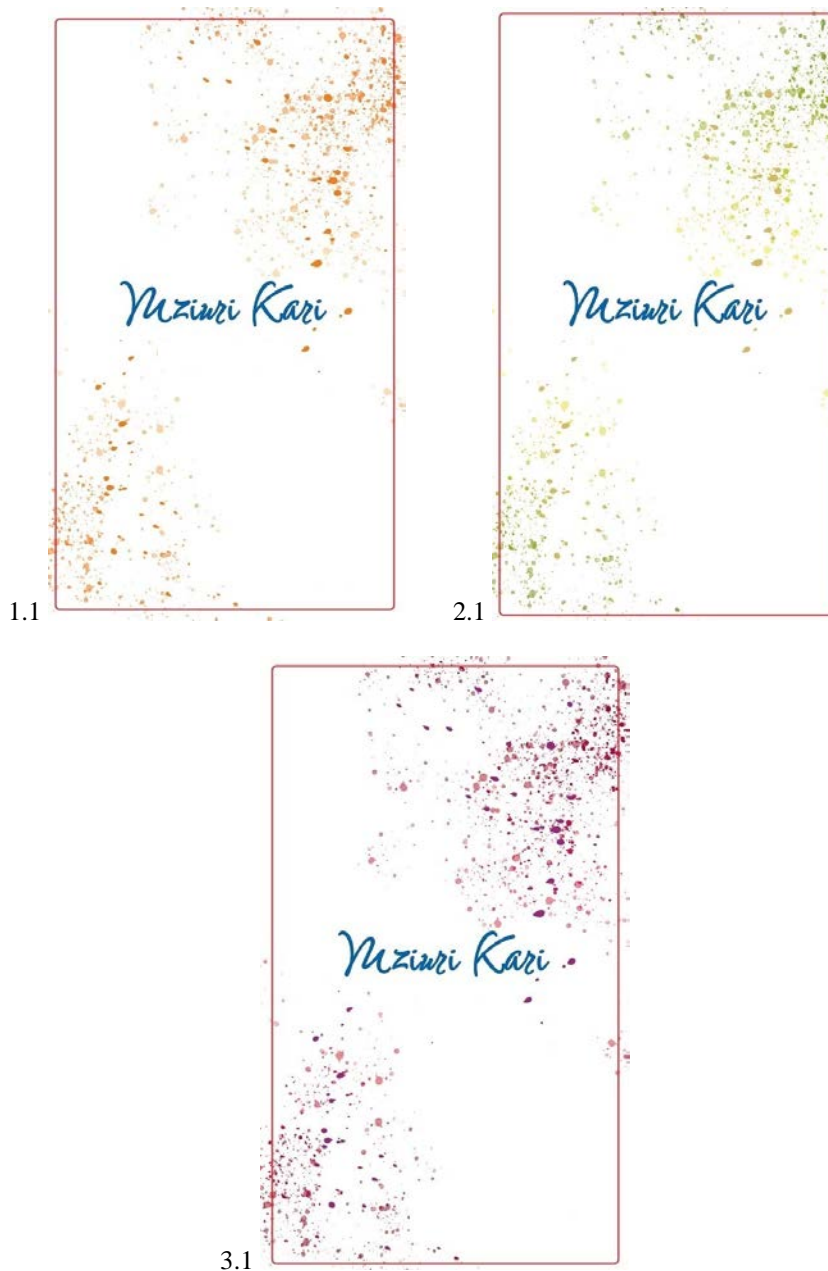

QYQYILI



4.1

QYQYILI

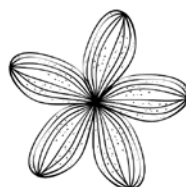

5.1

QYQYILI



6.1

QYQYILI



7.1

## DESIGNS, WHICH HAVE BEEN REGISTERED WITH THE INTERNATIONAL BUREAU CLAIMING PRIORITY ON THE TERRITORY OF GEORGIA

The decision can be appealed at the Chamber of Appeal of Sakpatenti within 3 months from the publication or at the Mtskheta District Court Administrative Cases Board (Address: №17, Samkhedro St., Mtskheta), within 1 month following the publication.

(11) DM/226 215

(51) 14-03

(15) 2022 09 13

(44) 04/2023 (2023 01 27)

(22) 2022 09 13

(28) 1

(73) LoxTop Kft.

Almaskerti Ipari Park 14.; Bekes-megye, 5600 Bekescsaba (HU)

(85) HU

(86) HU

(87) HU

(88) HU

(89) HU

(81) II. ML, BJ, IT, GA, CI, SN, GR, NE III. RO, CA, GE, OM, EE, RS, NO, RW, BG, SY, DK, EM, AM, BW, TJ, MD, VN, TN, PL, SR, MN, JP, KR, LT, CN, UA, OA, MA, SI, BX, ME, AZ, SM, WS, KG, LI, MK, US, BA, DE, EG, RU, JM, FI, IS, HU, ES, BY, GB, KH, TR, GH, ST, IL, KP, CH, HR, LV, AL, MX, BN, FR, NA, SG, MC, BZ, TM

(72) János Botyánszki

Almaskerti Ipari Park 14., Bekes-megye, 5600, Bekescsaba (HU)

(46) 2023 01 27

(54) 1. RADIO-FREQUENCY IDENTIFICATION [RFID] KEY HOLDER

(55)



1.1



1.2

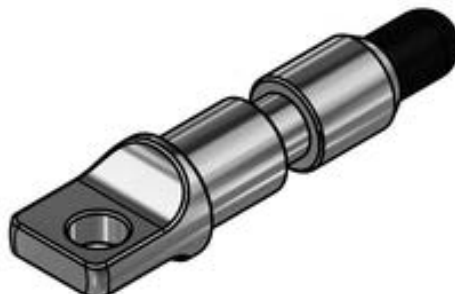

1.3

- (11) DM/222 474
- (15) 2022 07 29
- (22) 2022 07 29
- (28) 2
- (73) Montres Breguet SA (Montres Breguet AG) (Montres Breguet LTD)  
Place de la Tour 23, 1344 L'Abbaye (CH)
- (85) CH
- (86) CH
- (87) CH
- (88) CH
- (89) CH
- (81) III. KG, LI, MK, GE, TR, OM, BA, MN, NO, CH, EM, AL, AM, UA, SG, MA, MC, MD, ME, BZ, AZ, TN, GB
- (72) Vincenzo Laucella  
c/o Montres Breguet SA (Montres Breguet AG) (Montres Breguet Ltd), Place de La Tour 23, 1344, L'Abbaye (CH)
- (74) The Swatch Group SA (The Swatch Group AG) (The Swatch Group LTD.)  
Faubourg du Lac 6, 2501 Biel / Bienne (CH)
- (46) 2023-02-03
- (54) 1.-2. WATCH
- (55)

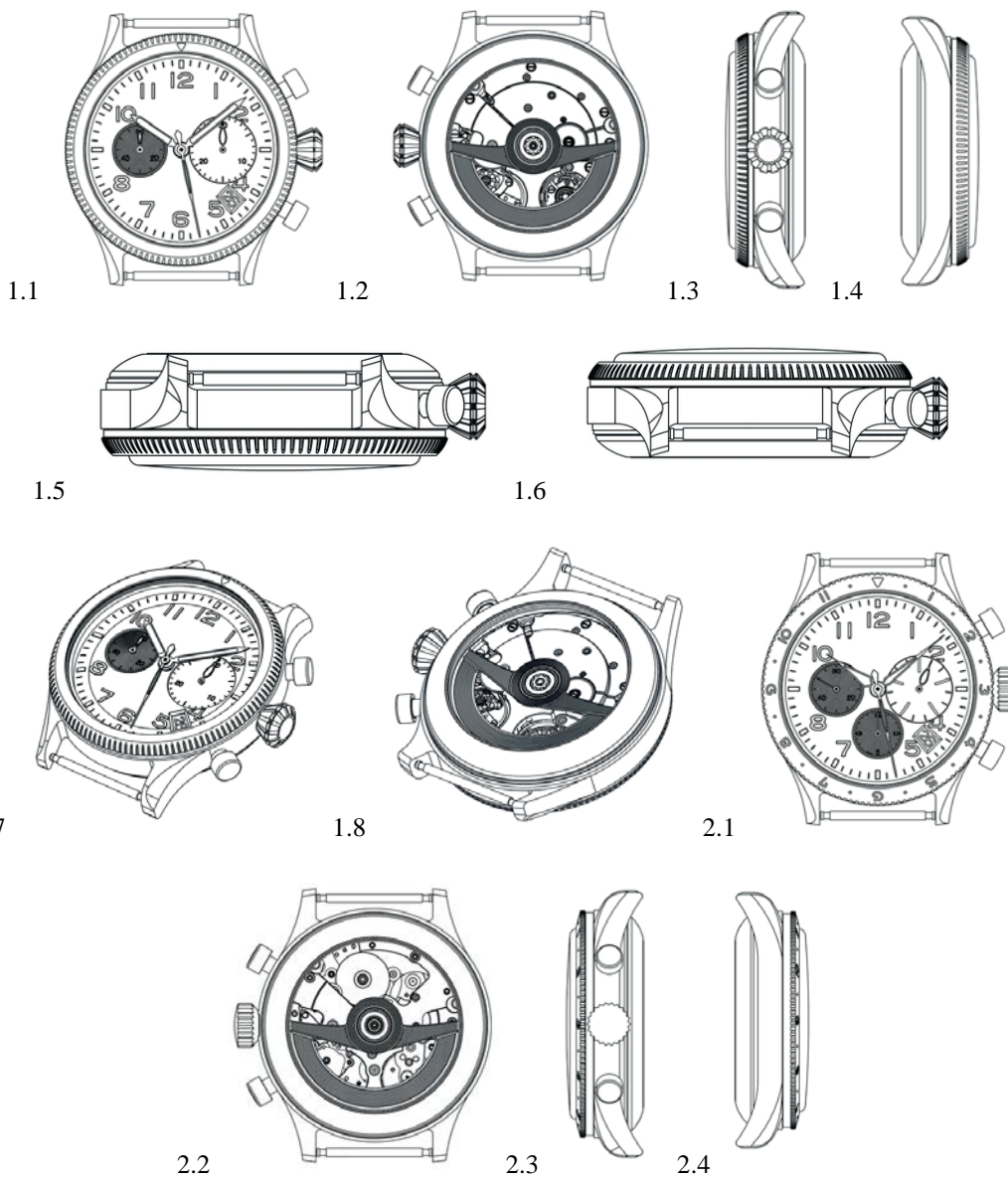

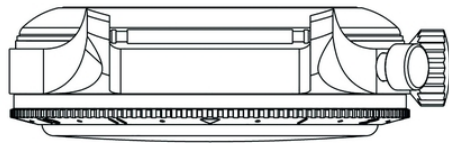

2.5

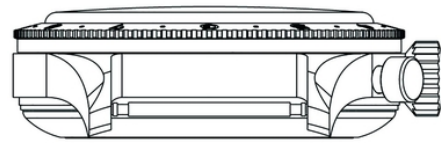

2.6



2.7

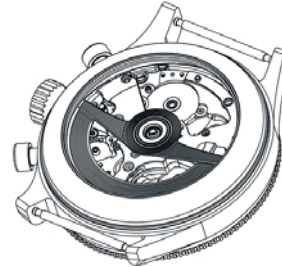

2.8

(11) DM/222 532

(15) 2022 07 29

(22) 2022 07 29

(28) 1

(73) Harry Winston SA

Chemin Du Tourbillon 8, 1228 Plan-les-Ouates (CH)

(85) CH

(86) CH

(87) CH

(88) CH

(89) CH

(81) III. KG, LI, OM, CA, GE, MK, BA, NO, RU, EM, AM, MD, TN, GB, TR, MN, CH, AL, UA, MA, SG, MC, ME, BZ, AZ

(72) Delphine ABDOURAHIM

C/o Harry Winston Inc. 718 Fifth Avenue, 10019, New York (US)

(74) The Swatch Group AG (The Swatch Group SA) (The Swatch Group LTD.)

Faubourg Du Lac 6, 2501 Biel/Bienne (CH)

(46) 2023 02 03

(54) 1. FINGER RING

(55)



1.1



1.2



1.3



1.4



1.5



1.6



1.7



1.8

- (11) DM/226 420 (51) 02-01  
(15) 2022 10 21 (44) 06/2023 (2023 02 10)  
(22) 2022 10 21  
(28) 6  
(30) No1: 21.04.2022; 2022/004633; TR; No2: 21.04.2022; 2022/004633; TR; No3: 21.04.2022; 2022/004633; TR;  
No4: 21.04.2022; 2022/004633; TR; No5: 21.04.2022; 2022/004633; TR; No6: 21.04.2022; 2022/004633; TR  
(73) Hayat Kimya Sanayi Anonim Şirketi  
Mahir İz Caddesi No:25 Altunizade, Üsküdar İstanbul (TR)  
(85) TR  
(86) TR  
(87) TR  
(88) TR  
(89) TR  
(81) III. KG, GE, US, MK, CA, BA, RS, NO, EG, RU, JM, RW, EM, IS, AM, TJ, MD, BY, VN, TN, GB, KH, SR,  
GH, MN, IL, CH, JP, KR, AL, MX, CN, UA, OA, NA, MA, SG, MC, ME, AZ, TM  
(72) Nihat Toslu  
Mahir İz Caddesi No:25 Altunizade, Üsküdar, İstanbul, TR; Halil Gevgilili, Mahir İz Caddesi No:25  
Itunizade, Üsküdar, İstanbul (TR)  
(74) Ankara Patent Bureau  
Bestekar Sokak, No: 10 Kavaklıdere, 06680 Ankara (TR)  
(46) 2023 02 10  
(54) 1.-6. DIAPER WITH CHANNELS  
(55)

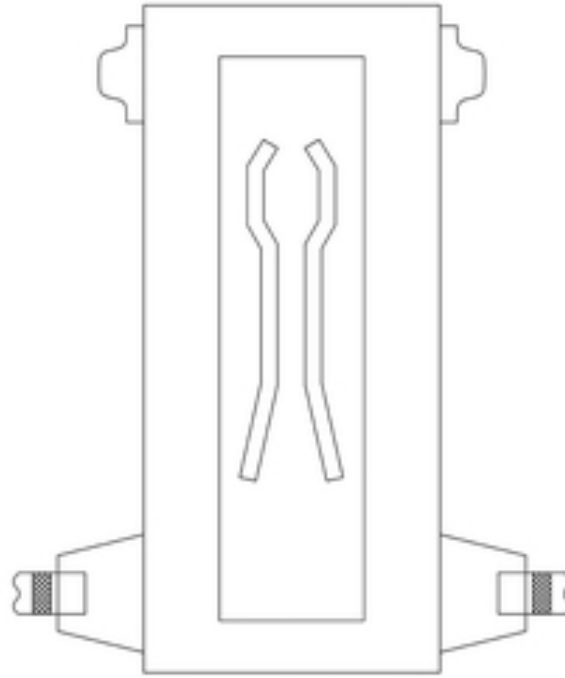

1.1



1.2



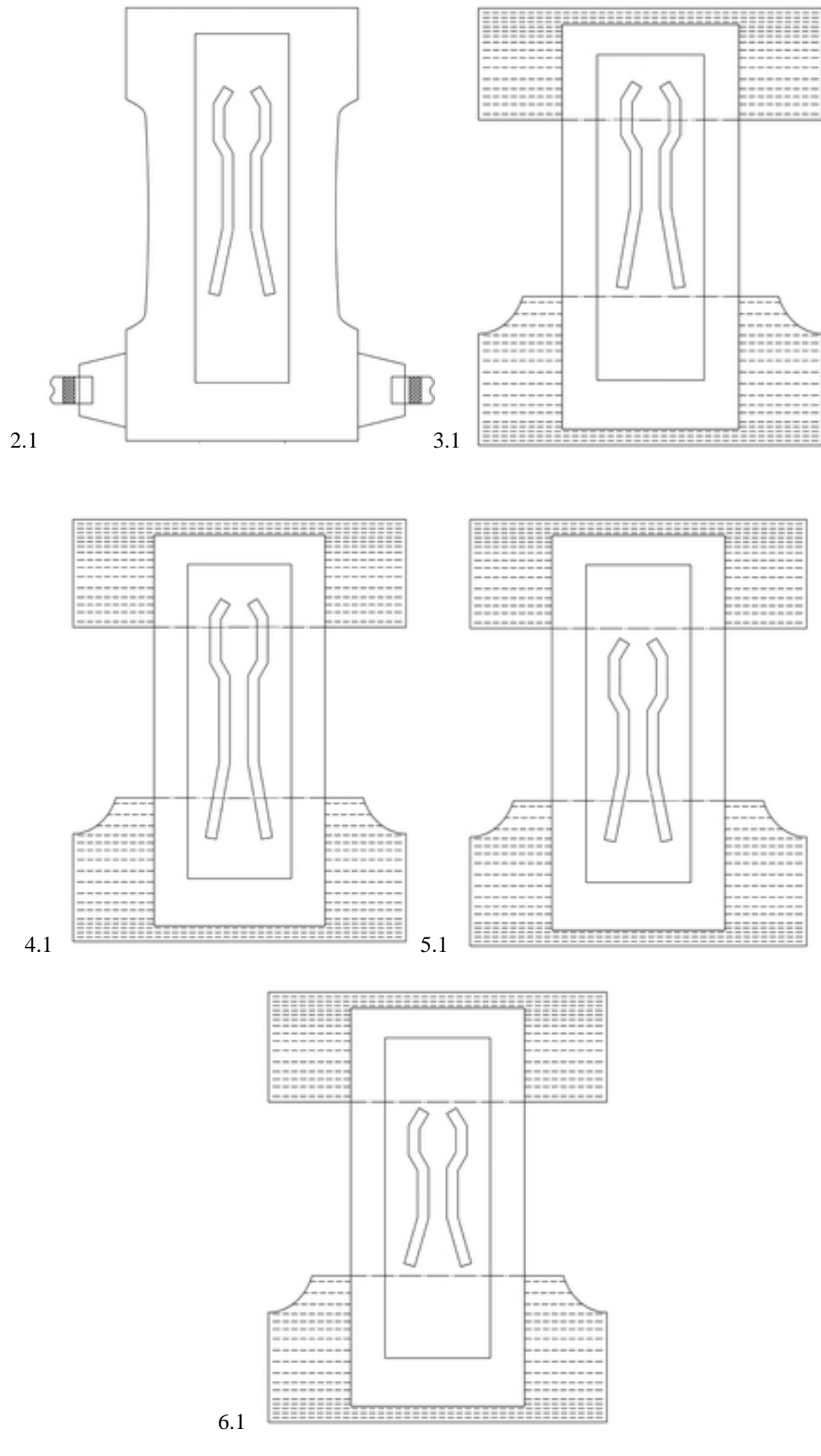

---

# TRADEMARKS

## APPLICATIONS FILED UNDER THE NATIONAL PROCEDURE APPROVED FOR REGISTRATION

The decision can be appealed at the Chamber of Appeal of Sakpatenti within 3 months from the publication or at the Mtskheta District Court Administrative Cases Board (Address: №17, Samkhedro St., Mtskheta), within 1 month following the publication.

(260) AM 2023 103095 A\*  
(210) AM 103095  
(220) 2019 05 14  
(731) JSC "Insurance company Imedi L"  
Anna Politkovskaya Str. 9, Tbilisi, Georgia  
(740) Giorgi Taktakishvili  
(540)

**იმედი ელ**  
**IMEDI L**

(591) Black-white  
(511) 36

---

(260) AM 2023 117558 A  
(210) AM 117558  
(220) 2022 04 21  
(731) Vivo Mobile Communication Co. LTD  
Dongguan, Chang'an, Vivo Road №1,  
Guangdong, 0100, People's Republic of China  
(740) Irakli Gvilia  
(540)

**X Play**

(591) Black-white  
(531) 27.05.01  
(511) 9

---

(260) AM 2023 118077 A  
(210) AM 118077  
(220) 2022 06 08  
(731) Metamorfoza d.o.o.  
Radnička cesta 43, 10000 Zagreb, Croatia  
(740) Liliana Darakhvelidze  
(540)



მეტამორფოზის  
მ ა ზ

(591) Black-white  
(531) 27.01.01; 27.01.25; 28.19  
(511) 41

---

(260) AM 2023 118410 A  
(210) AM 118410  
(220) 2022 07 07  
(731) LTD "Marbano"  
Patman Str. 10, ap. 15, Vill. Dighomi,  
Saburtalo District, Tbilisi, Georgia  
(540)



**MARBANO**

(591) Black-white  
(531) 05.03.04; 05.07.10; 27.05.01  
(511) 33, 35

---

(260) AM 2023 118561 A  
(210) AM 118561  
(220) 2022 07 14  
(731) Enriko Beridze  
G. Tsitsishvili Str. 18, Tbilisi, Georgia  
(740) Salome Jeladze  
(540)

**Meshech Winery**

(591) Black-white  
(511) 33, 35

---

(260) AM 2023 118651 A  
(210) AM 118651  
(220) 2022 07 20  
(731) LTD "Adjara Group"  
Merab Kostava Str. 14, 0108, Tbilisi, Georgia  
(740) Giorgi Taktakishvili  
(540)



(591) Black-white  
(531) 26.01.18; 28.19  
(526) აჭარა  
(511) 9, 36

---

(260) AM 2023 118652 A  
 (210) AM 118652  
 (220) 2022 07 20  
 (731) LTD "Adjara Group"  
 Merab Kostava Str. 14, 0108, Tbilisi, Georgia  
 (740) Giorgi Taktakishvili  
 (540)

 **ADJARA GROUP**

(591) Black-white  
 (531) 26.01.18; 26.01.24; 27.05.01; 27.05.21  
 (526) ADJARA  
 (511) 9, 36

(260) AM 2023 118761 A  
 (210) AM 118761  
 (220) 2022 07 28  
 (731) LTD "Borjomi Products"  
 Adjacent to Gamarjveba Str. 1200, Borjomi,  
 Georgia  
 (540)



(591) Orange, black, silver  
 (531) 19.03.01; 27.05.01; 29.01.12  
 (511) 32

(260) AM 2023 118763 A  
 (210) AM 118763  
 (220) 2022 07 28  
 (731) LTD "Borjomi Products"  
 Adjacent to Gamarjveba Str. 1200, Borjomi,  
 Georgia  
 (540)



(591) Green, black, silver  
 (531) 19.03.01; 27.05.01; 27.05.24; 29.01.12  
 (511) 32

(260) AM 2023 118764 A  
 (210) AM 118764  
 (220) 2022 07 28  
 (731) LTD "Borjomi Products"  
 Adjacent to Gamarjveba Str. 1200, Borjomi,  
 Georgia  
 (540)



(591) Blue, black, silver  
 (531) 19.03.01; 27.05.01; 27.05.24; 29.01.12  
 (511) 32

(260) AM 2023 118832 A  
 (210) AM 118832  
 (220) 2022 07 29  
 (731) LTD "Nami 8"  
 Adam Mitskevich Str. 29b, Commercial  
 Space 2, 0194, Tbilisi Georgia  
 (540)



(591) White, black, blue, lilac, light green, pink  
 (531) 26.04.02; 26.04.22; 26.04.24; 27.05.01;  
 27.05.24; 27.07.24; 29.01.15  
 (511) 40

(260) AM 2023 118941 A  
 (210) AM 118941  
 (220) 2022 08 11  
 (731) Kraft Foods Sverige Intellectual Property AB  
 194 86 Upplands Väsby, Sweden  
 (740) Giorgi Taktakishvili  
 (540)

**DAIM**

(591) Black-white  
 (511) 30

(260) AM 2023 118993 A  
 (210) AM 118993  
 (220) 2022 08 12  
 (731) LTD "Blink"  
 Davit Bakradze Str. 6, 0119, Tbilisi, Georgia

(540)



(591) 000000 black, FFFFFFF white, FF1D25 red  
(531) 02.09.04; 26.01.14; 29.01.13  
(511) 34, 35, 43

(260) AM 2023 118996 A  
(210) AM 118996  
(220) 2022 08 15  
(731) LLC "Barambo"  
Vill. Natakhtari, 3308, Mtskheta, Georgia  
(540)

**პარფე**  
**Parfee**

(591) Black-white  
(511) 30

(260) AM 2023 118997 A  
(210) AM 118997  
(220) 2022 08 15  
(731) LLC "Barambo"  
Vill. Natakhtari, 3308, Mtskheta, Georgia  
(540)

**გლოსო**  
**Glossy**

(591) Black-white  
(511) 30

(260) AM 2023 118998 A  
(210) AM 118998  
(220) 2022 08 15  
(731) LLC "Barambo"  
Vill. Natakhtari, 3308, Mtskheta, Georgia  
(540)

**ბარამბო – პეჩო**  
**barambo – Pecho**

(591) Black-white  
(511) 30

(260) AM 2023 118999 A  
(210) AM 118999  
(220) 2022 08 15  
(731) LLC "Barambo"  
Vill. Natakhtari, 3308, Mtskheta, Georgia

(540)

**ბარამბო ქოქო სი**  
**barambo CocoSea**

(591) Black-white  
(511) 30

(260) AM 2023 119003 A  
(210) AM 119003  
(220) 2022 08 16  
(731) LTD "Petro Plus"  
Krtsanisi Str. 3, bls. 3, ap. 17, 0114, Tbilisi,  
Georgia  
(740) Giorgi Taktakishvili  
(540)



(591) Purple, green, white, black  
(531) 26.03.01; 26.03.12; 26.03.24; 27.05.01;  
29.01.14  
(511) 4, 9, 37

(260) AM 2023 119008 A  
(210) AM 119008  
(220) 2022 08 17  
(731) Monster Energy Company  
a Delaware Corporation  
1 Monster Way, Corona, California 92879,  
USA  
(740) Tamaz Shilakadze  
(540)

**REHAB THE BEAST!**

(591) Black-white  
(511) 30, 32

(260) AM 2023 119009 A  
(210) AM 119009  
(220) 2022 08 17  
(731) Monster Energy Company  
a Delaware Corporation  
1 Monster Way, Corona, California 92879,  
USA  
(740) Tamaz Shilakadze  
(540)

**MONSTER ENERGY**

(591) Black-white  
(511) 30, 32

(260) AM 2023 119026 A  
(210) AM 119026  
(220) 2022 08 19  
(731) Ani Kachkachishvili  
Giorgi Saakadze Str. 4/47, 3700, Rustavi,  
Georgia

(540)

ზევინო

(591) Black-white  
(511) 33(260) AM 2023 119074 A  
(210) AM 119074  
(220) 2022 08 19  
(731) Kraft Foods Danmark Intellectual  
Property ApS  
Ringager 2 A, 2, DK-2605 Brøndby, Denmark  
(740) Giorgi Taktakishvili  
(540)(591) White, red, yellow, green, blue, sky-blue, orange,  
pink, lilac, crimson, black  
(531) 19.03.03; 26.03.01; 26.03.02; 26.03.19;  
26.03.24; 27.05.02; 27.05.07; 27.05.10;  
29.01.15  
(511) 30(260) AM 2023 119077 A  
(210) AM 119077  
(220) 2022 08 19  
(731) Philip Morris Brands Sàrl  
Quai Jeanrenaud 3, 2000 Neuchâtel,  
Switzerland  
(740) Pavle Meipariani  
(540)**MARLBORO CRAFTED**(591) Black-white  
(511) 34(260) AM 2023 119103 A  
(210) AM 119103  
(220) 2022 08 25  
(731) LTD "Ori Nabiji"  
Navtlughi Str. 39-41, 0113, Isani District,  
Tbilisi, Georgia  
(540)(591) White, blue, light sky-blue, golden  
(531) 03.09.01; 03.09.24; 26.04.06; 26.04.22;  
26.04.24; 27.03.01; 27.03.03; 27.05.08;  
27.05.14; 27.05.24; 29.01.13  
(511) 29, 30, 31(260) AM 2023 119105 A  
(210) AM 119105  
(220) 2022 08 25  
(731) LTD "Ori Nabiji"  
Navtlughi Str. 39-41, 0113, Isani District,  
Tbilisi, Georgia  
(540)(591) Sky-blue, pink, white, bordeaux, green, red  
(531) 02.03.01; 06.19.07; 06.19.11; 06.19.13;  
06.19.16; 11.01.02; 26.04.22; 26.04.24; 28.19;  
29.01.15  
(511) 29, 30(260) AM 2023 119179 A  
(210) AM 119179  
(220) 2022 08 26  
(310) SD2022/0044970  
(320) 2022 05 05  
(330) CO  
(731) RCN Televisión S.A.  
Av. De Las Americas No. 65- 82, Bogota D.C.,  
Colombia  
(740) Shalva Gvaramadze  
(540)(591) Green, black, white, blue  
(531) 27.05.01; 27.05.22; 29.01.13  
(511) 38, 41(260) AM 2023 119180 A  
(210) AM 119180  
(220) 2022 08 26  
(310) SD2022/0044971  
(320) 2022 05 05  
(330) CO  
(731) RCN Televisión S.A.  
Av. De Las Americas No. 65- 82, Bogota D.C.,  
Colombia  
(740) Shalva Gvaramadze  
(540)(591) Green, blue, black, white  
(531) 27.05.01; 27.05.22; 29.01.13  
(511) 38, 41

(260) AM 2023 119185 A  
 (210) AM 119185  
 (220) 2022 08 26  
 (731) LTD "Zinuru"  
 O. Oniashvili Str. 30, ap. 8, 0160, Saburtalo  
 District, Tbilisi, Georgia  
 (740) Tamunia Sologhashvili  
 (540)

### Ideal Group

(591) Black-white  
 (511) 16, 21, 37, 40

(260) AM 2023 119186 A  
 (210) AM 119186  
 (220) 2022 08 26  
 (731) Enriko Beridze  
 G. Tsitsishvili Str. 18, Tbilisi, Georgia  
 (740) Salome Jeladze  
 (540)

### Meshech Wine Tradition

(591) Black-white  
 (511) 33, 35

(260) AM 2023 119187 A  
 (210) AM 119187  
 (220) 2022 08 26  
 (731) JSC "Nizhegorodskiy Khimiko-Pharmaceuti-  
 cheskiy Zavod"  
 Salganskaya Str. 7, Nizhny Novgorod, 603600,  
 Russian Federation  
 (740) Giorgi Taktakishvili  
 (540)



(591) Red, white  
 (531) 26.04.01; 26.04.02; 26.04.05; 26.04.22;  
 26.04.24; 26.11.11; 26.11.22; 27.05.24; 28.05;  
 29.01.12  
 (511) 5

(260) AM 2023 119188 A  
 (210) AM 119188  
 (220) 2022 08 26  
 (731) LTD "Sooley & Co."  
 Ilia Chavchavadze Ave. 62, ap. 53, Tbilisi,  
 Georgia  
 (740) Giorgi Taktakishvili

(540)



(591) Black-white  
 (531) 01.01.01; 01.01.05; 01.01.09; 01.15.11;  
 02.09.04; 03.07.16; 03.07.24; 05.05.03;  
 05.05.20; 27.01.12; 27.05.24  
 (511) 33

(260) AM 2023 119190 A  
 (210) AM 119190  
 (220) 2022 08 29  
 (731) Otar Chekurishvili  
 Tskneti Highway 23, ap. 37, 0179, Tbilisi,  
 Georgia  
 (540)

### რქაფერავი

(591) Black-white  
 (511) 33

(260) AM 2023 119192 A  
 (210) AM 119192  
 (220) 2022 08 29  
 (731) Oakley Inc.  
 One Icon, Foothill Ranch, CA 92610, USA  
 (740) Giorgi Taktakishvili  
 (540)



(591) Black-white  
 (531) 26.15.01; 27.05.01  
 (511) 9, 35

(260) AM 2023 119193 A  
 (210) AM 119193  
 (220) 2022 08 29  
 (731) LLC "Georgian Wine House"  
 Vill. Zegaani, 1500, Gurjaan, Georgia  
 (540)

### ანარა Anara Anara

(591) 000000 black-white  
(511) 33

(260) AM 2023 119196 A  
(210) AM 119196  
(220) 2022 08 31  
(731) LLC "My House"  
University Street, plot 06/034/University  
Street 5, Tbilisi, Georgia  
(540)

**GreenHill**  
**Residence**

(591) Light green, white, dark green  
(511) 36, 37

(260) AM 2023 119212 A  
(210) AM 119212  
(220) 2022 09 02  
(731) KT & G Corporation  
71, Beotkkot-gil, Daedeok-gu, Daejeon,  
Republic of Korea, Republic of Korea  
(740) Pavle Meipariani  
(540)

**ESSE SPECIAL BLACK**

(591) Black-white  
(511) 34

(260) AM 2023 119267 A  
(210) AM 119267  
(220) 2022 09 02  
(731) Mikael Vardanyan  
Bairon Str. 3, ap. 8, Yerevan, Armenia  
(740) Giorgi Taktakishvili  
(540)

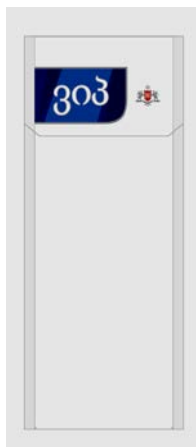

(591) Blue, red, silver, sly-blue, white  
(531) 19.03.03; 19.03.05; 19.03.24; 24.01.15;  
29.01.14  
(511) 34

(260) AM 2023 119269 A  
(210) AM 119269  
(220) 2022 09 02  
(731) LLC "Grand Tobacco"  
22 Hrant Vardanyan Str., 0061, Yerevan,  
Armenia  
(740) Giorgi Taktakishvili  
(540)



(591) White, golden  
(531) 19.03.03; 19.03.05; 19.03.24; 29.01.12  
(511) 34

(260) AM 2023 119270 A  
(210) AM 119270  
(220) 2022 09 02  
(731) Mikael Vardanyan  
Bairon Str. 3, ap. 8, Yerevan, Armenia  
(740) Giorgi Taktakishvili  
(540)



(591) White, black, red, yellow, brown, grey, golden  
(531) 05.03.01; 05.03.14; 19.03.24; 24.01.15;  
29.01.15  
(511) 34

(260) AM 2023 119271 A  
 (210) AM 119271  
 (220) 2022 09 02  
 (731) Token Ödeme Hizmetleri ve Elektronik Para Anonim Şirketi  
 Ayazağa Mahallesi, Mimar Sinan Sokak,  
 A Blok, No:21/A - 44 Sarıyer İstanbul, Türkiye  
 (740) Tamaz Shilakadze  
 (540)

 **Odero**

(591) Black, green, white  
 (531) 26.03.01; 26.03.19; 26.03.24; 27.05.01;  
 29.01.12  
 (511) 9, 35, 36, 38, 42

(260) AM 2023 119273 A  
 (210) AM 119273  
 (220) 2022 09 04  
 (731) LTD "Lerto"  
 Aleksandre Kazbegi Ave. 11a, ap. 21, 0160,  
 Tbilisi, Georgia  
 (540)



(591) Golden, white  
 (531) 05.03.13; 25.01.25; 26.11.01; 26.11.12; 28.19;  
 29.01.02  
 (511) 43

(260) AM 2023 119274 A  
 (210) AM 119274  
 (220) 2022 09 05  
 (310) 40 2022 0043714  
 (320) 2022 03 08  
 (330) KR  
 (731) KT & G Corporation  
 71, Beotkot-gil, Daedeok-gu, Daejeon,  
 Republic of Korea  
 (740) Giorgi Taktakishvili  
 (540)

 **AIIM**

(591) Black-white  
 (531) 27.05.01  
 (511) 34

(260) AM 2023 119276 A  
 (210) AM 119276  
 (220) 2022 09 05  
 (731) Barrister Spirits Limited  
 c/o Coddan CPM LTD, 3rd Floor 120 Baker  
 Street, London, England, W1U 6TU, United  
 Kingdom  
 (740) Giorgi Taktakishvili  
 (540)

**BARRISTER**

(591) Black-white  
 (511) 33

(260) AM 2023 119278 A  
 (210) AM 119278  
 (220) 2022 09 05  
 (731) Otar Chekurishvili  
 Tskneti Highway 23, ap. 37, 0179, Tbilisi,  
 Georgia  
 (540)



(591) Black-white  
 (511) 33

(260) AM 2023 119280 A  
 (210) AM 119280  
 (220) 2022 09 06  
 (731) LTD "Jolio"  
 Dimitri Gulia Str. 4, 0114, Tbilisi, Georgia  
 (540)



(591) F9F2E8 white, F05A26 orange  
 (531) 01.03.07; 29.01.01  
 (511) 29

(260) AM 2023 119283 A  
 (210) AM 119283  
 (220) 2022 09 07  
 (731) Decathlon  
 4 Boulevard de Mons, 59650 Villeneuve  
 D'ascq, France  
 (740) Giorgi Kartvelishvili  
 (540)

**DECATHLON**

(591) Black-white  
 (511) 3, 9, 11, 12, 14, 18, 20, 21, 22, 24, 25, 28, 29,  
 30, 32



(260) AM 2023 119287 A  
 (210) AM 119287  
 (220) 2022 09 07  
 (731) Augmented Reality Concepts Inc.  
 344 S Warren St., Suite 200, Syracuse,  
 New York 13202, USA  
 (740) Giorgi Taktakishvili  
 (540)

**IMPEL**

(591) Black-white  
 (511) 9, 42

(260) AM 2023 119343 A  
 (210) AM 119343  
 (220) 2022 09 09  
 (731) Slazengers Limited  
 Unit A, Brook Park East, Shirebrook  
 NG20 8RY, United Kingdom  
 (740) Merab Kvimsadze  
 (540)



(591) Black-white  
 (531) 03.01.04; 03.01.21; 26.11.08; 27.05.01;  
 27.05.11  
 (511) 3, 18, 25, 28

(260) AM 2023 119345 A  
 (210) AM 119345  
 (220) 2022 09 09  
 (731) Diageo Scotland Limited  
 11 Lochside Place, Edinburgh, Scotland,  
 EH12 9HA, United Kingdom  
 (740) Tamar Kotchlamazashvili  
 (540)



(591) Black-white  
 (531) 02.01.02; 02.01.04; 19.01.05; 23.01.01  
 (511) 33

(260) AM 2023 119347 A  
 (210) AM 119347  
 (220) 2022 09 12  
 (731) LLC "Sante GM T Products"  
 Kakheti Highway 10th km., 0182, Tbilisi,  
 Georgia  
 (540)

**stay strong**

(591) 0A0000 black-white  
 (511) 29

(260) AM 2023 119348 A  
 (210) AM 119348  
 (220) 2022 09 12  
 (731) LLC "Sante GM T Products"  
 Kakheti Highway 10th km., 0182, Tbilisi,  
 Georgia  
 (540)

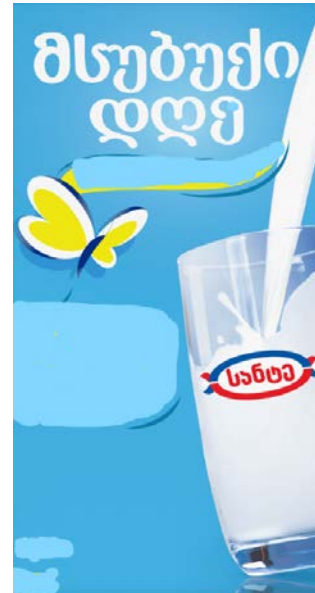

(591) White, 1F8FE0 sky-blue, yellow, red  
 (531) 03.13.01; 08.03.01; 11.03.02; 26.01.02;  
 26.01.20; 28.19; 29.01.14  
 (511) 29

(260) AM 2023 119351 A  
 (210) AM 119351  
 (220) 2022 09 12  
 (731) Leo Institute  
 Petriashvili Str. 25-27-29; Gali Str. 4,  
 Entrance 1, ap. 13, floor VII-VIII,  
 0179, Mtatsminda District, Tbilisi,  
 Georgia  
 (540)

**გამონათე**

(591) Black-white  
 (511) 35, 41

(260) AM 2023 119352 A  
 (210) AM 119352  
 (220) 2022 09 12  
 (731) Leo Institute  
 Petriashvili Str. 25-27-29; Gali Str. 4,  
 Entrance 1, ap. 13, floor VII-VIII,  
 0179, Mtatsminda District, Tbilisi,  
 Georgia

(540)

**InsideMySelf**

(591) Black-white  
 (511) 35, 41

(260) AM 2023 119364 A  
 (210) AM 119364  
 (220) 2022 09 14  
 (731) The News Hub Limited  
 Office at 10th Floor, Building 7 Chiswick Park,  
 566 Chiswick High Road, London, W4 5YG,  
 United Kingdom

(540)

**ARAB WORLD PRESS (AWP)**

(591) Black-white  
 (531) 27.05.01  
 (511) 38, 41

(260) AM 2023 119368 A  
 (210) AM 119368  
 (220) 2022 09 14  
 (731) Neli Gigauri  
 Vill. Tezami, Mtskheta, Georgia

(740) Gvantsa Kurkhuli  
 (540)

**ტროი მანდილი**

(591) Black-white  
 (511) 41

(260) AM 2023 119372 A  
 (210) AM 119372  
 (220) 2022 09 15  
 (731) LTD "Masra"  
 Merab Kostava Str. 26, ap. 36, Old  
 Tbilisi District, Tbilisi, Georgia

(540)

**მასრა Masra**

(591) Black-white  
 (531) 27.05.01; 28.19  
 (511) 34, 41

(260) AM 2023 119374 A  
 (210) AM 119374  
 (220) 2022 09 15  
 (731) GSH Trademarks Limited  
 Afroditis, 25, 2nd floor, flat/office 204, Nicosia,  
 Cyprus  
 (740) Giorgi Taktakishvili  
 (540)



(591) Black-white  
 (531) 03.07.16; 19.07.16; 25.01.25  
 (511) 33

(260) AM 2023 119483 A  
 (210) AM 119483  
 (220) 2022 09 19  
 (731) LTD "Jolio"  
 Dimitri Gulia Str. 4, 0114, Tbilisi, Georgia

(540)

**შეფი**

(591) Black-white  
 (511) 30

(260) AM 2023 119489 A  
 (210) AM 119489  
 (220) 2022 09 19  
 (731) Decathlon  
 4 Boulevard de Mons, 59650 Villeneuve  
 D'ascq, France  
 (740) Giorgi Kartvelishvili

(540)



(591) Black-white

(531) 26.11.02; 26.11.06; 26.11.08; 26.11.12

(511) 3, 9, 11, 12, 14, 18, 20, 21, 22, 24, 25, 28, 29, 30, 32, 35, 41

(260) AM 2023 119492 A

(210) AM 119492

(220) 2022 09 20

(731) Kerten Unlimited Company  
13-18 City Quay, Dublin 2, Ireland

(740) Giorgi Kartvelishvili

(540)



(591) Black-white

(531) 24.17.02; 26.11.12; 27.05.01; 27.07.01

(511) 43

(260) AM 2023 119493 A

(210) AM 119493

(220) 2022 09 20

(731) JSC "Corporation Kindzmarauli"  
Ilia Chavchavadze Str. 55, 4800,  
Kvareli, Georgia

(540)

თაობა  
Поколение  
Generation

(591) Black-white

(511) 32, 33

(260) AM 2023 119581 A

(210) AM 119581

(220) 2022 09 23

(731) LLC "Inex Group"  
Atskuri Str. 45, floor 1, Tbilisi, Georgia

(540)



(591) Black, red

(531) 27.05.01; 27.05.22; 28.05; 28.19; 29.01.12

(511) 12, 35, 39

(260) AM 2023 119596 A

(210) AM 119596

(220) 2022 09 26

(731) Ana Zazadze

Davit Gareji Str. 14a, ap. 38, Rustavi, Georgia

(740) Irakli Gvilia

(540)



(591) Purple, white, yellow

(531) 02.09.01; 07.01.09; 26.04.02; 26.04.16;  
26.04.22; 26.04.24; 28.19; 29.01.13

(511) 35

(260) AM 2023 119675 A

(210) AM 119675

(220) 2022 09 30

(731) LTD "Jolio"

Dimitri Gulia Str. 4, 0114, Tbilisi, Georgia

(540)



(591) 333333 black, F05A26 orange, white

(531) 01.03.07; 29.01.12

(511) 30

**REGISTERED TRADEMARKS**

(111) M 2023 36640 R  
(151) 2023 03 17  
(181) 2033 03 17  
(260) AM 2022 116402 A  
(220) 2022 01 31

(732) Public Joint Stok Company "Gazprom Neft"  
Ul. Pochtamtskaya, Dom. 3-5, Liter A,  
Ch. Pomeshchenie 1n, Kabinet 2401,  
Str. Petersburg, 190000, the Russian Federation

---

(111) M 2023 36641 R  
(151) 2023 03 17  
(181) 2033 03 17  
(260) AM 2022 116405 A  
(220) 2022 01 31

(732) Public Joint Stok Company "Gazprom Neft"  
Ul. Pochtamtskaya, Dom. 3-5, Liter A,  
Ch. Pomeshchenie 1n, Kabinet 2401,  
Str. Petersburg, 190000, the Russian Federation

---

(111) M 2023 36646 R  
(151) 2023 03 20  
(181) 2033 03 20  
(260) AM 2022 116519 A  
(220) 2022 02 04

(732) Apivita S.A.  
Industrial Park of Markopoulo Mesogaiais,  
Markopoulo Mesogaiais,19003, Athens, Greece

---

(111) M 2023 36647 R  
(151) 2023 03 20  
(181) 2033 03 20  
(260) AM 2022 116525 A  
(220) 2022 02 08

(732) Mikheil Mchedlishvili  
V. Dolidze Str. 2/1, 0171, Tbilisi, Georgia

---

(111) M 2023 36648 R  
(151) 2023 03 20  
(181) 2033 03 20  
(260) AM 2022 116336 A  
(220) 2022 01 28

(732) Tamar Keshelava  
Zakaria Paliashvili Str. 39a, 0179, Tbilisi,  
Georgia

---

(111) M 2023 36651 R  
(151) 2023 03 21  
(181) 2033 03 21  
(260) AM 2022 116538 A

(732) GF Group  
Samtredia Str. 1, ap. 31, 0119, Tbilisi, Georgia

---

(111) M 2023 36652 R  
(151) 2023 03 21  
(181) 2033 03 21  
(260) AM 2022 116756 A  
(220) 2022 02 22

(732) Mariam Lapiashvili  
Nino Ramishvili Str., II Lane 5, app. 14, 0179,  
Tbilisi, Georgia

---

(111) M 2023 36653 R  
(151) 2023 03 21  
(181) 2033 03 21  
(260) AM 2022 116520 A  
(220) 2022 02 04

(732) Apivita S.A.  
Industrial Park of Markopoulo Mesogaiais,  
Markopoulo Mesogaiais,19003, Athens, Greece

---

(111) M 2023 36654 R  
(151) 2023 03 21  
(181) 2033 03 21  
(260) AM 2022 116868 A  
(220) 2022 03 04

(732) LTD "Akhmeta Wine House"  
Shota Rustaveli Str. 38, 0900, Akhmeta, Georgia

---

(111) M 2023 36655 R  
(151) 2023 03 21  
(181) 2033 03 21  
(260) AM 2022 117904 A  
(220) 2022 05 20

(732) Monster Energy Company  
a Delaware Corporation  
1 Monster Way, Corona, CA 92879, USA

---

(111) M 2023 36656 R  
(151) 2023 03 21  
(181) 2033 03 21  
(260) AM 2022 117822 A  
(220) 2022 05 17

(732) Emil Kurbanov  
Sulkhan Tsintsadze Str. 58, 0160, Tbilisi, Georgia

---

(111) M 2023 36657 R  
(151) 2023 03 21  
(181) 2033 03 21  
(260) AM 2022 117662 A  
(220) 2022 05 03  
(732) LTD "Georgian Wine House"  
Vill. Zegaani, 1500, Gurjaani, Georgia

---

(111) M 2023 36663 R  
(151) 2023 03 21  
(181) 2033 03 21  
(260) AM 2021 114754 A  
(220) 2021 09 29  
(732) LTD "Praktali"  
Isakadze Str. 12, ap. 22, 0170, Tbilisi, Georgia

---

(111) M 2023 36658 R  
(151) 2023 03 21  
(181) 2033 03 21  
(260) AM 2022 117618 A  
(220) 2022 04 27  
(732) Borisi Berulava  
Mukhiani II mcr., bld. 37, ap. 13, 0101, Tbilisi,  
Georgia

---

(111) M 2023 36659 R  
(151) 2023 03 21  
(181) 2033 03 21  
(260) AM 2022 117422 A  
(220) 2022 04 11  
(732) LTD "Concept Pharma"  
University Str. 2, ap. 5, Block A, 0177, Tbilisi,  
Georgia

---

(111) M 2023 36660 R  
(151) 2023 03 21  
(181) 2033 03 21  
(260) AM 2022 117421 A  
(220) 2022 04 11  
(732) LTD "Concept Pharma"  
University Str. 2, ap. 5, Block A, 0177, Tbilisi,  
Georgia

---

(111) M 2023 36661 R  
(151) 2023 03 21  
(181) 2033 03 21  
(260) AM 2022 116426 A  
(220) 2022 02 02  
(732) Philip Morris Products S.A.  
Quai Jeanrenaud 3, 2000 Neuchâtel,  
Switzerland

---

(111) M 2023 36662 R  
(151) 2023 03 21  
(181) 2033 03 21  
(260) AM 2022 116314 A  
(220) 2022 01 24  
(732) Tamaz Tskhakaia  
Zakaria Paliashvili Str. 37/2, Arakishvili Str. 2,  
Tbilisi, Georgia

---

## TRADEMARKS REGISTERED ACCORDING TO THE ACCELERATED PROCEDURE

The decision can be appealed at the Chamber of Appeal of Sakpatenti within 3 months from the publication.

(111) M 2023 36642 R

(151) 2023 03 20

(181) 2033 03 20

(210) AM 121852

(220) 2023 02 27

(732) LTD "Marlo"

Nutsubidze Plateau, II m/r., I qu., bld. 1,  
ap. 31, Tbilisi, Georgia

(540)



**BLACK OPAL**

(591) Black-white

(531) 21.03.01; 26.01.02; 26.01.12; 27.05.01

(511) 41, 43

(111) M 2023 36643 R

(151) 2023 03 20

(181) 2033 03 20

(210) AM 121865

(220) 2023 03 02

(732) LLC "Geophysics International Group"

Tsotne Dadiani Str., II m/r., bld. 2, ap. 97,  
Tbilisi Georgia

(540)



(591) White, blue

(531) 01.05.02; 26.01.01; 26.01.04; 26.01.13;  
26.01.21; 27.01.06; 29.01.12

(511) 42

(111) M 2023 36644 R

(151) 2023 03 20

(181) 2033 03 20

(210) AM 121851

(220) 2023 02 27

(732) LTD "Walls"

Gio Khutsishvili Str. 3, Tbilisi, Georgia

(540)



(591) White, green, dark yellow (color of carrot)

(531) 26.04.02; 26.04.04; 26.04.09; 26.11.03;

26.11.05; 26.11.06; 26.11.07; 28.19; 29.01.12

(511) 36, 37

(111) M 2023 36645 R

(151) 2023 03 20

(181) 2033 03 20

(210) AM 121850

(220) 2023 02 27

(732) LTD "Walls"

Gio Khutsishvili Str. 3, Tbilisi, Georgia

(540)



(591) White, green, dark yellow (color of carrot)

(531) 26.04.02; 26.04.09; 26.11.03; 26.11.05;

26.11.06; 26.11.07; 27.05.01; 27.05.10;

29.01.12

(511) 36, 37

(111) M 2023 36649 R

(151) 2023 03 20

(181) 2033 03 20

(210) AM 121749

(220) 2023 02 21

(732) Red Bull GMBH

Am Brunen 1, 5330 Fushl-am-zee, Austria

(740) Tamaz Shilakadze

(540)



(591) Blue, orange, yellow, white, black, silver,  
Golden, red  
(531) 01.03.01; 01.17.03; 01.17.04; 01.17.11;  
03.04.01; 03.04.04; 14.01.13; 14.01.15;  
14.01.16; 24.09.07; 27.05.02; 27.05.17;  
27.05.24; 29.01.15  
(511) 41

(111) M 2023 36650 R  
(151) 2023 03 20  
(181) 2033 03 20  
(210) AM 121766  
(220) 2023 02 22  
(732) JSC "Bank of Georgia"  
Gagarin Str. 29a, 0160, Tbilisi, Georgia  
(740) Giorgi Taktakishvili  
(540)

**ნაწილ-ნაწილ**

(591) Black-white  
(511) 9, 36

(111) M 2023 36664 R  
(151) 2023 03 21  
(181) 2033 03 21  
(210) AM 121925  
(220) 2023 03 07  
(732) LTD "Bolero & Company"  
Kuchishvili Str. 12-14-16, fl. 6, 0179,  
Tbilisi, Georgia  
(540)

**OAK HILLS**

(591) Black-white  
(511) 33

(111) M 2023 36665 R  
(151) 2023 03 21  
(181) 2033 03 21  
(210) AM 121935  
(220) 2023 03 09  
(732) Nino Paichadze  
Revaz Uridia Str. 26, 0101, Tbilisi, Georgia  
(540)

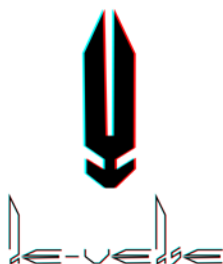

(591) 000000 black, 00FFFF sky-blue, FF0000 red  
(531) 26.13.25; 27.05.04; 29.01.13  
(511) 9, 25, 41

(111) M 2023 36666 R  
(151) 2023 03 21  
(181) 2033 03 21  
(210) AM 121933  
(220) 2023 03 09  
(732) Nino Paichadze  
Revaz Uridia Str. 26, 0101, Tbilisi, Georgia  
(540)

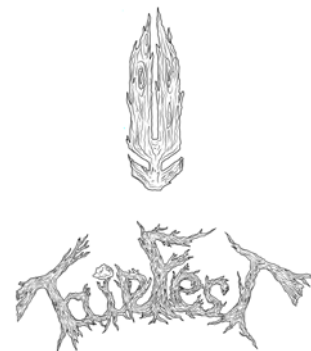

(591) Black-white  
(531) 05.01.16; 05.01.20; 05.01.21; 26.13.25;  
27.03.01; 27.03.11  
(511) 41

(111) M 2023 36667 R  
(151) 2023 03 21  
(181) 2033 03 21  
(210) AM 121508  
(220) 2023 02 06  
(732) Philip Morris Products S.A.  
Quai Jeanrenaud 3, 2000 Neuchâtel, Switzerland  
(740) Pavle Meipariani  
(540)

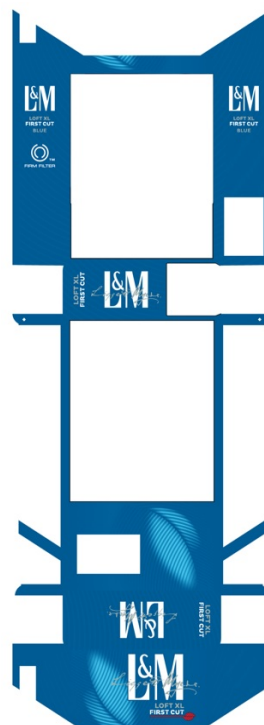

(591) Blue, sky-blue, grey, red, white

(531) 05.03.01; 05.03.14; 19.03.24; 27.05.10;  
27.05.24; 29.01.13  
(511) 34

(111) M 2023 36668 R  
(151) 2023 03 21  
(181) 2033 03 21  
(210) AM 121509  
(220) 2023 02 06  
(732) Philip Morris Products S.A.  
Quai Jeanrenaud 3, 2000 Neuchâtel, Switzerland  
(740) Pavle Meipariani  
(540)



(591) White, red, grey, sky-blue, dark blue  
(531) 05.03.01; 05.03.14; 19.03.24; 27.05.10;  
27.05.24; 29.01.14  
(511) 34

(111) M 2023 36669 R  
(151) 2023 03 21  
(181) 2033 03 21  
(210) AM 122015  
(220) 2023 03 10  
(732) LTD "Naturel"  
Vill. Karajala, Telavi Region, Georgia  
(540)



(591) Black-white

(531) 26.04.02; 26.04.05; 26.04.22; 26.04.24;  
27.05.24  
(511) 11

(111) M 2023 36670 R  
(151) 2023 03 21  
(181) 2033 03 21  
(210) AM 122020  
(220) 2023 03 13  
(732) LLC "Geo Telemedicine"  
Gamrekeli Str. 19, Commercial Space, fl. 2,  
0160, Tbilisi, Georgia  
(540)



**telemedicine**

(591) 00B9A3 green, 000000 black, FFFFFFF white  
(531) 04.05.04; 16.01.04; 16.01.05; 16.01.11;  
16.03.13; 19.13.22; 27.05.01; 29.01.13  
(511) 44

(111) M 2023 36671 R  
(151) 2023 03 21  
(181) 2033 03 21  
(210) AM 122033  
(220) 2023 03 15  
(732) LLC "Engineering and Procurement  
Corporation"  
Iosebidge Str. 60 (the same Iosebidge/  
Bulachauri Str. 60/4), Creative Hand-semi-  
basement floor, 0160, Tbilisi Georgia  
(540)



(591) Green, black  
(531) 24.15.07; 24.15.13; 24.15.15; 27.01.25;  
29.01.03; 29.01.12  
(511) 11

(111) M 2023 36672 R  
(151) 2023 03 21  
(181) 2033 03 21  
(210) AM 121768  
(220) 2023 02 22  
(732) JSC "Bank of Georgia"  
Gagarin Str. 29a, 0160, Tbilisi, Georgia  
(740) Giorgi Taktakishvili



(540)

**Buy Now -  
-pay Later**

(591) Lilac

(531) 27.05.01; 29.01.05

(511) 9

(111) M 2023 36673 R

(151) 2023 03 21

(181) 2033 03 21

(210) AM 121767

(220) 2023 02 22

(732) JSC "Bank of Georgia"

Gagarin Str. 29a, 0160, Tbilisi, Georgia

(740) Giorgi Taktakishvili

(540)

**ყიდულობ დღეს, იხდი მერე**

(591) Black-white

(511) 9

(111) M 2023 36674 R

(151) 2023 03 21

(181) 2033 03 21

(210) AM 121923

(220) 2023 03 06

(732) NNLE "International Federation of Georgian Wrestling"

Dodo Abashidze Str. 9, ap. 9, Tbilisi, Georgia

(740) Natia Gogadze

(540)



(591) 479927 green, E81010 red, FCFCFC white, 3F1F1F brown

(531) 01.05.01; 01.05.02; 01.05.07; 02.01.08; 26.01.01; 26.01.04; 26.01.14; 26.01.21; 29.01.15

(511) 41

(111) M 2023 36675 R

(151) 2023 03 22

(181) 2033 03 22

(210) AM 122014

(220) 2023 03 10

(732) LTD "Vartava"

Vill. Mukhattskaro, 3rd Street 24a 3307,

Mtskheta Region, Mtskheta, Georgia

(540)



(591) Ivory, beige, dark brown, white

(531) 26.01.01; 26.01.12; 26.01.18; 26.11.12; 27.05.21; 29.01.12

(511) 36

(111) M 2023 36676 R

(151) 2023 03 24

(181) 2033 03 24

(210) AM 122117

(220) 2023 03 20

(732) Shakir Niazov

Panaskerteli Str., next to bld. 17, Tbilisi, Georgia

(540)

**შაკ შაურმა**

**SHAK SHAWARMA**

(591) Black-white

(511) 43

(111) M 2023 36677 R

(151) 2023 03 24

(181) 2033 03 24

(210) AM 122021

(220) 2023 03 13

(732) Igor Dmitrievich Rabchinskiy

Str. Blagodatnaya 166/43, ap. 108, Rostov-on-Don, Russian Federation

(740) Shalva Gvaramadze

(540)

**aligo**

(591) Black-white

(511) 35, 42

(111) M 2023 36678 R

(151) 2023 03 24

(181) 2033 03 24

(210) AM 122112

(220) 2023 03 20

(732) Otkrytoe Aktsionernoe Obschestvo  
"Likerovodochniy Zavod "Glazovskiy"  
13, ul. 2-ya Naberezhnaya, g. Glazov,  
RU-427622 Udmurt, Russian Federation

(740) Giorgi Taktakishvili

(540)



(591) Golden, black, brown, red, ivory, white

(531) 19.07.01; 19.07.09; 24.09.01; 24.09.05;  
25.01.15; 25.01.19; 25.01.19

(554) Three-dimensional

(511) 33

(111) M 2023 36679 R

(151) 2023 03 24

(181) 2033 03 24

(210) AM 122115

(220) 2023 03 20

(732) LTD "Geokonditeri"  
Akaki Tsereteli Ave. 126, Tbilisi, Georgia

(540)



(591) White, red, golden

(531) 25.01.10; 25.01.15; 25.01.17; 25.01.19;  
27.05.01; 27.05.24; 29.01.13

(511) 30

(111) M 2023 36680 R

(151) 2023 03 24

(181) 2033 03 24

(210) AM 122011

(220) 2023 03 10

(732) Giorgi Khorbaladze  
Vill. Akha, Dmanisi Region, Georgia

(540)



(591) Green, brown, blue

(531) 03.09.04; 05.01.05; 27.05.01; 29.01.13

(526) AKHA

(511) 43

(111) M 2023 36681 R

(151) 2023 03 24

(181) 2033 03 24

(210) AM 121759

(220) 2023 02 22

(732) Closed Joint-Stock Company "Tabaterra"  
Khimik (Chemists), Sumgait Chemical  
Industrial Park, Sumgait, AZ5002, Azerbaijan

(740) Giorgi Kavlashvili

(540)

**FRIZ**  
**ფრიზი**

(591) Black-white

(511) 9, 11, 34

## INTERNATIONAL TRADEMARKS FOR WHICH A DECISION ON GRANTING PROTECTIONS IS TAKEN

The decision can be appealed at the Chamber of Appeal of Sakpatenti within 3 months from the publication or at the Mtskheta District Court Administrative Cases Board (Address: №17, Samkhedro St., Mtskheta), within 1 month following the publication.

(260) AM 2023 116797 A

(800) 1646686

(151) 2022 01 25

(891) 2022 01 25

(731) PROTEOS BIOTECH S.L.

C/ 3, Nº 50, Parcela 133-C, Pol. Ind. Romica,

Apdo. Correos 627, E-02080 Albacete, Spain

(540)

pbserum

(591) Black, white

(531) 27.05; 27.05.01

(511)

3 – Cosmetics.

5 – Pharmaceutical products; pharmaceutical preparations and compositions; chemical preparations for pharmaceutical use; parapharmaceutical products for use in dermatology; biological preparations for medical use; hygienic and sanitary products for medical use; enzymes for medical use.

(260) AM 2023 117636 A

(800) 1658268

(151) 2021 12 01

(891) 2021 12 01

(731) SME CORPORATION MALAYSIA

LEVEL 6, SME 1, BLOCK B, PLATINUM

SENTRAL, JALAN STESEN SENTRAL 2,

KUALA LUMPUR SENTRAL, 50470

KUALA LUMPUR, Malaysia

(540)



(591) Black, white

(531) 05.05.19; 05.05.20; 05.05.21; 24.03.07;

24.03.18; 27.03.11; 27.05.01; 27.05.09;

27.05.22

(526) "Malaysian Brand", "Quality, Excellence, Distinction".

(551) Collective

(511)

1 – Chemicals used in industry, science and photography, as well as in agriculture, horticulture and forestry; unprocessed artificial resins, unprocessed plastics; manures; fire extinguishing compositions; tempering and soldering preparations; chemical substances for preserving foodstuffs; tanning substances; adhesives used in industry.

2 – Paints, varnishes, lacquers; preservatives against rust and against deterioration of wood; colorants; mordants; raw natural resins; metal in foil and powder form for painters, decorators, printers and artists.

3 – Bleaching preparations and other substances for laundry use; cleaning, polishing, scouring and abrasive preparations; soaps; perfumery, essential oils, cosmetics, hair lotions; dentifrices.

4 – Industrial oils and greases; lubricants; dust absorbing, wetting and binding compositions; fuels (including motor spirit) and illuminants; candles and wicks.

5 – Pharmaceutical and veterinary and sanitary preparations for medical purpose; dietetic substances adapted for medical use, food for babies; plasters, materials for dressings; material for stopping teeth, dental wax; disinfectants; preparations for destroying vermin; fungicides, herbicides.

6 – Common metals and their alloys; metal building materials; transportable buildings of metal; materials of metal for railway tracks; non-electric cables and wires of common metal; ironmongery, small items of metal hardware; pipes and tubes of metal; safes; goods of common metal not included in other classes; ores.

7 – Machines and machine tools; motors and engines (except for land vehicles); machine coupling and transmission components (except for land vehicles); agricultural implements other than hand-operated; incubators for eggs; automatic vending machines.

8 – Hand tools and implements (hand operated); cutlery; side arms; razors.

9 – Scientific, nautical, surveying, photographic, cinematographic, optical, weighing, measuring, signaling, checking (supervision), life-saving and teaching apparatus and instruments; apparatus and instruments for conducting, switching, transforming, accumulating, regulating or controlling electricity; apparatus for recording, transmission or reproduction of sound or

images; magnetic data carries, recording discs; mechanisms for coin operated apparatus; cash registers, calculating machines, data processing equipment and computers; fire-extinguishing apparatus.

10 – Surgical, medical, dental and veterinary apparatus and instruments, artificial limbs, eyes and teeth; orthopedic articles; suture materials.

11 – Apparatus for lighting, heating, steam generating, cooking, refrigerating, drying, ventilating, water supply and sanitary purposes.

12 – Vehicles; apparatus for locomotion by land, air or water.

13 – Firearms, ammunition and projectiles; explosives; fireworks.

14 – Precious metals and their alloys and goods in precious metals or coated therewith, not included in other classes; jewellery, precious stones; horological and chronometric instruments.

15 – Musical instruments.

16 – Paper, cardboard and goods made from these materials, not included in other classes; printed matter; bookbinding materials; photographs; stationery; adhesives for stationery or household purposes; artists' materials; paint brushes; typewriters and office requisites (except furniture); instructional and teaching material (except apparatus); plastic materials for packaging (not included in other classes); printers' type; printing blocks.

17 – Rubber, gutta-percha, gum, asbestos, mica and goods made from these materials and not included in other classes; plastics in extruded form for use in manufacture; packing, stopping and insulating materials; flexible pipes, not of metal.

18 – Leather and imitations of leather, and goods made of these materials and not included in other classes; animal skins, hides; trunks and travelling bags; umbrellas, parasols and walking sticks; whips, harness and saddlery.

19 – Building materials (not of metal); non-metallic rigid pipes for building; asphalt, pitch and bitumen; non-metallic transportable buildings; monuments, not of metal.

20 – Furniture, mirrors, picture frames; goods (not included in other classes) of wood, cork, reed, cane, wicker, horn, bone, ivory, whalebone, shell, amber, mother-of-pearl, meerschaum and substitutes for all these materials, or of plastics.

21 – Household or kitchen utensils and containers (not of precious metal or coated therewith); combs and sponges; brushes (except paint brushes); brush-making materials; articles for cleaning purposes; steel wool; unworked or semi-worked glass (except glass

used in building); glassware, porcelain and earthenware not included in other classes.

22 – Ropes, string, nets, tents, awnings, tarpaulins, sails, textile packaging sacks and bags (not included in other in other classes); padding and stuffing materials (except of rubber, plastics, paper or cardboard); raw fibrous textile materials.

23 – Yarns and threads, for textile use.

24 – Textiles and textile goods, not included in other classes; bed and table covers.

25 – Clothing, footwear, headgear.

26 – Lace and embroidery, ribbons and braid; buttons, hooks and eyes, pins and needles; artificial flowers.

27 – Carpets, rugs, mats and matting, linoleum and other materials for covering existing floors; wall hangings (non-textile).

28 – Games and playthings; gymnastic and sporting articles not included in other classes; decorations for Christmas trees.

29 – Meat, fish, poultry and game; meat extracts; preserved, dried and cooked fruits and vegetables; jellies, jams, compotes; eggs, milk and milk products; edible oils and fats.

30 – Coffee, tea, cocoa, sugar, rice, tapioca, sago, artificial coffee; flour and preparations made from cereals, bread, pastry and confectionery, ices; honey, treacle; yeast, baking-powder; salt, mustard; vinegar, sauces (condiments); spices; ice.

31 – Agricultural, horticultural and forestry products and grains not included in other classes; live animals; fresh fruits and vegetables; seeds, natural plants and flowers; foodstuffs for animals, malt.

32 – Beers; mineral and aerated waters and other non-alcoholic drinks; fruit drinks and fruits juices; syrups and other preparations for making beverages.

33 – Alcoholic beverages (except beers).

34 – Tobacco; smokers' articles; matches.

35 – Advertising; business management; business administration; office functions.

36 – Insurance; financial affairs; monetary affairs; real estate affairs.

37 – Building construction; repair; installation services.

38 – Telecommunications services.

39 – Transport; packaging and storage of goods; travel arrangement.

40 – Treatment of materials.

41 – Education; providing of training; entertainment, sporting and cultural activities.

42 – Scientific and technological services and research and design relating thereto; industrial analysis and research services; design and development of computer hardware and software.

43 – Services for providing food and drink; temporary accommodation.

44 – Medical services; veterinary services; hygienic and beauty care for human beings or animals; agriculture, horticulture and forestry services.

45 – Personal and social services rendered by others to meet the needs of individuals; security services for the protection of property and individuals; legal services.

(260) AM 2023 117962 A

(800) 1663480

(151) 2022 03 22

(891) 2022 03 22

(731) PJSC "GAZPROM"

Lakhtinsky Avenue, 2, Bldg. 1, int. terr. of city municipal district Lakhta-Olgino, RU-197229 St. Petersburg, Russian Federation

(540)



(591) Blue and white

(531) 27.05.01; 27.05.07; 27.05.09; 27.05.10; 28.05; 29.01.12

(511)

9 – Coils, electric; particle accelerators; reflective articles for wear, for the prevention of accidents; protection devices for personal use against accidents; clothing for protection against accidents, irradiation and fire; accumulators, electric, for vehicles; batteries, electric, for vehicles; battery jars; battery boxes; acidimeters for batteries; hydrometers; plates for batteries; whistle alarms; acoustic alarms; acoustic conduits; sound recording discs; speaking tubes; actinometers; adding machines; aerometers; enlarging apparatus [photography]; electro-dynamic apparatus for the remote control of railway points; magnets; electromagnetic coils; air analysis apparatus; alarms; alcoholmeters; alidades; food analysis apparatus; igniting apparatus, electric, for igniting at a distance; ignition batteries; altimeters; asbestos gloves for protection against accidents; asbestos clothing for protection against fire; ammeters; amplifiers; amplifying tubes; anemometers; calibrating rings; fire extinguishers; anodes; anode batteries; aerials; anti-glare glasses; visors for helmets; anti-interference devices [electricity]; transformers [electricity]; apertometers [optics]; money counting and sorting machines; distribution boxes [electricity]; surveying instruments; surveying chains; lenses for astrophotography; thermionic valves; audiovisual

teaching apparatus; juke boxes, musical; mechanisms for coin-operated apparatus; mechanisms for counter-operated apparatus; calipers; comparators; fire alarms; automatic indicators of low pressure in vehicle tyres; protective suits for aviators; alarm bells, electric; rods for water diviners; life-saving rafts; scales; meteorological balloons; demagnetizing apparatus for magnetic tapes; tape recorders; magnetic tapes; barometers; weighing machines; weighbridges; fire beaters; chargers for electric accumulators; betatrons; ticket dispensers; cabinets for loudspeakers; close-up lenses; terminals [electricity]; pressure indicator plugs for valves; galvanometers; push buttons for bells; branch boxes [electricity]; tone arms for record players; spirit levels; punched card machines for offices; sheaths for electric cables; frames for photographic transparencies; circular slide rules; slide-rules; calculating machines; slide calipers; jigs [measuring instruments]; blueprint apparatus; cinematographic cameras; capillary tubes for laboratory use; sound recording carriers; protective helmets; respiratory masks, other than for artificial respiration; solderers' helmets; eyeglass chains; heat regulating apparatus; darkrooms [photography]; boiler control instruments; drying racks [photography]; apparatus for editing cinematographic film; printed circuits; flashing lights [luminous signals]; signal bells; containers for microscope slides; collectors, electric; electric installations for the remote control of industrial operations; switchboxes [electricity]; commutators; marine compasses; eyepieces; thread counters; pedometers; counters; metronomes; condensers [capacitors]; conductors, electric; electricity conduits; circuit closers; connectors [electricity]; junction boxes [electricity]; switchboards; contacts, electric; apparatus to check franking; regulating apparatus, electric; monitoring apparatus, other than for medical purposes; speed checking apparatus for vehicles; converters, electric; photocopiers [photographic, electrostatic, thermic]; eyeglass cords; retorts; retorts' stands; correcting lenses [optics]; objectives [lenses] [optics]; cosmographic instruments; diving suits; electric apparatus for commutation; switches, electric; limiters [electricity]; electric plugs; current rectifiers; cell switches [electricity]; dressmakers' measures; crucibles [laboratory]; appliances for measuring the thickness of leather; cyclotrons; counterfeit [false] coin detectors; shutter releases [photography]; densimeters; animated cartoons; laboratory trays; metal detectors for industrial or military purposes; sonars; detectors; shutters [photography]; diaphragms [acoustics]; centering apparatus for photographic transparencies; cameras [photography]; transparencies [photography]; slide projectors; distance measuring apparatus; dictating machines; diffraction apparatus [microscopy]; loudspeakers; circuit breakers; record players; microscopes; distance recording apparatus; range finders; distribution boards [electricity]; distribution consoles [electricity]; compasses for measuring; measures; measuring apparatus; dynamometers; water level indicators; fire escapes;

flash-bulbs [photography]; telephone receivers; fluorescent screens; projection screens; workmen's protective face-shields; screens [photography]; drainers for use in photography; electric loss indicators; measuring devices, electric; cables, electric; ducts [electricity]; control panels [electricity]; galvanic cells; connections for electric lines; couplings, electric; relays, electric; electrolysis apparatus for laboratory use; transmitters of electronic signals; transmitting sets [telecommunication]; cleaning apparatus for sound recording discs; sound recording strips; mileage recorders for vehicles; spools [photography]; mechanical signs; epidiascopes; test tubes; balancing apparatus; thermostats; ergometers; material testing instruments and machines; egg-candlers; gauges; gasoline gauges; spark-guards; cases especially made for photographic apparatus and instruments; testing apparatus not for medical purposes; refractometers; exposure meters [light meters]; invoicing machines; fermentation apparatus for laboratory use; railway traffic safety appliances; wires, electric; magnetic wires; plumb bobs; plumb lines; nets for protection against accidents; safety nets; safety tarpaulins; film cutting apparatus; filters for respiratory masks; filters for use in photography; battery chargers; high-frequency apparatus; frequency meters; fuses; radios; galena crystals [detectors]; galvanic batteries; gloves for protection against accidents; gloves for divers; gloves for protection against x-rays for industrial purposes; gas testing instruments; gasometers [measuring instruments]; surveying apparatus and instruments; levelling staffs [surveying instruments]; drying apparatus for photographic prints; glazing apparatus for photographic prints; rulers [measuring instruments]; measuring glassware; screens for photoengraving; grids for batteries; clothing for protection against fire; audio- and video-receivers; heliographic apparatus; holograms; hygrometers; identification threads for electric wires; identification sheaths for electric wires; life-saving apparatus and equipment; fire hose nozzles; fire engines; fire pumps; slope indicators; taximeters; quantity indicators; vacuum gauges; speed indicators; inductors [electricity]; armatures [electricity]; data processing apparatus; mirrors for inspecting work; intercommunication apparatus; carriers for dark plates [photography]; inverters [electricity]; ionization apparatus not for the treatment of air or water; peepholes [magnifying lenses] for doors; hemline markers; furniture especially made for laboratories; lactodensimeters; lactometers; darkroom lamps [photography]; optical lamps; magic lanterns; signal lanterns; lasers, not for medical purposes; optical lenses; letter scales; logs [measuring instruments]; sounding lines; magnifying glasses [optics]; signs, luminous; neon signs; eyeglasses; instruments containing eyepieces; surveyors' levels; spectacle lenses; eyewear; pressure gauges; periscopes; protective masks, not for medical purposes; mathematical instruments; coin-operated mechanisms for television sets; megaphones; computer memory devices;

carpenters' rules; mercury levels; speed measuring apparatus [photography]; precision measuring apparatus; measuring instruments; meteorological instruments; rules [measuring instruments]; micrometer screws for optical instruments; microphones; microtomes; time switches, automatic; mirrors [optics]; breathing apparatus for underwater swimming; nautical apparatus and instruments; naval signalling apparatus; navigational instruments; spectacle frames; batteries, electric; accumulators, electric; levels [instruments for determining the horizontal]; levelling instruments; prisms [optics]; observation instruments; octants; ohmmeters; wavemeters; optical apparatus and instruments; optical glass; computers; computer programs, recorded; oscillographs; oxygen transvasing apparatus; ozonizers [ozonators]; micrometers; signalling panels, luminous or mechanical; lightning conductors; parking meters; apparatus and instruments for astronomy; apparatus for measuring the thickness of skins; acid hydrometers; weighing apparatus and instruments; salinometers; washing trays [photography]; stands for photographic apparatus; viewfinders, photographic; photometers; phototelegraphy apparatus; apparatus and instruments for physics; steering apparatus, automatic, for vehicles; pince-nez; laboratory pipettes; plane tables [surveying instruments]; planimeters; ear plugs for divers; bells [warning devices]; weights; polarimeters; radiotelephony sets; radiotelegraphy sets; pressure measuring apparatus; pressure indicators; projection apparatus; cathodic anti-corrosion apparatus; teeth protectors; pyrometers; radar apparatus; vehicle radios; radiological apparatus for industrial purposes; protractors [measuring instruments]; apparatus and installations for the production of x-rays, not for medical purposes; x-ray tubes not for medical purposes; protection devices against x-rays, not for medical purposes; telephone apparatus; refractors; x-ray apparatus not for medical purposes; spectroscopes; resistances, electric; thermometers, not for medical purposes; respirators for filtering air; breathing apparatus, except for artificial respiration; rheostats; balances [steelyards]; signals, luminous or mechanical; saccharometers; probes for scientific purposes; satellites for scientific purposes; diaphragms for scientific apparatus; teaching apparatus; choking coils [impedance]; wire connectors [electricity]; locks, electric; sextants; signalling whistles; vehicle breakdown warning triangles; electro-dynamic apparatus for the remote control of signals; simulators for the steering and control of vehicles; sirens; sound transmitting apparatus; sound recording apparatus; sound reproduction apparatus; sounding apparatus and machines; sounding leads; sound locating instruments; spectrograph apparatus; spherometers; stereoscopes; stereoscopic apparatus; needles for record players; sulfitemeters; teleprinters; tachometers; screw-tapping gauges; telegraphs [apparatus]; television apparatus; telegraph wires; remote control apparatus; masts for wireless aerials; teleprompters; telephone transmitters; telerupters; binoculars;

telescopes; temperature indicators; time recording apparatus; theodolites; thermostats for vehicles; totalizers; revolution counters; speed regulators for record players; transmitters [telecommunication]; precision balances; marking gauges [joinery]; vacuum tubes [radio]; urinometers; variometers; verniers; videotapes; viscosimeters; theft prevention installations, electric; voltage regulators for vehicles; voting machines; voltmeters; apparatus for changing record player needles; stills for laboratory experiments; fuse wire; anticathodes; dog whistles; sighting telescopes for firearms; anti-theft warning apparatus; azimuth instruments; beacons, luminous; holders for electric coils; films, exposed; road signs, luminous or mechanical; life buoys; signalling buoys; buzzers; directional compasses; fog signals, non-explosive; cash registers; radiology screens for industrial purposes; identity cards, magnetic; photovoltaic cells; densitometers; disks, magnetic; floppy disks; head cleaning tapes [recording]; video recorders; computer keyboards; integrated circuits; semi-conductors; chips [integrated circuits]; cathodes; life jackets; life belts; chemistry apparatus and instruments; cinematographic film, exposed; materials for electricity mains [wires, cables]; contact lenses; containers for contact lenses; incubators for bacteria culture; solar batteries; copper wire, insulated; discharge tubes, electric, other than for lighting; electric discharge tubes, other than for lighting; diaphragms [photography]; distillation apparatus for scientific purposes; dosage dispensers; electric door bells; eyeglass cases; spectacle cases; furnaces for laboratory use; optical fibers [fibres] [light conducting filaments]; telephone wires; x-ray films, exposed; filters for ultraviolet rays, for photography; horns for loudspeakers; tripods for cameras; bar code readers; fiber optic cables; marking buoys; wafers for integrated circuits; chromatography apparatus for laboratory use; chronographs [time recording apparatus]; compact discs [audio-video]; compact discs [read-only memory]; computer operating programs, recorded; computer peripheral devices; computer software, recorded; optical condensers; acoustic couplers; couplers [data processing equipment]; decompression chambers; plotters; divers' masks; electronic pens [visual display units]; encoded magnetic cards; facsimile machines; fire boats; interfaces for computers; juke boxes for computers; knee-pads for workers; light dimmers [regulators], electric; magnetic data media; magnetic encoders; magnetic tape units for computers; microprocessors; modems; monitors [computer hardware]; monitors [computer programs]; mouse [computer peripheral]; optical character readers; optical data media; optical discs; printers for use with computers; processors [central processing units]; readers [data processing equipment]; safety restraints, other than for vehicle seats and sports equipment; scanners [data processing equipment]; smoke detectors; transistors [electronic]; x-ray photographs, other than for medical purposes; junction sleeves for electric cables; abacuses; electronic agendas; answer-

ring machines; camcorders; cassette players; compact disc players; diagnostic apparatus, not for medical purposes; disk drives for computers; electrified rails for mounting spot lights; electronic pocket translators; electronic tags for goods; fire blankets; flashlights [photography]; integrated circuit cards [smart cards]; measuring spoons; notebook computers; electronic notice boards; pocket calculators; shoes for protection against accidents, irradiation and fire; sprinkler systems for fire protection; starter cables for motors; sunglasses; time clocks [time recording devices]; video cassettes; video game cartridges; video screens; video telephones; goggles for sports; nose clips for divers and swimmers; protective helmets for sports; electronic publications, downloadable; computer programs, downloadable; navigation apparatus for vehicles [on-board computers]; decorative magnets; cordless telephones; mouse pads; personal stereos; wrist rests for use with computers; coaxial cables; fibre optic cables; covers for electric outlets; marine depth finders; electrified fences; computer game software, recorded; headphones; lighting ballasts; radio pagers; satellite navigational apparatus; solenoid valves [electromagnetic switches]; voltage surge protectors; walkie-talkies; wind socks for indicating wind direction; light-emitting electronic pointers; resuscitation mannequins [teaching apparatus]; stage lighting regulators; egg timers [sandglasses]; DNA chips; DVD players; automated teller machines [ATM]; traffic-light apparatus [signalling devices]; hands-free kits for telephones; asbestos screens for firemen; riding helmets; clothing especially made for laboratories; encoded identification bracelets, magnetic; transponders; downloadable ring tones for mobile phones; downloadable music files; downloadable image files; crash test dummies; laboratory centrifuges; printed circuit boards; USB flash drives; global positioning system [GPS] apparatus; portable media players; cell phone straps; light-emitting diodes [LED]; triodes; step-up transformers; laptop computers; fire hose; bags adapted for laptops; sleeves for laptops; digital photo frames; petri dishes; pitot tubes; stroboscopes; traffic cones; temperature indicator labels, not for medical purposes; computer software applications, downloadable; electronic book readers; smartphones; toner cartridges, unfilled, for printers and photocopiers; baby monitors; video baby monitors; lens hoods; tablet computers; encoded key cards; 3D spectacles; memory cards for video game machines; bullet-proof clothing; accelerometers; electrical adapters; life-saving capsules for natural disasters; computer hardware; solar panels for the production of electricity; mobile telephones; telescopic sights for artillery; digital signs; wearable activity trackers; chargers for electronic cigarettes; connected bracelets [measuring instruments]; covers for smartphones; cases for smartphones; selfie sticks [hand-held monopods]; calorimeters; flowmeters; reflective safety vests; electronic collars to train animals; joysticks for use with computers, other than for video games;

smartglasses; smartwatches; fire extinguishing apparatus; protective films adapted for computer screens; mouth guards for sports; head guards for sports; needles for surveying compasses; security tokens [encryption devices]; infrared detectors; covers for personal digital assistants [PDAs]; baby scales; electronic access control systems for interlocking doors; thermal imaging cameras; scales with body mass analysers; covers for tablet computers; black boxes [data recorders]; digital weather stations; charging stations for electric vehicles; interactive touch screen terminals; smart rings; electric and electronic effects units for musical instruments; audio interfaces; equalizers [audio apparatus]; subwoofers; bathroom scales; thermohygrometers; biochips; protective films adapted for smartphones; virtual reality headsets; electronic interactive whiteboards; humanoid robots with artificial intelligence for use in scientific research; audio mixers; batteries for electronic cigarettes; electronic key fobs being remote control apparatus; electronic sheet music, downloadable; t-squares for measuring; squares for measuring; square rulers for measuring; electronic numeric displays; laboratory robots; teaching robots; security surveillance robots; personal digital assistants [PDAs]; computer software platforms, recorded or downloadable; satellite finder meters; ring sizers; finger sizers; thin client computers; rearview cameras for vehicles; hand-held electronic dictionaries; resuscitation training simulators; electric wire harnesses for automobiles; snorkels; sports whistles; computer screen saver software, recorded or downloadable; selfie lenses; downloadable graphics for mobile phones; telecommunication apparatus in the form of jewellery; wearable computers; wearable video display monitors; magnetic resonance imaging [MRI] apparatus, not for medical purposes; rescue laser signalling flares; ink cartridges, unfilled, for printers and photocopiers; wah-wah pedals; height measuring instruments; hairdressing training heads [teaching apparatus]; devices for the projection of virtual keyboards; survival blankets; lifeboats; nanoparticle size analysers; ear pads for headphones; data gloves; trackballs [computer peripherals]; downloadable emoticons for mobile phones; telepresence robots; climate control digital thermostats; piezoelectric sensors; organic light-emitting diodes [OLED]; quantum dot light-emitting diodes [QLED]; droppers for measuring, other than for medical or household purposes; electric sockets; computer game software, downloadable; rescue flares, non-explosive and non-pyrotechnic; stands adapted for laptops; headgear being protective helmets; padlocks, electronic; weight belts for divers; earpieces for remote communication; parking sensors for vehicles; ticket printers; body harnesses for support when lifting loads; animal signalling rattles for directing livestock; video projectors; downloadable cryptographic keys for receiving and spending crypto assets; downloadable e-wallets; credit card terminals; biometric passports; biometric identity cards.

36 – Accident insurance underwriting; instalment loans; actuarial services; rental of real estate; brokerage; credit bureau services; real estate agency services; real estate brokerage; debt collection agency services; insurance brokerage; financial customs brokerage services; insurance underwriting; banking; real estate appraisal; charitable fund raising; mutual funds; capital investment; surety services; exchanging money; issuance of travelers' checks; clearing, financial; safe deposit services; organization of monetary collections; loans [financing]; fiscal valuation; financial evaluation [insurance, banking, real estate]; factoring; trusteeship; financing services; financial management; pawnbrokerage; real estate management; apartment house management; fire insurance underwriting; rental of apartments; rental of farms; health insurance underwriting; marine insurance underwriting; mortgage banking; savings bank services; lease-purchase financing; securities brokerage; life insurance underwriting; accommodation bureau services [apartments]; financial analysis; antique appraisal; art appraisal; cheque verification; financial consultancy; insurance consultancy; processing of credit card payments; processing of debit card payments; electronic funds transfer; providing financial information; providing insurance information; jewellery appraisal; numismatic appraisal; rent collection; stamp appraisal; issuance of tokens of value; deposits of valuables; stock exchange quotations; issuance of credit cards; rental of offices [real estate]; retirement payment services; financial sponsorship; online banking; business liquidation services, financial; repair costs evaluation [financial appraisal]; brokerage of carbon credits; financial evaluation of standing timber; financial evaluation of wool; lending against security; provident fund services; stock brokerage services; debt advisory services; arranging finance for construction projects; providing financial information via a website; financial management of reimbursement payments for others; investment of funds; stocks and bonds brokerage; providing rebates at participating establishments of others through use of a membership card; bail-bonding; rental of offices for co-working; financial appraisals in responding to calls for tenders; financial evaluation of development costs relating to the oil, gas and mining industries; financial research; real estate affairs; electronic transfer of crypto assets; financial valuation of intellectual property assets; preparation of quotes for cost estimation purposes; crowdfunding; e-wallet payment services; financial exchange of crypto assets.

42 – Chemical analysis; analysis for oil-field exploitation; architectural services; bacteriological research; chemistry services; chemical research; architectural consultancy; construction drafting; technological research; oil-well testing; cosmetic research; design of interior decor; industrial design; packaging design; material testing; conducting technical project studies; geological surveys; oil-field surveys; engineering; meteorological information; land surveying; computer



rental; computer programming; oil prospecting; research in the field of physics; mechanical research; textile testing; geological prospecting; geological research; authenticating works of art; calibration [measuring]; computer software design; updating of computer software; consultancy in the design and development of computer hardware; dress designing; graphic arts design; quality control; rental of computer software; research and development of new products for others; styling [industrial design]; underwater exploration; recovery of computer data; maintenance of computer software; computer system analysis; biological research; urban planning; surveying; computer system design; vehicle roadworthiness testing; duplication of computer programs; conversion of data or documents from physical to electronic media; creating and maintaining websites for others; hosting computer sites [web sites]; installation of computer software; cloud seeding; conversion of computer programs and data, other than physical conversion; computer software consultancy; rental of web servers; computer virus protection services; consultancy in the field of energy-saving; research in the field of environmental protection; providing search engines for the internet; digitization of documents [scanning]; handwriting analysis [graphology]; providing scientific information, advice and consultancy relating to carbon offsetting; quality evaluation of standing timber; quality evaluation of wool; monitoring of computer systems by remote access; water analysis; scientific laboratory services; energy auditing; website design consultancy; software as a service [SaaS]; information technology [IT] consultancy; scientific research; server hosting; clinical trials; off-site data backup; electronic data storage; providing information relating to computer technology and programming via a website; cartography services; providing virtual computer systems through cloud computing; information technology services provided on an outsourcing basis; technological consultancy; computer technology consultancy; telecommunications technology consultancy; weather forecasting; computer security consultancy; technical writing; interior design; unlocking of mobile phones; monitoring of computer systems to detect breakdowns; creating and designing website-based indexes of information for others [information technology services]; internet security consultancy; data security consultancy; data encryption services; monitoring of computer systems for detecting unauthorized access or data breach; electronic monitoring of personally identifying information to detect identity theft via the internet; electronic monitoring of credit card activity to detect fraud via the internet; software development in the framework of software publishing; platform as a service [PaaS]; development of computer platforms; business card design; scientific and technological research in the field of natural disasters; exploration services in the field of the oil, gas and mining industries; scientific and technological research relating to patent

mapping; research in the field of building construction; research in the field of telecommunications technology; research in the field of welding; medical research; graphic design of promotional materials; rental of meters for the recording of energy consumption; user authentication services using technology for e-commerce transactions; user authentication services using single sign-on technology for online software applications.

---

(260) AM 2023 118042 A

(800) 1664267

(151) 2022 01 27

(891) 2022 01 27

(731) WORLDWIDE EURO PROTECTION – WEP  
30 bis Rue Sainte Hélène, F-69002 LYON,  
France

(540)

## CLAW

(591) Black, white

(511)

35 – Administration of consumer loyalty programs; administration of commercial affairs; administrative processing of purchase orders; advertising; advice regarding communication [advertising]; online advertising on a computer network; advertising by mail order; direct mail advertising; bill-posting; production and dissemination of advertising material [leaflets, prospectuses, printed matter, samples]; marketing; affiliate marketing; organization and conducting of events, demonstrations, fairs and exhibitions for commercial, advertising and marketing purposes; sales promotion for others, especially on the Internet; presentation of goods on all communication media for retailing; providing information on commercial directories via the Internet; providing commercial information and advice to consumers regarding choice of goods and services; commercial information agency services; providing commercial information via websites; demonstration of goods; company administration and management; advice on business organization, administration and management; consultancy services for business management; providing advice relating to commercial transactions; negotiation and conclusion of commercial transactions for others; advisory services for creating in-store shelf spaces; assistance in the field of business management; commercial intermediation services; business management of wholesale and retail sale outlets; analysis of reactions to advertising and market studies; analysis of commercial data; compilation of information into computer databases; computerized file management services; import-export agency services; price comparison services; procurement services for others [purchasing goods and services for other businesses].

---

(260) AM 2023 118257 A

(800) 1667885

(151) 2022 04 21

(891) 2022 04 21

(731) SUOL INNOVATIONS LTD

Themistokli Dervi, 41,; HAWAII TOWER,

1st floor, Office 106; CY-1066 Nicosia, Cyprus

(540)



(591) Red, green, blue and black

(531) 27.05.10; 29.01.13

(511)

9 – Computer software applications for computers and mobile phones for coordinating transportation services, including computer software applications for automated scheduling and dispatch of motorized vehicles; computer software for automated planning and dispatch of motorized vehicles; computer programs, downloadable, for passengers, used to coordinate the cost and the drive with vehicle drivers.

39 – Traffic information; transportation information; transportation logistics, including arranging of passenger transportation services; passenger transport; providing driving directions for travel purposes; taxi transport; rental of automobiles.

(260) AM 2023 118272 A

(800) 1668358

(151) 2021 11 22

(891) 2021 11 22

(731) İHLAS HOLDİNG ANONİM ŞİRKETİ

Merkez Mahallesi, 29 Ekim Caddesi, İhlas

Plaza No:11 B/21, Yenibosna, Bahçelievler,

İstanbul, Türkiye

(540)



(591) Blue, grey and white

(531) 05.01.15; 05.01.16; 27.05.01; 29.01.13

(511)

9 – Measurement apparatus and equipment including those for scientific, nautical, topographic, meteorologic, industrial and laboratory purposes, thermometers, not for medical purposes, barometers, ammeters, voltmeters, hygrometers, testing apparatus not for medical purposes, telescopes, periscopes, directional compasses, speed indicators, laboratory apparatus, microscopes, magnifying glasses, binoculars, stills, ovens and furnaces for laboratory experiments; apparatus for recording, transmission or reproduction of sound or images, cameras, photographic cameras, television apparatus, video recorders, CD and DVD players and re-

orders, MP3 players, computers, desktop computers, tablet computers, wearable activity trackers, microphones, loudspeakers, earphones, telecommunications apparatus, apparatus for the reproduction of sound or images, computer peripheral devices, cell phones, covers for cell phones, telephone apparatus, computer printers, scanners [data processing equipment], photocopyers; magnetic and optical data carriers and computer software and programmes recorded thereto, downloadable and recordable electronic publications, encoded magnetic and optic cards; prerecorded motion picture films; prerecorded music videos; antennas, satellite antennas, amplifiers for antennas, parts of the aforementioned goods; ticket dispensers, automatic teller machines (ATM); electronic components used in the electronic parts of machines and apparatus, semi-conductors, electronic circuits, integrated circuits, chips [integrated circuits], diodes, transistors [electronic], magnetic heads for electronic apparatus, electronic locks, photocells, remote control apparatus for opening and closing doors, optical sensors; counters and quantity indicators for measuring the quantity of consumption, automatic time switches; clothing for protection against accidents, irradiation and fire, safety vests and life-saving apparatus and equipment; eyeglasses, sunglasses, optical lenses and cases, containers, parts and components thereof; apparatus and instruments for conducting, transforming, accumulating or controlling electricity, electric plugs, junction boxes [electricity], electric switches, circuit breakers, fuses, lighting ballasts, battery starter cables, electrical circuit boards, electric resistances, electric sockets, transformers [electricity], electrical adapters, battery chargers, electric door bells, electric and electronic cables, batteries, electric accumulators; solar panels for production of electricity; alarms and anti-theft alarms, other than for vehicles, electric bells; signalling apparatus and instruments, luminous or mechanical signs for traffic use; fire extinguishing apparatus, fire engines, fire hose and fire hose nozzles; radar apparatus, sonars, night vision apparatus and instruments; decorative magnets; metronomes.

16 – Paper and cardboard; paper and cardboard for packaging and wrapping purposes, cardboard boxes; paper towels; toilet paper; paper napkins; plastic materials for packaging and wrapping purposes; printing blocks and types; bookbinding material; printed publications; printed matter; books, magazines, newspapers, bill books, printed dispatch notes, printed vouchers, calendars; posters; photographs [printed]; paintings; stickers [stationery]; postage stamps; stationery, office stationery, instructional and teaching material [except furniture and apparatus]; writing and drawing implements; artists' materials; paper products for stationery purposes; adhesives for stationery purposes, pens, pencils, erasers, adhesive tapes for stationery purposes, cardboard cartons [artists' materials], writing paper, copying paper, paper rolls for cash registers, drawing materials, chalkboards, painting pencils,

watercolors [paintings]; office requisites; paint rollers and paintbrushes for painting.

35 – Advertising, marketing and public relations; organization of exhibitions and trade fairs for commercial or advertising purposes; development of advertising concepts; provision of an online marketplace for buyers and sellers of goods and services; office functions; secretarial services; arranging newspaper subscriptions for others; compilation of statistics; rental of office machines; systemization of information into computer databases; telephone answering for unavailable subscribers; business management, business administration and business consultancy; accounting; commercial consultancy services; personnel recruitment, personnel placement, employment agencies, import-export agencies; temporary personnel placement services; auctioneering; the bringing together, for the benefit of others, of a variety of goods, namely, machines, machine tools and industrial robots for processing and shaping wood, metals, glass, plastics and minerals, 3D printers, construction machines and robotic mechanisms (machines) for use in construction, bulldozers, diggers (machines), excavators, road construction and road paving machines, drilling machines, rock drilling machines, road sweeping machines, lifting, loading and transmission machines and robotic mechanisms (machines) for lifting, loading and transmission purposes: elevators, escalators and cranes, machines and robotic mechanisms (machines) for use in agriculture and animal breeding, machines and robotic mechanisms (machines) for processing cereals, fruits, vegetables and food, beverage preparation machines, electromechanical, beverage processing machines, engines and motors, other than for land vehicles, parts and fittings therefor, hydraulic and pneumatic controls for engines and motors, brakes other than for vehicles, brake linings for engines, crankshafts, transmission gears for machines, cylinders for engines, pistons for engines, turbines, not for land vehicles, filters for engines and motors, oil, air and fuel filters for land vehicle engines, exhausts for land vehicle engines, exhaust manifolds for land vehicle engines, engine cylinders for land vehicles, engine cylinder heads for land vehicles, pistons for land vehicle engines, carburetors for land vehicles, fuel conversion apparatus for land vehicle engines, injectors for land vehicle engines, fuel economisers for land vehicle engines, pumps for land vehicle engines, valves for land vehicle engines, starters for motors and engines, dynamos for land vehicle engines, sparking plugs for land vehicle engines, bearings (parts of machines), roller or ball bearings, machines for mounting and detaching tires, alternators, current generators, electric generators, current generators operated with solar energy, painting machines, automatic spray guns for paint, electric, hydraulic and pneumatic punching machines and guns, electric adhesive tape dispensers (machines), electric guns for compressed gas or liquid spraying machines, electric hand drills, electric hand saws,

electric jigsaw machines, spiral machines, compressed air machines, compressors (machines), vehicle washing installations, robotic mechanisms (machines) with the abovementioned functions, electric and gas-operated welding apparatus, electric arc welding apparatus, electric soldering apparatus, electric arc cutting apparatus, electrodes for welding machines, industrial robots (machines) with the abovementioned functions, printing machines, packaging machines, filling, plugging and sealing machines, labellers (machines), sorting machines, industrial robots (machines) with the abovementioned functions, electric packing machines for plugging and sealing of plastics, machines for textile processing, sewing machines, industrial robots (machines) with the abovementioned functions, pumps [machines], self-regulating fuel pumps, electric kitchen machines for chopping, grinding, crushing, mixing and mincing foodstuff, washing machines, laundry washing machines, dishwashers, spin driers (not heated), electric cleaning machines for cleaning floors, carpets or floorings, vacuum cleaners and parts thereof, automatic vending machines, galvanizing and electroplating machines, electric door openers and closers, joints (parts of engines), measurement apparatus and equipment including those for scientific, nautical, topographic, meteorologic, industrial and laboratory purposes, thermometers, not for medical purposes, barometers, ammeters, voltmeters, hygrometers, testing apparatus not for medical purposes, telescopes, periscopes, directional compasses, speed indicators, laboratory apparatus, microscopes, magnifying glasses, binoculars, stills, ovens and furnaces for laboratory experiments, apparatus for recording, transmission or reproduction of sound or images, cameras, photographic cameras, television apparatus, video recorders, CD and DVD players and recorders, MP3 players, computers, desktop computers, tablet computers, wearable activity trackers, microphones, loudspeakers, earphones, telecommunications apparatus, apparatus for the reproduction of sound or images, computer peripheral devices, cell phones, covers for cell phones, telephone apparatus, computer printers, scanners [data processing equipment], photocopiers, magnetic and optical data carriers and computer software and programmes recorded thereto, downloadable and recordable electronic publications, encoded magnetic and optic cards, prerecorded motion picture films, prerecorded music videos, antennas, satellite antennas, amplifiers for antennas, parts of the aforementioned goods, ticket dispensers, automatic teller machines (ATM), electronic components used in the electronic parts of machines and apparatus, semi-conductors, electronic circuits, integrated circuits, chips [integrated circuits], diodes, transistors [electronic], magnetic heads for electronic apparatus, electronic locks, photocells, remote control apparatus for opening and closing doors, optical sensors, counters and quantity indicators for measuring the quantity of consumption, automatic time switches, clothing for

protection against accidents, irradiation and fire, safety vests and life-saving apparatus and equipment, eyeglasses, sunglasses, optical lenses and cases, containers, parts and components thereof, apparatus and instruments for conducting, transforming, accumulating or controlling electricity, electric plugs, junction boxes [electricity], electric switches, circuit breakers, fuses, lighting ballasts, battery starter cables, electrical circuit boards, electric resistances, electric sockets, transformers [electricity], electrical adapters, battery chargers, electric door bells, electric and electronic cables, batteries, electric accumulators, solar panels for production of electricity, alarms and anti-theft alarms, other than for vehicles, electric bells, signalling apparatus and instruments, luminous or mechanical signs for traffic use, fire extinguishing apparatus, fire engines, fire hose and fire hose nozzles, radar apparatus, sonars, night vision apparatus and instruments, decorative magnets, metronomes, lighting installations, lights for vehicles and interior-exterior spaces, heating installations using solid, liquid or gas fuels or electricity, central heating boilers, boilers for heating installations, radiators [heating], heat exchangers, not parts of machines, stoves, kitchen stoves, solar thermal collectors [heating], steam, gas and fog generators, steam boilers, other than parts of machines, acetylene generators, oxygen generators, nitrogen generators, installations for air-conditioning and ventilating, cooling installations and freezers, electric and gas-powered devices, installations and apparatus for cooking, drying and boiling, cookers, electric cooking pots, electric water heaters, barbecues, electric laundry driers, hair driers, hand drying apparatus, sanitary installations, taps [faucets], shower installations, toilets [water-closets], shower and bathing cubicles, bath tubs, toilet seats, sinks, wash-hand basins [parts of sanitary installations], washers for water taps, water softening apparatus, water purification apparatus, water purification installations, waste water purification installations, electric bed warmers and electric blankets, not for medical use, electric pillow warmers, electric or non-electric footwarmers, hot water bottles, socks, electrically heated, filters for aquariums and aquarium filtration apparatus, industrial type installations for cooking, drying and cooling purposes, pasteurizers and sterilizers, paper and cardboard, paper and cardboard for packaging and wrapping purposes, cardboard boxes, paper towels, toilet paper, paper napkins, plastic materials for packaging and wrapping purposes, printing blocks and types, bookbinding material, printed publications, printed matter, books, magazines, newspapers, bill books, printed dispatch notes, printed vouchers, calendars, posters, photographs [printed], paintings, stickers [stationery], postage stamps, stationery, office stationery, instructional and teaching material [except furniture and apparatus], writing and drawing implements, artists' materials, paper products for stationery purposes, adhesives for stationery purposes, pens, pencils, erasers, adhesive

tapes for stationery purposes, cardboard cartons [artists' materials], writing paper, copying paper, paper rolls for cash registers, drawing materials, chalkboards, painting pencils, watercolors [paintings], office requisites, paint rollers and paintbrushes for painting, hand-operated non-electric cleaning instruments and appliances, brushes, other than paintbrushes, steel chips for cleaning, sponges for cleaning, steel wool for cleaning, cloths of textile for cleaning, gloves for dishwashing, non-electric polishing machines for household purposes, brooms for carpets, mops, toothbrushes, electric toothbrushes, dental floss, shaving brushes, hair brushes, combs, non-electric household or kitchen utensils, [other than forks, knives, spoons], services [dishes], pots and pans, bottle openers, flower pots, drinking straws, non-electric cooking utensils, ironing boards and shaped covers therefor, drying racks for washing, clothes drying hangers, cages for household pets, indoor aquariums, vivariums and indoor terrariums for animals and plant cultivation, ornaments and decorative goods of glass, porcelain, earthenware or clay, namely statues, figurines and vases, all made of glass, porcelain, earthenware or clay and cups, not of precious metal, mouse traps, insect traps, electric devices for attracting and killing flies and insects, fly catchers, fly swatters, perfume burners, perfume sprayers, perfume vaporizers, electric or non-electric make-up removing appliances, powder puffs, toilet cases, nozzles for sprinkler hose, nozzles for watering cans, watering devices, garden watering cans, unworked or semi-worked glass, except building glass, mosaics of glass and powdered glass for decoration, except for building, glass wool other than for insulation or textile use, enabling customers to conveniently view and purchase those goods, such services may be provided by retail stores, wholesale outlets, by means of electronic media or through mail order catalogues.

36 – Insurance services; financial and monetary affairs; real estate brokers, real estate agencies and real estate management; customs brokerage services.

37 – Construction services, rental of construction machines and equipment; cleaning services for buildings (interior and exterior), public areas, industrial premises; disinfecting, vermin exterminating services, other than for agriculture, rental of cleaning machines and equipment; vehicles service stations for land vehicles, maintenance, repair and refueling of land vehicles; vehicles service stations for marine vehicles, maintenance, repair and refueling of marine vehicles; repair and maintenance of air vehicles; upholstery, repair and restoration of furniture; installation, maintenance and repair of heating, cooling and sanitary installations; cleaning, care and repair of clothing; installation, maintenance and repair of industrial machines and equipment, office machines and equipment, communication apparatus, electric and electronic appliances; repair

and maintenance of lifts; clock and watch repair; mining extraction; repair of shoes, bags and belts.

38 – Radio and television broadcasting services; telecommunication services; providing access to the internet; news agencies.

39 – Land, water and air transport services; rental of land, water or air vehicles; arranging of travel tours; travel reservation; issuing of tickets for travel; courier services (messages or merchandise); car parking; garage rental; boat storage; transport by pipeline; electricity distribution; water supplying; rescue operations for vehicles and goods; storage, wrapping and packing of goods; transport and storage of trash; transport and storage of waste.

41 – Education and training; arranging and conducting of conferences, congresses and seminars; sporting and cultural activities; entertainment; ticket reservation and booking services for entertainment, sporting and cultural events, including ticket reservation and booking services for theatres, cinemas, museums and concerts; publication and editing of printed matter, including magazines, books, newspapers, other than publicity texts; electronic publication services; production of movie films, radio and television programmes; news reporters services; photographic reporting services; photography; translation.

42 – Scientific and industrial analysis and research services; engineering; engineering and architectural design services; testing services for the certification of quality and standards; computer services, namely, computer programming, computer virus protection services, computer system design, creating, maintaining and updating websites for others, computer software design, updating and rental of computer software, providing search engines for the internet, hosting websites, consultancy in the design and development of computer hardware, rental of computer hardware; industrial design services, other than engineering, computer and architectural design; graphic arts designing; authenticating works of art.

44 – Medical services; beauty care services; veterinary services, animal husbandry, animal breeding, shoeing horses [farrier services]; agriculture, horticulture and forestry services; landscape design; medical advisory services in the field of personnel health.

(260) AM 2023 118445 A  
(800) 1670851  
(151) 2022 05 12  
(891) 2022 05 12  
(731) Toruńskie Zakłady Materiałów Opatrunkowych, Spółka Akcyjna  
Żółkiewskiego 20/26, PL-87-100 Toruń, Poland  
(540)

**matosoft**

(591) Black, white  
(511)  
5 – Lining beneath cast bandages.

(260) AM 2023 118446 A  
(800) 1670874  
(151) 2022 01 12  
(891) 2022 01 12  
(731) SERANİT GRANİT SERAMİK SANAYİ VE TİCARET ANONİM ŞİRKETİ  
Sultantepe Mahallesi, Hüseyin Baykara Sokak,  
No:1, Üsküdar – İstanbul, Türkiye  
(540)

**aquanit**

(591) Light blue  
(531) 26.04.03; 26.04.18; 27.05.01; 29.01.04  
(511)  
19 – Building stone; artificial stone; calcareous stone; clinker stone; porphyry [stone]; slag stone; marble; granite; floor tiles, not of metal; wall tiles, not of metal.

(260) AM 2023 118447 A  
(800) 1670875  
(151) 2022 01 12  
(891) 2022 01 12  
(731) SERANİT GRANİT SERAMİK SANAYİ VE TİCARET ANONİM ŞİRKETİ  
Sultantepe Mahallesi, Hüseyin Baykara Sokak,  
No:1, Üsküdar – İstanbul, Türkiye  
(540)

**seranit**

(591) Dark red  
(531) 26.04.03; 26.04.18; 27.05.01; 29.01.01;  
29.01.12  
(511)  
19 – Building stone; artificial stone; calcareous stone; clinker stone; porphyry [stone]; slag stone; marble; granite; floor tiles, not of metal; wall tiles, not of metal.

(260) AM 2023 118448 A  
(800) 1670924  
(151) 2022 06 09  
(891) 2022 06 09  
(731) Tidel Engineering, L.P.  
№114, 2025 W. Belt Line Road, Carrollton  
TX 75006, USA  
(540)

**TIDEL**

(591) Black, white

(511)

9 – Electronic devices capable of receiving cash and negotiable instruments, and dispensing of cash for retail establishments and financial institution; devices capable of accepting, counting, storing, safekeeping, restricting access through timed access and other programmed policies, and reporting of all device transactions, including currency and negotiable instruments which are deposited into, and cash dispensed from, the device.

(260) AM 2023 118449 A

(800) 1670964

(151) 2022 01 19

(891) 2022 01 19

(731) ZHEJIANG RAGGIE IMP & EXP CO., LTD

Room 406, No. 937 Workers North Road,

Futian Street, Yiwu City, Jinhua City,

Zhejiang Province, China

(540)



(591) Black, white

(531) 01.03.02; 27.03.12; 27.05.01; 27.05.04

(511)

9 – Remote control apparatus; accumulators, electric; solar batteries; power station automatization equipment; electric apparatus for commutation; electronic agendas; phototelegraphy apparatus; camcorders; projection apparatus; monocrystalline silicon wafers; integrated circuits; solar panels for the production of electricity; wires, electric.

(260) AM 2023 118450 A

(800) 1671057

(151) 2021 09 17

(891) 2021 09 17

(731) Shastan Limited

62 The Street, Ashtead KT21 1AT,

United Kingdom

(540)

**CHRISTMAS PIG**

(591) Black, white

(511)

9 – Scientific, nautical, surveying, photographic, cinematographic, optical, weighing, measuring, signalling, checking (supervision), life-saving and teaching apparatus and instruments; apparatus and instruments for conducting, switching, transforming, accumulating, regulating or controlling electricity; apparatus for recording, transmission or reproduction of sound or images; magnetic data carriers, recording discs; compact discs, DVDs and other digital recording media;

mechanisms for coin-operated apparatus; cash registers, calculating machines, data processing equipment and computers; computer software; fire-extinguishing apparatus; motion picture films featuring comedy, drama, action, adventure and/or animation, and motion picture films for broadcast on television featuring comedy, drama, action, adventure and/or animation; pre-recorded vinyl records, audio tapes, audio-video tapes, audio video cassettes, audio video discs, and digital versatile discs featuring music, comedy, drama, action, adventure, and/or animation; stereo headphones; batteries; cordless telephones; mobile telephones; parts and accessories for mobile telephones; mobile telephone covers; mobile telephone cases; mobile telephone cases made of leather or imitation of leather; mobile telephone covers made of cloth or textile materials; telephone and/or radio pagers; hand-held calculators; audio cassette and CD players; CD-ROM games; video and computer game programs; video game discs, cartridges and cassettes; digital music (downloadable) provided from the Internet; digital music (downloadable) provided from MP3 Internet web sites; MP3 players; hand-held karaoke players, telephone and/or radio pagers; short motion picture film cassettes featuring comedy, drama, action, adventure and/or animation to be used with hand-held viewers or projectors; video cassette recorders and players, compact disc players, digital audio tape recorders and players, electronic diaries; radios; mouse pads; eyeglasses, sunglasses and cases therefore; audio tapes sold together with booklets; computer programs, namely, software linking digitised video and audio media to a global computer information network; video game cartridges and cassettes; and decorative magnets; global positioning systems; navigation apparatus for vehicles (on-board computers); parts and fittings for all of the aforementioned goods.

14 – Precious metals and their alloys and goods in precious metals or coated therewith, not included in other classes; jewellery, precious stones; horological and chronometric instruments; clocks; alarm clocks; desk clocks; watches; alarm watches; sporting watches; jewellery; costume jewellery; bracelets; ankle bracelets; brooches; chains; charms; cuff-links; earrings; lapel pins; tie pins; tie clips; necklaces; ornamental pins; pendants; rings; key rings; action figures (decorative) of precious metal; figurines of precious stones; figurines coated with precious metal; adhesive wall decorations of precious metal; amulets; cases for clocks, watches or jewels; cases and containers of precious metal; coins.

16 – Paper, cardboard and goods made from these materials, not included in other classes; printed matter; bookbinding material; photographs; stationery; adhesives for stationery or household purposes; artists' materials; paint brushes; typewriters and office requisites (except furniture); instructional and teaching material (except apparatus); plastic materials for packaging

(not included in other classes); printers' type; printing blocks; printed matter and paper goods, namely, books featuring characters from animated, action, adventure, comedy and/or drama features, comic books, children's books, magazines featuring characters from animated, action adventure, comedy and/or drama features, colouring books, children's activity books; booklets (all being sold together with audio tapes); writing paper, envelopes, notebooks, diaries, note cards; greeting cards, trading cards; lithographs; pens, pencils, cases therefor, erasers, crayons, markers, coloured pencils, painting sets, chalk and chalkboards; decals, heat transfers; posters; mounted and/or unmounted photographs; book covers, book marks, calendars, gift wrapping paper; paper party decorations, namely, paper napkins, paper doilies, paper place mats, crepe paper, invitations, paper table cloths, paper cake decorations; printed transfers for embroidery or fabric appliqué; printed patterns for costumes, pyjamas, sweatshirts and T-shirts; metal money clips; all the aforesaid being printed matter.

18 – Leather and imitations of leather, and goods made of these materials and not included in other classes; animal skins, hides; trunks and travelling bags; umbrellas and parasols; walking sticks; whips, harness and saddlery; athletic bags; toiletry bags, not fitted; beach bags; book bags; diaper bags; duffel bags; leather bags; school bags; shoe bags; shopping bags; tote bags; toiletry bags; suit carriers being travelling bags; waist bags; weekend bags; work bags; backpacks; knapsacks; fanny packs; waist packs; wallets; purses; chain mesh purses, not of precious metal; clutch purses; coin purses; cosmetic purses; evening purses; leather purses; purses, not of precious metal; parts and accessories for all of the aforementioned.

21 – Household or kitchen utensils and containers; combs and sponges; brushes (except paint brushes); brush-making materials; articles for cleaning purposes; steelwool; un-worked or semi-worked glass (except glass used in building); glassware, porcelain and earthenware not included in other classes; small domestic utensils and containers (not of precious metals, or coated therewith); brushes (other than paint brushes); cleaning articles and instruments, hand-operated; steel wool; unworked or semi-worked glass (excluding glass used in building); glassware, ceramic, porcelain and earthenware, not included in other classes; beverage glassware; cutting boards; bottles, sold empty; jugs; bowls; mugs; plastic water bottles; bottle openers; lunch boxes; cookie cutters; pans; kettles; dishes; non-electric waffle irons; non-electric coffee pots not of precious metal; plates not of precious metal; buckets; plastic buckets; ice pails buckets; champagne buckets; shower caddies, not of precious metal; tea caddies, not of precious metal; soap boxes; vacuum bottles; hair combs; cleaning combs; powder compacts sold empty; decorative boxes of glass; dusting

brushes; hair brushes; brushes for clothes; bathroom pails; cake molds; plastic coasters; coffee cups; all-purpose portable household containers; drinking glasses; demitasse sets consisting of cups and saucers; cocktail shakers; thermal insulated containers for food or beverages; cork screws; corn cob holders; decanters; drinking flasks; sugar and creamer sets; infant cups; cookie jars; napkin holders; towel holders; toothpicks; toothpick holders; paper cups; paper plates; non-metal piggy banks; plastic cups; salt shakers; pepper pots; shoe horns; window dusters; toothbrushes; toothbrush cases; wash basins; waste baskets; incense pots; baby bath tubs; bird cages; serving trays not of precious metal; serving utensils, namely, pie servers, cake turners, spatulas, scrapers and cake servers; vases not of precious metal; household containers of plastic for storing feminine hygiene products; toilet cases; candle holders, not of precious metal; statues and figurines made of china, ceramic, earthenware, glass and porcelain; chopsticks; gardening gloves; rubber household gloves; barbecue mitts, dish cloths, pot holders; parts and accessories for all of the aforementioned.

24 – Textiles and textile goods, not included in other classes; bed covers, table covers; travelling rugs; lap rugs; towels; bed linen, blankets, bedspreads, quilts, bed canopies, bed pads, bed sheets, pillow cases, comforters, duvet covers, mattress covers, mosquito nets, pillow shams; sleeping bags (sheeting); cloth; fabric; table covers and table linen; place mats; textile napkins, serviettes and table runners; kitchen linens, namely, cloth doilies, cloth napkins, fabric table cloths, kitchen towels, fabric place mats, oven mitts, washing mitts, fabric table runners, cloth coasters; curtains; draperies; curtain holders of cloth; banners; handkerchiefs; bath linen; bath towels and wash cloths; household linen; fabric place mats; coverings of textile and of plastic for furniture; covers for toilet lids of fabric; covers for cushions; loose covers for furniture; textile wall hangings; shower curtains; cotton, polyester and/or nylon fabric; fabric of imitation animal skins; upholstery fabrics; lingerie fabric; golf towels.

25 – Clothing, footwear, headgear; clothing for men, women and children, namely, shirts, T-shirts, sweatshirts, jogging suits, trousers, jeans, pants, shorts, tank tops, rainwear, cloth bibs, skirts, blouses; dresses, suspenders, sweaters, jackets, coats, raincoats, snow suits, ties, robes, hats, caps, sun visors, belts, scarves, sleepwear, pyjamas, lingerie, underwear, boots, shoes, sneakers, sandals, booties, slipper socks, swimwear and masquerade and Halloween costumes.

28 – Games and playthings; gymnastic and sporting articles not included in other classes; decorations for Christmas trees; toys and sporting goods, toys, action figures and accessories therefor; plush toys; balloons; bathtub toys; ride-on toys; playing cards; playing cards and card games; toy vehicles; dolls; flying discs; amusement apparatus for use in arcades; stand alone

video output game machines; coin or counter operated arcade games; pinball game machines; electronic hand-held game units; game equipment sold as a unit for playing a board game, a card game, a manipulative game, a parlor game, a parlor-type computer game, an action type target game; jigsaw and manipulative puzzles; paper party favors; paper hats; paper face masks; masquerade and Halloween masks; skateboards; ice skates; water squirting toys; balls, namely, playground balls, soccer balls, baseballs, basketballs; baseball gloves; surfboards; swimming floats for recreational use; kickboard flotation devices for recreational use; swim boards for recreational use; swim fins; toy zip guns; toy bakeware and toy cookware; toy banks; toy snow globes; Christmas tree ornaments; swimming floats; kickboard flotation devices; swim boards; paper party hats; game equipment sold as a unit for playing a parlor-type computer game; paper hats.

30 – Coffee, tea, cocoa and artificial coffee; rice, tapioca and sago; flour and preparations made from cereals; bread, pastry and confectionery; ices; sugar, honey, treacle; yeast, baking-powder; salt, mustard; vinegar, fruit sauces, sauces (condiments); spices; ice; pasta; cookies, breakfast cereal, bubble gum, cake decorations made of candy, chewing gum, frozen confections, crackers, frozen yoghurt, ice cream, pretzels, confectionery chips, malt for food; soybean malt; malt biscuits; sugar confectionery; candy, candy bars, candy mints; chocolate; chocolate confectionery; chocolate decorations for Christmas trees; cakes; cake preparations; edible decorations for cake; popcorn; flavoured popcorn; cereal based snack foods; rice cakes; crisp snack food products made from cereals; crispbread snacks; savory snack foods prepared from cereal, maize, rice and/or flour; flour based savory snacks; corn chips; tortillas; pastilles; pastries; custard; custard mixes and powder; coffee beverages with milk; cocoa beverages with milk, chocolate-based beverages, coffee and coffee-based beverages, cocoa and cocoa-based beverages; tea, ginseng tea, black tea, oolong tea, barley and barley-leaf tea; meat tenderisers for household purposes; binding agents for ice-cream; prepared meals consisting primarily of pasta or rice; flavorings, other than essential oils, for milk shakes; prepared cooked meals, prepared frozen meals, all included in this class; canned pasta foods.

32 – Beers; mineral and aerated waters and other non-alcoholic beverages; fruit beverages and fruit juices; syrups and other preparations for making beverages; vegetable juice for beverages; sweet drinks prepared with rice and malt, fruit powder, fruit syrup, concentrated fruit juice; lemonades and syrup for lemonade; cola syrup; powders for effervescing beverages; pastilles for effervescing beverages; non-alcoholic beverages, namely soft drinks, fruit nectars; fruit juices, fruit drinks, fruit flavoured soft drinks, fruit punch, seltzer water, soda water, drinking water and sports drinks;

preparations for making aerated water and juice; mineral and spring water.

35 – Advertising; business management; business administration; office functions; marketing and business research; promotion; advertising and promotions provided on-line from a computer data base or the internet; provision of space on web sites for advertising goods and services; market surveys; analysis of advertising response and market research; the bringing together, for the benefit of others, of a variety of goods, namely paints, varnishes, lacquers, preservatives against rust and against deterioration of wood, colourants, mordants, raw natural resins, metals in foil and powder form for painters, decorators, printers and artists, bleaching preparations and other substances for laundry use, cleaning, polishing, scouring and abrasive preparations, soaps, perfumery, essential oils, cosmetics, hair lotions, dentifrices, non-medicated toilet preparations, cosmetic and toilet preparations for use in the bath, preparations for the hair, shampoo and conditioners, liquid bath soap, gel soap, bar soap, bubble bath, shower gel, toothpaste, mouthwash, sun-tanning preparations, sunscreen preparations, namely cream and lotion, pre-shave and after-shave cream and lotions, cleansing, toning, moisturising and exfoliating preparations and substances, emollient preparations and substances, body cream and lotion, hand cream and lotion, skin cleanser and non-medicated body soaks, deodorant and anti-perspirant preparations, body deodorant, cologne and perfume, bath powder and perfumed body powder, bath oil, bath gel and non-medicated bath salts, baby oil, baby powder, baby gel and baby lotion, cosmetics all for sale as part of a kit, make-up preparations, lipstick, lip gloss, non-medicated lip balm, mascara, face powder, face cream, nail enamel, nail care and manicure kits, false nails, sachets for perfuming linen, essential oils, massage oils and lotions all for sale as part of a kit, aromatherapy preparations, incense, industrial oils and greases, lubricants, dust absorbing, wetting and binding compositions, fuels (including motor spirit) and illuminants, candles, wicks, pharmaceutical and veterinary preparations, sanitary preparations for medical purposes, dietetic substances adapted for medical use, plasters, materials for dressings, material for stopping teeth, dental wax, disinfectants, preparations for destroying vermin, fungicides, herbicides, food for babies, air fresheners, vitamins, drinks predominantly of vitamins, health food supplements made principally of vitamins, pharmaceutical preparations containing vitamins, vitamin and mineral supplements, preparations consisting of mixtures of vitamins and minerals, adhesive plastic and cloth bandages for skin wounds, alcohol for topical use, baby aspirin, common metals and their alloys, small items of metal hardware, goods of common metal, metal key holders, metal key rings, metal key chains, metal key clips and metal money clips, identification bracelets made of metal and non-precious metal bracelets, decorative metal boxes, je-



wellery boxes made of metal/non-precious metal, letter boxes made of metal, figurines of common metal, and decorative tin cans (made of non-precious metal), goods of common metal, scientific, nautical, surveying, electric, photographic, cinematographic, optical, weighing, measuring, signalling, checking (supervision), life-saving and teaching apparatus and instruments, apparatus and instruments for conducting, switching, transforming, accumulating, regulating or controlling electricity, apparatus for recording, transmission or reproduction of sound or images, magnetic data carriers, recording discs, automatic vending machines and mechanisms for coin-operated apparatus, cash registers, calculating machines, data processing equipment and computers, fire-extinguishing apparatus, motion picture films featuring comedy, drama, action, adventure and/or animation, and motion picture films for broadcast on television featuring comedy, drama, action, adventure and/or animation, pre-recorded vinyl records, audio tapes, audio-video tapes, audio video cassettes, audio video discs, and digital versatile discs featuring music, comedy, drama, action, adventure, and/or animation, stereo headphones, batteries, cordless telephones, mobile telephones, parts and accessories for mobile telephones, mobile telephone covers, mobile telephone cases, mobile telephone cases made of leather or imitation of leather, mobile telephone covers made of cloth or textile materials, telephone and/or radio pagers, hand-held calculators, audio cassette and CD players, CD-ROM games, video and computer game programs, video game discs, cartridges and cassettes, digital music (downloadable) provided from the Internet, digital music (downloadable) provided from MP3 Internet web sites, MP3 players, hand-held karaoke players, telephone and/or radio pagers, short motion picture film cassettes featuring comedy, drama, action, adventure and/or animation to be used with hand-held viewers or projectors, video cassette recorders and players, compact disc players, digital audio tape recorders and players, electronic diaries, radios, mouse pads, eyeglasses, sunglasses and cases therefore, audio tapes sold together with booklets, computer programs, namely, software linking digitised video and audio media to a global computer information network, game equipment sold as a unit for playing a parlor-type computer game, video and computer game programs, video game cartridges and cassettes, and decorative magnets, swimming floats, kickboard flotation devices, swim boards, global positioning systems, navigation apparatus for vehicles (on-board computers), parts and fittings for all of the aforementioned goods, precious metals and their alloys and goods in precious metals or coated therewith, jewellery, precious stones, horological and chronometric instruments, clocks, alarm clocks, desk clocks, watches, alarm watches, sporting watches, jewellery, costume jewellery, bracelets, ankle bracelets, brooches, chains, charms, cuff-links, earrings, lapel pins, tie

clips, necklaces, ornamental pins, pendants, rings, key rings, belt buckles of precious metal for clothing, action figures (decorative) of precious metal, figurines of precious stones, figurines coated with precious metal, adhesive wall decorations of precious metal, amulets, cases for clocks, watches or jewels, cases and containers of precious metal, coins, musical instruments, paper, cardboard and goods made from these materials, printed matter, bookbinding material, photographs, adhesives for stationery or household purposes, artists' materials, paint brushes, typewriters and office requisites, instructional and teaching material, plastic material for packaging, printers' type, printing blocks, printed matter and paper goods, namely, books featuring characters from animated, action, adventure, comedy and/or drama features, comic books, children's books, magazines featuring characters from animated, action adventure, comedy and/or drama features, colouring books, children's activity books, booklets (all being sold together with audio tapes), stationery, writing paper, envelopes, notebooks, diaries, note cards, greeting cards, trading cards, lithographs, pens, pencils, cases therefor, erasers, crayons, markers, coloured pencils, painting sets, chalk and chalkboards, decals, heat transfers, posters, mounted and/or unmounted photographs, book covers, book marks, calendars, gift wrapping paper, paper party decorations, namely, paper napkins, paper doilies, paper place mats, crepe paper, invitations, paper table cloths, paper cake decorations, printed transfers for embroidery or fabric appliquéés, printed patterns for costumes, pyjamas, sweatshirts and T-shirts, leather and imitations of leather, and goods made of these materials, animal skins, hides, trunks and travelling bags, umbrellas, parasols and walking sticks, whips, harness and saddlery, athletic bags, bath bags, beach bags, book bags, diaper bags, duffel bags, leather bags, school bags, shoe bags, shopping bags, tote bags, toiletry bags, suit carriers being travelling bags, waist bags, weekend bags, work bags, backpacks, knapsacks, fanny packs, waist packs, wallets, purses, chain mesh purses, not of precious metal, clutch purses, coin purses, cosmetic purses, evening purses, leather purses, purses, not of precious metal, parts and accessories for all of the aforementioned, furniture, office furniture, mirrors, picture frames, photograph frames, photograph frames of metal, wood or paper, wall plaques, key cards (not encoded), curtain holders, hooks, rails, rings, rods, rollers and tie-backs, bamboo, bamboo curtains and bamboo blinds, bead curtains, blinds, jewellery boxes, storage containers, trunks and chests, cabinets, chairs, desks and tables, dressing tables, easy chairs, beds and water beds, bedding (not including linen), bed fittings not of metal, bedsteads, furniture screens, clothes hooks and coat hangers, coat stands, garment covers, cushions, divans, mats, mattresses, pillows, support pillows for use in baby car safety seats, support pillows for use in baby seating, sleeping bags, door fittings and door furniture, drinking straws, flower

stands, footstools, hat stands, display boards, bottle caps not of metal, bottle casings of wood, bottle racks, magazine racks, plate racks, mirror tiles, trays not of metal, containers of wood and of plastic, high chairs for babies, playpens for babies and walkers for infants, mobiles, cots, cradles and cribs, chimes, inflatable publicity objects, statuettes and figurines of wood, wax, plaster and of plastic, works of art of wood, wax, plaster and of plastic, parts and accessories for the foregoing, small domestic utensils and containers (not of precious metals, or coated therewith), combs and sponges, brushes (other than paint brushes), brush-making materials, instruments and material for cleaning purposes, steel wool, unworked or semi-worked glass, glassware, ceramic, porcelain and earthenware, beverage glassware, cutting boards, bottles, sold empty, jugs, bowls, mugs, plastic water bottles, bottle openers, lunch boxes, cookie cutters, pans, kettles, dishes, non-electric waffle irons, non-electric coffee pots not of precious metal, plates not of precious metal, buckets, plastic buckets, ice pails buckets, champagne buckets, shower caddies, not of precious metal, tea caddies, not of precious metal, soap boxes, vacuum bottles, hair combs, cleaning combs, powder compacts sold empty, non-metal decorative boxes, dusting brushes, hair brushes, brushes for clothes, bathroom pails, cake moulds, plastic coasters, coffee cups, all purpose containers, drinking glasses, demitasse sets consisting of cups and saucers, plastic coasters, cocktail shakers, thermal insulated containers for food or beverages, cork screws, corn cob holders, decanters, drinking flasks, sugar and creamer sets, infant cups, cookie jars, napkin holders, towel holders, toothpicks, toothpick holders, paper cups, paper plates, non-metal piggy banks, plastic cups, salt shakers, pepper pots, shoe horns, window dusters, toothbrushes, toothbrush cases, wash basins, waste baskets, incense pots, baby bath tubs, bird cages, serving trays not of precious metal, serving utensils, namely, pie servers, cake turners, spatulas, scrapers and cake servers, vases not of precious metal, cases for personal hygiene products, toilet cases, candlestick holders not of precious metal, statues and figurines made of china, ceramic, earthenware, glass and porcelain, chopsticks, gardening gloves, rubber household gloves, parts and accessories for all of the aforementioned, textiles and textile goods, bed and table covers, rugs, travelling rugs, lap rugs, towels, bed linen, blankets, bedspreads, quilts, canopies, bed pads, bed sheets, pillow cases, comforters, duvet covers, mattress covers, crib bumpers, mosquito nets, pillow shams, sleeping bags (sheeting), cloth, fabric, table covers and table linen, place mats, napkins, serviettes and table runners, kitchen linens, namely, barbecue mitts, cloth doilies, cloth napkins, dish cloths, fabric table cloths, kitchen towels, fabric place mats, oven mitts, washing mitts, fabric table runners, pot holders, cloth coasters, curtains, draperies, curtain holders of cloth, banners, handkerchiefs, bath linen, bath towels and wash

cloths, household linen, mats of linen, coverings of textile and of plastic for furniture, covers for toilet lids of fabric, covers for cushions, loose covers for furniture, textile wall hangings, shower curtains, cotton, polyester and/or nylon fabric, fabric of imitation animal skins, upholstery fabrics, lingerie fabric, golf towels, clothing, footwear, headgear, clothing for men, women and children, namely, shirts, T-shirts, sweatshirts, jogging suits, trousers, jeans, pants, shorts, tank tops, rainwear, cloth bibs, skirts, blouses, dresses, suspenders, sweaters, jackets, coats, raincoats, snow suits, ties, robes, hats, caps, sun visors, belts, scarves, sleepwear, pyjamas, lingerie, underwear, boots, shoes, sneakers, sandals, booties, slipper socks, swimwear and masquerade and Halloween costumes, lace and embroidery, ribbons and braid, buttons, hooks and eyes, pins and needles, sewing thimbles, artificial flowers, buttons, badges for wear, not of precious metal, adhesive patches, articles and ornaments for the hair, hair bands, hair pins, barrettes, bows for the hair, decorative brooches (clothing accessories), sewing boxes, cosies for beverages or food, cushions for pins, decorative bows, ribbons and tapes, embroidery, haberdashery, shoe laces, carpets, rugs, mats and matting, floor coverings, linoleum and other materials for covering existing floors, vinyl floor coverings, wall hangings (non-textile), tapestry (wall hangings), not of textile, wallpaper, vinyl and linoleum floor coverings, ceiling coverings, bath mats, door mats, reed mats, gymnasium mats, toys, games and playthings, gymnastic and sporting articles toys and sporting goods, action figures and accessories therefor, plush toys, balloons, bathtub toys, ride-on toys, playing cards, equipment sold as a unit for playing card games, toy vehicles, dolls, flying discs, amusement apparatus for use in arcades, stand alone video output game machines, coin or counter operated arcade games, pinball game machines, electronic hand-held game units, game equipment sold as a unit for playing a board game, a card game, a manipulative game, a parlour game, a parlour-type computer game, an action type target game, jigsaw and manipulative puzzles, paper party favours, paper hats, paper face masks, masquerade and Halloween masks, skateboards, ice skates, water squirting toys, balls, namely, playground balls, soccer balls, baseballs, basketballs, baseball gloves, surfboards, swimming floats for recreational use, kickboard flotation devices for recreational use, swim boards for recreational use, swim fins, toy zip guns, toy bake ware and toy cookware, toy banks, toy snow globes, Christmas tree ornaments, meat, fish, poultry and game, meat extracts, preserved, dried and cooked fruits and vegetables, jellies, jams, eggs, milk and milk products, edible oils and fats, processed and dried vegetables, processed and dried fruits, processed ginseng, raisins, nuts, food products made from nuts, fruit salads, fruit jellies, dairy puddings, dessert puddings, marmalade, yoghurt, preserved onions, preserved olives, crystallized

fruits, vegetable and fruit juices for cooking, jams, chocolate nut butter, cocoa butter and peanut butter, canned fruits and vegetables, pickles, soybean-based food beverage used as a milk substitute, frozen fruits and vegetables, processed and dried meat, seafood, margarine, foodstuffs in the form of snack foods, snack foods made from meat, snack foods made from pre-cooked vegetables, snack foods made from eggs, corn snacks (other than confectionery), potato snacks, potato chips, potato crisps, cheese, cheese in the form of dips, spreads and sticks, milk shakes, dairy products for making milk shakes, preparations for making milk shakes, prepared meals, prepared cooked meals, prepared frozen meals, sugar, rice, tapioca, sago, artificial coffee, flour and preparations made from cereals, ices, pasta, honey, treacle, yeast, baking-powder, salt, mustard, vinegar, fruit sauces, sauces (condiments), spices, ice, cookies, breakfast cereal, bubble gum, cake decorations made of candy, chewing gum, frozen confections, crackers, frozen yoghurt, ice cream, pretzels, peanut butter, confectionery chips, malt for food, soybean malt, malt biscuits, sugar confectionery, candy, candy bars, candy mints, chocolate, chocolate confectionery, chocolate decorations for Christmas trees, cakes, cake preparations, edible decorations for cake, popcorn, flavoured popcorn, cereal based snack foods, rice cakes, crisp snack food products, crisp bread snacks, prepared savoury foodstuffs in the form of snack foods, flour based savoury snacks, corn chips, tortillas, pastilles, pastries, custard, custard mixes and powder, coffee beverages with milk, cocoa beverages with milk, chocolate-based beverages, coffee and coffee-based beverages, cocoa and cocoa-based beverages, tea, namely, ginseng tea, black tea, oolong tea, barley and barley-leaf tea, meat tenderisers for household purposes, binding agents for ice-cream, prepared meals, prepared cooked meals, prepared frozen meals, canned pasta foods, mineral and aerated waters and other non-alcoholic drinks, fruit drinks and fruit juices, syrups and other preparations for making beverages, vegetable juice for beverages, sweet drinks prepared with rice and malt, fruit powder, fruit syrup, concentrated fruit juice, lemonades and syrup for lemonade, cola syrup, powders for effervescing beverages, pastilles for effervescing beverages, non-alcoholic beverages, namely soft drinks, fruit nectars, fruit juices, fruit drinks, fruit flavoured soft drinks, fruit punch, seltzer water, soda water, drinking water and sports drinks, preparations for making aerated water and juice, mineral and spring water, industrial oils and greases, lubricants, dust absorbing, wetting and binding compositions, fuels (including motor spirit) and illuminants, candles and wicks for lighting, additives, non-chemical, to motor-fuel, alcohol [fuel], anthracite, arms [weapons] (grease for -), beeswax, belting wax, benzene, benzine, benzol, bone oil for industrial purposes, briquettes (combustible -), candles, carnauba wax, castor oil for technical purposes, ceresine, charcoal [fuel], Chris-

mas tree candles, coal, coal briquettes, coal dust [fuel], coal naphtha, coal tar oil, coke, combustible oil, cutting fluids, diesel oil, dust binding compositions for sweeping, dust laying compositions, dust removing preparations, electrical energy, ethanol [fuel], firelighters, firewood, fish oil, not edible, fuel, fuel gas, fuel with an alcoholic base, gas for lighting, gas (solidified -) [fuel], gasoline, grease for belts, grease for leather, grease for shoes, illuminating grease, illuminating wax, industrial grease, industrial oil, industrial wax, kerosene, lamp wicks, leather (preservatives for -) [oils and greases], lighting fuel, lignite, ligroin, lubricants, lubricating graphite, lubricating grease, lubricating oil, mazut, methylated spirit, mineral fuel, moistening oil, motor fuel, motor oil, naphtha, nightlights [candles], non-slipping preparations for belts, oil for the preservation of leather, oil for the preservation of masonry, oil-gas, oils for paints, oils for releasing form work [building], oleine, ozokerite [ozokerite], paper spills for lighting, paraffin, peat (blocks of -) [fuel], peat [fuel], perfumed candles, petroleum ether, petroleum jelly for industrial purposes, petroleum, raw or refined, producer gas, rape oil for industrial purposes, soya bean oil preparations for non-stick treatment of cooking utensils, stearine, sunflower oil for industrial purposes, tallow, textile oil, tinder, vaporized fuel mixtures, wax [raw material], wicks for candles, wood briquettes, wood spills for lighting, wool grease, xylene and xylol enabling customers to conveniently view and purchase said goods from a general merchandise catalogue, by mail order, by means of telecommunications, by means of a general merchandise store, internet web site, a department store, a toy, gift and novelty retail store, a film and television merchandise retail store and through a television shopping channel; management of performing artists; information, advice and consultancy relating to all the aforesaid services.

41 – Education; providing of training; entertainment; sporting and cultural activities; entertainment services in the nature of live-action, comedy, drama and/or animated television programmes; production of live-action comedy, drama and/or animated television programmes; entertainment services in the nature of live-action comedy, drama and/or animated motion picture theatrical films; production of live-action, comedy, drama and/or animated motion picture theatrical films; and theatrical performances both animated and live action; production of audio and video recording for recitals; education and entertainment services provided via a global computer network; information relating to education and entertainment provided on-line from a computer database or the Internet; electronic games services provided via a global computer network; providing on-line publications (non-downloadable); on-line publication of electronic books and journals (non-downloadable); publication of printed media and recordings; publication of sheet music; organising of entertainment and social events; booking

of entertainment; entertainer services; club entertainment services; provision of dancing facilities; night-club, discotheque, music hall, concert, dance hall, ballroom, cabaret services; circuses; provision of live entertainment; production of live entertainment; arranging of visual and musical entertainment; audio-visual display presentation services for entertainment purposes; organising of events, exhibitions and shows for entertainment purposes; production of audio entertainment; production of entertainment shows featuring dancers and singers; music competition services; organisation of balls; organisation of shows; providing karaoke services; providing entertainment services; training of performance artists; provision of entertainment services on cruise ships; video arcade services; providing amusement arcade services; amusement arcade machine rental services; theme park services; amusement park services with a theme of films; amusement park services with a theme of radio productions; amusement park services with a theme of television productions; education and training services relating to the establishment, operation, administration, management and conduct of amusement and theme parks; movie studios; recording studio services; television entertainment; cinema services; providing cinema and theatre facilities; booking agency services for cinema tickets; rental and leasing of movie projectors and accessories; rental of cinematographic and motion picture films; distribution of cinematographic and motion picture films; editing of cinematographic and motion picture films; showing of cinematographic and motion picture films; cinema theatre services; education and training services relating to the establishment, operation, administration, management and conduct of cinemas and theatres; training services for cinema technicians; providing of sports facilities; providing of recreation facilities, services and amenities; leisure centre and boating lake services; provision of swimming facilities, services and amenities; tenpin bowling alley and bowling green services; providing of golf facilities; providing of tennis court facilities; health and fitness club services; providing of casino and gaming facilities; booking of seats for shows; organisation of quizzes, games and competitions; organisation of beauty competitions; organisation of sporting competitions; rental of diving equipment; rental of sports equipment; arranging, planning and conducting of conferences, seminars and exhibitions; information, advice and consultancy relating to all the aforesaid services.

42 – Scientific and technological services and research and design relating thereto; industrial analysis and research services; design and development of computer hardware and software; consultancy in the design and development of computer hardware; computer software consultancy; computer programming; computer software support and consultation services for managing computer systems, databases and applications; graphic design for the compilation of web

pages on the Internet; technological information relating to computer hardware or software provided online from a global computer network or the internet; creating and maintaining web-sites; hosting the web-sites of others; computer software design for others and consultancy relating thereto; architectural services for the design of cinemas and theatres; information, advice and consultancy relating to all the aforesaid services.

45 – Legal services; security services for the protection of property and individuals; personal and social services rendered by others to meet the needs of individuals; intellectual property licensing services; issue of licensing rights relating to films, television productions and video productions; management of intellectual property rights; legal advisory services provided to cinema operators.

(260) AM 2023 118451 A

(800) 1671125

(151) 2022 05 06

(891) 2022 05 06

(731) Midea Group Co., Ltd.

B26-28F, Midea Headquarter Building, No. 6  
Midea Avenue, Beijiao, Shunde, Foshan,  
Guangdong, China

(540)

ALL EASY Pro

(591) Black, white

(531) 27.05.01; 27.05.25

(511)

11 – Air-conditioning installations; air-conditioning apparatus; ventilation [air-conditioning] installations and apparatus; ventilation [air-conditioning] installations for vehicles; air sterilizers; humidifiers; dehumidifiers; heat pumps; heating installations; disinfectant apparatus.

(260) AM 2023 118452 A

(800) 1671145

(151) 2022 04 20

(891) 2022 04 20

(731) Khmelevskaya Olga Mikhailovna

str. 40-letiya Pobedy, h. 16, fl. 272, Ul'yanovsk,  
RU-432017 Ul'yanovskaya obl., Russian  
Federation

(540)

ЗАЖИВИТЕЛЬ  

(591) White, green, red and black

(531) 26.04.09; 26.04.24; 28.05; 29.01.13

(511)

3 – Cosmetics, including cosmetic creams, beauty gels, beauty masks, balms, other than for medical pur-

poses, oils for cosmetic purposes; shampoos; cosmetic preparations for slimming purposes; essential oils; lotions for cosmetic purposes; cosmetic kits; non-medicated dentifrices; deodorants for personal use; sanitary preparations being toiletries; tissues impregnated with cosmetic lotions; bath salts, not for medical purposes; cosmetic preparations for baths; antiperspirants [toiletries].

(260) AM 2023 118453 A

(800) 1671174

(151) 2022 04 27

(891) 2022 04 27

(731) KIRIN HOLDINGS KABUSHIKI KAISHA

(also trading as Kirin Holdings Company, Limited)

10-2, Nakano 4-Chome, Nakano-Ku, Tokyo

164-0001, Japan

(540)

**KIRIN**

(591) Black, white

(531) 27.05.01; 27.05.17

(511)

1 – Lactic acid bacteria, other than for medical or veterinary purposes; lactic acid bacteria-based food additives [chemicals]; chemicals containing lactic acid bacteria; lactic acid; substances for regulating plant growth containing lactic acid bacteria; fertilizers containing lactic acid bacteria; higher fatty acids containing lactic acid bacteria; milk ferments for the food industry; lactic acid bacteria as an ingredient for food and beverages; lactic acid bacteria as an ingredient for dietary and nutritional supplements; lactic acid bacteria for use in the manufacture of food and beverages; lactic acid bacteria for use in the manufacture of dietary and nutritional supplements; lactic acid bacteria in the form of powders for use in the manufacture of food and beverages; lactic acid bacteria in the form of powders for use in the manufacture of dietary and nutritional supplements; lactic acid bacterial strain for use in the manufacture of food and beverages; lactic acid bacterial strain for use in the manufacture of dietary and nutritional supplements; lactic acid bacterial strain for use in the manufacture of animal feeds; lactic acid bacteria in the form of powders for use in the manufacture of animal feeds; artificial sweeteners containing lactic acid bacteria; flour and starch for industrial purposes containing lactic acid bacteria; bacteria for use in the manufacture of food; cultures of microorganisms, other than for medical and veterinary use; chemical additives for use in manufacture of food and beverages; chemicals for use in the manufacture of food and beverages; chemicals for use in the manufacture of dietary and nutritional supplements; chemicals for use in the manufacture of pharmaceuticals; chemicals; fertilizers; higher fatty acids; artificial sweeteners; flour and starch for industrial purposes.

(260) AM 2023 118455 A

(800) 1171079

(151) 2013 04 03

(891) 2022 04 25

(731) Khmelevskaya Olga Mikhailovna

str. 40-letiya Pobedy, h. 16, fl. 272,

RU-432017 Ul'yanovsk, Russian Federation

(540)



(591) White, green

(531) 26.04.18; 27.07.01; 28.05; 29.01.12

(511)

3 – Perfumery; essential oils; cosmetics; hair lotions including petroleum jelly for cosmetic purposes; perfumes; cosmetic pencils; cosmetic creams; nail polish; hair lotions; shaving lotions; lotions for cosmetic purposes; beauty masks; oils for cosmetic purposes; essential oils; medicated soap; cosmetic kits; eau de Cologne; cosmetic preparations for baths; cosmetic preparations for slimming purposes; cosmetic preparations for skin care; shampoos; deodorants and antiperspirants for personal use; hair spray; cleansing milk for toilet purposes; pomades for cosmetic purposes; toiletries; mouth washes, not for medical purposes; extracts of flowers [perfumes].

(260) AM 2023 118456 A

(800) 1195792

(151) 2014 02 13

(891) 2022 06 17

(731) Cult Beauty Limited

Ground Floor, 46 Colebrooke Row, London

N1 8AF, United Kingdom

(540)

**CULT BEAUTY**

(591) Black, white

(511)

3 – Perfume; eau de parfum, eau de toilette; cosmetics; skin care products, namely skin conditioners, skin lotions, skin cream and skin moisturisers; essential oils for personal use; beauty masks; cold cream, hand cream, night cream; body powder; soaps, namely skin soaps and liquid hand soaps; body scrubs; shower and bath washes, oils, gels and lotions; shampoos, conditioners, hair care products, hair spray, hair styling products, hair dyes and colorants, hair fragrances; cosmetics; skin care products; perfumes; toilet waters; non-medicated toilet preparations; cosmetics; soaps; essential oils; hair lotions, preparations for the hair; depilatory preparations; non-

medicated cleaning preparations for personal hygiene purposes; anti-perspirants; dentifrices; pot pourri; preparations for the bath.

(260) AM 2023 118457 A

(800) 1223972

(151) 2014 07 04

(891) 2022 06 07

(731) BTL Industries

8 Tzar Kaloyan str, BG-1000 Sofia, Bulgaria

(540)



(591) Black, white

(531) 27.05.11

(511)

10 – Medical and surgical apparatus and instruments, devices for treatment of cellulite, therapeutic devices for toning of the body.

(260) AM 2023 118458 A

(800) 1269210

(151) 2015 05 21

(891) 2022 06 07

(731) KOCAER TEKSTIL SANAYI VE TICARET A.S.

Adnan Menderes Bulvarı No. 53, Gümüşler Merkez Denizli, Türkiye

(540)



(591) Dark blue, white

(531) 26.13.25; 29.01.12

(511)

3 – Bleaching and cleaning preparations, detergents other than for use in manufacturing operations and for medical purposes, laundry bleach, fabric softeners for laundry use, stain removers, dishwasher detergents; soaps; dental care preparations, dentifrices, denture polishes, tooth whitening preparations, mouth washes, not for medical purposes; abrasive preparations; emery cloth; sandpaper; pumice stone; abrasive pastes; polishing preparations for leather, vinyl, metal and wood, polishes and creams for leather, vinyl, metal and wood, wax for polishing; perfumery; cosmetics; fragrances; deodorants for personal use and animals.

21 – Toothbrushes, electric toothbrushes, dental floss, shaving brushes, hair brushes, combs; non-electric household or kitchen utensils, included in this class, [other than forks, knives, spoons], services [dishes],

pots and pans, bottle openers, flower pots, drinking straws, non-electric cooking utensils; ironing boards and shaped covers therefor, drying racks for washing, clothes drying hangers; cages for household pets, indoor aquariums, vivariums and indoor terrariums for animals and plant cultivation; ornaments and decorative goods of glass, porcelain, earthenware or clay, included in this class, namely statues, figurines and vases, all made of glass, porcelain, earthenware or clay; hand-operated non-electric cleaning instruments and appliances, brushes, other than paintbrushes, steel chips for cleaning, sponges for cleaning, steel wool for cleaning, cloths of textile for cleaning, gloves for dishwashing, non-electric polishing machines for household purposes, brooms for carpets, mops; mouse traps, insect traps, electric devices for attracting and killing flies and insects, fly catchers, fly swatters; perfume burners, perfume sprayers, perfume vaporizers, electric or non-electric make-up removing appliances, powder puffs, toilet cases; nozzles for sprinkler hose, nozzles for watering cans, watering devices, garden watering cans; unworked or semi-worked glass, except building glass, mosaics of glass and powdered glass for decoration, except for building, glass wool other than for insulation or textile use; sprinklers; unworked or semi-worked glass, except building glass, mosaics of glass and powdered glass for decoration, except for building, glass wool other than for insulation or textile use.

24 – Woven or non-woven textile fabrics; textile goods for household use, not included in other classes: curtains, bed covers, sheets (textile), pillowcases, blankets, quilts, towels; flags, pennants, labels of textile; swaddling blankets.

25 – Clothing, including underwear and outer clothing, other than special purpose protective clothing; socks, mufflers [clothing], shawls, bandanas, scarves, belts [clothing]; footwear, shoes, slippers, sandals; headgear, hats, caps with visors, berets, caps [headwear], skull caps.

27 – Wallpaper, wall hangings not of textile; carpets, rugs, mats; prayer rugs; linoleum, artificial turf, linoleum for covering floors; gymnasium mats.

(260) AM 2023 118460 A

(800) 1357774

(151) 2017 03 17

(891) 2022 01 13

(731) FAZZINI S.r.l.

Via Alessandro Volta, 69, I-21010 Cardano al Campo (Varese), Italy

(540)



(591) Black, white

(531) 27.05.01

(511)

24 – Fabrics and textile products namely, blanket throws, coverlets, table cloths, sheet sets, quilts of textile, towels of textile, duvet covers, bedspreads, table coverings and table clothes, napkins, bed linen, quilted bedspread, quilt plaids and blankets, pillow cases; bath rugs made of textile.

25 – Bathrobes made of textile.

(260) AM 2023 118463 A

(800) 1527051

(151) 2020 03 10

(891) 2022 05 13

(731) NOVARTIS AG

CH-4002 Basel, Switzerland

(540)

(591) Coral pink and green

(531) 26.01.01; 27.05.01; 27.05.07; 27.05.17; 29.01.12

(511)

5 – Pharmaceutical preparations.

(260) AM 2023 118464 A

(800) 1541159

(151) 2020 05 25

(891) 2022 06 07

(731) BTL Industries

8 Tzar Kaloyan str, BG-1000 Sofia, Bulgaria

(540)

## EMBODY

(591) Black, white

(511)

10 – Medical and aesthetic apparatus and instruments, in particular apparatus and instruments generating electrical, magnetic, electromagnetic, mechanical or thermal therapeutic energy; medical and aesthetic apparatus and instruments, in particular apparatus and instruments for body shaping, fat removal, circumference reduction, skin tightening, cellulite reduction, skin rejuvenation, wrinkle reduction, scar reduction, stretch mark reduction; aesthetic massage apparatus, in particular apparatus for lymphatic drainage and increasing the circulation of bodily fluids; physical therapy apparatus, in particular apparatus for treating pain and preventing muscle cramps; aesthetic massage apparatus; gynaecological and urological apparatus and instruments; dental equipment; rehabilitation apparatus (body -) for medical purposes; physical therapy equipment; physiotherapy and rehabilitation equipment; beds specially made for medical purposes;

contraceptive devices; artificial limbs; orthopedic articles; suture materials.

(260) AM 2023 118567 A

(800) 1671233

(151) 2022 02 15

(891) 2022 02 15

(731) Limited Liability Company MAXIMA GROUP office 61, room I, floor 7, Krasnaya Presnya str. 24, RU-123376 Moscow, Russian Federation

(540)



(591) White and violet

(531) 26.04.05; 26.04.18; 26.04.22; 26.04.24; 27.05.01; 27.05.24; 28.05; 29.01.12

(511)

35 – Promoting the goods of others; procurement services for others [purchasing goods and services for other businesses]; retail and wholesale store services; retail services provided by means of mail order catalogs; retail services provided by television stores; on-line retail services.

(260) AM 2023 118572 A

(800) 1671333

(151) 2021 12 17

(891) 2021 12 17

(731) S&amp;P DJI NETHERLANDS B.V.

Zuidplein 160, World Trade Center, H19, NL-1077 XV Amsterdam, Netherlands

(540)

## US 500

(591) Black, white

(511)

35 – Advertising; business management; marketing research; business administration; office functions; providing commercial and business information; business management analysis and business consultancy; business advisory and information services; providing business analysis regarding the performance of legal entities; acquisition and merger consultation; providing business analysis and information based on an index; providing on-line retail store services relating to software applications in the field of financial-related data and company data over a global computer network; business administration services for the processing of sales made on a global computer network; administrative services relating to the management of legal dockets; business surveys; market surveys; business investigations; business assistance; assistance with business planning; business assistance, management and administrative services; assistance in mana-

gement of business activities; business file management; business record keeping services; arranging of presentations for business purposes; data collection services; data processing services; data inputting services; management of computer databases; data processing for the collection of data for business purposes; analysis of market research data and statistics; market research by means of a computer data base; providing business information, also via internet, the cable network or other forms of data transfer in the field of financial-related data and company data over a global computer network; preparation of market analysis reports; cost analysis; cost price analysis; research and analysis in the field of market manipulation; collection of financial information.

36 – Financial affairs, monetary affairs, insurance, real estate affairs, financial analysis, financial evaluation, capital investment; securities brokerage services; consultation, information, advisory, research and rating services relating to financial matters, financial and investment information services; financial data and stock research; financial risk management services; providing financial information, research and analysis on companies, industries and countries for financial investments through a global computer network; online information and rating services relating to finance and investments; rating services, namely regarding performance of securities and investments and regarding credit worthiness; providing information on financial indexes and investment concepts; providing financial information based on different asset class indexes; financial analysis relating to trade and financial information based on financial indexes; financial management in the nature of providing, calculating, and updating financial indexes that reflect the performance of markets the indexes measure; financial management in the nature of providing, calculating, and updating financial indexes in the nature of quantitative measurements for evaluating investments, analyzing markets, and evaluating market trends in the stock market; financial management in the nature of providing, calculating, and updating financial indexes for others and providing rules as to the makeup of the indexes; financial management in the nature of providing, calculating, and updating financial indices tailored to the specifications of others; financial trading analysis and financial information based on indexes, securities indexes; trading of securities index futures; providing financial consultancy and trading of financial products based on indexes, namely, mutual funds, exchange traded funds, trading of futures and options contracts and otc futures, trading of options and swaps, credit derivatives, CFDs, management of financial assets and financial management and brokerage of smart contracts, digital contracts, financial management services, including providing financial information in the nature of financial indices that measure returns on investments and providing information, ratings relating to financial instruments

used to invest futures; providing information relating to trusteeship of financial futures contracts; trading of futures contracts; providing stock market information; providing investors with financial information; financial services provided via the Internet; providing information and analysis via the Internet in the field of financial investments; arranging business fundraising activities in the field of finance; financial sponsorship services; fundraising; providing information, consultancy and advice in the field of financial valuation; financial investment in the field of securities; financial advisory services relating to securities; preparation of financial analyses relating to securities; advisory services relating to credit; advisory services relating to [financial] risk management; capital investment advisory services; computerized financial analysis; computer information services relating to financial management; computerized financial information services; financial advisory services relating to assets management; providing financial indices to enable consumers to evaluate investments and market trends in the securities market.

(260) AM 2023 118573 A

(800) 1671468

(151) 2022 05 19

(891) 2022 05 19

(731) Društvo za hotelierstvo, trgovija i uslugi  
TROKADERO INTERNACIONAL DOOEL  
Tetovo  
Ul. Ilindenska br. 350, Tetovo, The Republic  
of North Macedonia

(540)



(591) Black, white

(531) 01.15.03; 27.01.01; 27.05.01; 27.05.03;  
27.05.09; 27.05.10

(511)

32 – Non-alcoholic drinks; mineral and soda water; fruit drinks and fruit juices; water; flavored carbonated drinks; fruit-flavored soft drinks; lemonades; carbonated juices; refreshing soft drinks; isotonic beverages; energy drinks.



(260) AM 2023 118575 A

(800) 1671500

(151) 2022 04 06

(891) 2022 04 06

(731) Chivas Holdings (IP) Limited

Kilmalid, Stirling Road, Dumbarton G82 2SS,  
United Kingdom

(540)



(591) Brown, white

(531) 19.03.24; 23.01.01; 24.01.23; 24.01.25;

24.07.03; 24.07.05; 25.01.06; 29.01.13

(511)

33 – Alcoholic beverages, except beer.

(260) AM 2023 118576 A

(800) 1671508

(151) 2022 05 17

(891) 2022 05 17

(731) Richter Gedeon Nyrt.

Gyömrői út 19-21., H-1103 Budapest, Hungary

(540)

ΠΑΦΕΗΟΡΜ

(591) Black, white

(531) 28.05

(511)

5 – Pharmaceutical preparations.

(260) AM 2023 118577 A

(800) 1671672

(151) 2022 04 15

(891) 2022 04 15

(731) Honor Device Co., Ltd.

Suite 3401, Unit A, Building 6, Shum Yip Sky  
Park, No. 8089, Hongli West Road, Xiangmihu  
Street, Futian District, Shenzhen, 518040  
Guangdong, China

(540)

MagicBook X 15

(591) Black, white

(531) 27.05.01; 27.07.01

(511)

9 – Notebook computers; laptop computers; compu-  
ters; tablet computers; wearable computers; computer  
keyboards; mouse [computer peripheral]; smartwatches;  
computer software applications, downloadable;computer programs, recorded; computer hardware;  
stands adapted for laptops; data sets, recorded or  
downloadable; 3D scanners; haptic suits, other than  
for medical purposes; quantum computers; head-mo-  
unted displays; wireless portable printers for use with  
laptops and mobile devices; neural helmets, not for  
medical purposes; cooling pads for laptop computers;  
pedometers; face identification apparatus; bathroom  
scales; smartphones; routers; home automation hubs;  
foldable smartphones; mobile phone screen protec-  
tors; mobile phone ring holders; mobile phone ring  
stands; holders adapted for mobile telephones and  
smartphones; in-car telephone handset cradles; dash-  
board mats adapted for holding mobile telephones and  
smartphones; cabinets for loudspeakers; television ap-  
paratus; head-up display apparatus for vehicles; smart  
speakers; wearable speakers; wireless speaker micro-  
phones; headsets; headsets for playing video games;  
portable speakers; cameras; flash lamps for smartpho-  
nes; measuring instruments; teaching robots; optical  
lenses; USB cables; chips [integrated circuits]; electri-  
cal adapters; video screens; computer screens; electro-  
nic key fobs being remote control apparatus; biomet-  
ric locks; contact lens cases incorporating ultrasonic  
cleaning functions; mobile power supply (rechargeable  
batteries); portable power chargers; battery chargers  
for laptop computers; animated cartoons.

(260) AM 2023 118578 A

(800) 1671701

(151) 2022 05 31

(891) 2022 05 31

(731) PEPCO Poland Sp. z o.o.

Strzeszyńska 73A, PL-60-479 Poznań,  
Poland

(540)

**PETER COOK**

(591) Black, white

(511)

7 – Liquidizers [kitchen machines]; blenders, electric,  
for household purposes; fruit presses, electric, for  
household purposes.11 – Kettles; bread toasters; sandwich makers [toas-  
ters]; electric coffee brewers.

(260) AM 2023 118579 A

(800) 1671702

(151) 2022 05 31

(891) 2022 05 31

(731) PEPCO Poland Sp. z o.o.

Strzeszyńska 73A, PL-60-479 Poznań,  
Poland

(540)



(591) Black, white

(531) 03.01.14; 03.01.24; 21.01.25; 26.04.04;  
26.04.18; 26.04.24; 27.05.24

(511)

8 – Cutlery; table knives, forks and spoons for babies.  
10 – Feeding bottles; teething rings; dummies for babies; feeding bottle teats; gum massagers for babies; covers for baby feeding bottles.

21 – Baby bath tubs; chamber pots; heaters for feeding bottles, non-electric; mugs; training cups for babies and children; table plates.

24 – Bed clothes and blankets; bath linen, except clothing; receiving blankets; towels of textile; bed linen; bed throws; covers for cushions; mattress covers; flat bed sheets; sleeping bags for babies; baby blankets; towels [textile] for use in connection with babies; diaper changing cloths for babies.

25 – Bibs, not of paper.

28 – Toys; children's playthings; rattles [playthings]; baby gyms.

(260) AM 2023 118580 A

(800) 1671798

(151) 2022 05 11

(891) 2022 05 11

(731) Yiwu Baituan Commodities Co., LTD  
Unit 2, Building 32, District B, Xiazhu  
Village, Jiangdong Street, Yiwu City, Jinhua  
City, 322099 Zhejiang Province, China

(540)

# DANNY HOME

(591) Black, white

(531) 27.05.01

(511)

21 – Kitchen utensils; ceramics for household purposes; bowls [basins]; cups; table plates; cake moulds; utensils for household purposes; kitchen containers; thermally insulated containers for food.

(260) AM 2023 118581 A

(800) 1671820

(151) 2021 11 16

(891) 2021 11 16

(731) SONGÜL TURAN

GÜNEŞLİ MAH.1313 SOK.A, BLOK NO:61/1  
KAPI NO:45, BAĞCILAR /İSTANBUL,

Türkiye;

SAFA YENAL

ATAKÖY 1. KISIM MAH.ZÜBEYDE

HANIM, CAD. ATAKÖY 1. KISIM SİTESİ

NO:1, İÇ KAPI NO:14, BAKIRKÖY

/İSTANBUL, Türkiye

(540)



(591) Black, white

(531) 24.01.15; 24.01.20; 24.01.25; 24.09.02;  
24.09.07; 27.05.01

(511)

3 – Bleaching and cleaning preparations, detergents other than for use in manufacturing operations and for medical purposes, laundry bleach, fabric softeners for laundry use, stain removers, dishwasher detergents; perfumery; cosmetics; fragrances; deodorants for personal use and animals; soaps; dental care preparations: dentifrices, denture polishes, tooth whitening preparations, mouth washes, not for medical purposes.

(260) AM 2023 118582 A

(800) 1671825

(151) 2022 04 15

(891) 2022 04 15

(731) Shenzhen Noriyang Technology Co., LTD.  
101, 201, 301, Building 13, 4th Ye District,  
Hongxing Community, Yutang Street,  
Guangming District, Shenzhen, 518132  
Guangdong, China

(540)

# JUNO

(591) Black, white

(511)

34 – Chewing tobacco; cigarettes containing tobacco substitutes, not for medical purposes; cigarettes; electronic cigarettes; flavourings, other than essential oils, for tobacco; flavourings, other than essential oils, for use in electronic cigarettes; herbs for smoking; lighters for smokers; liquid solutions for use in electronic cigarettes; oral vaporizers for smokers.

(260) AM 2023 118583 A

(800) 1671848

(151) 2022 04 18

(891) 2022 04 18

(731) Xiaodao Science and Technology Corp.

Jiuyuan Industrial Park, Baodi District,  
301800 Tianjin City, China

(540)

**XDAO**

(591) Black, white

(531) 27.05.17

(511)

12 – Electric vehicles; motorcycles; hubs for motorcycle wheels; pumps for bicycle tires; bicycles; electric bicycles; tricycles.

(260) AM 2023 118585 A

(800) 1671913

(151) 2022 03 24

(891) 2022 03 24

(731) TOYOTA JIDOSHA KABUSHIKI KAISHA

(also trading as TOYOTA MOTOR  
CORPORATION)

1, Toyota-cho, Toyota-shi, Aichi-ken 471-8571,  
Japan

(540)



(591) Black, white

(531) 15.01.25; 26.01.01; 26.01.03; 26.02.01;

26.02.07; 26.11.03; 26.11.09; 26.13.25

(511)

12 – Traction engine; ropeways for cargo; ropeways for freight handling; driving motors for land vehicles; engine mounts for land vehicles; engines for land vehicles; jet engines for land vehicles; motors for land vehicles; propulsion mechanisms for land vehicles; turbines for land vehicles; axle journals; axles for land vehicles; spindles for land vehicles; drive shafts for land vehicles; shaft couplings for land vehicles; axle bearings for land vehicles; wheel bearings for land vehicles; universal joints for land vehicles; drive shaft couplings for land vehicles; drive chains for land vehicles; driving chains for land vehicles; connecting rods for land vehicles, other than parts of motors and engines; gear boxes for land vehicles; gearing for land vehicles; hydraulic circuits for land vehicles; reduction gears for land vehicles; torque converters for land

vehicles; transmission chains for land vehicles; transmission shafts for land vehicles; transmissions for land vehicles; power transmission belts for land vehicles; clutch mechanisms for land vehicles; steering units for land vehicles; shock absorbers for automobiles; shock absorbers for motorcycles; suspension springs for motor cars; shock absorbing springs for motor cars; shock absorbing springs for land vehicles; torsion bars for land vehicle suspensions; suspension systems for land vehicles; brake discs for land vehicles; brake linings for land vehicles; brake pads for automobiles; brake segments for land vehicles; brake shoes for land vehicles; brakes for land vehicles; brake systems for land vehicles; anti-lock braking systems for automobiles; traction control systems for automobiles; parachutes; anti-theft alarms for vehicles; alarm systems for motor vehicles; wheelchairs; electric wheelchairs; AC motors for land vehicles, not including their parts; DC motors for land vehicles not including their parts; motors, electric, for land vehicles; wheelchair motors; vessels [boats and ships]; structural parts for vessels; hovercraft; aircraft; structural parts for aircraft; electrically powered aircraft; helicopters; structural parts for helicopters; civilian drones; delivery drones; railway rolling stock; structural parts for trains; automobiles and structural parts thereof; buses; structural parts for buses; trucks; structural parts for trucks; vans [vehicles]; sports utility vehicles; coaches; electrically powered motor vehicles; electric cars; hybrid cars; electric tricycles; ambulances; racing cars; amphibious vehicles; snowmobiles; armored vehicles; fork lift trucks; camping cars; tractors; trailers; trolley buses; hearses; fuel cell cars; automobile bodies; automobile bonnets; automobile bumpers; automobile chassis; automobile dashboards; automobile doors; automobile door handles; automobile hoods; automobile horns; automobile seats; automobile seat covers; automobile sunroofs; automobile tires; automobile wheels; spokes for automobile wheels; inner tubes for automobile tires; automobile wheel rims; rearview mirrors for automobiles; automobile windows; automobile windscreens; automobile windshields; automobile convertible tops; safety belts for automobile seats; safety harnesses for automobile racing; safety harnesses for automobile seats; security harness for automobile seats; steering wheels for automobiles; steering wheel covers for automobiles; air bags for automobiles, buses and trucks; seat belt pretensioners for automobiles; brake pedals for land vehicles; direction signals for automobiles; leather upholstery for automobile seats; leather upholstery for automobiles; cigar lighters for automobiles; shaped automobile covers; mudguards for automobiles; luggage carriers for automobiles; spare wheel holders for automobiles; automobile roof racks; headlight wipers; windscreen wipers; windscreen wiper blades; motor vehicle brake control systems for applying emergency braking at low vehicle speeds; electronic brake control apparatus for automobiles; two-wheeled motor ve-

hicles; structural parts for two-wheeled motor vehicles; bicycles; structural parts for bicycles; motorcycles; structural parts for motorcycles; rickshaws; sleighs [vehicles]; trolleys; carts; horse drawn carriages; riyakah [two-wheeled carts]; adhesive rubber patches for repairing tubes or tires; baby carriages.

27 – Carpets for automobiles; floor mats for automobiles; bath mats; bathroom rugs; tatami mats; floor covering; carpets; rugs; beach mats; floor mats; door mats; wall hangings, not of textile; artificial turf; gymnastic mats; wallpaper.

(260) AM 2023 118586 A

(800) 1671916

(151) 2022 04 29

(891) 2022 04 29

(731) LIMITED LIABILITY COMPANY  
"PREMIORI"

street Levanevskoho, 91, t. Bila Tserkva,  
Kyiv region 09100, Ukraine

(540)

**Vimero 4 Seasons**

(591) Black, white

(531) 27.05.01; 27.07.01

(511)

12 – Automobile tires, casings for pneumatic tires, pneumatic tires.

(260) AM 2023 118587 A

(800) 1671984

(151) 2022 05 13

(891) 2022 05 13

(731) Hacker Pschorr Bräu GmbH

Ohlmüllerstraße 42, 81541 München,  
Germany

(540)



(591) Blue, red, gray, white

(531) 01.01.02; 14.07.03; 24.03.09; 26.01.17;  
26.01.18; 29.01.13

(511)

32 – Beer and brewery products; aerated water; non-alcoholic beverages; mineral water [beverages]; fruit beverages and fruit juices; preparations for making beverages; syrups for making beverages.

43 – Services for providing food and drink; providing temporary accommodation.

(260) AM 2023 118593 A

(800) 1672244

(151) 2022 03 25

(891) 2022 03 25

(731) Otkrytoe aktsionernoe obshchestvo  
"Beryozastroymaterialy"

ul. Komsomolskaya, d. 25, Beryoza, 225202  
Brestskaya obl., Belarus

(540)



**BELANI**

(591) Green and black

(531) 01.15.23; 26.01.01; 26.01.06; 29.01.12

(511)

19 – Alabaster; gypsum [building material]; plaster; potters' clay; building stones; artificial stone including ceramic granite; quartz; building materials, not of metal; refractory construction materials, not of metal; mosaics for building; tiles, not of metal for building; floor tiles, not of metal; paving slabs, not of metal; cladding, not of metal, for building included in this class.

35 – Demonstration of goods; marketing studies; business information; commercial information and advice for consumers (consumer advice shop); marketing research, organization of exhibitions for commercial or advertising purposes; shop window dressing; presentation of goods on communication media, for retail purposes; sales promotion for others; distribution of samples; direct mail advertising; advertising; on-line advertising on a computer network; procurement services for others (purchasing goods and services for other businesses); wholesale and retail trade services in regard to the goods indicated in classes 19, 21.

(260) AM 2023 118594 A

(800) 1672290

(151) 2022 05 11

(891) 2022 05 11

(731) Shenzhen Yuwen E-Commerce Co., Ltd.

Room 703, 7th Floor, (beside the gate of  
Gonghe Garden), Zhonghui Finance Building,  
153 Donghuan 1st Road, Longhua Street,  
Longhua New District, 518000 Shenzhen City,  
China

(540)

**AUVON**

(591) Black, white

(511)

10 – Blood testing apparatus; massage apparatus; medical apparatus and instruments; sphygmotensiometers; nasal aspirators; body composition monitors; gal-

vanic therapeutic appliances; electrodes for medical use; physiotherapy apparatus; commode chairs.

(260) AM 2023 118622 A  
 (800) 1522236  
 (151) 2020 02 13  
 (891) 2022 05 13  
 (731) Novartis AG  
 CH-4002 Basel, Switzerland  
 (540)

## SCSEMBLIX

(591) Black, white  
 (511)  
 5 – Pharmaceutical preparations.

(260) AM 2023 118623 A  
 (800) 1571745  
 (151) 2020 11 24  
 (891) 2022 06 20  
 (731) J. Choo Limited  
 10 Howick Place, London SW1P 1GW,  
 United Kingdom  
 (540)

## JIMMY CHOO

(591) Black, white  
 (511)  
 24 – Textile piece goods; towels; bath linen; face towels of textile; napkins or tissues of textile for removing make-up; handkerchiefs of textile; bed linen; bed spreads; mattress covers, pillow cases, quilts, sheets; table linen, table napkins, table runners, table mats, table cloths; travelling rugs; furniture covers; shower curtains; fabric for boots and shoes; lingerie fabric.

(260) AM 2023 118624 A  
 (800) 1632054  
 (151) 2021 09 28  
 (891) 2022 06 29  
 (731) EUROITALIA S.R.L.  
 Via Galileo Galilei, 5, I-20873 Cavenago di  
 Brianza (MB), Italy  
 (540)



(591) Black, white  
 (531) 03.01.14; 03.01.20; 03.01.22; 03.01.24;  
 24.01.05; 24.01.18; 24.01.19; 24.09.03;

24.09.05; 26.01.04; 26.01.16; 26.01.18;  
 27.05.01; 27.05.08; 27.05.10

(511)  
 3 – Stick fragrance diffusers; incense; fragrance refills for non-electric room fragrance dispensers; potpourris [fragrances]; air fragrancing preparations; shaving preparations; shaving mousse; shaving gel; shaving balm; shaving foams; shaving soaps; shaving sprays; shaving stones [astringents]; beard care preparations; shaving sets, comprised of shaving cream and aftershave; after-shave preparations; aftershave balm; mustache wax; beard dyes; perfumes; liquid perfumes; solid perfumes; eau de cologne; lavender water; scented waters; toilet waters; antiperspirants for personal use; body deodorants [perfumery]; fragrances for perfumes; cosmetic preparations for bath; bath pearls; non medicated bath gel; scented bathing salts; bubble bath; washing preparations for intimate hygiene or use as deodorant; bath oils for cosmetic purposes; balms, other than for medical purposes; skin conditioners (cosmetic); lip balms [non-medicated]; cosmetic preparations for skin care; body creams for cosmetic purposes; face creams for cosmetic use; perfumed creams; micellar water; skin cleansers [cosmetic]; make-up removing preparations; body emulsions; facial emulsions (for cosmetic use); cleansing milk for toilet purposes; beauty masks; mousses [cosmetics]; cosmetic kits; cotton swabs for cosmetic purposes; cotton wool for cosmetic purposes; cosmetic oils for the epidermis; essential oils; scented oils; massage oils; etheral essences; pre-moistened cosmetic wipes; perfumed tissues; soaps; soap in liquid form; perfumed soap; body talcum powder; beauty tonics for application to the face; tanning products [cosmetics]; cosmetic sunscreen preparations; make-up preparations; nail care products; nail varnishes; dentifrices; mouthwashes, not for medical purposes; shampoos; hair lotions; cosmetic products for the care and beauty of the hair; cosmetic dyes; cosmetics for animals; shampoo for pets [non-medicated grooming preparations]; depilatory preparations; decorative transfers for cosmetic purposes; massage candles for cosmetic purposes; cosmetics for children; body glitters.

4 – Candles; perfumed candles; beeswax.

8 – Razor blades; beard clippers; electric shavers; non-electric razors; mustache and beard trimmers; safety razors; razor cases; shaving sets; manicure sets; pedicure sets; manicure tools; scissors; tweezers; nail files; nail clippers, electric or non-electric.

18 – Shaving bags (empty); key cases; cosmetic cases (empty); vanity cases, not fitted; make-up bags; clutches; bags; handbags; purses; traveling bags; beach bags; bags for sports; bags [envelopes, pouches] of leather, for packaging; suitcases; attaché cases; suitcases with wheels; backpacks; leather briefcases; carrying cases for documents; business card cases; traveling trunks; shopping bags; umbrellas; parasols.

21 – Shaving brushes; shaving bowls; shaving saucers; shaving tools holders; shaving brush stands; make-up brushes; fitted vanity cases; cosmetic utensils; comb cases; hair combs; toilet brushes; hairbrushes; brushes for cosmetic use; nail brushes; toothbrushes; incense burners (for domestic use); vases; soap holders; perfume vaporizers.

(260) AM 2023 118625 A

(800) 1636172

(151) 2021 12 08

(891) 2022 06 13

(731) NIPPON PAINT HOLDINGS SG PTE. LTD.  
16 RAFFLES QUAY, #17-03 HONG LEONG  
BUILDING, SINGAPORE 048581, Singapore

(540)



(591) Blue, white, red

(531) 26.04.04; 26.04.18; 26.04.24; 27.05.02;  
27.05.17; 27.05.21; 29.01.13

(511)

2 – Paints, varnishes, lacquers; preservatives against rust and against deterioration of wood; colorants, dyes; inks for printing, marking and engraving; raw natural resins; metals in foil and powder form for use in painting, decorating, printing and art.

37 – Painting.

(260) AM 2023 118626 A

(800) 1650645

(151) 2022 01 20

(891) 2022 06 21

(731) CELLTRION, INC.  
23, Academy-ro, Yeonsu-gu, Incheon,  
Republic of Korea

(540)

## STEQEYMA

(591) Black, white

(511)

5 – Pharmaceutical preparations for the treatment of psoriasis; pharmaceutical preparations for the treatment of arthritis; pharmaceutical preparations for the treatment of inflammatory diseases; pharmaceutical preparations for the treatment of auto-immune diseases; pharmaceutical preparations for the treatment of crohn's disease.

(260) AM 2023 118627 A

(800) 1650646

(151) 2022 01 20

(891) 2022 06 21

(731) CELLTRION, INC.  
23, Academy-ro, Yeonsu-gu, Incheon,  
Republic of Korea

(540)

## QOYVOLMA

(591) Black, white

(511)

5 – Pharmaceutical preparations for the treatment of psoriasis; pharmaceutical preparations for the treatment of arthritis; pharmaceutical preparations for the treatment of inflammatory diseases; pharmaceutical preparations for the treatment of auto-immune diseases; pharmaceutical preparations for the treatment of crohn's disease.

(260) AM 2023 118628 A

(800) 1663275

(151) 2022 05 03

(891) 2022 06 13

(731) Janssen Pharmaceutica NV  
Turnhoutseweg 30, B-2340 Beerse, Belgium

(540)

## ISVAXDEN

(591) Black, white

(511)

5 – Vaccines.

(260) AM 2023 118666 A

(800) 1672819

(151) 2022 04 28

(891) 2022 04 28

(731) Holcim AG  
Grafenauweg 10, CH-6300 Zug, Switzerland

(540)

## ELEVATE

(591) Black, white

(511)

1 – Adhesives for use in industry; adhesives for use in the building industry; glues for roofing.

2 – Priming paints; water-repellent paints; waterproof paints; damp-proofing paints; coating compositions in the form of paints for industrial applications; coating products having water-repellent properties (paints).

17 – Insulating materials; insulating materials for construction, insulating materials for the building industry; insulating foam for use in building and construction; substances for insulating buildings against moisture; insulating materials made of polyurethane foam; insulating bands; duct tapes; sealant compounds for joints; adhesive sealant compounds; adhesive caul-

king sealants; stuffing materials; caulking sealants; insulating waterproofing membranes; rubber sheets for insulation; rubber sheets for sealing.

19 – Non-metallic construction materials; roof coverings, not of metal; roofing underlay; textiles for roofing; asphalt roof coatings (building materials); bituminous sealants for roofing (building materials); tar-based sealants for roofing (construction materials); bituminous coatings for roofing; sealing coats for roofs.

37 – Construction services; installation and repair services; waterproofing and sealing of buildings; sealing services (building); roofing services.

(260) AM 2023 118667 A

(800) 1672896

(151) 2022 04 06

(891) 2022 04 06

(731) Navasard Limited

Agiar Irinis 16, Office 101, Aglantzia, CY-2102  
Nicosia, Cyprus

(540)



(591) Dark blue, Light Blue, White

(531) 27.05.17; 27.05.19; 27.07.01; 29.01.12

(511)

41 – Provision of information relating to racing; provision of information relating to jockeys; provision of information relating to racehorses; provision of information relating to sports; provision of information relating to motor sports; entertainment in the nature of golf tournaments; entertainment in the nature of wrestling contests; entertainment in the nature of basketball games; entertainment in the nature of yacht races; entertainment in the nature of boxing contests; entertainment in the nature of tennis tournaments; entertainment in the nature of football games; entertainment in the nature of soccer games; entertainment in the nature of automobile races; entertainment in the nature of gymnastic performances; entertainment in the nature of baseball games; entertainment in the nature of hockey games; entertainment in the nature of weight lifting competitions; entertainment in the nature of track and field competitions; provision of information relating to motor racing; racing information services; handicapping for sporting events; entertainment services in the nature of skating events; providing wrestling news and information via a global computer network; sporting results services; betting services; horses (betting on -); casino, gaming and gambling services; providing of casino and gaming

facilities; dog races; football pools services; wagering services; online gaming services; gaming services for entertainment purposes; gaming services; gambling; gambling services; online gambling services; game services provided on-line from a computer network; electronic game services and competitions provided by means of the internet; games equipment rental; providing online electronic publications, not downloadable; operating lotteries; recreation information.

42 – Computer programming; computer software design; rental of computer software; rental of computer software and programs; rental and maintenance of computer software; creating and maintaining websites; creating and maintaining web sites for others; providing information on computer technology and programming via a web site; maintenance of computer software; updating and maintenance of computer software and programs.

(260) AM 2023 118668 A

(800) 1672955

(151) 2022 06 21

(891) 2022 06 21

(731) Joint Stock Company "APREL"

Neverova street, 33, RU-443036 Samara,  
Russian Federation

(540)

The Absolut logo consists of the word 'Absolut' in a bold, blue, italicized serif font.

(591) Blue

(531) 27.05.01; 27.05.17; 29.01.04

(511)

3 – Abrasives; descaling preparations for household purposes; antistatic preparations for household purposes; breath freshening sprays; canned pressurized air for cleaning and dusting purposes; balms, other than for medical purposes; basma [cosmetic dye]; lip glosses; nail glitter; body glitter; polishing stones; abrasive paper; emery paper; polishing paper; petroleum jelly for cosmetic purposes; shoe polish; cobblers' wax; cotton wool for cosmetic purposes; cotton wool impregnated with make-up removing preparations; drying agents for dishwashing machines; adhesives for cosmetic purposes; floor wax; wax for parquet floors; non-slipping wax for floors; depilatory wax; moustache wax; shoemakers' wax; tailors' wax; creams for leather; polish for furniture and flooring; polishing wax; massage gels, other than for medical purposes; heliotropine; dental bleaching gels; geraniol; starch glaze for laundry purposes; make-up; deodorants for pets; deodorants for human beings or for animals; depilatory preparations; non-slipping liquids for floors; windscreen cleaning liquids; greases for cosmetic purposes; volcanic ash for cleaning; decorative transfers for cosmetic purposes; shaving stones [astringents]; smoothing stones; eyebrow pencils; cosmetic pencils; silicon carbide [abrasive]; carbides of metal

[abrasives]; alum stones [astringents]; tripoli stone for polishing; adhesives for affixing false eyelashes; adhesives for affixing false hair; hair conditioners; quillaia bark for washing; corundum [abrasive]; beard dyes; colorants for toilet purposes; cosmetic dyes; body paint for cosmetic purposes; starch for laundry purposes; shoe cream; polishing creams; cosmetic creams; skin whitening creams; polishing rouge; hair spray; nail varnish; liquid latex body paint for cosmetic purposes; hair lotions; lotions for cosmetic purposes; beauty masks; sheet masks for cosmetic purposes; disposable steam-heated masks, not for medical purposes; oil of turpentine for degreasing; whitening; cleaning chalk; almond milk for cosmetic purposes; cleansing milk for toilet purposes; musk [perfumery]; soap; deodorant soap; shaving soap; soap for brightening textile; cakes of toilet soap; antiperspirant soap; soap for foot perspiration; almond soap; cosmetic kits; emery; gel eye patches for cosmetic purposes; nail art stickers; double eyelid tapes; false nails; toothpaste; pastes for razor strops; pumice stone; lipstick cases; hydrogen peroxide for cosmetic purposes; dressings for nail reconstruction; breath freshening strips; teeth whitening strips; sandcloth; glass cloth [abrasive cloth]; lipsticks; pomades for cosmetic purposes; shaving preparations; cosmetic preparations for baths; bath preparations, not for medical purposes; hair straightening preparations; hair waving preparations; laundry soaking preparations; grinding preparations; smoothing preparations [starching]; colour-removing preparations; leather bleaching preparations; polishing preparations; denture polishes; mouthwashes, not for medical purposes; preparations to make the leaves of plants shiny; cosmetic preparations for slimming purposes; eye-washes, not for medical purposes; fabric softeners for laundry use; dry-cleaning preparations; paint stripping preparations; lacquer-removing preparations; make-up removing preparations; floor wax removers [scouring preparations]; varnish-removing preparations; rust removing preparations; nail care preparations; cleaning preparations; preparations for cleaning dentures; wallpaper cleaning preparations; preparations for unblocking drain pipes; chemical cleaning preparations for household purposes; collagen preparations for cosmetic purposes; bleaching preparations [decolorants] for household purposes; aloe vera preparations for cosmetic purposes; colour-brightening chemicals for household purposes [laundry]; sunscreen preparations; breath freshening preparations for personal hygiene; shining preparations [polish]; make-up powder; diamantine [abrasive]; stain removers; nail varnish removers; vaginal washes for personal sanitary or deodorant purposes; scouring solutions; false eyelashes; antistatic dryer sheets; baby wipes impregnated with cleaning preparations; colour run prevention laundry sheets; tissues impregnated with cosmetic lotions; tissues impregnated with make-up removing preparations; saffrol; massage candles for cosmetic purposes; laundry blueing; turpentine for de-

greasing; bleaching soda; washing soda, for cleaning; bleaching salts; bath salts, not for medical purposes; leather preservatives [polishes]; ammonia [volatile alkali] [detergent]; cooling sprays for cosmetic purposes; astringents for cosmetic purposes; eyebrow cosmetics; make-up preparations; sun-tanning preparations [cosmetics]; hair dyes; neutralizers for permanent waving; laundry glaze; cosmetic preparations for eyelashes; laundry preparations; cosmetic preparations for skin care; dentifrices; cosmetics for children; cosmetics; cosmetics for animals; mascara; cleansers for intimate personal hygiene purposes, non medicated; douching preparations for personal sanitary or deodorant purposes [toiletries]; detergents, other than for use in manufacturing operations and for medical purposes; degreasers, other than for use in manufacturing processes; bleaching preparations [decolorants] for cosmetic purposes; laundry bleach; antiperspirants [toiletries]; toiletry preparations; phytocosmetic preparations; detergent tablets for coffee machines; talcum powder, for toilet use; cotton swabs for cosmetic purposes; emery cloth; toners for cosmetic purposes; cloths impregnated with a detergent for cleaning; henna [cosmetic dye]; bath tea for cosmetic purposes; shampoos; shampoos for animals [non-medicated grooming preparations]; shampoos for pets [non-medicated grooming preparations]; dry shampoos; sandpaper; cosmetic stamps, filled; soda lye; herbal extracts for cosmetic purposes.

(260) AM 2023 118675 A

(800) 1673092

(151) 2022 05 05

(891) 2022 05 05

(731) JOINT STOCK COMPANY "FATS AND OIL INTEGRATED WORKS"  
UL. TITOVA 27, EKATERINBURG,  
RU-620085 SVERDLOVSKAYA OBLAST,  
Russian Federation

(540)



(591) White, beige, yellow, green, light green and dark green

(531) 02.09.01; 05.03.13; 05.03.15; 08.07.05;  
26.04.04; 26.04.05; 26.04.16; 26.04.19; 28.05;  
29.01.14

(511)

30 – Mayonnaise; mayonnaise sauce; sauces [condiments]; pasta sauce; condiments; spices; seasonings; dressings for salad; food dressings on the base of vegetable oils.



(260) AM 2023 118676 A

(800) 1673108

(151) 2022 03 10

(891) 2022 03 10

(731) DR. S.CHANDRALEKHA, TRADING AS:

M/s. ISWARYA FERTILITY CENTRE

No. 238, Avarampalayam Road, Gandhipuram,

Coimbatore, Tamilnadu 641044, India

(540)

## ISWARYA FERTILITY CENTER

(591) Black, white

(531) 27.05.01

(511)

44 – Medical services provided by women care hospital and fertility centre, and other medical care centre services.

(260) AM 2023 118677 A

(800) 1673113

(151) 2022 05 02

(891) 2022 05 02

(731) Navasard Limited

Agias Irinis 16, Office 101, Aglantzia, CY-2102

Nicosia, Cyprus

(540)



(591) Dark blue, White

(531) 27.05.01; 27.05.17; 27.05.24; 27.07.01;  
29.01.12

(511)

35 – Production of advertising films; compilation of statistics; website traffic optimization; web site traffic optimisation.

41 – Provision of entertainment information relating horse races, namely racehorses; provision of information relating to sports; provision of information relating to motor sports; provision of information relating to racing; provision of entertainment information relating horse races, namely jockeys; racing information services; handicapping for sporting events; entertainment in the nature of basketball games; entertainment in the nature of hockey games; entertainment in the nature of football games; entertainment in the nature of soccer games; entertainment in the nature of automobile races; entertainment in the nature of gymnastic performances; entertainment in the nature of boxing contests; entertainment in the nature of baseball games; entertainment in the nature of yacht races; entertainment in the nature of golf tournaments; entertainment in the nature of wrestling contests; entertainment in the nature of tennis tournaments; enterta-

inment services in the nature of skating events; entertainment in the nature of ice hockey games; entertainment in the nature of weight lifting competitions; entertainment in the nature of track and field competitions; providing wrestling news and information via a global computer network; sporting results services; betting services; horses (betting on -); casino, gaming and gambling services; providing of casino and gaming facilities; providing casino facilities [gambling]; dog races; football pools services; wagering services; on-line gaming services; gaming services for entertainment purposes; gambling; gambling services; game services provided on-line from a computer network; electronic game services and competitions provided by means of the internet; games equipment rental; providing on-line electronic publications, not downloadable; operating lotteries; recreation information.

42 – Computer programming; computer software design; rental of computer software; rental of computer software and programs; rental and maintenance of computer software; creating and maintaining websites; creating and maintaining web sites for others; providing information on computer technology and programming via a web site; maintenance of computer software; updating and maintenance of computer software.

(260) AM 2023 118678 A

(800) 1673114

(151) 2022 05 02

(891) 2022 05 02

(731) Navasard Limited

Agias Irinis 16, Office 101, Aglantzia, CY-2102

Nicosia, Cyprus

(540)



(591) Dark blue, white

(531) 27.05.01; 27.05.17; 27.07.01; 29.01; 29.01.04

(511)

35 – Production of advertising films; compilation of statistics; website traffic optimization; web site traffic optimisation.

41 – Provision of entertainment information relating horse races, namely racehorses; provision of information relating to sports; provision of information relating to motor sports; provision of information relating to racing; provision of entertainment information relating horse races, namely jockeys; racing information services; handicapping for sporting events; entertainment in the nature of basketball games; entertainment in the nature of hockey games; entertainment in the nature of football games; entertainment in the nature of soccer games; entertainment in the nature of automobile races; entertainment in the nature of gymnastic performances; entertainment in the nature of

boxing contests; entertainment in the nature of baseball games; entertainment in the nature of yacht races; entertainment in the nature of golf tournaments; entertainment in the nature of wrestling contests; entertainment in the nature of tennis tournaments; entertainment services in the nature of skating events; entertainment in the nature of ice hockey games; entertainment in the nature of weight lifting competitions; entertainment in the nature of track and field competitions; providing wrestling news and information via a global computer network; sporting results services; betting services; horses (betting on -); casino, gaming and gambling services; providing of casino and gaming facilities; providing casino facilities [gambling]; dog races; football pools services; wagering services; on-line gaming services; gaming services for entertainment purposes; gambling; gambling services; game services provided on-line from a computer network; electronic game services and competitions provided by means of the internet; games equipment rental; providing on-line electronic publications, not downloadable; operating lotteries; recreation information.

42 – Computer programming; computer software design; rental of computer software; rental of computer software and programs; rental and maintenance of computer software; creating and maintaining websites; creating and maintaining web sites for others; providing information on computer technology and programming via a web site; maintenance of computer software; updating and maintenance of computer software.

(260) AM 2023 118699 A  
 (800) 1673723  
 (151) 2022 05 11  
 (891) 2022 05 11  
 (731) Kober Likör GmbH  
 Am alten Sägewerk 4, 95349 Thurnau,  
 Germany

(540)

## Kleiner Klopfer

(591) Black, white  
 (511)  
 32 – Beer; mineral and aerated waters and other non-alcoholic beverages; fruit drinks; juices; syrups and other preparations for making beverages.

33 – Alcoholic beverages (except beer).

(260) AM 2023 118700 A  
 (800) 1673745  
 (151) 2022 04 13  
 (891) 2022 04 13  
 (731) Novartis AG  
 CH-4002 Basel, Switzerland

(540)

## AVZIVI

(591) Black, white  
 (511)  
 5 – Pharmaceutical preparations for human use.

(260) AM 2023 118701 A  
 (800) 1673756  
 (151) 2022 06 20  
 (891) 2022 06 20  
 (731) "AnviLab" Company Limited  
 Festivalnaya str. 10, Urban settlement Sergiev  
 Posad, Sergiev-Posad municipal district,  
 Sergiev Posad, RU-141302 Moscow Region,  
 Russian Federation

(540)



(591) Red, blue, white and grey  
 (531) 19.13.21; 24.15.03; 25.05.03; 26.01.05; 28.05;  
 29.01.14

(526) R

(511)  
 5 – Amino acids for medical purposes; analgesics; anaesthetics; antibiotics; antiseptics; germicides; biocides; dietetic substances adapted for medical use; dietary supplements; immunostimulants; capsules for medicines; cachets for pharmaceutical purposes; medicines for human purposes; vitamin preparations; pharmaceutical preparations for skin care; styptic preparations; nutraceutical preparations for therapeutic or medical purposes; preparations of trace elements for human and animal use; pharmaceutical preparations; enzyme preparations for medical purposes; phytotherapy preparations for medical purposes; chemico-pharmaceutical preparations; dietetic foods adapted for medical purposes; pharmaceuticals; soporifics; adjuvants for medical purposes; febrifuges; depuratives; sedatives; tonics [medicines]; nervines; enzymes for medical purposes; ferments for pharmaceutical purposes.

(260) AM 2023 118703 A  
 (800) 1673836  
 (151) 2022 05 19  
 (891) 2022 05 19  
 (731) Pazu Games Ltd  
 1 Hatzmicha St., Yokneam Illit, Israel

(540)

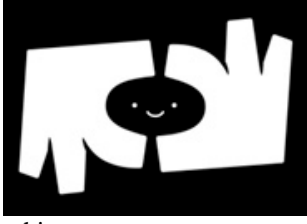

(591) Black, white

(531) 02.09.14; 04.05.21; 26.04.05; 26.04.16;  
26.13.25

(511)

9 – Downloadable computer games; computer games software; downloadable computer games software; computer software platform for programming, design and development of computer games.

28 – Games; toys; electronic games.

41 – Online games services; online game services provided via Internet and other communication networks.

(260) AM 2023 118704 A

(800) 1673851

(151) 2022 05 13

(891) 2022 05 13

(731) BİRİKİM KALIP YAPI ÜRÜNLERİ VE  
MAKİNA SANAYİ TİCARET LİMİTED  
ŞİRKETİ

DUDULLU O.S.B. MAH. 2. CADDE, NO:28/1  
ÜMRANİYE, İSTANBUL, Türkiye

(540)



(591) Black and red

(531) 14.01.18; 14.01.25; 27.05.01; 29.01.12

(526) dış cephe aksesuarları

(511)

6 – Doors, windows, shutters, жалousies and their cases and fittings of metal; ironmongery, small items of metal hardware, for example, bolts, screws, nails, nuts, pins, washers, chains, furniture casters, window fasteners, door and window handles of metal, hinges of metal, latches of metal, lock bolts, locks of metal, keys of metal, split rings of common metal for keys, reels of metal.

(260) AM 2023 118705 A

(800) 1673893

(151) 2022 02 06

(891) 2022 02 06

(731) DSM GRUP DANIŞMANLIK İLETİŞİM VE  
SATIŞ TİCARET A.Ş.

Maslak Mahallesi Büyükdere Caddesi,  
(Spine Plaza) No:243, İç Kapı No:19 Sarıyer,  
İstanbul, Türkiye

(540)

# TRENDYOL

## SHOES

(591) Black, white

(531) 27.05.01; 27.05.09; 27.05.10

(511)

25 – Clothing, footwear and headwear for human beings namely clothing; outer clothing; waterproof clothing; overalls; overcoats; paper clothing; parkas; pelerines; pelisses; petticoats; pockets for clothing; ponchos; rash guards; ready-made clothing; shirt fronts; shirts; shirt yokes; short-sleeve shirts; coats; collars [clothing]; combinations [clothing]; suits; dresses; dressing gowns; dress shields; sweaters; aprons [clothing]; jackets [clothing]; clothing of imitations of leather; clothing of leather; liveries; maniples; mantillas; masquerade costumes; leggings [leg warmers]; leggings [trousers]; leotards; tee-shirts; tights; trousers; trouser straps; uniforms; vests, babies' pants [underwear]; bibs, not of paper; layettes [clothing]; bathing caps; bathing suits; bathing trunks; bath robes; bath sandals; bath slippers; beach clothes; beach shoes; wet suits for water-skiing; cyclists' clothing jackets [clothing]; jerseys [clothing]; judo uniforms; jumper dresses; karate uniforms; kimonos; knitwear [clothing]; fishing vests; furs [clothing]; fur stoles; clothing containing slimming substances; clothing for gymnastics; clothing incorporating LEDs; motorists' clothing; belts [clothing]; money belts [clothing]; headwear; berets; caps being headwear; hats; headbands [clothing]; headscarves; hoods [clothing]; visors being headwear; ear muffs [clothing]; cuffs; detachable collars; gloves [clothing]; mittens; muffs [clothing]; neck gaiters; neckties; paper hats [clothing]; shower caps; ready-made linings [parts of clothing]; saris; sarongs; sashes for wear; scarfs; shawls; veils [clothing]; togas; turbans; bandanas [neckerchiefs]; ascots; bodices [lingerie]; camisoles; corselets; corsets [underclothing]; garters; girdles; boxer shorts; braces for clothing [suspenders]; gaiters; pyjamas; panties; brasieres; underpants; underwear; sweat-absorbent underwear; hosiery; stockings; stocking suspenders; footwear; shoes; footwear uppers; boots; boots for sports; boot uppers; sandals; football boots; foot muffs, not electrically heated; gymnastic shoes; half-boots; heel-pieces for footwear; heelpieces for stockings; heel protectors for shoes; heels; inner soles; galoshes; breeches for wear; non-slipping devices for footwear; ski boots; ski gloves; skirts; shorts; skull caps; sleep masks; slippers; slips [underclothing]; socks; sock suspenders; soles for footwear; sports jerseys; sports shoes; sports singlets.

35 – Advertising; business management; business administration; office functions; organization, operation and supervision of loyalty and incentive schemes; advertising services provided via the Internet; produc-

tion of television and radio advertisements; accountancy; auctioneering; trade fairs; opinion polling; data processing; provision of business information; advertising agency services; advertising services provided for others; database management; compilation of information into computer databases; business consulting services; business consulting services in the field of web based events, conferences, training programs, learning programs, and seminars; business consulting services in the field of delivering web-based knowledge; business consulting services in the field of online collaboration and collaboration technologies; business consulting services in the fields of sales and marketing; business project management services; business project management services relating to development, set up, staging, production, recording, monitoring and follow-up for web based events, conferences, training programs, learning programs, and seminars; market research and business consulting services; business consultancy services relating to facilitating the transaction of business via local and global computer networks by locating and providing referrals for the delivery of a wide variety of business and consumer products and services; dissemination of business information of goods and services of others via local and global computer networks; business consultancy services relating to providing a web site on a global computer network by which third parties can offer and source goods and services, place, determine the status of and fulfil trade leads and orders, enter into contracts and transact business; providing computerized online ordering services; advertising of goods and services of others via local and global computer networks; international import and export agency services; rental of advertising space on communication media; online trading services relating to electronic auctioneering and providing online business evaluation relating thereto; providing a directory of third party web sites to facilitate business transactions; business consultancy services relating to operating an electronic marketplace for the buyers and sellers of goods and/or services on a global computer network; business assistance relating to facilitating business transaction via local and global computer networks; corporate management consultancy services; marketing and promotion services; publication of publicity materials; marketing of vacant premises; dissemination of advertising materials, updating of advertising materials, compilation of advertisements for use as web pages on the Internet; rental of advertising space; computer data processing; sales, business and promotional information services; telephone answering (for unavailable subscribers); telephone answering (for others); auctioneering provided on the Internet; personnel management; provision of sales, business, advertising and promotional information through a global computer network and via the Internet; presentation of goods on communication media for retail purposes; retail and wholesale of cosmetics, perfumery, toiletri-

es, dentifrices, soaps, detergents, deodorants for personal use and household use, bleaching and cleaning preparations, dental care preparations, dentifrices, mouth washes, polishing preparations, candles, wax, pharmaceuticals, veterinary and medical preparations, disinfectants, dietary supplements, baby food, herbs and herbal beverages, sanitary preparations, sanitary diapers, sanitary pads, goods and materials of common metal used for storage, wrapping, packaging and sheltering purposes, containers of metal (storage, transport), metal boxes, packaging containers of metal, aluminium foil, storage containers of metal, metal containers for the transportation of goods, ladders of metal, ironmongery, small hardware of metal, safes of metal, machines, machine tools and industrial robots for processing and shaping wood, metals, glass, plastics and minerals, 3D printers, electric kitchen machines for chopping, grinding, crushing, mixing and mincing foodstuff, washing machines, laundry washing machines, dishwashers, spin driers (not heated), electric cleaning machines for cleaning floors, carpets or floorings, vacuum cleaners and parts thereof, forks, spoons, knives and non-electric cutters, slicers, peelers for kitchen use, including those made of precious metals, tools and apparatus for personal beauty care use: tools and apparatus for shaving, epilation, manicure and pedicure, electric hand implements for straightening and curling hair, scissors, handoperated hand tools for the repair of machines, apparatus and vehicles and for use in construction, agriculture, horticulture and forestry, electric or non-electric irons, steam irons, thermometers, microscopes, magnifying glasses, apparatus for recording, transmission or reproduction of sound or images, cameras, photographic cameras, television apparatus, video recorders, CD and DVD players and recorders, MP3 players, computers, desktop computers, tablet computers, microphones, loudspeakers, earphones, telecommunications apparatus, apparatus for the reproduction of sound or images, computer peripheral devices, cell phones, covers for cell phones, telephone apparatus, computer printers, scanners as data processing equipment, photocopiers, magnetic and optic data carriers and computer software and programmes recorded thereto, downloadable and recordable electronic publications, encoded magnetic and optic cards, photocells, optical sensors, counters, clothing for protection against accidents, irradiation and fire, safety vests and life-saving apparatus and equipment, eyeglasses, sunglasses, optical lenses and cases, containers, parts and components thereof, decorative magnets, metronomes, medical orthopaedic articles, corsets for medical purposes, orthopaedic shoes, elastic bandages and supportive bandages, condoms, babies' bottles, babies' pacifiers, teats, teeters for babies, lighting installations, hair driers, hand drying apparatus, water softening apparatus, electric bed warmers and electric blankets, not for medical use, electric pillow warmers, electric or nonelectric foot warmers, hot water bottles, pasteurizers and

sterilizers, motorcycles, mopeds, vehicle seats, headrests for vehicle seats, safety seats for children, for vehicles, seat covers for vehicles, vehicle covers, sunblinds adapted for vehicles, wipers for vehicles, baby carriages, wheelchairs, pushchairs, shopping carts, shopping trolleys, fireworks, sprays for personal defence, jewellery, watches, statuettes and figurines of precious metal, clocks, watches, parts thereof, chronometers, music instruments, their cases, paper and cardboard, paper and cardboard for packaging and wrapping purposes, cardboard boxes, paper towels, toilet paper, paper napkins, plastic materials for packaging and wrapping purposes, printed publications, printed matter, books, magazines, newspapers, bill books, printed dispatch notes, printed vouchers, calendars, posters, photographs [printed], paintings, stickers [stationery], postage stamps, stationery, office stationery, instructional and teaching material [except furniture and apparatus], writing and drawing implements, artists' materials, paper products for stationery purposes, adhesives for stationery purposes, pens, pencils, erasers, adhesive tapes for stationery purposes, cardboard cartons [artists' materials], writing paper, copying paper, paper rolls for cash registers, drawing materials, chalkboards, painting pencils, watercolours [paintings], stationery, instructional and teaching material, writing and drawing implements, artists' materials, paper products for stationery purposes, adhesives for stationery purposes, pens, pencils, erasers, adhesive tapes for stationery purposes, cardboard cartons [artists' materials], writing paper, copying paper, paper rolls for cash registers, drawing materials, chalkboards, painting pencils, watercolours [paintings], pint roller, paint brushes, rosaries, goods made of leather, imitations of leather or other materials designed for carrying items, bags, wallets, straps, boxes and trunks made of leather or stout leather, key cases, trunks [luggage], suitcases, umbrellas, parasols, walking sticks, monuments and statuettes of stone, concrete and marble, furniture, mattresses, pillows, air mattresses and cushions, sleeping bags for camping, water beds, mirrors, bouncing chairs for babies, playpens for babies, cradles, infant walkers, display boards, frames for pictures and paintings, identification plates, identification tags, nameplates, identification labels made of wood or synthetic materials, packaging containers of wood or plastics, storage containers, chests, ornaments and decorative goods of wood, cork, reed, cane, wicker, horn, bone, ivory, whalebone, shell, amber, mother-of-pearl, meerschaum, beeswax, plastic or plaster, figurines, holiday ornaments for walls and sculptures, baskets, kennels, nesting boxes and beds for household pets, cages for household pets, indoor aquariums, vivarium and indoor terrariums for animals and plant cultivation, bamboo curtains, roller indoor blinds [for interiors], slatted indoor blinds, strip curtains, bead curtains for decoration, curtain hooks, curtain rings, curtain tie-backs, curtain rods, hand-operated non-electric cleaning instruments and appliances, brushes,

other than paintbrushes, sponges for cleaning, steel wool for cleaning, cloths of textile for cleaning, gloves for dishwashing, non-electric polishing machines for household purposes, brooms for carpets, mops, tooth brushes, shaving brushes, hair brushes, non-electric household or kitchen utensils, service dishes, pots and pans, bottle openers, flower pots, drinking straws, non-electric cooking utensils, ironing boards and shaped covers therefor, drying racks for washing, clothes drying hangers, ornaments and decorative goods of glass, porcelain, earthenware or clay, statues, figurines and vases, perfume burners, perfume sprayers, perfume vaporizers, electric or non-electric make-up removing appliances, powder puffs, toilet cases, plant watering devices and containers, ropes, strings, hammocks, tents, bags of textile, yams, threads, textile goods for household use, curtains, bed covers, sheets (textile), pillowcases, blankets, quilts, towels, flags, labels, blankets, clothing, headgear, footwear, swimwear, scarves, hats, caps, laces and embroidery, guipures, festoons, ribbons (haberdashery), ribbons and braid, fastening tapes for clothing, cords for clothing, letters and numerals for marking linen, embroidered emblems, badges for wear, not of precious metal, shoulder pads for clothing, buttons for clothing, fasteners for clothing, eyelets for clothing, zippers, buckles for shoes and belts, fasteners, shoe and belt buckles, pins, other than jewellery, adhesive patches for decoration of textile articles, laces, needles, sewing needles, needles for sewing machines, needles for knitting and embroidery, boxes for needles, needle cushions, artificial flowers, artificial fruits, hair pins, hair buckles, hair bands, decorative articles for the hair, wigs, hair extensions, electric or non-electric hair curlers, carpets, rugs, mats, wallpaper, wall hangings, games, toys, gymnastic and sporting articles, fishing tackle, artificial fishing bait, decoys for hunting and fishing, Christmas trees of artificial material, ornaments for Christmas trees, artificial snow, rattles (playthings), novelties for parties, paper party hats, foodstuff, beverages, matches, tobacco and tobacco products enabling customers to conveniently view and purchase those goods, such services may be provided by retail stores, wholesale outlets, through vending machines, mail order catalogues or by means of electronic media, for example, through web sites or television shopping programmes.

(260) AM 2023 118711 A

(800) 1138512

(151) 2011 11 24

(891) 2022 06 17

(731) Cult Beauty Limited

Ground Floor, 46 Colebrooke Row, London  
N1 8AF, United Kingdom

(540)

**CULT BEAUTY**

(591) Black, white

(511)

35 – Retail services connected with the sale of toiletries and cosmetics, candles and incense, hand tools and implements, cutlery and razors, goods of precious metals and their alloys, photo frames, napkin rings and cutlery, jewellery and precious stones, horological and chronometric instruments, writing paper, photographs, stationery, goods of leather and imitation leather, trunks and travelling bags, umbrellas, furniture, mirrors and picture frames, household and kitchen utensils and containers, combs and sponges, brushes, goods of unworked or semi-worked glass, glassware, porcelain and earthenware, crockery, textiles and textile goods, bed and table ware, cushions, curtains and rugs, clothing, footwear, headgear, carpets, rugs, mats and matting, wall hangings, games and playthings, decorations for Christmas trees, soft toys, articles made of precious metals or coated or plated therewith, jewellery and imitation jewellery, horological and chronometric instruments, parts and fittings for all the aforesaid, precious stones, statues, cufflinks, tie pins, cigar and cigarette boxes; the bringing together for the benefit of others of a variety of toys, games (other than ordinary playing cards), playthings, golf bags, Christmas crackers and decorations (other than candles or lamps) for Christmas trees, ankle and wrist weights for exercise, athletic equipment, namely, training devices to be worn on the body for support, bags specially adapted for sports equipment, balls for sports, barbells, exercise balls, exercise bars, exercise equipment, exercise weights, leg weights, personal exercise mats, portable ski carriers, running gloves, shin guards for athletic use, shoulder pads for athletic use, stretch bands used for yoga and physical fitness purposes, treadmills, trolley bags specially adapted for sports equipment, weight lifting belts, weight lifting gloves, work-out gloves, wrist guards for athletic use, yoga mats, enabling customers to conveniently view and purchase those goods in a department store; consultancy services relating to the acquisition of goods and services; the bringing together for the benefit of others of a variety of clothing, scarves, shawls, footwear, boots, shoes, slippers, sandals, headgear, headbands, armbands, belts, ties, clothing, footwear and headgear, enabling customers to conveniently view and purchase those goods from a general merchandise Internet website.

(260) AM 2023 118714 A

(800) 1397153

(151) 2017 12 15

(891) 2022 06 06

(731) AGROHIM&amp;KEMOIMPEX DOO

Resavska 66, 11000 Beograd, Serbia

(540)

**KEMOIMPEX**

(591) Black, white

(511)

35 – Wholesale and retail sale of tires.

37 – Tire repair service; tire fitting service.

(260) AM 2023 118717 A

(800) 1584186

(151) 2020 12 09

(891) 2022 04 06

(731) SOFT MEDICAL AESTHETICS

55 Boulevard Pereire, F-75017 Paris,  
France

(540)



(591) Orange (Pantone No. 1505C)

(531) 26.04.02; 26.04.05; 27.05.09; 27.05.19;

27.05.24; 29.01.12

(511)

10 – Cannulas; needles for medical use; surgical, medical, dental and veterinary apparatus and instruments; suture material; massage apparatus; electric massage apparatus for household use; aesthetic massage apparatus; massage rollers; vibrating massager.

(260) AM 2023 118768 A

(800) 1674227

(151) 2022 02 18

(891) 2022 02 18

(731) Tianjin Fohoway Technology Development  
Co., Ltd.No.16 Hongsheng Avenue, Huaming  
Subdistrict Dongli District, 300300 Tianjin,  
China

(540)

**FUNDESEE**

(591) Black, white

(531) 27.05.01

(511)

3 – Soap; cakes of soap; laundry bleach; douching preparations for personal sanitary or deodorant purposes [toiletries]; cleansers for intimate personal hygiene purposes, non medicated; cosmetics; washing soda, for cleaning; detergents, other than for use in manufacturing operations and for medical purposes; scouring solutions; degreasers, other than for use in manufacturing processes.

(260) AM 2023 118770 A

(800) 1674284

(151) 2022 06 27

(891) 2022 06 27

(731) Aktsionernoe obshchestvo "Moskovsky pivo-

bezalkogolny kombinat "OCHAKOVO"  
ul. Ryabinovaya, d. 44, RU-121471 MOSKVA,  
Russian Federation

(540)



(591) Orange, purple and white

(531) 25.05.03; 27.05.10; 27.05.17; 27.05.24;  
29.01.13

(511)

32 – Aperitifs, non-alcoholic; barley wine [beer]; carbonated water; lithia water; seltzer water; soda water; mineral water [beverages]; waters [beverages]; table waters; kvass; cocktails, non-alcoholic; beer-based cocktails; lemonades; non-alcoholic beverages; non-alcoholic dried fruit beverages; isotonic beverages; non-alcoholic honey-based beverages; rice-based beverages, other than milk substitutes; soya-based beverages, other than milk substitutes; aloe vera drinks, non-alcoholic; whey beverages; protein-enriched sports beverages; soft drinks; non-alcoholic beverages flavoured with coffee; non-alcoholic beverages flavoured with tea; non-alcoholic fruit juice beverages; energy drinks; fruit nectars, non-alcoholic; orgeat; beer; ginger beer; malt beer; powders for effervescing beverages; sarsaparilla [non-alcoholic beverage]; syrups for lemonade; syrups for beverages; starch-based dry mixes for beverage preparation; smoothies; vegetable juices [beverages]; fruit juices; tomato juice [beverage]; cider, non-alcoholic; preparations for making carbonated water; must; grape must, unfermented; beer wort; malt wort; pastilles for effervescing beverages; shandy; non-alcoholic fruit extracts; extracts of hops for making beer; non-alcoholic essences for making beverages; sherbets [beverages].

(260) AM 2023 118771 A

(800) 1674318

(151) 2022 05 30

(891) 2022 05 30

(731) KİNG PAZARLAMA VE DIŞ TİCARET  
ANONİM ŞİRKETİ  
DEFTERDAR MH. OTAKÇILAR CD.,  
SINPAŞ FLATOFİS 78 99 EYÜPSULTAN,  
İSTANBUL, Türkiye

(540)



(591) Black, white

(531) 24.09.07; 27.05.01

(511)

7 – Electric fruit juice extractors; electric food blender; hand-held blenders being electric food blenders; electric hand-held mixer for household purposes; electric food chopper; vacuum cleaners; automatic cleaning machines; electric hand sweepers; ironing machines and ironing presses; electric kitchen machines for chopping, grinding, crushing, mixing and mincing foodstuff, washing machines, laundry washing machines, dishwashers, spin driers (not heated), electric cleaning machines for cleaning floors, carpets or floorings, vacuum cleaners and parts thereof; electric hand drills, electric hand saws, electric jigsaw machines, spiral machines, compressed air machines, compressors (machines), vehicle washing installations, robotic mechanisms (machines) with the abovementioned functions.

8 – Electric or non-electric irons; steam irons; hair clippers and hair trimmers; depilation appliances; forks, spoons, knives and non-electric cutters, slicers, peelers for kitchen use, including those made of precious metals; side arms and blades (weapons); tools and apparatus included in this class for personal beauty care use: tools and apparatus included in this class for shaving, epilation, manicure and pedicure, electric hand implements for straightening and curling hair, scissors; hand-operated [non-electric] hand tools included in this class for the repair of machines, apparatus and vehicles and for use in construction, agriculture, horticulture and forestry, none of them being power tools.

11 – Electric tea machines; electric coffee machines; kettles, electric; toast machines, toaster machines; water heaters, electric water boilers; water boilers and their parts; electric grills; electric barbecue grills; electric bread toasters; electric deep fryer; air fryer; electric hair dryers; heaters for baths; electrical water boilers; water heaters for household use; electric heating fans; air-conditioning fans; lighting installations; lights for vehicles and interior-exterior spaces; heating installations using solid, liquid or gas fuels or electricity, central heating boilers, boilers for heating installations, radiators [heating], heat exchangers, not parts of machines, stoves, kitchen stoves, solar thermal collectors [heating]; steam boilers, other than parts of machines, acetylene generators; installations for air-conditioning and ventilating; cooling installations and freezers; electric and gas-powered devices, installations and apparatus for cooking, drying and boiling; cookers, electric cooking pots, electric water heaters, barbecues, electric laundry driers; hair driers; hand drying apparatus; industrial type installations for cooking, drying and cooling purposes; pasteurizers and sterilizers.

(260) AM 2023 118774 A

(800) 1674358

(151) 2022 04 07

(891) 2022 04 07

(731) IONOS SE

Elgendorfer Str. 57, 56410 Montabaur,  
Germany

(540)

**IONOS**

(591) Black, white

(511)

42 – Hosting computer sites [web sites]; cloud hosting provider services; server hosting; hosting platforms on the Internet; cloud computing; providing virtual computer systems through cloud computing; software as a service [SaaS]; infrastructure as a service [IaaS]; programming of operating software for accessing and using a cloud computing network; rental of computer software; consulting in the field of cloud computing networks and applications; information technology [IT] consultancy; providing search engines for the Internet; electronic data storage; off-site data backup; technological consultancy; rental of computers and computer software; technical research; web site design consultancy; software design for others; computer hardware development; programming of software for online advertising; programming of software for website development; programming of software for e-commerce platforms; programming of software for Internet platforms; design and development of electronic greeting cards; design, creation and programming of web pages; updating websites for others; development, updating and maintenance of software and database systems; provision of on-line support services for computer program users; computer software technical support services; computer firewall services; troubleshooting of computer hardware and software problems.

(260) AM 2023 118775 A

(800) 1674377

(151) 2022 06 01

(891) 2022 06 01

(731) Japan Tobacco Inc.

1-1, Toranomon 4-chome, Minato-ku, Tokyo,  
Japan

(540)

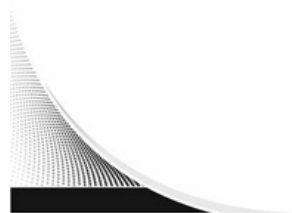

(591) Black, white

(531) 25.07.25; 26.04.04; 26.04.05; 26.04.24;  
26.11.01; 26.11.12

(511)

34 – Tobacco, raw or manufactured; smoking tobacco, pipe tobacco, rolling tobacco, chewing tobacco, snus; cigarettes, electronic cigarettes, liquid for electronic cigarettes, tobacco vaporizers, cigars, cigarillos; snuff; smokers' articles included in this class; cigarette paper, cigarette tubes and matches.

(260) AM 2023 118776 A

(800) 1674439

(151) 2022 02 02

(891) 2022 02 02

(731) Verisure Sàrl

Chemin Jean-Baptiste Vandelle 3 A, CH-1290  
Versoix, Switzerland

(540)

**ARLO**

(591) Black, white

(511)

9 – Safety, security, protection and signalling devices; video surveillance monitoring and security systems; alarms; electric and electronic doorbells; alarm central units; alarm display units; alarm panels; control panels and keypads for security alarms; security control and security surveillance apparatus; access control devices; sound recording apparatus; identity checking units; monitoring instruments; electrical devices to prevent jamming; communication apparatus; global positioning systems; electronic tracking apparatus; sensors and detectors; computer hardware for IP video surveillance; radar units; radar systems, apparatus and displays; cameras; video cameras; digital photo apparatus; security cameras; surveillance cameras; wireless camera systems comprising a camera and also featuring a floodlight; application software; software; apparatus for processing, transmitting and/or receiving video and/or audio signals; baby monitors; electric and electronic locks; Wi-Fi transmitters and receivers.

11 – Artificial smoke generating machines.

38 – Electronic exchange of messages via chat lines and chat rooms; Voice and data transmission services.

42 – Hosting websites; Software as a service [SaaS] services; technical data analysis; computer services, namely provision of a website with technology facilitating the monitoring and control, from a remote location, by wired or wireless communication, of environmental control and monitoring devices, namely smoke alarms, carbon monoxide alarms, fire alarms, security alarms, cameras, bells and sensors; computer services, namely electronic storage of electronic media, namely images, text, audio and video data; providing chatbot services.

45 – Security services for the protection of property and individuals; monitoring and alarm monitoring ser-



vices; individual and pet position finding services; tracking of stolen property.

(260) AM 2023 118777 A

(800) 1674443

(151) 2022 05 17

(891) 2022 05 17

(731) ACM

17 rue de Neuilly, Impasse Passoir, F-92110

CLICHY, France

(540)

**AZEANE**

(591) Black, white

(511)

3 – Cosmetic soaps; perfumes; cosmetics; essential oils; non-medicated preparations and creams for skin, face and body care; beauty care and body cleaning preparations; micellar water; serum for cosmetic use; cosmetic sun-protecting preparations; hair lotions; shampoos; all these goods falling within the dermatological field other than for medical use and not being composed of salts and not for use in baths and spa baths.

(260) AM 2023 118778 A

(800) 1674456

(151) 2022 03 24

(891) 2022 03 24

(731) Henan Shuanghui Investment & Development Co., Ltd.

No. 1, Shuanghui Road, Luohe City, 462000

Henan Province, China

(540)



(591) Black, white

(531) 26.04.06; 26.04.07; 26.04.18; 26.04.24;

27.05.24; 28.03

(511)

29 – Quick-frozen instant dishes consisting primarily of meat, fish, poultry or vegetables; cooked meat products; packaged meats; fried chicken nuggets; chicken; fried meat; meat, preserved; prepared meat; beef; beef steaks; prepared beef; bacon; chicken meatballs; sausages in batter; hot dog sausages; corn dogs; pork steaks; prepared dishes consisting principally of meat; meatballs; beef meatballs; fish meatballs; crab meat; imitation crab meat; canned soups; prepared soup; dried eggs being egg products; prepared eggs; spiced corned eggs; boiled eggs in tea; sausage casings,

natural or artificial; fish sausages; charcuterie; meat; ham; bouillon; salted meats; liver pastes; sausages; smoked meats; beef tripe; poultry, not live; liver; cured meats; pork; bone oil for food; lard; suet for food; sunflower oil for food; vegetable salads; fruit salads; pectin for culinary purposes; jellies; preserved fruit for use as chewing gum base; nuts, prepared; dried edible fungi; albumen for culinary purposes; tofu products; cream, being dairy products; cheese; milk; milk beverages, milk predominating; milk products; yogurt; edible fats; rape oil for food; oils for food; corn oil; air-dried sausages; pressed salted duck; sliced meat; jerky; dried meat; frozen frog legs; meat floss; edible birds' nests; seaweed extracts for food; caviar; crustaceans, not live; fish fillets; fish, not live; shrimps, not live; oysters, not live; isinglass for food; lobsters, not live; shellfish, not live; sardines; salmon; tuna; fish-based foodstuffs; minced meat; fish, preserved; fish meal for human consumption; tinned seafood; frozen fruits; crystallized fruits; potato flakes; peanut butter; jams; processed betel nuts; vegetables, preserved; sea-cucumbers, not live; shark's fin; fish maw; dried fish; fish meat floss; squid; dried shrimps; salted jellyfish; dried scallops; shrimp paste; fish, canned; fruits, canned; meat, canned; vegetables, canned; vegetables, dried; soups; vegetable juices for cooking; pickles; preparations for making soup; salted vegetables; dehydrated vegetables; vegetables, instant frozen; eggs; powdered eggs; soya milk, milk substitutes; sesame oil; soybean milk; salted fermented soybean oil.

30 – Instant coffee; powdered coffee; coffee; rice-based snack food; high-protein cereal bars; cereal bars; hamburgers; breakfast cereal; stir-fried rice; deep-fried dough sticks; rice-based prepackaged lunch with meat, fish or vegetables; fried scallion pancakes; rice cakes; barbecue sauces; rice noodles in strips; coffee flavoring spices for use as a condiment; chocolate beverages with milk; coffee-based beverages; tea; tea-based beverages; sugar; candies; fruit jelly candy; honey; powdered seasonings containing chicken broth extracts with cordyceps; pastries; fried dough twists; moon cakes; cookies; cakes; bread; cereal-based breakfast food containing dried fruits and nuts; hot dogs; steamed buns; baozi; jiaozi; instant rice; glutinous rice wrapped in bamboo leaves (zongzi); pies; spring rolls; porridge; sweet dumplings made of glutinous rice flour; eight-treasure rice pudding; fermented glutinous rice; steamed twisted rolls; boxed meal consisting primarily of noodles or rice and also containing fish, meat, fruits, vegetable or dairy products; cereal preparations; hominy; rice; husked oats; wheat flour; chips, cereal products; flour products; noodles; rice flour; popcorn; shrimp chips; crispy rice crust; cereal-based snack food; edible gluten puffs; soya flour; starch for food; food made from cereal flour; konjaku flour; vermicelli in strips; lotus root flour; sweet potato flour; potato flour; pumpkin flour; ice cream; ice, natural or artificial; powders for making ice cream; frozen yo-

gurt, confectionery ices; salt for preserving foodstuffs; cooking salt; vinegar; soya sauce; artificial vinegar made of acetic acid; salt for preserving soy sauce; seaweed for use as a condiment; star aniseed; infusions, not medicinal; condiments; cinnamon for use as spice; curry for use as spice; cloves for use as spice; turmeric; peppers for use as seasoning; allspice; mustard meal; ground ginger; mustard; nutmegs; pepper; saffron for use as seasoning; flavorings, other than essential oils; flavorings, other than essential oils, for beverages; chow-chow for use as a condiment; relish for use as a condiment; seawater for cooking; ketchup sauce; mayonnaise; dressings for salad; chutney for use as a condiment; meat gravies; seasonings for instant boiled mutton; douchi [fermented black soybeans]; shrimp oil for use as a seasoning or condiment; sauce made from fermented grains; oyster sauce; fish sauce; shrimp sauce; essence of chicken for use as a condiment; chinese cinnamon; chili oil; Chinese prickly ash powder for use as a seasoning or condiment; fish flavour powder for use as a seasoning or condiment; five spice powder; seafood flavour powder for use as a seasoning or condiment; smoked multiflavored seasonings for food; monosodium glutamate; garlic sauce; sauce for use as a condiment; fruit oil for use as a seasoning or condiment; yeast; ferments for pastes; essences for foodstuffs, except etheric essences and essential oils; meat tenderizers for household purposes; preparations for stiffening whipped cream; gluten additives for culinary purposes.

(260) AM 2023 118779 A

(800) 1674480

(151) 2022 04 26

(891) 2022 04 26

(731) GRUPO MASSIMO DUTTI, S.A.

AVENIDA DE LA DIPUTACION, EDIFICIO  
INDITEX, E-15143 ARTEIXO (A CORUÑA),  
Spain

(540)

## MASSIMO DUTTI

(591) Black, white

(511)

4 – Oils and greases for industrial use; lubricants; compositions for absorbing, wetting and binding dust; fuels (including gasoline for engines) and illuminating materials; candles and wicks for lighting; beeswax.

(260) AM 2023 118780 A

(800) 1674546

(151) 2022 06 15

(891) 2022 06 15

(731) Limited Liability Company "KAVZ"

Avtozavodskaya St., 5, Kurgan, RU-640008  
Kurgan region, Russian Federation

(540)

## KAVZ

(591) Black, white

(511)

12 – Motor buses; motor coaches; automobile bodies; bodies for vehicles.

(260) AM 2023 118782 A

(800) 1674568

(151) 2021 08 19

(891) 2021 08 19

(731) GRATİS İÇ VE DIŞ TİCARET ANONİM  
ŞİRKETİ

Levent Mah. Yapı Kredi Plaza, C Blok Cömert  
Sok 1C Kat.5, Beşiktaş, İstanbul, Türkiye

(540)

## authoriderm

— GLOBAL DERMAL INSTITUTE —

(591) Black, white

(531) 26.11.02; 26.11.08; 27.05.01; 27.05.09;

27.05.10

(511)

3 – Bleaching and cleaning preparations, detergents other than for use in manufacturing operations and for medical purposes, laundry bleach, fabric softeners for laundry use, stain removers, dishwasher detergents; perfumery; non-medicated cosmetics; fragrances; deodorants for personal use and animals; soaps; dental care preparations; dentifrices, denture polishes, tooth whitening preparations, mouth washes, not for medical purposes; abrasive preparations; emery cloth; sandpaper; pumice stone; abrasive pastes; polishing preparations for leather, vinyl, metal and wood, polishes and creams for leather, vinyl, metal and wood, wax for polishing.

5 – Pharmaceutical and veterinary preparations for medical purposes; chemical preparations for medical and veterinary purposes, chemical reagents for pharmaceutical and veterinary purposes; medicated cosmetics; dietary supplements for pharmaceutical and veterinary purposes; dietary supplements; nutritional supplements; medical preparations for slimming purposes; food for babies; herbs and herbal beverages adapted for medicinal purposes; dental preparations and articles; teeth filling material, dental impression material, dental adhesives and material for repairing teeth; sanitary preparations for medical use; hygienic pads; hygienic tampons; plasters; materials for dressings; diapers made of paper and textiles for babies, adults and pets; preparations for destroying vermin; herbicides, fungicides, preparations for destroying rodents; deodorants, other than for human beings or for animals; air purifying preparations; air deodorising preparations; disinfectants; antiseptics; detergents for medical purposes; medicated soaps; disinfectant soaps; antibacterial hand lotions.

35 – Advertising, marketing and public relations; organization of exhibitions and trade fairs for commercial or advertising purposes; development of advertising concepts; provision of an online marketplace for buyers and sellers of goods and services; office functions; secretarial services; arranging newspaper subscriptions for others; compilation of statistics; rental of office machines; systemization of information into computer databases; telephone answering for unavailable subscribers; business management, business administration and business consultancy; accounting; commercial consultancy services; personnel recruitment, personnel placement, employment agencies, import-export agencies; temporary personnel placement services; auctioneering; the bringing together, for the benefit of others, of bleaching and cleaning preparations, detergents other than for use in manufacturing operations and for medical purposes, laundry bleach, fabric softeners for laundry use, stain removers, dishwasher detergents, perfumery, non-medicated cosmetics, fragrances, deodorants for personal use and animals, soaps, dental care preparations, dentifrices, denture polishes, tooth whitening preparations, mouth washes, not for medical purposes, abrasive preparations, emery cloth, sandpaper, pumice stone, abrasive pastes, polishing preparations for leather, vinyl, metal and wood, polishes and creams for leather, vinyl, metal and wood, wax for polishing, pharmaceutical and veterinary preparations for medical purposes, chemical preparations for medical and veterinary purposes, chemical reagents for pharmaceutical and veterinary purposes, medicated cosmetics, dietary supplements for pharmaceutical and veterinary purposes, dietary supplements, nutritional supplements, medical preparations for slimming purposes, food for babies, herbs and herbal beverages adapted for medicinal purposes, dental preparations and articles, teeth filling material, dental impression material, dental adhesives and material for repairing teeth, sanitary preparations for medical use, hygienic pads, hygienic tampons, plasters, materials for dressings, diapers made of paper and textiles for babies, adults and pets, preparations for destroying vermin, herbicides, fungicides, preparations for destroying rodents, deodorants, other than for human beings or for animals, air purifying preparations, air deodorising preparations, disinfectants, antiseptics, detergents for medical purposes, medicated soaps, disinfectant soaps, antibacterial hand lotions, forks, spoons, knives and non-electric cutters, slicers, peelers for kitchen use, including those made of precious metals, side arms and blades (weapons), tools and apparatus included in this class for personal beauty care use, tools and apparatus included in this class for shaving, epilation, manicure and pedicure, electric hand implements for straightening and curling hair, scissors, hand-operated [non-electric] hand tools included in this class for the repair of machines, apparatus and vehicles and for use in construction, agriculture, horticultural and forestry,

none of them being power tools, electric or non-electric irons, steam irons, handles for hand-operated hand tools, surgical, medical, dental and veterinary apparatus and instruments, furniture especially made for medical purposes, artificial limbs and prostheses, medical orthopaedic articles, corsets for medical purposes, orthopaedic shoes, elastic bandages and supportive bandages, surgical gowns and surgical sterile sheets, adult sexual aids, condoms, babies' bottles, babies' pacifiers, teats, teethers for babies, bracelets and rings for medical purposes, anti-rheumatism bracelets, anti-rheumatism rings, hand-operated non-electric cleaning instruments and appliances, brushes, other than paintbrushes, steel chips for cleaning, sponges for cleaning, steel wool for cleaning, cloths of textile for cleaning, gloves for dishwashing, non-electric polishing machines for household purposes, brooms for carpets, mops, toothbrushes, electric toothbrushes, dental floss, shaving brushes, hair brushes, combs, non-electric household or kitchen utensils, included in this class, [other than forks, knives, spoons], services [dishes], pots and pans, bottle openers, flower pots, drinking straws, non-electric cooking utensils, ironing boards and shaped covers therefor, drying racks for washing, clothes drying hangers, cages for household pets, indoor aquariums, vivariums and indoor terrariums for animals and plant cultivation, ornaments and decorative goods of glass, porcelain, earthenware or clay namely statues, figurines, vases, and trophies, mouse traps, insect traps, electric devices for attracting and killing flies and insects, fly catchers, fly swatters, perfume burners, perfume sprayers, perfume vaporizers, electric or non-electric make-up removing appliances, powder puffs, toilet cases, nozzles for sprinkler hose, nozzles for watering cans, watering devices, garden watering cans, unworked or semi-worked glass, except building glass, mosaics of glass and powdered glass for decoration, except for building, glass wool other than for insulation or textile use, enabling customers to conveniently view and purchase those goods, such services may be provided by retail stores, wholesale outlets, by means of electronic media or through mail order catalogues.

(260) AM 2023 118783 A

(800) 1674569

(151) 2021 08 19

(891) 2021 08 19

(731) GRATIS İÇ VE DIŞ TİCARET ANONİM ŞİRKETİ

Levent Mah. Yapı Kredi Plaza, C Blok Cömert Sok 1C Kat.5, Beşiktaş, İstanbul, Türkiye

(540)



(591) Black, violet, brown, pink  
(531) 02.09.01; 26.04.04; 26.04.09; 26.04.24;  
27.05.01; 27.05.10; 29.01.14

(511)

3 – Bleaching and cleaning preparations, detergents other than for use in manufacturing operations and for medical purposes, laundry bleach, fabric softeners for laundry use, stain removers, dishwasher detergents; perfumery; non-medicated cosmetics; fragrances; deodorants for personal use and animals; soaps; dental care preparations; dentifrices, denture polishes, tooth whitening preparations, mouth washes, not for medical purposes; abrasive preparations; emery cloth; sandpaper; pumice stone; abrasive pastes; polishing preparations for leather, vinyl, metal and wood, polishes and creams for leather, vinyl, metal and wood, wax for polishing.

5 – Pharmaceutical and veterinary preparations for medical purposes; chemical preparations for medical and veterinary purposes, chemical reagents for pharmaceutical and veterinary purposes; medicated cosmetics; dietary supplements for pharmaceutical and veterinary purposes; dietary supplements; nutritional supplements; medical preparations for slimming purposes; food for babies; herbs and herbal beverages adapted for medicinal purposes; dental preparations and articles; teeth filling material, dental impression material, dental adhesives and material for repairing teeth; sanitary preparations for medical use; hygienic pads; hygienic tampons; plasters; materials for dressings; diapers made of paper and textiles for babies, adults and pets; preparations for destroying vermin; herbicides, fungicides, preparations for destroying rodents; deodorants, other than for human beings or for animals; air purifying preparations; air deodorising preparations; disinfectants; antiseptics; detergents for medical purposes; medicated soaps; disinfectant soaps; antibacterial hand lotions.

21 – Hand-operated non-electric cleaning instruments and appliances, brushes, other than paintbrushes, steel scrub sponges for cleaning, sponges for cleaning, steel wool for cleaning, cloths of textile for cleaning, gloves for dishwashing, non-electric polishing machines for household purposes, brooms for carpets, mops; toothbrushes, electric toothbrushes, dental floss, shaving brushes, hair brushes, combs; non-electric household or kitchen utensils, included in this class, [other than forks, knives, spoons], services [dishes], pots and pans, bottle openers, flower pots, drinking straws, non-electric cooking utensils; ironing boards and shaped covers therefor, drying racks for washing, clothes drying hangers; cages for household pets, indoor aquariums, vivariums and indoor terrariums for animals and plant cultivation; ornaments and decorative goods of glass, porcelain, earthenware or clay namely statues, figurines, vases, and trophies; mouse traps, insect traps, electric devices for attracting and killing flies and insects, fly catchers, fly swatters; perfume

burners, perfume sprayers, perfume vaporizers, electric or non-electric make-up removing appliances, powder puffs, toilet cases; nozzles for sprinkler hose, nozzles for watering cans, watering devices, garden watering cans; unworked or semi-worked glass, except building glass, mosaics of glass and powdered glass for decoration, except for building, glass wool other than for insulation or textile use.

35 – The bringing together, for the benefit of others, of forks, spoons, knives and non-electric cutters, slicers, peelers for kitchen use, including those made of precious metals, side arms and blades (weapons), tools and apparatus included in this class for personal beauty care use, tools and apparatus included in this class for shaving, epilation, manicure and pedicure, electric hand implements for straightening and curling hair, scissors, hand-operated [non-electric] hand tools included in this class for the repair of machines, apparatus and vehicles and for use in construction, agriculture, horticultural and forestry, none of them being power tools, electric or non-electric irons, steam irons, handles for hand-operated hand tools, surgical, medical, dental and veterinary apparatus and instruments, furniture especially made for medical purposes, artificial limbs and prostheses, medical orthopaedic articles, corsets for medical purposes, orthopaedic shoes, elastic bandages and supportive bandages, surgical gowns and surgical sterile sheets, adult sexual aids, condoms, babies' bottles, babies' pacifiers, teats, teethingers for babies, bracelets and rings for medical purposes, anti-rheumatism bracelets, anti-rheumatism rings enabling customers to conveniently view and purchase those goods, such services may be provided by retail stores, wholesale outlets, by means of electronic media or through mail order catalogues; advertising, marketing and public relations; organization of exhibitions and trade fairs for commercial or advertising purposes; development of advertising concepts; provision of an online marketplace for buyers and sellers of goods and services; office functions; secretarial services; arranging newspaper subscriptions for others; compilation of statistics; rental of office machines; systemization of information into computer databases; telephone answering for unavailable subscribers; business management, business administration and business consultancy; accounting; commercial consultancy services; personnel recruitment, personnel placement, employment agencies, import-export agencies; temporary personnel placement services; auctioneering; the bringing together, for the benefit of others, of bleaching and cleaning preparations, detergents other than for use in manufacturing operations and for medical purposes, laundry bleach, fabric softeners for laundry use, stain removers, dishwasher detergents, perfumery, non-medicated cosmetics, fragrances, deodorants for personal use and animals, soaps, dental care preparations, dentifrices, denture polishes, tooth whitening preparations, mouth washes, not for medical purposes, abrasive preparations, emery cloth, sand-

paper, pumice stone, abrasive pastes, polishing preparations for leather, vinyl, metal and wood, polishes and creams for leather, vinyl, metal and wood, wax for polishing, pharmaceutical and veterinary preparations for medical purposes, chemical preparations for medical and veterinary purposes, chemical reagents for pharmaceutical and veterinary purposes, medicated cosmetics, dietary supplements for pharmaceutical and veterinary purposes, dietary supplements, nutritional supplements, medical preparations for slimming purposes, food for babies, herbs and herbal beverages adapted for medicinal purposes, dental preparations and articles, teeth filling material, dental impression material, dental adhesives and material for repairing teeth, sanitary preparations for medical use, hygienic pads, hygienic tampons, plasters, materials for dressings, diapers made of paper and textiles for babies, adults and pets, preparations for destroying vermin, herbicides, fungicides, preparations for destroying rodents, deodorants, other than for human beings or for animals, air purifying preparations, air deodorising preparations, disinfectants, antiseptics, detergents for medical purposes, medicated soaps, disinfectant soaps, antibacterial hand lotions, hand-operated non-electric cleaning instruments and appliances, brushes, other than paintbrushes, steel scrub sponges for cleaning, sponges for cleaning, steel wool for cleaning, cloths of textile for cleaning, gloves for dishwashing, non-electric polishing machines for household purposes, brooms for carpets, mops, toothbrushes, electric toothbrushes, dental floss, shaving brushes, hair brushes, combs, non-electric household or kitchen utensils, included in this class, [other than forks, knives, spoons], services [dishes], pots and pans, bottle openers, flower pots, drinking straws, non-electric cooking utensils, ironing boards and shaped covers therefor, drying racks for washing, clothes drying hangers, cages for household pets, indoor aquariums, vivariums and indoor terrariums for animals and plant cultivation, ornaments and decorative goods of glass, porcelain, earthenware or clay namely statues, figurines, vases, and trophies, mouse traps, insect traps, electric devices for attracting and killing flies and insects, fly catchers, fly swatters, perfume burners, perfume sprayers, perfume vaporizers, electric or non-electric make-up removing appliances, powder puffs, toilet cases, nozzles for sprinkler hose, nozzles for watering cans, watering devices, garden watering cans, unworked or semi-worked glass, except building glass, mosaics of glass and powdered glass for decoration, except for building, glass wool other than for insulation or textile use enabling customers to conveniently view and purchase those goods, such services may be provided by retail stores, wholesale outlets, by means of electronic media or through mail order catalogues.

- (260) AM 2023 118784 A  
 (800) 1674572  
 (151) 2021 11 29  
 (891) 2021 11 29  
 (731) GlaxoSmithKline Consumer Healthcare (UK)  
 IP Limited  
 980 Great West Road, Brentford, Middlesex  
 TW8 9GS, United Kingdom  
 (540)

## HALEON

- (591) Black, white  
 (511)  
 3 – Cleaning, polishing, scouring and abrasive preparations; soaps; perfumery; essential oils; cosmetics; shampoos for the scalp and hair; non-medicated skin-care and cleansing preparations; skin creams, skin and hair lotions, skin gels, skin ointments, cold cream; skin care preparations; preparations for sun protection; skin whitening preparations; dentifrices and mouthwashes not for medical purposes; breath fresheners; dental gels; toothpaste; tooth bleaching preparations, tooth polishing preparations, tooth whitening preparations and accelerators, cosmetic tooth stain removal preparations; non-medicated toilet preparations; non-medicated oral care preparations; preparations for cleaning, washing, polishing and deodorizing dentures.  
 5 – Pharmaceutical and medicinal preparations and substances, excluding surgical and/or professional vision care preparations and substances; therapeutic agents (medical), excluding surgical and/or professional vision care agents; adhesive patches for medical purposes, excluding adhesive patches for use in the surgical and/or professional vision care fields; adhesive patches for surgical purposes, excluding adhesive patches for use in the surgical and/or professional vision care fields; adhesive patches incorporating a pharmaceutical preparation, excluding adhesive patches for use in the surgical and/or professional vision care fields; medicated patches, plasters and dressings for the treatment of skin diseases, conditions and disorders; vaccines; vitamins, minerals and food supplements; dietary preparations; dietetic substances including foods and drinks adapted for medical use; foods for infants and invalids; weight loss preparations; medicated oral care preparations, namely medicated toothpastes, medicated mouthwashes; medicated bleaching preparations; preparations for sterilizing dentures; medicated chewing gum and lozenges for dental hygiene; denture adhesives, denture fixatives, medicated dental gels; smoking cessation preparations.  
 9 – Scientific apparatus and instruments; computer software to enable healthcare professionals to access information on pharmaceutical and medical related products and services; electrical and computer software; software applications for use in connection with medical devices; electronic monitoring devices; elec-

tric measuring apparatus; software applications (apps) delivered online or as downloadable applications; software and/or software applications (apps) for medical and/or surgical applications; data collecting systems for medical purposes; all the aforementioned goods excluding surgical and/or professional vision care products or for use in the surgical and/or professional vision care fields.

10 – Surgical and medical apparatus and instruments, excluding surgical and/or professional vision care products; dental care apparatus; dental trays; nasal dilators; diagnostic equipment; medical testing apparatus and instruments for use in the diagnosis and treatment of diseases, conditions and disorders; artificial skin; suture materials; biopsy punches; medical diagnostic testing apparatus for skin; medical instruments for allergy tests; transcutaneous electrical nerve stimulation (TENS) devices; devices for posture improvement; sleep monitoring devices; electromagnetic therapy devices; infrared therapy devices; ultra-sound therapy devices; laser therapy devices; diagnostic apparatus for medical purposes; electronic instruments for medical use; thermometers for medical use; all the aforementioned goods excluding surgical and/or professional vision care products; cooling patches for medical purposes; disposable steam-heated patches for therapeutic purposes.

21 – Toothbrushes, electric toothbrushes, floss for dental purposes, toothpicks, toothpick holders (not of precious metal) and plastic containers for holding toothbrushes.

29 – Meat, fish, poultry and game; meat extracts; preserved, dried and cooked fruits and vegetables; jellies, jams, fruit compotes; eggs, milk and milk products; edible oils and fats.

30 – Coffee, tea, cocoa and artificial coffee; rice, pasta and noodles; tapioca and sago; flour and preparations made from cereals; bread, pastries and confectionery; chocolate; ice cream, sorbets and other edible ices; sugar, honey, treacle; yeast, baking-powder; salt, seasonings, spices, preserved herbs; vinegar, sauces and other condiments; ice.

32 – Mineral and aerated waters; fruit drinks; non-alcoholic beverages, namely carbonated beverages; non-alcoholic beverages flavoured with tea; non-alcoholic beverages containing fruit juices; preparations for making beverages, namely energy drinks and fruit drinks; sports drinks enhanced with vitamins, minerals, nutrients; fruit juices and energy drinks containing nutritional supplements; non-alcoholic fruit extracts used in the preparation of beverages.

35 – Promotional and advertising services; provision of the aforementioned services on-line, via cable and/or the Internet; provision of promotional and advertising information relating to pharmaceutical, medical, healthcare and fitness products through an

on-line computer network; retail or wholesale services for pharmaceutical, veterinary and sanitary preparations and medical supplies; retail or wholesale services for pharmaceuticals; all the aforementioned services excluding services relating to surgical and/or professional vision care.

36 – Charitable fundraising; distributing funds and grants for charitable purposes; distributing funds and grants for disaster relief; distributing gift matching funds; financial arrangements to facilitate charitable giving; providing of information regarding corporate donations and payroll donations by employees.

41 – Educational services relating to pharmaceutical, diagnostic, vaccines, proprietary medicines, health, medical, toiletries, skin care and cosmetic industries, excluding educational services relating to the surgical and/or professional vision care fields; education, providing of training, entertainment, educational services and providing of training in relation to smoking control and smoking cessation; educational services relating to weight loss, diet, nutrition and fitness.

42 – Scientific research for medical and healthcare purposes.

44 – Medical, hygienic and beauty care; healthcare services; provision of medical information and services; information provided to patients and healthcare professionals concerning pharmaceutical products, vaccines, medical diseases and disorders and related treatments via the Internet; gene and cell therapy; medical and psychological counselling services; medical and health care services; all the aforementioned services excluding services relating to surgical and/or professional vision care.

(260) AM 2023 118785 A

(800) 1674628

(151) 2022 05 23

(891) 2022 05 23

(731) Environmental Science U.S. LLC

5000 Centregreen Way, Suite 400, Cary NC  
27513, USA

(540)

**ENVU**

(591) Black, white

(511)

1 – Agricultural chemicals, except fungicides, herbicides, insecticides and parasiticides; horticultural chemicals, except fungicides, herbicides, insecticides and parasiticides; chemicals for use in forestry, except fungicides, herbicides, insecticides and parasiticides; seed treatment chemicals for agricultural use; plant growth regulating preparations; biotechnologically-formed genes, microbes and enzymes for use in the production of agricultural seeds to enhance plants' growth therefrom; fertilizers; fertilizing preparations;

animal manure; chemicals for use in aquaculture; growing media for plants.

5 – Fungicides; herbicides; weed killers; preparations for killing weeds and destroying noxious plants; insecticides; parasiticides; vermin destroying preparations.

9 – Downloadable computer application software for mobile phones, computers, handheld computers, and mobile computing devices, namely, software for use in the field of agriculture and horticulture, namely, computer software used to increase crop yield, profitability and ecological sustainability of farms; downloadable computer software for mobile phones, computers, handheld computers, and mobile computing devices for collecting, organizing, tracking, and analyzing field data with agronomic and weather data in the fields of agronomy and agriculture; electronic database in the field of agriculture and horticulture recorded on computer media.

42 – Scientific and technological services, namely, scientific and technological design, industrial analysis and research services; design and development of software and hardware for use in the field of horticulture; cartography and mapping; providing temporary use of online non-downloadable software applications for collecting local microclimate data, assessing turf health, and assisting with agronomic planning; electronic storage of agricultural, horticultural, and agronomic data; software as a service (SaaS) services featuring software for tracking, recording, processing, storing, monitoring, and analyzing agricultural, horticultural, and agronomic data; software as a service (SaaS) featuring software for use in the field of agriculture and horticulture, namely, computer software used to increase crop yield, profitability and ecological sustainability of farms; software as a service (SaaS) featuring software for collecting, organizing, tracking, and analyzing field data with agronomic and weather data in the fields of agronomy and agriculture; technical consultancy in the field of environmental science; scientific and technological services, namely, providing technical consulting regarding the application of manures, herbicides, fungicides, pesticides, and insecticides in the field of horticulture and agriculture, and providing technical consulting regarding particular, tailored recommendations for farmers in the field of cultivation management and analysis of agricultural production; environmental services, namely, technical consultation in the field of environmental science.

44 – Agricultural advice; agricultural advice, namely, providing agricultural and horticultural advice regarding the application of manures, herbicides, fungicides, pesticides and insecticides, and advice regarding particular, tailored recommendations for farmers in the field of cultivation management and analysis of agricultural production; consultancy relating to horti-

culture; pest control services for agriculture, aquaculture, horticulture and forestry.

(260) AM 2023 118786 A

(800) 1674641

(151) 2022 06 01

(891) 2022 06 01

(731) TÜRKİYE TURİZM TANITIM VE  
GELİŞTİRME AJANSI  
Esentepe Mahallesi, Büyükdere Caddesi,  
Astoria 127 B/71, Şişli, İstanbul, Türkiye  
(540)

(591) Red, black and white

(531) 27.05.01; 29.01.13

(511)

35 – Advertising, marketing and public relations; organization of exhibitions and trade fairs for commercial or advertising purposes; development of advertising concepts; provision of an online marketplace for buyers and sellers of goods and services; office functions; secretarial services; arranging newspaper subscriptions for others; compilation of statistics; rental of office machines; systemization of information into computer databases; telephone answering for unavailable subscribers; business management, business administration and business consultancy; accounting; commercial consultancy services; personnel recruitment, personnel placement, employment agencies, import-export agencies; temporary personnel placement services; auctioneering.

39 – Land, water and air transport services; rental of land, water or air vehicles; arranging of travel tours; travel reservation; issuing of tickets for travel; courier services (messages or merchandise); car parking; garage rental.

(260) AM 2023 118804 A

(800) 1675117

(151) 2022 06 01

(891) 2022 06 01

(731) WEKA MEDIA PUBLISHING GmbH  
Richard-Reitzner Allee 2, 85540 Haar,  
Germany

(540)

(591) Black

(531) 27.05.04; 27.05.17

(511)

9 – Electronic magazines.

16 – Periodicals, magazines (periodicals), printed periodicals, professional magazines.

42 – Quality control testing, product quality testing, quality control.

(260) AM 2023 118818 A

(800) 610018

(151) 1993 10 20

(891) 2022 07 08

(731) Export Service S.r.l.

Via Leon Battista Alberti 5, I-20149 Milano,  
Italy

(540)

**FLORELLE**

(591) Black, white

(531) 27.05.01; 27.05.17

(511)

3 – Cosmetics.

(260) AM 2023 118819 A

(800) 800742

(151) 2003 03 07

(891) 2022 07 07

(731) SOCIETE BIC

12-22 boulevard Victor Hugo, F-92110 Clichy,  
France

(540)

**EASY-GLIDE SYSTEM**

(591) Black, white

(531) 27.05.01

(511)

16 – Writing instruments and their parts, pencils, propelling pencils, pens, ball-point pens, fountain pens, inks for writing instruments.

(260) AM 2023 118820 A

(800) 1106582

(151) 2011 11 29

(891) 2022 07 14

(731) 3GP S.r.l.

Piazza Filodrammatici, 4, I-31100 Treviso  
(TV), Italy

(540)



(591) Black, white

(531) 26.11.07

(511)

32 – Beers; mineral and aerated waters and other non-alcoholic drinks; fruit drinks and fruit juices; syrups and other preparations for making beverages.

33 – Alcoholic beverages (except beers).

(260) AM 2023 118821 A

(800) 1338415

(151) 2016 09 29

(891) 2022 07 12

(731) MANUFACTURAS TOMAS, S.A.

C/Budapest, 19-29, Pol. Ind. Cabezo Beaza,  
E-30353 Cartagena, Spain

(540)



(591) Black, white

(531) 27.05.02

(511)

9 – Protective and safety equipment; protective helmets for motorcyclists, cyclists and drivers; protective helmets for sports in general; protective helmets and masks for workers and for preventing accidents and parts for protective helmets, jackets, overalls, shoes, boots, hats, gloves, suits and goggles, all for protection against accidents.

(260) AM 2023 118823 A

(800) 1543670

(151) 2020 03 17

(891) 2022 06 27

(731) Individual entrepreneur Solovyov Sergey

Yurievich

Askarov street, 4, apartment 1506, 050043  
Almaty city, Kazakhstan

(540)



(591) Blue, black and red

(531) 24.17.25; 27.03.15; 29.01.12

(511)

3 – Amber [perfume]; air fragrancing preparations; aromatics [essential oils]; balms, other than for medical purposes; lip glosses; nail glitter; petroleum jelly for cosmetic purposes; scented water; toilet water; depilatory wax; mustache wax; skin care waxes; skin creams; massage gels, other than for medical purposes; dental bleaching gels; deodorants for pets; deodorants for human beings or for animals; depilatory preparations; air fragrance reed diffusers; perfumes; greases for cosmetic purposes; perfumery; eyebrow pencils; cosmetic pencils; adhesives for affixing false eyelashes; adhesives for affixing false hair; hair con-



ditioners; beard dyes; colorants for toilet purposes; cosmetic dyes; cosmetic creams; skin whitening creams; hair spray; nail polish; hair lotions; lotions for cosmetic purposes; after-shave lotions; beauty masks; oils for perfumes and scents; oils for cosmetic purposes; oils for toilet purposes; essential oils; essential oils of cedarwood; essential oils of lemon; essential oils of citron; oils for cleaning purposes; jasmine oil; lavender oil; almond oil; rose oil; oil of turpentine for degreasing; almond milk for cosmetic purposes; cleansing milk for toilet purposes; deodorant soap; shaving soap; antiperspirant soap; soap for foot perspiration; soap; almond soap; mint for perfumery; cosmetic kits; gel eye patches for cosmetic purposes; nail art stickers; false nails; eau de Cologne; bases for flower perfumes; dentifrices; pumice stone; hydrogen peroxide for cosmetic purposes; breath freshening strips; teeth whitening strips; lipsticks; pomades for cosmetic purposes; shaving preparations; cosmetic preparations for baths; bath preparations, not for medical purposes; hair straightening preparations; hair waving preparations; denture polishes; mouthwashes, not for medical purposes; cosmetic preparations for slimming purposes; preparations for giving gloss; eye-washes, not for medical purposes; paint stripping preparations; lacquer-removing preparations; make-up removing preparations; floor wax removers [scouring preparations]; nail care preparations; cleaning preparations; aloe vera preparations for cosmetic purposes; sunscreen preparations; breath freshening preparations for personal hygiene; make-up powder; nail varnish removers; vaginal washes for personal sanitary or deodorant purposes; false eyelashes; baby wipes impregnated with cleaning preparations; tissues impregnated with cosmetic lotions; tissues impregnated with make-up removing preparations; massage candles for cosmetic purposes; potpourris [fragrances]; bath salts, not for medical purposes; fumigation preparations [perfumes]; preservatives for leather [polishes]; ammonia [volatile alkali] [detergent]; astringents for cosmetic purposes; eyebrow cosmetics; make-up preparations; sun-tanning preparations [cosmetics]; hair dyes; neutralizers for permanent waving; cosmetic preparations for eyelashes; cosmetic preparations for skin care; cosmetics; cosmetics for children; cosmetics for animals; mascara; cleansers for intimate personal hygiene purposes, non medicated; douching preparations for personal sanitary or deodorant purposes [toilettries]; detergents, other than for use in manufacturing operations and for medical purposes; degreasers, other than for use in manufacturing processes; bleaching preparations [decolorants] for cosmetic purposes; antiperspirants [toilettries]; toiletry preparations; phyto-cosmetic preparations; talcum powder, for toilet use; cotton sticks for cosmetic purposes; terpenes [essential oils]; henna [cosmetic dye]; shampoos for animals [non-medicated grooming preparations]; shampoos for pets [non-medicated grooming preparations]; dry shampoos; shampoos; herbal extracts for cosmetic

purposes; extracts of flowers [perfumes]; ethereal essences; badian essence; mint essence [essential oil].

5 – Medicine cases, portable, filled; antiseptics; first-aid boxes, filled; balms for medical purposes; bracelets impregnated with insect repellent; petroleum jelly for medical purposes; oxygen baths; antiseptic cotton; aseptic cotton; absorbent cotton; wadding for medical purposes; cotton for medical purposes; dietetic substances adapted for medical use; Melissa water for pharmaceutical purposes; sea water for medicinal bathing; mineral waters for medical purposes; thermal water; sexual stimulant gels; glycerine for medical purposes; mud for baths; medicinal mud; disinfectants; air deodorising preparations; deodorants, other than for human beings or for animals; deodorants for clothing and textiles; capsules for medicines; cachets for pharmaceutical purposes; hemostatic pencils; wart pencils; caustic pencils; corn rings for the feet; medicated sweets; lotions for veterinary purposes; medicated hair lotions; lotions for pharmaceutical purposes; medicated after-shave lotions; personal sexual lubricants; ointments for pharmaceutical purposes; sunburn ointments; medicinal oils; dental mastics; antibacterial soap; disinfectant soap; medicated soap; mint for pharmaceutical purposes; injectable dermal fillers; cotton sticks for medical purposes; stick liquorice for pharmaceutical purposes; sulfur sticks [disinfectants]; medicated dentifrices; compresses; bunion pads; pomades for medical purposes; bacterial preparations for medical and veterinary use; bacteriological preparations for medical and veterinary use; balsamic preparations for medical purposes; biological preparations for veterinary purposes; albuminous preparations for medical purposes; biological preparations for medical purposes; vitamin preparations; bath preparations for medical purposes; therapeutic preparations for the bath; hemorrhoid preparations; preparations for callouses; acne treatment preparations; preparations for the treatment of burns; air purifying preparations; corn remedies; pharmaceutical preparations for treating dandruff; pharmaceutical preparations for skin care; medicated eye-washes; medicinal hair growth preparations; nutraceutical preparations for therapeutic or medical purposes; aloe vera preparations for pharmaceutical purposes; pharmaceutical preparations; pharmaceutical preparations for treating sunburn; phytotherapy preparations for medical purposes; chemico-pharmaceutical preparations; chemical preparations for pharmaceutical purposes; collyrium; pharmaceuticals; sanitary towels; panty liners [sanitary]; chewing gum for medical purposes; nicotine gum for use as an aid to stop smoking; tissues impregnated with pharmaceutical lotions; massage candles for therapeutic purposes; soporifics; bath salts for medical purposes; salts for mineral water baths; salts for medical purposes; potassium salts for medical purposes; smelling salts; mineral water salts; medicinal alcohol; cooling sprays for medical purposes; antibacterial handwashes; adjuvants for medical purposes;

astringents for medical purposes; disinfectants for hygiene purposes; mouthwashes for medical purposes; animal washes [insecticides]; detergents for medical purposes; remedies for foot perspiration; remedies for perspiration; tonics [medicines]; sanitary tampons; vulnerary sponges; insecticidal animal shampoos; medicated shampoos; medicated shampoos for pets; pediculicidal shampoos; medicated dry shampoos; eucalyptus for pharmaceutical purposes; herbal extracts for medical purposes; plant extracts for pharmaceutical purposes; elixirs [pharmaceutical preparations]; ethers for pharmaceutical purposes; esters for pharmaceutical purposes; cellulose esters for pharmaceutical purposes; the simple cellulose ethers for pharmaceutical purposes.

35 – Arranging subscriptions to telecommunication services for others; import-export agency services; commercial information agency services; advertising agency services; cost price analysis; rental of advertising space; business auditing; financial auditing; business intermediary services relating to the matching of potential private investors with entrepreneurs needing funding; employment agency services; computerized file management; book-keeping; invoicing; demonstration of goods; transcription of communications [office functions]; opinion polling; market studies; business information; information and advice for consumers in the field of choosing products and services; business investigations; business research; marketing research; personnel recruitment; business management and organization consultancy; business organization consultancy; business management consultancy; personnel management consultancy; professional business consultancy; consultancy regarding public relations communication strategies; consultancy regarding advertising communication strategies; layout services for advertising purposes; marketing; marketing of software publications; targeted marketing; business management of performing artists; business management of sports people; writing of resumes for others; scriptwriting for advertising purposes; news clipping services; updating and maintenance of information in registries; updating and maintenance of data in computer databases; updating of advertising material; word processing; online retail services for downloadable and pre-recorded music and movies; online retail services for downloadable ring tones; online retail services for downloadable digital music; organization of exhibitions for commercial or advertising purposes; arranging newspaper subscriptions for others; organization of fashion shows for promotional purposes; organization of exhibitions for commercial or advertising purposes; shop window dressing; development of advertising concepts; business appraisals; payroll preparation; data search in computer files for others; sponsorship search; administrative assistance in responding to calls for tenders; business management assistance; commercial or industrial management assistance; commercial intermediation services;

providing business information via a web site; providing commercial and business contact information; provision of an online marketplace for buyers and sellers of goods and services; web indexing for commercial or advertising purposes; presentation of goods on communication media, for retail purposes; economic forecasting; auctioneering; retail services for works of art provided by art galleries; sales promotion for others; promotion of goods and services through sponsorship of sports events; production of teleshopping programmes; production of advertising films; office machines and equipment rental; rental of advertising time on communication media; publicity material rental; rental of billboards [advertising boards]; rental of vending machines; rental of sales stands; rental of photocopying machines; publication of publicity texts; radio advertising; bill-posting; distribution of samples; dissemination of advertising matter; direct mail advertising; registration of written communications and data; writing of publicity texts; advertising; online advertising on a computer network; advertising by mail order; television advertising; reproduction of documents; compilation of statistics; compilation of information into computer databases; business inquiries; systemization of information into computer databases; advisory services for business management; negotiation of business contracts for others; negotiation and conclusion of commercial transactions for third parties; compiling indexes of information for commercial or advertising purposes; tax preparation; drawing up of statements of accounts; telemarketing services; psychological testing for the selection of personnel; wholesale of pharmaceutical, veterinary, hygiene products and medical supplies; retail sale of pharmaceutical, veterinary, hygiene products and medical supplies; interim business management; outsourced administrative management for companies; business management of hotels; business management for freelance service providers; business project management services for construction projects; commercial administration of the licensing of the goods and services of others; business management of reimbursement programs for others; administration of consumer loyalty programs; administration of frequent flyer programs; administrative processing of purchase orders; public relations; competitive intelligence services; modelling for advertising or sales promotion; typing; market intelligence services; appointment reminder services [office functions]; web site traffic optimization; administrative services for the relocation of businesses; tax filing services; search engine optimization for sales promotion; appointment scheduling services [office functions]; gift registry services; price comparison services; pay per click advertising; secretarial services; procurement services for others [purchasing goods and services for other businesses]; shorthand; outsourcing services [business assistance]; telephone answering for unavailable subscribers; photocopying services; business efficiency expert services; media

relations services; corporate communications services; rental of office equipment in co-working facilities; commercial lobbying services.

(260) AM 2023 118825 A  
(800) 1640097  
(151) 2021 12 08  
(891) 2022 06 13  
(731) NIPPON PAINT HOLDINGS SG PTE. LTD.  
16 RAFFLES QUAY, #17-03 HONG LEONG  
BUILDING, SINGAPORE 048581, Singapore  
(540)



(591) Blue, green, red, yellow, white  
(531) 26.04.04; 26.04.05; 26.04.18; 26.11.01;  
26.11.12; 27.05.01; 27.05.02; 27.05.09;  
27.05.10; 29.01.15  
(511)  
2 – Paints, varnishes, lacquers; preservatives against rust and against deterioration of wood; colorants, dyes; inks for printing, marking and engraving; raw natural resins; metals in foil and powder form for use in painting, decorating, printing and art.  
37 – Painting.

(260) AM 2023 118826 A  
(800) 1640165  
(151) 2021 12 08  
(891) 2022 06 13  
(731) NIPPON PAINT HOLDINGS SG PTE. LTD.  
16 RAFFLES QUAY, #17-03 HONG LEONG  
BUILDING, SINGAPORE 048581, Singapore  
(540)



(591) Blue, red, white  
(531) 26.04.04; 26.04.05; 26.04.18; 26.04.24;  
27.05.01; 27.05.02; 27.05.09; 27.05.10;  
29.01.13  
(511)  
2 – Paints, varnishes, lacquers; preservatives against rust and against deterioration of wood; colorants, dyes; inks for printing, marking and engraving; raw natural resins; metals in foil and powder form for use in painting, decorating, printing and art.  
37 – Painting.

(260) AM 2023 118865 A  
(800) 1675497  
(151) 2022 07 04  
(891) 2022 07 04  
(731) "Froneri Rus" Limited Liability Company  
Kosmodamianskaya naberezhnaya, 52, bld. 1,  
4 floor, ap. 2, office 4, RU-115054 Moscow,  
Russian Federation  
(540)

## Sunreme

(591) Black, white  
(511)  
30 – Binding agents for ice cream; frozen yogurt [confectionery ices]; ice for refreshment; ice, natural or artificial; edible ices; ice pops; ice cream; powders for making ice cream; sorbets [ices].

(260) AM 2023 118881 A  
(800) 1675911  
(151) 2022 01 27  
(891) 2022 01 27  
(731) AYPİMA AYAKKABI İMALAT  
PAZARLAMA VE MATBACILIK SANAYİ  
TİCARET LİMİTED ŞİRKETİ  
Hastane Mah., Edirne-Istanbul Demiryolu Cad.  
53 1, Arnavutköy, İSTANBUL, Türkiye  
(540)



(591) Black, white  
(531) 27.05.01; 27.05.22  
(511)  
25 – Clothing, including underwear and outer clothing, other than special purpose protective clothing; socks, mufflers [clothing], shawls, bandanas, scarves, belts [clothing]; footwear, shoes, work shoes, golf shoes, soccer shoes, rain shoes, boots, rain boots, work boots, hunting boots, athletics shoes, sports shoes, gymshoes, shoes for infants, dress shoes, sandals, slippers, sneakers, headgear, hats, caps with visors, berets, caps [headwear], skull caps.  
35 – The bringing together, for the benefit of others, of a variety of goods, namely, clothing, including underwear and outer clothing, other than special purpose protective clothing, socks, mufflers [clothing], shawls, bandanas, scarves, belts [clothing], footwear, shoes, work shoes, golf shoes, soccer shoes, rain shoes, boots, rain boots, work boots, hunting boots, athletics shoes, sports shoes, gymshoes, shoes for infants, dress shoes, sandals, slippers, sneakers, headgear, hats, caps with visors, berets, caps [headwear], skull caps, enabling customers to conveniently view and purchase those goods, such services may be provided by retail stores, wholesale outlets, by means of electronic media or through mail order catalogues.

(260) AM 2023 118882 A  
 (800) 1675932  
 (151) 2022 04 26  
 (891) 2022 04 26  
 (731) NSK OTOMOTİV SANAYİ VE TİCARET  
 ANONİM ŞİRKETİ  
 TAVŞANLI MAH. 412 SK. NSK 1-4 1,  
 Karacabey, Bursa, Türkiye  
 (540)



(591) Blue and red  
 (531) 01.01.17; 27.05.17; 29.01.12  
 (526) ®  
 (511)

12 – Automobiles, trucks, buses, tow trucks, tractors, refrigerated vehicles, concrete mixing trucks, military vehicles for transport, ambulances, hose carts, golf carts, garbage trucks, vehicles having catering facilities, fork lift trucks, vacuum trucks, engines for land vehicles; vehicle parts, namely, chassis, shafts, axles, rods, ball joints, gears, reduction gears for land vehicles, clutches, fitted liners for the cargo area of vehicles and tyre liners, turbines; transmission chains, wheel suspensions, wheel rims for vehicles, bumpers for vehicles, car doors, bonnets, vehicle bumper covers, fenders for bicycles and motorcycles, transmission cases for land vehicles, tractor trailers, refrigerated trailers, lifting cars, shock absorbers, hydraulic, pneumatic, electrical or mechanical springs for vehicles, brake cylinders for vehicles, brake repair kits and components, brake systems for motor vehicles and parts, brakes, brake pads and shoes, vehicle seats, head rests for seats, children's safety seats for automobiles, direction signals for vehicles, windshield wipers for automobiles, windshield wiper blades, automobile tires (tyres), tubeless tires (tyres) for bicycles, cycles, repair outfits for inner tubes, adhesive rubber patches for repairing inner tubes, valves for vehicle tires (tyres), windshields for vehicles, windscreens, rearview mirrors, anti-skid chains, non-skid devices for vehicle tires (tyres), fuel tanks for vehicles, luggage racks for vehicles, bicycle carriers for vehicles, air pumps (vehicle accessories), anti-theft alarms for vehicles, horns for vehicles, safety belts for vehicle seats, air bags for vehicles, seat covers for vehicles, car covers, trailer hitches; umbrellas to be affixed to baby strollers, parasols to be affixed to baby strollers, pushchairs, wheelchairs; wheelbarrows, shopping trolleys (carts), dollies (hand trucks), cable car, carriages (railways), locomotives, passenger trains, tramcars, railcars, ski lifts, chairlifts; air vehicles; motors for land vehicles, air balloons, airplanes, helicopters, parachutes.

(260) AM 2023 118894 A  
 (800) 1676284  
 (151) 2022 05 23  
 (891) 2022 05 23  
 (731) Eagleline Limited  
 The Victoria Centre, Unit 2, Lower Ground  
 Floor, Valletta Road, MST 9012 MOSTA,  
 Malta  
 (540)

## Lucky Chessmate

(591) Black, white  
 (511)  
 9 – Games software; computer gaming software; software programs for video games; interactive video game programs; computer game cartridges; software; educational software; application software; communication software; computer telephony software; interactive computer software; electronic components for gambling machines; games cartridges for use with electronic games apparatus; juke boxes, musical; automated teller machines [ATM].

28 – Games; sports games; manipulative games; musical games; electronic games; parlour games; tabletop games; quiz games; arcade games; skill and action games; electronic hand-held game units; mechanical games; lottery wheels; lottery tickets; slot machines [gaming machines]; coin-operated amusement machines; LCD game machines; bill-operated gaming equipment; counters [discs] for games; board games; amusement apparatus for use in arcades.

41 – Gambling services; organization of lotteries; prize draws [lotteries]; organising and conducting lotteries; games equipment rental; casino services; providing casino facilities; providing casino facilities [gambling]; casino, gaming and gambling services; providing of casino and gaming facilities.

(260) AM 2023 118895 A  
 (800) 1676288  
 (151) 2022 05 30  
 (891) 2022 05 30  
 (731) Gulf Air B.S.C. (c)  
 P.O. Box 138, Manama, Bahrain  
 (540)



(591) Black, gold, white  
 (531) 03.07.01; 03.07.16; 03.07.24; 27.05.11;  
 29.01.12

(511)

35 – Advertising services; dissemination of advertising materials; business management; business administration; office functions; organisation, operation and supervision of loyalty schemes and incentive schemes; presentation of goods on communications media, for retail purposes; retail services connected with the sale of jewellery, time instruments, watches, toiletries, perfumery and fragrances, colognes, beauty implements for humans, cosmetics, printed matter, books, pens, stationery, games, toys, playing cards, information technology equipment, audio-visual equipment, sunglasses, cases for mobile phones, mobile phone straps, tobacco, articles for use with tobacco, non-alcoholic beverages, alcoholic beverages and beer.

39 – Transport; packaging and storage of goods; travel arrangement; vehicle parking services; car parking services; rental of vehicle parking spaces; rental of car parking spaces; air transport, air transport of passengers, air transport of goods; air travel services; travel agency services for the organisation of travel and tours; arranging tours, transport, travel and vehicle rental; air ticket and airline booking services; reservation services for transportation, travel and tours; issuing of tickets for travel; itinerary planning services; itinerary travel advice services; airline and airport check-in services; airport baggage handling; ground support freight handling services provided at airports; ground traffic control services for aircraft; passenger cargo and escort services; accompanying of travellers; air cargo transport; air freight transportation; loading of air freight and cargo; air charter services; air traffic control services; runway services namely, aircraft parking and runway inspection; aircraft trucking and storage; arranging for the storage and transportation of goods; luggage storage services; inspection of aircraft and goods for transportation; management of aircraft and airfield operations; piloting; portage and porter services; airplane rental; air ambulance services; information, support, assistance, consultancy and advisory services in relation to the foregoing.

43 – Services for providing food and drink; temporary accommodation; booking services for hotel accommodation; catering for air travel passengers; provision of hospitality lounges; child minding services; information, support, assistance, consultancy and advisory services in relation to the foregoing.

(260) AM 2023 118896 A

(800) 1676289

(151) 2022 05 30

(891) 2022 05 30

(731) Gulf Air B.S.C. (c)

P.O. Box 138, Manama, Bahrain

(540)



(591) Black, gold, white

(531) 03.07.01; 03.07.17; 03.07.24; 26.11.01;  
26.11.08; 28.01; 29.01.12

(511)

35 – Advertising services; dissemination of advertising materials; business management; business administration; office functions; organisation, operation and supervision of loyalty schemes and incentive schemes; presentation of goods on communications media, for retail purposes; retail services connected with the sale of jewellery, time instruments, watches, toiletries, perfumery and fragrances, colognes, beauty implements for humans, cosmetics, printed matter, books, pens, stationery, games, toys, playing cards, information technology equipment, audio-visual equipment, sunglasses, cases for mobile phones, mobile phone straps, tobacco, articles for use with tobacco, non-alcoholic beverages, alcoholic beverages and beer.

39 – Transport; packaging and storage of goods; travel arrangement; vehicle parking services; car parking services; rental of vehicle parking spaces; rental of car parking spaces; air transport, air transport of passengers, air transport of goods; air travel services; travel agency services for the organisation of travel and tours; arranging tours, transport, travel and vehicle rental; air ticket and airline booking services; reservation services for transportation, travel and tours; issuing of tickets for travel; itinerary planning services; itinerary travel advice services; airline and airport check-in services; airport baggage handling; ground support freight handling services provided at airports; ground traffic control services for aircraft; passenger cargo and escort services; accompanying of travellers; air cargo transport; air freight transportation; loading of air freight and cargo; air charter services; air traffic control services; runway services namely, aircraft parking and runway inspection; aircraft trucking and storage; arranging for the storage and transportation of goods; luggage storage services; inspection of aircraft and goods for transportation; management of aircraft and airfield operations; piloting; portage and porter services; airplane rental; air ambulance services; information, support, assistance, consultancy and advisory services in relation to the foregoing.

43 – Services for providing food and drink; temporary accommodation; booking services for hotel accommo-

ation; catering for air travel passengers; provision of hospitality lounges; child minding services; information, support, assistance, consultancy and advisory services in relation to the foregoing.

(260) AM 2023 118897 A

(800) 1676290

(151) 2022 06 14

(891) 2022 06 14

(731) Anhui Zhongke Optic-electronic Color Sorter Machinery Co., Ltd  
Taohua Town, Feixi County, Hefei, Anhui Province, China

(540)



(591) Black, white

(531) 27.05.01; 27.05.22

(511)

7 – Grain husking machines; filtering machines; sifting machines; foundry machines; agricultural machines.

(260) AM 2023 118898 A

(800) 1676333

(151) 2022 06 15

(891) 2022 06 15

(731) JACKERY INC.  
48531 Warm Springs Blvd 408, Fremont CA  
94539-7793, USA

(540)

Jackery

(591) Black, white

(531) 27.05.01

(511)

7 – Lawnmowers [machines]; food preparation machines, electromechanical; dynamos; kitchen machines, electric; washing machines [laundry]; wind turbines; hydraulic turbines; alternators; emergency power generators; dust removing installations for cleaning purposes.

11 – Pocket warmers; heating apparatus; solar furnaces; coffee machines, electric; refrigerators; disinfectant apparatus; lighting apparatus and installations; cooking apparatus and installations; refrigerating apparatus and machines; air-conditioning installations.

(260) AM 2023 118899 A

(800) 1676339

(151) 2022 06 30

(891) 2022 06 30

(731) JOINT STOCK COMPANY "FATS AND OIL INTEGRATED WORKS"

UL. TITOVA 27, EKATERINBURG,  
RU-620085 SVERDLOVSKAYA OBLAST,  
Russian Federation

(540)



(591) White, black, red, pink, light-pink, dark-pink, blue, brown, dark-brown, beige, light-beige, dark-beige, yellow, and dark-yellow

(531) 02.03.01; 02.03.11; 02.03.23; 08.01.15;  
25.01.05; 28.05; 29.01.15

(511)

29 – Oils and fats for food; butter; margarine; cream-vegetable oils for food; spreads, namely dairy-based spreads, spreads made from vegetable oils and fats; buttercream; fat-containing mixtures for bread slices.

(260) AM 2023 118900 A

(800) 1676371

(151) 2022 04 02

(891) 2022 04 02

(731) Honor Device Co., Ltd.  
Suite 3401, Unit A, Building 6, Shum Yip Sky Park, No. 8089, Hongli West Road, Xiangmihu Street, Futian District, Shenzhen, 518040  
Guangdong, China

(540)

MotionSync

(591) Black, white

(531) 27.05.01

(511)

9 – Computer chatbot software for simulating conversations; downloadable mobile applications; tablet computers; stands adapted for tablet computers; smartwatches [data processing apparatus]; notebook computers; capacitive styluses for touch screen devices; computers; computer program (downloadable software); face recognition apparatus; USB wireless router; cellphone mounts and stands; protective films adapted for mobile telephone screens; selfie sticks for mobile phones; smartphones; wearable activity trackers; network routers; telecommunication apparatus in the form of jewellery; portable media players; trail cameras; cabinets for loudspeakers; camcorders; wireless headset for smartphones; webcams; earphones; headsets for virtual reality games; dashboard cameras; cameras [photography]; camera tripods; selfie lenses; video projectors; sensors; electronic chips; video screens; touch screens; displays for smart phones; integrated circuits; digital door locks; 3d spectacles; spectacles; mobile power (rechargeable battery).

(260) AM 2023 118909 A  
 (800) 1309672  
 (151) 2016 05 19  
 (891) 2022 07 19  
 (731) HIJOS DE JOSE CASAPONSA, S.A.  
 Ctra. Nacional 260, km. 86, E-17813 Vall de  
 Bianya (Girona), Spain  
 (540)



(591) Black, white  
 (531) 04.03.07; 24.01.15; 24.01.19; 26.04.03;  
 26.04.09; 26.04.24  
 (511)  
 29 – Sausages and meat products, fish, poultry and  
 game, meat extracts, preserved, dried and cooked fru-  
 its and vegetables; jellies, jams, compotes; eggs, milk  
 and dairy products; edible oils and fats.

(260) AM 2023 118910 A  
 (800) 1450852  
 (151) 2018 12 17  
 (891) 2022 06 16  
 (731) Heineken Brouwerijen B.V.  
 Tweede Weteringplantsoen 21, Amsterdam,  
 NL-1017 ZD, Netherlands  
 (5400)



(591) Red, white, grey, green and blue  
 (531) 01.01.02; 01.01.10; 25.01.06; 25.01.15;  
 26.13.25; 27.05.24; 27.07.24; 29.01.15  
 (511)  
 32 – Beers and non-alcoholic beers.

(260) AM 2023 118911 A  
 (800) 1460564  
 (151) 2019 02 18  
 (891) 2022 07 08  
 (731) F. Hoffmann-La Roche AG  
 Grenzacherstrasse 124, CH-4070 Basel,  
 Switzerland  
 (540)

**OMLIAGO**

(591) Black, white  
 (511)  
 5 – Pharmaceutical preparations.

(260) AM 2023 118912 A  
 (800) 1479026  
 (151) 2019 05 23  
 (891) 2022 07 21  
 (731) Chanel SARL  
 Quai du Général-Guisan 24, CH-1204 Genève,  
 Switzerland  
 (540)

**GABRIELLE**

(591) Black, white  
 (511)  
 3 – Preparations for cosmetic use for skin, scalp, hair  
 or nail care; preparations for cosmetic use for applica-  
 tion on the skin, scalp, hair or nails; soaps; perfumery  
 products; perfumes; eau de Cologne; eaux de toilette;  
 after-shave lotions; shaving soap; shaving products;  
 essential oils; make-up products; cosmetics; toilettries  
 for non-medical use; talcum powder for toilet use;  
 deodorants/antiperspirants for personal use; make-up  
 removing products, tissues impregnated with make-up  
 removing preparations; nail polish removers; cosmetic  
 skin-tanning preparations, sunscreen preparations, tis-  
 sues impregnated with cosmetic lotions, massage gels  
 other than for medical use; nail polish; artificial nails  
 for cosmetic use; nail art stickers; adhesives for affi-  
 xing false nails; temporary tattoos for cosmetic use;  
 false eyelashes; air fragrances; potpourris [fragran-  
 ces].

(260) AM 2023 118913 A  
 (800) 1535986  
 (151) 2020 05 07  
 (891) 2022 07 08  
 (731) Beiersdorf AG  
 Unnastr. 48, 20253 Hamburg, Germany  
 (540)



(591) Dark blue, turquoise, green and white  
 (531) 01.15.15; 25.12.03; 26.01.03; 26.11.02;  
 26.11.12; 29.01.12  
 (511)  
 3 – Non-medicated cosmetics; cosmetic skin care pre-  
 parations.

(260) AM 2023 118914 A  
 (800) 1634726  
 (151) 2021 10 25  
 (891) 2022 07 08  
 (731) Janssen Pharmaceutica NV  
 Turnhoutseweg 30, B-2340 Beerse, Belgium  
 (540)

## LAZCLUZE

(591) Black, white  
 (511)  
 5 – Pharmaceutical preparations for human purposes.

(260) AM 2023 118915 A  
 (800) 1664153  
 (151) 2022 02 17  
 (891) 2022 06 20  
 (731) Lantmännen ek för  
 Box 30192, SE-104 25 Stockholm, Sweden  
 (540)



(591) Green  
 (531) 26.11.01; 26.11.12; 29.01; 29.01.03  
 (511)

5 – Dietetic foods and dietetic substances adapted for medical or veterinary use, food for babies; dietetic foods adapted for infants; gluten-free porridge and food for infants; gluten-free porridge and food for adults for medical use; dietary supplements for humans and animals; dietary and nutritional preparations for medical use; vitamin supplements; hand-sanitizing preparations; preparations for destroying vermin; fungicides, herbicides.

29 – Meat, fish, poultry and game; meat extracts; preserved, frozen, dried and cooked fruits and vegetables; peas, processed; yellow split peas; processed chickpeas; beans; dried lentils; fruit-based snack food; jellies, jams, compotes; eggs; milk, cheese, butter, yoghurt and other milk products; milk substitutes; lactose free milk; oat milk; soya milk; oat-based beverages (milk substitute); edible oils and fats for cooking; prepared dishes consisting principally of meat; potato pancakes; falafel.

30 – Coffee, tea, cocoa and substitutes therefor; rice, pasta and noodles; prepared pasta; tapioca and sago; groats for human food; processed oats; flour and preparations made from cereals; wheat flour; buckwheat flour; rye flour; graham flour; spelled flour; durum wheat flour; oat flakes; semolina; bread, pastries and confectionery; gluten-free bread; multigrain bread; bakery goods; rusks; cereal-based snack food; bread,

pastries and confectionery incorporating bread and croissants with or without stuffing or topping, Danish pastries, croissants, pumpernickel, buns, bagels, baguettes, breakfast buns, sandwich loaves and biscuits, pitta bread, hot dog sandwiches and hamburgers contained in bread rolls, buns, cakes, muffins and pies; dough; all the aforesaid goods in the form of ready-made, fermented, frozen or vacuum-packed goods; starch for food; icing; cereal preparations; cereal bars; chips (cereal products); muesli; granola; oat-based food; pastry mixes; pancake mixes; cake powder; cake mixes; pizza dough mix; doughnut mixes; ice cream mixes; chocolate; cocoa (roasted, powdered, granulated, or in drinks); ice pops and ice cream, sorbet (water ices); frozen yogurt; sugar, honey, treacle; yeast, baking-powder; salt, spices, preserved herbs; salt for preserving foodstuffs; salt for preserving animal feeds; glucose syrups for food; fructose syrup for use in the manufacture of foods; starch syrup (for food); vinegar; sauces and other condiments; prepared meals consisting primarily of pasta; pancakes; crepes; waffles; all the aforesaid goods in the form of ready-made, fermented, frozen or vacuum-packed goods.

31 – Raw and unprocessed agricultural, aquacultural, crops, horticulture and forestry products; raw and unprocessed grains and seeds; unprocessed grain; unprocessed beans; oats; wheat; wheat seed; rye; fresh fruit and vegetables, fresh herbs; barley; lentils, fresh; natural plants and flowers; bulbs, seedlings and seeds for planting; seeds for planting; vegetable seeds; seeds for fruit; seeds for flowers; foodstuffs and beverages for animals; grams for animal consumption; lime for animal forage; seeds prepared for consumption by animals; meal for animals; wheat germ for animal consumption; malt; malt for brewing and distilling.

32 – Beer; non-alcoholic beverages; mineral and aerated waters; fruit drinks and fruit juices; syrups and other non-alcoholic preparations for making beverages; non-alcoholic malt drinks; soft drinks; cereal-based beverages, other than milk substitutes; plant-based drinks.

40 – Treatment of materials; food and drink preservation; food grinding; preservation of food; food smoking; flour milling; freezing of foods; fruit crushing; recycling of waste and trash; recycling of waste, trash and by-products of food manufacture; waste management services (recycling); information, consultancy and advisory services relating to all of the aforesaid services.

41 – Education; providing of training; education relating to bakery operations; education relating to food safety issues; arranging and conducting of seminars, conferences and workshops; fitness club services; providing health club and gymnasium services; education and instruction services relation to diet and training; entertainment by means of blogging relating to agriculture and sustainable horticulture; publication of



magazines; publishing a newspaper for customers on the Internet; provision of entertainment via podcast; creation (writing) of podcasts; creation (writing) of educational content for podcasts; information, consultancy and advisory services relating to all of the aforesaid services.

(260) AM 2023 118943 A

(800) 1676509

(151) 2022 02 24

(891) 2022 02 24

(731) SPORT & FASHION MANAGEMENT PTE. LTD.

6 Shenton Way, #18-11 OUE Downtown 2,  
Singapore 068809, Singapore

(540)



(591) Black, white, yellow

(531) 09.09.01; 09.09.11; 27.05.01; 29.01.12

(511)

16 – Packing [cushioning, stuffing] materials of paper or cardboard; general purpose plastic bags; paper bags for household purposes; pouches of paper for packaging; bags [envelopes, pouches] of paper or plastics for packaging, including shopping bags, shopping pouches; shopping bags of paper; bags [envelopes, pouches] of paper or plastics, for merchandise packaging.

18 – Rucksacks; bags for sports; bags; umbrellas and parasols; waist bags; textile shopping bags; shopping bags of non-woven fabrics; reusable shopping bags; canvas shopping bags; leather and imitations of leather; luggage and carrying bags; souvenir bags.

25 – Footwear, including beach shoes; socks; clothing; headwear; trousers; sandals; uniforms; sports shoes; Tee-shirts; jackets [clothing]; shorts; sports suits; sneakers; plimsolls; sweaters; sportswear; flip-flops [footwear]; sports headwear; accessories for clothing, footwear, headwear, including non-slipping devices for footwear, boas [necklets], dress shields, braces for clothing [suspenders], shawls, sock suspenders, garters, stocking suspenders, shirt fronts, furs [clothing], detachable collars, ear muffs, fur stoles, cuffs, muffs, fingerless gloves, pelerines, veils, mantillas, pocket squares, aprons and sleeved bibs, not of paper; parts of clothing, footwear, headwear; long-sleeved T-shirts; sweatshirts; hooded sweatshirts; beach slippers; pool slippers.

35 – Import-export agency services; dissemination of advertising matter; demonstration of goods; direct mail advertising; distribution of samples; auctioneering; publicity material rental; publication of publicity

texts; advertising; publicity; shop window dressing; modelling for advertising or sales promotion; organization of exhibitions for commercial or advertising purposes; rental of advertising space; sales promotion for others, including promotion of goods through influencers; online advertising on a computer network; procurement services for others [purchasing goods and services for other businesses]; rental of vending machines; price comparison services; presentation of goods on communication media, for retail purposes; commercial administration of the licensing of the goods and services of others; outsourcing services [business assistance]; layout services for advertising purposes; organization of fashion shows for promotional purposes; production of advertising films; telemarketing services; rental of sales stands; search engine optimization for sales promotion; business management of reimbursement programs for others; rental of billboards [advertising boards]; promotion of goods and services through sponsorship of sports events; gift registry services; outdoor advertising; business management services; business administration services; office functions; online ordering services; commercial intermediation services; provision of an online marketplace for buyers and sellers of goods and services; retail and wholesale services including online retail and wholesale services; providing commercial information and advice for consumers in the choice of products and services; organization of trade fairs; development of advertising concepts; retail and wholesale services including online retail and wholesale services provided by sports footwear stores, footwear stores, sports stores, stores of headwear, clothing and footwear; business management, organization and administration.

(260) AM 2023 119035 A

(800) 1678069

(151) 2022 06 08

(891) 2022 06 08

(731) AMB SARL

1 Rue Jean Jaurès, F-74000 Annecy, France

(540)



(591) Blue, white, grey and red

(531) 26.03.23; 29.01.13

(511)

33 – Vodka; kirsch; anisette; bitters; liqueurs; sweet liqueurs.

(260) AM 2023 119037 A

(800) 1678194

(151) 2022 07 13

(891) 2022 07 13

(731) LTD "VALENTA-INTELLEKT"

ul. Ryabinovaya, d.26, str.10, k.6-26,

RU-121471 Moscow, Russian Federation

(540)

**ИНТРАРОСА**

(591) Black, white

(531) 28.05

(511)

5 – Pharmaceutical preparations for the prevention and treatment of vaginal atrophy, decreased libido and sexual dysfunction.

(260) AM 2023 119038 A

(800) 1678199

(151) 2022 04 13

(891) 2022 04 13

(731) ECOTANK s. r. o.

Elektrárėnská 4, SK-830 14 Bratislava,

Slovakia

(540)



(591) Black, white

(531) 07.05.15; 26.11.25; 27.05.01

(511)

7 – Distributors for filling liquids for windshield washers and antifreeze for windshield washers; motors and engines, other than for land vehicles; agricultural implements, other than hand-operated hand tools; incubators for eggs; automatic distribution machines; fuel-dispensing pumps for service stations; distribution machines other than vending machines; pumps (machines); distributors (parts of machines); regulating valves for pumps; washing installations for vehicles; electric window-cleaning machines; current generators; electricity generators; clutches other than for land vehicles; transmissions for machines; transmissions other than for land vehicles; machine tools.

(260) AM 2023 119039 A

(800) 1678229

(151) 2022 01 07

(891) 2022 01 07

(731) Tchibo Coffee International Ltd

Tchibo House, 7-8 Blenheim Road, Epsom,

Surrey KT19 9BE, United Kingdom

(540)

**SMOKIN' BEAN**

(591) Black, white

(511)

20 – Furniture; mirrors; picture frames; containers, not of metal, for storage or transport; unworked or semi-worked bone, horn, whalebone or mother-of-pearl; shells; meerschaum; yellow amber; bedding; indoor window blinds and shades; commercial furniture; kitchen furniture; furniture for use in the preparation, storage and presentation of food and beverages; parts and fittings for all the aforesaid.

21 – Household and kitchen utensils and containers; cookware; tableware, except forks, knives and spoons; combs; sponges; brushes, except paintbrushes; brush-making materials; articles for cleaning purposes; unworked or semi-worked glass, except building glass; glassware; porcelain; earthenware; non-electric apparatus, utensils and vessels for making, brewing, dispensing, containing, transporting and consuming beverages, including coffee, tea, cocoa and/or chocolate beverages; portable beverage dispensers; coffee pots; coffee grinders; coffee scoops; non-electric coffee filters; tea filters; beverageware; cups; mugs; disposable cups, mugs, lids and drinking vessels; coffee stirrers; drinks containers; portable and disposable beverage containers, vessels and holders; vacuum flasks for holding drinks; food storage containers; drinking straws, dispensers for drinking straws; glassware; dishes, plates, bowls; bottles; jugs; coasters; corkscrews; utensils for storing, containing, transporting and serving food; utensils and containers for use in the preparation, presentation and storage of food and beverages; parts and fittings for all the aforesaid.

30 – Coffee, tea, cocoa and substitutes therefor; rice; pasta; noodles; tapioca; sago; flour; preparations made from cereals; bread; pastries; confectionery; chocolate; ice cream; sorbets; edible ices; sugar; honey; treacle; yeast, baking-powder; salt, seasonings, spices, preserved herbs; vinegar, sauces and other condiments; ice (frozen water); pizza; pies; sandwiches; cereal-based food and snack food; potato-based snack food; chocolate and ice-cream desserts; flavourings, other than essential oils, for beverages; food flavourings, other than essential oils; coffee essences; coffee extracts; coffee-based beverages; cocoa-based beverages; chocolate-based beverages; tea-based beverages; coffee beans; ground coffee beans; chicory (coffee substitute); tea extracts; infusions; preparations made principally of cocoa or chocolate.

(260) AM 2023 119040 A

(800) 1678248

(151) 2021 12 30

(891) 2021 12 30

(731) TECTONE TEKNOLOJI SANAYI VE

TICARET ANONIM SIRKETI

Organize Sanayi Bolgesi Ataturk, Caddesi 8.

Sokak No:8, Karaagac Koyu Kapakli, Tekirdag,

Türkiye

(540)



(591) Black, red

(531) 26.04.03; 26.04.05; 27.05.01; 29.01.12

(511)

7 – Machines, machine tools and industrial robots for processing and shaping wood, metals, glass, plastics and minerals, 3D printers; construction machines and robotic mechanisms (machines) for use in construction: bulldozers, diggers (machines), excavators, road construction and road paving machines, drilling machines, rock drilling machines, road sweeping machines; lifting, loading and transmission machines and robotic mechanisms (machines) for lifting, loading and transmission purposes: elevators, escalators and cranes; machines and robotic mechanisms (machines) for use in agriculture and animal breeding, machines and robotic mechanisms (machines) for processing cereals, fruits, vegetables and food, engines and motors, other than for land vehicles, parts and fittings therefor; hydraulic and pneumatic controls for engines and motors, brakes other than for vehicles, brake linings for engines, crankshafts, gearboxes, other than for land vehicles, gearboxes, cylinders for engines, pistons for engines, turbines, not for land vehicles, filters for engines and motors, oil, air and fuel filters for land vehicle engines, exhausts for land vehicle engines, exhaust manifolds for land vehicle engines, engine cylinders for land vehicles, engine cylinder heads for land vehicles, pistons for land vehicle engines, carburetors for land vehicles, fuel conversion apparatus for land vehicle engines, injectors for land vehicle engines, fuel economisers for land vehicle engines, pumps for land vehicle engines, valves for land vehicle engines, starter motors for land vehicles, dynamos for land vehicle engines, sparking plugs for land vehicle engines; bearings (parts of machines), roller or ball bearings; machines for mounting and detaching tires; alternators, current generators, electric generators, current generators operated with solar energy; painting machines, automatic spray guns for paint, electric, hydraulic and pneumatic punching machines and guns, electric adhesive tape dispensers (machines), electric guns for compressed gas or liquid spraying machines, electric hand drills, electric hand saws, electric jigsaw machines, spiral machines, compressed air machines, compressors (machines), vehicle washing installations, robotic mechanisms (machines) with the abovementioned functions; electric and gas-operated welding apparatus, electric arc welding apparatus, electric soldering apparatus, electric arc cutting apparatus, electrodes for welding machines, industrial robots (machines) with the abovementioned functions; printing machines; packaging machines, filling, plugging and sealing machines, labellers (machines), sorting machines, industrial robots (machines) with the abovementioned functions, electric pac-

king machines for plugging and sealing of plastics; machines for textile processing, sewing machines, industrial robots (machines) with the abovementioned functions; pumps (machine), electric pumps, hydraulic pumps, fuel dispensing pumps for service stations, self-regulating fuel pumps; electric kitchen machines for chopping, grinding, crushing, mixing and mincing foodstuff, washing machines, laundry washing machines, dishwashers, spin driers (not heated), electric cleaning machines for cleaning floors, carpets or floorings, vacuum cleaners and parts thereof; automatic vending machines; galvanizing and electroplating machines; electric door openers and closers; joints (parts of engines).

8 – Forks, spoons, knives and non-electric cutters, slicers, peelers for kitchen use, including those made of precious metals; side arms and blades (weapons); tools and apparatus included in this class for personal beauty care use: tools and apparatus included in this class for shaving, epilation, manicure and pedicure, electric hand implements for straightening and curling hair, scissors; hand-operated [non-electric] hand tools included in this class for the repair of machines, apparatus and vehicles and for use in construction, agriculture, horticulture and forestry, none of them being power tools; electric or non-electric irons; steam irons; tool handles made of all kinds of materials.

9 – Measurement apparatus and equipment including those for scientific, nautical, topographic, meteorological, industrial and laboratory purposes, thermometers, not for medical purposes, barometers, ammeters, voltmeters, hygrometers, testing apparatus not for medical purposes, telescopes, periscopes, directional compasses, speed indicators, laboratory apparatus, microscopes, magnifying glasses, stills, ovens and furnaces for laboratory experiments; apparatus for recording, transmission or reproduction of sound or images, cameras, photographic cameras, television apparatus, video recorders, CD and DVD players and recorders, MP3 players, computers, desktop computers, tablet computers, wearable technological devices, namely, smartwatches, smart wristbands and head-mounted cameras, microphones, loudspeakers, earphones, telecommunications apparatus, apparatus for the reproduction of sound or images, computer peripheral devices, cell phones, covers for cell phones, telephone apparatus, computer printers, scanners [data processing equipment], photocopiers; magnetic and optical data carriers and computer software and programmes recorded thereto, downloadable and recordable electronic publications, encoded magnetic and optical cards; antennas, satellite antennas, amplifiers for antennas, parts of the aforementioned goods; ticket dispensers, automatic teller machines (ATM); electronic components used in the electronic parts of machines and apparatus, semi-conductors, electronic circuits, integrated circuits, chips [integrated circuits], diodes, transistors [electronic], magnetic heads for electronic

apparatus, electronic locks, photocells, remote control apparatus for opening and closing doors, optical sensors; counters and quantity indicators for measuring the quantity of consumption, automatic time switches; clothing for protection against accidents, irradiation and fire, safety vests and life-saving apparatus and equipment; eyeglasses, sunglasses, optical lenses and cases, containers, parts and components thereof; apparatus and instruments for conducting, transforming, accumulating or controlling electricity, electric plugs, junction boxes [electricity], electric switches, circuit breakers, fuses, lighting ballasts, battery starter cables, electrical circuit boards, electric resistances, electric sockets, transformers [electricity], electrical adapters, battery chargers, electric door bells, electric and electronic cables, batteries, electric accumulators, solar panels for electrical energy production; alarms and anti-theft alarms, other than for vehicles, electric bells; signalling apparatus and instruments, luminous or mechanical signs for traffic use; fire extinguishing apparatus, fire engines, fire hose and fire hose nozzles; radar apparatus, sonars, night vision apparatus and instruments; decorative magnets; metronomes.

10 – Surgical, medical, dental and veterinary apparatus and instruments; furniture especially made for medical purposes; artificial limbs and prostheses; medical orthopaedic articles: corsets for medical purposes, orthopaedic shoes, elastic bandages and supportive bandages; surgical gowns and surgical sterile sheets; adult sexual aids; condoms; babies' bottles; babies' pacifiers; teats; teethers for babies; bracelets and rings for medical purposes, anti-rheumatism bracelets and rings.

11 – Lighting installations; lights for vehicles and interior-exterior spaces; heating installations using solid, liquid or gas fuels or electricity, central heating boilers, boilers for heating installations, radiators [heating], heat exchangers, not parts of machines, stoves, kitchen stoves, solar thermal collectors [heating]; steam, gas and fog generators, steam boilers, other than parts of machines, acetylene generators, oxygen generators, nitrogen generators; installations for air-conditioning and ventilating; cooling installations and freezers; electric and gas-powered devices, installations and apparatus for cooking, drying and boiling: cookers, electric cooking pots, electric water heaters, barbecues, electric laundry driers; hair driers; hand drying apparatus; sanitary installations, taps [faucets], shower installations, toilets [water-closets], shower and bathing cubicles, bath tubs, toilet seats, sinks, wash-hand basins [parts of sanitary installations], gaskets for faucets, interior kit of faucets; water softening apparatus; water purification apparatus; water purification installations; waste water purification installations; electric bed warmers and electric blankets, not for medical use; electric pillow warmers; electric or non-electric footwarmers; hot water bottles, electric heated socks; filters for aquariums and aquarium filt-

ration apparatus; industrial type installations for cooking, drying and cooling purposes; pasteurizers and sterilizers.

21 – Hand-operated non-electric cleaning instruments and appliances, brushes, other than paintbrushes, steel chips for cleaning, sponges for cleaning, steel wool for cleaning, cloths of textile for cleaning, gloves for dishwashing, non-electric polishing machines for household purposes, brooms for carpets, mops; toothbrushes, electric toothbrushes, dental floss, shaving brushes, hair brushes, combs; non-electric household or kitchen utensils, included in this class, [other than forks, knives, spoons], services [dishes], pots and pans, bottle openers, flower pots, drinking straws, non-electric cooking utensils; ironing boards and shaped covers therefor, drying racks for washing, clothes drying hangers; cages for household pets, indoor aquariums, vivariums and indoor terrariums for animals and plant cultivation; ornaments and decorative goods of glass, porcelain, earthenware or clay, included in this class, namely statues, figurines, vases, cups given in competitions; mouse traps, insect traps, electric devices for attracting and killing flies and insects, fly catchers, fly swatters; perfume burners, perfume sprayers, perfume vaporizers, electric or non-electric make-up removing appliances, powder puffs, toilet cases; nozzles for sprinkler hose, nozzles for watering cans, watering devices, garden watering cans; unworked or semi-worked glass, except building glass, mosaics of glass and powdered glass for decoration, except for building, glass wool other than for insulation or textile use.

34 – Tobacco, chewing tobacco, cigarettes, cigars; smokers' articles including those made of precious metals: pipes, mouthpieces for cigars and cigarettes, ashtrays, tobacco boxes, pocket apparatus for rolling cigarettes, cigarette paper, tobacco pipes, firestones, lighters for smokers, electronic cigarettes and the pods used with them, matches.

35 – Advertising, marketing and public relations; organization of exhibitions and trade fairs for commercial or advertising purposes, development of advertising concepts; providing an online marketplace for buyers and sellers of goods and services; office functions; secretarial services; arranging newspaper subscriptions for others; compilation of statistics; rental of office machines; systemization of information into computer databases; telephone answering for unavailable subscribers; business management, business administration and business consultancy; accounting; commercial consultancy services; personnel recruitment, personnel placement, employment agencies, import-export agencies; temporary personnel placement services; auctioneering; the bringing together, for the benefit of others, of a variety of goods, namely, machines, machine tools and industrial robots for processing and shaping wood, metals, glass, plastics and minerals, 3D printers, construction machines and ro-

botic mechanisms (machines) for use in construction, bulldozers, diggers (machines), excavators, road construction and road paving machines, drilling machines, rock drilling machines, road sweeping machines, lifting, loading and transmission machines and robotic mechanisms (machines) for lifting, loading and transmission purposes, elevators, escalators and cranes, machines and robotic mechanisms (machines) for use in agriculture and animal breeding, machines and robotic mechanisms (machines) for processing cereals, fruits, vegetables and food, engines and motors, other than for land vehicles, parts and fittings therefor, hydraulic and pneumatic controls for engines and motors, brakes other than for vehicles, brake linings for engines, crankshafts, gearboxes, other than for land vehicles, gearboxes, cylinders for engines, pistons for engines, turbines, not for land vehicles, filters for engines and motors, oil, air and fuel filters for land vehicle engines, exhausts for land vehicle engines, exhaust manifolds for land vehicle engines, engine cylinders for land vehicles, engine cylinder heads for land vehicles, pistons for land vehicle engines, carburetors for land vehicles, fuel conversion apparatus for land vehicle engines, injectors for land vehicle engines, fuel economisers for land vehicle engines, pumps for land vehicle engines, valves for land vehicle engines, starter motors for land vehicles, dynamos for land vehicle engines, sparking plugs for land vehicle engines, bearings (parts of machines), roller or ball bearings, machines for mounting and detaching tires, alternators, current generators, electric generators, current generators operated with solar energy, painting machines, automatic spray guns for paint, electric, hydraulic and pneumatic punching machines and guns, electric adhesive tape dispensers (machines), electric guns for compressed gas or liquid spraying machines, electric hand drills, electric hand saws, electric jigsaw machines, spiral machines, compressed air machines, compressors (machines), vehicle washing installations, robotic mechanisms (machines) with the abovementioned functions, electric and gas-operated welding apparatus, electric arc welding apparatus, electric soldering apparatus, electric arc cutting apparatus, electrodes for welding machines, industrial robots (machines) with the abovementioned functions, printing machines, packaging machines, filling, plugging and sealing machines, labellers (machines), sorting machines, industrial robots (machines) with the abovementioned functions, electric packing machines for plugging and sealing of plastics, machines for textile processing, sewing machines, industrial robots (machines) with the abovementioned functions, pumps other than parts of machines or engines, fuel dispensing pumps for service stations, self-regulating fuel pumps, electric kitchen machines for chopping, grinding, crushing, mixing and mincing foodstuff, washing machines, laundry washing machines, dishwashers, spin driers (not heated), electric cleaning machines for cleaning floors, carpets or floorings, va-

cuum cleaners and parts thereof, automatic vending machines, galvanizing and electroplating machines, electric door openers and closers, joints (parts of engines), forks, spoons, knives and non-electric cutters, slicers, peelers for kitchen use, side arms and blades (weapons), tools and apparatus for personal beauty care use, tools and apparatus for shaving, epilation, manicure and pedicure, electric hand implements for straightening and curling hair, scissors, hand-operated [non-electric] hand tools for the repair of machines, apparatus and vehicles and for use in construction, agriculture, horticulture and forestry, none of them being power tools, electric or non-electric irons, steam irons, tool handles made of all kinds of materials, measurement apparatus and equipment for scientific, nautical, topographic, meteorologic, industrial and laboratory purposes, thermometers, not for medical purposes, barometers, ammeters, voltmeters, hygrometers, testing apparatus not for medical purposes, telescopes, periscopes, directional compasses, speed indicators, laboratory apparatus, microscopes, magnifying glasses, stills, ovens and furnaces for laboratory experiments, apparatus for recording, transmission or reproduction of sound or images, cameras, photographic cameras, television apparatus, video recorders, CD and DVD players and recorders, MP3 players, computers, desktop computers, tablet computers, wearable technological devices, namely, smartwatches, smart wristbands and head-mounted cameras, microphones, loudspeakers, earphones, telecommunications apparatus, apparatus for the reproduction of sound or images, computer peripheral devices, cell phones, covers for cell phones, telephone apparatus, computer printers, scanners [data processing equipment], photocopiers, magnetic and optical data carriers and computer software and programmes recorded thereto, downloadable and recordable electronic publications, encoded magnetic and optical cards, antennas, satellite antennas, amplifiers for antennas, parts of the aforementioned goods, ticket dispensers, automatic teller machines (ATM), electronic components used in the electronic parts of machines and apparatus, semiconductors, electronic circuits, integrated circuits, chips [integrated circuits], diodes, transistors [electronic], magnetic heads for electronic apparatus, electronic locks, photocells, remote control apparatus for opening and closing doors, optical sensors, counters and quantity indicators for measuring the quantity of consumption, automatic time switches, clothing for protection against accidents, irradiation and fire, safety vests and life-saving apparatus and equipment, eyeglasses, sunglasses, optical lenses and cases, containers, parts and components thereof, apparatus and instruments for conducting, transforming, accumulating or controlling electricity, electric plugs, junction boxes [electricity], electric switches, circuit breakers, fuses, lighting ballasts, battery starter cables, electrical circuit boards, electric resistances, electric sockets, transformers [electricity], electrical adapters, battery

chargers, electric door bells, electric and electronic cables, batteries, electric accumulators, solar panels for electrical energy production, alarms and anti-theft alarms, other than for vehicles, electric bells, signalling apparatus and instruments, luminous or mechanical signs for traffic use, fire extinguishing apparatus, fire engines, fire hose and fire hose nozzles, radar apparatus, sonars, night vision apparatus and instruments, decorative magnets, metronomes, surgical, medical, dental and veterinary apparatus and instruments, furniture especially made for medical purposes, artificial limbs and prostheses, medical orthopaedic articles, corsets for medical purposes, orthopaedic shoes, elastic bandages and supportive bandages, surgical gowns and surgical sterile sheets, adult sexual aids, condoms, babies' bottles, babies' pacifiers, teats, teethingers for babies, bracelets and rings for medical purposes, anti-rheumatism bracelets and rings, lighting installations, lights for vehicles and interior-exterior spaces, heating installations using solid, liquid or gas fuels or electricity, central heating boilers, boilers for heating installations, radiators [heating], heat exchangers, not parts of machines, stoves, kitchen stoves, solar thermal collectors [heating], steam, gas and fog generators, steam boilers, other than parts of machines, acetylene generators, oxygen generators, nitrogen generators, installations for air-conditioning and ventilating, cooling installations and freezers, electric and gas-powered devices, installations and apparatus for cooking, drying and boiling, cookers, electric cooking pots, electric water heaters, barbecues, electric laundry driers, hair driers, hand drying apparatus, sanitary installations, taps [faucets], shower installations, toilets [water-closets], shower and bathing cubicles, bath tubs, toilet seats, sinks, wash-hand basins [parts of sanitary installations], gaskets for faucets, interior kit of faucets, water softening apparatus, water purification apparatus, water purification installations, waste water purification installations, electric bed warmers and electric blankets, not for medical use, electric pillow warmers, electric or non-electric footwarmers, hot water bottles, electric heated socks, filters for aquariums and aquarium filtration apparatus, industrial type installations for cooking, drying and cooling purposes, pasteurizers and sterilizers, hand-operated non-electric cleaning instruments and appliances, brushes, other than paintbrushes, steel chips for cleaning, sponges for cleaning, steel wool for cleaning, cloths of textile for cleaning, gloves for dishwashing, non-electric polishing machines for household purposes, brooms for carpets, mops, toothbrushes, electric toothbrushes, dental floss, shaving brushes, hair brushes, combs, non-electric household or kitchen utensils, [other than forks, knives, spoons], services [dishes], pots and pans, bottle openers, flower pots, drinking straws, non-electric cooking utensils, ironing boards and shaped covers therefor, drying racks for washing, clothes drying hangers, cages for household pets, indoor aquariums, vivariums and indoor terrari-

ums for animals and plant cultivation, ornaments and decorative goods of glass, porcelain, earthenware or clay, namely statues, figurines, vases, cups given in competitions, mouse traps, insect traps, electric devices for attracting and killing flies and insects, fly catchers, fly swatters, perfume burners, perfume sprayers, perfume vaporizers, electric or non-electric make-up removing appliances, powder puffs, toilet cases, nozzles for sprinkler hose, nozzles for watering cans, watering devices, garden watering cans, unworked or semi-worked glass, except building glass, mosaics of glass and powdered glass for decoration, except for building, glass wool other than for insulation or textile use, tobacco, chewing tobacco, cigarettes, cigars, smokers' articles those made of precious metals, pipes, mouthpieces for cigars and cigarettes, ashtrays, tobacco boxes, pocket apparatus for rolling cigarettes, cigarette paper, tobacco pipes, firestones, lighters for smokers, electronic cigarettes and the pods used with them, matches, enabling customers to conveniently view and purchase those goods, such services may be provided by retail stores, wholesale outlets, by means of electronic media or through mail order catalogues.

(260) AM 2023 119041 A

(800) 1678276

(151) 2022 04 06

(891) 2022 04 06

(731) BONAITI SERRATURE S.P.A.

Via Fratelli Bonacina, 20, CALOLZIOCORTE,  
I-23801 LECCO, Italy

(540)



(591) Black, white

(531) 26.04.18; 28.07

(511)

6 – Metal locks; metal door bolts, metal latches and metal padlocks; metal security lock cylinders; metal striker plates for locks; metal handles and knobs; keys (of metal); metal hinges; Cremonese mechanism [for locks]; front plates (of metal) for doors and locks.

(260) AM 2023 119042 A

(800) 1678357

(151) 2022 05 25

(891) 2022 05 25

(731) Bezer Iurie

Str. Ghidighici nr.3/14, MD-2069 Chişinău,  
Republic of Moldova

---

(540)

## **ImmuFast**

(591) Black, white

(511)

5 – Pharmaceuticals, medical and veterinary preparations; sanitary preparations for medical purposes; dietetic food and substances adapted for medical or veterinary use, food for babies; dietary supplements for human beings and animals; plasters, materials for dressings; material for stopping teeth, dental wax; disinfectants; preparations for destroying vermin; fungicides, herbicides.

---

(260) AM 2023 119060 A

(800) 1678873

(151) 2022 07 26

(891) 2022 07 26

(731) "Froneri Rus" Limited Liability Company

Kosmodamianskaya naberezhnaya, 52,

bld. 1, 4 floor, ap. 2, office 4, RU-115054

Moscow, Russian Federation

(540)

# **MONTEERRA**

(591) Black, white

(531) 06.01.02; 06.01.04; 27.03.12; 27.05.01

(511)

30 – Binding agents for ice cream; frozen yogurt [confectionery ices]; ice for refreshment; ice, natural or artificial; edible ices; ice pops; ice cream; powders for making ice cream; sorbets [ices].

---

---

**INTERNATIONAL TRADEMARKS PROTECTED IN GEORGIA**

(260) AM 2023 116344 A  
(800) 1640318  
(151) 2021 12 17  
(181) 2031 12 17  
(891) 2021 12 17  
(511) 05

---

(260) AM 2023 116695 A  
(800) 1644816  
(151) 2021 11 30  
(181) 2031 11 30  
(891) 2021 11 30  
(511) 09

---

(260) AM 2023 116460 A  
(800) 1641523  
(151) 2021 12 17  
(181) 2031 12 17  
(891) 2021 12 17  
(511) 27

---

(260) AM 2023 116696 A  
(800) 1644823  
(151) 2021 12 07  
(181) 2031 12 07  
(891) 2021 12 07  
(511) 34

---

(260) AM 2023 116576 A  
(800) 1643138  
(151) 2021 06 09  
(181) 2031 06 09  
(891) 2021 06 09  
(511) 03, 05

---

(260) AM 2023 116697 A  
(800) 1644865  
(151) 2021 11 24  
(181) 2031 11 24  
(891) 2021 11 24  
(511) 30

---

(260) AM 2023 116690 A  
(800) 1644613  
(151) 2021 12 31  
(181) 2031 12 31  
(891) 2021 12 31  
(511) 30

---

(260) AM 2023 116699 A  
(800) 1644982  
(151) 2021 09 24  
(181) 2031 09 24  
(891) 2021 09 24  
(511) 18

---

(260) AM 2023 116691 A  
(800) 1644664  
(151) 2021 10 18  
(181) 2031 10 18  
(891) 2021 10 18  
(511) 09, 28, 41

---

(260) AM 2023 116700 A  
(800) 1645130  
(151) 2021 11 29  
(181) 2031 11 29  
(891) 2021 11 29  
(511) 35

---

(260) AM 2023 116692 A  
(800) 1644665  
(151) 2021 11 01  
(181) 2031 11 01  
(891) 2021 11 01  
(511) 09, 28, 41

---

(260) AM 2023 116701 A  
(800) 1645164  
(151) 2021 12 22  
(181) 2031 12 22  
(891) 2021 12 22  
(511) 25

---

(260) AM 2023 116693 A  
(800) 1644668  
(151) 2021 09 24  
(181) 2031 09 24  
(891) 2021 09 24  
(511) 10

---

(260) AM 2023 116702 A  
(800) 1645241  
(151) 2022 01 14  
(181) 2032 01 14  
(891) 2022 01 14  
(511) 01, 05

---



(260) AM 2023 116703 A  
(800) 1645243  
(151) 2021 12 13  
(181) 2031 12 13  
(891) 2021 12 13  
(511) 34

---

(260) AM 2023 116705 A  
(800) 1645288  
(151) 2021 11 26  
(181) 2031 11 26  
(891) 2021 11 26  
(511) 05, 10

---

(260) AM 2023 116706 A  
(800) 1645319  
(151) 2022 01 04  
(181) 2032 01 04  
(891) 2022 01 04  
(511) 44

---

(260) AM 2023 116708 A  
(800) 1645394  
(151) 2021 10 18  
(181) 2031 10 18  
(891) 2021 10 18  
(511) 28, 41

---

(260) AM 2023 116713 A  
(800) 1645576  
(151) 2021 09 21  
(181) 2031 09 21  
(891) 2021 09 21  
(511) 29, 30

---

(260) AM 2023 116724 A  
(800) 1192248  
(151) 2013 08 16  
(181) 2023 08 16  
(891) 2021 12 17  
(511) 03

---

(260) AM 2023 116772 A  
(800) 1645947  
(151) 2021 10 26  
(181) 2031 10 26  
(891) 2021 10 26  
(511) 08

---

(260) AM 2023 116773 A  
(800) 1645966  
(151) 2021 10 25  
(181) 2031 10 25  
(891) 2021 10 25  
(511) 36

---

(260) AM 2023 116774 A  
(800) 1646005  
(151) 2021 12 15  
(181) 2031 12 15  
(891) 2021 12 15  
(511) 05

---

(260) AM 2023 116775 A  
(800) 1646030  
(151) 2021 10 18  
(181) 2031 10 18  
(891) 2021 10 18  
(511) 09, 28, 41

---

(260) AM 2023 116776 A  
(800) 1646032  
(151) 2021 09 15  
(181) 2031 09 15  
(891) 2021 09 15  
(511) 07, 08, 09

---

(260) AM 2023 116783 A  
(800) 1646458  
(151) 2021 12 23  
(181) 2031 12 23  
(891) 2021 12 23  
(511) 05, 29, 30, 32

---

(260) AM 2023 116789 A  
(800) 1646487  
(151) 2021 12 08  
(181) 2031 12 08  
(891) 2021 12 08  
(511) 33

---

(260) AM 2023 116796 A  
(800) 1646675  
(151) 2021 12 16  
(181) 2031 12 16  
(891) 2021 12 16  
(511) 09

---

(260) AM 2023 116799 A  
(800) 1646754  
(151) 2022 01 13  
(181) 2032 01 13  
(891) 2022 01 13  
(511) 30

---

(260) AM 2023 116804 A  
(800) 1646860  
(151) 2021 04 16  
(181) 2031 04 16  
(891) 2021 04 16  
(511) 01, 03, 05, 29, 30, 32

---

(260) AM 2023 116812 A  
(800) 1647018  
(151) 2021 12 16  
(181) 2031 12 16  
(891) 2021 12 16  
(511) 03, 05

---

(260) AM 2023 116826 A  
(800) 1612846  
(151) 2021 07 20  
(181) 2031 07 20  
(891) 2022 02 09  
(511) 09, 10, 21, 25, 42

---

(260) AM 2023 116870 A  
(800) 1647180  
(151) 2021 07 27  
(181) 2031 07 27  
(891) 2021 07 27  
(511) 01, 34, 35

---

(260) AM 2023 116873 A  
(800) 1647228  
(151) 2021 12 23  
(181) 2031 12 23  
(891) 2021 12 23  
(511) 03

---

(260) AM 2023 116874 A  
(800) 1647236  
(151) 2021 12 17  
(181) 2031 12 17  
(891) 2021 12 17  
(511) 03

---

(260) AM 2023 116876 A  
(800) 1647377  
(151) 2021 09 24  
(181) 2031 09 24  
(891) 2021 09 24  
(511) 07, 08, 09

---

(260) AM 2023 116879 A  
(800) 1647480  
(151) 2021 11 12  
(181) 2031 11 12  
(891) 2021 11 12  
(511) 09

---

(260) AM 2023 116880 A  
(800) 1647506  
(151) 2022 01 24  
(181) 2032 01 24  
(891) 2022 01 24  
(511) 10

---

(260) AM 2023 116881 A  
(800) 1647523  
(151) 2021 11 10  
(181) 2031 11 10  
(891) 2021 11 10  
(511) 05

---

(260) AM 2023 116882 A  
(800) 1647560  
(151) 2021 09 27  
(181) 2031 09 27  
(891) 2021 09 27  
(511) 32

---

(260) AM 2023 116883 A  
(800) 1647561  
(151) 2022 01 13  
(181) 2032 01 13  
(891) 2022 01 13  
(511) 28

---

(260) AM 2023 116884 A  
(800) 1647584  
(151) 2021 09 14  
(181) 2031 09 14  
(891) 2021 09 14  
(511) 05, 35

---

(260) AM 2023 116885 A  
(800) 1647595  
(151) 2021 06 15  
(181) 2031 06 15  
(891) 2021 06 15  
(511) 09, 35, 38, 41, 42, 44

---

(260) AM 2023 116899 A  
(800) 1647953  
(151) 2022 01 11  
(181) 2032 01 11  
(891) 2022 01 11  
(511) 03

---

(260) AM 2023 116886 A  
(800) 1647599  
(151) 2021 12 07  
(181) 2031 12 07  
(891) 2021 12 07  
(511) 09, 35, 36, 42

---

(260) AM 2023 116900 A  
(800) 1647954  
(151) 2022 01 11  
(181) 2032 01 11  
(891) 2022 01 11  
(511) 03

---

(260) AM 2023 116891 A  
(800) 1647788  
(151) 2021 12 18  
(181) 2031 12 18  
(891) 2021 12 18  
(511) 07, 08, 11

---

(260) AM 2023 116901 A  
(800) 1647962  
(151) 2022 01 19  
(181) 2032 01 19  
(891) 2022 01 19  
(511) 10

---

(260) AM 2023 116892 A  
(800) 1647819  
(151) 2022 01 12  
(181) 2032 01 12  
(891) 2022 01 12  
(511) 01, 05, 09, 35, 37, 39, 42

---

(260) AM 2023 116902 A  
(800) 1647964  
(151) 2022 01 19  
(181) 2032 01 19  
(891) 2022 01 19  
(511) 10

---

(260) AM 2023 116893 A  
(800) 1647825  
(151) 2021 10 07  
(181) 2031 10 07  
(891) 2021 10 07  
(511) 09, 28, 41

---

(260) AM 2023 116910 A  
(800) 1648154  
(151) 2021 10 19  
(181) 2031 10 19  
(891) 2021 10 19  
(511) 09, 38, 42, 45

---

(260) AM 2023 116894 A  
(800) 1647855  
(151) 2021 11 16  
(181) 2031 11 16  
(891) 2021 11 16  
(511) 37

---

(260) AM 2023 116911 A  
(800) 1648216  
(151) 2021 12 21  
(181) 2031 12 21  
(891) 2021 12 21  
(511) 35

---

(260) AM 2023 116898 A  
(800) 1647939  
(151) 2021 12 13  
(181) 2031 12 13  
(891) 2021 12 13  
(511) 18, 25

---

(260) AM 2023 116912 A  
(800) 1648232  
(151) 2022 01 19  
(181) 2032 01 19  
(891) 2022 01 19  
(511) 10

---

(260) AM 2023 116923 A  
 (800) 1648522  
 (151) 2021 12 13  
 (181) 2031 12 13  
 (891) 2021 12 13  
 (511) 41

---

(260) AM 2023 116930 A  
 (800) 966191  
 (151) 2008 01 14  
 (181) 2028 01 14  
 (891) 2022 02 03  
 (511) 01, 05

---

(260) AM 2023 116924 A  
 (800) 1648523  
 (151) 2021 12 13  
 (181) 2031 12 13  
 (891) 2021 12 13  
 (511) 41

---

(260) AM 2023 116931 A  
 (800) 1099969  
 (151) 2011 11 11  
 (181) 2031 11 11  
 (891) 2022 02 15  
 (511) 14

---

(260) AM 2023 116925 A  
 (800) 1648527  
 (151) 2022 01 04  
 (181) 2032 01 04  
 (891) 2022 01 04  
 (511) 32

---

(260) AM 2023 116932 A  
 (800) 1104945  
 (151) 2011 07 05  
 (181) 2031 07 05  
 (891) 2022 01 28  
 (511) 32

---

(260) AM 2023 116926 A  
 (800) 1648575  
 (151) 2022 01 18  
 (181) 2032 01 18  
 (891) 2022 01 18  
 (511) 42

---

(260) AM 2023 116934 A  
 (800) 1264589  
 (151) 2014 12 19  
 (181) 2024 12 19  
 (891) 2022 02 15  
 (511) 05

---

(260) AM 2023 116927 A  
 (800) 159681  
 (151) 1952 02 11  
 (181) 2032 02 11  
 (891) 2022 02 16  
 (511) 05

---

(260) AM 2023 116935 A  
 (800) 1264992  
 (151) 2014 12 19  
 (181) 2024 12 19  
 (891) 2022 02 15  
 (511) 05

---

(260) AM 2023 116928 A  
 (800) 735519  
 (151) 2000 06 06  
 (181) 2030 06 06  
 (891) 2022 02 15  
 (511) 05

---

(260) AM 2023 116936 A  
 (800) 1264993  
 (151) 2014 12 19  
 (181) 2024 12 19  
 (891) 2022 02 15  
 (511) 05

---

(260) AM 2023 116929 A  
 (800) 798070  
 (151) 2002 12 04  
 (181) 2022 12 04  
 (891) 2022 01 31  
 (511) 01

---

(260) AM 2023 116937 A  
 (800) 1264997  
 (151) 2014 12 19  
 (181) 2024 12 19  
 (891) 2022 02 15  
 (511) 05

---

(260) AM 2023 116938 A  
(800) 1264999  
(151) 2014 12 19  
(181) 2024 12 19  
(891) 2022 02 15  
(511) 05

---

(260) AM 2023 116939 A  
(800) 1265000  
(151) 2014 12 19  
(181) 2024 12 19  
(891) 2022 02 15  
(511) 05

---

(260) AM 2023 116940 A  
(800) 1265001  
(151) 2014 12 19  
(181) 2024 12 19  
(891) 2022 02 15  
(511) 05

---

(260) AM 2023 116941 A  
(800) 1265003  
(151) 2014 12 19  
(181) 2024 12 19  
(891) 2022 02 15  
(511) 05

---

(260) AM 2023 116942 A  
(800) 1265004  
(151) 2015 01 30  
(181) 2025 01 30  
(891) 2022 02 15  
(511) 05

---

(260) AM 2023 117003 A  
(800) 1648758  
(151) 2022 01 07  
(181) 2032 01 07  
(891) 2022 01 07  
(511) 09, 12, 37, 42

---

(260) AM 2023 117004 A  
(800) 1648769  
(151) 2022 01 20  
(181) 2032 01 20  
(891) 2022 01 20  
(511) 30, 35

---

(260) AM 2023 117005 A  
(800) 1648770  
(151) 2021 12 27  
(181) 2031 12 27  
(891) 2021 12 27  
(511) 01, 05, 07, 08, 11, 31, 35

---

(260) AM 2023 117006 A  
(800) 1648797  
(151) 2021 12 17  
(181) 2031 12 17  
(891) 2021 12 17  
(511) 03

---

(260) AM 2023 117007 A  
(800) 1648816  
(151) 2021 10 25  
(181) 2031 10 25  
(891) 2021 10 25  
(511) 16, 20, 27

---

(260) AM 2023 117008 A  
(800) 1648828  
(151) 2021 12 30  
(181) 2031 12 30  
(891) 2021 12 30  
(511) 05

---

(260) AM 2023 117009 A  
(800) 1648875  
(151) 2022 01 13  
(181) 2032 01 13  
(891) 2022 01 13  
(511) 09, 18, 25, 28, 35, 41

---

(260) AM 2023 117010 A  
(800) 1648899  
(151) 2021 10 07  
(181) 2031 10 07  
(891) 2021 10 07  
(511) 09, 28, 41

---

(260) AM 2023 117011 A  
(800) 1648903  
(151) 2021 10 07  
(181) 2031 10 07  
(891) 2021 10 07  
(511) 05

---

(260) AM 2023 117012 A  
(800) 1648909  
(151) 2021 10 13  
(181) 2031 10 13  
(891) 2021 10 13  
(511) 01

---

(260) AM 2023 117014 A  
(800) 1648932  
(151) 2021 11 19  
(181) 2031 11 19  
(891) 2021 11 19  
(511) 29, 30

---

(260) AM 2023 117015 A  
(800) 1648935  
(151) 2022 01 12  
(181) 2032 01 12  
(891) 2022 01 12  
(511) 25

---

(260) AM 2023 117016 A  
(800) 1648939  
(151) 2022 01 19  
(181) 2032 01 19  
(891) 2022 01 19  
(511) 36

---

(260) AM 2023 117017 A  
(800) 1648940  
(151) 2022 01 19  
(181) 2032 01 19  
(891) 2022 01 19  
(511) 38

---

(260) AM 2023 117018 A  
(800) 1648951  
(151) 2021 12 23  
(181) 2031 12 23  
(891) 2021 12 23  
(511) 05

---

(260) AM 2023 117019 A  
(800) 1649033  
(151) 2021 10 20  
(181) 2031 10 20  
(891) 2021 10 20  
(511) 04, 07, 08, 09, 18

---

(260) AM 2023 117020 A  
(800) 1649057  
(151) 2022 01 14  
(181) 2032 01 14  
(891) 2022 01 14  
(511) 09

---

(260) AM 2023 117021 A  
(800) 1649072  
(151) 2021 11 10  
(181) 2031 11 10  
(891) 2021 11 10  
(511) 05

---

(260) AM 2023 117022 A  
(800) 1649118  
(151) 2021 09 16  
(181) 2031 09 16  
(891) 2021 09 16  
(511) 09, 35, 38, 41

---

(260) AM 2023 117023 A  
(800) 1649151  
(151) 2021 11 08  
(181) 2031 11 08  
(891) 2021 11 08  
(511) 09, 28, 41

---

(260) AM 2023 117024 A  
(800) 1649173  
(151) 2021 11 22  
(181) 2031 11 22  
(891) 2021 11 22  
(511) 05

---

(260) AM 2023 117025 A  
(800) 1649178  
(151) 2021 12 07  
(181) 2031 12 07  
(891) 2021 12 07  
(511) 05

---

(260) AM 2023 117026 A  
(800) 1649179  
(151) 2021 12 07  
(181) 2031 12 07  
(891) 2021 12 07  
(511) 05

---

(260) AM 2023 117027 A  
(800) 1649180  
(151) 2021 12 07  
(181) 2031 12 07  
(891) 2021 12 07  
(511) 05

---

(260) AM 2023 117110 A  
(800) 1649912  
(151) 2022 01 13  
(181) 2032 01 13  
(891) 2022 01 13  
(511) 09, 42

---

(260) AM 2023 117028 A  
(800) 1649181  
(151) 2021 12 07  
(181) 2031 12 07  
(891) 2021 12 07  
(511) 05

---

(260) AM 2023 117112 A  
(800) 1649970  
(151) 2022 01 18  
(181) 2032 01 18  
(891) 2022 01 18  
(511) 07

---

(260) AM 2023 117029 A  
(800) 1649184  
(151) 2021 12 07  
(181) 2031 12 07  
(891) 2021 12 07  
(511) 05

---

(260) AM 2023 117113 A  
(800) 1649991  
(151) 2021 12 31  
(181) 2031 12 31  
(891) 2021 12 31  
(511) 12

---

(260) AM 2023 117030 A  
(800) 1649200  
(151) 2021 11 12  
(181) 2031 11 12  
(891) 2021 11 12  
(511) 33

---

(260) AM 2023 117117 A  
(800) 1650064  
(151) 2021 12 27  
(181) 2031 12 27  
(891) 2021 12 27  
(511) 38, 41

---

(260) AM 2023 117031 A  
(800) 1649221  
(151) 2022 01 07  
(181) 2032 01 07  
(891) 2022 01 07  
(511) 43

---

(260) AM 2023 117148 A  
(800) 1650991  
(151) 2021 10 15  
(181) 2031 10 15  
(891) 2021 10 15  
(511) 05, 30, 32, 35, 41, 43

---

(260) AM 2023 117052 A  
(800) 1649863  
(151) 2021 10 27  
(181) 2031 10 27  
(891) 2021 10 27  
(511) 03, 21, 44

---

(260) AM 2023 117149 A  
(800) 1650994  
(151) 2021 09 21  
(181) 2031 09 21  
(891) 2021 09 21  
(511) 06, 07

---

(260) AM 2023 117061 A  
(800) 1641525  
(151) 2021 12 27  
(181) 2031 12 27  
(891) 2022 02 18  
(511) 43

---

(260) AM 2023 117150 A  
(800) 1650997  
(151) 2021 10 29  
(181) 2031 10 29  
(891) 2021 10 29  
(511) 05, 10

---

(260) AM 2023 117151 A  
(800) 1651002  
(151) 2021 11 04  
(181) 2031 11 04  
(891) 2021 11 04  
(511) 05, 10

---

(260) AM 2023 117152 A  
(800) 1651022  
(151) 2021 10 07  
(181) 2031 10 07  
(891) 2021 10 07  
(511) 03, 14, 18, 25, 35

---

(260) AM 2023 117153 A  
(800) 1651025  
(151) 2021 11 28  
(181) 2031 11 28  
(891) 2021 11 28  
(511) 36, 42, 45

---

(260) AM 2023 117154 A  
(800) 1651085  
(151) 2022 01 20  
(181) 2032 01 20  
(891) 2022 01 20  
(511) 30, 35

---

(260) AM 2023 117156 A  
(800) 1132478  
(151) 2012 02 29  
(181) 2032 02 28  
(891) 2022 03 03  
(511) 09, 37, 42

---

(260) AM 2023 117157 A  
(800) 1211398  
(151) 2014 02 05  
(181) 2024 02 05  
(891) 2022 01 21  
(511) 09, 18, 25

---

(260) AM 2023 117161 A  
(800) 1626222  
(151) 2021 09 28  
(181) 2031 09 28  
(891) 2022 02 24  
(511) 05

---

(260) AM 2023 117206 A  
(800) 1651328  
(151) 2021 12 03  
(181) 2031 12 03  
(891) 2021 12 03  
(511) 31

---

(260) AM 2023 117207 A  
(800) 1651351  
(151) 2021 10 08  
(181) 2031 10 08  
(891) 2021 10 08  
(511) 03, 05, 10, 16, 17

---

(260) AM 2023 117208 A  
(800) 1651359  
(151) 2021 10 11  
(181) 2031 10 11  
(891) 2021 10 11  
(511) 01

---

(260) AM 2023 117209 A  
(800) 1651370  
(151) 2021 11 30  
(181) 2031 11 30  
(891) 2021 11 30  
(511) 11, 35

---

(260) AM 2023 117210 A  
(800) 1651411  
(151) 2021 08 31  
(181) 2031 08 31  
(891) 2021 08 31  
(511) 35, 36, 37, 38, 39, 40, 41, 42, 43, 44, 45

---

(260) AM 2023 117213 A  
(800) 1651604  
(151) 2022 01 18  
(181) 2032 01 18  
(891) 2022 01 18  
(511) 07

---

(260) AM 2023 117214 A  
(800) 1651605  
(151) 2022 01 18  
(181) 2032 01 18  
(891) 2022 01 18  
(511) 07

---



(260) AM 2023 117215 A  
(800) 1651673  
(151) 2022 02 06  
(181) 2032 02 06  
(891) 2022 02 06  
(511) 43

---

(260) AM 2023 117216 A  
(800) 1651674  
(151) 2021 12 10  
(181) 2031 12 10  
(891) 2021 12 10  
(511) 07

---

(260) AM 2023 117217 A  
(800) 1651714  
(151) 2021 12 23  
(181) 2031 12 23  
(891) 2021 12 23  
(511) 29, 30

---

(260) AM 2023 117218 A  
(800) 1651724  
(151) 2021 08 10  
(181) 2031 08 10  
(891) 2021 08 10  
(511) 06, 07, 08, 09, 11

---

(260) AM 2023 117219 A  
(800) 1651766  
(151) 2021 12 29  
(181) 2031 12 29  
(891) 2021 12 29  
(511) 32

---

(260) AM 2023 117220 A  
(800) 1651775  
(151) 2021 10 14  
(181) 2031 10 14  
(891) 2021 10 14  
(511) 09, 35, 41, 42

---

(260) AM 2023 117221 A  
(800) 1651809  
(151) 2022 01 19  
(181) 2032 01 19  
(891) 2022 01 19  
(511) 10

---

(260) AM 2023 117222 A  
(800) 1651852  
(151) 2022 01 26  
(181) 2032 01 26  
(891) 2022 01 26  
(511) 34, 35

---

(260) AM 2023 117223 A  
(800) 1651915  
(151) 2021 10 01  
(181) 2031 10 01  
(891) 2021 10 01  
(511) 03, 05

---

(260) AM 2023 117224 A  
(800) 1651916  
(151) 2021 10 01  
(181) 2031 10 01  
(891) 2021 10 01  
(511) 03, 05

---

(260) AM 2023 117227 A  
(800) 1651919  
(151) 2021 10 01  
(181) 2031 10 01  
(891) 2021 10 01  
(511) 03, 05

---

(260) AM 2023 117229 A  
(800) 1651932  
(151) 2022 02 07  
(181) 2032 02 07  
(891) 2022 02 07  
(511) 05

---

(260) AM 2023 117230 A  
(800) 1651934  
(151) 2021 12 08  
(181) 2031 12 08  
(891) 2021 12 08  
(511) 05

---

(260) AM 2023 117240 A  
(800) 1652156  
(151) 2021 08 11  
(181) 2031 08 11  
(891) 2021 08 11  
(511) 09, 14, 16, 20, 25, 28, 35, 38, 41, 42, 45

---

(260) AM 2023 117322 A  
 (800) 1652458  
 (151) 2022 02 15  
 (181) 2032 02 15  
 (891) 2022 02 15  
 (511) 25

---

(260) AM 2023 117347 A  
 (800) 1653493  
 (151) 2022 02 15  
 (181) 2032 02 15  
 (891) 2022 02 15  
 (511) 09, 39

---

(260) AM 2023 117323 A  
 (800) 1652548  
 (151) 2022 02 11  
 (181) 2032 02 11  
 (891) 2022 02 11  
 (511) 03

---

(260) AM 2023 117348 A  
 (800) 1653514  
 (151) 2022 02 23  
 (181) 2032 02 23  
 (891) 2022 02 23  
 (511) 05

---

(260) AM 2023 117324 A  
 (800) 1652589  
 (151) 2021 10 06  
 (181) 2031 10 06  
 (891) 2021 10 06  
 (511) 01, 16, 17, 20, 21

---

(260) AM 2023 117349 A  
 (800) 1653535  
 (151) 2022 02 25  
 (181) 2032 02 25  
 (891) 2022 02 25  
 (511) 33

---

(260) AM 2023 117325 A  
 (800) 1652590  
 (151) 2021 10 06  
 (181) 2031 10 06  
 (891) 2021 10 06  
 (511) 01, 16, 17, 20, 21

---

(260) AM 2023 117351 A  
 (800) 1653576  
 (151) 2021 11 25  
 (181) 2031 11 25  
 (891) 2021 11 25  
 (511) 16, 17, 19, 35, 42

---

(260) AM 2023 117326 A  
 (800) 1652599  
 (151) 2021 11 23  
 (181) 2031 11 23  
 (891) 2021 11 23  
 (511) 29, 30

---

(260) AM 2023 117367 A  
 (800) 1620433  
 (151) 2021 07 16  
 (181) 2031 07 16  
 (891) 2022 03 16  
 (511) 12

---

(260) AM 2023 117338 A  
 (800) 1653020  
 (151) 2021 09 10  
 (181) 2031 09 10  
 (891) 2021 09 10  
 (511) 42, 44

---

(260) AM 2023 117376 A  
 (800) 1653884  
 (151) 2022 02 02  
 (181) 2032 02 02  
 (891) 2022 02 02  
 (511) 03

---

(260) AM 2023 117345 A  
 (800) 1653421  
 (151) 2022 01 04  
 (181) 2032 01 04  
 (891) 2022 01 04  
 (511) 20, 24, 25, 35

---

(260) AM 2023 117378 A  
 (800) 1654040  
 (151) 2022 02 08  
 (181) 2032 02 08  
 (891) 2022 02 08  
 (511) 30

---

(260) AM 2023 117379 A  
(800) 1654042  
(151) 2022 02 18  
(181) 2032 02 18  
(891) 2022 02 18  
(511) 41

---

(260) AM 2023 117381 A  
(800) 1654163  
(151) 2021 10 13  
(181) 2031 10 13  
(891) 2021 10 13  
(511) 41, 45

---

(260) AM 2023 117382 A  
(800) 1654236  
(151) 2021 10 06  
(181) 2031 10 06  
(891) 2021 10 06  
(511) 01, 16, 17, 20, 21

---

(260) AM 2023 117383 A  
(800) 1654265  
(151) 2022 01 25  
(181) 2032 01 25  
(891) 2022 01 25  
(511) 33

---

(260) AM 2023 117385 A  
(800) 1654352  
(151) 2022 03 08  
(181) 2032 03 08  
(891) 2022 03 08  
(511) 09

---

(260) AM 2023 117386 A  
(800) 1654384  
(151) 2021 10 05  
(181) 2031 10 05  
(891) 2021 10 05  
(511) 06, 07, 08, 11, 12, 19, 20, 22, 28

---

(260) AM 2023 117473 A  
(800) 1655549  
(151) 2022 03 03  
(181) 2032 03 03  
(891) 2022 03 03  
(511) 09, 41, 42

---

(260) AM 2023 117474 A  
(800) 1655560  
(151) 2022 03 04  
(181) 2032 03 04  
(891) 2022 03 04  
(511) 37

---

(260) AM 2023 117475 A  
(800) 1655611  
(151) 2021 06 09  
(181) 2031 06 09  
(891) 2021 06 09  
(511) 16, 30, 35, 39, 43

---

(260) AM 2023 117493 A  
(800) 1656023  
(151) 2021 12 20  
(181) 2031 12 20  
(891) 2021 12 20  
(511) 03, 05, 35

---

(260) AM 2023 117498 A  
(800) 1656163  
(151) 2021 10 21  
(181) 2031 10 21  
(891) 2021 10 21  
(511) 35, 44

---

(260) AM 2023 117594 A  
(800) 1657472  
(151) 2021 12 28  
(181) 2031 12 28  
(891) 2021 12 28  
(511) 01, 04

---

(260) AM 2023 117595 A  
(800) 1657500  
(151) 2022 02 09  
(181) 2032 02 09  
(891) 2022 02 09  
(511) 06, 19

---

(260) AM 2023 117633 A  
(800) 1658085  
(151) 2022 02 23  
(181) 2032 02 23  
(891) 2022 02 23  
(511) 10

---

(260) AM 2023 117634 A  
(800) 1658103  
(151) 2021 12 16  
(181) 2031 12 16  
(891) 2021 12 16  
(511) 09, 28, 41

---

(260) AM 2023 117635 A  
(800) 1658262  
(151) 2021 10 21  
(181) 2031 10 21  
(891) 2021 10 21  
(511) 02, 03, 07, 08, 09, 10, 11, 12, 14, 15, 16, 18, 21,  
24, 25, 28, 35, 36, 37, 38, 39, 41, 42, 45

---

(260) AM 2023 117637 A  
(800) 1658303  
(151) 2022 01 26  
(181) 2032 01 26  
(891) 2022 01 26  
(511) 04

---

(260) AM 2023 117671 A  
(800) 1658917  
(151) 2022 02 28  
(181) 2032 02 28  
(891) 2022 02 28  
(511) 32, 43

---

(260) AM 2023 117672 A  
(800) 1658937  
(151) 2021 11 15  
(181) 2031 11 15  
(891) 2021 11 15  
(511) 35, 38, 40, 41, 42

---

(260) AM 2023 117673 A  
(800) 1658986  
(151) 2021 11 09  
(181) 2031 11 09  
(891) 2021 11 09  
(511) 05, 29, 30, 32

---

(260) AM 2023 117697 A  
(800) 1659706  
(151) 2022 03 22  
(181) 2032 03 22  
(891) 2022 03 22  
(511) 05

---

(260) AM 2023 117698 A  
(800) 1659709  
(151) 2021 12 09  
(181) 2031 12 09  
(891) 2021 12 09  
(511) 06, 07, 11, 19

---

(260) AM 2023 117699 A  
(800) 1659725  
(151) 2021 11 19  
(181) 2031 11 19  
(891) 2021 11 19  
(511) 05

---

(260) AM 2023 117700 A  
(800) 1659726  
(151) 2022 01 11  
(181) 2032 01 11  
(891) 2022 01 11  
(511) 03

---

(260) AM 2023 117701 A  
(800) 1659796  
(151) 2021 12 23  
(181) 2031 12 23  
(891) 2021 12 23  
(511) 01, 02

---

(260) AM 2023 117793 A  
(800) 1443392  
(151) 2018 06 21  
(181) 2028 06 21  
(891) 2022 04 22  
(511) 03, 04, 35

---

(260) AM 2023 117796 A  
(800) 1602299  
(151) 2021 04 27  
(181) 2031 04 27  
(891) 2022 04 26  
(511) 09, 20, 24, 28

---

(260) AM 2023 117874 A  
(800) 1662248  
(151) 2021 11 30  
(181) 2031 11 30  
(891) 2021 11 30  
(511) 19

---

(260) AM 2023 117875 A  
(800) 1662285  
(151) 2022 02 11  
(181) 2032 02 11  
(891) 2022 02 11  
(511) 10

---

(260) AM 2023 117876 A  
(800) 1662286  
(151) 2022 02 11  
(181) 2032 02 11  
(891) 2022 02 11  
(511) 10

---

(260) AM 2023 117878 A  
(800) 1662410  
(151) 2021 11 22  
(181) 2031 11 22  
(891) 2021 11 22  
(511) 06, 07, 09, 10, 11, 35, 38, 41, 42

---

(260) AM 2023 117879 A  
(800) 1662435  
(151) 2022 01 19  
(181) 2032 01 19  
(891) 2022 01 19  
(511) 09, 16, 35, 40, 41, 42

---

(260) AM 2023 117880 A  
(800) 1662446  
(151) 2021 07 15  
(181) 2031 07 15  
(891) 2021 07 15  
(511) 42, 44

---

(260) AM 2023 117881 A  
(800) 1662472  
(151) 2022 03 11  
(181) 2032 03 11  
(891) 2022 03 11  
(511) 03, 05, 10, 14

---

(260) AM 2023 117882 A  
(800) 1662487  
(151) 2022 04 05  
(181) 2032 04 05  
(891) 2022 04 05  
(511) 29, 30

---

(260) AM 2023 117883 A  
(800) 1662488  
(151) 2022 04 05  
(181) 2032 04 05  
(891) 2022 04 05  
(511) 29, 30

---

(260) AM 2023 117969 A  
(800) 1302336  
(151) 2016 05 10  
(181) 2026 05 10  
(891) 2022 05 06  
(511) 39

---

(260) AM 2023 117970 A  
(800) 1304713  
(151) 2016 05 10  
(181) 2026 05 10  
(891) 2022 05 06  
(511) 39

---

(260) AM 2023 117974 A  
(800) 1642003  
(151) 2021 11 19  
(181) 2031 11 19  
(891) 2022 05 02  
(511) 06, 07, 20

---

(260) AM 2023 117975 A  
(800) 1657078  
(151) 2022 01 24  
(181) 2032 01 24  
(891) 2022 05 02  
(511) 07, 09

---

---

**OFFICIAL NOTIFICATIONS  
INVENTIONS  
RESTORATION OF PATENTS**

(21) AP 2012 12942  
(11) P 2014 6058 B  
(73) Besik Surguladze  
(54) PREPARATION FOR SECONDARY DISSEMINATION DIAGNOSTICATION AND TREATMENT AT MALIGNANT TUMOR  
DATE OF PATENT CANCELLATION: 2022 12 25  
DATE OF PATENT RESTORATION: 2023 04 10

---

(21) AP 2016 14600  
(11) P 2021 7282 B  
(73) Atea Pharmaceuticals Inc.  
(54)  $\beta$ -D-2'-DEOXY-2' $\alpha$ -FLUORO-2'- $\beta$ -C-SUBSTITUTED-2-MODIFIED-N6-SUBSTITUTED PURINE NUCLEOTIDES FOR HCV TREATMENT  
DATE OF PATENT CANCELLATION: 2023 03 07  
DATE OF PATENT RESTORATION: 2023 04 10

---

**ABOLITION OF PATENTS WITH THE RIGHT TO RESTORE**

(21) AP 2012 13223  
(11) P 2016 6566 B  
(73) Chiesi Farmaceutici S.P.A.  
(54) ISOXAZOLIDINE DERIVATIVES  
DATE OF PATENT CANCELLATION: 2023 03 14  
LIMITED DATE OF PATENT RESTORATION: 2024 03 14

---

(21) AP 2013 13603  
(11) P 2017 6721 B  
(73) Alios Biopharma Inc.  
(54) SUBSTITUTED NUCLEOSIDES, NUCLEOTIDES AND ANALOGS THEREOF  
DATE OF PATENT CANCELLATION: 2023 03 19  
LIMITED DATE OF PATENT RESTORATION: 2024 03 19

---

(21) AP 2013 13674  
(11) P 2021 7251 B  
(73) The Regents Of The University Of California (US);  
University Of Vienna (AT);  
Charpentier, Emmanuelle (DE)  
(54) METHODS AND COMPOSITIONS FOR RNA-DIRECTED TARGET DNA MODIFICATION AND FOR RNA-DIRECTED MODULATION OF TRANSCRIPTION  
DATE OF PATENT CANCELLATION: 2023 03 15  
LIMITED DATE OF PATENT RESTORATION: 2024 03 15

---

(21) AP 2015 14317  
(11) P 2021 7247 B  
(73) Iomet Pharma LTD  
(54) INDOLE DERIVATIVES FOR USE IN MEDICINE  
DATE OF PATENT CANCELLATION: 2023 03 19  
LIMITED DATE OF PATENT RESTORATION: 2024 03 19

---

(21) AP 2017 14452  
(11) P 2018 6914 B  
(73) Raul Turmanidze;  
Giorgi Popkhadze;  
Vasil Bachanadze  
(54) FACILITY TO GRINDING MACHINE FOR SPIRAL OR SCREW GROOVES WITH VARIABLE  
INCLINATION TREATMENT  
DATE OF PATENT CANCELLATION: 2023 03 16  
LIMITED DATE OF PATENT RESTORATION: 2024 03 16

---

(21) AP 2016 14609  
(11) P 2020 7127 B  
(73) Ecole Polytechnique Federale De Lausanne (EPFL)  
(54) 2-HOMOPIPERAZINE-1-YL-4H-1,3-BENZOTHIAZINE-4-ONE DERIVATIVES AND PROCESS FOR  
THE PREPARATION OF 2-(HOMO)PIPERAZINE 1,3-BENZOTHIAZINE-4-ONE HYDROCHLORIDES  
DATE OF PATENT CANCELLATION: 2023 03 23  
LIMITED DATE OF PATENT RESTORATION: 2024 03 23

---

(21) AP 2016 14821  
(11) P 2021 7258 B  
(73) Ecole Polytechnique Federale De Lausanne (EPFL)  
(54) 2-HOMOPIPERAZINE-1-YL-4H-1,3-BENZOTHIAZINE-4-ONE DERIVATIVES AND PROCESS FOR  
THE PREPARATION OF 2-(HOMO)PIPERAZINE 1,3-BENZOTHIAZINE-4-ONE HYDROCHLORIDES  
DATE OF PATENT CANCELLATION: 2023 03 23  
LIMITED DATE OF PATENT RESTORATION: 2024 03 23

---

(21) AP 2018 15192  
(11) P 2021 7256 B  
(73) Richter Gedeon Nyrt.  
(54) PHARMACOLOGICALLY ACTIVE ALICYCLIC-SUBSTITUTED PYRAZOLO[1,5-a]PYRIMIDINE  
DERIVATIVES  
DATE OF PATENT CANCELLATION: 2023 03 12  
LIMITED DATE OF PATENT RESTORATION: 2024 03 12

---

## DATE OF PATENTS RESTORATION EXPIRATION

(21) AP 2010 12443  
(11) P 2015 6393 B  
(73) Geox S.P.A.  
(54) WATERPROOF AND VAPOR-PERMEABLE SHOE  
DATE OF PATENT CANCELLATION: 2022 03 12  
DATE OF PATENT RESTORATION EXPIRATION: 2023 03 12

---

(21) AP 2010 12444  
(11) P 2015 6394 B  
(73) Geox S.P.A.  
(54) METHOD FOR MANUFACTURING WATERPROOF AND VAPOR-PERMEABLE SHOE  
DATE OF PATENT CANCELLATION: 2022 03 12  
DATE OF PATENT RESTORATION EXPIRATION: 2023 03 12

---

(21) AP 2013 13596  
(11) P 2017 6774 B  
(73) Lupin Limited  
(54) HETEROCYCLYL COMPOUNDS  
DATE OF PATENT CANCELLATION: 2022 03 11  
DATE OF PATENT RESTORATION EXPIRATION: 2023 03 11

---

(21) AP 2013 13599  
(11) P 2018 6900 B  
(73) Millennium Pharmaceuticals Inc.  
(54) METHODS OF TREATING CANCER USING AURORA KINASE INHIBITORS  
DATE OF PATENT CANCELLATION: 2022 03 19  
DATE OF PATENT RESTORATION EXPIRATION: 2023 03 19

---

(21) AP 2015 14297  
(11) P 2020 7083 B  
(73) Pfizer Inc.  
(54) THERAPEUTIC NANOPARTICLES COMPRISING THERAPEUTIC AGENT AND METHODS  
OF MAKING AND USING SAME  
DATE OF PATENT CANCELLATION: 2022 03 13  
DATE OF PATENT RESTORATION EXPIRATION: 2023 03 13

---

(21) AP 2016 14604  
(11) P 2019 7007 B  
(73) Kyowa Kirin Co., LTD  
(54) THERAPEUTIC AGENT FOR FRONTAL LOBE DYSFUNCTION  
DATE OF PATENT CANCELLATION: 2022 03 18  
DATE OF PATENT RESTORATION EXPIRATION: 2023 03 18

---



(21) AP 2019 15024  
(11) P 2021 7275 B  
(73) Mikheil Ivanishvili;  
    Mariam Kublashvili  
(54) TOY CONSTRUCTOR  
DATE OF PATENT CANCELLATION: 2022 03 19  
DATE OF PATENT RESTORATION EXPIRATION: 2023 03 19

---

## UTILITY MODELS RESTORATION OF PATENT

(21) AU 2017 14631  
(11) U 2019 1999 Y  
(73) Besiki Surguladze  
(54) DRUG FOR MALIGNANT TUMORS SECONDARY METASTASES TREATMENT  
DATE OF PATENT CANCELLATION: 2022 12 28  
DATE OF PATENT RESTORATION: 2023 04 10

---

## ABOLITION OF PATENT WITH THE RIGHT TO RESTORE

(21) AU 2018 14729  
(11) U 2020 2051 Y  
(73) Konstantine Maghradze;  
    Nugzar Joglidze  
(54) BAKERY PRODUCT FOR OSTEOPOROSIS PROLIFERATION  
DATE OF PATENT CANCELLATION: 2023 03 16  
LIMITED DATE OF PATENT RESTORATION: 2024 03 16

---

## DATE OF PATENT RESTORATION EXPIRATION

(21) AU 2020 15300  
(11) U 2020 2055 Y  
(73) Nikoloz Osikmishvili  
(54) TRANSPARENT BEEHIVE  
DATE OF PATENT CANCELLATION: 2022 03 17  
DATE OF PATENT RESTORATION EXPIRATION: 2023 03 17

---

## DESIGNS

### EXTENSION OF TERMS OF DESIGN REGISTRATION

- (11) D 2018 763 S
  - (73) LTD "Cherie" (GE)  
Didi Lilo, Plot 726, 0198, Tbilisi Georgia (GE)
  - (54) 1.-15. PACKING
  - (28) 15
  - (24) 2018 05 07
  - (18) 2028 05 07
  - (58) 2023 04 03
- 

### CANCELLATION OF DESIGN REGISTRATION

- (11) D 2018 762 S
  - (73) Nikolai Spesivcev (RU)  
Ul. Alpiyskaya, Bld. 70, 354000, Sochi, Krasnodar Region, Russian Federation (RU)  
Irakli Tchapandze (GE)  
J. Rapava Str. 37, 2100, Zugdidi, Georgia (GE)  
Vadim Pravednikov (RU)  
Ul. Vorovskogo, Bld. 4, ap. 23, 354000, Sochi, Krasnodar Region, Russian Federation (RU)
  - (54) 1.-8. GAME TABLES
  - (18) 2022 09 12
  - (58) 2023 03 21
- 

### EXTENTION OF TERMS OF INTERNATIONAL DESIGNS REGISTRATION

- (11) DM/100177
  - (73) Harry Winston SA  
Chemin du Tourbillon 8, CH-1228 Plan-les-Ouates (CH)
  - (15) 2018 03 02
  - (24) 2018 03 02
  - (18) 2028 03 02
  - (28) 1
  - (28') 1
  - (54) ALARM CLOCK
- 

- (11) DM/100181
  - (73) Blancpain SA  
Le Rocher 12, CH-1348 Le Brassus (CH)
  - (15) 2018 03 02
  - (24) 2018 03 02
  - (18) 2028 03 02
  - (28) 1
  - (28') 1
  - (54) DIAL
-

(11) DM/100183  
(73) Omega SA (Omega AG) (Omega LTD.)  
Jakob-Stämpfli-Strasse 96, CH-2502 Biel/Bienne (CH)  
(15) 2018 03 05  
(24) 2018 03 05  
(18) 2028 03 05  
(28) 4  
(28') 4  
(54) 1.-2. DIALS, 3. WATCH CASE, 4. DIAL

---

(11) DM/100185  
(73) Montres Breguet SA (Montres Breguet AG) (Montres Breguet Ltd)  
Place de la Tour 23 1344 L'Abbaye (CH)  
(15) 2018 03 05  
(24) 2018 03 05  
(18) 2028 03 05  
(28) 1  
(28') 1  
(54) WATCH MOVEMENT PART

---

(11) DM/100219  
(73) Harry Winston SA  
Chemin du Tourbillon 8, CH-1228 Plan-les-Ouates (CH)  
(15) 2018 03 02  
(24) 2018 03 02  
(18) 2028 03 02  
(28) 1  
(28') 1  
(54) SIGNING MACHINE

---

(11) DM/100 325  
(73) Tissot SA (Tissot AG) (Tissot LTD)  
Chemin Des Tourelles 17, CH-2400, Le Locle (CH)  
(15) 2018 03 19  
(24) 2018 03 19  
(18) 2028 03 19  
(28) 1  
(28') 1  
(54) 1. WATCH DIAL

---

(11) DM/100455  
(73) Omega SA (Omega AG) (Omega LTD.)  
Jakob-Stämpfli-Strasse 96, CH-2502 Biel/Bienne (CH)  
(15) 2018 03 21  
(24) 2018 03 21  
(18) 2028 03 21  
(28) 2  
(28') 2  
(54) WATCH, WATCH MOVEMENT

---

(11) DM/102 299  
(73) Sire Spirits LLC  
264 West 40th Street, 15th Floor, 10018, New York (US)  
(15) 2018 05 16

---

(24) 2018 05 16  
(18) 2028 05 16  
(28) 1  
(28') 1  
(54) 1. BEVERAGE BOTTLE

---

(11) DM/103330  
(73) Europcar International  
13 Ter Boulevard Berthier, F-75017 Paris (FR)  
(15) 2018 05 03  
(24) 2018 05 03  
(18) 2028 05 03  
(28) 7  
(28') 7  
(54) UNIFORMS

---

(11) DM/69843  
(73) The Swatch Group Management Services AG (The Swatch Group Management Services SA)  
(The Swatch Group Management Services LTD.)  
Seevorstadt 6, CH-2502 Bienne (CH)  
(15) 2008 03 18  
(24) 2008 03 18  
(18) 2028 03 18  
(28) 5  
(28') 3  
(54) WATCH CASE WITH BRACELET, WATCH CASE WITH STRAP, WRISTWATCHES

---

(11) DM/69848  
(73) Swatch AG (Swatch Sa)(Swatch LTD)  
Jakob-Stämpfli-Strasse 94, CH-2502 Biel/Bienne (CH)  
(15) 2008 03 18  
(24) 2008 03 18  
(18) 2028 03 18  
(28) 3  
(28') 3  
(54) WRISTWATCHES

---

(11) DM/69849  
(73) Swatch AG (Swatch Sa)(Swatch LTD)  
Jakob-Stämpfli-Strasse 94, CH-2502 Biel/Bienne (CH)  
(15) 2008 03 18  
(24) 2008 03 18  
(18) 2028 03 18  
(28) 2  
(28') 1  
(54) WRISTWATCHES

---

(11) DM/69893  
(73) Société Des Produits Nestlé S.A.  
CH-1800 VEVEY (CH)  
(15) 2008 02 27  
(24) 2008 02 27  
(18) 2028 02 27  
(28) 1

---

(28') 1  
(54) CHOCOLATE

---

(11) DM/69915  
(73) Blancpain SA  
Le Rocher 12, CH-1348 LE Brassus (CH)  
(15) 2008 03 25  
(24) 2008 03 25  
(18) 2028 03 25  
(28) 3  
(28') 3  
(54) WATCH PARTS

---

(11) DM/69916  
(73) Montres Breguet SA (Montres Breguet AG) (Montres Breguet LTD)  
Place de la Tour 23 1344 L'Abbaye (CH)  
(15) 2008 03 25  
(24) 2008 03 25  
(18) 2028 03 25  
(28) 3  
(28') 3  
(54) WATCHES

---

(11) DM/69917  
(73) Omega SA (Omega AG) (Omega LTD.)  
Jakob-Stämpfli-Strasse 96, CH-2502 Biel/Bienne (CH)  
(15) 2008 03 25  
(24) 2008 03 25  
(18) 2028 03 25  
(28) 1  
(28') 1  
(54) WATCH

---

(11) DM/69924  
(73) Omega SA (Omega AG) (Omega LTD.)  
Jakob-Stämpfli-Strasse 96, CH-2502 Biel/Bienne (CH)  
(15) 2008 03 27  
(24) 2008 03 27  
(18) 2028 03 27  
(28) 4  
(28') 3  
(54) WRISTWATCHES; WATCH CASE BACK

---

(11) DM/69926  
(73) Montres Breguet S.A.  
CH-1344 L'abbaye (CH)  
(15) 2008 03 27  
(24) 2008 03 27  
(18) 2028 03 27  
(28) 1  
(28') 1  
(54) DIAL

---

(11) DM/69933  
(73) Omega SA (Omega AG) (Omega LTD.)  
    Jakob-Stämpfli-Strasse 96, CH-2502 Biel/Bienne (CH)  
(15) 2008 03 31  
(24) 2008 03 31  
(18) 2028 03 31  
(28) 1  
(28') 1  
(54) CUFF LINKS

---

(11) DM/69934  
(73) Omega SA (Omega AG) (Omega LTD.)  
    Jakob-Stämpfli-Strasse 96 (CH)  
(15) 2008 03 31  
(24) 2008 03 31  
(18) 2028 03 31  
(28) 12  
(28') 12  
(54) JEWELRY, IN PARTICULAR RINGS (1, 3, 5, 6, 8, 12), PENDANTS (2, 4, 7, 9, 10) AND EARRINGS (11)

---

(11) DM/69935  
(73) Omega SA (Omega AG) (Omega LTD.)  
    Jakob-Stämpfli-Strasse 96, CH-2502 Biel/Bienne (CH)  
(15) 2008 03 31  
(24) 2008 03 31  
(18) 2028 03 31  
(28) 2  
(28') 2  
(54) WATCH, WATCH CASING

---

(11) DM/69981  
(73) Rado Uhren AG (Rado Watch Co.LTD.) (Montres Rado SA),  
    Bielstrasse 45, CH-2543 LENGNAU (CH)  
(15) 2008 03 27  
(24) 2008 03 27  
(18) 2028 03 27  
(28) 1  
(28') 1  
(54) WRISTWATCH

---

(11) DM/70110  
(73) Allied Domecq Spirits & Wine Limited  
    72 Chancellors Road, London W6 9RS (EM)  
(15) 2008 05 09  
(24) 2008 05 09  
(18) 2028 05 09  
(28) 1  
(28') 1  
(54) BOTTLE

---

(11) DM/70451  
(73) Glashütter Uhrenbetriebe GMBH  
01768 Altenberger Strasse 1 (DE)  
(15) 2008 03 28  
(24) 2008 03 28  
(18) 2028 03 28  
(28) 8  
(28') 3  
(54) WATCH DIALS

---

(11) DM/79266  
(73) Phoenix Product Development Limited  
Unit 1 West Point, 11 Durham Road, Basildon, Essex SS15 6PH (GB)  
(15) 2012 08 28  
(24) 2012 08 28  
(18) 2027 08 28  
(28) 2  
(28') 2  
(54) WATER CLOSETS

---

(11) DM/80286  
(73) Columbus Mckinnon Industrial Products GMBH  
Am Lindenkamp 31, 42549 Velbert (DE)  
(15) 2013 02 13  
(24) 2013 02 13  
(18) 2028 02 13  
(28) 4  
(28') 4  
(54) TOOLS FOR LIFTING

---

(11) DM/80295  
(73) Omega SA (Omega AG) (Omega LTD.)  
Jakob-Stämpfli-Strasse 96, CH-2502 Biel/Bienne (CH)  
(15) 2013 03 08  
(24) 2013 03 08  
(18) 2028 03 08  
(28) 1  
(28') 1  
(54) WRISTWATCH

---

(11) DM/80347  
(73) Montres Breguet S.A.  
CH-1344 L'abbaye (CH)  
(15) 2013 03 12  
(24) 2013 03 12  
(18) 2028 03 12  
(28) 4  
(28') 4  
(54) WATCHES

---

(11) DM/80399  
(73) Blancpain SA  
Le Rocher 12, CH-1348 LE Brassus (CH)  
(15) 2013 03 14  
(24) 2013 03 14  
(18) 2028 03 14  
(28) 3  
(28') 3  
(54) WATCHES

---

(11) DM/80402  
(73) Swatch AG (Swatch SA)(Swatch LTD)  
Jakob-Stämpfli-Strasse 94, CH-2502 Bienne (CH)  
(15) 2013 03 18  
(24) 2013 03 18  
(18) 2028 03 18  
(28) 1  
(28') 1  
(54) WRISTWATCH

---

(11) DM/80435  
(73) Omega SA (Omega AG) (Omega LTD.)  
Jakob-Stämpfli-Strasse 96, CH-2502 Biel/Bienne (CH)  
(15) 2013 03 22  
(24) 2013 03 22  
(18) 2028 03 22  
(28) 5  
(28') 5  
(54) EARRINGS, FINGER RINGS, PENDANT

---

(11) DM/80436  
(73) Omega SA (Omega AG) (Omega LTD.)  
Jakob-Stämpfli-Strasse 96, Ch-2502 Biel/Bienne (Ch)  
(15) 2013 03 22  
(24) 2013 03 22  
(18) 2028 03 22  
(28) 1  
(28') 1  
(54) KEY RING

---

(11) DM/80438  
(73) Omega SA (Omega AG) (Omega LTD.)  
Jakob-Stämpfli-Strasse 96, Ch-2502 Biel/Bienne (Ch)  
(15) 2013 03 22  
(24) 2013 03 22  
(18) 2028 03 22  
(28) 2  
(28') 2  
(54) WRISTWATCHES

---



(11) DM/80462  
(73) Glashütter Uhrenbetrieb GMBH  
Altenberger Str. 1, 01768 Glashütte (De)  
(15) 2013 03 22  
(24) 2013 03 22  
(18) 2028 03 22  
(28) 7  
(28') 7  
(54) DIALS

---

(11) DM/80486  
(73) ETA SA Manufacture Horlogère Suisse  
Ch-2540 Grenchen (Ch)  
(15) 2013 03 25  
(24) 2013 03 25  
(18) 2028 03 25  
(28) 5  
(28') 5  
(54) WATCH CASES

---

(11) DM/80509  
(73) Montres Breguet SA (Montres Breguet AG) (Montres Breguet LTD)  
Place De La Tour 23 1344 L'Abbaye (CH)  
(15) 2013 03 27  
(24) 2013 03 27  
(18) 2028 03 27  
(28) 1  
(28') 1  
(54) WATCH

---

(11) DM/80997  
(73) Hermann Staib GMBH  
Grimmigweg 27, 75179 Pforzheim (De)  
(15) 2013 05 03  
(24) 2013 05 03  
(18) 2028 05 03  
(28) 1  
  
(28') 1  
(54) WATCH BRACELET

---

(11) DM/82488  
(73) Franz Antonio Wakefield Cooltvnetwork.Com Inc.  
17731 North West 14th Court, Miami, FL 33169 (EM)  
(15) 2013 05 27  
(24) 2013 05 27  
(18) 2028 05 27  
(28) 2  
(28') 2  
(54) MOBILE SMARTPHONES

---

## CANCELLATION OF INTERNATIONAL DESIGNS REGISTRATION

(11) DM/96863  
(73) Valentino S.P.A.  
Via Turati, 16/18, I-20121 Milano (IT)  
DATE OF REGISTRATION CANCELLATION: 2022 07 11  
(58) 2023 03 20

---

(11) DM/96948  
(73) Valentino S.P.A.  
Via Turati, 16/18, I-20121 Milano (IT)  
DATE OF REGISTRATION CANCELLATION: 2022 07 11  
(58) 2023 03 20

---

(11) DM/97515  
(73) Edge Of Belgravia Limited  
Department 140, 128 Aldersgate street, London EC1A 4LA (EM)  
DATE OF REGISTRATION CANCELLATION: 2022 08 16  
(58) 2023 03 20

---

(11) DM/97608  
(73) Valentino S.P.A.  
Via Turati, 16/18, I-20121 Milano (EM)  
DATE OF REGISTRATION CANCELLATION: 2022 09 01  
(58) 2023 03 20

---

(11) DM/98390  
(73) Peugeot Citroën Automobiles SA  
Route de Gisy, F-78140 Velizy-Villacoublay (FR)  
DATE OF REGISTRATION CANCELLATION: 2022 02 27  
(58) 2023 03 20

---

## TRADEMARKS

### EXTENSION OF TERMS OF TRADEMARKS REGISTRATION

(111) M 2003 15297 R2

(151) 2003 10 15

(186) 2033 10 15

(732) PT Sumatra Tobacco Trading Company  
Jln. Pattimura No3, Pematang Siantar,  
Sumatera Utara, Indonesia

(111) M 2012 22617 R1

(151) 2012 05 16

(186) 2032 05 16

(732) LLC "EM Consulting and Software, EMCoS"  
Pekini Ave. 27, 0160, Tbilisi, Georgia

(111) M 2003 14982 R2

(151) 2003 02 12

(186) 2033 02 12

(732) Teva Pharma EAD  
ul. Lyuba Velichkova 9, 1407 Sofia, Bulgaria

(111) M 2012 22618 R1

(151) 2012 05 16

(186) 2032 05 16

(732) LLC "EM Consulting and Software, EMCoS"  
Pekini Ave. 27, 0160, Tbilisi, Georgia

(111) M 2003 15045 R2

(151) 2003 03 28

(732) Besins healthcare Luxemburg  
S.A.R.L.  
2-8 rue Julien Vesque, L-2668 Luxembourg, L,  
Luxembourg

(111) M 2012 22619 R1

(151) 2012 05 16

(186) 2032 05 16

(732) LLC "EM Consulting and Software, EMCoS"  
Pekini Ave. 27, 0160, Tbilisi, Georgia

(111) M 2003 15134 R2

(151) 2003 05 19

(186) 2033 05 19

(732) Diageo Brands B.V.  
Molenwerf 12, 1014 BG Amsterdam,  
Netherlands

(111) M 2012 22620 R1

(151) 2012 05 16

(186) 2032 05 16

(732) LLC "EM Consulting and Software, EMCoS"  
Pekini Ave. 27, 0160, Tbilisi, Georgia

(111) M 2003 15167 R2

(151) 2003 06 11

(186) 2033 06 11

(732) Takeda Pharmaceutical Company  
Limited  
1-1, Doshomachi 4-chome, Chuo-ku, Osaka,  
Japan

(111) M 2012 22560 R1

(151) 2012 04 30

(186) 2032 04 30

(732) LLC "EM Consulting and Software, EMCoS"  
Pekini Ave. 27, 0160, Tbilisi, Georgia

(111) M 2012 23028 R1

(151) 2012 11 02

(186) 2032 11 02

(732) LLC "EM Consulting and Software, EMCoS"  
Pekini Ave. 27, 0160, Tbilisi, Georgia

(111) M 2013 23267 R1

(151) 2013 01 25

(186) 2033 01 25

(732) Abc Farmaceutici S.P.A.  
Corso vittorio Emanuele II 72, 10121, Torino,  
Italy

(111) M 2012 22616 R1

(151) 2012 05 16

(186) 2032 05 16

(732) LLC "EM Consulting and Software, EMCoS"  
Pekini Ave. 27, 0160, Tbilisi, Georgia

(111) M 2012 22947 R1

(151) 2012 09 24

(186) 2032 09 24

(732) Aleksandr Slobodian  
ul. Radunskaia, d. 26, kv. 55, 02097 Kyiv,  
Ukraine

(111) M 2013 23783 R1  
(151) 2013 06 25  
(186) 2033 06 25  
(732) Takeda Pharmaceutical Company Limited  
1-1, Doshomachi 4-chome, Chuo-ku, Osaka,  
Japan

---

(111) M 2013 23784 R1  
(151) 2013 06 25  
(186) 2033 06 25  
(732) Takeda Pharmaceutical Company Limited  
1-1, Doshomachi 4-chome, Chuo-ku, Osaka,  
Japan

---

(111) M 2013 23294 R1  
(151) 2013 01 25  
(186) 2033 01 25  
(732) Payless ShoeSource Worldwide Inc.  
Jayhawk Towers, 700 Southwest Jackson  
Street, Suite 202, Topeka, Kansas 66603, USA

---

(111) M 2013 23563 R1  
(151) 2013 04 12  
(186) 2033 04 12  
(732) The Gillette Company LLC  
One Gillette Park, Boston, Massachusetts  
02127, USA

---

(111) M 2013 23674 R1  
(151) 2013 05 17  
(186) 2033 05 17  
(732) Bayer Consumer Care AG, a Swiss company  
Peter Merian-Str. 84, CH-4052 Basel,  
Switzerland

---

(111) M 2013 23397 R1  
(151) 2013 02 27  
(186) 2033 02 27  
(732) Hallmark Cards, Incorporated  
2501 McGee Trafficway, Kansas-Sity,  
Missouri 64108, USA

---

(111) M 2013 23398 R1  
(151) 2013 02 27  
(186) 2033 02 27  
(732) Hallmark Cards, Incorporated  
2501 McGee Trafficway, Kansas-Sity,  
Missouri 64108, USA

---

(111) M 2013 23453 R1  
(151) 2013 03 13  
(186) 2033 03 13  
(732) Obshchestvo s ogranichennoy  
otvetstvennost'yu "KDV Tula"  
Shosse Novomoskovskoe, dom 54,  
pomeshchenie 3, ofis 318, etazh 3, g. Tula,  
Tul'skaya oblast, 300045, Russian Federation

---

(111) M 2013 23726 R1  
(151) 2013 06 07  
(186) 2033 06 07  
(732) LTD "Novator Pharma"  
Vill. Irganchai, 1707, Dmanisi region,  
Georgia

---

(111) M 2013 23727 R1  
(151) 2013 06 07  
(186) 2033 06 07  
(732) LTD "Novator Pharma"  
Vill. Irganchai, 1707, Dmanisi region,  
Georgia

---

(111) M 2013 23728 R1  
(151) 2013 06 07  
(186) 2033 06 07  
(732) LTD "Novator Pharma"  
Vill. Irganchai, 1707, Dmanisi region,  
Georgia

---

(111) M 2013 23729 R1  
(151) 2013 06 07  
(186) 2033 06 07  
(732) LTD "Novator Pharma"  
Vill. Irganchai, 1707, Dmanisi region,  
Georgia

---

(111) M 2013 23730 R1  
(151) 2013 06 07  
(186) 2033 06 07  
(732) LTD "Novator Pharma"  
Vill. Irganchai, 1707, Dmanisi region,  
Georgia

---

(111) M 2013 23731 R1  
(151) 2013 06 07  
(186) 2033 06 07  
(732) LTD "Novator Pharma"  
Vill. Irganchai, 1707, Dmanisi region,  
Georgia

---

(111) M 2013 23402 R1  
(151) 2013 02 27  
(186) 2033 02 27  
(732) Hallmark Cards, Incorporated  
2501 McGee Trafficway, Kansas-Sity,  
Missouri 64108, USA

---

(111) M 2013 23403 R1  
(151) 2013 02 27  
(186) 2033 02 27  
(732) Igor Barkovskiy  
Kyivo-Sviatoshinski District, Vill. Kriukovsh-  
china, Lvyv Str.6, Kyiv Region, Ukraine

---

(111) M 2013 23787 R1  
(151) 2013 06 25  
(186) 2033 06 25  
(732) Akcionernoe Obchestvo "Nizegorodsky  
Khimiko-Pharmaceuticheskiy Zavod"  
Salganskaya Str. 7, Nizhniy Novgorod,  
RU-603950, Russian Federation

---

(111) M 2013 23518 R1  
(151) 2013 03 27  
(186) 2033 03 27  
(732) Nufarm  
11 rue du Débarcadère, F-92700 Colomb,  
France

---

(111) M 2013 23745 R1  
(151) 2013 06 07  
(186) 2033 06 07  
(732) LTD "Novator Pharma"  
Vill. Irganchai, 1707, Dmanisi region,  
Georgia

---

(111) M 2013 23746 R1  
(151) 2013 06 07  
(186) 2033 06 07  
(732) LTD "Novator Pharma"  
Vill. Irganchai, 1707, Dmanisi region,  
Georgia

---

(111) M 2013 23747 R1  
(151) 2013 06 07  
(186) 2033 06 07  
(732) LTD "Novator Pharma"  
Vill. Irganchai, 1707, Dmanisi region,  
Georgia

---

(111) M 2013 23748 R1  
(151) 2013 06 07  
(186) 2033 06 07  
(732) LTD "Novator Pharma"  
Vill. Irganchai, 1707, Dmanisi region,  
Georgia

---

(111) M 2013 23749 R1  
(151) 2013 06 07  
(186) 2033 06 07  
(732) LTD "Novator Pharma"  
Vill. Irganchai, 1707, Dmanisi region,  
Georgia

---

(111) M 2013 23750 R1  
(151) 2013 06 07  
(186) 2033 06 07  
(732) LTD "Novator Pharma"  
Vill. Irganchai, 1707, Dmanisi region,  
Georgia

---

(111) M 2013 23539 R1  
(151) 2013 03 27  
(186) 2033 03 27  
(732) AbbVie Inc.  
a Corporation of the State of Delaware  
1 N. Waukegan Road, North Chicago, Illinois  
60064, USA

---

(111) M 2013 23756 R1  
(151) 2013 06 07  
(186) 2033 06 07  
(732) Banana Republic (ITM) Inc.  
2 Folsom Street, San Francisco, California  
94105, USA

---

(111) M 2013 23757 R1  
(151) 2013 06 07  
(186) 2033 06 07  
(732) Gap (ITM) Inc.  
2 Folsom Street, San Francisco, CA 94105,  
USA

---

(111) M 2013 23885 R1  
(151) 2013 08 14  
(186) 2033 08 14  
(732) XL Energy Marketing Sp. z o. o  
Ul. Zlota 59, 00-120 Warsaw, Poland

---

(111) M 2013 23886 R1 (151) 2013 08 14 (186) 2033 08 14 (732) LLC "Tegeta Motors" Davit Aghmashenebeli Alley 129, 0131, Tbilisi Georgia	Vill. Irganchai, 1707, Dmanisi region, Georgia
(111) M 2013 23973 R1 (151) 2013 09 02 (186) 2033 09 02 (732) Evergreen Marine Corporation (Taiwan) Ltd. 1-4F, N166, Sec. 2, Minsheng E. Rd., Taipei 104, Taiwan, Province of China	(111) M 2013 24228 R1 (151) 2013 11 04 (186) 2033 11 04 (732) LTD "Novator Pharma" Vill. Irganchai, 1707, Dmanisi region, Georgia
(111) M 2013 24173 R1 (151) 2013 10 17 (186) 2033 10 17 (732) Brimag Digital Age Ltd. 19 Hashikma Street Azur 58001, Israel	(111) M 2013 24229 R1 (151) 2013 11 04 (186) 2033 11 04 (732) LTD "Novator Pharma" Vill. Irganchai, 1707, Dmanisi region, Georgia
(111) M 2013 24174 R1 (151) 2013 10 17 (186) 2033 10 17 (732) Brimag Digital Age Ltd. 19 Hashikma Street Azur 58001, Israel	(111) M 2013 24290 R1 (151) 2013 11 18 (186) 2033 11 18 (732) Merck KgaA Frankfurter Straße 250, 64293 Darmstadt, Germany
(111) M 2013 24224 R1 (151) 2013 11 04 (186) 2033 11 04 (732) LTD "Novator Pharma" Vill. Irganchai, 1707, Dmanisi region, Georgia	(111) M 2013 23256 R1 (151) 2013 01 15 (186) 2033 01 15 (732) LLC "Direct Debit Georgia" Beliashvili Str. 106, floor 1, area 11, 0159, Tbilisi, Georgia
(111) M 2013 24225 R1 (151) 2013 11 04 (186) 2033 11 04 (732) LTD "Novator Pharma" Vill. Irganchai, 1707, Dmanisi region, Georgia	(111) M 2013 23257 R1 (151) 2013 01 15 (186) 2033 01 15 (732) LLC "Direct Debit Georgia" Beliashvili Str. 106, floor 1, area 11, 0159, Tbilisi, Georgia
(111) M 2013 24226 R1 (151) 2013 11 04 (186) 2033 11 04 (732) LTD "Novator Pharma" Vill. Irganchai, 1707, Dmanisi region, Georgia	
(111) M 2013 24227 R1 (151) 2013 11 04 (186) 2033 11 04 (732) LTD "Novator Pharma"	

## COMPLETE TRANSFER OF RIGHTS

- 
- (111) M 2021 34585 R  
 (732) Potrebitelskoe Obschestvo "Torgovo-Zakupochniy Souz Arkhangelskoy Oblasti"  
 Ul. Gagarina, dom 46, office 13, Arkhangelsk,  
 Russian Federation  
 (770) Rost-Brand Ltd  
 Leningradskiy prospect, dom 37, bld. 9, office  
 808, 125167, Moscow, Russian Federation  
 (580) 2023 02 10
- 
- (111) M 2022 35473 R  
 (732) Pioneer Foods Groceries Proprietary Limited  
 Glacier Place, 1 Sportica Crescent,  
 Tygervalley 7530, South Africa  
 (770) Ceres Fruit Juices (PTY) LTD  
 Glacier Place, 1 Sportica Crescent,  
 Tygervalley, Bellville 7530, South Africa  
 (580) 2023 03 15
- 
- (111) M 2022 35732 R  
 (732) Eaton Corporation  
 1000 Eaton Boulevard, Cleveland, OH 44122,  
 USA  
 (770) Trippe Manufacturing Company  
 1111 West 35th Street, Chicago Illinois 60609,  
 USA  
 (580) 2023 02 24
- 
- (111) M 2022 36142 R  
 (732) Tovarischestvo s Ogranichenoy Otvetstven-  
 nostyu "Art and Part"  
 Ul. Fizuli 48/9, Turksibskiy Raion, 050040  
 Almaty, Kazakhstan  
 (770) Dmytro Yakovtsev  
 12 Volkova Street, Aparment 53,  
 Kropivnitskiy, Ukraine  
 (580) 2023 02 22
- 
- (111) M 2023 36453 R  
 (732) Irakli Shioshvili  
 Al. Chavchavadze Lane II, House 4, 0181,  
 Tskneti, Tbilisi, Georgia  
 (770) LLC "Kakhuri"  
 Tbilisi Highway 1, Telavi, Georgia  
 (580) 2023 03 17
- 
- (111) M 2023 36452 R  
 (732) Irakli Shioshvili  
 Al. Chavchavadze Lane II, House 4, 0181,  
 Tskneti, Tbilisi, Georgia
- 
- (770) LLC "Kakhuri"  
 Tbilisi Highway 1, Telavi, Georgia  
 (580) 2023 03 17
- 
- (111) M 1998 8602 R  
 (732) Daimler Truck AG  
 Fasanenweg 10, 70771 Leinfelden –  
 Echterdingen, Germany  
 (770) Daimler AG  
 Mercedesstrasse 137, 70327 Stuttgart,  
 Germany  
 (580) 2023 03 23
- 
- (111) M 1998 9422 R  
 (732) Daimler Truck AG  
 Fasanenweg 10, 70771 Leinfelden-Echter-  
 dingen, Germany  
 (770) Daimler AG  
 Mercedesstrasse 137, 70327 Stuttgart,  
 Germany  
 (580) 2023 03 23
- 
- (111) M 1996 2046 R  
 (732) Daimler Truck AG  
 Fasanenweg 10, 70771 Leinfelden-Echter-  
 dingen, Germany  
 (770) Daimler AG  
 Mercedesstrasse 137, 70327 Stuttgart,  
 Germany  
 (580) 2023 03 23
- 
- (111) M 2003 14979 R  
 (732) Teva Pharma EAD  
 ul. Lyuba Velichkova 9, 1407 Sofia, Bulgaria  
 (770) Balkanfarma Dupnitsa ad  
 Samokovsko shosse; 3, Dupnitsa 2600,  
 Bulgaria;  
 Teva Pharma EAD  
 ul. Lyuba Velichkova 9, 1407 Sofia, Bulgaria  
 (580) 2023 02 17
- 
- (111) M 2003 14980 R  
 (732) Teva Pharma EAD  
 ul. Lyuba Velichkova 9, 1407 Sofia, Bulgaria  
 (770) Balkanfarma Dupnitsa ad  
 Samokovsko shosse; 3, Dupnitsa 2600,  
 Bulgaria;  
 Teva Pharma EAD  
 ul. Lyuba Velichkova 9, 1407 Sofia, Bulgaria  
 (580) 2023 02 17
-

(111) M 2003 14981 R  
(732) Teva Pharma EAD  
ul. Lyuba Velichkova 9, 1407 Sofia, Bulgaria  
(770) Teva Pharma EAD  
ul. Lyuba Velichkova 9, 1407 Sofia, Bulgaria;  
alkanfarma Dupnitsa ad  
Samokovsko shosse; 3, Dupnitsa 2600,  
Bulgaria  
(580) 2023 02 17

---

(111) M 2008 18341 R  
(732) Cilag Gmbh International  
Gubelstrasse 34, CH-6300, Zug, Switzerland  
(770) Astex Pharmaceuticals, Inc.  
4420 Rosewood Drive, Suite 200 Plessanton,  
California 94588, USA  
(580) 2023 01 09

---

(111) M 2009 19785 R  
(732) Cilag Gmbh International  
Gubelstrasse 34, 6300, Zug, Switzerland  
(770) Astex Pharmaceuticals, Inc.  
4420 Rosewood Drive, Suite 200 Plessanton,  
California 94588, USA  
(580) 2023 01 09

---

(111) M 1996 2938 R  
(732) R. Twining and Company Limited  
Weston Centre, 10 Grosvenor Street London  
W1K 4QY, United Kingdom  
(770) Associated British Foods Plc  
Weston Centre, 10 Grosvenor Street, London  
W1K 4QY, United Kingdom  
(580) 2023 03 17

---

(111) M 2012 23009 R  
(732) Daimler Truck AG  
Fasanenweg 10, 70771 Leinfelden –  
Echterdingen, Germany  
(770) Daimler AG  
Mercedesstrasse 137, 70327 Stuttgart,  
Germany  
(580) 2023 03 23

---

(111) M 2012 23010 R  
(732) Daimler Truck AG  
Fasanenweg 10, 70771 Leinfelden-Echter-  
dingen, Germany  
(770) Daimler AG  
Mercedesstrasse 137, 70327 Stuttgart,  
Germany  
(580) 2023 03 23

---

(111) M 2017 28064 R  
(732) ZeniMax Media Inc.  
1370 Piccard Drive, Rockville, Maryland,  
20850, USA  
(770) Id Software LLC  
1500 North Greenville Avenue, Floor 7,  
Richardson, Texas 75081, USA  
(580) 2023 03 27

---

(111) M 2019 31833 R  
(732) Potrebitelskoe Obschestvo "Torgovo-  
Zakupochny Soyuz Arkhangel'skoy Oblasti"  
ul. Gagarina, dom 46, office 13, Arkhangel'sk,  
Russian Federation  
(770) Rost-Brand LTD  
Leningradskiy Prospect, dom 37, bld. 9,  
office 808, Moscow 125167, Russian  
Federation  
(580) 2023 02 10

---



## CHANGES OF NAMES AND/OR ADDRESSES OF TRADEMARKS OWNERS

(111) M 2019 30773 R  
(732) Diageo Ireland Unlimited Company  
Str. James's Gate, Dublin 8, Ireland  
(770) Diageo Ireland  
Str. James's Gate, Dublin 8, Ireland  
(580) 2023 03 14

---

(111) M 2019 31039 R  
(732) Diageo Ireland Unlimited Company  
Str. James's Gate, Dublin 8, Ireland  
(770) Diageo Ireland  
Str. James's Gate, Dublin 8, Ireland  
(580) 2023 03 10

---

(111) M 2019 31040 R  
(732) Diageo Ireland Unlimited Company  
Str. James's Gate, Dublin 8, Ireland  
(770) Diageo Ireland  
Str. James's Gate, Dublin 8, Ireland  
(580) 2023 03 10

---

(111) M 1996 3943 R  
(732) Eutelsat S.A.  
32 Boulevard Gallieni, 92130 Issy les  
Moulineaux, France  
(770) Eutelsat S.A.  
70, rue Blard, 75015 Paris, France  
(580) 2023 02 24

---

(111) M 2020 33117 R  
(732) LLC "Sauer Krim Master"  
Zahesi Settlement, Mikheil  
Tsinamdzghvrishvili Str. 19, Gldani District,  
Tbilisi, Georgia  
(770) LLC "Albatros"  
near Zahesi Mikheil Tsinamadzghvrishvili  
St. 19, Gldani district, Tbilisi,  
Georgia  
(580) 2023 03 20

---

(111) M 2020 33118 R  
Zahesi Settlement, Mikheil  
Tsinamdzghvrishvili Str. 19, Gldani District,  
Tbilisi, Georgia  
(770) LLC "Albatros"  
near Zahesi Mikheil Tsinamadrishvi  
Lee St. 19, Gldani district, Tbilisi,  
Georgia  
(580) 2023 03 20

---

(111) M 2020 32719 R  
(732) LTD "Jolio"  
Dimitri Gulia Str. 4, Tbilisi, Georgia  
(770) LTD "Jolio"  
Ilia Chavchavadze Ave. 83, ap. 49, Tbilisi,  
Georgia  
(580) 2023 03 21

---

(111) M 1997 4459 R  
(732) Diageo Ireland Unlimited Company  
Str. James's Gate, Dublin 8, Ireland  
(770) Diageo Ireland  
Str. James's Gate, Dublin 8, Ireland  
(580) 2023 03 10

---

(111) M 1997 5993 R  
(732) R & A Bailey & Co Unlimited Company  
Nangor House, Western Estate, Dublin 12,  
Ireland  
(770) R & A Bailey & CO  
Nangor House, Western Estate, Dublin 12,  
Ireland  
(580) 2023 03 10

---

(111) M 2003 15297 R  
(732) PT Sumatra Tobacco Trading Company  
Jln. Pattimura No3, Pematang Siantar,  
Sumatera Utara, Indonesia  
(770) N.V. Sumatra Tobacco Trading Company  
Jln. Pattimura No3, Pematang Siantar,  
Sumatera Utara, Indonesia  
(580) 2023 03 10

---

(111) M 1997 7039 R  
(732) Diageo Ireland Unlimited Company  
Str. James's Gate, Dublin 8, Ireland  
(770) Diageo Ireland  
Str. James's Gate, Dublin 8, Ireland  
(580) 2023 03 10

---

(111) M 2003 14979 R  
(732) Balkanfarma Dupnitsa ad  
Samokovsko shosse; 3, Dupnitsa 2600,  
Bulgaria;  
Teva Pharma Ead  
ul. Lyuba Velichkova 9, 1407 Sofia, Bulgaria  
(770) Balkanfarma Dupnitsa ad  
Samokovsko shosse; 3, Dupnitsa 2600,  
Bulgaria;

---

"Actavis" Ead  
ul. Athanas Dukov 29, Sofia, Raion Lozenets,  
Bulgaria  
(580) 2023 02 17

---

(111) M 2003 14980 R  
(732) Balkanfarma Dupnitsa ad  
Samokovsko shosse; 3, Dupnitsa 2600,  
Bulgaria;  
Teva Pharma Ead  
ul. Lyuba Velichkova 9, 1407 Sofia, Bulgaria  
(770) Balkanfarma Dupnitsa ad  
Samokovsko shosse; 3, Dupnitsa 2600,  
Bulgaria;  
"Actavis" Ead  
ul. Athanas Dukov 29, Sofia, Raion Lozenets,  
Bulgaria  
(580) 2023 02 17

---

(111) M 2003 14981 R  
(732) Teva Pharma Ead  
ul. Lyuba Velichkova 9, 1407 Sofia, Bulgaria;  
Balkanfarma Dupnitsa ad  
Samokovsko shosse; 3, Dupnitsa 2600,  
Bulgaria  
(770) "Actavis" Ead  
ul. Athanas Dukov 29, Sofia, Raion Lozenets,  
Bulgaria;  
Balkanfarma Dupnitsa ad  
Samokovsko shosse; 3, Dupnitsa 2600,  
Bulgaria  
(580) 2023 02 17

---

(111) M 2003 14982 R  
(732) Teva Pharma Ead  
ul. Lyuba Velichkova 9, 1407 Sofia, Bulgaria  
(770) "Aqtavis" Ead  
ul. Athanas Dukov 29, Sofia, Raion Lozenets,  
Bulgaria  
(580) 2023 02 17

---

(111) M 2003 15010 R  
(732) Egis Gyógyszergyár Zrt  
Keresztúri út. 30-38, Budapest H-1106,  
Hungary  
(770) Egis Gyógyszergyár Nyilvánosan Működő  
Részvénytársaság  
Keresztúri út. 30-38, Budapest H-1106,  
Hungary  
(580) 2023 03 06

---

(111) M 2003 15045 R  
(732) Besins Healthcare Luxemburg S.A.R.L.  
2-8 rue Julien Vesque, L-2668 Luxembourg,  
(770) Besins Healthcare Luxemburg S.A.R.L.  
67 boulevard Grande-Duchesse Charlotte  
L-1331 luxembourg, Luxembourg  
(580) 2023 02 03

---

(111) M 2003 15062 R  
(732) Osram Gmbh  
Marcel-Breuer-Straße 6, 80809 Munchen,  
Germany  
(770) Osram Gesellschaft Mit  
Beschränkter Haftung  
Marcel-Breuer-Straße 6, 80809 Munchen,  
Germany  
(580) 2023 03 27

---

(111) M 2003 15134 R  
(732) Diageo Brands B.V.  
Molenwerf 12, 1014 BG Amsterdam,  
Netherlands  
(770) Diageo Brands B.V.  
Molenwerf 10-12, 1014 BG Amsterdam,  
Netherlands  
(580) 2023 03 09

---

(111) M 2006 17128 R  
(732) Diageo Ireland Unlimited Company  
Str. James's Gate, Dublin 8, Ireland  
(770) Diageo Ireland  
Str. James's Gate, Dublin 8, Ireland  
(580) 2023 03 10

---

(111) M 2009 19250 R  
(732) Diageo Ireland Unlimited Company  
Str. James's Gate, Dublin 8, Ireland  
(770) Diageo Ireland  
Str. James's Gate, Dublin 8, Ireland  
(580) 2023 03 10

---

(111) M 2010 20617 R  
(732) R & A Bailey & Co Unlimited Company  
Nangor House, Western Estate, Nengor Road,  
Dublin 12, Ireland  
(770) R & A Bailey & Co.  
Nangor House, Western Estate, Nengor Road,  
Dublin 12, Ireland  
(580) 2023 03 10

---

(111) M 2012 22560 R  
(732) LLC "EM Consulting and Software, EMCoS"  
Pekini (Beijing) Ave. 27, 0160, Tbilisi,  
Georgia  
(770) LLC "EM Consulting" Software, EMCoS"  
Besiki Square 3, 0108, Tbilisi, Georgia  
(580) 2023 02 24

---

(111) M 2013 23518 R  
(732) Nufarm  
11 rue du Débarcadère, F-92700 Colomb,  
France  
(770) Nufarm  
28 boulevard Camélinat, 92230 Gennevilliers,  
France  
(580) 2023 02 13

---

(111) M 2013 23885 R  
(732) XL Energy Marketing Sp. z o. o  
ul. Zlota 59, 00-120 Warsaw, Poland  
(770) XL Energy Marketing Sp. z o. o  
ul. Niegolewskiego 17, 01-570 Warsaw,  
Poland  
(580) 2023 03 13

---

(111) M 2013 23987 R  
(732) R & A Bailey & Co Unlimited Company  
Nangor House, Western Estate, Nengor Road,  
Dublin 12, Ireland  
(770) R & A Bailey & Co.  
Nangor House, Western Estate, Nengor Road,  
Dublin 12, Ireland  
(580) 2023 03 10

---

(111) M 2013 23256 R  
(732) LLC "Direct Debit Georgia"  
Beliashvili Str. 106, floor 1, area 11, 0159,  
Tbilisi, Georgia  
(770) LLC "Direct Debit Georgia"  
Luxemburg Str. 25/36, 0160, Tbilisi, Georgia  
(580) 2023 02 24

---

(111) M 2013 23257 R  
(732) LLC "Direct Debit Georgia"  
Beliashvili Str. 106, floor 1, area 11, 0159,  
Tbilisi, Georgia  
(770) LLC "Direct Debit Georgia"  
Luxemburg Str. 25/36, 0160, Tbilisi, Georgia  
(580) 2023 02 24

---

(111) M 2014 25385 R  
(732) R & A Bailey & Co Unlimited Company  
Nangor House, Western Estate, Nengor Road,  
Dublin 12, Ireland  
(770) R & A Bailey & Co.  
Nangor House, Western Estate, Nengor Road,  
Dublin 12, Ireland  
(580) 2023 03 10

---

(111) M 2019 31464 R  
(732) R & A Bailey & Co Unlimited Company  
Nangor House Western Estate 12, Dublin,  
Ireland  
(770) R & A Bailey & Co.  
Nangor House Western Estate 12, Dublin,  
Ireland  
(580) 2023 03 10

---

## CANCELLATION OF TRADEMARKS REGISTRATION

(111) M 2002 14613 R

(151) 2002 09 13

(732) BP P.L.C.

1 St James's Square, London SW1Y 4PD,

United Kingdom

(141) 2023 03 22

---

(111) M 2002 14614 R

(151) 2002 09 13

(732) Intersun Holding FZCO

P.O. Box: 61051, Jebel Ali Free Zone, Dubai,

United Arab Emirates

(141) 2023 03 22

---

(111) M 2002 14620 R

(151) 2002 09 13

(732) Mars Incorporated

a Delaware Corporation

6885 Elm Street, McLean, Virginia

22101-3883, USA

(141) 2023 03 22

---

(111) M 2002 14622 R

(151) 2002 09 13

(732) British American Tobacco (BrandS) Limited

Globe House, 4 Temple Place, London,

WC2R 2PG, United Kingdom

(141) 2023 03 22

---

(111) M 2002 14682 R

(151) 2002 09 16

(732) Harrington Development Inc.

Elivira Mendez Street, Valerino Bldg,

3rd Floor, Panama, Republic of Panama

(141) 2023 03 24

---

(111) M 2002 14683 R

(151) 2002 09 16

(732) Harrington Development Inc.

Elivira Mendez Street, Valerino Bldg,

3rd Floor, Panama, Republic of Panama

(141) 2023 03 24

---

(111) M 2002 14602 R

(151) 2002 09 13

(732) Zoetis LLC

100 Campus Drive, Florham Park, NJ 07932,

USA

(141) 2023 04 03

---

(111) M 2002 14627 R

(151) 2002 09 13

(732) Mars Incorporated

a Delaware Corporation

6885 Elm Street, McLean, Virginia

22101-3883, USA

(141) 2023 03 22

---

(111) M 2002 14608 R

(151) 2002 09 13

(732) JSC "Nobel Ilac Sanayii Ve Ticaret

Anonim Sirketi" Representative in Georgia

Freedom Square 4, 0105, Tbilisi, Georgia

(141) 2023 03 22

---

(111) M 2002 14611 R

(151) 2002 09 13

(732) "Sopharma" AD

16 Iliensko Shaussee Str. 1220 Sofia, Bulgaria

(141) 2023 03 22

---

(111) M 2002 14618 R

(151) 2002 09 13

(732) "Sopharma" AD

16 Iliensko Shause Str., 1220 Sofia,

Bulgaria

(141) 2023 03 22

---

(111) M 2002 14638 R

(151) 2002 09 13

(732) C.P. Pharmaceuticals International C.V.

c/o General Partners, Pfizer Manufacturing

LLC and Pfizer Production LLC, 235 East

42nd Street, New York, NY 10017, USA

(141) 2023 03 22

---

(111) M 2002 14667 R

(151) 2002 09 13

(732) Gallaher Limited

Members Hill, Brooklands Road, Weybridge,

Surrey KT13 0QU, United Kingdom

(141) 2023 03 22

---

(111) M 2002 14668 R

(151) 2002 09 13

(732) Gallaher Limited

Members Hill, Brooklands Road, Weybridge,

Surrey KT13 0QU, United Kingdom

(141) 2023 03 22

---

(111) M 2002 14669 R  
(151) 2002 09 13  
(732) Gallaher Limited  
Members Hill, Brooklands Road, Weybridge,  
Surrey KT13 0QU, United Kingdom  
(141) 2023 03 22

---

(111) M 2002 14676 R  
(151) 2002 09 13  
(732) Unilever N.V.  
Weena 455, NL-3013 AL Rotterdam,  
Netherlands  
(141) 2023 03 22

---

(111) M 2002 14678 R  
(151) 2002 09 13  
(732) Ssangyong Motor Company  
150-3 Chilkoi-dong, Pyungtaek-si, Kyunggi-  
do, 459-050, Republic of Korea  
(141) 2023 03 22

---

(111) M 2012 22934 R  
(151) 2012 09 24  
(732) JSC Bank "Republica"  
Grigol Abashidze Str. 2, 0179, Tbilisi,  
Georgia  
(141) 2023 04 03

---

(111) M 2012 22935 R  
(151) 2012 09 24  
(732) Avantha Holdings Limited  
First India Plase, Tower-C, Mehrauli-Gurgaon  
Road, Gurgaon, Haryana-122002, India  
(141) 2023 04 03

---

(111) M 2012 22936 R  
(151) 2012 09 24  
(732) General Motors LLC  
300 Renaissance Center, City of Detroit,  
State of Michigan 48265-3000, USA  
(141) 2023 04 03

---

(111) M 2012 22937 R  
(151) 2012 09 24  
(732) JSC "Nobel ilac Sanayii ve Ticaret  
Anonim Sirketi" Representative in Georgia  
Freedom Square 4, 0105, Tbilisi, Georgia  
(141) 2023 04 03

---

(111) M 2012 22938 R  
(151) 2012 09 24  
(732) JSC "Nobel Ilac Sanay Ve Ticaret  
Anonim Sirketi" Representative in Georgia  
Freedom Square 4, 0105, Tbilisi, Georgia  
(141) 2023 04 03

---

(111) M 2012 22939 R  
(151) 2012 09 24  
(732) LTD "Alta"  
Saburtalo Str. 35, 0194, Tbilisi, Georgia  
(141) 2023 04 03

---

(111) M 2012 22940 R  
(151) 2012 09 24  
(732) LTD "Shumeri"  
Left bank the River Mtkvari, Agladze Str. 34,  
0119, Tbilisi, Georgia  
(141) 2023 04 03

---

(111) M 2012 22942 R  
(151) 2012 09 24  
(732) LTD "Berta"  
Tserovani, 3318, Mtskheta, Georgia  
(141) 2023 04 03

---

(111) M 2012 22943 R  
(151) 2012 09 24  
(151) 2012 09 24  
(732) LTD "AgroDevelopment"  
Samgori Str., Lane 4, 0120, Isani District,  
Tbilisi, Georgia  
(141) 2023 04 03

---

(111) M 2012 22944 R  
(151) 2012 09 24  
(732) LTD "AgroDevelopment"  
Samgori Str., Lane 4, 0120, Isani District,  
Tbilisi, Georgia  
(141) 2023 04 03

---

(111) M 2012 22945 R  
(151) 2012 09 24  
(732) LTD "Via Travel"  
Abashidze Str. 24, 0179, Tbilisi, Georgia  
(141) 2023 04 03

---

(111) M 2012 22948 R  
(151) 2012 09 24  
(732) LTD "Iberieli"  
Nutsbidze Slope, III mcr., II qu., bld. 3,  
0183, Tbilisi, Georgia

---

(141) 2023 04 03

---

(111) M 2012 22949 R  
(732) LTD "Ibereli"  
Nutsbidze Slope, III mcr., II qu., bld. 3,  
0183, Tbilisi, Georgia

(141) 2023 04 03

---

(111) M 2012 22951 R  
(151) 2012 09 24  
(732) N(N)LE "Agrobusiness Center-Lanchkhuti"  
Merab Kostava Str. 37, 2800, Lanchkhuti,  
Georgia

(141) 2023 04 03

---

(111) M 2012 22953 R  
(151) 2012 09 24  
(732) Braun-Forman Polska Sp. Z.O.O.  
E Polish Limited Company  
Ul. Postepu 21 d, 02-645 Warshava, Poland

(141) 2023 04 03

---

(111) M 2012 22956 R  
(151) 2012 09 24  
(732) LTD "Ballis"  
Davit Aghmashenebeli Str. 115-d, 0170,  
Akhalkalaki, Georgia

(141) 2023 04 03

---

(111) M 2012 22960 R  
(151) 2012 09 24  
(732) LTD "Ballis"  
Davit Aghmashenebeli Str. 115-d, 0170,  
Akhalkalaki, Georgia

(141) 2023 04 03

---

(111) M 2012 22961 R  
(151) 2012 09 24  
(732) LTD "Ballis"  
Davit Aghmashenebeli Str. 115-d, 0170,  
Akhalkalaki, Georgia

(141) 2023 04 03

---

(111) M 2012 22962 R  
(151) 2012 09 24  
(732) Societe Nationale d'Exploitation Industrielle  
des Tabacs et Allumettes, SA  
143 boulevard Romain Rolland, Cedex 14,  
Paris 75685, France

(141) 2023 04 03

---

(111) M 2012 22963 R  
(151) 2012 09 24  
(732) International Fund for Innovative Technologies  
Jikia Str. 8, 0186, Tbilisi, Georgia

(141) 2023 04 03

---

(111) M 2012 22968 R  
(151) 2012 09 24  
(732) Soso Mamuladze  
Tsulukidze Str. 23-b, ap. 91, 0154, Tbilisi,  
Georgia

(141) 2023 04 03

---

(111) M 2012 22969 R  
(151) 2012 09 24  
(732) Japan Tobacco Inc.  
2-2-1 Toranomom Minato-ku, Tokyo, Japan

(141) 2023 04 03

---

(111) M 2012 22971 R  
(151) 2012 09 24  
(732) Caspian Household Appliances Trading  
(L.L.C)  
P.O. Box: 16579, Dubai, United Arab Emirates

(141) 2023 04 03

---

(111) M 2012 22932 R  
(151) 2012 09 24  
(732) LTD "BTM Textile"  
Melikishvili Str. 25, d. 3, 6000, Batumi,  
Georgia

(141) 2023 04 03

---

(111) M 2012 22974 R  
(151) 2012 09 27  
(732) Japan Tobacco Inc.  
2-2-1, Toranomom, Minato-ku, Tokyo, Japan

(141) 2023 04 04

---

(111) M 2012 22925 R  
(151) 2012 09 13  
(732) LTD "Fast Gaz"  
Kakheti Highway, the area around the  
Cosmonaut Monument, Tbilisi, Georgia

(141) 2023 03 22

---

(111) M 2012 22973 R  
(151) 2012 09 25  
(732) Koba Machkhidze  
V. Sarajishvili st. 26, 0108, Tbilisi, Georgia

(141) 2023 04 03

---

(111) M 2012 22927 R  
 (151) 2012 09 20  
 (732) LTD Namera  
 Vazha-Pshavela Ave., II qu., bld. 5, ap. 50,  
 0186, Tbilisi, Georgia  
 (141) 2023 03 28

---

(111) M 2012 22972 R  
 (151) 2012 09 25  
 (732) LTD "Maknatuna"  
 Gugunava Str. 13, (Plot N4-3/2), 4600,  
 Kutaisi, Georgia  
 (141) 2023 04 03

---

## REGISTRATION OF LICENSE AGREEMENTS

(111) M 1999 11683 R  
 (732) Public Joint-Stock Company "Oil Company  
 "Lukoil"  
 11 Sretenskiy Boulevard, 101000, Moscow,  
 Russian Federation  
 (791) LLC "Lukoil-Georgia"  
 Right bank of the River Mtkvari, the area  
 around Gotua Street, Tbilisi, Georgia  
 (793) № 1777  
 From 01 01 2022 to 01 01 2027  
 Non-exclusive  
 Class: 35, 37, 39, 42

---

(111) M 1999 11683 R  
 (732) Public Joint-Stock Company "Oil Company  
 "Lukoil"  
 11 Sretenskiy Boulevard, 101000, Moscow,  
 Russian Federation  
 (791) LLC "Lukoil-Georgia"  
 Right bank of the River Mtkvari, the area  
 around Gotua Street, Tbilisi, Georgia  
 (793) №1768  
 From 30 12 2021 to 31 12 2026  
 Simple  
 Class: 35, 37, 39, 42

---

(111) M 1999 11684 R  
 (732) Public Joint-Stock Company "Oil Company  
 "Lukoil"  
 11 Sretenskiy Boulevard, 101000, Moscow,  
 Russian Federation  
 (791) LLC "Lukoil-Georgia"  
 Right bank of the River Mtkvari, the area  
 around Gotua Street, Tbilisi, Georgia

(793) №1769  
 from 30 12 2021 to 31 12 2026  
 Simple  
 Class: 35, 37, 39, 42

---

(111) M 1999 11684 R  
 (732) Public Joint-Stock Company "Oil Company  
 "Lukoil"  
 11 Sretenskiy Boulevard, 101000, Moscow,  
 Russian Federation  
 (791) LLC "Lukoil-Georgia"  
 Right bank of the River Mtkvari, the area  
 around Gotua Street, Tbilisi, Georgia  
 (793) №1778  
 from 01 01 2022 to 01 01 2027  
 Non-exclusive  
 Class: 35, 37, 39, 42

---

(111) M 1999 11685 R  
 (732) Public Joint-Stock Company "Oil Company  
 "Lukoil"  
 11 Sretenskiy Boulevard, 101000, Moscow,  
 Russian Federation  
 (791) LLC "Lukoil-Georgia"  
 Right bank of the River Mtkvari, the area  
 around Gotua Street, Tbilisi, Georgia  
 (793) №1779  
 from 01 01 2022 to 01 01 2027  
 Non-exclusive  
 Class: 35, 37, 39, 42

---

(111) M 1999 11685 R  
(732) Public Joint-Stock Company "Oil Company  
"Lukoil"  
11 Sretenskiy Boulevard, 101000, Moscow,  
Russian Federation  
(791) LLC "Lukoil-Georgia"  
Right bank of the River Mtkvari, the area  
around Gotua Street, Tbilisi, Georgia  
(793) №1770  
from 30 12 2021 to 31 12 2026  
Simple  
Class: 35, 37, 39, 42

---

(111) M 2022 35112 R  
(732) Federal Treasury Enterprise  
"Sojuzplodoimport" (FKP "Sojuzplodo-  
import")  
Orlikov lane, bldg. 1/11, Moscow, 107139,  
Russian Federation  
(791) LTD "Lavanda 2017"  
Tsodne Dadiani Str. 148, ap. 36, 0180,  
Tbilisi, Georgia  
(793) №1774  
from 01 01 2023 to 01 01 2033  
Special  
Class: 33

---

(111) M 2022 35110 R  
(732) Federal Treasury Enterprise  
"Sojuzplodoimport" (FKP "Sojuzplodo-  
import")  
Orlikov lane, bldg. 1/11, Moscow, 107139,  
Russian Federation  
(791) LTD "Lavanda 2017"  
Tsodne Dadiani Str. 148, ap. 36, 0180,  
Tbilisi, Georgia  
(793) №1773  
from 01 01 2023 to 01 01 2033  
Special  
Class: 33

---



## INTERNATIONAL LICENSE AGREEMENTS

(800) 980745  
(732) Public Joint Stock Company "Oil Company  
"Lukoil"  
Sretenskiy bouvar 11, RU-101000 Moskow,  
Russian Federation  
(791) LLC "Lukoil-Georgia"  
Right bank of the River Mtkvari, the area  
around Gotua Street, Tbilisi, Georgia  
(793) №1771  
Simple  
from 30 12 2021 to 31 12 2026  
Class: 35, 37, 43

---

(800) 980745  
(732) Public Joint Stock Company "Oil Company  
"Lukoil"  
Sretenskiy bouvar 11, RU-101000 Moskow,  
Russian Federation  
(791) LLC "Lukoil-Georgia"  
Right bank of the River Mtkvari, the area  
around Gotua Street, Tbilisi, Georgia  
(793) №1776  
Non-exclusive  
from 01 01 2022 to 01 01 2027  
Class: 35, 37, 43

---

(800) 1001044  
(732) Public Joint Stock Company "Oil Company  
"Lukoil"  
Sretenskiy bouvar 11, RU-101000 Moskow,  
Russian Federation  
(791) LLC "Lukoil-Georgia"  
Right bank of the River Mtkvari, the area  
around Gotua Street, Tbilisi, Georgia  
(793) №1772  
Simple  
from 30 12 2021 to 31 12 2026  
Class: 35, 37, 43

---

(800) 1001044  
(732) Public Joint Stock Company "Oil Company  
"Lukoil"  
Sretenskiy bouvar 11, RU-101000 Moskow,  
Russian Federation  
(791) LLC "Lukoil-Georgia"  
Right bank of the River Mtkvari, the area  
around Gotua Street, Tbilisi, Georgia  
(793) №1775  
Non-exclusive  
from 01 01 2022 to 01 01 2027  
Class: 35, 37, 43

---

# CLASSIFICATION INDEXES

## INVENTIONS

### CONCORDANCE TABLE OF INTERNATIONAL CLASSIFICATION INDEX AND PUBLICATION NUMBERS

INTERNATIONAL CLASSIFICATION INDEXES (51)	NUMBER OF PUBLISHED APPLICATION (10)
A 21 D 13/11; A 21 D 13/13; A 21 D 13/41	AP 2023 15661 A
A 61 K 39/00; A 61 K 47/18; A 61 K 47/26; A 61 K 9/00; C 07 K 16/24	AP 2023 15302
B 01 F 13/10; B 08 B 7/00; B 44 D 3/08	AP 2023 15542 A

### CONCORDANCE TABLE OF PUBLICATION NUMBERS AND INTERNATIONAL CLASSIFICATION INDEX

NUMBER OF PUBLISHED APPLICATION (10)	INTERNATIONAL CLASSIFICATION INDEXES (51)
AP 2023 15302	A 61 K 39/00; A 61 K 47/18; A 61 K 47/26; A 61 K 9/00; C 07 K 16/24
AP 2023 15542 A	B 01 F 13/10; B 08 B 7/00; B 44 D 3/08
AP 2023 15661 A	A 21 D 13/11; A 21 D 13/13; A 21 D 13/41

### CONCORDANCE TABLE OF INTERNATIONAL CLASSIFICATION INDEX, PATENT NUMBERS AND PUBLICATION NUMBERS

INTERNATIONAL CLASSIFICATION INDEX (51)	NUMBER OF PATENT (11)	NUMBER OF PUBLISHED APPLICATION (10)
A 01 N 43/80; C 07 D 261/04	P 2023 7490 B	AP 2022 15389 A
A 23 F 3/34	P 2023 7489 B	AP 2022 15589 A
A 61 K 9/08; A 61 K 31/437; A 61 K 9/00; A 61 P 25/20	P 2023 7492 B	AP 2022 15600 A
A 61 K 31/4178; A 61 P 11/00; A 61 P 37/00; C 07 D 403/12	P 2023 7493 B	AP 2022 15523 A
A 61 P 35/00; C 07 D 401/14	P 2023 7494 B	AP 2022 15620 A
C 04 B 28/14; C 04 B 11/00	P 2023 7495 B	AP 2022 15261 A
C 07 B 59/00; C 07 D 295/145	P 2023 7496 B	AP 2022 15719 A
C 07 B 59/00; C 07 D 295/145	P 2023 7497 B	AP 2022 15720 A
C 07 C 51/16; C 07 C 231/02; C 07 D 265/32	P 2023 7498 B	AP 2022 15407 A
H 01 Q 15/20	P 2023 7491 B	AP 2022 15604 A

**CONCORDANCE TABLE OF PATENT NUMBERS,  
PUBLICATION NUMBERS AND INTERNATIONAL CLASSIFICATION INDEX**

NUMBER OF PATENT (11)	NUMBER OF PUBLISHED APPLICATION (10)	INTERNATIONAL CLASSIFICATION INDEX (51)
P 2023 7489 B	AP 2022 15589 A	A 23 F 3/34
P 2023 7490 B	AP 2022 15389 A	A 01 N 43/80; C 07 D 261/04
P 2023 7491 B	AP 2022 15604 A	H 01 Q 15/20
P 2023 7492 B	AP 2022 15600 A	A 61 K 9/08; A 61 K 31/437; A 61 K 9/00; A 61 P 25/20
P 2023 7493 B	AP 2022 15523 A	A 61 K 31/4178; A 61 P 11/00; A 61 P 37/00; C 07 D 403/12
P 2023 7494 B	AP 2022 15620 A	A 61 P 35/00; C 07 D 401/14
P 2023 7495 B	AP 2022 15261 A	C 04 B 28/14; C 04 B 11/00
P 2023 7496 B	AP 2022 15719 A	C 07 B 59/00; C 07 D 295/145
P 2023 7497 B	AP 2022 15720 A	C 07 B 59/00; C 07 D 295/145
P 2023 7498 B	AP 2022 15407 A	C 07 C 51/16; C 07 C 231/02; C 07 D 265/32

**CONCORDANCE TABLE OF APPLICATION NUMBERS,  
PUBLICATION NUMBERS AND PATENTS**

NUMBER OF APPLICATION (21)	NUMBER OF PUBLISHED APPLICATION (10)	NUMBER OF PATENT (11)
AP 2017 15261	AP 2022 15261 A	P 2023 7495 B
AP 2018 15389	AP 2022 15389 A	P 2023 7490 B
AP 2019 15407	AP 2022 15407 A	P 2023 7498 B
AP 2019 15523	AP 2022 15523 A	P 2023 7493 B
AP 2021 15589	AP 2022 15589 A	P 2023 7489 B
AP 2019 15600	AP 2022 15600 A	P 2023 7492 B
AP 2021 15604	AP 2022 15604 A	P 2023 7491 B
AP 2019 15620	AP 2022 15620 A	P 2023 7494 B
AP 2014 15719	AP 2022 15719 A	P 2023 7496 B
AP 2014 15720	AP 2022 15720 A	P 2023 7497 B

## UTILITY MODELS

### CONCORDANCE TABLE OF INTERNATIONAL CLASSIFICATION INDEX AND PUBLICATION NUMBERS

INTERNATIONAL CLASSIFICATION INDEXES (51)	NUMBER OF PUBLISHED APPLICATION (10)
A 61 G 10/00	AU 2023 16056 U
F 41 F 3/00; F 41 F 7/00	AU 2023 16007 U

### CONCORDANCE TABLE OF PUBLICATION NUMBERS AND INTERNATIONAL CLASSIFICATION INDEX

NUMBER OF PUBLISHED APPLICATION (10)	INTERNATIONAL CLASSIFICATION INDEXES (51)
AU 2023 16007 U	F 41 F 3/00; F 41 F 7/00
AU 2023 16056 U	A 61 G 10/00

### CONCORDANCE TABLE OF INTERNATIONAL CLASSIFICATION INDEX, PATENT NUMBERS AND PUBLICATION NUMBERS

INTERNATIONAL CLASSIFICATION INDEX (51)	NUMBER OF PATENT (11)	NUMBER OF PUBLISHED APPLICATION (10)
E 02 B 8/06	U 2023 2148 Y	AU 2022 15738 U

### CONCORDANCE TABLE OF PATENT NUMBERS, PUBLICATION NUMBERS AND INTERNATIONAL CLASSIFICATION INDEX

NUMBER OF PATENT (11)	NUMBER OF PUBLISHED APPLICATION (10)	INTERNATIONAL CLASSIFICATION INDEX (51)
U 2023 2148 Y	AU 2022 15738 U	E 02 B 8/06

### CONCORDANCE TABLE OF APPLICATION NUMBERS, PUBLICATION NUMBERS AND PATENTS

NUMBER OF APPLICATION (21)	NUMBER OF PUBLISHED APPLICATION (10)	NUMBER OF PATENT (11)
AU 2021 15738	AU 2022 15738 U	U 2023 2148 Y

**DESIGNS****CONCORDANCE TABLE OF INTERNATIONAL CLASSIFICATION INDEX  
AND PUBLICATION NUMBERS**

INTERNATIONAL CLASSIFICATION INDEXES (51)	NUMBER OF PUBLISHED APPLICATION (10)
11-01	AD 2023 1284 S

**CONCORDANCE TABLE OF PUBLICATION NUMBERS  
AND INTERNATIONAL CLASSIFICATION INDEX**

NUMBER OF PUBLISHED APPLICATION (10)	INTERNATIONAL CLASSIFICATION INDEXES (51)
AD 2023 1284 S	11-01

**DESIGNS REGISTERED ACCORDING TO THE ACCELERATED  
PROCEDURE****CONCORDANCE TABLE OF INTERNATIONAL CLASSIFICATION INDEX  
AND PUBLICATION NUMBERS**

INTERNATIONAL CLASSIFICATION INDEXES (51)	NUMBER OF REGISTRATION (11)
19-08	D 2023 968 S

**CONCORDANCE TABLE OF PUBLICATION NUMBERS  
AND INTERNATIONAL CLASSIFICATION INDEX**

NUMBER OF REGISTRATION (11)	INTERNATIONAL CLASSIFICATION INDEXES (51)
D 2023 968 S	19-08

**CONCORDANCE TABLE OF APPLICATION NUMBERS,  
PUBLICATION NUMBERS AND PATENTS**

NUMBER OF APPLICATION (21)	NUMBER OF REGISTRATION (11)
AD 2023 1301	D 2023 968 S

## TRADEMARKS

### CONCORDANCE TABLE OF REGISTRATION NUMBERS, APPLICATION NUMBERS, PUBLICATION NUMBERS AND BULLETIN NUMBERS

NUMBER OF REGISTRATION (111)	NUMBER OF APPLICATIONS (210)	NUMBER OF PUBLISHED APPLICATIONS (260)	NUMBER OF BULLETIN
M 2023 36640 R	AM 116402	AM 2022 116402 A	16(595)2022
M 2023 36641 R	AM 116405	AM 2022 116405 A	16(595)2022
M 2023 36642 R	AM 121852	–	7(610)2023
M 2023 36643 R	AM 121865	–	7(610)2023
M 2023 36644 R	AM 121851	–	7(610)2023
M 2023 36645 R	AM 121850	–	7(610)2023
M 2023 36646 R	AM 116519	AM 2022 116519 A	17(596)2022
M 2023 36647 R	AM 116525	AM 2022 116525 A	18(597)2022
M 2023 36648 R	AM 116336	AM 2022 116336 A	17(596)2022
M 2023 36649 R	AM 121749	–	7(610)2023
M 2023 36650 R	AM 121766	–	7(610)2023
M 2023 36651 R	AM 116538	AM 2022 116538 A	18(597)2022
M 2023 36652 R	AM 116756	AM 2022 116756 A	17(596)2022
M 2023 36653 R	AM 116520	AM 2022 116520 A	17(596)2022
M 2023 36654 R	AM 116868	AM 2022 116868 A	22(601)2022
M 2023 36655 R	AM 117904	AM 2022 117904 A	22(601)2022
M 2023 36656 R	AM 117822	AM 2022 117822 A	22(601)2022
M 2023 36657 R	AM 117662	AM 2022 117662 A	22(601)2022
M 2023 36658 R	AM 117618	AM 2022 117618 A	23(602)2022
M 2023 36659 R	AM 117422	AM 2022 117422 A	22(601)2022
M 2023 36660 R	AM 117421	AM 2022 117421 A	22(601)2022
M 2023 36661 R	AM 116426	AM 2022 116426 A	17(596)2022
M 2023 36662 R	AM 116314	AM 2022 116314 A	17(596)2022
M 2023 36663 R	AM 114754	AM 2022 114754 A	19(598)2022
M 2023 36664 R	AM 121925	–	7(610)2023
M 2023 36665 R	AM 121935	–	7(610)2023
M 2023 36666 R	AM 121933	–	7(610)2023
M 2023 36667 R	AM 121508	–	7(610)2023
M 2023 36668 R	AM 121509	–	7(610)2023
M 2023 36669 R	AM 122015	–	7(610)2023
M 2023 36670 R	AM 122020	–	7(610)2023
M 2023 36671 R	AM 122033	–	7(610)2023
M 2023 36672 R	AM 121768	–	7(610)2023
M 2023 36673 R	AM 121767	–	7(610)2023
M 2023 36674 R	AM 121923	–	7(610)2023
M 2023 36675 R	AM 122014	–	7(610)2023
M 2023 36676 R	AM 122117	–	7(610)2023
M 2023 36677 R	AM 122021	–	7(610)2023
M 2023 36678 R	AM 122112	–	7(610)2023
M 2023 36679 R	AM 122115	–	7(610)2023
M 2023 36680 R	AM 122011	–	7(610)2023
M 2023 36681 R	AM 121759	–	7(610)2023

CONCORDANCE TABLE OF PUBLICATION NUMBERS  
AND APPLICATION NUMBERS

NUMBER OF PUBLISHED APPLICATION (260)	NUMBER OF APPLICATION (210)	1	2
1	2		
AM 2023 103095 A*	AM 103095	AM 2023 119188 A	AM 119188
AM 2023 117558 A	AM 117558	AM 2023 119190 A	AM 119190
AM 2023 118077 A	AM 118077	AM 2023 119192 A	AM 119192
AM 2023 118410 A	AM 118410	AM 2023 119193 A	AM 119193
AM 2023 118561 A	AM 118561	AM 2023 119196 A	AM 119196
AM 2023 118651 A	AM 118651	AM 2023 119212 A	AM 119212
AM 2023 118652 A	AM 118652	AM 2023 119267 A	AM 119267
AM 2023 118761 A	AM 118761	AM 2023 119269 A	AM 119269
AM 2023 118763 A	AM 118763	AM 2023 119270 A	AM 119270
AM 2023 118764 A	AM 118764	AM 2023 119271 A	AM 119271
AM 2023 118832 A	AM 118832	AM 2023 119273 A	AM 119273
AM 2023 118941 A	AM 118941	AM 2023 119274 A	AM 119274
AM 2023 118993 A	AM 118993	AM 2023 119276 A	AM 119276
AM 2023 118996 A	AM 118996	AM 2023 119278 A	AM 119278
AM 2023 118997 A	AM 118997	AM 2023 119280 A	AM 119280
AM 2023 118998 A	AM 118998	AM 2023 119283 A	AM 119283
AM 2023 118999 A	AM 118999	AM 2023 119287 A	AM 119287
AM 2023 119003 A	AM 119003	AM 2023 119343 A	AM 119343
AM 2023 119008 A	AM 119008	AM 2023 119345 A	AM 119345
AM 2023 119009 A	AM 119009	AM 2023 119347 A	AM 119347
AM 2023 119026 A	AM 119026	AM 2023 119348 A	AM 119348
AM 2023 119074 A	AM 119074	AM 2023 119351 A	AM 119351
AM 2023 119077 A	AM 119077	AM 2023 119352 A	AM 119352
AM 2023 119103 A	AM 119103	AM 2023 119364 A	AM 119364
AM 2023 119105 A	AM 119105	AM 2023 119368 A	AM 119368
AM 2023 119179 A	AM 119179	AM 2023 119372 A	AM 119372
AM 2023 119180 A	AM 119180	AM 2023 119374 A	AM 119374
AM 2023 119185 A	AM 119185	AM 2023 119483 A	AM 119483
AM 2023 119186 A	AM 119186	AM 2023 119489 A	AM 119489
AM 2023 119187 A	AM 119187	AM 2023 119492 A	AM 119492
		AM 2023 119493 A	AM 119493
		AM 2023 119581 A	AM 119581
		AM 2023 119596 A	AM 119596
		AM 2023 119675 A	AM 119675

CONCORDANCE TABLE OF INDEX OF GOODS AND/OR SERVICES  
AND APPLICATION NUMBERS

INDEX OF GOODS AND/OR SERVICES (511)	NUMBER OF PUBLISHED APPLICATIONS (260)	1	2
1	2	30	AM 2023 118996 A
3	AM 2023 119283 A	30	AM 2023 118997 A
3	AM 2023 119343 A	30	AM 2023 118998 A
3	AM 2023 119489 A	30	AM 2023 118999 A
4	AM 2023 119003 A	30	AM 2023 119008 A
5	AM 2023 119187 A	30	AM 2023 119009 A
9	AM 2023 117558 A	30	AM 2023 119074 A
9	AM 2023 118651 A	30	AM 2023 119103 A
9	AM 2023 118652 A	30	AM 2023 119105 A
9	AM 2023 119003 A	30	AM 2023 119283 A
9	AM 2023 119192 A	30	AM 2023 119483 A
9	AM 2023 119271 A	30	AM 2023 119489 A
9	AM 2023 119283 A	30	AM 2023 119675 A
9	AM 2023 119287 A	31	AM 2023 119103 A
9	AM 2023 119489 A	32	AM 2023 118761 A
11	AM 2023 119283 A	32	AM 2023 118763 A
11	AM 2023 119489 A	32	AM 2023 118764 A
12	AM 2023 119283 A	32	AM 2023 119008 A
12	AM 2023 119489 A	32	AM 2023 119009 A
12	AM 2023 119581 A	32	AM 2023 119283 A
14	AM 2023 119283 A	32	AM 2023 119489 A
14	AM 2023 119489 A	32	AM 2023 119493 A
16	AM 2023 119185 A	33	AM 2023 118410 A
18	AM 2023 119283 A	33	AM 2023 118561 A
18	AM 2023 119343 A	33	AM 2023 119026 A
18	AM 2023 119489 A	33	AM 2023 119186 A
20	AM 2023 119283 A	33	AM 2023 119188 A
20	AM 2023 119489 A	33	AM 2023 119190 A
21	AM 2023 119185 A	33	AM 2023 119193 A
21	AM 2023 119283 A	33	AM 2023 119199 A
21	AM 2023 119489 A	33	AM 2023 119276 A
22	AM 2023 119283 A	33	AM 2023 119278 A
22	AM 2023 119489 A	33	AM 2023 119345 A
24	AM 2023 119283 A	33	AM 2023 119374 A
24	AM 2023 119489 A	33	AM 2023 119493 A
25	AM 2023 119283 A	34	AM 2023 118993 A
25	AM 2023 119343 A	34	AM 2023 119077 A
25	AM 2023 119489 A	34	AM 2023 119212 A
28	AM 2023 119283 A	34	AM 2023 119267 A
28	AM 2023 119343 A	34	AM 2023 119269 A
28	AM 2023 119489 A	34	AM 2023 119270 A
29	AM 2023 119103 A	34	AM 2023 119274 A
29	AM 2023 119105 A	34	AM 2023 119372 A
29	AM 2023 119280 A	35	AM 2023 118410 A
29	AM 2023 119283 A	35	AM 2023 118561 A
29	AM 2023 119347 A	35	AM 2023 118993 A
29	AM 2023 119348 A	35	AM 2023 119186 A
29	AM 2023 119489 A	35	AM 2023 119192 A
30	AM 2023 118941 A	35	AM 2023 119271 A
		35	AM 2023 119351 A
		35	AM 2023 119352 A
		35	AM 2023 119489 A
		35	AM 2023 119581 A



1	2	1	2
35	AM 2023 119596 A	40	AM 2023 119185 A
36	AM 2023 103095 A*	41	AM 2023 118077 A
36	AM 2023 118651 A	41	AM 2023 119179 A
36	AM 2023 118652 A	41	AM 2023 119180 A
36	AM 2023 119196 A	41	AM 2023 119351 A
36	AM 2023 119271 A	41	AM 2023 119352 A
37	AM 2023 119003 A	41	AM 2023 119364 A
37	AM 2023 119185 A	41	AM 2023 119368 A
37	AM 2023 119196 A	41	AM 2023 119372 A
38	AM 2023 119179 A	41	AM 2023 119489 A
38	AM 2023 119180 A	42	AM 2023 119271 A
38	AM 2023 119271 A	42	AM 2023 119287 A
38	AM 2023 119364 A	43	AM 2023 118993 A
39	AM 2023 119581 A	43	AM 2023 119273 A
40	AM 2023 118832 A	43	AM 2023 119492 A

**CONCORDANCE TABLE OF INDEX OF GOODS AND/OR SERVICES  
AND NUMBERS OF TRADEMARKS REGISTERED ACCORDING  
TO THE ACCELERATED PROCEDURE**

INDEX OF GOODS AND/OR SERVICES (511)	NUMBERS OF REGISTERED ACCORDING TO THE ACCELERATED PROCEDURE (111)
1	2
9	M 2023 36650 R
9	M 2023 36665 R
9	M 2023 36672 R
9	M 2023 36673 R
9	M 2023 36681 R
11	M 2023 36669 R
11	M 2023 36671 R
11	M 2023 36681 R
25	M 2023 36665 R
30	M 2023 36679 R
33	M 2023 36664 R
33	M 2023 36678 R
34	M 2023 36667 R
34	M 2023 36668 R
34	M 2023 36681 R
35	M 2023 36677 R
36	M 2023 36644 R
36	M 2023 36645 R
36	M 2023 36650 R
36	M 2023 36675 R
37	M 2023 36644 R
37	M 2023 36645 R
41	M 2023 36642 R
41	M 2023 36649 R
41	M 2023 36665 R
41	M 2023 36666 R

1	2
41	M 2023 36674 R
42	M 2023 36643 R
42	M 2023 36677 R
43	M 2023 36642 R
43	M 2023 36676 R
43	M 2023 36680 R
44	M 2023 36670 R

# OFFICIAL BULLETIN OF THE INDUSTRIAL PROPERTY

**INVENTIONS**  
**UTILITY MODELS**  
**DESIGNS**  
**TRADEMARKS**

## **7(610)**

EDITOR-IN-CHIEF: N. Bebrishvili

EDITOR-TRANSLATOR: E. Gabunia

PROOFREADER: A. Shixashvili

COMPUTER LAYOUT: M. Ordenidze  
K. Svanidze

ISSN 2720-8486

[info@sakpatenti.gov.ge](mailto:info@sakpatenti.gov.ge)  
[www.sakpatenti.gov.ge](http://www.sakpatenti.gov.ge)