



**NATIONAL INTELLECTUAL PROPERTY CENTER OF GEORGIA
SAKPATENTI**

**OFFICIAL BULLETIN
OF THE INDUSTRIAL PROPERTY**

9(493)

**2018
TBILISI**

**NATIONAL INTELLECTUAL PROPERTY CENTER OF GEORGIA
SAKPATENTI**

**OFFICIAL BULLETIN
OF THE INDUSTRIAL PROPERTY**

9(493)

**INVENTIONS
UTILITY MODELS
DESIGNS
TRADEMARKS**

**DATE OF PUBLICATION
2018 05 10**

CONTENTS

PUBLISHED TITLES OF PROTECTION	3
INVENTIONS	
▪ APPLICATIONS APPROVED FOR GRANTING PATENTS	4
▪ PATENTED INVENTIONS	8
UTILITY MODEL	
▪ APPLICATION APPROVED FOR GRANTING PATENT	9
DESIGNS	
▪ APPLICATIONS APPROVED FOR REGISTRATION	10
▪ REGISTERED DESIGNS	11
▪ DESIGNS, WHICH HAVE BEEN REGISTERED WITH THE INTERNATIONAL BUREAU CLAIMING PRIORITY ON THE TERRITORY OF GEORGIA	12
TRADEMARKS	
▪ APPLICATIONS FILED UNDER THE NATIONAL PROCEDURE APPROVED FOR REGISTRATION	59
▪ REGISTERED TRADEMARKS	65
▪ TRADEMARKS REGISTERED ACCORDING TO THE ACCELERATED PROCEDURE	70
▪ INTERNATIONAL TRADEMARKS FOR WHICH A DECISION ON GRANTING PROTECTION IS TAKEN	72
▪ INTERNATIONAL TRADEMARKS PROTECTED IN GEORGIA	149
OFFICIAL NOTIFICATIONS	
TRADEMARKS	
▪ RENEWAL OF REGISTRATIONS	156
▪ COMPLETE TRANSFER OF RIGHTS	165
▪ CHANGES IN NAMES AND/OR ADDRESSES OF OWNERS	167
▪ CANCELLATION OF TRADEMARK SERVICE REGISTRATION	174
CLASSIFICATION INDEXES	
INVENTIONS	175
UTILITY MODELS	176
DESIGNS	177
TRADEMARKS	179

PUBLISHED TITLES OF PROTECTION

INVENTIONS

- **APPLICATIONS APPROVED FOR GRANTING PATENT:**
14335; 14160; 14428; 14402; 14288; 14266; 14569
- **PATENTED INVENTIONS:**
6848-6851

UTILITY MODEL

- **APPLICATION APPROVED FOR GRANTING PATENT:**
14260

DESIGNS

- **APPLICATIONS APPROVED FOR REGISTRATION:**
962; 1001
- **REGISTERED DESIGNS:**
757-760
- **DESIGNS WHICH HAVE BEEN REGISTERED WITH THE INTERNATIONAL BUREAU CLAIMING PRIORITY ON THE TERRITORY OF GEORGIA:**
97212; 97501; 99386; 99388; 87133; 97355; 99441; 99446; 97515; 99540, 99541; 99817

TRADEMARKS

- **APPLICATIONS FILED UNDER THE NATIONAL PROCEDURE APPROVED FOR REGISTRATION:**
88282; 89904; 93221, 93222; 93224, 93225; 93525; 93818; 93840; 93913; 93986; 94016; 94055; 94063; 94168; 94170, 94171; 94177, 94178; 94191; 94224; 94254; 94259-94261; 94309, 94310; 94314-94316; 94318; 94333; 94348-94350; 94356; 94358; 94372
- **REGISTERED TRADEMARKS:**
29570-29578; 29580-29622
- **TRADEMARKS REGISTERED ACCORDING TO THE ACCELERATED PROCEDURE:**
29564-29569; 29579; 29623
- **INTERNATIONAL TRADEMARKS FOR WHICH A DECISION ON GRANTING PROTECTIONS IS TAKEN:**
74983*; 90265; 90910; 91246; 92240; 92244; 92281; 92320; 92520, 92521; 92566; 92569; 92578; 92650; 92652; 92656, 92657; 92659, 92660; 92673-92676; 92757; 92820; 92823; 92825-92830; 92834; 92858; 92892; 92896; 92898; 92905; 92910; 92927; 92930, 92931; 92935; 92941; 92945; 92950; 92977; 93022; 93161-93163; 93165, 93166; 93168, 93169; 93172-93175; 93177; 93179-93181; 93230; 93257; 93259, 93260; 93266, 93267; 93300; 93311, 93312; 93317; 93319; 93321; 93324; 93341-93347; 93350-93354; 93357-93359; 93364; 93366; 93372-93380; 93382; 93386; 93389; 93390; 93394-93397; 93465; 93470; 93474-93478; 93480, 93481; 93487, 93488; 93495-93498; 93501, 93502; 93504-93508; 93512-93515; 93549, 93550; 93552-93555; 93567-93576; 93579; 93585; 93635-93639; 93672; 93675; 93677; 93685; 93688; 93692-93697; 93827; 93829; 93832; 93841; 93844; 93847, 93848; 93978-93980; 93982-93985; 93987, 93988
- **INTERNATIONAL TRADEMARKS PROTECTED IN GEORGIA:**
88837, 90821, 90822; 90824; 90826-90831; 91011; 91013-91016; 91019; 91022; 91028; 91148; 91214; 91216-91219; 91222-91224; 91244, 91245; 91247; 91249; 91251-91253; 91326, 91327; 91334; 91336- 91338, 91363; 91365-91368; 91423; 91429, 91430; 91432-91434; 91436; 91439; 91442, 91443; 91446, 91447; 91452-91455; 91487; 91492; 91496; 91549-91551; 91553; 91557; 91559-91564; 91601, 91602; 91758; 91825, 91826; 91828, 91829; 91892; 92006; 92008, 92009; 92090-92092; 92095

INVENTIONS

APPLICATIONS APPROVED FOR GRANTING PATENTS

The decision can be appealed at the Chamber of Appeal of Sakpatenti within 3 months from the publication or at the Mtskheta District Court Administrative Cases Board (Address: №17, Samkhedro str., Mtskheta), within 1 month following the publication.

PART A

A 61

- (10) AP 2018 14335 A (51) Int. Cl. (2006)
A 61 K 31/4015
A 61 P 31/00
A 61 P 25/02
- (21) AP 2015 014335 (22) 2015 05 14
(31) P-14-39
(32) 2014 05 14
(33) LV
(71) AKCIJU SABIEDRIBA "OLAINFARM" (LV)
Akciju Sabiedriba "Olainfarm" 5 Rupnicu
street LV-2114 Olaine (LV)
(72) ZVEJNIECE, Liga (LV);
DAMBROVA, Maija (LV);
VEINBERGS, Grigorijs (LV);
VORONA, Maksims (LV);
KALVINS, Ivars (LV)
(74) Aleksandre Gegechkori
(85) 2016 12 01
(86) PCT/IB2015/053554, 2015 05 14
(54) **PHARMACEUTICAL
COMPOSITION FOR THE PREVENTION
AND TREATMENT OF DISEASES
ASSOCIATED WITH ELEVATED
INDUCIBLE NITRIC OXIDE SYNTHASE**
(57) Pharmaceutical composition containing (4R)-
2-(4-phenyl-2-oxopyrrolidin-1-yl) acetamide,
applied at the treatment of pathological condition,
induced by sepsis or peripheral neuropathy
characterized with high expression of iNOS gene.
Claims: 1 independent
1 dependent
Fig.: 4
-

PART B

B 22

- (10) AP 2018 14160 A (51) Int. Cl. (2006)
B 22 F 1/00
B 82 B 1/00
C 22 C 29/00
C 01 B 35/00
- (21) AP 2016 014160 (22) 2016 06 01
(71) LEPL Ferdinand Tavadze Metallurgy
And Materials Science Institute (GE)
Mindelis q. 10, 0186, Tbilisi (GE)
(72) Otar Tsagareishvili (GE);
Archil Mikeladze (GE);
Roin Chedia (GE);
Levan Chkhartishvili (GE)
(54) **METHOD TO RECEIVE
NANOSTRUCTURED SOLID
MATERIALS ON BORON CARBIDE
BASIS**
(57) A method provides mixing initial componentry
thermal treatment; at that, a charge is a suspension
consisting of titanium oxide powder, amorphous
boron, glycerine and water. After mixing, it is
additionally dried, at the temperature 100-110 °C,
and thermally treated with high temperature
synthesis, at the temperature 1250-1300 °C, with
receiving powder composites of boron carbide and
titanium boride, in nanocrystalline condition.
Claims: 1 independent
Fig.: 2
-

B 66

- (10) AP 2018 14428 A (51) Int. Cl. (2006)
B 66 B 9/00
- (21) AP 2017 014428 (22) 2017 02 17
(71) Giorgi Lekvinadze (GE)
Tsiskris q. 10, 0103, Tbilisi (GE)
(72) Giorgi Lekvinadze (GE)
(54) **LIFT**
(57) A lift includes two, disposed in parallel
relative to each other the shafts 3 having fastened
on the walls the guides 4, wherein having three-
layered 31, 32, and 33 bottom, and high 22 and
short 23 doors with locks the cubicles-

counterbalances 1 and 2 are moving. The lift includes fastened onto the cubicles the cable 8 thrown over couple of drive wheel rolles 7 fastened onto shaft roof 5, as well. The lift additionally includes automatic shaft speed centrifugally controlling mechanism executed as couple of horizontally rotating main bearings, which outer immovable iron rings 11 are disposed so, that the cables vertically descended from both, right and left rolls would be capable to pass through rotation center of rotating particles 12 and to rotate around said bearing axle, engaged with generator 17 rotating wheel 18 by means of rubber toothed covering 16; brake gear preventing cubicles-counterbalances falling into the shaft, executed as very compressed springs 26, set into the chargers 25 rigid under the ceiling separately in four corners of side walls of each cubicle, shooting from the cubicles to outer side and adjoining to steel braking plate 27 of segmental-shape; mechanism of gradual locking and whole stoping of each cubicle-counterbalance executed as striped bent metallic wide guides 34 providing narrowing from four sides of shaft and installed in lower part of shaft, and eight wheels 35 rolling on guides surfaces directed to diagonals of cubicle bottom from outer side, perpendicularly of shaft and cubicle, where on each wheel plug 36 handle the pressured spring 37 inserted in the charger. Furthermore, the lift for control is equipped with microprocessor 45 and informational electric panel 20 mounted in the cubicles and connected to accumulators 21 and generators 19 feeding thereof.

Claims: 1 independent

3 dependent

Fig.: 5

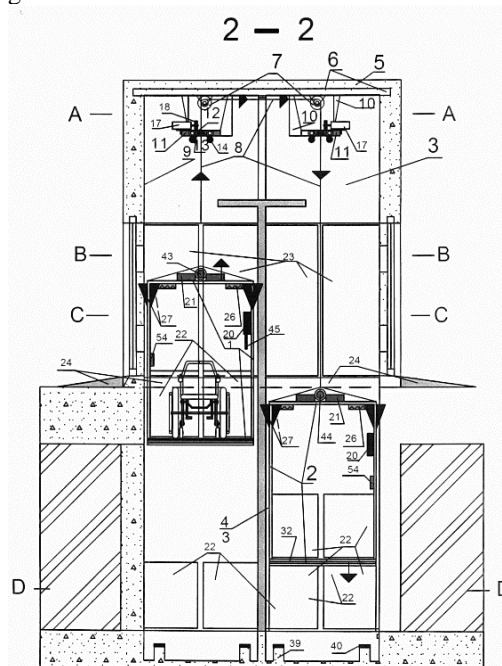

Fig. 1

PART C

C 04

(10) AP 2018 14402 A (51) Int. Cl. (2006)

C 04 B 7/52

C 04 B 14/14

(21) AP 2017 014402 (22) 2017 02 02

(71) LEPL GEORGIAN TECHNICAL

UNIVERSITY (GE)

M. Kostavas q. 77, 0175, Tbilisi (GE);

LEPL Shota Rustaveli National Science

Foundation (GE)

M. Aleksidzis q. 1, 0193, Tbilisi (GE)

(72) Razhden Skhvitaridze (GE);

Teimuraz Kordzakhia (GE);

Giorgi Tsintskhaladze (GE);

Irakli Giorgadze (GE);

Shalva Verulava (GE);

Akaki Skhvitaridze (GE);

Giorgi Kavtashvili (GE)

(74) Givi Sibashvili

(54) **METHOD FOR CEMENT PRODUCTION**

(57) Cement production method includes burning clinker in a furnace at the temperature 1450°C, cleaning from a dust with filtration in a filter of furnace gas containing CO₂, Sox, NOx at the temperature 150-350°C, and emission into atmosphere with a chimney, joint grinding of received clinker and termally treated in drying device at the temperature no more than 600-700°C a tuff and a gypsum; at that, the clinoptilolite is added as tuff including zeolitic tuff termally treated in drying device with feeding furnace gas and at the time it is modified with cleaned from a dust with filtration in a filter with furnace gas containing CO₂, Sox, NOx at the temperature 150-350°C.

Claims: 1 independent

C 07

(10) AP 2018 14288 A (51) Int. Cl. (2006)

C 07 D 207/26

C 07 D 207/273

C 07 D 209/52

C 07 D 215/48

C 07 D 217/02

C 07 D 217/22

C 07 D 217/24

C 07 D 239/86

C 07 D 239/88

C 07 D 263/24

C 07 D 401/12

C 07 D 401/14

C 07 D 403/12

C 07 D 405/12

C 07 D 405/14

C 07 D 413/12
 C 07 D 417/12
 C 07 D 487/04
 C 07 D 491/056
 C 07 D 498/04
 C 07 C 69/94
 C 07 C 235/66
 C 07 F 7/18
 A 61 K 31/47
 A 61 K 31/4709
 A 61 K 31/472
 A 61 K 31/4725
 A 61 K 31/517
 A 61 P 19/02
 A 61 P 29/00
 A 61 P 11/06
 A 61 P 13/12
 A 61 P 17/06

(21) AP 2015 014288 (22) 2015 03 26

(31) 61/975,473

(32) 2014 04 04

(33) US

(71) PFIZER INC. (US)

235 East 42nd Street New York,
 NY 10017 (US)

(72) ANDERSON, David Randolph (US);

BUNNAGE, Mark Edward (GB);

CURRAN, Kevin Joseph (US);

DEHNHARDT, Christoph Martin (US);

GAVRIN, Lori Krim (US);

GOLDBERG, Joel Adam (US);

HAN, Seungil (US);

HEPWORTH, David (US);

HUANG, Horng-Chih (US);

LEE, Arthur (US);

LEE, Katherine Lin (US);

LOVERING, Frank Eldridge (US);

LOWE, Michael Dennis (US);

MATHIAS, John Paul (GB);

PAPAIOANNOU, Nikolaos (US);

PATNY, Akshay (IN);

PIERCE, Betsy Susan (US);

SAIAH, Eddine (US);

STROHBACH, Joseph Walter (US);

TRZUPEK, John David (US);

VARGAS, Richard (US);

WANG, Xiaolun (US);

WRIGHT, Stephen Wayne (US);

ZAPF, Christoph Wolfgang (US)

(74) Tamar Kochlamazashvili

(85) 2016 10 03

(86) PCT/IB2015/052251, 2015 03 26

(54) **BICYCLIC-FUSED HETEROARYL
 OR ARYL COMPOUNDS AND THEIR
 USE AS IRAK4 INHIBITORS**

(57) Compound of formula III,

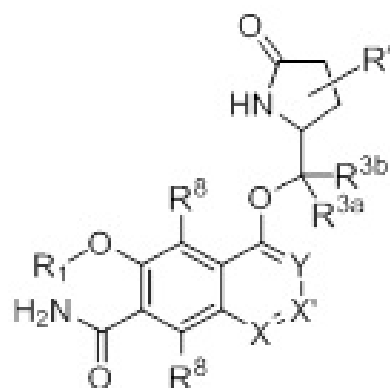

III

pharmaceutical compositions on basis thereof and their usage at the treatment of autoimmune and inflammatory diseases modulating function of IRAK4.

Claims: 15 independent

17 dependent

Table: 3

Fig.: 2

(10) AP 2018 14266 A

(51) Int. Cl. (2006)

C 07 D 401/04

C 07 D 241/26

C 07 D 241/28

A 61 K 31/497

A 61 K 31/5377

A 61 P 25/00

(21) AP 2015 014266

(22) 2015 02 13

(31) 61/940,294

(32) 2014 02 14

(33) US

(71) TAKEDA PHARMACEUTICAL
 COMPANY LIMITED (JP)

1-1, Doshomachi 4-chome, Chuo-ku

Osaka-shi, Osaka 541-0045 (JP)

(72) HOPKINS, Maria (US);

ADAMS, Mark E. (US);

BROWN, Jason W. (US);

HITCHCOCK, Stephen (US);

KIKUCHI, Shota (US);

LAM, Betty (US);

MONENSCHIEIN, Holger (US);

REICHARD, Holly (US);

SUN, Huikai (US)

(74) Aleksandre Gegechkori

(85) 2016 09 13

(86) PCT/US2015/015841, 2015 02 13

(54) **PYRAZINES MODULATORS OF GPR6**

(57) Compound of formula I,

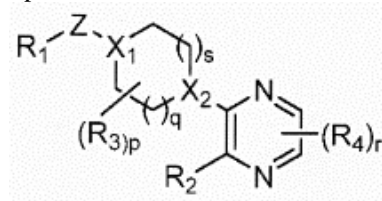

I

pharmaceutical compositions on basis thereof and their usage at the treatment of conditions related to GPR6.

Claims: 4 independent
7 dependent

Table: 1

C 10

(10) AP 2018 14569 A (51) Int. Cl. (2006)

C 10 J 3/12

(21) AP 2017 14569 (22) 2017 08 15

(71) LTD "EKOI" (GE)
K. Shevardnizis q. 5, b. 46, 0160,
Tbilisi, (GE)

(72) Levan Sharikadze (GE)

(74) Nugzar Ksovreli

(54) DEVICE FOR SYNTHETIC GAS PRODUCTION

(57) Synthetic gas production device includes a bin 1 and heating section 2, which is disposed in combustion chamber and has diffusive part, which restricting area is directed to mixing chamber 7 and connected therewith passing pipe with diameter equal of said restricting area diameter. Mixing chamber 7 is executed in a form of truncated cone and disposed above gasification section. Raw bin is connected to mixing chamber with auger feeder 4. Water vapor feeding section 6 is disposed above gasification section, in mixing chamber area so, that together with raw mix and heat carrier feeding into gasification section the vapor feeding would be provided directly to said mix stream motion. Gasification section has diffusion part, as well, which restricting area is connected to a regenerator 8, having diffusive part connected to delivery mouth 10. Productional gas outlet means is connected to gasification section; furthermore, a device is equipped with a transporter 12 carrying outgoing heat carrier-catalyst from device inner capacity through a lattice 11 into receiving bin 1.

Claims: 1 independent
8 dependent

Fig.: 1

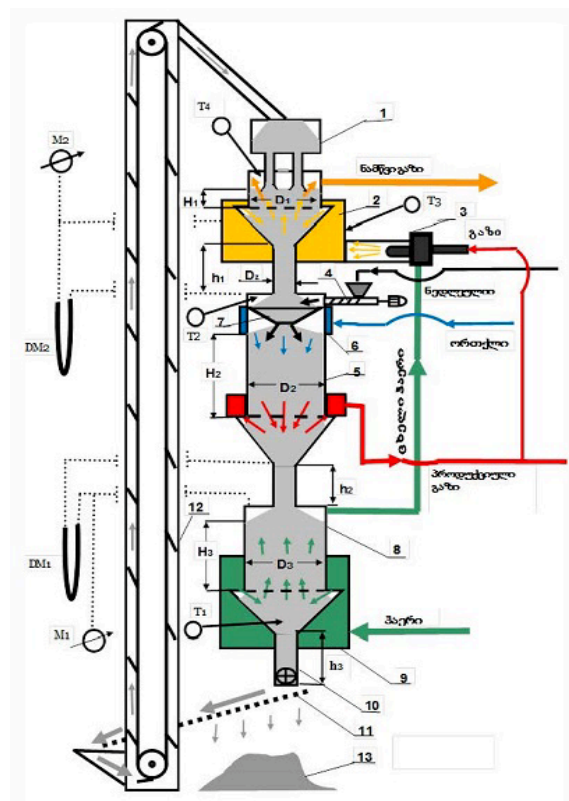

Fig. 1

PATENTED INVENTIONS
PART A**A 47**

- (11) P 2018 6850 B** (51) **Int. Cl. (2006)**
A 47 J 44/02
B 01 F 13/04
- (10) AP 2018 14131 A (44) 2(486)/2018
(21) AP 2014 014131
(22) 2014 10 06
(24) 2014 10 06
(31) 14/507,180; 14/047,954
(32) 2014 10 06; 2013 10 07
(33) US; US
(86) PCT/US2014/059345, 2014 10 06
(73) CAPBRAN HOLDINGS LLC (US)
Suite 2300 11601 Wilshire Blvd.,
Los Angeles, CA 90025 (US)
(72) SAPIRE, Colin (US)
(74) Tamar Kochlamazashvili
(54) **BLENDER**
-

A 61

- (11) P 2018 6849 B** (51) **Int. Cl. (2006)**
A 61 K 31/495
A 61 P 25/18
- (10) AP 2018 13870 A (44) 2(486)/2018
(21) AP 2013 013870
(22) 2013 11 28
(24) 2013 11 28
(31) P1200691
(32) 2012 11 29
(33) HU
(86) PCT/IB2013/060465, 2013 11 28
(73) RICHTER GEDEON NYRT (HU)
Dion Roy Ut. 19 - 21, H-1103 Budapest (HU)
(72) PITTER, János György (HU);
SZATMÁRI, Balázs (HU);
DEBELLE, Marc (FR);
NÉMETH, György József (HU);
LASZLOVSZKY, István (HU)
(74) Liliana Darakhvelidze
(54) **Trans-4-{2-[4-(2,3-Dichlorophenyl)-
Piperazin-1-YI]-Ethyl}-N,N-Dimethyl-
carbamoyl-Cyclohexylamine for Treating
Negative Symptoms of Schizophrenia**
-

PART C**C 01**

- (11) P 2018 6848 B** (51) **Int. Cl. (2006)**
C 01 B 3/24
C 01 B 31/18
C 01 J 3/00
- (10) AP 2018 13525 A (44) 2(486)/2018
(21) AP 2012 013525
(22) 2012 12 20
(24) 2012 12 20
(31) 10 2011 122 562.9; 10 2012 008 933.3;
10 2012 015 314.7
(32) 2011 12 20; 2012 04 05; 2012 08 02
(33) DE; DE; DE
(86) PCT/EP2012/005309, 2012 12 20
(73) LEPL TECHNOLOGY GMBH (DE)
Weissenburger Str. 7 81667 München (DE)
(72) KÜHL, Olaf (DE)
(74) Tamaz Shilakadze
(54) **PROCESS AND SYSTEM FOR
CONVERSION OF CARBON DIOXIDE
TO CARBON MONOXIDE**
-

- (11) P 2018 6851 B** (51) **Int. Cl. (2006)**
C 01 G 15/00
C 01 G 19/00
C 01 G 49/08
C 09 K 9/00
C 09 K 11/62
C 09 K 11/77
G 01 N 33/02
G 01 N 33/15
- (10) AP 2018 14213 A (44) 2(486)/2018
(21) AP 2014 014213
(22) 2014 12 18
(24) 2014 12 18
(31) PCT/EP2013/077823; 61/919,037
(32) 2013 12 20; 2013 12 20
(33) EP; US
(86) PCT/EP2014/078388, 2014 12 18
(73) SICPA HOLDING SA (CH)
Avenue de Florissant 41 CH-1008 Prilly (CH)
(72) MILOS-SCHOUWINK, Mia (CH);
RAEMY, Xavier Cédric (CH);
DORIER, Jean-Luc (CH)
(74) Larisa Amirkhanyan
(54) **THERMOLUMINESCENT COMPO-
SITE PARTICLE AND MARKING
COMPRISING SAME**
-

UTILITY MODEL

APPLICATION APPROVED FOR GRANTING PATENT

The decision can be appealed at the Chamber of Appeal of Sakpatenti within 3 months from the publication or at the Mtskheta District Court Administrative Cases Board (Address: №17, Samkhedro str., Mtskheta), within 1 month following the publication.

PART B

B 67

(10) AU 2018 14260 U (51) Int. Cl. (2006)
B 67 D 3/00
G 07 F 13/00

(21) AU 2016 014260 (22) 2016 09 06

(71) LTD "GOODWINE" (GE)

S. Janashias q. 11a, 0179, Tbilisi (GE)

(72) Giorgi Mordehashvili (GE);

Nika Khazaradze (GE);

Giorgi Tandashvili (GE)

(74) Vakhtang Torotadze

(54) **SLOT MACHINE**

(57) Slot machine 1 includes several changeable containers 17 disposed in a case, at least with one kind wine and device to select sort of wine and dosage pouring from container into open tare 2 at retail, control units 20 and 21. Furthermore, slot machine additionally includes unit for free delivery of tasting dose of 120 ml of each kind wine, connected to existed control unit executed as a button, sensor or similar means freely available for a consumer, and executed onto control unit 22.

Claims: 1 independent

Fig.: 4

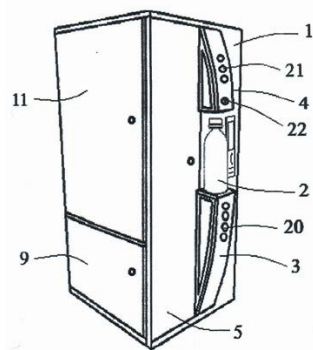

Fig. 1

DESIGNS

APPLICATIONS APPROVED FOR REGISTRATION

The decision can be appealed at the Chamber of Appeal of Sakpatenti within 3 months from the publication or at the Mtskheta District Court Administrative Cases Board (Address: №17, Samkhedro str., Mtskheta), within 1 month following the publication.

(10) **AD 2018 962 S** (51) **14-99**
(21) AD 2017 962 (22) 2017 06 05
(28) 1
(71) Shalva Nikolaishvili (GE)
Sulkhan Tsintsadzis q. 48, b. 14, 0160, Tbilisi (GE)
(72) Shalva Nikolaishvili (GE)
(54) **MOBILE OR TABLET POST**
(55)



1.1



1.2

(10) **AD 2018 1001 S** (51) **32-00**
(21) AD 2017 1001 (22) 2017 11 09
(28) 1
(71) Natela Kakhniashvili (GE)
Dighmis Mas., kvart. II, korp. 9a, b. 46, 0139, Tbilisi (GE)
(72) Natela Kakhniashvili (GE)
(74) Zviad Matiashvili (GE)
(54) **LOGO**
(55)



1.1

REGISTERED DESIGNS**(11) D 2018 759 S**

(10) AD 2018 975 S

(21) AD 2017 975

(24) 2017 08 03

(28) 1

(18) 2022 08 03

(73) Giorgi Gomelauri (GE)

G. Chanturias q. 14, 0900, Akhmeta, Georgia (GE)

(72) Giorgi Gomelauri (GE)

(54) **GLASS POT FOR HONEY****(51) 09-01**

(44) 2(486)/2018

(22) 2017 08 03

(11) D 2018 760 S

(10) AD 2018 977 S

(21) AD 2017 977

(24) 2017 08 08

(28) 2

(18) 2022 08 08

(31) 2017500691; 2017500691

(32) 2017 02 14; 2017 02 14

(33) RU; RU

(73) LTD "PARLIAMENT DISTRIBUTION" (RU)

Ul. Popovka, dom 5, Balashikha, Saltikovka m/r, 143916, Moscow, Russia (RU)

(72) Rustam Vasilyevich Tariko (RU)

(74) Aleksandre Gegechkori (GE)

(54) **1.-2. BOTTLE****(51) 09-01**

(44) 2(486)/2018

(22) 2017 08 08

(11) D 2018 757 S

(10) AD 2018 987 S

(21) AD 2017 987

(24) 2017 09 08

(28) 1

(18) 2022 09 08

(73) SOLAR ECO SYSTEMS (AE)

Sharjah Saif Zone Authority, Sharjah, united Arab Emirates (AE)

(72) Peter Jagger (AE)

(74) Shalva Gvaramadze (GE)

(54) **SUNSHINE DEVICE FOR CIRCLE LIGHTENING****(51) 26-03**

(44) 2(486)/2018

(22) 2017 09 08

(11) D 2018 758 S

(10) AD 2018 988 S

(21) AD 2017 988

(24) 2017 09 08

(28) 1

(18) 2022 09 08

(73) SOLAR ECO SYSTEMS (AE)

Sharjah Saif Zone Authority, Sharjah, united Arab Emirates (AE)

(72) Peter Jagger (AE)

(74) Shalva Gvaramadze (GE)

(54) **SUNSHINE DEVICE FOR LINEAR LIGHTENING**

DESIGNS, WHICH HAVE BEEN REGISTERED WITH THE INTERNATIONAL BUREAU CLAIMING PRIORITY ON THE TERRITORY OF GEORGIA

The decision can be appealed at the Chamber of Appeal of Sakpatenti within 3 months from the publication or at the Mtskheta District Court Administrative Cases Board (Address: №17, Samkhedro Str., Mtskheta), within 1 month following the publication.

(11) DM/097212

(15) 2017 07 31

(22) 2017 07 31

(28) 1

(73) MONTRES JAQUET DROZ SA (MONTRES JAQUET DROZ AG) (MONTRES JAQUET DROZ LTD)
Allée du Tourbillon 2, CH-2300 La Chaux-de-Fonds (CH)

(85) CH

(86) CH

(87) CH

(88) CH

(89) CH

(81) II. BZ, MA III. AL, AM, AZ, BA, CH, EM, GE, KG, LI, MC, MD, ME, MK, MN, NO, OM, SG, TN, TR, UA

(72) Christian LATTMANN

Chemin de Château-Neuf 17, CH-1125 Monnaz, Suisse;

Yann LEIGGENER

Avenue Léopold-Robert 11, CH-2300 La Chaux-de-Fonds, Suisse

(54) 1. Signing machine

(55)

(51) 19-06

(45) 2018/04 (2018 02 02)

1.1

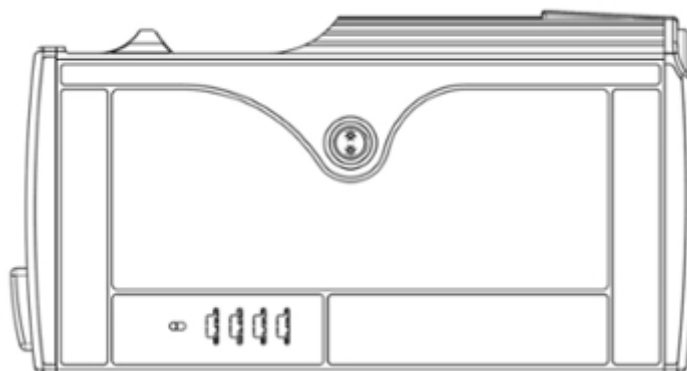

1.2

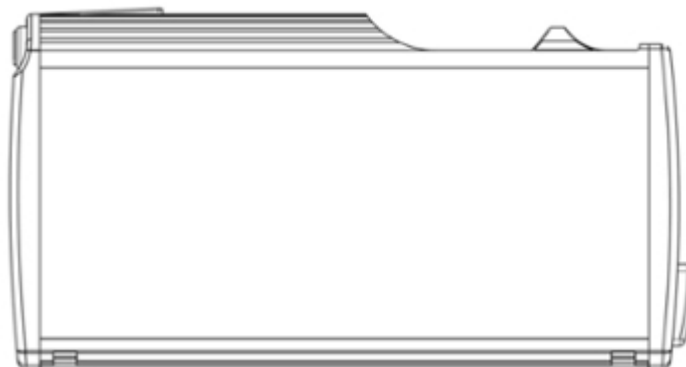

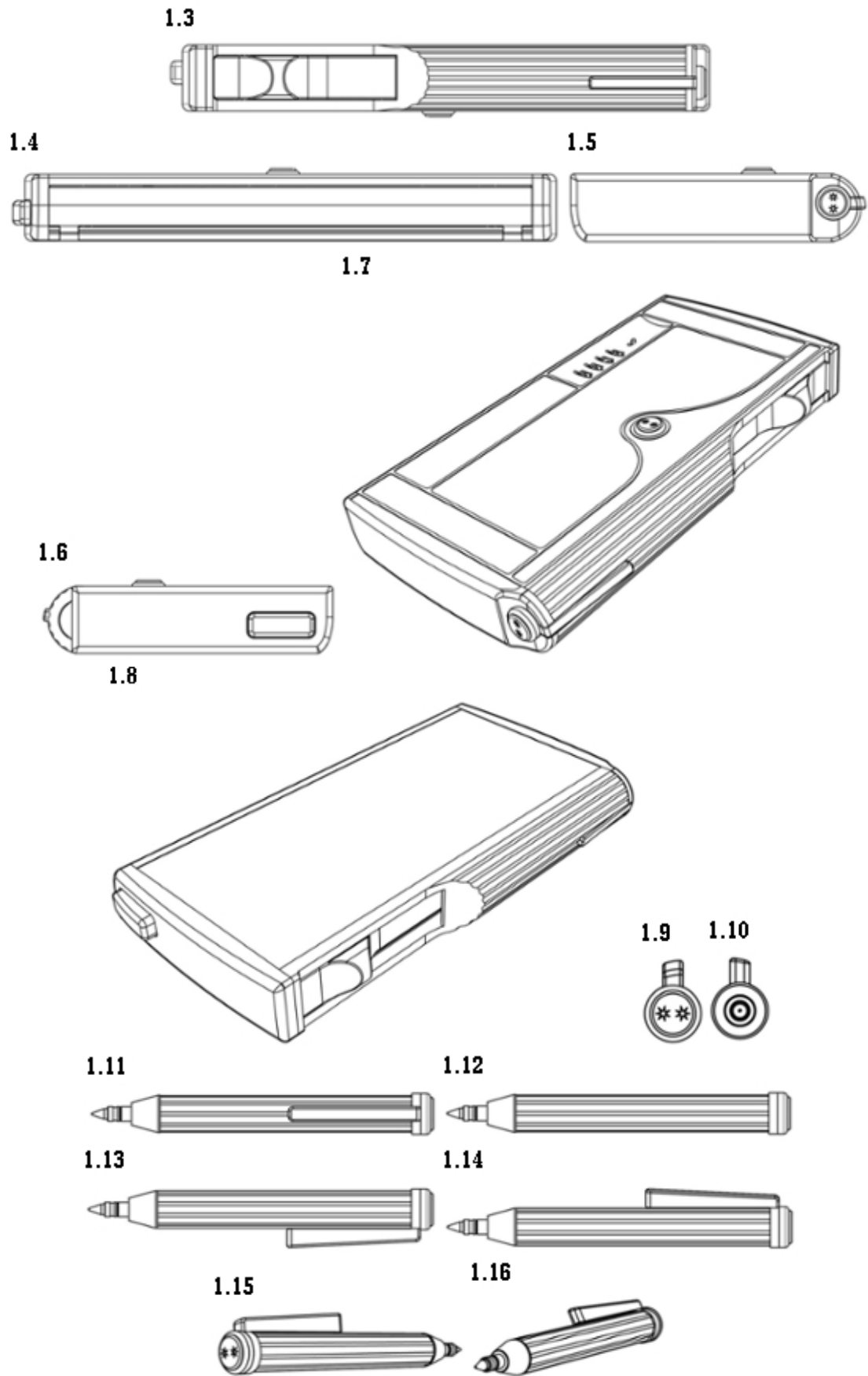

(11) DM/097501

(51) 10-02, 07

(15) 2017 07 28

(45) 2018/04 (2018 02 02)

(22) 2017 07 28

(28) 5

(30) No. 1: 09.02.2017; 143132; CH; Nos. 2, 3, 4, 5: 16.02.2017; 142990; CH

(73) ROLEX SA

3-5-7 rue François-Dussaud, CH-1211 Genève 26 (CH)

(85) CH

(86) CH

(87) CH

(88) CH

(89) CH

(81) II. BZ, MA, SR III. AL, AM, AZ, BA, BN, BW, EG, EM, GE, GH, IS, JP, KG, KH, KP, KR, LI, MC, MD, ME, MK, MN, NA, NO, OA, OM, RS, RW, SG, ST, SY, TJ, TM, TN, TR, UA

(72) Maria Cristina CALVANI

12, chemin David Munier, 1223 Coligny, Suisse

(54) 1. Watch bezel; 2.-3. Watches; 4.-5. Parts of watch dial

(55)

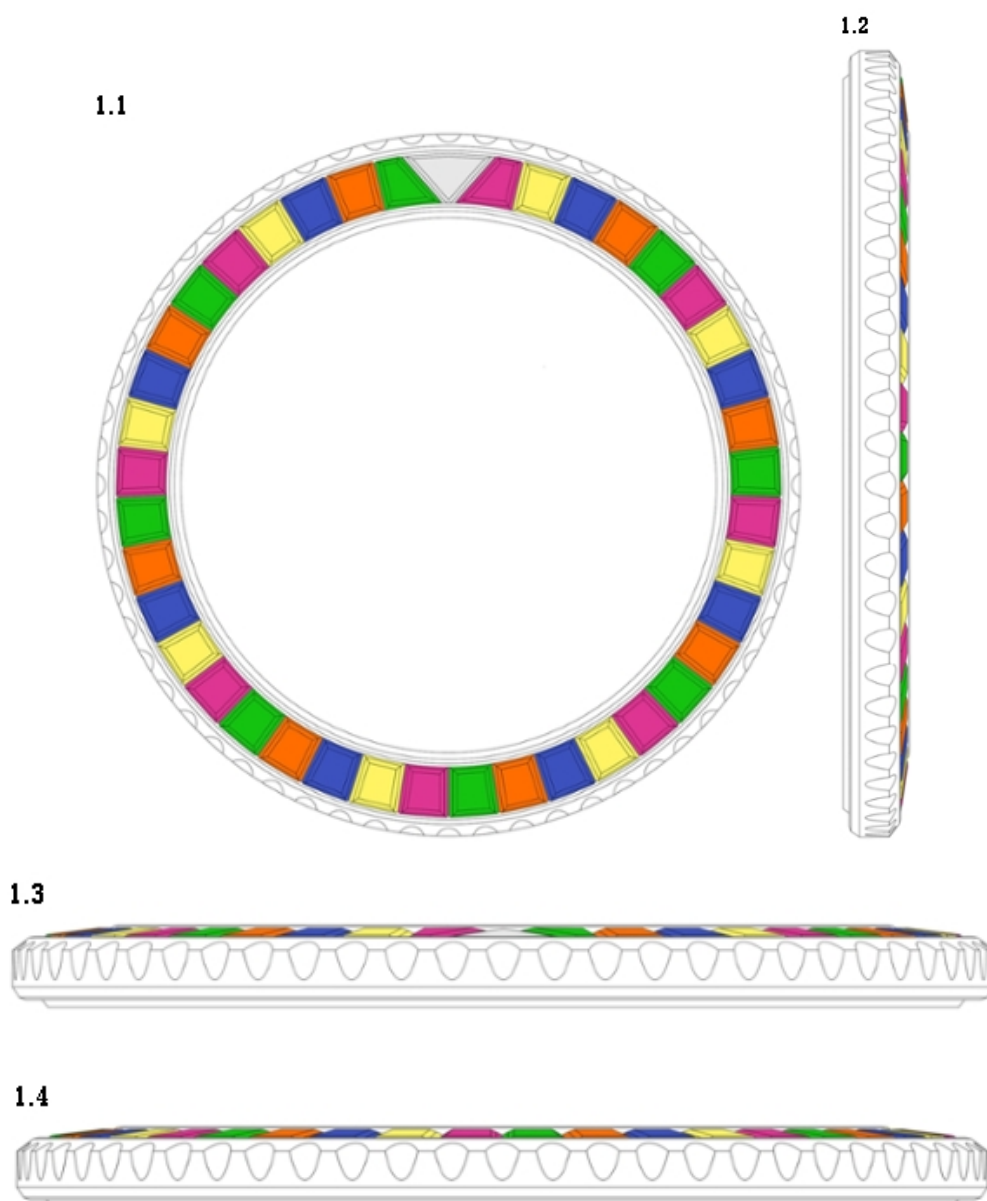

1.5

1.6

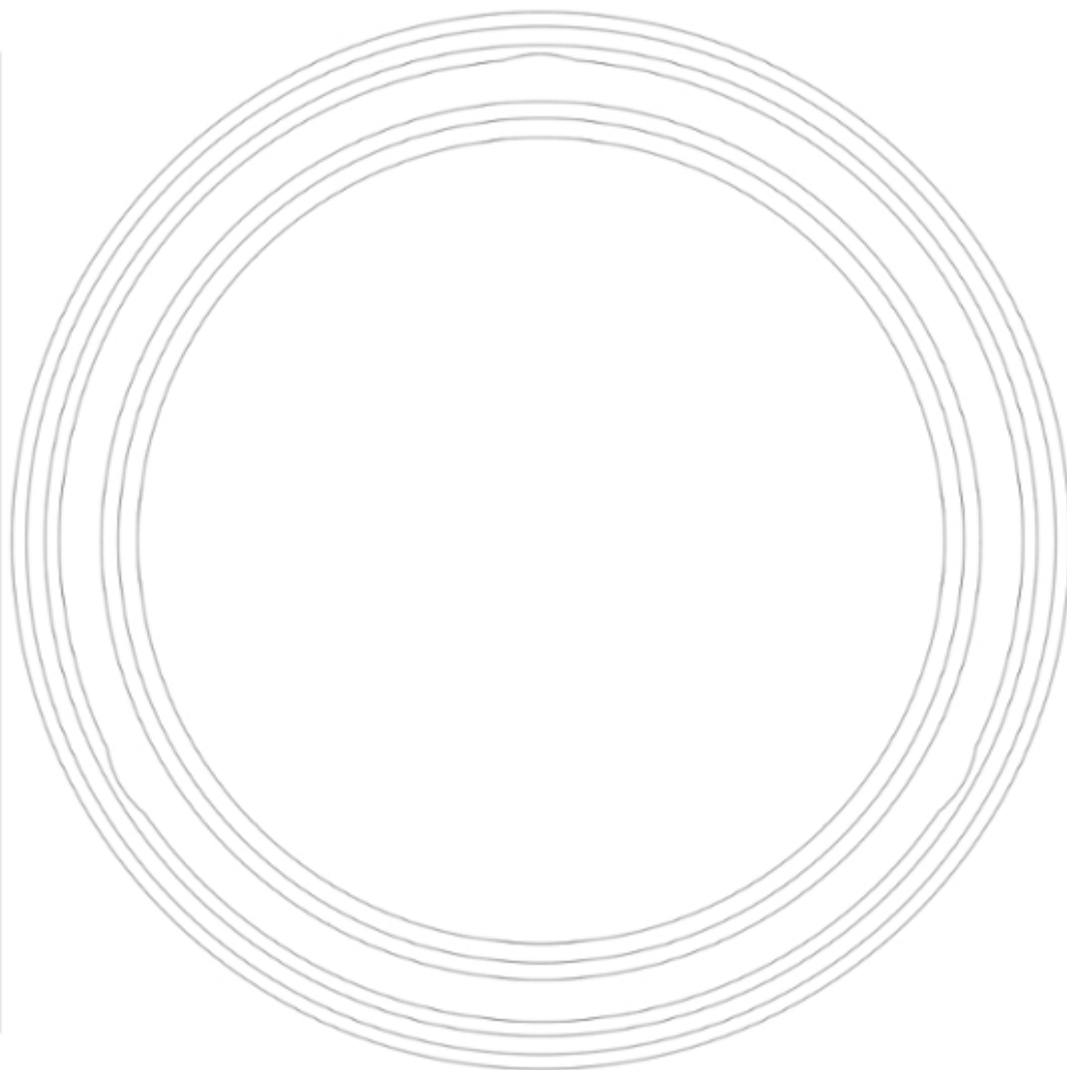
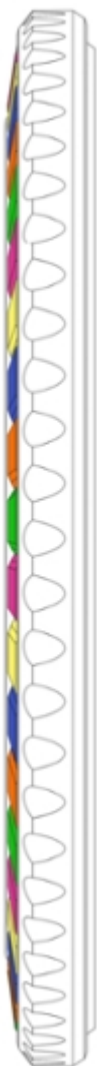

1.7



2.1

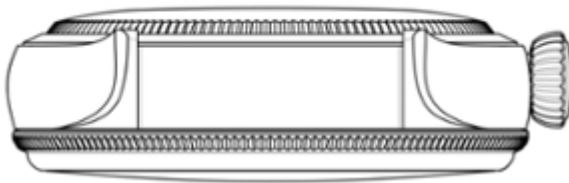

2.2

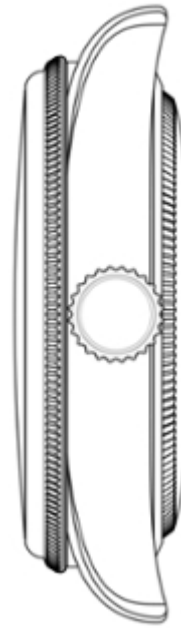

2.3

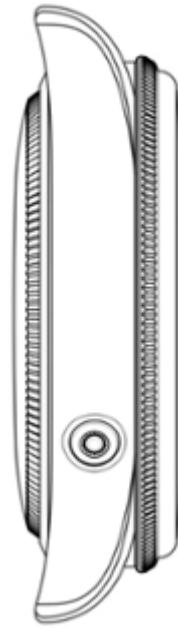

2.4

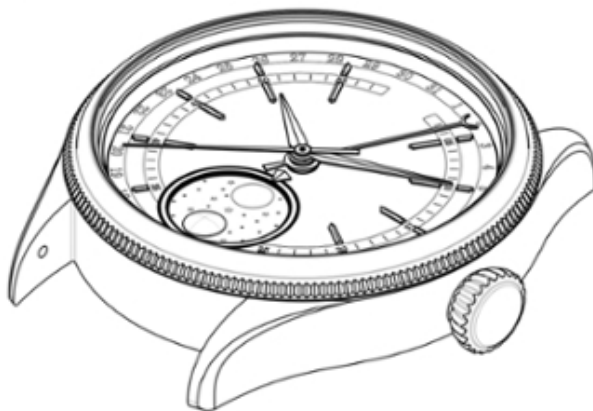

2.5



2.6

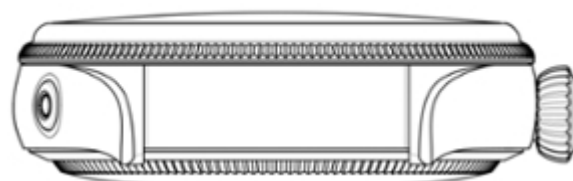

2.7



3.1

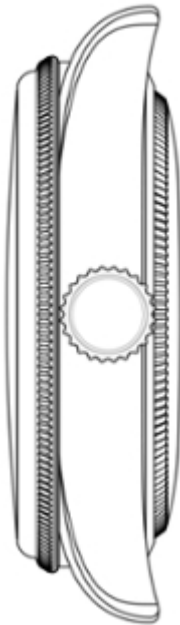

3.3

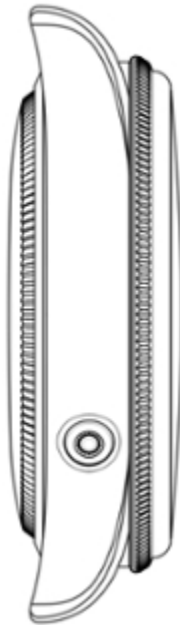

3.2

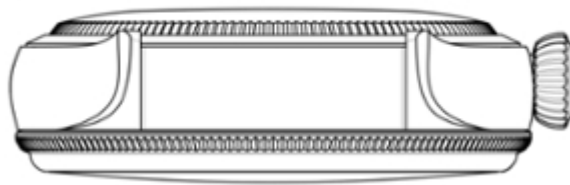

3.4

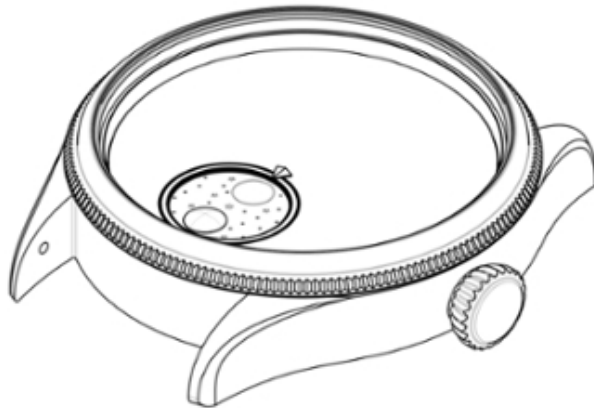

3.5

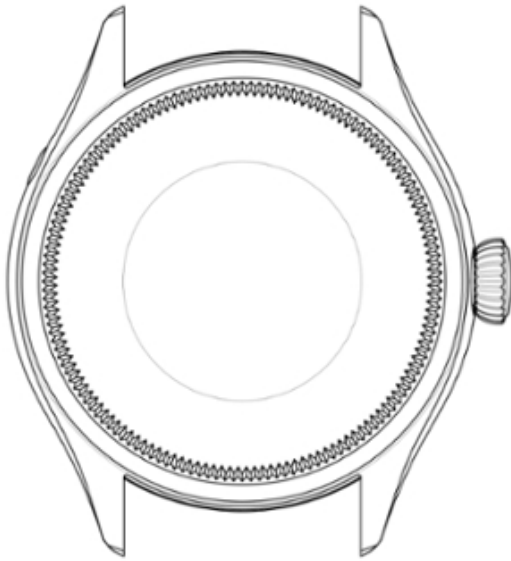

3.6

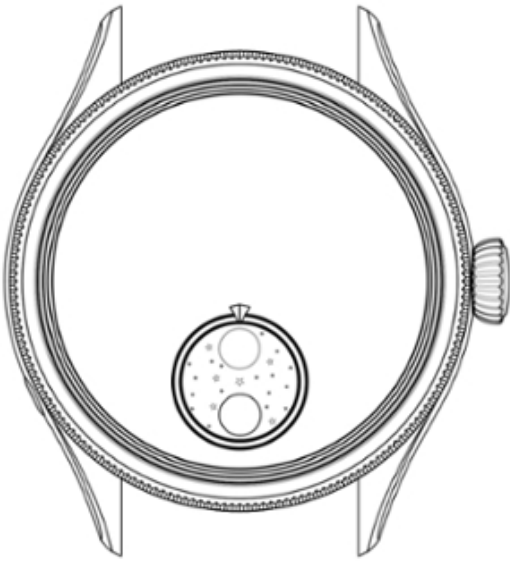

4.1

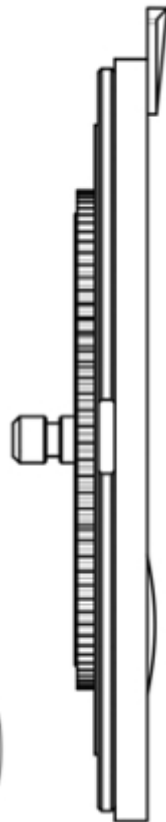

3.7

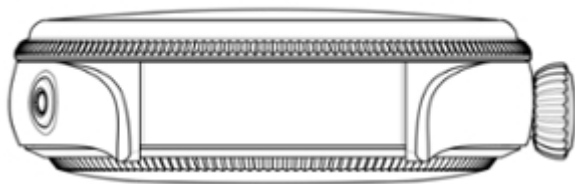

4.2



4.3

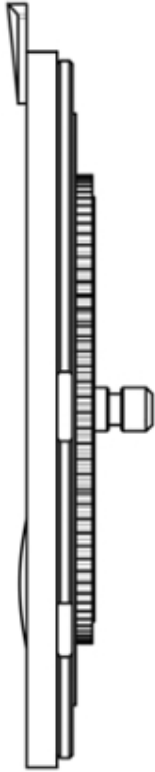

4.4

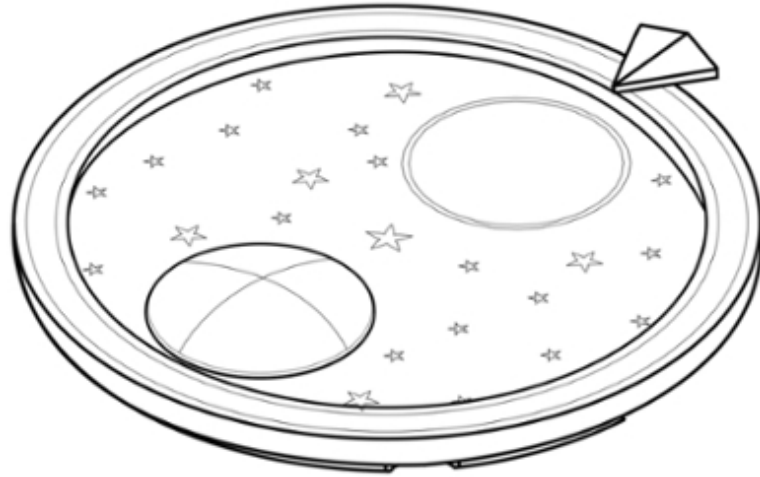

4.5

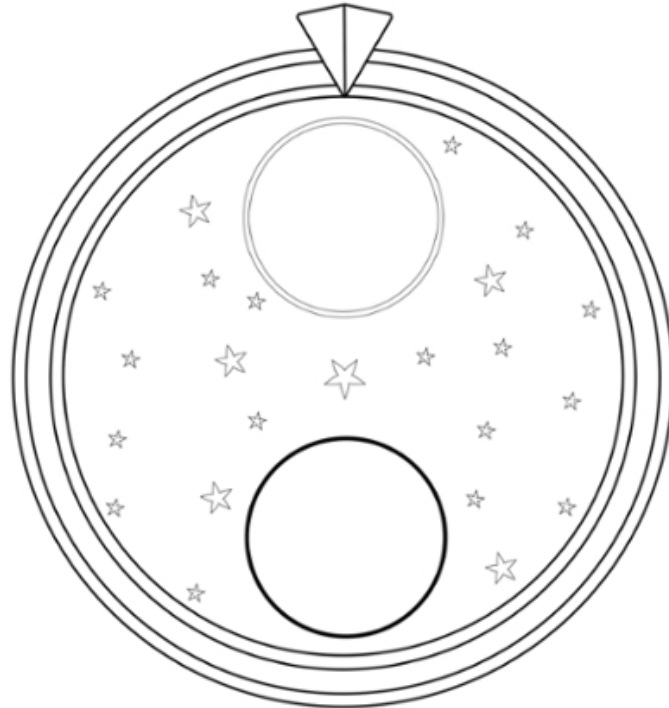

4.6

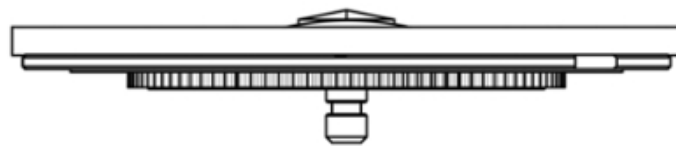

4.7

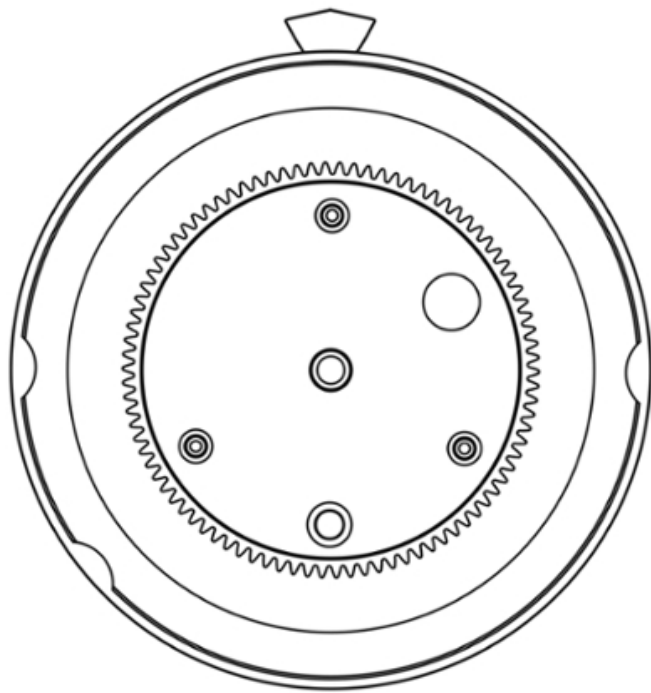

5.1

5.2

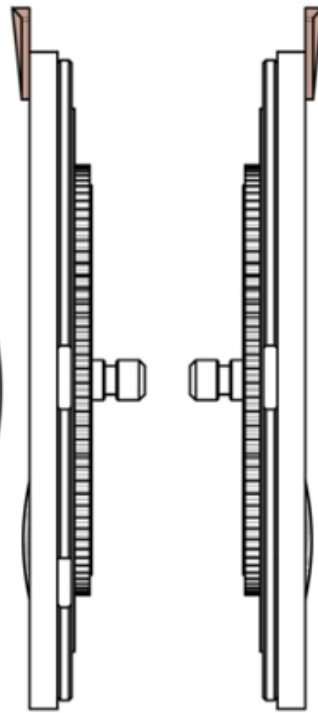

5.3

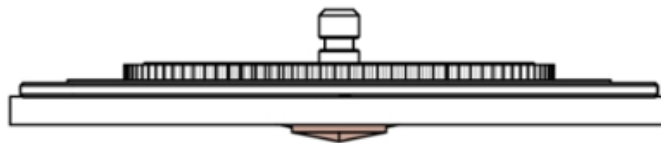

5.4

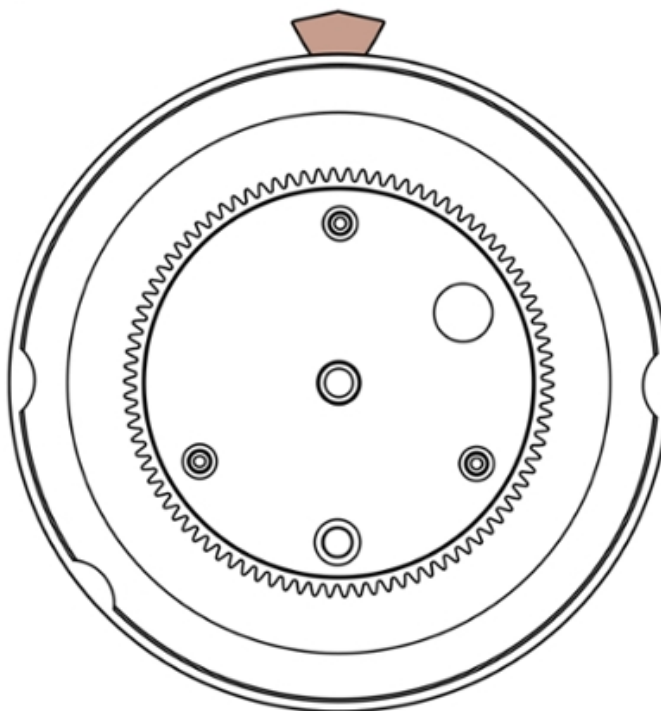

5.5

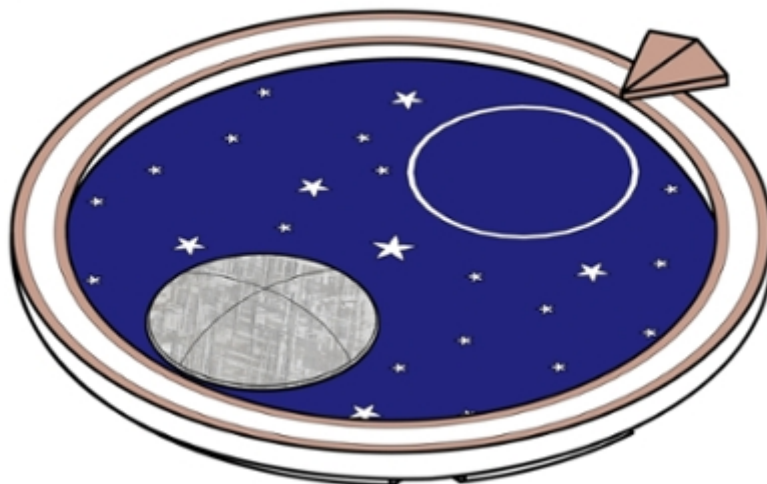

5.6

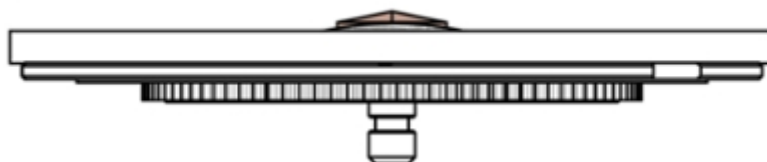

5.7

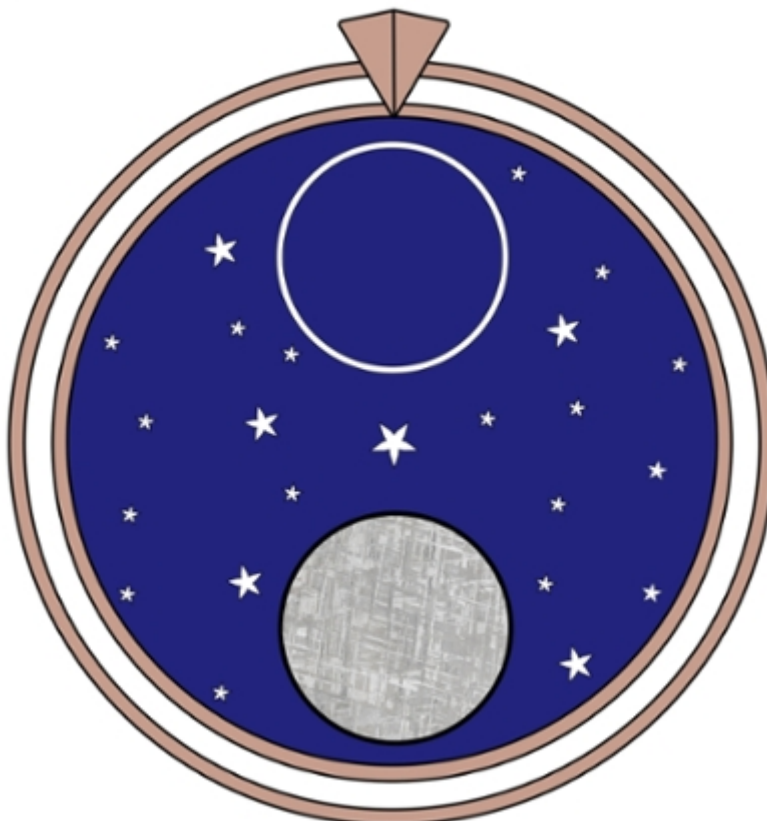

(11) DM/099386

(51) 32-00

(15) 2018 01 12

(45) 2018/04 (2018 02 02)

(22) 2018 01 12

(28) 1

(73) FICOSOTA SYNTEZ OOD

Madara Blvd. 48, BG-9700 SHUMEN (BG)

(85) –

(86) BG, EM

(87) BG, EM

(88) BG, EM

(89) BG

(81) III. AM, EM, GE, MD, MK, RS, TR, UA

(72) Krasen Angelov Kyurkchiev

77 Porek str., 9700 Shumen, Bulgaria

(54) 1. Decorative pattern for surfaces

(55)

1

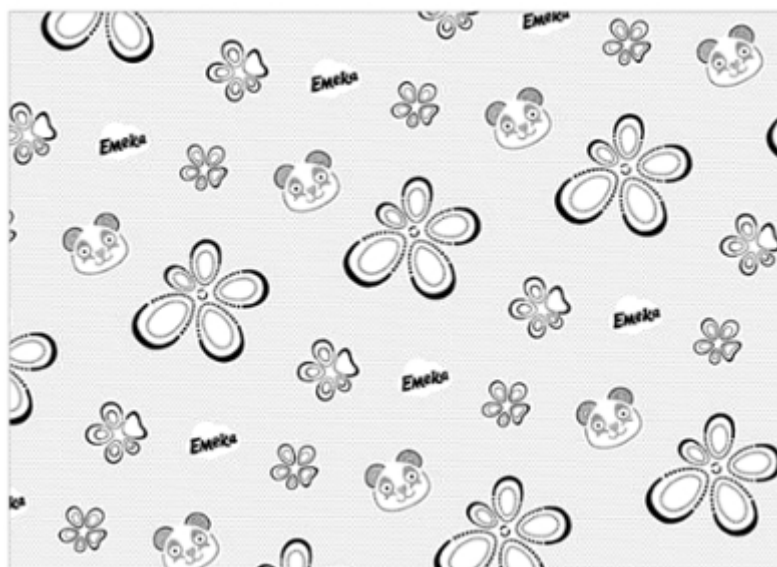

(11) DM/099388 (51) 23-03

(15) 2017 05 24 (45) 2018/04 (2018 02 02)

(22) 2017 05 24 (28) 8

(30)

(73) SC BIODOME EUROPE SRL

Str. Florilor 4, sc. A, ap 20, Sighisoara (RO)

(85) –

(86) RO, EM

(87) RO, EM

(88) RO, EM

(89) RO

(81) III. AL, AM, AZ, BA, GE, MD, ME, MK, RS, TR, UA

(54) 1.-4. Heating boilers; 5. Bowl for pellets for heating boiler; 6. Turbulator for heating boiler;

7.-8. Central heating boilers

(55)

1.1

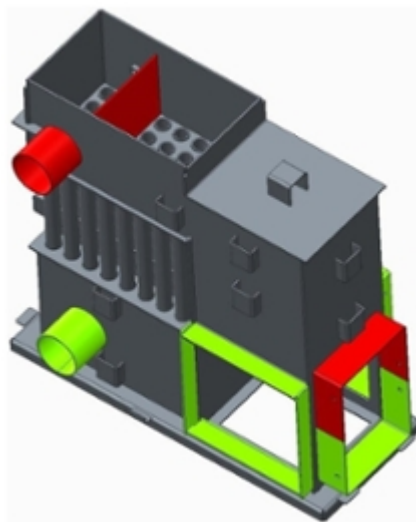

1.2

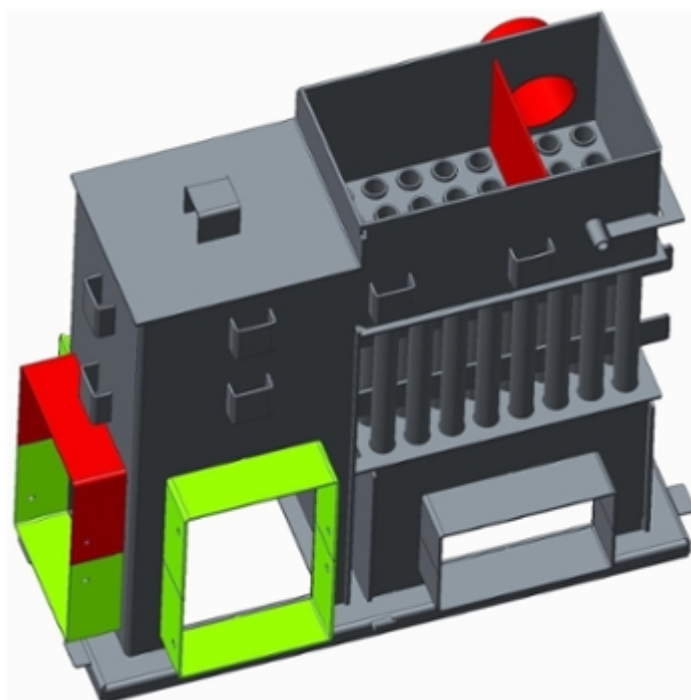

2.1



2.2



3.1

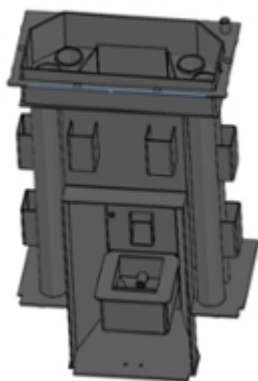

3.2

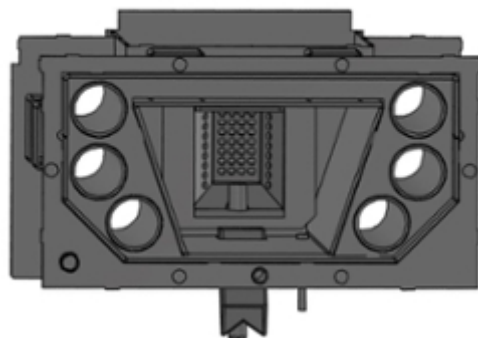

4.1

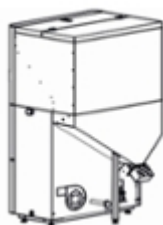

4.2

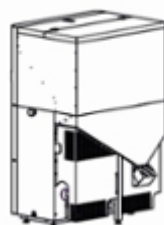

4.3



4.4

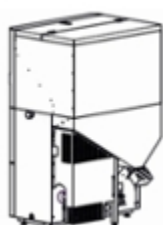

4.5



4.6

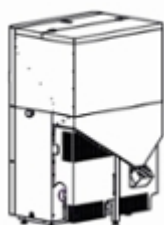

4.7

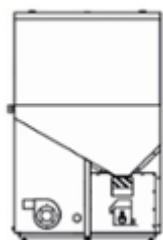

4.8

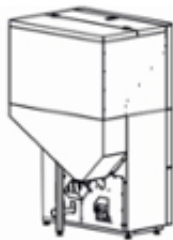

4.9



5.1



5.2



6



7.1



7.2



7.3



7.4



7.5



7.6



7.7



8.1



8.2



8.3

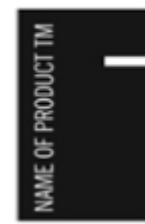

8.4



8.5



8.6



8.7



(11) DM/087133

(15) 2015 08 03

(22) 2015 08 03

(28) 19

(73) SOREMARTEC S.A.

Findel Business Center, Complexe B, Rue de Trèves, L-2632 Findel (LU)

(85) –

(86) BX, EM

(87) BX, EM

(88) BX, EM

(89) EM

(81) III. CH, EG, EM, GE, NA, TR

(54) 1.-15. Packaging envelopes; 16.-18. Packaging; 19. Shaped wrapping [packaging]

(55)

(51) 09-05

(45) 2018/05 (2018 02 09)

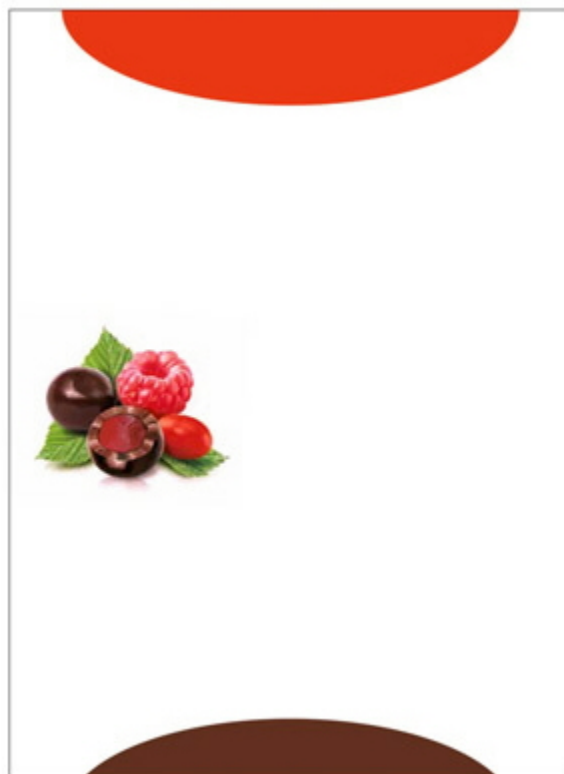
1.1**1.2**

2.1



2.2



3.1



3.2

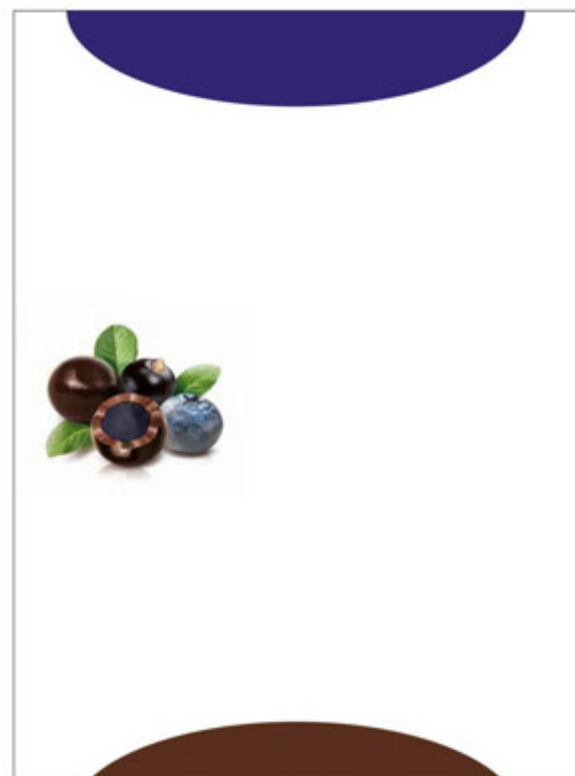

4.1

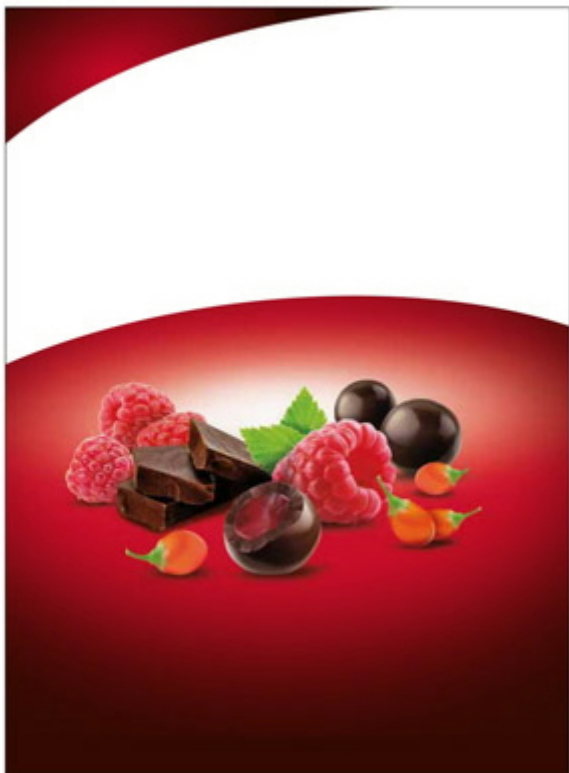

4.2

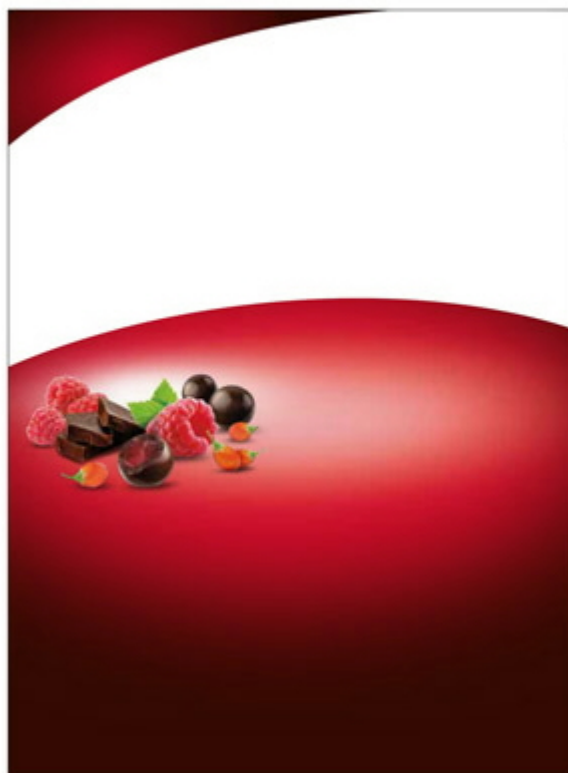

5.1



5.2

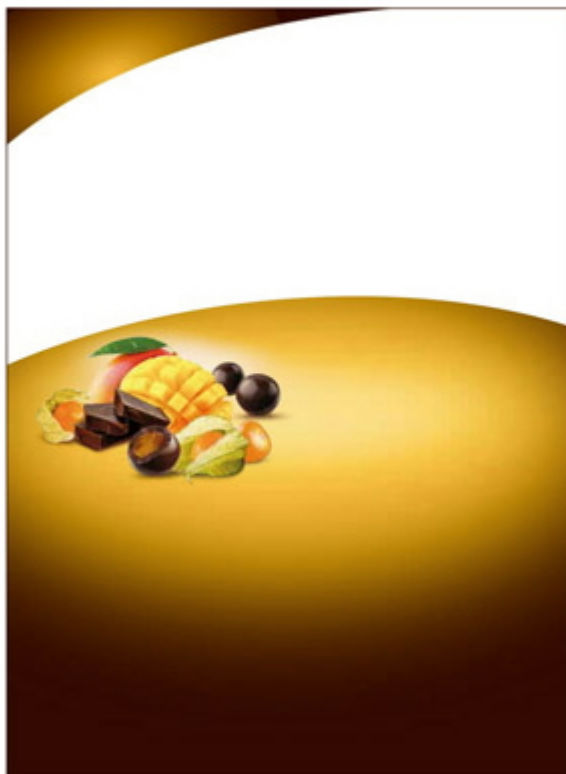

6.1

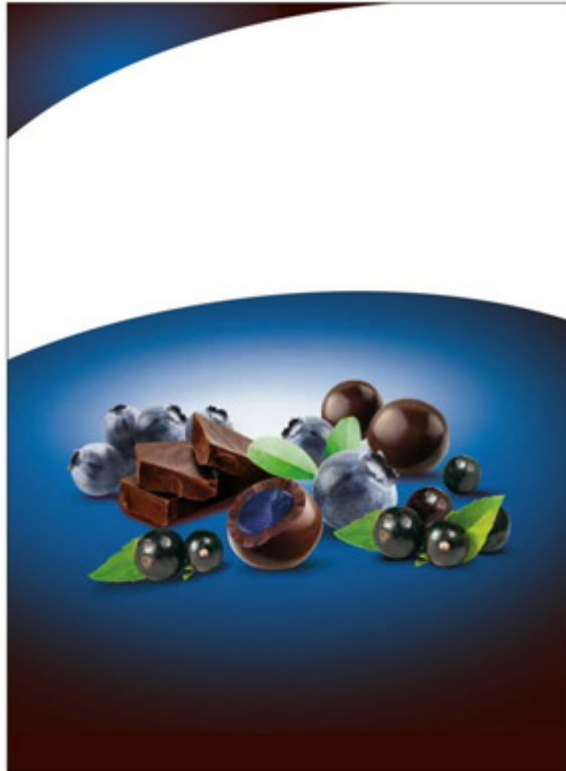

6.2

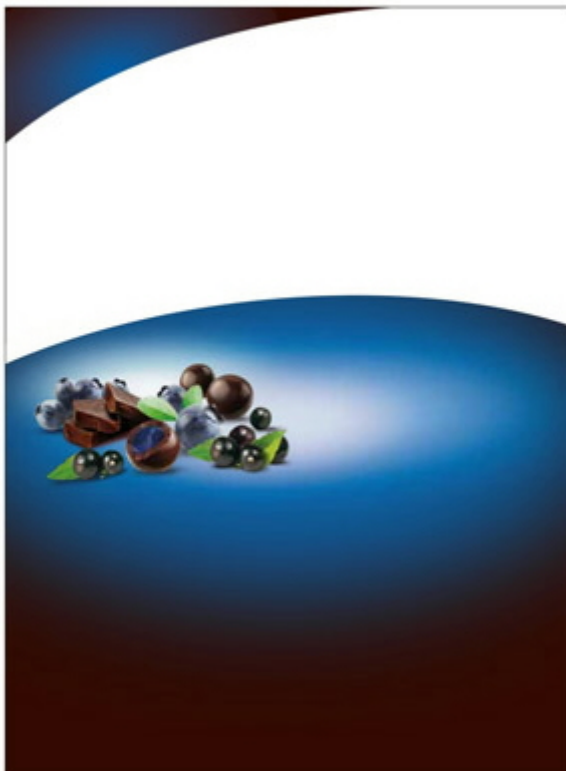

7.1



7.2



8.1



8.2



9.1



9.2

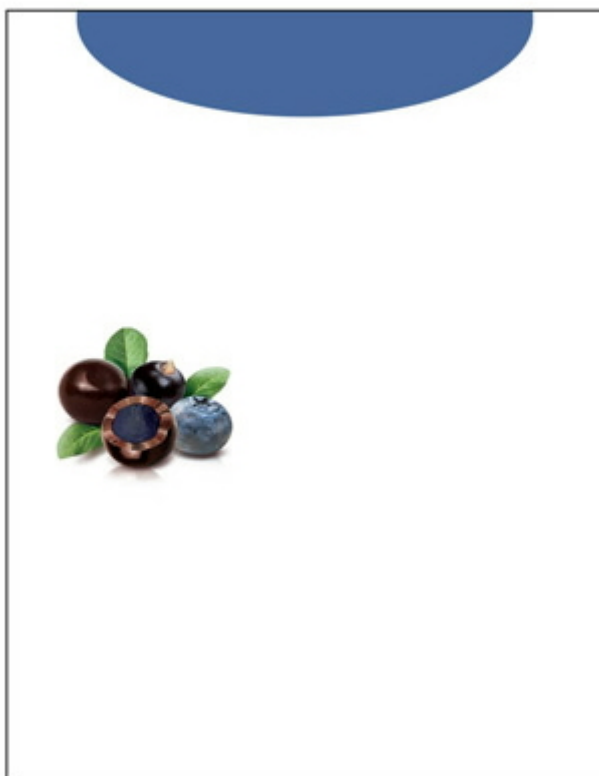

10.1



10.2



10.3



10.4

10.5



10.6

10.7



11.1



11.2



11.3



11.4

11.5



11.6

12.1

11.7



12.2



12.3

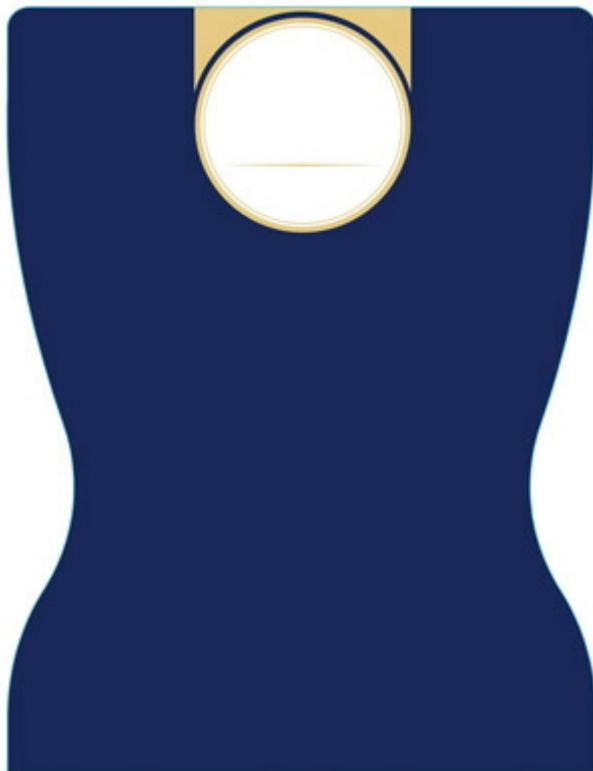

12.4



12.5



12.6



13.1



12.7

13.2



13.3



13.4

13.5



13.6

14.1



13.7

14.2



14.3

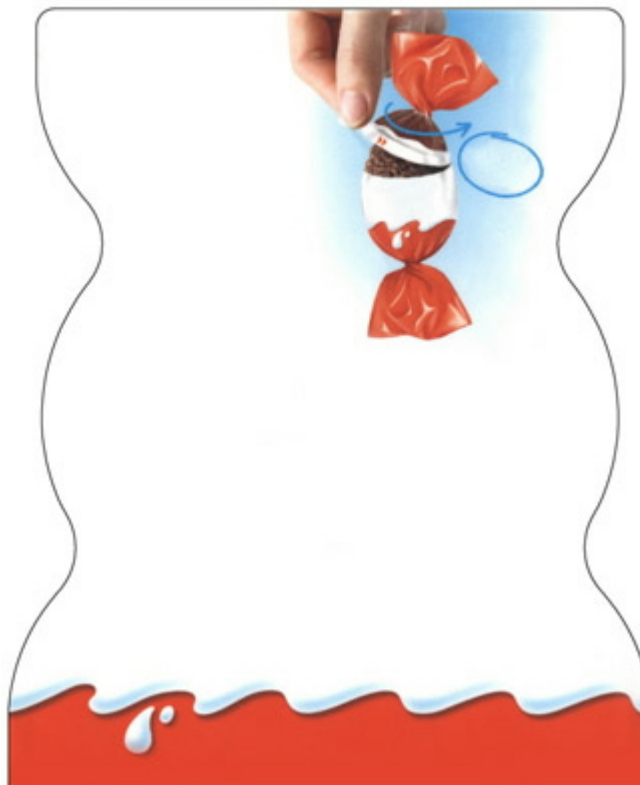

14.6

14.4

14.5



15.1



14.7

15.2



15.3



15.4 15.5



15.6



16.1



16.2



16.3



16.4



16.5



16.6



16.7



17.1



17.2



17.3



17.4



17.5



17.6



17.7



18.1

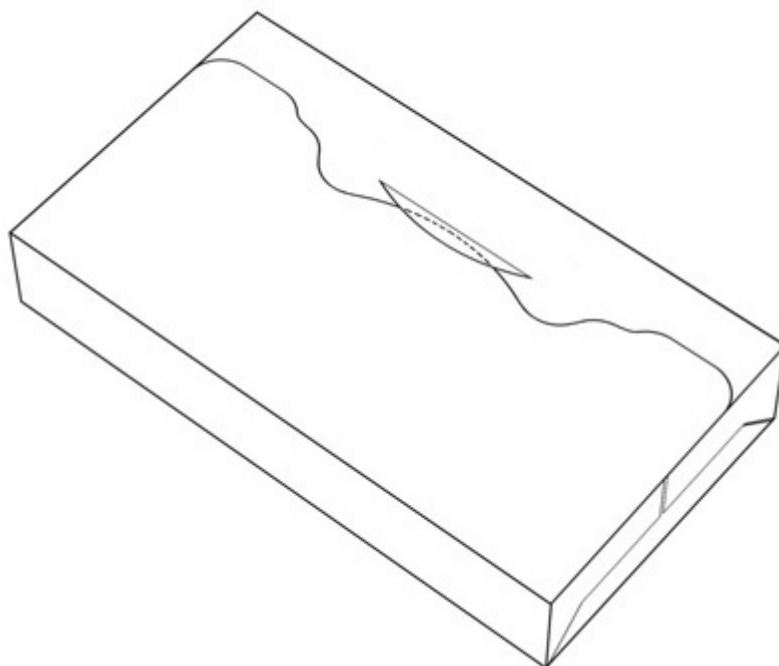

18.2

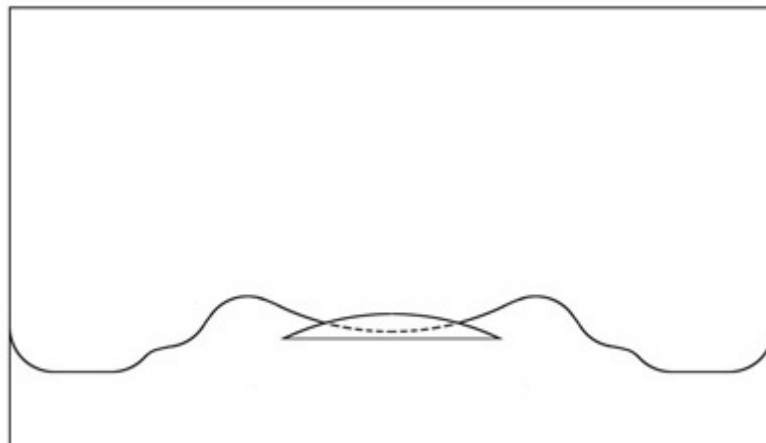

18.4

18.5

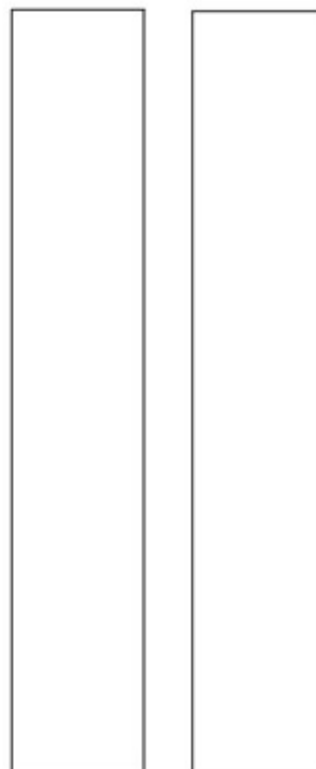

18.3

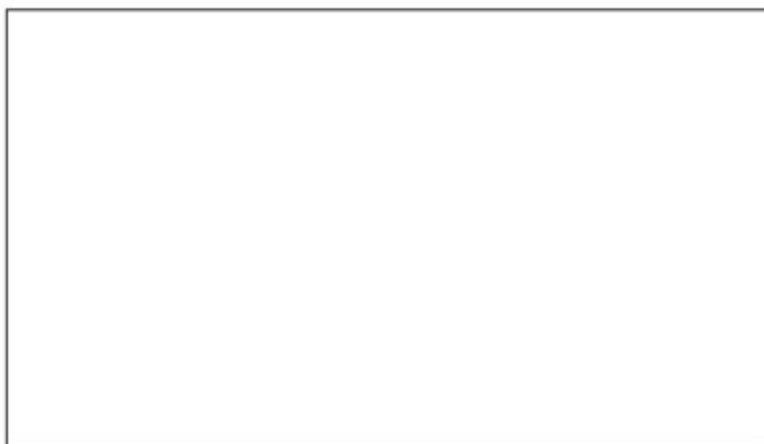

18.6



18.7

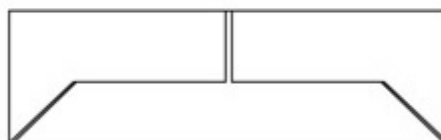

19.1

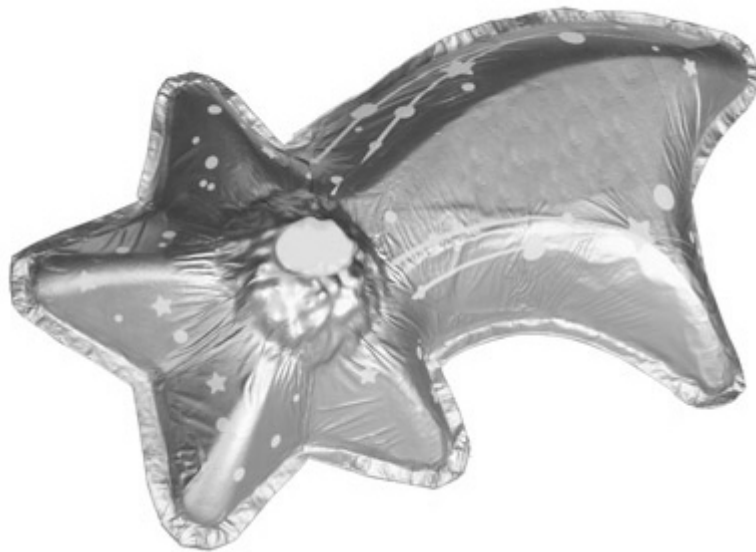

19.2



19.3



19.4



19.5



19.6

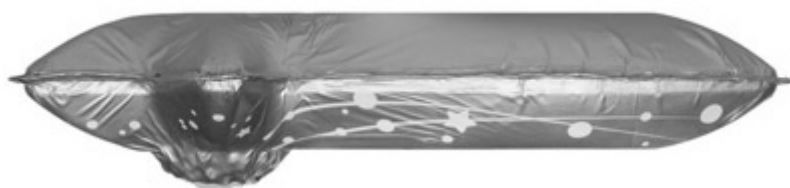

19.7



(11) DM/097355

(51) 32-00

(15) 2017 08 09

(45) 2018/05 (2018 02 09)

(22) 2017 08 09

(28) 4

(73) TISSOT SA (TISSOT AG) (TISSOT LTD)

Chemin des Tourelles 17, CH-2400 Le Locle (CH)

(85) CH

(86) CH

(87) CH

(88) CH

(89) CH

(81) II. BZ, MA III. AL, AM, AZ, BA, CH, EM, GE, KG, LI, MC, MD, ME, MK, MN, NO, OM, SG, TN, TR, UA

(72) Sonia KAYA

5 rue des Moulins, 2000 Neuchâtel, Suisse

(54) 1.-4. Logos to be affixed to all media

(55)

1

SWISSMATIC
2MIS22MVA+IC

2

SWISSMATIC
2MIS22MVA+IC

3

SWISSMATIC
2MIS22MVA+IC

4

SWISSMATIC
2MIS22MVA+IC

(11) DM/099441

(51) 13-03

(15) 2018 01 12

(45) 2018/05 (2018 02 09)

(22) 2018 01 12

(28) 4

(73) MONO ELEKTRİK MALZEMELERİ SANAYİ VE DIŞ TİCARET LİMİTED ŞİRKETİ

Akpinar Sanayi Bölgesi Yassıören Köyü Hadımköy Caddesi No:162, Arnavutköy - İSTANBUL (TR)

(85) TR

(86) TR

(87) TR

(88) TR

(89) TR

(81) III. AZ, BA, CH, EM, GE, GH, HU, KG, MD, ME, MK, NO, RS, TJ, TM, TN, UA

(72) İLKER DOĞAN

Akpinar Sanayi Bölgesi Yassıören Köyü Hadımköy Cad. No:162 Arnavutköy, İSTANBUL, Turkey

(54) 1.-2. Electric plugs; 3. Electrical switch; 4. Electrical socket

(55)

1.1



1.2



1.3



1.4



1.5

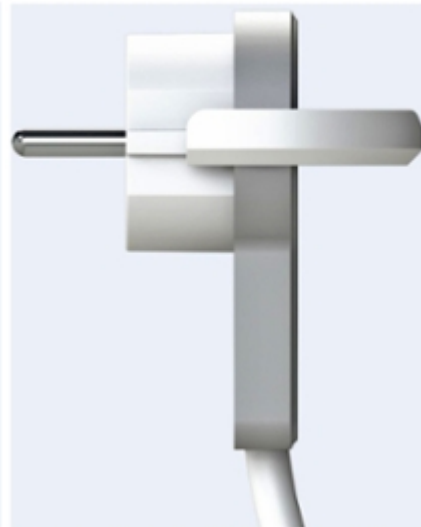

2.1



2.2



2.3



2.4



2.5

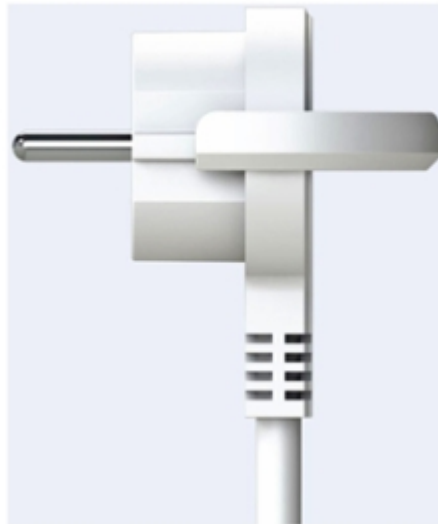

3.1

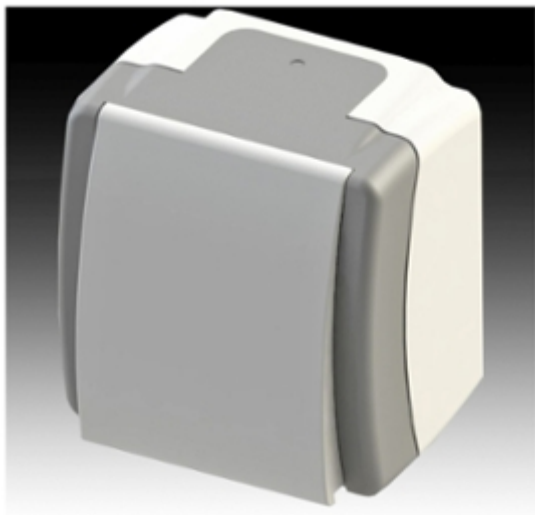

3.2



3.3



3.4



4.1

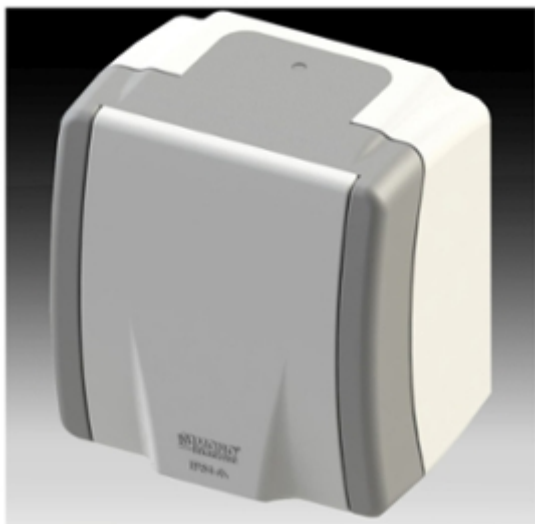

4.2



4.3



4.4



(11) DM/099446

(51) 06-01

(15) 2017 10 12

(45) 2018/05 (2018 02 09)

(22) 2017 10 12

(28) 1

(73) PROSTORIA LTD

Pustodol Začretski 19G, HR-49223 Sveti Križ Začretje (HR)

(85) –

(86) HR, EM

(87) –

(88) –

(89) HR

(81) II. MA, SN III. AM, AZ, BA, CH, EM, GE, GH, IS, JP, KR, LI, MC, MD, ME, MK, NO, OA, OM, RS, SG, TN, TR, UA, US

(72) Simon Morasi Pipercic

Matije Gupca 37, 42220 Novi Marof, Croacia

(54) 1. Lounge chair

(55)

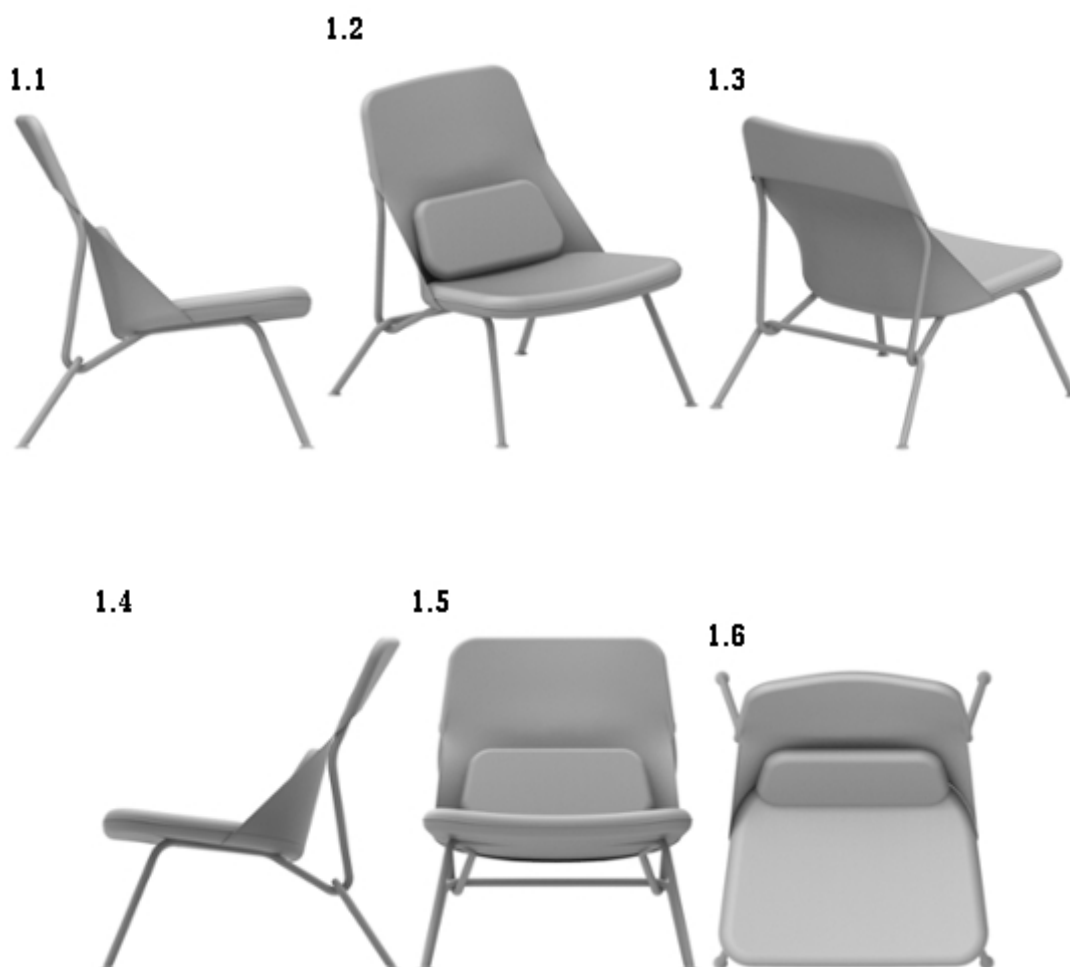

(11) DM/097515**(51) 07-04**

(15) 2017 08 16

(45) 2018/06 (2018 02 16)

(22) 2017 08 16

(28) 2

(73) EDGE OF BELGRAVIA LIMITED

Department 140, 128 Aldersgate street, London EC1A 4LA (GB)

(85) EM

(86) EM

(87) EM

(88) EM

(89) EM

(81) III. AL, AM, AZ, BA, BG, BN, BW, CH, EG, EM, GE, GH, IS, JP, KG, KH, KP, KR, LI, MC, MD, ME, MK, MN, NA, NO, OA, OM, RS, RW, SG, ST, SY, TJ, TM, TN, TR, UA, US

(72) Frederick Ostlund

Department 140 128 Aldersgate street, EC1A 4LA London, United Kingdom

(54) 1.-2. Chopping boards

(55)

1.1**1.2****1.3****1.4****2.1****2.2****2.3****2.4**

(11) DM/099540

(51) 14-02

(15) 2016 07 06

(45) 2018/06 (2018 02 16)

(22) 2016 07 06

(28) 2

(30) 06.01.2016; 29/550,680; US

(73) DOCK TECHNOLOGIES INC.

30 W. Mifflin St. 6th Floor, Madison WI 53703 (US)

(85) US

(86) US

(87) US

(88) -

(89) US

(81) III. AL, AM, AZ, BA, BG, BN, BW, CH, DE, DK, EE, EG, EM, ES, FI, FR, GE, GH, HR, IS, LI, LT, LV, MC, ME, MK, MN, NA, NO, OM, PL, RO, RS, RW, SG, SI, ST, SY, TJ, TM, TN, TR, UA

(72) Sarah R. Sandock

9400 N Spruce Rd., 53217, Madison, US

(54) 1.-2. Wearable display devices

(55)

1.1

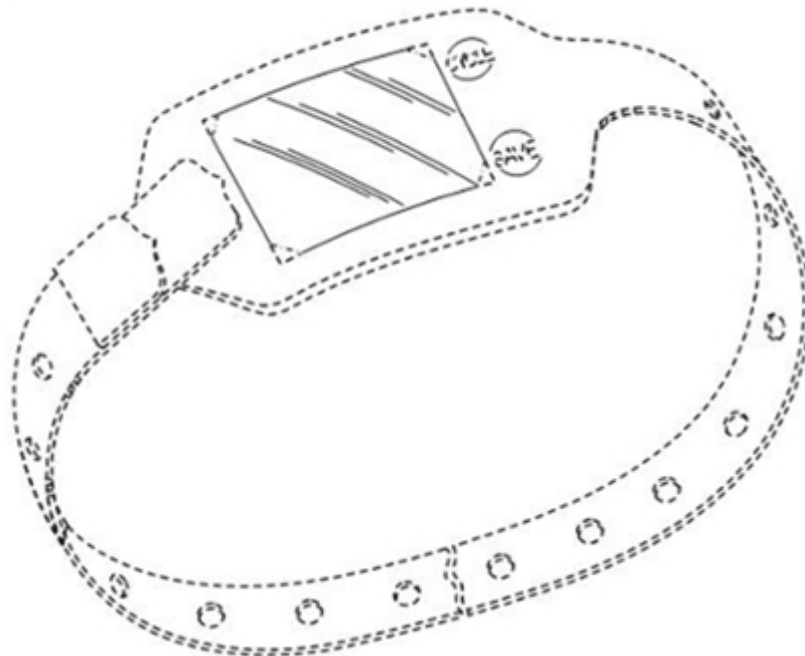

1.2

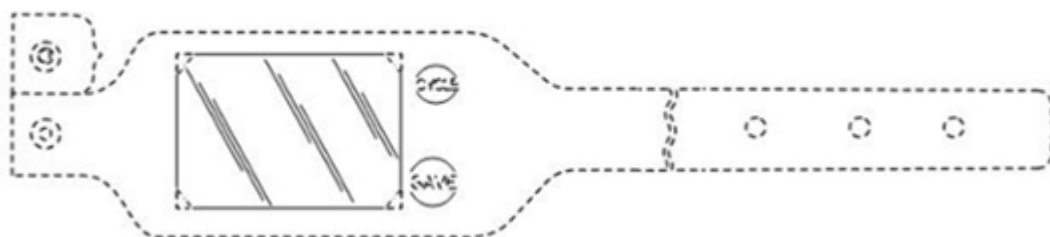

1.3



1.4



1.5



1.6

1.7

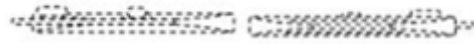

2.1

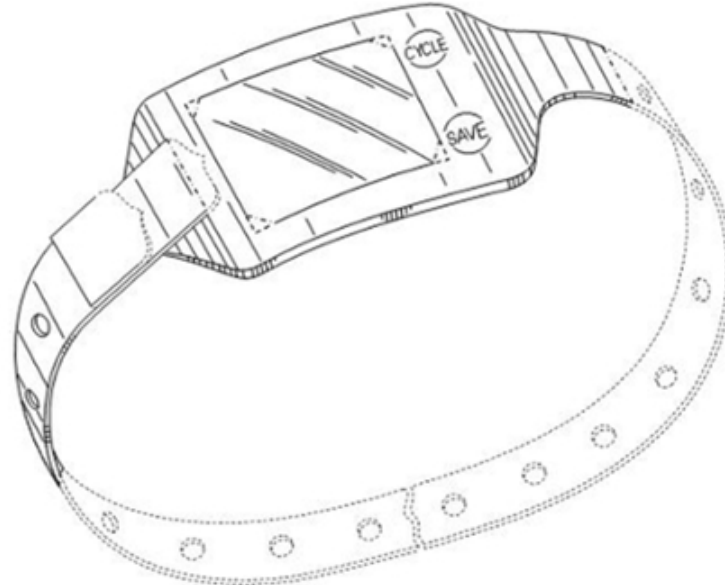

2.2

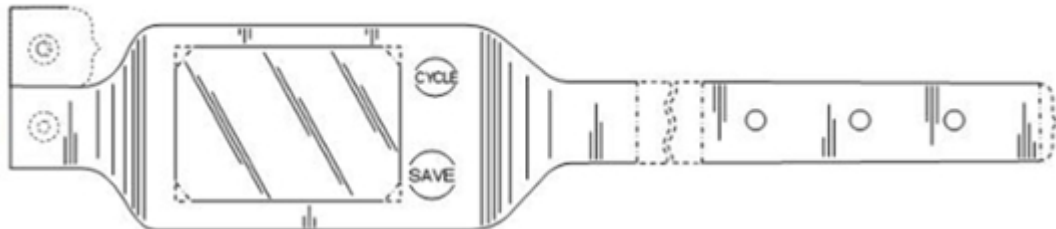

2.3

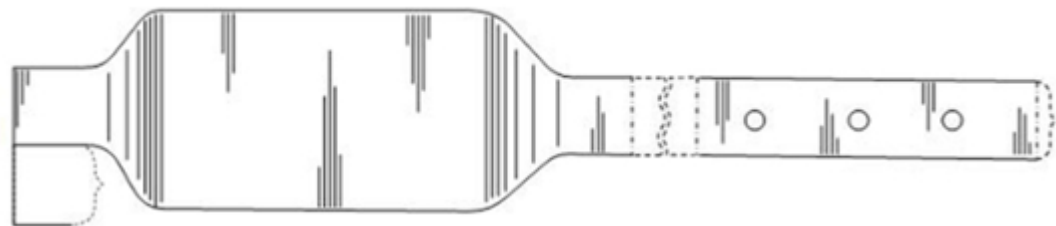

2.4



2.5



2.6

2.7



(11) DM/099541

(51) 14-02

(15) 2016 07 06

(45) 2018/06 (2018 02 16)

(22) 2016 07 06

(28) 2

(30) No. 2: 06.01.2016; 29/550,681; US

(73) DOCK TECHNOLOGIES INC.

30 W. Mifflin St. 6th Floor, Madison WI 53703 (US)

(85) US

(86) US

(87) US

(88) -

(89) US

(81) III. AL, AM, AZ, BA, BG, BN, BW, CH, DE, DK, EE, EG, EM, ES, FI, FR, GE, GH, HR, IS, LI, LT, LV, MC, ME, MK, MN, NA, NO, OM, PL, RO, RS, RW, SG, SI, ST, SY, TJ, TM, TN, TR, UA

(72) Sarah R. Sandock

9400 N Spruce Rd., 53217, Madison, US

(54) 1.-2. Wearable display devices

(55)

1.1

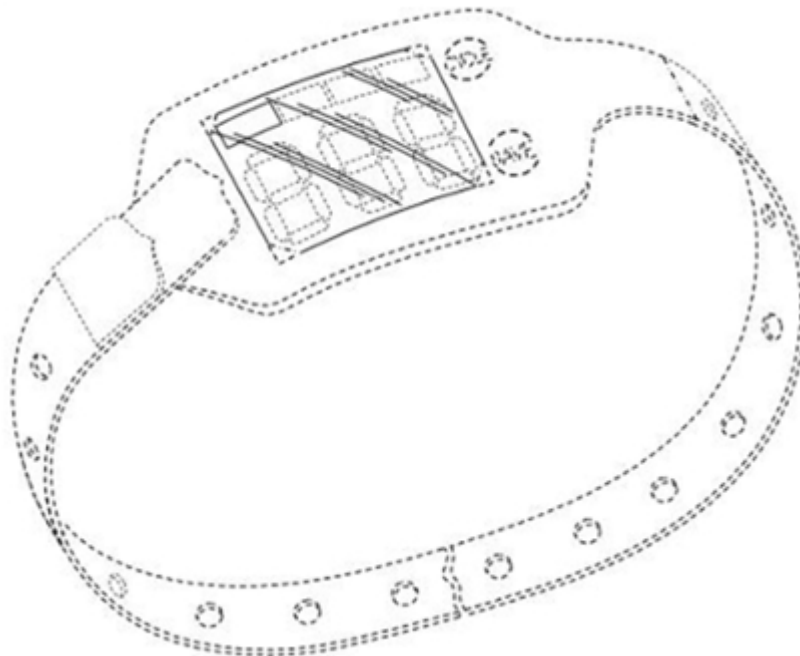

1.2

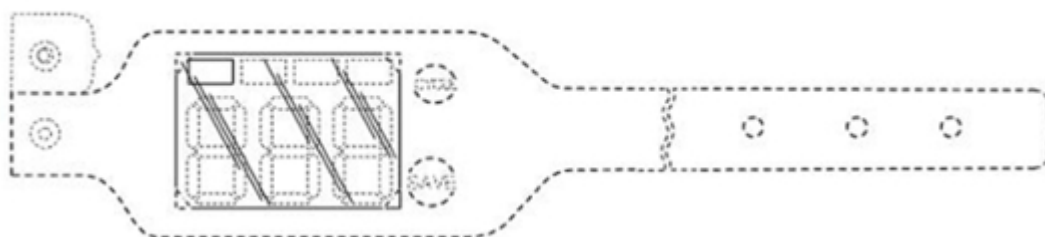

1.3



1.4



1.5



1.6



1.7



2.1

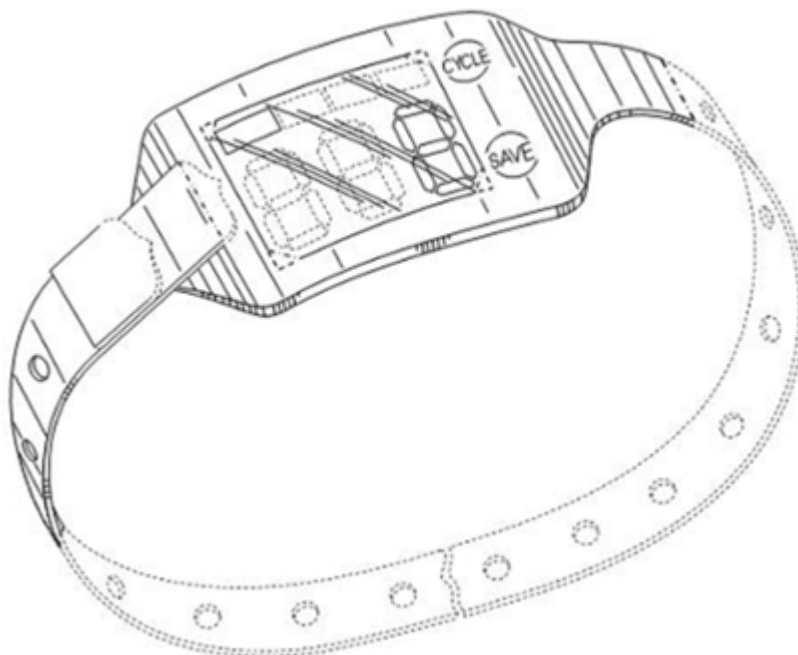

2.2

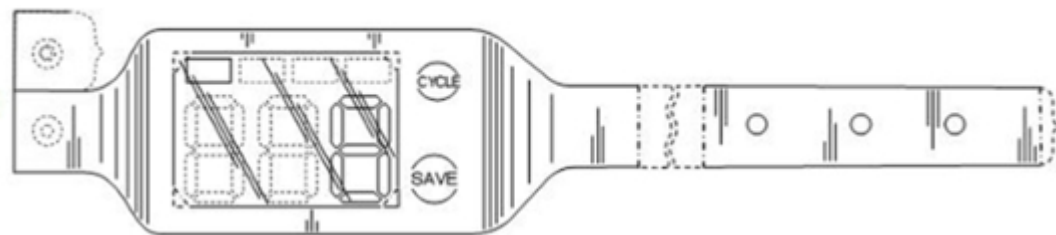

2.3

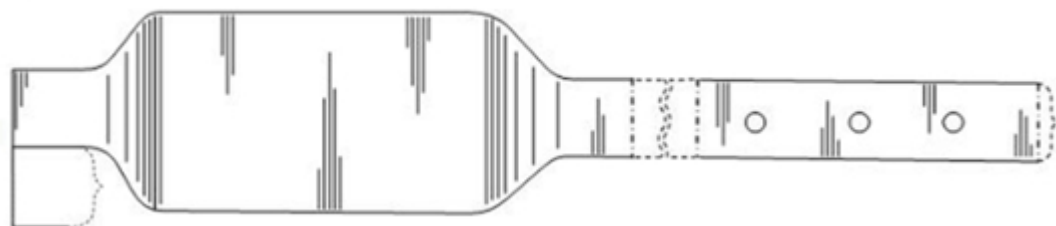

2.4



2.5



2.6



2.7



(11) DM/097817

(15) 2017 08 22

(22) 2017 08 22

(28) 3

(73) EDGE OF BELGRAVIA LIMITED

Dept 140, 128 Aldersgate Street, London EC1A 4AE (GB)

(85) EM

(86) EM

(87) EM

(88) EM

(89) EM

(81) III. AL, AM, AZ, BA, BG, BN, BW, CH, EG, EM, GE, GH, IS, KG, KH, KP, KR, LI, MC, MD, ME, MK, MN, NA, NO, OA, OM, RS, RW, SG, ST, SY, TJ, TM, TN, TR, UA, US

(72) Christian Bird

18 Clerkenwell Close London, EC1R0QN London, United Kingdom

(54) 1.-3. Kitchen knives

(55)

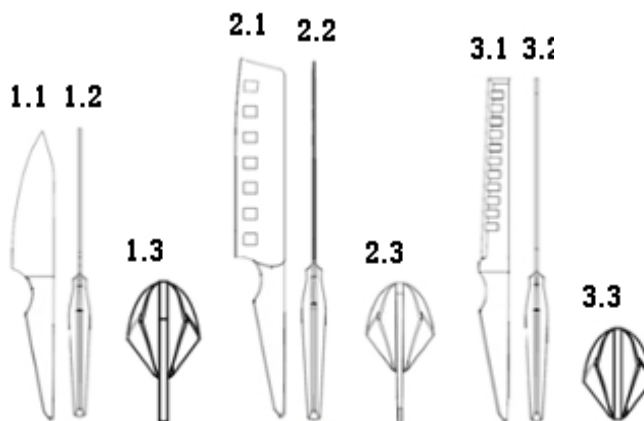

TRADEMARKS

APPLICATIONS FILED UNDER THE NATIONAL PROCEDURE APPROVED FOR REGISTRATION

The decision can be appealed at the Chamber of Appeal of Sakpatenti within 3 months from the publication or at the Mtskheta District Court Administrative Cases Board (Address: №17, Samkhedro St., Mtskheta), within 1 month following the publication.

(260) AM 2018 88282 A
(210) AM 88282
(220) 2016 08 15
(731) LTD "ZHORZHOLIANI TRADING"
Nutsubidzis IV m/r, korp. 17, Saburtalos
r-ni, Tbilisi, Georgia
(540)



(591) Red, blue, golden, white
(531) 02.09.01; 05.13.08; 24.09.07; 25.01.05;
27.05.10; 28.19; 29.01.14
(511) 29, 30, 31, 32, 33, 35, 43

(260) AM 2018 89904 A
(210) AM 89904
(220) 2016 12 12
(731) AVAYA INC.
4655 Great America Parkway, Santa Clara,
California 95054, USA
(740) Shalva Gvaramadze
(540)

ZANG

(511) 9, 42

(260) AM 2018 93221 A
(210) AM 93221
(220) 2017 07 06
(731) JSC "GEPHA"
Sanapiros q. 6, 0108, Tbilisi, Georgia
(740) Salome Jeladze
(540)

ფიზიონორმი – იზოტონიკი
PHYSIONORM – ISOTONIC
ФИЗИОНОРМ – ИЗОТОНИК

(511) 5

(260) AM 2018 93222 A
(210) AM 93222
(220) 2017 07 06
(731) JSC "GEPHA"
Sanapiros q. 6, 0108, Tbilisi, Georgia
(740) Salome Jeladze
(540)

ოტომაქს - ჯი
OTOMAX - G
ОТОМАКС - G

(511) 5

(260) AM 2018 93224 A
(210) AM 93224
(220) 2017 07 06
(731) JSC "GEPHA"
Sanapiros q. 6, 0108, Tbilisi, Georgia
(740) Salome Jeladze
(540)

უნოცეფო
UNOCEF
УНОЦЕФ

(511) 5

(260) AM 2018 93225 A
(210) AM 93225
(220) 2017 07 06
(731) JSC "GEPHA"
Sanapiros q. 6, 0108, Tbilisi, Georgia
(740) Salome Jeladze
(540)

კორვალოლი A
CORVALOL A
КОРВАЛОЛ А

(511) 5

(260) AM 2018 93525 A
(210) AM 93525
(220) 2017 07 27

(731) GÜROK TURİZM VE MADENCİLİK
ANONİM ŞİRKETİ
Eşqishehir Qaraiolu Iuzeri 5. Km. Merqez,
Kütahya, Turkey
(740) Vakhtang Torotadze
(540)

innocam

(591) Black, white
(531) 27.05.17
(511) 21

(260) AM 2018 93818 A
(210) AM 93818
(220) 2017 08 18
(731) DENSO CORPORATION
1-1 Showa-cho, Kariya-city, Aichi-pref, Japan
(740) Shalva Gvaramadze
(540)

DENSO

(591) Black, white
(531) 27.05.17
(511) 42

(260) AM 2018 93840 A
(210) AM 93840
(220) 2017 08 22
(731) GIORGI MACHITIDZE-ALOE VERA
Georgian Individual Entrepreneur
A. Razmadzis q. 34, 0179, Tbilisi, Georgia
(740) Rusudan Goginava
(540)



GEORGE MACHITA

(591) White, black, green
(531) 26.01.18; 26.01.24; 26.11.14; 27.05.10;
27.05.11; 27.05.17; 29.01.13
(511) 5, 32, 35

(260) AM 2018 93913 A
(210) AM 93913
(220) 2017 08 29
(731) ASSUTA MEDICAL CENTERS LTD.
Habarzel St., Tel-Aviv-Yafo, Israel
(740) Natela Otariidze

(540)
ASSUTA
(591) Black, white
(511) 44

(260) AM 2018 93986 A
(210) AM 93986
(220) 2017 09 01
(731) LTD "DOCTOR BUBNOVSKIY CENTER"
M. Kostavas q. 74, b. 66, 0171, Tbilisi,
Georgia
(540)



საბავშვო

(591) Green, blue, white
(531) 26.04.01; 26.04.04; 26.04.05; 26.04.12;
26.04.18; 26.04.24; 27.05.21; 28.19; 29.01.13
(511) 16, 28, 44

(260) AM 2018 94016 A
(210) AM 94016
(220) 2017 09 04
(731) JSC "TELIANI VALLEY"
Tbilisis gzatk. 3, Telavi, Georgia
(740) Tinatin Katsitadze
(540)

mtavruli
mtawruli
მთავრული
МТАВРУЛИ

(511) 32, 33

(260) AM 2018 94055 A
(210) AM 94055
(220) 2017 09 05
(731) LTD "NUR"
Kvantalianis q. 17a, Vashlijvari, 0159, Tbilisi,
Georgia
(540)



(591) Black, white

(531) 24.13.01; 24.13.23; 26.04.02; 26.04.05;
26.04.22; 27.05.08
(511) 7, 8, 11, 21, 35

(260) AM 2018 94063 A
(210) AM 94063
(220) 2017 09 06
(731) BIOPHA
PARC D'ACTIVITE SUD LOIRE,
BOUFFERE, 85612 MONTAIGU Cedex,
France
(740) Pavle Meipariani
(540)

ბიოლანი

(591) Black, white
(511) 3

(260) AM 2018 94168 A
(210) AM 94168
(220) 2017 09 12
(731) VITA SUN LTD
Sut 1, 2 Steishen Qort, Taunmid Roud,
London, United Kingdom
(740) Nugzar Ksovreli
(540)

CLOSUN

(511) 5

(260) AM 2018 94170 A
(210) AM 94170
(220) 2017 09 12
(731) VITA SUN LTD
Sut 1, 2 Steishen Qort, Taunmid Roud,
London, United Kingdom
(740) Nugzar Ksovreli
(540)

GRIPCIL

(511) 5

(260) AM 2018 94171 A
(210) AM 94171
(220) 2017 09 12
(731) VITA SUN LTD
Sut 1, 2 Steishen Qort, Taunmid Roud,
London, United Kingdom
(740) Nugzar Ksovreli
(540)

LACTOPRIM

(511) 5

(260) AM 2018 94177 A
(210) AM 94177
(220) 2017 09 12
(731) VITA SUN LTD
Sut 1, 2 Steishen Qort, Taunmid Roud,
London, United Kingdom
(740) Nugzar Ksovreli
(540)

LIV CARE

(511) 5

(260) AM 2018 94178 A
(210) AM 94178
(220) 2017 09 12
(731) VITA SUN LTD
Sut 1, 2 Steishen Qort, Taunmid Roud,
London, United Kingdom
(740) Nugzar Ksovreli
(540)



(591) Blue, white, yellow, pale yellow, pink,
dark green, light pink, aluminish-blue
(531) 26.01.04; 26.01.06; 26.04.02; 26.04.10;
27.05.24; 29.01.15
(511) 5

(260) AM 2018 94191 A
(210) AM 94191
(220) 2017 09 14
(731) LTD "TELEGRAPH"
D. Aghmasheneblis gamz. 44,
Tchorokhis q. 9, 0144, Tbilisi, Georgia
(540)

ფოსტამტი
postamt

(591) Black, white
(511) 41, 43

(260) AM 2018 94224 A
(210) AM 94224
(220) 2017 09 20
(731) GENEVA LABORATORIES LIMITED
Palm Grove House, P.O. Box 438, Road
Town, Tortola, Virgin Islands (British)
(740) Pavle Meipariani

(540)



(591) Brown, white
 (531) 05.03.13; 05.03.14; 26.11.03; 26.11.08;
 29.01.02
 (511) 3

(260) AM 2018 94254 A
 (210) AM 94254
 (220) 2017 09 20
 (731) LASHA GOGUADZE
 Bakhtrionis q. 13 b. 68, 0194, Tbilisi, Georgia
 (540)



(591) Black, white and yellow
 (531) 01.15.23; 26.04.02; 26.04.22; 26.04.24;
 27.03.15; 27.05.24; 29.01.13
 (511) 9, 34

(260) AM 2018 94259 A
 (210) AM 94259
 (220) 2017 09 21
 (731) JSC "GEPHA"
 Sanapiros q. 6, 0108, Tbilisi, Georgia
 (740) Salome Jeladze
 (540)

el-Rx

(511) 9, 35

(260) AM 2018 94260 A
 (210) AM 94260
 (220) 2017 09 21
 (731) JSC "GEPHA"
 Sanapiros q. 6, 0108, Tbilisi, Georgia
 (740) Salome Jeladze
 (540)

e-Rx

(511) 9, 35

(260) AM 2018 94261 A
 (210) AM 94261
 (220) 2017 09 21
 (731) JSC "GEPHA"
 Sanapiros q. 6, 0108, Tbilisi, Georgia
 (740) Salome Jeladze
 (540)

eRx

(591) Black, white
 (511) 9, 35

(260) AM 2018 94309 A
 (210) AM 94309
 (220) 2017 09 25
 (731) LTD "PARK GIDA"
 S. Khutsubani, me-5 ubani q. 46a, 6200,
 Kobuleti, Georgia
 (740) Dato Jaiani
 (540)

avante
 ავანთე

(511) 32

(260) AM 2018 94310 A
 (210) AM 94310
 (220) 2017 09 26
 (731) HARRINGTON DEVELOPMENT INC.
 Elvira Mendesis Striti, Valarino Bldg, Me-3
 Sart., Panamis Respublika, Panama
 (740) Givi Akopashvili
 (540)



(531) 26.01.02; 26.01.18; 26.04.10; 26.04.22;
 26.04.24; 27.05.21; 27.05.24; 28.07
 (511) 35, 37

(260) AM 2018 94314 A
 (210) AM 94314
 (220) 2017 09 26
 (731) LTD "IBERWINE"
 Al. Kazbegis gamz. 12a, 0160, Tbilisi,
 Georgia
 (740) Tamar Tchavtchanidze

(540)



ნაბერაული
NABERAULI

(591) Terracotta
(531) 05.07.10; 26.01.15; 26.01.18; 27.05.21; 28.19;
29.01.01; 29.01.02
(511) 29, 30, 32, 33, 43

(260) AM 2018 94315 A
(210) AM 94315
(220) 2017 09 26
(731) LTD "IBERVAINI"
Al. Kazbegis Gamz. 12a, 0160, Tbilisi,
Georgia
(740) Tamar Tchavtchanidze
(540)



MESTUMRE

(591) Golden
(531) 27.05.01; 28.19; 29.01.02
(511) 39, 43

(260) AM 2018 94316 A
(210) AM 94316
(220) 2017 09 26
(731) LTD "IBERVAINI"
Al. Kazbegis Gamz. 12a, 0160, Tbilisi,
Georgia
(740) Tamar Tchavtchanidze
(540)



ენკობაქტერიოფაგი

(591) Golden
(531) 28.19; 29.01.02
(511) 39, 43

(260) AM 2018 94318 A
(210) AM 94318
(220) 2017 09 26
(731) TYCO FIRE PRODUCTS LP
1400 Pennbrook Parkway, Lansdale,
Pennsylvania 19446, USA
(740) Shalva Gvaramadze
(540)

R-102

(591) Black, white
(511) 9

(260) AM 2018 94333 A
(210) AM 94333
(220) 2017 09 27
(731) SKY ZONE, LLC
1201 W. Fifth Street, Suite T-340,
Los Angeles, CA 90017, USA
(740) Merab Kvimsadze
(540)



(591) Black, white
(531) 26.04.09; 26.04.18; 26.04.24; 27.05.23;
27.05.24
(511) 25, 35, 41

(260) AM 2018 94348 A
(210) AM 94348
(220) 2017 09 28
(731) LIA TKEMALADZE
Tashkents q. 31, 0160, Tbilisi, Georgia;
NANA TOPURIA-NAKAIDZE
Paliashvilis q. 72, b. 30, 0179, Tbilisi, Georgia;
TARASI GABISONIA
I. Tchavtchavadzis gamz. 39b, 0162, Tbilisi,
Georgia;
INGA GIORGADZE
I. Nikoladzis q. 7, 0179, Tbilisi, Georgia;
LEPL G. Eliava Institute of Bacteriophage,
Microbiology and Virusology
Gotuas q. 3, 0160, Tbilisi, Georgia
(540)

ენკო ბაქტერიოფაგი
Enko Bacteriophage

(511) 5

(260) AM 2018 94349 A
 (210) AM 94349
 (220) 2017 09 28
 (731) LIA TKEMALADZE
 Tashkentis q. 31, 0160, Tbilisi, Georgia;
 NANA TOPURIA-NAKAIDZE
 Paliashvilis q. 72, b. 30, 0179, Tbilisi, Georgia;
 TARASI GABISONIA
 I. Tchavtchavadzis gamz. 39b, 0162, Tbilisi,
 Georgia;
 INGA GIORGADZE
 I. Nikoladzis q. 7, 0179, Tbilisi, Georgia;
 LEPL G. Eliava Institute of Bacteriophage,
 Microbiology and Virusology
 Gotuas q. 3, 0160, Tbilisi, Georgia

(540)

ფერსისი ბაქტერიოფაგი
Fersisi Bacteriophage

(511) 5

(260) AM 2018 94350 A
 (210) AM 94350
 (220) 2017 09 28
 (731) LIA TKEMALADZE
 Tashkentis q. 31, 0160, Tbilisi, Georgia;
 NANA TOPURIA-NAKAIDZE
 Paliashvilis q. 72, b. 30, 0179, Tbilisi, Georgia;
 TARASI GABISONIA
 I. Tchavtchavadzis gamz. 39b, 0162, Tbilisi,
 Georgia;
 INGA GIORGADZE
 I. Nikoladzis q. 7, 0179, Tbilisi, Georgia;
 LEPL G. Eliava Institute of Bacteriophage,
 Microbiology and Virusology
 Gotuas q. 3, 0160, Tbilisi, Georgia

(540)

სეს ბაქტერიოფაგი
SES Bacteriophage

(511) 5

(260) AM 2018 94356 A
 (210) AM 94356
 (220) 2017 09 29
 (731) REIMA OY
 Karhumaentie 3, 01530 Vantaa, Finland
 (740) Giorgi Taktakishvili

(540)

REIMA

(591) Black, white
 (511) 18, 25

(260) AM 2018 94358 A
 (210) AM 94358
 (220) 2017 09 29
 (731) LTD "VIP TRANS"
 Z. Paliashvilis q. 21, 0186, Akhaltsikhe,
 Georgia

(540)

 The logo for 'VIP trans' features the word 'VIP' in a large, bold, blue font with a white dashed outline, and the word 'trans' in a smaller, pink, lowercase font. A horizontal dashed line is positioned below the text.

(591) Blue, white, pink
 (531) 26.11.14; 27.05.10; 27.05.11; 27.05.23;
 29.01.13

(511) 39

(260) AM 2018 94372 A
 (210) AM 94372
 (220) 2017 10 02
 (731) BANANA REPUBLIC (ITM) INC.
 2 Folsom Striti, San-francisko, 94105
 Kalifornia, USA

(740) Tamar Kochlamazashvili

(540)



(591) Black, white
 (531) 03.02.01
 (511) 25

REGISTERED TRADEMARKS

(111) M 2018 29570 R
 (151) 2018 05 02
 (181) 2028 05 02
 (260) AM 2015 80183 A
 (220) 2015 01 12
 (732) BEKA GREMELASHVILI
 Shavgulidzis q. 7a, b.30, 0183, Tbilisi, Georgia

(111) M 2018 29576 R
 (151) 2018 05 02
 (181) 2028 05 02
 (260) AM 2017 90774 A
 (220) 2017 02 09
 (732) LTD "BINADARI"
 Nutsubidzis q. 60, b. 13, 0186, Tbilisi, Georgia

(111) M 2018 29571 R
 (151) 2018 05 02
 (181) 2028 05 02
 (260) AM 2015 84931 A
 (220) 2015 11 30
 (732) LTD "MARS"
 Imedadzis q. 41, 0162, Tbilisi, Georgia

(111) M 2018 29577 R
 (151) 2018 05 02
 (181) 2028 05 02
 (260) AM 2017 90863 A
 (220) 2017 02 15
 (732) LEVAN LASHKARASHVILI
 Sanzona, Gudamakris q. 10, 0141, Tbilisi, Georgia

(111) M 2018 29572 R
 (151) 2018 05 02
 (181) 2028 05 02
 (260) AM 2016 86965 A
 (220) 2016 04 11
 (732) Homag Group AG.
 Homagstrasse 3-5 D-72296 Schopfloch,
 Germany

(111) M 2018 29578 R
 (151) 2018 05 02
 (181) 2028 05 02
 (260) AM 2017 90869 A
 (220) 2017 02 16
 (732)) LTD "GARDABANI THERMAL PLANT 2"
 D. Aghmasheneblis q. 2b, 1300, Gardabani, Georgia

(111) M 2018 29573 R
 (151) 2018 05 02
 (181) 2028 05 02
 (260) AM 2016 89879 A
 (220) 2016 12 08
 (732) EUOPHARMA GEORGIA
 Machabelis q. 5, 0114, Tbilisi, Georgia

(111) M 2018 29580 R
 (151) 2018 05 03
 (181) 2028 05 03
 (260) AM 2017 90871 A
 (220) 2017 02 17
 (732) LTD "ORI NABIJI"
 Navtlughis q. 39/41, Tbilisi, Georgia

(111) M 2018 29574 R
 (151) 2018 05 02
 (181) 2028 05 02
 (260) AM 2017 90451 A
 (220) 2017 01 17
 (732) LEVAN KALMAKHELIDZE
 Nucubidzis 3 mkr., I kvart., korp. 8 , b. 24,
 0183, Tbilisi, Georgia

(111) M 2018 29581 R
 (151) 2018 05 03
 (181) 2028 05 03
 (260) AM 2017 90876 A
 (220) 2017 02 17
 (732) E. I. DU PONT DE NEMOURS AND
 COMPANY
 Chestnut Run Plaza, 974 Centre Road,
 Wilmington, DE 19805, USA

(111) M 2018 29575 R
 (151) 2018 05 02
 (181) 2028 05 02
 (260) AM 2017 90762 A
 (220) 2017 02 08
 (732) LTD "NIKALA"
 Qucha I kheivani, 12, 0114, Tbilisi, Georgia

(111) M 2018 29582 R
 (151) 2018 05 03
 (181) 2028 05 03
 (260) AM 2017 90877 A
 (220) 2017 02 17
 (732) E. I. DU PONT DE NEMOURS AND COMPANY
 Chestnut Run Plaza, 974 Centre Road,
 Wilmington, DE 19805, USA

(111) M 2018 29583 R
(151) 2018 05 03
(181) 2028 05 03
(260) AM 2017 90929 A
(220) 2017 02 20
(732) LTD "TFILISI"
Vazha-Pshavelas gamz., VII kvart., korp. 23,
b. 31a, Georgia

(111) M 2018 29584 R
(151) 2018 05 03
(181) 2028 05 03
(260) AM 2017 90953 A
(220) 2017 02 22
(732) LTD "SHATEAU GREMI"
Budapeshtis q. 6, b. 28, Tbilisi, Georgia

(111) M 2018 29585 R
(151) 2018 05 03
(181) 2028 05 03
(260) AM 2017 91066 A
(220) 2017 02 28
(732) CHOICE HOTELS INTERNATIONAL INC.
1 Choice Hotels Circle, Rockville, Maryland
20850, USA

(111) M 2018 29586 R
(151) 2018 05 03
(181) 2028 05 03
(260) AM 2017 91083 A
(220) 2017 03 01
(732) LTD "GEOMIL"
Chirnakhulis q. 4, 0151, Tbilisi, Georgia

(111) M 2018 29587 R
(151) 2018 05 03
(181) 2028 05 03
(260) AM 2017 91084 A
(220) 2017 03 01
(732) LTD "GEOMIL"
Chirnakhulis q. 4, 0151, Tbilisi, Georgia

(111) M 2018 29588 R
(151) 2018 05 03
(181) 2028 05 03
(260) AM 2017 91132 A
(220) 2017 03 06
(732) LTD "AGROKARTLI"
Tskhinvalis gzatk. 4, 1400, Gori, Georgia

(111) M 2018 29589 R
(151) 2018 05 03
(181) 2028 05 03

(260) AM 2017 91155 A
(220) 2017 03 07
(732) IE "ALINA KAZANDJYAN – ONEGIN
ROOMS"
Al. Kazbegis gamz. 33, b. 1, 0177, Tbilisi,
Georgia

(111) M 2018 29590 R
(151) 2018 05 03
(181) 2028 05 03
(260) AM 2017 91189 A
(220) 2017 03 10
(732) ALTECO CHEMICAL PTE LTD
19, Tuas Avenue 11, Singapore 639084,
Singapore

(111) M 2018 29591 R
(151) 2018 05 03
(181) 2028 05 03
(260) AM 2017 91190 A
(220) 2017 03 10
(732) ALTECO CHEMICAL PTE LTD
19, Tuas Avenue 11, Singapore 639084,
Singapore

(111) M 2018 29592 R
(151) 2018 05 03
(181) 2028 05 03
(260) AM 2017 91195 A
(220) 2017 03 10
(732) CJSC "CANONPHARMA PRODUCTION"
Ul Zarechnaya 105, 141100, Moscow district,
Sholkovo District, Sholkovo, Russian
Federation

(111) M 2018 29593 R
(151) 2018 05 03
(181) 2028 05 03
(260) AM 2017 91278 A
(220) 2017 03 16
(732) PANDROL LIMITED OSPREY HOUSE
63 Station Road, Addlestone Weybridge, Surrey
KT15 2AR, United Kingdom

(111) M 2018 29594 R
(151) 2018 05 03
(181) 2028 05 03
(260) AM 2017 91385 A
(220) 2017 03 24
(732) SONGWON INDUSTRIAL CO., LTD.
83, Jangsaengpo-ro, Nam-gu, Ulsan, Republic
of Korea

(111) M 2018 29595 R
(151) 2018 05 03
(181) 2028 05 03
(260) AM 2017 91405 A
(220) 2017 03 28
(732) JSC LEKHIM
Shota Rustaveli St. 23, 01033 Kyiv, Ukraine

(111) M 2018 29596 R
(151) 2018 05 03
(181) 2028 05 03
(260) AM 2017 91515 A
(220) 2017 03 29
(732) LTD "G.W.H."
Gldani 3 m/r, korp. 72, b. 157, Tbilisi, Georgia

(111) M 2018 29597 R
(151) 2018 05 03
(181) 2028 05 03
(260) AM 2017 91516 A
(220) 2017 03 29
(732) PAATA JAVAKHISHVILI
I. Javakhishvilis q. 66, 0102, Tbilisi, Georgia;
KETEVA ABASHIDZE-MUJE
K. Abashidzis q. 4, 0102, Tbilisi, Georgia;
LEVAN TSINTSADZE
I. Javakhishvilis q. 66, 0102, Tbilisi, Georgia

(111) M 2018 29598 R
(151) 2018 05 03
(181) 2028 05 03
(260) AM 2017 91543 A
(220) 2017 04 03
(732) LTD "KANTI"
Samgoris chikhi 4 (nakv. 8/89), 0120, Tbilisi,
Georgia

(111) M 2018 29599 R
(151) 2018 05 03
(181) 2028 05 03
(260) AM 2017 91578 A
(220) 2017 04 05
(732) MATTEL INC.
333 Continental Boulevard, El Segundo,
California 90245, USA

(111) M 2018 29600 R
(151) 2018 05 03
(181) 2028 05 03
(260) AM 2017 91579 A
(220) 2017 04 05
(732) MATTEL INC.
333 Continental Boulevard, El Segundo,
California 90245, USA

(111) M 2018 29601 R
(151) 2018 05 03
(181) 2028 05 03
(260) AM 2017 91584 A
(220) 2017 04 05
(732) CANADIAN CLUB CANADA INC
3300 Bloor Street West, Center Tower, 5th
floor, Suite 2510, Toronto, Ontario M8X 2X3,
Canada

(111) M 2018 29602 R
(151) 2018 05 03
(181) 2028 05 03
(260) AM 2017 91587 A
(220) 2017 04 05
(732) TOYOTA JIDOSHA KABUSHIKI KAISHA
(also trading as Toyota Motor Corporation)
1, Toioto-cho, Toioto-shi, Aichi-ken, Japan

(111) M 2018 29603 R
(151) 2018 05 03
(181) 2028 05 03
(260) AM 2017 91609 A
(220) 2017 04 06
(732) TAMAR KOBERIDZE
Atenis q., korp. 3, b. 32, 0179, Tbilisi, Georgia

(111) M 2018 29604 R
(151) 2018 05 03
(181) 2028 05 03
(260) AM 2017 91680 A
(220) 2017 04 12
(732) LTD "NPS GROUP"
Ketevan Tsamebulis gamz./-Bochormis
q. 50/18, b. 19, 0144, Tbilisi, Georgia

(111) M 2018 29605 R
(151) 2018 05 03
(181) 2028 05 03
(260) AM 2017 91734 A
(220) 2017 04 18
(732) KOÇ HOLDING A.Ş.
Nakkastepe, Azizbey Sok. No:1, Kuzguncuk,
Istanbul, Turkey

(111) M 2018 29606 R
(151) 2018 05 03
(181) 2028 05 03
(260) AM 2017 91781 A
(220) 2017 04 20
(732) KIMBERLY-CLARK WORLDWIDE, INC
Niina, Uiskonsini 54956, USA

(111) M 2018 29607 R
(151) 2018 05 03
(181) 2028 05 03
(260) AM 2017 91816 A
(220) 2017 04 24
(732) ASTRAZENECA AB
SE-151 85 Södertälje, Sweden

(111) M 2018 29608 R
(151) 2018 05 03
(181) 2028 05 03
(260) AM 2017 91817 A
(220) 2017 04 24
(732) ASTRAZENECA AB
SE-151 85 Södertälje, Sweden

(111) M 2018 29609 R
(151) 2018 05 03
(181) 2028 05 03
(260) AM 2017 91818 A
(220) 2017 04 24
(732) LTD "IONFASH GEORGIA"
Libanis q .6, 0189, Tbilisi, Georgia

(111) M 2018 29610 R
(151) 2018 05 03
(181) 2028 05 03
(260) AM 2017 91819 A
(220) 2017 04 24
(732) LTD "IONFASH GEORGIA"
Libanis q .6, 0189, Tbilisi, Georgia

(111) M 2018 29611 R
(151) 2018 05 03
(181) 2028 05 03
(260) AM 2017 91885 A
(220) 2017 05 01
(732) HAMED MAHMOUDI
c/o Gulf Emerald General Trading LLC
Unit No.104, B Block, Baniyas Complex,
Maktoum Street, Dubai, 181239, United
Arab Emirates

(111) M 2018 29612 R
(151) 2018 05 03
(181) 2028 05 03
(260) AM 2017 91886 A
(220) 2017 05 01
(732) HAMED MAHMOUDI
c/o Gulf Emerald General Trading LLC
Unit No.104, B Block, Baniyas Complex,
Maktoum Street, Dubai, 181239, United
Arab Emirates

(111) M 2018 29613 R
(151) 2018 05 03
(181) 2028 05 03
(260) AM 2017 91888 A
(220) 2017 05 01
(732) HAMED MAHMOUDI
c/o Gulf Emerald General Trading LLC
Unit No.104, B Block, Baniyas Complex,
Maktoum Street, Dubai, 181239, United
Arab Emirates

(111) M 2018 29614 R
(151) 2018 05 03
(181) 2028 05 03
(260) AM 2017 92166 A
(220) 2017 05 16
(732) JSC "TELIANI VALLEY"
Tbilisis gzat. 3, Telavi, Georgia

(111) M 2018 29615 R
(151) 2018 05 03
(181) 2028 05 03
(260) AM 2017 92254 A
(220) 2017 05 19
(732) LTD "GALLERY TBILISI"
Rustavelis gamz. 2/4, (nakv. 65/003), 0108,
Tbilisi, Georgia

(111) M 2018 29616 R
(151) 2018 05 03
(181) 2028 05 03
(260) AM 2017 92306 A
(220) 2017 05 22
(732) C. T. S. LTD
4 Haharash St., Hod-hasharon 45240 P.O. Box
10, Israel

(111) M 2018 29617 R
(151) 2018 05 03
(181) 2028 05 03
(260) AM 2017 92338 A
(220) 2017 05 23
(732) JSC "CREDITINFO GEORGIA"
Tarkhnishvilis q. 2, 0179, Tbilisi, Georgia

(111) M 2018 29618 R
(151) 2018 05 03
(181) 2028 05 03
(260) AM 2017 92363 A
(220) 2017 05 25
(732) N(N)LE "Kartli Family Cellar Association"
Sop. Tsedisi, 1402, Goris r-ni, Georgia

(111) M 2018 29619 R
(151) 2018 05 03
(181) 2028 05 03
(260) AM 2017 92474 A
(220) 2017 05 30
(732) PROCTER & GAMBLE BUSINESS
SERVICES CANADA COMPANY
Suite 800, 1959 Upper Water Street,
P.O. Box 997, Halifax, Nova Scotia
B3J 2X2, Canada

(111) M 2018 29620 R
(151) 2018 05 03
(181) 2028 05 03
(260) AM 2017 92483 A
(220) 2017 05 31
(732) LTD "GLOBALPHARMI"
Almasianis q. 13a/ Berbutis q. 8, 0171, Tbilisi,
Georgia

(111) M 2018 29621 R
(151) 2018 05 03
(181) 2028 05 03
(260) AM 2017 92606 A
(220) 2017 06 07
(732) NIKA GOLETIANI
Bakhtrionis q. 60, 2200, Telavi, Georgia

(111) M 2018 29622 R
(151) 2018 05 03
(181) 2028 05 03
(260) AM 2017 93608 A
(220) 2017 08 02
(732) LTD "GALLERY TBILISI"
Rustavelis gamz. 2/4, (nakv. 65/003), 0108,
Tbilisi, Georgia

TRADEMARKS REGISTERED ACCORDING TO THE ACCELERATED PROCEDURE

The decision can be appealed at the Chamber of Appeal of Sakpatenti within 3 months from the publication.

(111) M 2018 29564 R

(151) 2018 04 24

(181) 2028 04 24

(210) AM 96938

(220) 2018 03 21

(732) BRITISH AMERICAN TOBACCO
(BRANDS) INC. (a Delaware corporation)
251 Little Falls Drive, Suite 100, Delaware,
Wilmington, 19808-1674, USA

(740) Tamar Kochlamazashvili

(540)



(591) Blue, dark blue, silver

(531) 25.07.15; 26.01.01; 26.01.03; 26.01.12;
26.01.19; 26.04.02; 26.04.10; 26.04.12;
26.11.09; 27.05.24; 29.01.13

(511) 34

(111) M 2018 29565 R

(151) 2018 04 25

(181) 2028 04 25

(210) AM 97219

(220) 2018 04 12

(732) LTD "CAPSULO"
Delisis q. 9/7, 0177, Tbilisi, Georgia

(540)

მეამა
Meama
MEAMA
meama

(591) Black, white

(511) 30

(111) M 2018 29566 R

(151) 2018 04 27

(181) 2028 04 27

(210) AM 95114

(220) 2017 11 17

(732) NINO BUTSKHRIKIDZE

Shevchenkos q. I, sad. II, b. 55, Tbilisi,
Georgia

(540)

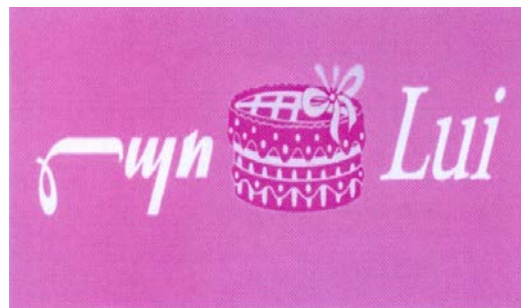

(591) Pink, dark pink, white

(531) 08.01.17; 19.03.15; 27.05.01; 27.05.24;
29.01.12

(511) 43

(111) M 2018 29567 R

(151) 2018 04 27

(181) 2028 04 27

(210) AM 97217

(220) 2018 04 12

(732) LTD SAH & Co
T. Abuladzis q. 32, b. 17, 0162, Tbilisi,
Georgia

(740) Besarion Urumashvili

(540)



(591) Green, silver, yellow, blue

(531) 05.07.12; 05.07.22; 26.04.22; 26.04.24;
27.05.24; 29.01.13

(511) 32

(111) M 2018 29568 R

(151) 2018 04 27

(181) 2028 04 27

(210) AM 97186

(220) 2018 04 04

(732) LTD "ASKANELI GROUP"

Kakhetis gzatk. 110a (nakv. 01/016), 0190,

Tbilisi, Georgia

(740) Giorgi Taktakishvili

(540)

დარეჯანი

Darejani

Дареджани

(591) Black, white

(511) 33

(540)



GEORGIA

(591) Black, white

(531) 26.01.05; 27.05.04; 27.05.05; 27.05.21

(526) GEORGIA

(511) 29, 30, 31, 32,33

(111) M 2018 29569 R

(151) 2018 05 01

(181) 2028 05 01

(210) AM 97396

(220) 2018 04 24

(732) LTD "SA PARTNERS"

Rustavelis gamz. 40/40a, 0108, Tbilisi,

Georgia

(540)

(591) Blue, green, gray, yellow, blue, red, pink,
purple(531) 01.05.01; 01.05.05; 01.05.15; 26.11.13;
27.05.01; 27.05.10; 27.05.21; 29.01.15

(511) 41

(111) M 2018 29623 R

(151) 2018 05 03

(181) 2028 05 03

(210) AM 97176

(220) 2018 04 03

(732) LTD "MALTISOFT"

Oniashvilis q. 67, 0160, Tbilisi, Georgia

(740) Zurab Lutidze

(541)

მარტივი

MARTIVI

(591) Black, white

(511) 9, 28

(111) M 2018 29579 R

(151) 2018 05 03

(181) 2028 05 03

(210) AM 97033

(220) 2018 03 29

(732) LTD "GEOIMPEX"

Nodar Bokhua St. 4, floor 3, 0159, Tbilisi,

Georgia

(740) Giorgi Kartvelishvili

INTERNATIONAL TRADEMARKS FOR WHICH A DECISION ON GRANTING PROTECTIONS IS TAKEN

The decision can be appealed at the Chamber of Appeal of Sakpatenti within 3 months from the publication or at the Mtskheta District Court Administrative Cases Board (Address: №17, Samkhedro str., Mtskheta), within 1 month following the publication.

(260) AM 2018 74983 A*

(800) 1182770

(151) 2013 10 22

(891) 2013 10 22

(731) DE LONGHI BENELUX SA

49, Boulevard Prince Henri, Grand Duchy of Luxembourg, L-1724, Luxembourg

(540)

KENWOOD

(591) Black, white

(511)

7 – Machines for mixing, kneading, pulping, grinding, mincing, chopping, blending and shredding foodstuffs; machines for peeling vegetables; dishwashing machines, washing machines, drying machines, spin dryers, machines for airing clothes, rotary ironing machines; waste disposal machines, refuse compactors; machines for making mixing or dispensing beverages; machines for making ice cream or sorbets (non-refrigerating); electric food liquidisers; electric food processors; electric food slicers, electric can openers, electric carving knives, electric knife/scissor sharpeners; electric juice extractors; electric coffee grinders.

9 – Kitchen weighing scales; apparatus and instruments for charging or recharging battery operated domestic kitchen appliances; thermometers.

11 – Electrically operated installations, apparatus and appliances for lighting, heating, cooking, refrigerating, drying and ventilating; water filtration and filtering apparatus and installations; water purification apparatus and installations; water softening apparatus and installations; water filters; air conditioning installations and apparatus; refrigerators, freezers; clothes dryers; air filtering apparatus and installations; air purifying apparatus and machines; ionization apparatus for the treatment of air; electric pressure cookers; electric slow cookers and electric cooking pans; electric hot plates/hot stone cookers; griddle plates; electric cooking utensils for fondue; extractor fans; humidifiers, dehumidifiers; foot and facial spas; jacuzzis; cooking hobs; electric cookers, gas cookers, electric cooking ranges, gas cooking ranges; food warmers; hot cabinets, ovens; microwave ovens; clothes steamers; tea makers; rice cookers; espresso coffee machines and coffee percolators and filter machines; toasters; electrical saucepans, elec-

tric pancake makers, electric hot-dog makers, electric sandwich makers, electric waffle makers; deep fat fryers; hair dryers; beverage cooling apparatus; electric kettles, electric tea-infusers; electric jugs (kettles); apparatus for steaming foodstuffs; electric bread making apparatus; electric woks; machines for making ice cream or sorbets (refrigerating).

(260) AM 2018 90265 A

(800) 1325637

(151) 2016 06 10

(891) 2016 06 10

(731) TADIM GIDA MADDELERİ SANAYİ VE TİCARET ANONİM ŞİRKETİ
Gebze Organize Sanayi Bölgesi, 1100. Sok.
No:1105, ÇAYIROVA/KOCAELI, Turkey

(540)



(591) Light green, grey, white, beige, green, dark green, maroon, brown, red and black

(531) 05.03.15; 05.07.01; 05.07.06; 05.07.09;
19.03.05; 26.11.07; 26.11.13; 27.05.24;
29.01.15

(511)

29 – Dried pulses; dried, preserved, frozen, cooked, smoked or salted fruits; prepared nuts and dried fruits as snacks; hazelnut and peanut paste; tahini (sesame seed paste); potato chips.

(260) AM 2018 90910 A

(800) 1284033

(151) 2015 09 18

(891) 2016 12 19

(731) DEVA HOLDİNG AŞ

Halkalı Merkez mah. Basın, Ekspres cad.
No:1, Küçükçekmece/İstanbul, Turkey

(540)

Depores

(511)

5 – Pharmaceutical and veterinary preparations; sanitary preparations for medical purposes; dietetic food and substances adapted for medical or veterinary use, food for babies; dietary supplements for humans and animals; plasters, materials for dressings; material for stopping teeth, dental wax; disinfectants; preparations for destroying vermin; fungicides, herbicides.

(260) AM 2018 91246 A

(800) 1334102

(151) 2016 09 19

(891) 2016 09 19

(731) BAKER & MCKENZIE LLP

300 East Randolph Street, Suite 5000,
Chicago, IL 60601, USA

(540)

**Baker
McKenzie.**

(591) The color(s) red and maroon is/are claimed as a feature of the mark.

(531) 27.05.17; 29.01.01

(511)

9 – Downloadable computer software for use in applications for mobile devices enabling access to information in the field of law.

16 – Printed publications, namely, newsletters, books, booklets, manuals, guides, pamphlets and brochures in the field of law.

41 – Arranging and conducting seminars, workshops, training courses and non-downloadable webinars in the field of law; providing non-downloadable electronic publications in the nature of newsletters, books, booklets, manuals, guides, pamphlets, and brochures in the field of law.

45 – Legal services.

(260) AM 2018 92240 A

(800) 1344586

(151) 2017 01 25

(891) 2017 01 25

(731) ALBRECHT JUNG GMBH & CO. KG

Volmestraße 1, 58579 Schalksmühle,
Germany

(540)

Smart Visu Server

(591) Black, white

(511)

9 – Electric connectors, in particular electric connection devices, couplings, adapters, electric sockets, plugs, terminals for electric cables; branch boxes (electricity); junction boxes (electricity); antennas; switchboards; alarms and alarm systems; indicators (electric/electronic); covering plates for covering of electro-technical and electronic apparatus for home and building technology; limiters (electricity); computer programs, recorded; computer software (recorded); inductor coils; anti-interference devices (electricity); remote control devices; fire alarms; electric/electronic devices/apparatus, for house and building technology, connected using wireless and/or cable technology, in particular via an installation bus system, and for transmitting commands to modulate regulating, control, checking (supervision), measuring, transmission and recording devices/apparatus; interfaces, in particular for home automation and building technology; couplers (data processing equipment); optical lamps; light emitting diodes (LEDs); light regulators, light signalling apparatus, in particular dimmers; photometers; regulating, control, checking (supervision), measuring, monitoring, switching and recording devices/apparatus, in particular for home automation and building technology; electric/electronic switches, in particular installation switches, built-in switches for equipment, toggle switches, rocker switches, rotary switches, press-button switches, touch contacts, pull switches, slide switches and multiple-circuit breakers; control consoles and panels (electricity); transmitters of electric and electronic signals; smart cards [integrated circuit cards]; coils (electric and electromagnetic); electrical controls; rectifiers; converters, electric; current relays, in particular for lighting devices; sensors for detecting movements (movement indicators), sounds, brightness, gases, smoke, temperature and other physical variables for home automation and building technology, in particular for the control of lighting, room and building surveillance; electric/electronic transformers (combinational circuit parts); distribution boxes and boards (electricity); time switch apparatus, in particular for controlling electric equipment, lighting devices, blinds, roller blinds.

11 – Lighting apparatus and installations; lighting apparatus utilising light emitting diodes (LEDs); lamps (electric and electronic); light diffusers.

37 – Installation, maintenance and repair of electrical apparatus (servicing).

(260) AM 2018 92244 A

(800) 1344588

(151) 2017 02 02

(891) 2017 02 02

(731) Obshchestvo s ogranichennoy

otvetstvennostyu "ODIN DOM"
Avenue General Ostryakova, Apartment 16,
Building 128, RU-299040 the city of
Sevastopol, Russian Federation

(540)



(591) White, gray and black. White background,
grey frame with an ornament, the black
sheep's head and black letters

(531) 03.04.11; 03.04.13; 05.07.10; 25.01.01;
29.01.13

(511)

33 – Aperitifs; arrack [arak]; brandy; wine; piquette;
whisky; vodka; anisette [liqueur]; kirsch; gin; diges-
ters [liqueurs and spirits]; cocktails; curacao; anise
[liqueur]; liqueurs; pre-mixed alcoholic beverages,
other than beer-based; alcoholic beverages contain-
ing fruit; distilled beverages; spirits [beverages];
mead [hydromel]; peppermint liqueurs; bitters; rum;
sake; perry; cider; rice alcohol; alcoholic extracts;
fruit extracts, alcoholic; alcoholic essences.

35 – Import-export agency services; organization of
exhibitions for commercial or advertising purposes;
organization of trade fairs for commercial or adver-
tising purposes; administrative processing of purcha-
se orders; commercial administration of the licensing
of the goods and services of others; arranging and
conducting of promotional and marketing events;
promoting the goods and services of others on the
Internet; business management assistance; commer-
cial or industrial management assistance; sales pro-
motion for others; on-line advertising on a computer
network; commercial intermediation services; nego-
tiation and conclusion of commercial transactions
for third parties; administration of consumer loyalty
programs; providing business information via a web
site.

(260) AM 2018 92281 A

(800) 1067855

(151) 2011 02 04

(891) 2016 12 19

(731) GS YUASA CORPORATION

1, Inobaba-cho, Nishinosho, Kisshoin,
Minami-ku, Kyoto-shi Kyoto 601-8520,
Japan

(540)



(591) Black, white

(531) 26.01.04; 26.01.24; 26.07.01; 26.07.25

(511)

9 – Batteries and cells.

(260) AM 2018 92320 A

(800) 1344197

(151) 2016 11 02

(891) 2016 11 02

(731) VENELIN STOIANOV GEORGIEV
apartment 13, "Asenovska" street 32A,
BG-8800 Sliven (BG), Bulgaria

(540)

Бимопт Vimopt

(591) Black, white

(531) 27.05.17; 28.05

(511)

5 – Absorbent cotton; acaricides; acetates for phar-
maceutical purposes; acids for pharmaceutical pur-
poses; acne treatment preparations; aconitine; adhe-
sive plasters; adhesive bands for medical purposes;
adhesives for dentures; adjuvants for medical pur-
poses; air purifying preparations; air deodorising
preparations; albumin dietary supplements; albu-
minous foodstuffs for medical purposes; albuminous
preparations for medical purposes; alcohol for phar-
maceutical purposes; aldehydes for pharmaceutical
purposes; algicides; alginate dietary supplements;
alginates for pharmaceutical purposes; alkaline iodi-
des for pharmaceutical purposes; alkaloids for me-
dical purposes; alloys of precious metals for dental
purposes; aloe vera preparations for pharmaceutical
purposes; aluminium acetate for pharmaceutical pur-
poses; amino acids for medical purposes; amino
acids for veterinary purposes; anaesthetics; analge-
sics; angostura bark for medical purposes; animal
feed supplements for veterinary purposes; animal
washes; anthelmintics; anti-rheumatism bracelets;
anti-rheumatism rings; anti-uric preparations; anti-
biotics; anticryptogamic preparations; antioxidant
pills; antiparasitic preparations; antiparasitic collars
for animals; antiseptic cotton; antiseptics; appetite
suppressants for medical purposes; appetite suppres-
sant pills; aseptic cotton; asthmatic tea; babies' dia-
pers [napkins]; babies' napkin-pants [diaper-pants].

(260) AM 2018 92520 A

(800) 1345562

(151) 2016 06 27

(891) 2016 06 27

(731) ELTOS EL ALETLERİ HIRDAVAT
MAKİNA SANAYİ VE TİCARET LİMİTED
ŞİRKETİ

Vatan Mah. Esenler Cad. Sinan Sk.

No:2/1-2 Bayrampaşa İstanbul, Turkey

(540)



(591) Red, dark blue

(531) 02.09.15; 27.05.02; 27.05.03; 29.01.14

(511)

6 – Non-electric cables and wires of metal, welding and soldering wire of metal, metal pallets and metal ropes for lifting, loading and transportation purposes, metal hangers, ties, straps, tapes and bands used for load-lifting and load-carrying, anchors, ironmongery, small hardware of metal, screws of metal, nails, eye bolts, bolts, flat, nuts of metal, pegs of metal, horseshoe nails, chains of metal, bed casters of metal, furniture casters of metal, hinges of metal, locks of metal, other than electric, keys, fittings of metal for furniture; bells, tool handles of metal, ropes of metal, metal shelf brackets; badges of metal for vehicles, letters and numerals of common metal, except type; ironwork for doors and windows; ventilation ducts, vents, vent covers, pipes, chimney caps, manhole covers, grilles of metal for ventilation, heating, sewage, telephone, underground electricity and air conditioning installations, letter boxes of metal, tin cans, boxes of common metal, tool boxes of metal, empty, wheel chocks made primarily of metal.

8 – Hand-operated [non-electric] hand tools included in this class for the repair of machines, apparatus and vehicles and for use in construction, agriculture, horticulture and forestry, none of them being power tools, saws [hand tools], lawn clippers [hand instruments], wrenches, scythes, axes, hammers [hand tools], sledgehammers, dies [hand tools], hand pumps, cutters, screwdrivers, augers [hand tools], sharpening stones, pliers, tongs, lifting jacks, hand-operated, levers, adzes [tools], rabbeting planes, spatulas [hand tools], bits [parts of hand tools], cutting tools [hand tools], squares [hand tools].

9 – Weighing apparatus and instruments, scales, balances [steelyards], safety vests and life-saving apparatus and equipment, life jackets, life buoys, breathing apparatus for underwater swimming, diving

suits, divers' masks; life belts, nets for protection against accidents; gloves for protection against accidents, protective helmets, clothing for protection against accidents; signaling whistles, flashing lights [luminous signals], signaling buoys; electric door bells, spirit levels, counters, plumb lines, ear plugs for divers.

12 – Repair outfits for inner tubes, adhesive rubber patches for repairing inner tubes, anti-skid chains, air pumps [vehicle accessories], wheelbarrows; shopping carts, single or multi-wheeled wheelbarrows; shopping trolleys, grocery carts, handling carts.

17 – Rubber, gutta-percha, gum, asbestos, mica and semi-finished synthetic goods made from these materials in the form of powder, bars, panels and foils included in this class, soundproofing materials, dielectrics [insulators], glass wool for insulation; asbestos packing, insulation, stopping and sealing materials; insulation paints, insulation fabrics, insulating tape and band, insulation covers for industrial machinery, sealant compounds for joints, gaskets, O-rings for sealing purposes, insulating paints, insulating oils, self-adhesive tapes, other than stationery and not for medical or household purposes, insulating tapes, asbestos cloth, asbestos coverings, asbestos felt, stops of rubber, chemical compositions for repairing leaks, flexible pipes made from rubber and plastic; hoses made of plastic and rubber, including those used for vehicles, junctions for pipes of plastic and rubber, pipe jackets of plastic and rubber, hoses of textile material; junctions for pipes, not of metal, pipe jackets, not of metal, connecting hose for vehicle radiators, synthetic resins [semi-finished products], rubber, raw or semi-worked, plastic film, other than for wrapping, brake lining materials, partly processed, clutch linings, threads of plastic materials, not for textile use, threads of rubber, not for use in textiles, bags [envelopes, pouches] of rubber, for packaging, shock-absorbing buffers of rubber, rubber stoppers, sleeves of rubber for protecting parts of machines, gaskets, reinforcing materials, not of metal, for pipes.

35 – Advertising, marketing and public relations; organization of exhibitions and trade fairs for commercial or advertising purposes, television, radio and direct mail advertising, dissemination of advertising matter, modelling for advertising or sales promotion, market studies, marketing, sales promotion for others, shop window dressing, public relations, office functions; secretarial services, arranging newspaper subscriptions for others, compilation of statistics, rental of office machines, systemization of information into computer databases, telephone answering services for unavailable subscribers, shorthand, photocopying services, typing, word processing, compilation of information into computer databases; business management, business administration and business consultancy, accounting, commercial consultancy servi-

ces, personnel recruitment, personnel placement, employment agencies, import-export agencies; temporary personnel placement services, commercial or industrial management assistance, business management of hotels, business appraisals, business research, compilation of statistics, personnel management consultancy, book-keeping, business auditing, cost price analysis, economic forecasting, payroll preparation, tax preparation; import-export agency services, business management of performing artists, business efficiency expert services, auctioneering, demonstration of goods.

(260) AM 2018 92521 A

(800) 1345589

(151) 2016 11 11

(891) 2016 11 11

(731) ROSE GESELLSCHAFT M.B.H.

Modecenterstraße 22/A4 A-1030 Wien,
Austria

(540)

EASY
BY
Jones

(591) Black and white

(531) 27.05.01; 27.05.15

(511)

3 – Cosmetics, perfumes.

9 – Anti-glare spectacles, spectacle frames and spectacle cases.

14 – Anti-glare spectacles, spectacle frames and spectacle cases.

18 – Goods made of leather and imitation leather, namely beach bags, purses, handbags and travelling bags, trunks and suitcases, credit-card holders and holders in the nature of cases for keys, business card cases; backpacks; umbrellas.

21 – Cleaning cloths for spectacles.

25 – Ladies clothing and knitwear (clothing); scarves, collar protectors for wear, headgear for wear, belts, shoes, boots, socks, stockings, tights.

(260) AM 2018 92566 A

(800) 1346062

(151) 2016 06 01

(891) 2016 06 01

(731) FIRST S.r.l.

Via Santa Lucia, 62 I-80132 NAPOLI, Italy

(540)



(591) Dark green, golden yellow and white

(531) 24.09.02; 24.09.03; 29.01.13

(511)

35 – Advertising; business management; business administration; office functions; providing advisory and assistance services to business management and business operations to retailers in the franchising sector; retailing and wholesaling in relation to food-stuffs, cosmetic and beauty preparations, perfumery, cosmetic accessories, spectacles, crash helmets, imitation jewellery, clocks and watches, in the field of clothing, bags and accessories therefor, footwear and accessories therefor, utensils for household purposes, glassware, porcelain, stationery, the aforesaid services being provided by retail outlets, wholesale warehouses, via mail order catalogues or via electronic media, websites or teleshopping programmes; business assistance relating to the establishment of franchises; business management and organisation consultancy concerning the operation of restaurants and other establishments or facilities in providing food and drinks prepared for consumption and for drive-through facilities, preparation and provision of takeaway food, designing of restaurants, establishments and facilities for others, construction planning and construction consulting for restaurants for others; business consultation and management regarding launching of new products; retail services in relation to jewellery; retail services in relation to clothing; retail services in relation to toiletries; retail services in relation to cleaning preparations; retail services in relation to hygienic implements for humans; retail services in relation to beauty implements for humans; wholesale services in relation to jewellery; wholesale services in relation to toiletries; wholesale services in relation to cleaning articles; wholesale services in relation to clothing; wholesale services in relation to hygienic implements for humans; wholesale services in relation to beauty implements for humans; wholesale services in relation to bags; mail order retail services connected with clothing accessories; retail services connected with the sale of clothing and clothing accessories; department store retail services connected with the sale of beauty products, toiletries, machines for household use, hand tools, optical goods, domestic electrical and electronic equipment.

43 – Serving food and drinks; hotel restaurant services; catering for the provision of food and beverages; hospitality services [food and drink]; mobile restaurant services; self-service restaurants; snack-bars; night club services [provision of food]; take-out restaurant services; arranging of wedding receptions [food and drink]; restaurant services provided by hotels; club services for the provision of food and drink; restaurant services incorporating licensed bar facilities; hospitality services [accommodation].

(260) AM 2018 92569 A

(800) 1346153

(151) 2017 02 07

(891) 2017 02 07

(731) Barilla G. e R. Fratelli – Società per Azioni

Via Mantova,166 PARMA (PR), Italy

(540)



(591) Blue, white and yellow.

(531) 08.07.03; 26.04.07; 26.04.22; 26.04.24;
27.05.01; 27.05.24; 29.01.13

(511)

35 – Advertising; business management; business administration; office functions; commercial administration of the licensing of the goods and services of others; dissemination of advertising matter; demonstration of goods; direct mail advertising; marketing; organization of exhibitions for commercial or advertising purposes; organization of trade fairs for commercial or advertising purposes; presentation of goods on communication media, for retail purposes; sales promotion for others; publication of publicity texts; on-line advertising on a computer network; television advertising; retail and e-commerce services for meat, fish, poultry and game, meat extracts, preserved, frozen, dry and cooked fruits and vegetables, jellies, jams, compotes, eggs, milk and milk products, edible oils and fats, anchovy, broth, soups, caviar, tinned fruits, tinned vegetables, cheese, smoothies, fruit chips, frozen fruits, preserved fruit, fruit preserved in alcohol, stewed fruits, crystallised fruits, preserved mushrooms, gelatine for food, jellies for food, fruit jellies, vegetable soup preparations, preserved vegetables, cooked vegetables, dried vegetables, preserved lentils, fruit salads, vegetable salads, margarine, whipped cream, cream (dairy products), potato crisps, low-fat French fries, preserved fish, poultry, not live, preparations for making soup, fruit-based snack food, vegetable juices for cooking,

tomato juice for cooking, yoghurt, coffee, tea, cocoa and artificial coffee, rice, tapioca and sago, hour and preparations made from cereals, bread, pastry and confectionery, ices, sugar, honey, treacle, yeast, baking-powder, salt, mustard, vinegar, sauces (condiments), spices, ice, oat-based food, farinaceous foods, starch for food, aniseed, star aniseed, seasonings, coffee flavourings, flavourings, other than essential oils, flavourings, other than essential oils, for beverages, flavourings, other than essential oils, for cakes, crushed oats, husked oats, high-protein cereal bars, liquorice sticks (confectionery), cocoa-based beverages, coffee-based beverages, chocolate-based beverages, tea-based beverages, bicarbonate of soda for cooking purposes, cookies, biscuits, malt biscuits, petit-beurre biscuits, sweets, buns, puddings, cocoa, cocoa beverages with milk, coffee beverages with milk, unroasted coffee, cinnamon (spice) toffees, condiments, crackers, couscous (semolina), cakes, wheat flour, meal; fruit jellies (confectionery), edible ices, yeast powder, macaroni, mayonnaise, rusks, unleavened bread, breadcrumbs, bread rolls, pasta, pesto (sauce), pizzas, preparations made from cereals, ravioli, rice, cooking salt, tomato sauce, soya sauce, dressings for salad, sandwiches, peppers (seasonings), oatmeal, semolina, corn semolina, cereal-based snack food, rice-based snack food, sorbets (ices), spaghetti, meat gravies (sauces), noodles, tarts, vermicelli (noodles), saffron (seasoning), ginger (spice).

41 – Education; providing of training; entertainment; sporting and cultural activities; academies [education]; practical training (demonstration); education information; recreation information; gymnastic instruction; correspondence courses; organising cookery courses; organising of competitions; organization of sports competitions; organization of competitions [education or entertainment]; organization of exhibitions for cultural or educational purposes; organization of shows [impresario services]; arranging and conducting of concerts; arranging and conducting of conferences; arranging and conducting of congresses; arranging and conducting of colloquiums; arranging and conducting of seminars; arranging and conducting of symposiums; arranging and conducting of workshops [training]; entertainment party planning; publication of books; publication of texts, other than publicity texts; publication of electronic books and journals on-line; electronic desktop publishing; presentation of live performances; game services provided on-line from a computer network.

(260) AM 2018 92578 A

(800) 1346205

(151) 2016 12 15

(891) 2016 12 15

(731) PEARSON PLC

80 Strand London WC2R 0RL, United Kingdom

(540)



(591) Black, white

(531) 26.05.22; 26.05.24; 27.05.24

(511)

9 – Educational teaching, instruction or research apparatus and instruments; electronic apparatus and instruments for teaching, instruction, training, research, education, testing, examination and assessment purposes; media bearing electronic publications and data; electronic publications and instructional and educational material; downloadable electronic publications and instructional material provided on-line from a database or the Internet; downloadable text and information provided electronically, by telecommunications networks, by online delivery, by way of the Internet or world wide web; electronic databases; videotapes; computer software, hardware and firmware; application software; computer software, hardware and firmware for the provision of teaching, instruction, training, research, education, testing, examination and assessments, learning objectives, curriculum materials, including software for operation over computer networks or by remote computer access; software, for the creation, management, updating and operating of databases; computer software for authoring, downloading, transmitting, receiving, editing, extracting, encoding, decoding, displaying, storing and organizing text, graphics, images, and electronic publications; computer software for converting data pertaining to development and assessment of language skills, grammar and vocabulary; downloadable mobile applications for converting data; downloadable mobile applications for converting data pertaining to the development and assessment of language skills, grammar and vocabulary.

16 – Printed matter; printed publications; educational materials in printed form; examination papers; syllabi in printed form; diplomas, academic and vocational certificates in printed form; printed examination regulations; books; magazines; periodicals; journals; publications; testing materials in printed form; textbooks; exercise books and notebooks; newspapers; handbooks and manuals; study guides; instructional or teaching materials; stationery; posters; educational materials for use in language and grammar instruction and assessment, namely, printed course materials in the field of language, grammar and vocabulary instruction, assessment, testing and measuring and vocabulary and grammar development, textbooks, workbooks and teacher guides for language, grammar and vocabulary instruction,

testing and assessment and vocabulary and grammar development.

41 – Provision of training, teaching, academic, education, instruction, examination, testing and assessment services; provision of training, teaching, academic, education, instruction, examination, testing and assessment services electronically, by means of telecommunications networks, by online delivery, by way of the Internet or world wide web; computer assisted, computer mediated and on-line computer services, all for training, teaching, academic, education, instruction, examination, testing and assessment purposes; educational services, namely, providing curriculum design, learning objectives and courses in the field of language, grammar and vocabulary instruction, testing, measuring and assessment and vocabulary and grammar development, distribution of course material therewith; services for virtual schools, namely, student assessment and performance analysis consultation and consultation on curriculum design, learning objectives and courses in the field of language and grammar instruction, testing, measuring and assessment and vocabulary and grammar development; online services for the teaching and assessment of language; provision and publication of instruction, teaching, training, examination, testing and assessment material; providing online non-downloadable textbooks, workbooks, teacher guides, toolkits and course materials in the field of language, grammar and vocabulary instruction, assessment, testing and measuring and vocabulary and grammar development; publishing services; publication of texts, books, textbooks, brochures, syllabi, examination papers, assessments, magazines, journals and newspapers; electronic publishing; online publication of electronic texts, books, textbooks, teacher guides, instructor toolkits, brochures, syllabi, examination papers, assessments, magazines, research and scholarly articles and papers, journals and newspapers; examination services; educational assessment services; distribution of informational material in the field of language, grammar and vocabulary instruction, assessment, testing and measuring and vocabulary and grammar development; educational certification services; certification in relation to examinations and other forms of assessment, education, training and awards; conferral of degrees; organisation and provision of courses, examinations, assessment, teaching and training using distance learning methods; preparation and validation, accreditation, conducting and administration of examinations, assessments and tests; educational research services; production and distribution of educational films, television programmes and video recordings; arranging, organising and conducting courses, seminars, workshops, symposiums, conferences, congresses and exhibitions; information, advisory and consultancy services relating to all of the aforesaid services.

42 – Application service provider (ASP) services featuring computer software; application service provider (ASP) services featuring software for authoring, downloading, transmitting, receiving, editing, extracting, encoding, decoding, displaying, storing and organizing text, graphics, images, and electronic publications; design of web sites for curriculums, learning objectives, vocabulary and grammar inventories; design of computer software concerning curriculums, learning objectives, vocabulary and grammar inventories; application service provider (ASP) services featuring software for use in connection with online subscription service that enables users to access educational audio, video, text and multimedia content; providing temporary use of non-downloadable software to enable users to access educational audio, video, text and multimedia content and non-downloadable software for converting, analyzing and evaluating data pertaining to development and assessment of language skills, grammar and vocabulary, instruction, testing and measuring and vocabulary and grammar development; information, advisory and consultancy services relating to all of the aforesaid services.

(260) AM 2018 92650 A

(800) 1346909

(151) 2017 02 18

(891) 2017 02 18

(731) EFE AYAKKABI PAZARLAMA SAN. İTH. İHR. LTD. ŞTİ.

Akçaburgaz Mahallesi Akçaburgaz, Caddesi
No:28 Kıraç, Esenyurt Bağcılar İstanbul,
Turkey

(540)

HAMMER JACK

(591) Black, white

(531) 27.05.17

(511)

10 – Orthopaedic footwear.

25 – Footwear

(260) AM 2018 92652 A

(800) 1346941

(151) 2016 12 02

(891) 2016 12 02

(731) URSA Salgótarján Glass Wool Close Co., Ltd.
Szépvölgyi út 41,2/2 H-1037 BUDAPEST,
Hungary

(540)

URSA PUREONE

(591) Black, white

(531) 27.05.17

(511)

17 – Insulating, soundproofing and stopping materials; fabrics, felts, webs, plates, panels and sheets for use as insulation material; rubber or plastics for padding and stuffing; mineral wool, glass wool, stone wool, rock wool, slag wool and fiber glass for thermal or acoustic insulation; glass fibers for insulation; slag wool, glass wool blankets and panels for insulation; wood fiber, plastic insulation materials, especially foamed plastic materials; insulation boards, made from polystyrene, especially made from extruded polystyrene; XPS (extruded polystyrene) material for packing and stuffing; XPS (extruded polystyrene) panels for insulation; plastic film, other than for packaging purposes; substances for insulating buildings against moisture; sealant compounds for joints; insulating paper, insulating tape and band, rubber, gutta-percha, gum, asbestos, mica; plastics in extruded form for use in manufacture; joint packings for flexible pipes; membranes and other materials for air tightness and vapor barriers (membrane for moisture protection); vapor barriers; insulating adhesives for sealing and/or attaching or linking membranes of air tightness and/or vapor barriers (for moisture protection) to anything that has to pass through like carpentry, timber studs, tubes, chimney, parts used for ventilation, ducts; insulating adhesives, especially in the form of tapes to be used in combination with insulating material, like mineral wool and XPS (extruded polystyrene); adhesive tapes for industrial purposes; insulating material for buildings and/or to glass mineral wool for insulation purposes together with the respective fixing material for fastening the insulation material and/or mineral wool to the construction of a building, namely warm frame construction, cold frame construction, wall/floor junction timber floor, cavity batts, made of mineral fibers, pitched roof insulation, roof junctions for separating wall / attic space, roof junctions for separating wall / room in the roof.

19 – Building materials (non-metallic), including panels and sheets of mineral fibers (especially fiber glass) for buildings; ducts for air conditioning, self-bearing duct designs made from mineral wool especially glass fiber panels used for HVAC (heating, ventilation and air conditioning); mineral wool panels with woven or non-woven facings or coverings; non-metallic rigid pipes for building; asphalt, pitch and bitumen; non-metallic transportable buildings; monuments, not of metal; waterproofing claddings.

(260) AM 2018 92656 A

(800) 1348108

(151) 2017 03 03

(891) 2017 03 03

(731) MOSHNINA ELENA VALERIEVNA

ul. Lenina, d. 71, kv. 9, g. Zarechniy RU-442965
Penzenskaya oblast, Russian Federation

(540)



ARMOPLASTIKA

(591) Dark brown and pink

(531) 26.11.13; 27.05.01; 29.01.12

(511)

35 – Business management; rental of advertising space; commercial information and advice for consumers [consumer advice shop]; business management of performing artists; updating of advertising material; organization of exhibitions for commercial or advertising purposes; sales promotion for others; dissemination of advertising matter; direct mail advertising; advertising; on-line advertising on a computer network; presentation of goods on communication media, for retail purposes.

41 – Academies [education]; physical education; education information; recreation information; health club services [health and fitness training]; correspondence courses; practical training [demonstration]; providing recreation facilities; arranging and conducting of conferences; arranging and conducting of concerts; arranging and conducting of workshops [training]; arranging and conducting of seminars; teaching.

44 – Rest home services; sanatorium services; pharmacy advice; aromatherapy services; chiropractic; massage; medical assistance; medical equipment rental; beauty salon services; health counselling; medical clinic services; alternative medicine services; services of a psychologist; therapy services; pharmacists' services to make up prescriptions; nursing, medical; physical therapy; plastic surgery; health center services.

(260) AM 2018 92657 A

(800) 1348109

(151) 2017 03 03

(891) 2017 03 03

(731) MOSHNINA ELENA VALERIEVNA
ul. Lenina, d. 71, kv. 9, g. Zarechniy
RU-442965 Penzenskaya oblast, Russian
Federation

(540)



(591) Dark brown and pink

(531) 02.03.16; 02.03.23; 29.01.12

(511)

35 – Business management; rental of advertising space; commercial information and advice for consumers [consumer advice shop]; business management of performing artists; updating of advertising material; organization of exhibitions for commercial or advertising purposes; sales promotion for others; dissemination of advertising matter; direct mail advertising; advertising; on-line advertising on a computer network; presentation of goods on communication media, for retail purposes.

41 – Academies [education]; physical education; education information; recreation information; health club services [health and fitness training]; correspondence courses; practical training [demonstration]; providing recreation facilities; arranging and conducting of conferences; arranging and conducting of concerts; arranging and conducting of workshops [training]; arranging and conducting of seminars; teaching.

44 – Rest home services; sanatorium services; pharmacy advice; aromatherapy services; chiropractic; massage; medical assistance; medical equipment rental; beauty salon services; health counselling; medical clinic services; alternative medicine services; services of a psychologist; therapy services; pharmacists' services to make up prescriptions; nursing, medical; physical therapy; plastic surgery; health center services.

(260) AM 2018 92659 A

(800) 1348226

(151) 2016 12 02

(891) 2016 12 02

(731) URSA Salgótarján Glass Wool Close Co., Ltd.
Szépvölgyi út 41, 2/2 Szépvölgyi út 41, 2/2
H-1037 BUDAPEST, Hungary

(540)

URSA

(591) Black and white

(511)

17 – Insulating, soundproofing and stopping materials; fabrics, felts, webs, plates, panels and sheets for use as insulation material; rubber or plastics for padding and stuffing; mineral wool, glass wool, stone wool, rock wool, slag wool and fiber glass for thermal or acoustic insulation; glass fibers for insulation; slag wool, glass wool blankets and panels for insulation; wood fiber, plastic insulation materials, especially foamed plastic materials; insulation boards, made from polystyrene, especially made from extruded polystyrene; XPS (extruded polystyrene) material for packing and stuffing; XPS (extruded polystyrene) panels for insulation; plastic film, other than for packaging purposes; substances for insulating buildings against moisture; sealant compounds for joints; insulating paper, insulating tape and band,

rubber, gutta-percha, gum, asbestos, mica; plastics in extruded form for use in manufacture; joint packings for flexible pipes; membranes and other materials for air tightness and vapor barriers (membrane for moisture protection); vapor barriers; insulating adhesives for sealing and/or attaching or linking membranes of air tightness and/or vapor barriers (for moisture protection) to anything that has to pass through like carpentry, timber studs, tubes, chimney, parts used for ventilation, ducts; insulating adhesives, especially in the form of tapes to be used in combination with insulating material, like mineral wool and XPS (extruded polystyrene); adhesive tapes for industrial purposes; insulating material for buildings and/or to glass mineral wool for insulation purposes together with the respective fixing material for fastening the insulation material and/or mineral wool to the construction of a building, namely warm frame construction, cold frame construction, wall/floor junction timber floor, cavity batts, made of mineral fibers, pitched roof insulation, roof junctions for separating wall / attic space, roof junctions for separating wall / room in the roof.

19 – Building materials (non-metallic), including panels and sheets of mineral fibers (especially fiber glass) for buildings; ducts for air conditioning, self-bearing duct designs made from mineral wool especially glass fiber panels used for HVAC (heating, ventilation and air conditioning); mineral wool panels with woven or non-woven facings or coverings; non-metallic rigid pipes for building; asphalt, pitch and bitumen; non-metallic transportable buildings; monuments, not of metal; waterproofing claddings.

(260) AM 2018 92660 A

(800) 1348244

(151) 2016 09 08

(891) 2016 09 08

(731) BERKO ILAC VE KIMYA SANAYI A.S.

Yenisehir Mah. Ozgur Sok. No:16-18 Atasehir
Istanbul, Turkey

(540)

N-CORT

(591) Black and white

(511)

5 – Pharmaceutical and veterinary preparations for medical purposes; chemical preparations for medical purposes; chemical reagents for pharmaceutical purposes; nutritional supplements.

(260) AM 2018 92673 A

(800) 817653

(151) 2003 12 16

(891) 2017 03 07

(731) HAGLEITNER HYGIENE
INTERNATIONAL GMBH

Lunastraße 5 A-5700 Zell am See, Austria

(540)

INTEGRAL

(591) Black and white

(511)

9 – Electric dosing devices for detergents, bleaching preparations and other substances for laundry use.

(260) AM 2018 92674 A

(800) 1347020

(151) 2016 12 21

(891) 2016 12 21

(731) IVOCLAR VIVADENT AG

Bendererstrasse 2, FL-9494 Schaan,
Liechtenstein

(540)

ProArt CAD

(591) Black, white

(531) 27.05.01

(511)

5 – Materials for use in dentistry; materials and auxiliary materials for the manufacture of dental impressions, models, crowns, bridges, inlays, prostheses, artificial teeth; dental waxes; artificial veneers; synthetic materials for the fabrication of crowns, bridges, artificial teeth; wax material for the fabrication of crowns, bridges, artificial teeth.

10 – Apparatus, devices, tools, and instruments for dental use; artificial teeth; ingots made of wax, resin, metal, or ceramic for the manufacture of dental crowns, bridges, inlays, prostheses, artificial teeth; dental crowns and bridges; templates for the cementation of denture teeth into denture bases; bite plates for dental use; impression trays for dental use; try-in bodies for dental use; denture frameworks; implant abutments; prefabricated parts for crowns, bridges, and pontics.

(260) AM 2018 92675 A

(800) 843782

(151) 2004 07 20

(891) 2016 11 18

(731) ZORLUTEKS TEKSTIL TICARET VE
SANAYI ANONIM ŞİRKETİ

Vasif Çınar Cad. No:91 Sultanhamam
Eminönü İstanbul, Turkey

(540)

BRIELLE

(591) Black and white

(531) 27.05.17

(511)

24 – Fiberglass fabrics for textile use; waterproof fabrics; fabrics, impervious to gases for aeronautical balloons; fabrics of imitation animal skins; textile linings; filtering materials of textile; curtains of textile or plastic, shower curtains of textile or plastic; household linen; table cloths including oilcloth not of paper; bed cloths, bed covers, bed linen, quilts, pillowcases; covers for furniture; serviettes of textile; prayer rugs; bed covers of paper; bundles of textile; comforters; blankets; bath linen, towels of textile; face and bath towels; wall coverings of fabric; handkerchiefs of textile; napkins of cloth for removing make up; flags not of paper; labels of fabric; laundry bags.

(260) AM 2018 92676 A

(800) 1347029

(151) 2016 11 25

(891) 2016 11 25

(731) FIIZY OÜ

Toom-Kooli 1, EE-10130 Tallinn, Estonia

(540)

FIIZY

(591) Black, white

(511)

35 – Commercial trading and consumer information services; advertising, marketing and promotional services; business analysis, research and information services; business assistance, management and administrative services.

36 – Financial and monetary services, and banking; valuation services; insurance underwriting; real estate services; fundraising and sponsorship; provision of prepaid cards and tokens (term considered too vague by the International Bureau – Rule 13(2)(b) of the Common Regulations).

(260) AM 2018 92757 A

(800) 1347463

(151) 2016 08 08

(891) 2016 08 08

(731) TURKCELL İLETİŞİM HİZMETLERİ

ANONİM ŞİRKETİ

Aydınevler Mah. İnönü Cad. No:20,

Küçükyalı Ofispark Maltepe İstanbul,

Turkey

(540)

Bip

(591) Black, white

(531) 27.05.17; 27.05.23

(511)

9 – Communication machines and devices, namely apparatus for recording, transmission or reproduction of sound and images; computers and peripheral hardware, namely card readers; barcode readers; scanners; computers; disk drivers; data gathering terminals; word processors; printers; monitors; plotters; keyboards; computer mice; multi-media disc players; DVD players; data storage media; magnetic data media, video and audio recordings, CD-ROM, DVD, disks, optic disks, cassettes, audio and video tapes, exposed films, compact discs; laser discs; electronic audiovisual equipment; digital audio tapes; magnetic cards; smart cards; telecommunication devices, namely telephones, mobile phones, radio phones, cordless phones, telephone switchboards.

41 – Education and instruction services; arranging and conducting of symposia, conferences, congresses and seminars; sports, cultural activities and entertainment services; publication and editing of printed matter, including magazines, books, newspapers; production of film, television and radio programs; news program services, news reporter services; photographer services; translation services.

42 – Scientific and industrial analysis and research services, engineering services, consultancy relating to computer hardware and software, industrial design services, other than engineering, computer and architectural design; graphic arts designing; authenticating works of art.

(260) AM 2018 92820 A

(800) 1349136

(151) 2017 03 20

(891) 2017 06 19

(731) M. GOBET Thierry

9 place de l'Eglise, Château de la Celle,

F-78720 LA CELLE LES BORDES, France

(540)

**TOT'HEMA
TOTEMA**

(591) Black, white

(531) 27.05.01; 28.05

(511)

5 – Pharmaceutical products for iron deficiency prevention and treatment.

(260) AM 2018 92823 A

(800) 1348613

(151) 2017 02 16

(891) 2017 02 16

(731) CANDULOR AG

Boulevard Lilienthal 8 CH-8152 Glattpark

(Opfikon), Switzerland

(540)

PHYSIOSELECT

(591) Black and white

(511)

10 – Artificial teeth and veneers.

(260) AM 2018 92825 A

(800) 1348627

(151) 2016 09 08

(891) 2016 09 08

(731) APPLE INC.

1 Infinite Loop, Cupertino CA 95014, USA

(540)

macOS

(591) Black and white

(531) 27.05.10

(511)

9 – Computer operating software; computer operating software; computer software development tools.

(260) AM 2018 92826 A

(800) 1349147

(151) 2017 01 26

(891) 2017 01 26

(731) KRKA, tovarna zdravil, d.d., Novo mesto

Šmarješka cesta 6, SI-8000 Novo mesto,
Slovenia

(540)

VILGAL

(591) Black, white

(511)

5 – Pharmaceutical preparations.

(260) AM 2018 92827 A

(800) 1348630

(151) 2017 02 14

(891) 2017 02 14

(731) BAYER AKTIENGESELLSCHAFT

Kaiser-Wilhelm-Ring 51373 Leverkusen,
Germany

(540)



(591) Green and yellow

(531) 26.01.05; 26.11.25; 29.01.13

(511)

5 – Pharmaceutical preparations and substances.

10 – Medical instruments and apparatus, inhaling and diffusing gadgets for medical purposes.

(260) AM 2018 92828 A

(800) 1348675

(151) 2016 12 30

(891) 2016 12 30

(731) EKOL LOJISTIK ANONIM SIRKETI

Ekol Caddesi No.2 TR-34935 Sultanbeyli
İstanbul, Turkey

(540)

LOJİSTİK DÖRT SIFIR

(591) Black and white

(531) 27.05.05; 27.05.17

(511)

39 – Land, rail, water, and air transport services for the carriage of freight; courier services (for merchandise); establishment and operation of warehouses, namely warehousing services.

(260) AM 2018 92829 A

(800) 1348678

(151) 2017 02 06

(891) 2017 02 06

(731) TURNER BROADCASTING SYSTEM

EUROPE LIMITED

Turner House, 16 Great Marlborough Street
London W1F 7HS, United Kingdom

(540)

THE HAPPOS FAMILY

(591) Black and white

(511)

41 – Entertainment services, namely providing entertainment programs and content via television, satellite, the internet, wireless networks and other electronic communication networks; providing non-downloadable online publications; providing audio visual content, entertainment information and online games via a website; providing on-line music, not downloadable, providing on-line videos, not downloadable, presenting live entertainment performances; amusement park services; production of films, television and digital entertainment content.

(260) AM 2018 92830 A

(800) 1348731

(151) 2017 04 12

(891) 2017 04 12

(731) TAKEDA PHARMACEUTICAL COMPANY
LIMITED1-1, Doshomachi 4-chome, Chuo-ku Osaka
540-8645, Japan

(540)

Эдарби Кло

(591) Black and white

(531) 28.05

(511)

5 – Pharmaceutical preparations.

(260) AM 2018 92834 A

(800) 1349184

(151) 2015 11 25

(891) 2015 11 25

(731) GOTHALS LIMITED

Themistokli Dervi 5, Elenion Building,
CY-1066 Nicosia, Cyprus

(540)



(591) Black, white, red

(531) 26.04.19; 26.04.22; 26.04.24; 27.05.01;
27.05.24; 29.01.13

(511)

18 – Imitations of leather, fur, briefcases, trunks, umbrellas, backpacks, wallets, garment carriers, purses, handbags, suitcases.

25 – Clothing, footwear, headgear.

35 – Sale of clothes and fashion articles; retail or wholesale services featuring clothes, shoes and haberdashery.

(260) AM 2018 92858 A

(800) 1349431

(151) 2015 11 25

(891) 2015 11 25

(731) GOTHALS LIMITED

Themistokli Dervi 5, Elenion Building,
CY-1066 Nicosia, Cyprus

(540)



(591) Black, white

(531) 26.04.24; 27.05.24

(511)

18 – Imitations of leather, fur, briefcases, trunks, umbrellas, backpacks, wallets, garment carriers, purses, handbags, suitcases.

25 – Clothing, footwear, headgear.

35 – Sale of clothes and fashion articles; retail or wholesale services featuring clothes, shoes and haberdashery.

(260) AM 2018 92892 A

(800) 1348995

(151) 2017 03 16

(891) 2017 03 16

(731) SONOSCAPE MEDICAL CORP.

4/F, 5/F, 8/F, 9/F & 10/F, Yizhe Building,
Yuquan Road, Nanshan, Shenzhen,
518051 Guangdong, China

(540)

SonoScape

(591) Black, White

(531) 27.05.17

(511)

5 – Diagnostic preparations for medical purposes; chemical reagents for medical or veterinary purposes; reagent paper for medical or veterinary purposes; disinfectants; nutritional supplements; depuratives; chemical preparations for veterinary purposes; biocides; adhesive bands for medical purposes; adhesives for dentures.

10 – Medical apparatus and instruments; medical ultrasound equipment; testing apparatus for medical purposes; surgical apparatus and instruments; blood testing apparatus; diagnostic apparatus for medical purposes; otolaryngology equipment; ophthalmic apparatus; electrocardiographs; apparatus for use in medical analysis.

35 – Retail or wholesale services for pharmaceutical, veterinary and sanitary preparations and medical supplies; advertising; organization of exhibitions for commercial or advertising purposes; import-export agencies; marketing; personnel management consultancy; relocation services for businesses; systemization of information into computer databases; sponsorship search; sales promotion for others.

(260) AM 2018 92896 A

(800) 1349016

(151) 2017 04 07

(891) 2017 04 07

(731) DOĞAL KİMYEVİ MADDELER VE ZIRAI
İLAÇLAR SANAYİ VE TİCARET
ANONİM ŞİRKETİToplarönü Sk.No:16, Anadoluhisari
TR-34810 Beykoz Istanbul, Turkey

(540)



(591) Black, white, green, Yellow

(531) 01.03.17; 05.03.15; 26.03.23; 26.11.08;
27.05.10; 27.05.11; 29.01.14

(511)

1 – Chemicals used in industry, science, photography, agriculture, horticulture and forestry, manures and soils, unprocessed artificial resins and unprocessed plastics, fire extinguishing compositions, adhesives not for medical, household and stationery purposes.

2 – Paints, varnishes, lacquers, preservatives against rust, preservatives against deterioration of wood, thinners and binders for paints, pigments, preservatives for metals, shoe dyes, printing dyes and ink, toners (including filled toner cartridges), colorants for food, pharmaceuticals and beverages, raw natural resins, metals in foil and powder form for painters, decorators, printers and artists.

44 – Medical services, beauty care services, veterinary services, animal husbandry, animal breeding, shoeing horses [farrier services], agriculture, horticulture and forestry services, medical advisory services in the field of personnel health.

(260) AM 2018 92898 A

(800) 1349035

(151) 2016 08 04

(891) 2016 08 04

(731) BRUNO RIMINI LTD

309 Ballards Lane, London N12 8LY,

United Kingdom

(540)

SILOSTOP

(591) Black, white

(511)

16 – Wrapping and packaging materials; sacks and bags of plastic films, in particular shrink films, tubular films; wrapping and packaging materials for industrial, agricultural, horticultural, waste management and commercial use; films and sheets of plastics; sacks and bags made of plastics materials; heavy duty bags; cling films made wholly or principally of plastics materials; stretch film; plastic wrap; plastic bale wrap; silage bale stretch wrap; all the foregoing being for wrapping and packaging purposes; garbage bags, refuse sacks, resealable plastic bags; polythene bags; parts and fittings for the aforesaid goods.

17 – Plastics; semi-processed plastic substances; plastic fibres; recycled plastic pellets; plastic film, not for wrapping; flexible plastic films, other than for packaging; plastics in the form of sheets, films, foils, blocks, rods, slabs and tubes; semi-processed plastic films, including shrink films, film strips and tubular films; plastics materials in the form of mouldings and extrusions; foils, boards, poles and pipes made of plastic; tubes made of plastic; sealing, packaging and insulating materials; packing, padding and stuffing materials of plastics or rubber; synthetic resins;

waterproofing film (plastic -) [other than for wrapping]; waterproofing film (plastic -) [other than for packaging]; plastic sheet for agricultural purposes; plastic sheeting for agricultural purposes; plastic sheeting for use in horticulture; plastic sheeting for use in agriculture; plastic sheeting for preventing weed growth; plastics in extruded form for use in manufacture, and for use in agriculture and horticulture; plastics sheeting for industrial or agricultural use; interlocking knitted polyethylene sheets for use in agriculture; interlocking knitted polyethylene sheeting for protecting stored agricultural feeds, namely, silage sheets, silage pits, silage clamps, silage bales, straw bales and stacks; plastic mulches for use in agriculture and horticulture; protective sheeting (non-woven) for agricultural purposes; plastic bunker covers for agricultural purposes; plastic film covers for agricultural purposes; plastic forage covers; plastic hay covers; plastic silage covers; silage sheets; oxygen barrier films for the protection of silage; oxygen barrier films for the protection of silage in bunkers, piles and bales; forage covers; bunker films; parts and fittings for the aforesaid goods.

19 – Low tunnels [non-metallic or non-metallic frame] for the protection of plants; polytunnels made of plastics materials; fumigation tunnels made of plastics materials; parts and fittings for the aforesaid goods.

22 – Tarpaulins; plastic sheet materials [tarpaulins]; coverings in the nature of tarpaulins; plastic sheet materials for use as tarpaulins; tarpaulins made from plastic films, in particular shrink films, tubular films, tarpaulins and sacks; silage bags; non-textile bags for the bulk storage of silage; non-textile bags for the transportation of silage in bulk; nets, round bale nets, raschel-knit nets of plastic; parts and fittings for the aforesaid goods.

(260) AM 2018 92905 A

(800) 1350245

(151) 2017 04 04

(891) 2017 04 04

(731) DRINKSTAR GMBH

Äußere Oberraustrasse 36, 83028 Rosenheim,
Germany

(540)



(591) Black, white

(531) 01.01.01; 01.01.02; 01.01.10; 26.11.12;
27.05.01; 27.05.07; 27.05.08

(511)

1 – Chemical products for use in industry; food preservative compositions; chemical substances for preserving foodstuffs.

5 – Disinfectants; sterilising preparations.

7 – Controlled volume pumps; food and beverage processing and preparation machines and apparatus; beverage making machines; pumps [machines] for the beverage industry; carbonating machines.

35 – Advertising; business planning services.

39 – Transport services; transport; distribution services relating to beverages, such as alcoholic beverages.

42 – Development of new products; research and development services; research and development services in the field of chemistry; research and development of new products for others; engineering consultancy services; chemistry consultation; technical consultancy in relation to the technical research in the field of food and beverages.

(260) AM 2018 92910 A

(800) 1350298

(151) 2016 12 05

(891) 2016 12 05

(731) THE GIN COMPANY LIMITED

Level 2, 104 Richmond Road, Ponsonby,
Auckland, New Zealand

(540)

SCAPEGRACE

(591) Black, white

(511)

32 – Beers; non-alcoholic cocktails; soda water; water (bottled); mineral and aerated waters.

33 – Alcoholic beverages (except beers); alcoholic essences; alcoholic extracts; anise (liqueur); aperitifs; beverages (distilled); bitters; brandy; cocktails; gin; kirsch; liqueurs; pre-mixed alcoholic beverages other than beer-based; rum; spirits; vodka; whisky; cider; wine.

(260) AM 2018 92927 A

(800) 1349964

(151) 2016 12 01

(891) 2016 12 01

(731) ROSSELLA GIORDANO

Via Piazza, 18, I-80044 OTTAVIANO (NA),
Italy

(540)



(591) Green

(531) 05.03.06; 27.05.08; 27.05.17; 29.01.03

(511)

25 – Clothing; headgear; casualwear; menswear; clothing made of fur; rainproof clothing; clothing of imitations of leather; leather clothing; knitted underwear; clothing for gymnastics; leisurewear; clothing for skiing; boys' clothing; sportswear; gowns; suits; women's ceremonial dresses; evening wear; dresses made from skins; leisure suits; robes; bathrobes; beach robes; rainwear; bandanas [neckerchiefs]; Bermuda shorts; nightwear; ladies' underwear; babies' undergarments; underwear; bikinis; blazers; boas; boas [necklets]; leotards; snap crotch shirts for infants and toddlers; boleros; boxer shorts; stocking suspenders; suspender belts for men; corsets; caftans; stockings; men's socks; socks; slipper socks; woollen socks; breeches; swimming trunks; shirts; collared shirts; dress shirts; shirts for suits; casual shirts; tank tops; vest tops; capes; coats; leather jackets; fur coats and jackets; coats of denim; cardigans; sports jackets; belts [clothing]; chemises; evening suits; tutus; pantsuits; swimming costumes; beachwear; neckties; knickers; turtle-necks; cummerbunds; kerchiefs [clothing]; sweat shirts; silk scarves; neckerchiefs; scarves; jackets [clothing]; dinner jackets; smoking jackets; men's and women's jackets, coats, trousers, vests; down jackets; rainproof jackets; denim jackets; knit jackets; long jackets; bushjackets; suede jackets; sleeveless jackets; gilets; leather waistcoats; blousons; skirts; culotte skirts; gloves [clothing]; knitted gloves; gloves including those made of skin, hide or fur; mackintoshes; ready-to-wear clothing; fleeces; denim jeans; hosiery; undershirts; sweaters; mantles; cloaks; negligees; camiknickers; waistcoats; short trousers; shorts; trunks; trousers; dress pants; trousers of leather; bowties; beach wraps; parkas; bathing suit cover-ups; pyjamas; polo shirts; pullovers; shawls; shawls and headscarves; topcoats; outerclothing for girls; outerclothing for men; outerclothing; shirt fronts; shoulder scarves; short-sleeved or long-sleeved t-shirts; skirt suits; tee-shirts; bathwraps; trench coats; twin sets; lounging robes; shift dresses; berets; rain hats; sun hats; beach hats; woolly hats; leather headwear; flat caps; bonnets; visors; footwear; footwear; pumps [footwear]; wooden shoes; non-slipping devices for footwear; footwear for men; inner socks for footwear; desert boots; insoles for footwear; children's footwear; infants' footwear; footwear for women; training shoes; Japanese split-toed work footwear (jikatabi); beach shoes; heelpieces for footwear; leisure shoes; dress shoes; shoe soles; boots; mules; slipper socks; leather slippers; bath slippers; women's foldable slippers.

(260) AM 2018 92930 A

(800) 1350010

(151) 2017 03 03

(891) 2017 03 03

(731) MARCHI & BREVETTI INTERPRISE S.r.l.
Via Pietro Bortolotti,18,I-41125 MODENA
(MO), Italy

(540)



(591) Black, white

(531) 03.07.01; 03.07.16; 27.05.17

(511)

1 – Disincrustants, water purifying preparations, water softening preparations, chemicals for the treatment of water and swimming pool and spa water, chemicals for swimming pools and spas, chemicals for swimming pool and spa maintenance, chlorine, chlorine reducers, buffer solutions (chemicals), preparations for chemical analysis of swimming pool and spa water, chemical additives for disinfection of water, insulating moisture-proof compounds, other than varnishes, bacteriological preparations, not being for medical or veterinary use, carbon for filters, chemical additives for insecticides, bactericides, other than those for medical and veterinary use, for treatment of swimming pool and spa water, chemical additives for fungicides.

3 – Bath salts, not for medical purposes; detergents; cleaning preparations in the form of foams; cleaning, polishing, scouring and abrasive preparations; soaps; bleaching preparations and other substances for cleaning.

5 – Disinfectants; disinfectant soap; preparations for the disinfection of water; preparations for destroying vermin; fungicides, herbicides, algacides, pharmaceutical, veterinary and sanitary preparations.

(260) AM 2018 92931 A

(800) 1350038

(151) 2017 03 02

(891) 2017 03 02

(731) JANSSEN SCIENCES IRELAND UC
Eastgate Village, Little Island, Co. Cork,
Ireland

(540)

ARVOIK

(591) Black, white

(511)

5 – Human pharmaceutical preparations.

(260) AM 2018 92935 A

(800) 1350042

(151) 2017 03 02

(891) 2017 03 02

(731) JANSSEN SCIENCES IRELAND UC
Eastgate Village, Little Island, Co. Cork,
Ireland

(540)

SYMTUZA

(591) Black, white

(511)

5 – Human pharmaceutical preparations.

(260) AM 2018 92941 A

(800) 1350089

(151) 2015 12 24

(891) 2015 12 24

(731) LE SHI INTERNET INFORMATION &
TECHNOLOGY (BEIJING)
CORPORATION

Room 6184, 6th Floor, Building 19, No.68
Xueyuan South Road, Haidian District
Beijing, China

(540)

Le

(591) Black, white

(531) 27.05.17; 27.05.23

(511)

20 – Trestles [furniture]; stands for television; audio stand (furniture); office furniture; chests for toys; mirrors [looking glasses]; plaited straw, except matting; works of art, of wood, wax, plaster or plastic; resinoid artware; curtain rings.

45 – Security consultancy; chaperoning; clothing rental; funerary undertaking; dating services; on-line social networking services; marriage agencies; licensing of intellectual property; copyright management.

(260) AM 2018 92945 A

(800) 1350355

(151) 2017 03 31

(891) 2017 03 31

(731) APPLE INC.

1 Infinite Loop, Cupertino CA 95014, USA

(540)

WAVEBURNER

(591) Black, white

(531) 27.05.05

(511)

9 – Computer software for the mastering, encoding and burning of compact discs.

(260) AM 2018 92950 A

(800) 1080484

(151) 2011 05 19

(891) 2017 03 29

(731) OETTINGER BRAUEREI GMBH
Brauhausstrasse 8, 86732 Oettingen, Germany

(540)



(591) Black, white

(531) 25.01.05; 25.01.09; 25.01.15; 27.01.12;
27.07.24

(511)

32 – Beers; mineral and aerated waters and other non-alcoholic drinks; fruit drinks and fruit juices.

(260) AM 2018 92977 A

(800) 1349789

(151) 2017 03 15

(891) 2017 03 15

(731) COLGATE-PALMOLIVE COMPANY
300 Park Avenue New York NY 10022, USA

(540)

**Everyone Deserves A Future
They Can Smile About**

(591) Black and white

(531) 27.05.15

(511)

3 – Dentifrices, mouthwash, tooth whitening preparations.

5 – Medicated oral care products, namely, a professional tooth whitening kit comprised of whitening gel, syringes and mouth tray, for at-home use.

16 – Printed materials, namely, pamphlets, brochures, newsletters, journals, magazines in the field of oral hygiene.

21 – Toothbrushes.

41 – Educational services, namely, conducting classes and seminars in the field of oral care hygiene.

(260) AM 2018 93022 A

(800) 1350852

(151) 2017 03 23

(891) 2017 03 23

(731) ORANGE RESTAURANTS BRANDS
LIMITED

2 Riga Feraiou Street, Limassol Center,
Block B, 6th floor, Office 601 CY-3095
Limassol, Cyprus

(540)



(591) Red, orange, black and yellow

(531) 01.15.05; 26.04.24; 27.05.05; 29.01.13

(511)

43 – Bar services; café services; cafeteria services; canteen services; food and drink catering; restaurant services; self-service restaurant services; snack-bar services.

(260) AM 2018 93161 A

(800) 1353009

(151) 2016 11 03

(891) 2016 11 03

(731) EURO GAMES TECHNOLOGY LTD.

"Maritsa" Str. 4, "Vranya-Lozen-Triugulnika",
BG-1151 Sofia, Bulgaria

(540)



(591) Green, yellow, brown and red. Green, yellow, brown, red for the word and figurative elements

(531) 24.17.09; 24.17.18; 27.05.03; 29.01.14

(511)

9 – Apparatus for recording, transmission or reproduction of sound or images, computer software /recorded/, monitors [computer hardware].

28 – Games that are not included in other classes; gaming machines operating with coins, banknotes and cards; gaming machines for gambling.

(260) AM 2018 93162 A

(800) 1353010

(151) 2016 11 03

(891) 2016 11 03

(731) EURO GAMES TECHNOLOGY LTD.

"Maritsa" Str. 4, "Vranya-Lozen-Triugulnika"
BG-1151 Sofia (BG), Bulgaria

(540)



(591) Green, yellow, brown and red. Green, yellow, brown, red for the word and figurative elements

(531) 03.13.09; 05.13.08; 27.05.02; 27.05.03;
27.05.04; 29.01.14

(511)

9 – Apparatus for recording, transmission or reproduction of sound or images, computer software /recorded/, monitors [computer hardware].

28 – Games that are not included in other classes; gaming machines operating with coins, banknotes and cards; gaming machines for gambling.

(260) AM 2018 93163 A

(800) 1353011

(151) 2016 12 09

(891) 2016 12 09

(731) ALTUNKAYA İNŞAAT NAKLİYAT GIDA
TİCARET ANONİM ŞİRKETİ
4. Organize Sanayi Bölgesi, nolu Cadde, No:8
Şehitkamil, TR-83409 Gaziantep, Turkey

(540)

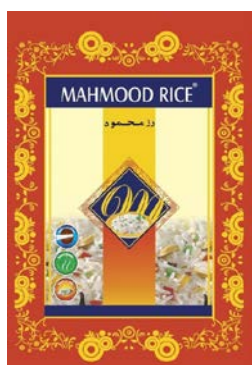

(591) Red, yellow, blue, green, brown and orange

(531) 05.07.01; 08.07.05; 08.07.25; 11.03.20;
25.01.25; 28.01; 29.01.15

(526) Rice ®

(511)

30 – Rice.

(260) AM 2018 93165 A

(800) 1353022

(151) 2017 03 02

(891) 2017 03 02

(731) JANSSEN SCIENCES IRELAND UC
Eastgate Village, Little Island, Co. Cork,
Ireland

(540)

REKAMBYS

(591) Black, white

(511)

5 – Human pharmaceutical preparations.

(260) AM 2018 93166 A

(800) 1352228

(151) 2017 02 09

(891) 2017 02 09

(731) USANOV IGOR' VLADIMIROVICH
ul. Kol'skaya, 2, korp. 5, kv. 90, RU-129329
Moskva, Russian Federation

(540)

Kalinov Rodnik

(591) Black and white

(531) 27.05.17

(511)

32 – Mineral and aerated waters and other non-alcoholic beverages; fruit beverages and fruit juices; syrups and other preparations for making beverages; aperitifs, non-alcoholic; lithia water; seltzer water; soda water; waters [beverages]; table waters; kvass [non-alcoholic beverage]; cocktails, non-alcoholic; lemonades; non-alcoholic beverages; isotonic beverages; non-alcoholic honey-based beverages; aloe vera drinks, nonalcoholic; whey beverages; non-alcoholic fruit juice beverages; fruit nectars, non-alcoholic; orgeat; powders for effervescing beverages; sarsaparilla [non-alcoholic beverage]; syrups for lemonade; syrups for beverages; smoothies; tomato juice [beverage]; cider, non-alcoholic; vegetable juices [beverages]; preparations for making aerated water; preparations for making mineral water; pastilles for effervescing beverages; sherbets [beverages]; non-alcoholic fruit extracts; essences for making beverages.

(260) AM 2018 93168 A

(800) 1352248

(151) 2017 03 13

(891) 2017 03 13

(731) KRKA, tovarna zdravil, d.d., Novo mesto
Šmarješka cesta 6, SI-8000 Novo mesto, Slovenia

(540)

SLEEPZONE

(591) Black and white

(511)

5 – Pharmaceutical preparations.

(260) AM 2018 93169 A

(800) 1352256

(151) 2017 03 13

(891) 2017 03 13

(731) KRKA, tovarna zdravil, d.d., Novo mesto
Šmarješka cesta 6, SI-8000 Novo mesto, Slovenia

(540)

CALMESAN

(591) Black and white

(511)

5 – Pharmaceutical preparations.

(260) AM 2018 93172 A

(800) 1353044

(151) 2017 05 02

(891) 2017 05 02

(731) SQM Europe, naamloze vennootschap
Houtdok-Noordkaai 25 a, B-2030 Antwerpen
Belgium

(540)



(591) Several shades of green

(531) 26.04.12; 26.11.12; 27.05.17; 27.05.23;
27.05.24; 29.01.12

(511)

1 – Chemicals used in industry and science, as well as in fish-breeding, agriculture, horticulture and forestry; fertilizers; fertilizing preparations.

(260) AM 2018 93173 A

(800) 1352275

(151) 2017 03 16

(891) 2017 03 16

(731) TRUSSARDI S.P.A.

Piazza Della Scala, 5 I-20121 Milano, Italy

(540)

TRUSSARDI
RIFLESSO

(591) Black and white

(531) 27.05.17

(511)

3 – Perfumes; perfumery and fragrances; essential oils and aromatic extracts; cosmetics.

(260) AM 2018 93174 A

(800) 1352281

(151) 2017 04 21

(891) 2017 04 21

(731) WENZHOU YAWEI ELECTRIC CO., LTD.

No.18 Donggong Road, Dongmen village,
Haicheng Street, Economic and Technological
Development Zone Wenzhou, Zhejiang, China

(540)

YAWEITAI

(591) Black and white

(531) 27.05.01; 27.05.17

(511)

9 – Connectors [electricity]; junction boxes [electricity]; switches, electric; plugs, sockets and other

contacts [electric connections]; circuit breakers; light dimmers [regulators], electric; lighting ballasts; voltage surge protectors; wires, electric; electricity mains (materials for-) [wires, cables].

(260) AM 2018 93175 A

(800) 1347284

(151) 2016 06 03

(891) 2017 06 09

(731) ALFRED KÄRCHER GMBH & CO. KG

Alfred-Kärcher-Strasse 28-40, 71364

Winnenden, Germany

(540)

KÄRCHER

(591) Black and yellow

(531) 26.11.01; 26.11.08; 27.05.11; 27.05.17;
29.01.12

(511)

3 – Cleaning agents; cleaning agents and care products for carpets and wall-to-wall carpets; chemical products for the cleaning and care of motor vehicles; blasting abrasives for mechanical surface treatment, in particular mineral blasting abrasives and sand-blasting abrasives; polishing preparations; laundry detergents; soaps.

7 – Mechanical spraying, rinsing and cleaning apparatus, and installations consisting thereof, in particular high-pressure cleaning apparatus, steam cleaning and steam jet apparatus, particle jet apparatus, spray extraction apparatus, brushing machines, vacuum cleaners, floor polishing apparatus, carpet brushing vacuum cleaners, cleaning machines for hard surfaces, cleaning machines for hard floors, cleaning machines for textile covers, sweepers, apparatus for cleaning the inside of containers, cleaning machines for glass surfaces, mechanical window cleaning apparatus, mechanically operated apparatus for cleaning motor vehicles, cleaning machines for parts made of metal, plastic and/or glass, degreasing machines; electric suction apparatus for industrial purposes; vehicle washing installations; mechanical apparatus for removing preservatives from vehicles; washing machines; dishwashers; hydraulic controls for machines; mechanical apparatus for extracting gas from tanks; mechanical apparatus for producing dry-ice granulate; parts of the aforesaid goods, in particular brushes, hoses, hand-held spray guns, suction heads, spray nozzles, jet tubes, vacuum cleaner hoses, vacuum cleaner bags, vacuum cleaner filters; mechanical hose reels; motor-powered gardening implements; motor-powered forestry implements and machines; motor-powered agricultural implements and machines; motor-powered mowing implements and mowing machines; harvesting machines; power saws; chains for power saws; brush

cutters (machines); scythes (machines); hedge trimmers (machines); lawn mowers (machines); scarifiers (machines); horticultural machines; machines for cleaning streets; earth moving machines; shovels for earth moving machines; motor-powered spreading implements and spreading machines; accessories for motor-powered spreading implements and spreading machines (included in this class); snow blowers; snow ploughs; snow clearing machines; snow plough shovels; front loaders; shovels for front loaders; clearing machines and clearing blades; motor-powered soil cultivation implements and soil cultivation machines; working equipment mountable on vehicles for horticulture, agriculture and forestry purposes; working equipment drawn by vehicles for horticulture, agriculture and forestry purposes; pumps (included in this class), in particular water pumps, pumps for ponds, submersible pumps, garden pumps, house water pumps, high-pressure pumps, metering pumps; leaf vacuums; leaf blowers; mechanical high-pressure water jet apparatus for cleaning, removing and treating surfaces and for cutting, drilling and deburring; high-pressure water tools, in particular high-pressure lances and high-pressure spray guns; water jet nozzles, nozzle supports (parts of machines); valves (parts of machines); injectors (parts of machines); filter apparatus (machines); pneumatic, hydraulic, electric or manually driven handling machines, positioning devices, feed mechanisms and robots for guiding high-pressure water tools.

9 – Apparatus and instruments for conducting, switching, transforming, accumulating, regulating and controlling electricity; wireless transmitters and receivers; data storage media; mobile data communications apparatus; electric controls, including coin-operated; electric controllers; radio remote controls; time switches; electric connection cables; extension cords; batteries (electric); rechargeable electric batteries; chargers for electric batteries; electric irrigation control apparatus; readers for the contactless reading of markings, in particular bar code readers and RFID (Radio Frequency Identification) readers; measuring apparatus; dosimeters; data processing equipment and computers; computer software (stored); computer software (downloadable); application software; protective clothing for protection against fire, radioactive radiation, biological contamination and chemical contamination; protective and safety equipment; protective helmets; protective glasses; protective masks; protective boots; respiratory masks, other than for artificial respiration; filters for respiratory masks; protective work clothing.

11 – Drying apparatus, in particular for motor vehicles; apparatus for cleaning the body, namely body showers; garden showers; cooling and heating apparatus and installations; steam generating apparatus; hot air generating apparatus; water heaters (appara-

tus); irrigation sprinklers; water dispensing apparatus; dispensers for dispensing mineral waters, carbonated waters, table waters, fruit beverages, fruit juices, lemonades; water distribution installations; drop nozzles for irrigation installations; water filters; filters for drinking water; air filters; blowers for ventilation purposes; air purifiers; air dryers; thermal oil heaters; electric cooking appliances and cooking installations; mobile field kitchens, namely, transportable electric, fuel-powered or gas-powered cooking appliances; field laundries, namely, transportable electric, fuel-powered or gas-powered laundry dryers; drinking water and waste water treatment apparatus and installations.

35 – Wholesale and retail services, including wholesale and retail services via the Internet and mail order services, in the fields of cleaning agents, detergents, soaps, household goods, electric goods, electronic goods, data carriers, domestic technology, communications technology, cleaning technology, washing installations, material treatment and surface treatment technology, horticultural, agricultural and forestry apparatus, mechanical and hand-operated gardening implements, water treatment technology, cooling, heating and cooking technology; organizational and business management consultancy for companies, in particular with regard to optimizing processes; compiling data in computer databases; analysis and evaluation of marketing, business and commercial data; systematization of data in computer databases.

37 – Building construction; domestic maintenance, repair and cleaning services (caretaker services); assembling of machine plant (installation work); maintenance, upkeep and servicing of buildings; street cleaning; car park cleaning; cleaning of articles made of metal, plastic and glass; interior and exterior cleaning of buildings; window cleaning; facade cleaning; maintenance and repair of cleaning, water treatment, cooling, heating and cooking apparatus and installations and of mechanical high-pressure water jet apparatus, high-pressure water tools, handling machines, positioning devices, feed mechanisms and robots for guiding high-pressure water tools; maintenance and repair of horticultural, agricultural and forestry apparatus; cleaning, servicing and maintenance of motor vehicles; provision of motor vehicle cleaning installations and motor vehicle servicing installations; operation of self-service vehicle washing installations.

(260) AM 2018 93177 A

(800) 1352326

(151) 2016 12 20

(891) 2016 12 20

(731) NOVARTIS AG

CH-4002 Basel (CH), Switzerland

(540)



(591) gray, black and white

(531) 01.15.05; 19.11.01; 26.03.05; 26.11.12;
26.11.13

(511)

9 – Scientific, surveying, photographic, optical, weighing, measuring, signalling, checking (supervision), life-saving and teaching apparatus and instruments; apparatus for recording, transmission or reproduction of sound or images; digital recording media; data processing equipment; computer programs, software; computer hardware, particularly digital projectors; computer peripheral devices; interfaces [for computers]; hand held computers, tablet computers, personal digital assistants and handheld personal computers and software related thereto, particularly for use in the fields of medicine, health, fitness, exercise and wellness; telecommunication apparatus for mobile networks for the sending, receiving and storing of digital data, particularly for use in the fields of medicine, health, fitness, exercise and wellness; software and application software for use on electronic telecommunication apparatus, particularly handheld personal computers or tablet computers for use in collecting and storing patient data and medical information, such as drug ingestion information, pulse, heart rate, respiratory rate, body temperature, electric pressure in the body, human motion, human position or sleeping condition; software for accessing, browsing and searching downloadable audio and video files, information and commentary available online from databases or the Internet; chemistry apparatus and instruments; reusable scientific laboratory apparatus; optical lenses; contact lenses; measuring apparatus for values concerning fitness and exercise; data processing apparatus for use in collecting and storing patient data and medical information, such as drug ingestion information, pulse, heart rate, respiratory rate, body temperature, electric pressure in the body, human motion, human position or sleeping condition; data communication apparatus that transmit data and information to databases.

10 – Surgical, medical, dental and veterinary apparatus and instruments; artificial limbs, eyes and teeth; orthopedic articles; medical apparatus and instruments, particularly testing apparatus for medical use or diagnostic apparatus for medical use; medical ap-

paratus for introducing pharmaceutical preparations into the human body, particularly for the deferred, controlled or immediate release of medicated substances; inhalers; syringes for injections for medical use; syringes and medical measuring apparatus, particularly such that can directly transmit data to a database, particularly thermometers, pulse meters and apparatus for measuring respiratory rates and sleeping conditions.

41 – Education, training, providing training on-line, particularly in the fields of medicine, health, fitness, exercise and wellness; sporting and cultural activities; teaching; arranging and conducting of conferences, congresses, seminars, symposiums, lectures, lessons and training courses; provision of information relating to education, training; practical training [demonstration]; organization and conducting of training workshops; provision of non-downloadable online electronic publications; provision of non-downloadable videos online; organization and conducting of non-virtual educational forums; services provided by consultants relating to education and training, particularly for healthcare professionals.

42 – Scientific and technological services as well as research and design relating thereto; design and development of computers and software; chemical analysis; chemistry services; chemical research; software development [design]; scientific laboratory services; providing support services, particularly on-line, on the use of software, computer applications, apparatus and instruments in the fields of medicine, health, fitness, exercise and wellness; hosting customized web pages, particularly for regular processing of customized information, particularly blog posts, multimedia content and other on-line content and on-line web links to other websites; provision of information relating to medical and scientific research in the field of pharmaceutical products, programming of software for Internet portals, chat rooms, chat lines and Internet forums, particularly in the fields of medicine, health, fitness, sports and wellness; hosting platforms on the Internet, hosting web portals, particularly in the fields of medicine, health, fitness, exercise and wellness.

44 – Medical services, particularly personalized medical services; services provided by consultants in the field of body and beauty care; medical consultancy services; medical and health care services; medical assistance; provision of information relating to medical services; providing health care information; consultancy services relating to pharmaceutical products; medical information services provided via the Internet; consultancy and information services provided via the Internet relating to pharmaceutical products; medical imaging services.

(260) AM 2018 93179 A
 (800) 1352334
 (151) 2017 04 20
 (891) 2017 04 20
 (731) MONTRES TUDOR SA
 Rue François-Dussaud 3 CH-1211
 Genève 26, Switzerland

(540)

BORN TO DARE

(591) Black and white

(511)

14 – Timepieces, namely watches, wristwatches, component parts of timepieces and accessories for timepieces not included in other classes, clocks and other chronometric instruments, chronometers, chronographs (timepieces), apparatus for timing sports events, time measuring and marking apparatus and instruments not included in other classes; watch bands, dials (for timepieces), cases and presentation cases for timepieces and jewelry, watch movements and their parts; jewelry; precious stones and semi-precious stones; precious metals and their alloys.

(260) AM 2018 93180 A
 (800) 888233
 (151) 2006 05 10
 (891) 2017 06 09
 (731) MAPED (Société par Actions Simplifiée)
 530, route de Pringy, F-74370 ARGONAY,
 French Guiana

(540)



(591) Black, white
 (531) 26.02.09; 27.05.24
 (511)

8 – Hand tools and implements (hand-operated); cutlery, cutters with retractable blades, guillotine cutters and other hand-operated implements for cutting paper or cardboard, scissors, side arms, razors.

9 – Protractors (measuring instruments), slide-rules, magnifying glasses (optics), magnets.

16 – Paper, cardboard and goods made from these materials, namely: cardboard articles, bags, sachets, envelopes, and pouches for packaging, of paper; printed matter; plastics for packaging not included in other classes, namely: bags, sachets, film and sheets; magazines (periodicals); photographs; writing material; adhesives for stationery or household purposes; artists' materials; paintbrushes; typewriters and offi-

ce requisites (except furniture); bulldog clips, drawing pins, paper clamps, map pins, elastic bands for offices, stapling appliances, staples, staple removers, paper perforating apparatus, stamps, inking pads, telephone directories; instructional and teaching material (except apparatus); writing or drawing instruments, compasses, bow compasses, rulers, triangular rulers, lettering stencils, fountain pens, pencils, pencil sharpeners, drawing inks and inks for writing instruments, India ink, writing slates, sponges for writing slates, geographical maps for drawing, rubber erasers, instruments for erasing ink.

(260) AM 2018 93181 A
 (800) 1352633
 (151) 2017 04 11
 (891) 2017 04 11
 (731) YUNXIN LI
 Zhongzheng Bldg., Zengtang Village,
 Hedong Town, Wuhua County Meizhou
 Guangdong, China

(540)

汾江
 Fen Jiang

(591) Black, white
 (531) 27.05.19; 28.03
 (511)

9 – Wires, electric; telephone wires; materials for electricity mains [wires, cables]; junction sleeves for electric cables; sheaths for electric cables; fibre [fiber (am.)] optic cables; copper wire, insulated identification threads for electric wires; coaxial cables; cables, electric.

(260) AM 2018 93230 A
 (800) 1354308
 (151) 2017 03 13
 (891) 2017 03 13
 (731) NOKIA CORPORATION
 Karaportti 3, FI-02610 Espoo (FI), Finland

(540)

NOKIA

(591) Black, white
 (511)

11 – Apparatus for lighting, heating, steam generating, cooking, refrigerating, drying, ventilating, water supply and sanitary purposes; acetylene generators; air deodorising apparatus; air cooling apparatus; air conditioning installations and apparatus; air filtering installations, apparatus and machines; alcohol burners; anti-dazzle devices for vehicles [lamp fittings]; aquarium filtration apparatus, heaters and

lights; arc lamps; autoclaves [electric pressure cookers]; bakers' ovens; barbecues; bath tubs and bath installations; bedwarmers; beverage cooling apparatus; bidets; blankets, electric, not for medical purposes; boilers, other than parts of machines; toasters; bread-making machines; burners; ceiling lights; central heating radiators; fairy lights for festive decoration; chromatography apparatus for industrial purposes; coffee machines, electric; cookers; cooking utensils, electric; cooking apparatus and installations; cooling installations, appliances and machines; dampers [heating]; defrosters for vehicles; dental ovens; deodorising apparatus, not for personal use; desalination plants; desiccating apparatus; disinfectant apparatus; distillation apparatus; diving lights; drip irrigation emitters; drying apparatus and installations; evaporators; extractor hoods for kitchens; fans [air-conditioning]; filters [parts of household or industrial installations]; fireplaces, domestic; flares; foot warmers, electric or non-electric; forges, portable; fountains; freezers; fruit roasters; fumigation apparatus, not for medical purposes; fire bars; ovens, other than for laboratory use; scrubbers [parts of gas installations]; gas condensers, other than parts of machines; germicidal burners; glue-heating appliances; hair driers [dryers]; hand drying apparatus for washrooms; hearths; heat pumps; heating installations; heating apparatus, electric; hot plates; hydrants; ice machines and apparatus; ice boxes; incinerators; kettles, electric; kilns; kitchen ranges [ovens]; laboratory burners; lamps; washing coppers; laundry dryers, electric; lava rocks for use in barbecue grills; level controlling valves in tanks; light bulbs; light-emitting diodes [LED] lighting apparatus; lighters; lighting apparatus and installations; lights for vehicles; lights, electric, for Christmas trees; microwave ovens [cooking apparatus]; microwave ovens for industrial purposes; nuclear reactors; atomic piles; oil burners; ornamental fountains; pasteurisers; pipes [parts of sanitary installations]; pocket warmers; polymerisation installations; radiators [heating]; refrigerating appliances and installations; regulating and safety accessories for water or gas apparatus and pipes; roasting apparatus; griddles [cooking appliances]; grills [cooking appliances]; rotisseries; sanitary apparatus and installations; sauna and spa bath installations; showers; sinks; sockets for electric lights; solar thermal collectors [heating]; steam generating installations; sterilizers; stills; stoves; swimming pool chlorinating apparatus; tanning apparatus [sun beds]; taps [faucets]; thermostatic valves [parts of heating installations]; toilets [water-closets]; searchlights; urinals [sanitary fixtures]; ventilation [air-conditioning] installations and apparatus; waffle irons, electric; warming pans; wash-hand basins [parts of sanitary installations]; water heaters; water distribution installations; water filtering apparatus and machines; flushing apparatus; watering installations, automatic; watering machines for agricultural

purposes; whirlpool-jet apparatus; parts, fittings and accessories of all the aforementioned goods.

12 – Vehicles; apparatus for locomotion by land, air or water; aeronautical apparatus, machines and appliances; air vehicles; air balloons; air bags [safety devices for automobiles]; anti-glare devices for vehicles; anti-skid chains; anti-theft devices for vehicles; automobiles; axle journals; audible warning systems for vehicles; stands for cycles; cycles; boats; brakes for vehicles; cable transport apparatus and installations; caissons [vehicles]; motor homes; canoes; caravans; carriages [railways]; cars; carts; chairlifts; cigar lighters for automobiles; civilian and military drones; concrete mixing vehicles; direction signals for vehicles; driverless vehicles [autonomous vehicles]; ejector seats for aircraft; engines, electric motors and propulsion mechanisms for vehicles; fenders for ships; funiculars; golf carts; wipers for vehicles; hydroplanes; inclined ways for boats; kick sledges; launches; fork lift trucks; locomotives; lorries; military vehicles for transport; mobility scooters; mopeds; motor buses; motor coaches; motorcycles; parachutes; pontoons; portholes; baby carriages; strollers; fitted stroller mosquito nets; refrigerated vehicles; remote control vehicles, other than toys; oars; rudders; saddlebags for cycles; safety belts for vehicle seats; safety seats for children, for vehicles; screw-propellers; sculls; seaplanes; side cars; side and rear view mirrors and displays for vehicles; sensors for vehicles; sleighs; snowmobiles; space vehicles; sun-blinds adapted for vehicles; tipping apparatus, parts of trucks and wagons; trailers; tricycles; trolleys; luggage trucks; sack-barrows; undercarriages for vehicles; upholstery for vehicles; vans; vehicle chassis; vehicle bumpers; vehicle running boards; vehicle suspension springs; vehicle seats; vehicle covers [shaped]; vehicle joysticks; electric vehicles; vehicles for locomotion by land, air, water or rail; wagons; wheelbarrows; wheelchairs; windows for vehicles; windscreens; yachts; parts, fittings and accessories of all the aforementioned goods.

44 – Medical services; veterinary services; hygienic and beauty care services for human beings or animals; agriculture, horticulture and forestry services; aerial and surface spreading of fertilizers and other agricultural chemicals; alternative medicine services; animal breeding and grooming; aquaculture services; aromatherapy services; artificial insemination services; blood bank services; body piercing; chiropractic; convalescent home services; dentistry services; farming equipment rental; flower arranging; gardening; hair implantation; hairdressing; health care; health spa services; health center services; health counseling; provision of nutrition information; provision of wellbeing information (health); hospital services; landscape design; massage; medical clinic services; medical assistance; medical equipment ren-

tal; medical advice for individuals with disabilities; midwife services; nursing home services; nursing, medical; optician services; orthodontic services; palliative care; pharmacy advice; physiotherapy; plant nursery services; plastic surgery; services of a psychologist; public bath services for hygiene purposes; reforestation services; rehabilitation for substance abuse patients; rest home services; sanatorium services; rental of sanitation facilities; sauna services; solarium services; speech therapy services; tattooing; telemedicine services; remote patient monitoring services; medical analysis services relating to the treatment of persons; diagnosis, treatment and rehabilitation of diseases; medical clinic services relating to patient treatment for improvement of patient/physician interaction; therapy services; tree surgery; tree planting for carbon offsetting purposes; Turkish bath services; vermin exterminating for agriculture, horticulture and forestry; veterinary assistance; weed killing; wreath making.

(260) AM 2018 93257 A

(800) 1353828

(151) 2027 04 10

(891) 2017 04 10

(731) ZHEJIANG TIANYAN HOLDING CO., LTD
Chengjiang Industrial Area, Huangyan
District, Taizhou City Zhejiang Province,
China

(540)



(591) Black, white

(531) 26.04.01; 26.04.05; 27.05.06; 27.05.17;
27.05.23

(511)

19 – Framework for building, not of metal; water-pipes, not of metal; water-pipe valves, not of metal or plastic; branching pipes, not of metal; rigid pipes, not of metal, for building; building materials, not of metal; drain pipes, not of metal; drain traps [valves], not of metal or plastic; penstock pipes, not of metal; plastic ducts used in construction.

(260) AM 2018 93259 A

(800) 1353880

(151) 2016 08 29

(891) 2016 08 29

(731) URTİM KALIP VE İSKELE SİSTEMLERİ
SANAYİ VE TİCARET ANONİM ŞİRKETİ
Hastane Mahallesi, Orgeneral Nurettin
Baransel Caddesi, No:50 Hadımköy
Arnavutköy İstanbul, Turkey

(540)



(591) Blue and white

(531) 27.01.01; 27.03.15; 29.01.04

(511)

6 – Ores of non-precious metal; common metals and their alloys and semi-finished products made of these materials, goods and materials of common metal used for storage, wrapping, packaging and sheltering purposes, containers of metal (storage, transport), buildings of metal, frames of metal for building, poles of metal for building, metal boxes, packaging containers of metal, aluminium foil, fences made of metal, guard barriers of metal, metal tubes, storage containers of metal, metal containers for the transportation of goods, ladders of metal; doors, windows, shutters, jalousies and their cases and fittings of metal; non-electric cables and wires of metal; ironmongery, small hardware of metal; ventilation ducts, vents, vent covers, pipes, chimney caps, man-hole covers, grilles of metal for ventilation, heating, sewage, telephone, underground electricity and air conditioning installations; metal panels or boards (non-luminous and non-mechanical) used for signalling, route showing, publicity purposes, signboards of metal, advertisement columns of metal, signaling panels of metal, non-luminous and non-mechanical traffic signs of metal; pipes of metal for transportation of liquids and gas, drilling pipes of metal and their metal fittings, valves of metal, couplings of metal for pipes, elbows of metal for pipes, clips of metal for pipes, connectors of metal for pipes; safes (strong boxes) of metal; metal railway materials, metal rails, metal railway ties, railway switches; bollards of metal, floating docks of metal, mooring buoys of metal, anchors; metal moulds for casting, other than machine parts; works of art made of common metals or their alloys; metal closures, bottle caps of metal; metal poles; metal pallets and metal ropes for lifting, loading and transportation purposes; metal hangers, ties, straps, tapes and bands used for load-lifting and load-carrying; wheel chocks made primarily of metal; formworks of metal; casings of metal; slab formwork systems (casings of metal); metal panel formwork systems (casings of metal); metal climbing formwork systems; access platforms of metal for casings of metal; single side metal formwork systems; circular wall metal formwork systems; metal shaft platform formwork systems; modular metal formwork systems; beams of common metal for formwork systems; building beams of metal; framework scaffolding of metal; metal scaffolding, tower scaffolding of metal; metal stacking tower systems (metal scaffolding); flanged scaffolding systems (metal scaffolding); cuplock scaffolding

systems (metal scaffolding); pipe-rack suspended scaffolding (metal scaffolding); metal scaffolding for facades; mobile platforms [scaffolding] of metal; beams of common metal for scaffolding; mobile aerial work platforms [scaffolding] of metal; platform staging of metal for use with scaffolding; platform steps of metal for use with scaffolding; safety scaffolding of metal; metal windbreak systems; metal mounting and installation equipment (formworks and scaffolding), metal pipes, metal clamps, clip clamps of metal, rolling towers (metal scaffolding); metal ladders for scaffolding; metal girder formwork systems (casings of metal).

(260) AM 2018 93260 A

(800) 1353894

(151) 2017 12 08

(891) 2016 12 08

(731) VALIO LTD

Meijeritie 6, FI-00370 Helsinki, Finland

(540)



(591) Yellow, brown, beige, white, grey, red and black

(531) 02.01.07; 29.01.15

(511)

5 – Dietetic food and substances adapted for medical use; food for babies; substitutes for mother's milk; dietary supplements for humans, food supplements, protein dietary supplements, dietary supplemental drinks, vitamin drinks, vitamin preparations, dietary and nutritional supplements; lactose; lactic acid bacteria; lactobacillus.

29 – Meat, fish, poultry and game; meat extracts; preserved, frozen, dried and cooked fruits and vegetables; jellies, jams, compotes; eggs; dairy products and dairy substitutes, including but not limited to milk; smetana [sour cream]; prostokvasha [soured milk]; whey; milk powders, dried whey-based food products and whey powders; yogurt; yogurt drinks; drinks made from dairy products; cheese; drinking yogurts; whiteners [dairy] for beverages; double cream; milk ferments for culinary purposes; cheese spreads; peanut milk for culinary purposes; beverages made from or containing (predominantly) milk; butter; edible oils and fats; lactic acid bacteria

drinks; fruit purees, vegetable purees; prepared meals and snacks containing (predominantly) any of the aforesaid goods.

30 – Coffee, tea, cocoa and artificial coffee; rice; tapioca and sago; flour and preparations made from cereals; bread, pastry and confectionery; ices; sugar, honey, treacle; yeast, baking-powder; salt; mustard; vinegar, sauces (condiments); spices; ice; cheese sauce; snacks made from cereals, honey, cocoa, chocolate or coffee; protein cereal bars and protein chocolate bars; hamburgers, pizzas, bread, porridge, gruel, drinks made from cocoa, coffee beverages with milk, frozen yoghurt.

32 – Beers; mineral and aerated waters and other non-alcoholic drinks; fruit drinks and fruit juices; syrups and other preparations for making beverages.

(260) AM 2018 93266 A

(800) 1354597

(151) 2016 12 06

(891) 2016 12 06

(731) Euro Games Technology Ltd. "Maritsa"

Str. 4, "Vranya-Lozen-Triugulnika", BG-1151 Sofia, Bulgaria

(540)



(591) Light yellow, orange, red, brown, white, green, light green and black. Light yellow, orange, red, brown, white, green, light green, black for the word elements

(531) 27.01.01; 27.05.02; 27.05.03; 27.05.04; 29.01.15

(511)

9 – Photographic, optical, weighing, measuring, signalling, checking, supervision apparatus and instruments; apparatus and instruments for conducting, switching, transporting, accumulating, regulating and controlling electricity; apparatus for recording, transmission or reproduction of sound or images; magnetic data carriers, recording discs; coin-operated mechanisms for vending machines; cash registers, calculating machines, data processing equipment and computers.

28 – Games and playthings; gymnastic and sporting articles, which are not included in other classes.

(260) AM 2018 93267 A

(800) 1354757

(151) 2017 04 26

(891) 2017 07 11

(731) TURI, INC.

936 N. 34th Street, Suite 208 Seattle WA 98103, USA

(540)

TURI

(591) Black, white

(511)

9 – Software for performing and providing machine learning, artificial intelligence, data mining, data analytics and data analysis; software for performing and providing machine learning, artificial intelligence, data mining, data analytics, and data analysis application development; software development tools; computer software for creating searchable databases of information and data.

(260) AM 2018 93300 A

(800) 1353201

(151) 2017 04 25

(891) 2017 04 25

(731) NAOS

355 rue Pierre-Simon Laplace F-13290
AIX-EN-PROVENCE, France

(540)

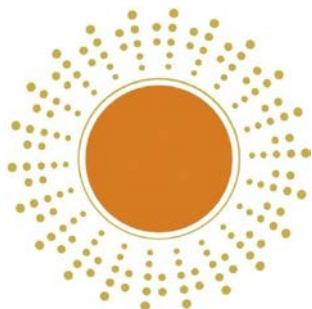

(591) orange

(531) 01.03.02; 29.01.12

(511)

3 – Soaps; perfumery; essential oils; cosmetics; creams; deodorants for personal use; hair lotions; dentifrices; cosmetic preparations for skin toning; cosmetic preparations for whitening the skin; cosmetic preparations for cleansing the skin; cosmetic preparations for slimming; cosmetic preparations for tanning and sun protection; depilatory products.

(260) AM 2018 93311 A

(800) 1353433

(151) 2017 05 05

(891) 2017 05 05

(731) DELSEY

215 avenue des Nations F-93290
TREMBLAY EN FRANCE, Switzerland

(540)

DELSEY

(591) Black and white

(511)

18 – Trunks and suitcases; handbags; traveling bags; backpacks; small attache cases for documents; traveling sets (leatherware); shopping bags; wheeled

shopping bags; bags for climbers; school bags; satchels; satchels with wheels; bags for campers; beach bags; bags (envelopes, pouches) for packaging of leather; garment bags for travel; briefcases; wallets; purses (coin purses); empty toiletry sets; card cases (notecases); key cases [leather goods]; umbrellas and parasols; walking sticks; whips, harness and saddle; business luggage.

(260) AM 2018 93312 A

(800) 1353437

(151) 2016 11 22

(891) 2016 11 22

(731) KAAANLAR GIDA SANAYİ VE TİCARET ANONİM ŞİRKETİ

Kocatepe Mahallesi, Mega Center C12, Blok
No:97-98-99-100-101-102 Bayrampasa –
İstanbul, Turkey

(540)



(591) Black, red and white

(531) 24.09.05; 24.09.09; 25.01.05; 25.07.02;
25.07.03; 26.11.03; 26.11.09; 27.05.08;
27.05.17; 29.01.13

(511)

29 – Meat, fish, poultry and game; processed meat products; dried pulses; soups, bouillon; processed olives, olive paste; milk and milk products, butter, cheese, sheep cheese, white cheese, processed cheese, Parmesan cheese; cream cheese; edible oils; dried, preserved, frozen, cooked, smoked or salted fruits and vegetables; tomato paste; prepared nuts and dried fruits as snacks; hazelnut spreads and peanut butter; tuhini [sesame seed paste]; eggs and powdered eggs; potato chips.

(260) AM 2018 93317 A

(800) 1353473

(151) 2017 03 30

(891) 2017 03 30

(731) PANKRATOV ALEXEY VLADIMIROVICH

Borisa Galushkina street, 25-105 RU-129301
Moscow, Russian Federation

(540)



(591) Black and white

(531) 25.05.05; 25.05.25; 26.01.01; 26.01.16;
27.05.01

(511)

6 – Fittings of metal for compressed air lines; fittings of metal for building; beams of metal; reels of

metal, non-mechanical, for flexible hoses; window pulleys; ingots of common metal; anchors; bolts of metal; eye bolts; casks of metal; letters and numerals of common metal, except type; valves of metal, other than parts of machines; screws of metal; hoppers of metal, non-mechanical; sleeves [metal hardware]; ferrules of metal for handles; signboards of metal; nuts of metal; nails; vice claws of metal; doors of metal; wall plugs of metal; packaging containers of metal; jalousies of metal; iron strip; roof gutters of metal; tinsplate; iron slabs; door bolts of metal; window fasteners of metal; bolts, flat; crampons of metal [cramps]; rivets of metal; padlocks; box fasteners of metal; locks of metal, other than electric; latches of metal; buckles of common metal [hardware]; paint spraying booths of metal; ropes of metal; greenhouse frames of metal; cornices of metal; keys of metal; elbows of metal for pipes; furniture casters of metal; pegs of metal; copper rings; ferrules of metal; split rings of common metal for keys; rings of metal; door fittings of metal; fittings of metal for windows; buildings of metal; tool boxes of metal, empty; taps of metal for casks; hooks [metal hardware]; sash fasteners of metal for windows; wrapping or binding bands of metal; staircases of metal; steel sheets; building materials of metal; sheets and plates of metal; moldings of metal for cornices; pipe muffs of metal; anvils; anvils [portable]; beak-irons [bick-irons]; rope thimbles of metal; belt stretchers of metal; stretchers for metal bands [tension links]; wire stretchers [tension links]; stretchers for iron bands [tension links]; grease nipples; thread of metal for tying-up purposes; strap-hinges of metal; steel strip; sills of metal; brazing alloys; silver solder; collars of metal for fastening pipes; aluminium wire; iron wire; wire of common metal; copper wire, not insulated; soldering wire of metal; steel wire; springs [metal hardware]; rods of metal for welding; rods of metal for brazing and welding; rods of metal for brazing; peeled metal bars; drawn and polished metal bars; bright steel bars; window frames of metal; straps of metal for handling loads; door handles of metal; safes [metal or non-metal]; junctions of metal for pipes; nozzles of metal; silver-plated tin alloys; alloys of common metal; bindings of metal; posts of metal; steps [ladders] of metal; slings of metal for handling loads; wire cloth; cables of metal, non-electric; wire rope; pipes of metal; steel pipes; angle irons of metal; tinsplate packings; flanges of metal [collars]; chains of metal; washers of metal; hinges of metal; pulleys of metal, other than for machines; window casement bolts; pins [hardware]; latch bars of metal; labels of metal; tool chests of metal, empty; boxes of common metal.

7 – Vending machines; welding machines, electric; welding apparatus, gas-operated; vulcanisation apparatus; high pressure washers; electrical apparatus for sealing plastics [packaging]; electric arc cutting apparatus; electric arc welding apparatus; electric wel-

ding apparatus; soldering apparatus, electric; fittings for engine boilers; expansion tanks [parts of machines]; drums [parts of machines]; reels, mechanical, for flexible hoses; concrete mixers [machines]; reels [parts of machines]; harrows; journal boxes [parts of machines]; bulldozers; crank shafts; valves [parts of machines]; fans for motors and engines; saw benches [parts of machines]; winnowers; water heaters [parts of machines]; bellows [parts of machines]; lawnmowers [machines]; card clothing [parts of carding machines]; nail pullers, electric; emergency power generators; alternators; dynamos; bicycle dynamos; generators of electricity; mufflers for motors and engines; drilling heads [parts of machines]; drilling bits [parts of machines]; cylinder heads for engines; soldering blow pipes, gas-operated; gas-operated blow torches; raking machines; stalk separators [machines]; sieves [machines or parts of machines]; tarring machines; hydraulic engines and motors; compressed air engines; motors, other than for land vehicles; disintegrators; holding devices for machine tools; pump diaphragms; chisels for machines; jacks [machines]; rack and pinion jacks; electric hand drills; reapers; injectors for engines; tools [parts of machines]; hand-held tools, other than hand-operated; agricultural implements, other than hand-operated; carburettors; crankcases for machines, motors and engines; steamrollers; pressure valves [parts of machines]; clack valves [parts of machines]; pressure reducers [parts of machines]; can openers, electric; cowlings [parts of machines]; machine wheels; freewheels, other than for land vehicles; piston segments; grease rings [parts of machines]; compressors [machines]; air pumps [garage installations]; belt conveyors; diggers [machines]; grease boxes [parts of machines]; harvesting machines; coffee grinders, other than hand-operated; taps [parts of machines, engines or motors]; cranes [lifting and hoisting apparatus]; spray guns for paint; cranks [parts of machines]; grindstones [parts of machines]; cultivators [machines]; soldering lamps; winches; lubricators [parts of machines]; igniting magnetos; handling machines, automatic [manipulators]; machine fly-wheels; hair clipping machines for animals; blowing machines; galvanizing machines; bending machines; ironing machines; electroplating machines; bottle sealing machines; embossing machines; engraving machines; finishing machines; crushing machines; blade sharpening [stropping] machines; earth moving machines; cord making machines; grinding machines; painting machines; whitewashing machines; road sweeping machines, self-propelled; weeding machines; sifting machines; packaging machines; die-stamping machines; stamping machines; wrapping machines; machines and apparatus for cleaning, electric; machines and apparatus for polishing [electric]; sizing machines; riveting machines; kitchen machines, electric; hemming machines; braiding machines; cutting machines; steam engines; printing

machines; compressed air machines; trimming machines; filling machines; cutters [machines]; agricultural machines; mixing machines; washing machines [laundry]; spin driers [not heated]; looms; typographic machines; packing machines; filtering machines; molding machines; sewing machines; labellers [machines]; mills [machines]; machine wheelwork; mixers [machines]; threshing machines; pneumatic hammers; hammers [parts of machines]; tilt hammers; reeling apparatus, mechanical; motorized cultivators; motors for boats; meat choppers [machines]; superchargers; guides for machines; pumps [machines]; vacuum pumps [machines]; compressed air pumps; blades [parts of machines]; knives, electric; shears, electric; scissors, electric; pulverisers [machines]; axles for machines; chucks [parts of machines]; drill chucks [parts of machines]; soldering irons, gas-operated; soldering irons, electric; gears, other than for land vehicles; reduction gears, other than for land vehicles; drilling machines; saws [machines]; chain saws; glue guns, electric; compressed air guns for the extrusion of mastics; ploughs; hangers [parts of machines]; roller bearings; ball-bearings; elevators [lifts]; saw blades [parts of machines]; pistons [parts of machines or engines]; torque converters, other than for land vehicles; presses [machines for Industrial purposes]; swaging machines; food processors, electric; springs [parts of machines]; punches for punching machines; vacuum cleaners; radiators [cooling] for motors and engines; air brushes for applying colour; regulators [parts of machines]; pressure regulators [parts of machines]; knives [parts of machines]; cutting blow pipes, gas-operated; blade holders [parts of machines]; belts for machines; elevator belts; robots [machines]; stuffing boxes [parts of machines]; whisks, electric, for household purposes; sparking plugs for internal combustion engines; glow plugs for diesel engines; brake segments, other than for vehicles; steam/oil separators; ball rings for bearings; sowers [machines]; snow ploughs; shaft couplings [machines]; stands for machines; machine tools; die-cutting and tapping machines; wood-working machines; sharpening machines; bicycle assembling machines; mortising machines; stone-working machines; metalworking machines; threading machines; planing machines; lathes [machine tools]; milling machines; trueing machines; starters for motors and engines; stators [parts of machines]; glaziers' diamonds [parts of machines]; tables for machines; derricks; slide rests [parts of machines]; heat exchangers [parts of machines]; transmissions for machines; turbines, other than for land vehicles; turbo-compressors; connecting rods for machines, motors and engines; joints [parts of engines]; washing installations for vehicles; sifting installations; lifting apparatus; air suction machines; door closers, hydraulic; washing apparatus; handling apparatus for loading and unloading; elevating apparatus; aprons [parts of machines]; filter presses; filters [parts of

machines or engines]; journals [parts of machines]; elevator chains [parts of machines]; driving chains, other than for land vehicles; cylinders for motors and engines; pneumatic jacks; shuttles [parts of machines]; universal joints [cardan joints]; pulleys [parts of machines]; screwdrivers, electric; brushes [parts of machines]; carbon brushes [electricity]; excavators; motors, electric, other than for land vehicles; electrodes for welding machines; electric hammers.

8 – Glaziers' diamonds [parts of hand tools]; razors, electric or non-electric; sharpening steels; scythe stones; gimlets [hand tools]; borers; augers [hand tools]; carpenters' augers; hand drills, hand-operated; levers; table forks; agricultural forks [hand tools]; lawn clippers [hand instruments]; harpoons for fishing; nail pullers, hand-operated; rakes [hand tools]; cutter bars [hand tools]; whetstone holders; priming irons [hand tools]; lifting jacks, hand-operated; clamps for carpenters or coopers; spades [hand tools]; rabbeting planes; chisels; engraving needles; edge tools [hand tools]; garden tools, hand-operated; abrading instruments [hand instruments]; numbering punches; goffering irons; implements for decanting liquids [hand tools]; sharpening instruments; blade sharpening instruments; nail clippers, electric or non-electric; polishing irons [glazing tools]; tube cutting instruments; wire strippers [hand tools]; riveters [hand tools]; expanders [hand tools]; cutting tools [hand tools]; hand tools, hand-operated; stamping-out tools [hand tools]; sharpening stones; trowels; centre punches [hand tools]; mallets [hand instruments]; pliers; punch pliers [hand tools]; annular screw plates; spanners [hand tools]; tap wrenches; foundry ladles [hand tools]; breast drills; lasts [shoemakers' hand tools]; scythe rings; diggers [hand tools]; rams [hand tools]; scythes; fire irons; emery grinding wheels; grindstones [hand tools]; sledgehammers; thistle extirpators [hand tools]; nail nippers; tree pruners; nail drawers [hand tools]; ice picks; blades [hand tools]; razor blades; blades for planes; plane irons; jig-saws; plastic spoons, table forks and table knives; crow bars; trowels [gardening]; shovels [hand tools]; palette knives; hair clippers for personal use, electric and non-electric; hair clippers for animals [hand instruments]; taps [hand tools]; fireplace bellows [hand tools]; hammers [hand tools]; fullers [hand tools]; stone hammers; riveting hammers [hand tools]; weeding forks [hand tools]; mincing knives [hand tools]; manicure sets; manicure sets, electric; pedicure sets; needle files; bits [hand tools]; files [tools]; emery files; air pumps, hand-operated; shaving cases; scaling knives; molding irons; ceramic knives; can openers, non-electric; budding knives; hunting knives; penknives; grafting tools [hand tools]; braiders [hand tools]; bill-hooks; paring knives; shears; border shears; pruning shears; shearers [hand instruments]; vegetable slicers; agricultural implements, hand-operated; stropping instruments; screwdrivers, non-electric; reamer sockets;

drill holders [hand tools]; perforating tools [hand tools]; pestles for pounding [hand tools]; emery boards; nail files; saws [hand tools]; bow saws; tweezers; hair-removing tweezers; guns [hand tools]; non-electric caulking guns; guns, hand-operated, for the extrusion of mastics; dies [hand tools]; fruit pickers [hand tools]; saw blades [parts of hand tools]; shear blades; tool belts [holders]; table cutlery [knives, forks and spoons]; crimping irons; hand implements for hair curling; vegetable choppers; money scoops; hackles [hand tools]; pin punches; nail punches; fish tapes [hand tools]; punches [hand tools]; insecticide sprayers [hand tools]; syringes for spraying insecticides; reamers; frames for handsaws; saw holders; rasps [hand tools]; cutters; paring irons [hand tools]; graving tools [hand tools]; milling cutters [hand tools]; planes; scythe handles; knife handles; handles for hand-operated hand tools; marline spikes; bits [parts of hand tools]; hollowing bits [parts of hand tools]; secateurs; silver plate [knives, forks and spoons]; pruning knives; sickles; drawing knives; scrapers [hand tools]; mortise chisels; caulking irons; gouges [hand tools]; mortars for pounding [hand tools]; mitre [miter (Am.)] boxes [hand tools]; branding irons; adzes [tools]; vices; bench vices [hand implements]; hoop cutters [hand tools]; axes; holing axes; fulling tools [hand tools]; earth rammers [hand tools]; tube cutters [hand tools]; squares [hand tools]; extension pieces for braces for screw taps; embossers [hand tools]; apparatus for destroying plant parasites, hand-operated; metal wire stretchers [hand tools]; metal band stretchers [hand tools]; flat irons; irons [non-electric hand tools]; ratchets [hand tools]; scraping tools [hand tools]; awls; spatulas [hand tools]; bayonets.

9 – Electrical adapters; accumulators, electric; accumulators, electric, for vehicles; accelerometers; actinometers; alidades; altimeters; ammeters; anemometers; anodes; antennas; apertometers [optics]; high-frequency apparatus; sound recording apparatus; diffraction apparatus [microscopy]; sound transmitting apparatus; cash registers; projection apparatus; blueprint apparatus; telephone apparatus; acid hydrometers; salinometers; acidimeters for batteries; aerometers; barometers; batteries for lighting; solar batteries; batteries, electric; balances [steelyards]; binoculars; electronic tags for goods; lens hoods; directional compasses; vacuum gauges; electrolyzers; variometers; verniers; scales; levelling staffs [surveying instruments]; camcorders; micrometer screws for optical instruments; viscosimeters; wavemeters; voltmeters; mechanical signs; switchboxes [electricity]; current rectifiers; gas testing instruments; gasometers [measuring instruments]; galvanometers; hands-free kits for telephones; heliographic apparatus; hygrometers; hydrometers; peepholes [magnifying lenses] for doors; plumb bobs; range finders; densimeters; densitometers; optical goods; dynamometers; light-emitting diodes [LED]; disks, magne-

tic; circular slide rules; locks, electric; electric door bells; mirrors for inspecting work; buzzers; measures; pressure measuring apparatus; inverters [electricity]; pressure indicators; temperature indicators; measuring instruments; mathematical instruments; levelling instruments; instruments containing eyepieces; surveying instruments; azimuth instruments; coaxial cables; fibre [fiber (Am.)] optic cables; cables, electric; calipers; slide calipers; screw-tapping gauges; calculating machines; identity cards, magnetic; encoded magnetic cards; automated teller machines [ATM]; cathodes; solenoid valves [electromagnetic switches]; wire connectors [electricity]; push buttons for bells; calibrating rings; compact discs [audio-video]; comparators; laptop computers; condensers [capacitors]; contacts, electric; distribution boxes [electricity]; junction boxes [electricity]; covers for electric outlets; logs [measuring instruments]; vacuum tubes [radio]; surveying chains; rulers [measuring instruments]; square rulers for measuring; slide-rules; optical lenses; measuring spoons; magnifying glasses [optics]; magnets; pressure gauges; solderers' helmets; protective masks; material testing instruments and machines; metronomes; rules [measuring instruments]; carpenters' rules; dressmakers' measures; mechanisms for coin-operated apparatus; micrometers; microscopes; microphones; modems; selfie sticks [hand-held monopods]; terminals [electricity]; junction sleeves for electric cables; knee-pads for workers; headphones; sound recording carriers; magnetic data media; optical data media; weighing machines; computer apparatus; objectives [lenses] [optics]; egg-candlers; ozonisers [ozonators]; octants; eyepieces; ohmmeters; oscillographs; plumb lines; mirrors [optics]; eyeglasses; transmitters [telecommunication]; switches, electric; gloves for protection against accidents; pyrometers; planimeters; plane tables [surveying instruments]; semiconductors; polarimeters; fuses; circuit breakers; converters, electric; diagnostic apparatus, not for medical purposes; distance measuring apparatus; time recording apparatus; apparatus and instruments for astronomy; surveying apparatus and instruments; weighing apparatus and instruments; nautical apparatus and instruments; navigational instruments; optical apparatus and instruments; apparatus and instruments for physics; chemistry apparatus and instruments; measuring apparatus; measuring devices, electric; observation instruments; regulating apparatus, electric; precision measuring apparatus; audio- and video-receivers; prisms [optics]; test tubes; pressure indicator plugs for valves; telephone wires; wires, electric; conductors, electric; copper wire, insulated; fuse wire; computer programs [downloadable software]; computer operating programs, recorded; distribution consoles [electricity]; control panels [electricity]; transmitting sets [telecommunication]; radios; flowmeters; walkie-talkies; cell switches [electricity]; marking gauges [joinery]; T-squa-

res for measuring; time switches, automatic; relays, electric; rheostats; respirators for filtering air; refractometers; refractors; saccharometers; optical fibers [fibres] [light conducting filaments]; sextants; signals, luminous or mechanical; scanners [data processing equipment]; couplings, electric; sound locating instruments; resistances, electric; spectrograph apparatus; spectroscopes; speed indicators; alcoholmeters; protection devices for personal use against accidents; audiovisual teaching apparatus; personal stereos; stereoscopes; stroboscopes; sulfimeters; spherometers; counters; revolution counters; abacuses; taximeters; tachometers; cellular phones; thermometers, not for medical purposes; thermostats; transistors [electronic]; protractors [measuring instruments]; transformers [electricity]; triodes; squares for measuring; gauges; quantity indicators; automatic indicators of low pressure in vehicle tires [tyres]; gasoline gauges; water level indicators; electric loss indicators; slope indicators; levels [instruments for determining the horizontal]; spirit levels; urinometers; balancing apparatus; video recorders; data processing apparatus; battery chargers; chargers for electric batteries; readers [data processing equipment]; heat regulating apparatus; bar code readers; filters for respiratory masks; USB flash drives; chronographs [time recording apparatus]; compasses for measuring; frequency meters; jigs [measuring instruments]; pedometers.

11 – Heat accumulators; air deodorising apparatus; refrigerating apparatus and machines; drying apparatus and installations; freezers; structural plates for ovens; fans [air-conditioning]; roasting spits; water heaters; water heaters [apparatus]; air reheaters; acetylene burners; gas burners; alcohol burners; friction lighters for igniting gas; heating apparatus; refrigerating chambers; air valves for steam heating installations; level controlling valves in tanks; thermostatic valves [parts of heating installations]; air-conditioning apparatus; gas boilers; heating boilers; coffee machines, electric; mixer taps for water pipes; forges, portable; electric lamps; watering machines for agricultural purposes; multicookers; brackets for gas burners; anti-splash tap nozzles; heat pumps; hot air bath fittings; bath fittings; kiln furniture [supports]; refrigerating appliances and installations; lamp reflectors; vehicle reflectors; food steamers, electric; lamp mantles; stoves [heating apparatus]; kitchen ranges [ovens]; microwave ovens [cooking apparatus]; kilns; hot plates; water intake apparatus; oil-scrubbing apparatus; glue-heating appliances; water filtering apparatus; air purifying apparatus and machines; cooling appliances and installations; lighting apparatus and installations; sanitary apparatus and installations; lighting apparatus for vehicles; light-emitting diodes [LED] lighting apparatus; heating apparatus for solid, liquid or gaseous fuels; heating apparatus, electric; safety accessories for water or gas apparatus and pipes; regulating accessories for

water or gas apparatus and pipes; radiator caps; washers for water taps; radiators [heating]; drip irrigation emitters [irrigation fittings]; lamps; sterilizers; air dryers; pipes [parts of sanitary installations]; water conduits installations; watering installations, automatic; water purification installations; water distribution installations; air filtering installations; ventilation [air-conditioning] installations and apparatus; cooling installations and machines; heating installations; water supply installations; air cooling apparatus; cooking utensils, electric; vehicle headlights; filters for air conditioning; filters for drinking water; bicycle lights; lights for vehicles; electric torches; lanterns for lighting; bread-making machines; kettles, electric; carbon for arc lamps; heating elements.

18 – Bags [envelopes, pouches] of leather, for packaging; tool bags, empty; key cases.

21 – Buckets; dishes; saucers; mugs; bottles; vases; cooking skewers of metal; funnels; carpet beaters [hand instruments]; flower pots; glue-pots; decanters; abrasive sponges for scrubbing the skin; sponges for household purposes; sponge holders; soap dispensers; ironing boards; cutting boards for the kitchen; strainers for household purposes; containers for household or kitchen use; heat-insulated containers; chamois leather for cleaning; works of art of porcelain, ceramic, earthenware or glass; brush goods; kitchen grinders, non-electric; cleaning instruments, hand-operated; stew-pans; polishing leather; glass bulbs [receptacles]; shoe trees [stretchers]; coin banks; baskets for household purposes; mess-tins; cauldrons; dish covers; pitchers; watering cans; spatulas for kitchen use; butter dishes; polishing materials for making shiny, except preparations, paper and stone; polishing apparatus and machines, for household purposes, non-electric; mills for household purposes, hand-operated; isothermic bags; bowls [basins]; soap boxes; cooking pot sets; nozzles for watering hose; sprinklers; pepper pots; gloves for household purposes; car washing mitts; polishing gloves; gardening gloves; dripping pans; scouring pads; pots; cooking pots; tableware, other than knives, forks and spoons; porcelain ware; earthenware; crystal [glassware]; spice sets; apparatus for wax-polishing, non-electric; bottle openers, electric and non-electric; clothes-pegs; combs; grills [cooking utensils]; sifters [household utensils]; salad bowls; sugar bowls; beaters, non-electric; services [dishes]; coffee services [tableware]; tea services [tableware]; sieves [household utensils]; frying pans; scoops for household purposes; salt cellars; glasses [receptacles]; soup bowls; drying racks for laundry; basins [receptacles]; table plates; graters for kitchen use; insulating flasks; watering devices; utensils for household purposes; kitchen utensils; cooking utensils, non-electric; hip flasks; molds [kitchen utensils]; bread bins; kettles, non-electric; cups; garlic presses

[kitchen utensils]; mops; corkscrews, electric and non-electric; dishwashing brushes; scrubbing brushes; brushes.

35 – Rental of advertising space; computerized file management; demonstration of goods; commercial information and advice for consumers [consumer advice shop]; marketing research; layout services for advertising purposes; marketing; updating and maintenance of data in computer databases; updating of advertising material; organization of exhibitions for commercial or advertising purposes; organization of trade fairs for commercial or advertising purposes; shop window dressing; design of advertising materials; commercial intermediation services; provision of an on-line marketplace for buyers and sellers of goods and services; presentation of goods on communication media, for retail purposes; auctioneering; publicity material rental; rental of sales stands; bill-posting; distribution of samples; dissemination of advertising matter; direct mail advertising; advertising; on-line advertising on a computer network; advertising by mail order; systemization of information into computer databases; negotiation and conclusion of commercial transactions for third parties; administrative processing of purchase orders; pay per click advertising; procurement services for others [purchasing goods and services for other businesses].

37 – Rebuilding machines that have been worn or partially destroyed; vulcanization of tires [tyres] [repair]; knife sharpening; repair information; construction information; riveting; varnishing; re-tinning; vehicle washing; rustproofing; pumicing; vehicle maintenance; paper hanging; painting or repair of signs; vehicle polishing; vehicle breakdown repair services; rental of cleaning machines; rental of construction equipment; laying of cable; plumbing; masonry; roofing services; painting, interior and exterior; carpentry services; plastering; repair of security locks; motor vehicle maintenance and repair; clock and watch repair; pump repair; vehicle lubrication [greasing]; tire balancing; installation of doors and windows; heating equipment installation and repair; electric appliance installation and repair; vehicle cleaning.

40 – Galvanization; electroplating; engraving; metal tempering; gilding; gold plating; material treatment information; cadmium plating; permanent-press treatment of fabrics; laminating; lithographic printing; metal casting; tin plating; boilermaking; magnetization; nickel plating; abrasion; metal treating; waste treatment [transformation]; textile treating; soldering; metal plating; burnishing by abrasion; rental of generators; rental of space heating apparatus; blacksmithing; custom assembling of materials for others; welding services; sawing of materials; silver plating; planing of materials; key cutting; dyeing services;

sandblasting services; millworking; chromium plating; silkscreen printing.

41 – Practical training [demonstration]; organization of exhibitions for cultural or educational purposes; arranging and conducting of workshops [training]; arranging and conducting of in-person educational forums; arranging and conducting of seminars; organization of competitions [education or entertainment]; rental of audio equipment; rental of video cameras; rental of video cassette recorders; tutoring; photography.

42 – Graphic arts design; mechanical research; research and development of new products for others; technical research; design of interior decor; packaging design; physics [research].

(260) AM 2018 93319 A

(800) 1353489

(151) 2017 01 19

(891) 2017 01 19

(731) BROCK Kehrtechnik GmbH

Salinger Feld 10a 58454 Witten, Germany

(540)



(591) Red, black

(531) 26.11.11; 27.05.02; 27.05.03; 27.05.11;
29.01.13

(511)

7 – Road sweeping machines (self-propelled); washing apparatus; vehicle washing installations; disintegrators; machines and apparatus for cleaning, electric; waste disposals; dredging machines; agricultural machines; harvesting machines; mixing machines; road rollers; excavators; bulldozers; loading machines; hoists; concrete mixers (machines); road making machines; diggers (machines); earth moving machines; multipurpose machines for road maintenance; lifts, other than ski-lifts; handling apparatus for loading and unloading; jacks (machines); derricks; truck lifts; waggon lifts; cranes (lifting and hoisting apparatus); conveyors (machines); lifting apparatus; hoppers (mechanical discharging); foundry machines; pneumatic transporters; oil pumps for vehicles; water pumps for vehicles; suction pumps; pumps (machines); motors, other than for land vehicles; combustion engines, other than for land vehicles; centrifugal machines; centrifugal pumps; compressors (machines); electric generators; concrete mixers [machines]; sweeping machines; casting machines.

12 – Vehicles for locomotion by land, air, water or rail; cars; trucks; tractors; motorcycles; motor coac-

hes; forklift trucks; lifting cars (lift cars); trailers (vehicles); hose carts; waggons; refrigerated vehicles; engines for land vehicles; ambulances; sprinkling trucks; motor buses; tilting-carts; electric vehicles; automobile chassis; automobile tyres; trolleys; automobile bodies; tipping apparatus, parts of trucks and waggons; vans (vehicles).

(260) AM 2018 93321 A

(800) 1353493

(151) 2017 02 15

(891) 2017 02 15

(731) VEGAPHARM LLP

Las Suite, 5 Percy Street London W1T 1DG,
United Kingdom

(540)

ABVGDeika

(591) Black and white

(511)

5 – Adhesive band for medical use; adhesive bands for medical purposes; adhesive compositions for medical use; adhesive plaster; adhesive tapes for medical purposes; alcohol for pharmaceutical purposes; allergy medications; allergy relief medication; anti-allergic medicines; antibiotics; antitussives; appetite stimulant preparations; baby foods; balms for medical purposes; balsamic preparations for medical purposes; biological preparations for medical purposes; cardiovascular preparations; chemical preparations for medical purposes; chemical preparations for pharmaceutical purposes; chemical preparations for testing blood for medical purposes; chemical preparations for the diagnosis of diabetes; cotton for medical purposes; cough syrups; court plaster; dietary supplemental drinks; dietary supplements; dietary supplements for humans and animals; dietary supplements for infants; dietary supplements for medical use; dietetic beverages adapted for medical purposes; dietetic confectionery adapted for medical purposes; dietetic food and substances adapted for medical or veterinary use, food for babies; dietetic foods adapted for infants; dietetic foods adapted for invalids; dietetic foods adapted for medical purposes; dietetic foods for medicinal purposes; dietetic foodstuffs for medical purposes; dietetic infusions for medical use; dietetic preparations adapted for medical use; dietetic products for medical purposes; dietetic substances adapted for medical use; dietetic sugar for medical use; disinfectants; disinfectants for hygiene purposes; disinfectants for medical instruments; dragees [medicines]; dressing retention materials; dressings, medical; medicinal drinks; elixirs for preventing chills; elixirs for preventing colds; elixirs for relieving asthma; elixirs for relieving chills; elixirs for relieving colds; elixirs [pharmaceutical preparations]; enzyme dietary supplements; enzyme preparations for medical purposes; enzyme preparations for veterinary purposes; enzymes for

medical purposes; enzymes for veterinary purposes; eye drops; eye lotions for medical use; eye ointment for medical use; food for babies; food for diabetics; food for infants; food for invalids; food supplements for dietetic use; foodstuffs for diabetics [specially made for]; medicated foot balms; medicated foot creams; gastrointestinal preparations; glucose dietary supplements; glucose for medical purposes; glucose preparations for medical purposes; hemoglobin; herbal medicine; medicinal herbs; immunoassay reagents for medical use; immunomodulators; medical preparation for slimming purposes; medicated baby powders; medicated balms; medicated plasters; medicated skin lotions; medicated sugar; medicinal beverages; medicinal creams for skin care; medicinal herbal extracts for medical purposes; medicinal infusions; medicinal oils; medicinal preparations for stimulating hair growth; medicated mineral drinks; mineral food supplements; mineral salts for medical purposes; mineral water salts; mineral waters for medical purposes; nasal decongestants; nervines; nutritional supplements; ointments for pharmaceutical purposes; ophthalmologic preparations; pain relief medication; pharmaceutical and veterinary preparations; pharmaceutical compositions; pharmaceutical creams; pharmaceutical implants; pharmaceutical lipsalves; pharmaceutical preparations; pharmaceutical preparations for animal skincare; pharmaceutical preparations for animals; pharmaceutical preparations for skin care; pharmaceutical preparations for treating dandruff; pharmaceutical preparations for veterinary use; pharmaceutical preparations in strip form; pharmaceutical skin lotions; pharmaceutical sweets; pharmaceuticals for the treatment of erectile dysfunction; plasters [dressings]; plasters for medical purposes; plasters, materials for dressings; preparations for destroying pests; preparations for destroying vermin; preparations for ocular lubrication; medicated food supplements for human consumption; sanitary knickers; sanitary pads; sanitary panties; sanitary preparations for medical purposes; sanitary tampons; sanitary towels; sanitary wear; siccatives [drying agents] for medical purposes; styptic preparations; sugar for medical purposes; sugar substitutes for diabetics; tampons [sanitary]; therapeutic creams [medical]; tonics preparations for medical purposes; vitamins for animals.

(260) AM 2018 93324 A

(800) 1353532

(151) 2017 05 22

(891) 2017 05 22

(731) NOVARTIS AG

CH-4002 Basel, Switzerland

(540)



(591) Black and white
 (531) 27.05.17
 (511)
 9 – Contact lenses.

(260) AM 2018 93341 A
 (800) 1355876
 (151) 2017 05 03
 (891) 2017 05 03
 (731) SHANGHAI HUGONG ELECTRIC
 (GROUP) CO., LTD
 7177 WaiQingSong Hwy, Qingpu District,
 201700 Shanghai, China
 (540)



(591) Black, white
 (531) 26.04.18; 26.04.24; 27.05.24
 (511)
 7 – Soldering apparatus, electric; soldering irons, electric; electric welding apparatus; electric arc welding apparatus; electric arc cutting apparatus; electrodes for welding machines; soldering lamps; soldering apparatus, gas-operated; gas-operated blow torches; welding machines, electric.

(260) AM 2018 93342 A
 (800) 1355289
 (151) 2016 11 03
 (891) 2016 11 03
 (731) Obshchestvo s ogranichennoy
 otvetstvennostyu "GUSTUS"
 M. Levshinsky per., 10, of. 3, pom. IV
 RU-119034 Moscow, Russian Federation

(540)

(591) Grey, white and red.
 (531) 26.04.04; 26.04.18; 27.05.17; 27.05.21;
 27.05.24; 29.01.13
 (511)
 16 – Paper, cardboard and goods made from these materials, not included in other classes; printed matter; bookbinding material; photographs; stationery; adhesives for stationery or household purposes; artists' materials; paint brushes; typewriters and office

requisites (except furniture); instructional and teaching material (except apparatus); plastic materials for packaging (not included in other classes); printers' type; printing blocks; fountain pens; aquarelles; albums; almanacs; document laminators for office use; mimeograph apparatus and machines; atlases; posters; paper bows; table linen of paper; tickets; forms, printed; announcement cards [stationery]; note books; pads [stationery]; drawing pads; loose-leaf binders; wristbands for the retention of writing instruments; pamphlets; booklets; paper sheets [stationery]; waxed paper; paper for recording machines; paper for radiograms; electrocardiograph paper; drawer liners of paper, perfumed or not; wood pulp paper; carbon paper; copying paper [stationery]; parchment paper; writing paper; luminous paper; Xuan paper for Chinese painting and calligraphy; toilet paper; wrapping paper; filter paper; paper; blotters; newsletters; rollers for typewriters; house painters' rollers; composing sticks; modelling wax, not for dental purposes; signboards of paper or cardboard; sewing patterns; newspapers; electrotypes; hectographs; modelling clay; polymer modelling clay; terrestrial globes; drawing sets; engravings; slate pencils; pencil leads; document holders [stationery]; pencil holders; chalk holders; page holders; holders for checkbooks [cheque books]; holders for stamps [seals]; diagrams; engraving plates; writing slates; blackboards; galley racks [printing]; drawing boards; advertisement boards of paper or cardboard; duplicators; punches [office requisites]; cream containers of paper; magazines [periodicals]; money clips; tags for index cards; pen clips; bookmarkers; etching needles; tracing needles for drawing purposes; periodicals; printed publications; paper shredders for office use; graphic representations; credit card imprinters, non-electric; graining combs; drawing instruments; calendars; tracing paper; tracing cloth; tracing patterns; gums [adhesives] for stationery or household purposes; lithographic stones; ink stones [ink reservoirs]; pencils; pencil lead holders; charcoal pencils; pictures; transfers [decalcomanias]; paintings [pictures], framed or unframed; wood pulp board [stationery]; cardboard; hat boxes of cardboard; files [office requisites]; cards; index cards [stationery]; geographical maps; paper tapes and cards for the recordal of computer programmes; trading cards other than for games; perforated cards for Jacquard looms; catalogues; spools for inking ribbons; covers of paper for flower pots; paintbrushes; painters' brushes; writing brushes; typewriter keys; glue for stationery or household purposes; isinglass for stationery or household purposes; gluten [glue] for stationery or household purposes; starch paste [adhesive] for stationery or household purposes; books; manifolds [stationery]; comic books; drawing pins; cigar bands; envelopes [stationery]; cases for stamps [seals]; boxes of cardboard or paper; paint boxes [articles for use in school]; correcting fluids [office requ-

isites]; stencils [stationery]; French curves; paper ribbons; typewriter ribbons; gummed tape [stationery]; adhesive bands for stationery or household purposes; correcting tapes [office requisites]; inking ribbons; inking ribbons for computer printers; adhesive tapes for stationery or household purposes; self-adhesive tapes for stationery or household purposes; drawing rulers; square rulers; flyers; absorbent sheets of paper or plastic for foodstuff packaging; humidity control sheets of paper or plastic for foodstuff packaging; viscose sheets for wrapping; sheets of reclaimed cellulose for wrapping; plastic bubble packs for wrapping or packaging; steel letters; type [numerals and letters]; lithographs; paint trays; architects' models; postage stamps; plastics for modelling; graphic prints; modelling materials; teaching materials [except apparatus]; sealing compounds for stationery purposes; adhesives [glues] for stationery or household purposes; stuffing of paper or cardboard; packaging material made of starches; packing [cushioning, stuffing] materials of paper or cardboard; filtering materials [paper]; addressing machines; pencil sharpening machines, electric or non-electric; bookbinding apparatus and machines [office equipment]; typewriters, electric or non-electric; folders [stationery]; franking machines for office use; chalk for lithography; writing chalk; tailors' chalk; marking chalk; bags [envelopes, pouches] of paper or plastics, for packaging; garbage bags of paper or of plastics; painters' easels; hand-rests for painters; printing sets, portable [office requisites]; bibs of paper; stickers [stationery]; finger-stalls [office requisites]; writing cases [stationery]; cords for bookbinding; paper knives [cutters] [office requisites]; numbering apparatus; bottle envelopes of cardboard or paper; sealing wafers; covers [stationery]; passport holders; plastic cling film, extensible, for palletization; embroidery designs [patterns]; handwriting specimens for copying; oleographs; musical greeting cards; greeting cards; postcards; etchings; conical paper bags; bags for microwave cooking; palettes for painters; ink sticks; pantographs [drawing instruments]; folders for papers; papier mâché; pastels; modelling paste; pen cases; bookbindings; pen wipers; office perforators; pens [office requisites]; nibs of gold; nibs; steel pens; drawing pens; song books; seals [stamps]; sealing stamps; clipboards; address plates for addressing machines; handkerchiefs of paper; plastic film for wrapping; desk mats; letter trays; trays for sorting and counting money; coasters of paper; bookends; stamp stands; mats for beer glasses; stands for pens and pencils; photograph stands; obliterating stamps; inking pads; stamp pads; binding strips [bookbinding]; towels of paper; inking sheets for document reproducing machines; inking sheets for duplicators; bookbinding cloth; gummed cloth for stationery purposes; printers' blankets, not of textile; portraits; paperweights; writing cases [sets]; inkstands; office requisites, ex-

cept furniture; writing materials; writing instruments; drawing materials; school supplies [stationery]; adhesive tape dispensers [office requisites]; hand labelling appliances; lithographic works of art; prospectuses; printed timetables; ledgers [books]; printers' galleys; indexes; rubber erasers; elastic bands for offices; drawing T-squares; graphic reproductions; penholders; marking pens; tissues of paper for removing make-up; face towels of paper; table napkins of paper; place mats of paper; tablemats of paper; tablecloths of paper; paper clasps; document files [stationery]; scrapers [erasers] for offices; paper-clips; staples for offices; erasing products; biological samples for use in microscopy [teaching materials]; histological sections for teaching purposes; steatite [tailor's chalk]; writing board erasers; composing frames [printing]; sealing wax; arithmetical tables; placards of paper or cardboard; writing or drawing books; fabrics for bookbinding; pencil sharpeners, electric or non-electric; transparencies [stationery]; stencil plates; cardboard tubes; Indian inks; moisteners [office requisites]; moisteners for gummed surfaces [office requisites]; drawing squares; chart pointers, non-electronic; bottle wrappers of cardboard or paper; envelope sealing machines, for offices; sealing machines for offices; vignetting apparatus; apparatus for mounting photographs; stapling presses [office requisites]; manuals [handbooks]; figurines [statuettes] of papier mâché; paper coffee filters; flags of paper; silver paper; molds for modelling clays [artists' materials]; photo-engravings; photographs [printed]; stencil cases; canvas for painting; chromolithographs [chromos]; compasses for drawing; numbers [type]; watercolor [watercolour] saucers for artists; correcting ink [heliography]; ink; inkwells; blueprints; rosaries; stencils; erasing shields; balls for ball-point pens; cabinets for stationery [office requisites]; printing type; address stamps; stamps [seals]; shields [paper seals]; prints [engravings]; labels, not of textile.

21 – Household or kitchen utensils and containers; combs and sponges; brushes (except paint brushes); brush-making materials; articles for cleaning purposes; steelwool; unworked or semi-worked glass (except glass used in building); glassware, porcelain and earthenware not included in other classes; pressure cookers [autoclaves], non-electric; indoor aquaria; buckets; cookie jars; candle jars [holders]; china ornaments; dishes; paper plates; vegetable dishes; saucers; mugs; candy boxes; bottles; demijohns; busts of porcelain, ceramic, earthenware or glass; vases; epergnes; fruit cups; bird baths; baby baths, portable; plungers for clearing blocked drains; waffle irons, non-electric; coolers [ice pails]; mop wringer buckets; buckets made of woven fabrics; whisks, non-electric, for household purposes; cooking skewers of metal; towel rails and rings; hair for brushes; birdcages; funnels; carpet beaters [hand instruments]; signboards of porcelain or glass; candle ex-

tinguishers; flower pots; chamber pots; glue-pots; cruets; decanters; large-toothed combs for the hair; combs for animals; tea cosies; abrasive sponges for scrubbing the skin; make-up sponges; sponges for household purposes; toilet sponges; sponge holders; toothpick holders; soap holders; napkin holders; holders for flowers and plants [flower arranging]; shaving brush stands; toilet paper holders; soap dispensers; toilet paper dispensers; ironing boards; cutting boards for the kitchen; bread boards; washing boards; crushers for kitchen use, non-electric; strainers; smoke absorbers for household purposes; containers for household or kitchen use; kitchen containers; glass jars [carboys]; heat-insulated containers; heat-insulated containers for beverages; thermally insulated containers for food; glass flasks [containers]; frying pans; closures for pot lids; chamois leather for cleaning; toothpicks; ceramics for household purposes; majolica; works of art of porcelain, ceramic, earthenware or glass; brush goods; kitchen grinders, non-electric; cleaning instruments, hand-operated; cabarets [trays]; stew-pans; covers, not of paper, for flower pots; shaving brushes; make-up brushes; cages for household pets; baking mats; polishing leather; hot pots, not electrically heated; glass bulbs [receptacles]; boot trees [stretchers]; shoe trees [stretchers]; napkin rings; poultry rings; rings for birds; piggy banks; bread baskets, domestic; baskets for domestic use; waste paper baskets; feeding troughs; mangers for animals; lunch boxes; tea caddies; washtubs; earthenware saucepans; mess-tins; cauldrons; coffee percolators, non-electric; coffee-pots, non-electric; coffee grinders, hand-operated; fused silica [semi-worked product], other than for building; beer mugs; tankards; rat traps; pot lids; aquarium hoods; butter-dish covers; dish covers; cheese-dish covers; buttonhooks; pitchers; perfume burners; non-electric portable coldboxes; watering cans; fly traps; insect traps; mixing spoons [kitchen utensils]; basting spoons [cooking utensils]; pie servers; scoops [tableware]; spatulas [kitchen utensils]; butter dishes; material for brush-making; polishing materials for making shiny, except preparations, paper and stone; noodle machines, hand-operated; polishing apparatus and machines, for household purposes, non-electric; pepper mills, hand-operated; mills for domestic purposes, hand-operated; feather-dusters; brooms; isothermic bags; confectioners' decorating bags [pastry bags]; bowls [basins]; mosaics of glass, not for building; saucepan scourers of metal; soap boxes; mouse traps; cooking pot sets; nozzles for watering cans; spouts; nozzles for watering hose; fitted picnic baskets, including dishes; toilet cases; floss for dental purposes; fiberglass thread, not for textile use; cookie [biscuit] cutters; pastry cutters; sprinklers; syringes for watering flowers and plants; cotton waste for cleaning; wool waste for cleaning; cleaning tow; chopsticks; cocktail stirrers; food steamers, non-electric; pepper pots; oven mitts;

gloves for household purposes; car washing mitts; polishing gloves; gardening gloves; plates to prevent milk boiling over; dripping pans; trays for domestic purposes; trays for domestic purposes, of paper; lazy susans; heaters for feeding bottles, non-electric; candleabra [candlesticks]; trivets [table utensils]; coasters, not of paper and other than table linen; grill supports; menu card holders; knife rests for the table; flat-iron stands; egg cups; abrasive pads for kitchen purposes; scouring pads; drinking troughs; powdered glass for decoration; pottery; pots; cooking pots; painted glassware; tableware, other than knives, forks and spoons; porcelain ware; earthenware; crystal [glassware]; cosmetic utensils; toilet utensils; trouser presses; tortilla presses, non-electric [kitchen utensils]; deodorising apparatus for personal use; cruet sets for oil and vinegar; tie presses; potholders; clothes-pegs; glass stoppers; powder compacts; perfume vaporizers; powder puffs; dusting apparatus, non-electric; combs; electric combs; grills [cooking utensils]; sifters [household utensils]; drinking horns; shoe horns; candle rings; salad bowls; sugar bowls; beaters, non-electric; coffee services [tableware]; liqueur sets; services [dishes]; tea services [tableware]; sieves [household utensils]; cinder sifters [household utensils]; tea strainers; pipettes [wine-tasters]; siphon bottles for carbonated water; rolling pins, domestic; steel wool for cleaning; currycombs; blenders, non-electric, for household purposes; fruit presses, non-electric, for household purposes; drinking straws; salt cellars; drinking vessels; vessels of metal for making ices and iced drinks; refrigerating bottles; bulb basters; cups of paper or plastic; drinking glasses; glasses [receptacles]; statues of porcelain, ceramic, earthenware or glass; figurines [statuettes] of porcelain, ceramic, earthenware or glass; glass for vehicle windows [semi-finished product]; glass wool other than for insulation; fiberglass other than for insulation or textile use; vitreous silica fibers [fibres], not for textile use; plate glass [raw material]; opal glass; glass, unworked or semi-worked, except building glass; opaline glass; glass incorporating fine electrical conductors; enamelled glass, not for building; soup bowls; drying racks for laundry; basins [receptacles]; table plates; disposable table plates; graters for kitchen use; insulating flasks; indoor terrariums [plant cultivation]; indoor terrariums [vivariums]; cloth for washing floors; cloths for cleaning; dusting cloths [rags]; furniture dusters; litter boxes [trays] for pets; urns; aerosol dispensers, not for medical purposes; wax-polishing appliances, non-electric, for shoes; water apparatus for cleaning teeth and gums; electric devices for attracting and killing insects; watering devices; utensils for household purposes; kitchen utensils; cooking utensils, non-electric; strainers for household purposes; coffee filters, non-electric; flasks; hip flasks; drinking bottles for sports; cake molds [moulds]; ice cube molds [mo-

ulds]; cookery molds [moulds]; molds [kitchen utensils]; deep fryers, non-electric; comb cases; bread bins; fly swatters; teapots; kettles, non-electric; cups; garlic presses [kitchen utensils]; ironing board covers, shaped; tea infusers; glass bowls; mops; mop wringers; cocktail shakers; cosmetic spatulas; corkscrews, electric and non-electric; animal bristles [brushware]; pig bristles; brushes; dishwashing brushes; ski wax brushes; brushes for cleaning tanks and containers; lamp-glass brushes; horse brushes; scrubbing brushes; toothbrushes; toothbrushes, electric; basting brushes; carpet sweepers; brushes for footwear; tar-brushes, long handled; toilet brushes; electric brushes, except parts of machines; eyebrow brushes; nail brushes; nest eggs, artificial; boxes for dispensing paper towels; dustbins; window-boxes; boxes of glass.

29 – Meat, fish, poultry and game; meat extracts; preserved, frozen, dried and cooked fruits and vegetables; jellies, jams, compotes; eggs; milk and milk products; edible oils and fats; ajvar [preserved peppers]; aloe vera prepared for human consumption; alginates for culinary purposes; anchovy; peanuts, prepared; artichokes, preserved; albumen for culinary purposes; white of eggs; beans, preserved; soya beans, preserved, for food; bouillon; ginger jam; ham; fatty substances for the manufacture of edible fats; toasted laver; edible birds' nests; peas, preserved; mushrooms, preserved; game, not live; gelatine; meat jellies; jellies for food; fruit jellies; yolk of eggs; coconut fat; bone oil, edible; lard; suet for food; edible fats; fruit-based snack food; charcuterie; raisins; caviar; eggplant paste; vegetable marrow paste; fish roe, prepared; yogurt; sauerkraut; kephir [milk beverage]; isinglass for food; clams, not live; milk shakes; black pudding [blood sausage]; arrangements of processed fruit; compotes; meat, tinned [canned (Am.)]; vegetables, tinned [canned (Am.)]; fish, tinned [canned (Am.)]; fruits, tinned [canned (Am.)]; bouillon concentrates; gherkins; shrimps, not live; prawns, not live; buttercream; croquettes; silkworm chrysalis, for human consumption; kumys [kumyss] [milk beverage]; spiny lobsters, not live; lecithin for culinary purposes; salmon, not live; onions, preserved; margarine; piccalilli; marmalade; edible oils; peanut butter; cocoa butter for food; coconut oil; coconut butter; corn oil; sesame oil; linseed oil for culinary purposes; olive oil for food; palm oil for food; palm kernel oil for food; sunflower oil for food; colza oil for food; butter; shellfish, not live; almonds, ground; animal marrow for food; mussels, not live; milk; peanut milk for culinary purposes; milk of almonds for culinary purposes; rice milk [milk substitute]; condensed milk; soya milk [milk substitute]; albumin milk; powdered milk; fish meal for human consumption; vegetable mousses; fish mousses; fruit pulp; meat; meat, preserved; milk beverages, milk predominating; vegetables, preserved; vegetables, cooked; vegetables, dried; potato

fritters; olives, preserved; lobsters, not live; flavored nuts; candied nuts; coconut, desiccated; nuts, prepared; tomato purée; liver pâté; pectin for culinary purposes; liver; pickles; jams; powdered eggs; milk products; fish-based foodstuffs; curd; prostokvasha [soured milk]; poultry, not live; bulgogi [Korean beef dish]; pollen prepared as foodstuff; cranberry sauce [compote]; apple purée; crayfish, not live; crustaceans, not live; fish, preserved; fish, not live; salted fish; vegetable salads; fruit salads; bacon; sardines, not live; pork; herrings, not live; seeds, prepared; sunflower seeds, prepared; whipped cream; cream [dairy products]; fat-containing mixtures for bread slices; smetana [sour cream]; vegetable juices for cooking; tomato juice for cooking; salted meats; sausages; sausages in batter; preparations for making bouillon; preparations for making soup; tripe; soups; vegetable soup preparations; whey; cheese; tahini [sesame seed paste]; tofu; sea-cucumbers, not live; truffles, preserved; tuna, not live; oysters, not live; milk ferments for culinary purposes; rennet; fish fillets; dates; crystallized fruits; frozen fruits; fruit, preserved; fruit preserved in alcohol; fruit, stewed; hazelnuts, prepared; potato flakes; hummus [chickpea paste]; fruit peel; preserved garlic; lentils, preserved; potato chips; low-fat potato chips; fruit chips; non-alcoholic eggnog; seaweed extracts for food; berries, preserved; snail eggs for consumption; yakitori.

30 – Coffee, tea, cocoa and artificial coffee; rice; tapioca and sago; flour and preparations made from cereals; bread, pastry and confectionery; ices; sugar, honey, treacle; yeast, baking-powder; salt; mustard; vinegar, sauces (condiments); spices; ice; aromatic preparations for food; vanilla flavorings for culinary purposes; flavorings, other than essential oils, for cakes; flavorings, other than essential oils, for beverages; coffee flavorings; food flavorings, other than essential oils; star aniseed; baozi [stuffed buns]; cereal bars; high-protein cereal bars; pancakes; no-odde-based prepared meals; buns; bread rolls; edible rice paper; edible paper; burritos; vanillin [vanilla substitute]; vareniki [stuffed dumplings]; waffles; vermicelli [noodles]; natural sweeteners; sausage binding materials; binding agents for ice cream [edible ices]; sea water for cooking; seaweed [condiment]; malt biscuits; cloves [spice]; cake frosting [icing]; glucose for culinary purposes; gluten additives for culinary purposes; yeast; thickening agents for cooking foodstuffs; leaven; rice-based snack food; cereal-based snack food; artificial coffee; vegetal preparations for use as coffee substitutes; dressings for salad; fruit jellies [confectionery]; candy decorations for cakes; confectionery for decorating Christmas trees; cakes; pastries; peanut confectionery; almond confectionery; pasta; ginger [spice]; frozen yogurt [confectionery ices]; cocoa; cream of tartar for culinary purposes; capers; caramels [candy]; curry [spice]; ketchup [sauce]; gimhap [Korean

rice dish]; quiches; gluten prepared as foodstuff; sweetmeats [candy]; liquorice [confectionery]; peppermint sweets; cinnamon [spice]; coffee; unroasted coffee; starch for food; crackers; custard; hominy grits; semolina; oatmeal; crushed barley; groats for human food; corn, milled; corn, roasted; meat pies; turmeric; couscous [semolina]; noodles; ice for refreshment; candy; ice, natural or artificial; edible ices; rice cakes; mayonnaise; macaroons [pastry]; macaroni; maltose; hominy; marinades; marzipan; honey; royal jelly; ice cream; bean meal; tapioca flour; potato flour; corn flour; nut flours; flour; wheat flour; soya flour; barley meal; dessert mousses [confectionery]; chocolate mousses; muesli; mint for confectionery; cocoa beverages with milk; coffee beverages with milk; coffee-based beverages; cocoa-based beverages; tea-based beverages; chocolate beverages with milk; chocolate-based beverages; infusions, not medicinal; crushed oats; husked oats; okonomiyaki [Japanese savory pancakes]; chocolate-coated nuts; nutmegs; stick liquorice [confectionery]; soya bean paste [condiment]; pastilles [confectionery]; molasses for food; pâtés en croûte; pelmeni [dumplings stuffed with meat]; pepper; allspice; peppers [seasonings]; pesto [sauce]; cookies; petit-beurre biscuits; pies; pizzas; meat gravies; fondants [confectionery]; popcorn; powders for making ice cream; baking powder; mustard meal; pralines; condiments; meat tenderizers, for household purposes; cereal preparations; oat-based food; propolis; gingerbread; petits fours [cakes]; puddings; rice pudding; cake powder; fruit coulis [sauces]; ravioli; ramen [Japanese noodle-based dish]; chewing gum; relish [condiment]; wheat germ for human consumption; spring rolls; sago; sugar; palm sugar; aniseed; linseed for human consumption; golden syrup; confectionery; batter mixes for okonomiyaki [Japanese savory pancakes]; baking soda [bicarbonate of soda for cooking purposes]; malt for human consumption; salt for preserving foodstuffs; cooking salt; celery salt; sherbets [ices]; ham glaze; soya sauce; tomato sauce; pasta sauce; sauces [condiments]; spaghetti; seasonings; preparations for stiffening whipped cream; rusks; breadcrumbs; sushi; sandwiches; tabbouleh; tacos; tapioca; tarts; dough; pastry dough; almond paste; rice pulp for culinary purposes; cake dough; tortillas; garden herbs, preserved [seasonings]; chocolate decorations for cakes; vinegar; beer vinegar; ferments for pastes; halvah; bread; unleavened bread; corn flakes; oat flakes; chips [cereal products]; flowers or leaves for use as tea substitutes; jiaozi [stuffed dumplings]; chicory [coffee substitute]; tea; iced tea; chutneys [condiments]; minced garlic [condiment]; cheeseburgers [sandwiches]; chow-chow [condiment]; saffron [seasoning]; chocolate; malt extract for food; essences for foodstuffs, except etheric essences and essential oils; husked barley.

35 – Advertising; business management; business administration; office functions; arranging subscriptions to telecommunication services for others; import-export agency services; commercial information agency services; advertising agency services; cost price analysis; rental of advertising space; business auditing; employment agency services; computerized file management; book-keeping; outsourced administrative management for companies; invoicing; demonstration of goods; transcription of communications [office functions]; opinion polling; market studies; business information; commercial information and advice for consumers [consumer advice shop]; business investigations; business research; marketing research; personnel recruitment; business management and organization consultancy; business organization consultancy; business management consultancy; personnel management consultancy; professional business consultancy; layout services for advertising purposes; marketing; business management of performing artists; business management of sports people; writing of résumés for others; scriptwriting for advertising purposes; news clipping services; updating and maintenance of data in computer databases; updating of advertising material; word processing; organization of exhibitions for commercial or advertising purposes; arranging newspaper subscriptions for others; organization of fashion shows for promotional purposes; organization of trade fairs for commercial or advertising purposes; shop window dressing; design of advertising materials; business appraisals; payroll preparation; data search in computer files for others; sponsorship search; business management assistance; commercial or industrial management assistance; commercial intermediation services; providing business information via a web site; provision of commercial and business contact information; provision of an on-line marketplace for buyers and sellers of goods and services; web indexing for commercial or advertising purposes; presentation of goods on communication media, for retail purposes; economic forecasting; auctioneering; retail or wholesale services for pharmaceutical, veterinary and sanitary preparations and medical supplies; sales promotion for others; production of advertising films; office machines and equipment rental; rental of advertising time on communication media; publicity material rental; rental of billboards [advertising boards]; rental of vending machines; rental of sales stands; rental of photocopying machines; publication of publicity texts; radio advertising; bill-posting; distribution of samples; dissemination of advertising matter; direct mail advertising; writing of publicity texts; on-line advertising on a computer network; advertising by mail order; television advertising; document reproduction; compilation of information into computer databases; compilation of statistics; business inquiries; systemization of information into computer data-

bases; advisory services for business management; negotiation and conclusion of commercial transactions for third parties; tax preparation; drawing up of statements of accounts; telemarketing services; psychological testing for the selection of personnel; business management of hotels; business management for freelance service providers; business project management services for construction projects; commercial administration of the licensing of the goods and services of others; business management of reimbursement programs for others; administration of consumer loyalty programs; administration of frequent flyer programs; administrative processing of purchase orders; public relations; modelling for advertising or sales promotion; typing; appointment reminder services [office functions]; web site traffic optimization; relocation services for businesses; tax filing services; search engine optimization for sales promotion; appointment scheduling services [office functions]; price comparison services; pay per click advertising; secretarial services; procurement services for others [purchasing goods and services for other businesses]; shorthand; outsourcing services [business assistance]; telephone answering for unavailable subscribers; photocopying services; business efficiency expert services.

43 – Services for providing food and drink; temporary accommodation; accommodation bureau services [hotels, boarding houses]; rental of temporary accommodation; rental of meeting rooms; tourist home services; hotel reservations; boarding house bookings; temporary accommodation reservations; hotel services; retirement home services; snack-bar services; café services; cafeteria services; motel services; boarding house services; boarding for animals; rental of cooking apparatus; rental of chairs, tables, table linen, glassware; rental of lighting apparatus; rental of tents; rental of transportable buildings; rental of drinking water dispensers; restaurant services; self-service restaurant services; food sculpting; canteen services; holiday camp services [lodging]; bar services; providing campground facilities; food and drink catering; day-nursery [crèche] services.

(260) AM 2018 93343 A
(800) 1355294
(151) 2017 01 19
(891) 2017 01 19
(731) DAFNI HAIR PRODUCTS LTD
11 Hayetzira, Raanana, Israel
(540)

DAFNI
black

(591) Black, white

(531) 27.05.01; 27.05.17

(511)

8 – Electric hair straighteners; electric hair straightening irons; electric hand-held hair styling irons.

21 – Electrically heated hair brushes; electric hair combs; electric rotary hair brush for styling a user's hair; hair brushes; hair combs; hot air hair brushes; electric and non-electric hair straightening combs and brushes.

(260) AM 2018 93344 A
(800) 1355946
(151) 2017 05 19
(891) 2017 05 19
(731) CELGENE CORPORATION
86 Morris Avenue, Summit NJ 07901, USA
(540)

ZEPTOROZ

(591) Black, white

(531) 27.05.05

(511)

5 – Pharmaceutical preparations for use in the treatment of multiple sclerosis, leukemia, auto inflammatory disease, autoimmune disease, blood disease, cancer, ulcerative colitis, arthritis, musculoskeletal and skin diseases; pharmaceutical preparations, namely, cytokine inhibitory drugs; pharmaceutical preparations that modulate the immune system.

(260) AM 2018 93345 A
(800) 1355295
(151) 2017 01 19
(891) 2017 01 19
(731) DAFNI HAIR PRODUCTS LTD
11 Hayetzira, Raanana, Israel
(540)

DAFNI
go

(591) Black, white

(531) 27.05.01; 27.05.17

(511)

8 – Electric hair straighteners; electric hair straightening irons; electric hand-held hair styling irons.

21 – Electrically heated hair brushes; electric hair combs; electric rotary hair brush for styling a user's hair; hair brushes; hair combs; hot air hair brushes; electric and non-electric hair straightening combs and brushes.

(260) AM 2018 93346 A
(800) 1355333
(151) 2017 03 22

(891) 2017 03 22

(731) BOLOGNAFIERE COSMOPROF S.P.A.

Via Maserati, 16 I-40128 Bologna (BO) (IT),
Italy

(540)



Hairdresser Award

(591) Black, white

(531) 14.07.20; 27.03.15; 27.05.22

(511)

16 – Printed matter; pictures; graphic representations; carrier bags; paper envelopes for packaging; paper bows; conical paper bags; diaries; sketchbooks; stationery; office requisites; note pads; sketch pads; printed calendars; writing paper; adhesive labels; paper sheets [stationery]; document portfolios; desk sets; notebooks; stamps [seals]; book binders; printing type; printing blocks; cords for bookbinding; ink; fabrics for bookbinding; printing sets; scrapbooks; almanacs; printed tickets; printed patterns; caricatures; catalogues; posters; photographs; comics; newspapers; invitation cards; advertising posters; pamphlets; journals; periodicals; printed periodicals in the field of figurative arts; printed publications; periodicals; promotional publications; printed advertisements; daily newspaper; printed art reproductions; graphic reproductions; poster magazines; color prints; prints; photographs [printed]; flyers; bookbinding material; paper; signboards of paper or cardboard; cardboard tubes; parchment paper; publication paper.

41 – Editorial consultation; publishing by electronic means; editing of printed matter containing pictures, other than for advertising purposes; provision of non-downloadable electronic publications; providing on-line publications; provision of information relating to publishing; layout services, other than for advertising purposes; electronic desktop publishing; publication of calendars of events; publishing of song lyrics in book form; publishing services for books and magazines; publication of periodicals and books in electronic form; publication of posters; publication of magazines; publishing of web magazines; publication of printed matter; publication of texts and images, including in electronic form, except for advertising purposes; publication of leaflets; publication and editing of printed matter; editing of written texts; publishing services; news reporters services; publishing services for periodical and non-periodical publications, other than publicity texts; publishing services; publication of magazines; conducting of seminars and congresses; arranging of award ceremonies; organisation of artistic competi-

tions; organisation of competitions and awards; arranging of lectures; arranging of conferences; organising of education exhibitions; organising of education exhibitions; organisation of meetings and conferences; arranging and conducting award ceremonies; arranging and conducting of seminars; arranging and conducting of seminars and workshops; photography; workshops for training purposes; photo editing; photographic reporting; photography; photographic composition for others; educational seminars relating to hairdressing techniques; educational seminars relating to beauty therapy.

(260) AM 2018 93347 A

(800) 1355970

(151) 2017 05 23

(891) 2017 05 23

(731) TURNER NETWORK TELEVISION, INC.

1050 Techwood Drive, Atlanta GA 30318, USA

(540)

DEADLIER THAN THE MALE

(591) Black, white

(531) 27.05.15

(511)

9 – Audio visual recordings in all media, featuring entertainment in the nature of an on-going television series in the field of comedy, action, drama and adventure; downloadable television programming featuring comedy, action, drama and adventure distributed via the internet and wireless communications.

41 – Entertainment services, namely, a multimedia program series featuring comedy, action, drama and adventure distributed via various platforms across multiple forms of transmission media.

(260) AM 2018 93350 A

(800) 1355397

(151) 2017 04 20

(891) 2017 04 20

(731) OPUS GROUP AB

Bäckstersgatan 11, SE-431 49 Mölndal, Sweden

(540)



(591) Green, light green, white and dark green

(531) 26.11.12; 26.15.01; 27.05.17; 29.01.13

(511)

37 – Vehicle maintenance; vehicle maintenance; vehicle maintenance; vehicle maintenance; service stations for the maintenance of vehicles; inspection of vehicles prior to maintenance; vehicle maintenance and repair; vehicle maintenance and repair; vehicle

maintenance and repair; vehicle maintenance and repair; vehicle maintenance and repair; vehicle maintenance and repair; vehicle maintenance and repair; vehicle maintenance and repair; vehicle service, repair, maintenance and refuelling; provision of information relating to the maintenance of vehicles; vehicle maintenance and repair.

41 – Provision of training courses; provision of tuition; training services; educational examination; provision of tuition; computer training; driver safety training; driving instruction; training of car drivers; driving instruction; driver training; advanced driving instruction for drivers of motor cars; providing training in motor vehicle driving; school services.

42 – Automotive inspections; testing of vehicles; testing [inspection] of vehicles for roadworthiness; testing [inspection] of vehicles for roadworthiness; sampling for pollution; greenhouse gas emission measuring and analysis; surveying; technical inspection services; surveying and exploration; inspection of motor vehicles [for roadworthiness]; inspection of motor land vehicles [for roadworthiness]; surveying; surveys (conducting -); vehicle roadworthiness testing.

(260) AM 2018 93351 A

(800) 777289

(151) 2002 03 05

(891) 2017 05 12

(731) CORTEFIEL, S.A.

Avda. del Llano Castellano, 51, E-28034

MADRID, Spain

(540)

SPRINGFIELD

(591) Black, white

(511)

3 – Bleaching preparations and other substances for laundry use; cleaning, polishing, grease removing and abrasive preparations; soaps; perfumery, essential oils, cosmetics, hair lotions; dentifrices.

(260) AM 2018 93352 A

(800) 1355402

(151) 2017 04 26

(891) 2017 04 26

(731) Joint-Stock Company

"OBNINSKORGSIINTEZ"

RU-249032 57 Kievskoye Shosse, Obninsk,

Kaluga region, Russian Federation

(540)



(591) Black, white

(531) 03.11.11

(511)

1 – Acetate of cellulose, unprocessed; acetates [chemicals]; acetic anhydride; acetone; acetylene; acids; acidulated water for recharging batteries; acrylic resins, unprocessed; actinium; adhesives for billposting; adhesives for industrial purposes; adhesives for wall tiles; adhesives for wallpaper; agar-agar; agglutinants for concrete; agricultural chemicals, except fungicides, herbicides, insecticides and parasiticides; albumin [animal or vegetable, raw material]; albuminized paper; alcohol; aldehydes; alginates for Industrial purposes; alginates for the food industry; alkalis; alkaline iodides for industrial purposes; alkaline metals; alkaline-earth metals; alkaloids; alumina; aluminium acetate; aluminium alum; aluminium chloride; aluminium hydrate; aluminium iodide; aluminium silicate; americium; ammonia [volatile alkali] for industrial purposes; ammonia alum; ammonia; ammoniacal salts; ammonium aldehyde; ammonium salts; amyl acetate; anhydrides; anhydrous ammonia; animal albumen [raw material]; animal carbon preparations; anthranilic acid; anti-boil preparations for engine coolants; antifreeze; anti-frothing solutions for batteries; anti-incrustants; anti-knock substances for internal combustion engines; antimony oxide; antimony sulfide; antistatic preparations, other than for household purposes; anti-tarnishing chemicals for windows; argon; arsenic; arsenious acid; artificial resins, unprocessed; artificial sweeteners [chemical preparations]; astatine; auxiliary fluids for use with abrasives; bacterial preparations other than for medical and veterinary use; bacteriological preparations for acetification; bacteriological preparations other than for medical and veterinary use; balm of gurjun [gurjon, gurjan] for making varnish; barium; barium sulfate; baryta; baryta paper; barytes; bases [chemical preparations]; basic gallate of bismuth; bauxite; bate for dressing skins; beer preserving agents; beer-clarifying and preserving agents; bentonite; benzene derivatives; benzene-based acids; benzoic acid; berkelium; bicarbonate of soda for chemical purposes; bichloride of tin; bichromate of potassium; bichromate of soda; biochemical catalysts; biological preparations, other than for medical or veterinary purposes; bismuth; bismuth subnitrate for chemical purposes; bleaching preparations [decolorants] for industrial purposes; blueprint paper; borax; boric acid for industrial purposes; brake fluid; brickwork preservatives, except paints and oils; bromine for chemical purposes; calcined soda; calcium carbide; calcium cyanamide [fertilizer]; calcium salts; californium; camphor, for industrial purposes; carbide; carbolineum for the protection of plants; carbon disulfide; carbon for filters; carbonates; carbonic acid; casein for industrial purposes; casein for the food industry; cassiopium [lutetium]; catalysts; cautechu; caustic soda for industrial purposes; caustics

for industrial purposes; cement [metallurgy]; cement for mending broken articles; cement preservatives, except paints and oils; cement-waterproofing chemicals, except paints; ceramic compositions for sintering [granules and powders]; ceramic glazings; ceramic materials in particulate form, for use as filtering media; chemical additives for oils; chemical additives to drilling muds; chemical additives to fungicides; chemical additives to insecticides; chemical additives to motor fuel; chemical condensation preparations; chemical preparations for analyses in laboratories, other than for medical or veterinary purposes; chemical preparations for decarbonising engines; chemical preparations for facilitating the alloying of metals; chemical preparations for scientific purposes, other than for medical or veterinary use; chemical preparations for smoking meat; chemical preparations to prevent mildew; chemical preparations to prevent wheat smut; chemical preparations, except pigments, for the manufacture of enamel; chemical reagents, other than for medical or veterinary purposes; chemical substances for preserving foodstuffs; china clay; chlorates; cholic acid; chromates; chrome alum; chrome salts; chromic acid; chromic salts; chromium oxide; cinematographic films, sensitized but not exposed; citric acid for industrial purposes; coal saving preparations; cobalt oxide for industrial purposes; collodion; color-brightening chemicals for industrial purposes; combusting preparations [chemical additives to motor fuel]; compositions for repairing inner tubes of tires [tyres]; compositions for repairing tires [tyres]; compost; concrete-aeration chemicals; condensation-preventing chemicals; coolants for vehicle engines; copper sulfate [blue vitriol]; corrosive preparations; chemicals for the manufacture of paints; currying preparations for skins; cyanides [prussiates]; damp-proofing chemicals, except paints, for masonry; dry ice [carbon dioxide]; dysprosium; earth for growing; earth metals; electrophoresis gels, other than for medical or veterinary purposes; emulsifiers; enamel-staining chemicals; enzyme preparations for industrial purposes; enzymes for the food industry; epoxy resins, unprocessed; ethyl alcohol; europium; expanded-clay for hydroponic plant growing [substrate]; fat-bleaching chemicals; fatty acids; fermium; ferrotype plates [photography]; fertilizing preparations; filtering materials [chemical preparations]; filtering materials [mineral substances]; filtering materials [unprocessed plastics]; filtering materials [vegetable substances]; filtering preparations for the beverages industry; finishing preparations for use in the manufacture of steel; fire extinguishing compositions; fish meal fertilizers; fissionable material for nuclear energy; fixing baths [photography]; flashlight preparations; flour for industrial purposes; flower preservatives; fluids for hydraulic circuits; formic acid; foundry binding substances; foundry molding [moulding] preparations; foundry sand; fuel-saving prepa-

rations; fuller's earth for use in the textile industry; fulling preparations for use in the textile industry; gadolinium; gallic acid for the manufacture of ink; gallium; gallnuts; gallotannic acid; galvanizing baths; galvanizing preparations; gambier; gas purifying preparations; gelatine for industrial purposes; gelatine for photographic purposes; genes of seeds for agricultural production; getters [chemically active substances]; glass-frosting chemicals; glass-staining chemicals; glaziers' putty; glucose for Industrial purposes; glucose for the food industry; glucosides; gluten [glue], other than for stationery or household purposes; gluten for industrial purposes; glycerides; glycerine for industrial purposes; glycol; gold salts; grafting mastic for trees; grafting wax for trees; graphite for industrial purposes; guano; gum arabic for industrial purposes; gums [adhesives], other than for stationery or household purposes; heavy water; helium; holmium; hormones for hastening the ripening of fruit; horticultural chemicals, except fungicides, herbicides, insecticides and parasiticides; humus; humus top dressing; hydrates; hydrazine; hydrochloric acid; hydrofluoric acid; hydrogen; hydrogen peroxide; hypochlorite of soda; hyposulfites; iodic acid; iodine for chemical purposes; iodine for industrial purposes; iodised albumen; iodised salts; ion exchangers [chemicals]; iron salts; isinglass other than for stationery, household or alimentary purposes; isotopes for industrial purposes; kainite; ketones; kieselgur; krypton; lactic acid; lactose [raw material]; lactose for industrial purposes; lactose for the food industry; lanthanum; lead acetate; lead arsenate; lead oxide; leather glues; leather-dressing chemicals; leather-impregnating chemicals; leather-waterproofing chemicals; lecithin [raw material]; lecithin for industrial purposes; lecithin for the food industry; lime acetate; lime carbonate; lime chloride; limestone hardening substances; liquids for removing sulfates from batteries; lithia [lithium oxide]; lithium; litmus paper; magnesite; magnesium carbonate; magnesium chloride; magnetic fluid for Industrial purposes; malt albumen; manganate; manganese dioxide; mangrove bark for industrial purposes; masonry preservatives, except paints and oils; mastic for leather; mastic for tires [tyres]; meat tenderizers for industrial purposes; mercury salts; metal annealing preparations; metal hardening preparations; metal tempering preparations; metalloids; methane; methyl benzol; mineral acids; moderating materials for nuclear reactors; moistening [wetting] preparations for use in bleaching; moistening [wetting] preparations for use in dyeing; moistening [wetting] preparations for use in the textile industry; mold-release preparations; mordants for metals; must-fining preparations; naphthalene; neodymium; neon; neptunium; nitrate of uranium; nitrate paper; nitrates; nitric acid; nitrogen; nitrogenous fertilizers; nitrous oxide; oenological bactericides [chemical preparations for use in wine making]; oil cement [putty]; oil

dispersants; oil-bleaching chemicals; oil-purifying chemicals; oils for currying leather; oils for preparing leather in the course of manufacture; oils for tanning leather; oils for the preservation of food; oil-separating chemicals; oleic acid; olivine [silicate mineral]; opacifiers for enamel; opacifiers for enamel or glass; opacifiers for glass; oxalates; oxalic acid; oxygen; palladium chloride; paper pulp; peat [fertiliser]; peat pots for horticulture; pectin [photography]; pectin for industrial purposes; pectin for the food industry; perborate of soda; percarbonates; perchlorates; persulfates; persulfuric acid; petroleum dispersants; phenol for industrial purposes; phosphates [fertilisers]; phosphoric acid; photometric paper; picric acid; plant growth regulating preparations; plasticizers; plastics, unprocessed; plastisols; plutonium; polish removing substances; polonium; potash; potash water; potassium; potassium dioxalate; potato flour for industrial purposes; power steering fluid; praseodymium; preparations for preventing the tarnishing of glass; preparations for preventing the tarnishing of lenses; preparations for stimulating cooking for industrial purposes; preparations for the separation of greases; preparations of microorganisms, other than for medical and veterinary use; preparations of the distillation of wood alcohol; preparations of trace elements for plants; preservatives for pharmaceutical preparations; preservatives for tiles, except paints and oils; propellant gases for aerosols; protective gases for welding; purification preparations; pyrogallol; quebracho for industrial purposes; radiator flushing chemicals; radioactive elements for scientific purposes; rare earths; reagent paper, other than for medical or veterinary purposes; reducing agents for use in photography; refrigerants; renovating preparations for phonograph records; rock salt; rubber preservatives; sal ammoniac; salicylic acid; salt for preserving, other than for foodstuffs; salt, raw; saltpeter; salts [chemical preparations]; salts [fertilisers]; salts for coloring [colouring] metal; salts for galvanic cells; salts for industrial purposes; salts from rare earth metals; salts of alkaline metals; salts of precious metals for industrial purposes; scale removing preparations, other than for household purposes; seawater for industrial purposes; seaweeds [fertilizers]; sebacic acid; seed preserving substances; self-toning paper [photography]; sensitized paper; sensitized plates for offset printing; separating and unsticking [ungluing] preparations; silicates; silicon; silicones; silver nitrate; sizing preparations; slag [fertilisers]; soap [metallic] for industrial purposes; soda ash; sodium; sodium salts [chemical compounds]; solidified gases for industrial purposes; solutions for cyanotyping; solvents for varnishes; sorrel salt; spirits of salt; spirits of vinegar [dilute acetic acid]; stain-preventing chemicals for use on fabrics; starch for industrial purposes; starch paste [adhesive], other than for stationery or household purposes; starch-

liquifying chemicals [ungluing agents]; stearic acid; stem cells other than for medical or veterinary purposes; substances for preventing runs in stockings; sulfates; sulfides; sulfuric acid; sulfurous acid; superphosphates [fertilisers]; surface-active chemical agents; synthetic materials for absorbing oil; synthetic resins, unprocessed; tan; tannic acid; tanning substances; tan-wood; tapioca flour for industrial purposes; tartar other than for pharmaceutical purposes; tartaric acid; test paper, chemical; textile-brightening chemicals; textile-impregnating chemicals; textile-waterproofing chemicals; titanium dioxide for industrial purposes; toning salts [photography]; toxic gas neutralizers; transmission fluid; tree cavity fillers [forestry]; tungstic acid; uranium oxide; vine disease preventing chemicals; viscose; vulcanisation accelerators; vulcanising preparations; wallpaper removing preparations; water glass [soluble glass]; water-purifying chemicals; water-softening preparations; wax-bleaching chemicals; welding chemicals; wine finings; witherite; wood pulp; xenon; X-ray films, sensitized but not exposed; ytterbium; yttrium; zirconia.

(260) AM 2018 93353 A

(800) 1355443

(151) 2017 04 10

(891) 2017 04 10

(731) HUGEL INC.

61-20, SINBUK-RO, SINBUK-EUP,
CHUNCHEON-SI GANGWON-DO,
Korea (Republic of)

(540)

BOTULAX

(591) Black, white

(511)

5 – Biological preparations for medical purposes; pharmaceutical preparations for ocular or intraocular surgery; veterinary preparations; antitoxic sera; hemorrhoid preparations; pharmaceutical preparations for diagnosis; reagents for medical use; chemical reagents for medical or veterinary purposes; pharmaceutical preparations for digestive system; botulinum toxin; biological preparations for medical or veterinary purposes; pharmaceutical and veterinary preparations; muscle relaxants; therapeutic drugs and agents; injectable dermal filler; pharmaceutical preparations for skin care; preparations for the treatment of muscle fatigue; pharmaceutical preparations for the treatment of wrinkles; preparations for treating dystonia; poisons; vaccines; pharmaceutical agents affecting peripheral nervous system; pharmaceutical preparations for use in treating urogenital system diseases and conditions; bacterial toxins; ophthalmic preparations; ointments for pharmaceutical purposes; chemical preparations for pharmaceutical purposes; pharmaceutical agents for epidermis; drugs for medical purposes; adjuvants for me-

dical purposes; medicines for human purposes; pharmaceutical preparations for central nervous system; pharmaceutical preparations for dental purposes; analgesics; pharmaceutical preparations for use in dermatology; pharmaceutical preparations for treating skin disorders; antibiotic preparations; appetite suppressants for medical purposes; preparations for treating hemorrhoid; pharmaceutical preparations for treating neurological diseases and disorders; pharmaceutical preparations for the treatment of pain; pharmaceutical agents for treating physically caused lesions; medicated lotions; pharmaceutical preparations for the treatment of spasm; microorganisms for medical purposes; cultures of microorganisms for medical or veterinary use; bacteriological preparations for medical and veterinary use; hyaluronic acid in ampoule form for medical purposes; pharmaceutical preparations mainly based on hyaluronic acid; medical gels for activation of tissues; hyaluronic acid preparations for medical purposes; modified hyaluronic acid preparations for medical purposes; pharmaceutical preparations used in cosmetic surgery; pharmaceutical preparations containing botulinum toxin; pharmaceutical preparations; pharmaceutical preparations for the treatment of hyperhidrosis; pharmaceutical preparations for the treatment of headache; pharmaceutical preparations for use in orthopedics; pharmaceutical preparations containing botulinum toxin fragments for the treatment of wrinkles; pharmaceutical preparations containing botulinum toxin for the treatment of wrinkles; pharmaceutical preparations for the treatment of psychiatric diseases and disorders.

(260) AM 2018 93354 A
(800) 1355446
(151) 2017 05 16
(891) 2017 05 16
(731) WITT/KIEFFER INC.
Suite 510, 2015 Spring Road Oak Brook
IL 60523, USA
(540)

WITT/KIEFFER

(591) Black, white
(511)
35 – Business management consultation in the field of executive and leadership development; business management consulting; business management consulting in the field of team development; business organization consulting; business succession planning; executive recruiting services; executive search and placement services.

(260) AM 2018 93357 A
(800) 1355470
(151) 2017 05 03
(891) 2017 05 03

(731) IQ Nutrition, LLC
C/o Moritt Hock & Hamroff LLP, 400 Garden
City Plaza, Garden City NY 11530, USA
(540)

PEDIAMIL

(591) Black, white
(511)
5 – Nutritional supplements; nutritional supplements for medical use; maternal nutritional supplements; food for babies.
29 – Dried fruits and vegetables; and milk and milk products excluding ice cream, ice milk and frozen yogurt.
30 – Processed cereal; cereal based snack food; breakfast cereals; and ready-to-eat cereals.

(260) AM 2018 93358 A
(800) 928273
(151) 2006 05 03
(891) 2017 04 28
(731) CAFFITALY SYSTEM S.p.A.
Via Panigali, 38-38A, I-40041 Gaggio
Montano (Bologna), Italy
(540)



(591) Black, white
(531) 25.01.09; 26.04.04; 26.11.13; 27.05.01;
27.05.10
(511)
11 – Machines for preparing coffee.
30 – Coffee, tea, cocoa, sugar, artificial coffee.

(260) AM 2018 93359 A
(800) 1355491
(151) 2016 11 10
(891) 2016 11 10
(731) GOLUB SVITLANA ISAAKIVNA
vul. Bolgarska, 82, kv. 8 m. Odesa 65000,
Ukraine
(540)



BOLGRAD БОЛГРАД

(591) Black, white

(531) 26.01.01; 26.01.04; 26.01.18; 26.01.24;
27.05.10; 28.05

(511)

33 – Alcoholic beverages, except beer; aperitifs; wine; brandy; whisky; gin; arak [arrack]; anisette [liqueur]; anise [liqueur]; hydromel [mead]; vodka; kirsch; perry; cocktails; curacao; liqueurs; peppermint liqueurs; distilled beverages; pre-mixed alcoholic beverages, other than beer-based; alcoholic beverages containing fruit; bitters; nira [sugarcane-based alcoholic beverage]; piquette; rice alcohol; rum; sake; cider; spirits [beverages]; alcoholic extracts; alcoholic essences; fruit extracts, alcoholic; digesters [liqueurs and spirits]; fruit extracts, alcoholic.

(260) AM 2018 93364 A

(800) 1034794

(151) 2009 12 23

(891) 2017 04 27

(731) CARREFOUR, SA

33 Avenue Emile Zola, F-92100 BOULOGNE
BILLANCOURT, France

(540)



(591) Red Pantone 032C, light red

(531) 03.09.01; 03.09.24; 26.04.03; 26.04.18;
27.05.01; 27.05.10; 29.01.12

(511)

35 – Advertising; business management; business administration; office functions; direct mail advertising (tracts, prospectuses, printed matter, samples); arranging newspaper subscriptions (for others); business management and organisation consultancy; assistance in the operation or management of commercial or industrial enterprises; assistance in the operation or management of business centres; accounting; document reproduction; employment agencies; computerized file management; organisation of exhibitions for commercial or advertising purposes; online advertising on a computer network; rental of advertising time on all means of communication; publication of publicity texts; rental of advertising space; dissemination of advertisements; public relations; organization and management of business operations to obtain customer loyalty; sales promotion (for others); the bringing together, for the benefit of others, of multimedia, computer, audiovisual, telephone, music and photography goods, printed matter, stationery, books, goods for artistic and cultural activities, games and playthings, goods for the maintenance, renovation and decoration of houses (interior and exterior), goods for the garden, gardening and outdoor activities, electric household goods (small and large), furniture (for indoors and outdoors), lighting, household or kitchen utensils and containers,

linen, textiles and textile goods, ironmongery, DIY goods, tools, car and bicycle goods, clothing, footwear, headgear, luggage, leatherware, food and drink, hygienic and beauty preparations, child care articles, parapharmaceuticals, jewellery, clocks and watches, goods for animals, enabling customers to conveniently view, choose and purchase those goods; presentation of goods on all means of communication for retail sale; retailing in supermarkets or hypermarkets of the aforesaid goods, namely multimedia, computer, audio-visual, telephone, music and photographic goods, printed matter, stationery, books, goods for artistic and cultural activities, games and playthings, goods for maintenance, renovation and decoration (interior and exterior) of houses, goods for the garden, gardening and outdoor activities, electric household goods (small and large), furniture (interior and exterior of houses), lighting goods, household or kitchen utensils and containers, linen, textiles and fabrics, ironmongery, DIY goods, tools, car and bicycle goods, clothing, footwear, headgear, luggage, leatherware, food and drink, hygiene and beauty preparations, child care articles, parapharmaceuticals, jewellery, clocks and watches, goods for animals.

(260) AM 2018 93366 A

(800) 1154344

(151) 2012 10 25

(891) 2017 02 09

(731) MINDBREEZE GMBH

Honauerstraße 2-4, A-4020 Linz, Austria

(540)

ILLUMINATING INFORMATION

(591) Black, white

(511)

9 – Data processing apparatus, magnetic data carriers, compact discs containing software for use in data processing, computers, computer software for search operations on websites and other data sources, computer hardware especially keyboards, monitors, mice, printers, scanners and digital cameras, modems, speakers and video recorders.

35 – Business organization consultancy in the field of electronic data processing.

37 – Maintenance and repair of data processing apparatus and computers.

38 – Providing telecommunication services via internet in order to inform users regarding information offered by providers of web services.

41 – Training services, instruction and holding of and carrying out of seminars in the field of electronic data processing, namely search operations on websites and other data sources.

42 – Technical consultancy in the field of information technology, compilation of computer software.

(260) AM 2018 93372 A

(800) 1354837

(151) 2017 04 07

(891) 2017 04 07

(731) PHILIP MORRIS PRODUCTS S.A.

Quai Jeanrenaud 3 CH-2000 Neuchâtel,

Switzerland

(540)

CEEGS

(591) Black and white

(511)

9 – Batteries for electronic cigarettes; batteries for electronic devices that are used for heating tobacco, chargers for electronic devices that are used for heating tobacco; USB chargers for electronic devices that are used for heating tobacco; car chargers for electronic cigarettes; car chargers for devices that are used for heating tobacco; battery chargers for electronic cigarettes.

11 – Electronic vaporizers except electronic cigarettes; apparatus for heating liquids; apparatus for generating vapor.

34 – Wired vaporizers for electronic cigarettes and electronic smoking devices; tobacco, raw or manufactured; tobacco products, including cigars, cigarettes, cigarillos, tobacco for roll-your-own cigarettes, pipe tobacco, chewing tobacco, snuff tobacco, kretek; snus; tobacco substitutes (not for medical purposes); smokers' articles, including cigarette paper and tubes, cigarette filters, tobacco tins, cigarette cases and ashtrays, pipes, pocket apparatus for rolling cigarettes, lighters; matches; tobacco sticks, tobacco products for the purpose of being heated, electronic devices and their parts for the purpose of heating cigarettes or tobacco in order to release nicotine-containing aerosol for inhalation; liquid nicotine solutions for use in electronic cigarettes; electronic smoking devices; electronic cigarettes; electronic cigarettes as substitute for traditional cigarettes; electronic devices for the inhalation of nicotine-containing aerosol; oral vaporizing devices for use by smokers, tobacco products and tobacco substitutes; smokers' articles for electronic cigarettes; parts and fittings for the aforesaid products included in this class; extinguishers for heated cigarettes and cigars as well as heated tobacco sticks; electronic rechargeable cigarette cases.

(260) AM 2018 93373 A

(800) 1354838

(151) 2017 04 07

(891) 2017 04 07

(731) PHILIP MORRIS PRODUCTS S.A.

Quai Jeanrenaud 3 CH-2000 Neuchâtel,
Switzerland

(540)

TEEPS

(591) Black and white

(531) 27.05.01

(511)

9 – Batteries for electronic cigarettes; batteries for electronic devices that are used for heating tobacco, chargers for electronic devices that are used for heating tobacco; USB chargers for electronic devices that are used for heating tobacco; car chargers for electronic cigarettes; car chargers for devices that are used for heating tobacco; battery chargers for electronic cigarettes.

11 – Electronic vaporizers except electronic cigarettes; apparatus for heating liquids; apparatus for generating vapor.

34 – Wired vaporizers for electronic cigarettes and electronic smoking devices; tobacco, raw or manufactured; tobacco products, including cigars, cigarettes, cigarillos, tobacco for roll-your-own cigarettes, pipe tobacco, chewing tobacco, snuff tobacco, kretek; snus; tobacco substitutes (not for medical purposes); smokers' articles, including cigarette paper and tubes, cigarette filters, tobacco tins, cigarette cases and ashtrays, pipes, pocket apparatus for rolling cigarettes, lighters; matches; tobacco sticks, tobacco products for the purpose of being heated, electronic devices and their parts for the purpose of heating cigarettes or tobacco in order to release nicotine-containing aerosol for inhalation; liquid nicotine solutions for use in electronic cigarettes; electronic smoking devices; electronic cigarettes; electronic cigarettes as substitute for traditional cigarettes; electronic devices for the inhalation of nicotine-containing aerosol; oral vaporizing devices for use by smokers, tobacco products and tobacco substitutes; smokers' articles for electronic cigarettes; parts and fittings for the aforesaid products included in this class; extinguishers for heated cigarettes and cigars as well as heated tobacco sticks; electronic rechargeable cigarette cases.

(260) AM 2018 93374 A

(800) 1308624

(151) 2016 04 27

(891) 2017 05 11

(731) VOROLA FINANCIAL LTD.

33 Porter Road, P.O. Box 3169 PMB 103,

Road Town Tortola (VG), Virgin Islands

(British)

(540)

Marcello Rosso

(591) Black, white

(531) 27.05.17

(551) Collective

(511)

14 – Agates; diamonds; amulets [jewellery, jewelry (Am.)]; anchors [clock- and watchmaking]; barrels [clock- and watchmaking]; bracelets [jewellery, jewelry (Am.)]; watch bands; charms [jewellery, jewelry (Am.)]; key rings [trinkets or fobs]; brooches [jewellery, jewelry (Am.)]; alarm clocks; pins [jewellery, jewelry (Am.)]; ornamental pins; tie pins; beads for making jewelry; pearls made of ambroid [pressed amber]; jet, unwrought or semi-wrought; pearls [jewellery, jewelry (Am.)]; copper tokens; tie clips; cufflinks; badges of precious metal; gold, unwrought or beaten; ivory jewelry; works of art of precious metal; jewelry; jewelry of yellow amber; iridium; precious stones; semi-precious stones; spun silver [silver wire]; necklaces [jewellery, jewelry (Am.)]; rings [jewellery, jewelry (Am.)]; boxes of precious metal; watch cases [parts of watches]; clock cases; pendulums [clock- and watchmaking]; medals; lockets [jewellery, jewelry (Am.)]; precious metals, unwrought or semi-wrought; movements for clocks and watches; clockworks; coins; gold thread [jewellery, jewelry (Am.)]; threads of precious metal [jewellery, jewelry (Am.)]; silver thread [jewellery, jewelry (Am.)]; olivine [gems]; osmium; palladium; platinum [metal]; chronometric instruments; watch springs; rhodium; ruthenium; stopwatches; silver, unwrought or beaten; earrings; ingots of precious metals; alloys of precious metal; statues of precious metal; figurines [statuettes] of precious metal; watch glasses; paste jewellery [costume jewelry (Am.)]; clock hands [clock and watch making]; ornaments [jewellery, jewelry (Am.)]; shoe ornaments of precious metal; hat ornaments of precious metal; ornaments of jet; cases for watches [presentation]; cases for clock- and watchmaking; chronographs [watches]; chronometers; chronoscopes; chains [jewellery, jewelry (Am.)]; watch chains; dials [clock- and watchmaking]; atomic clocks; watches; sundials; clocks and watches, electric; control clocks [master clocks]; clocks; wristwatches; jewelry boxes; spinel [precious stones].

18 – Mountaineering sticks; pocket wallets; business card cases; card cases [notecases]; reins; harness fittings; parts of rubber for stirrups; chamois leather, other than for cleaning purposes; umbrellas; parasols; saddlery; frames for umbrellas or parasols; handbag frames; cases of leather or leatherboard; valves of leather; whips; imitation leather; leather, unworked or semi-worked; leatherboard; casings, of leather, for springs; umbrella rings; hat boxes of leather; boxes of leather or leatherboard; boxes of vulcanised fibre; chain mesh purses; purses; fastenings for saddles; butts [parts of hides]; saddle trees; bags [envelopes, pouches] of leather, for packaging; moleskin [imitation of leather]; travelling sets [leatherware]; knee-pads for horses; muzzles; hal-

ters; vanity cases, not fitted; leather thread; furniture coverings of leather; gut for making sausages; clothing for pets; trimmings of leather for furniture; collars for animals; music cases; slings for carrying infants; goldbeaters' skin; cat o' nine tails; leather leashes; pads for horse saddles; horseshoes; girths of leather; horse blankets; shoulder belts [straps] of leather; briefcases; traces [harness]; fur; haversacks; leather straps; straps for soldiers' equipment; harness straps; straps for skates; straps of leather [saddlery]; chin straps, of leather; stirrup leathers; umbrella handles; walking stick handles; suitcase handles; rucksacks; travelling bags; riding saddles; net bags for shopping; umbrella or parasol ribs; stirrups; bags; bags for climbers; sling bags for carrying infants; garment bags for travel; valises; handbags; tool bags of leather, empty; beach bags; bags for sports; bags for campers; shopping bags; wheeled shopping bags; school satchels; pouch baby carriers; travelling trunks; nose bags [feed bags]; bridoons; walking sticks; umbrella sticks; walking stick seats; bits for animals [harness]; bridles [harness]; harness for animals; key cases; horse collars; trunks [luggage]; suitcases; attaché cases; covers for horse saddles; umbrella covers; kid; curried skins; animal skins; cattle skins; leather laces; blinkers [harness]; game bags [hunting accessories].

25 – Wimples; bandanas [neckerchiefs]; underwear; sweat-absorbent underwear; berets; overalls; boas [necklets]; teddies [undergarments]; half-boots; ski boots; boots for sports; breeches for wear; trousers; football boots; brassieres; detachable collars; collars [clothing]; pelerines; shirt yokes; veils [clothing]; gabardines [clothing]; galoshes; neckties; ascots; leggings [leg warmers]; gaiters; boot uppers; corselets; jerseys [clothing]; vests; sports jerseys; hosiery; heels; hoods [clothing]; hat frames [skeletons]; pockets for clothing; neck scarfs [mufflers]; visors [headwear]; cap peaks; tights; slips [undergarments]; combinations [clothing]; wet suits for water-skiing; bodices [lingerie]; corsets [underclothing]; suits; bathing suits; masquerade costumes; beach clothes; jackets [clothing]; stuff jackets [clothing]; fishing vests; leggings [trousers]; liveries; camisoles; cuffs; short-sleeve shirts; mantillas; coats; sleep masks; furs [clothing]; mittens; miters [hats]; muffs [clothing]; footmuffs, not electrically heated; heelpieces for footwear; bibs, not of paper; fur stoles; ear muffs [clothing]; socks; beach shoes; sports shoes; footwear; paper clothing; outerclothing; ready-made clothing; motorists' clothing; cyclists' clothing; clothing for gymnastics; clothing of imitations of leather; clothing of leather; uniforms; clothing; fittings of metal for footwear; maniples; overcoats; parkas; gloves [clothing]; ski gloves; pajamas (Am.); bathing trunks; shirt fronts; scarfs; pocket squares; dresses; waterproof clothing; headbands [clothing]; garters; sock suspenders; stocking suspenders; ready-made linings [parts of clothing]; dress shields; soles

for footwear; braces for clothing [suspenders]; lace boots; ponchos; girdles; belts [clothing]; money belts [clothing]; layettes [clothing]; non-slipping devices for footwear; heelpieces for stockings; welts for footwear; chasubles; shirts; wooden shoes; sandals; bath sandals; boots; sarongs; jumper dresses; saris; sweaters; footwear uppers; inner soles; bath slippers; togas; knitwear [clothing]; underpants; gymnastic shoes; slippers; shoes; skull caps; turbans; headgear for wear; aprons [clothing]; tee-shirts; dressing gowns; bath robes; top hats; tips for footwear; stockings; sweat-absorbent stockings; shawls; caps [headwear]; paper hats [clothing]; shower caps; bathing caps; sashes for wear; studs for football boots; hats; babies' pants [clothing]; trouser straps; pelisses; esparto shoes or sandals; skirts; petticoats; skorts.

(260) AM 2018 93375 A

(800) 1354860

(151) 2016 12 24

(891) 2016 12 24

(731) BASF Colors & Effects GmbH

An der Rheinschanze 1 67059 Ludwigshafen
am Rhein, Germany

(540)



(591) Red, blue, green, orange, white, grey and black

(531) 26.05.03; 27.05.01; 29.01.15

(511)

1 – Chemicals used in the colorant industry; chemicals used in the manufacture of paints; chemicals used in the manufacture of varnishes; chemicals used in the manufacture of lacquers; chemicals used in the manufacture of dyes; chemicals used in the manufacture of pigments; chemicals used in the manufacture of colorants; chemicals used in the manufacture of mordants; chemicals used in the manufacture of printing ink; unprocessed plastics.

2 – Paints; varnishes; lacquers; dyes; pigments; colorants; mordants; metals in powder form for use in painting; coatings; printing ink.

(260) AM 2018 93376 A

(800) 1317260

(151) 2016 07 29

(891) 2017 06 14

(731) KITH RETAIL, LLC

628 Broadway, Suite 404, New York
NY 10012, USA

(540)

KITH

(591) Black, white

(511)

25 – Caps; footwear; headwear; jackets; jeans; shirts; sweatshirts.

35 – On-line retail store services featuring footwear, headwear, apparel, backpacks, and fashion accessories; retail apparel stores; retail store services featuring footwear, headwear, apparel, backpacks, and fashion accessories.

(260) AM 2018 93377 A

(800) 1354923

(151) 2017 05 04

(891) 2017 05 04

(731) IWI AG

Industriestrasse 13-C CH-6304 Zug,
Switzerland

(540)



(591) Black and white

(531) 01.13.01; 01.13.15; 26.01.01; 26.01.21

(511)

3 – Balms, other than for medical purposes; breath freshening sprays; dental bleaching gels; lotions for cosmetic purposes; dentifrices; cakes of toilet soap; cosmetic kits; breath freshening strips; teeth whitening strips; toiletry preparations; antiperspirants [toiletries]; hair shampoos; hair conditioners; cosmetic creams; oils for cosmetic purposes; hair lotions; beauty masks; cosmetic preparations for baths; make-up removing preparations; make-up preparations; cosmetic preparations for skin care.

21 – Toothbrushes; toothbrushes, electric; floss for dental purposes.

(260) AM 2018 93378 A

(800) 1330933

(151) 2016 08 25

(891) 2017 06 21

(731) ALTESSE

Valamas F-07310 SAINT-MARTIN-DE-
VALAMAS, France

(540)

LES GEORGETTES

(591) Black, white

(531) 27.05.01

(511)

14 – Precious metals and their alloys; works of art made of precious metals; jewelry boxes; boxes made of precious metal; jewelry, costume jewelry; medals; precious stones; key rings [trinkets or fobs]; jewelry rolls; jewelry organizer rolls for travel; rings (jewelry); rings (jewelry); wrist bands (jewelry); bracelets (jewelry); chains (jewelry); brooches (jewelry); necklaces (jewelry); ornaments (jewelry); diadems (jewelry); earrings (jewelry); pendants; timepieces and chronometric instruments; cases or caskets for timepieces; watch cases, bands, chains, springs or glasses.

(260) AM 2018 93379 A

(800) 1354955

(151) 2017 04 11

(891) 2017 04 11

(731) PHILIP MORRIS PRODUCTS S.A.

Quai Jeanrenaud 3 CH-2000 Neuchâtel,
Switzerland

(540)

EEZE

(591) Black and white

(511)

9 – Batteries for electronic cigarettes; batteries for electronic devices that are used for heating tobacco, chargers for electronic devices that are used for heating tobacco; USB chargers for electronic devices that are used for heating tobacco; car chargers for electronic cigarettes; car chargers for devices that are used for heating tobacco; battery chargers for electronic cigarettes.

11 – Electronic vaporizers except electronic cigarettes; apparatus for heating liquids; apparatus for generating vapor.

34 – Wired vaporizers for electronic cigarettes and electronic smoking devices; tobacco, raw or manufactured; tobacco products, including cigars, cigarettes, cigarillos, tobacco for roll-your-own cigarettes, pipe tobacco, chewing tobacco, snuff tobacco, kretek; snus; tobacco substitutes (not for medical purposes); smokers' articles, including cigarette paper and tubes, cigarette filters, tobacco tins, cigarette cases and ashtrays, pipes, pocket apparatus for rolling cigarettes, lighters; matches; tobacco sticks, tobacco products for the purpose of being heated, electronic devices and their parts for the purpose of heating cigarettes or tobacco in order to release nicotine-containing aerosol for inhalation; liquid nicotine solutions for use in electronic cigarettes; electronic smoking devices; electronic cigarettes; electronic cigarettes as substitute for traditional cigarettes; electronic devices for the inhalation of nicotine-containing aerosol; oral vaporizing devices for use by smokers, tobacco products and tobacco substitutes; smokers' articles for electronic cigarettes;

parts and fittings for the aforesaid products included in this class; extinguishers for heated cigarettes and cigars as well as heated tobacco sticks; electronic rechargeable cigarette cases.

(260) AM 2018 93380 A

(800) 1333502

(151) 2016 11 15

(891) 2017 04 26

(731) MM MODA GRUP TEKSTIL SANAYI VE
TICARET LIMITED SIRKETI

M. Nesih Özmen Mah. Fatih Cad. Köknar
Sok. 4 Güngören İstanbul, Turkey

(540)

Maxi Milano

(591) Black, white

(511)

25 – Clothing, footwear, headgear, all aforesaid goods produced in Italy.

35 – Advertising; business management; business administration; office functions; the bringing together, for the benefit of others, of a variety of goods, namely, clothing, footwear, headgear, enabling customers to conveniently view and purchase those goods, such services may be provided by retail stores, wholesale outlets, by means of electronic media or through mail order catalogues.

(260) AM 2018 93382 A

(800) 1337908

(151) 2017 01 17

(891) 2017 05 16

(731) ADP GAUSELMANN GMBH

Merkur-Allee 1-15, 32339 Espelkamp,
Germany

(540)

Diamond Casino

(591) Black, white

(511)

9 – Scientific, nautical, surveying, photographic, cinematographic, optical, weighing, measuring, signalling, checking (supervision), life-saving and teaching apparatus and instruments; apparatus and instruments for conducting, switching, transforming, accumulating, regulating or controlling electricity; apparatus for recording, transmission or reproduction of sound or images; magnetic data carriers, recording discs; compact discs, DVDs and other digital recording media; cash registers, calculating machines, data processing equipment, computers; computer software; fire-extinguishing apparatus; musical jukeboxes and parts for the aforesaid automatic machines; automatic cash dispensers, automatic money counting and money changing machines; coin-operated mechanisms; computer and video games soft-

ware; games software for use on any computer platform, including electronic entertainment and games consoles; computer game programs; computer games programs; video games (software); computer games provided through a global computer network or supplied by means of multi-media electronic broadcast or through telecommunications or electronic transmission or via the internet; computer games, leisure and recreational software, video games and computer software, all being provided in the form of storage media; programs for operating electric and electronic apparatus for games, amusement and/or entertainment purposes; automatic lottery machines; computer software for computer games on the internet; online games (software), in particular for online betting games, online prize games, online gambling games, online games of skill and online casino games; computer software in the form of an app for mobile devices and computers; calculating apparatus in coin-operated machines and parts for the aforesaid goods; apparatus for recording, transmission, processing or reproduction of data, including sound or images, including parts for all the aforesaid goods, except radio sets, television receivers, hi-fi systems, video recorders, telephone apparatus, fax machines and telephone answering machines; computer hardware and software for casino and amusement arcade games, for gaming machines, slot machines or video lottery gaming machines or games of chance via the internet; electric, electronic, optical or automatic apparatus, for identifying data carriers, identity cards and credit cards, bank notes and coins; electric, electronic or optical alarm and monitoring installations, including video cameras and apparatus for image transmission and image processing; data processing apparatus and computers, including data processing apparatus and computers being components for data networks and parts facilitating data network communications; electric wiring harnesses; circuit boards, printed circuit boards (electronic components) and combinations thereof, being assemblies and parts for apparatus, included in this class.

(260) AM 2018 93386 A
 (800) 1341223
 (151) 2016 12 21
 (891) 2017 06 21
 (731) FRANCESCO PAOLO SALERNO
 Via Molfetta, 40, I-71121 Foggia, Italy
 (540)

FRANCESCO PAOLO SALERNO

(591) Black, white
 (511)
 25 – Waterproof clothing; clothing for gymnastics; leisure suits; clothing for men, women and children; clothing for sports; suits; ceremonial dresses for wo-

men; wedding dresses; bath robes; clothing; bandanas [neckerchiefs]; pumps [footwear]; Bermuda shorts; underwear; bikinis; blazers; bomber jackets; braces for clothing [suspenders]; footwear; stockings; breeches for wear; blouses; shirts; tank tops; sports vests; windproof clothing; hats; coats; hoods [clothing]; cardigans; belts [clothing]; tights; men's suits; bathing suits; neckties; sweatshirts; foulards [clothing articles]; gabardines [clothing]; jackets [clothing]; sports jackets; heavy jackets; sport coats; garters; waistcoats; blousons; skirts; overalls; gloves [clothing]; jeans; flip-flops [footwear]; jerseys [clothing]; leggings [leg warmers]; hosiery; sports jerseys; sweaters; capes; miniskirts; vests; trousers; slippers; ear muffs [clothing]; pareus; sarongs; ski balaclavas; furs [clothing]; pajamas (Am.); polo shirts; sandals; gymnastic shoes; shawls; sashes for wear; shorts; ties; tuxedos; overcoats; chemises; petticoats; half-boots; boots; tailleurs; tee-shirts; tops [clothing]; combinations [clothing]; tracksuits; veils [clothing]; dressing gowns; wooden shoes.

(260) AM 2018 93389 A
 (800) 1355022
 (151) 2016 11 05
 (891) 2016 11 05
 (731) E. MIROGLIO EAD
 Industrialna Zona BG-8800 SLIVEN, Bulgaria
 (540)



(591) Blue and grey
 (531) 01.15.15; 27.05.15; 27.05.24; 29.01.13
 (511)
 23 – Yarns and threads for textile use; spun wool; woollen thread and yarn; elastic thread and yarn for textile use; spun cotton; spun wool; spun silk; spun thread and yarn; worsted; hemp thread and yarn; thread; embroidery thread and yarn; rayon thread and yarn; coir thread and yarn; silk thread and yarn; linen thread and yarn; cotton thread and yarn; yarn; jute thread and yarn.

24 – Textiles and textile goods, not included in other classes; bed covers; table covers; calico; printed calico cloth; bed linen; brocades; covers for cushions; woollen cloth; woollen fabric; gauze [cloth]; tapestry [wall hangings], of textile; drugget; damask; wall hangings of textile; fustian; dimity; elastic woven material; esparto fabric; labels [cloth]; jersey [fabric]; curtains of textile or plastic; zephyr [cloth]; canvas for tapestry or embroidery; buckram; flannel [fabric]; hemp cloth; hemp fabric; silk [cloth]; silk fabrics for printing patterns; crepe [fabric]; crepon; bedspreads; bed blankets; household linen; linen

cloth; marabouts [cloth]; textile material; loose covers for furniture; furniture coverings of textile; moleskin [fabric]; fabric for footwear; travelling rugs [lap robes]; cotton fabrics; bunting; haircloth [sackcloth]; cloth; knitted fabric; hat linings, of textile, in the piece; linings [textile]; pillow shams; coverlets [bedspreads]; table cloths [not of paper]; shrouds; bed clothes; diapered linen; taffeta [cloth]; cheese cloth; table runners; trellis [cloth]; bolting cloth; fabric; fabric for footwear; lingerie fabric; lining fabric for shoes; upholstery fabrics; fabrics for textile use; rayon fabric; ramie fabric; fibreglass fabrics for textile use; jute fabric; adhesive fabric for application by heat; fabric of imitation animal skins; tissues of textile for removing make-up; tulle; filtering materials of textile; felt; flags [not of paper]; sanitary flannel; frieze [cloth]; cheviots [cloth]; printers' blankets of textile.

25 – Parkas; overcoats; berets; underwear; teddies [undergarments]; half-boots; breeches [for wear]; stuff jackets; veils; outerclothing; topcoats; leggings [leg warmers]; spats; pelisses; clothing; chasubles; stockings; heel pieces for stockings; sweat-absorbent stockings; jackets; jerseys; waistcoats; leggings [trousers]; combinations; ready-made clothing; camisoles; corselets; suits; masquerade costumes; socks; mantillas; wristbands; muffs; footmuffs, not electrically heated; mitres [hats]; shirt fronts; shoulder wraps; coats; top coats; pants, trousers; pelerines; pyjamas; shirt yokes; ready-made linings; skorts; skirts; ponchos; vests; aprons; sweaters, pullovers; shirts; dresses; smocks; mittens; jumper dresses; tee-shirts; togas; hosiery; knitwear; gaiter straps; turbans; headgear for wear; uniforms; dressing gowns; tights; shawls; bandanas [neckerchiefs]; scarfs; gaudardines; gaiters; collars.

(260) AM 2018 93390 A
(800) 1355031
(151) 2017 01 06
(891) 2017 01 06
(731) INVICTA WATCH COMPANY OF
AMERICA, INC.
3069 Taft Street Hollywood FL 33021, USA

(540)

S. COIFMAN

(591) Black and white
(511)
9 – Eyewear.

14 – Watches.

(260) AM 2018 93394 A
(800) 1355050
(151) 2017 05 10
(891) 2017 05 10
(731) JANSSEN PHARMACEUTICA NV
Turnhoutseweg 30 B-2340 BEERSE, Belgium

(540)

FONTELVO

(591) Black and white

(511)

5 – Human pharmaceutical preparations.

(260) AM 2018 93395 A

(800) 1355069

(151) 2016 11 14

(891) 2016 11 14

(731) ZHEJIANG TAIZHOU XIDEBAO SHOES
CO., LTD.

No.888, Zechu Road, Zeguo Town, Wenling
City Zhejiang Province, China

(540)



(591) Royal, green

(531) 26.01.02; 26.01.19; 26.11.12; 27.05.17;
29.01.12

(511)

10 – Teeth rings (term considered too vague by the International Bureau – Rule 13.2.b of the Common Regulations); feeding bottles/babies' bottles; breast pumps; babies' pacifiers [teats]; feeding bottle valves; feeding bottle teats.

12 – Bicycles/cycles; rims for wheels of bicycles; hand cars; baby carriages; wheelchairs; shopping trolleys; safety seats for children, for vehicles; vehicle seats.

18 – Purses; school bags/school satchels; garment bags for travel; rucksacks/backpacks; handbags; briefcases; suitcases; boxes of leather or leather board; bags for sports; umbrellas.

(260) AM 2018 93396 A

(800) 1355071

(151) 2016 12 27

(891) 2016 12 27

(731) GD MIDEA AIR-CONDITIONING
EQUIPMENT CO., LTD.

Lingang Road, Beijiao, Shunde, Foshan
Guangdong, China

(540)

Vandelo

(591) Black and white

(531) 27.05.17

(511)

7 – Whisks, electric, for household purposes; washing machines [laundry]; spin driers [not heated]; wringing machines for laundry; dry washer; dish-

washers; kitchen machines, electric; fruit and vegetable juice extractor, electric; fruit presses, electric, for household purposes; food processors, electric; soybean milk machines for household purposes; compressors [machines]; compressed air machines; food processor, electric.

9 – Remote controller for household purposes; flashing lights [luminous signals]; electronic notice boards; traffic-light apparatus [signalling devices]; neon lights; lamp box; materials for electricity mains [wires, cables]; converters, electric; switches, electric; plugs, sockets and other contacts [electric connections]; time switches, automatic.

11 – Air conditioners; water heater for shower; central air conditioners; hot plate; refrigerators; showers; freezers; ice machines and apparatus; refrigerating cabinets; water filtering apparatus; drinking water dispensers; water purifying apparatus and machines; air purifying apparatus and machines; dehumidifiers; humidifiers; electric fans; ceiling fans; ventilators; thermantidotes; electric hair drier; cooking utensils, electric; electric kettles; rice cookers; induction cookers; commercial induction cookers; microwave ovens [cooking apparatus]; microwave ovens for industrial purposes; pressure cookers [autoclaves], electric; bread baking machines; bread baking machines; electric coffee kettles; electric steamer; electric saucepan; cooking apparatus and machines; gas stoves; gas furnaces; kitchen ranges [ovens]; fireplace; ovens; extractor hoods for kitchen; exhaust fans for kitchen; tableware disinfection cabinets; sterilized cupboard; heating equipments; solar water heaters; air source heat pump water heater; electric heaters; warmers; bed-warmers; electric laundry dryers; fabric steamers; lighting apparatus and installations; electric lamps; projector lamps; pendant lamps; table lights; kitchen lamps.

(260) AM 2018 93397 A

(800) 1355083

(151) 2017 02 10

(891) 2017 02 10

(731) SHENZHEN MINDRAY BIO-MEDICAL ELECTRONICS CO., LTD
Mindray Building, Keji 12th Road South,
High-tech Industrial Park, Nanshan
518057 Shenzhen, China

(540)

mindray

(591) Black and white

(531) 27.05.17

(511)

10 – Surgical apparatus and instruments; anaesthetic apparatus; medical apparatus and instruments; testing apparatus for medical purposes; apparatus for use in medical analysis; diagnostic apparatus for me-

dical purposes; radiotherapy apparatus; medical ultrasound apparatus; diagnostic ultrasound instruments for medical use; defibrillators; beds, specially made for medical purposes; pumps for medical purposes; sphygmotensimeters; electrodes for medical use; surgical implants [artificial materials]; apparatus for artificial respiration; blood testing apparatus; haemocytometers; medical ultrasound instruments; all the aforementioned goods excluding dentomaxillofacial x-ray units and apparatus specially designed for dentomaxillofacial use.

(260) AM 2018 93465 A

(800) 1356930

(151) 2016 09 26

(891) 2016 09 26

(731) Otkrytoe aktsionernoe obshchestvo
"NEVSKAYA KOSMETIKA"
prospect Oboukhovskoy oborony, 80,
RU-192029 Saint-Petersburg, Russian
Federation

(540)



(591) Yellow, white, beige, light brown and dark brown

(531) 02.05.06; 29.01.13

(511)

3 – Abrasives; scale removing preparations for household purposes; aromatics [essential oils]; air fragrances; preparations; breath freshening sprays; canned pressurized air for cleaning and dusting purposes; balms other than for medical purposes; lip glosses; petroleum jelly for cosmetic purposes; cotton wool for cosmetic purposes; sachets for perfuming linen; drying agents for dishwashing machines; toilet water; laundry wax; massage gels other than for medical purposes; dental bleaching gels; perfumes; windshield cleaning liquids; windscreen cleaning liquids; perfumery; quillaia bark for washing; colorants for toilet purposes; cosmetic dyes; creams for leather; waxes for leather; cosmetic creams; skin whitening creams; hair spray; nail polish; hair lotions; lotions for cosmetic purposes; after-shave lotions; beauty masks; oils for perfumes and scents; oils for cosmetic purposes; oils for toilet purposes; essential oils of citron; oils for cleaning purposes; bergamot oil; gaultheria oil; jasmine oil; lavender oil; almond oil; rose oil; oil of turpentine for degreasing; almond milk for cosmetic purposes; clean-

sing milk for toilet purposes; soap; disinfectant soap; deodorant soap; shaving soap; cakes of toilet soap; medicated soap; antiperspirant soap; soap for foot perspiration; almond soap; cosmetic kits; cotton sticks for cosmetic purposes; dentifrices; breath freshening strips; lipsticks; pomades for cosmetic purposes; shaving preparations; cosmetic preparations for baths; toiletries; laundry soaking preparations; douching preparations for personal sanitary or deodorant purposes [toiletries]; denture polishes; mouthwashes, not for medical purposes; refurbishing preparations; fabric softeners for laundry use; laundry bleach; dry-cleaning preparations; make-up removing preparations; nail care preparations; cleaning preparations; preparations for cleaning dentures; laundry preparations; aloe vera preparations for cosmetic purposes; sunscreen preparations; scouring solutions; tissues impregnated with cosmetic lotions; potpourris [fragrances]; bleaching soda; washing soda, for cleaning; bath salts, not for medical purposes; bleaching salts; cosmetic preparations for skin care; mascara; detergents other than for use in manufacturing operations and for medical purposes; cloths impregnated with a detergent for cleaning; shampoos; ethereal essences.

5 – Balms for medical purposes; antiseptic cotton; wadding for medical purposes; glycerine for medical purposes; air deodorising preparations; deodorants for clothing and textiles; lotions for pharmaceutical purposes; sunburn ointments; babies' diapers [napkins]; pomades for medical purposes; aloe vera preparations for pharmaceutical purposes; sanitary towels; sanitary pads; panty liners [sanitary]; chewing gum for medical purposes; tissues impregnated with pharmaceutical lotions; mouthwashes for medical purposes; detergents for medical purposes; babies' napkin-pants.

(260) AM 2018 93470 A
(800) 1356382
(151) 2017 03 31
(891) 2017 03 31
(731) UAB "PREKIŲŽENKLŲ VALDYMAS"
Panerių g. 47 LT-03160 Vilnius, Lithuania
(540)

COCOIN

(591) Black and white
(531) 26.04.24; 27.05.17; 27.05.24
(511)
33 – Vodka; cocktails, alcoholic.

(260) AM 2018 93474 A
(800) 1356386
(151) 2017 05 30

(891) 2017 05 30
(731) JANSSEN PHARMACEUTICA NV
Turnhoutseweg 30 B-2340 BEERSE, Belgium
(540)

ERDELFA

(591) Black and white
(511)
5 – Human pharmaceutical preparations for the prevention and treatment of viral diseases, auto-immune and inflammatory diseases, cardiovascular diseases, central nervous system diseases, pain, dermatologic diseases, gastro-intestinal diseases, infectious-related diseases, metabolic diseases, oncologic diseases, ophthalmic diseases and respiratory diseases; vaccines.

(260) AM 2018 93475 A
(800) 1356387
(151) 2017 05 30
(891) 2017 05 30
(731) JANSSEN PHARMACEUTICA NV
Turnhoutseweg 30 B-2340 BEERSE, Belgium
(540)

NUZOLTRI

(591) Black and white
(511)
5 – Human pharmaceutical preparations for the prevention and treatment of viral diseases, auto-immune and inflammatory diseases, cardiovascular diseases, central nervous system diseases, pain, dermatologic diseases, gastro-intestinal diseases, infectious-related diseases, metabolic diseases, oncologic diseases, ophthalmic diseases and respiratory diseases; vaccines.

(260) AM 2018 93476 A
(800) 1356388
(151) 2017 05 30
(891) 2017 05 30
(731) JANSSEN PHARMACEUTICA NV
Turnhoutseweg 30 B-2340 BEERSE, Belgium
(540)

SURDEFTO

(591) Black and white
(511)
5 – Human pharmaceutical preparations for the prevention and treatment of viral diseases, auto-immune and inflammatory diseases, cardiovascular diseases, central nervous system diseases, pain, dermatologic diseases, gastro-intestinal diseases, infectious-related diseases, metabolic diseases, oncologic diseases, ophthalmic diseases and respiratory diseases; vaccines.

(260) AM 2018 93477 A
(800) 1356389
(151) 2017 05 30

(891) 2017 05 30
 (731) JANSSEN PHARMACEUTICA NV
 Turnhoutseweg 30 B-2340 BEERSE, Belgium
 (540)

BRUVELSO

(591) Black and white
 (511)
 5 – Human pharmaceutical preparations for the prevention and treatment of viral diseases, auto-immune and inflammatory diseases, cardiovascular diseases, central nervous system diseases, pain, dermatologic diseases, gastro-intestinal diseases, infectious-related diseases, metabolic diseases, oncologic diseases, ophthalmic diseases and respiratory diseases; vaccines.

(260) AM 2018 93478 A
 (800) 1356394
 (151) 2016 11 25
 (891) 2016 11 25
 (731) Chengde Yushi Jindan Pharmaceutical Company Limited
 (No. 88, Jinwei Road) North of Railway Station, Longhua Town, Longhua County, Chengde City Hebei Province, China
 (540)

御室

(591) Black and white
 (531) 28.03
 (511)
 35 – Publicity; business management assistance; sales promotion for others; personnel management consultancy; relocation services for businesses; secretarial services; accounting; sponsorship search; rental of vending machines; retail or wholesale services for pharmaceutical, veterinary and sanitary preparations and medical supplies.

(260) AM 2018 93480 A
 (800) 1356966
 (151) 2017 01 11
 (891) 2017 01 11
 (731) UYONG CULTURE & MEDIA CO., LTD.
 Suite 2205, No.38 Building, Haidian Street, Haidian District 100016 Beijing, China
 (540)

Ubbie 伏彼

(591) Black, white
 (531) 03.01.14; 03.01.16; 27.05.02; 28.03

(511)
 9 – Computers; laptop (notebook PC); electronic publications, downloadable; computer programs [downloadable software]; computer game software; encoded identification bracelets, magnetic; downloadable music files; computer software applications, downloadable; telephone apparatus; portable media players; electronic book readers; baby monitors; learning machine; compact disc (video); measuring apparatus; teaching apparatus; animated cartoons.

28 – Games; puppets; apparatus for games; toy cars; intelligent toy; toy watches; toys; chess; balls for games; body-training apparatus; archery implements; swimming pools [play articles]; plastic running track; swimming rings; in-line roller skates; Christmas trees of synthetic material; fishing tackle; sweat absorption band for racket; camouflage screens [sports articles].

41 – Teaching; organization of shows [impresario services]; mobile library services; publication of books; video tape distribution; providing on-line electronic publications, not downloadable; on-line publication of electronic books and journals; film production, other than advertising films; production of radio and television programmes; theatre productions; television entertainment; health club services [health and fitness training]; presentation of live performances; toy rental; games equipment rental.

(260) AM 2018 93481 A
 (800) 1356969
 (151) 2016 12 16
 (891) 2016 12 16
 (731) Arnold & Richter Cine Technik GmbH & Co. Betriebs KG
 Türkenstr. 89, 80799 München, Germany
 (540)

ARRI

(591) Black, white
 (531) 26.01.02; 26.01.22; 27.05.14; 27.05.17
 (511)
 8 – Hand tools and implements, hand-operated; cutlery; side arms, other than firearms; razors; pocket knives.
 9 – Webcams; electronic power banks; cases adapted for the storage and transport of cameras; travel adaptors for electric plugs; covers for smartphones; covers and cases for iPads; loudspeakers for mobile phones; selfie sticks used as smartphone accessories; mouse pads; touch screen pens; USB flash drives; lanyards [straps] for cellular phones; camera straps; sun-glasses; spectacle cases; spectacle chains and spectacle straps; optical filters; optical filter holders (metal frames for moving optical filters); adaptors,

batteries, storage batteries, power supplies, voltage transformers and control apparatus for lights, spotlights, headlights and other lighting items; electric ballast for lights, spotlights, headlights and other lighting items, other than being parts of the aforesaid goods; flashlights and flash-bulbs [photography]; optical fibres, namely, light guides; light-emitting diodes (LED); light dimmers [regulators]; focusing circuits for cameras; diaphragms (photography); diaphragm shutters (as parts of cameras); control devices and ballast devices for lighting apparatus and installations; film, photo and cinematographic apparatus; film, photo and cinematographic cameras; camera equipment, namely diaphragms, flashlights, filters, tripods, suspensions and mountings, lenses, objectives, object filters, light filters, self-timers, photographic shutters, protective caps for cameras, tilting heads, viewfinders; film and video recorders; film and video editing devices; apparatus for analyzing film and video shots; fittings for the aforesaid goods, included in this class; fitted transport cases for carrying the aforesaid goods; electrical adapters for luminaires and lamps.

10 – Surgical cameras for medical purposes; fittings for the aforesaid goods.

11 – Lighting apparatus; pocket searchlights; lamps with USB port; table lamps; film lighting, video lighting and stage lighting apparatus and installations; luminaires; spotlights; headlights and other lighting items; lamp stands; fitted suspension devices for lights, namely pantographs and telescopic suspensions; light-emitting diodes (LED) lighting apparatus; fittings for the aforementioned goods, namely devices for influencing colour, brightness and reflective features (parts of lamps), included in this class; adapted control facilities for luminaires and lamps, in particular motor brackets, as well as fittings, in particular fixtures, included in this class.

16 – Printed matter; bookbinding material; photographs; stationery; adhesives for stationery or household purposes; artists' materials; paint brushes; typewriters and office requisites, except furniture; plastic materials for packaging, included in this class; bags and articles for packaging, wrapping and storage of paper, cardboard or plastics; files [office requisites]; ball pens; pencils; pens [stationery]; metal money clips; envelopes [stationery]; notebooks; office binders; notepads; stickers [stationery]; calendars; posters.

18 – Trunks and travelling bags; umbrellas and parasols; handbags; shopping bags of textile; briefcases, briefbags; shoulder bags; cross-body bags; coin purses; purses; wallets; key cases; credit-card cases; credit-card holders; business card cases [wallets]; business card holders.

20 – Furniture; mirrors [looking glasses]; picture frames; chairs [seats]; director's chairs.

21 – Household or kitchen utensils and containers; glassware, porcelain and earthenware, included in this class; cups; mugs; insulating flasks; heat-insulated containers; beer mugs.

25 – Clothing, footwear, headgear; Tee-shirts; sweat shirts; jackets [clothing]; vests; dresses; scarfs and shawls; neck scarfs [mufflers]; caps [headwear]; baseball caps; gloves with conductive fingertips that may be worn while using handheld electronic touch screen devices; flip-flops.

28 – Games and playthings; gymnastic and sporting articles; rubber duck.

34 – Smokers' articles; matches; cigarette lighters.

(260) AM 2018 93487 A

(800) 1357013

(151) 2017 02 14

(891) 2017 02 14

(731) CARRARO S.p.A.

via Olmo, 37, I-35011 Campodarsego
(Padova), Italy

(540)



(591) Black, white

(531) 03.03.01; 27.05.17

(511)

7 – Machines and agricultural implements other than hand-operated.

12 – Tractors.

(260) AM 2018 93488 A

(800) 1357033

(151) 2017 03 15

(891) 2017 03 15

(731) A.T.Ü. TURİZM İŞLETMECİLİĞİ ANONİM
ŞİRKETİ

Büyükdere Cad. No:107/8, Bengün Han,
Gayrettepe Şişli, TR-80300 İstanbul, Turkey

(540)

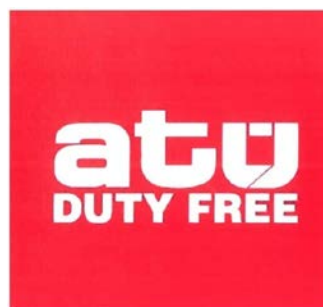

(591) Red, white
 (531) 26.04.22; 26.04.24; 27.05.10; 27.05.17;
 27.05.23; 27.05.24; 29.01.12

(511)
 35 – The bringing together, for the benefit of others, of a variety of goods, enabling customers to conveniently view and purchase those goods, such services may be provided by retail stores, wholesale outlets, by means of electronic media or through mail order catalogues.

(260) AM 2018 93495 A
 (800) 1356442
 (151) 2017 02 17
 (891) 2017 02 17
 (731) "KONTI-RUS" JOINT STOCK COMPANY
 ul. Zolotaia, 13 RU-305000 Kursk, Russian Federation
 (540)



(591) Black and white
 (531) 03.04.02; 03.04.25; 19.03.24; 25.07.25;
 27.05.01
 (511)
 30 – Cookies; waffles; pastries; caramels (candy); sweetmeats (candy); crackers; pastilles (confectionery); biscuits; fondants (confectionery); chocolate.

(260) AM 2018 93496 A
 (800) 1356459
 (151) 2017 04 27
 (891) 2017 04 27
 (731) Nemiroff Intellectual Property Establishment
 Städtle 31 FL-9490 Vaduz, Liechtenstein
 (540)



(591) Black and red
 (531) 05.09.15; 26.01.19; 27.05.01; 29.01.12
 (511)
 33 – Alcoholic beverages (except beers).

35 – Advertising; business management; business administration; office functions.

41 – Education; providing of training; entertainment; sporting and cultural activities.

(260) AM 2018 93497 A
 (800) 1356477
 (151) 2017 04 20
 (891) 2017 04 20
 (731) BIOFARMA
 50 rue Carnot F-92284 SURESNES cedex,
 France
 (540)

БИСОДУКТАЛ

(591) Black and white
 (531) 28.05
 (511)
 5 – Pharmaceutical preparations; veterinary preparations; sanitary products for medical purposes; dietetic substances for medical use; dietetic substances for veterinary use; food for babies; dietetic preparations and food supplements; food supplements for animals; plasters, materials for dressings; teeth filling materials; dental impression materials; disinfectants; products for destroying vermin; fungicides; herbicides.

(260) AM 2018 93498 A
 (800) 1357049
 (151) 2017 03 06
 (891) 2017 03 06
 (731) TCL Corporation
 No.19 Zone, Zhongkai High Technology
 Development Zone, Huizhou, Guangdong
 Province, China

(540)
XESS

(591) Black, white
 (531) 27.05.17
 (511)
 7 – Food preparation machines, electromechanical; fruit presses, electric, for household purposes; ironing machines; dishwashers; kitchen machines, electric; blenders, electric, for household purposes; soy-milk machines, for household purposes; dry cleaning machines; washing machines [laundry]; wringing machines for laundry; filters for cleaning cooling air, for engines; compressors for air conditioners; machines and apparatus for cleaning, electric; vacuum cleaners; 3D printers.
 9 – Computer programs [downloadable software]; computer peripheral devices; monitors [computer hardware]; computers; tablet computers; smartwat-

ches; electronic agendas; facsimile machines; electronic notice boards; telephone apparatus; mobile telephones; navigational instruments; network communication apparatus; television apparatus; camcorders; headphones; DVD players; audio and video receivers; sound reproduction apparatus; sound recording apparatus; sound transmitting apparatus; cameras [photography]; audiovisual teaching apparatus; materials for electricity mains [wires, cables]; integrated circuits; light-emitting diodes [LED]; switches, electric; sockets, plugs and other contacts [electric connections]; video screens; remote control apparatus for household purpose; anti-theft warning apparatus; 3D spectacle; portable power supplies; batteries, electric.

11 – Lamps; cooking utensils, electric; cooking apparatus and installations; grills [cooking appliances]; gas burners; pressure cooking saucepans, electric; coffee machines, electric; kettles, electric; microwave ovens [cooking apparatus]; bread-making machines; refrigerators; freezers; ice machines and apparatus; air conditioning apparatus and installations; air purifying apparatus and machines; dehumidifier for household purpose; extractor hoods for kitchens; laundry dryers, electric; fans [air-conditioning]; fabric steamers; hair driers [dryers]; humidifiers; heating apparatus; heating installations; heaters for showers; hand drying apparatus for washrooms; heaters for baths; water purifying apparatus and machines; water dispenser; sterilizers; heating apparatus, electric.

35 – Advertising; display of goods and services by electronic means for the purpose of teleshopping and home shopping; business management consultancy; public relations; providing business information via a web site; sales promotion for others; provision of an on-line marketplace for buyers and sellers of goods and services; human resources management; compilation or systemization of information into computer databases; book-keeping.

(260) AM 2018 93501 A

(800) 1356478

(151) 2017 04 20

(891) 2017 04 20

(731) BIOFARMA

50 rue Carnot F-92284 SURESNES Cedex,
France

(540)

БИСОКТАЛ

(591) Black and white

(531) 28.05

(511)

5 – Pharmaceutical preparations; veterinary preparations; sanitary products for medical purposes; dietetic substances for medical use; dietetic substances for veterinary use; food for babies; dietetic prepara-

tions and food supplements; food supplements for animals; plasters, materials for dressings; teeth filling materials; dental impression materials; disinfectants; products for destroying vermin; fungicides; herbicides.

(260) AM 2018 93502 A

(800) 1356519

(151) 2016 12 06

(891) 2016 12 06

(731) EURO GAMES TECHNOLOGY LTD.

"Maritsa" Str. 4, "Vranya-Lozen-Triugulnika"
BG-1151 Sofia, Bulgaria

(540)



(591) Green, yellow, red, blue and brown

(531) 05.03.04; 05.03.11; 05.03.16; 23.01.01;

27.05.02; 29.01.15

(511)

9 – Apparatus for recording, transmission or reproduction of sound or images; computer software (recorded), monitors, computer hardware.

28 – Games that are not included in other classes; gaming machines operating with coins, banknotes and cards; gaming machines for gambling.

(260) AM 2018 93504 A

(800) 1356594

(151) 2017 04 06

(891) 2017 04 06

(731) DROPSA S.P.A.

Via Besana, 5 I-20122 Milano (MI), Italy

(540)

DROPSA

(591) Black and white

(511)

7 – Pumps [machines]; pneumatic pumps; electrical pumps; hydraulic pumps; rotary pumps; axial pumps; centrifugal pumps; positive displacement pumps; controlled volume pumps; fluid pumps; diaphragm pumps; lubricating pumps; pressure pumps; compressed air pumps; high pressure pumps; rotary lobe pumps; pump control valves; rotary gear pumps; volumetric rotating gear pumps; self-regulating pumps [other than for the delivery of fuel at filling stations]; lubrication machines; lubricators [parts of machines]; power-operated lubricant dispensers for machines; lubricators [parts of machines]; pressure regulators for lubricating installations; valves; hydraulic valves; actuators for valves; shutter valves; actuators for valves; valves for pumps; val-

ves (clack -) [parts of machines]; hydraulic valve actuators; power operated valves; valves [parts of machines]; valve closure mechanisms; dosing valves [parts of machines]; pressure valves [parts of machines]; compressed air switch valves; regulators [parts of machines]; slide valves [parts of machines]; valves operated automatically by pneumatic control; spray valves [parts of machines]; ball valves being parts of machines; cocks [valves] of metal parts of machines; regulators [parts of machines]; valves operated by changes in pressure; dispensing valves being machine parts; metal safety valves [parts of machines]; pressure controllers [valves] being parts of machines; level regulating valves [parts of machines]; valves [mechanical] for regulating fluid flow; spray nozzles being parts of machines; mixer nozzles (machine parts); nebulisers (parts of machines); atomisers (parts of machines); pressure regulators.

9 – Flowmeters; flowmeters; flow control installations [electric]; solenoid valves [electromagnetic switches]; solenoid valves [electromagnetic switches]; electric control valves; valve operators [electric controls]; valves (electric controls for automatically operating -); electronic controllers; control circuits; terminal controllers [electric]; programmable controllers; electronic control units; electronic control systems; sensors used in plant control; pressure measuring apparatus; pressure recorders; pressure sensors; dosimeters.

(260) AM 2018 93505 A
 (800) 1356621
 (151) 2017 04 21
 (891) 2017 04 21
 (731) BEIJING AUTOMOBILE GROUP CO. LTD
 No.99 Shuanghe Street, Shunyi District
 Beijing, China
 (540)



(591) Black and white
 (531) 24.11.25
 (511)

12 – Rolling stock for railways; locomotives; tractors; electric vehicles; cars; engines for land vehicles; propulsion mechanisms for land vehicles; vehicle chassis; gear boxes for land vehicles; cycle cars; air vehicles; aeroplanes; aeronautical apparatus, machines and appliances; vehicles for locomotion by land, air, water or rail.

37 – Building construction supervision; repair information; building of fair stalls and shops; electric ap-

pliance installation and repair; vehicle maintenance; vehicle service stations [refueling and maintenance]; motor vehicle wash; vehicle breakdown assistance [repair]; shipbuilding; retreading of tires [tyres]; airplane maintenance and repair.

(260) AM 2018 93506 A
 (800) 1357122
 (151) 2016 10 27
 (891) 2016 10 27
 (731) STRELLSON AG
 Sonnenwiesenstrasse 21, CH-8280
 Kreuzlingen, Switzerland
 (540)



(591) Black, white
 (531) 05.05.05
 (511)

8 – Hand apparatus for extracting, sharpening steels, oyster openers, cutlery (knives, forks and spoons), flat irons (non-electric), tin-openers (non-electric), ice picks, forks, hand implements for hair curling, non-electric, vegetable slicers, vegetable choppers, razor blades, spoons, manicure sets, knives, cutlery, mortars for pounding, nail files, electric or non-electric nail clippers, shaving kits, nutcrackers, tongs, electric or non-electric razors, razor strops, scissors, silverware (knives, forks and spoons), sugar tongs.

(260) AM 2018 93507 A
 (800) 1357154
 (151) 2017 01 13
 (891) 2017 01 13
 (731) SUBWAY IP INC.
 700 S. Royal Poinciana Blvd., Suite 500,
 Miami Springs FL 33166, USA
 (540)



(591) Yellow, White
 (531) 24.15.08; 24.15.17; 26.04.22; 26.04.24;
 27.05.06; 27.05.24; 29.01.13

(511)

29 – Salads made with various ingredients, namely, fruit, garden and vegetable salads; milk; fruit; potato chips; processed apples.

30 – Sandwiches and wraps for consumption on or off the premises; baked goods for consumption on or off the premises; snacks namely pretzels, corn chips, tortilla chips, puffed corn curls, popped corn, cakes, pastries, cookies; dressings for salads, salad dressings used on salads, combination meals consisting primarily of a sandwich, a snack and a soft drink for consumption on or off the premises, coffee, tea, iced tea.

32 – Beverages, fruit juices, vegetable juices, soft drinks, bottled drinking water, tea flavored beverages, coffee flavored beverages, for consumption on or off the premises.

35 – Consumer loyalty services for commercial, promotional and advertising purposes, namely providing an incentive rewards programs for customers through the issuance and processing of customer loyalty points and credits, and loyalty cards for the purchase of goods and services, and providing contests, sweepstakes, games and prizes; administration of an incentive rewards program enabling participants to obtain discounts and complimentary goods and services through membership; online ordering services in the field of restaurant take-out and delivery; retail services relating to food and drink.

43 – Restaurant services, namely providing of food and beverages for consumption on and off the premises; restaurant services featuring sandwiches; catering services; eat-in and take-out food restaurant services; restaurants featuring home delivery.

(260) AM 2018 93508 A

(800) 1357158

(151) 2016 12 16

(891) 2016 12 16

(731) Arnold & Richter Cine Technik GmbH & Co.

Betriebs KG

Türkenstr. 89, 80799 München, Germany

(540)

ARRI

(591) Black, white

(511)

8 – Hand tools and implements, hand-operated; cutlery; side arms, other than firearms; razors; pocket knives.

9 – Webcams; electronic power banks; cases adapted for the storage and transport of cameras; travel adaptors for electric plugs; covers for smartphones; covers and cases for iPads; loudspeakers for mobile phones; selfie sticks used as smartphone accessories; mouse pads; touch screen pens; USB flash drives;

lanyards [straps] for cellular phones; camera straps; sun-glasses; spectacle cases; spectacle chains and spectacle straps; optical filters; optical filter holders (metal frames for moving optical filters); adapters, batteries, storage batteries, power supplies, voltage transformers and control apparatus for lights, spotlights, headlights and other lighting items; electric ballast for lights, spotlights, headlights and other lighting items, other than being parts of the aforesaid goods; flashlights and flash-bulbs [photography]; optical fibres, namely, light guides; light-emitting diodes (LED); light dimmers [regulators]; focusing circuits for cameras; diaphragms (photography); diaphragm shutters (as parts of cameras); control devices and ballast devices for lighting apparatus and installations; film, photo and cinematographic apparatus; film, photo and cinematographic cameras; camera equipment, namely diaphragms, flashlights, filters, tripods, suspensions and mountings, lenses, objectives, object filters, light filters, self-timers, photographic shutters, protective caps for cameras, tilting heads, viewfinders; film and video recorders; film and video editing devices; apparatus for analyzing film and video shots; fittings for the aforesaid goods, included in this class; fitted transport cases for carrying the aforesaid goods; electrical adapters for luminaires and lamps.

10 – Surgical cameras for medical purposes; fittings for the aforesaid goods.

11 – Lighting apparatus; pocket searchlights; lamps with USB port; table lamps; film lighting, video lighting and stage lighting apparatus and installations; luminaires; spotlights; headlights and other lighting items; lamp stands; fitted suspension devices for lights, namely pantographs and telescopic suspensions; light-emitting diodes (LED) lighting apparatus; fittings for the aforementioned goods, namely devices for influencing colour, brightness and reflective features (parts of lamps), included in this class; adapted control facilities for luminaires and lamps, in particular motor brackets, as well as fittings, in particular fixtures, included in this class.

16 – Printed matter; bookbinding material; photographs; stationery; adhesives for stationery or household purposes; artists' materials; paint brushes; typewriters and office requisites, except furniture; plastic materials for packaging, included in this class; bags and articles for packaging, wrapping and storage of paper, cardboard or plastics; files [office requisites]; ball pens; pencils; pens [stationery]; metal money clips; envelopes [stationery]; notebooks; office binders; notepads; stickers [stationery]; calendars; posters.

18 – Trunks and travelling bags; umbrellas and parasols; handbags; shopping bags of textile; briefcases, briefbags; shoulder bags; cross-body bags; coin purses; purses; wallets; key cases; credit-card cases;

credit-card holders; business card cases [wallets]; business card holders.

20 – Furniture; mirrors [looking glasses]; picture frames; chairs [seats]; director's chairs.

21 – Household or kitchen utensils and containers; glassware, porcelain and earthenware, included in this class; cups; mugs; insulating flasks; heat-insulated containers; beer mugs.

25 – Clothing, footwear, headgear; Tee-shirts; sweat shirts; jackets [clothing]; vests; dresses; scarfs and shawls; neck scarfs [mufflers]; caps [headwear]; baseball caps; gloves with conductive fingertips that may be worn while using handheld electronic touch screen devices; flip-flops.

28 – Games and playthings; gymnastic and sporting articles; rubber duck.

34 – Smokers' articles; matches; cigarette lighters.

(260) AM 2018 93512 A

(800) 1149504

(151) 2013 01 28

(891) 2017 06 29

(731) NORDEX HOLDING A/S

Nordre Ringgade 2, DK-9330 Dronninglund,
Denmark

(540)



(591) White and blue

(531) 07.01.18; 26.04.06; 26.04.24; 27.05.01;
27.05.24

(511)

29 – Meat, fish, poultry and game; meat extracts; preserved, frozen, dried and cooked fruits and vegetables; jellies, jams, compotes; eggs; milk and milk products; edible oils and fats.

(260) AM 2018 93513 A

(800) 1277888

(151) 2015 11 06

(891) 2017 07 05

(731) JACOBS DOUWE EGBERTS DE GMBH

Langemarckstrasse 4-20, 28199 Bremen,
Germany

(540)

Jacobs Monarch

(591) Black, white

(511)

30 – Coffee, coffee extract, coffee substitutes, tea and tea extract.

(260) AM 2018 93514 A

(800) 1319887

(151) 2016 10 13

(891) 2017 07 03

(731) CONTITECH ANTRIEBSSYSTEME GMBH

Vahrenwalder Str. 9, 30165 Hannover,
Germany

(540)

AGRIDUR

(591) Black, white

(511)

7 – Fan belts for agricultural machines; drive belts for agricultural machines; power transmission belts for agricultural machines; belts for machines, motors and engines; drive pulleys for power transmission belts of agricultural machines.

(260) AM 2018 93515 A

(800) 1343869

(151) 2017 01 31

(891) 2017 06 23

(731) F5 NETWORKS, INC.

401 Elliott Avenue West Seattle WA
98119-4017, USA

(540)

F5 Application IQ

(591) Black, white

(526) APPLICATION

(511)

9 – Computer software and computer hardware for use monitoring and analyzing network infrastructure performance, security, and application deployment and upgrade status.

(260) AM 2018 93549 A

(800) 1357924

(151) 2017 05 09

(891) 2017 05 09

(731) PHILIP MORRIS BRANDS SÀRL

Quai Jeanrenaud 3, CH-2000 Neuchâtel,
Switzerland, Switzerland

(540)



(591) Gold

(531) 24.01.15; 25.01.01; 26.03.23; 27.05.01;
29.01.13

(511)
34 – Tobacco, raw or manufactured; tobacco products; cigars, cigarettes, cigarillos, tobacco for roll-your-own cigarettes, pipe tobacco, chewing tobacco, snuff tobacco, kretek; snus; tobacco substitutes (not for medical purposes); electronic cigarettes; tobacco products for the purpose of being heated; electronic devices and their parts for the purpose of heating cigarettes or tobacco in order to release nicotine-containing aerosol for inhalation; liquid nicotine solutions for use in electronic cigarettes; smokers' articles, cigarette paper, cigarette tubes, cigarette filters, tobacco tins, cigarette cases, ashtrays, pipes, pocket apparatus for rolling cigarettes, lighters, matches.

(260) AM 2018 93550 A
(800) 1357933
(151) 2017 06 01
(891) 2017 06 01
(731) JANSSEN PHARMACEUTICA NV
Turnhoutseweg 30, B-2340 BEERSE,
Belgium
(540)

BALVERSA

(591) Black, white
(511)
5 – Human pharmaceutical preparations for the prevention and treatment of viral diseases, auto-immune and inflammatory diseases, cardiovascular diseases, central nervous system diseases, pain, dermatologic diseases, gastro-intestinal diseases, infectious-related diseases, metabolic diseases, oncologic diseases, ophthalmic diseases and respiratory diseases; vaccines.

(260) AM 2018 93552 A
(800) 1357968
(151) 2017 06 02
(891) 2017 06 02
(731) JANSSEN PHARMACEUTICA NV
Turnhoutseweg 30, B-2340 BEERSE,
Belgium
(540)

ALPRENSO

(591) Black, white
(511)
5 – Human pharmaceutical preparations for the prevention and treatment of viral diseases, auto-immune and inflammatory diseases, cardiovascular diseases, central nervous system diseases, pain, dermatologic diseases, gastro-intestinal diseases, infectious-related diseases, metabolic diseases, oncologic diseases, ophthalmic diseases and respiratory diseases; vaccines.

(260) AM 2018 93553 A
(800) 1357970
(151) 2017 06 02
(891) 2017 06 02
(731) JANSSEN PHARMACEUTICA NV
Turnhoutseweg 30, B-2340 BEERSE,
Belgium
(540)

NURILYFT

(591) Black, white
(511)
5 – Human pharmaceutical preparations for the prevention and treatment of viral diseases, auto-immune and inflammatory diseases, cardiovascular diseases, central nervous system diseases, pain, dermatologic diseases, gastro-intestinal diseases, infectious-related diseases, metabolic diseases, oncologic diseases, ophthalmic diseases and respiratory diseases.

(260) AM 2018 93554 A
(800) 488719
(151) 1984 09 28
(891) 2017 05 02
(731) BK Giulini GmbH
Giulinistraße 2, 67065 Ludwigshafen,
Germany
(540)



(591) Black, white
(531) 02.01.15; 26.01.14
(511)
1 – Chemical products for industrial purposes as auxiliaries and additives for the production and processing of foodstuffs, including meat, charcuterie, fish, as well as crustaceans, namely, blowing agents and binding agents, including lacto-protein, agents for holding or processing food structure, products for preserving and improving natural color, for preventing the coagulation of slaughtering blood, for the separation of blood for removal of blood plasma, chemical additives for meat processed with cutter, chemical products used for enhancing the flavor of food, chemical additives and mixtures of chemical additives with spices, flavors and salts for curing, smoking, preserving and keeping the freshness of foodstuffs.

30 – Chemical products for industrial purposes as auxiliaries and additives for the production and pro-

cessing of foodstuffs, including meat, fish, charcuterie, as well as crustaceans, namely, foaming agents and binding agents, including lacto-protein, chemical products used for enhancing food flavor, chemical additives and mixtures of chemical additives with spices, flavors and salts for curing and smoking of foodstuffs; cooking salt, spices, flavors.

(260) AM 2018 93555 A

(800) 1127192

(151) 2011 12 15

(891) 2017 04 19

(731) TAKASAGO KORYO KOGYO

KABUSHIKI KAISHA

(also trading as Takasago International Corporation)

37-1, Kamata 5-chome, Ohta-ku, Tokyo

144-8721, Japan

(540)



(591) Black, white

(531) 07.03.02; 26.04.09; 26.04.24

(511)

1 – Chemicals; plant growth regulating preparations; adhesives (not for stationery or household purposes); higher fatty acids; actinium; americium; antimony; yttrium; uranium; erbium; gadolinium; gallium; californium; curium; samarium; dysprosium; silicon (metal element); mercury; scandium; strontium; cesium; cerium; selenium; bismuth; thallium; thulium; technetium; terbium; tellurium; thorium; neodymium; neptunium; berkelium; barium; fermium; praseodymium; francium; plutonium; protactinium; promethium; holmium; europium; radium; lanthanum; lithium; rubidium; rhenium; non-metallic minerals; unprocessed plastics (plastics in primary form); pulp; flour and starch for industrial purposes; fertilizers; photographic chemicals; blueprint paper; photographic paper; photographic sensitizers; photographic dry plates; photographic developers; flashlight preparations; photographic fixers; unexposed photographic films; artificial sweeteners; ceramic glazings; biochemical catalysts; catalysts; chemical preparations used for coloring; chemical preparations made from spice extracts; chemical preparations used for food additives; chemical substances being food additives used as acidulants. Processed with cutter, chemical products used for enhancing the flavor of food, chemical additives and mixtures of chemical additives with spices, flavors

and salts for curing, smoking, preserving and keeping the freshness of foodstuffs.

3 – Soaps and detergents; perfumery, fragrances and incenses (other than perfumes used as cosmetics or toiletries); cosmetics and toiletries; perfumes; adhesives for affixing false hair; false nails; false eyelashes; adhesives for affixing false eyelashes; dentifrices; antistatic preparations for household purposes; de-greasing preparations for household purposes; rust removing preparations; stain removing benzine; fabric softeners for laundry use; laundry starch; laundry bleach; seaweed gelatine for laundry use (funori); polishing preparations; abrasive paper (sandpaper); abrasive cloth; abrasive sand; artificial pumice stone; polishing paper; impregnated cloths for polishing; shoe and boot cream; shoe black (shoe polish); paint stripping preparations; essential oils; flavorings for beverages or foods (essential oils); fumigation preparations (perfumes); joss sticks.

30 – Coffee and cocoa; unroasted coffee (unprocessed); tea; seasonings; spices; aromatic preparations for food (not from "essential oils"); husked rice; husked oats; husked barley; flour for food; gluten for food; cereal preparations; Chinese stuffed dumplings (gyouza, cooked); sandwiches; Chinese steamed dumplings (shumai, cooked); sushi; fried balls of batter mix with small pieces of octopus (takoyaki); steamed buns stuffed with minced meat (niku-manjū); hamburgers (prepared); pizzas (prepared); boxed lunches consisting of rice, with added meat, fish or vegetables; hot dogs (prepared); meat pies (prepared); ravioli (prepared); confectionery, bread and buns; instant confectionery mixes; ice cream mixes; sherbet mixes; almond paste; yeast powder; fermented malted rice; yeast; baking powder; ice; binding agents for ice cream; meat tenderizers for household purposes; preparations for stiffening whipped cream; sake lees (for food); natural sweeteners; vinegar; vinegar mixes; spice extracts.

(260) AM 2018 93567 A

(800) 1138212

(151) 2012 10 08

(891) 2017 07 12

(731) ERAM

F-49111 SAINT-PIERRE-MONTLIMART
CEDEX, France

(540)



(591) Dark taupe, green

(531) 26.04.22; 26.04.24; 27.05.08; 27.05.24;
29.01.13

(511)
18 – Leather and imitations of leather, leather or imitation leather goods (excluding cases adapted to the products for which they are intended, gloves and belts), briefcases, card holders, purses, wallets, trunks and suitcases, traveling sets, handbags, travel bags, school bags, backpacks, sports bags, wheeled bags, umbrellas, parasols and walking sticks.

25 – Clothing, footwear, headgear; belts (clothing).

35 – Retail sale of footwear, clothing, headgear and leather goods.

(260) AM 2018 93568 A

(800) 1160472

(151) 2013 04 30

(891) 2017 07 11

(731) CONTINENTAL MATADOR RUBBER,
S.R.O.
Terézie Vansovej 1054, SK-020 01 Púchov,
Slovakia

(540)

MAXILLA

(591) Black, white

(511)

12 – Tires.

(260) AM 2018 93569 A

(800) 1160476

(151) 2013 04 30

(891) 2017 07 11

(731) CONTINENTAL MATADOR RUBBER,
S.R.O.
Terézie Vansovej 1054, SK-020 01 Púchov,
Slovakia

(540)

HECTORRA

(591) Black, white

(511)

12 – Tires.

(260) AM 2018 93570 A

(800) 1166125

(151) 2013 04 24

(891) 2017 07 11

(731) CONTINENTAL MATADOR RUBBER, S.R.O.
Terézie Vansovej 1054, SK-020 01 Púchov,
Slovakia

(540)

IZZARDA

(591) Black, white

(511)

12 – Tires.

(260) AM 2018 93571 A

(800) 1216132

(151) 2013 11 01

(891) 2017 04 19

(731) Takasago Koryo Kogyo Kabushiki Kaisha
also trading as Takasago International
Corporation
37-1, Kamata 5-chome, Ota-ku, Tokyo
144-8721, Japan

(540)

TAKASAGO

(591) Black, white

(531) 27.05.01

(511)

1 – Chemicals; surface-active agents [surfactants]; foaming agents for use in the manufacture of perfumery, flavorings, cosmetics, toiletries, deodorants and household products; chemical adsorbents for use in the manufacture of perfumery, flavorings, cosmetics, toiletries, deodorants, and household products; finishing assistants, namely finishing preparations for use in the manufacture of perfumery, flavorings, cosmetics, toiletries, deodorants, and household products; moistening or wetting agents; fabric softeners [not for laundry use]; defoaming agents; weaving agents for use in the manufacture of textiles; dye penetrants; degumming assistants; moistening and wetting preparations for use in dyeing; anti-static preparations [not for household use]; degreasing agents [not for household use]; decoloring agents [decolorants]; emulsifiers; water repellents; dispersing agents [dispersants]; waterproof finishing agents; oil proof finishing agents; mould-release preparations; chemical agents; galvanizing preparations; ion-exchange resins [chemical preparation]; ion-exchange resin membranes [chemical preparation]; chemical reagents; preparations to eliminate solid particles from liquids; plasticizers; carburizing agents; wallpaper removing preparations; vulcanisation accelerators [chemical preparation]; reducing agents; metal welding flux; metal welding assistants (welding chemicals); air entraining agents [AE agents]; steel quenching agents; rubber processing preparations; oxidizing agents; fire extinguishing compositions; catalytic agents; food preservatives; anti-incrustants; cement set accelerators; cement blending agents; fireproofing preparations; water resistant agents; anti-puncture preparations; steel forging preparations; casting preparations; neutralizing agents; delustering agents; spreading agents; battery anti-sulphurizing agents; soil stabilizing agents; water softening preparations; fuel saving agents; ungluing preparations; exothermic agents; soldering fluxes; leather processing preparations; clothes pleating agents; bleaching preparations [not for laundry use]; antifreeze; mildew proofing agents; damp proofing agents; anti-shrink agents; anti-creasing agents; waterproofing chemical compositions;

metal tempering preparations; solvents; refrigerants; filtering clarificants; plastic adhesives not for stationery or household purposes; gum Arabic glue [not for stationery or household purposes]; casein glue [not for stationery or household purposes]; rubber cements; gelatine glue; dextrine size; starch paste [not for stationery or household purposes]; animal glue [not for stationery or household purposes]; plastic adhesives [not for stationery or household purposes]; water glass [soluble glass]; latex glue [not for stationery or household purposes]; plant growth regulating preparations; plant nutrient preparations; plant hormones [phytohormones]; soil improving agents; germination inhibitors [anti-sprouting agents]; priming putty; higher fatty acids; oleic acid; stearic acid; palmitic acid; chemical compositions for developing, printing and enlarging photographs; blueprint paper; photographic paper; photographic sensitizers; photographic dry plates; photographic developers; flash powder; photographic fixers; unexposed photographic films; reagent paper; catalysts; chemical preparations for coloring for use as an additive to foods [chemicals]; chemical preparations made from spice extracts for use as an additive to foods [chemicals]; chemical preparations for acidulant for use as an additive to foods [chemicals]; chemical preparation for use as an additive to foods; lactose for industrial purposes; chemical preparations made from tea extracts for use as an additive to foods [chemicals]; chemical preparations for sweetener for use as an additive to foods [chemicals]; chemical preparations made from flavour material containing chemical agents for use as an additive to foods.

3 – Antistatic preparations for household purposes; de-greasing preparations for household purposes; rust removing preparations; stain removing benzine; fabric softeners for laundry use; laundry bleach; adhesives for affixing false hair; adhesives for affixing false eyelashes; laundry starch; seaweed gelatine for laundry use [funori]; breath freshening preparations; deodorants for animals; soaps and detergents; pet shampoos; washing powder; glass cleaning preparations; scouring preparations [cleanser]; toilet soap; industrial soap; shampoos; detergents prepared from petroleum; laundry soap; dry cleaning preparations; hand cleaners [hand cleaning preparations]; toilet bowl detergents; scrubbing powder; liquid soap; medicated soap; dentifrices; toothpaste in soft cake form; tooth powder; moistened tooth powder; non-medicated mouthwash; tooth paste; non-medicated dental rinse; cosmetics and toiletries; make-up powder; face-powder on paper; creamy face powder; pressed face powder; loose face powder; make-up bases in the form of pastes; liquid foundation [mizu-oshiroi]; toilet water; common skin-care lotions; eau de Cologne [Cologne water]; skin lotions; milky skincare lotions; viscous skincare lotions; hand lotions; shaving lotions; cosmetic lotions

and creams with active ingredients; cosmetic creams; cleansing creams [cosmetic]; cold creams; hygienic creams for cosmetic use; vanishing creams; hand creams; shaving creams; suntan creams [self-tanning creams]; sunscreen creams; skin whitening creams; creamy foundation; lip creams; cosmetic rouges; lipsticks; creamy rouges; cheek colors; hair care preparations; hair oils; color rinses for hair; cold waving solutions; hair styling preparations, namely combing oils and wave-set lotions; hair dyes; stick pomades for cosmetic purposes; permanent wave preparations; Japanese hair fixing oil [bintsuke-abura]; hair creams; hair spray; hair tonics; hair treatments; hair fixers; hair lacquers; hair rinses [shampoo-conditioners]; bay rums; hair pomades; perfumes; liquid perfumes; clotted perfumes; perfumed paste; perfumed powder; eye shadows; tissues impregnated with cosmetic lotions; deodorants for human beings; depilatories; talcum powder [for toilet use]; nail polish; nail polish removers; bath oils; bath salts; beauty masks; baby oils; baby powder; mascaras; eyebrow pencils; hair bleaches; perfume, essential oils for use as food flavorings; natural perfumery prepared from vegetables; jasmine oil; clove oil [essential oil]; peppermint oil [perfumery]; vanilla oil; rose oil; bergamot oil; lavender oil; natural perfumery prepared from animals; musk [natural]; ambergris [natural]; synthetic perfumery; geraniol [synthetic]; synthetic musk; vanillin [synthetic]; heliotropine [synthetic]; compound perfumery; flavorings for beverages [essential oils]; food flavorings prepared from essential oils.

30 – Aromatic preparations for food [not from "essential oils"]; Aromatic preparations for beverages [not from "essential oils"]; tea; oolong tea [Chinese tea]; black tea [English tea]; tea of salty kelp powder [kombu-cha]; mugi-cha [roasted barley tea]; Japanese green tea; coffee; cocoa; prepared coffee and coffee-based beverages; coffee [roasted, powdered, granulated, or in drinks]; coffee-based beverages; artificial coffee; roasted coffee beans; coffee beverages with milk; prepared cocoa and cocoa-based beverages; cocoa [roasted, powdered, granulated, or in drinks]; chocolate-based beverages; cocoa beverages with milk; Worcester sauce; meat gravies; ketchup; soy sauce [soya sauce]; vinegar; vinegar mixes; seasoning soy sauce [soba-tsuyu]; salad dressings; white sauce; mayonnaise; sauces for barbecued meat; unroasted coffee beans; instant confectionery mixes; instant jelly mixes; instant doughnut mixes; instant pudding mixes; instant pancake mixes; mizuyokan-no-moto [mixes for making sweet adzuki-bean jelly]; pasta sauce; flavorings, other than essential oils, for beverages; flavorings, other than essential oils.

(260) AM 2018 93572 A
 (800) 1308161
 (151) 2016 07 22
 (891) 2017 07 07
 (731) CHANEL SARL
 Quai du Général-Guisan 24 CH-1204 Genève,
 Switzerland
 (540)

COCO CHANEL

(591) Black, white
 (511)
 4 – Candles, tallow candles, tapers (wax candles);
 perfumed candles; Christmas tree candles; night-
 lights [candles].

(260) AM 2018 93573 A
 (800) 1357250
 (151) 2017 05 30
 (891) 2017 05 30
 (731) JANSSEN PHARMACEUTICA NV
 Turnhoutseweg 30 B-2340 BEERSE, Belgium
 (540)

JAMULTRI

(591) Black and white
 (511)
 5 – Human pharmaceutical preparations for the pre-
 vention and treatment of viral diseases, auto-immune
 and inflammatory diseases, cardiovascular diseases,
 central nervous system diseases, pain, dermatologic
 diseases, gastro-intestinal diseases, infectious-related
 diseases, metabolic diseases, oncologic diseases, op-
 ththalmic diseases and respiratory diseases; vaccines.

(260) AM 2018 93574 A
 (800) 1312910
 (151) 2016 07 04
 (891) 2017 07 07
 (731) BIOFARMA
 50 rue Carnot F-92284 SURESNES cedex,
 France
 (540)

BISOCTAL

(591) Black, white
 (531) 27.05.05
 (511)
 5 – Pharmaceutical preparations; veterinary prepara-
 tions; sanitary products for medical purposes; die-
 tetic substances for medical use; dietetic substances
 for veterinary use; food for babies; dietetic prepa-
 rations and food supplements; food supplements for
 animals; plasters, materials for dressings; teeth fil-
 ling material; dental impression materials; disinfec-
 tants; products for destroying vermin; fungicides;
 herbicides.

(260) AM 2018 93575 A
 (800) 1357251
 (151) 2017 05 30
 (891) 2017 05 30
 (731) JANSSEN PHARMACEUTICA NV
 Turnhoutseweg 30 B-2340 BEERSE, Belgium
 (540)

JUMULTRI

(591) Black and white
 (511)
 5 – Human pharmaceutical preparations for the pre-
 vention and treatment of viral diseases, auto-immune
 and inflammatory diseases, cardiovascular diseases,
 central nervous system diseases, pain, dermatologic
 diseases, gastro-intestinal diseases, infectious-related
 diseases, metabolic diseases, oncologic diseases, op-
 ththalmic diseases and respiratory diseases; vaccines.

(260) AM 2018 93576 A
 (800) 1357260
 (151) 2017 05 30
 (891) 2017 05 30
 (731) BOHNENKAMP AG
 Dieselstraße 9-13 49076 Osnabrück, Germany
 (540)

CARGOPOWER

(591) Black and white
 (511)
 12 – Vehicles and conveyances; transmission chains
 for land vehicles; rims for vehicle wheels; solid tyres
 for vehicle wheels; tires for vehicle wheels; inner tu-
 bes for pneumatic tires [tyres]; valves for vehicle ti-
 res [tyres]; solid tyres for vehicle wheels.

(260) AM 2018 93579 A
 (800) 1313186
 (151) 2016 04 27
 (891) 2017 05 11
 (731) VOROLA FINANCIAL LTD.
 33 Porter Road, P.O. Box 3169 PMB 103,
 Road Town, Tortola, Virgin Islands (British)
 (540)

Fabio Solano

(591) Black, white
 (511)
 14 – Agates; diamonds; amulets [jewellery, jewelry
 (Am.)]; anchors [clock- and watchmaking]; barrels
 [clock- and watchmaking]; bracelets [jewellery, je-
 welry (Am.)]; watch bands; charms [jewellery, je-
 welry (Am.)]; key rings [trinkets or fobs]; brooches
 [jewellery, jewelry (Am.)]; alarm clocks; pins [je-
 jewellery, jewelry (Am.)]; ornamental pins; tie pins;
 beads for making jewelry; pearls made of ambroid
 [pressed amber]; jet, unwrought or semi-wrought;
 pearls [jewellery, jewelry (Am.)]; copper tokens; tie

clips; cufflinks; badges of precious metal; gold, unwrought or beaten; ivory jewelry; works of art of precious metal; jewelry; jewelry of yellow amber; iridium; precious stones; semi-precious stones; spun silver [silver wire]; necklaces [jewellery, jewelry (Am.)]; rings [jewellery, jewelry (Am.)]; boxes of precious metal; watch cases [parts of watches]; clock cases; pendulums [clock- and watchmaking]; medals; lockets [jewellery, jewelry (Am.)]; precious metals, unwrought or semi-wrought; movements for clocks and watches; clockworks; coins; gold thread [jewellery, jewelry (Am.)]; threads of precious metal [jewellery, jewelry (Am.)]; silver thread [jewellery, jewelry (Am.)]; olivine [gems]; osmium; palladium; platinum [metal]; chronometric instruments; watch springs; rhodium; ruthenium; stopwatches; silver, unwrought or beaten; earrings; ingots of precious metals; alloys of precious metal; statues of precious metal; figurines [statuettes] of precious metal; watch glasses; paste jewellery [costume jewelry (Am.)]; clock hands [clock and watch making]; ornaments [jewellery, jewelry (Am.)]; shoe ornaments of precious metal; hat ornaments of precious metal; ornaments of jet; cases for watches [presentation]; cases for clock- and watchmaking; chronographs [watches]; chronometers; chronoscopes; chains [jewellery, jewelry (Am.)]; watch chains; dials [clock- and watchmaking]; atomic clocks; watches; sundials; clocks and watches, electric; control clocks [master clocks]; clocks; wristwatches; jewelry boxes; spinel [precious stones].

18 – Mountaineering sticks; pocket wallets; business card cases; card cases [notecases]; reins; harness fittings; parts of rubber for stirrups; chamois leather, other than for cleaning purposes; umbrellas; parasols; saddlery; frames for umbrellas or parasols; handbag frames; cases of leather or leatherboard; valves of leather; whips; imitation leather; leather, unworked or semi-worked; leatherboard; casings, of leather, for springs; umbrella rings; hat boxes of leather; boxes of leather or leatherboard; boxes of vulcanised fibre; chain mesh purses; purses; fastenings for saddles; butts [parts of hides]; saddle trees; bags [envelopes, pouches] of leather, for packaging; moleskin [imitation of leather]; travelling sets [leatherware]; knee-pads for horses; muzzles; halters; vanity cases, not fitted; leather thread; furniture coverings of leather; gut for making sausages; clothing for pets; trimmings of leather for furniture; collars for animals; music cases; slings for carrying infants; goldbeaters' skin; cat o' nine tails; leather leashes; pads for horse saddles; horseshoes; girths of leather; horse blankets; shoulder belts [straps] of leather; briefcases; traces [harness]; fur; haversacks; leather straps; straps for soldiers' equipment; harness straps; straps for skates; straps of leather [saddlery]; chin straps, of leather; stirrup leathers; umbrella handles; walking stick handles; suitcase handles; rucksacks; travelling bags; riding saddles; net bags for shop-

ping; umbrella or parasol ribs; stirrups; bags; bags for climbers; sling bags for carrying infants; garment bags for travel; valises; handbags; tool bags of leather, empty; beach bags; bags for sports; bags for campers; shopping bags; wheeled shopping bags; school satchels; pouch baby carriers; travelling trunks; nose bags [feed bags]; bridoons; walking sticks; umbrella sticks; walking stick seats; bits for animals [harness]; bridles [harness]; harness for animals; key cases; horse collars; trunks [luggage]; suitcases; attaché cases; covers for horse saddles; umbrella covers; kid; curried skins; animal skins; cattle skins; leather laces; blinkers [harness]; game bags [hunting accessories].

25 – Wimples; bandanas [neckerchiefs]; underwear; sweat-absorbent underwear; berets; overalls; boas [necklets]; teddies [undergarments]; half-boots; ski boots; boots for sports; breeches for wear; trousers; football boots; brassieres; detachable collars; collars [clothing]; pelerines; shirt yokes; veils [clothing]; gabardines [clothing]; galoshes; neckties; ascots; leggings [leg warmers]; gaiters; boot uppers; corselets; jerseys [clothing]; vests; sports jerseys; hosiery; heels; hoods [clothing]; hat frames [skeletons]; pockets for clothing; neck scarfs [mufflers]; visors [headwear]; cap peaks; tights; slips [undergarments]; combinations [clothing]; wet suits for water-skiing; bodices [lingerie]; corsets [underclothing]; suits; bathing suits; masquerade costumes; beach clothes; jackets [clothing]; stuff jackets [clothing]; fishing vests; leggings [trousers]; liveries; camisoles; cuffs; short-sleeve shirts; mantillas; coats; sleep masks; furs [clothing]; mittens; miters [hats]; muffs [clothing]; footmuffs, not electrically heated; heelpieces for footwear; bibs, not of paper; fur stoles; ear muffs [clothing]; socks; beach shoes; sports shoes; footwear; paper clothing; outerclothing; ready-made clothing; motorists' clothing; cyclists' clothing; clothing for gymnastics; clothing of imitations of leather; clothing of leather; uniforms; clothing; fittings of metal for footwear; maniples; overcoats; parkas; gloves [clothing]; ski gloves; pajamas (Am.); bathing trunks; shirt fronts; scarfs; pocket squares; dresses; waterproof clothing; headbands [clothing]; garters; sock suspenders; stocking suspenders; ready-made linings [parts of clothing]; dress shields; soles for footwear; braces for clothing [suspenders]; lace boots; ponchos; girdles; belts [clothing]; money belts [clothing]; layettes [clothing]; non-slipping devices for footwear; heelpieces for stockings; welts for footwear; chasubles; shirts; wooden shoes; sandals; bath sandals; boots; sarongs; jumper dresses; saris; sweaters; footwear uppers; inner soles; bath slippers; togas; knitwear [clothing]; underpants; gymnastic shoes; slippers; shoes; skull caps; turbans; headgear for wear; aprons [clothing]; tee-shirts; dressing gowns; bath robes; top hats; tips for footwear; stockings; sweat-absorbent stockings; shawls; caps [headwear]; paper hats [clothing]; shower caps; bat-

hing caps; sashes for wear; studs for football boots; hats; babies' pants [clothing]; trouser straps; pelisses; esparto shoes or sandals; skirts; petticoats; skorts.

(260) AM 2018 93585 A

(800) 1357485

(151) 2017 06 01

(891) 2017 06 01

(731) APPLE INC.

1 Infinite Loop Cupertino CA 95014, USA

(540)

SIRI

(591) Black and white

(531) 27.05.17

(511)

38 – Communication and telecommunication services, namely, electronic transmission and retrieval of data, images, audio, video and documents, including text, messages, and electronic mail, over local or global communications networks, including the internet, intranets, extranets, mobile communication, cellular and satellite networks; communications by computer terminals; communication between computer terminals; delivery of digital music by telecommunications; electronic transmission of streamed and downloadable audio and video files via computer and other communications networks; delivery of messages by electronic transmission; electronic transmission of audio and video files via communications networks.

(260) AM 2018 93635 A

(800) 1358796

(151) 2017 04 16

(891) 2017 04 16

(731) BAYLAN ÖLÇÜ ALETLERİ SANAYİ VE TİCARET LİMİTED ŞİRKETİ

10032 Sokak, No:16, AOSB Çiğli – İzmir, Turkey

(540)

BAYLAN

(591) Red

(531) 27.05.17; 29.01.01

(511)

9 – Electricity meters, water meters, gas meters, parking meters, timers, egg timers [mechanical or electric], hourglasses [time measuring apparatus]; calorimeters; electrical and electronic control apparatus for use with apparatus or installations for heating.

(260) AM 2018 93636 A

(800) 1358808

(151) 2017 05 02

(891) 2017 05 02

(731) AVAYA INC.

4655 Great America Parkway, Santa Clara
CA 95054, USA

(540)



(591) Black, white

(531) 26.04.04; 26.04.09; 26.04.24

(511)

9 – Software which provides unified communication capabilities, namely, voice, video data, teleconferencing and video conferencing, messaging, and collaboration through mobile devices, phones, PCs, laptops and tablets having operating systems and/or search engines, contact center capabilities, email and chat capabilities, inbound and outbound voice calling with telephony and dialer capabilities, skills-based routing, address book access to agents, real time and historical reporting for all media channels, Interactive Voice Response (IVR) and task flow editor script capabilities; software which provides cloud-based video conferencing capabilities, namely, video, audio, data collaboration, and text chat; software which provides persistent collaboration and communications environments through allowing users to communicate in both real time and asynchronous modes, with one or multiple other users, via text, voice, and/or video; software which provides a contextual repository of communications artifacts that enable users to review previous communications sorted or selected by participants, subject, date/time, and other parameters; software which provides programming and interface tools to connect communications services with business applications providing open, configurable connections of cloud-based solutions and capabilities as well as on-premise solutions and capabilities.

42 – Application service provider (ASP) featuring software for use in telephony and messaging applications; application service provider (ASP) featuring software for persistent collaboration and communications environments through allowing users to communicate in both real time and asynchronous modes, with one or multiple other users, via text, voice, and/or video; application service provider (ASP) featuring software which provides a contextual repository of communications artifacts that enable users to review previous communications sorted or selected by participants, subject, date/time, and other parameters; application service provider (ASP) featuring software which provides programming and interface tools to connect communications services with business applications providing open, configurable connections of cloud-based solutions and capabilities as well as on-premise solutions and capabilities.

(260) AM 2018 93637 A
 (800) 1358809
 (151) 2017 05 03
 (891) 2017 05 03
 (731) G-COIN LLC
 109 North Post Oak Lane, Suite 435,
 Houston TX 77024, USA

(540)



(591) Black, white
 (531) 26.01.03; 26.01.18; 26.01.24; 27.05.21
 (511)

36 – Providing an on-line exchange for trading in virtual currency and electronic money; brokerage services in the nature of virtual currency and electronic money trading; electronic funds transfer services; financial services, namely, providing a virtual currency for use by and transfer among members of an on-line community via a global computer network; currency trading services; currency transfer services; virtual currency exchange transaction services for transferable electronic cash equivalent units having specified cash value; provision of prepaid tokens, namely, processing electronic payments made through prepaid purchase tokens; money transfer services; currency dealing services, namely, currency trading services; brokerage of currency; electronic cash transactions; issuance of virtual currency tokens; virtual money exchange services.

(260) AM 2018 93638 A
 (800) 1358872
 (151) 2017 05 30
 (891) 2017 05 30
 (731) BEDGEAR, LLC
 110 Bi-County Blvd, Suite 101,
 Farmingdale NY 11735, USA

(540)

**SLEEP FUELS
 EVERYTHING**

(591) Black, white
 (531) 27.05.05
 (511)
 35 – Promoting the sales of 3rd party mattresses through provision of labeled pillows and hygienic sheets for covering the pillows to allow customers to sample 3rd party mattresses.

(260) AM 2018 93639 A
 (800) 1358882
 (151) 2017 06 01
 (891) 2017 06 01
 (731) APPLE INC.
 1 Infinite Loop, Cupertino CA 95014, USA

(540)

SIRI

(591) Black, white
 (511)
 41 – Providing information, news and commentary in the fields of entertainment, popular culture, recreation and leisure activities, sports and sporting events, educational services, concerts, cultural events, and live theatrical productions; providing information relating to the organizing of educational, cultural, sporting, and entertainment exhibitions, and community, sporting and cultural activities, contests and games; providing non-downloadable audio publications over computer networks, namely, periodicals and reports on the subjects of education, entertainment, popular culture, recreation and leisure activities, sports and sporting events, technology, concerts, cultural events, and live theatrical productions; providing information in the field of educational and entertainment activities and events for children; providing classes, workshops, and instruction in using voice-enabled software applications.

42 – Providing weather information; application service provider services featuring computer software and providing online non-downloadable software, namely, computer game software.

(260) AM 2018 93672 A
 (800) 1358219
 (151) 2017 03 07
 (891) 2017 03 07
 (731) HONSOAR NEW BUILDING MATERIAL
 CO., LTD.
 No.678 Fushi Street, Shouguang City,
 Weifang City Shandong Province, China

(540)

HONSOAR

(591) Black and white
 (531) 27.05.01; 27.05.17
 (511)
 19 – Wood, semi-worked; manufactured timber; wood veneers; veneer wood; slate; refractory construction materials, not of metal; door panels, not of metal; windows, not of metal; floors, not of metal; safety glass.

(260) AM 2018 93675 A
 (800) 1358261
 (151) 2017 06 07

(891) 2017 06 07
 (731) RUGGERI & C. S.P.A.
 Via Pra' Fontana, 4 VALDOBBIADENE
 (TV), Italy
 (540)

GIUSTINO B.

(591) Black and white
 (511)
 33 – Spirits [beverages]; alcoholic beverages (except beer); alcoholic fruit extracts; alcoholic extracts; alcoholic essences; digestives (liqueurs and spirits); cocktails; liqueurs; cider; wine; sparkling wines; sparkling white wines; rosé wines; wines of protected appellation of origin; table wines; still wine; sweet wines; wine-based aperitifs; bitters; aperitifs; wine-based aperitifs; liquor-based aperitifs; alcoholic aperitif bitters; alcoholic beverages containing fruit; wine-based drinks; alcoholic fruit cocktail drinks; prepared alcoholic cocktails; wine punch; grappa.

(260) AM 2018 93677 A
 (800) 1358280
 (151) 2017 03 07
 (891) 2017 03 07
 (731) EGIS GYÓGYSZERGYÁR ZRT.
 Keresztúri út 30-38 H-1106 Budapest,
 Hungary
 (540)

НИТРОМИНТ

(591) Black and white
 (511)
 5 – Pharmaceutical preparations for human use.

(260) AM 2018 93685 A
 (800) 1358318
 (151) 2017 03 22
 (891) 2017 03 22
 (731) "KONTI-RUS" JOINT STOCK COMPANY
 ul. Zolotaia, 13 RU-305000 Kursk, Russian
 Federation
 (540)



(591) Blue, dark blue, light blue, white and black
 (531) 01.07.06; 01.07.08; 01.11.01; 01.11.09;
 01.15.15; 03.01.06; 03.01.19; 19.03.24;
 26.11.13; 28.05; 29.01.12

(526), „Slivochnaia”
 (511)
 30 – Waffles; caramels [candy]; confectionery; candy; biscuits; cakes; fondants [confectionery]; gingerbread; chocolate.

(260) AM 2018 93688 A
 (800) 1358413
 (151) 2016 12 30
 (891) 2016 12 30
 (731) REABOLD HOLDINGS LTD
 Staslkratous 20, KRAMBI BUILDING,
 1st floor, Flat/Office 101, CY-1065
 Nicosia (CY), Cyprus

(540)

AFROJACK

(591) Black, white
 (511)
 9 – Musical sound recordings; musical recordings in the form of discs; audio visual recordings; video recordings; audiovisual apparatus; downloadable musical sound recordings; downloadable ring tones for mobile phones; downloadable graphics for mobile phones; apparatus for recording, transmission or reproduction of sound or images; magnetic data carriers, recording discs; data processing equipment and computers; downloadable electronic sheet music; headphones; personal stereos; loudspeakers; loudspeaker systems; software applications for mobile telephones, smartphones, tablet computers, notebook computers, computers and media players; recording discs; apparatus for recording sound; downloadable sound and video recordings; electronic publications, downloadable; electronic photographs (downloadable); electronic publications recorded on computer media; MP3's; software programs for video games; videodiscs; covers (shaped -) for computers, laptop computers and mobile phones and other electronic devices; spectacles [optics]; sunglasses; eyewear accessories, namely cases and lanyards; audio tapes, audio and video cassettes, CDs and DVDs; phonograph turntables; record bags; computers and peripheral devices therefor; apparatus for recording, transmission or reproduction of sound and/or images, including record players and cd players and parts therefor; audio processing apparatus.

16 – Printed matter; photographs; stationery; artists' materials; printing blocks; calendars; events programmes; advertising posters; postcards; agendas; stickers [stationery]; printed publications; books; magazines [periodicals]; music books; music magazines; posters made of paper; printed folded sheet articles; booklets; paper and cardboard; flyers.

25 – Clothing, footwear, headgear.

35 – Production of advertising and promotional audio visual recordings, videotapes and video discs;

compilation and systemization of information into computer databases.

41 – Entertainment; sporting and cultural activities; entertainment; music recording studio services; production of sound and music recordings; production of audio-visual recordings; fan clubs in the nature of entertainment; musical entertainment services; production of shows; audio production; production of audio entertainment; production of musical videos; production of live performances; disc jockeys for parties and special events; fetes (organisation of -) for entertainment purposes; entertainment services; entertainment services provided at nightclubs; artistic direction of performing artists; arranging and conducting of concerts; entertainment services in the form of concert performances; arranging and conducting of concerts; deejay services; recording studios; entertainer services; music publishing services; sound recording and video entertainment services; editing or recording of sounds and images; publication of books and magazines; entertainment services in the nature of performances rendered by musical artists through the medium of television, radio, and audio and video recordings; publishing of electronic publications; publication of electronic magazines; film production services; performances (presentation of live -); publishing services for books and magazines; arranging of exhibitions for cultural or educational purposes; music, film, radio and television studios; photographic reporting; dance events; shows and films production; booking of seats for shows; club [discotheque] services; theatrical ticket agency services; sound recording studios.

45 – Licensing services relating to music publishing.

(260) AM 2018 93692 A
(800) 1358418
(151) 2016 12 30
(891) 2016 12 30
(731) EKOL LOJISTIK ANONIM SIRKETI
Ekol Caddesi No:2, TR-34935 Sultanbeyli,
İstanbul, Turkey
(540)



(591) Blue and white
(531) 26.04.18; 27.05.21; 29.01.12

(511)
39 – Land, rail, water, and air transport services for the carriage of freight; courier services (for merchandise); establishment and operation of warehouses, namely warehousing services.

(260) AM 2018 93693 A
(800) 1358499
(151) 2017 06 05
(891) 2017 06 05
(731) THEOCORP HOLDING COMPANY, LLC
3512 8th Street, Metairie LA 70002, USA
(540)



(591) Black, white
(531) 05.07.06; 25.01.25
(511)
3 – Dental care products, namely, toothpaste having compounds containing natural or synthesized theobromine.

(260) AM 2018 93694 A
(800) 1358503
(151) 2017 05 02
(891) 2017 05 02
(731) RAUCH Fruchtsäfte GmbH
Langgasse 1, A-6830 Rankweil, Austria
(540)

RAUCH MY TEA

(591) Black, white
(511)
30 – Tea; iced tea; tea-based beverages; tea-based drinks.
32 – Non-alcoholic beverages; non-alcoholic beverages containing tea or tea extracts or with a tea flavour.

(260) AM 2018 93695 A
(800) 1358533
(151) 2017 06 29
(891) 2017 06 29
(731) KHASHMINSKY GENE
108-4950 YONGE ST., M2N 6K1 NORTH
YORK, ON, Canada
(540)

BO-PO

(591) Black, white
(511)
3 – Nail polish.

(260) AM 2018 93696 A

(800) 1358583

(151) 2016 11 21

(891) 2016 11 21

(731) SAYIM TEKSTİL SANAYİİÇ VE DIŞ
TİCARET LİMİTED ŞİRKETİ
Çobançesme Mah. Mithatpaşa, Cad. Badem
Sk. No:11, Yenibosna Bahcelievler, İstanbul,
Turkey

(540)



(591) Black, white

(531) 24.17.01; 24.17.02; 27.05.01

(511)

18 – Unworked or semi-worked leather and animal skins, imitations of leather, stout leather, leather used for linings; goods made of leather, imitations of leather or other materials, designed for carrying items, included in this class; bags, wallets, boxes and trunks made of leather or stout leather; keycases, trunks [luggage], suitcases; umbrellas; parasols; sun umbrellas; walking sticks; whips; harness; saddlery; stirrups; straps of leather (saddlery).

35 – Advertising, marketing and publicity services; organization of exhibitions and trade fairs for commercial or advertising purposes; office functions; advisory services for business management; business accounts management; import-export agencies; business efficiency experts; auction and reverse auction services; the bringing together, for the benefit of others, of unworked or semi-worked leather and animal skins, imitations of leather, stout leather, leather used for linings, goods made of leather, imitations of leather or other materials, designed for carrying items, bags, wallets, boxes and trunks made of leather or stout leather, keycases, trunks [luggage], suitcases, umbrellas, parasols, sun umbrellas, walking sticks, whips, harness, saddlery, stirrups, straps of leather (saddlery), clothing, including underwear and outer clothing, other than special purpose protective clothing, socks, footwear, headgear (excluding the transport thereof), enabling customers to conveniently view and purchase those goods from wholesale outlets, retail outlets and from a general merchandise catalogue by mail order or by means of telecommunications.

(260) AM 2018 93697 A

(800) 1358624

(151) 2017 02 17

(891) 2017 02 17

(731) Obshchestvo s ogranichennoy

otvetstvennostyu "GAMMA"

ul. Sr. Kalitnikovskaya, 28, str. 4, RU-109029
Moscow, Russian Federation

(540)



(591) Black, white, green and cherry-colored.

The letters of a word performed in black color; the cherry performed in green and cherry-colored colors; the curl on the cherry performed in white color

(531) 05.07.16; 27.05.01; 29.01.13

(511)

14 – Precious metals and their alloys; jewellery, precious stones; horological and chronometric instruments; agates; charms [jewellery]; anchors [clock and watch making]; bracelets for watches; bracelets [jewellery]; bracelets [imitation jewellery]; sets comprising beads and imitation stones for making children's jewellery; key rings [trinkets or fobs]; trinkets [jewellery]; brooches [jewellery]; brooches [imitation jewellery]; alarm clocks; ornamental pins; tie pins; pins [jewellery]; beads for making jewellery and imitation jewellery; busts of precious metals; jet, unwrought or semi-wrought; pearls [jewellery]; copper tokens; tie clips; cuff links; gold, unwrought or beaten; cloisonné jewellery; ivory [jewellery]; works of art of precious metals; jewellery of yellow amber; iridium; semiprecious stones; spun silver [silver wire]; necklaces [jewellery]; rings [jewellery]; boxes of precious metals; clock cases; pendulums [clock and watch making]; medals; medallions [jewellery]; clockworks; coins; gold thread [jewellery]; threads of precious metal [jewellery]; silver thread; olivine [gems]; osmium; palladium; platinum [metal]; chronometrical instruments; rhodium; ruthenium; stop-watches; silver, unwrought or beaten; earrings; ingots of precious metals; statues of precious metals; figurines [statuettes] of precious metal; watch glasses; paste jewelry [costume jewelry]; watch hands; shoe ornaments of precious metals; hat ornaments of precious metals; ornaments of jet; cases for clock and watchmaking; chronographs [watches]; chronometers; chronoscopes; chains [jewellery]; watch chains; dials [clock and watch making]; atomic clocks; clocks; sundials; clocks and watches, electric; control clocks [master clocks]; jewellery boxes; spinel [precious stones]; jewellery pins for use on hats; clip-on earrings.

26 – Artificial flowers; artificial fruit; barrettes [hair-slides]; beads other than for making jewelry; belt clasps; blouse fasteners; bodkins; braids; brassards; brooches [clothing accessories]; buckles [clothing accessories]; buttons; eyelets for clothing; cords for

rimming, for clothing; darning needles; heat adhesive patches for decoration of textile articles [haberdashery]; edgings for clothing; embroidery; festoons [embroidery]; frills for clothing; frills [lacework]; fringes; gold embroidery; haberdashery, except thread; hair bands; hair nets; hair ornaments; hat ornaments, not of precious metal; hook and pile fastening tapes; embroidering crochet hooks; hooks [haberdashery]; lace for edgings; lace trimmings; mica spangles; needle cases; ornamental novelty badges [buttons]; picot [lace]; pin cushions; ribbons [haberdashery]; rosettes [haberdashery]; sewing boxes; sewing needles; silver embroidery; skirt flounces; snap fasteners; spangles for clothing; tassels [haberdashery]; sewing thimbles; tinsels [trimmings for clothing]; top-knots [pompoms]; trimmings for clothing.

(260) AM 2018 93827 A
(800) 1360199
(151) 2017 01 27
(891) 2017 01 27
(731) BERARDI BULLONERIE S.R.L.
Via della Concia, 10 CASTEL GUELFO
DI BOLOGNA (Bologna), Italy

(540)



(591) Black, white
(531) 14.03.01; 14.03.09; 26.05.18; 27.05.17
(511)
6 – Metal screws; metal bolts; metal springs; goods of common metal not included in other classes.

(260) AM 2018 93829 A
(800) 1360868
(151) 2017 06 28
(891) 2017 06 28
(731) JANSSEN PHARMACEUTICA NV
Turnhoutseweg 30, B-2340 BEERSE (BE),
Belgium

(540)

TELTARGA

(591) Black, white
(511)
5 – Human pharmaceutical preparations.

(260) AM 2018 93832 A
(800) 1360228
(151) 2017 04 27
(891) 2017 04 27
(731) ASTELLAS PHARMA INC.
5-1, Nihonbashi-Honcho 2-chome, Chuo-ku,
Tokyo 103-8411, Japan

(540)

QEGRITY

(591) Black, white
(531) 27.05.01; 27.05.17
(511)
5 – Vaccines for human use.

(260) AM 2018 93841 A
(800) 1360229
(151) 2017 04 27
(891) 2017 04 27
(731) ASTELLAS PHARMA INC.
5-1, Nihonbashi-Honcho 2-chome, Chuo-ku,
Tokyo 103-8411, Japan

(540)

QASPIDA

(591) Black, white
(531) 27.05.01; 27.05.17
(511)
5 – Vaccines for human use.

(260) AM 2018 93844 A
(800) 1360230
(151) 2017 04 24
(891) 2017 04 24
(731) ASTELLAS PHARMA INC.
5-1, Nihonbashi-Honcho 2-chome, Chuo-ku,
Tokyo 103-8411, Japan

(540)

XUPLORIS

(591) Black, white
(531) 27.05.01
(511)
5 – Vaccines for human use.

(260) AM 2018 93847 A
(800) 1360872
(151) 2017 06 10
(891) 2017 06 10
(731) ESSENER SEIFENFABRIK GMBH
Worringstraße 250, 45289 Essen, Germany

(540)

Rhein

(591) Black, white
(511)
3 – Bleaching preparations; laundry detergents; dishwasher rinsing agents; cosmetics; shampoos; shower preparations; soap.

(260) AM 2018 93848 A
 (800) 1360890
 (151) 2017 03 15
 (891) 2017 03 15
 (731) Union des Associations Européennes de Football (UEFA)
 Route de Genève 46, CH-1260 Nyon,
 Switzerland

(540)

EURO 2020

(591) Black, white

(511)

28 – Toys; sports balls; play balloons; tables for indoor football; dolls and plush toys; vehicles (toys); balloons; inflatable toys; confetti; gymnastic and sporting articles; football equipment, namely balls for football, gloves, knee guards, elbow guards, shoulder guards, shin guards; football goals; sports bags and containers (adapted to objects) for carrying sports articles; party hats (toys); small electronic games designed for use with a television set; video game apparatus; game consoles; video game accessories; electronic games other than those designed to be used only with a television set; steering wheels for video games and mats for video games (for dancing upon); hands made of rubber or foam (toys); entertainment robots; appliances for gymnastics; kites; roller skates; scooters; skateboards; coin-operated video games for game halls (arcade games); electronic games with liquid crystal display; joysticks for video games, manually or voice-activated joysticks for video games; lottery tickets; scratch cards; all the aforesaid goods are from Europe.

(260) AM 2018 93978 A
 (800) 1361847
 (151) 2017 07 14
 (891) 2017 07 14
 (731) JANSSEN PHARMACEUTICA NV
 Turnhoutseweg 30 B-2340 BEERSE, Belgium
 (540)

SERPLANO

(591) Black and white

(511)

5 – Human pharmaceutical preparations for the prevention and treatment of viral diseases, auto-immune and inflammatory diseases, cardiovascular diseases, central nervous system diseases, pain, dermatologic diseases, gastro-intestinal diseases, infectious-related diseases, metabolic diseases, oncologic diseases, ophthalmic diseases and respiratory diseases; vaccines.

(260) AM 2018 93979 A
 (800) 1361602
 (151) 2017 06 29
 (891) 2017 06 29

(731) SOCIÉTÉ DES PRODUITS NESTLÉ S.A.
 CH-1800 Vevey, Switzerland

(540)

Шоколлаж

(591) Black, white

(531) 28.05

(511)

30 – Cocoa and cocoa-based beverages and preparations; chocolate, chocolate products, chocolate-based beverages and preparations; biscuits, cookies; confectionery; sugar confectionery; cookies; cakes; wafers; caramels; puddings; candy; chewing gum not for medical use; bakery products; bread; powdered mixture for cakes; pastry; desserts (included in this class); edible ices, water ices, sherbets, iced confectionery products, iced cakes, ice cream, iced desserts, iced yogurts.

(260) AM 2018 93980 A
 (800) 1361871
 (151) 2016 05 20
 (891) 2016 05 20
 (731) PUBLIC JOINT STOCK COMPANY
 GAZPROM NEFT
 Galenarya Ul, 5, Lit A RU-190000
 St-Petersburg, Russian Federation

(540)



(591) Orange, gray and white

(531) 27.05.03; 27.05.17; 29.01.12

(511)

12 – Vehicles; apparatus for locomotion by land, air or water; motor buses; motor coaches; motor homes; cars; sports cars; concrete mixing vehicles; refrigerated vehicles; caravans; shock absorbers for automobiles; suspension shock absorbers for vehicles; space vehicles; aircraft; aeronautical apparatus, machines and appliances; air cushion vehicles; hot air balloons; luggage carriers for vehicles; ski carriers for cars; bumpers for automobiles; vehicle bumpers; tires for vehicle wheels; barges; brake shoes for vehicles; tailboard lifts [parts of land vehicles]; buffers for railway rolling stock; dining cars [carriages]; wagons; tilt trucks; carriages [railways]; sleeping cars; dining cars; refrigerated wagons [railroad vehicles]; transmission shafts for land vehicles; bicycles; valves for vehicle tires [tyres]; automobile hoods; stroller hoods; hoods for vehicles; oars; sculls; screws [propellers] for ships; hydroplanes; seaplanes; flanges for railway wheel tires [tyres]; trucks; horns for vehicles; treads for vehicles [tractor type]; doors for vehicles; bicycle motors; engines for land vehicles; jet engines for land vehicles; driving motors for land vehicles; screw-propellers; screw-pro-

pellers for boats; dirigible balloons [airships]; brake discs for vehicles; trolley railways [cable cars]; dredgers [boats]; trolleys; adhesive rubber patches for repairing inner tubes; rearview mirrors; portholes; cars for cable transport installations; inner tubes for pneumatic tires [tyres]; hoods for vehicle engines; crankcases for land vehicle components, other than for engines; boats; caissons [vehicles]; bicycle wheels; vehicle wheels; mine cart wheels; casters for trolleys [vehicles] [carts (Am.)]; brake pads for automobiles; hub caps; strollers; side cars; brake linings for vehicles; ships; baskets adapted for bicycles; gear boxes for land vehicles; ships' hulls; fenders for ships; bands for wheel hubs; ejector seats for aircraft; wheelchairs; caps for vehicle petrol [gas] tanks; boat hooks; automobile bodies; tipping bodies for lorries [trucks]; bodies for vehicles; treads for retreading tires [tyres]; locomotives; masts for boats; sprinkling trucks; propulsion mechanisms for land vehicles; mopeds; motorcycles; freewheels for land vehicles; clutches for land vehicles; repair outfits for inner tubes; air pumps [vehicle accessories]; pumps for bicycle tires; upholstery for vehicles; rims for bicycle wheels; rims for vehicle wheels; windows for vehicles; omnibuses; axles for vehicles; headlight wipers; parachutes; ferry boats; bicycle pedals; gearing for land vehicles; carts; head-rests for vehicle seats; vehicle running boards; air bags [safety devices for automobiles]; ski lifts; chairlifts; casings for pneumatic tires [tyres]; sleeping berths for vehicles; pontoons; torque converters for land vehicles; cigar lighters for automobiles; anti-glare devices for vehicles; anti-theft devices for vehicles; sun-blinds adapted for automobiles; non-skid devices for vehicle tires [tyres]; balance weights for vehicle wheels; shock absorbing springs for vehicles; bicycle frames; spars for ships; reduction gears for land vehicles; safety belts for vehicle seats; security harness for vehicle seats; vehicle suspension springs; steering wheels for vehicles; rudders; bicycle handlebars; bicycle cranks; aeroplanes; amphibious airplanes; sleighs [vehicles]; kick sledges; brake segments for vehicles; bicycle saddles; luggage nets for vehicles; dress guards for bicycles; anti-theft alarms for vehicles; reversing alarms for vehicles; safety seats for children, for vehicles; vehicle seats; hydraulic circuits for vehicles; push scooters [vehicles]; snowmobiles; rolling stock for railways; rolling stock for funicular railways; spokes for bicycle wheels; vehicle wheel spokes; spoilers for vehicles; air vehicles; vehicles for locomotion by land, air, water or rail; ambulances; water vehicles; remote control vehicles, other than toys; electric vehicles; tricycles; delivery tricycles; inclined ways for boats; windcreens; windshield wipers; motorcycle kickstands; hubs for bicycle wheels; hubs for vehicle wheels; saddlebags adapted for bicycles; railway couplings; trailer hitches for vehicles; couplings for land vehicles; wheelbarrows; handling carts; two-wheeled trolleys; shopping tro-

lleys [carts (Am.)]; hose carts; bogies for railway cars; casting carriages; tilting-carts; lifting cars [lift cars]; cleaning trolleys; bicycle brakes; brakes for vehicles; torsion bars for vehicles; tractors; tramcars; transmissions, for land vehicles; military vehicles for transport; aerial conveyors; trailers [vehicles]; funnels for ships; funnels for locomotives; cleats [nautical]; turbines for land vehicles; direction indicators for bicycles; direction signals for vehicles; rowlocks; disengaging gear for boats; steering gears for ships; cable transport apparatus and installations; spoke clips for wheels; tipping apparatus, parts of trucks and waggons; funiculars; vans [vehicles]; automobile chains; bicycle chains; driving chains for land vehicles; anti-skid chains; transmission chains for land vehicles; stroller covers; spare wheel covers; covers for vehicle steering wheels; saddle covers for bicycles or motorcycles; seat covers for vehicles; vehicle covers [shaped]; automobile chassis; vehicle chassis; connecting rods for land vehicles, other than parts of motors and engines; axle journals; gears for bicycles; tubeless tires for bicycles; bicycle tyres; automobile tires [tyres]; tires for land vehicles; pneumatic tires; spikes for tires; davits for boats; launches; timbers [frames] for ships; mudguards; bicycle mudguards; motors, electric, for land vehicles; yachts; undercarriages for vehicles.

16 – Printed matter; stationery; artists' materials; typewriters and office requisites [except furniture]; instructional and teaching material [except apparatus]; printing blocks; fountain pens; aquarelles; albums; almanacs; document laminators for office use; mimeograph apparatus and machines; atlases; posters; paper bows; table linen of paper; tickets; forms, printed; announcement cards [stationery]; note books; pads [stationery]; drawing pads; loose-leaf binders; wristbands for the retention of writing instruments; pamphlets; booklets; paper sheets [stationery]; waxed paper; paper for recording machines; paper for radiograms; electrocardiograph paper; wood pulp paper; carbon paper; copying paper [stationery]; parchment paper; writing paper; luminous paper; Xuan paper for Chinese painting and calligraphy; toilet paper; wrapping paper; filter paper; blotters; newsletters; rollers for typewriters; house painters' rollers; composing sticks; modelling wax, not for dental purposes; signboards of paper or cardboard; sewing patterns; newspapers; electrotypes; hectographs; modelling clay; terrestrial globes; drawing sets; engravings; slate pencils; pencil leads; document holders [stationery]; pencil holders; chalk holders; holders for checkbooks [cheque books]; holders for stamps [seals]; diagrams; engraving plates; writing slates; blackboards; galley racks [printing]; drawing boards; advertisement boards of paper or cardboard; duplicators; punches [office requisites]; cream containers of paper; magazines [periodicals]; money clips; tags for index cards; pen clips; book-markers; etching needles; tracing needles for dra-

wing purposes; periodicals; printed publications; paper shredders for office use; graphic representations; credit card imprinters, non-electric; graining combs; drawing instruments; calendars; tracing paper; tracing cloth; tracing patterns; gums [adhesives] for stationery or household purposes; lithographic stones; ink stones [ink reservoirs]; pencils; pencil lead holders; charcoal pencils; pictures; transfers [decal-comanias]; paintings [pictures], framed or unframed; wood pulp board [stationery]; hat boxes of cardboard; files [office requisites]; cards; index cards [stationery]; geographical maps; paper tapes and cards for the recordal of computer programmes; trading cards other than for games; perforated cards for Jacquard looms; catalogues; spools for inking ribbons; covers of paper for flower pots; paintbrushes; painters' brushes; writing brushes; typewriter keys; glue for stationery or household purposes; gluten [glue] for stationery or household purposes; starch paste [adhesive] for stationery or household purposes; books; manifolds [stationery]; comic books; drawing pins; cigar bands; envelopes [stationery]; cases for stamps [seals]; boxes of cardboard or paper; paint boxes [articles for use in school]; correcting fluids [office requisites]; stencils [stationery]; French curves; paper ribbons; typewriter ribbons; gummed tape [stationery]; adhesive bands for stationery or household purposes; correcting tapes [office requisites]; inking ribbons; inking ribbons for computer printers; adhesive tapes for stationery or household purposes; self-adhesive tapes for stationery or household purposes; drawing rulers; square rulers; absorbent sheets of paper or plastic for foodstuff packaging; humidity control sheets of paper or plastic for foodstuff packaging; viscose sheets for wrapping; sheets of reclaimed cellulose for wrapping; plastic bubble packs for wrapping or packaging; steel letters; type [numerals and letters]; lithographs; paint trays; architects' models; postage stamps; plastics for modelling; graphic prints; modelling materials; teaching materials [except apparatus]; sealing compounds for stationery purposes; adhesives [glues] for stationery or household purposes; bookbinding material; packaging material made of starches; filtering materials [paper]; addressing machines; pencil sharpening machines, electric or non-electric; bookbinding apparatus and machines [office equipment]; typewriters, electric or non-electric; folders [stationery]; franking machines for office use; chalk for lithography; writing chalk; tailors' chalk; marking chalk; bags [envelopes, pouches] of paper or plastics, for packaging; garbage bags of paper or of plastics; painters' easels; hand-rests for painters; writing cases [stationery]; printing sets, portable [office requisites]; bibs of paper; stickers [stationery]; finger-stalls [office requisites]; cords for bookbinding; paper knives [cutters] [office requisites]; numbering apparatus; bottle envelopes of cardboard or paper; sealing wafers; covers [stationery]; passport holders; plastic cling film,

extensible, for palletization; embroidery designs [patterns]; handwriting specimens for copying; oleographs; musical greeting cards; greeting cards; postcards; etchings; conical paper bags; bags for microwave cooking; palettes for painters; ink sticks; pantographs [drawing instruments]; folders for papers; papier mâché; pastels [crayons]; modelling paste; pen cases; bookbindings; pen wipers; office perforators; pens [office requisites]; nibs of gold; nibs; steel pens; drawing pens; song books; seals [stamps]; sealing stamps; clipboards; address plates for addressing machines; handkerchiefs of paper; plastic film for wrapping; letter trays; trays for sorting and counting money; coasters of paper; bookends; stamp stands; mats for beer glasses; stands for pens and pencils; photograph stands; inking pads; stamp pads; binding strips [bookbinding]; towels of paper; inking sheets for document reproducing machines; inking sheets for duplicators; bookbinding cloth; gummed cloth for stationery purposes; printers' blankets, not of textile; portraits; paperweights; writing cases [sets]; inkstands; writing materials; writing instruments; drawing materials; school supplies [stationery]; adhesive tape dispensers [office requisites]; hand labelling appliances; lithographic works of art; prospectuses; printed timetables; ledgers [books]; printers' galleys; indexes; rubber erasers; elastic bands for offices; drawing T-squares; graphic reproductions; penholders; marking pens [stationery]; tissues of paper for removing make-up; face towels of paper; table napkins of paper; place mats of paper; tablemats of paper; tablecloths of paper; paper clasps; document files [stationery]; scrapers [erasers] for offices; paper-clips; staples for offices; erasing products; biological samples for use in microscopy [teaching materials]; histological sections for teaching purposes; steatite [tailor's chalk]; writing board erasers; composing frames [printing]; sealing wax; arithmetical tables; placards of paper or cardboard; writing or drawing books; fabrics for bookbinding; pencil sharpeners, electric or non-electric; transparencies [stationery]; stencil plates; cardboard tubes; Indian inks; moisteners [office requisites]; moisteners for gummed surfaces [office requisites]; drawing squares; chart pointers, non-electronic; bottle wrappers of cardboard or paper; envelope sealing machines, for offices; sealing machines for offices; vignetting apparatus; apparatus for mounting photographs; stapling presses [office requisites]; manuals [handbooks]; figurines [statuettes] of papier mâché; paper coffee filters; flags of paper; silver paper; molds for modelling clays [artists' materials]; photoengravings; photographs [printed]; stencil cases; canvas for painting; compasses for drawing; numbers [type]; watercolor [watercolour] saucers for artists; correcting ink [heliography]; ink; inkwells; blueprints; rosaries; stencils; erasing shields; balls for ball-point pens; cabinets for stationery [office requisites]; printing type; address stamps; stamps

[seals]; shields [paper seals]; prints [engravings]; labels, not of textile; paper and cardboard; plastic materials for packaging; flyers.

25 – Clothing, footwear, headgear; wimples; bandanas [neckerchiefs]; underwear; sweat-absorbent underwear; berets; overalls; boas [necklets]; teddies [undergarments]; ski boots; boots for sports; breeches for wear; trousers; football boots; brassieres; detachable collars; collars [clothing]; shirt yokes; veils [clothing]; gabardines [clothing]; galoshes; neckties; ascots; leggings [leg warmers]; gaiters; boot uppers; corselets; jerseys [clothing]; vests; sports jerseys; hosiery; heels; hoods [clothing]; hat frames [skeletons]; pockets for clothing; neck scarfs [mufflers]; visors [headwear]; cap peaks; tights; slips [undergarments]; combinations [clothing]; wet suits for water-skiing; bodices [lingerie]; corsets [underclothing]; suits; bathing suits; masquerade costumes; beach clothes; jackets [clothing]; stuff jackets [clothing]; fishing vests; leggings [trousers]; liveries; camisoles; cuffs; short-sleeve shirts; mantillas; coats; sleep masks; furs [clothing]; mittens; miters [hats]; muffs [clothing]; footmuffs, not electrically heated; heelpieces for footwear; bibs, not of paper; fur stoles; ear muffs [clothing]; socks; beach shoes; sports shoes; paper clothing; outerclothing; ready-made clothing; motorists' clothing; cyclists' clothing; clothing for gymnastics; clothing of imitations of leather; clothing of leather; uniforms; fittings of metal for footwear; maniples; overcoats; parkas; pelerines; gloves [clothing]; ski gloves; pajamas (Am.); bathing trunks; shirt fronts; scarfs; pocket squares; dresses; headbands [clothing]; garters; sock suspenders; stocking suspenders; ready-made linings [parts of clothing]; dress shields; soles for footwear; braces for clothing [suspenders]; lace boots; ponchos; girdles; belts [clothing]; money belts [clothing]; layettes [clothing]; non-slipping devices for footwear; heelpieces for stockings; welts for footwear; chasubles; shirts; wooden shoes; sandals; bath sandals; boots; sarongs; jumper dresses; saris; sweaters; footwear uppers; inner soles; bath slippers; togas; knitwear [clothing]; underpants; gymnastic shoes; slippers; shoes; skull caps; turbans; aprons [clothing]; tee-shirts; dressing gowns; bath robes; top hats; tips for footwear; stockings; sweat-absorbent stockings; shawls; caps [headwear]; paper hats [clothing]; shower caps; bathing caps; sashes for wear; studs for football boots; hats; trouser straps; pelisses; esparto shoes or sandals; skirts; petticoats; skorts.

(260) AM 2018 93982 A
(800) 1361896
(151) 2016 11 10
(891) 2016 11 10
(731) LES LABORATOIRES SERVIER,
Société par actions simplifiée
50 rue Carnot F-92284 SURESNES cedex,
France

(540)

WEHEALTH BY SERVIER

(591) Black and white

(511)

5 – Pharmaceutical products, medical and veterinary preparations; sanitary products for medical purposes; dietetic food and substances for medical or veterinary use, food for babies; food supplements for humans and animals; plasters, materials for dressings; material for dental fillings and dental impressions; disinfectants; products for destroying vermin; fungicides, herbicides.

9 – Scientific, optical, weighing, measuring, signaling, checking (supervision), life-saving and teaching apparatus and instruments; apparatus and instruments for conducting, switching, transforming, accumulating, regulating or controlling electricity; apparatus for recording, transmission or reproduction of sound or images; magnetic recording media; sound recording disks; data and information processing apparatus and equipment; software; computer programs; data processing equipment; software recorded on magnetic media or downloaded from a remote computer network; downloadable computer software applications; software for monitoring physiological signals; software for the analysis, storage and monitoring of physiological data, including diagnostic, surveillance and warning tools; personal digital assistants; transmitters of electronic signals; connected bracelets; video cameras; wearable activity sensors; digital health (terms too vague in the opinion of the International Bureau – Rule 13(2)(b) of the Regulations).

10 – Surgical, medical, dental and veterinary apparatus and instruments; orthopedic articles; artificial limbs, eyes and teeth; suture material; medical devices; diagnostic and monitoring devices for medical use.

44 – Medical services; health counseling services; pharmacy advice; health services; telemedicine services; therapeutic services; medical diagnosis services; medical diagnostic services via electronic and telematic means.

(260) AM 2018 93983 A

(800) 1361901

(151) 2017 03 02

(891) 2017 03 02

(731) ONDULINE

35 rue Baudin F-92300 LEVALLOIS-
PERRET, France

(540)

ONDULINE TILE

(591) Black and white
(511)

17 – Insulating materials; thermal and acoustic insulators for all types of buildings; waterproof packings; semi-processed plastic materials in the form of membranes, sheets, tapes and plates for sealing and thermal and sound insulation for all types of buildings; membranes for false roofs, roofs, walls, roads and all types of applications in the building sector and public works (insulating materials).

19 – Non-metallic building materials; transportable buildings not of metal; non-metallic ridge materials for all types of buildings; products (bituminous) for building; non-metallic roof coverings; tiles not of metal; plates made of fibers and materials of all kinds (building materials, not of metal); covering and cladding plates (building materials not of metal); transparent or translucent plates for building (non-metallic building materials); membranes for false roofs, roofs, walls, roads (non-metallic building materials), bitumen-based roofing rolls, partitions not of metal for all types of applications in the building sector and public works.

(260) AM 2018 93984 A

(800) 1361643

(151) 2017 02 27

(891) 2017 02 27

(731) PODLYESNYI YURIY VASYLOVYCH

Vul. Vyborzka 22A, kv. 32, Kyiv 03056,
Ukraine

(540)

RACE NATION

(591) Black, white

(531) 27.05.01

(511)

35 – Advertising; business management; business administration; office functions; administrative processing of purchase orders; market studies; opinion polling; organization of exhibitions for commercial or advertising purposes; organization of trade fairs for commercial or advertising purposes; demonstration of goods; business management assistance; compilation of information into computer databases; compilation of statistics; import-export agency services; on-line advertising on a computer network; computerized file management; business management of performing artists; business management of sports people; commercial information and advice for consumers [consumer advice shop]; commercial administration of the licensing of the goods and services of others; business management consultancy; business organization consultancy; layout services for advertising purposes; marketing; provision of business information via the Internet; provision of commercial and business contact information; rental of advertising space; publicity material rental; rental

of vending machines; rental of sales stands; rental of advertising time on communication media; writing of publicity texts; procurement services for others [purchasing goods and services for other businesses]; modelling for advertising or sales promotion; public relations; commercial intermediation services; retail or wholesale services for pharmaceutical, veterinary and sanitary preparations and medical supplies; sponsorship search; presentation of goods on communication media, for retail purposes; publication of publicity texts; radio advertising; advertising by mail order; advertising agency services; distribution of samples; dissemination of advertising matter; direct mail advertising; sales promotion for others [mediation]; production of advertising films; television advertising; telemarketing services.

41 – Education; providing of training; entertainment; sporting and cultural activities; educational services; teaching; nursery schools; training; organization of shows [impresario services]; organization of competitions [education or entertainment]; arranging and conducting of congresses; arranging and conducting of colloquiums; arranging and conducting of conferences; arranging and conducting of concerts; arranging and conducting of workshops [training]; arranging and conducting of seminars; arranging of beauty contests; organization of exhibitions for cultural or educational purposes; organization of lotteries; holiday camp services [entertainment]; organization of sports competitions; gymnastic instruction; production of radio and television programmes; club services [entertainment or education]; providing recreation facilities; providing sports facilities; correspondence courses; recording studio services; game services provided on-line from a computer network; education information; recreation information; entertainment information; videotape editing; tutoring; academies [education]; providing entertainment services; providing on-line videos, not downloadable; rental of show scenery; games equipment rental; rental of skin diving equipment; rental of sports grounds; rental of sports equipment, except vehicles; rental of stadium facilities; rental of tennis courts; amusement park services; vocational retraining; party planning [entertainment]; booking of seats for shows; entertainer services; coaching [training]; personal trainer services [fitness training]; sport camp services; health club services [health and fitness training]; gambling services; practical training [demonstration]; conducting fitness classes; vocational guidance [education or training advice]; production of shows; film production, other than advertising films; television entertainment; physical education; timing of sports events; boarding school education.

(260) AM 2018 93985 A

(800) 1361688

(151) 2017 04 18

(891) 2017 04 18

(731) Open Joint-Stock Company "PUSHKINSKIY ZAVOD"
Yaroslavskoe shosse, 1-A, Pushkino
RU-141200 Moskovskaia oblast, Russian Federation

(540)



(591) White, black, yellow

(531) 25.03.01; 26.01.03; 26.01.12; 29.01.13

(511)

1 – Solvents for varnishes; industrial chemicals; surface-active chemical agents; water-purifying chemicals; distilled water; glycol ether; anti-frothing solutions for accumulators; anti-knock substances for internal combustion engines; coolants for vehicle engines; acidulated water for recharging accumulators; brake fluid; acetates [chemicals]; additives, chemical, to motor fuel; antifreeze; filtering materials [unprocessed plastics]; power steering fluid; transmission fluid; oil-purifying chemicals; acetone; fluids for hydraulic circuits; chemicals for the manufacture of paints; cement for pneumatic tires [tyres]; chemical additives for oils; oil dispersants; water-softening preparations; oil cement [putty]; ethers; anti-boil preparations for engine coolants; glycerine for industrial purposes; petroleum dispersants; filtering materials [chemical preparations]; detergent additives to gasoline [petrol]; liquids for removing sulfates from accumulators; filtering materials [mineral substances]; fissionable chemical elements; benzene; benzol; xylene; xylol.

2 – Lacquers; anti-rust greases; anti-corrosive preparations; binding preparations for paints; paints; anti-rust oils; enamels [varnishes]; thinners for lacquers; protective preparations for metals; oils for the preservation of wood; colorants; anti-rust preparations; primers.

3 – Rust removing preparations; paint stripping preparations; color-removing preparations; dry-cleaning preparations; laundry preparations; detergents, other than for use in manufacturing operations and for medical purposes; refurbishing preparations; descaling preparations for household purposes; soap; cleaning preparations; polishing wax; abrasives; cloths impregnated with a detergent for cleaning; oils for cleaning purposes; windshield cleaning liquids; shining preparations [polish]; polishing preparations; ammonia [volatile alkali] [detergent].

4 – Dust absorbing compositions; mineral fuel; industrial oil; petrol; diesel oil; industrial grease; oils for paints; grease for leather; petroleum jelly for industrial purposes; sunflower oil for industrial purposes; alcohol [fuel]; naphtha; methylated spirit; carburetors; lubricating grease; benzine; cutting fluids; mo-

tor oil; dust laying compositions; lubricating oil; petroleum, raw or refined; tallow; vaporized fuel mixtures; mazut; non-slipping preparations for belts; dust binding compositions for sweeping; grease for belts; fuel with an alcoholic base; dust removing preparations; lubricants.

(260) AM 2018 93987 A

(800) 1361913

(151) 2017 06 16

(891) 2017 06 16

(731) BIOMA SA

Via Luserte SUD 8 CH-6572 Quartino,
Switzerland

(540)

EPYCA

(591) Black and white

(511)

1 – Chemical and biological preservatives for wine-making.

(260) AM 2018 93988 A

(800) 1361944

(151) 2017 05 30

(891) 2017 05 30

(731) VOESTALPINE TUBULARS GMBH & CO KG

Alpinestraße 17 A-8652 Kindberg-Aumühl,
Austria

(540)

VAXPLORER

(591) Black and white

(511)

6 – Metal tubing, in particular of steel; penstock pipes of steel for the transport of petroleum and/or natural gas; junctions of metal for pipes, in particular of steel, in particular for oil pipelines or gas pipelines; gas-tight thread coupling of metal, in particular of steel, in particular for oil pipelines or gas pipelines; pipe muffs of metal, in particular of steel; threaded pipes of metal, in particular of steel; manifolds of metal for pipelines; pipe strings of metal for the extraction of petroleum and natural gas; oilfield pipes of metal; drill strings of metal for oil and gas fields.

37 – Installation of threaded pipes and/or gas-tight thread couplings of metal; repair and maintenance of threaded pipes and/or gas-tight thread couplings of metal.

INTERNATIONAL TRADEMARKS PROTECTED IN GEORGIA

(260) AM 2018 88837 A
(800) 1310969
(151) 2016 04 06
(181) 2026 04 06
(891) 2016 04 06
(511) 01, 05

(260) AM 2018 90829 A
(800) 1330658
(151) 2016 11 04
(181) 2026 11 04
(891) 2016 11 04
(511) 36

(260) AM 2018 90821 A
(800) 1330560
(151) 2016 10 14
(181) 2026 10 14
(891) 2016 10 14
(511) 30

(260) AM 2018 90830 A
(800) 1330268
(151) 2016 03 03
(181) 2026 03 03
(891) 2016 03 03
(511) 16, 35, 38, 41, 43

(260) AM 2018 90822 A
(800) 1330238
(151) 2016 10 12
(181) 2026 10 12
(891) 2016 10 12
(511) 05, 10

(260) AM 2018 90831 A
(800) 657904
(151) 1996 04 01
(181) 2006 04 01
(891) 2017 01 18
(511) 16, 35, 41

(260) AM 2018 90824 A
(800) 1330239
(151) 2016 10 28
(181) 2026 10 28
(891) 2016 10 28
(511) 33

(260) AM 2018 91011 A
(800) 1331718
(151) 2016 12 20
(181) 2026 12 20
(891) 2016 12 20
(511) 05, 29

(260) AM 2018 90826 A
(800) 1330652
(151) 2016 10 13
(181) 2026 10 13
(891) 2016 10 13
(511) 05

(260) AM 2018 91013 A
(800) 1331725
(151) 2016 09 20
(181) 2026 09 20
(891) 2016 09 20
(511) 16, 35, 41, 45

(260) AM 2018 90827 A
(800) 1330259
(151) 2016 10 13
(181) 2026 10 13
(891) 2016 10 13
(511) 12

(260) AM 2018 91014 A
(800) 1331727
(151) 2016 06 08
(181) 2026 06 08
(891) 2016 06 08
(511) 07, 09, 11

(260) AM 2018 90828 A
(800) 1330653
(151) 2016 10 14
(181) 2026 10 14
(891) 2016 10 14
(511) 05

(260) AM 2018 91015 A
(800) 1332743
(151) 2016 11 18
(181) 2026 11 18
(891) 2016 11 18
(511) 09, 42

(260) AM 2018 91016 A
(800) 1331738
(151) 2016 06 16
(181) 2026 06 16
(891) 2016 06 16
(511) 10, 11

(260) AM 2018 91019 A
(800) 1331904
(151) 2015 11 05
(181) 2025 11 05
(891) 2015 11 05
(511) 25, 35

(260) AM 2018 91022 A
(800) 1331916
(151) 2016 10 28
(181) 2026 10 28
(891) 2016 10 28
(511) 34

(260) AM 2018 91028 A
(800) 1331979
(151) 2016 09 27
(181) 2026 09 27
(891) 2016 09 27
(511) 34

(260) AM 2018 91148 A
(800) 1275584
(151) 2015 09 17
(181) 2025 09 17
(891) 2016 11 16
(511) 29, 30

(260) AM 2018 91214 A
(800) 1333645
(151) 2016 12 07
(181) 2026 12 07
(891) 2016 12 07
(511) 14

(260) AM 2018 91216 A
(800) 1333652
(151) 2016 08 05
(181) 2026 08 05
(891) 2016 08 05
(511) 41, 44

(260) AM 2018 91217 A
(800) 799629
(151) 2002 06 28
(181) 2012 06 28

(891) 2016 12 29
(511) 04

(260) AM 2018 91218 A
(800) 1072257
(151) 2011 03 18
(181) 2021 03 18
(891) 2017 02 14
(511) 07, 21

(260) AM 2018 91219 A
(800) 1085535
(151) 2011 06 29
(181) 2021 06 29
(891) 2017 02 14
(511) 07, 21

(260) AM 2018 91222 A
(800) 1114836
(151) 2012 01 27
(181) 2022 01 27
(891) 2016 12 14
(511) 09, 41

(260) AM 2018 91223 A
(800) 1221939
(151) 2014 08 26
(181) 2024 08 26
(891) 2016 12 21
(511) 14

(260) AM 2018 91224 A
(800) 1333685
(151) 2016 06 03
(181) 2026 06 03
(891) 2016 06 03
(511) 02, 08, 16, 18, 25, 28

(260) AM 2018 91244 A
(800) 1333732
(151) 2016 08 03
(181) 2026 08 03
(891) 2016 08 03
(511) 05, 32

(260) AM 2018 91245 A
(800) 1333749
(151) 2016 08 29
(181) 2026 08 29
(891) 2016 08 29
(511) 25

(260) AM 2018 91247 A
(800) 1333804
(151) 2016 11 10
(181) 2026 11 10
(891) 2016 11 10
(511) 29

(260) AM 2018 91249 A
(800) 1333834
(151) 2016 11 17
(181) 2026 11 17
(891) 2016 11 17
(511) 29

(260) AM 2018 91251 A
(800) 1333839
(151) 2016 12 09
(181) 2026 12 09
(891) 2016 12 09
(511) 05, 35

(260) AM 2018 91252 A
(800) 1334127
(151) 2016 10 27
(181) 2026 10 27
(891) 2016 10 27
(511) 03, 05, 10, 35

(260) AM 2018 91253 A
(800) 1333883
(151) 2016 10 03
(181) 2026 10 03
(891) 2016 10 03
(511) 01, 05, 35, 40, 42, 45

(260) AM 2018 91326 A
(800) 1335033
(151) 2016 11 23
(181) 2026 11 23
(891) 2016 11 23
(511) 41

(260) AM 2018 91327 A
(800) 1334780
(151) 2016 09 14
(181) 2026 09 14
(891) 2016 09 14
(511) 09, 28

(260) AM 2018 91334 A
(800) 1335084
(151) 2016 11 15
(181) 2026 11 15

(891) 2016 11 15
(511) 03

(260) AM 2018 91336 A
(800) 476778
(151) 1983 05 24
(181) 1993 05 24
(891) 2017 01 20
(511) 33

(260) AM 2018 91337 A
(800) 1334804
(151) 2016 07 29
(181) 2026 07 29
(891) 2016 07 29
(511) 29, 30

(260) AM 2018 91338 A
(800) 1334809
(151) 2016 09 06
(181) 2026 09 06
(891) 2016 09 06
(511) 12

(260) AM 2018 91363 A
(800) 1335148
(151) 2016 12 26
(181) 2026 12 26
(891) 2016 12 26
(511) 33

(260) AM 2018 91365 A
(800) 1335217
(151) 2016 08 26
(181) 2026 08 26
(891) 2016 08 26
(511) 09, 16, 35, 36, 38, 41, 42

(260) AM 2018 91366 A
(800) 1335237
(151) 2016 06 01
(181) 2026 06 01
(891) 2016 06 01
(511) 14

(260) AM 2018 91367 A
(800) 1018307
(151) 2009 09 28
(181) 2019 09 28
(891) 2017 01 25
(511) 08

(260) AM 2018 91368 A
(800) 1079830
(151) 2011 03 22
(181) 2021 03 22
(891) 2017 01 20
(511) 27

(260) AM 2018 91423 A
(800) 1335864
(151) 2017 01 24
(181) 2027 01 24
(891) 2017 01 24
(511) 08, 21

(260) AM 2018 91429 A
(800) 1335524
(151) 2016 11 04
(181) 2026 11 04
(891) 2016 11 04
(511) 11

(260) AM 2018 91430 A
(800) 1335535
(151) 2016 12 16
(181) 2026 12 16
(891) 2016 12 16
(511) 30

(260) AM 2018 91432 A
(800) 1335547
(151) 2017 01 05
(181) 2027 01 05
(891) 2017 01 05
(511) 14

(260) AM 2018 91433 A
(800) 1335550
(151) 2016 08 01
(181) 2026 08 01
(891) 2016 08 01
(511) 35, 41

(260) AM 2018 91434 A
(800) 1335934
(151) 2016 10 05
(181) 2026 10 05
(891) 2016 10 05
(511) 30

(260) AM 2018 91436 A
(800) 1335643
(151) 2016 12 12
(181) 2026 12 12

(891) 2016 12 12
(511) 05, 29, 30

(260) AM 2018 91439 A
(800) 1336184
(151) 2016 12 22
(181) 2026 12 22
(891) 2016 12 22
(511) 09

(260) AM 2018 91442 A
(800) 1336189
(151) 2016 12 16
(181) 2026 12 16
(891) 2016 12 16
(511) 30

(260) AM 2018 91443 A
(800) 1335707
(151) 2016 11 22
(181) 2026 11 22
(891) 2016 11 22
(511) 10

(260) AM 2018 91446 A
(800) 1335741
(151) 2017 01 12
(181) 2027 01 12
(891) 2017 01 12
(511) 05

(260) AM 2018 91447 A
(800) 1336194
(151) 2016 12 21
(181) 2026 12 21
(891) 2016 12 21
(511) 04

(260) AM 2018 91452 A
(800) 1335744
(151) 2016 12 14
(181) 2026 12 14
(891) 2016 12 14
(511) 43

(260) AM 2018 91453 A
(800) 1336196
(151) 2016 12 05
(181) 2026 12 05
(891) 2016 12 05
(511) 01, 04

(260) AM 2018 91454 A
(800) 1336027
(151) 2016 11 02
(181) 2026 11 02
(891) 2016 11 02
(511) 43

(260) AM 2018 91455 A
(800) 1335755
(151) 2016 04 26
(181) 2026 04 26
(891) 2016 04 26
(511) 03, 05, 10, 16, 25, 29, 30, 35, 41, 42, 44

(260) AM 2018 91487 A
(800) 1336075
(151) 2016 10 27
(181) 2026 10 27
(891) 2016 10 27
(511) 05

(260) AM 2018 91492 A
(800) 1336109
(151) 2016 12 21
(181) 2026 12 21
(891) 2016 12 21
(511) 04

(260) AM 2018 91496 A
(800) 1336117
(151) 2016 12 28
(181) 2026 12 28
(891) 2016 12 28
(511) 05

(260) AM 2018 91549 A
(800) 1336230
(151) 2016 11 21
(181) 2026 11 21
(891) 2016 11 21
(511) 11

(260) AM 2018 91550 A
(800) 1336240
(151) 2016 11 24
(181) 2026 11 24
(891) 2016 11 24
(511) 35

(260) AM 2018 91551 A
(800) 1336261
(151) 2016 11 21
(181) 2026 11 21

(891) 2016 11 21
(511) 09

(260) AM 2018 91553 A
(800) 1336283
(151) 2016 12 19
(181) 2026 12 19
(891) 2016 12 19
(511) 05

(260) AM 2018 91557 A
(800) 1336292
(151) 2016 12 27
(181) 2026 12 27
(891) 2016 12 27
(511) 33

(260) AM 2018 91559 A
(800) 1336343
(151) 2016 10 12
(181) 2026 10 12
(891) 2016 10 12
(511) 25, 35

(260) AM 2018 91560 A
(800) 1336354
(151) 2016 12 16
(181) 2026 12 16
(891) 2016 12 16
(511) 03, 05

(260) AM 2018 91561 A
(800) 1336359
(151) 2016 08 18
(181) 2026 08 18
(891) 2016 08 18
(511) 18, 25

(260) AM 2018 91562 A
(800) 1336386
(151) 2016 12 27
(181) 2026 12 27
(891) 2016 12 27
(511) 33

(260) AM 2018 91563 A
(800) 1336401
(151) 2016 11 21
(181) 2026 11 21
(891) 2016 11 21
(511) 09

(260) AM 2018 91564 A
(800) 1336448
(151) 2017 01 24
(181) 2027 01 24
(891) 2017 01 24
(511) 30

(260) AM 2018 91601 A
(800) 1336671
(151) 2016 12 22
(181) 2026 12 22
(891) 2016 12 22
(511) 05

(260) AM 2018 91602 A
(800) 1336677
(151) 2016 12 22
(181) 2026 12 22
(891) 2016 12 22
(511) 05

(260) AM 2018 91758 A
(800) 1338919
(151) 2016 11 23
(181) 2026 11 23
(891) 2016 11 23
(511) 35, 36, 38, 39, 41, 42, 43

(260) AM 2018 91825 A
(800) 1339634
(151) 2016 10 28
(181) 2026 10 28
(891) 2016 10 28
(511) 03, 05

(260) AM 2018 91826 A
(800) 1339635
(151) 2016 10 28
(181) 2026 10 28
(891) 2016 10 28
(511) 03, 05

(260) AM 2018 91828 A
(800) 1339679
(151) 2016 11 23
(181) 2026 11 23
(891) 2016 11 23
(511) 09

(260) AM 2018 91829 A
(800) 1339682
(151) 2016 12 02
(181) 2026 12 02

(891) 2016 12 02
(511) 05, 29, 30, 32

(260) AM 2018 91892 A
(800) 1339796
(151) 2016 11 23
(181) 2026 11 23
(891) 2016 11 23
(511) 09

(260) AM 2018 92006 A
(800) 1341528
(151) 2017 01 03
(181) 2027 01 03
(891) 2017 01 03
(511) 09

(260) AM 2018 92008 A
(800) 1341531
(151) 2016 11 23
(181) 2026 11 23
(891) 2016 11 23
(511) 09

(260) AM 2018 92009 A
(800) 1341532
(151) 2016 11 23
(181) 2026 11 23
(891) 2016 11 23
(511) 09

(260) AM 2018 92090 A
(800) 1209032
(151) 2014 03 17
(181) 2024 03 17
(891) 2017 01 11
(511) 12

(260) AM 2018 92091 A
(800) 1296609
(151) 2016 02 19
(181) 2026 02 19
(891) 2017 01 12
(511) 03

(260) AM 2018 92092 A
(800) 1325740
(151) 2016 10 28
(181) 2026 10 28
(891) 2017 02 20
(511) 34, 41

(260) AM 2018 92095 A
(800) 1341684
(151) 2016 11 15
(181) 2026 11 15
(891) 2016 11 15
(511) 07, 09, 12, 14, 25, 35, 36, 37, 42

OFFICIAL NOTIFICATIONS

TRADEMARKS

RENEWAL OF REGISTRATIONS

(111) M 1998 9684 R2

(156) 1998 06 11

(186) 2028 06 11

(732) MIH INTELPROP HOLDINGS LIMITED

a Mauritian Company

of 3rd Floor, Les Cascades, Edith Cavell

Street, Port Louis, Mauritius

(111) M 1998 8969 R2

(156) 1998 04 24

(186) 2028 04 24

(732) ŠKODA INVESTMENT a.s.

Vaclavske nam. 837/11, 110 00, Praha 1,

Czech Republic

(111) M 1998 8970 R2

(156) 1998 04 24

(186) 2028 04 24

(732) ŠKODA INVESTMENT a.s.

Vaclavske nam. 837/11, 110 00, Praha 1,

Czech Republic

(111) M 1998 9698 R2

(156) 1998 06 11

(186) 2028 06 11

(732) Wyeth Holdings LLC

235 East 42nd Street New York, New York

10017, USA

(111) M 1998 9246 R2

(156) 1998 05 06

(186) 2028 05 06

(732) RED BULL GMBH

Am Brunnen 1, A-5330 Fuschl am See,

Austria

(111) M 1998 9707 R2

(156) 1998 06 11

(186) 2028 06 11

(732) HEWLETT PACKARD ENTERPRISE

DEVELOPMENT LP

11445 Compaq Center Drive West, Houston,

Texas 77070, USA

(732) MUNDIPHARMA AG.

St. Alban-Rheinweg 74, CH-4020 Basel,

Switzerland

(111) M 1998 10171 R2

(156) 1998 08 05

(186) 2028 08 05

(732) MICROSOFT CORPORATION

One Microsoft Way, Redmond, Washington

98052-6399, USA

(111) M 1998 8343 R2

(156) 1998 02 17

(186) 2028 02 17

(732) KOOKAI SAS

6-10 Boulevard Fosh, 93800 Epinay-sur-

seine, France

(111) M 1998 9037 R2

(156) 1998 04 29

(186) 2028 04 29

(732) RED BULL GMBH

Am Brunnen 1, A-5330 Fuschl am See,

Austria

(111) M 1998 9023 R2

(156) 1998 04 28

(186) 2028 04 28

(732) ABBOT POINT OF CARE INC.

400 College Road East, Princeton, New

Jersey 08540, USA

(111) M 1998 8233 R2

(156) 1998 02 04

(186) 2028 02 04

(732) FORD MOTOR COMPANY

One American Road, Dearborn, Michigan

48126, USA

(111) M 1998 8779 R2

(156) 1998 04 06

(186) 2028 04 06

(732) HAITAI CONFECTIONERY AND FOODS

CO., LTD

321-4 Chonheung-ri, Sungguh-eup, Cheonan
City, Choongchungnam-do, Korea (Republic of)

(111) M 1998 9079 R2

(156) 1998 04 29

(186) 2028 04 29

(732) CITIZEN TOKEI KABUSHIKI KAISHA
also trading as CITIZEN WATCH CO.,
LTD
1-12,6-Chome, Tanashi-cho, Nishi-tokyo-
shi, Tokyo, Japan

(111) M 1998 8879 R2

(156) 1998 04 10

(186) 2028 04 10

(732) FILA LUXEMBOURG S.A.R.L.
26, Boulevard Royal, L-2449, Luxembourg,
Luxembourg

(111) M 1998 8588 R2

(156) 1998 03 09

(186) 2028 03 09

(732) COBRA ELECTRONICS CORPORATION
a Delaware State Corporation
6500, West Cortland Street, Chicago,
Illinois, USA

(111) M 1997 7923 R2

(156) 1997 12 22

(186) 2027 12 22

(732) FORD MOTOR COMPANY
One American Road, Dearborn, Michigan
48126, USA

(111) M 1998 8045 R2

(156) 1998 01 15

(186) 2028 01 15

(732) FORD MOTOR COMPANY
One American Road, Dearborn, Michigan
48126, USA

(111) M 1997 7924 R2

(156) 1997 12 22

(186) 2027 12 22

(732) FORD MOTOR COMPANY
One American Road, Dearborn, Michigan
48126, USA

(111) M 1998 8752 R2

(156) 1998 03 27

(186) 2028 03 27

(732) SAN MIGUEL BREWING

INTERNATIONAL LIMITED
Romasco Place, Wickhams Cay 1, Road
Town, Tortola, British Virgin Islands c/o 9/F
Citimark Building 28 Yuen Shum Circuit,
Sha Tin, NT, Hong Kong

(111) M 1998 8754 R2

(156) 1998 03 27

(186) 2028 03 27

(732) ISUZU JIDOSHA KABUSHIKI
KAISHA
26-1, Minami-Oi 6-Chome, Shinagawa-Ku,
Tokyo, Japan

(111) M 1998 9846 R2

(156) 1998 06 23

(186) 2028 06 23

(732) HOLT LLOYD BV
Stravinskilaan 3127, Me-8 Sartuli, 1077 ZX,
Amsterdami, Netherlands

(111) M 1998 9847 R2

(156) 1998 06 23

(186) 2028 06 23

(732) BAYER CONSUMER CARE AG
Peter Merian-Str. 84, 4052 Basel, Switzerland

(111) M 1998 9849 R2

(156) 1998 06 24

(186) 2028 06 24

(732) BAYER CONSUMER CARE AG
Peter Merian-Str. 84, 4052 Basel, Switzerland

(111) M 1998 9850 R2

(156) 1998 06 24

(186) 2028 06 24

(732) BAYER CONSUMER CARE AG
Peter Merian-Str. 84, 4052 Basel, Switzerland

(111) M 1998 9851 R2

(156) 1998 06 24

(186) 2028 06 24

(732) BAYER CONSUMER CARE AG
Peter Merian-Str. 84, 4052 Basel, Switzerland

(111) M 1998 9852 R2

(156) 1998 06 24

(186) 2028 06 24

(732) BAYER CONSUMER CARE AG
Peter Merian-Str. 84, 4052 Basel, Switzerland

(111) M 1998 9856 R2
(156) 1998 06 24
(186) 2028 06 24
(732) BAYER CONSUMER CARE AG
Peter Merian-Str. 84, 4052 Basel, Switzerland

(111) M 1998 9857 R2
(156) 1998 06 24
(186) 2028 06 24
(732) BAYER CONSUMER CARE AG
Peter Merian-Str. 84, 4052 Basel, Switzerland

(111) M 1998 9858 R2
(156) 1998 06 24
(186) 2028 06 24
(732) BAYER CONSUMER CARE AG
Peter Merian-Str. 84, 4052 Basel, Switzerland

(111) M 1998 9860 R2
(156) 1998 06 24
(186) 2028 06 24
(732) BAYER CONSUMER CARE AG
Peter Merian-Str. 84, 4052 Basel, Switzerland

(111) M 1998 9861 R2
(156) 1998 06 24
(186) 2028 06 24
(732) BAYER CONSUMER CARE AG
Peter Merian-Str. 84, 4052 Basel, Switzerland

(111) M 1998 8170 R2
(156) 1998 01 29
(186) 2028 01 29
(732) EGIS GYÓGYSZERGYÁR ZRT.
Keresztúri út 30-38, 1106 Budapest, Hungary

(111) M 1998 8829 R2
(156) 1998 04 08
(186) 2028 04 08
(732) INTERNATIONAL FOODSTUFFS CO.
Al-Wahda Street, Industrial Area N1,
P.O. BOX 4115, Sharjah, United Arab
Emirates

(111) M 1998 9462 R2
(156) 1998 05 28
(186) 2028 05 28
(732) ISCAR LTD
P.O. Box 11, Tefen 24959, Israel

(111) M 1998 8831 R2
(156) 1998 04 08
(186) 2028 04 08
(732) IVECO S.p.A.
Via Puglia 35, Turin, P/C 10156, Italy

(111) M 1998 9897 R2
(156) 1998 06 26
(186) 2028 06 26
(732) PPG ARCHITECTURAL FINISHES, INC.
One PPG Place, Pittsburgh, Pennsylvania
15272, USA

(111) M 1998 8836 R2
(156) 1998 04 10
(186) 2028 04 10
(732) PASABAHCE CAM SANAYI VE TICARET
A.S.
İçmeler Mah. D-100 Karayolu Cad. Çarşı
Ofis Binasi A Blok N44 A1 34947 Tuzla
Istanbul, Turkey

(111) M 1998 9584 R2
(156) 1998 06 04
(186) 2028 06 04
(732) EISAI R&D MANAGEMENT CO., LTD
No.6-10, Koishikawa 4-chome, Bunkyo-ku,
Tokyo, Japan

(111) M 1998 9428 R2
(156) 1998 05 25
(186) 2028 05 25
(732) Hyundai Motor Company
231, Yangjae-Dong, Seocho-Gu, Seoul,
Korea (Republic of)

(111) M 1998 9977 R2
(156) 1998 07 07
(186) 2028 07 07
(732) HERMES INTERNATIONAL (Societe en
commandite par actions)
24, rue du Faubourg Saint Honore, 75008
Paris, France

(111) M 1998 10402 R2
(156) 1998 08 20
(186) 2028 08 20
(732) HORIBA ABX SAS
Rue du Caducee, Parc Euromedecine, 34000
Montpellier, France

(111) M 1998 10465 R2
(156) 1998 08 20
(186) 2028 08 20
(732) BOLSIUS INTERNATIONAL B.V.
Kerkendijk 126, 5482 KK Schijndel,
Netherlands

(111) M 1998 10079 R2
(156) 1998 07 30
(186) 2028 07 30
(732) THE JUICE PLUS+ COMPANY, LLC
140 Crescent Drive, Collierville, Shelby
Country, Tennessee 38017, USA

(111) M 1998 10161 R2
(156) 1998 08 05
(186) 2028 08 05
(732) ADVANCE MAGAZINE PUBLISHERS INC.
Uan Uorld Treid Senteri, Niu-iorki,
NY 10007, USA

(111) M 1998 9461 R2
(156) 1998 05 28
(186) 2028 05 28
(732) COLOP-STEMPELERZEUGUNG
SKOPEK GESELLSCHAFT M.B.H. & CO.
KG
Dr. F.-Arming-Strasse 5, A-4600 Wels,
Austria

(111) M 1998 10165 R2
(156) 1998 08 05
(186) 2028 08 05
(732) RICOLA AG. (RICOLA LTD)
Baselstrasse 31, CH-4242 Laifen,
Switzerland

(111) M 1998 10543 R2
(156) 1998 08 26
(186) 2028 08 26
(732) ADVANCE MAGAZINE PUBLISHERS
INC.
One World Trade Center, New York,
NY 10007, USA

(111) M 1998 10541 R2
(156) 1998 08 26
(186) 2028 08 26
(732) ADVANCE MAGAZINE PUBLISHERS
INC.
One World Trade Center, New York, NY
10007, USA

(111) M 1998 10542 R2
(156) 1998 08 26
(186) 2028 08 26
(732) ADVANCE MAGAZINE PUBLISHERS INC.
One World Trade Center, New York, NY
10007, USA

(111) M 1998 10809 R2
(156) 1998 09 15
(186) 2028 09 15
(732) V.I.P. INDUSTRIES LIMITED
78A, MIDS Estate, Satpur, Nashik 422007,
India

(111) M 1998 11022 R2
(156) 1998 10 28
(186) 2028 10 28
(732) Wm. WRIGLEY JR. COMPANY
1132 West Blackhawk Street, Chicago,
Illinois 60642, USA

(111) M 1998 11023 R2
(156) 1998 10 28
(186) 2028 10 28
(732) Wm. WRIGLEY JR. COMPANY
1132 West Blackhawk Street, Chicago,
Illinois 60642, USA

(111) M 1998 11027 R2
(156) 1998 10 28
(186) 2028 10 28
(732) Wm. WRIGLEY JR. COMPANY
1132 West Blackhawk Street, Chicago,
Illinois 60642, USA

(111) M 1998 11175 R2
(156) 1998 12 02
(186) 2028 12 02
(732) OOO Henkel RUS
107045, Moscow, Kolokolnikov pereulok 11,
Russian Federation

(111) M 1998 11290 R2
(156) 1998 12 14
(186) 2028 12 14
(732) WM.WRIGLEY JR.COMPANY
1132 West Blackhawk Street, Chicago,
Illinois 60642, USA

(111) M 1998 8286 R2
(156) 1998 02 06
(186) 2028 02 06

(732) GENERAL CIGAR CO., INC.
10900 Nuckols Road, Suite 100, Glen Allen,
Virginia 23060, USA

(111) M 1998 8266 R2
(156) 1998 02 06
(186) 2028 02 06

(732) HUGO BOSS Trade Mark Management
mbH & Co. KG
Dieselstrasse 12, 72555 Metzingen, Germany

(111) M 1998 8268 R2
(156) 1998 02 06
(186) 2028 02 06

(732) CHIVAS HOLDINGS (IP) LIMITED
111/113 Renfrew Road, Paisley
Renfrewshire, PA3 4DY, Scotland, United
Kingdom

(111) M 1998 8968P1 R2
(156) 1998 04 24
(186) 2028 04 24

(732) ŠKODA INVESTMENT a.s.
Vaclavske nam. 837/11, 110 00, Praha 1,
Czech Republic

(111) M 2007 17882 R1
(156) 2007 10 10
(186) 2027 10 10

(732) NIKOLOZ MEDULASHVILI
Kakhetis gzatk. 36-v, b. 34, 0190, Tbilisi,
Georgia

(111) M 1998 9455 R2
(156) 1998 05 28
(186) 2028 05 28

(732) VELCRO BVBA
Industrielaan 16, 9800 Deinze, Belgium

(111) M 2007 17823 R1
(156) 2007 09 18
(186) 2027 09 18

(732) KAREN VARDANYAN
Baironis q. 3, b.36, Yerevan, Armenia

(111) M 2007 17824 R1
(156) 2007 09 18
(186) 2027 09 18

(732) KAREN VARDANYAN
Baironis q. 3, b. 36, Yerevan, Armenia

(111) M 2008 18191 R1
(156) 2008 01 28
(186) 2028 01 28

(732) Pharmaceutical Chemical Cosmetic Industry-
ALKALOID AD, Skopje
Bulevar Aleksandar Makedonski No12,
MK-1000 Skopje, Macedonia (the former
Yugoslav Republic of)

(111) M 2008 18320 R1
(156) 2008 03 27
(186) 2028 03 27

(732) GENERAL MOTORS LLC
300 Renaissance Center, City of Detroit,
State of Michigan 48265-3000, USA

(111) M 2008 18348 R1
(156) 2008 04 14
(186) 2028 04 14

(732) HAYAT KIMYA SANAYI A.Ş.
Mahir Iz Caddesi No: 25 Altunizade üsküdar,
Istanbul, Turkey

(111) M 2008 18513 R1
(156) 2008 06 16
(186) 2028 06 16

(732) YKK Corporation
1, Kanda Izumi-Cho, Chiyoda-Ku, Tokyo,
Japan

(111) M 2008 18196 R1
(156) 2008 01 28
(186) 2028 01 28

(732) SHALVA GVARAMADZE
Bakhtionis q., korp. I, b. 10, 0194, Tbilisi,
Georgia

(111) M 2008 18304 R1
(156) 2008 03 17
(186) 2028 03 17

(732) GSH TRADEMARKS LIMITED
Afroditis St. 25, 2nd floor, office 204,
Nicosia, Cyprus

(111) M 2008 18451 R1
(156) 2008 05 16
(186) 2028 05 16

(732) APOLLO TYRES LTD
Apollo House, 7, Institutional Area, Sector-32,
Gurgaon, Haryana-122001, India

(111) M 2008 18306 R1
(156) 2008 03 17
(186) 2028 03 17
(732) LTD "G-M-P"
Sop. Ponitchala 65, 0165, Tbilisi, Georgia

(111) M 2008 18333 R1
(156) 2008 03 27
(186) 2028 03 27
(732) GSH Trademarks Limited
Afroditis, 25, 2nd floor, office 204, Nicosia,
Cyprus

(111) M 2008 18292 R1
(156) 2008 02 28
(186) 2028 02 28
(732) WORLD MEDICINE LIMITED
48 Quenn Anne Street, London W1G9JJ,
United Kingdom

(111) M 2008 18359 R1
(156) 2008 04 14
(186) 2028 04 14
(732) LTD "G-M-P"
Sop. Ponitchala 65, 0165, Tbilisi, Georgia

(111) M 2008 18360 R1
(156) 2008 04 14
(186) 2028 04 14
(732) LTD "G-M-P"
Sop. Ponitchala 65, 0165, Tbilisi, Georgia

(111) M 2008 18366 R1
(156) 2008 04 14
(186) 2028 04 14
(732) THE PRUDENTIAL INSURANCE
COMPANY OF AMERICA
(a New Jersey Corporation)
751 Broad street, Newark, New Jersey, USA

(111) M 2008 18539 R1
(156) 2008 06 16
(186) 2028 06 16
(732) AMERICAN EXPRESS MARKETING &
DEVELOPMENT CORP.
200 Vesey St., 49-12, New York, N.Y.
10285, USA

(111) M 2008 18391 R1
(156) 2008 04 29
(186) 2028 04 29
(732) THE COCA-COLA COMPANY

One Coca-Cola Plaza, Atlanta,
Georgia 30313, USA

(111) M 2008 18392 R1
(156) 2008 04 29
(186) 2028 04 29
(732) THE COCA-COLA COMPANY
One Coca-Cola Plaza, Atlanta, Georgia
30313, USA

(111) M 2008 18421 R1
(156) 2008 05 01
(186) 2028 05 01
(732) WYETH LLC
235 Ist 42 Striti, Niu-iorki, Niu-iorki 10017,
USA

(111) M 2008 18473 R1
(156) 2008 05 16
(186) 2028 05 16
(732) MIKAYEL VARDANYAN
Bairon St. 3, ap. 38, Yerevan, Armenia

(111) M 1998 8389 R2
(156) 1998 02 20
(186) 2028 02 20
(732) CHAMPAGNE PERRIER-JOUET
28, avenue de Champagne, F-51200 Epernay,
France

(111) M 1998 8390 R2
(156) 1998 02 20
(186) 2028 02 20
(732) CHAMPAGNE PERRIER-JOUET
28, avenue de Champagne, F-51200 Epernay,
France

(111) M 1998 10660 R2
(156) 1998 09 10
(186) 2028 09 10
(732) NALCO COMPANY
1601 W. Diehl Road, Naperville, Illinois,
USA

(111) M 1998 9285 R2
(156) 1998 05 11
(186) 2028 05 11
(732) BACARDI & COMPANY LIMITED
Aeulestrasse 5, 9490 Vaduz, Liechtenstein,
Liechtenstein

(111) M 1998 8697 R2
(156) 1998 03 20
(186) 2028 03 20
(732) LEGRAND FRANCE
128, avenue du Marechal de Lattre de
Tassigny, F-87000 Limoges, France

(111) M 1998 8727 R2
(156) 1998 03 25
(186) 2028 03 25
(732) LEGRAND FRANCE
128, avenue du Marechal de Lattre de
Tassigny, F-87000 Limoges, France

(111) M 1998 8736 R2
(156) 1998 03 26
(186) 2028 03 26
(732) AKEBONO BRAKE INDUSTRY CO., LTD
N 19-5, Nihonbashi Koami-cho, Chuo-ku,
Tokyo, Japan

(111) M 1998 8737 R2
(156) 1998 03 26
(186) 2028 03 26
(732) AKEBONO BRAKE INDUSTRY CO., LTD
N 19-5, Nihonbashi Koami-cho, Chuo-ku,
Tokyo, Japan

(111) M 1998 9471 R2
(156) 1998 05 29
(186) 2028 05 29
(732) BEIERSDORF AG
Unnastrasse 48, D-20253 Hamburg, Germany

(111) M 1998 9473 R2
(156) 1998 05 29
(186) 2028 05 29
(732) BEIERSDORF AG
Unnastrasse 48, D-20253 Hamburg, Germany

(111) M 1998 9478 R2
(156) 1998 05 29
(186) 2028 05 29
(732) BEIERSDORF AG
Unnastrasse 48, D-20253 Hamburg, Germany

(111) M 1998 9480 R2
(156) 1998 05 29
(186) 2028 05 29
(732) FMC CORPORATION
a Delaware Corporation
1735 Market Street, Philadelphia,
Pennsylvania 19103, USA

(111) M 1998 9482 R2
(156) 1998 05 29
(186) 2028 05 29
(732) FMC CORPORATION
a Delaware Corporation
1735 Market Street, Philadelphia,
Pennsylvania 19103, USA

(111) M 1998 9486 R2
(156) 1998 05 29
(186) 2028 05 29
(732) FMC CORPORATION
a Delaware Corporation
1735 Market Street, Philadelphia,
Pennsylvania 19103, USA

(111) M 1998 9493 R2
(156) 1998 06 01
(186) 2028 06 01
(732) FMC CORPORATION
a Delaware Corporation
1735 Market Street, Philadelphia,
Pennsylvania 19103, USA

(111) M 1998 8442 R2
(156) 1998 02 26
(186) 2028 02 26
(732) INA ECQUISITION CORP.
2711 Centerville Road, Suite 400,
Wilmington, Delaware 19808, USA

(111) M 1998 8443 R2
(156) 1998 02 26
(186) 2028 02 26
(732) INA ECQUISITION CORP.
2711 Centerville Road, Suite 400,
Wilmington, Delaware 19808, USA

(111) M 1998 8444 R2
(156) 1998 02 26
(186) 2028 02 26
(732) INA ECQUISITION CORP.
2711 Centerville Road, Suite 400,
Wilmington, Delaware 19808, USA

(111) M 1998 11115 R2
(156) 1998 11 27
(186) 2028 11 27
(732) ADIDAS INTERNATIONAL MARKETING
B.V.
Hoogoordreef 9A, 1101 BA Amsterdam,
Netherlands

(111) M 1998 11116 R2
(156) 1998 11 27
(186) 2028 11 27
(732) ADIDAS INTERNATIONAL MARKETING
B.V.
Hoogoordreef 9A, 1101 BA Amsterdam,
Netherlands

(111) M 1998 11118 R2
(156) 1998 11 27
(186) 2028 11 27
(732) ADIDAS INTERNATIONAL MARKETING
B.V.
Hoogoordreef 9A, 1101 BA Amsterdam,
Netherlands

(111) M 1998 11119 R2
(156) 1998 11 27
(186) 2028 11 27
(732) ADIDAS INTERNATIONAL MARKETING
B.V.
Hoogoordreef 9A, 1101 BA Amsterdam,
Netherlands

(111) M 1998 11120 R2
(156) 1998 11 27
(186) 2028 11 27
(732) ADIDAS INTERNATIONAL MARKETING
B.V.
Hoogoordreef 9A, 1101 BA Amsterdam,
Netherlands

(111) M 1998 10002 R2
(156) 1998 07 09
(186) 2028 07 09
(732) GE Healthcare AS
Nycoveien 2, 0485 Oslo, Norway

(111) M 1998 11142 R2
(156) 1998 11 27
(186) 2028 11 27
(732) GE Healthcare AS
Nycoveien 2, 0485 Oslo, Norway

(111) M 1997 7874 R2
(156) 1997 12 16
(186) 2027 12 16
(732) ABLOY OY
Wahlforssinkatu 20, FIN-80101 Joensuu,
Finland

(111) M 1997 7875 R2
(156) 1997 12 16
(186) 2027 12 16
(732) ASHLAND LICENSING AND
INTELLECTUAL PROPERTY LLC
5200 Blazer Parkway, Dublin, Ohio 43017,
USA

(111) M 1998 8649 R2
(156) 1998 03 12
(186) 2028 03 12
(732) REEMTSMA CIGARETTENFABRIKEN
GMBH
Maqs-born-shtrase 4, 22761 Hamburgi,
Germany

(111) M 1998 9306 R2
(156) 1998 05 13
(186) 2028 05 13
(732) ADIDAS AG
Adi-dassler-Shtrasse 1, 91074
Herzogenaurach, Germany

(111) M 1998 9307 R2
(156) 1998 05 13
(186) 2028 05 13
(732) ADIDAS AG
Adi-Dassler-Strasse 1, 91074
Herzogenarrach, Germany

(111) M 1998 9308 R2
(156) 1998 05 13
(186) 2028 05 13
(732) ADIDAS AG
Adi-Dassler-Strasse 1, 91074
Herzogenarrach, Germany

(111) M 1998 9310 R2
(156) 1998 05 13
(186) 2028 05 13
(732) WARNER BROS. ENTERTAINMENT
INC., a Delaware corporation
4000 Warner Blvd., Burbank, California
91522, USA

(111) M 1998 8457 R2
(156) 1998 02 26
(186) 2028 02 26
(732) SOMFY ACTIVITES SA
50, Avenue du Nouveau Monde-74300
Cluses, France

(111) M 1998 9750 R2
(156) 1998 06 15
(186) 2028 06 15
(732) MAYTAG PROPERTIES LLC
(a Michigan Limited liability company)
500 Renaissance Drive, Suite 101, St. Joseph,
Michigan 49085, USA

(111) M 1998 9294 R2
(156) 1998 05 13
(186) 2028 05 13
(732) DK COMPANY A/S
La Cours Vej 6, 7430 Ikast, Denmark

(111) M 1998 9352 R2
(156) 1998 05 19
(186) 2028 05 19
(732) KASTO MACHINENBAU GmbH
CO KG
14, Industriestrasse, D-7590 Achern,
Germany

(111) M 1998 9367 R2
(156) 1998 05 20
(186) 2028 05 20
(732) ERCO GmbH
Brochhauzer Weg 80-82, 5880 Ludenscheid,
Germany

(111) M 1998 8500 R2
(156) 1998 03 02
(186) 2028 03 02
(732) INTERCONTINENTAL GREAT BRANDS
LLC.
100 Deforest Ave, East Hanover, NJ, 07936,
USA

(111) M 1998 10785 R2
(156) 1998 09 15
(186) 2028 09 15
(732) Wm. WRIGLEY Jr. Company
1132 West Blackhawk Street, Chicago,
Illinois 60642, USA

(111) M 1998 9117 R2
(156) 1998 04 30
(186) 2028 04 30
(732) ROHM AND HAAS COMPANY
Independence Mall West, City of
Philadelphia, State of Pennsylvania 19105,
USA

(111) M 1998 9613 R2
(156) 1998 06 08
(186) 2028 06 08
(732) ROHM AND HAAS COMPANY
Independence Mall West, City of
Philadelphia, State of Pennsylvania
19105, USA

(111) M 1998 10046 R2
(156) 1998 07 09
(186) 2028 07 09
(732) KIA MOTORS CORPORATION
12 Heolleung-ro, Seocho-gu, Seuli,
(Republic of Korea)

(111) M 1998 8748 R2
(156) 1998 03 27
(186) 2028 03 27
(732) TRINECKE ZELEZARNY A.S.
Prumyslová 100 Staré Město, 739 61 Třinec,
Czech Republic

(111) M 1998 8762 R2
(156) 1998 03 30
(186) 2028 03 30
(732) ZIMMER INC.
345 east Main Street, Warsaw, Indiana
46580, USA

(111) M 1998 9655 R2
(156) 1998 06 09
(186) 2028 06 09
(732) FRUIT OF THE LOOM, INC.
One Fruit of the Loom Drive, Bowling
Green, Kentucky 42103, USA

(111) M 1998 9667 R2
(156) 1998 06 09
(186) 2028 06 09
(732) WRANGLER APPAREL CORP.
3411 Silverside Road, Wilmington, DE
19810, USA

COMPLETE TRANSFER OF RIGHTS

-
- | | |
|---|---|
| <p>(111) M 1997 4381 R
 (732) BOEHRINGER INGELHEIM PHARMA
 GMBH & CO. KG
 55218 Ingelheim, Germany
 (770) BOEHRINGER INGELHEIM
 CORPORATE CENTER GMBH
 Binger Strasse 173, 55216 Ingelheim am
 Rhein, Germany
 (580) 2018 01 23</p> | <p>(770) STARBUCKS CORPORATION D/B/A
 STARBUCKS COFFEE COMPANY
 (a Washington Corporation)
 2401 Utah Avenue South, Seattle,
 Washington 98134, USA</p> |
|---|---|
-
- | | |
|---|---|
| <p>(111) M 1998 8831 R
 (732) IVECO S.p.A.
 Via Puglia 35, Turin, P/C 10156, Italy
 (770) NUOVE INIZIATIVE FINANZIARE 5
 S.P.A.
 Via Puglia 35, Turin, P/C 10156, Italy
 (580) 2018 03 30</p> | <p>(111) M 1998 8726 R
 (732) ILLVA SARONNO S.p.A.(in short I.S.
 S.p.A.)
 Via Archimede 243 - 21047 Saronno (VA),
 Italy
 (770) ILLVA SARONNO S.p.A.(in short I.S.
 S.p.A.)
 Via Archimede n 311, 21047 Saronno (VA),
 Italy
 (580) 2018 03 02</p> |
|---|---|
-
- | | |
|--|---|
| <p>(111) M 1998 10848 R
 (732) ESSILOR INTERNATIONAL
 147, Riu De Pari, 94220 Sharanton Le Ponti,
 France
 (770) ESSILOR INTERNATIONAL
 (COMPAGNIE GENERAL D'OPTIQUE)
 147, rue de Paris, 94220 Charenton le Pont,
 France
 (580) 2018 01 18</p> | <p>(111) M 2008 18828 R
 (732) JSC "Corporation Kindzmarauli"
 Ilia Tchavtchavadzis q. 55, 4800, Kvareli,
 Georgia
 (770) TAMAZ KONCHOSHVILI
 Ilia Tchavtchavadzis q. 55, 4800, Kvareli,
 Georgia
 (580) 2018 03 15</p> |
|--|---|
-
- | | |
|--|---|
| <p>(111) M 1998 11175 R
 (732) OOO Henkel RUS
 107045, Moscow, Kolokolnikov pereulok 11,
 Russian Federation
 (770) OAO HENKEL-ERA
 187000, Leningradskaia obl., Tosno,
 Moskovskoe shosse, d. 1, Russian Federation
 (580) 2018 02 27</p> | <p>(111) M 1996 2513 R
 (732) ESSILOR INTERNATIONAL
 147, rue de Paris, 94220 Charenton le Pont,
 France
 (770) ESSILOR INTERNATIONAL
 (COMPAGNIE GENERAL D'OPTIQUE)
 147, rue de Paris, 94220 Charenton le Pont,
 France
 (580) 2018 01 18</p> |
|--|---|
-
- | | |
|---|---|
| <p>(111) M 2003 15203 R
 (732) ALLIED GLOBAL TOBACCO LIMITED
 Wey Court West, Union Road, Farnham
 GU9 7PT, Surrey, United Kingdom
 (770) HARRINGTON DEVELOPMENT INC.
 Elivira Mendez Street, Valerino Bldg, 3rd
 Floor, Panama, Panama
 (580) 2018 04 16</p> | <p>(111) M 1996 2514 R
 (732) ESSILOR INTERNATIONAL
 147, rue de Paris, 94220 Charenton le Pont,
 France
 (770) ESSILOR INTERNATIONAL
 (COMPAGNIE GENERAL D'OPTIQUE)
 147, rue de Paris, 94220 Charenton le Pont,
 France
 (580) 2018 01 18</p> |
|---|---|
-
- | | |
|---|--|
| <p>(111) M 2006 16551 R
 (732) STARBUCKS CORPORATION
 2401 Utah Avenue South, Seattle,
 Washington 98134, USA</p> | <p>(111) M 1996 2515 R
 (732) ESSILOR INTERNATIONAL
 147, rue de Paris, 94220 Charenton le Pont,
 France</p> |
|---|--|
-

(770) ESSILOR INTERNATIONAL
(COMPAGNIE GENERAL D'OPTIQUE)
147, rue de Paris, 94220 Charenton le Pont,
France
(580) 2018 01 18

(111) M 2012 23094 R
(732) LTD "SAMOCDATSAMETI"
L. Kiachelis q. 28, Tbilisi, Georgia
(770) LTD "Georgian Distribution Marketing
Company"
Moskovis gamz. 31a, 0120, Tbilisi, Georgia
(580) 2018 03 19

(111) M 2013 24378 R
(732) MCDONALD'S INTERNATIONAL
PROPERTY COMPANY LTD
251 Little Falls Drive, Wilmington, Delaware
19808, USA
(770) LTD "T & K Restaurants"
Dzmebi Kakabadzebis q. 1, 0108, Tbilisi,
Georgia
(580) 2018 03 23

(111) M 2013 24379 R
(732) MCDONALD'S INTERNATIONAL
PROPERTY COMPANY LTD
251 Little Falls Drive, Wilmington, Delaware
19808, USA
(770) LTD "T & K Restaurants"
Dzmebi Kakabadzebis q. 1, 0108, Tbilisi,
Georgia
(580) 2018 03 23

(111) M 2015 25754 R
(732) PJSC "MYRONOVSKY KHLIBOPRODUCT"
Ul. Elevatornaya 1, G. Mironovka,
Mironovski r-n, Kievskaya Obl., 08800,
Ukraine
(770) LTD "WEST INVEST"
Tevdore Mghvdilis q. 27, 0154, Tbilisi,
Georgia;
LTD "WEST INVEST"
Kairos q.13a (nakveti 2/64), Georgia
(580) 2018 02 05

(111) M 2018 29210 R
(732) LTD "IMPORT TO GEORGIA"
Pekinis Shesakh. 28, 0171, Tbilisi, Georgia
(770) LTD "Family Products"
Tsatskhvebis q. 1, Isianis 2a, 4600, Kutaisi,
Georgia
(580) 2018 01 15

(111) M 2017 29046 R
(732) LTD "BARBARESTAN"
Vazha-Pshavelas gamz., III kvart., korp. 10,
b. 60, Tbilisi, Georgia
(770) ANZOR KURASBEDIANI
Machablis q. 3, Tbilisi, Georgia
(580) 2018 04 18

(111) M 1999 12036 R
(732) ADP GAUSELMANN GMBH
Merkur-Allee 1-15, 32339 Espelkamp,
Germany
(770) MERKUR GAMING GMBH
Borsigstraße 26, 32312 Lübbecke, Germany
(580) 2018 03 21

(111) M 2016 27820 R
(732) JSC "Metro Atlas Georgia"
Gogolis q. 1, Batumi, Georgia
(770) JSC METRO GODERDZI
Gogolis q.1, Batumi, Georgia
(580) 2018 01 23

(111) M 2016 27820 R
(732) JSC "Metro Atlas Georgia"
Gogolis q. 1, Batumi, Georgia
(770) JSC METRO GODERDZI
Gogolis q. 1, Batumi, Georgia
(580) 2018 01 23

(111) M 2017 28998 R
(732) GENADI VASILEVICH JURAVLOV
Prospeqt Federativni 28, d. 47, g. Moskva
111399 (IHH 772004611262), Russian
Federation
(770) LTD "TIFLISSKI VINNI POGREB"
Iumashevis q. 27, 0198, Tbilisi, Georgia
(580) 2018 02 27

CHANGES IN NAMES AND/OR ADDRESSES OF OWNERS

(111) M 1998 9698 R
 (732) WYETH HOLDINGS LLC
 235 East 42nd Street New York, New York
 10017, USA

(770) WYETH HOLDINGS LLC
 Five Giralda Farms, Madison, New Jersey
 07940-0874, USA
 (580) 2018 03 26

(111) M 1998 9218 R
 (732) Egis Gyógyszergyár Zrt.
 30-38 Kereszturi Ut, Budapest, H-1106,
 Hungary
 (770) EGIS GYOGYSZERGYAR NYRT.
 30-38 Kereszturi Ut, Budapest H-1106,
 Hungary
 (580) 2018 03 09

(111) M 1998 9218 R
 (732) Egis Gyógyszergyár Zrt.
 30-38 Kereszturi Ut, Budapest, H-1106,
 Hungary
 (770) EGIS GYOGYSZERGYAR NYRT.
 30-38 Kereszturi Ut, Budapest H-1106,
 Hungary
 (580) 2018 03 09

(111) M 1998 8343 R
 (732) KOOKAI SAS
 6-10 Boulevard Fosh, 93800 Epinay-sur-
 seine, France
 (770) KOOKAI
 45, Avenue Victor Hugo, Bat.201, 93300
 Aubervilliers, France
 (580) 2018 03 06

(111) M 1998 9023 R
 (732) ABBOT POINT OF CARE INC.
 400 College Road East, Princeton,
 New Jersey 08540, USA
 (770) ABBOT POINT OF CARE INC.
 100 Abbot Park Road, Abbot Park,
 Illinois 60064, USA
 (580) 2018 04 05

(111) M 1998 9086 R
 (732) TATA GLOBAL BEVERAGES GB
 LIMITED
 325 Oldfeild Lane North, Greenford,
 Middlesex UB6 0AZ, United Kingdom
 (770) TATA GLOBAL BEVERAGES GB
 LIMITED

Parkview, 82 Oxford Road, Uxbridge,
 Middlesex UB8 1UX, United Kingdom
 (580) 2018 04 05

(111) M 1998 8170 R
 (732) EGIS GYÓGYSZERGYÁR ZRT.
 Keresztúri út 30-38, 1106 Budapest, Hungary
 (770) EGIS Gyógyszergyár Nyilvánosan Működő
 Részvénytársaság
 30-38, Keresztúri út. Budapest, H-1106,
 Hungary
 (580) 2018 03 09

(111) M 1998 8831 R
 (732) IVECO S.p.A.
 Via Puglia 35, Turin, P/C 10156, Italy
 (770) NUOVE INIZIATIVE FINANZIARE 5
 S.P.A.
 Via Puglia 35, Turin, P/C 10156, Italy
 (580) 2018 03 30

(111) M 1998 8836 R
 (732) PASABAHCE CAM SANAI VE TICARET
 A.S.
 İçmeler Mah. D-100 Karayolu Cad. Çarşı
 Ofis Binasi A Blok N44 A1 34947 Tuzla
 Istanbul, Turkey
 (770) PASABAHCE CAM SANAI VE TICARET
 A.S.
 Is Kuleleri Kule-3, 4 levent/Istanbul, Turkey
 (580) 2018 04 10

(111) M 1998 10397 R
 (732) STARBUCKS CORPORATION
 2401 Utah Avenue South, Seattle,
 Washington 98134, USA
 (770) STARBUCKS CORPORATION doing
 business as STARBUCKS COFFEE
 COMPANY
 2401 Utah Avenue South, Seattle,
 Washington 98134, USA
 (580) 2018 03 21

(111) M 1998 10398 R
 (732) STARBUCKS CORPORATION
 2401 Utah Avenue South, Seattle,
 Washington 98134, USA
 (770) STARBUCKS CORPORATION (doing
 bussines as STARBUCKS COFFE
 COMPANY)
 2401 Utah Avenue South, P.O. Box 34067,
 Seattle, Washington, USA
 (580) 2018 03 21

(111) M 1998 10766 R
(732) RAPETO A.S.
Čeliv 17, 349 53 Kokašice, Czech Republic
(770) RAPETO A.S.
Čeliv 17, 349 53 Bezdrůžice, Czech
Republic
(580) 2018 04 03

(111) M 1998 11322 R
(732) RACCORDES ET PLASTIQUES NICOLL
Rue Pierre et Marie CURie, 49300 Cholet,
France
(770) S.A. RACCORDES ET PLASTIQUES
NICOLL
37 Rue Pierre et Marie CURie, 49309 Cholet,
France
(580) 2018 03 13

(111) M 1999 11931 R
(732) STARBUCKS CORPORATION
2401 Utah Avenue South, Seattle,
Washington 98134, USA
(770) STARBUCKS CORPORATION (doing
business as Starbucks Coffee Company),
a Washington Corporation
2401 Utah Avenue South, Seattle,
Washington 98134, USA
(580) 2018 03 21

(111) M 1998 8286 R
(732) GENERAL CIGAR CO., INC.
10900 Nuckols Road, Suite 100, Glen Allen,
Virginia 23060, USA
(770) GENERAL CIGAR CO., INC.
7300 Beaufont Springs Drive, Richmond,
Virginia 23225, USA
(580) 2018 03 12

(111) M 2005 16061 R
(732) STARBUCKS CORPORATION
2401 Utah Avenue South, Seattle,
Washington 98134, USA
(770) STARBUCKS CORPORATION D/B/A
STARBUCKS COFFEE COMPANY
(a Washington Corporation)
2401 Utah Avenue South, Seattle,
Washington 98134, USA
(580) 2018 03 21

(111) M 2005 16062 R
(732) STARBUCKS CORPORATION
2401 Utah Avenue South, Seattle,
Washington 98134, USA
(770) STARBUCKS CORPORATION D/B/A

STARBUCKS COFFEE COMPANY
(a Washington Corporation)
2401 Utah Avenue South, Seattle,
Washington 98134, USA
(580) 2018 03 21

(111) M 2005 16063 R
(732) STARBUCKS CORPORATION
2401 Utah Avenue South, Seattle,
Washington 98134, USA
(770) STARBUCKS CORPORATION D/B/A
STARBUCKS COFFEE COMPANY
(a Washington Corporation)
2401 Utah Avenue South, Seattle,
Washington 98134, USA
(580) 2018 03 21

(111) M 2005 16348 R
(732) STARBUCKS CORPORATION
2401 Utah Avenue South, Seattle,
Washington 98134, USA
(770) STARBUCKS CORPORATION doing
business as STARBUCKS COFFEE
COMPANY
2401 Utah Avenue South, Seattle,
Washington 98134, USA
(580) 2018 03 21

(111) M 2005 16370 R
(732) STARBUCKS CORPORATION
2401 Utah Avenue South, Seattle,
Washington 98134, USA
(770) STARBUCKS CORPORATION doing
business as STARBUCKS COFFEE
COMPANY
2401 Utah Avenue South, Seattle,
Washington 98134, USA
(580) 2018 03 21

(111) M 2006 16551 R
(732) STARBUCKS CORPORATION
2401 Utah Avenue South, Seattle,
Washington 98134, USA
(770) STARBUCKS CORPORATION D/B/A
STARBUCKS COFFEE COMPANY
(a Washington Corporation)
2401 Utah Avenue South, Seattle,
Washington 98134, USA
(580) 2018 03 21

(111) M 2006 16552 R
(732) STARBUCKS CORPORATION
2401 Utah Avenue South, Seattle,
Washington 98134, USA
(770) STARBUCKS CORPORATION D/B/A

(111) STARBUCKS COFFEE COMPANY
(a Washington Corporation)
2401 Utah Avenue South, Seattle,
Washington 98134, USA
(580) 2018 03 21

(111) M 2006 16500 R
(732) STARBUCKS CORPORATION
2401 Utah Avenue South, Seattle,
Washington 98134, USA
(770) STARBUCKS CORPORATION d/b/a
STARBUCKS COFFEE COMPANY
(a Washington corporation)
2401 Utah Avenue South, Seattle,
Washington 98134, USA
(580) 2018 03 21

(111) M 2006 17198 R
(732) GOOGLE LLC
1600 Amphitheatre Parkway, Mountain
View, CA 94043, USA
(770) GOOGLE INC.
1600 Amphitheatre Parkway, Mountain
View, CA 94043, USA
(580) 2018 02 13

(111) M 2006 17200 R
(732) GOOGLE LLC
1600 Amphitheatre Parkway, Mountain
View, CA 94043, USA
(770) GOOGLE INC.
1600 Amphitheatre Parkway, Mountain
View, CA 94043, USA
(580) 2018 02 14

(111) M 2007 17899 R
(732) STARBUCKS CORPORATION
2401 Utah Avenue South, Seattle,
Washington 98134, USA
(770) STARBUCKS CORPORATION d/b/a
STARBUCKS COFFEE COMPANY
(a Washington corporation)
2401 Utah Avenue South, Seattle,
Washington 98134, USA
(580) 2018 03 21

(111) M 2007 18063 R
(732) PIER BALMEN S.A.S.
44, rue Francois 1er, 75008 Paris, France
(770) PIERRE BALMAIN S.A.
44, rue Francois 1er, 75008 Paris, France
(580) 2018 03 09

(111) M 2008 18195 R
(732) LTD "Georgian Distribution Marketing
Company"
Moskovis gamz. 31b, 0120, Tbilisi, Georgia
(770) LTD " Georgian Distribution Marketing
Company "
D. Aghmaseneblis gamz.78, 0102, Tbilisi,
Georgia

(111) M 2008 18358 R
(732) VIENNA INSURANCE GROUP AG Wiener
Versicherung Gruppe
Schottenring 30, 1010 Wien, Austria
(770) VIENNA INSURANCE GROUP WIENER
Stadtische Versicherung AG
Schottenring 30, 1010 Wien, Austria
(580) 2018 03 14

(111) M 2008 18358 R
(732) VIENNA INSURANCE GROUP AG Wiener
Versicherung Gruppe
Schottenring 30, 1010 Wien, Austria
(770) VIENNA INSURANCE GROUP WIENER
Stadtische Versicherung AG
Schottenring 30, 1010 Wien, Austria
(580) 2018 03 14

(111) M 1998 8009 R
(732) SMITHS MEDICAL INTERNATIONAL
LIMITED
1500 Eureka Park, Lower Pemberton,
Ashford, Kent, TN25 4BF, United Kingdom
(770) SMITHS MEDICAL INTERNATIONAL
LIMITED
765, Finchley Road, London NW11 8DS,
United Kingdom
(580) 2018 02 23

(111) M 2012 22565 R
(732) STARBUCKS CORPORATION
2401 Utah Avenue South, Seattle,
Washington 98134, USA
(770) STARBUCKS CORPORATION D/B/A
STARBUCKS COFFEE COMPANY
(a Washington Corporation)
2401 Utah Avenue South, Seattle,
Washington 98134, USA
(580) 2018 03 21

(111) M 2014 24476 R
(732) STARBUCKS CORPORATION
2401 Utah Avenue South, Seattle,
Washington 98134, USA
(770) STARBUCKS CORPORATION D/B/A
STARBUCKS COFFEE COMPANY

(a Washington Corporation)
2401 Utah Avenue South, Seattle,
Washington 98134, USA
(580) 2018 03 21

(111) M 2014 24700 R
(732) STARBUCKS CORPORATION
2401 Utah Avenue South, Seattle,
Washington 98134, USA
(770) STARBUCKS CORPORATION, D/B/A
STARBUCKS COFFEE COMPANY,
a Washington corporation
2401 Utah Avenue South, Seattle,
Washington 98134, USA
(580) 2018 03 21

(111) M 2014 24708 R
(732) STARBUCKS CORPORATION
2401 Utah Avenue South, Seattle,
Washington 98134, USA
(770) STARBUCKS CORPORATION d/b/a
STARBUCKS COFFEE COMPANY
(a Washington corporation)
2401 Utah Avenue South, Seattle,
Washington 98134, USA
(580) 2018 03 27

(111) M 2014 24979 R
(732) STARBUCKS CORPORATION
2401 Utah Avenue South, Seattle,
Washington 98134, USA
(770) STARBUCKS CORPORATION d/b/a
STARBUCKS COFFEE COMPANY
(a Washington corporation)
2401 Utah Avenue South, Seattle,
Washington 98134, USA
(580) 2018 03 21

(111) M 2014 24980 R
(732) STARBUCKS CORPORATION
2401 Utah Avenue South, Seattle,
Washington 98134, USA
(770) STARBUCKS CORPORATION d/b/a
STARBUCKS COFFEE COMPANY
(a Washington corporation)
2401 Utah Avenue South, Seattle,
Washington 98134, USA
(580) 2018 03 21

(111) M 2014 24743 R
(732) STARBUCKS CORPORATION
2401 Utah Avenue South, Seattle,
Washington 98134, USA
(770) STARBUCKS CORPORATION d/b/a
STARBUCKS COFFEE COMPANY

(a Washington corporation)
2401 Utah Avenue South, Seattle,
Washington 98134, USA
(580) 2018 03 21

(111) M 2014 25162 R
(732) STARBUCKS CORPORATION
2401 Utah Avenue South, Seattle,
Washington 98134, USA
(770) STARBUCKS CORPORATION d/b/a
STARBUCKS COFFEE COMPANY
(a Washington corporation)
2401 Utah Avenue South, Seattle,
Washington 98134, USA
(580) 2018 03 21

(111) M 2014 24709 R
(732) STARBUCKS CORPORATION
2401 Utah Avenue South, Seattle,
Washington 98134, USA
(770) STARBUCKS CORPORATION d/b/a
STARBUCKS COFFEE COMPANY
(a Washington corporation)
2401 Utah Avenue South, Seattle,
Washington 98134, USA
(580) 2018 03 21

(111) M 2014 24676 R
(732) STARBUCKS CORPORATION
2401 Utah Avenue South, Seattle,
Washington 98134, USA
(770) STARBUCKS CORPORATION d/b/a
STARBUCKS COFFEE COMPANY
(a Washington corporation)
2401 Utah Avenue South, Seattle,
Washington 98134, USA
(580) 2018 03 21

(111) M 2014 24983 R
(732) STARBUCKS CORPORATION
2401 Utah Avenue South, Seattle,
Washington 98134, USA
(770) STARBUCKS CORPORATION d/b/a
STARBUCKS COFFEE COMPANY
(a Washington corporation)
2401 Utah Avenue South, Seattle,
Washington 98134, USA
(580) 2018 03 21

(111) M 2014 24984 R
(732) STARBUCKS CORPORATION
2401 Utah Avenue South, Seattle,
Washington 98134, USA
(770) STARBUCKS CORPORATION d/b/a
STARBUCKS COFFEE COMPANY

(a Washington corporation)
2401 Utah Avenue South, Seattle,
Washington 98134, USA
(580) 2018 03 21

(111) M 2014 25164 R
(732) STARBUCKS CORPORATION
2401 Utah Avenue South, Seattle,
Washington 98134, USA
(770) STARBUCKS CORPORATION d/b/a
STARBUCKS COFFEE COMPANY
(a Washington corporation)
2401 Utah Avenue South, Seattle,
Washington 98134, USA
(580) 2018 03 21

(111) M 2014 24985 R
(732) STARBUCKS CORPORATION
2401 Utah Avenue South, Seattle,
Washington 98134, USA
(770) STARBUCKS CORPORATION d/b/a
STARBUCKS COFFEE COMPANY
(a Washington corporation)
2401 Utah Avenue South, Seattle,
Washington 98134, USA
(580) 2018 03 21

(111) M 2014 24986 R
(732) STARBUCKS CORPORATION
2401 Utah Avenue South, Seattle,
Washington 98134, USA
(770) STARBUCKS CORPORATION d/b/a
STARBUCKS COFFEE COMPANY
(a Washington corporation)
2401 Utah Avenue South, Seattle,
Washington 98134, USA
(580) 2018 03 21

(111) M 2014 24987 R
(732) STARBUCKS CORPORATION
2401 Utah Avenue South, Seattle,
Washington 98134, USA
(770) STARBUCKS CORPORATION d/b/a
STARBUCKS COFFEE COMPANY
(a Washington corporation)
2401 Utah Avenue South, Seattle,
Washington 98134, USA
(580) 2018 03 21

(111) M 2014 24988 R
(732) STARBUCKS CORPORATION
2401 Utah Avenue South, Seattle,
Washington 98134, USA
(770) STARBUCKS CORPORATION d/b/a

STARBUCKS COFFEE COMPANY
(a Washington corporation)
2401 Utah Avenue South, Seattle,
Washington 98134, USA
(770) STARBUCKS CORPORATION d/b/a
STARBUCKS COFFEE COMPANY
(a Washington corporation)
2401 Utah Avenue South, Seattle,
Washington 98134, USA
(580) 2018 03 21

(111) M 2014 24989 R
(732) STARBUCKS CORPORATION
2401 Utah Avenue South, Seattle,
Washington 98134, USA
(770) STARBUCKS CORPORATION d/b/a
STARBUCKS COFFEE COMPANY
(a Washington corporation)
2401 Utah Avenue South, Seattle,
Washington 98134, USA
(580) 2018 03 21

(111) M 2014 24990 R
(732) STARBUCKS CORPORATION
2401 Utah Avenue South, Seattle,
Washington 98134, USA
(770) STARBUCKS CORPORATION d/b/a
STARBUCKS COFFEE COMPANY
(a Washington corporation)
2401 Utah Avenue South, Seattle,
Washington 98134, USA
(580) 2018 03 21

(111) M 2014 24991 R
(732) STARBUCKS CORPORATION
2401 Utah Avenue South, Seattle,
Washington 98134, USA
(770) STARBUCKS CORPORATION d/b/a
STARBUCKS COFFEE COMPANY
(a Washington corporation)
2401 Utah Avenue South, Seattle,
Washington 98134, USA
(580) 2018 03 21

(111) M 2014 25306 R
(732) STARBUCKS CORPORATION
2401 Utah Avenue South, Seattle,
Washington 98134, USA
(770) STARBUCKS CORPORATION d/b/a
STARBUCKS COFFEE COMPANY
(a Washington corporation)
2401 Utah Avenue South, Seattle,
Washington 98134, USA
(580) 2018 03 21

(111) M 2014 25307 R
 (732) STARBUCKS CORPORATION
 2401 Utah Avenue South, Seattle,
 Washington 98134, USA
 (770) STARBUCKS CORPORATION d/b/a
 STARBUCKS COFFEE COMPANY
 (a Washington corporation)
 2401 Utah Avenue South, Seattle,
 Washington 98134, USA
 (580) 2018 03 21

(111) M 2014 24992 R
 (732) STARBUCKS CORPORATION
 2401 Utah Avenue South, Seattle,
 Washington 98134, USA
 (770) STARBUCKS CORPORATION d/b/a
 STARBUCKS COFFEE COMPANY
 (a Washington corporation)
 2401 Utah Avenue South, Seattle,
 Washington 98134, USA
 (580) 2018 03 21

(111) M 2014 24995 R
 (732) STARBUCKS CORPORATION
 2401 Utah Avenue South, Seattle,
 Washington 98134, USA
 (770) STARBUCKS CORPORATION d/b/a
 STARBUCKS COFFEE COMPANY
 (a Washington corporation)
 2401 Utah Avenue South, Seattle,
 Washington 98134, USA
 (580) 2018 03 21

(111) M 2014 24996 R
 (732) STARBUCKS CORPORATION
 2401 Utah Avenue South, Seattle,
 Washington 98134, USA
 (770) STARBUCKS CORPORATION d/b/a
 STARBUCKS COFFEE COMPANY
 (a Washington corporation)
 2401 Utah Avenue South, Seattle,
 Washington 98134, USA
 (580) 2018 03 21

(111) M 2015 25908 R
 (732) PIER BALMEN S.A.S.
 44, rue Francois 1er, 75008 Paris, France
 (770) PIERRE BALMAIN S.A.
 44, rue Francois 1er, 75008 Paris, France
 (580) 2018 03 09

(111) M 2014 25228 R
 (732) STARBUCKS CORPORATION
 2401 Utah Avenue South, Seattle,
 Washington 98134, USA
 (770) STARBUCKS CORPORATION d/b/a
 STARBUCKS COFFEE COMPANY
 (a Washington corporation)
 2401 Utah Avenue South, Seattle,
 Washington 98134, USA
 (580) 2018 03 21

(111) M 1999 12010 R
 (732) PENTAIR TECHNICAL SOLUTIONS UK
 LIMITED
 3 Rutherford Road, Stephenson Industrial
 Estate, Washington, Tyne & Wear, NE37
 3HX, United Kingdom
 (770) PENTAIR THERMAL MANAGEMENT UK
 LIMITED
 3 Rutherford Road, Stephenson Industrial
 Estate, Washington, Tyne & Wear, NE37
 3HX, United Kingdom
 (580) 2018 03 09

(111) M 1999 12010 R
 (732) PENTAIR TECHNICAL SOLUTIONS UK
 LIMITED
 3 Rutherford Road, Stephenson Industrial
 Estate, Washington, Tyne & Wear, NE37
 3HX, United Kingdom
 (770) PENTAIR THERMAL MANAGEMENT UK
 LIMITED
 3 Rutherford Road, Stephenson Industrial
 Estate, Washington, Tyne & Wear, NE37
 3HX, United Kingdom
 (580) 2018 03 09

(111) M 2015 25978 R
 (732) STARBUCKS CORPORATION
 2401 Utah Avenue South, Seattle,
 Washington 98134, USA
 (770) STARBUCKS CORPORATION D/B/A
 STARBUCKS COFFEE COMPANY
 (a Washington corporation)
 2401 Utah Avenue South, Seattle,
 Washington 98134, USA
 (580) 2018 03 21

(111) M 2015 26447 R
 (732) STARBUCKS CORPORATION
 2401 Utah Avenue South, Seattle,
 Washington 98134, USA
 (770) STARBUCKS CORPORATION D/B/A
 STARBUCKS COFFEE COMPANY
 (a Washington corporation)

2401 Utah Avenue South, Siettle,
Washington 98134, USA
(580) 2018 03 21

(111) M 2015 26448 R
(732) STARBUCKS CORPORATION
2401 Utah Avenue South, Seattle,
Washington 98134, USA
(770) STARBUCKS CORPORATION D/B/A
STARBUCKS COFFEE COMPANY
(a Washington corporation)
2401 Utah Avenue South, Siettle,
Washington 98134, USA
(580) 2018 03 21

(111) M 2015 26561 R
(732) PIER BALMEN S.A.S.
44, rue Francois 1er, 75008 Paris, France
(770) PIERRE BALMAIN S.A.
44, rue Francois 1er, 75008 Paris, France
(580) 2018 03 09

(111) M 2015 26500 R
(732) PIER BALMEN S.A.S.
44, rue Francois 1er, 75008 Paris, France
(770) PIERRE BALMAIN S.A.
44, rue Francois 1er, 75008 Paris, France
(580) 2018 03 09

(111) M 2016 26848 R
(732) STARBUCKS CORPORATION
2401 Utah Avenue South, Seattle,
Washington 98134, USA
(770) STARBUCKS CORPORATION D/B/A
STARBUCKS COFFEE COMPANY
(a Washington corporation)
2401 Utah Avenue South, Siettle,
Washington 98134, USA
(580) 2018 03 21

(111) M 2015 25754 R
(732) PJSC "MYRONIVSKY HLIBOPRODUCT"
(770) LTD "WEST INVEST"
Tevdore Mghvdilis q. 27, 0154, Tbilisi, Georgia;
LTD "WEST INVEST"
Kairos q.13a (nakveti 2/64), Georgia
(580) 2018 02 02

(111) M 2016 28014 R
(732) PIER BALMEN S.A.S.
44, rue Francois 1er, 75008 Paris, France

(770) PIERRE BALMAIN S.A.
44, rue Francois 1er, 75008 Paris, France
(580) 2018 03 09

(111) M 2016 28015 R
(732) PIER BALMEN S.A.S.
44, rue Francois 1er, 75008 Paris, France
(770) PIERRE BALMAIN S.A.
44, rue Francois 1er, 75008 Paris, France
(580) 2018 03 09

(111) M 1998 8748 R
(732) TRINECKE ZELEZARNY A.S.
Prumyslová 100 Staré Město, 739 61 Třinec,
Czech Republic
(770) TRINECKE ZELEZARNY A.S.
Trinec, Czech Republic
(580) 2018 03 26

CANCELATION OF TRADEMARK SERVICE REGISTRATION

(111) M 1997 6874 R

(732) KOGNIS IP MANAGEMENT GmbH

Henkelstrasse 67, Dusseldorf, 40589, Germany

(540)

LANETTE

(511)

1 – Chemical products used in industry, science, photography; Non-synthetic synthetic resins; Unprocessed plastics; Fertilizers; Fire extinguishing materials; Chemical substances for the presence and control of metals; Chemical substances that can be used for food processing; Tanning substances; Industrial and adhesive substances and other substances that are included in this class.

(580) 2018 02 27

GROUND(S): Order №15 (29 03 2018) of the Chairman of "SAKPATENTI" on administration of legally enforced decision (Case №2/28334-17 (330210017002133978)) of Tbilisi City Court Civil Cases Board.

CLASSIFICATION INDEXES

INVENTIONS

CONCORDANCE TABLE OF INTERNATIONAL CLASSIFICATION INDEX AND PUBLICATION NUMBERS

INTERNATIONAL CLASSIFICATION INDEXES (51)	NUMBER OF PUBLISHED APPLICATION (10)
A 61 K 31/4015; A 61 P 31/00; A 61 P 25/02	AP 2018 14335 A
B 22 F 1/00; B 82 B 1/00; C 22 C 29/00; C 01 B 35/00	AP 2018 14160 A
B 66 B 9/00	AP 2018 14428 A
C 04 B 7/52, 14/14	AP 2018 14402 A
C 07 D 207/26; C 07 D 207/273; C 07 D 209/52; C 07 D 215/48; C 07 D 217/02; C 07 D 217/22; C 07 D 217/24; C 07 D 239/86; C 07 D 239/88; C 07 D 263/24; C 07 D 401/12; C 07 D 401/14; C 07 D 403/12; C 07 D 405/12; C 07 D 405/14; C 07 D 413/12; C 07 D 417/12; C 07 D 487/04; C 07 D 491/056; C 07 D 498/04; C 07 C 69/94; C 07 C 235/66; C 07 F 7/18; A 61 K 31/47; A 61 K 31/4709; A 61 K 31/472; A 61 K 31/4725; A 61 K 31/517; A 61 P 19/02; A 61 P 29/00; A 61 P 11/06; A 61 P 13/12; A 61 P 17/06	AP 2018 14288 A
C 07 D 401/04; C 07 D 241/26; C 07 D 241/28; A 61 K 31/497; A 61 K 31/5377; A 61 P 25/00	AP 2018 14266 A
C 10 J 3/12	AP 2018 14569 A

CONCORDANCE TABLE OF PUBLICATION NUMBERS AND INTERNATIONAL CLASSIFICATION INDEX

NUMBER OF PUBLISHED APPLICATION (10)	INTERNATIONAL CLASSIFICATION INDEXES (51)
AP 2018 14160 A	B 22 F 1/00; B 82 B 1/00; C 22 C 29/00; C 01 B 35/00
AP 2018 14266 A	C 07 D 401/04; C 07 D 241/26; C 07 D 241/28; A 61 K 31/497; A 61 K 31/5377; A 61 P 25/00
AP 2018 14288 A	C 07 D 207/26; C 07 D 207/273; C 07 D 209/52; C 07 D 215/48; C 07 D 217/02; C 07 D 217/22; C 07 D 217/24; C 07 D 239/86; C 07 D 239/88; C 07 D 263/24; C 07 D 401/12; C 07 D 401/14; C 07 D 403/12; C 07 D 405/12; C 07 D 405/14; C 07 D 413/12; C 07 D 417/12; C 07 D 487/04; C 07 D 491/056; C 07 D 498/04; C 07 C 69/94; C 07 C 235/66; C 07 F 7/18; A 61 K 31/47; A 61 K 31/4709; A 61 K 31/472; A 61 K 31/4725; A 61 K 31/517; A 61 P 19/02; A 61 P 29/00; A 61 P 11/06; A 61 P 13/12; A 61 P 17/06
AP 2018 14335 A	A 61 K 31/4015; A 61 P 31/00; A 61 P 25/02
AP 2018 14402 A	C 04 B 7/52, 14/14
AP 2018 14428 A	B 66 B 9/00
AP 2018 14569 A	C 10 J 3/12

**CONCORDANCE TABLE OF INTERNATIONAL CLASSIFICATION INDEX,
PATENT NUMBERS AND PUBLICATION NUMBERS**

INTERNATIONAL CLASSIFICATION INDEX (51)	NUMBER OF PATENT (11)	NUMBER OF PUBLISHED APPLICATION (10)
A 47 J 44/02; B 01 F 13/04	P 2018 6850 B	AP 2018 14131 A
A 61 K 31/495; A 61 P 25/18	P 2018 6849 B	AP 2018 13870 A
C 01 B 3/24; C 01 B 31/18; C 01 J 3/00	P 2018 6848 B	AP 2018 13525 A
C 01 G 15/00; C 01 G 19/00; C 01 G 49/08; C 09 K 9/00; C 09 K 11/62; C 09 K 11/77; G 01 N 33/02; G 01 N 33/15	P 2018 6851 B	AP 2018 14213 A

**CONCORDANCE TABLE OF PATENT NUMBERS,
PUBLICATION NUMBERS AND INTERNATIONAL CLASSIFICATION INDEX**

NUMBER OF PATENT (11)	NUMBER OF PUBLISHED APPLICATION (10)	INTERNATIONAL CLASSIFICATION INDEX (51)
P 2018 6848 B	AP 2018 13525 A	C 01 B 3/24; C 01 B 31/18; C 01 J 3/00
P 2018 6849 B	AP 2018 13870 A	A 61 K 31/495; A 61 P 25/18
P 2018 6850 B	AP 2018 14131 A	A 47 J 44/02; B 01 F 13/04
P 2018 6851 B	AP 2018 14213 A	C 01 G 15/00; C 01 G 19/00; C 01 G 49/08; C 09 K 9/00; C 09 K 11/62; C 09 K 11/77; G 01 N 33/02; G 01 N 33/15

**CONCORDANCE TABLE OF APPLICATION NUMBERS, PUBLICATION NUMBERS
AND PATENTS**

NUMBER OF APPLICATION (21)	NUMBER OF PUBLISHED APPLICATION (10)	NUMBER OF PATENT (11)
AP 2012 013525	AP 2018 13525 A	P 2018 6848 B
AP 2013 013870	AP 2018 13870 A	P 2018 6849 B
AP 2014 014131	AP 2018 14131 A	P 2018 6850 B
AP 2014 014213	AP 2018 14213 A	P 2018 6851 B

UTILITY MODEL

**CONCORDANCE TABLE OF INTERNATIONAL CLASSIFICATION INDEX
AND PUBLICATION NUMBERS**

INTERNATIONAL CLASSIFICATION INDEXES (51)	NUMBER OF PUBLISHED APPLICATION (10)
B 67 D 3/00; G 07 F 13/00	AU 2018 14260 U

**CONCORDANCE TABLE OF PUBLICATION NUMBERS
AND INTERNATIONAL CLASSIFICATION INDEX**

NUMBER OF PUBLISHED APPLICATION (10)	INTERNATIONAL CLASSIFICATION INDEXES (51)
AU 2018 14260 U	B 67 D 3/00; G 07 F 13/00

DESIGNS

**CONCORDANCE TABLE OF INTERNATIONAL CLASSIFICATION INDEX
AND PUBLICATION NUMBERS**

INTERNATIONAL CLASSIFICATION INDEXES (51)	NUMBER OF PUBLISHED APPLICATION (10)
14-99	AD 2018 962 S
32-00	AD 2018 1001 S

**CONCORDANCE TABLE OF PUBLICATION NUMBERS
AND INTERNATIONAL CLASSIFICATION INDEX**

NUMBER OF PUBLISHED APPLICATION (10)	INTERNATIONAL CLASSIFICATION INDEXES (51)
AD 2018 962 S	14-99
AD 2018 1001 S	32-00

**CONCORDANCE TABLE OF INTERNATIONAL CLASSIFICATION INDEX,
PATENT NUMBERS AND PUBLICATION NUMBERS**

INTERNATIONAL CLASSIFICATION INDEX (51)	NUMBER OF PATENT (11)	NUMBER OF PUBLISHED APPLICATION (10)
09-01	D 2018 759 S	AD 2018 975 S
09-01	D 2018 760 S	AD 2018 977 S
26-03	D 2018 757 S	AD 2018 987 S
26-03	D 2018 758 S	AD 2018 988 S

CONCORDANCE TABLE OF PATENT NUMBERS,
PUBLICATION NUMBERS AND INTERNATIONAL CLASSIFICATION INDEX

NUMBER OF PATENT (11)	NUMBER OF PUBLISHED APPLICATION (10)	INTERNATIONAL CLASSIFICATION INDEX (51)
D 2018 757 S	AD 2018 987 S	26-03
D 2018 758 S	AD 2018 988 S	26-03
D 2018 759 S	AD 2018 975 S	09-01
D 2018 760 S	AD 2018 977 S	09-01

CONCORDANCE TABLE OF APPLICATION NUMBERS, PUBLICATION NUMBERS
AND PATENTS

NUMBER OF APPLICATION (21)	NUMBER OF PUBLISHED APPLICATION (10)	NUMBER OF PATENT (11)
AD 2017 975	AD 2018 975 S	D 2018 759 S
AD 2017 977	AD 2018 977 S	D 2018 760 S
AD 2017 987	AD 2018 987 S	D 2018 757 S
AD 2017 988	AD 2018 988 S	D 2018 758 S

TRADEMARKS

CONCORDANCE TABLE OF REGISTRATION NUMBERS, APPLICATION NUMBERS, PUBLICATION NUMBERS AND BULLETIN NUMBERS

NUMBER OF REGISTRATION (111)	NUMBER OF APPLICATIONS (210)	NUMBER OF PUBLISHED APPLICATIONS (260)	NUMBER OF BULLETIN
M 2018 29564 R	AM 96938	-	9(493)2018
M 2018 29565 R	AM 97219	-	9(493)2018
M 2018 29566 R	AM 95114	-	9(493)2018
M 2018 29567 R	AM 97217	-	9(493)2018
M 2018 29568 R	AM 97186	-	9(493)2018
M 2018 29569 R	AM 97396	-	9(493)2018
M 2018 29570 R	AM 80183	AM 2015 80183 A	24(436)2015
M 2018 29571 R	AM 84931	AM 2015 84931 A	18(478)2017
M 2018 29572 R	AM 86965	AM 2016 86965 A	24(484)2017
M 2018 29573 R	AM 89879	AM 2016 89879 A	19(479)2017
M 2018 29574 R	AM 90451	AM 2017 90451 A	19(479)2017
M 2018 29575 R	AM 90762	AM 2017 90762 A	19(479)2017
M 2018 29576 R	AM 90774	AM 2017 90774 A	19(479)2017
M 2018 29577 R	AM 90863	AM 2017 90863 A	19(479)2017
M 2018 29578 R	AM 90869	AM 2017 90869 A	19(479)2017
M 2018 29579 R	AM 97033	-	9(493)2018
M 2018 29580 R	AM 90871	AM 2017 90871 A	21(481)2017
M 2018 29581 R	AM 90876	AM 2017 90876 A	20(480)2017
M 2018 29582 R	AM 90877	AM 2017 90877 A	20(480)2017
M 2018 29583 R	AM 90929	AM 2017 90929 A	19(479)2017
M 2018 29584 R	AM 90953	AM 2017 90953 A	20(480)2017
M 2018 29585 R	AM 91066	AM 2017 91066 A	23(483)2017
M 2018 29586 R	AM 91083	AM 2017 91083 A	20(480)2017
M 2018 29587 R	AM 91084	AM 2017 91084 A	20(480)2017
M 2018 29588 R	AM 91132	AM 2017 91132 A	22(482)2017
M 2018 29589 R	AM 91155	AM 2017 91155 A	19(479)2017
M 2018 29590 R	AM 91189	AM 2017 91189 A	19(479)2017
M 2018 29591 R	AM 91190	AM 2017 91190 A	19(479)2017
M 2018 29592 R	AM 91195	AM 2017 91195 A	19(479)2017
M 2018 29593 R	AM 91278	AM 2017 91278 A	20(480)2017
M 2018 29594 R	AM 91385	AM 2017 91385 A	23(483)2017
M 2018 29595 R	AM 91405	AM 2017 91405 A	21(481)2017
M 2018 29596 R	AM 91515	AM 2017 91515 A	20(480)2017
M 2018 29597 R	AM 91516	AM 2017 91516 A	20(480)2017
M 2018 29598 R	AM 91543	AM 2017 91543 A	23(483)2017
M 2018 29599 R	AM 91578	AM 2017 91578 A	23(483)2017
M 2018 29600 R	AM 91579	AM 2017 91579 A	23(483)2017
M 2018 29601 R	AM 91584	AM 2017 91584 A	23(483)2017
M 2018 29602 R	AM 91587	AM 2017 91587 A	23(483)2017
M 2018 29603 R	AM 91609	AM 2017 91609 A	20(480)2017
M 2018 29604 R	AM 91680	AM 2017 91680 A	23(483)2017
M 2018 29605 R	AM 91734	AM 2017 91734 A	23(483)2017
M 2018 29606 R	AM 91781	AM 2017 91781 A	23(483)2017
M 2018 29607 R	AM 91816	AM 2017 91816 A	23(483)2017
M 2018 29608 R	AM 91817	AM 2017 91817 A	23(483)2017
M 2018 29609 R	AM 91818	AM 2017 91818 A	23(483)2017

1	2	3	4
M 2018 29610 R	AM 91819	AM 2017 91819 A	23(483)2017
M 2018 29611 R	AM 91885	AM 2017 91885 A	23(483)2017
M 2018 29612 R	AM 91886	AM 2017 91886 A	23(483)2017
M 2018 29613 R	AM 91888	AM 2017 91888 A	23(483)2017
M 2018 29614 R	AM 92166	AM 2017 92166 A	1(485)2018
M 2018 29615 R	AM 92254	AM 2017 92254 A	1(485)2018
M 2018 29616 R	AM 92306	AM 2017 92306 A	1(485)2018
M 2018 29617 R	AM 92338	AM 2017 92338 A	1(485)2018
M 2018 29618 R	AM 92363	AM 2018 92363 A	1(485)2018
M 2018 29619 R	AM 92474	AM 2017 92474 A	23(483)2017
M 2018 29620 R	AM 92483	AM 2018 92483 A	1(485)2018
M 2018 29621 R	AM 92606	AM 2018 92606 A	2(486)2018
M 2018 29622 R	AM 93608	AM 2018 93608 A	1(485)2018
M 2018 29623 R	AM 97176	-	9(493)2018

**CONCORDANCE TABLE OF PUBLICATION NUMBERS
AND APPLICATION NUMBERS**

NUMBER OF PUBLISHED APPLICATION (260)	NUMBER OF APPLICATION (210)	1	2
		1	2
AM 2018 88282 A	AM 88282	AM 2018 94177 A	AM 94177
AM 2018 89904 A	AM 89904	AM 2018 94178 A	AM 94178
AM 2018 93221 A	AM 93221	AM 2018 94191 A	AM 94191
AM 2018 93222 A	AM 93222	AM 2018 94224 A	AM 94224
AM 2018 93224 A	AM 93224	AM 2018 94254 A	AM 94254
AM 2018 93225 A	AM 93225	AM 2018 94259 A	AM 94259
AM 2018 93525 A	AM 93525	AM 2018 94260 A	AM 94260
AM 2018 93818 A	AM 93818	AM 2018 94261 A	AM 94261
AM 2018 93840 A	AM 93840	AM 2018 94309 A	AM 94309
AM 2018 93913 A	AM 93913	AM 2018 94310 A	AM 94310
AM 2018 93986 A	AM 93986	AM 2018 94314 A	AM 94314
AM 2018 94016 A	AM 94016	AM 2018 94315 A	AM 94315
AM 2018 94055 A	AM 94055	AM 2018 94316 A	AM 94316
AM 2018 94063 A	AM 94063	AM 2018 94318 A	AM 94318
AM 2018 94168 A	AM 94168	AM 2018 94333 A	AM 94333
AM 2018 94170 A	AM 94170	AM 2018 94348 A	AM 94348
AM 2018 94171 A	AM 94171	AM 2018 94349 A	AM 94349
		AM 2018 94350 A	AM 94350
		AM 2018 94356 A	AM 94356
		AM 2018 94358 A	AM 94358
		AM 2018 94372 A	AM 94372

CONCORDANCE TABLE OF INDEX OF GOODS AND/OR SERVICES
AND APPLICATION NUMBERS

INDEX OF GOODS AND/OR SERVICES (511)	NUMBER OF PUBLISHED APPLICATIONS (26)	1	2
1	2	29	AM 2018 88282 A
3	AM 2018 94063 A	29	AM 2018 94314 A
3	AM 2018 94224 A	30	AM 2018 88282 A
5	AM 2018 93221 A	30	AM 2018 94314 A
5	AM 2018 93222 A	31	AM 2018 88282 A
5	AM 2018 93224 A	32	AM 2018 88282 A
5	AM 2018 93225 A	32	AM 2018 93840 A
5	AM 2018 93840 A	32	AM 2018 94016 A
5	AM 2018 94168 A	32	AM 2018 94309 A
5	AM 2018 94170 A	32	AM 2018 94314 A
5	AM 2018 94171 A	33	AM 2018 88282 A
5	AM 2018 94177 A	33	AM 2018 94016 A
5	AM 2018 94178 A	33	AM 2018 94314 A
5	AM 2018 94348 A	34	AM 2018 94254 A
5	AM 2018 94349 A	35	AM 2018 88282 A
5	AM 2018 94350 A	35	AM 2018 93840 A
7	AM 2018 94055 A	35	AM 2018 94055 A
8	AM 2018 94055 A	35	AM 2018 94259 A
9	AM 2018 89904 A	35	AM 2018 94260 A
9	AM 2018 94254 A	35	AM 2018 94261 A
9	AM 2018 94259 A	35	AM 2018 94310 A
9	AM 2018 94260 A	35	AM 2018 94333 A
9	AM 2018 94261 A	37	AM 2018 94310 A
9	AM 2018 94318 A	39	AM 2018 94315 A
11	AM 2018 94055 A	39	AM 2018 94316 A
16	AM 2018 93986 A	39	AM 2018 94358 A
18	AM 2018 94356 A	41	AM 2018 94191 A
21	AM 2018 93525 A	41	AM 2018 94333 A
21	AM 2018 94055 A	42	AM 2018 89904 A
25	AM 2018 94333 A	42	AM 2018 93818 A
25	AM 2018 94356 A	43	AM 2018 88282 A
25	AM 2018 94372 A	43	AM 2018 94191 A
28	AM 2018 93986 A	43	AM 2018 94314 A
		43	AM 2018 94315 A
		43	AM 2018 94316 A
		44	AM 2018 93913 A
		44	AM 2018 93986 A

CONCORDANCE TABLE OF INDEX OF GOODS AND/OR SERVICES
AND NUMBERS OF TRADEMARKS REGISTERED ACCORDING
TO THE ACCELERATED PROCEDURE

INDEX OF GOODS AND/OR SERVICES (511)	NUMBERS OF REGISTERED ACCORDING TO THE ACCELERATED PROCEDURE (111)
9	M 2018 29623 R
28	M 2018 29623 R
29	M 2018 29579 R
30	M 2018 29565 R
30	M 2018 29579 R
31	M 2018 29579 R
32	M 2018 29567 R
32	M 2018 29579 R
33	M 2018 29568 R
33	M 2018 29579 R
34	M 2018 29564 R
41	M 2018 29569 R
43	M 2018 29566 R

OFFICIAL BULLETIN OF THE INDUSTRIAL PROPERTY

INVENTIONS
UTILITY MODELS
DESIGNS
TRADEMARKS

9(493)

EDITOR-IN-CHIEF: N. Bebrishvili

EDITOR-TRANSLATOR: E. Gabunia

PROOFREADER: A. Shikhashvili

COMPUTER LAYOUT: M. Ordenidze
K. Svanidze

www.sakpatenti.gov.ge

E-mail: info@sakpatenti.org.ge