



საქართველოს ინტელექტუალური საკუთრების ეროვნული ცენტრი
NATIONAL INTELLECTUAL PROPERTY CENTER OF GEORGIA

საქპატენტი
SAKPATENTI

**OFFICIAL BULLETIN
OF THE INDUSTRIAL PROPERTY**

9(517)

2019
TBILISI

INID CODES FOR IDENTIFICATION OF BIBLIOGRAPHIC DATA

INVENTIONS, UTILITY MODELS

- (10) Number of publication for application, which has been examined
- (11) Number of patent and kind of document
- (21) Serial number of application
- (22) Date of filing of the application
- (23) Date of exhibition or the date of the earlier filing and the number of application, if any
- (24) Date from which patent may have effect
- (31) Number of priority application
- (32) Date of filing of priority application
- (33) Code of the country or regional organization allotting priority application number
- (44) Date of publication of application not granted, but examined and number of bulletin
- (45) Date of publication of registered document
- (51) International Patent Classification Index
- (54) Title of the invention
- (57) Abstract
- (60) Number of examined patent document granted by foreign patent office, date from which patent has effect and country code
- (62) Number of the earlier application and in case of divided application, date of filing an application
- (71) Name, surname and address of applicant (country code)
- (72) Name, surname of inventor (country code)
- (73) Name, surname and address of patent owner (country code)
- (74) Name, surname of representative or patent attorney
- (85) Date of commencement of the national phase of International Application
- (86) Number and date of filing of international application
- (87) Number and date of publication of international application

DESIGNS

- (10) Number of publication for application
- (11) Number of patent and kind of document or number of registration
- (15) Date of registration/Date of patent renewal
- (18) Expected expiration date of patent or registration
- (21) Serial number of application
- (22) Date of filing of the application
- (23) Date of exhibition or the date of the earlier filing and the number of application, if any
- (24) Date from which patent may have effect
- (28) Number of designs included in the application
- (30) Data relating to priority (number of application, date of filing of application, two-letter code identifying the authority with whom the priority application was made)
- (31) Number of priority application
- (32) Date of filing of priority application
- (33) Code of the country or regional organization allotting priority application number
- (34) Two-letter code according to WIPO St.3 identifying the authority with which the priority application was made
- (44) Date of publication of design and number of bulletin (the first publication)
- (45) Date of publication of design registered by WIPO and number of bulletin
- (51) International Classification for designs (class and subclass of the Locarno Classification)
- (54) Title of the invention
- (55) Reproduction of the design
- (57) Description of characteristic features of the design including indication of colors
- (58) Date of recording of any kind of amendment in the Register
- (62) Number of the earlier application, registration and document number and if available the date of filing an application in case of divided application
- (71) Name, surname and address of applicant (country code)
- (72) Name, surname of creator (country code)
- (73) Name, surname and address of patent owner (country code)
- (74) Name, surname of representative or patent attorney
- (81) Contracting states concerned
 - II designated contracting states according to the 1960 Act
 - III designated contracting states according to the 1999 Act
- (85) Owner's permanent address
- (86) Owner's nationality
- (87) Owner's residence
- (88) State in which the owner has a real and effective industrial or commercial establishment

TRADEMARKS

- (111) – Number of registration
- (151) – Date of registration
- (156) – Date of the renewal
- (181) – Expected expiration date of registration
- (186) – Renewal expiration date of registration
- (141) – Date of cancel of duration of the mark
- (210) – Serial number of application
- (220) – Date of filing of the application
- (230) – Date concerning exhibition
- (260) – Number of application, for which favorable decision of examination about registration has been taken (publication number)
- (310) – Number of the first application
- (320) – Date of filing of the first application
- (330) – Code, identifying national or regional Office where the first application was made
- (511) – International Classification of Goods and Services for the purposes of registration of trade marks and/or list of goods and/or services classified according thereto
- (531) – Description of figurative elements of Trade Marks according to the International Classification of the Figurative Elements of Marks
- (540) – Reproduction of Trade Mark
- (550) – Nature and kind of Trade Mark
- (580) – Date of recording of any kind changes in respect of applications or registrations
- (591) – Information concerning colors claimed
- (731) – Name and address of the applicant
- (732) – Name and address of the holder of the registration
- (740) – Name and address of the representative
- (750) – Address for correspondence
- (770) – Name and address of the previous applicant or holder in case of change in ownership
- (771) – Previous name and address of the applicant or holder in case of change in ownership
- (791) – Name and address of the licensee
- (793) – Indication of conditions and/or restrictions under the license (Type of license, number of license agreement, data of license, data of validity of license)
- (800) – Certain data relating to the international registration of Trade Marks under the Protocol Relating to Madrid Agreement (International registration number)

CODES FOR PUBLICATION IN BULLETIN

- (21) AP 0000 000000 – serial number of application for invention
- (10) AP 0000 0000 A – number of published application for invention (first publication)
- (11) P 0000 0000 B – number of patent for invention (second publication)
- (21) API 0000 000000 – number of application for imported patent
- (11) PI 0000 0000 A – number of imported patent (first publication)
- (21) AU 0000 000000 – serial number of application for utility model
- (10) AU 0000 000 U – number of published application for utility model (first publication)
- (11) U 0000 000 Y – number of patent for utility model (second publication)
- (21) AD 0000 000000 – serial number of application for design
- (10) AD 0000 000 S – number of published application for design (first publication)
- (11) D 0000 000 S – number of patent for design (second publication)

INTERNATIONAL PATENT CLASSIFICATION FOR INVENTIONS AND UTILITY MODELS

- SECTION A – HUMAN NECESSITIES
- SECTION B – PERFORMING OPERATIONS; TRANSPORTING
- SECTION C – CHEMISTRY; METALLURGY
- SECTION D – TEXTILES; PAPER
- SECTION E – FIXED CONSTRUCTIONS
- SECTION F – MECHANICAL ENGINEERING; LIGHTING; HEATING; WEAPONS; BLASTING
- SECTION G – PHYSICS
- SECTION H – ELECTRICITY

-
- M – Trade Mark
 - (210) AM 0000 000000 – Serial number of application;
 - (260) AAM 0000 00000 A – Publication number of application;
 - (111) M 0000 00000 R – Number of registration;
 - (111) MMM0000 00000 Rn – Number of renewals, in which n=1,2,3;
 - (111) M 0000 00000 R(P) – Number of registration under partial assignment of rights
-

LIST OF CODES, IN ALPHABETIC SEQUENCE, AND THE CORRESPONDING (SHORT) NAMES OF STATES, OTHER ENTITIES AND INTERGOVERNMENTAL ORGANIZATIONS
(WIPO STANDARD ST.3)

AD	Andorra				
AE	United Arab Emirates				
AF	Afghanistan				
AG	Antigua and Barbuda				
AI	Anguilla				
AL	Albania				
AM	Armenia				
AN	Netherlands Antilles				
AO	Angola				
AP	African Regional Intellectual Property Organization (ARIPO)				
AR	Argentina				
AT	Austria				
AU	Australia				
AW	Aruba				
AZ	Azerbaijan				
BA	Bosnia and Herzegovina				
BB	Barbados				
BD	Bangladesh				
BE	Belgium				
BF	Burkina Faso				
BG	Bulgaria				
BH	Bahrain				
BI	Burundi				
BJ	Benin				
BM	Bermuda				
BN	Brunei Darussalam				
BO	Bolivia				
BR	Brazil				
BS	Bahamas				
BT	Bhutan				
BV	Bouvet Island				
BW	Botswana				
BX	Benelux Office for Intellectual Property (BOIP)				
BY	Belarus				
BZ	Belize				
CA	Canada				
CD	Democratic Republic of the Congo				
CF	Central African Republic				
CG	Congo				
CH	Switzerland				
CI	Cote d'Ivoire				
CK	Cook Islands				
CL	Chile				
CM	Cameroon				
CN	China				
CO	Colombia				
CR	Costa Rica				
CU	Cuba				
CV	Cape Verde				
CY	Cyprus				
CZ	Czech Republic				
DE	Germany				
DJ	Djibouti				
DM	Dominica				
DO	Dominican Republic				
DZ	Algeria				
EA	Eurasian Patent Organization (EAPO)				
EC	Ecuador				
EE	Estonia				
EG	Egypt				
EH	Western Sahara				
EM	Office for Harmonization in the Internal Market (Trademarks and Designs)(OHIM)				
EP	European Patent Office (EPO)				
ER	Eritrea				
ES	Spain				
ET	Ethiopia				
FI	Finland				
FJ	Fiji				
FK	Falkland Islands (Malvinas)				
FO	Faroe Islands				
FR	France				
GA	Gabon				
GB	United Kingdom				
GC	Patent Office of the Cooperation Council for the Arab States of the Gulf (GCC)				
GD	Grenada				
GG	Guernsey				
GH	Ghana				
GI	Gibraltar				
GT	Guatemala				
GW	Guinea- Bissau				
GY	Guyana				
HK	The Hong Kong Special Administrative Region of the People's Republic of China				
HN	Honduras				
HR	Croatia				
HT	Haiti				
HU	Hungary				
IB	International Bureau of the World Intellectual Property Organization (WIPO)				
ID	Indonesia				
IE	Ireland				
IL	Israel				
IM	Isle of Man				
IN	India				
IQ	Iraq				
ID	Indonesia				
IE	Ireland				
IL	Israel				
IM	Isle of Man				
IN	India				
IQ	Iraq				
IR	Iran (Islamic Republic of)				
IS	Iceland				
IT	Italy				
JE	Jersey				
JM	Jamaica				
JO	Jordan				
JP	Japan				
KE	Kenya				
KG	Kyrgyzstan				
KH	Cambodia				
KI	Kiribati				
KM	Saint Kitts and Nevis				
KP	Democratic People's Republic of Korea				
KR	Republic of Korea				
KW	Kuwait				
KY	Cayman Islands				
KZ	Kazakhstan				
LA	Lao People's Democratic Republic				
LB	Lebanon				
LC	Saint Lucia				
LI	Liechtenstein				
LK	Sri Lanka				
LR	Liberia				
LS	Lesotho				
LT	Lithuania				
LU	Luxembourg				
LV	Latvia				
LY	Libyan Arab Jamahiriya				
MA	Morocco				
MC	Monaco				
MD	Republic of Moldova				
ME	Montenegro				
MG	Madagascar				
MK	The former Yugoslav Republic of Macedonia				
ML	Mali				
MM	Myanmar				
MN	Mongolia				
MO	Macao				
MP	Northern Mariana Islands				
MR	Mauritania				
MS	Montserrat				
MT	Malta				
MU	Mauritius				
MV	Maldives				
MW	Malawi				
MX	Mexico				
MY	Malaysia				
MZ	Mozambique				
NA	Namibia				
NE	Niger				
NG	Nigeria				
NI	Nicaragua				
NL	Netherlands				
NO	Norway				
NP	Nepal				
NR	Nauru				
NZ	New Zealand				
OA	African Intellectual Property Organization (OAPI)				
OM	Oman				
PA	Panama				
PE	Peru				
PG	Papua New Guinea				
PH	Philippines				
PK	Pakistan				
PL	Poland				
PT	Portugal				
PW	Palau				
PY	Paraguay				
QA	Qatar				
QZ	Community Plant Variety Office (European Community) (CPVO)				
RO	Romania				
RS	Serbia				
RU	Russian Federation				
RW	Rwanda				
SA	Saudi Arabia				
SB	Solomon Islands				
SC	Seychelles				
SD	Sudan				
SG	Singapore				
SH	Saint Helena				
SI	Slovenia				
SK	Slovakia				
SL	Sierra Leone				
SM	San Marino				
SN	Senegal				
SO	Somalia				
SR	Suriname				
ST	Sao Tome and Principe				
SV	El Salvador				
SY	Syrian Arab Republic				
SZ	Swaziland				
TC	Turks and Caicos Islands				
TD	Chad				
TG	Togo				
TH	Thailand				
TJ	Tajikistan				
TL	Timor-Leste				
TM	Turkmenistan				
TN	Tunisia				
TO	Tonga				
TR	Turkey				
SE	Sweden				
TT	Trinidad and Tobago				
TV	Tuvalu				
TW	Taiwan, Province of China				
TZ	United Republic of Tanzania				
UA	Ukraine				
UG	Uganda				
US	United States of America				
UY	Uruguay				
UZ	Uzbekistan				
VA	Holy See				
VC	Saint Vincent and the Grenadines				
VE	Venezuela				
VG	Virgin Islands (British)				
VN	Viet Nam				
VU	Vanuatu				
WO	World Intellectual Property Organization (WIPO)				
WS	Samoa				
XN	Nordic Patent Institute (NPI)				
YE	Yemen				
ZA	South Africa				
ZM	Zambia				
ZW	Zimbabwe				

OFFICIAL BULLETIN OF THE INDUSTRIAL PROPERTY

9(517)

INVENTIONS

UTILITY MODELS

DESIGNS

TRADEMARKS

APPELLATION OF ORIGIN OF GOOD

DATE OF PUBLICATION

2019 05 10

CONTENTS

PUBLISHED TITLES OF PROTECTION	3
INVENTIONS	
▪ APPLICATIONS APPROVED FOR GRANTING PATENTS	4
▪ PATENTED INVENTION	5
UTILITY MODELS	
▪ PATENTED UTILITY MODELS	6
DESIGNS	
▪ REGISTERED DESIGNS	7
▪ DESIGNS, WHICH HAVE BEEN REGISTERED WITH THE INTERNATIONAL BUREAU CLAIMING PRIORITY ON THE TERRITORY OF GEORGIA	8
TRADEMARKS	
▪ APPLICATIONS FILED UNDER THE NATIONAL PROCEDURE APPROVED FOR REGISTRATION	15
▪ REGISTERED TRADEMARKS	24
▪ TRADEMARKS REGISTERED ACCORDING TO THE ACCELERATED PROCEDURE	28
▪ INTERNATIONAL TRADEMARKS FOR WHICH A DECISION ON GRANTING PROTECTION IS TAKEN	32
▪ INTERNATIONAL TRADEMARKS PROTECTED IN GEORGIA	73
APPELLATION OF ORIGIN OF GOOD	
AMENDMENTS TO THE REGISTRATION OF APPELLATION OF ORIGIN OF GOOD	78
OFFICIAL NOTIFICATIONS	
INVENTIONS	
▪ RENEWAL OF PATENTS	80
▪ ABOLITION OF PATENTS WITH THE RIGHT TO RESTORE	80
▪ EXPIRATION OF TERM OF RESTORATION OF PATENTS	82
UTILITY MODELS	
▪ RENEWAL OF PATENTS	83
▪ EXPIRATION OF TERM OF RESTORATION OF PATENTS	84
▪ TRANSFER OF RIGHTS	84
DESIGNS	
CANCELLATION OF REGISTRATIONS	85
TRADEMARKS	
▪ RENEWAL OF REGISTRATIONS	86
▪ COMPLETE TRANSFER OF RIGHTS	89
▪ CHANGES OF NAMES AND/OR ADDRESSES OF OWNERS	90
▪ TERMINATION OF TRADEMARKS REGISTRATION	91
CLASSIFICATION INDEXES	
INVENTIONS	94
UTILITY MODELS	95
DESIGNS	95
TRADEMARKS	97

PUBLISHED TITLES OF PROTECTION

INVENTIONS

- **APPLICATIONS APPROVED FOR GRANTING PATENT:**
14035; 14622
- **PATENTED INVENTION:**
6971

UTILITY MODELS

- **PATENTED UTILITY MODELS:**
2007-2008

DESIGNS

- **REGISTERED DESIGNS:**
804-807
- **DESIGNS WHICH HAVE BEEN REGISTERED WITH THE INTERNATIONAL BUREAU CLAIMING PRIORITY ON THE TERRITORY OF GEORGIA:**
200124; 103369; 100186

TRADEMARKS

- **APPLICATIONS FILED UNDER THE NATIONAL PROCEDURE APPROVED FOR REGISTRATION:**
94169; 95028, 95029; 95362*; 98673; 98962; 99194; 99299; 99302; 99306, 99307; 99311; 99327, 99328; 99335, 99336; 99349; 99352; 99367; 99430; 99434; 99441; 99444, 99445; 99452-99456; 99460; 99463; 99501; 99517; 99672; 99759; 99761; 99774; 99936, 99937; 99941, 99942; 99944, 99945; 99953, 99954; 99990; 99992-99999
- **REGISTERED TRADEMARKS:**
31116-31153
- **TRADEMARKS REGISTERED ACCORDING TO THE ACCELERATED PROCEDURE:**
31101-31115; 31154-31158
- **INTERNATIONAL TRADEMARKS FOR WHICH A DECISION ON GRANTING PROTECTIONS IS TAKEN:**
95251; 95753; 97576; 97613; 97916; 98135; 98263; 98463, 98464; 98466, 98467; 98495, 98496; 98502; 98504; 98507; 98509-98511; 98514-98522; 98526-98528; 98531; 98533-98538; 98540; 98542, 98543; 98622-98625; 98628-98633; 98700; 98705; 98707, 98708; 98711; 98715; 98717; 98719-98722; 98724-98726; 98728-98732; 98734; 98750; 98753, 98754; 98834-98836; 98913, 98914; 98922-98927; 98929-98932; 98934-98937; 98939-98941; 99098; 99217; 99536
- **INTERNATIONAL TRADEMARKS PROTECTED IN GEORGIA:**
92288; 93285; 93287; 93362, 93363; 95761; 95768; 95955; 96210; 96825, 96826; 96830; 96930; 96944, 96945; 96948; 96964; 96966, 96967; 96972; 96983; 96987; 97064; 97093, 97094; 97134; 97153; 97234-97236; 97241; 97279, 97280; 97325; 97327-97332; 97334; 97336; 97338-97340; 97342, 97343; 97493; 97498; 97514; 97557, 97558; 97560; 97562- 97567; 97572, 97573; 97664; 97666; 97668

APPELLATION OF ORIGIN OF GOOD

AMENDMENTS TO THE REGISTRATION OF APPELLATION OF ORIGIN OF GOOD:

INVENTIONS

APPLICATIONS APPROVED FOR GRANTING PATENTS

The decision can be appealed at the Chamber of Appeal of Sakpatenti within 3 months from the publication or at the Mtskheta District Court Administrative Cases Board (Address: №17, Samkhedro str., Mtskheta), within 1 month following the publication.

PART A

A 61

- (10) AP 2019 14035 A (51) Int. Cl. (2006)
A 61 K 9/32
A 01 N 33/08
- (21) AP 2014 14035 (22) 2014 06 17
(31) 61/835,965
(32) 2013 06 17
(33) US
(71) RAPTOR PHARMACEUTICALS INC. (US)
7 Hamilton Landing, Suite 100 Novato,
CA 94949 (US)
(72) POWELL, Kathlene (US);
MUTTAVARAPU, Ramesh (US)
(74) Shalva Gvaramadze
(85) 2016 01 12
(86) PCT/US2014/042607, 2014 06 17
(54) **DELAYED RELEASE CYSTEAMINE
BEAD FORMULATION CONTAINING
CYSTEAMINE GRANULES, PREPARA-
TION METHODS AND USAGE
THEREOF**
(57) Dosage form contains cysteamine granules
with delayed release. The granule consists of core
containing cysteamine, a binder, and enterosoluble
cover.
Claims: 1 independent
22 dependent
-

- (10) AP 2019 14622 A (51) Int. Cl. (2006)
A 61 K 31/495
A 61 P 25/24
A 61 P 25/28
A 61 P 25/18
C 07 D 295/096
C 07 D 207/28
- (21) AP 2016 14622 (22) 2016 05 11
(31) PA 2015 00284
(32) 2015 05 13
(33) DK
(71) H. LUNDBECK A/S (DK)
Ottliavej 9 2500 Valby (DK)
(72) KATEB, Jens (SE);
DE DIEGO, Heidi, Lopez (DK);

- CHRISTENSEN, Kim, Lasse (DK);
HOLM, Rene (DK)
(74) Tamaz Shilakadze
(85) 2017 11 10
(86) PCT/EP2016/060540, 2016 05 11
(54) **VORTIOXETINE PYROGLUTAMATE**
(57) There is represented vortioxetine pyrogluta-
mate salt and pharmaceutical composition on a ba-
sis thereof.
Claims: 12 independent
4 dependent
Fig.: 14
-

PATENTED INVENTION

PART A

A 61

- (11) P 2019 6971 B (51) Int. Cl. (2006)
A 61 K 8/37
A 61 K 8/92
A 61 K 8/67
A 61 K 8/04
- (10) AP 2019 14731 A (44) 2(510)/2019
(21) AP 2016 14731
(22) 2016 09 19
(24) 2016 09 19
(31) 102015000055392
(32) 2015 09 25
(33) IT
(86) PCT/EP2016/072097, 2016 09 19
(73) BIO. LO. GA. S.R.L. (IT)
Via Giuseppe Lazzarin, 31015, Conegliano,
Treviso (IT)
(72) PANIN, Giorgio (IT)
(74) Nugzar Ksovreli
(85) 2018 03 19
(86) PCT/EP2016/072097, 2016 09 19
(54) **HYDROPHOBIC GEL BASED ON
VITAMIN E FREE FROM SILICONE
PRODUCTS FOR TOPICAL APPLICATION**
-

UTILITY MODELS

PATENTED UTILITY MODELS

PART A

A 01

(11) U 2019 2008 Y (51) Int. Cl. (2006)
A 01 C 23/00

(10) AU 2018 14419 U (44) 23(507)/2018

(21) AU 2017 14419

(22) 2017 02 10

(24) 2017 02 10

(73) Lukhum Tchelidze (GE)

Nikeas q. 32/3, 4600, Kutaisi (GE);

Rani Tchabukiani (GE)

Solomon I, shes. I, No. 3, 4600, Kutaisi (GE);

Soso Tavberidze (GE)

Gugunavas q. 22, 4600, Kutaisi (GE);

Emzar Kilasonia (GE)

Leselidzis q. 1, 4600, Kutaisi (GE)

(72) Lukhum Tchelidze (GE);

Rani Tchabukiani (GE);

Soso Tavberidze (GE);

Emzar Kilasonia (GE)

(74) Archil Geguchadze

(54) **DEVICE FOR SOIL FERTILIZING
BETWEEN PLANT STEMS**

(72) Merab Zhgenti (GE);

Levan Gulua (GE);

Tamar Turmanidze (GE)

(54) **METHOD FOR UNCOOKED
BILBERRIES STORAGE**

A 23

(11) U 2019 2007 Y (51) Int. Cl. (2006)
A 23 B 7/00

(10) AU 2018 14621 U (44) 22(506)/2018

(21) AU 2017 14621

(22) 2017 11 07

(24) 2017 11 07

(73) Merab Zhgenti (GE)

Terevenkos q. 36, b. 49, Tbilisi (GE);

Levan Gulua (GE)

A. Mirtskhulavas q. 3a, b. 37, Tbilisi (GE);

Tamar Turmanidze (GE)

D/Dighomi, D. Tavdadebulis q.

41/16, 8. 20, Tbilisi (GE);

LEPL Shota Rustaveli National Science

Foundation (GE)

Merab Aleksidzis q. 1, 0193, Tbilisi (GE);

NLE Agricultural University of Georgia (GE)

D. Aghmasheneblis Kheivani 240, 0131,

Tbilisi (GE)

DESIGNS

REGISTERED DESIGNS

- | | | |
|---|-------------------|--|
| (11) D 2019 806 S | (51) 12-08 | (73) Giorgi Keburia (GE) |
| (10) AD 2019 1053 S | (44) 2(510)/2019 | Sopiko Chiaurelis q. 16, 0179, Tbilisi (GE) |
| (21) AD 2018 1053 | | (72) Giorgi Keburia (GE) |
| (22) 2018 09 03 | | (54) 1.-2. SUNGLASSES |
| (24) 2018 09 03 | | |
| (28) 1 | | |
| (18) 2023 09 03 | | |
| (31) 3-2018-00415 | | (11) D 2019 804 S |
| (32) 2018 03 02 | | (51) 25-01; 25-02 |
| (33) VN | | (10) AD 2019 1047 S |
| (73) Vinfast Trading And Production Limited | | (44) 2(510)/2019 |
| Liability Company (VN) | | (21) AD 2018 1047 |
| Dinh Vu-Cat Hai Economic Zone, Cat Hai | | (22) 2018 07 18 |
| Island, Cat Hai Town, Cat Hai District, | | (24) 2018 07 18 |
| Hai Phong City (VN) | | (28) 12 |
| (72) MATTEO, Piguzzi (IT); | | (18) 2023 07 18 |
| BONZANIGO, Carlo Alessandro Tullio | | (73) LTD "WINTEC PRO" (GE) |
| Maria (IT); | | Sanapiros q. 2a, 0105, Tbilisi (GE) |
| NAZZARENO, Epifani (IT) | | (72) Luka Ananidze (GE) |
| (74) Shalva Gvaramadze (GE) | | (74) Shalva Gvaramadze (GE) |
| (54) CAR | | (54) 1.-11. WINDOW PROPHILE, 12. WINDOW |
-
- | | | |
|---|-------------------|--|
| (11) D 2019 807 S | (51) 12-08 | |
| (10) AD 2019 1055 S | (44) 2(510)/2019 | |
| (21) AD 2018 1055 | | |
| (22) 2018 09 03 | | |
| (24) 2018 09 03 | | |
| (28) 1 | | |
| (18) 2023 09 03 | | |
| (31) 3-2018-00432 | | |
| (32) 2018 03 02 | | |
| (33) VN | | |
| (73) Vinfast Trading And Production Limited | | |
| Liability Company (VN) | | |
| Dinh Vu-Cat Hai Economic Zone, Cat Hai | | |
| Island, Cat Hai Town, Cat Hai District, | | |
| Hai Phong City (VN) | | |
| (72) PERINI, Filippo (IT) | | |
| (74) Shalva Gvaramadze (GE) | | |
| (54) CAR | | |
-
- | | | |
|--------------------------|-------------------|--|
| (11) D 2019 805 S | (51) 16-06 | |
| (10) AD 2019 1049 S | (44) 2(510)/2019 | |
| (21) AD 2018 1049 | | |
| (22) 2018 08 01 | | |
| (24) 2018 08 01 | | |
| (28) 2 | | |
| (18) 2023 08 01 | | |
-

DESIGNS, WHICH HAVE BEEN REGISTERED WITH THE INTERNATIONAL BUREAU CLAIMING PRIORITY ON THE TERRITORY OF GEORGIA

The decision can be appealed at the Chamber of Appeal of Sakpatenti within 3 months from the publication or at the Mtskheta District Court Administrative Cases Board (Address: №17, Samkhedro Str., Mtskheta), within 1 month following the publication.

- (11) **DM/200 124** (51) **11-01**
(15) 2018 12 10 (44) 09/2019 (2019 03 01)
(22) 2018 12 10
(28) 3
(73) HARRY WINSTON SA
 Chemin Du Tourbillon 8, 1228 Plan-Les-Ouates (CH)
(85) CH
(86) CH
(87) CH
(88) CH
(89) CH
(81) II. BZ, MA III. UA, AM, AL, AZ, ME, MD, MC, SG, MN, NO, BA, OM, GE, MK, TR, LI, KG, GB,
 TN, EM, CH
(72) 2-3 Rie YATSUGI-KANG
 C/o Harry Winston Inc.
 718 Fifth Avenue, 10019 New York (US);
 1 Delphine ABDOURAHIM
 C/o Harry Winston Inc.
 718 Fifth Avenue, 10019 New York (US)
(74) The Swatch Group AG (The Swatch Group SA) (The Swatch Group Ltd.)
 Faubourg Du Lac 6, 2501 BIEL/BIENNE (CH)
(54) 1. Necklace, 2. Earring, 3. Finger ring
(55)

1.1



1.2



1.3



2.1



2.2



2.3



2.4



2.5



2.6



2.7



2.8



3.1



3.2



3.3



3.4



3.5



3.6



3.7



3.8



(11) DM/103 369

(51) 14-02

(15) 2018 08 28

(44) 09/2019 (2019 03 01)

(22) 2018 08 28

(28) 2

(73) SWATCH AG (SWATCH SA) (SWATCH LTD.)

94, Rue Jakob Stämpfli, CH-2502 Biel/Bienne (CH)

(85) CH

(86) CH

(87) CH

(88) CH

(89) CH

(81) II. BZ, MA III. AL, AM, AZ, BA, CH, EM, GE, KG, LI, MC, MD, ME, MK, MN, NO, OM, SG, TN, TR, UA

(72) 1 Christoph Stauber

Stauffacherstrasse 106, 8004 Zürich (CH);

2 Ernest Anthony Deane

Länggasse 85, 2500 Biel/Bienne (CH)

(74) The Swatch Group AG (The Swatch Group SA) (The Swatch Group Ltd.)

Faubourg Du Lac 6, CH-2501 Biel/Bienne (CH)

(54) 1. Display screen with graphical user interface, 2. Graphical user interface for display panel

(55)



(11) DM/100 186

(15) 2018 03 06

(22) 2018 03 06

(28) 3

(73) TISSOT SA (TISSOT AG) (TISSOT LTD)

Chemin Des Tourelles 17, CH-2400 Le Locle (CH)

(85) CH

(86) CH

(87) CH

(88) CH

(89) CH

(81) II. BZ, MA III. AL, AM, AZ, BA, CH, EM, GE, KG, LI, MD, ME, MK, MN, OM, SG, TN, TR

(72) Fiona MATTHEY

Rue Neuve 3, 2300 La Chaux-de-Fonds (CH)

(74) The Swatch Group AG (The Swatch Group SA) (The Swatch Group Ltd.)

Faubourg Du Lac 6, CH-2501 Biel/Bienne (CH)

(46) 2019-03-06

(54) 1. Watch case, 2. Watch dials, 3. Watch dials

(55)

(51) 10-07

(44) 10/2019 (2019 03 08)

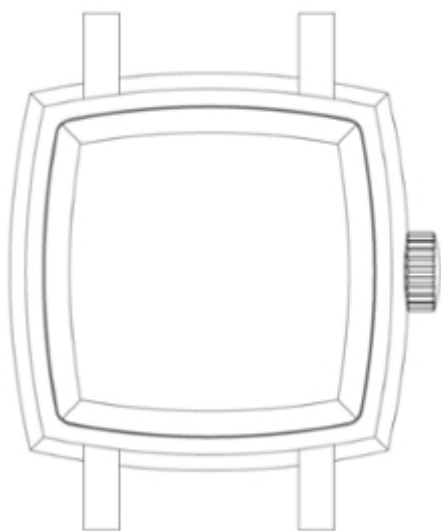
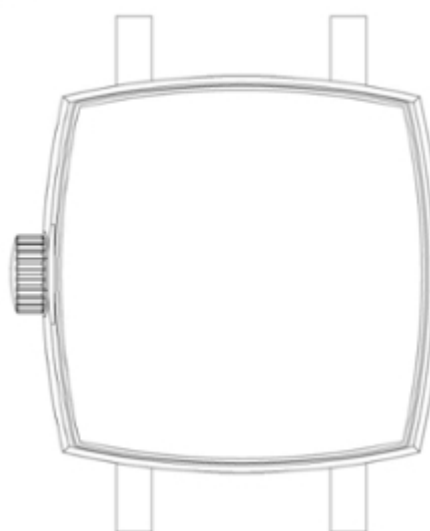
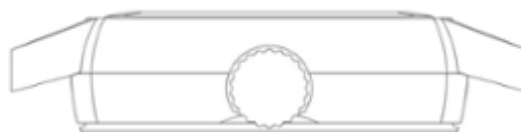
1.1**1.2****1.3****1.4****1.5****1.6**

1.7

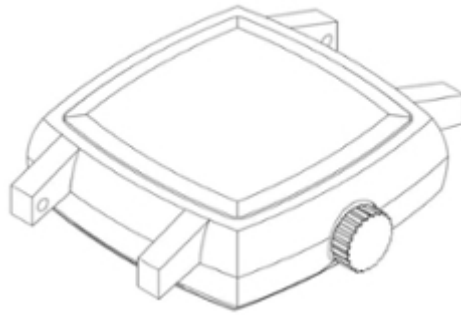

2.1



2.2

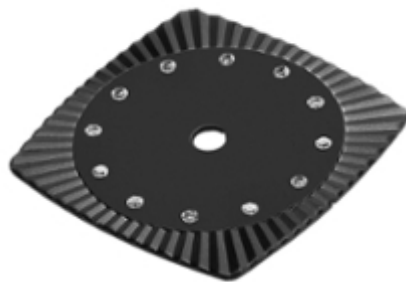

3.1

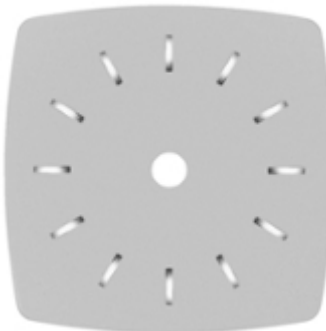

3.2

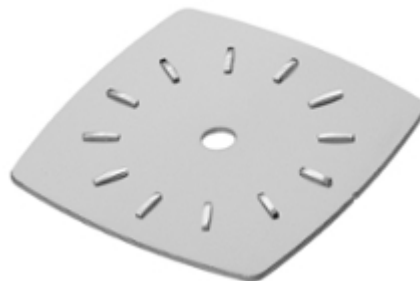

TRADEMARKS

APPLICATIONS FILED UNDER THE NATIONAL PROCEDURE APPROVED FOR REGISTRATION

The decision can be appealed at the Chamber of Appeal of Sakpatenti within 3 months from the publication or at the Mtskheta District Court Administrative Cases Board (Address: №17, Samkhedro St., Mtskheta), within 1 month following the publication.

(260) AM 2019 94169 A
(210) AM 94169
(220) 12 09 2017
(731) "VITA SUN" LTD
Suite 1, 2 Station Court, Townmead Road,
London, United Kingdom
(740) Nugzar Ksovveli
(540)

FINER

(511) 5

(260) AM 2019 95028 A
(210) AM 95028
(220) 15 10 2018
(731) LTD "ICR Catering"
D. Aghmashenebeli Alley 12th kilometer,
Shopping and Business Center "My House"
Floor I, Dighomi Training-Trial Farming
Area, 0159, Tbilisi Georgia
(740) Mariam Gobejishvili
(540)



(591) Black, white
(531) 26.01.04; 26.01.19; 28.19
(511) 41, 43

(260) AM 2019 95029 A
(210) AM 95029
(220) 15 10 2018
(731) LTD "ICR Catering"
D. Aghmashenebeli Alley 12th kilometer,
Shopping and Business Center "My House"
Floor I, Dighomi Training-Trial Farming
Area,
0159, Tbilisi Georgia

(540)



(591) Black, white
(531) 26.01.04; 26.01.19; 27.05.01
(511) 41, 43

(260) AM 2019 95362 A*
(210) AM 95362
(220) 05 12 2017
(731) Amazon Europe Core S.à r.l.
5, Riu Pleti, L-2338, Luxembourg
(740) Tamaz Shilakadze
(540)

ECHO

(591) Black, white
(511) 35

(260) AM 2019 98673 A
(210) AM 98673
(220) 24 07 2018
(731) "CCLA" LLC
S. Tsintsadze Str. 26, Entrance 3, Floor 3,
Ap. 3-01, Blok II, Vake-Saburtalo
District, 0160, Tbilisi, Georgia
(540)

ლობოტი

(591) Black, white
(511) 35, 42, 45

(260) AM 2019 98962 A
(210) AM 98962
(220) 10 08 2018

(731) LTD "Lithuanian Bakery+"
T. Eristavi Str. 1, 0192, Tbilisi, Georgia
(540)



(591) Green, white, red, yellow, black, brown
(531) 02.01.02; 02.01.04; 02.01.20; 03.03.01;
03.03.17; 05.07.02; 25.01.01; 25.01.25; 28.19;
29.01.15
(511) 30, 35

(260) AM 2019 99194 A
(210) AM 99194
(220) 06 09 2018
(731) Wyndham Hotels and Resorts LLC
Sylvan Way, Parsippany, New Jersey
07054, USA
(740) Tamaz Shilakadze
(540)

WYNDHAM GRAND

(591) Black, white
(511) 43

(260) AM 2019 99299 A
(210) AM 99299
(220) 07 09 2018
(731) Vhg (jerzi) Limitid
13-14 Esplanade, JE1 1EE St. Helier, Jersey
(740) Tamaz Shilakadze
(540)

TRYP

(591) Black, white
(511) 43

(260) AM 2019 99302 A
(210) AM 99302
(220) 2018 09 07
(731) LLC "Dinamo Football Club Tbilisi"
B. Paichadze Str. 11, 0159, Tbilisi, Georgia
(740) Giorgi Taktakishvili
(540)

**ჩვენსი ქალაქი, ჩვენსი გუნდი!
OUR CITY, OUR TEAM!**

(591) Dark blue
(531) 28.19; 29.01.04
(511) 14, 16, 18, 21, 24, 25, 28, 35, 41

(260) AM 2019 99306 A
(210) AM 99306
(220) 07 09 2018
(731) Exxon Mobil Corporation
5959 Las Colinas Boulevard, Irving, Texas
75039-2298, USA
(740) Shalva Gvaramadze
(540)

MOBIL 1

(591) Black, white
(511) 1, 37

(260) AM 2019 99307 A
(210) AM 99307
(220) 07 09 2018
(731) RAMON GUIRAL BROTO
Calle Alta no. 13, 22124 Las Cellas, Huesca,
Spain
(740) Shalva Gvaramadze
(540)



(591) Black, white
(531) 27.05.01; 27.05.19
(511) 41, 43

(260) AM 2019 99311 A
(210) AM 99311
(220) 10 09 2018
(731) Varaz Aspanidze
Aleksidze Str. 1, Build. 4, Entrance 2, Ap. 25,
0193, Tbilisi, Georgia

(540)



(591) Black, orange, white
 (531) 27.07.24; 28.19; 29.01.13
 (511) 32

(260) AM 2019 99327 A
 (210) AM 99327
 (220) 12 09 2018
 (731) Ltd "ALPEN MILK"
 D. Aghmashenebeli Str. 28/1, Akhalkalaki,
 Georgia

(740) Shalva Gvaramadze
 (540)

ЗОЛОТОЙ ЗАМОК

(591) Black, white
 (511) 30

(260) AM 2019 99328 A
 (210) AM 99328
 (220) 12 09 2018
 (310) 724362018
 (320) 24 04 2018
 (330) CH
 (731) The Procter & Gamble Company,
 Uan Prokter End Gembl Plaza, Cincinnati,
 Ohaio 45202, USA

(740) Merab Kvimsadze
 (540)

GO SCALPBRAVE

(591) Black, white
 (531) 27.05.01
 (511) 3, 44

(260) AM 2019 99335 A
 (210) AM 99335
 (220) 12 09 2018
 (731) Ltd "AVERSI-PHARMA"
 D. Aghmashenebeli Ave. 148/2, 0112,
 Tbilisi, Georgia
 (540)

ოსტეოლაითი
Остеолайт
Osteolight

(591) Black, white
 (511) 5

(260) AM 2019 99336 A
 (210) AM 99336
 (220) 12 09 2018
 (310) 724342018
 (320) 24 04 2018
 (330) CH
 (731) The Procter & Gamble Company,
 Uan Prokter End Gembl Plaza, Cincinnati,
 Ohaio 45202, USA

(740) Merab Kvimsadze
 (540)

SCALPBRAVE

(591) Black, white
 (531) 27.05.01
 (511) 3, 44

(260) AM 2019 99349 A
 (210) AM 99349
 (220) 12 09 2018
 (731) Ltd "AVERSI-PHARMA"
 D. Aghmashenebeli Ave. 148/2, 0112,
 Tbilisi, Georgia

(540)

დივალაინი
Дивалайн
Divaline

(591) Black, white
 (511) 5

(260) AM 2019 99352 A
 (210) AM 99352
 (220) 13 09 2018
 (731) PPG INDUSTRIES OHIO INC.
 3800 West 143rd St., Cleveland, Ohio
 44111, USA

(740) Giorgi Taktakishvili
 (540)



(591) Black, white
 (531) 01.05.01; 01.05.06
 (511) 2

(260) AM 2019 99367 A
 (210) AM 99367
 (220) 14 09 2018
 (731) Mobile Outfitters LLC
 Suite 106, 3901B Main Street, Philadelphia,
 Pennsylvania 19127, USA
 (740) Tamaz Shilakadze
 (540)



(591) Black, white
 (531) 26.04.04; 26.04.22; 26.04.24; 27.05.24
 (511) 9

(260) AM 2019 99430 A
 (210) AM 99430
 (220) 2018 09 17
 (731) JSC "KOTEKHI"
 "Gurjaani Wine Factory"
 K. Koroghlishvili Str. 38, 1500, Gurjaani,
 Georgia
 (740) Dimitri Dzamukashvili
 (540)

DIDVALLEY

დიდვალე

(591) Black, white
 (511) 33

(260) AM 2019 99434 A
 (210) AM 99434
 (220) 18 09 2018
 (731) Toyota Jidosha Kabushiki Kaisha
 (also trading as Toyota Motor Corporation)
 1, Toyota-cho, Toyota-shi, Aichi-ken, Japan
 (740) Tamar Kotchlamazashvili
 (540)

GR 86

(591) Black, white
 (511) 12

(260) AM 2019 99441 A
 (210) AM 99441
 (220) 2018 09 19
 (731) Ltd "STALKER"
 Ak. Tsereteli Ave. 142, Floor 4, 0160, Tbilisi,
 Georgia
 (740) Tamaz Urtmelidze

(540)

STALKER

(591) Black, white
 (531) 27.05.01; 28.11
 (511) 43

(260) AM 2019 99444 A
 (210) AM 99444
 (220) 20 09 2018
 (731) JURA Elektroapparate AG
 Kaffeeweltstrasse 10, 4626 Niederbuchsiten,
 Switzerland
 (740) Giorgi Taktakishvili
 (540)

ENA

(591) Black, white
 (531) 27.05.01; 27.05.23
 (511) 11

(260) AM 2019 99445 A
 (210) AM 99445
 (220) 20 09 2018
 (731) JURA Elektroapparate AG
 Kaffeeweltstrasse 10, 4626 Niederbuchsiten,
 Switzerland
 (740) Giorgi Taktakishvili
 (540)

jura

(591) Black, white
 (531) 27.05.19
 (511) 11

(260) AM 2019 99452 A
 (210) AM 99452
 (220) 20 09 2018
 (731) Sundaram-Clayton Limited
 "Jayalakshmi Estates" No. 29 (Old No. 8),
 Haddows Road, Chennai 600 006, India
 (740) Tamaz Shilakadze
 (540)



(591) Black, blue, red, white
 (531) 03.01.26; 03.03.01; 27.05.01; 27.05.23;
 29.01.13
 (511) 12

(260) AM 2019 99453 A
 (210) AM 99453
 (220) 20 09 2018
 (731) Sundaram-Clayton Limited
 "Jayalakshmi Estates" No. 29 (Old No. 8),
 Haddows Road, Chennai 600 006, India
 (740) Tamaz Shilakadze
 (540)



(591) Black, blue, red, white
 (531) 26.04.22; 26.04.24; 27.05.01; 27.05.09;
 27.05.10; 27.05.17; 27.05.23; 27.05.24;
 29.01.13
 (511) 12

(260) AM 2019 99454 A
 (210) AM 99454
 (220) 20 09 2018
 (731) Sundaram-Clayton Limited
 "Jayalakshmi Estates" No. 29 (Old No. 8),
 Haddows Road, Chennai 600 006, India
 (740) Tamaz Shilakadze
 (540)



(591) Black, red, grey
 (531) 27.05.02; 27.05.10; 27.07.02; 29.01.13
 (511) 12

(260) AM 2019 99455 A
 (210) AM 99455
 (220) 20 09 2018
 (731) Sundaram-Clayton Limited
 "Jayalakshmi Estates" No. 29 (Old No. 8),
 Haddows Road, Chennai 600 006, India
 (740) Tamaz Shilakadze
 (540)



(591) Black, red, grey
 (531) 27.05.02; 27.05.09; 27.05.10; 27.07.02;
 29.01.13
 (511) 12

(260) AM 2019 99456 A
 (210) AM 99456
 (220) 20 09 2018
 (731) Sundaram-Clayton Limited
 "Jayalakshmi Estates" No. 29 (Old No. 8),
 Haddows Road, Chennai 600 006, India
 (740) Tamaz Shilakadze
 (540)



(591) Black, light grey, dark grey
 (531) 24.13.01; 24.13.09; 27.05.02; 27.05.09
 (511) 12

(260) AM 2019 99460 A
 (210) AM 99460
 (220) 20 09 2018
 (731) Ltd "MATIANE"
 Moscow Ave., Build. 38, Ap. 113,
 Samgori District, 0137, Tbilisi,
 Georgia
 (740) Levan Nanobashvili
 (540)

მატიანე

(591) Black, white
 (511) 33

(260) AM 2019 99463 A
 (210) AM 99463
 (220) 21 09 2018
 (731) ALLERGAN HOLDINGS France SAS
 12 Place de la Defense, 4eme etage, 92400,
 Courbevoie, France
 (740) Shalva Gvaramadze
 (540)

VOLBELLA

(511) 3, 5, 10

(260) AM 2019 99501 A
 (210) AM 99501
 (220) 24 09 2018
 (731) Al Saily Commerce & Industry Tobacco
 A Shoha bemelk Sobh Abu Alenien
 Abu Alenien Alfar, Mansoura Center,
 Al Dakahleya, Egypt
 (740) Merab Kvimsadze

(540)



(591) Black, white, gray, dark gray, light gray, red, dark red, light brown, brown, yellow

(531) 26.01.02; 26.01.04; 26.01.20; 26.01.24; 27.05.01; 27.05.03; 27.05.10; 27.05.24; 29.01.15

(511) 34

(260) AM 2019 99517 A

(210) AM 99517

(220) 26 09 2018

(731) City Sightseeing Limited
Stanley House, 49a High Street, Henley-in-Arden, Warwickshire B95 5AA,
United Kingdom

(740) Giorgi Taktakishvili

(540)

City Sightseeing

(591) Black, white

(511) 12, 35

(260) AM 2019 99672 A

(210) AM 99672

(220) 04 10 2018

(731) JSC "BETOBE"

Zurab and Teimuraz Zaldastanishvili Str. 16,
0177, Tbilisi, Georgia

(540)



(591) White, greenish-blue

(531) 26.01.01; 26.01.19; 26.04.10; 26.04.22; 26.04.24; 29.01.12

(511) 9, 35, 36, 39, 42

(260) AM 2019 99759 A

(210) AM 99759

(220) 09 10 2018

(310) 75590

(320) 03 08 2018

(330) JM

(731) Caterpillar Inc.(a Delaware corporation)
510 Lake Cook Road, Suite 100, Illinois,
Dirfield, 60015, USA

(740) Tamar Kochlamazashvili

(540)



(591) Black, white, gray, red, yellow

(531) 03.13.05; 26.05.03; 26.05.08; 26.05.19; 27.05.08; 27.05.17; 27.05.24; 29.01.14

(511) 7, 12

(260) AM 2019 99761 A

(210) AM 99761

(220) 09 10 2018

(310) 75592

(320) 03 08 2018

(330) JM

(731) Caterpillar Inc.(a Delaware corporation)
510 Lake Cook Road, Suite 100, Illinois,
Dirfield, 60015, USA

(740) Tamar Kochlamazashvili

(540)



(591) Black, white

(531) 03.13.05; 26.03.01; 26.03.24; 26.05.03; 26.05.04; 27.05.08; 27.05.17

(511) 7, 12

(260) AM 2019 99774 A

(210) AM 99774

(220) 2018 10 10

(731) HYUNDAI MOTOR COMPANY
12, Heolleung-ro, Seocho-gu, Seoul, Republic
of Korea

(740) Shalva Gvaramadze

(540)

GENESIS G95

(511) 12

(260) AM 2019 99936 A

(210) AM 99936

(220) 19 10 2018

(731) Ltd "AVERSI-PHARMA"
D. Aghmashenebeli Ave. 148/2, 0112,
Tbilisi, Georgia

(540)

ცენტური
Центур
Centur

(511) 5

(260) AM 2019 99937 A

(210) AM 99937

(220) 19 10 2018

(731) Ltd "AVERSI-PHARMA"

D. Aghmashenebeli Ave. 148/2, 0112,
Tbilisi, Georgia

(540)

კენანდრა
Кенандра
Kenandra

(591) Black, white

(511) 5

(260) AM 2019 99941 A

(210) AM 99941

(220) 22 10 2018

(731) Abdi İbrahim İlaç Sanayi ve Ticaret Anonim Şirketi

Reşitpaşa Mahallesi Eski Büyükdere Caddesi
No:4 34467 Maslak Sarıyer İstanbul,
Turkey

(740) Tamaz Shilakadze

(540)

ესონიტი

(591) Black, white

(531) 28.19

(511) 5

(260) AM 2019 99942 A

(210) AM 99942

(220) 22 10 2018

(731) Abdi İbrahim İlaç Sanayi ve Ticaret Anonim Şirketi

Reşitpaşa Mahallesi Eski Büyükdere Caddesi
No:4 34467 Maslak Sarıyer İstanbul, Turkey

(740) Tamaz Shilakadze

(540)

ESSONITE

(591) Black, white

(511) 5

(260) AM 2019 99944 A

(210) AM 99944

(220) 22 10 2018

(731) Abdi İbrahim İlaç Sanayi ve Ticaret Anonim Şirketi

Reşitpaşa Mahallesi Eski Büyükdere Caddesi
No:4 34467 Maslak Sarıyer İstanbul, Turkey

(740) Tamaz Shilakadze

(540)

TENAF

(591) Black, white

(511) 5

(260) AM 2019 99945 A

(210) AM 99945

(220) 22 10 2018

(731) Abdi İbrahim İlaç Sanayi ve Ticaret Anonim Şirketi

Reşitpaşa Mahallesi Eski Büyükdere Caddesi
No:4 34467 Maslak Sarıyer İstanbul, Turkey

(740) Tamaz Shilakadze

(540)

ცენაფი

(591) Black, white

(531) 28.19

(511) 5

(260) AM 2019 99953 A

(210) AM 99953

(220) 22 10 2018

(731) JSC "LIBERTY BANK"

I. Chavchavadze Ave. 74, 0162, Tbilisi,
Georgia

(740) Mikheil Kvaraia

(540)

ლიბერტი
ბანკი

(591) Red, black

(531) 27.05.01; 27.05.04; 27.05.05; 27.05.23;
27.05.25; 28.19; 29.01.12

(511) 36

(260) AM 2019 99954 A

(210) AM 99954

(220) 22 10 2018

(731) JSC "LIBERTY BANK"

I. Chavchavadze Ave. 74, 0162, Tbilisi,
Georgia

(740) Mikheil Kvaraia

(540)

**LIBERTY
WEALTH**

(591) Red, black
(531) 27.05.01; 27.05.04; 27.05.23; 27.05.25;
29.01.13
(511) 36

(260) AM 2019 99990 A
(210) AM 99990
(220) 23 10 2018
(731) Ltd "AVERSI-PHARMA"
D. Aghmashenebeli Ave. 148/2, 0112,
Tbilisi, Georgia

(540)

**სარაბინო
Сарабин
Sarabin**

(591) Black, white
(511) 5

(260) AM 2019 99992 A
(210) AM 99992
(220) 23 10 2018
(731) Ltd "AVERSI-PHARMA"
D. Aghmashenebeli Ave. 148/2, 0112,
Tbilisi, Georgia

(540)

**ფოსფოლიზუმი
Фосфолизум
Fosfolizum**

(591) Black, white
(511) 5

(260) AM 2019 99993 A
(210) AM 99993
(220) 23 10 2018
(731) Ltd "AVERSI-PHARMA"
D. Aghmashenebeli Ave. 148/2, 0112,
Tbilisi, Georgia

(540)

**ეთიოპრილი
Этиоприл
Ethiopril**

(591) Black, white
(511) 5

(260) AM 2019 99994 A
(210) AM 99994
(220) 23 10 2018
(731) Ltd "AVERSI-PHARMA"
D. Aghmashenebeli Ave. 148/2, 0112,
Tbilisi, Georgia

(540)

**კრონეზი
КронеЗ
Cronez**

(591) Black, white
(511) 5

(260) AM 2019 99995 A
(210) AM 99995
(220) 23 10 2018
(731) Ltd "AVERSI-PHARMA"
D. Aghmashenebeli Ave. 148/2, 0112,
Tbilisi, Georgia

(540)

**არტიკრონი
Артикрон
Articron**

(591) Black, white
(511) 5

(260) AM 2019 99996 A
(210) AM 99996
(220) 23 10 2018
(731) Ltd "AVERSI-PHARMA"
D. Aghmashenebeli Ave. 148/2, 0112,
Tbilisi, Georgia

(540)

**იმპრესტი
Импрест
Imprest**

(591) Black, white
(511) 5

(260) AM 2019 99997 A
(210) AM 99997
(220) 23 10 2018
(731) Ltd "AVERSI-PHARMA"
D. Aghmashenebeli Ave. 148/2, 0112,
Tbilisi, Georgia

(540)

**ოკლუპრილი
Оклуприл
Oclupril**

(591) Black, white
(511) 5

(260) AM 2019 99998 A
(210) AM 99998
(220) 23 10 2018
(731) Ltd "AVERSI-PHARMA"
D. Aghmashenebeli Ave. 148/2, 0112,
Tbilisi, Georgia
(540)

ტეტრაკლარი
Тетраклар
Tetraclar

(591) Black, white
(511) 5

(260) AM 2019 99999 A
(210) AM 99999
(220) 23 10 2018
(731) Ltd "AVERSI-PHARMA"
D. Aghmashenebeli Ave. 148/2, 0112,
Tbilisi, Georgia
(540)

მონოგლი
Моногли
Monogli

(591) Black, white
(511) 5

REGISTERED TRADEMARKS

(111) M 2019 31116 R
(151) 02 05 2019
(181) 02 05 2029
(260) AM 2018 95886 A
(220) 10 01 2018
(732) SAS GROUP
Mashtots Ave. 18, Yerevan, Armenia

(111) M 2019 31117 R
(151) 02 05 2019
(181) 02 05 2029
(260) AM 2018 95931 A
(220) 10 01 2018
(732) LTD "ZENA DEVELOPMENT"
AP. Kvernadze str. 8, ap. 21, 0171, Tbilisi,
Georgia

(111) M 2019 31118 R
(151) 02 05 2019
(181) 02 05 2029
(260) AM 2018 96272 A
(220) 07 02 2018
(732) GELA BEZARASHVILI
Tamar Mepe str. 10, 1500, Gurjaani, Georgia

(111) M 2019 31119 R
(151) 02 05 2019
(181) 02 05 2029
(260) AM 2018 96284 A
(220) 08 02 2018
(732) LTD "GEORGIAN WINES"
I. Chavchavadzis ave. 29-31-33, ap. 72,
0179, Tbilisi, Georgia

(111) M 2019 31120 R
(151) 02 05 2019
(181) 02 05 2029
(260) AM 2018 96370 A
(220) 15 02 2018
(732) LTD "LITHUANIAN BAKERY +"
T. Eristavi str. 1, 0192, Tbilisi, Georgia

(111) M 2019 31121 R
(151) 02 05 2019
(181) 02 05 2029
(260) AM 2018 96556 A
(220) 26 02 2018
(732) Vengard Treidmark Holdingz Usa LLC
600 Corporate Park Drive, St. Louis, Missouri,
63105, USA

(111) M 2019 31122 R
(151) 02 05 2019
(181) 02 05 2029
(260) AM 2018 96766 A
(220) 12 03 2018
(732) HANKOOK TIRE CO., LTD
133, Teheran-ro (Yeoksam-dong), Gangnam-gu,
Seoul, Republic of Korea

(111) M 2019 31123 R
(151) 02 05 2019
(181) 02 05 2029
(260) AM 2018 96770 A
(220) 12 03 2018
(732) HANKOOK TIRE CO., LTD
133, Teheran-ro (Yeoksam-dong), Gangnam-gu,
Seoul, Republic of Korea

(111) M 2019 31124 R
(151) 02 05 2019
(181) 02 05 2029
(260) AM 2018 96811 A
(220) 14 03 2018
(732) LTD "AEROSOFT"
D. Agmashenebeli ave. 124, 0102, Tbilisi,
Georgia

(111) M 2019 31125 R
(151) 02 05 2019
(181) 02 05 2029
(260) AM 2018 96860 A
(220) 15 03 2018
(732) INPHA LLP Representative Lobbyist Office
in Georgia
Besiki str. 4, (plot 46/10), 0108, Tbilisi,
Georgia

(111) M 2019 31126 R
(151) 02 05 2019
(181) 02 05 2029
(260) AM 2018 97013 A
(220) 27 03 2018
(732) CILAG GMBH INTERNATIONAL
Gubelstrasse 34, CH-6300, Zug, Switzerland

(111) M 2019 31127 R
(151) 02 05 2019
(181) 02 05 2029
(260) AM 2018 97179 A
(220) 03 04 2018
(732) LTD "GEORGIAN WINE"

Besiki str., II Shesakhvevi 6, Mtatsminda District, 0108, Tbilisi, Georgia	(111) M 2019 31134 R (151) 02 05 2019 (181) 02 05 2029 (260) AM 2018 97446 A (220) 03 05 2018 (732) LIXIN TIAN N1, DongSi San Tiao, Beijing, 100013, China
(111) M 2019 31128 R (151) 02 05 2019 (181) 02 05 2029 (260) AM 2018 97187 A (220) 04 04 2018 (732) MOPEDEPOT Irakli Abashidze str. 21, ap. 7, 0179, Tbilisi, Georgia	(111) M 2019 31135 R (151) 02 05 2019 (181) 02 05 2029 (260) AM 2018 97456 A (220) 04 05 2018 (732) INPHA LLP Representative Lobbyist Office in Georgia Besiki str. 4 (nakveti 46/10), 0108, Tbilisi, Georgia
(111) M 2019 31129 R (151) 02 05 2019 (181) 02 05 2029 (260) AM 2018 97211 A (220) 10 04 2018 (732) NOVARTIS AG 4002 Basel, Switzerland	(111) M 2019 31136 R (151) 02 05 2019 (181) 02 05 2029 (260) AM 2018 97466 A (220) 07 05 2018 (732) LTD "FORMOSA" R. Mamisashvili str. 31a, 0182, Tbilisi, Georgia
(111) M 2019 31130 R (151) 02 05 2019 (181) 02 05 2029 (260) AM 2018 97388 A (220) 24 04 2018 (732) LTD "AGROLINX" Al. Kazbegi ave. 34, ap. 12a, 0177, Tbilisi, Georgia	(111) M 2019 31137 R (151) 02 05 2019 (181) 02 05 2029 (260) AM 2018 97689 A (220) 14 05 2018 (732) JSC "COPRORATION KINDZMARAUЛИ" I. Chavchavadze str. 55, 4800, Kvareli, Georgia
(111) M 2019 31131 R (151) 02 05 2019 (181) 02 05 2029 (260) AM 2018 97402 A (220) 25 04 2018 (732) THE DOW CHEMICAL COMPANY Midland, Michigan, 48674, USA	(111) M 2019 31138 R (151) 02 05 2019 (181) 02 05 2029 (260) AM 2018 97690 A (220) 14 05 2018 (732) GILEAD SCIENCES IRELAND UC IDA Business and Technology Park, Carrigtohill, Co. Cork, Ireland
(111) M 2019 31132 R (151) 02 05 2019 (181) 02 05 2029 (260) AM 2018 97443 A (220) 03 05 2018 (732) LTD "TXC 2000" Samgoris dasakhleba 30, ap. 84, 0190, Tbilisi, Georgia	(111) M 2019 31139 R (151) 02 05 2019 (181) 02 05 2029 (260) AM 2018 97783 A (220) 22 05 2018 (732) Aleksandre Simonyan Delisis II str. 8, 0177, Tbilisi, Georgia
(111) M 2019 31133 R (151) 02 05 2019 (181) 02 05 2029 (260) AM 2018 97445 A (220) 03 05 2018 (732) LIXIN TIAN N1, Dongsan San Tiao, Beijing, 100013, China	(111) M 2019 31140 R (151) 02 05 2019 (181) 02 05 2029

(260) AM 2018 97789 A
(220) 23 05 2018
(732) LTD "EURO CAUCASUS SUPLIES"
Samgori Lane 5, 0144, Tbilisi, Georgia

(111) M 2019 31141 R
(151) 02 05 2019
(181) 02 05 2029
(260) AM 2018 97790 A
(220) 23 05 2018
(732) LTD "EURO CAUCASUS SUPLIES"
Samgori Lane 5, 0144, Tbilisi, Georgia

(111) M 2019 31142 R
(151) 02 05 2019
(181) 02 05 2029
(260) AM 2018 97792 A
(220) 23 05 2018
(732) IRFAN COKOVIC
2802 Sheikh Zaiede str, Dubai, United
Arab Emirates

(111) M 2019 31143 R
(151) 02 05 2019
(181) 02 05 2029
(260) AM 2018 97807 A
(220) 24 05 2018
(732) LTD "GEORGIAN ALLIANCE"
G. Nadareishvili str. 9, 0120, Tbilisi, Georgia

(111) M 2019 31144 R
(151) 02 05 2019
(181) 02 05 2029
(260) AM 2018 97808 A
(220) 24 05 2018
(732) LTD "MEAMA"
Givi Amilakhvari str. 2, Samgoris District,
Tbilisi, Georgia

(111) M 2019 31145 R
(151) 02 05 2019
(181) 02 05 2029
(260) AM 2018 97809 A
(220) 24 05 2018
(732) LTD "MEAMA"
Givi Amilakhvari str. 2, Samgori District,
Tbilisi, Georgia

(111) M 2019 31146 R
(151) 02 05 2019
(181) 02 05 2029
(260) AM 2018 97896 A
(220) 30 05 2018
(732) Irakli Tchapandze
J. Rapava str. 37, Zugdidi, Georgia;

Vadim Evgenievich Pravednikov
Ul. Vorovskogo d. 4, ap. 23, Sochi, Krasno-
darskiy Kray, 354000, Russian Federation

(111) M 2019 31147 R
(151) 02 05 2019
(181) 02 05 2029
(260) AM 2018 97899 A
(220) 30 05 2018
(732) Irakli Tchapandze
J. Rapavas str. 37, Zugdidi, Georgia;
Vadim Evgenievich Pravednikov
Ul. Vorovskogo d. 4, ap. 23, Sochi, Krasno-
darskiy Kray, 354000, Russian Federation

(111) M 2019 31148 R
(151) 02 05 2019
(181) 02 05 2029
(260) AM 2018 97958 A
(220) 01 06 2018
(732) LTD "GLAVSPIRTPROM"
Lilo str. 51, 0198, Tbilisi, Georgia

(111) M 2019 31149 R
(151) 03 05 2019
(181) 03 05 2029
(260) AM 2018 96077 A
(220) 23 01 2018
(732) LTD "BORAN CONSTRUCTION"
Kandelaki str. 8, ap. 56, 0160, Tbilisi, Georgia

(111) M 2019 31150 R
(151) 03 05 2019
(181) 03 05 2029
(260) AM 2018 96078 A
(220) 23 01 2018
(732) LTD "BORAN CONSTRUCTION"
Kandelaki str. 8, ap. 56, 0160, Tbilisi, Georgia

(111) M 2019 31151 R
(151) 03 05 2019
(181) 03 05 2029
(260) AM 2018 97164 A
(220) 30 03 2018
(732) BEIJING XIAOXIYANG TECHNOLOGY
DEVELOPMENT CO., LTD
1-27, HUOXING 3RD ST., SOUTH AREA,
TONGZHOU ECONOMIC & TECHNOLO-
GICAL DEVELOPMENT ZONE, BEIJING,
China

(111) M 2019 31152 R
(151) 03 05 2019
(181) 03 05 2029

(260) AM 2018 97165 A
(220) 30 03 2018
(732) SMYK GLOBAL ASSETS GMBH
Schwanengasse 5/7, 3011 Berne, Switzerland

(111) M 2019 31153 R
(151) 03 05 2019
(181) 03 05 2029
(260) AM 2018 97410 A
(220) 26 04 2018
(732) TIENS GROUP CO., LTD
WU QING DEVELOPMENT ZONE, TIAN-
JIN NEW TECH INDUSTRIAL PARK,
TIANJIN, 301700, China

TRADEMARKS REGISTERED ACCORDING TO THE ACCELERATED PROCEDURE

The decision can be appealed at the Chamber of Appeal of Sakpatenti within 3 months from the publication.

(111) M 2019 31101 R
 (151) 22 04 2019
 (181) 22 04 2029
 (210) AM 102264
 (220) 21 03 2019
 (732) "Big Service" LLC
 Krtsanisi str. 22-24, (plot 15/67),
 Floor 1, office space 3, blok A,
 Krtsanisi District, Tbilisi, Georgia
 (740) Levan Nikoladze
 (540)

aigroup

(591) Black, white
 (511) 6, 12, 35, 37, 38, 39, 42

(111) M 2019 31102 R
 (151) 23 04 2019
 (181) 23 04 2029
 (210) AM 102543
 (220) 08 04 2019
 (732) "Big Service" LLC
 Krtsanisi str. 22-24, (plot 15/67),
 Floor 1, office space 3, blok A,
 Krtsanisi District, Tbilisi, Georgia
 (540)



aiPRODUCTION

(591) White, green
 (531) 16.01.01; 18.01.09; 29.01.03
 (511) 12, 35

(111) M 2019 31103 R
 (151) 23 04 2019
 (181) 23 04 2029
 (210) AM 102557
 (220) 10 04 2019
 (732) JSC "PASHA BANK GEORGIA"
 G. Tabidze str. 1/G. Leonidze str. 2, 0105,
 Tbilisi, Georgia

(540)
 მაქსი | ანაბარი

 Maxi | Deposit

(591) Black, white
 (531) 26.01.01; 26.01.16; 26.11.07; 27.05.01
 (511) 36

(111) M 2019 31104 R
 (151) 23 04 2019
 (181) 23 04 2029
 (210) AM 102560
 (220) 10 04 2019
 (732) JSC "PASHA BANK GEORGIA"
 G. Tabidze str. 1/G. Leonidze str. 2, 0105,
 Tbilisi, Georgia
 (540)

 ტოპ | ქარტი

 Top | Card

(591) Black, white
 (531) 24.15.02; 26.01.01; 26.01.10; 26.01.16;
 26.11.07; 27.05.01
 (511) 36

(111) M 2019 31105 R
 (151) 25 04 2019
 (181) 25 04 2029
 (210) AM 102531
 (220) 04 04 2019
 (732) Hayk Petrosyan
 Gaia ave., build. 8, ap. 62, Yerevan,
 Armenia
 (740) Lolita Revazishvili
 (540)



(591) Black, white
 (531) 13.01.01; 13.01.12; 13.01.13; 13.01.17;
 13.01.25; 25.01.25; 27.05.01; 27.05.19
 (511) 35

(111) M 2019 31106 R
 (151) 25 04 2019
 (181) 25 04 2029
 (210) AM 102823
 (220) 23 04 2019
 (732) Aleksii Morchiladze
 Tschkondideli srt. 22, 0180, Tbilisi, Georgia
 (540)

AUGUST

(591) Black, white
 (511) 30, 43

(111) M 2019 31107 R
 (151) 30 04 2019
 (181) 30 04 2029
 (210) AM 102809
 (220) 19 04 2019
 (732) Ltd "PHARKONI"
 Tamr Mepe str. 51, Kutaisi, Georgia
 (540)

დიაბეტოფიტოლი diabetofitol диабетофитол

(591) Black, white
 (511) 5

(111) M 2019 31108 R
 (151) 30 04 2019
 (181) 30 04 2029
 (210) AM 102816
 (220) 22 04 2019
 (732) შპს "E.P.J."
 Akhlagazrdobis ave. 84/24, Kutaisi, Georgia
 (541)

carglass ქარგლას карглас

(591) Black, white
 (511) 35

(111) M 2019 31109 R
 (151) 01 05 2019
 (181) 01 05 2029
 (210) AM 102250

(220) 19 03 2019
 (310) 19000437
 (320) 31 01 2019
 (330) RU
 (732) Ltd "DELFUUD"
 Berzarina str., dom 34, zdanie 3, floor 2,
 steyp 1, ap. 14, 123060, Moscow, Russian
 Federation
 (740) Sulkhan Metreveli
 (540)



(591) Black, light green, white, light cream,
 cream
 (531) 06.07.02; 06.07.04; 06.07.07; 06.07.08;
 06.07.25; 25.01.25; 29.01.13
 (511) 29, 30

(111) M 2019 31110 R
 (151) 01 05 2019
 (181) 01 05 2029
 (210) AM 102813
 (220) 22 04 2019
 (732) Ltd "Georgian Alliance"
 Giorgi Nadareishvili str. 9, 0120, Tbilisi,
 Georgia
 (540)

Счастливые Грибочки



(591) თეთრი, შავი, ყავისფერი, კრემისფერი
 (531) 05.11.05; 28.05
 (511) 30

(111) M 2019 31111 R
 (151) 01 05 2019
 (181) 01 05 2029
 (210) AM 102696
 (220) 12 04 2019
 (732) Ltd "NEXSTRA GROUP"
 Irodion Evdoshvili str. 18, floor 2,
 Office Space 3, Didube-Chughureti
 District, 0154, Tbilisi, Georgia

(540)

სოლუმოქსი
Solumox
Солумокс

(591) Black, white
(511) 5

(111) M 2019 31112 R

(151) 01 05 2019

(181) 01 05 2029

(210) AM 102702

(220) 12 04 2019

(732) Ltd "NEXSTRA GROUP"

Irodion Evdoshvili str. 18, floor 2,
Office Space 3, Didube-Chughureti
District, 0154, Tbilisi, Georgia

(540)

დროქსინატი
Droxinat
Дроксинат

(591) Black, white
(511) 5

(111) M 2019 31113 R

(151) 01 05 2019

(181) 01 05 2029

(210) AM 102703

(220) 12 04 2019

(732) Ltd "NEXSTRA GROUP"

Irodion Evdoshvili str. 18, floor 2,
Office Space 3, Didube-Chughureti
District, 0154, Tbilisi, Georgia

(540)

ზოლობრინი
Zolobrin
Золобрин

(591) Black, white
(511) 5

(111) M 2019 31114 R

(151) 01 05 2019

(181) 01 05 2029

(210) AM 102705

(220) 12 04 2019

(732) Ltd "NEXSTRA GROUP"

Irodion Evdoshvili str. 18, floor 2,
Office Space 3, Didube-Chughureti
District, 0154, Tbilisi, Georgia

(540)

აილოპტი
Eylopt
Аильопт

(591) Black, white
(511) 5

(111) M 2019 31115 R

(151) 01 05 2019

(181) 01 05 2029

(210) AM 102725

(220) 17 04 2019

(732) Ltd "NEW PHARM GROUP"

Irodion Evdoshvili str. 18, floor 2,
Office Space 2, Didube-Chughureti
District, 0154, Tbilisi, Georgia

(540)

სომნოფლუდი
Somnoflud
Сомнофлуд

(591) Black, white
(511) 5

(111) M 2019 31154 R

(151) 03 05 2019

(181) 03 05 2029

(210) AM 102811

(220) 19 04 2019

(732) Akaki Chkhaidze

Mtatsminda Lane 7A, ap.14, 0108, Tbilisi,
Georgia

(540)

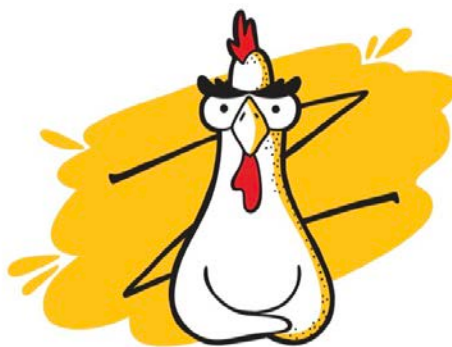

mAZAKi

(591) Red, black, white, yellow
(531) 01.15.15; 03.07.03; 26.13.25; 27.05.01;
29.01.14
(511) 43

(111) M 2019 31155 R
 (151) 03 05 2019
 (181) 03 05 2029
 (210) AM 102544
 (220) 08 04 2019
 (732) LTD "Georgian Wine House"
 Village Zegaani, 1500, Gurjaani District,
 Georgia
 (740) Sopio Vacheishvili
 (540)

White Ice
Белый Лёд

(591) Black, white
 (511) 33

(111) M 2019 31156 R
 (151) 2019 05 03
 (181) 2029 05 03
 (210) AM 102559
 (220) 2019 04 10
 (732) LTD "GE COMERCY"
 P. Kavtaradze str. 44, Blok B, Comercial
 Space 8, Vake district, 0186, Tbilisi,
 Georgia
 (740) Mariam Mikeltadze
 (540)

VENDOO
306EY

(591) Crimson, lilac, blue, sky-blue, green,
 orange
 (531) 27.05.01; 28.19; 29.01.15
 (511) 35, 36, 39

(111) M 2019 31157 R
 (151) 2019 05 03
 (181) 2029 05 03
 (210) AM 102724
 (220) 2019 04 17
 (732) LTD "GEO COOP"
 A. Tvaltchrelidze str. 2, Isani-Samgori
 District, 0182, Tbilisi, Georgia
 (540)

COOPOLIVA

(591) Yellow, red
 (531) 25.01.05; 27.05.24; 29.01.12
 (511) 30

(111) M 2019 31158 R
 (151) 2019 05 06
 (181) 2029 05 06
 (210) AM 102695
 (220) 2019 04 12
 (732) JSC "POLIMAT GROUP"
 D. Agmashenebeli ave. 79, 0102,
 Tbilisi, Georgia
 (740) Giorgi Taktakishvili
 (540)

area group

(591) Black, white
 (511) 9, 35, 36

INTERNATIONAL TRADEMARKS FOR WHICH A DECISION ON GRANTING PROTECTIONS IS TAKEN

The decision can be appealed at the Chamber of Appeal of Sakpatenti within 3 months from the publication or at the Mtskheta District Court Administrative Cases Board (Address: №17, Samkhedro str., Mtskheta), within 1 month following the publication.

(260) AM 2019 95251 A

(800) 1375168

(151) 2017 08 30

(891) 2017 08 30

(731) PROMETEON TYREF GROUP S.R.L.

Viale Sarca, 222, I-20126 Milano (MI), Italy

(540)

PROMETEON

(591) Black, white

(511)

12 – Vehicles; apparatus for locomotion by land, air or water; parts and fittings for vehicles; treads for vehicles tire; rubber articles for vehicles and tires; adhesive rubber patches for repairing inner tube; pneumatic tyres; pneumatic, semi-pneumatic and/or solid tyres; vehicle wheels; wheel trims; inner tubes and mousse for vehicle tyres; casings for pneumatic tires (tyres); tire repair patches; treads for retreading tires; rings for retreading tires; anti-skid chains; automobile chassis; automobile bodies; automobile chains; automobile hoods; balance weights for vehicle wheels; bands for wheel hubs; brake linings for vehicles; electric vehicles; non-skid devices for vehicle tires; repair outfits for inner tubes; shock absorbers for automobiles; shock absorbing springs for vehicles; valves for vehicle tires.

17 – Rubber, gutta-percha, gum, asbestos, mica; rings of rubber, tyre components of rubber, rubber strips; plastics in extruded form for use in manufacture; packing, stopping and insulating material; flexible pipes, not of metal; acrylic resins [semi-finished products]; adhesive bands other than stationery and not for medical or household purposes; anti-dazzle films for windows [tinted films]; bark covering for sound insulation; brake lining materials, partly processed; canvas hose pipes; carbon fibers (fibres), other than for textile use; caulking materials; cellulose acetate, semi-processed; chemical compositions for repairing leaks; clack valves of rubber; clutch linings; cords of rubber; cylinder jointings; ebonite molds; ebonite (vulcanite); elastic yarns, not for use in textiles; expansion joint fillers; filtering material (semi-processed foams or films of plastic); flexible tubes, not of metal; foam supports for flower arrangements [semi-finished products]; hoses of textile material; insulating fabrics; insulating felt; insulating materials; insulating oils; insulating paints; in-

sulators; junctions for pipes, not of metal; latex [rubber]; liquid rubber; mica, raw or partly processed; packing [cushioning, stuffing] materials of rubber or plastics; plastic fibers, not for use in textiles; plastic film, not for wrapping; plastic substances, semi-processed; reinforcing materials, not of metal, for pipes; rings of rubber; rubber material for recapping tyres; rubber, raw or semi-worked; rubber sleeves for protecting parts of machines; rubber solutions; rubber stoppers; sealant compounds for joints; seals; self-adhesive tapes, other than stationery and not for medical or household purposes; shock absorbing buffers of rubber; soundproofing materials; stops of rubber; stuffing of rubber or plastic; stuffing rings; substances for insulating buildings against moisture; synthetic resins [semi-finished products]; synthetic rubber; threads of plastic materials, not for textile use; threads of rubber, not for use in textiles; valves of india-rubber or vulcanized fiber [fibre]; viscose sheets, other than for wrapping; vulcanized fiber; washers of rubber or vulcanized fiber [fibre].

35 – Advertising; business management; business administration; office functions; accounting; administrative processing of purchase orders; advertising by mail order; advisory services for business management; bill-posting; business efficiency expert services; business information; business inquiries; business investigations; business management and organization consultancy; business management assistance; business management consultancy; business organization consultancy; business research; commercial administration of the licensing of the goods and services of others; commercial information agencies; commercial information and advice for consumers [consumer advice shop]; commercial or industrial management assistance; compilation of information into computer databases; compilation of statistics; computerized file management; cost price analysis; data search in computer files for others; demonstration of goods; direct mail advertising; dissemination of advertising matter; distribution of samples; document reproduction; drawing up of statements of accounts; economic forecasting; employment agencies; import-export agencies; invoicing; layout services for advertising purposes; marketing; marketing research; marketing studies; modelling for advertising or sales promotion; news clipping services; on-line advertising on a computer network; opinion polling; organization of exhibitions for commercial or advertising purposes; organization of trade fairs for com-

mercial or advertising purposes; presentation of goods on communication media, for retail purposes; price comparison services; procurement services for others [purchasing goods and services for other businesses]; production of advertising films; professional business consultancy; public relations; publication of publicity texts; publicity; publicity agencies; publicity columns preparation; publicity material rental; radio advertising; relocation services for businesses; rental of advertising space; rental of advertising time on communication media; sales promotion for others; secretarial services; shop window dressing; shorthand; sponsorship search; systemization of information into computer databases; tax preparation; telemarketing services; television advertising; transcription; typing; updating of advertising material; word processing; writing of publicity texts; customer loyalty services and customer club services, for commercial, promotional and/or advertising purposes; distribution services through shops namely, retail of automobile spare parts and accessories, tyre repair kits, tyre pressure checkers, and tools for fitting and removing tyres and wheels.

37 – Building construction; repairing services; vehicle repair services, vehicle installation services; vehicle maintenance services; tyre repair services, repair of tyre parts; tyre installation services, tire maintenance services; tire retreading services; installation, maintenance repair and replacement services for vehicle equipment, instruments and electric and electronic devices; information and advice services for drivers and vehicle fleet managers related to vehicle maintenance and repair; information and advisory services relating to the maintenance and repair of vehicles; maintenance, repair, retreading, re-cutting, fitting, removing and replacement of pneumatic tyres and inner tubes for pneumatic tyres; wheel balancing; car maintenance and repair, spare parts and accessories therefor; information services relating to repair or maintenance of cars; services relating to the inspection of cars, namely checking the technical state of cars; emergency motor vehicle recovery, including services relating to pneumatic tyres for motor vehicles.

39 – Transport; packaging and storage of goods; travel arrangement; vehicle breakdown assistance (towing); delivery of equipment, instruments and electric and electronic devices for vehicles and their component parts, and of tires and/or vehicle wheels; storage of equipment, instruments and electric and electronic devices for vehicles and their component parts, and of tires and/or vehicle wheels; information and advice services for drivers and vehicle fleet managers related to vehicle geolocation and routes; transport services for passengers and freight; vehicle transport; storage services; conveyance of persons, goods and motor vehicles; vehicle rental (including car sharing and courtesy car); chauffeur services; car

parking services; parking place rental and procurement of parking places for motor vehicles; carpooling; transport and delivery; storage, delivery and transportation of tyres; vehicle towing services; vehicle breakdown recovery services; recovery of vehicles; providing information relating to vehicle driving service; providing kinetic information on vehicle; tire pressure information.

(260) AM 2019 95753 A

(800) 1380011

(151) 2016 12 29

(891) 2016 12 29

(731) DAIMLER AG

Mercedesstrasse 137, 70327 Stuttgart,
Germany

(540)

ROAD EFFICIENCY

(591) Black,white

(511)

9 – Apps; software; hardware for data communication; electronic control instruments; navigation devices.

14 – Key fobs.

16 – Printed matter and brochures; newspapers; stationery and office articles (excluding furniture), in particular ballpoint and ink pens, pencils and coloured pens, conference folders, notepads, postcards; stickers; calendar; pictures; transparencies; printed advertisements made of paper.

35 – Advertising in the field of motor vehicles and efficiency strategies; commercial management relating to the management and operation of a vehicle fleet for others; marketing concepts for the efficiency comparison of motor vehicles; real-time support for truck maintenance; advisory services for truck drivers on effectiveness of driving analysis, also by telephone; invoice processing services in relation to fleet management.

36 – Financial services; insurance services; financial management relating to fleet management, namely management and operation of a vehicle fleet for others; financing of vehicles; lease-purchase financing; financial advisory services relating to the repair and maintenance of vehicles.

38 – Telephone services; telecommunication services, in particular electronic telecommunications services, for the transmission of data and information; telecommunications via platform and portals on the Internet.

41 – Training and provision of seminars and other events in the motor vehicle sector; driving and safety training.

(260) AM 2019 97576 A

(800) 1372858

(151) 2016 11 23

(891) 2018 02 08

(731) BIG CITY BEATS GMBH

Cassellastraße 30-32, 60386 Frankfurt am
Main, Germany

(540)

WORLD CLUB DOME

(591) Black, white

(511)

9 – Computer hardware and -software, in particular apps; peripherals adapted for use with computers; apparatus for recording and transmission, for voice, data, or image transmission as well as equipment and accessories; machine-readable data carriers; databases; magnetic data media; electronic databases recorded on computer media; audio recordings; compact discs featuring music; disc storage containers; downloadable digital music; downloadable music files; downloadable multi-media files; downloadable musical sound recordings; electronic databases recorded on computer media; pre-recorded audio tapes; pre-recorded DVDs; musical video recordings; musical sound recording; sound recording; video recordings; pre-recorded CD-Is; pre-recorded CD-ROMs; sound recording carriers in particular compact discs, dvds, compact discs [read-only memory], mini-disks, cassettes, sound recording discs; telephone apparatus; mobile phones; fittings for mobile phones as far as included in this class; electronic publications [downloadable]; spectacles (optics); sports glasses; sunglasses; spectacle cases.

10 – Medical apparatus for physical treatment; ear protection devices, in particular ear plugs; pacifiers for babies; feeding aids; sex aids; medical and veterinary apparatus and instruments; protective clothing for medical purposes; orthopedic apparatus; walking aids for medical purposes.

14 – Gemstones, pearls and precious metals, and imitations thereof; jewellery in particular pendants; key rings; time instruments in particular watches; jewellery boxes and watch boxes.

16 – Decoration and art materials and media, in particular pencils, crayons, fountain pens, ball pens; stationery and educational supplies, in particular flags, flags of paper; printed matter; disposable paper products.

18 – Umbrellas and parasols; walking sticks; luggage, bags, wallets and other carriers; leather and imitations of leather, fur and animal skins; saddlery; whips; animal apparel.

20 – Fans for personal use, non-electric.

24 – Fabrics; textiles, in particular flags; bed clothes; linens.

25 – Clothing, in particular t-shirts, sweatshirts; trousers; outer clothing; raincoats; scarfs; headgear; footwear.

35 – Business management of performing artists; presentation of companies on the Internet and other media for advertising purposes; demonstration of goods and services for retail purposes; services for advertising agencies; rental of advertising space also on the Internet; computerized file management; updating of advertising material; public relations services; on-line advertising on a computer network; advertising via electronic media and specifically the Internet; arranging and conducting of advertising events; organization of exhibitions for commercial or advertising purposes; business project management for electronic data; employment agencies; presentation of goods on communication media, for retail purposes; publications of printed matter [also electronic] for advertising purposes; advertising via radio channels; consumer advice; writing of publicity texts; computerized file management particularly customer information and user profiles in databases; statistical evaluations of data by computer programs; arranging subscriptions and rental of addresses and data for commercial or advertising purposes; negotiation of commercial transactions for third parties within the scope of e-commerce, mobile-commerce and e-business; arranging of business contacts; arranging of contracts for the purchase and sale of goods and services, for others.

38 – Telecommunication services provided via Internet platforms and portals, in particular for data creation, data maintenance and for the exchange of documents, data and informations; providing of portals, electronic discussion forums, newsgroups and internet chatrooms on the internet; communication provided on the internet, at open networks and other electronic media; electronic mail services; short messages service; electronic exchange of messages via chatlines, chatrooms and internet forums; transmission, dissemination, distribution and redirecting of television-, radio-, telecommunication-, and informationsignals via any networks; collection and delivery of messages by electronic transmission; internet service, in particular providing access to information via Internet, providing access to the internet, communications by cellular phones; news agency services for electronic transmission; providing telecommunication channels for teleshopping services; electronic transmission of broadcasts and downloadable files [particularly audio- and video data via electronic communication networks]; broadcasting of audio- and video content via a global computernetwork [IP-TV]; digital video broadcast [DVB]; transmission of data and addresses for advertising and commercial purposes; provision of access to databases on the internet in the field of music, video, radio, television, news, sports, games, cultural events as well

as arts and leisure via communication networks; provision of access to information, audio, video, graphics, texts and other media content on the aforementioned fields on the internet; provision of platforms on the internet, in particular for arranging private and business contacts and for the exchange of information; providing access to data bases in computer networks on the internet, particularly for music-, audio-, and video data; providing access to platforms on the internet for the valuation and discovering of media content, particularly of audio- and video data; rental and arranging access time to databases.

41 – Radio entertainment; production and compilation of educational, informing and entertaining radio and television programs; operation of a recording studio, also in the Internet; organisation and conducting of concerts, dance events, live events, balls, in particular music events with DJ's (discjockey), bands; events with electronic music in the form of festivals, concerts, club parties; organisation and conduction of events in halls and other locations for entertainment purposes; music performances; organisation of competitions in the fields of education, entertainment and sports; organisation gambling and raffles; provision of entertainment programs on the Internet; publishing of sound recordings and pictures; publishing of texts and images, also in electronic form, except for advertising purposes; provision of [online] games on the Internet; box office services, ticket agency services; correspondence courses; party planning; recreation information about leisure activities; editorial care for online presence, in particular editing of written texts for publishing on the Internet; music publishing services [except printing].

45 – Intellectual property consultancy; security guard services including personal security and factory security; baggage inspection for security purposes; granting of licenses for movies, tv- productions and videoproductions; exploitation of industrial property rights; registration of domain names [legal services]; lost property return; personal body guarding; granting of licenses to commercial property- and copy rights; granting of licenses to franchising concepts; administration of copyrights; guard services.

(260) AM 2019 97613 A

(800) 1400265

(151) 2017 06 29

(891) 2017 06 29

(731) Musatov Oleksandr Volodymyrovych

Vul. Baumana, bud. 16, kv. 11, Kyiv 03190, Ukraine;

Lazarev Serhii Mykolaiovych

Vul. Shcherbakova, bud. 42/44 kv. 8, Kyiv 04111, Ukraine;

Katkova Anna Andriivna

Vul. Baumana, bud. 16, kv. 11, Kyiv 03190, Ukraine

(540)

True Burger

(591) Black, white

(511)

41 – Academies [education]; aikido instruction; amusement park services; providing amusement arcade services; animal training; rental of artwork; rental of audio equipment; arranging of beauty contests; boarding school education; booking of seats for shows; calligraphy services; providing casino facilities [gambling]; movie theatre presentations; rental of cinematographic apparatus; club services [entertainment or education]; coaching [training]; arranging and conducting of colloquiums; arranging and conducting of concerts; arranging and conducting of conferences; arranging and conducting of congresses; correspondence courses; disc jockey services; discotheque services; dubbing; education information; educational examination; educational services provided by schools; electronic desktop publishing; entertainer services; entertainment services; entertainment information; film production, other than advertising films; providing films, not downloadable, via video-on-demand transmission services; conducting fitness classes; gambling services; game services provided on-line from a computer network; games equipment rental; providing golf facilities; conducting guided tours; gymnastic instruction; health club services [health and fitness training]; holiday camp services [entertainment]; arranging and conducting of in-person educational forums; rental of indoor aquaria; karaoke services; language interpreter services; layout services, other than for advertising purposes; lending library services; rental of lighting apparatus for theatrical sets or television studios; microfilming; mobile library services; modelling for artists; rental of motion pictures; movie studio services; providing museum facilities [presentation, exhibitions]; music composition services; production of music; news reporters services; nightclub services [entertainment]; nursery schools; on-line publication of electronic books and journals; providing on-line electronic publications, not downloadable; providing on-line music, not downloadable; providing on-line videos, not downloadable; orchestra services; organization of competitions [education or entertainment]; organization of exhibitions for cultural or educational purposes; organization of sports competitions; organization of lotteries; organization of balls; organization of shows [impresario services]; organization of fashion shows for entertainment purposes; party planning [entertainment]; personal trainer services [fitness training]; photographic reporting; photography; physical education; practical training [demonstration]; presentation of circus performances; presentation of variety shows; presentation of live performances; publication of texts, other than publicity texts; publication of books; radio entertainment; rental of radio and televi-

sion sets; production of radio and television programmes; recording studio services; providing recreation facilities; recreation information; religious education; sado instruction [tea ceremony instruction]; screenplay writing; scriptwriting, other than for advertising purposes; arranging and conducting of seminars; rental of show scenery; production of shows; sign language interpretation; rental of skin diving equipment; songwriting; rental of sound recordings; sport camp services; providing sports facilities; rental of sports equipment, except vehicles; rental of sports grounds; rental of stadium facilities; rental of stage scenery; subtitling; arranging and conducting of symposiums; teaching; television entertainment; providing television programmes, not downloadable, via video-on-demand transmission services; rental of tennis courts; theatre productions; ticket agency services [entertainment]; timing of sports events; toy rental; training services provided via simulators; translation; tutoring; rental of video cassette recorders; rental of video cameras; videotape editing; rental of videotapes; videotaping; vocational guidance [education or training advice]; vocational retraining; arranging and conducting of workshops [training]; writing of texts; zoological garden services.

43 – Accommodation bureau services [hotels, boarding houses]; boarding house services; boarding house bookings; boarding for animals; providing campground facilities; canteen services; rental of chairs, tables, table linen, glassware; rental of cooking apparatus; day-nursery [crèche] services; rental of drinking water dispensers; food and drink catering; food sculpting; holiday camp services [lodging]; hotel services; hotel reservations; rental of lighting apparatus; rental of meeting rooms; motel services; reception services for temporary accommodation [management of arrivals and departures]; restaurant services; retirement home services; rental of temporary accommodation; temporary accommodation reservations; rental of tents; tourist home services; rental of transportable buildings;

(260) AM 2019 97916 A

(800) 1404096

(151) 2017 12 01

(891) 2017 12 01

(731) MARLOW FOODS LIMITED

Station Road, Stokesley, North Yorkshire

TS9 7AB, United Kingdom

(540)

QUORN. PROTEIN FOR THE PLANET

(591) Black, white

(511)

5 – Nutritional and dietetic food products for use in body maintenance and weight control for medical

purposes, including meal replacement and nutritional drinks in powder mix and liquid form.

16 – Printed matter, books and periodicals concerning the use of protein, including mycoprotein, in food preparation.

29 – Formed textured fungal protein and vegetable protein, including for use a meat substitute, including mycoprotein; savouries predominately consisting of vegetable or dairy products and containing protein, including mycoprotein; ready made meals consisting primarily of vegetables or meat substitutes; ready made meals consisting primarily of vegetables or meat substitutes and containing protein, including mycoprotein, including those with vegetables; dietetic and slimming foodstuffs and substances predominately containing vegetables or meat substitutes containing high quantity of protein, including mycoprotein; prepared meals and snacks for human consumption but not included in other classes; prepared frozen foods and meals consisting primarily of vegetables and meat substitutes containing protein, including mycoprotein; dairy products and substitutes therefor; cheese; cheese substitutes; pâtés; nut-based, dairy-based, vegetable-based spreads, margarine and vegetable oils; milk drinks; milk drink substitutes; milk shakes; shakes of milk substitutes; milk shake powder; powdered milk or milk substitutes; desserts and dessert puddings of milk substitutes; desserts made primarily from milk products and milk substitutes; yoghurts.

30 – Prepared meals and snacks for human consumption but not included in other classes; prepared rice dishes; prepared pasta dishes; pastry products; dry seasoning mixes; sandwiches; prepared frozen meals consisting primarily of pasta, rice, and cereal; chocolate desserts; dessert puddings; dessert chocolate toppings and topping syrups; mousse confections; chocolate-based spreads; prepared meals and snacks included in this class; mixes for cheese sauce, mixes for white sauce, mixes for sauces, mixes for cakes, mixes for bread and pizza dough, mixes for cookies, mixes for muffins, mixes for doughnuts; sauces; cooking sauces; prepared frozen meals consisting primarily of flour, rice, pasta, or noodles which include protein, including mycoprotein, and vegetables; dietetic foodstuffs in this class and tea-based, coffee-based, chocolate-based beverages, not for medical use; namely prepared meals and snacks for human consumption but not included in other classes, prepared rice dishes, prepared pasta dishes, prepared noodle dishes, pizzas, sauces, cooking sauces, processed grains, boxed lunches consisting of rice, boxed lunches consisting of pasta, boxed lunches consisting of noodles and rice crisps; slimming foodstuffs, not for medical use, namely prepared meals and snacks for human consumption but not included in other classes, prepared rice dishes, prepared pasta dishes, prepared noodle dishes, pizzas, sauces, coo-

king sauces, processed grains, boxed lunches consisting of rice, boxed lunches consisting of pasta, boxed lunches consisting of noodles and rice crisps; slimming beverages, namely, tea and tea-based beverages not for medical use; ice creams; frozen ices; ice desserts; frozen yoghurt; cereal bars; cereal based food bars; confectionery, sweets, toffees; chocolates; chocolate products; chocolate bars; flapjacks; muffins; cakes; cake bars; dessert puddings.

43 – Information and advice concerning cooking protein, including mycoprotein; providing recipe information over a global computer network.

44 – Information and advice concerning dietary and health aspects of using protein, including mycoprotein, for food.

(260) AM 2019 98135 A

(800) 681379

(151) 1997 10 10

(891) 2018 03 30

(731) Monsieur Daniel FLACHAIRE

14, avenue Bosio, MC-98000 MONACO,
Monaco

(540)

BANANA MOON

(591) Black, white

(511)

25 – Clothing for men, women and children, prêt-à-porter, ready-made clothing, shoes, swimsuits.

(260) AM 2019 98263 A

(800) 1407984

(151) 2018 01 31

(891) 2018 01 31

(731) BOBKOV GLEB VIKTOROVICH

Trofimova ul, d.10, kv. 179, RU-115432
Moscow, Russian Federation

(540)



(591) Pink, yellow and dark-yellow

(531) 24.09.02; 24.09.05; 24.09.07; 25.03.01; 28.05;
29.01.12

(526) ®

(511)

3 – Make-up preparations; make-up removing preparations; mascara; massage gels, other than for medical purposes; mint essence [essential oil]; mint for perfumery; mouthwashes, not for medical purposes; musk [perfumery]; mustache wax; nail art stickers;

nail care preparations; nail polish; nail varnish removers; neutralizers for permanent waving; non-slipping liquids for floors; non-slipping wax for floors; oil of turpentine for degreasing; oils for cleaning purposes; oils for cosmetic purposes; oils for perfumes and scents; oils for toilet purposes; paint stripping preparations; pastes for razor strops; perfumery; perfumes; petroleum jelly for cosmetic purposes; polish for furniture and flooring; polishing creams; polishing paper; polishing preparations; polishing rouge; polishing stones; polishing wax; pomades for cosmetic purposes; potpourris [fragrances]; preparations for cleaning dentures; preparations for unblocking drain pipes; preparations to make the leaves of plants shiny; preservatives for leather [polishes]; pumice stone; quillaia bark for washing; rose oil; rust removing preparations; sachets for perfuming linen; safrol; sandpaper; scented water; scented wood; scouring solutions; shampoos; shampoos for pets [non-medicated grooming preparations]; shaving preparations; shaving soap; shaving stones [astringents]; shining preparations [polish]; shoe cream; shoemakers' wax; shoe polish; shoe wax; silicon carbide [abrasive]; skin whitening creams; smoothing preparations [starching]; smoothing stones; soap; soap for brightening textile; soap for foot perspiration; soda lye; stain removers; starch glaze for laundry purposes; sunscreen preparations; sun-tanning preparations [cosmetics]; tailors' wax; talcum powder, for toilet use; terpenes [essential oils]; tissues impregnated with cosmetic lotions; tissues impregnated with make-up removing preparations; toiletry preparations; toilet water; tripoli stone for polishing; turpentine for degreasing; varnish-removing preparations; volcanic ash for cleaning; wallpaper cleaning preparations; washing soda, for cleaning; whitening; windshield cleaning liquids.

(260) AM 2019 98463 A

(800) 1410506

(151) 2018 01 19

(891) 2018 01 19

(731) SHANDONG GOLD PHOENIX CO., LTD.

No.999 Fule Ave., Leling City, Shandong
Province, China

(540)

TOP STOP

(591) Black, white

(531) 27.05.01

(511)

12 – Shock absorbers for automobiles; brake pads for automobiles; automobile chassis; automobile wheel hubs; brake shoes for vehicles; brakes for vehicles; brake linings for vehicles; clutches for land vehicles; windshield wipers; clips (spoke -).

(260) AM 2019 98464 A
 (800) 1410517
 (151) 2017 12 21
 (891) 2017 12 21
 (731) "BREEZE HOTEL" LLC
 Nasimi district, 28 May str., 5, AZ-1014
 Baku, Azerbaijan
 (540)



(591) Black, white
 (531) 26.04.01; 26.04.05; 26.04.16; 26.04.22;
 26.13.25; 27.05.15; 27.05.17
 (511)
 35 – Advertising.
 41 – Education; providing of training; entertainment;
 sporting and cultural activities.

(260) AM 2019 98466 A
 (800) 1410588
 (151) 2018 04 03
 (891) 2018 04 03
 (731) FIBROGEN, INC.
 409 Illinois Street, San Francisco, CA 94158,
 USA
 (540)

POWMERU

(591) Black, white
 (511)
 5 – Pharmaceutical preparations and substances.

(260) AM 2019 98467 A
 (800) 1410607
 (151) 2018 05 15
 (891) 2018 05 15
 (731) MONTRES TUDOR SA
 Rue François-Dussaud 3, CH-1211 Genève
 26, Switzerland
 (540)

BLACK BAY FIFTY-EIGHT

(591) Black, white
 (511)
 14 – Timepieces, namely, watches, wrist-watches,
 component parts for timepieces and accessories for
 timepieces not included in other classes, clocks and
 other chronometric instruments, chronometers, chro-
 nographs (timepieces), watch bands, dials (timepi-
 eces), boxes and cases for timepieces and jewelry,
 watch movements and their parts; jewelry; precious

stones and semi-precious stones; precious metals and
 their alloys.

(260) AM 2019 98495 A
 (800) 1096649
 (151) 2011 07 07
 (891) 2018 06 14
 (731) SANDERS & STASSEN N.V.
 Veldstraat 99, B-3500 Hasselt, Belgium
 (540)

CAYMON

(591) Black, white
 (511)
 6 – Metal transport containers, parts of transport
 containers, metal frameworks for installation of equ-
 ipment, metal mouldings for loudspeakers.
 20 – Wooden transport containers.

(260) AM 2019 98496 A
 (800) 1169270
 (151) 2013 06 17
 (891) 2018 06 21
 (731) IMPERIAL TOBACCO LIMITED
 121 Winterstoke Road, Bristol BS3 2LL,
 United Kingdom
 (540)



(591) Dark green, green, gold and black
 (531) 05.03.01; 05.03.15; 25.01.01; 25.01.06;
 27.07.12; 29.01.13

(511)
 34 – Tobacco, whether manufactured or unmanufac-
 tured; tobacco products; tobacco substitutes, none
 being for medicinal or curative purposes; hand rol-
 ling tobacco; cigarettes; cigarette papers, cigarette
 tubes, cigarette filters, pocket cigarette rolling ma-
 chines, hand held machines for injecting tobacco in-
 to paper tubes; smokers' articles and matches.

(260) AM 2019 98502 A
 (800) 1411464
 (151) 2017 10 31
 (891) 2017 10 31
 (731) Obshchestvo s ogranichennoy
 otvetstvennostyu "MULTIKUBIK"
 ul. Nobelya, d. 7, korp. 1, Territoria
 SKOLKOVO, Innovatsionnogo centra,
 RU-121205 Moscow, Russian Federation

(540)

CINEMOOD
 STORYTELLER

(591) Black, white, blue and red

(531) 27.05.10; 27.05.17; 29.01.14

(511)

9 – DVD players; sound recording apparatus; inter-communication apparatus; projection apparatus; sound transmitting apparatus; blueprint apparatus; flashing lights [luminous signals]; stereoscopic apparatus; telephone apparatus; computer memory devices; camcorders; video baby monitors; video telephones; video screens; holograms; loudspeakers; optical goods; slide projectors; transparency projection apparatus; dictating machines; sound recording discs; disks, magnetic; optical discs; disk drives for computers; buzzers; temperature indicators; interfaces for computers; fibre [fiber (Am.)] optic cables; cinematographic cameras; video game cartridges; memory cards for video game machines; electronic book readers; electronic agendas; compact discs [audio-video]; computers; laptop computers; tablet computers; notebook computers; lasers, not for medical purposes; optical lenses; portable media players; microphones; modems; monitors [computer hardware]; monitors [computer programs]; headphones; optical data media; computer software, recorded; objectives [lenses] [optics]; electronic pocket translators; transmitters of electronic signals; wafers for integrated circuits; compact disc players; teaching apparatus; audio- and video-receivers; prisms [optics]; wires, electric; computer programmes [programs], recorded; computer game software; computer programs [downloadable software]; computer operating programs, recorded; record players; processors [central processing units]; electronic publications, downloadable; radios; audiovisual teaching apparatus; personal stereos; stereoscopes; television apparatus; video recorders; sound reproduction apparatus; centering apparatus for photographic transparencies; battery chargers; computer peripheral devices; readers [data processing equipment]; bar code readers; computer software applications, downloadable; downloadable image files; downloadable music files; animated cartoons; USB flash drives; cameras [photography]; sleeves for laptops; projection screens.

35 – Arranging subscriptions to telecommunication services for others; demonstration of goods; marketing; organization of exhibitions for commercial or advertising purposes; presentation of goods on communication media, for retail purposes; sales promotion for others; advertising.

39 – Delivery of goods; wrapping of goods; storage of goods.

(260) AM 2019 98504 A

(800) 1411484

(151) 2018 02 13

(891) 2018 02 13

(731) ADP GAUSELMANN GMBH

Merkur-Allee 1-15, 32339 Espelkamp,
 Germany

(540)

AZTEC CASH

(591) Black, white

(511)

9 – Computer software; coin-operated mechanisms; computer and video games software; games software in particular for use on any computer platform, including electronic entertainment and games consoles; computer game programs; video games (software); computer games provided through a global computer network or supplied by means of multi-media electronic broadcast or through telecommunications or electronic transmission or via the internet; computer games, leisure and recreational software, video games and computer software, all being provided in the form of storage media; programs for operating electric and electronic apparatus for games, amusement and/or entertainment purposes; computer software for computer games on the internet; online games (software), in particular for online betting games, online prize games, online gambling games, online games of skill and online casino games; computer software in the form of an app for mobile devices and computers; calculating apparatus in coin-operated machines and parts for the aforesaid goods; electric, electronic, optical or automatic apparatus, for identifying data carriers, identity cards and credit cards, bank notes and coins; software in particular for casino and/or amusement arcade games, for gaming machines and/or slot machines each one with or without prize payouts; gaming software that generates or displays wager outcomes of gaming machines; operational computer games software; computer software for managing of games (game collection); computer programs for video games.

28 – Games; toys; gaming apparatus (including coin-operated apparatus); coin-operated arcade games (machines); games for amusement arcades (included in this class); coin-operated video gaming apparatus; video games apparatus adapted for use with external screens or monitors only; casino fittings, namely roulette tables, roulette wheels; coin-operated automatic gaming machines and gaming machines, in particular for gaming arcades, with or without a prize payout; electronic or electrotechnical gaming apparatus, automatic gaming machines, gaming machines, slot machines operated by coins, tokens, banknotes, tickets or by means of electronic, magnetic or biometric storage media, in particular for commercial use in casinos and amusement arcades, with or without a prize payout; automatic gaming

machines and gaming machines, in particular for commercial use in casinos and gaming arcades, with or without a prize payout; coin-operated gaming machines and/or electronic money-based gaming apparatus (machines), with or without prizes; housings adapted for gaming machines, gaming apparatus and automatic gaming machines, operated by means of coins, tokens, tickets or by means of electronic, magnetic or biometric storage media, in particular for commercial use in casinos and gaming arcades, with or without a prize payout; electronic games; electronic game entertainment apparatus and parts thereof; video output game machines; drawing apparatus for prize games and lotteries, draws or raffles; housings of metal, plastic and/or wood for coin-operated automatic machines; apparatus for games (including video games), other than adapted for use with external screens or monitors only; electropneumatic and electric slot machines with pulling handles (gaming machines); gaming tables, in particular for table football, billiards, sliding games; flying discs (toys) and darts; gaming machines, namely, electric, electronic or electromechanical apparatus for bingo games, lotteries or video lottery games and for betting offices, connected or unconnected to a computer network; LCD games consoles; automatic gaming machines; all the aforesaid automatic gaming machines operating in networks; apparatus and devices for accepting and storing money, being fittings for the aforesaid automatic machines, included in this class; automatic lottery machines.

(260) AM 2019 98507 A
 (800) 1411579
 (151) 2018 04 04
 (891) 2018 04 04
 (731) Limited Liability Company "NEW LINE"
 Panfilov Str., 2, pom. 3, RU-141407
 g. Khimki, Moscow Region, Russian
 Federation
 (540)

bright&quick
BQ

(591) Red and white
 (531) 27.05.01; 27.05.10; 29.01.12
 (511)
 9 – Accumulators, electric; high-frequency apparatus; sound transmitting apparatus; telephone apparatus; anode batteries; galvanic batteries; batteries, electric; encoded identification bracelets, magnetic; video telephones; computers; laptop computers; tablet computers; notebook computers; monitors [computer hardware]; monitors [computer programs]; telephone transmitters; navigation apparatus for vehicles [on-board computers]; audio- and video-recei-

vers; smartphones; radiotelephony sets; cordless telephones; transistors [electronic]; amplifiers; computer peripheral devices; acoustic couplers; sleeves for laptops.

(260) AM 2019 98509 A
 (800) 1411734
 (151) 2018 04 09
 (891) 2018 04 09
 (731) ACCESSORIZE LIMITED
 1 Nicholas Road, London W11 4AN, United
 Kingdom
 (540)



(591) Black, white
 (531) 03.07.17; 27.05.21
 (511)
 35 – Advertising; organization, operation and supervision of loyalty programmes and of sales and promotional incentive schemes; promotional services; business consultancy; business information; management of computer databases; compilation of information onto computer databases; advisory and consultancy services relating to database management and marketing; data analysis; business research and analysis; organization of exhibitions or trade fairs for commercial or advertising purposes; retail services connected with soaps and shampoos (for personal use), perfumery, perfumes, toilet waters, eau de cologne, aromatherapy oils, fragrances, essential oils, non-medicated toilet preparations for application to, conditioning and care of the skin, body and scalp, depilatory preparations, shaving preparations, non-medicated hair preparations, dentifrices, antiperspirants, preparations for the bath and shower, bath oils, bath salts, talcum powder, cosmetics, make-up, eye shadow, makeup palettes, eyeliner, blush, rouge, face powder and foundations, lipsticks, lip gloss, lip balm, lip liner, false nails, nail polish, nail stickers, products and preparations for decoration of, cleaning, care and treatment of the nails, makeup removal preparations, hair straightening irons, travel hair straightening irons, curling tongs, hair waving irons, heated rollers, hair care appliances operated by gas, catalytic combustion or electricity, crimping tongs, straightening tongs, curlers and hair-curlers, parts of the aforesaid appliances, electric flat irons, scales for household and personal use, calculating machines, cases for pocket calculators, electric cables, electric plugs, electric switches, optical apparatus and instruments, optical glass and lenses, spectacles, sunglasses, frames, lenses, cases, cords and chains for spectacles, contact lenses, mobile phone cases and covers, tablet cases and covers, photographic apparatus and instruments, apparatus and ins-

truments all for receiving, transmitting and recording and reproduction of sound, visual images and video, computers, computer programs and computer games, pre recorded or blank, videos, CDs, DVDs, cassettes and tapes, memory chips and usb drives, jewellery and imitation jewellery, costume jewellery, earrings, necklaces, bracelets, anklet chains, brooches, rings, precious stones, watches and clocks, tiaras, body art crystals (crystals for body decorations), jewellery, body jewellery, body jewels made of crystals, crystal tattoos (crystals for body decorations), precious metals and their alloys, precious stones, trunks and travelling bags, bags, tote bags, handbags, shoulder bags, shopping bags, sports bags, duffle bags, bum bags, bags and cases for carrying products for babies, infants, children and expectant mothers, cosmetic bags, luggage, holdalls, rucksacks, backpacks, satchels, travel bags, briefcases, luggage, reusable shopping bags, wallets, purses, credit card holders, umbrellas and parasols, clothing for dogs, cats, collars, leads, bags and blankets for dogs and cats, articles of clothing, headgear, hats, balaclavas, earmuffs, visors, neckwear, swimwear, swimsuits, bikinis, surf suits, swim dresses, dresses, beachwear, beach cover-ups, bathing suit cover-ups, cover-ups, footwear, nightwear, dressing gowns, underwear, lingerie, sportswear, rainwear, footwear, shoes, boots, trainers, flip-flops, sandals, gloves, capes, mittens, scarves, snoods, wrist bands, hats, caps, hosiery socks, tights, shawls, ponchos, kaftans, bandanas and belts for wear, fancy dress costumes, hair ornaments, articles for the hair, hair pins, hair slides, hair ribbons, hair clips, hairbands, headbands, elasticated hair bands, alic bands, braids, ribbons, lace, embroidery and badges, buttons, hooks and eyes, pins and needles, artificial flowers.

(260) AM 2019 98510 A
 (800) 1411743
 (151) 2018 04 06
 (891) 2018 04 06
 (731) NECHYTAILO SVIATOSLAV
 IHOROVYCH
 vul. Zankovetskoi, 4, kv. 27, KYIV 01001,
 Ukraine;
 TOVARYSTVO Z OBMEZHENOIU
 VIDPOVIDALNISTIU "NATSIONALNA
 HORILCHANA KOMPANIJA"
 Smilianske shose, 8-i kilometr, bud. 2,
 s. Stepanyk, Cherkaskyi raion, Cherkaska
 oblast 19632, Ukraine

(540)
HLIBNY DAR

(591) Black, white
 (511)
 33 – Alcoholic beverages, except beer; alcoholic beverages containing fruit; anisette [liqueur], anise [li-

queur]; aperitifs; arrack [arak]; baijiu [Chinese distilled alcoholic beverage]; brandy; wine; whisky, vodka; kirsch; perry; gin; digesters [liqueurs and spirit]; cocktails; curacao; liqueurs; hydromel [mead]; peppermint liqueurs; pre-mixed alcoholic beverages, other than beer-based; bitters; nira [sugarcane-based alcoholic beverage]; distilled beverages; piquette; rice alcohol; rum; sake; cider; spirits [beverages]; alcoholic extracts; alcoholic essences; fruit extracts, alcoholic.

(260) AM 2019 98511 A
 (800) 1411789
 (151) 2018 03 27
 (891) 2018 03 27
 (731) HAMLET, naamloze vennootschap
 Kerkstraat 77, B-9120 VRASENE, Belgium
 (540)



(591) Black, white
 (531) 26.01.02; 26.01.20; 26.01.24; 27.05.01;
 27.05.11; 27.05.24
 (511)
 30 – Chocolate; chocolate candy; pralines; chocolate truffles; stuffed chocolate; candy.

(260) AM 2019 98514 A
 (800) 1411900
 (151) 2018 04 19
 (891) 2018 04 19
 (731) "FARMALAKT" Limited Liability Company
 Noginsk-Tekhnopark, d 3, room 19, Noginsk,
 Noginsky district, RU-142434 Moskow
 region, Russian Federation

(540)
MAMELLE

(591) Black, white
 (511)
 5 – Food for babies; foodstuff being food for babies, including women milk substitutes; baby formula milk; powdered milk for babies; lacteal flour for babies; infant formula; dietetic food and substances for therapy or preventive child nutrition.

(260) AM 2019 98515 A
 (800) 1411919
 (151) 2018 05 16
 (891) 2018 05 16
 (731) SAGITAS
 3, rue de Messine, F-75008 PARIS, France

(540)

R-co

(591) Black, white

(511)

36 – Financial affairs; financial analysis; raising or investing capital; financial information and advice; financial evaluation (banking); financial management; management of mutual funds; investment services; undertakings for collective investment in transferable securities, namely financial services; fund investment.

(260) AM 2019 98516 A

(800) 1411927

(151) 2017 11 27

(891) 2017 11 27

(731) WIZZ AIR HUNGARY KFT.

Kőér u. 2/A. B. ép. II-V, H-1103 Budapest,
Hungary

(540)



(591) Pink (Pantone 233) and purple (Pantone 2613)

(531) 27.05.01; 27.05.17; 27.05.19; 27.05.25;
29.01.12

(511)

10 – Ear plugs.

16 – Paper and paper products; pens; pencils; stationery; gift stationery; colouring books; colouring pencils; pastels [crayons]; printed gift vouchers, not encoded; magazines [periodicals]; inflight magazines; printed periodicals in the field of tourism; printed advertisements; brochures, printed matter.

18 – Baggage, travel baggage.

20 – Cushions; inflatable pillows; neck support cushions, not for medical purposes; inflatable neck support cushions.

24 – Lap blankets; travelling rugs [lap robes]; bed blankets.

25 – Clothing; footwear; headgear; sports headgear [other than helmets]; sports clothing; sports footwear; sleep masks.

28 – Toys; toy aircraft; inflatable toys resembling air vehicles; toy dolls; toys, games, playthings and novelties; sporting articles and equipment.

35 – Retail services in relation to toiletries; retail services relating to jewellery; retail services in relation to toys; retail services in relation to watches; retail services in relation to electronic devices; loyalty scheme services; management of customer loyalty,

ty, incentive or promotional schemes; advertising; magazine advertising; providing advertising space in periodicals, newspapers and magazines; online advertising; preparing advertisements for others; dissemination of advertising matter.

36 – Contributory benefit scheme services; bail bonding services; issuance of coupons of value; issuance of electronic payment cards in connection with bonus and reward schemes; issuance of vouchers; issuance of travel vouchers; issuance of tokens of value in the nature of gift vouchers; issuance of payment gift vouchers; provision of loans; instalment loans; financing of personal loans.

39 – Airline services; transport; transport of passengers; transport of goods; travel arrangements; travel booking agency services; organising of travel tours; operating of travel tours; airline transport; priority boarding, check-in, seating and reservation services for frequent air travellers; booking of air tickets; airline bookings; airline ticket services; booking of airport parking; booking and arranging of access to airport lounges; car parking; car parking [valet] services; vehicle parking and storage; car rental; rental of car parking spaces; providing information relating to car rental services.

41 – Entertainment; magazine publishing; publication of electronic magazines; training; pilot and cabin crew training; training services provided via simulators.

43 – Food and drink catering; temporary accommodation; hotel reservations; hotel information; hotel services; booking of hotel accommodation; hotels, hostels and boarding houses, holiday and tourist accommodation.

(260) AM 2019 98517 A

(800) 1411979

(151) 2017 12 12

(891) 2017 12 12

(731) "KONTI-RUS" JOINT STOCK COMPANY
13, ul. Zolotaia, RU-305000 Kursk, Russian
Federation

(540)



(591) Light brown, brown and dark brown

(531) 01.01.01; 01.07.06; 08.01.10; 08.01.12;
08.01.15; 26.01.03; 29.01.07

(511)
30 – Confectionery; pastries; crackers; almond cookies; biscuits; cookies; cookies glazed with chocolate; cookies with various fillings; chocolate cookies; petit-beurre biscuits.

(260) AM 2019 98518 A
(800) 1412138
(151) 2018 04 11
(891) 2018 04 11
(731) SOCIÉTÉ JAS HENNESSY & CO.
Rue de la Richonne, Cognac, F-16100, France
(540)

HARMONY. MASTERED FROM CHAOS.

(591) Black, white
(511)
33 – Alcoholic beverages (except beers); alcoholic essences; alcoholic extracts; alcoholic fruit extracts.
35 – Advertising; dissemination of advertisements; publication of advertising texts; public relations; organization of promotional communication events, ceremonies, exhibitions, trade shows, customer loyalty activities, all these services for commercial or advertising purposes; retail sale of alcoholic beverages in stores, on the Internet and by mail order.

(260) AM 2019 98519 A
(800) 1412172
(151) 2018 06 14
(891) 2018 06 14
(731) BEIERSDORF AG
Unnastr. 48, 20253 Hamburg, Germany
(540)

micellHAIR

(591) Black, white
(511)
3 – Cosmetic preparations for the cleansing, care and embellishment of the hair.

(260) AM 2019 98520 A
(800) 1412177
(151) 2018 06 19
(891) 2018 06 19
(731) NV Biscuits Delacre SA
Avenue Emile van Becelaere 2, B-1170
Watermael-Boitsfort, Belgium
(540)

DÔME TRUFFÉ

(591) Black, white
(511)
30 – Biscuits and cookies.

(260) AM 2019 98521 A
(800) 1412213
(151) 2018 01 10
(891) 2018 01 10
(731) PASCAL WIDMER
Felsenstrasse 56, CH-8832 Wollerau,
Switzerland;
ROMINA KÄLIN
Felsenstrasse 56, CH-8832 Wollerau,
Switzerland;
ROMINA KARAT
Felsenstrasse 56, CH-8832 Wollerau,
Switzerland

(540)



(591) Black, white
(531) 17.02.01; 17.02.02; 27.05.14; 27.05.22
(511)

14 – Precious metals and their alloys; jewelry, precious and semi-precious stones; amulets (jewelry); precious metals and their alloys and goods made of these materials or coated therewith not included in other classes; jewelry, precious stones; timepieces and chronometric instruments; finger rings (jewelry), silver thread (jewelry), silver jewelry, objects of art of precious metal, cloisonné jewelry, earrings, cuff links, bracelets (jewelry), watch straps, pendants (jewelry), brooches (jewelry), chains (jewelry), hat ornaments of precious metal, shoe ornaments of precious metal, chronometric instruments, fashion key fobs (jewelry), neck chains (jewelry), tie pins, tie clips, diamonds, jewelry cases, cases for watches, ornamental pins (jewelry), figurines (statuettes) of precious metal, timepieces, badges of precious metal, ivory jewelry, precious stones as jewels, cuff links, medals, medallions (jewelry), wrist watches, pearls (jewelry), gemstones, semi-precious stones.

18 – Leather and imitations of leather; luggage and transport bags; collars, leashes and clothing for animals; leather and imitations of leather, goods made of these materials and not included in other classes; animal skins; trunks and suitcases; umbrellas and parasols; handbags, backpacks of all kinds, leather shoulder belts, hat boxes of leather, cases of leather or leather board, boxes of vulcanized fiber, purses, boxes of leather or leather board, boxes of vulcanized fiber, bags for campers, school backpacks, card protectors (wallets), key cases (leather goods), traveling trunks, vanity cases, attaché cases, school bags, sling bags for carrying infants, net bags for shopping, umbrella covers, furs (animal skins), leather trimmings for furniture, clothing for animals, kit

bags, leather leashes, traveling trunks, attaché cases, trimmings of leather for furniture, parasols, umbrellas, beach bags, wallets, purses not of precious metal, handbags, wheeled bags, empty tool bags, bags (envelopes, pouches) of leather for packaging, backpacks, handbags, traveling bags, garment bags for travel, traveling sets (leather goods) suitcases, purses, chain mesh purses.

25 – Clothing, footwear, headgear; belts (clothing), swimwear; bathing suits, bath robes, bath sandals, stockings, berets, suits (clothing), boas (necklets), leotards, knitwear (clothing), cardigans, knitted caps, caps, boots, half-boots, suspenders, work boots, neck warmers, boxer shorts, corselets, sun visors, waist belts (clothing), money belts (clothing), shawls, dressing gowns, pullovers, hats, socks, sock suspenders, bedroom slippers, footwear, beach shoes, ski boots, sports footwear, shirts, vests, tights, neck collars, shirts, shirt collars, maternity lingerie, clothing, underwear, corsets (underclothing), suits, neckties, clothing of leather, clothing of imitations of leather, balloon pants, neck scarves, textile shoes (espadrilles), shawls (furs), heelpieces for footwear, scarves, furs (parts of clothing), gabardines (clothing), girdles (underwear), gloves (clothing), vests, brassieres, garters, gymnastic shoes, waterproof coats, leggings, garters, skirts, slips (underclothing), ties, layettes, muffs (clothing), coats, mittens, overcoats (clothing), balloon pants, bedroom slippers, parkas, fishing jackets, pelerines, pelisses, pullovers, pajamas, clothing, dressing gowns, sandals, saris, slips, overalls (clothing), t-shirts, turbans, lasers, jackets, visors (headgear).

26 – Lace and embroidery, ribbons and braid; buttons, hooks and eyes, pins and needles; artificial flowers; false hair; ornamental novelty badges; hair ribbons; hair grips; buckles (clothing accessories); buttons; snap fasteners; fastenings for suspenders; trinkets other than for jewelry and key rings; hat ornaments; footwear ornaments; hair ornaments; belt clasps; badges (for wear) not of precious metal; shoe eyelets; eyelets (haberdashery) for clothing; heat adhesive patches for decoration of textile articles (haberdashery); bows for the hair.

35 – Advertising; commercial business management; commercial administration; office functions; retail sale; retail sale via global computer networks (the Internet); electronic commerce (e-commerce) services, namely advertising in the form of data, texts, images or sounds, alone or in combination, by means of computer networks, for the sale of goods and services of all types; electronic commerce (e-commerce) services, namely making product information available via telecommunication networks for advertising and sales purposes; advertising and marketing services for jewelry and jewelry of precious and non-precious metal, namely articles of precious stones, handbags of all kinds, backpacks of all kinds,

fanny packs, clothing, clothing accessories, footwear, watches and headgear.

(260) AM 2019 98522 A
(800) 1412311
(151) 2018 04 06
(891) 2018 04 06
(731) HERMANN HARTJE KG
Deichstr. 120 – 122, 27318 Hoya, Germany
(540)



(591) Black, white
(531) 26.04.18; 26.04.24; 26.11.02; 26.11.12;
27.05.22; 27.05.24

(511)
6 – Locks of metal for vehicles.

8 – Hand-operated tools.

9 – Batteries (electric); spectacles; sunglasses; anti-glare glasses; protective helmets, especially cyclist helmets; chargers for electric batteries; tachometers; bicycle computers.

11 – Vehicle headlights; lighting apparatus for bicycles.

12 – Bicycles; bicycle parts, as included in class 12, except those formed completely or essentially from rubber or rubber-like plastics; luggage nets; panniers adapted for cycles.

25 – Clothing; footwear; headgear; cyclists' clothing.

(260) AM 2019 98526 A
(800) 1412413
(151) 2018 06 05
(891) 2018 06 05
(731) BAYER AKTIENGESELLSCHAFT
Kaiser-Wilhelm-Allee, 51373 Leverkusen,
Germany
(540)

VERILUTRO

(591) Black, white
(511)
5 – Pharmaceutical preparations and products.

(260) AM 2019 98527 A
(800) 1412423
(151) 2018 06 05
(891) 2018 06 05
(731) BAYER AKTIENGESELLSCHAFT
Kaiser-Wilhelm-Allee, 51373 Leverkusen,
Germany

(540)

VERQUVO

(591) Black, white

(511)

5 – Pharmaceutical preparations and products.

(260) AM 2019 98528 A

(800) 1412436

(151) 2018 06 05

(891) 2018 06 05

(731) BAYER AKTIENGESELLSCHAFT

Kaiser-Wilhelm-Allee, 51373 Leverkusen, Germany

(540)

VERQALIF

(591) Black, white

(511)

5 – Pharmaceutical preparations and products.

(260) AM 2019 98531 A

(800) 945586

(151) 2007 10 02

(891) 2018 06 01

(731) MCE

7 rue de Tilsitt, F-75017 PARIS, France

(540)

BELESTHETIQUE

(591) Black, white

(531) 27.05.01

(511)

44 – Beauty and body care services for human beings; beauty parlors, hairstyling salons, perfumery parlors, namely giving advice and treatments in relation to perfumery; services in manicure, advice on beauty care and hairstyling, physiotherapy.

(260) AM 2019 98533 A

(800) 1231067

(151) 2014 11 26

(891) 2018 06 25

(731) INDÚSTRIA DE CALÇADO CELITA, LDA.

Rua Cidade de Guimarães No.187, P-4800-858 SÃO TORCATO, Portugal

(540)



(591) Black, white

(531) 01.01.01; 01.01.03; 01.01.10; 03.07.01;
03.07.02; 04.03.20; 27.01.12

(511)

25 – Footwear; clothing; headgear.

(260) AM 2019 98534 A

(800) 1279766

(151) 2015 10 06

(891) 2018 06 27

(731) ENERGIE ET TRANSFERT THERMIQUE

Route de Brest, F-29830 PLOUDALMEZEAU,
France

(540)



(591) Dark blue and light blue

(531) 03.07.16; 03.07.21; 03.07.24; 27.05.01;
29.01.04

(511)

11 – Air conditioning, ventilation, heating and dehumidifying apparatus.

37 – Maintenance, repair and servicing of air-conditioning, ventilation, heating and dehumidifying apparatus.

42 – Technical auditing of the operation of air-conditioning, ventilation, heating and dehumidifying apparatus.

(260) AM 2019 98535 A

(800) 1286933

(151) 2015 12 01

(891) 2018 06 25

(731) INDÚSTRIA DE CALÇADO CELITA, LDA.

Rua Cidade de Guimarães, No. 187,
P-4800-858 São Torcato, Portugal

(540)

**SUIT
RUNNERS**

(591) Black, white

(531) 26.11.08; 26.11.21; 27.05.08

(511)

25 – Footwear, clothing, headgear.

(260) AM 2019 98536 A

(800) 1325116

(151) 2016 08 30

(891) 2018 05 31

(731) LIN, RUI HONG

E26 1st Floor, Southern Watch Center,
ZhanXi Building, No.59 Mineral Spring

ZhanXi Road, YueXiu district, GuangZhou
city, 510000 GuangDong Province, China
(540)



(591) Black, white
(531) 24.01.05; 24.01.15; 27.05.22
(511)
14 – Wristwatches; clocks and watches, electric;
watch chains; watch bands; watch glasses; watch
springs; watch bag (sheath); dials [clock- and watch
making]; charms [jewellery].

(260) AM 2019 98537 A
(800) 1325493
(151) 2016 09 13
(891) 2018 05 31
(731) XI'AN NOVASTAR TECH CO., LTD
4F Block D, Qinfeng Pavilion, Xi'an Software
Park, No.68 2nd Keji Rd., Xi'an, Shaanxi,
China
(540)



(591) Black, white
(531) 26.01.03; 26.01.19; 27.05.17
(511)
9 – Computer programmes [programs], recorded;
computer operating programs, recorded; computer
software, recorded; monitors [computer programs];
computer programs [downloadable software]; com-
puter peripheral devices; couplers [data processing
equipment]; microprocessors; integrated circuit
cards [smart cards], data processing apparatus.

(260) AM 2019 98538 A
(800) 1351143
(151) 2017 04 26
(891) 2018 06 25
(731) INDÚSTRIA DE CALÇADO CELITA, LDA.
RUA CIDADE DE GUIMARÃES, N° 187,
P-4800-858 SÃO TORCATO, Portugal
(540)



(591) Black, white
(531) 26.03.23; 27.05.01
(511)
25 – Clothing, footwear, headgear.

(260) AM 2019 98540 A
(800) 1373722
(151) 2017 08 08
(891) 2018 05 31
(731) ZHENG CHUANG HONG
Room 402, Bldg 27, Danxiazhuang West,
Jinxia Community, Longhu District, Shantou
City, Guangdong Province, China
(540)



(591) Black, white
(531) 24.01.03; 27.05.01; 28.03
(511)
9 – Network communication apparatus; telephone
sheath; intercommunication apparatus; masts for
wireless aerials; cell phone straps; signal lanterns;
coils, electric; theft prevention installations, electric;
chargers for electric batteries; batteries, electric.

(260) AM 2019 98542 A
(800) 1375184
(151) 2017 06 21
(891) 2018 05 15
(731) Limited Liability Company
"SWISSPHARMCOSMETICS"
Lomonosovsky prospect, 43, bld. 2, comp. 1,
room 24, RU-119192 Moscow, Russian
Federation
(540)



(591) Black, white
(511)
3 – Air fragrancng preparations; breath freshening
sprays; canned pressurized air for cleaning and dust-
ing purposes; balms, other than for medical pur-
poses; sachets for perfuming linen; adhesives for
cosmetic purposes; scented water; toilet water; laun-
dry wax; depilatory wax; massage gels, other than
for medical purposes; dental bleaching gels; non-sli-
pping liquids for floors; windshield cleaning liquids;
greases for cosmetic purposes; perfumery; creams
for leather; cosmetic creams; skin whitening creams;
hair spray; nail polish; hair lotions; lotions for cos-
metic purposes; after-shave lotions; beauty masks;
oils for cosmetic purposes; oils for toilet purposes;
oils for cleaning purposes; cleansing milk for toilet
purposes; soap; deodorant soap; shaving soap; soap
for brightening textile; cakes of toilet soap; antiper-

spirant soap; soap for foot perspiration; cosmetic kits; toothpaste; dentifrices; pomades for cosmetic purposes; shaving preparations; cosmetic preparations for baths; laundry soaking preparations; douching preparations for personal sanitary or deodorant purposes [toilettries]; smoothing preparations [starching]; color-removing preparations; leather bleaching preparations; mouthwashes, not for medical purposes; cosmetic preparations for slimming purposes; starch glaze for laundry purposes; furbishing preparations; fabric softeners for laundry use; laundry bleach; dry-cleaning preparations; paint stripping preparations; lacquer-removing preparations; make-up removing preparations; nail care preparations; cleaning preparations; preparations for unblocking drain pipes; laundry preparations; aloe vera preparations for cosmetic purposes; sunscreen preparations; color- [colour-] brightening chemicals for household purposes [laundry]; shining preparations [polish]; stain removers; scouring solutions; tissues impregnated with cosmetic lotions; laundry blueing; bath salts, not for medical purposes; bleaching salts; astringents for cosmetic purposes; sun-tanning preparations [cosmetics]; hair dyes; cosmetic preparations for eyelashes; depilatory preparations; cosmetic preparations for skin care; cosmetics; detergents, other than for use in manufacturing operations and for medical purposes; degreasers, other than for use in manufacturing processes; bleaching preparations [decolorants] for cosmetic purposes; antiperspirants [toilettries]; shampoos; dry shampoos.

5 – Antiseptics; germicides; balms for medical purposes; biocides; thermal water; mud for baths; medicinal mud; air deodorising preparations; deodorants for clothing and textiles; mineral food supplements; nutritional supplements; albumin dietary supplements; insecticides; hemostatic pencils; wart pencils; dental lacquer; lotions for pharmaceutical purposes; personal sexual lubricants; liniments; ointments for pharmaceutical purposes; sunburn ointments; frost-bite salve for pharmaceutical purposes; medicinal oils; bunion pads; pomades for medical purposes; bacterial preparations for medical and veterinary use; bacteriological preparations for medical and veterinary use; balsamic preparations for medical purposes; therapeutic preparations for the bath; preparations for the treatment of burns; air purifying preparations; corn remedies; pharmaceutical preparations for treating dandruff; pharmaceutical preparations for skin care; medicinal hair growth preparations; anticryptogamic preparations; aloe vera preparations for pharmaceutical purposes; preparations of trace elements for human and animal use; pharmaceutical preparations; pharmaceutical preparations for treating sunburn; chilblain preparations; vaginal washes; insect repellents; insect repellent incense; tissues impregnated with pharmaceutical lotions; syrups for pharmaceutical purposes; greases for medical purposes; bath salts for medical purposes; salts

for mineral water baths; salts for medical purposes; smelling salts; cooling sprays for medical purposes; adjuvants for medical purposes; styptic preparations; disinfectants for hygiene purposes; disinfectants for chemical toilets; mouthwashes for medical purposes; detergents for medical purposes; remedies for perspiration; remedies for foot perspiration; serums; elixirs [pharmaceutical preparations]; disinfectant soap; medicated soap.

(260) AM 2019 98543 A

(800) 1380059

(151) 2017 06 09

(891) 2018 06 22

(731) BOYASAN BOYA KİMYEVİ MADDE VE MALZEME TİCARET VE SANAYİ LİMİTED ŞİRKETİ
Organize Sanayi Bölgesi 12.Cad. No.11,
Melikgazi, KAYSERİ, Turkey

(540)



(591) Dark blue, blue and green.

(531) 26.11.03; 26.11.09; 27.05.10; 27.05.23;
29.01.12

(511)

2 – Paints; varnishes; lacquers; preservatives against rust; preservatives against deterioration of wood; thinners and binders for paints; pigments; preservatives for metals; shoe dyes; printing dyes and ink; toners (including filled toner cartridges); colorants for food, pharmaceuticals and beverages; raw natural resins; metals in foil and powder form for painters, decorators, printers and artists.

(260) AM 2019 98622 A

(800) 1413423

(151) 2017 12 18

(891) 2017 12 18

(731) NLMK INTERNATIONAL B.V.,
Société de droit néerlandais Strawinskylaan
1331, Tower B, World Trade Centre, NL-1077
XX AMSTERDAM, Netherlands

(540)



(591) Blue

(531) 26.01.04; 26.01.20; 29.01.04; 29.01.12

(511)

1 – Chemicals intended for neutralizing stainless alloys of steel, iron and metals of various colors; chemicals intended for the production and/or processing of metals, iron and steel; dolomite; steel finishing preparations; calcium-silicon alloys coated with metal intended for steel-making; iron oxides; iron salts; iron alum; iron phosphate; iron chloride; iron nitrate; additives made from iron oxide for foundry sand for use in the manufacture of castings of metal; ground natural iron oxide; preparations made from iron salt for industrial use; iron sulphide; micaceous iron oxide; magnetic iron oxide; chemical additives for casting of metals; alkaline chemicals for galvanizing metal substances; salts of alkaline metals; alkaline metals; alloys of rare earth metals; chemical products for facilitating the alloying of metals; chemical preparations used for removing deposits on metals; cement [metallurgy]; brightening chemicals for metal surfaces; chemical additives intended for producing fluids for metal working; chemical compounds intended for drawing metals; chemical agents intended for metal cutting; chemical liquids for metalworking; slag [fertilizers]; oil-purifying chemicals; chemical compositions for the treatment of water; oil-separating chemicals; chemical products intended for metal plating; chemical preparations for removing metal coatings; chemical substances intended for metallurgy; chemical substances intended for the treatment and finishing of metals; chemicals intended for treating metals; chemicals intended for metalworking; chemicals intended for the treatment of metal surfaces; metal earths; chemicals used for the metal coating of non-conducting surfaces; salts for coloring metal; chemical preparations for the manufacture of paints; magnetic fluids for industrial use for use in metalworking; compositions intended for metal finishing; metal annealing preparations; electroplating preparations for metals on substrates; gas for carbonizing metal; gas intended for the production of metal; metal-hardening preparations; industrial gases intended for metal production; metal chlorides; limestone hardening substances; compounds for stamping metal; treatment products for metals; metal oxides; metal salts; compositions for metal plating; welding fluxes for metals; metallates [metallic salts of acids]; products for protecting metals [chemical products]; exchange resins for metals; products for fluatation; metal oxide powders for industrial use; compositions for hardening of metals; preparations for metal hardening and tempering [tempering chemical]; metallocenes; metalloids; metalworking agents with cleaning properties; metalworking agents with cooling properties; metalworking fluids excluding cutting fluids; mordants for metals; non-metallic oxides; pastes containing metallic glass intended for industry; scou-

ring solutions intended for removing deposits on metal; scouring solutions intended for removing metal coatings; tempering compounds intended for metal shaping processes; sand intended for metallurgy; metallic soaps for industrial use; tempering fluids for metalworking; sulfur [non-metallic element]; chemicals for tempering intended for metalworking; carbide alloy metal coatings by thermal spraying; nitrogen; volatile alkali [ammonia] for industrial purposes; ammonia; argon; acetylene; acetone; gas purifying products; protective gas for welding; hydrogen; getters [chemically active substances]; distilled water; concrete-aeration chemicals; chemicals for aerating concrete; foundry binding substances; surface-active chemical agents; water softening products; oxygen; adhesives for wall tiles; glues for use in industry; adhesives for wallpaper; neon; krypton; adhesives for use in industry; ceramic materials in particulate form used as filtering media; xenon; filtering materials [mineral substances]; degreasing products for use in manufacturing processes; naphthalene; corrosive products; fertilizing preparations; toluol; galvanizing baths; solvents for varnishes; benzene derivatives; aluminum silicate; ammonium salts; fluxes for welding; benzol; xylol.

4 – Benzine; fuel gas; combustible briquettes; fuels; lubricating graphite; cutting fluids; kerosene; coke; fuel oil; combustible oils (fuel oil); industrial oils; coal tar oil; motor oils; raw or refined petroleum; coal dust [fuel]; peat [fuel]; coal [fuel]; coal briquettes.

6 – Common metals and their alloys; transportable buildings of metal; building materials made of metal; non-electric cables and wires of metal; building materials of metal; iron for direct reduction and the directly reduction of iron; ores of metal, including crude or processed ores; alloy additives for the production of steel; alloy steel scraps; alloy steel wire [non-electric]; steel alloys; balls of steel; steel in the form of bars; junctions of metal for tubes and pipes including in alloy steel and titanium; bright steel; bars of bright steel; tubes of bright steel; carbon steel; cast steel; gabions of steel wire; common metals and their alloys, including stainless steel; elbows of metal for pipes, including in alloy steel and titanium; cold-finished steel bars; stainless steel; cold-rolled steel strips; coated plates and sheets of steel; galvanized steel plates; galvanized steel sheets; heavy metals; anodized metals; hollow steel bars; steel strips; hot-rolled steel bars; fences of metal; iron or steel scraps; hot-rolled steel tubes; joists of iron or steel; junctions of metal for pipes, including in alloy steel and titanium; modular prefabricated steel frames; plated steels; pipes of metal, including in alloy steel and titanium; steel sections; rerolled steel; metal rods for brazing and welding, including in alloy steel and titanium; rolled steel; roller blinds of steel; steel sheets; sheets of metal, including in alloy steel and titanium; steel forgings; steel fibers; stain-

less steel in the form of sheets; metal brazing for stainless steel; stainless steel in the form of tapes; tubes of stainless steel; unwrought or semi-wrought steel alloys; steel; beams of steel; building materials of steel; steel castings [semi-finished]; steel cylinders for compressed gas; steel bottles for liquid air; steel drums [sold empty]; steel barrels, sold empty; steel buildings; steel for cans; steel frames for building; steel grilles; grinding balls of steel; grinding bars of steel; steel in the form of sheets, rods, bars and billets; steel rods; steel in the form of rolls; steel in the form of sheets; steel in the form of plates; steel in the form of sheets; steel masts; steel tubes; rails of steel; steel poles; reinforcing steel intended for the construction of concrete floors; steel sheet metal for automobile bodies; steel sheet metal for building; steel storage silos; unwrought or semi-wrought steel; steel wires; wire rope; steel in the form of reels; building steels; tubes of steel, including laminated, peeled or milled; unwrought steel; valves of metal other than parts of machines, including in alloy steel and titanium; vinyl coated steel plates; vinyl coated steel sheets; welding steel; zinc-coated steel sheets; iron; tungsten iron; hardware of metal; molybdenum iron; iron pyrites; chrome iron; titanium iron; silicon iron; iron alloys; sponge iron; cast iron; steel balls; pig iron; iron ores; iron wire; iron strip; galvanized steel; unwrought or semi-wrought cast iron; cast iron railway material; cast iron pipes; chromite; ductile pipes of iron; stretchers for iron bands [tension links]; stretchers for iron bands (tension links); iron foundries [semi-finished]; carbon steel alloys; unwrought or semi-wrought iron; coating plates of metal for building; floors of metal; metal profiles; partitions of metal; multi-layered metal panels; wall linings of metal; coatings and linings of metal (building materials); hardware of metal for building; ironwork for windows; metals for cast iron welding; non-electric cables of iron; non-electric wires; pure iron ingots; rails of metal; common metals; metal wires [common metal]; billets of metal; floors of metal; sheets of metal; roofing of metal; railings of metal; pallets of metal; forged metal parts; grilles of metal; sheet metal; tubes of metal; tubes of metal; roofing structures of metal; metal for plating; ores of metal; brazing alloys; rolled metals; ferrous metals; blooms [metallurgy]; drain pipes of metal; metal collection tins; structures of metal; processed ores of metal; alloys of common metals; fittings of metal for compressed air ducts; fittings of metal for building; beams of metal; tin cans of metal; vats of metal; swimming pools of metal [structures]; pulleys of metal, other than for machines; ingots of common metals; bolts of metal; eye bolts; casks of metal; casks of metal; bells; silos of metal; busts of common metal; loading gage rods, of metal, for railway wagons; screws of metal; nuts of metal; nails; tombs of metal; chimney pots of metal; doors of metal; paving blocks of metal; chimney shafts of

metal; metal packaging containers; limonite; jalousies of metal; cornices of metal; flat bolts; crampons of metal; manifolds of metal for pipelines; rivets of metal; pillars of metal for building; framework of metal for building; door frames of metal; wrapping or binding bands of metal; staircases of metal; metal sheets; reinforcing materials, of metal, for concrete; fish plates (rails); metal duckboards; tree protectors of metal; palings of metal; shuttering of metal for concrete; windows of metal; platforms, prefabricated, of metal; iron slabs; transport pallets of metal; window frames of metal; railway points; zinc; tiles of metal; railroad ties of metal; oriented grain steel; non-oriented grain steel; cast iron parts for pipes [parts of machines].

7 – Cutting presses for metalworking; steel sheet separators [machines]; machines and machine tools; motors and engines other than for land vehicles; motors and engines (other than for land vehicles); machine couplings and transmission components (other than for land vehicles); rolling mills; reels (machine parts); bits for mining machines; drills for the mining industry; extractors for mines; bits for mining machines; sharpeners for mining drill apparatus; mineworking machines; grinders [for mining purposes]; grinders for the mining industry; converters for steelworks; steel winches; metalworking machines; machining centers for metal working; metal extrusion presses; bending machines for metalworking; bending machines [for metalworking]; drilling machines for metalworking; pinning machines for [metalworking]; casting machines for molten metals; grinding machines for metalworking; honing machines for metalworking; hot-metal extruding machines; hydraulic presses for metalworking; industrial robots for metalworking; metalworking machine tools; metalworking machines; machines for machining of metals; mechanical presses for metalworking; machines for forming metals; presses for shaping metals; milling and grinding machines intended for the treatment of ceramics and metal; hydraulic oil presses intended metalworking; drilling machines intended for metalworking; shearing machines for metalworking; machines for planing sheet metal; machines for working steel sheets; machines for profiling metal; rolling mills for metal [machines]; robotic mechanisms for shaping metal; robot-operated presses for metalworking; rolling mill cylinders and other cylinders [machine parts]; continuous metal casting machines; machines for shaping, oxygenating, machining, welding, straining and punching metal, sheets and plates.

9 – Apparatus and instruments for measuring, weighing, detecting and recording; operating system programs for computers; software; computer peripheral devices; recording apparatus; furnaces for laboratory experiments; downloadable electronic publications.

11 – Industrial ovens and furnaces (not for food or beverages); ovens and furnaces for metallurgy; gas combination ovens intended for the production of steel; gas ovens with hearths and tanks for the production of steel; sanitary installations of stainless steel; washing sink tops of stainless steel [sanitary equipment]; degassing heating rods of steel; cast-iron components of pipes [parts of sanitary installations]; furnaces for melting metals; furnaces for decontaminating metals; furnaces for melting metal waste; furnaces for removing coatings from metal waste; ovens for recycling metals; furnaces for recycling metal waste; heating apparatus intended for the treatment of metals; casting channels for retaining the impurities of molten metal; filter chambers for liquid metal [components of blast furnaces].

16 – Printed matter; printed publications; printed reports, all these products relating to the production, marketing, advertising and/or distribution and/or education and/or advisory services relating to the production of metal and steel products in connection with common metals and their alloys.

35 – Commercial management services; information relating to business management; commercial information and consultancy services; assistance in the operation or management of industrial or commercial companies; business organization appraisals (commercial analysis); cost price analysis; marketing studies, all these services relating to the production, marketing, advertising and/or distribution of steel and metal products; extraction of data.

36 – Fundraising and sponsorship; financial sponsorship of cultural events; financial sponsorship of sporting activities; financial sponsorship of sporting activities; charitable fundraising services.

37 – Mining extraction; maintenance and cleaning of mining equipment; maintenance and repair of mining equipment; provision of information relating to the rental of mining machines and apparatus; provision of information relating to the repair or maintenance of mining machines and apparatus; repair or maintenance of machines and apparatus intended for mining; repair of mining machinery; rental of mining machines and apparatus; rental of drilling and mining apparatus; rental of self-propelled machines intended for mining; mining of natural resources; construction of steel fabrications; construction of steel structures for buildings; rental of masts; repair of hardware; repair of installations for use in metal production, metal processing and metal working; abrasive cleaning of metal surfaces; repair of machines and apparatus for metalworking; application of paint to metal surfaces to prevent corrosion; maintenance and repair of presses for processing metals; repair or maintenance of machines and tools for metalworking; repair and maintenance of machines and machine tools for treating and processing

metals; provision of information relating to the repair or maintenance of tools and machine tools for metalworking; assembly of metal profiles (for others); advice on construction, including with regard to the selection and use of steels.

39 – Transport by air, rail, sea and road of merchandise, especially steel and metal materials; distribution of merchandise (transport); packaging of merchandise; warehousing and storage of goods; storage of ores, metals and alloys; transport of merchandise by air, sea and land.

40 – Treatment of materials using chemicals, heat and/or pressure; treatment of ores, steel, common metals and alloys thereof; treatment of metals and all mechanical, thermo-mechanical or chemical processing of properties and characteristics of metals, including direct reduction of iron, metal tempering, tin plating, nickel plating, soldering, galvanization, anodic oxidation, rolling, sintering, magnetization, electrolytic galvanization, molding, chromium plating, coating [plating], polishing, casting, milling, shaping, tin-plating, nickel plating, rolling, shielding, cutting, polishing, magnetization, cutting, polishing, plating, drawing, stripping and welding; recycling of metal products; treatment of materials during the manufacturing processing of metal products, such as forging, pressing, milling, deburring, rolling and shaping of metals; vacuum treatment; nitriding [treatment of materials]; treatment of materials for boiler making and sheet metal working; application of finishings to rolls and sheets of stainless steel; thermal treatment and coating of steel; cutting of steel; polishing of stainless steel; brushing of stainless steel; treatment of iron oxide; surface finishing of metal articles; embossing [metal treatment]; metal tempering; forging [metal treatment]; profiling [metal treatment]; stamping [metal treatment]; enameling [metal treatment]; vapor deposition on surfaces of metal [metal treatment]; metal treatment [tempering]; treatment and coating of metal surfaces; treatment of metals; anti-corrosion treatment of metal parts; treatment of metal parts to prevent corrosion using hot-dip galvanizing and coating processes in the form of powder; treatment of slag from metal casting; treatment and processing of ores and ore concentrates.

41 – Teaching; technical and non-technical training; editing and publication of books, magazines, periodicals, instructional manuals or user manuals; organization and conducting of colloquiums, conferences, seminars and congresses; organization of fairs and exhibitions for cultural or educational purposes; entertainment; organization of games and competitions (leisure and culture).

42 – Scientific and technological services; industrial research and analysis services; design and development of software; technical project studies; technical

and scientific advice and information; expertise and engineering in the field of metallurgy and iron metallurgy; expertise and engineering in the field of metallurgy and iron metallurgy; design and development of software, especially for iron and steelworking; mining exploration and mining; geophysical exploration for the mining industry; geophysical exploration for the oil, gas and mining industries; testing of building fittings; research on metals; metallurgical testing; design services in connection with metalworking tools; design of metal presses; development of coatings for non-metallic materials; development of coatings for metals; engineering services in connection with metal shaping systems; engineering services in connection with the handling of metal; analysis in the field of metallurgy; laboratory research services in the field of metallurgy; chemistry services relating to ores.

(260) AM 2019 98623 A
 (800) 1413450
 (151) 2018 04 18
 (891) 2018 04 18
 (731) GDK International Limited
 110 Easter Queenslie Road, Glasgow G33
 4UL, United Kingdom
 (540)



(591) Black, white
 (531) 08.07.10; 26.13.25; 27.03.01; 27.05.24
 (511)
 43 – Services for providing food and drink; food preparation; fast-food restaurants; restaurant, canteen, buffet, food bar, snack bar, salad bar, coffee shop, delicatessen and cafeteria services; grill restaurants; self-service restaurants; take away fast food restaurants; carry-out restaurants; hospitality services [food and drink]; catering services; wine bar services; restaurant services incorporating licensed bar facilities; consultancy services in relation to food and drink preparation; rental of food service equipment.

(260) AM 2019 98624 A
 (800) 1413495
 (151) 2018 05 01
 (891) 2018 05 01
 (731) ARROWHEAD PHARMACEUTICALS,
 INC.
 225 SOUTH LAKE AVE., SUITE 1050,
 PASADENA CA 91101, USA

(540)

(591) Black, white
 (531) 26.13.25; 27.05.01; 27.05.10; 27.05.21
 (526) PHARMACEUTICALS
 (511)
 5 – Pharmaceutical and medicinal preparations to treat intractable diseases in humans.
 42 – Development of pharmaceutical preparations and medicines; pharmaceutical products development; pharmaceutical research and development.

(260) AM 2019 98625 A
 (800) 1413520
 (151) 2016 10 12
 (891) 2016 10 12
 (731) ILKO ILAC SANAYI VE TICARET
 ANONIM SIRKETI
 Veysel Karani Mah. Colakoglu Sok. No:10,
 Kat: 7-8-9, Sancaktepe, Istanbul, Turkey

(540)

(591) Blue and light brown
 (531) 27.05.01; 27.05.01; 27.05.10; 29.01.12
 (511)
 3 – Bleaching and cleaning preparations, detergents other than for use in manufacturing operations and for medical purposes, laundry bleach, fabric softeners for laundry use, stain removers, dishwasher detergents; perfumery; cosmetics, fragrances, deodorants for personal use and animals; soaps; dental care preparations, dentifrices, dental bleaching gels, denture polishes, mouth washes not for medical purposes; abrasive preparations; emery cloth; sandpaper; pumice stone; abrasive pastes; polishing preparations for leather, vinyl, metal and wood, polishes and creams for leather, vinyl, metal and wood, wax for polishing.
 5 – Pharmaceutical and veterinary preparations for medical purposes; chemical preparations for medical and veterinary purposes, chemical reagents for pharmaceutical and veterinary purposes; dietary supplements for pharmaceutical and veterinary purposes; dietary supplements; nutritional supplements; medicinal preparations for slimming purposes; food for babies; herbs and herbal beverages adapted for medicinal purposes; dental preparations and articles, teeth filling material, dental impression material, dental adhesives and material for repairing teeth; sanitary preparations for medical use; sanitary pads; sanitary tampons; plasters; materials for dressings;

diapers, including those made of paper and textiles; preparations for destroying vermin; fungicides, herbicides; deodorants, other than for human beings or for animals; air deodorising preparations; disinfectants; antiseptics; detergents for medical purposes.

10 – Surgical, medical, dental and veterinary apparatus and instruments; furniture especially made for medical purposes, artificial limbs and prostheses; medical orthopaedic articles, corsets for medical purposes, orthopedic shoes, elastic and support bandages; adult sexual aids, condoms; babies' bottles; babies' pacifiers; teats; teethers for babies.

35 – Advertising, marketing and public relations; organization of exhibitions and trade fairs for commercial or advertising purposes; office functions; secretarial services; arranging newspaper subscriptions for others; compilation of statistics; rental of office machines; systemization of information into computer databases; telephone answering for unavailable subscribers; business management, business administration and business consultancy; accounting; commercial consultancy services; personnel recruitment, personnel placement, employment agencies, import-export agencies; temporary personnel placement services; the bringing together, for the benefit of others, of a variety of goods, namely, chemicals used in industry, science, photography, agriculture, horticulture and forestry, manures and soils, unprocessed artificial resins and unprocessed plastics, fire extinguishing compositions, adhesives not for medical, household and stationery purposes, bleaching and cleaning preparations, detergents other than for use in manufacturing operations and for medical purposes, laundry bleach, fabric softeners for laundry use, stain removers, dishwasher detergents, perfumery, cosmetics, fragrances, deodorants for personal use and animals, soaps, dental care preparations, dentifrices, denture polishes, tooth whitening preparations, mouth washes, not for medical purposes, abrasive preparations, emery cloth, sandpaper, pumice stone, abrasive pastes, polishing preparations for leather, vinyl, metal and wood, polishes and creams for leather, vinyl, metal and wood, wax for polishing, pharmaceutical and veterinary preparations for medical purposes, chemical preparations for medical and veterinary purposes, chemical reagents for pharmaceutical and veterinary purposes, dietary supplements for pharmaceutical and veterinary purposes, dietary supplements, nutritional supplements, medical preparations for slimming purposes, food for babies, herbs and herbal beverages adapted for medicinal purposes, dental preparations and articles, teeth filling material, dental impression material, dental adhesives and material for repairing teeth, sanitary preparations for medical use, sanitary pads, sanitary tampons, plasters, materials for dressings, diapers, including those made of paper and textiles, preparations for destroying vermin, fungi-

cides, herbicides, deodorants, other than for human beings or for animals, air deodorising preparations, disinfectants, antiseptics, detergents for medical purposes, surgical, medical, dental and veterinary apparatus and instruments, furniture especially made for medical purposes, artificial limbs and prostheses, medical orthopaedic articles, corsets for medical purposes, orthopaedic shoes, elastic bandages and supportive bandages, surgical gowns and surgical sterile sheets, adult sexual aids, condoms, babies' bottles, babies' pacifiers, teats, teethers for babies, enabling customers to conveniently view and purchase those goods, such services may be provided by retail stores, wholesale outlets, by means of electronic media or through mail order catalogues.

44 – Medical services; beauty care services; medical advisory relating to personal health.

(260) AM 2019 98628 A

(800) 1413571

(151) 2018 03 19

(891) 2018 03 19

(731) AB BUSINESS LTD

Suite 1, 5 Percy Street, Fitzrovia, London
W1T 1DG, United Kingdom

(540)



(591) Black, white

(531) 26.04.22; 27.05.01

(511)

18 – Luggage tags; valises; trunks [luggage]; carried skins; business card cases; boxes of vulcanised fibre; key cases; vanity cases, not fitted; purses; chain mesh purses; shopping bags; wheeled shopping bags; travelling trunks; travelling bags; labels of leather; chamois leather, other than for cleaning purposes / skins of chamois, other than for cleaning purposes; fastenings for saddles; handbag frames; frames for umbrellas or parasols; pocket wallets; umbrella rings; valves of leather; boxes of leather or leatherboard; hat boxes of leather; butts [parts of hides]; kid; travelling sets [leatherware]; umbrellas; parasols; leather straps; shoulder belts [straps]; beach bags; briefcases; grips for holding shopping bags; suitcase handles; backpacks; bags for sports; bags [envelopes, pouches] of leather, for packaging; garment bags for travel; handbags; bags for campers; bags; canes; umbrella sticks; card cases; wallets; suitcases; suitcases with wheels; umbrella covers; school bags; imitation leather; leather, unworked or semi-worked; leatherboard; animal skins / pelts; cattle skins; leather laces.

25 – Bandanas; berets; underclothing; ankle boots; brassieres; camisoles; felted boots; bath slippers; fo-

otwear; veils; leggings, leg warmers; spats; gymnastic shoes; ready-made clothing; corselets; fittings of metal for footwear; underwear; detachable collars; galoshes; hats; slippers; tights; lingerie; neckties; sleep masks; heel pieces for footwear; ear muffs; headbands; headgear for wear; half-boots; waterproof clothing; tips for footwear; hosiery; stockings; paper clothing; paper hats; heels; garters; soles for footwear; suspenders; pajamas; bathing trunks; beach shoes; beach clothes; ponchos; belts; non-slipping devices for footwear; heel pieces for stockings; welts for footwear; gloves; sandals; bath sandals; sports shoes; knitwear; boxer shorts; shoes; skull caps; inner soles; tee-shirts; bath robes; boot uppers; pocket squares; scarves; top hats; boots; lace boots; shawls; socks.

35 – Administrative processing of purchase orders; cost price analysis; negotiation of business contracts for others; market studies; invoicing; demonstration of goods; economic forecasting; providing business information via a web site; marketing; marketing research; price comparison services; procurement services for others; import-export agency services; sponsorship search; search engine optimization for sales; negotiation and conclusion of commercial transactions for third parties; bringing together, for the benefit of other goods in classes 18 and 25, enabling customers to conveniently view and purchase those goods; such services may be provided by retail stores, wholesale outlets, through vending machines, mail order catalogues or by means of electronic media, for example, through web sites.

(260) AM 2019 98629 A

(800) 1413592

(151) 2018 04 19

(891) 2018 04 19

(731) RRI Financial, Inc.

605 South Front Street, Columbus OH 43215,
USA

(540)

THE RED COLLECTION

(591) Black, white

(526) COLLECTION

(511)

35 – Franchising, namely, offering business management assistance in the establishment and/or operation of hotels and motels.

43 – Hotel and motel services; reservation of temporary accommodation; providing information in the field of temporary accommodations for travelers.

(260) AM 2019 98630 A

(800) 1413593

(151) 2018 02 15

(891) 2018 02 15

(731) LASCARAY, S.A.

Portal de Arriaga, No.78, E-01013 Vitoria-Gasteiz (Alava), Spain

(540)



(591) Dark blue, light blue and white

(531) 01.15.15; 24.17.09; 24.17.25; 27.05.02;
27.05.09; 29.01.12

(511)

3 – Bath creams, gels and soaps; shaving foam; shampoos; perfumery products; essential oils; cosmetics; hair lotions; deodorants for personal use; tissues impregnated with cosmetic lotions; baby wipes; intimate tissues; after-shave balms; moistened cleaning wipes for hygienic and cosmetic use; pre-moistened cosmetic wipes; wipes impregnated with a skin cleanser; wipes impregnated with make-up removing preparations; feminine hygiene tissues; depilatory foam; hand creams; moisturizing body cream; depilatory bands; dentifrices.

21 – Toothbrushes; dental floss; bath sponges; hair brushes and combs; shaving brushes.

(260) AM 2019 98631 A

(800) 1413599

(151) 2018 03 27

(891) 2018 03 27

(731) GETCONTACT LIMITED LIABILITY
PARTNERSHIP

5th Floor, 86 Jermyn Street, London SW1Y
6AW, United Kingdom

(540)



(591) Blue

(531) 16.01.11; 26.13.25; 27.05.01; 29.01.04;
29.01.12

(511)

9 – Computer software, namely, computer programs (downloadable software); computer software applications, downloadable; computer software development tools; downloadable mobile applications for use telephone services.

38 – Radio and television broadcasting services; telecommunication services; providing access to the

Internet; news agencies; telecommunication services; data communication services; transmission and dissemination of data base information through telecommunication networks; granting access to databases; transmission of messages; transmission of electronic mail; telephone services; granting access to the global network for information transfer and dissemination; electronic transmission of messages, data and documents; transmission of data base information via the telecommunication network; audiovisual communication services; audio-visual transmission services; audio-visual data transmission.

(260) AM 2019 98632 A
(800) 1413737
(151) 2018 06 15
(891) 2018 06 15
(731) Salk Institute for Biological Studies
10010 N. Torrey Pines Road, La Jolla CA
92037, USA

(540)

IDEAL PLANTS

(591) Black, white
(511)
42 – Scientific research and development.

(260) AM 2019 98633 A
(800) 1413743
(151) 2018 05 22
(891) 2018 05 22
(731) XIAMEN GOLDENHOME CO., LTD.
No.190 Jihe Rd, Tongan Industrial District,
Xiamen, China

(540)



(591) Black, white
(531) 26.01.03; 26.01.18; 26.01.21; 27.05.10
(511)

20 – Sideboards; sofas; furniture fittings, not of metal; tables; doors for furniture; furniture of metal; plate racks; indoor window shades [furniture]; furniture; chests of drawers; showcases [furniture]; bookcases; wardrobes.

(260) AM 2019 98700 A
(800) 1414222
(151) 2018 02 07

(891) 2018 02 07
(731) INTERNATIONAL ELECTROTECHNICAL
COMMISSION
Rue de Varembe 3, CH-1202 Genève,
Switzerland

(540)

INTERNATIONAL ELECTROTECHNICAL COMMISSION

(591) Black, white

(511)

9 – Publications on optical disks; publications on digital recording carriers; downloadable electronic publications; downloadable computer software applications; recorded computer programs.

16 – Printed publications; magazines [periodicals]; periodicals; newsletters; manuals [handbooks]; newspapers; pamphlets; prospectuses.

42 – Technical writing; development and technical writing on international standards, specifications and information publications for electric and electronic technologies, renewable energy and related technologies; evaluation of the technical competence of personnel from repair and revision service providers for certification in the field of electric and electronic technologies, renewable energy and related technologies; evaluation and auditing of technical procedures used by repair and revisions service providers for certification in the field of electric and electronic technologies, renewable energy and related technologies; evaluation and auditing in the field of electric and electronic technologies, renewable energy and related technologies, repair and revision operations for quality assurance; evaluation and auditing in the field of electric and electronic technologies, renewable energy and related technologies, manufacturing operations for quality assurance; testing, analysis and evaluation for the certification in the field of electric and electronic technologies, renewable energy and related technologies, equipment, products and services of others; monitoring of quality control systems for repair service providers, of repair and revision service providers, and of manufacturers; quality control of equipment, products and services in the field of electric and electronic technologies, renewable energy and related technologies; certification of conformity, certification of skills, and services in connection with certification of compliance with norms, standards and other national and international regulatory documents in the field of electric and electronic technologies, renewable energy and related technologies, products, equipment, repair and revision services and of personnel.

(260) AM 2019 98705 A
 (800) 1414390
 (151) 2017 11 28
 (891) 2017 11 28
 (731) LANEБ PARIS S.A.
 Francesc Juanolà 36, baixos, E-08341
 Manresa, Spain

(540)



(591) Golden
 (531) 27.05.01; 29.01.12
 (511)
 3 – Bleaching preparations and other substances for laundry use; cleaning, polishing, degreasing and abrasive preparations; soaps; perfumery products, essential oils, cosmetics, hair lotions; dentifrices.
 35 – Wholesale and retail sale services by means of commercial establishments and via global computer networks for perfumery products and cosmetics.

(260) AM 2019 98707 A
 (800) 1414433
 (151) 2018 04 27
 (891) 2018 04 27
 (731) AGF88 HOLDING
 Via del Palù, 7/D, I-35018 San Martino di
 Lupari (PD), Italy

(540)



(591) Black, white
 (531) 26.11.01; 26.11.08; 27.05.10; 27.05.11
 (511)
 3 – Cosmetics, soaps, perfumery, essential oils, hair lotions, dyes (cosmetic -), hair dyes, shampoo, gel, nail varnish and hair lacquers, hair creams, oils for hair conditioning, hair dyes, hair spray, hair dyes, hair balm, bleaching preparations for the hair, preparations for dyeing, decolouring and bleaching the hair; anti-dandruff preparations, hair creams and powders, preparations to prevent hair loss, dentifrices.

(260) AM 2019 98708 A
 (800) 1414444
 (151) 2018 04 06
 (891) 2018 04 06
 (731) Obshchestvo s ogranichennoy
 otvetstvennostyu «Upravljajushhaja kompanija
 "MAJESTRO"
 Bol'shoj Putinkovskij pereulok, dom 5,
 RU-127006 Moskva, Russian Federation

(540)



(591) White and green
 (531) 25.01.13; 26.03.23; 29.01.12
 (511)
 16 – Posters; advertisement boards of paper or cardboard; albums; scrapbooks; pictures; prints [engravings]; aquarelles; watercolors [paintings]; watercolours [paintings]; paintings [pictures], framed or unframed; newspapers; periodicals; atlases; loose-leaf binders; tickets; printing blocks; drawing pads; pads [stationery]; pamphlets; writing or drawing books; note books; cards; charts; teaching materials [except apparatus]; index cards [stationery]; catalogues; song books; folders for papers; jackets for papers; chromolithographs [chromos]; chromos; conical paper bags; transfers [decalcomanias]; decalcomanias; graphic prints; envelopes [stationery]; etchings; shields [paper seals]; photographs [printed]; indexes; forms, printed; graphic reproductions; graphic representations; postcards; printed publications; manuals [handbooks]; handbooks [manuals]; paperweights; lithographs; booklets; papier mâché; oleographs; stationery; sewing patterns; photo-engravings; portraits; prospectuses; printers' galleys; magazines [periodicals]; bookmarkers; greeting cards; postage stamps; transparencies [stationery]; almanacs; calendars; flags of paper; paper shredders for office use; labels of paper or cardboard; signboards of paper or cardboard; comic books; musical greeting cards; newsletters.
 36 – Instalment loans; actuarial services; brokerage; credit bureau services; debt collection agency services; real estate appraisal; charitable fund raising; capital investment; surety services; issuance of travelers' checks; issuance of travellers' cheques; clearing, financial; clearing-houses, financial; safe deposit services; organization of collections; loans [financing]; fiscal valuation; financial evaluation [insurance, banking, real estate]; factoring; financial management; pawnbrokerage; mortgage banking; lease-purchase financing; hire-purchase financing; financial analysis; antique appraisal; art appraisal; financial consultancy; processing of credit card payments; processing of debit card payments; electronic funds transfer; financial information; jewellery [jewelry (Am.)] appraisal; jewellery appraisal; jewelry appraisal; numismatic appraisal; stamp appraisal; issuance of tokens of value; deposits of valuables; stock exchange quotations; issuance of credit cards; retire-

ment payment services; financial sponsorship; business liquidation services, financial; repair costs evaluation [financial appraisal]; financial activity, including services on acceptance of rates, services on payment of rewards, services of bookmaker offices.

41 – Amusement park services; entertainment services; rental of cinematographic apparatus; entertainer services; movie studio services; organization of competitions [education or entertainment]; rental of show scenery; providing recreation facilities; radio entertainment; publication of texts, other than publicity texts; teaching; educational services; instruction services; rental of sound recordings; rental of motion pictures; film production, other than advertising films; lending library services; publication of books; rental of radio and television sets; production of radio and television programmes; theatre productions; production of shows; television entertainment; rental of stage scenery; providing sports facilities; modelling for artists; providing casino facilities [gambling]; club services [entertainment or education]; entertainment information; organization of exhibitions for cultural or educational purposes; gambling services; health club services [health and fitness training]; holiday camp services [entertainment]; presentation of live performances; cinema presentations; movie theatre presentations; organization of sports competitions; party planning [entertainment]; providing museum facilities [presentation, exhibitions]; recording studio services; recreation information; rental of skin diving equipment; rental of sports equipment, except vehicles; rental of stadium facilities; rental of video cassette recorders; rental of videotapes; sport camp services; timing of sports events; arranging and conducting of workshops [training]; arranging of beauty contests; booking of seats for shows; dubbing; organization of lotteries; organization of balls; organization of shows [impresario services]; providing amusement arcade services; rental of audio equipment; rental of lighting apparatus for theatrical sets or television studios; rental of video cameras; rental of camcorders; scriptwriting, other than for advertising purposes; videotape editing; on-line publication of electronic books and journals; electronic desktop publishing; subtitling; game services provided on-line from a computer network; providing karaoke equipment; music composition services; nightclub services [entertainment]; providing on-line electronic publications, not downloadable; photographic reporting; photography; news reporters services; microfilming; ticket agency services [entertainment]; arranging and conducting of concerts; layout services, other than for advertising purposes.

43 – Accommodation bureau services [hotels, boarding houses]; food and drink catering; retirement home services; café services; cafeteria services; provi-

ding campground facilities; canteen services; rental of temporary accommodation; boarding house services; tourist home services; hotel services; restaurant services; boarding house bookings; hotel reservations; self-service restaurant services; snack-bar services; boarding for animals; bar services; holiday camp services [lodging]; rental of transportable buildings; temporary accommodation reservations; motel services; rental of chairs, tables, table linen, glassware; rental of meeting rooms; rental of tents; rental of lighting apparatus.

(260) AM 2019 98711 A

(800) 1414475

(151) 2018 04 23

(891) 2018 04 23

(731) GDK International Limited

110 Easter Queenslie Road, Glasgow G33
4UL, United Kingdom

(540)



(591) Black, white

(531) 08.07.10; 26.04.02; 26.04.05; 26.04.16;
26.04.18; 26.04.24; 27.05.22

(511)

43 – Services for providing food and drink; food preparation; fast-food restaurants; restaurant services; hospitality service [food and drink]; food cooking services; catering of food and drink; offsite services for providing food and drink; catering services; delicatessens [restaurants]; grill restaurants; self-service restaurants; carry-out restaurants; snack-bars; salad bars; wine bars; wine bar services; restaurant services incorporating licensed bar facilities; provision of information relating to restaurants and bars; consultancy services in relation to food and drink preparation; rental of food service equipment; temporary accommodation.

(260) AM 2019 98715 A

(800) 1414576

(151) 2018 05 24

(891) 2018 05 24

(731) NOVARTIS AG

CH-4002 Basel, Switzerland

(540)

FINESSE REFLEX

(591) Black, white

(511)
10 – Surgical apparatus and instruments for ophthalmic surgery.

(260) AM 2019 98717 A

(800) 1414614

(151) 2018 04 18

(891) 2018 04 18

(731) CALPEDA SPA

Via Roggia di Mezzo, 39, I-36050 Montorso
Vicentino (VI), Italy

(540)

CALPEDA

(591) Black, white

(511)

7 – Pumps, centrifugal pumps, multistage pumps, self-priming pumps, self-priming centrifugal pumps, submersible pumps, self-priming pumps for swimming pools, speed governors for machines, circulating water pumps, pressure switches as parts of machines, water pumps for spa baths, submersible vertical pumps, submersible drain pumps, water lifting systems, submersible electric pumps, gear pumps, axial flow pumps, submersible electric motors [other than for vehicles], filters for self-priming pumps, pumping systems for fire fighting apparatus.

9 – Switchboards, pump switches, electronic regulators for pumps.

11 – Circulators, linear air diffusers, regulating and safety accessories for water apparatus, waste water purification installations, water supply systems, water pressure systems.

(260) AM 2019 98719 A

(800) 1414659

(151) 2017 10 06

(891) 2017 10 06

(731) APPLE INC.

1 Infinite Loop, Cupertino CA 95014, USA

(540)



(591) The color (s) purple, white and grey is/are claimed as a feature of the mark.

(531) 02.01.23; 02.03.23; 04.05.05; 16.01.01;
26.01.04; 26.01.05; 26.04.04; 29.01.13

(511)

41 – Entertainment services in the nature of providing ongoing podcasts in the fields of entertainment, music, news, current events, public affairs, politics, government, sports, fitness, recreation, health, medicine, business, finance, history, arts, culture, society,

education, science, technology, children, families, religion, spirituality, games, hobbies, fiction, and topics of general interest.

42 – Hosting a website for the uploading, storing, sharing, viewing and posting of podcasts.

(260) AM 2019 98720 A

(800) 1414692

(151) 2018 03 16

(891) 2018 03 16

(731) PEPSICO, INC.

(a North Carolina corporation)

700 Anderson Hill Road, Purchase, New York
10577, USA

(540)



(591) Yellow, white, orange and red

(531) 25.01.06; 26.15.01; 27.05.03; 29.01.14

(511)

29 – Meat, fish, poultry and game; meat extracts; preserved, dried and cooked fruits and vegetables; snack foods consisting primarily of potatoes, nuts, fruits or vegetables or combinations thereof including potato chips, taro chips; jellies, jams; eggs, milk and milk products; edible oils and fats.

30 – Coffee, tea, cocoa, sugar, rice, tapioca, sago, artificial coffee; flour and preparations made from cereals, ready to eat snack foods consisting of grains, including corn chips, tortilla chips, rice chips, crackers, pretzels and puffed and extruded snacks; popcorn, candy coated popcorn and peanuts; snack foods based on crushed grains; bread, pastry and confectionery; ice cream; honey, treacle; yeast, baking powder; salt, mustard; vinegar; sauces [condiments]; spices; ice.

(260) AM 2019 98721 A

(800) 1414706

(151) 2018 05 10

(891) 2018 05 10

(731) REHA YAVUZER

Harbiye Mah. Tesvikiye Cad., Varol Apt.

No.7 K.3 D.4, Nişantaşı Sisli, Istanbul, Turkey

(540)

Beauty Omelette

(591) Black, white

(511)

3 – Bleaching and cleaning preparations, detergents other than for use in manufacturing operations and for medical purposes, laundry bleach, fabric softeners for laundry use, stain removers, dishwasher detergents, perfumery, cosmetics, fragrances, deodorants for personal use and animals, soaps, dental care preparations, dentifrices, denture polishes, tooth whitening preparations, mouth washes, not for medical purposes, abrasive preparations, emery cloth, sandpaper, pumice stone, abrasive pastes, polishing preparations for leather, vinyl, metal and wood, polishes and creams for leather, vinyl, metal and wood, wax for polishing.

25 – Clothing, including underwear and outerclotting, other than special purpose protective clothing; socks, mufflers (clothing), shawls, bandanas, scarves, belts (clothing); footwear, shoes, slippers, sandals; headgear, hats, caps with visors, berets, caps (headwear), skull caps.

35 – The bringing together, for the benefit of others, of a variety of goods, namely, bleaching and cleaning preparations, detergents other than for use in manufacturing operations and for medical purposes, laundry bleach, fabric softeners for laundry use, stain removers, dishwasher detergents, perfumery, cosmetics, fragrances, deodorants for personal use and animals, soaps, dental care preparations, dentifrices, denture polishes, tooth whitening preparations, mouth washes, not for medical purposes, abrasive preparations, emery cloth, sandpaper, pumice stone, abrasive pastes, polishing preparations for leather, vinyl, metal and wood, polishes and creams for leather, vinyl, metal and wood, wax for polishing enabling customers to conveniently view and purchase those goods, such services may be provided by retail stores, wholesale outlets, by means of electronic media or through mail order catalogues.

41 – Education and training, arranging and conducting of conferences, congresses and seminars, sporting and cultural activities; entertainment; ticket reservation and booking services for entertainment, sporting and cultural events, including ticket reservation and booking services for theatres, cinemas, museums and concerts, publication and editing of printed matter, including magazines, books, newspapers, other than publicity texts; electronic publication services, production of movie films, radio and television programmes, news reporters services; photographic reporting services, photography, translation.

(260) AM 2019 98722 A

(800) 1414707

(151) 2018 06 08

(891) 2018 06 08

(731) ROCHE DIAGNOSTICS GMBH

Sandhofer Str. 116, 68305 Mannheim,
Germany

(540)

DANSR

(591) Black, white

(511)

1 – Chemical, biological and biochemical preparations for scientific and research purposes; in vitro diagnostic reagents for scientific use; chemical reagents, preparations and test kits for laboratory analysis of nucleic acids for scientific purposes; chemical reagents, preparations and test kits for determining genetic variations for research use.

5 – Chemical, biological and biochemical preparations for medical purposes; diagnostic reagents for medical purposes; chemical reagents for analyzing and testing body fluids to determine chromosomal or genetic abnormalities for medical purposes; test kits consisting primarily of reagents for nucleic acid detection and analysis for medical purposes; biological preparations for detecting genetic predispositions for medical purposes.

44 – Medical services for genetic analysis; nucleic acid based testing for medical purposes; medical services in the field of nucleic acid analysis.

(260) AM 2019 98724 A

(800) 1414746

(151) 2018 05 04

(891) 2018 05 04

(731) HANOVER VENTURES MARKETPLACE,
LLC

93 Pearl Street, 3rd Floor, New York NY
10004, USA

(540)



(591) Black, white

(531) 26.01.01; 26.01.04; 26.01.18; 26.01.24;
27.05.09; 27.05.10; 27.05.21; 27.05.24;
27.07.24

(526) EST. 2015

(511)

30 – Coffee; coffee based beverages; bakery desserts; bakery goods; baking spices; biscotti; biscuits; cakes; chocolate mousse; cookies; crepes; croissants; cumin powder; curry; dried chives; eclairs; edible

spices; edible turmeric; espresso drinks; food seasonings; ground coffee beans; hot pepper powder; ice cream; ice cream desserts; muffins; natural spices; nutmeg; nutmegs; oatmeal; organic spices; pastry; pepper spice; powdered garlic; roasted coffee beans; sandwiches; scones; sea salt for cooking; seasonings; sponge cakes.

(260) AM 2019 98725 A

(800) 1414751

(151) 2018 03 29

(891) 2018 03 29

(731) Tovarystvo z obmezheniou vidpovidalnistiu "TALAMUS LTD"
vul. Malynovskogo, 16 A, Odesa 65017,
Ukraine

(540)

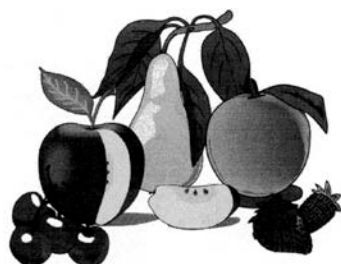

(591) Black, white

(531) 05.07.08; 05.07.13; 05.07.14; 05.07.15;
05.07.16; 05.07.22; 05.07.24

(511)

6 – Casks of metal; packaging containers of metal; tinplates; sealing caps of metal, jerrycans of metal; bottle caps of metal; preserving boxes of metal; containers of metal [storage, transport]; boxes of common metal; closures of metal for containers; bottle closures of metal; metal caps for glass jars; tinplate packings; chests of metal; foils of metal for wrapping and packaging.

(260) AM 2019 98726 A

(800) 1414865

(151) 2018 04 06

(891) 2018 04 06

(731) KANSAI PAINT CO., LTD.
33-1, Kanzaki-cho, Amagasaki-shi, Hyogo
661-8555, Japan

(540)

EPOTECT

(591) Black, white

(511)

2 – Paints; varnishes; lacquers; paint thinners.

(260) AM 2019 98728 A

(800) 1414907

(151) 2018 05 23

(891) 2018 05 23

(731) KACCINO S.R.L.

Via Nazionale, 69, I-40065 Pianoro (BO),
Italy



(591) Black, white

(531) 26.04.04; 26.04.18; 26.04.24; 27.05.24

(511)

30 – Coffee, tea, herb tea.

(260) AM 2019 98729 A

(800) 1414925

(151) 2018 03 19

(891) 2018 03 19

(731) Autonomous nonprofit organization
"TV-Novosti"

Borovaya street, 3, korp. 1, RU-111020
Moscow, Russian Federation

(540)

ICYMI

(591) Black, white

(511)

38 – News agency services; television broadcasting; cable television broadcasting; electronic bulletin board services [telecommunications services]; information about telecommunication; providing access to databases; providing telecommunications connections to a global computer network; message sending; computer aided transmission of messages and images; transmission of telegrams; rental of message sending apparatus; rental of modems; rental of telecommunication equipment; rental of telephones; rental of facsimile apparatus; radio broadcasting; communications by fiber optic networks; communications by cellular phones; communications by computer terminals; satellite transmission; communications by telegrams; communications by telephone; facsimile transmission; telex services; voice mail services; telegraph services; telephone services; telecommunications routing and junction services; providing Internet chatrooms; providing user access to the Internet [service providers]; providing telecommunication channels for teleshopping services; transmission of electronic mail; rental of access time to global computer networks; teleconferencing services.

41 – Modelling for artists; academies [education]; videotaping; physical education; discotheque services; animal training; dubbing; gambling services; publication of books; education information; recreation information; entertainment information; movie

studio services; microfilming; videotape editing; production of radio and television programs; religious education; gymnastic instruction; correspondence courses; practical training [demonstration]; organization of balls; arranging and conducting of colloquiums; arranging and conducting of congresses; arranging and conducting of conferences; arranging and conducting of concerts; arranging and conducting of workshops [training]; arranging and conducting of seminars; arranging and conducting of symposiums; arranging of beauty contests; organization of lotteries; organization of shows [impresario services]; organization of sports competitions; vocational guidance [education or training advice]; amusement park services; sign language interpretation; television entertainment; mobile library services; providing golf facilities; providing amusement arcade services; cinema presentations; presentation of live performances; theatre productions; educational examination; production of motion pictures; rental of audio equipment; rental of video cameras; rental of video cassette recorders; rental of videotapes; rental of show scenery; rental of motion pictures; rental of lighting apparatus for theatrical sets or television studios; rental of radio and television sets; electronic desktop publishing; on-line publication of electronic books and journals; radio entertainment; entertainer services; entertainment services; writing of texts; news reporters services; party planning [entertainment]; music composition services; subtitling; calligraphy services; teaching; orchestra services; translation; recording studio services; photography; photographic reporting; boarding school education; production of shows; booking of seats for shows; sport camp services; providing museum facilities [presentation, exhibitions]; scriptwriting, other than for advertising purposes; ticket agency services [entertainment]; publication of texts, other than publicity texts; rental of stadium facilities; rental of cinematographic apparatus; rental of sound recordings; holiday camp services [entertainment]; organization of competitions [education or entertainment]; providing recreation facilities; organization of exhibitions for cultural or educational purposes; providing on-line electronic publications, not downloadable; game services provided online from a computer network; presentation of variety shows; layout services, other than for advertising purposes; nightclub services [entertainment]; entertainment club services; health club services [health and fitness training]; nursery schools; providing television programs, not downloadable, via video-on-demand services; providing films, not downloadable, via video-on-demand services.

(260) AM 2019 98730 A
(800) 1414927
(151) 2018 05 03

(891) 2018 05 03
(731) APPLE INC.
One Apple Park Way, Cupertino CA 95014,
USA
(540)



(591) Blue, white.
(531) 26.01.03; 26.01.18; 27.05.21; 29.01.12
(511)
42 – Design and development of computer hardware and software for video and music recognition; electronic data storage; providing computer hardware or software information online; computer software services, namely technical support services for video and music recognition software; non-downloadable software for sound, video, and music recognition; non-downloadable software enabling discovery, interaction with, and sharing of audio, video, printed, multimedia or augmented reality content.
45 – Online social networking services.

(260) AM 2019 98731 A
(800) 1414945
(151) 2018 06 26
(891) 2018 06 26
(731) ROYAL CARIBBEAN CRUISES LTD.
1050 Caribbean Way, Miami FL 33132, USA
(540)

COME SEEK

(591) Black, white
(511)
39 – Cruise ship services; arranging of cruises; transportation of passengers by cruise ship.

(260) AM 2019 98732 A
(800) 1414950
(151) 2018 03 12
(891) 2018 03 12
(731) INVERSIONES ARTEMISA, S.L.
Valencia, 229, 1º, 2ª, E-08007 Barcelona,
Spain
(540)



(591) Black, white
(531) 05.05.20; 26.01.01; 26.01.05; 26.01.15;
27.05.10

(511)

3 – Non-medicinal toiletry preparations and cosmetic products; non-medicinal dentifrices; essential oils for manufacture of perfumed products; laundry bleach products; laundry preparations; degreasing substances; polishing preparations; abrasives; cleaning products; antiperspirants [toiletries]; bath salts other than for medical use; cotton wool for cosmetic use; false eyelashes; false nails; paint-stripping products; shampoos; cotton sticks for cosmetic use; non-medicinal toiletries.

8 – Electric manicure instrument cases; manicure sets; cases for manicure instruments; manicure instruments; nail buffers for use in manicure; manicure and pedicure utensils; hairdressing utensils; nail scissors; cuticle scissors; scissors for hairdressing; nail clippers; nail clippers, electric or non-electric; clippers for nails; nail nippers; nail files; nail files [electric]; nail files, non-electric; safety razors.

21 – Combs; comb cases; electric combs; sponges; body sponges; sponges for personal hygiene; bath sponges; abrasive sponges for scrubbing the skin; facial sponges for applying make-up; sponges for applying body powders; toiletry sponges; sponge holders [sponge bags]; brushes; mascara brushes for eyelashes; nail brushes; electric brushes, except parts of machines; skin cleaning brushes; brushes for personal hygiene; eyebrow brushes; eyelash brushes; make-up brushes, brushes and articles for brush-making; shaving brushes; shaving brush stands; holders for make-up brushes; vanity cases; toilet utensils.

35 – Advertising agency services; commercial business management; commercial administration; office functions; wholesale and retail services in stores and via global computer networks for perfumery products and accessories, cosmetics and toiletries, manicure, pedicure and hairdressing utensils and accessories and cleaning products, as well as information and advisory services relating to the sale of these goods; import and export services.

(260) AM 2019 98734 A

(800) 1414989

(151) 2018 02 26

(891) 2018 02 26

(731) ECEM OTOMOTİV KAUÇUK
MAKİNA VE YEDEK PARÇA SANAYİ
TİCARET LİMİTED ŞİRKETİ
Ankara Asfaltı No.317, Bornova, TR-35050
İzmir, Turkey

(540)



(591) Black, white

(531) 26.02.01; 26.02.05; 27.05.09; 27.05.21

(511)

9 – Measurement apparatus and equipment including those for scientific, nautical, topographic, meteorologic, industrial and laboratory purposes, thermometers, not for medical purposes, barometers, ammeters, voltmeters, hygrometers, testing apparatus not for medical purposes, telescopes, periscopes, directional compasses, speed indicators, laboratory apparatus, microscopes, magnifying glasses, stills, binoculars, ovens and furnaces for laboratory experiments, apparatus for recording, transmission or reproduction of sound or images, cameras, photographic cameras, television apparatus, video recorders, CD and DVD players and recorders, MP3 players, computers, desktop computers, tablet computers, wearable technological devices (smart watches, wristbands, head-mounted devices) microphones, loudspeakers, earphones, telecommunications apparatus, apparatus for the reproduction of sound or images, computer peripheral devices, cell phones, covers for cell phones, telephone apparatus, computer printers, scanners [data processing equipment, photocopiers, magnetic and optic data carriers and computer software and programmes recorded thereto, downloadable and recordable electronic publications, encoded magnetic and optic cards, movies, tv series and video music clips recorded on magnetic, optical and electronic media, antennas, satellite antennas, amplifiers for antennas, parts of the aforementioned goods, ticket dispensers, automatic teller machines (ATM), electronic components used in the electronic parts of machines and apparatus, semiconductors, electronic circuits, integrated circuits, chips [integrated circuits], diodes, transistors [electronic], magnetic heads for electronic apparatus, electronic locks, photocells, remote control apparatus for opening and closing doors, optical sensors, counters and quantity indicators for measuring the quantity of consumption, automatic time switches, clothing for protection against accidents, irradiation and fire, safety vests and life-saving apparatus and equipment, eyeglasses, sunglasses, optical lenses and cases, containers, parts and components thereof, apparatus and instruments for conducting, transforming, accumulating or controlling electricity, electric plugs, junction boxes [electricity], electric switches, circuit breakers, fuses, lighting ballasts, battery starter cables, electrical circuit boards, electric resistances, electric sockets, transformers [electricity], electrical adapters, battery chargers, electric door bells, electric and electronic cables, batteries, electric accumulators, solar panels for production of electricity, alarms and anti-theft alarms, other than for vehicles, electric bells, signalling apparatus and instruments, luminous or mechanical signs for traffic use, fire extinguishing apparatus, fire engines, fire hose and fire hose nozzles, radar apparatus, sonars,

night vision apparatus and instruments, decorative magnets, metronomes.

12 – Motor land vehicles, motorcycles, mopeds, engines and motors for land vehicles, clutches for land vehicles, transmissions, transmission belts and transmission chains for land vehicles, gearing for land vehicles, brakes, brake discs and brake linings for land vehicles, vehicle chassis, automobile bonnets, vehicle suspension springs, shock absorbers for automobiles, gearboxes for land vehicles, steering wheels for vehicles, rims for vehicle wheels, bicycles and their bodies; handlebars and mudguards for bicycles, vehicle bodies, tipping bodies for trucks, trailers for tractors, frigorific bodies for land vehicles, trailer hitches for vehicles, vehicle seats, head-rests for vehicle seats, safety seats for children, for vehicles, seat covers for vehicles, vehicle covers (shaped), sunblinds adapted for vehicles, direction signals and arms for direction signals for vehicles, windscreen wipers and wiper arms for vehicles, inner and outer tires for vehicle wheels, tubeless tires, tire-fixing sets comprised of tire patches and tire valves for vehicles, windows for vehicles, safety windows for vehicles, rearview mirrors and wing mirrors for vehicles, anti-skid chains for vehicles, luggage carriers for vehicles, bicycle and ski carriers for cars, saddles for bicycles or motorcycles, air pumps for vehicles, for inflating tires, anti-theft alarms for vehicles, horns for vehicles, safety belts for vehicle seats, air bags (safety devices for automobiles), baby carriages, wheelchairs, pushchairs, wheelbarrows, shopping carts, single or multi-wheeled wheelbarrows, shopping trolleys, grocery carts, handling carts, rail vehicles, locomotives, trains, trams; wagons, cable cars, chairlifts, vehicles for locomotion by water and their parts, other than their motors and engines, vehicles for locomotion by air and their parts, other than their motors and engines.

17 – Rubber, gutta-percha, gum, asbestos, mica and semi-finished synthetic goods made from these materials in the form of powder, bars, panels and foils included in this class, insulation, stopping and scaling materials, insulation paints, insulation fabrics, insulating tape and band, insulation covers for industrial machinery, joint sealant compounds for joints, gaskets, O-rings for sealing purposes (other than gaskets for motors, cylinders and washer for water taps), flexible pipes made from rubber and plastic, hoses made of plastic and rubber, including those used for vehicles, junctions for pipes of plastic and rubber, pipe jackets of plastic and rubber, hoses of textile material, junctions for pipes, not of metal, pipe jackets, not of metal, connecting hose for vehicle radiators.

(260) AM 2019 98750 A

(800) 1333647

(151) 2016 11 11

(891) 2018 06 19

(731) MH MEDICAL HEMP GMBH

Wilhelm-Kabus-Strasse 74, 10829 Berlin, Germany

(540)



(591) Green, black and red

(531) 03.13.05; 26.05.04; 29.01.13

(526) Medical hemp.

(511)

3 – Essential oils; cosmetics; dentifrices, all aforementioned goods based on medical hemp.

5 – Pharmaceuticals; nutritional supplements; medical preparations; veterinary preparations; dietetic preparations adapted for medical use; dietetic substances for veterinary purposes, all aforementioned goods based on medical hemp.

35 – Retailing relating to essential oils, cosmetics, dentifrices, pharmaceuticals, medical preparations, veterinary preparations, dietetic substances adapted for medical use, dietetic substances adapted for veterinary use, dietary supplements, all aforementioned services only related to goods based on medical hemp.

(260) AM 2019 98753 A

(800) 1390712

(151) 2017 10 16

(891) 2018 06 20

(731) SHELL BRANDS INTERNATIONAL AG

Baarermatte, CH-6340 Baar, Switzerland

(540)

deli by Shell

(591) Black, white

(511)

29 – Meat, fish, seafood, poultry and game; preparations mainly made from meat, fish, seafood, poultry and/or game; meat and vegetable extracts; preserved, dried and cooked fruit and vegetables; gelatin; jellies; jams; canned food; eggs, milk and dairy products; edible oils and fats; salads based on fruit and vegetables; prepared salads; preserves in vinegar (pickles); soups; fillings for sandwiches; spreads; preparations for sandwiches; snacks based on fruit and vegetables; hamburgers made with meat and vegetables; prepared dishes and snacks; prepared me-

als; prepared curry dishes (with or without rice); sausages; hot dog sausages; kebabs; French fries; potato chips; food consisting wholly or mainly of potatoes; desserts, mainly consisting of fruit, dried fruit, cooked and frozen fruit, nuts, jellies, gelatine, jams, eggs or powdered eggs, milk or dairy products, edible oils and fats, dairy products, milk substitutes, yogurt.

30 – Coffee; coffee-based beverages containing milk; coffee-based beverages; coffee flavorings; tea; tea-based beverages; cocoa; sugar; rice; tapioca; sago; artificial coffee; flour and preparations made from cereals; bread; baguettes; bread and buns; sandwiches; hot and cold sandwiches; hot and cold filled baguettes; hot and cold stuffed bread and buns; stuffed bread; toasted sandwiches; toasted stuffed bread; hamburger buns (sandwiches); bread and buns with hamburgers; sausage sandwiches; bread and buns with sausages; pizzas; pasta; pita bread with kebabs; pasta; cakes and pastries; fresh crusted pâtés; pasties; sausage rolls; pastry; pastries made with puff pastry; croissants; cakes; bread rolls; Viennese pastries; donuts; scones; biscuits, cookies; muffins; biscuits made with oat flakes; tartlets; desserts; puddings; confectionery products, excluding packaged chocolate bars; chocolate, excluding packaged chocolate bars; edible ices; ice cream sandwiches; deep-frozen confectionery products; ice cream; honey; golden syrup; yeast; baking powder; salt; mustard; vinegars; sauces; spices; ice for refreshment; salad dressing; hamburgers (sandwiches).

31 – Fresh fruit and vegetables; nuts; seeds.

32 – Beers; mineral waters; soda water; carbonated water; non-alcoholic beverages; fruit drinks and fruit juices; syrups and other preparations for making beverages.

35 – Retail services for food and beverages in service stations and vehicle service stations; retail services for food and beverages via shops of consumer goods; advertising and sales promotion relating to food and beverages.

43 – Services for providing food and drink; take-away food services; fast food restaurant services; restaurant services; self-service restaurant services; coffee shop services; serving of food and beverages (waiter service) in cafeterias; canteen services; restaurant services; preparation of food and beverages; preparation of food and beverages; providing information about food, beverages and catering services; catering services provided online via a computer database or via the Internet; information about food, beverages and catering services provided via a computer database or the Internet.

(260) AM 2019 98754 A

(800) 1398748

(151) 2018 01 04

(891) 2018 06 19

(731) MH MEDICAL HEMP GMBH

Wilhelm-Kabus-Straße 74, 10829 Berlin,
Germany

(540)



(591) Green, black and red

(531) 03.13.05; 26.05.04; 29.01.13

(511)

1 – Pharmaceutical active ingredients for use in the manufacture of pharmaceutical preparations to combat chronic pain, anxiety, post-traumatic stress disorders, sleep disorders, nervous conditions, nausea and feelings of sickness caused by chemotherapy, tics syndrome, fits, epilepsy, all aforementioned goods based on medical hemp.

35 – Retailing and wholesaling in relation to pharmaceutical active ingredients for use in the manufacture of pharmaceutical preparations to combat chronic pain, anxiety, post-traumatic stress disorders, sleep disorders, nervous conditions, nausea and feelings of sickness caused by chemotherapy, tics syndrome, fits, epilepsy, all aforementioned services only related to goods based on medical hemp.

(260) AM 2019 98834 A

(800) 1415853

(151) 2018 03 30

(891) 2018 03 30

(731) DAIICHI SANKYO COMPANY,
LIMITED

3-5-1, Nihonbashi Honcho, Chuo-ku, Tokyo
103-8426, Japan

(540)

Онкуэлва

(591) Black, white

(531) 28.05

(511)

5 – Pharmaceutical preparations and substances.

(260) AM 2019 98835 A

(800) 1415868

(151) 2018 02 27

(891) 2018 02 27

(731) Obshestvo s ogranichennoy otvetstvennostyu
"J-UNITED GROUP"
OOO "J-UNITED GROUP", 83, Beruniy
street, Olmazarskiy district, Tashkent city
100020, Uzbekistan

(540)



AMILOV

(591) Black, white

(531) 05.13.25; 25.01.25; 27.05.22

(511)

29 – Meat, fish, poultry and game; meat extracts; preserved, frozen, dried and cooked fruits and vegetables; jellies, jams, compotes; eggs; milk and milk products; oils and fats for food.

30 – Coffee, tea, cocoa and artificial coffee; rice; tapioca and sago; flour and preparations made from cereals; bread, pastries and confectionery; edible ices; sugar, honey, treacle; yeast, baking-powder; salt; mustard; vinegar, sauces [condiments]; spices; ice [frozen water].

(260) AM 2019 98836 A

(800) 1415878

(151) 2018 04 28

(891) 2018 04 28

(731) Limited liability company

"CONFECTIONERY COMPLEX

"OZERSKY SOUVENIR"

room 3, lit. M, 13, Lenina street, Ozery

RU-140560 Moscow region, Russian

Federation

(540)

ETRE

(591) Black, white

(531) 27.05.01

(511)

30 – Coffee, tea, cocoa and artificial coffee; cocoa beverages with milk; coffee beverages with milk.

(260) AM 2019 98913 A

(800) 1416423

(151) 2018 04 02

(891) 2018 04 02

(731) KIA MOTORS CORPORATION

12, Heolleung-ro, Seocho-gu, Seoul, Republic
of Korea

(540)



(591) Red, white

(531) 24.11.25; 26.01.03; 26.01.18; 27.05.01;
29.01.12

(511)

35 – Providing information via the Internet relating to the sale of automobiles; sales agency services for automobile; sales administration for the sale of automobiles; wholesale services featuring vehicles; retail services featuring vehicles; sales agency services for parts and accessories for vehicles; sales arranging of parts and accessories for vehicles; wholesale services featuring parts and accessories for vehicles; retail store services featuring parts and accessories for vehicles.

37 – Repair of rear sensors for automotive; repair, maintenance and overhaul of automobiles; repair and maintenance of engines for motor vehicles; repair or maintenance of automobile audio apparatus; automobile cleaning and car washing; tuning of motors and engines for automobiles.

(260) AM 2019 98914 A

(800) 1416447

(151) 2018 04 18

(891) 2018 04 18

(731) HNC Healthy Nutrition Company GmbH

Senefelderstr. 44, 51469 Bergisch Gladbach,

Germany

(540)

shameless smoothies

(591) Black, white

(511)

32 – Non-alcoholic cocktails; non-alcoholic fruit juice beverages; non-alcoholic fruit beverages; non-alcoholic vegetable beverages; juices, in particular fruit juices and concentrates for making soft drinks; syrups for making beverages; non-alcoholic beverages flavoured with herbs and herbal preparations other than for medical purposes; non-alcoholic carbonated beverages; non-alcoholic non-carbonated beverages; sodas; flavoured and unflavoured sparkling water; flavoured and unflavoured still water; non-alcoholic bitter beverages; energy drinks; sports drinks; isotonic beverages; non-alcoholic spritzers; beers; beer-based cocktails; protein-enriched beverages; whey beverages; syrups for beverages; beverage capsules for making non-alcoholic beverages; non-alcoholic beverage capsules for making non-alcohol-

lic carbonated beverages, sodas, flavoured still water, flavoured and unflavoured sparkling water, bitter beverages, energy drinks, sports drinks, isotonic beverages, spritzers, juices, in particular fruit juices, vegetable juices or fruit/vegetable juices, smoothies, fruit nectars, beers, beer cocktails, protein-enriched beverages, whey beverages; non-alcoholic carbonated or non-carbonated beverages, sodas, flavoured and unflavoured sparkling water, flavoured and unflavoured still water, bitter beverages, energy drinks, sports drinks, isotonic beverages, spritzers, juices, in particular fruit juices, vegetable juices or fruit/vegetable juices, smoothies, fruit nectars, beers, beer cocktails, protein-enriched beverages, whey beverages, all the aforementioned goods other than for medical purposes; dietetic beverages, not for medical purposes; isotonic powders used in the preparation of soft drinks for making non-alcoholic beverages, not for medical purposes.

(260) AM 2019 98922 A
 (800) 1416591
 (151) 2018 06 15
 (891) 2018 06 15
 (731) NV BISCUITS DELACRE SA
 Avenue Emile van Becelaere 2, B-1170
 Watermael-Boitsfort, Belgium
 (540)

DELACRE

(591) Black, white
 (511)
 30 – Biscuits and cookies, cakes, pastry, confectionery, chocolate and chocolate-based products.

(260) AM 2019 98923 A
 (800) 1416596
 (151) 2017 11 27
 (891) 2017 11 27
 (731) JIANGSU OPPEAL DAILY COSMETICS
 CORP., LTD.
 BaoNv Village, Yangshou Town, Hanjiang
 District, Yangzhou City, Jiangsu Province,
 China
 (540)

Antichi Profumi

(591) Black, white
 (531) 27.05.01; 27.05.19
 (511)
 3 – Soap; cleansing shampoo; cleansing milk for toilet purposes; toilet soap; shampoos; hair conditioners; facial cleanser; bath foam; bath salts; liquid soap; laundry preparations; washing powder; dish-washing liquid; cotton sticks for cosmetic purposes;

cosmetics; perfumes; cosmetic preparations for skin care; deodorants for human beings or for animals; after-shave lotions; hair spray; talcum powder; mouthwashes, not for medical purposes; toothpaste; sunscreen preparations.

21 – Soap boxes; soap dispensers; dustbins; shoe horns; combs; nail brushes; toothbrushes; toothpicks; floss for dental purposes; perfume vaporizers.

(260) AM 2019 98924 A
 (800) 1416624
 (151) 2018 05 08
 (891) 2018 05 08
 (731) DR. KORMAN LABORATORIES LTD.
 Yosef Levi 23, Kiriyat Bialik, 2751123, Israel
 (540)

Evolution

(591) Black, white
 (531) 27.05.01; 27.05.19
 (511)
 5 – Gels based on hyaluronic acid for subdermal and intradermal injections; gels based on hyaluronic acid used for correction of age and mimic wrinkles on the face, as well as to give an extra volume to the lips and other areas of the body; preparations based on hyaluronic acid; preparations for biorevitalization and contouring products.

10 – Syringes for injections; hypodermic syringes.

35 – Professional business consultancy; demonstration of goods; procurement services for others [purchasing goods and services for other businesses]; retail services relating to goods of classes 05 and 10, including internet retail.

(260) AM 2019 98925 A
 (800) 1416695
 (151) 2018 06 08
 (891) 2018 06 08
 (731) EUROPCAR INTERNATIONAL
 13 Ter Boulevard Berthier, F-75017 Paris,
 France
 (540)

EUROPCAR MOBILITY GROUP

(591) Black, white
 (511)
 12 – Vehicles; apparatus for locomotion by land, air or water; vehicles for locomotion by air, land or water; vehicles for travel by land, air, rail or water; motor vehicles for use in the transporting of people; automobiles for carrying goods; motor cars; cars for

transporting people; cars for transporting goods; sports cars; touring cars; motor homes; mobile homes (caravans); motor caravans; vehicles in the nature of vans; motor vans; camper vans; camping cars; trucks being motor land vehicles; trucks for transporting; commercial trucks; industrial trucks; bicycles; motorcycles; lorries; coaches; buses.

35 – Advertising; business management; business administration; office functions; organisation, operation and supervision of loyalty and incentive schemes; advertising services provided via the Internet; production of television and radio advertisements; accountancy; auctioneering; trade fairs; opinion polling; data processing; provision of business information; marketing services; promotion services; database management services; business information services provided online from a computer database or the Internet; composing advertisements for use as web pages; market surveys; analysis of advertising response and market research; business services in the field of the rental of vehicles; transport business fleet management services; cost analysis and statistics relating to vehicles; business enquiries; business investigations; demonstration of computer products; computerised file management; collection and organization of data in a master file in the field of automobile advertising and vehicle rental; customer loyalty services and customer club services, for commercial, promotional and/or advertising purposes; organisation of exhibitions for advertising purposes relating to the automobile and vehicle rental fields; retail services connected with the sale of vehicles and apparatus for travel by land, air, rail or water; information and advice relating to all these services.

36 – Insurance; financial affairs; monetary affairs; credit services relating to motor vehicles; financial services relating to motor vehicles; financial services for the purchase of vehicles; provision of finance for the purchase of vehicles; financial services for the leasing of vehicles; insurance services relating to vehicles; financial services relating to the insurance of motor vehicles; lease purchase financing of vehicles; lease-financing consultancy; vehicle costs and vehicle investment consultancy; information and advice relating to all these services.

39 – Transport; packaging and storage of goods; travel arrangement; transportation of persons or merchandise (by air, land or water); arranging for the transportation of persons or merchandise (by air, land or water); rental of vehicles for locomotion by air, land or water; rental of cars, bicycles, motorcycles, scooters, camping cars, trucks, lorries, vans, coaches, buses, caravans; vehicle leasing services; arranging for the rental of vehicles for locomotion by air, land or water; rental of vehicle equipment and accessories; vehicle and transport reservation services; chauffeur services; rental of chauffeur driven vehicles; car sharing; van sharing; bicycle sharing;

car pooling; scooter pooling, transport fleet management services; haulage services; courier services (messages or merchandise); vehicle towing services; hiring of transportation vehicles; information and advice relating to all these services.

(260) AM 2019 98926 A

(800) 1416705

(151) 2018 06 20

(891) 2018 06 20

(731) ROCHE DIAGNOSTICS GMBH

Sandhofer Str. 116, 68305 Mannheim,
Germany

(540)

COBAS PRIME

(591) Black, white

(511)

9 – Laboratory instruments for use in research and science; laboratory instruments for research and diagnostic purposes; apparatus for pre-analytical treatment for scientific purposes; laboratory equipment, namely automated sample handling equipment; computer hardware and software for medical and diagnostic purposes; computer software for the provision of automated diagnostic laboratory processes; computer software and hardware for use with laboratory instruments, namely, for use in providing remote automated control, connection, data analysis, and data management.

10 – Analyzers for in-vitro diagnostic testing for medical purposes; laboratory apparatus for medical and diagnostic purposes; apparatus for pre-analytical treatment for medical purposes.

(260) AM 2019 98927 A

(800) 1416721

(151) 2018 03 01

(891) 2018 03 01

(731) HANSA-FLEX International GmbH

Zum Panrepel 44, 28307 Bremen, Germany

(540)

HANSA-FLEX

(591) Black, white

(511)

6 – Flexible tubes of metal; connection fittings and chafer devices for the aforesaid flexible tubes; pipes and tubes of metal; screw fittings for pipes, adapters, hydraulic couplings and hydraulic ball-valves, pipe clips, pipe fastening systems.

7 – Hydraulic tubes, steam tubes, concrete pump and feed tubes, compressed air tubes; hydraulic pipes; hydraulic tubes and hydraulic pipelines ready for installation.

9 – Flame-protection devices for the tubes, namely fire detectors and fire alarms; pressure gauges; articles for hydraulic measurement, namely apparatus for measuring pressure, temperature and flow speed, including parts thereof, namely screw fittings, couplings, connection tubes.

17 – Flexible tubes of plastic; connection fittings and chafer devices for the aforesaid flexible tubes; packing, stopping and insulating materials; pipes of rubber and plastic; flexible tubes for tankers.

(260) AM 2019 98929 A

(800) 1416736

(151) 2018 01 31

(891) 2018 01 31

(731) ON-MEDIA Limited Liability Company
Kutuzovskiy prospect, 350 bld. 1, RU-121165
Moscow, Russian Federation

(540)



(591) White, orange, transparent.

(531) 26.04.05; 26.04.18; 26.04.24; 27.05.02;
27.05.17; 27.05.24; 29.01.12

(511)

38 – Television broadcasting; cable television broadcasting; news agency services; providing internet chatrooms; satellite transmission; providing telecommunication channels for teleshopping services; streaming of data; providing telecommunications connections to a global computer network.

(260) AM 2019 98930 A

(800) 1416759

(151) 2018 04 30

(891) 2018 04 30

(731) DENK PHARMA GmbH & Co. KG
Prinzregentenstrasse 79, 81675 München,
Germany

(540)

TADALA-DENK

(591) Black, white

(511)

5 – Pharmaceuticals and chemicals for medical purposes; preparations for health care; dietetic substances adapted for medical use based on vitamins, minerals, trace elements, proteins and carbohydrates; food supplements for medical and non medical purposes.

(260) AM 2019 98931 A

(800) 1416823

(151) 2018 03 22

(891) 2018 03 22

(731) VTB Bank (public joint-stock company)
ul. Bolshaya Morskaya, 29, RU-190000
St.-Petersburg, Russian Federation

(540)



Private Banking

(591) White, black and light brown

(531) 26.11.03; 26.11.06; 26.11.08; 27.05.10;
29.01.12

(511)

36 – Credit bureau services; debt collection agency services; real estate agency services; financial analysis; rental of apartments; rental of real estate; rental of offices [real estate]; lease-purchase financing; savings bank services; accommodation bureau services [apartments]; rent collection; issuance of travelers' checks; issuance of credit cards; issuance of tokens of value; capital investment; insurance information; financial information; clearing, financial; insurance consultancy; financial consultancy; debt advisory services; stock exchange quotations; lending against security; business liquidation services, financial; brokerage, included in this class; financial management; exchanging money; online banking; processing of debit card payments; processing of credit card payments; factoring; real estate affairs; organization of collections; arranging finance for construction projects; antique appraisal; jewelry appraisal; financial evaluation of standing timber; stamp appraisal; real estate appraisal; numismatic appraisal; art appraisal; financial evaluation of wool; financial evaluation [insurance, banking, real estate]; repair costs evaluation [financial appraisal]; electronic funds transfer; surety services; securities brokerage; financial brokerage; real estate brokerage; brokerage of carbon credits; insurance brokerage; pensions brokerage; providing information relating to securities trading; advisory services relating to pensions; providing rebates at participating establishments of others through use of a membership card; loans [financing]; pawnbrokerage; providing financial information via a web site; check verification; investment of funds, including pension funds; charitable fund raising; stocks and bonds brokerage; financial sponsorship; mortgage banking; instalment loans; insurance underwriting; life insurance underwriting; health insurance underwriting; accident insurance underwriting; marine insurance underwriting; fire insurance underwriting; apartment house management; real estate management; pension fund management; financial management of reimbursement payments for others; actuarial services; banking; stock brokerage services; retirement payment services; bail-bonding; trusteeship; provident fund services, including pension funds; financial customs

brokerage services; financial services, including services related to pension funds; financial services, including factoring; financial services of depositories and specialized depositories; mutual funds; financing services; safe deposit services; deposits of valuables; securities deposit services; fiscal valuation; rental of offices for co-working; rental of farms; equity research; investment management; asset and portfolio management; real estate lease surrender services; provident fund services.

(260) AM 2019 98932 A
 (800) 1416835
 (151) 2018 05 29
 (891) 2018 05 29
 (731) VIEGA Holding GmbH & Co. KG
 Viega Platz 1, 57439 Attendorn, Germany
 (540)

prevista

(591) Black, white
 (511)
 6 – Building materials of metal; metal modular building units; mounting racks of metal for fixing of WCs [building materials]; mounting racks of metal for fixing of vanity units [building materials]; mounting racks of metal for fixing of bidets [building materials]; mounting racks of metal for fixing of urinals [building materials]; parts and accessories to the aforementioned goods, as far as included in this class.

11 – Sanitary installations; cisterns; flushing apparatus for urinals; drainage connectors for mounting in mounting racks [as parts of sanitary installations]; parts and accessories to the aforementioned goods, as far as included in this class.

17 – Sound-damping covering materials, not of metal; parts and accessories to the aforementioned goods, as far as included in this class.

19 – Building materials, not of metal; parts and accessories to the aforementioned goods, as far as included in this class.

(260) AM 2019 98934 A
 (800) 1416953
 (151) 2018 02 21
 (891) 2018 02 21
 (731) SASAN GHANBARIKAKAVANDI
 Irn, Kermanshah, Iran (Islamic Republic of)
 (540)

Owner

(591) Black, white
 (531) 27.05.02

(511)
 16 – Stationery.

(260) AM 2019 98935 A
 (800) 1416954
 (151) 2018 06 13
 (891) 2018 06 13
 (731) TAMASU BUTTERFLY EUROPA GMBH
 Kommunikationsstr. 8, 47807 Krefeld,
 Germany
 (540)

Tenergy

(591) Black, white
 (511)
 24 – Towels of textile.

25 – Clothing, in particular t-shirts, sportswear and leisurewear, sports shirts, sports trousers, tracksuits, jogging suits and leotards, sweatbands and headbands, sports socks, sweaters, polo shirts, jersey clothing; footwear, particularly athletic shoes for tennis and table tennis; headgear, in particular caps.

28 – Sports equipment; sports and games apparatus for table tennis and parts therefor.

(260) AM 2019 98936 A
 (800) 1417004
 (151) 2018 04 24
 (891) 2018 04 24
 (731) APPLE INC.
 One Apple Park Way, Cupertino CA 95014,
 USA
 (540)

AIRMAC

(591) Black, white
 (511)
 9 – Computer software for wireless communication between multiple computers and between computers and local and global computer networks.

(260) AM 2019 98937 A
 (800) 1417015
 (151) 2018 05 29
 (891) 2018 05 29
 (731) BIOFARMA
 50 rue Carnot, F-92284 Suresnes Cedex,
 France
 (540)



(591) Dark blue, light blue, white
 (531) 26.04.04; 26.04.05; 26.04.12; 26.04.24;
 26.11.03; 26.11.13; 29.01.12

(511)
 38 – Electronic bulletin services (telecommunication services); provision of telecommunication access to video and audio content and information on the Internet; provision of online discussion forums; provision of access to newsletters and blogs (electronic magazines) on the Internet; provision of access to chat rooms on the Internet; provision of online forums; provision of discussion forums and newsletter services for transmission among users; radio and television broadcasting services provided via the Internet or other communication networks.

41 – Education and training services, organization and conducting of seminars, courses, workshops and conferences.

44 – Medical services; advice relating to health, consulting relating to pharmacy.

(260) AM 2019 98939 A
 (800) 1417058
 (151) 2018 01 12
 (891) 2018 01 12
 (731) ZHEJIANG BOOU SANITARY WARE
 TECHNOLOGY CO., LTD.
 No.888 Haifeng Road, Taizhou City, 318000
 Zhejiang, China

(540)

(591) Black, white
 (531) 27.05.17
 (511)
 11 – Light bulbs; searchlights; lights for vehicles; taps [faucets]; pipes [parts of sanitary installations]; water-pipes for sanitary installations; hot water heating installations; radiators [heating]; pressure water tanks; water conduits installations; pipe line cocks [spigots]; floor drains for sanitary installations.

(260) AM 2019 98940 A
 (800) 1417062
 (151) 2018 07 11
 (891) 2018 07 11
 (731) JHO Intellectual Property Holdings, LLC
 1600 North Park Drive, Weston FL 33326,
 USA

(540)

(591) Black, white
 (511)
 5 – Dietary supplemental drinks; dietary supplements.

32 – Energy drinks; isotonic drinks; sports drinks.

(260) AM 2019 98941 A
 (800) 1417134
 (151) 2018 05 25
 (891) 2018 05 25
 (731) BIOFARMA
 50 rue Carnot, F-92284 SURESNES cedex,
 France

(540)

(591) Black, white
 (531) 28.05
 (511)
 5 – Pharmaceutical products, medical and veterinary preparations; sanitary products for medical purposes; dietetic food and substances for medical or veterinary use, food for babies; food supplements for humans and animals; plasters, materials for dressings; material for dental fillings and dental impressions; disinfectants; products for destroying vermin; fungicides, herbicides.

(260) AM 2019 99098 A
 (800) 1419020
 (151) 2018 05 03
 (891) 2018 05 03
 (731) SELUZ KİMYA KOZMETİK TİCARET VE
 SANAYİ ANONİM ŞİRKETİ
 Selimpaşa Yeni San. Böl. 6043 Sok.
 No:6, Selimpaşa Silivri, İstanbul, Turkey

(540)

(591) Black and green
 (531) 26.04.05; 26.04.24; 27.05.17; 29.01.12
 (511)
 3 – Bleaching and cleaning preparations, detergents other than for use in manufacturing operations and for medical purposes, laundry bleach, fabric softeners for laundry use, stain removers, dishwasher detergents, perfumery, non-medicated cosmetics, fragrances, deodorants for personal use and animals, soaps, dental care preparations, dentifrices, denture polishes, tooth whitening preparations, mouth washes, not for medical purposes, abrasive preparations, emery cloth, sandpaper, pumice stone, abrasive pastes, polishing preparations for leather, vinyl, metal and wood, polishes and creams for leather, vinyl, metal and wood, wax for polishing.

5 – Pharmaceutical and veterinary preparations for medical purposes; chemical preparations for medical and veterinary purposes, chemical reagents for phar-

maceutical and veterinary purposes, medicated cosmetics, dietary supplements for pharmaceutical and veterinary purposes, dietary supplements, nutritional supplements, medical preparations for slimming purposes, food for babies, herbs and herbal beverages adapted for medicinal purposes, dental preparations and articles, teeth filling material, dental impression material, dental adhesives and material for repairing teeth, sanitary preparations for medical use, hygienic pads, hygienic tampons, plasters, materials for dressings, diapers made of paper and textiles for babies, adults and pets, preparations for destroying vermin, herbicides, fungicides, preparations for destroying rodents, deodorants, other than for human beings or for animals, air purifying preparations, air deodorising preparations, disinfectants; antiseptics, detergents for medical purposes, medicated soaps, disinfectant soaps, antibacterial hand lotions.

35 – Advertising, marketing and public relations, organization of exhibitions and trade fairs for commercial or advertising purposes, design of advertising material, provision of an online marketplace for buyers and sellers of goods and services, office functions, secretarial services, arranging newspaper subscriptions for others, compilation of statistics, rental of office machines, systemization of information into computer databases, telephone answering for unavailable subscribers, business management, business administration and business consultancy, accounting, commercial consultancy services, personnel recruitment, personnel placement, employment agencies, import-export agencies, temporary personnel placement services, auctioneering, the bringing together, for the benefit of others, of bleaching and cleaning preparations, detergents other than for use in manufacturing operations and for medical purposes, laundry bleach, fabric softeners for laundry use, stain removers, dishwasher detergents, perfumery, non-medicated cosmetics, fragrances, deodorants for personal use and animals, soaps, dental care preparations, dentifrices, denture polishes, tooth whitening preparations, mouth washes, not for medical purposes, abrasive preparations, emery cloth, sandpaper, pumice stone, abrasive pastes, polishing preparations for leather, vinyl, metal and wood, polishes and creams for leather, vinyl, metal and wood, wax for polishing, pharmaceutical and veterinary preparations for medical purposes, chemical preparations for medical and veterinary purposes, chemical reagents for pharmaceutical and veterinary purposes, medicated cosmetics, dietary supplements for pharmaceutical and veterinary purposes, dietary supplements, nutritional supplements, medical preparations for slimming purposes, food for babies, herbs and herbal beverages adapted for medicinal purposes, dental preparations and articles, teeth filling material, dental impression material, dental adhesives and material for repairing teeth, sanitary preparations for medical use, hygienic pads, hygienic tam-

pons, plasters, materials for dressings, diapers made of paper and textiles for babies, adults and pets, preparations for destroying vermin, herbicides, fungicides, preparations for destroying rodents, deodorants, other than for human beings or for animals, air purifying preparations, air deodorising preparations, disinfectants, antiseptics, detergents for medical purposes, medicated soaps, disinfectant soaps, antibacterial hand lotions, enabling customers to conveniently view and purchase those goods, such services may be provided by retail stores, wholesale outlets, by means of electronic media or through mail order catalogues.

(260) AM 2019 99217 A

(800) 1420450

(151) 2018 01 23

(891) 2018 01 23

(731) Товариство з обмеженою відповідальністю "DZHOIN AP!"

vul. Kharkivske shose, bud. 201-203, lit. 2 A, m., Kyiv 02121, Ukraine

(540)

JoinUP! to travel.

(591) Black, white

(511)

39 – Bus transport; car transport; barge transport; freight brokerage; towing; freight [shipping of goods]; arranging of cruises; arranging of transportation for travel tours; water supplying; delivery of newspapers; flower delivery; message delivery; parcel delivery; delivery of goods; delivery of goods by mail order; providing driving directions for travel purposes; stevedoring; railway transport; booking of seats for travel; launching of satellites for others; guarded transport of valuables; storage; storage of goods; boat storage; collection of recyclable goods [transport]; refloating of ships; traffic information; storage information; transportation information; operating canal locks; lighterage services; transportation logistics; piloting; marine transport; wrapping of goods; garage rental; parking place rental; rental of warehouses; packaging of goods; car parking; passenger transport; transport; ambulance transport; armored-car transport; hauling; cash replenishment of automated teller machines; carting; transport and storage of waste; transporting furniture; transport of travellers; pleasure boat transport; boat transport; portorage; air transport; travel reservation; transport reservation; ferry-boat transport; transport brokerage; vehicle breakdown towing services; car sharing services; removal services; bottling services; ice-breaking; courier services [messages or merchandise]; shipbrokerage; taxi transport; chauffeur services; salvaging; rental of aircraft engines; motor coach rental; car rental; rental of vehicle roof racks; railway truck rental; rental of diving bells; rental of diving suits; rental of motor racing cars; rental of

electric wine cellars; refrigerator rental; horse rental; rental of storage containers; rental of wheelchairs; aircraft rental; rental of freezers; rental of navigational systems; railway coach rental; rental of tractors; vehicle rental; boat rental; river transport; unloading cargo; water distribution; electricity distribution; distribution of energy; rescue operations [transport]; underwater salvage; salvage of ships; escorting of travellers; tram transport; freight forwarding; transport services for sightseeing tours; transport by pipeline; gift wrapping; physical storage of electronically stored data or documents; franking of mail; freighting.

43 – Accommodation bureau services [hotels, boarding houses]; retirement home services; hotel services; providing campground facilities; snack-bar services; boarding house bookings; canteen services; café services; cafeteria services; food and drink catering; motel services; rental of meeting rooms; rental of temporary accommodation; boarding house services; boarding for animals; bar services; holiday camp services [lodging]; rental of drinking water dispensers; rental of tents; rental of cooking apparatus; rental of lighting apparatus; rental of transportable buildings; rental of chairs, tables, table linen, glassware; hotel reservations; temporary accommodation reservations; restaurant services; self-service restaurant services; food sculpting; tourist home services; day-nursery [crèche] services.

(260) AM 2019 99536 A

(800) 1423465

(151) 2018 08 03

(891) 2018 08 03

(731) Obschestvo s ogranitchennoi otvetstvennostyuu "AURICA"
ul. Razanskaya, d. 4, RU-300026 g. Tula,
Russian Federation

(540)

Helikson

Хеликсон

(591) Black, white

(531) 28.05

(511)

10 – Surgical, medical, dental and veterinary apparatus and instruments; artificial limbs; artificial eyes; orthopedic articles; suture materials; blood testing apparatus; anaesthetic apparatus; galvanic therapeutic appliances; apparatus for artificial respiration; apparatus for the treatment of deafness; testing apparatus for medical purposes; physical exercise apparatus for medical purposes; body rehabilitation apparatus for medical purposes; dental apparatus and instruments; surgical apparatus and instruments; resuscita-

tion apparatus; dental apparatus, electric; physiotherapy apparatus; hot air therapeutic apparatus; diagnostic apparatus for medical purposes; traction apparatus for medical purposes; radiotherapy apparatus; microdermabrasion apparatus; fumigation apparatus for medical purposes; apparatus and installations for the production of X-rays, for medical purposes; radiological apparatus for medical purposes; X-ray apparatus for medical purposes; hearing aids; programmable hearing aids; digital hearing aids; electric hearing aids; electronic hearing aids; trusses; maternity belts; bandages, elastic; cupping glasses; dental burs; air cushions for medical purposes; hot air vibrators for medical purposes; vibromassage apparatus; gastroscopes; hemocytometers; surgical sponges; defibrillators; containers especially made for medical waste; clips, surgical; mirrors for dentists; mirrors for surgeons; probes for medical purposes; urethral probes; acupuncture needles; suture needles; needles for medical purposes; surgical implants comprised of artificial materials; inhalers; injectors for medical purposes; incubators for medical purposes; incubators for babies; obstetric apparatus; obstetric apparatus for cattle; electric acupuncture instruments; surgical cutlery; surgical instruments; insufflators; cannulae; droppers for medical purposes; dropper bottles for medical purposes; heart pacemakers; catheters; catgut; enema apparatus for medical purposes; artificial skin for surgical purposes; compressors [surgical]; thermo-electric compresses [surgery]; abdominal corsets; corsets for medical purposes; lasers for medical purposes; lamps for medical purposes; quartz lamps for medical purposes; ultraviolet ray lamps for medical purposes; lancets; lenses [intraocular prostheses] for surgical implantation; artificial lenses for implantation in the eye; anaesthetic masks; douche bags; breast pumps; urinals [vessels]; knee bandages, orthopaedic; pumps for medical purposes; thread, surgical; knives for surgical purposes; scissors for surgery; boots for medical purposes; orthopaedic footwear; clothing especially for operating rooms; blankets, electric, for medical purposes; supports for flat feet; ophthalmometers; ophthalmoscopes; slings [supporting bandages]; pessaries; saws for surgical purposes; ear picks; spittoons for medical purposes; plaster bandages for orthopaedic purposes; supportive bandages; suspensory bandages; abdominal belts; hypogastric belts; orthopaedic belts; umbilical belts; aerosol dispensers for medical purposes; sphygmomanometers; pulse meters; urological apparatus and instruments; orthodontic appliances; brushes for cleaning body cavities; appliances for washing body cavities; corn knives; hair prostheses; artificial breasts; artificial jaws; ice bags for medical purposes; surgical bougies; X-ray photographs for medical purposes; respirators for artificial respiration; ear trumpets; scalpels; tongue scrapers; receptacles for applying medicines; spirometers [medical apparatus]; vaginal syringes; hea-

ring protectors; stents; stethoscopes; instrument cases for use by doctors; arch supports for footwear; ear plugs [tear protection devices]; thermal packs for first aid purposes; thermometers for medical purposes; trocars; drainage tubes for medical purposes; X-ray tubes for medical purposes; radium tubes for medical purposes; balling guns; protection devices against X-rays, for medical purposes; filters for ultraviolet rays, for medical purposes; cases fitted for medical instruments; elastic stockings for surgical purposes; stockings for varices; splints, surgical; syringes for injections; syringes for medical purposes; hypodermic syringes; uterine syringes; urethral syringes; forceps; castrating pincers; radiology screens for medical purposes; electrodes for medical use; electrocardiographs; all the aforementioned goods not for use in the field of dialysis or blood purification.

INTERNATIONAL TRADEMARKS PROTECTED IN GEORGIA

(260) AM 2019 92288 A
(800) 1146129
(151) 2012 12 14
(181) 2022 12 14
(891) 2017 04 24
(511) 44

(260) AM 2019 95955 A
(800) 1383759
(151) 2017 10 18
(181) 2027 10 18
(891) 2017 10 18
(511) 07, 13, 37

(260) AM 2019 93285 A
(800) 948459
(151) 2007 09 17
(181) 2027 09 17
(891) 2017 04 05
(511) 36

(260) AM 2019 96210 A
(800) 1385769
(151) 2017 12 01
(181) 2027 12 01
(891) 2017 12 01
(511) 09

(260) AM 2019 93287 A
(800) 948460
(151) 2007 09 17
(181) 2027 09 17
(891) 2017 04 05
(511) 36

(260) AM 2019 96825 A
(800) 1391413
(151) 2017 10 31
(181) 2027 10 31
(891) 2017 10 31
(511) 09, 42

(260) AM 2019 93362 A
(800) 960497
(151) 2007 09 17
(181) 2027 09 17
(891) 2017 04 05
(511) 09, 38, 41

(260) AM 2019 96826 A
(800) 1391949
(151) 2017 11 10
(181) 2027 11 10
(891) 2017 11 10
(511) 02

(260) AM 2019 93363 A
(800) 960498
(151) 2007 09 17
(181) 2027 09 17
(891) 2017 04 05
(511) 09, 36, 38, 41

(260) AM 2019 96830 A
(800) 1392021
(151) 2017 11 23
(181) 2027 11 23
(891) 2017 11 23
(511) 11

(260) AM 2019 95761 A
(800) 1380070
(151) 2017 05 12
(181) 2027 05 12
(891) 2017 05 12
(511) 01, 02, 03, 17, 35, 41

(260) AM 2019 96930 A
(800) 1393039
(151) 2017 12 04
(181) 2027 12 04
(891) 2017 12 04
(511) 09

(260) AM 2019 95768 A
(800) 1380157
(151) 2027 08 07
(181) 2027 08 07
(891) 2018 08 07
(511) 06, 11, 19, 20

(260) AM 2019 96944 A
(800) 1393116
(151) 2017 11 28
(181) 2027 11 28
(891) 2017 11 28
(511) 36

(260) AM 2019 96945 A
(800) 1393129
(151) 2017 12 22
(181) 2027 12 22
(891) 2017 12 22
(511) 29, 30

(260) AM 2019 96948 A
(800) 1393289
(151) 2017 11 30
(181) 2027 11 30
(891) 2017 11 30
(511) 01, 09, 35

(260) AM 2019 96964 A
(800) 1393502
(151) 2017 12 07
(181) 2027 12 07
(891) 2017 12 07
(511) 03, 05

(260) AM 2019 96966 A
(800) 1393503
(151) 2017 12 07
(181) 2027 12 07
(891) 2017 12 07
(511) 03, 05

(260) AM 2019 96967 A
(800) 1393511
(151) 2017 09 18
(181) 2027 09 18
(891) 2017 09 18
(511) 03, 08, 18, 25

(260) AM 2019 96972 A
(800) 1393658
(151) 2017 10 30
(181) 2027 10 30
(891) 2017 10 30
(511) 18, 25

(260) AM 2019 96983 A
(800) 1393674
(151) 2017 12 07
(181) 2027 12 07
(891) 2017 12 07
(511) 35

(260) AM 2019 96987 A
(800) 1393700
(151) 2017 12 22
(181) 2027 12 22

(891) 2017 12 22
(511) 03

(260) AM 2019 97064 A
(800) 1394105
(151) 2017 12 08
(181) 2027 12 08
(891) 2017 12 08
(511) 05

(260) AM 2019 97093 A
(800) 1394896
(151) 2018 01 15
(181) 2028 01 15
(891) 2018 01 15
(511) 29, 35

(260) AM 2019 97094 A
(800) 1394968
(151) 2017 11 27
(181) 2027 11 27
(891) 2017 11 27
(511) 17

(260) AM 2019 97134 A
(800) 1395653
(151) 2017 12 08
(181) 2027 12 08
(891) 2017 12 08
(511) 12

(260) AM 2019 97153 A
(800) 1242989
(151) 2014 07 18
(181) 2024 07 18
(891) 2018 02 09
(511) 03, 05, 35

(260) AM 2019 97234 A
(800) 1395701
(151) 2017 12 12
(181) 2027 12 12
(891) 2017 12 12
(511) 09, 22, 24, 25

(260) AM 2019 97235 A
(800) 1395711
(151) 2018 02 06
(181) 2028 02 06
(891) 2018 02 06
(511) 30, 43

(260) AM 2019 97236 A
(800) 1395755
(151) 2017 10 10
(181) 2027 10 10
(891) 2017 10 10
(511) 01, 04, 35, 39

(260) AM 2019 97241 A
(800) 1395883
(151) 2018 01 05
(181) 2028 01 05
(891) 2018 01 05
(511) 03

(260) AM 2019 97279 A
(800) 1337122
(151) 2016 07 21
(181) 2026 07 21
(891) 2018 02 04
(511) 03, 05

(260) AM 2019 97280 A
(800) 1353045
(151) 2017 05 02
(181) 2027 05 02
(891) 2018 03 19
(511) 01

(260) AM 2019 97325 A
(800) 1397069
(151) 2017 12 26
(181) 2027 12 26
(891) 2017 12 26
(511) 34

(260) AM 2019 97327 A
(800) 1397087
(151) 2018 01 15
(181) 2028 01 15
(891) 2018 01 15
(511) 29, 35

(260) AM 2019 97328 A
(800) 1397088
(151) 2018 01 15
(181) 2028 01 15
(891) 2018 01 15
(511) 29, 35

(260) AM 2019 97329 A
(800) 1397089
(151) 2018 01 15
(181) 2028 01 15

(891) 2018 01 15
(511) 29, 35

(260) AM 2019 97330 A
(800) 1397090
(151) 2018 01 15
(181) 2028 01 15
(891) 2018 01 15
(511) 29, 35

(260) AM 2019 97331 A
(800) 1397091
(151) 2018 01 25
(181) 2028 01 25
(891) 2018 01 25
(511) 29, 35

(260) AM 2019 97332 A
(800) 1397124
(151) 2018 01 24
(181) 2028 01 24
(891) 2018 01 24
(511) 01, 05

(260) AM 2019 97334 A
(800) 1397152
(151) 2018 01 22
(181) 2028 01 22
(891) 2018 01 22
(511) 41, 43, 45

(260) AM 2019 97336 A
(800) 1397187
(151) 2017 12 12
(181) 2027 12 12
(891) 2017 12 12
(511) 09, 22, 24, 25

(260) AM 2019 97338 A
(800) 1397314
(151) 2017 11 20
(181) 2027 11 20
(891) 2017 11 20
(511) 05

(260) AM 2019 97339 A
(800) 1397322
(151) 2017 12 27
(181) 2027 12 27
(891) 2017 12 27
(511) 43

(260) AM 2019 97340 A
(800) 1397323
(151) 2017 10 30
(181) 2027 10 30
(891) 2017 10 30
(511) 09

(260) AM 2019 97342 A
(800) 1397375
(151) 2017 12 14
(181) 2027 12 14
(891) 2017 12 14
(511) 03

(260) AM 2019 97343 A
(800) 1397388
(151) 2017 08 16
(181) 2027 08 16
(891) 2017 08 16
(511) 09, 11, 35, 42

(260) AM 2019 97493 A
(800) 1397816
(151) 2018 01 04
(181) 2028 01 04
(891) 2018 01 04
(511) 16

(260) AM 2019 97498 A
(800) 1397950
(151) 2018 01 10
(181) 2028 01 10
(891) 2018 01 10
(511) 03, 05

(260) AM 2019 97514 A
(800) 1280370
(151) 2015 10 19
(181) 2025 10 19
(891) 2016 04 10
(511) 29, 30, 31, 32, 33

(260) AM 2019 97557 A
(800) 769867
(151) 2001 10 10
(181) 2021 10 10
(891) 2018 03 15
(511) 39

(260) AM 2019 97558 A
(800) 927721
(151) 2007 03 21
(181) 2027 03 21

(891) 2018 03 15
(511) 39

(260) AM 2019 97560 A
(800) 963148
(151) 2008 03 27
(181) 2028 03 27
(891) 2018 03 28
(511) 07, 09

(260) AM 2019 97562 A
(800) 969332
(151) 2008 06 20
(181) 2018 06 20
(891) 2018 03 30
(511) 29

(260) AM 2019 97563 A
(800) 1091089
(151) 2011 08 08
(181) 2021 08 08
(891) 2018 01 25
(511) 35, 37, 42

(260) AM 2019 97564 A
(800) 1207422
(151) 2013 11 12
(181) 2023 11 12
(891) 2018 03 19
(511) 01

(260) AM 2019 97565 A
(800) 1228070
(151) 2014 11 20
(181) 2024 11 20
(891) 2017 12 04
(511) 05

(260) AM 2019 97566 A
(800) 1239754
(151) 2014 08 11
(181) 2024 08 11
(891) 2018 03 19
(511) 03, 05

(260) AM 2019 97567 A
(800) 1287195
(151) 2015 12 29
(181) 2025 12 29
(891) 2018 03 15
(511) 05

(260) AM 2019 97572 A
(800) 1354128
(151) 2017 02 13
(181) 2027 02 13
(891) 2018 01 09
(511) 43

(260) AM 2019 97573 A
(800) 1355132
(151) 2017 03 10
(181) 2027 03 10
(891) 2018 02 07
(511) 03

(260) AM 2019 97664 A
(800) 1401480
(151) 2018 03 19
(181) 2028 03 19
(891) 2018 03 19
(511) 29

(260) AM 2019 97666 A
(800) 1401498
(151) 2018 01 31
(181) 2028 01 31
(891) 2018 01 31
(511) 30

(260) AM 2019 97668 A
(800) 881436
(151) 2005 10 05
(181) 2025 10 05
(891) 2018 03 26
(511) 11

APPELLATION OF ORIGIN (AOs)

AMENDMENTS TO THE REGISTRATION OF APPELLATION OF ORIGIN OF GOOD

KHVANCHKARA

(Reg. No.1; Reg. Data: 14.07.2005)

"In accordance with the Order No.4678/06 of 03.05.2019 of the Head of the Department of Trademarks, Geographical Indications and Design of the LEPL National Intellectual Property Centre of Georgia – SAKPATENTI was made an Amendment to the Production Specifications of the PDO Wine "KHVANCHKARA" registered at National Intellectual Property Centre of Georgia "SAKPATENTI".

The above-mentioned information according to the Legislation of Georgia "On Appellations of Origin and Geographical Indications of Goods" shall be published in the Official Bulletin of Industrial Property of Georgia, in central and local newspapers. The remarks and additional information submitted to "SAKPATENTI" within three months from publication of the materials shall be sent for study to the Ministry of Agriculture of Georgia. If no information is submitted to "SAKPATENTI" within three months, the published data on the amendments of production specifications of the PDO Wine "KHVANCHKARA" shall be reflected in the State Register of Appellations of Origin and Geographical Indications.

Paragraphes 3, 4 and 7 of Specifications shall be Amended and be Formulated as Following:

3. TYPE, COLOUR, AND MAIN REQUIREMENTS

"KHVANCHKARA" – red, naturally demi-doux wine.

"KHVANCHKARA" shall be meet the following requirements:

- Colour – from light to dark ruby;
- Taste and Aroma – flawless, microbiologically healthy, harmonized, fine, velvet, pleasantly demi-doux wine, characterized with aroma and flavor specified by vine variety and local environmental conditions;
- Volumetric spirit content – no less than 11 %;
- Concentration of finished extract mass – no less than 22 g/l;
- Sugar content – 30-45 g/l;
- Titrated/ Volatile acidity – no less than 5 g/l;
- Other characteristics shall meet requirements provided by the Legislation of Georgia.

4. SPECIFIC ZONE AVAILABLE AREAS:

The micro-zone Khvanchkara is located in Ambrolauri – Administrative Region of Racha, situated on the southern slopes of Lechkhumi Ridge, on the right bank of River Rioni, and the northern slope of Racha Ridge, on the left bank of River Rioni. Said area is located between the coordinates: the northern latitude 42°30' and the eastern longitude 43°00'. The micro-zone Khvanchkara includes the South-East part of Municipality Lechkhumi, as well.

The micro-zone Khvanchkara includes the following villages: Khvanchkara, Tsesi, Kvatskhuti, Sadmeli, Ghviara, Bostana, Didi Chorjo, Patara Chorjo, Meore Tola, Pirveli Tola, Chrebalo, Chkvishi, Zhoshkha, Kvishari, Ghvardia, Bareuli, Ghadishi, Baji, Bugeuli, Saketsia, Jvarisa, Itsa, Krikhi, Akhalsopeli, Gori, Khimshi, Abanoeti, Dzirageuli and Tsageri Region villages: Alpana and Orbeli, as well.

7. GRAPE MATURITY, VINTAGE, TRANSPORTATION:

- The Wine "KHVANCHKARA" is produced with only ripe grapes. Sugar content in the grapes shall be no less than 24%.
- Grapes transportation is permitted only with wooden or plastic boxes, which capacity shall be no more than 40 kg.
- Usage of polyethylene packages and/or bags for grape transportation is prohibited.
- Grape shall be maximally protected from possible pollution at the transportation.

Article 11 of Specification shall be excluded.

OFFICIAL NOTIFICATION

INVENTIONS

RENEWAL OF PATENTS

(21) AP 2010 11815

(11) P 2013 5759 B

(73) Anzor Getsadze;

Leila Getsadze

(54) **VEGETABLE COLLECTION TREATING BRONCHITIS (ACUTE, HRONIC) AND BRONCHIAL ASTHMA**

DATE OF CANCELLATION OF PATENT: 2018 05 28

DATE OF RESTORATION OF PATENT: 2019 05 10

(21) AP 2016 14233

(11) P 2017 6750 B

(73) LEPL "Raphiel Dvali Machine and Mechanic Institute"

(54) **METHOD AND DEVICE FOR EXTRACTION BIOLOGICALLY ACTIVE SUBSTANCES FROM PLANT RAW MATERIAL WITH USAGE OF NON TRADITIONAL TECHNOLOGIES**

DATE OF CANCELLATION OF PATENT: 2018 08 02

DATE OF RESTORATION OF PATENT: 2019 05 10

ABOLITION OF PATENTS WITH THE RIGHT TO RESTORE

(21) AP 2006 10386

(11) P 2011 5157 B

(73) Intel Corporation

(54) **HYBRID ORTHOGONAL FREQUENCY DIVISION MULTIPLE ACCESS SYSTEM AND METHOD**

DATE OF CANCELLATION OF PATENT: 2019 04 20

PATENT RESTORATION IS AVAILABLE: 2020 04 20

(21) AP 2015 13790

(11) P 2016 6596 B

(73) LEPL "Agricultural Research Research Center"

(54) **TEA BUSH CUTTING-BREAKING AGREGATE**

DATE OF CANCELLATION OF PATENT: 2019 04 14

PATENT RESTORATION IS AVAILABLE: 2020 04 14

(21) AP 2015 13796

(11) P 2017 6682 B

(73) Garegin Zakharov;

Zurab Aslamazashvili;

Giorgi Tavadze;

Giorgi Oniashvili;

Archil Chirakadze;

Avtandil Khvadagiani;

Giorgi Mikaberidze

(54) **METHOD AND EQUIPMENT FOR RECEIVING CAST ALLOYS**

DATE OF CANCELLATION OF PATENT: 2019 04 15

PATENT RESTORATION IS AVAILABLE: 2020 04 15

(21) AP 2002 7214

(11) P 2006 3742 B

(73) Intel Corporation

(54) **DYNAMIC CHANNEL QUALITY MEASUREMENT PROCEDURE FOR ADAPTIVE MODULATION AND CODING TECHNIQUES**

DATE OF CANCELLATION OF PATENT: 2019 04 15

PATENT RESTORATION IS AVAILABLE: 2020 04 15

(21) AP 2003 8506

(11) P 2007 4148 B

(73) Bristol-Myers Squibb Company

(54) **PYRROLO-TRIAZINE ANILINE COMPOUNDS USEFUL AS KINASE INHIBITORS**

DATE OF CANCELLATION OF PATENT: 2019 04 15

PATENT RESTORATION IS AVAILABLE: 2020 04 15

(21) AP 2002 8717

(11) P 2008 4324 B

(73) Intel Corporation

(54) **BASE STATION AND USER EQUIPMENT FOR DYNAMIC CHANNEL QUALITY MEASUREMENT PROCEDURE FOR ADAPTIVE MODULATION AND CODING TECHNIQUES**

DATE OF CANCELLATION OF PATENT: 2019 04 15

PATENT RESTORATION IS AVAILABLE: 2020 04 15

(21) AP 2005 8755

(11) P 2006 3843 B

(73) Gugu Kiknavelidze

(54) **PISTON PUSH-PULL INTERNAL COMBUSTION ENGINE**

DATE OF CANCELLATION OF PATENT: 2019 04 21

PATENT RESTORATION IS AVAILABLE: 2020 04 21

(21) AP 2002 9929

(11) P 2012 5528 B

(73) Intel Corporation

(54) **DYNAMIC CHANNEL QUALITY MEASUREMENT PROCEDURE FOR ADAPTIVE MODULATION AND CODING TECHNIQUES**

DATE OF CANCELLATION OF PATENT: 2019 04 15

PATENT RESTORATION IS AVAILABLE: 2020 04 15

EXPIRATION OF TERM OF RESTORATION OF PATENTS

(21) AP 2006 10384

(11) P 2012 5474 B

(73) Interdigital Corporation

(54) **WIRELESS COMMUNICATION METHOD AND WLAN FOR SIGNALING DEFERRAL
MANAGEMENT MESSAGES**

DATE OF CANCELLATION OF PATENT: 2018 04 13

THE TERM OF RESTORATION OF PATENT VALIDITY HAS EXPIRED: 2019 04 13

(21) AP 2010 11766

(11) P 2014 6023 B

(73) Merab Ruadze

(54) **ELECTROMAGNETIC ACTUATOR**

DATE OF CANCELLATION OF PATENT: 2018 04 22

THE TERM OF RESTORATION OF PATENT VALIDITY HAS EXPIRED: 2019 04 22

(21) AP 2014 13979

(11) P 2017 6675 B

(73) Pfizer Inc.

(54) **IMIDAZO-TRIAZINE DERIVATIVES AS PDE10 INHIBITORS**

DATE OF CANCELLATION OF PATENT: 2018 04 23

THE TERM OF RESTORATION OF PATENT VALIDITY HAS EXPIRED: 2019 04 23

(21) AP 2001 6688

(11) P 2006 3798 B

(73) Les Laboratoires Servier

(54) **METHOD FOR SYNTHESIS OF N-[(S)-1-CARBOXYBUTYL]-(S)-ALANINE ESTERS
AND USE IN SYNTHESIS OF PERINDOPRIL**

DATE OF CANCELLATION OF PATENT: 2018 04 10

THE TERM OF RESTORATION OF PATENT VALIDITY HAS EXPIRED: 2019 04 10

(21) AP 2003 8402

(11) P 2006 3822 B

(73) Aziende Chimiche Riunite Angelini Francesco A.C.R.A.F. S.p.A.

(54) **DICLOFENAC-BASED COMPOSITION FOR THE TOPICAL TREATMENT OF
OROPHARYNGEAL CAVITY DISORDERS**

DATE OF CANCELLATION OF PATENT: 2018 04 16

THE TERM OF RESTORATION OF PATENT VALIDITY HAS EXPIRED: 2019 04 16

(21) AP 2004 9111

(11) P 2007 4183 B

(73) Aziende Chimiche Riunite Angelini Francesco A.C.R.A.F. S.p.A.

(54) **INDAZOLE HAVING ANALGESIC ACTIVITY**

DATE OF CANCELLATION OF PATENT: 2018 04 23

THE TERM OF RESTORATION OF PATENT VALIDITY HAS EXPIRED: 2019 04 23

UTILITY MODELS**RENEWAL OF PATENTS**

(21) AU 2010 11779

(11) U 2012 1697 Y

(73) Nino Urushadze

(54) METHOD OF MANUFACTURE OF MEDICAL AND MEDICAL-COSMETIC APPLICATIONS WITH THE USE OF BENTONITIC (AQUAMARINE) CLAY EXTRACTED IN ASKANA VILLAGE OF OZURGETI AREA

DATE OF CANCELLATION OF PATENT: 2018 04 30

DATE OF RESTORATION OF PATENT: 2019 05 10

(21) AU 2013 12969

(11) U 2014 1812 Y

(73) Eter Kemertelidze;

Meri Alania

(54) METHOD FOR OBTAINING ROBININ

DATE OF CANCELLATION OF PATENT: 2019 01 17

DATE OF RESTORATION OF PATENT: 2019 05 10

(21) AU 2015 13988

(11) U 2018 1977 Y

(73) Temur Chakhunashvili;

Teimuraz Rokva;

Zhiuli Keadze;

Merab Dadunashvili;

Zinaida Vatsadze

(54) ANODE FOR RECEIVING ELECTROLYTIC MANGANESE DIOXIDE

DATE OF CANCELLATION OF PATENT: 2018 11 09

DATE OF RESTORATION OF PATENT: 2019 05 10

(21) AU 2015 13989

(11) U 2018 1978 Y

(73) Temur Chakhunashvili;

Teimuraz Rokva;

Zhiuli Keadze;

Merab Dadunashvili;

Zinaida Vatsadze

(54) CATHODE FOR RECEIVING ELECTROLYTIC MANGANESE DIOXIDE

DATE OF CANCELLATION OF PATENT: 2018 11 09

DATE OF RESTORATION OF PATENT: 2019 05 10

(21) AU 2016 14069

(11) U 2017 1928 Y

(73) LEPL Institute "OPTICA"

(54) HOLOGRAPHIC COLLIMATOR TARGET

DATE OF CANCELLATION OF PATENT: 2019 02 25

DATE OF RESTORATION OF PATENT: 2019 05 10

(21) AU 2016 14085
(11) U 2017 1926 Y
(73) Guram Makharadze;
Arkadi Rikrikadze
(54) **DOUBLE-WINDING THREE-PHASE ELECTRIC MACHINE**
DATE OF CANCELLATION OF PATENT: 2019 03 09
DATE OF RESTORATION OF PATENT: 2019 05 10

EXPIRATION OF TERM OF RESTORATION OF PATENTS

(21) AU 2013 13058
(11) U 2015 1870 Y
(73) Zhora Gabrichidze;
Nani Miqava;
Nata Gogokhia
(54) **METHOD OF "QVEVRI" MECHANICAL PRODUCTION**
DATE OF CANCELLATION OF PATENT: 2018 04 16
THE TERM OF RESTORATION OF PATENT VALIDITY HAS EXPIRED: 2019 04 16

(21) AU 2015 13799
(11) U 2016 1897 Y
(73) Natela Ananiashvili
(54) **ELECTROLYTE FOR NICKELIZING ALUMINUM AND ALLOYS THEREOF**
DATE OF CANCELLATION OF PATENT: 2018 04 16
THE TERM OF RESTORATION OF PATENT VALIDITY HAS EXPIRED: 2019 04 16

(21) AU 2016 14121
(11) U 2017 1937 Y
(73) Shalva Bitchiashvili
(54) **METHOD FOR PLANT PHYSIOLOGICAL CONDITION DETERMINATION**
DATE OF CANCELLATION OF PATENT: 2018 04 19
THE TERM OF RESTORATION OF PATENT VALIDITY HAS EXPIRED: 2019 04 19

TRANSFER OF RIGHTS

(21) AU 2013 12969
(11) U 2014 1812 Y
(54) **METHOD FOR OBTAINING ROBININ**
NEW OWNER AND ADDRESSES: Eter Kemertelidze (GE)
Pekini Str. 33a, ap. 40, 0160, Tbilisi (GE)
Meri Alania (GE)
Nutsbidze Str., Build. 77b, ap. 36, 0177, Tbilisi (GE)
LAST OWNER AND ADDRESSES: Eter Kemertelidze (GE)
Pekini Str. 33a, ap. 40, 0160, Tbilisi (GE)
Meri Alania (GE)
Dolidze Str. 20, ap. 20, 0171, Tbilisi, Georgia (GE)
DATE OF REGISTRY: 19 04 2019

DESIGNS

CANCELLATION OF REGISTRATIONS

(11) D 2013 564 S

(73) LTD "KRASNAYA GORKA" (RU)

Ul. Tsentralnaya, Dom 70A, 141014, Mitishchi, Moskovskaya Oblast, Russian Federation (RU)

(54) **BEVERAGE BOTTLE WITH LID**

(18) 2018 05 20

(58) 2019 04 18

(11) D 2013 560 S

(73) Zurab Bakradze (GE)

Zh. Shartava Str. 38, ap. 25, 0160, Tbilisi, Georgia (GE)

(54) **GRAPHIC SYMBOL**

(18) 2018 08 22

(58) 2019 04 18

TRADEMARKS**RENEWAL OF REGISTRATIONS**

(111) M 1999 12328 R2
(156) 1999 06 08
(186) 2029 06 08
(732) Alchawaf Group for Industry & Trade Limited
Liability Co. (Al Afrah Detergents).
Hama, P.O. Box 334, Syrian Arab Republic

(111) M 1999 11799 R2
(156) 1999 04 19
(186) 2029 04 19
(732) LTD "KROKO"
Rustavelis Gamz. 5, 0108, Tbilisi, Georgia

(111) M 1999 11880 R2
(156) 1999 04 20
(186) 2029 04 20
(732) COSE DI LANA S.P.A.
Zona Industriale S. Fiora, 52037 Sansepolcro,
Arezzo, Italy

(111) M 1999 12273 R2
(156) 1999 05 14
(186) 2029 05 14
(732) PEDROLLO S.P.A.
via Enrico Fermi, 7, 37047 San Bonifacio
(Verona), Italy

(111) M 1999 12358 R2
(156) 1999 06 15
(186) 2029 06 15
(732) ELI LILLY AND COMPANY
Lilly Corporate Center, Indianapolis, Indiana,
USA

(111) M 1999 12360 R2
(156) 1999 06 15
(186) 2029 06 15
(732) ELI LILLY AND COMPANY
Lilly Corporate Center, Indianapolis, Indiana,
USA

(111) M 1999 12364 R2
(156) 1999 06 15
(186) 2029 06 15
(732) ELI LILLY AND COMPANY
Lilly Corporate Center, Indianapolis, Indiana,
USA

(111) M 1999 12367 R2
(156) 1999 06 15
(186) 2029 06 15
(732) ELI LILLY AND COMPANY
Lilly Corporate Center, Indianapolis, Indiana,
USA

(111) M 2008 18518 R1
(156) 2008 06 16
(186) 2028 06 16
(732) NIAZ DIASAMIDZE
Faliashvilis 2.33a, 0179, Tbilisi, Georgia
ZAZA KORINTELI
Nutsubidzis IV Plato, Korp. 21, b.49, 0183,
Tbilisi, Georgia
GIORGI BARAMIDZE
Paliashvilis q. 50, b. 12, 0179, Tbilisi, Georgia
MARIA LANEVSKAYA
T. Tabidzis q.10, 0179, Tbilisi, Georgia
NIKA ANJAFARIDZE
Kostavas q. 58, b. 3, 0179, Tbilisi, Georgia

(111) M 2009 19214 R1
(156) 2009 04 21
(186) 2029 04 21
(732) MARRIOTT WORLDWIDE
CORPORATION
10400 Fernvud Roudi, Betezda, Merilendi
20817, USA

(111) M 2009 19473 R1
(156) 2009 06 29
(186) 2029 06 29
(732) HYUNDAI MOTOR COMPANY
231, Yangjae-Dong, Seocho-Gu, Seoul,
Republic of Korea

(111) M 2009 19474 R1
(156) 2009 06 29
(186) 2029 06 29
(732) HYUNDAI MOTOR COMPANY
231, Yangjae-Dong, Seocho-Gu, Seoul
Republic of Korea

(111) M 2009 19475 R1
(156) 2009 06 29
(186) 2029 06 29
(732) HYUNDAI MOTOR COMPANY

231, Yangjae-Dong, Seocho-Gu, Seoul,
Republic of Korea

(111) M 2009 19432 R1
(156) 2009 06 16
(186) 2029 06 16
(732) WYETH LLC

235 East 42 nd Street, New York, NY 10017,
USA

(111) M 2009 19918 R1
(156) 2009 11 02
(186) 2029 11 02

(732) HANGZHOU HIKVISION DIGITAL
TECHNOLOGY CO., LTD
No.555, Qianmo Road, Binjiang District,
Hangzhou, Zhejiang Province, China

(111) M 2009 20025 R1
(156) 2009 11 18
(186) 2029 11 18

(732) NOVARTIS AG
4002 Basel, Switzerland

(111) M 1999 11643 R2
(156) 1999 02 18
(186) 2029 02 18

(732) MAGNETTI MARELLI S.P.A.
Viale Aldo Borletti 61/63, 20011 Corbetta,
Milano, Italy

(111) M 1999 11746 R2
(156) 1999 03 17
(186) 2029 03 17

(732) Feilo Sylvania Fixtures Netherlands B.V.
Prins Bernhardplein 200, 1097 JB Amsterdam,
Netherlands

(111) M 1999 12076 R2
(156) 1999 05 10
(186) 2029 05 10

(732) ASPEN GLOBAL INCORPORATED
GBS Plaza, Cnr. La Salette & Royal Roads,
Grand Bay, Mauritius

(111) M 1999 12082 R2
(156) 1999 05 10
(186) 2029 05 10

(732) ASPEN GLOBAL INCORPORATED
GBS Plaza, Cnr. La Salette & Royal Roads,
Grand Bay, Mauritius

(111) M 1999 12083 R2
(156) 1999 05 10
(186) 2029 05 10

(732) ASPEN GLOBAL INCORPORATED
GBS Plaza, Cnr. La Salette & Royal Roads,
Grand Bay, Mauritius

(111) M 1999 11949 R2
(156) 1999 05 06
(186) 2029 05 06

(732) ASPEN GLOBAL INCORPORATED
GBS Plaza, Cnr. La Salette & Royal Roads,
Grand Bay, Mauritius

(111) M 1999 11951 R2
(156) 1999 05 06
(186) 2029 05 06

(732) ASPEN GLOBAL INCORPORATED
GBS Plaza, Cnr. La Salette & Royal Roads,
Grand Bay, Mauritius

(111) M 1999 12089 R2
(156) 1999 05 10
(186) 2029 05 10

(732) ASPEN GLOBAL INCORPORATED
GBS Plaza, Cnr. La Salette & Royal Roads,
Grand Bay, Mauritius

(111) M 1999 12090 R2
(156) 1999 05 10
(186) 2029 05 10

(732) ASPEN GLOBAL INCORPORATED
GBS Plaza, Cnr. La Salette & Royal Roads,
Grand Bay, Mauritius

(111) M 1999 12091 R2
(156) 1999 05 10
(186) 2029 05 10

(732) ASPEN GLOBAL INCORPORATED
GBS Plaza, Cnr. La Salette & Royal Roads,
Grand Bay, Mauritius

(111) M 1998 11347 R2
(156) 1998 12 18
(186) 2028 12 18

(732) EMERI OLEOKHEMIKALS GMBH
Paul-Thomas-Strasse 56, 40599 Duesseldorf,
Germany

(111) M 1998 11348 R2
(156) 1998 12 18
(186) 2028 12 18

(732) EMERY OLEOCHEMICALS GMBH
Paul-Thomas-Strasse 56, 40599 Duesseldorf,
Germany

COMPLETE TRANSFER OF RIGHTS

(111) M 1997 5444 R
(732) LEICA CAMERA AG
Hauptstrasse 104, 2560 Nidau, Switzerland
(770) SINAR PHOTOGRAPHY AG
Farbhofstrasse 21, 8048 Zurich, Switzerland
(580) 17 04 2019

(111) M 1997 6255 R
(732) SAMSON AKTIENGEZELLSCHAFT
Weismüllerstrasse 3, 60314 Frankfurt am
Main, Germany
(770) SAMSON Prozessautomation GMBH
Weismüllerstrasse 3, 60314 Frankfurt,
Germany
(580) 05 04 2019

CHANGES OF NAMES AND/OR ADDRESS OF OWNERS

(111) M 1999 12273 R
(732) PEDROLLO S.P.A.
Via Enrico Fermi, 7, 37047 San Bonifacio
(Verona), Italy
(770) PEDROLLO S.P.A.
via Enrico Fermi, 75/0, 37047 San Bonifacio
(Verona), Italy
(580) 10 04 2019

(770) SAMSOMATIC GMBH
Weismüllerstrasse 3, 60314 Frankfurt,
Germany
(580) 05 04 2019

(111) M 1999 12318 R
(732) RHEINMETALL AUTOMOTIVE AG
Karl-Schmidt-Strasse 2-8, 74172 Neckarsulm,
Germany
(770) KSPG AG
Karl-Schmidt-Strasse 2-8, 74172 Neckarsulm,
Germany
(580) 04 04 2019

(111) M 1998 11347 R
(732) EMERI OLEOKHEMIKALS GMBH
Paul-Thomas-Strasse 56, 40599 Duesseldorf,
Germany
(770) EMERY OLEOCHEMICALS GMBH
Paul-Thomas-Strasse 56, 40599 Duesseldorf,
Germany
(580) 22 03 2019

(111) M 1998 11348 R
(732) EMERY OLEOCHEMICALS GMBH
Paul-Thomas-Strasse 56, 40599 Duesseldorf,
Germany
(770) COGNIS OLEOCHEMICALS GmbH
Henkelstrasse 67, 40589 Dusseldorf, Germany
(580) 22 03 2019

(111) M 1999 12093 R
(732) SOLVAY FRANCE
25, rue de Clichy, F-75009 Paris, France
(770) RHODIA a French Societe Anonyme
110 Esplanade Charles de Gaulle-Immeuble
Coeur Defenswe- Tour A-92400 Courbevoie,
France
(580) 12 04 2019

(111) M 1997 6255 R
(732) SAMSON PROZESSAUTOMATION GMBH
Weismüllerstrasse 3, 60314 Frankfurt,
Germany

TERMINATION OF TRADEMARKS REGISTRATION

(111) M 2008 18764 R
 (151) 2008 10 16
 (732) LTD "BEDIA"
 Khosharaulis q. 25, 0119, Tbilisi, Georgia

(111) M 2008 18761 R
 (151) 2008 10 09
 (732) LTD "ZHORZHOLIANI TRADING"
 Zhiuli Shartavas q. 43, 0160, Tbilisi, Georgia

(111) M 2008 18765 R
 (151) 2008 10 16
 (732) JSC "GEORGIAN CREDIT"
 Al. Kazbegis gamz. 30, 0177, Tbilisi,
 Georgia

(111) M 2008 18723 R
 (151) 2008 09 26
 (732) LTD "ZHORZHOLIANI TRADING"
 Zhiuli Shartavas q. 43, 0160, Tbilisi, Georgia

(111) M 2008 18681 R
 (151) 2008 09 17
 (732) LTD "A-B-C PHARMACEUTICAL"
 Lisis Tba 1, 0177, Tbilisi, Georgia

(111) M 2008 18724 R
 (151) 2008 09 26
 (732) LTD "ZHORZHOLIANI TRADING"
 Zhiuli Shartavas q. 43, 0160, Tbilisi, Georgia

(111) M 2008 18658 R
 (151) 2008 08 29
 (732) LTD "ATLANTIKA"
 Giorgi Brtskinvalis q. 21, 0131, Tbilisi,
 Georgia

(111) M 2008 18725 R
 (151) 2008 09 26
 (732) LTD "ZHORZHOLIANI TRADING"
 Zhiuli Shartavas q. 43, 0160, Tbilisi, Georgia

(111) M 2008 18659 R
 (151) 2008 08 29
 (732) ELENE ABAZADZE
 Iliа Chavchavadzis gamz. 54a, 0179, Tbilisi,
 Georgia

(111) M 2008 18683 R
 (151) 2008 09 17
 (732) BEKA MIKAUTADZE
 Nutsubidzis q. 211, korp. 4, b. 40-41, 0186,
 Tbilisi, Georgia

(111) M 2008 18766 R
 (151) 2008 10 16
 (732) LTD "KASPER GEORGIA"
 Pekinis q. 16/20, 0194, Tbilisi, Georgia

(111) M 2008 18625 R
 (151) 2008 07 31
 (732) LTD "POLU"
 Vakhushti Bagrationis q. 23, 0154, Tbilisi, Georgia

(111) M 2008 18767 R
 (151) 2008 10 16
 (732) LLC "ARLINE"
 Prospekt Abaia 50a, Almaati 050008,
 Kazakhstan

(111) M 2008 18663 R
 (151) 2008 08 29
 (732) LTD "VAINMEN SH.P.S"
 Gudiashevils q. 11, 0105, 0105, Tbilisi, Georgia

(111) M 2008 18768 R
 (151) 2008 10 16
 (732) LLC "ARLINE"
 Prospekt Abaia 50a, Almaati 050008,
 Kazakhstan

(111) M 2008 18769 R
 (151) 2008 10 16
 (732) LTD "BEMONI"
 Mitskevichis q. 21/23, 0194, Tbilisi, Georgia

(111) M 2008 18770 R
 (151) 2008 10 16
 (732) LTD "SAMEPO"
 Nikeas q., II shesakhv. 2a, 4600, Kutaisi,
 Georgia

-
- (111) M 2008 18776 R
(151) 2008 10 16
(732) LTD "KINOKALAKI"
Ilia Chavchavadzis gamz. 11, Tbilisi, 0179,
Georgia
-
- (111) M 2008 18782 R
(151) 2008 10 16
(732) IBERIAN PONTOMARINE
AQUACULTURE LTD.
Memed Abashidze str. 56, 6000, Batumi,
Georgia
-
- (111) M 2008 18783 R
(151) 2008 10 16
(732) JSC "PROCREDIT BANK"
D. Agmasheneblis gamz. 154, 0112, Tbilisi,
Georgia
-
- (111) M 2008 18784 R
(151) 2008 10 16
(732) VIQTOR BUACHIDZE
Irakli Abashizis q. 68, b. 8, Tbilisi, 0162,
Georgia
-
- (111) M 2008 18785 R
(151) 2008 10 16
(732) VIKTOR BUACHIDZE
Irakli Abashizis q. 68, b. 8., Tbilisi, 0162,
Georgia
-
- (111) M 2008 18786 R
(151) 2008 10 16
(732) VALID ARFUSH
Ul. Kruglouniversitetskaya, dom. 14, kv. 21,
Kiev, Ukraine
-
- (111) M 2008 18787 R
(151) 2008 10 16
(732) Andalus Alsharq General Trading (LLC)
P.O. Box 113518 Dubai, United Arab
Emirates
-
- (111) M 2008 18700 R
(151) 2008 09 17
(732) LTD "TERA 1 AEROPORTI"
Shardenis q. 14, 0105, Tbilisi, Georgia
-
- (111) M 2008 18788 R
(151) 2008 10 16
(732) LTD „SOFIA +“
Vazha-Pshavelas gamz., VII kvar., korp. 6,
b. 20, 0186, Tbilisi, Georgia
-
- (111) M 2008 18790 R
(151) 2008 10 16
(732) LTD "TURIST STOPI"
Vazha-Pshavelas gamz. 13, b. 15, 0160,
Tbilisi, Georgia
-
- (111) M 2008 18791 R
(151) 2008 10 16
(732) JSC "PEOPLE'S INSURANCE"
Ilia Chavchavadzis gamz. 74, 0162, Tbilisi,
Georgia
-
- (111) M 2008 18792 R
(151) 2008 10 16
(732) RAYDIL HOLDINGS INC.
c.o. Trident Trust Company (B.V.I.) Limited,
Trident Chambers, P.O. Box 146, Road
Town, Tortola, Virgin Islands (British)
-
- (111) M 2008 18714 R
(151) 2008 09 17
(732) LTD "Radio Broadcasting For Children
and Young People"
Vazha-Pshavelas gamz. 76b, 1086, Tbilisi,
Georgia
-
- (111) M 2008 18795 R
(151) 2008 10 16
(732) BAYER CONSUMER CARE AG
Peter Merian-Str. 84, 4052 Basel, Switzerland
-
- (111) M 2008 18797 R
(151) 2008 10 16
(732) LTD "BEDEGI"
Gagarinis q. 21, 3700, Rustavi, Georgia
-
- (111) M 2008 18715 R
(151) 2008 09 17
(732) KORNELI KORCHILAVA
Mikaberidzis q. 37, Poti, 4400, Georgia
-
- (111) M 2008 18716 R
(151) 2008 09 17
(732) VAKHTANG MGELIASHVILI
Sairmis q., korp. 8, b. 30, 0194, Tbilisi,
Georgia
-

(111) M 2008 18801 R
(151) 2008 10 16
(732) Nemiroff Intellectual Property
Establishment Haus Rechsteiner, P.O. Box
634/Stadtlet 31, LI-9490 Vaduz, Liechtenstein

(111) M 2008 18802 R
(151) 2008 10 16
(732) Nemiroff Intellectual Property Establishment
Haus Rechsteiner, P.O. Box 634/Stadtlet 31,
LI-9490 Vaduz, Liechtenstein

(111) M 2008 18803 R
(151) 2008 10 16
(732) Nemiroff Intellectual Property Establishment
Haus Rechsteiner, P.O. Box 634/Stadtlet 31,
LI-9490 Vaduz, Liechtenstein

(111) M 2008 18804 R
(151) 2008 10 16
(732) Nemiroff Intellectual Property Establishment
Haus Rechsteiner, P.O. Box 634/Stadtlet 31,
LI-9490 Vaduz, Liechtenstein

(111) M 2008 18805 R
(151) 2008 10 16
(732) Nemiroff Intellectual Property Establishment
Haus Rechsteiner, P.O. Box 634/Stadtlet 31,
LI-9490 Vaduz, Liechtenstein

(111) M 2008 18806 R
(151) 2008 10 16
(732) Nemiroff Intellectual Property Establishment
Haus Rechsteiner, P.O. Box 634/Stadtlet 31,
LI-9490 Vaduz, Liechtenstein

(111) M 2008 18807 R
(151) 2008 10 16
(732) Nemiroff Intellectual Property Establishment
Haus Rechsteiner, P.O. Box 634/Stadtlet 31,
LI-9490 Vaduz, Liechtenstein

(111) M 2008 18808 R
(151) 2008 10 16
(732) Nemiroff Intellectual Property Establishment
Haus Rechsteiner, P.O. Box 634/Stadtlet 31,
LI-9490 Vaduz, Liechtenstein

(111) M 2008 18809 R
(151) 2008 10 16
(732) Nemiroff Intellectual Property Establishment

Haus Rechsteiner, P.O. Box 634/Stadtlet 31,
LI-9490 Vaduz, Liechtenstein

(111) M 2008 18811 R
(151) 2008 10 16
(732) Nemiroff Intellectual Property Establishment
Haus Rechsteiner, P.O. Box 634/Stadtlet 31,
LI-9490 Vaduz, Liechtenstein

(111) M 2008 18812 R
(151) 2008 10 16
(732) Nemiroff Intellectual Property Establishment
Haus Rechsteiner, P.O. Box 634/Stadtlet 31,
LI-9490 Vaduz, Liechtenstein

(111) M 2008 18813 R
(151) 2008 10 16
(732) Nemiroff Intellectual Property Establishment
Haus Rechsteiner, P.O. Box 634/Stadtlet 31,
LI-9490 Vaduz, Liechtenstein

(111) M 2008 18814 R
(151) 2008 10 16
(732) Nemiroff Intellectual Property Establishment
Haus Rechsteiner, P.O. Box 634/Stadtlet 31,
LI-9490 Vaduz, Liechtenstein

(111) M 2008 18815 R
(151) 2008 10 16
(732) Nemiroff Intellectual Property Establishment
Haus Rechsteiner, P.O. Box 634/Stadtlet 31,
LI-9490 Vaduz, Liechtenstein

(111) M 2018 29836 R
(151) 2018 06 21
(732) ANDRO TCHIABRISHVILI
Ts. Dadianis q. 319, b. 8, 0192, Tbilisi,
Georgia
(141) 2019 05 03

CLASSIFICATION INDEXES

INVENTIONS

CONCORDANCE TABLE OF INTERNATIONAL CLASSIFICATION INDEX AND PUBLICATION NUMBERS

INTERNATIONAL CLASSIFICATION INDEXES (51)	NUMBER OF PUBLISHED APPLICATION (10)
A 61 K 9/32; A 01 N 33/08	AP 2019 14035 A
A 61 K 31/495; A 61 P 25/24; A 61 P 25/28; A 61 P 25/18; C 07 D 295/096; C 07 D 207/28	AP 2019 14622 A

CONCORDANCE TABLE OF PUBLICATION NUMBERS AND INTERNATIONAL CLASSIFICATION INDEX

NUMBER OF PUBLISHED APPLICATION (10)	INTERNATIONAL CLASSIFICATION INDEXES (51)
AP 2019 14035 A	A 61 K 9/32; A 01 N 33/08
AP 2019 14622 A	A 61 K 31/495; A 61 P 25/24; A 61 P 25/28; A 61 P 25/18; C 07 D 295/096; C 07 D 207/28

CONCORDANCE TABLE OF INTERNATIONAL CLASSIFICATION INDEX, PATENT NUMBERS AND PUBLICATION NUMBERS

INTERNATIONAL CLASSIFICATION INDEX (51)	NUMBER OF PATENT (11)	NUMBER OF PUBLISHED APPLICATION (10)
A 61 K 8/37 ; A 61 K 8/92; A 61 K 8/67; A 61 K 8/04	P 2019 6971 B	AP 2019 14731 A

CONCORDANCE TABLE OF PATENT NUMBERS, PUBLICATION NUMBERS AND INTERNATIONAL CLASSIFICATION INDEX

NUMBER OF PATENT (11)	NUMBER OF PUBLISHED APPLICATION (10)	INTERNATIONAL CLASSIFICATION INDEX (51)
P 2019 6971 B	AP 2019 14731 A	A 61 K 8/37 ; A 61 K 8/92; A 61 K 8/67; A 61 K 8/04

CONCORDANCE TABLE OF APPLICATION NUMBERS, PUBLICATION NUMBERS AND PATENTS

NUMBER OF APPLICATION (21)	NUMBER OF PUBLISHED APPLICATION (10)	NUMBER OF PATENT (11)
AP 2016 14731	AP 2019 14731 A	P 2019 6971 B

UTILITY MODELS

CONCORDANCE TABLE OF INTERNATIONAL CLASSIFICATION INDEX, PATENT NUMBERS AND PUBLICATION NUMBERS

INTERNATIONAL CLASSIFICATION INDEX (51)	NUMBER OF PATENT (11)	NUMBER OF PUBLISHED APPLICATION (10)
A 01 C 23/00	AU 2019 2008 U	AU 2018 14419 U
A 23 B 7/00	AU 2019 2007 U	AU 2018 14621 U

CONCORDANCE TABLE OF PATENT NUMBERS, PUBLICATION NUMBERS AND INTERNATIONAL CLASSIFICATION INDEX

NUMBER OF PATENT (11)	NUMBER OF PUBLISHED APPLICATION (10)	INTERNATIONAL CLASSIFICATION INDEX (51)
AU 2019 2007 U	AU 2018 14621 U	A 23 B 7/00
AU 2019 2008 U	AU 2018 14419 U	A 01 C 23/00

CONCORDANCE TABLE OF APPLICATION NUMBERS, PUBLICATION NUMBERS AND PATENTS

NUMBER OF APPLICATION (21)	NUMBER OF PUBLISHED APPLICATION (10)	NUMBER OF PATENT (11)
AU 2017 14419 U	AU 2018 14419 U	AU 2019 2008 U
AU 2017 14621 U	AU 2018 14621 U	AU 2019 2007 U

DESIGNS

CONCORDANCE TABLE OF INTERNATIONAL CLASSIFICATION INDEX, REGISTRATION NUMBERS AND PUBLICATION NUMBERS

INTERNATIONAL CLASSIFICATION INDEX (51)	NUMBER OF REGISTRATION (11)	NUMBER OF PUBLISHED APPLICATION (10)
12-08	D 2019 806 S	AD 2019 1053 S
12-08	D 2019 807 S	AD 2019 1055 S
16-06	D 2019 805 S	AD 2019 1049 S
25-01; 25-02	D 2019 804 S	AD 2019 1047 S

**CONCORDANCE TABLE OF REGISTRATION NUMBERS,
PUBLICATION NUMBERS AND INTERNATIONAL CLASSIFICATION INDEX**

NUMBER OF REGISTRATION (11)	NUMBER OF PUBLISHED APPLICATION (10)	INTERNATIONAL CLASSIFICATION INDEX (51)
D 2019 804 S	AD 2019 1047 S	25-01; 25-02
D 2019 805 S	AD 2019 1049 S	16-06
D 2019 806 S	AD 2019 1053 S	12-08
D 2019 807 S	AD 2019 1055 S	12-08

**CONCORDANCE TABLE OF APPLICATION NUMBERS, PUBLICATION NUMBERS
AND REGISTRATION NUMBERS**

NUMBER OF APPLICATION (21)	NUMBER OF PUBLISHED APPLICATION (10)	NUMBER OF REGISTRATION (11)
AD 2018 1047	AD 2019 1047 S	D 2019 804 S
AD 2018 1049	AD 2019 1049 S	D 2019 805 S
AD 2018 1053	AD 2019 1053 S	D 2019 806 S
AD 2018 1055	AD 2019 1055 S	D 2019 807 S

TRADEMARKS

CONCORDANCE TABLE OF REGISTRATION NUMBERS, APPLICATION NUMBERS, PUBLICATION NUMBERS AND BULLETIN NUMBERS

NUMBER OF REGISTRATION (111)	NUMBER OF APPLICATIONS (210)	NUMBER OF PUBLISHED APPLICATIONS (260)	NUMBER OF BULLETIN
M 2019 31101 R	AM 102264	-	9(517)2019
M 2019 31102 R	AM 102543	-	9(517)2019
M 2019 31103 R	AM 102557	-	9(517)2019
M 2019 31104 R	AM 102560	-	9(517)2019
M 2019 31105 R	AM 102531	-	9(517)2019
M 2019 31106 R	AM 102823	-	9(517)2019
M 2019 31107 R	AM 102809	-	9(517)2019
M 2019 31108 R	AM 102816	-	9(517)2019
M 2019 31109 R	AM 102250	-	9(517)2019
M 2019 31110 R	AM 102813	-	9(517)2019
M 2019 31111 R	AM 102696	-	9(517)2019
M 2019 31112 R	AM 102702	-	9(517)2019
M 2019 31113 R	AM 102703	-	9(517)2019
M 2019 31114 R	AM 102705	-	9(517)2019
M 2019 31115 R	AM 102725	-	9(517)2019
M 2019 31116 R	AM 95886	AM 2018 95886 A	20(504)2018
M 2019 31117 R	AM 95931	AM 2018 95931 A	19(503)2018
M 2019 31118 R	AM 96272	AM 2018 96272 A	23(507)2018
M 2019 31119 R	AM 96284	AM 2018 96284 A	23(507)2018
M 2019 31120 R	AM 96370	AM 2018 96370 A	19(503)2018
M 2019 31121 R	AM 96556	AM 2019 96556 A	1(509)2019
M 2019 31122 R	AM 96766	AM 2018 96766 A	21(505)2018
M 2019 31123 R	AM 96770	AM 2018 96770 A	21(505)2018
M 2019 31124 R	AM 96811	AM 2018 96811 A	21(505)2018
M 2019 31125 R	AM 96860	AM 2018 96860 A	23(507)2018
M 2019 31126 R	AM 97013	AM 2018 97013 A	21(505)2018
M 2019 31127 R	AM 97179	AM 2018 97179 A	23(507)2018
M 2019 31128 R	AM 97187	AM 2018 97187 A	23(507)2018
M 2019 31129 R	AM 97211	AM 2018 97211 A	23(507)2018
M 2019 31130 R	AM 97388	AM 2018 97388 A	22(506)2018
M 2019 31131 R	AM 97402	AM 2019 97402 A	1(509)2019
M 2019 31132 R	AM 97443	AM 2019 97443 A	1(509)2019
M 2019 31133 R	AM 97445	AM 2019 97445 A	1(509)2019
M 2019 31134 R	AM 97446	AM 2019 97446 A	1(509)2019
M 2019 31135 R	AM 97456	AM 2018 97456 A	23(507)2018
M 2019 31136 R	AM 97466	AM 2018 97466 A	24(508)2018
M 2019 31137 R	AM 97689	AM 2018 97689 A	24(508)2018
M 2019 31138 R	AM 97690	AM 2019 97690 A	1(509)2019
M 2019 31139 R	AM 97783	AM 2018 97783 A	24(508)2018
M 2019 31140 R	AM 97789	AM 2018 97789 A	24(508)2018
M 2019 31141 R	AM 97790	AM 2018 97790 A	24(508)2018
M 2019 31142 R	AM 97792	AM 2018 97792 A	24(508)2018
M 2019 31143 R	AM 97807	AM 2019 97807 A	1(509)2019
M 2019 31144 R	AM 97808	AM 2019 97808 A	1(509)2019
M 2019 31145 R	AM 97809	AM 2019 97809 A	1(509)2019
M 2019 31146 R	AM 97896	AM 2018 97896 A	24(508)2018
M 2019 31147 R	AM 97899	AM 2018 97899 A	24(508)2018

1	2	3	4
M 2019 31148 R	AM 97958	AM 2019 97958 A	1(509)2019
M 2019 31149 R	AM 96077	AM 2018 96077 A	15(499)2018
M 2019 31150 R	AM 96078	AM 2018 96078 A	15(499)2018
M 2019 31151 R	AM 97164	AM 2018 97164 A	21(505)2018
M 2019 31152 R	AM 97165	AM 2018 97165 A	21(505)2018
M 2019 31153 R	AM 97410	AM 2018 97410 A	23(507)2018
M 2019 31154 R	AM 102811	-	9(517)2019
M 2019 31155 R	AM 102544	-	9(517)2019
M 2019 31156 R	AM 102559	-	9(517)2019
M 2019 31157 R	AM 102724	-	9(517)2019
M 2019 31158 R	AM 102695	-	9(517)2019

**CONCORDANCE TABLE OF PUBLICATION NUMBERS
AND APPLICATION NUMBERS**

NUMBER OF PUBLISHED APPLICATION (260)	NUMBER OF APPLICATION (210)	1	2
		1	2
AM 2019 94169 A	AM 94169	AM 2019 99453 A	AM 99453
AM 2019 95028 A	AM 95028	AM 2019 99454 A	AM 99454
AM 2019 95029 A	AM 95029	AM 2019 99455 A	AM 99455
AM 2019 95362 A*	AM 95362	AM 2019 99456 A	AM 99456
AM 2019 98673 A	AM 98673	AM 2019 99460 A	AM 99460
AM 2019 98962 A	AM 98962	AM 2019 99463 A	AM 99463
AM 2019 99194 A	AM 99194	AM 2019 99501 A	AM 99501
AM 2019 99299 A	AM 99299	AM 2019 99517 A	AM 99517
AM 2019 99302 A	AM 99302	AM 2019 99672 A	AM 99672
AM 2019 99306 A	AM 99306	AM 2019 99759 A	AM 99759
AM 2019 99307 A	AM 99307	AM 2019 99761 A	AM 99761
AM 2019 99311 A	AM 99311	AM 2019 99774 A	AM 99774
AM 2019 99327 A	AM 99327	AM 2019 99936 A	AM 99936
AM 2019 99328 A	AM 99328	AM 2019 99937 A	AM 99937
AM 2019 99335 A	AM 99335	AM 2019 99941 A	AM 99941
AM 2019 99336 A	AM 99336	AM 2019 99942 A	AM 99942
AM 2019 99349 A	AM 99349	AM 2019 99944 A	AM 99944
AM 2019 99352 A	AM 99352	AM 2019 99945 A	AM 99945
AM 2019 99367 A	AM 99367	AM 2019 99953 A	AM 99953
AM 2019 99430 A	AM 99430	AM 2019 99954 A	AM 99954
AM 2019 99434 A	AM 99434	AM 2019 99990 A	AM 99990
AM 2019 99441 A	AM 99441	AM 2019 99992 A	AM 99992
AM 2019 99444 A	AM 99444	AM 2019 99993 A	AM 99993
AM 2019 99445 A	AM 99445	AM 2019 99994 A	AM 99994
AM 2019 99452 A	AM 99452	AM 2019 99995 A	AM 99995
		AM 2019 99996 A	AM 99996
		AM 2019 99997 A	AM 99997
		AM 2019 99998 A	AM 99998
		AM 2019 99999 A	AM 99999

CONCORDANCE TABLE OF INDEX OF GOODS AND/OR SERVICES
AND APPLICATION NUMBERS

INDEX OF GOODS AND/OR SERVICES (511)	NUMBER OF PUBLISHED APPLICATIONS (26)	1	2
1	2		
1	AM 2019 99306 A	12	AM 2019 99759 A
2	AM 2019 99352 A	12	AM 2019 99761 A
3	AM 2019 99328 A	12	AM 2019 99774 A
3	AM 2019 99336 A	14	AM 2019 99302 A
3	AM 2019 99463 A	16	AM 2019 99302 A
5	AM 2019 94169 A	18	AM 2019 99302 A
5	AM 2019 99335 A	21	AM 2019 99302 A
5	AM 2019 99349 A	24	AM 2019 99302 A
5	AM 2019 99463 A	25	AM 2019 99302 A
5	AM 2019 99936 A	28	AM 2019 99302 A
5	AM 2019 99937 A	30	AM 2019 98962 A
5	AM 2019 99941 A	30	AM 2019 99327 A
5	AM 2019 99942 A	32	AM 2019 99311 A
5	AM 2019 99944 A	33	AM 2019 99430 A
5	AM 2019 99945 A	33	AM 2019 99460 A
5	AM 2019 99990 A	34	AM 2019 99501 A
5	AM 2019 99992 A	35	AM 2019 95362 A*
5	AM 2019 99993 A	35	AM 2019 98673 A
5	AM 2019 99994 A	35	AM 2019 98962 A
5	AM 2019 99995 A	35	AM 2019 99302 A
5	AM 2019 99996 A	35	AM 2019 99517 A
5	AM 2019 99997 A	35	AM 2019 99672 A
5	AM 2019 99998 A	36	AM 2019 99672 A
5	AM 2019 99999 A	36	AM 2019 99953 A
7	AM 2019 99759 A	36	AM 2019 99954 A
7	AM 2019 99761 A	37	AM 2019 99306 A
9	AM 2019 99367 A	39	AM 2019 99672 A
9	AM 2019 99672 A	41	AM 2019 95028 A
10	AM 2019 99463 A	41	AM 2019 95029 A
11	AM 2019 99444 A	41	AM 2019 99302 A
11	AM 2019 99445 A	41	AM 2019 99307 A
12	AM 2019 99434 A	42	AM 2019 98673 A
12	AM 2019 99452 A	42	AM 2019 99672 A
12	AM 2019 99453 A	43	AM 2019 95028 A
12	AM 2019 99454 A	43	AM 2019 95029 A
12	AM 2019 99455 A	43	AM 2019 99194 A
12	AM 2019 99456 A	43	AM 2019 99299 A
12	AM 2019 99517 A	43	AM 2019 99307 A
		43	AM 2019 99441 A
		44	AM 2019 99328 A
		44	AM 2019 99336 A
		45	AM 2019 98673 A

CONCORDANCE TABLE OF INDEX OF GOODS AND/OR SERVICES
AND NUMBERS OF TRADEMARKS REGISTERED ACCORDING
TO THE ACCELERATED PROCEDURE

INDEX OF GOODS AND/OR SERVICES (511)	NUMBERS OF REGISTERED ACCORDING TO THE ACCELERATED PROCEDURE (111)
5	M 2019 31107 R
5	M 2019 31111 R
5	M 2019 31112 R
5	M 2019 31113 R
5	M 2019 31114 R
5	M 2019 31115 R
6	M 2019 31101 R
9	M 2019 31158 R
12	M 2019 31101 R
12	M 2019 31102 R
29	M 2019 31109 R
30	M 2019 31106 R
30	M 2019 31109 R
30	M 2019 31110 R
30	M 2019 31157 R
33	M 2019 31155 R
35	M 2019 31101 R
35	M 2019 31102 R
35	M 2019 31105 R
35	M 2019 31108 R
35	M 2019 31156 R
35	M 2019 31158 R
36	M 2019 31103 R
36	M 2019 31104 R
36	M 2019 31156 R
36	M 2019 31158 R
37	M 2019 31101 R
38	M 2019 31101 R
39	M 2019 31101 R
39	M 2019 31156 R
42	M 2019 31101 R
43	M 2019 31106 R
43	M 2019 31154 R

OFFICIAL BULLETIN OF THE INDUSTRIAL PROPERTY

**INVENTIONS
UTILITY MODELS
DESIGNS
TRADEMARKS
APPELLATION OF ORIGIN OF GOOD**

9(517)

EDITOR-IN-CHIEF: N. Bebrishvili

EDITOR-TRANSLATOR: E. Gabunia

PROOFREADER: A. Shikhashvili

COMPUTER LAYOUT: M. Ordenidze
K. Svanidze

www.sakpatenti.gov.ge

E-mail: info@sakpatenti.org.ge