

# Official Bulletin of the Industrial Property

Inventions

Utility Models

Designs

Trademarks

Appellations of Origin of Goods



საქართველოს ინტელექტუალური  
საკუთრების ეროვნული ცენტრი

**საქპატენტი**

**SAKPATENTI**

NATIONAL INTELLECTUAL PROPERTY  
CENTER OF GEORGIA

[www.sakpatenti.gov.ge](http://www.sakpatenti.gov.ge)

Date of Publication – 2022 05 10

9(588)

# INID CODES FOR IDENTIFICATION OF BIBLIOGRAPHIC DATA

## INVENTIONS, UTILITY MODELS

- (10) Number of publication for application, which has been examined
- (11) Number of patent and kind of document
- (21) Serial number of application
- (22) Date of filing of the application
- (23) Date of exhibition or the date of the earlier filing and the number of application, if any
- (24) Date from which patent may have effect
- (31) Number of priority application
- (32) Date of filing of priority application
- (33) Code of the country or regional organization allotting priority application number
- (44) Date of publication of application not granted, but examined and number of bulletin
- (45) Date of publication of registered document
- (51) International Patent Classification Index

- (54) Title of the invention
- (57) Abstract
- (60) Number of examined patent document granted by foreign patent office, date from which patent has effect and country code
- (62) Number of the earlier application and in case of divided application, date of filing an application
- (71) Name, surname and address of applicant (country code)
- (72) Name, surname of inventor (country code)
- (73) Name, surname and address of patent owner (country code)
- (74) Name, surname of representative or patent attorney
- (85) Date of commencement of the national phase of International Application
- (86) Number and date of filing of international application
- (87) Number and date of publication of international application
- (94) Calculated date of expiry of the SPC or the duration of the SPC

## DESIGNS

- (10) Number of publication for application
- (11) Number of patent and kind of document or number of registration
- (15) Date of registration/Date of patent renewal
- (18) Expected expiration date of patent or registration
- (21) Serial number of application
- (22) Date of filing of the application
- (23) Date of exhibition or the date of the earlier filing and the number of application, if any
- (24) Date from which patent may have effect
- (28) Number of designs included in the application
- (30) Data relating to priority (number of application, date of filing of application, two-letter code identifying the authority with whom the priority application was made)
- (31) Number of priority application
- (32) Date of filing of priority application
- (33) Code of the country or regional organization allotting priority application number
- (34) Two-letter code according to WIPO St.3 identifying the authority with which the priority application was made
- (44) Date of publication of design and number of bulletin (the first publication)
- (45) Date of publication of design registered by WIPO and number of bulletin

- (51) International Classification for designs (class and subclass of the Locarno Classification)
- (54) Title of the invention
- (55) Reproduction of the design
- (57) Description of characteristic features of the design including indication of colors
- (58) Date of recording of any kind of amendment in the Register
- (62) Number of the earlier application, registration and document number and if available the date of filing an application in case of divided application
- (71) Name, surname and address of applicant (country code)
- (72) Name, surname of creator (country code)
- (73) Name, surname and address of patent owner (country code)
- (74) Name, surname of representative or patent attorney
- (81) Contracting states concerned
  - II designated contracting states according to the 1960 Act
  - III designated contracting states according to the 1999 Act
- (85) Owner's permanent address
- (86) Owner's nationality
- (87) Owner's residence
- (88) State in which the owner has a real and effective industrial or commercial establishment

## TRADEMARKS

- (111) - Number of registration
- (151) - Date of registration
- (156) - Date of the renewal
- (181) - Expected expiration date of registration
- (186) - Renewal expiration date of registration
- (141) - Date of cancel of duration of the mark
- (210) - Serial number of application
- (220) - Date of filing of the application
- (230) - Data concerning exhibition
- (260) - Number of application, for which favorable decision of examination about registration has been taken (publication number)
- (310) - Number of the first application
- (320) - Date of filing of the first application
- (330) - Code, identifying national or regional Office where the first application was made
- (511) - International Classification of Goods and Services for the purposes of registration of trade marks and/or list of goods and/or services classified according thereto
- (526) - Disclaimer
- (531) - Description of figurative elements of Trade Marks according to the International Classification of the Figurative Elements of Marks

- (540) - Reproduction of Trade Mark
- (550) - Nature and kind of Trade Mark
- (551) - Indication to the effect that the mark is a collective mark, a certification mark or a guarantee mark
- (554) - Three-dimensional mark
- (580) - Date of recording of any kind changes in respect of applications or registrations
- (591) - Information concerning colors claimed
- (731) - Name and address of the applicant
- (732) - Name and address of the holder of the registration
- (740) - Name and address of the representative
- (750) - Addreses for correspondence
- (770) - Name and address of the previous applicant or holder in case of change in ownership
- (771) - Previous name and address of the applicant or holder in case of change in ownership
- (791) - Name and address of the licensee
- (793) - Indication of conditions and/or restrictions under the license (Type of license, number of license agreement, data of license, data of validity of license)
- (800) - Certain data relating to the international registration of Trade Marks under the Protocol Relating to Madrid Agreement (International registration number
- (852) - Partial cancellation of the list of goods and services
- (891) - Date of subsequent designation

## CODES FOR PUBLICATION IN BULLETIN

- (21) AP 0000 000000 - serial number of application for invention
- (10) AP 0000 0000 A - number of published application for invention (first publication)
- (11) P 0000 0000 B - number of patent for invention (second publication)
- (21) API 0000 000000 - number of application for imported patent
- (11) PI 0000 0000 A - number of imported patent (first publication)
- (21) AU 0000 000000 - serial number of application for utility model
- (10) AU 0000 000 U - number of published application for utility model (first publication)
- (11) U 0000 000 Y - number of patent for utility model (second publication)
- (21) AD 0000 000000 - serial number of application for design
- (10) AD 0000 000 S - number of published application for design (first publication)
- (11) D 0000 000 S - registered design

## INTERNATIONAL PATENT CLASSIFICATION FOR INVENTIONS AND UTILITY MODELS

- SECTION A - HUMAN NECESSITIES
- SECTION B - PERFORMING OPERATIONS; TRANSPORTING
- SECTION C - CHEMISTRY; METALLURGY
- SECTION D - TEXTILES; PAPER
- SECTION E - FIXED CONSTRUCTIONS
- SECTION F - MECHANICAL ENGINEERING; LIGHTING; HEATING; WEAPONS; BLASTING
- SECTION G - PHYSICS
- SECTION H - ELECTRICITY

- 
- M - Trade Mark
  - (210) AM 0000 000000 - Serial number of application;
  - (260) AAM 0000 00000 A - Publication number of application;
  - (111) M 0000 00000 R - Number of registration;
  - (111) MMM0000 00000 Rn - Number of renewals, in which n=1,2,3;
  - (111) M 0000 00000 R(P) - Number of registration under partial assignment of rights
-

# Official Bulletin of the Industrial Property

Inventions

Utility Models

Designs

Trademarks

Appellations of Origin of Goods

# CONTENT

|  |     |
|--|-----|
| <b>PUBLISHED TITLES OF PROTECTION</b> .....  | 3   |
| <b>INVENTIONS</b>  |     |
| ▪ APPLICATIONS APPROVED FOR GRANTING PATENT .....  | 4   |
| ▪ PATENTED INVENTIONS .....  | 7   |
| <b>UTILITY MODELS</b>  |     |
| APPLICATIONS APPROVED FOR GRANTING PATENT .....  | 9   |
| <b>DESIGNS</b>   |     |
| ▪ REGISTERED DESIGN .....  | 10  |
| ▪ DESIGNS, WHICH HAVE BEEN REGISTERED WITH THE INTERNATIONAL BUREAU<br>CLAIMING PRIORITY ON THE TERRITORY OF GEORGIA ..... | 11  |
| <b>TRADEMARKS</b>  |     |
| ▪ APPLICATIONS FILED UNDER THE NATIONAL PROCEDURE APPROVED FOR<br>REGISTRATION .....                                       | 20  |
| ▪ REGISTERED TRADEMARKS .....  | 26  |
| ▪ TRADEMARKS REGISTERED ACCORDING TO THE ACCELERATED PROCEDURE .....   | 33  |
| ▪ INTERNATIONAL TRADEMARKS FOR WHICH A DECISION ON GRANTING PROTECTION<br>IS TAKEN .....                                   | 36  |
| ▪ INTERNATIONAL TRADEMARKS PROTECTED IN GEORGIA .....  | 104 |
| <b>APPELLATIONS OF ORIGIN OF GOODS</b>   |     |
| ▪ WINE SPECIFICATIONS "ZEGAANI" .....  | 108 |
| ▪ WINE SPECIFICATIONS "OKESHURI USAKHELOURI" .....   | 113 |
| <b>OFFICIAL NOTIFICATIONS</b>  |     |
| <b>INVENTIONS</b>  |     |
| ▪ RESTORATION OF PATENTS .....   | 118 |
| ▪ ABOLITION OF PATENTS WITH THE RIGHT TO RESTORE .....   | 119 |
| ▪ EXPIRATION OF TERMS OF RESTORATION OF PATENTS .....  | 120 |
| ▪ EXPIRATION OF TERMS OF PATENT .....  | 121 |
| ▪ CHANGES OF NAMES AND/OR ADDRESSES OF PATENTOWNERS .....  | 121 |
| ▪ PATENTS REMAIN IN FORCE ON THE BASIS OF RE-EXAMINATION .....   | 122 |
| <b>UTILITY MODELS</b>  |     |
| ABOLITION OF PATENTS WITH THE RIGHT TO RESTORE .....   | 123 |
| <b>DESIGNS</b>   |     |
| ▪ EXTENSION OF TERMS OF DESIGN REGISTRATION .....  | 123 |
| ▪ CANCELLATION OF DESIGN REGISTRATION .....  | 123 |
| ▪ EXTENSION OF TERMS OF INTERNATIONAL DESIGNS REGISTRATION .....   | 124 |
| <b>TRADEMARKS</b>  |     |
| ▪ EXTENSION OF TERMS OF TRADEMARKS REGISTRATION .....  | 128 |
| ▪ COMPLETE TRANSFER OF RIGHTS .....  | 130 |
| ▪ CHANGES OF NAMES AND/OR ADDRESSES OF TRADEMARKS OWNERS .....   | 131 |
| ▪ CANCELLATION OF TRADEMARKS REGISTRATION .....  | 133 |
| ▪ CORRECTION OF PUBLISHED INFORMATION .....  | 137 |
| <b>CLASSIFICATION INDEXES</b>  |     |
| INVENTIONS .....   | 138 |
| UTILITY MODELS .....   | 139 |
| DESIGNS .....  | 140 |
| TRADEMARKS .....   | 141 |

## **PUBLISHED TITLES OF PROTECTION**

### **INVENTIONS**

- **APPLICATIONS APPROVED FOR GRANTING PATENT:**  
15842; 15134; 15499; 15429; 15051; 15612
- **PATENTED INVENTIONS:**  
7375-7379

### **UTILITY MODELS**

- **APPLICATIONS APPROVED FOR GRANTING PATENT:**  
15609; 15319

### **DESIGNS**

- **REGISTERED DESIGN:**  
934
- **DESIGNS, WHICH HAVE BEEN REGISTERED WITH THE INTERNATIONAL BUREAU CLAIMING PRIORITY ON THE TERRITORY OF GEORGIA:**  
219047; 216533; 219069; 216101; 219160

### **TRADEMARKS**

- **APPLICATIONS FILED UNDER THE NATIONAL PROCEDURE APPROVED FOR REGISTRATION:**  
111163; 114319; 114691; 114693, 114694; 114696; 114699; 114737; 114741; 114758; 114761; 114794; 114812; 114817; 114914; 114919; 114927; 114973; 114986; 114988; 115011; 115013; 115015, 115016; 115019; 115024-115028; 115110, 115111; 115114; 115117, 115118; 115131
- **REGISTERED TRADEMARKS:**  
35328-35352; 35359-35380; 35387-35413
- **TRADEMARKS REGISTERED ACCORDING TO THE ACCELERATED PROCEDURE:**  
35327; 35353-35358; 35381-35386; 35414
- **INTERNATIONAL TRADEMARKS FOR WHICH A DECISION ON GRANTING PROTECTIONS IS TAKEN:**  
102134\*\*; 111254\*; 111265\*; 112427; 113630; 113713; 113842; 113844; 113899-113908; 113935-113937; 113944-113947; 113949; 113951-113953; 113955, 113956; 113962, 113963; 114009; 114012; 114016; 114018, 114019; 114066-114069; 114071-114074; 114081; 114084, 114085; 114087; 114089-114092; 114098, 114099; 114101-114108; 114110-114116; 114122-114124; 114157-114161; 114172-114175; 114177; 114179- 114183; 114189-114196; 114204; 114209; 114255-114259; 114266; 114271-114275; 114306-114308; 114348; 114350; 114357; 114359; 114439; 114441; 114523-114525; 114548, 114549; 114580; 114582-114584; 114646-114649; 114655-114664; 114703, 114704; 114710-114714; 114729; 114769; 114830, 114831; 114833; 114836; 114964
- **INTERNATIONAL TRADEMARKS PROTECTED IN GEORGIA:**  
105478; 107703; 109343; 110176; 110311; 112316; 112319; 112326-112329; 112437; 112441; 112448-112450; 112512, 112513; 112537-112540; 112557; 112559-112561; 112567-112571; 112630, 112631; 112747, 112748; 112751; 112759-112764; 112772-112776; 112809-112811; 112878; 112982

### **APPELLATIONS OF ORIGIN OF GOODS**

3510/6; 3512/6

# INVENTIONS

## APPLICATIONS APPROVED FOR GRANTING PATENT

The decision can be appealed at the Chamber of Appeal of Sakpatenti within 3 months from the publication or at the Mtskheta District Court Administrative Cases Board (Address: №17, Samkhedo St., Mtskheta), within 1 month following the publication.

### PART A

#### A 01

- (10) AP 2022 15842 A (51) Int. Cl. (2006)  
A 01 D 46/04
- (21) AP 2021 15842 (22) 2021 12 27
- (71) Temur Revishvili (GE);  
Metsniereba St. 10, Ozurgeti, Georgia (GE);  
Zurab Andghuladze (GE);  
Ilia Chavchavadze St. 10, Ozurgeti,  
Georgia (GE);  
Bakhva Dolidze (GE);  
I. Shemokmedeli St. 32, 3500, Ozurgeti,  
Georgia (GE);  
Dennis Meseroll (FR)  
56440, Languedoc, France (FR);  
Tamaz Mikadze (GE)  
Tsereteli St. 276s/31, Kutaisi, Georgia (GE);  
Davit Apkhazava (GE)  
N. Dumbadze St., I Lane 4, 3500, Ozurgeti,  
Georgia (GE);  
Revaz Makharadze (GE)  
Rustaveli St. 77, Ozurgeti, Georgia (GE)
- (72) Temur Revishvili (GE);  
Zurab Andghuladze (GE);  
Bakhva Dolidze (GE);  
Dennis Meseroll (FR);  
Tamaz Mikadze (GE);  
Davit Apkhazava (GE);  
Revaz Makharadze (GE)
- (54) TEA PICKING MANUAL APPARATUS
- (57) An apparatus includes installed onto the Π-shaped case 1 the cutting working body, and actuating mechanism having a drive 5, which is screw-cylinder reducer 6; and cutting working body is executed as vertical shafts 2 disposed parallel, whereon fixable, and capable to regulate height of cut the changeable star- 3 or disc-shaped 4 cutters are installed.
- Claims: 1 independent  
1 dependent

Fig.: 5

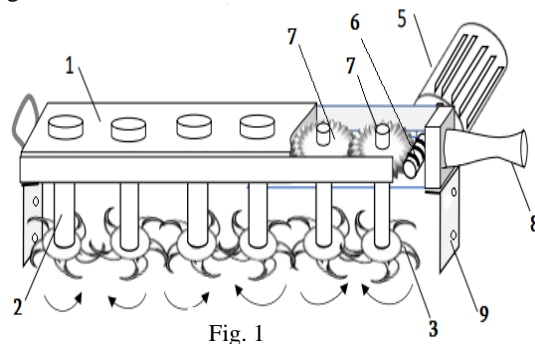

#### A 61

- (10) AP 2022 15134 A (51) Int. Cl. (2006)  
A 61 K 31/423  
A 61 P 37/00  
C 07 D 513/04  
C 07 D 498/04  
C 07 D 487/04  
C 07 D 471/04  
C 07 D 413/12  
C 07 D 413/06  
C 07 D 413/14
- (21) AP 2017 15134 (22) 2017 12 21
- (31) 62/438,009; 62/487,336; 62/551,033
- (32) 2016 12 22; 2017 04 19; 2017 08 28
- (33) US; US; US
- (71) NCYTE CORPORATION (US)  
1801 Augustine Cut-Off Wilmington, DE 19803,  
USA (US)
- (72) WU, Liangxing (US);  
LI, Jingwei (US);  
QI, Chao (US);  
ZHANG, Fenglei (US);  
LI, Zhenwu (US);  
ZHU, Wenyu (US);  
YU, Zhiyong (US);  
XIAO, Kaijiong (US);  
LU, Liang (US);  
MEI, Song (US);  
QIAN, Ding-Quan (US);  
HE, Chunhong (US);  
YE, Yingda (US);  
XU, Meizhong (US);  
YAO, Wenqing (US)
- (74) Tamaz Shilakadze

- (85) 2019 07 10  
 (86) PCT/US2017/067951, 2017 12 21  
 (54) HETEROCYCLIC COMPOUNDS AS IMMUNOMODULATORS  
 (57) Compound of formula (IIc-4):

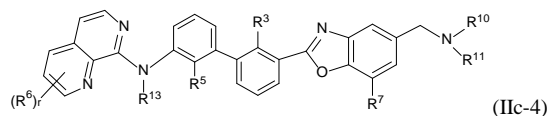

wherein  $r$  is an integer 1, 2 or 3, and values of  $R^3$ ,  $R^5$ ,  $R^6$ ,  $R^7$ ,  $R^{10}$ ,  $R^{11}$ ,  $R^{13}$  substitutes are provided in the claims, or pharmaceutically acceptable salt, and pharmaceutical compositions on the basis thereof.

Claims: 3 independents

17 dependents

Table: 18

- (10) AP 2022 15499 A (51) Int. Cl. (2006)  
 A 61 K 31/438  
 A 61 P 25/00  
 C 07 D 417/14  
 C 07 D 417/04  
 C 07 D 413/04  
 C 07 D 413/14  
 (21) AP 2019 15499 (22) 2019 04 29  
 (31) 62/665,091  
 (32) 2018 05 01  
 (33) US  
 (71) MERCK SHARP & DOHME CORP. (US)  
 126 East Lincoln Ave., Rahway, NJ 07065-0907, USA (US)  
 (72) CROWLEY, Brendan, M. (US);  
 CAMPBELL, Brian, T. (GE);  
 CHOBANIAN, Harry, R. (US);  
 FELLS, James, I. (US);  
 GUIADEEN, Deodial, G. (US);  
 GRESHOCK, Thomas, J. (US);  
 LEAVITT, Kenneth, J. (US);  
 RADA, Vanessa, L. (US);  
 BELL, Ian, M. (US)  
 (74) Shalva Gvaramadze  
 (85) 2020 11 26  
 (86) PCT/US2019/029561, 2019 04 29  
 (54) SPIROPIPERIDINE ALLOSTERIC MODULATORS OF NICOTINIC ACETYLCHOLINE RECEPTORS  
 (57) Compound of formula (I):

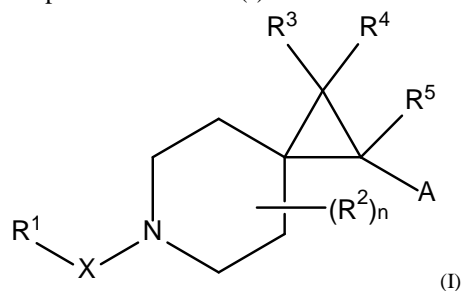

wherein  $n$  is 0, 1 or 2;  $X$  is  $S(O)_2$  and values of  $R^1$ ,  $R^2$ ,  $R^3$ ,  $R^4$ ,  $R^5$ ,  $A$  substitutes are provided in the claims, or pharmaceutically acceptable salt, pharmaceutical composition on the basis thereof, and usage therefor the treatment of cognitive disorders associated with Alzheimer's and Parkinson's diseases, and schizophrenia.

Claims: 21 independents

16 dependents

Table: 19

## PART B

### B 01

- (10) AP 2022 15429 A (51) Int. Cl. (2006)  
 B 01 J 19/00  
 C 07 D 471/04  
 (21) AP 2019 15429 (22) 2019 02 05  
 (31) 18155470.0  
 (32) 2018 02 07  
 (33) EP  
 (71) Aziende Chimiche Riunite Angelini Francesco  
 A.C.R.A.F. S.P.A. (IT)  
 Viale Amelia 70, I-00181 Roma, Italy (IT)  
 (72) IACOANGELI, Tommaso (IT);  
 MORO, Leonardo Mario (IT);  
 CARACCILO TORCHIAROLO,  
 Giuliano (IT);  
 CAVARISCHIA, Claudia (IT);  
 FURLOTTI, Guido (IT)  
 (74) Liliana Darakhvelidze  
 (85) 2020 09 02  
 (86) PCT/EP2019/052690, 2019 02 05  
 (54) CONTINUOUS PROCESS FOR TRAZODONE PREPARATION  
 (57) A process for trazodone preparation comprises at least one step consisting of continuous process performed in flow reactor.  
 Claims: 1 independent  
 22 dependents  
 Fig.: 4

**PART E**

**E 01**

- (10) AP 2022 15051 A (51) Int. Cl. (2006)  
E 01 F 7/04  
E 02 D 17/20
- (21) AP 2017 15051 (22) 2017 10 16
- (31) 2016-213130
- (32) 2016 10 31
- (33) JP
- (71) TOKYO ROPE MFG.CO., LTD. (JP)  
6-2, Nihonbashi 3-chome, chuo-ku, Tokyo  
1038306, Japan (JP)
- (72) ARITA, Takeshi (JP);  
HIRASE, Masashi (JP);  
ISHIMOTO, Kazuhiro (JP);  
TAKAMORI, Kiyoshi (JP);  
OKAYAMA, Takahiro (JP)
- (74) Shalva Gvaramadze
- (85) 2019 04 19
- (86) PCT/JP2017/037333, 2017 10 16
- (54) HIGH-STRENGTH WIRE MESH AND  
ROCK FALL PREVENTION NET
- (57) High-strength wire mesh is formed with a wire having tensile strength exceeding 2200 MPa, diameter whereof is between 1.0-3.0 mm-s. The length of 1 m<sup>2</sup> mesh woven linear wire is at least 50 m, wherein it is formed in spiral shape. High-strength wire mesh has mesh body with a deflection of at least 707 mm.

Claims: 6 independents  
4 dependents

Fig.: 15

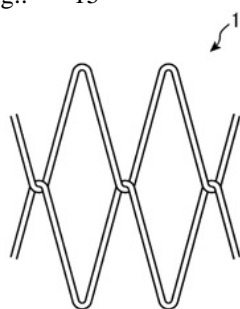

Fig. 1A

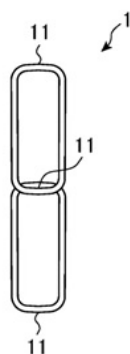

Fig. 1B

**PART F**

**F 17**

- (10) AP 2022 15612 A (51) Int. Cl. (2006)  
F 17 C 3/00  
F 25 D 3/10
- (21) AP 2021 15612 (22) 2021 04 21
- (71) Guram Dgebuadze (GE)  
Tsinamdzghvrishvili St. 121, app. 94, 0164,  
Tbilisi, Georgia (GE)
- (72) Guram Dgebuadze (GE);  
Guram Bokuchava (GE);  
Bezhan Bendeliani (GE);  
Giorgi Giorganashvili (GE);  
Ioseb Metskhvarishvili (GE);  
Nadezhda Mumladze (GE);  
Ekaterine Sanaia (GE);  
Kakha Shamatava (GE);  
Revaz Giorganashvili (GE);  
Vladimer Chanturidze (GE)
- (54) HIGH-TEMPERATURE SUPERCONDUCTORS (HTS) RESEARCH CRYOSTAT
- (57) A cryostat includes a case 1 having a lid 3, and coaxially disposed liquid 5 and solid 9 nitrogen vessels placed therein. The case has decomposable construction, and is made with mirror-polished stainless steel, wherein the vessels are hermetically hung on the lid by means of liquid nitrogen pouring and evaporating gas release tubes 6; and siphon thermodemper to reduce heat flows. At that, cylindric high-temperature superconductors (HTS) research cup-chamber 10, wherein a solenoid is placed, is built-in into solid nitrogen vessel, the HTS physical parameters measuring sensors 15 and special purpose rope, whereon the superconducting sample is fastened, and cryosorption pumps 8 and 11, having copper optically opaque porous screen, are built-in into the liquid and solid nitrogen vessels from bellow. Furthermore, vacuum valves 20, emergency valve 16, and inert air inlet valves 19 are located on the lid.

Claims: 1 independent

Fig.: 1

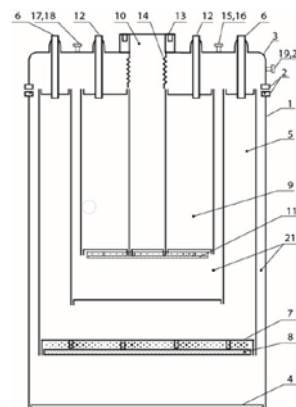

Fig. 1



# PATENTED INVENTIONS

## PART A

### A 01

- (11) P 2022 7375 B (51) Int. Cl. (2006)  
A 01 G 25/02  
C 02 F 1/14
- (10) AP 2021 15388 A (44) 18(574)/2021  
(21) AP 2020 15388  
(22) 2020 07 13  
(24) 2020 07 13
- (73) Aleksandre Vashakidze (GE)  
L. Gudiashvili St. 27, 0181, Tskneti,  
Tbilisi, Georgia (GE);  
Giorgi Gakhokidze (GE)  
El. Andronikashvili St. 103, 0117,  
Tbilisi, Georgia (GE);  
Nugzar Meladze (GE)  
Bakhtrioni St., corp. 30, app. 41, 0194,  
Tbilisi, Georgia (GE)
- (72) Aleksandre Vashakidze (GE);  
Giorgi Gakhokidze (GE);  
Nugzar Meladze (GE)
- (54) METHOD FOR RECEIVING WATER  
H<sub>2</sub>O<sub>2</sub> CONTAINING FOURTH PHASE  
AND DEVICE FOR EXECUTING  
THEREOF

### A 61

- (11) P 2022 7378 B (51) Int. Cl. (2006)  
A 61 K 31/415  
A 61 P 29/00  
C 07 D 231/12  
C 07 D 231/56  
C 07 D 333/28  
C 07 D 333/38  
C 07 D 233/64  
C 07 D 241/12  
C 07 D 495/04  
C 07 D 213/56  
C 07 D 277/56  
C 07 D 333/58
- (10) AP 2021 15141 A (44) 22(578)/2021  
(21) AP 2017 15141  
(22) 2017 12 18  
(24) 2017 12 18  
(31) 16206750.8  
(32) 2016 12 23  
(33) EP  
(86) PCT/EP2017/083290, 2017 12 18  
(73) Bayer Pharma Aktiengesellschaft (DE)

Müllerstraße 178, Berlin, 13353,  
Germany (DE)

- (72) SCHMIDT, Nicole (DE);  
ROTGERI, Andrea (DE);  
STIMSON, Christopher (GB);  
NAGEL, Jens (DE);  
GRÖTICKE, Ina (DE);  
RAUSCH, Alexandra (DE);  
KLAR, Jürgen (DE);  
DYRKS, Thomas (DE);  
DAVENPORT, Adam James (GB);  
BÄURLE, STEFAN (DE)
- (74) Tamar Kochlamazashvili
- (54) CARBOXYLIC ACID AROMATIC  
AMIDES AS ANTAGONISTS OF  
BRADYKININ B1 RECEPTOR

## PART B

### B 61

- (11) P 2022 7377 B (51) Int. Cl. (2006)  
B 61 H 1/00  
F 16 D 65/06  
F 16 D 69/00
- (10) AP 2021 15524 A (44) 23(579)/2021  
(21) AP 2019 15524  
(22) 2019 04 11  
(24) 2019 04 11  
(31) 2018119426  
(32) 2018 05 25  
(33) RU  
(86) PCT/RU2019/000237, 2019 04 11  
(73) Public Joint Stock Company "Ural Plant  
of Auto-Textile Products" (RU)  
Plekhanov St., 64, Asbest, Sverdlovsk rgn.  
624269, Russian Federation (RU)
- (72) SUKHAREV, Evgeniy Albertovich (RU);  
ROMANENKO, Vitaliy Valerievich (RU);  
KUZMINYIKH, Andrey Germanovich (RU)
- (74) Larisa Amirkhanyan
- (54) BRAKE SHOE FOR A RAIL VEHICLE

---

**PART F****F 01**

- (11) P 2022 7379 B (51) Int. Cl. (2006)  
F 01 K 25/10  
H 02 K 7/18  
H 02 K 35/02
- (10) AP 2021 15458 A (44) 22(578)/2021  
(21) AP 2019 15458  
(22) 2019 02 07  
(24) 2019 02 07  
(31) 2018-036840  
(32) 2018 03 01  
(33) JP  
(86) PCT/JP2019/004410, 2019 02 07  
(73) KOBAYASHI, Takaitso (JP)  
3-16-33, Nekozone, Urayasu-si, Chiba  
2790004, Japan (JP)  
(72) KOBAYASHI, Takaitso (JP)  
(74) Shalva Gvaramadze  
(54) WORKING MEDIUM PROPERTY  
DIFFERENCE POWER GENERATION  
SYSTEM AND WORKING MEDIUM  
PROPERTY DIFFERENCE POWER  
GENERATION METHOD THAT USES  
THE POWER GENERATION SYSTEM
- 

**F 03**

- (11) P 2022 7376 B (51) Int. Cl. (2006)  
F 03 B 11/06  
F 16 C 23/00  
G 01 B 21/16
- (10) AP 2022 15428 A (44) 1(580)/2022  
(21) AP 2019 15428  
(22) 2019 10 25  
(24) 2019 10 25  
(31) 62/751,033; 16/664,153  
(32) 2018 10 26; 2019 10 25  
(33) US; US  
(86) PCT/IB2019/001158, 2019 10 25  
(73) Andritz Hydro Canada Inc. (CA)  
6100 Route Transcanadienne, Pointe-Claire,  
QC H9R 1B9, Canada (CA)  
(72) ELAHI, Sarmad (CA);  
WALE, Shawn (CA);  
BYRNE, Ryan (CA);  
WODOSLAWSKY, Andrew (CA)  
(74) Tamar Kochlamazashvili  
(54) SYSTEM AND METHOD FOR RADIAL  
CLEARANCE MAINTAIN BETWEEN  
VARIABLE GUIDE BEARING AND  
TURBINE SHAFT
-

---

# UTILITY MODELS

## APPLICATIONS APPROVED FOR GRANTING PATENT

The decision can be appealed at the Chamber of Appeal of Sakpatenti within 3 months from the publication or at the Mtskheta District Court Administrative Cases Board (Address: №17, Samkhedro St., Mtskheta), within 1 month following the publication.

### PART A

#### A 21

- (10) AU 2022 15609 U (51) Int. Cl. (2006)  
A 21 C 1/00  
A 21 D 10/04
- (21) AU 2021 15609 (22) 2021 04 18
- (71) Ramini Ghvaladze (GE)  
Varketili 3, IV m/r., bld. 414, app. 165, Tbilisi,  
Georgia (GE)
- (72) Ramini Ghvaladze (GE)
- (74) Ramini Ghvaladze
- (54) YEAST-FREE BREAD BAKING MACHINE
- (57) A method provides white flour placement into dough boiler, water supply, creating 5-10 bar pressure of carbon dioxide gas, and kneading a dough maintaining existing pressure; then, dough boiler is released from the gas pressure causing carbon dioxide release from the water, as a result whereof the bubbles are created in the dough and it is fermented and puffing.
- Claims: 1 independent
- 

### PART C

#### C 12

- (10) AU 2022 15319 U (51) Int. Cl. (2006)  
C 12 G 3/06
- (21) AU 2020 15319 (22) 2020 04 20
- (71) Teimuraz Lomsadze (GE)  
Sairme St. 5, app. 27, 0194, Tbilisi,  
Georgia (GE)
- (72) Teimuraz Lomsadze (GE)
- (74) Shalva Gvaramadze
- (54) METHOD FOR MAKING FORTIFIED WINE
- (57) A method provides 100-350 variety vine ripe, high-sugar grapes crushing, clearing, making juice, sadimenting, removing juice from the sadiment, placing therein a qvevri, and fermenting; then, spiriting therewith pre-made mixture of alcoholic blend of wine brandy and chacha, spirited wine-material maturation in the qvevri, and then – in a barrel.
- Claims: 1 independent
-

---

## DESIGNS REGISTERED DESIGN

(11) D 2022 934 S      (51) 25-01  
(10) AD 2022 1239 S    (44) 2022 01 25 №2  
(21) AD 2021 1239  
(22) 2021 09 21  
(24) 2021 09 21  
(28) 1  
(18) 2026 09 21  
(73) Elguja Beridze (GE)  
      Kvareli St. 131, 0148, Tbilisi, Georgia (GE)  
(72) Elguja Beridze (GE)  
(54) CLAMP FOR ARMATURE

---

## DESIGNS, WHICH HAVE BEEN REGISTERED WITH THE INTERNATIONAL BUREAU CLAIMING PRIORITY ON THE TERRITORY OF GEORGIA

The decision can be appealed at the Chamber of Appeal of Sakpatenti within 3 months from the publication or at the Mtskheta District Court Administrative Cases Board (Address: №17, Samkhedro St., Mtskheta), within 1 month following the publication.

- (11) DM/219 047 (51) 09-03  
 (15) 2022 02 10 (44) 08/2022 (2022 02 25)  
 (22) 2022 02 10  
 (28) 5  
 (73) TADIM GIDA MADDELERİ SANAYİ VE TİCARET ANONİM ŞİRKETİ  
 Gebze Organize Sanayi Bölgesi 1100. Sok. No:1105 Çayırova, 41420 KOCAELİ (TR)  
 (85) TR  
 (86) TR  
 (87) TR  
 (88) TR  
 (89) TR  
 (81) III. AZ, EM, GE  
 (72) EMRE TEKİNALP  
 Gebze Organize Sanayi Bölgesi 1100. Sok. No:1105 Çayırova, 41420, KOCAELİ (TR)  
 (74) DIŞ PATENT MARKA TESCİL VE DANIŞMANLIK HİZMETLERİ LTD.  
 ŞTİ, BAY PLAZA Girne Mah. Elifli Sok. No:27 Kat:5-6-7 PK 34852 Maltepe, 34852 İSTANBUL (TR)  
 (46) 2022 02 25  
 (54) 1.-5. Graphic design for packaging  
 (55)

1.1



2.1



3.1



4.1



5.1



- (11) DM/216 533 (51) 10-02; 10-07  
 (15) 2024 08 25 (44) 08/2022 (2022 02 25)  
 (22) 2021 08 25  
 (28) 2  
 (73) TISSOT SA (TISSOT AG) (TISSOT LTD)  
 17, Chemin Des Tourelles, 2400 Le Locle (CH)  
 (85) CH  
 (86) CH  
 (87) CH  
 (88) CH  
 (89) CH  
 (81) II. MA III. AL, BA, CH, EM, GB, GE, MD, ME, MK, NO, RU, SG, TN, TR, UA  
 (72) 1: Lorenzo Vallone  
 Place De L'Eglise 19, 1255, Veyrier (CH)  
 1: Pierre Meinen  
 Rue Des Aubepines 4, F-25650, Gilley (FR)  
 2: David Quinche  
 Rue Du Crêt-de-la-Fin 30, CH-2023, Gorgier (CH)  
 (74) The Swatch Group AG (The Swatch Group SA) (The Swatch Group Ltd)  
 6, Faubourg Du Lac, 2501 Biel/Bienne (CH)  
 (54) 1. Watch, 2. Watch casing  
 (55)



1.1

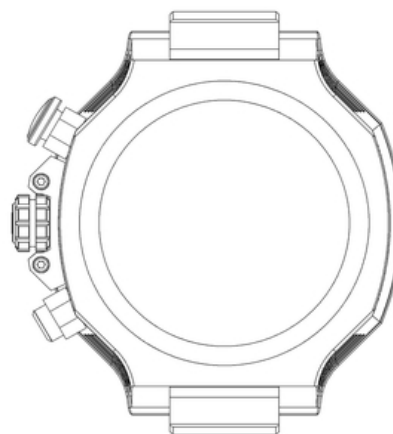

1.2

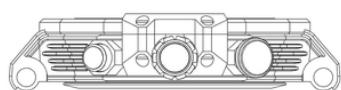

1.3



1.4



1.5

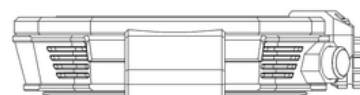

1.6



1.7

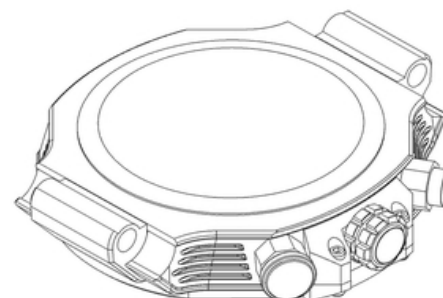

1.8

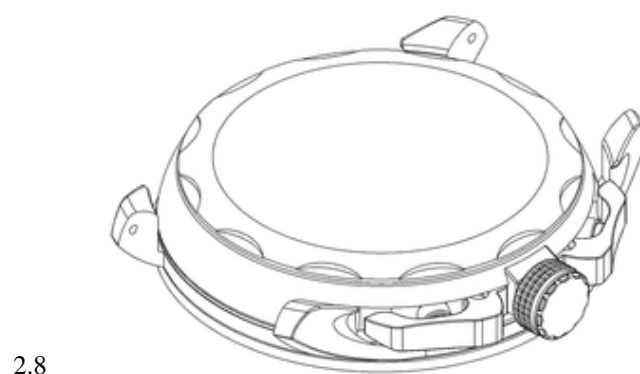
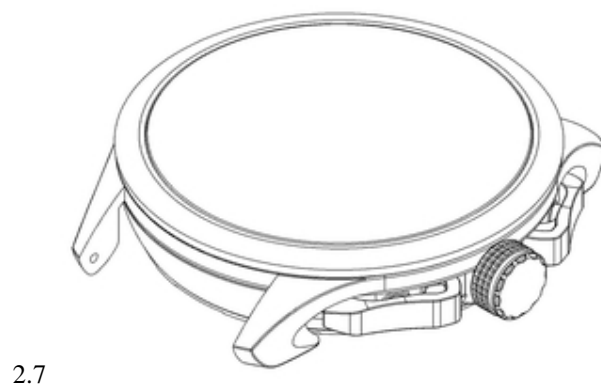
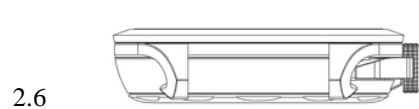
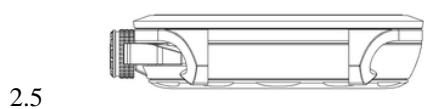
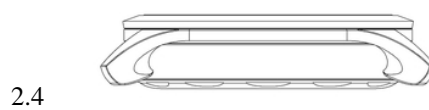
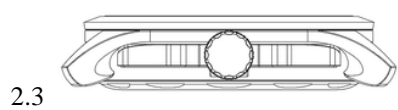
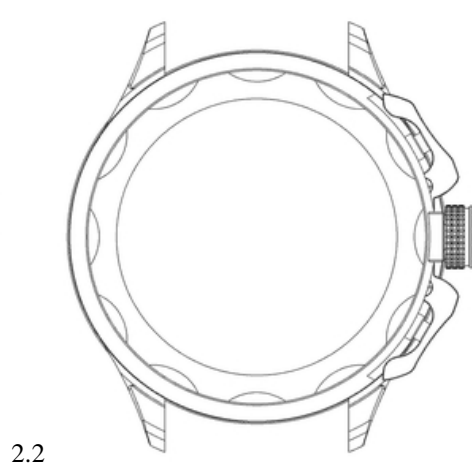
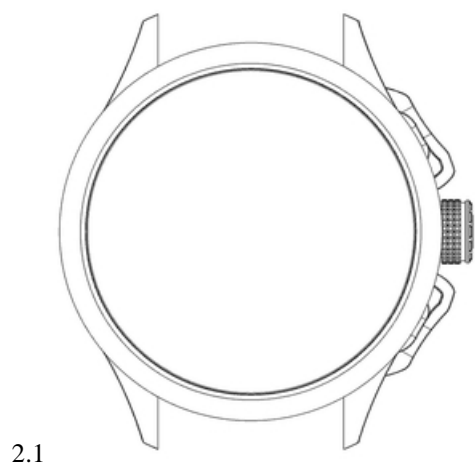



- (11) DM/219 069 (51) 12-11  
(15) 2021 07 20 (44) 08/2022 (2022 02 25)  
(22) 2021 07 20  
(28) 1  
(73) Scoot & Ride Holding GmbH  
Steiffstrasse 1, 4710 Grieskirchen (AT)  
(85) –  
(86) –  
(87) –  
(88) EM  
(89) EM  
(81) III. CA, EG, GE, IL, IS, JP, RS, SG, VN  
(72) Robert Kirchschrager  
Steiffstraße 1, 4710, Grieskirchen (AT)  
(74) Burgstaller & Partner  
Landstraße 12, 4020 Linz (AT)  
(46) 2022 02 25  
(54) 1. Scooter  
(55)



1.1



1.2



1.3



1.4

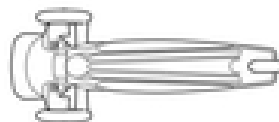

1.5



1.6



1.7

(11) DM/216 101 (51) 24-04  
(15) 2021 08 24 (44) 08/2022 (2022 02 25)  
(22) 2021 08 24  
(28) 1  
(73) AH License ApS  
Høgevej 19, 3400 Hillerød (DK)  
(85) DK  
(86) DK  
(87) DK  
(88) DK  
(89) DK  
(81) III. BA, CA, CH, EG, EM, GB, GE, IL, JP, KR, MK, NO, OM, RS, SG, TR  
(72) Henrik Larsen  
Gøgevænget 12, Gadevang, 3400, Hillerød (DK)  
(74) Elmann IPR  
Stockholmegade 41, 2100 Copenhagen Ø (DK)  
(54) 1. Pacifier for babies  
(55)



1.1



1.2



1.3



1.4



1.5



1.6



1.7

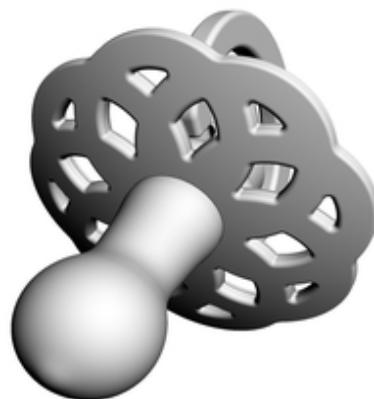

1.8



1.9



1.10



1.11

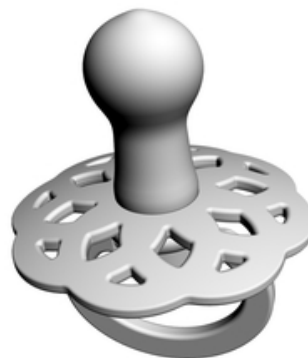

1.12

---

- (11) DM/219 160 (51) 09-07  
(15) 2022 02 09 (44) 09/2022 (2022 03 04)  
(22) 2022 02 09  
(28) 1  
(73) UAB "RETAL Baltic Films"  
Pramonės Str. 14, LT-94102 Klaipėda (LT)  
(85) –  
(86) –  
(87) LT  
(88) LT  
(89) LT  
(81) III. EM, GE, IL, OA, RU, UA, US  
(72) Olexandr Kachanov  
Kriviu Str. 5-119, 01204, Vilnius (LT)  
(74) Law / Ausra Pakeniene  
A.Gostauto Str. 40B, 03163 Vilnius (LT)  
(46) 2022 03 04  
(54) 1. Closure for beverage bottles  
(55)

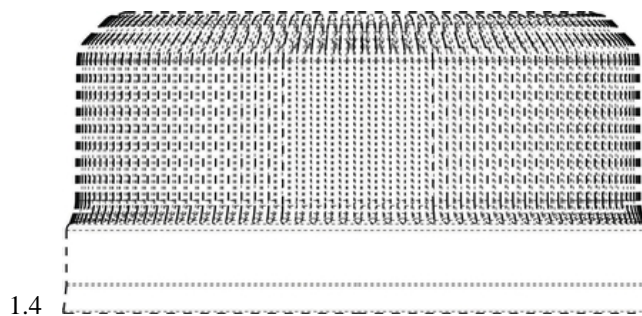
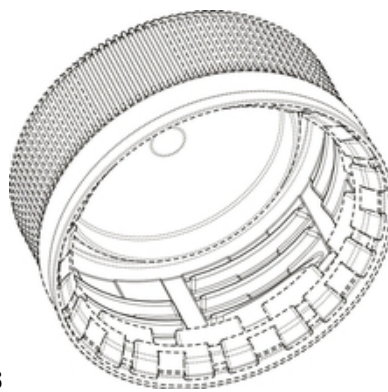
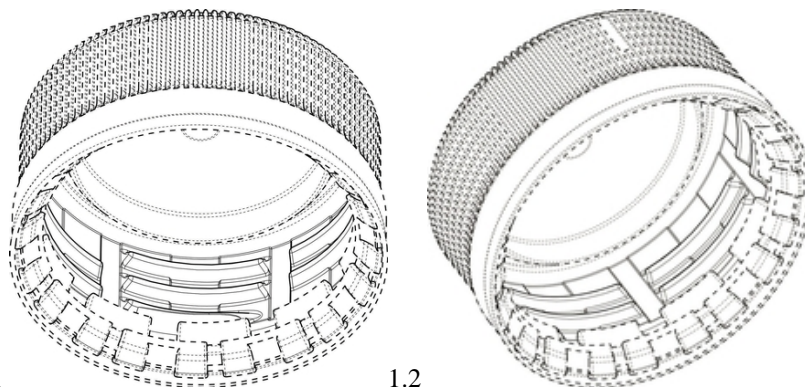

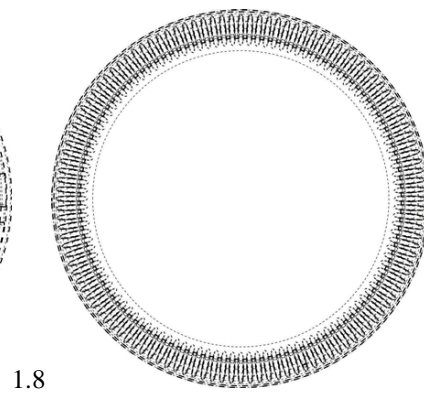
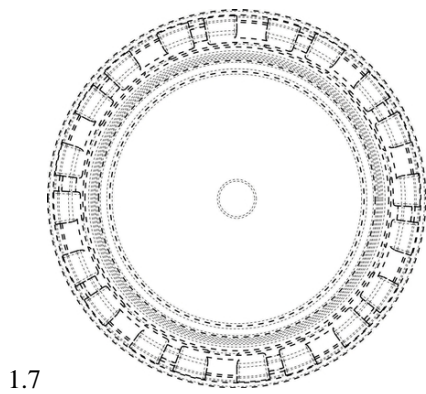
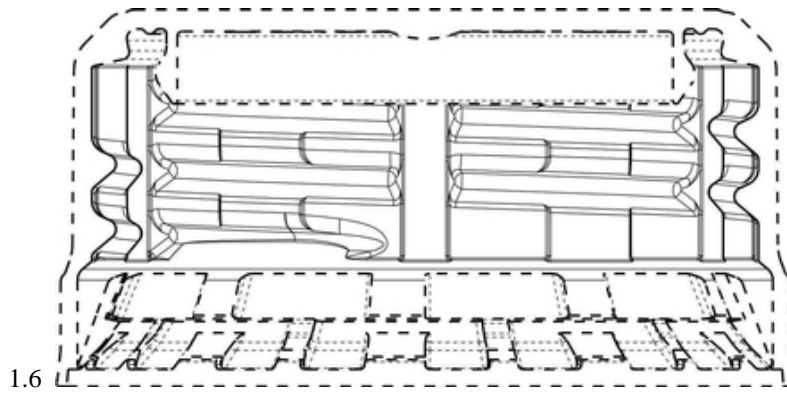
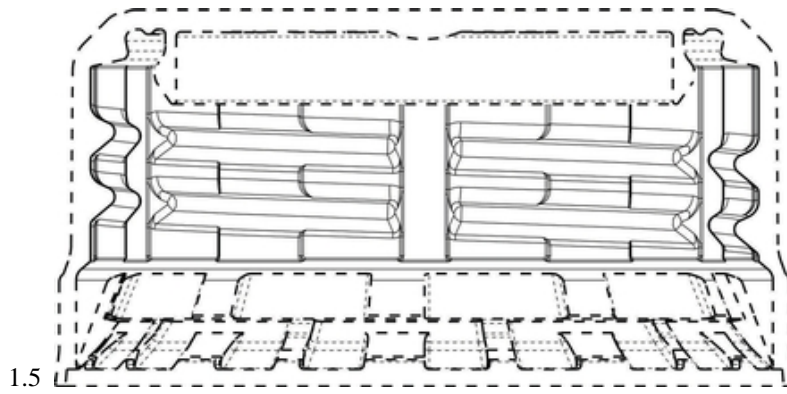

# TRADEMARKS

## APPLICATIONS FILED UNDER THE NATIONAL PROCEDURE APPROVED FOR REGISTRATION

The decision can be appealed at the Chamber of Appeal of Sakpatenti within 3 months from the publication or at the Mtskheta District Court Administrative Cases Board (Address: №17, Samkhedro St., Mtskheta), within 1 month following the publication.

(260) AM 2022 111163 A

(210) AM 111163

(220) 2021 01 07

(731) Mey Alkollu Ickiler Sanayii Ve Ticaret

Anonim Sirketi

Biuiuqdere Qad. Bakhar Soq. №:13 River

Plaza Kat:25 34394 Shishli, İstanbul,

Turkey

(740) Liliana Darakhvelidze

(540)



(591) Dark blue, black

(531) 27.05.01; 27.05.09; 27.05.10; 29.01.12

(511) 33

(740) Shalva Gvaramadze

(540)



(591) Light green, light lilac, crimson, black, white

(531) 02.09.01; 26.04.09; 26.04.18; 26.04.24;

28.05; 29.01.15

(511) 5

(260) AM 2022 114319 A

(210) AM 114319

(220) 2021 08 16

(731) JSC "Savane-Wine №1 Factory"

Petriashvili Str. 1, 0179, Tbilisi,

Old Tbilisi District, Georgia

(540)



(591) 000000 black, FFFFFFF white

(531) 07.01.01; 07.01.08; 07.01.12; 28.19

(526) სავანე

(511) 32, 33, 41, 43

(260) AM 2022 114693 A

(210) AM 114693

(220) 2021 09 22

(731) LTD "Askaneli Dzmebi"

Kakheti Highway 110a, 0198, Isani-Samgori

District, Tbilisi, Georgia

(740) Davit Dzamukashvili

(540)



(591) White, sky-blue

(531) 26.04.02; 26.04.22; 26.04.24; 27.05.01;

27.05.24; 29.01.12

(511) 33

(260) AM 2022 114691 A

(210) AM 114691

(220) 2021 09 21

(731) Obshchestvo s Ogranichennoy Otvetstven-

nostyu "Parapharm"

Ul. Sverdlova, dom 4, 440026, Penza,

Russian Federation

(260) AM 2022 114694 A

(210) AM 114694

(220) 2021 09 23

(731) Davit Abaiadze

Gamsakhurdia Str., II qu., bld. 6b, app. 18,

Tbilisi, Georgia

(740) Davit Abaiadze  
(540)

პეშვი  
**Peshvi**  
ПЕШВИ

(591) Black-white  
(511) 33

(260) AM 2022 114696 A  
(210) AM 114696  
(220) 2021 09 23  
(731) Nani Kamashidze  
Melikishvili Str. 129, 6010, Batumi, Georgia  
(540)

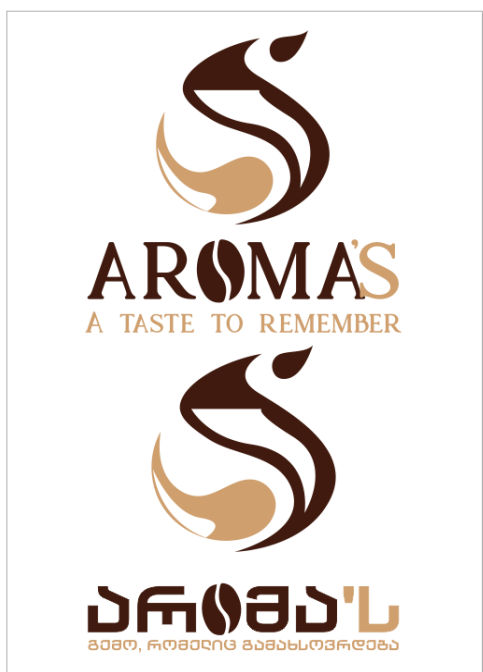

(591) Beige, brown  
(531) 05.07.01; 05.07.27; 26.13.25; 27.03.11;  
27.05.01; 27.05.10; 28.19; 29.01.13  
(511) 30, 35

(260) AM 2022 114699 A  
(210) AM 114699  
(220) 2021 09 24  
(731) UPL Corporation Limited  
5<sup>th</sup> Floor, Newport Building, Louis Pasteur  
Street, Port Louis, Mauritius  
(740) Pavle Meipariani  
(540)

**Xonil**

(591) Black-white  
(511) 5

(260) AM 2022 114737 A  
(210) AM 114737  
(220) 2021 09 24  
(731) Aleksandre Tavkheldze  
Pekin Ave. 2, app. 59, Tbilisi, Georgia  
(740) Tamar Kharazishvili  
(540)

**Winguard**

(591) Black-white  
(511) 42

(260) AM 2022 114741 A  
(210) AM 114741  
(220) 2021 09 27  
(731) Davit Katamadze  
Nino Zhvania Str. 63, app. 5, Tbilisi, Georgia  
(540)



(591) Grey, brown, white, black, blue, red  
(531) 03.01.14; 03.01.17; 03.01.20; 03.01.24;  
03.01.25; 26.04.01; 26.04.09; 27.05.01;  
27.05.09; 27.05.10; 27.05.11; 28.19; 29.01.15  
(511) 11

(260) AM 2022 114758 A  
(210) AM 114758  
(220) 2021 09 30  
(731) YETI Coolers LLC  
7601 Southwest Parkway, Austin, Texas  
78735, USA  
(740) Giorgi Meipariani  
(540)

**YETI**

(591) Black-white  
(511) 21

(260) AM 2022 114761 A  
(210) AM 114761  
(220) 2021 09 30  
(731) Nobel Food Industry LLC  
Nizami District, Haydar Aliyev avenue, House  
92a, Block 2023, Baku, AZ1029, Azerbaijan  
(740) Mariam Gogitidze  
(540)

**Joysi**

(591) Black-white  
(511) 29, 30, 31, 35

(260) AM 2022 114794 A  
 (210) AM 114794  
 (220) 2021 10 01  
 (731) LTD "G-T MOTORS"  
 David Aghmashenebeli Alley 155, 0131,  
 Saburtalo District, Tbilisi, Georgia  
 (540)



(591) F2F7F6 white, 213084 blue  
 (531) 26.04.04; 26.04.05; 26.04.22; 26.04.24;  
 27.05.01; 27.05.10; 27.05.19; 27.05.24;  
 29.01.12  
 (511) 12, 37

(260) AM 2022 114812 A  
 (210) AM 114812  
 (220) 2021 10 06  
 (731) LTD "Laghi"  
 Vill. Natakhtari, Mtskheta, Georgia  
 (740) Khatuna Imnadze  
 (540)



(591) White, red, black, sky-blue  
 (531) 01.15.19; 01.15.24; 01.15.25; 06.01.01;  
 06.01.04; 25.01.19; 26.11.03; 26.11.05;  
 26.11.12; 27.05.01; 28.19; 29.01.14  
 (511) 32

(260) AM 2022 114817 A  
 (210) AM 114817  
 (220) 2021 10 07  
 (731) Jacobs Douwe Egberts De GmbH  
 Langemarckstrasse 4-20, D-281 99 Bremen,  
 Germany  
 (740) Giorgi Taktakishvili  
 (540)

**JACOBS VELVET**

(591) Black-white  
 (511) 30

(260) AM 2022 114914 A  
 (210) AM 114914  
 (220) 2021 10 12  
 (731) Maia Belkania  
 Sairme Str. 12, app. 32, Tbilisi, Georgia  
 (740) Shalva Gvaramadze  
 (540)

**NETAV  
 HETAB  
 ნეტავ**

(591) Black-white  
 (511) 33

(260) AM 2022 114919 A  
 (210) AM 114919  
 (220) 2021 10 13  
 (731) LTD "Tu Le Ju"  
 Davit Aghmashenebeli Ave. 24, 4600,  
 Kutaisi, Georgia  
 (540)



(591) Black, white, light red  
 (531) 04.05.01; 04.05.02; 04.05.05; 05.05.20;  
 26.01.15; 29.01.12  
 (511) 43

(260) AM 2022 114927 A  
 (210) AM 114927  
 (220) 2021 10 14  
 (731) LLC "MOLECULE"  
 Ul. Zorge, Dom 5, Str. 3, Moscow, 123308,  
 Russian Federation  
 (740) Nino Bakhtadze  
 (540)

**MOLECULE**

(591) Black-white  
 (511) 35

(260) AM 2022 114973 A  
 (210) AM 114973  
 (220) 2021 10 15  
 (731) Nino Melanashvili  
 Gldani, VI mcr., bld. 23, app. 3, Tbilisi,  
 Georgia



(540)



(591) Black, grey, orange, yellow, red  
 (531) 08.01.04; 08.01.06; 08.01.15; 08.07.10;  
 08.07.25; 11.01.01; 11.01.05; 26.01.01;  
 26.01.04; 26.01.16; 26.01.21; 26.01.22;  
 26.01.24; 28.19; 29.01.14  
 (511) 43

(260) AM 2022 114986 A  
 (210) AM 114986  
 (220) 2021 10 18  
 (731) LTD "Global Orthopedic"  
 26 May Str. 80, fl. 4, Marneuli, Georgia  
 (540)



(591) White, black, blue, lilac  
 (531) 01.05.01; 01.17.02; 01.17.04; 01.17.05;  
 27.03.15; 27.05.08; 27.05.09; 27.05.10; 29.01.13  
 (511) 44

(260) AM 2022 114988 A  
 (210) AM 114988  
 (220) 2021 10 18  
 (731) LTD "Global Orthopedic"  
 26 May Str. 80, fl. 4, Marneuli, Georgia  
 (540)



(591) White, black, blue, lilac  
 (531) 01.05.01; 01.17.02; 01.17.04; 01.17.05;  
 26.01.13; 26.01.16; 26.11.02; 26.11.13;  
 28.19; 29.01.13  
 (511) 44

(260) AM 2022 115011 A  
 (210) AM 115011  
 (220) 2021 10 19  
 (731) LTD "Aragvi Valley"  
 Rustaveli Str. 6, 1813, Borough Zhinvali,  
 Dusheti, Georgia  
 (540)



(591) FCF9F9 white, 000000 black  
 (531) 14.07.01; 14.07.06; 26.13.25; 27.03.15;  
 27.05.01  
 (511) 33

(260) AM 2022 115013 A  
 (210) AM 115013  
 (220) 2021 10 20  
 (731) LTD "Bolero & Company"  
 Kuchishvili Str. 12-14-16, 0179, Tbilisi,  
 Georgia  
 (540)

ფანდური  
 ПАНДУРИ  
 Panduri

(591) Black-white  
 (511) 33

(260) AM 2022 115015 A  
 (210) AM 115015  
 (220) 2021 10 21  
 (731) BTC Media LLC  
 438 Houston St., No. 257, Nashville,  
 Tennessee, 37203, USA  
 (740) Tamar Kochlamazashvili  
 (540)



(591) Orange, black, white  
 (531) 26.11.03; 26.11.06; 26.11.07; 26.11.09;  
 29.01.12  
 (511) 9, 16, 25, 41

(260) AM 2022 115016 A  
 (210) AM 115016  
 (220) 2021 10 21  
 (731) BTC Media LLC  
 438 Houston St., No. 257, Nashville,  
 Tennessee, 37203, USA  
 (740) Tamar Kochlamazashvili  
 (540)



(591) Orange, black, white  
 (531) 26.11.03; 26.11.06; 26.11.07; 26.11.09;  
 27.05.01; 27.05.10; 29.01.12  
 (511) 9, 16, 25, 41

(260) AM 2022 115019 A  
 (210) AM 115019  
 (220) 2021 10 21  
 (731) Tetiana Shor  
 Niko Pirosmiani Str. 18d, app. 214, 6010,  
 Batumi, Georgia  
 (540)



(591) Red, black  
 (531) 26.01.01; 26.01.03; 26.01.24; 27.01.06;  
 27.05.01; 27.05.10; 27.05.22; 29.01.12  
 (511) 43

(260) AM 2022 115024 A  
 (210) AM 115024  
 (220) 2021 10 21  
 (731) Ashley Furniture Industries LLC  
 One Ashley Way, Arcadia, WI 54612, USA  
 (740) Tamaz Shilakadze  
 (540)

**ASHLEY FURNITURE  
 HOMESTORE**

(591) Black-white  
 (511) 35

(260) AM 2022 115025 A  
 (210) AM 115025  
 (220) 2021 10 21  
 (731) Ashley Furniture Industries LLC  
 One Ashley Way, Arcadia, WI 54612, USA

(740) Tamaz Shilakadze  
 (540)

**ემლი ავეჯის სახლის  
 მაღაზია**

(591) Black-white  
 (511) 35

(260) AM 2022 115026 A  
 (210) AM 115026  
 (220) 2021 10 21  
 (731) Ashley Furniture Industries LLC  
 One Ashley Way, Arcadia,  
 WI 54612, USA  
 (740) Tamaz Shilakadze  
 (540)

**ემლი**

(591) Black-white  
 (511) 20, 35

(260) AM 2022 115027 A  
 (210) AM 115027  
 (220) 2021 10 21  
 (731) Ashley Furniture Industries LLC  
 One Ashley Way, Arcadia,  
 WI 54612, USA  
 (740) Tamaz Shilakadze  
 (540)

**ემლი ჰომესტორი**

(591) Black-white  
 (511) 35

(260) AM 2022 115028 A  
 (210) AM 115028  
 (220) 2021 10 21  
 (731) Ashley Furniture Industries LLC  
 One Ashley Way, Arcadia,  
 WI 54612, USA  
 (740) Tamaz Shilakadze  
 (540)

**ეს არის სახლი**

(591) Black-white  
 (511) 20, 35

(260) AM 2022 115110 A  
 (210) AM 115110  
 (220) 2021 10 26  
 (731) Tornike Kurshitashvili  
 Givi Svanidze Str. 4, 0101, Tbilisi, Georgia;  
 Makhare Lepsveridze  
 Vill. Ikalto, 2206, Telavi, Georgia

(540)



(591) CC4F4F red, B54AAF lilac, DDDDDD white, DDD121 yellow, 66C3DD sky-blue, 3F48CC dark blue, 5753DB blue, E5AD95 pink, 070000 black  
 (531) 05.07.11; 05.07.12; 05.07.22; 11.03.02; 14.03.09; 14.07.09; 15.07.01; 26.01.01; 26.01.16; 27.05.01; 27.05.21; 29.01.15  
 (511) 25, 32, 43

(260) AM 2022 115111 A  
 (210) AM 115111  
 (220) 2021 10 26  
 (731) Eti Gida Sanayi Ve Ticaret Anonim Sirketi  
 Organize Sanayi Bolgesi 11 Cadde,  
 Eskisehir, Turkey  
 (740) Giorgi Kartvelishvili  
 (540)



(591) Dark brown, yellow, light grey, light red, white, black  
 (531) 05.11.19; 07.03.02; 07.03.20; 25.01.19; 26.11.06; 27.05.01; 27.05.02; 29.01.15  
 (511) 30

(260) AM 2022 115114 A  
 (210) AM 115114  
 (220) 2021 10 27  
 (731) Shenzhen Han Qing Da Technology Co., Ltd.  
 1/F & 2/F, Bldg.A4-101, Yulv industrial area,  
 Gongming Property Development  
 Corporation, Yulv Community, Yutang St.,  
 Guangming Dist., Shenzhen City, People's  
 Republic of China  
 (740) Shalva Gvaramadze

(540)

HQD

(591) Black-white  
 (531) 27.05.01; 27.05.23  
 (511) 34

(260) AM 2022 115117 A  
 (210) AM 115117  
 (220) 2021 10 27  
 (731) Tornike Kurshitashvili  
 Givi Svanidze Str. 4, 0101, Tbilisi, Georgia;  
 Makhare Lepsveridze  
 Vill. Ikalto, 2206, Telavi, Georgia

(540)

Kraken

(591) Black-white  
 (511) 33

(260) AM 2022 115118 A  
 (210) AM 115118  
 (220) 2021 10 27  
 (731) Riello S.P.A.  
 Via Ing. Pilade Riello, 7, 1-37048 Legnago,  
 Verona, Italy  
 (740) Liliana Darakhvelidze  
 (540)



(591) Black-white  
 (531) 26.04.01; 26.04.04; 26.04.12; 28.19  
 (511) 9, 11, 37

(260) AM 2022 115131 A  
 (210) AM 115131  
 (220) 2021 10 28  
 (731) LTD "Alfa"  
 Tevdore Mghvdeli Str. 53, 0154, Tbilisi,  
 Georgia  
 (740) Zurab Bezhashvili  
 (540)

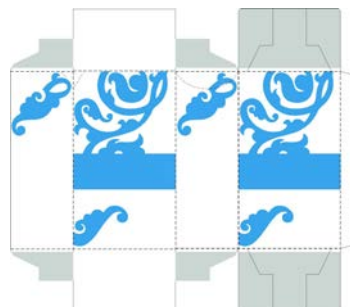

(591) 39A5EE sky-blue, silver, white  
 (531) 19.03.24; 25.01.25; 29.01.13  
 (511) 30

**REGISTERED TRADEMARKS**

(111) M 2022 35328 R  
(151) 2022 04 19  
(181) 2032 04 19  
(260) AM 2020 110303 A  
(220) 2020 10 29  
(732) GP Global Mag LLC  
National Industries Park, Dubai, United Arab  
Emirates

(111) M 2022 35329 R  
(151) 2022 04 19  
(181) 2032 04 19  
(260) AM 2021 111853 A  
(220) 2021 02 23  
(732) LTD "Gigi"  
Shalva Nutsubidze Plateau, III mcr., I qu.,  
bld. 16, app. 4, Saburtalo District, Tbilisi,  
Georgia

(111) M 2022 35330 R  
(151) 2022 04 19  
(181) 2032 04 19  
(260) AM 2021 111854 A  
(220) 2021 02 23  
(732) LTD "Gigi"  
Shalva Nutsubidze Plateau, III mcr., I qu.,  
bld. 16, app. 4, Saburtalo District, Tbilisi,  
Georgia

(111) M 2022 35331 R  
(151) 2022 04 19  
(181) 2032 04 19  
(260) AM 2021 111940 A  
(220) 2021 02 27  
(732) Pegas Touristik UK Limited  
16 Upper Woburn Place, London, England,  
WC1H 0BS, United Kingdom

(111) M 2022 35332 R  
(151) 2022 04 19  
(181) 2032 04 19  
(260) AM 2021 112367 A  
(220) 2021 03 26  
(732) LTD "Alt-Info"  
Vazha-Pshavela Av., VII qu., bld. 7,  
app. 52, Tbilisi, Georgia

(111) M 2022 35333 R  
(151) 2022 04 19  
(181) 2032 04 19  
(260) AM 2021 112421 A  
(220) 2021 06 09  
(732) LTD "Lab"  
N. Bokhua Str. 6, 0159, Tbilisi, Georgia

(111) M 2022 35334 R  
(151) 2022 04 19  
(181) 2032 04 19  
(260) AM 2021 112608 A  
(220) 2021 04 14  
(732) LTD "Boran Construction"  
Kandelaki Str. 8, app. 56, Tbilisi, Georgia

(111) M 2022 35335 R  
(151) 2022 04 19  
(181) 2032 04 19  
(260) AM 2021 112904 A  
(220) 2021 05 11  
(732) Hard Rock Limited  
26 New Street, Str. Helier Jersey JE2 3RA  
Channel Islands, United Kingdom

(111) M 2022 35336 R  
(151) 2022 04 19  
(181) 2032 04 19  
(260) AM 2021 112905 A  
(220) 2021 05 11  
(732) Hard Rock Limited  
26 New Street, Str. Helier Jersey JE2 3RA  
Channel Islands, United Kingdom

(111) M 2022 35337 R  
(151) 2022 04 19  
(181) 2032 04 19  
(260) AM 2021 112928 A  
(220) 2021 05 13  
(732) LTD "Draft"  
Uznadze Str. 111, bld. 2, app. 11, Tbilisi, Georgia

(111) M 2022 35338 R  
(151) 2022 04 19  
(181) 2032 04 19  
(260) AM 2021 112921 A  
(220) 2021 05 12  
(732) JSC "Corporation Kindzmarauli"  
Ilia Chavchavadze Str. 55, 4800, Kvareli, Georgia

(111) M 2022 35339 R  
 (151) 2022 04 19  
 (181) 2032 04 19  
 (260) AM 2021 112932 A  
 (220) 2021 05 13  
 (732) Yunnan Tobacco International Co., Ltd  
 №345 Panjing Street, Panlong District,  
 Kunming City, Yunnan Province, China

(111) M 2022 35345 R  
 (151) 2022 04 19  
 (181) 2032 04 19  
 (260) AM 2021 113189 A  
 (220) 2021 05 28  
 (732) LTD "Ornado Medicine ორნადო მედიცინა"  
 14<sup>th</sup> Str., II Lane 1, Vill. Irganchai, 1707,  
 Dmanisi Municipality, Georgia

(111) M 2022 35340 R  
 (151) 2022 04 19  
 (181) 2032 04 19  
 (260) AM 2021 113010 A  
 (220) 2021 05 14  
 (732) LLC "Imexpharm"  
 Right bank of the river Mtkvari, near the  
 entrance to the Bacteriophage, 0160,  
 Tbilisi, Georgia

(111) M 2022 35346 R  
 (151) 2022 04 19  
 (181) 2032 04 19  
 (260) AM 2021 113229 A  
 (220) 2021 05 31  
 (732) Tamaz Shilakadze  
 Ana Politkovskaya Str. 8g, 0186, Tbilisi, Georgia

(111) M 2022 35341 R  
 (151) 2022 04 19  
 (181) 2032 04 19  
 (260) AM 2021 113014 A  
 (220) 2021 05 14  
 (732) LTD "Boran Construction"  
 Kandelaki Str. 8, app. 56, Tbilisi, Georgia

(111) M 2022 35347 R  
 (151) 2022 04 19  
 (181) 2032 04 19  
 (260) AM 2021 113231 A  
 (220) 2021 05 31  
 (732) LLC "Lifferent"  
 Viktor Dolidze Str. 46/Meliton & Andria  
 Balanchivadze Str. 41, app. 47, block B,  
 Vake-Saburtalo District, Tbilisi, Georgia

(111) M 2022 35342 R  
 (151) 2022 04 19  
 (181) 2032 04 19  
 (260) AM 2021 113120 A  
 (220) 2021 05 25  
 (732) Tatia Eliadze  
 Baratashvili Str. 5, 38008, Ozurgeti, Georgia

(111) M 2022 35348 R  
 (151) 2022 04 19  
 (181) 2032 04 19  
 (260) AM 2021 113242 A  
 (220) 2021 06 01  
 (732) LTD "Wise Pharmaceutical Company"  
 14<sup>th</sup> Str., II Lane 1, Vill. Irganchai, 1707,  
 Dmanisi Municipality, Georgia

(111) M 2022 35343 R  
 (151) 2022 04 19  
 (181) 2032 04 19  
 (260) AM 2021 113137 A  
 (220) 2021 05 26  
 (732) Genzyme Corporation  
 50 Binney Street, Cambridge, MA 02142, USA

(111) M 2022 35349 R  
 (151) 2022 04 19  
 (181) 2032 04 19  
 (260) AM 2021 113253 A  
 (220) 2021 06 01  
 (732) LTD "Wise Pharmaceutical Company"  
 14<sup>th</sup> Str., II Lane 1, Vill. Irganchai, 1707,  
 Dmanisi Municipality, Georgia

(111) M 2022 35344 R  
 (151) 2022 04 19  
 (181) 2032 04 19  
 (260) AM 2021 113140 A  
 (220) 2021 05 27  
 (732) Hankook Tire & Technology Co., Ltd  
 286, Pangyo-ro, Bundang-gu, Seongnam-si,  
 Gyeonggi-do, Republic of Korea

(111) M 2022 35350 R  
 (151) 2022 04 19  
 (181) 2032 04 19  
 (260) AM 2021 113273 A  
 (220) 2021 06 02  
 (732) LLC "Alazani Winery"  
 Demetre Tavdadebuli Str. 3, 4800, Kvareli,  
 Georgia

(111) M 2022 35351 R  
(151) 2022 04 19  
(181) 2032 04 19  
(260) AM 2021 113398 A  
(220) 2021 06 08  
(732) Hankook & Company Co., LTD  
286, Pangyo-ro, Bundang-gu, Seongnam-si,  
Gyeonggi-do, Republic of Korea

---

(111) M 2022 35352 R  
(151) 2022 04 19  
(181) 2032 04 19  
(260) AM 2021 113494 A  
(220) 2021 06 14  
(732) LLC "Online Tickets"  
Irakli Abashidze Str. 3, app. 11, Tbilisi, Georgia

---

(111) M 2022 35359 R  
(151) 2022 04 28  
(181) 2032 04 28  
(260) AM 2021 112610 A  
(220) 2021 04 14  
(732) LLC "Chateau Ozhio"  
Vill. Sioni, Tianeti, Georgia

---

(111) M 2022 35360 R  
(151) 2022 04 28  
(181) 2032 04 28  
(260) AM 2021 112622 A  
(220) 2021 04 15  
(732) Giorgi Chkheidze  
Guram Panjikidze Str. 22, Block "A", app. 12,  
Tbilisi Georgia

---

(111) M 2022 35361 R  
(151) 2022 04 28  
(181) 2032 04 28  
(260) AM 2021 112707 A  
(220) 2021 04 22  
(732) Mohan Meakin Limited  
Solani Brewery P. O. N173 214, Shimla Hills,  
Himachal Pradesh, India

---

(111) M 2022 35362 R  
(151) 2022 04 28  
(181) 2032 04 28  
(260) AM 2021 112711 A  
(220) 2021 04 23  
(732) INTEL CORPORATION  
2200 Mission College Boulevard, Santa Clara,  
California 95052, USA

---

(111) M 2022 35363 R  
(151) 2022 04 28  
(181) 2032 04 28  
(260) AM 2021 112713 A  
(220) 2021 04 26  
(732) LTD "Lazieri"  
Peikrebi Str. 12, Nadzaladevi District, Tbilisi,  
Georgia

---

(111) M 2022 35364 R  
(151) 2022 04 28  
(181) 2032 04 28  
(260) AM 2021 113016 A  
(220) 2021 05 14  
(732) Acer Incorporated  
7F-5, No. 369, Fuxing N. Rd., Songshan Dist.,  
Taipei City 10541, Taiwan, Province of China

---

(111) M 2022 35365 R  
(151) 2022 04 28  
(181) 2032 04 28  
(260) AM 2021 113025 A  
(220) 2021 05 17  
(732) LTD "Fit +"  
Gomareti Str. 11, 0101, Nadzaladevi District,  
Tbilisi, Georgia

---

(111) M 2022 35366 R  
(151) 2022 04 28  
(181) 2032 04 28  
(260) AM 2021 113122 A  
(220) 2021 05 25  
(732) Exxon Mobil Corporation  
5959 Las Colinas Boulevard, Irving, Texas  
75039-2298, USA

---

(111) M 2022 35367 R  
(151) 2022 04 28  
(181) 2032 04 28  
(260) AM 2021 113147 A  
(220) 2021 05 28  
(732) Colgate-Palmolive Company,  
Delaware Corporation  
300 Park Avenue, New York, New York  
10022, USA

---

(111) M 2022 35368 R  
(151) 2022 04 28  
(181) 2032 04 28  
(260) AM 2021 113204 A  
(220) 2021 05 29  
(732) LTD "Wine Thieves"  
Bezhanishvili Str. 25, app. 10, 0183, Tbilisi,  
Georgia

---

(111) M 2022 35369 R  
(151) 2022 04 28  
(181) 2032 04 28  
(260) AM 2021 113213 A  
(220) 2021 05 31  
(732) LTD "Leto"  
Mukhran Machavariani Str. 6b, app. 8, Tbilisi,  
Georgia

---

(111) M 2022 35370 R  
(151) 2022 04 28  
(181) 2032 04 28  
(260) AM 2021 113214 A  
(220) 2021 05 31  
(732) LTD "Keria"  
Pekini Av. 25, app. 10, Tbilisi, Georgia

---

(111) M 2022 35371 R  
(151) 2022 04 28  
(181) 2032 04 28  
(260) AM 2021 113224 A  
(220) 2021 05 31  
(732) LTD "Biopolus"  
Noneshvili Str. 65, 6000, Batumi, Georgia

---

(111) M 2022 35372 R  
(151) 2022 04 28  
(181) 2032 04 28  
(260) AM 2021 113226 A  
(220) 2021 05 31  
(732) LTD "Biopolus"  
Noneshvili Str. 65, 6000, Batumi, Georgia

---

(111) M 2022 35373 R  
(151) 2022 04 28  
(181) 2032 04 28  
(260) AM 2021 113232 A  
(220) 2021 05 31  
(732) LTD "Biopolus"  
Noneshvili Str. 65, 6000, Batumi, Georgia

---

(111) M 2022 35374 R  
(151) 2022 04 28  
(181) 2032 04 28  
(260) AM 2021 113243 A  
(220) 2021 06 01  
(732) LTD "Biopolus"  
Noneshvili Str. 65, 6000, Batumi, Georgia

---

(111) M 2022 35375 R  
(151) 2022 04 28  
(181) 2032 04 28  
(260) AM 2021 113245 A  
(220) 2021 06 01  
(732) LTD "Biopolus"  
Noneshvili Str. 65, 6000, Batumi, Georgia

---

(111) M 2022 35376 R  
(151) 2022 04 28  
(181) 2032 04 28  
(260) AM 2021 113247 A  
(220) 2021 06 01  
(732) LTD "Biopolus"  
Noneshvili Str. 65, 6000, Batumi, Georgia

---

(111) M 2022 35377 R  
(151) 2022 04 28  
(181) 2032 04 28  
(260) AM 2021 113248 A  
(220) 2021 06 01  
(732) LTD "Biopolus"  
Noneshvili Str. 65, 6000, Batumi, Georgia

---

(111) M 2022 35378 R  
(151) 2022 04 28  
(181) 2032 04 28  
(260) AM 2021 113279 A  
(220) 2021 06 03  
(732) Ruslan Bolkvadze  
Javakhishvili Str. 78, app. 48, Batumi, Georgia

---

(111) M 2022 35379 R  
(151) 2022 04 28  
(181) 2032 04 28  
(260) AM 2021 113360 A  
(220) 2021 06 04  
(732) JSC "Gepha"  
Akaki Beliashvili Str. 142, 0159, Tbilisi, Georgia

---

(111) M 2022 35380 R  
(151) 2022 04 28  
(181) 2032 04 28  
(260) AM 2021 114545 A  
(220) 2021 09 09  
(732) LLC "Khairat Al Minafie Co. for Transport  
and General Trading"  
27 boulevard Saborni, Varna, 9000, Bulgaria

---

(111) M 2022 35387 R  
(151) 2022 05 04  
(181) 2032 05 04  
(260) AM 2021 111336 A  
(220) 2021 01 21  
(732) Holland & Barrett Interneshnl Limited  
Samuel Ryder House, Barling Way, Eliot Park,  
Nuneaton, Warwickshire, CV10 7RH, United  
Kingdom

---

(111) M 2022 35388 R  
(151) 2022 05 04  
(181) 2032 05 04  
(260) AM 2021 111432 A  
(220) 2021 06 28  
(732) LTD "Daxi"  
Gogebashvili Str. 3, Kutaisi, Georgia

---

(111) M 2022 35389 R  
(151) 2022 05 04  
(181) 2032 05 04  
(260) AM 2021 112256 A  
(220) 2021 03 19  
(732) S. C. Johnson & Son, Inc.  
1525 Howe Street, Racine, WI 53403-  
2236, USA

---

(111) M 2022 35390 R  
(151) 2022 05 04  
(181) 2032 05 04  
(260) AM 2021 112284 A  
(220) 2021 03 23  
(732) LLC "Bolero & Company"  
Kuchishvili Str. 12-14-16, 0179, Tbilisi, Georgia

---

(111) M 2022 35391 R  
(151) 2022 05 04  
(181) 2032 05 04  
(260) AM 2021 112503 A  
(220) 2021 04 07  
(732) Gocha Avkopashvili  
Ilia Chavchavadze Str. 127, Bolnisi, Georgia

---

(111) M 2022 35392 R  
(151) 2022 05 04  
(181) 2032 05 04  
(260) AM 2021 112505 A  
(220) 2021 04 08  
(732) LLC "International Masis Tabak"  
10 Hrant Vardanyan St., 0802 Masis, Ararat  
Region, Armenia

---

(111) M 2022 35393 R  
(151) 2022 05 04  
(181) 2032 05 04  
(260) AM 2021 112575 A  
(220) 2021 04 12  
(732) Swiss Pharma International AG  
Lindenstrasse 22, 8008 Zurich, Switzerland

---

(111) M 2022 35394 R  
(151) 2022 05 04  
(181) 2032 05 04  
(260) AM 2021 112576 A  
(220) 2021 04 12  
(732) PPG Industries Ohio Inc.  
3800 West 143rd St., Cleveland, Ohio,  
44111, USA

---

(111) M 2022 35395 R  
(151) 2022 05 04  
(181) 2032 05 04  
(260) AM 2021 112727 A  
(220) 2021 04 29  
(732) S. C. Johnson & Son Inc.  
1525 Howe Street, Racine, WI 53403-2236, USA

---

(111) M 2022 35396 R  
(151) 2022 05 04  
(181) 2032 05 04  
(260) AM 2021 112729 A  
(220) 2021 04 29  
(732) Dell Inc.  
One Dell Way, Round Rock, Texas 78682, USA

---

(111) M 2022 35397 R  
(151) 2022 05 04  
(181) 2032 05 04  
(260) AM 2021 113013 A  
(220) 2021 05 14  
(732) The Procter & Gamble Company  
One Procter & Gamble Plaza, Cincinnati,  
Ohio 45202, USA

---

(111) M 2022 35398 R  
(151) 2022 05 04  
(181) 2032 05 04  
(260) AM 2021 113112 A  
(220) 2021 05 24  
(732) LLC "Ch.Ch.Sh"  
G. Eliozishvili St., bld. 13, app. 18, Gori, Georgia

---



(111) M 2022 35399 R  
(151) 2022 05 04  
(181) 2032 05 04  
(260) AM 2021 113186 A  
(220) 2021 05 28  
(732) LTD "Agronomi"  
B. Kvernadze Str. 35, entrance 2, fl. 3, 0171,  
Tbilisi, Georgia

---

(111) M 2022 35400 R  
(151) 2022 05 04  
(181) 2032 05 04  
(260) AM 2021 113238 A  
(220) 2021 06 01  
(732) LTD "Ch.Ch.Sh"  
G. Eliozishvili St., bld. 13, app. 18, 1400,  
Gori, Georgia

---

(111) M 2022 35401 R  
(151) 2022 05 04  
(181) 2032 05 04  
(260) AM 2021 113244 A  
(220) 2021 06 01  
(732) Giorgi Jincharadze  
Ninoshvili Str. 58, Tbilisi, Georgia

---

(111) M 2022 35402 R  
(151) 2022 05 04  
(181) 2032 05 04  
(260) AM 2021 113338 A  
(220) 2021 06 04  
(732) Gilead Sciences Ireland UC  
IDA Business and Technology Park,  
Carrigtohill, Co. Cork, Ireland

---

(111) M 2022 35403 R  
(151) 2022 05 04  
(181) 2032 05 04  
(260) AM 2021 113342 A  
(220) 2021 06 04  
(732) LTD "Impexpharm"  
Right bank of the River Mtkvari, near the  
entrance to the Bacteriophage, 0160, Tbilisi,  
Georgia

---

(111) M 2022 35404 R  
(151) 2022 05 04  
(181) 2032 05 04  
(260) AM 2021 113344 A  
(220) 2021 06 04  
(732) LTD "Impexpharm"  
Right bank of the River Mtkvari, near the  
entrance to the Bacteriophage, 0160, Tbilisi,  
Georgia

---

(111) M 2022 35405 R  
(151) 2022 05 04  
(181) 2032 05 04  
(260) AM 2021 113347 A  
(220) 2021 06 04  
(732) LTD "Tiflisski Vinni Pogreb"  
Umashev Str. 27, 0198, Tbilisi, Georgia

---

(111) M 2022 35406 R  
(151) 2022 05 04  
(181) 2032 05 04  
(260) AM 2021 113356 A  
(220) 2021 06 04  
(732) LTD "Ritula"  
Uznadze Str. 111, bld. 2, app. 11, Tbilisi, Georgia

---

(111) M 2022 35407 R  
(151) 2022 05 04  
(181) 2032 05 04  
(260) AM 2021 113387 A  
(220) 2021 06 07  
(732) LTD "Kvarlis Sardapi"  
Vill. Chikaani, 4814, Kvareli, Georgia

---

(111) M 2022 35408 R  
(151) 2022 05 04  
(181) 2032 05 04  
(260) AM 2021 113389 A  
(220) 2021 06 07  
(732) LTD "Kvarlis Sardapi"  
Vill. Chikaani, 4814, Kvareli, Georgia

---

(111) M 2022 35409 R  
(151) 2022 05 04  
(181) 2032 05 04  
(260) AM 2021 113486 A  
(220) 2021 06 11  
(732) LTD "Impexpharm"  
Right bank of the River Mtkvari, near the  
entrance to the Bacteriophage, 0160, Tbilisi,  
Georgia

---

(111) M 2022 35410 R  
(151) 2022 05 04  
(181) 2032 05 04  
(260) AM 2021 113426 A  
(220) 2021 06 10  
(732) LTD "Joy Mail"  
Grigol Lortkipanidze Str. 6, app. 140, 6000,  
Batumi, Georgia

---

(111) M 2022 35411 R  
(151) 2022 05 04  
(181) 2032 05 04  
(260) AM 2021 113603 A  
(220) 2021 06 22  
(732) Aleksandre Sukiashvili  
Varketili III array, bld. 34, app. 27, 0182,  
Tbilisi Georgia

---

(111) M 2022 35412 R  
(151) 2022 05 04  
(181) 2032 05 04  
(260) AM 2021 113852 A  
(220) 2021 07 12  
(732) SENN-Caucasian Environmental NGO  
Network Bethlehem Str. 27, 0105, Tbilisi, Georgia

---

(111) M 2022 35413 R  
(151) 2022 05 04  
(181) 2032 05 04  
(260) AM 2021 104319 A  
(220) 2021 06 11  
(732) LTD "Rich Group"  
Vill. Mughanlo, Marneuli District, Georgia

---

## TRADEMARKS REGISTERED ACCORDING TO THE ACCELERATED PROCEDURE

The decision can be appealed at the Chamber of Appeal of Sakpatenti within 3 months from the publication.

(111) M 2022 35327 R  
(151) 2022 04 20  
(181) 2032 04 20  
(210) AM 117291  
(220) 2022 03 30  
(732) LLC "Qvevrula"  
Vill. Tkemlovana, Chiatura, Georgia  
(740) Salome Jeladze  
(540)

**ღვივილა**  
**Ghvivila**

(591) Black-white  
(511) 19, 21

(111) M 2022 35353 R  
(151) 2022 04 20  
(181) 2032 04 20  
(210) AM 117188  
(220) 2022 03 23  
(310) UK00003741862  
(320) 2022 01 11  
(330) UK  
(732) Innovation Worldwide Universal LLP  
2<sup>nd</sup> Floor College House, 17 King Edwards  
Road, Ruislip, London, HA4 7AE,  
United Kingdom  
(740) Giorgi Taktakishvili  
(540)

**PINKISS**

(591) Black-white  
(511) 5

(111) M 2022 35354 R  
(151) 2022 04 20  
(181) 2032 04 20  
(210) AM 117527  
(220) 2022 04 18  
(732) LTD "Mars"  
Kavtaradze Str. 5, Entrance 2, Floor 2, Office  
Space 2, 0186, Vake District, Tbilisi, Georgia  
(540)

**CrystalAuto**

(591) FDE053 yellow, 000000 black  
(511) 41

(111) M 2022 35355 R  
(151) 2022 04 20  
(181) 2032 04 20  
(210) AM 117526  
(220) 2022 04 18  
(732) LTD "Mars"  
Kavtaradze Str. 5, Entrance 2, Floor 2, Office  
Space 2, 0186, Vake District, Tbilisi, Georgia  
(540)

**CrystalSport**

(591) 000000 black, FDE053 yellow  
(511) 41

(111) M 2022 35356 R  
(151) 2022 04 21  
(181) 2032 04 21  
(210) AM 117413  
(220) 2022 04 08  
(732) LTD "New Pharm Group"  
Irodion Evdoshvili Str. 18, Office Space 2,  
0154, Tbilisi, Georgia  
(540)

**ქოლედევითი**  
**Choledevit**  
**Холедевит**

(591) Black-white  
(511) 5

(111) M 2022 35357 R  
(151) 2022 04 27  
(181) 2032 04 27  
(210) AM 117276  
(220) 2022 03 29  
(732) LTD "City Real Estate"  
Gamsakhurdia Ave. 30, Tbilisi, Georgia  
(540)



**ONYX HOTEL**

Our Promise engraved in stone

(591) Golden, black  
 (531) 26.03.04; 26.04.04; 26.04.09; 26.13.25;  
 27.05.01; 27.05.10; 27.05.11; 29.01.12  
 (511) 43, 44

(111) M 2022 35358 R  
 (151) 2022 04 27  
 (181) 2032 04 27  
 (210) AM 117430  
 (220) 2022 04 11  
 (732) Salumificio Fratelli Beretta S.P.A.  
 Via Garibaldi, 67, 23891 Barzanò LC, Italy  
 (740) Giorgi Taktakishvili  
 (540)



(591) Black-white  
 (531) 26.01.01; 26.01.17; 26.01.19; 26.11.12;  
 27.07.01; 27.07.17  
 (511) 29

(111) M 2022 35381 R  
 (151) 2022 04 28  
 (181) 2032 04 28  
 (210) AM 117304  
 (220) 2022 04 04  
 (732) JSC "Sarajishvili"  
 Sarajishvili Ave. 4, 0153, Tbilisi, Georgia  
 (540)



(591) Black-white  
 (531) 05.03.13; 05.03.15; 05.07.06; 09.01.07;  
 09.01.10; 25.01.05; 26.11.08; 27.05.01;  
 27.05.03; 27.05.09; 27.05.10; 27.05.11  
 (511) 33

(111) M 2022 35382 R  
 (151) 2022 05 02  
 (181) 2032 05 02  
 (210) AM 117615  
 (220) 2022 04 26

(732) LTD "New Pharm Group"  
 Irodion Evdoshvili Str. 18, Office Space 2,  
 0154, Tbilisi, Georgia  
 (540)

**ჰემოქსა**  
**Hemoxa**  
**Гемокса**

(591) Black-white  
 (511) 5

(111) M 2022 35383 R  
 (151) 2022 05 02  
 (181) 2032 05 02  
 (210) AM 117442  
 (220) 2022 04 12  
 (732) LTD "Bolero & Company"  
 Kuchishvili Str. 12-14-16, 0179, Tbilisi,  
 Georgia  
 (540)

**KING'S HAND**

(591) Black-white  
 (511) 33

(111) M 2022 35384 R  
 (151) 2022 05 02  
 (181) 2032 05 02  
 (210) AM 117440  
 (220) 2022 04 12  
 (732) LTD "Bolero & Company"  
 Kuchishvili Str. 12-14-16, 0179, Tbilisi,  
 Georgia  
 (540)

**OAKSHAFT**

(591) Black-white  
 (511) 33

(111) M 2022 35385 R  
 (151) 2022 05 02  
 (181) 2032 05 02  
 (210) AM 117441  
 (220) 2022 04 12  
 (732) LTD "Bolero & Company"  
 Kuchishvili Str. 12-14-16, 0179, Tbilisi,  
 Georgia  
 (540)

**UNWEDER HILL**

(591) Black-white  
 (511) 33

(111) M 2022 35386 R  
(151) 2022 05 04  
(181) 2032 05 04  
(210) AM 117611  
(220) 2022 04 26  
(732) Ontex Tüketim Ürünleri Sanayi Ve Ticaret  
Anonim Şirketi  
Vadistanbul Bulvar, Ayazağa Mah. Azerbay-  
can Cad. No: 109-E, 1d Blok, Kat 6 34485,  
Sarıyer/İstanbul, Turkey  
(740) Giorgi Taktakishvili  
(540)

*you & me*  
**yes!**

(591) Black-white  
(531) 24.17.04; 27.05.01; 27.05.10  
(511) 5, 35

(111) M 2022 35414 R  
(151) 2022 05 05  
(181) 2032 05 05  
(210) AM 117295  
(220) 2022 04 03  
(732) Philip Morris Brands Sàrl  
Quai Jeanrenaud 3, 2000 Neuchâtel,  
Switzerland  
(740) Pavle Meipariani  
(540)



**THE LEADING GLOBAL CIGARETTE BRAND SINCE 1972**

(591) Black-white  
(531) 01.05.01; 01.05.02; 27.05.01; 27.07.01  
(511) 34

## INTERNATIONAL TRADEMARKS FOR WHICH A DECISION ON GRANTING PROTECTIONS IS TAKEN

The decision can be appealed at the Chamber of Appeal of Sakpatenti within 3 months from the publication or at the Mtskheta District Court Administrative Cases Board (Address: №17, Samkhedro St., Mtskheta), within 1 month following the publication.

(260) AM 2022 102134 A\*\*

(800) 1342799

(151) 2016 12 27

(891) 2019 02 08

(731) "INTERNATIONAL MASIS TABAK" LLC  
10 Hrant Vardanyan str., Masis, 0802 Ararat region, Armenia

(540)



(591) Dark and light brown, golden and red

(531) 26.04.09; 26.04.18; 27.05.10; 29.01.14

(526) Virginia Blend, Slim Size, Filter Cigarettes.

(511)

34 – Tobacco, smokers' articles, matches; gas containers for lighters; absorbent paper for tobacco pipes, cigarette papers; lighters for smokers; tobacco pouches (bags); books of cigarette papers; humidors; match boxes, firestones; cigar cutters; tobacco pipes, pipe racks for tobacco pipes, tips of yellow amber for cigar and cigarette holders; ashtrays; spittoons for tobacco; tobacco holders; pipe cleaners for tobacco pipes, cigarettes; cigarillos; cigars; tobacco jars, match boxes, not from precious metals; chewing tobacco; snuff; tobacco cases; pipes, pocket machines for rolling cigarettes, cigarette filters; cigar cases, cigarette cases for tobacco.

(260) AM 2022 111254 A\*

(800) 1570189

(151) 2020 07 30

(891) 2020 07 30

(731) Baxter S.r.l.

Via Trento 68, I-20821 Meda (MB),  
Italy

(540)

### BAXTER

(591) Black, white

(511)

20 – Furniture; metal furniture; leather furniture; plastic furniture; office furniture; school furniture; wardrobes; sofas; tables; armchairs; chairs; beds; mattresses; pillows; bedside tables; dressers; sideboards; furniture shelves; furniture parts; umbrella stands; magazine racks; coat racks; garden furniture; mirrors; furniture, mirrors, picture frames; cabinetry; mannequins.

35 – Retail and wholesale services of lighting fixtures and fittings, chandeliers, stem lamps, arc lamps, oil lamps, laboratory lamps, electric lamps, lighting lamps, lighting bulbs, lighting lanterns, lampshades, lighting torches, lamp tubes, lighting tubes, glass for lamps; retail and wholesale services of leather articles, leathers, leather goods, imitation leather goods, bags, handbags, suitcases, rucksacks, wallets, purses, briefcases, leather and imitation leather briefcases, trunks, leather key cases, umbrellas, harnesses and other saddlery; retail and wholesale services of furniture, metal furniture, leather furniture, plastic furniture, office furniture, school furniture, wardrobes, sofas, tables, armchairs, chairs, beds, mattresses, pillows, bedside tables, dressers, sideboards, furniture shelves, furniture parts, wooden or plastic staircases, umbrella stands, magazine racks, coat racks, garden furniture, mirrors, frames, cabinetry, mannequins; retail and wholesale services of carpets, door mats, mats, floor coverings, non-textile wall coverings, upholstery papers, fabric wall coverings, foot-cleaners [door mats], matting, bath mats, rugs.

(260) AM 2022 111265 A\*

(800) 1478790

(151) 2019 05 23

(891) 2020 10 28

(731) OLIMP LABORATORIES Sp. z o.o.

Pustynia 84 F, PL-39-200 Dębica, Poland

(540)

### Olimp Labs

(591) Black, white

(511)

5 – dietetic substances for humans for medicinal use; energising supplements for humans containing parapharmaceutical preparations used in prophylaxis and in convalescence, for medicinal purposes; dietary supplements for humans adapted for medical use.

(260) AM 2022 112427 A  
 (800) 1583491  
 (151) 2021 01 28  
 (891) 2021 01 28  
 (731) SEARA ALIMENTOS LTDA  
 Avenida Marginal Direita do Tiete, 500 – Bloco  
 II – Subsolo – Sala 13, 05118-100 SÃO  
 PAULO – SP, Brazil

(540)



(591) Red, yellow and white  
 (531) 01.03.02; 26.01.03; 26.01.16; 26.01.18;  
 26.01.24; 27.05.01; 27.05.08; 27.05.24;  
 29.01.13

(511)

29 – Poultry, not live; lard; bacon; meat; pork; meat, preserved; croquettes; margarine; pickles; ham; cheese; hot dog sausages; meatballs; chicken stock; jerky [dried salted meat]; chispe [pork's foot]; ribs [cut of meat]; cold cuts; hamburger patties; sausages; loin meats; mortadella; paio [lusobrazilian pork sausage]; meat pâté; rabada [stew oxtail-based dish]; salami; pickled vegetables; frozen vegetables; salted meats; liver pâté; french fries; fat-containing mixtures for bread slices; prepared meals consisting primarily of meat, fish, poultry or vegetables.

(260) AM 2022 113630 A  
 (800) 1597690  
 (151) 2021 02 15  
 (891) 2021 02 15  
 (731) SEÇİL ETEK GİYİM SANAYİ VE TİCARET  
 ANONİM ŞİRKETİ  
 Ehlbeyt Mah. 6. Sokak No:31, Balgat Cankaya,  
 Ankara, Turkey

(540)

**IL MIO**

(591) Black, white

(511)

25 – Clothing, including underwear and outer clothing, other than special purpose protective clothing; socks; footwear; headgear.

(260) AM 2022 113713 A  
 (800) 1599135  
 (151) 2021 03 31  
 (891) 2021 03 31  
 (731) Unitron Prom Ltd  
 Gornaya str., 3A, RU-440000 Penza,  
 Russian Federation

(540)

**NUTS FOR LIFE**

(591) Black, white

(531) 27.05.01

(511)

29 – Nuts, prepared.

(260) AM 2022 113842 A

(800) 1580793

(151) 2021 01 19

(891) 2021 05 21

(731) Rillius Holding Limited

Christodoulou Chatzipavlou, 199, 4th Floor,  
 Flat/Office 4E, CY-3036 Limasso, Cyprus

(540)



(591) Yellow and black

(531) 26.04.09; 26.04.18; 26.04.24; 27.05.01;  
 29.01.12

(511)

35 – Web indexing for commercial or advertising purposes; business management of performing artists; business management of sports people; organization of exhibitions for commercial or advertising purposes; business intermediary services relating to the matching of potential private investors with entrepreneurs needing funding; business efficiency expert services; outsourcing services [business assistance]; sponsorship search; advertising / publicity; pay per click advertising; online advertising on a computer network; dissemination of advertising matter; systemization of information into computer databases; sales promotion for others; promotion of goods and services through sponsorship of sports events; negotiation and conclusion of commercial transactions for third parties; professional business consultancy.

41 – Academies [education]; arranging and conducting of conferences; arranging and conducting of in-person educational forums; arranging and conducting of seminars; electronic desktop publishing; providing user reviews for entertainment or cultural purposes; providing information in the field of education; providing information in the field of entertainment; providing information relating to recreational activities; providing online videos, not downloadable; providing online electronic publications, not downloadable; providing television programmes, not downloadable, via video-on-demand services / providing television programs, not downloadable, via video-on-demand servi-

ces; providing films, not downloadable, via video-on-demand services; providing user rankings for entertainment or cultural purposes / providing user ratings for entertainment or cultural purposes; providing sports facilities; providing casino facilities [gambling]; booking of seats for shows; game services provided online from a computer network; organization of shows [impresario services]; organization of exhibitions for cultural or educational purposes; organization of lotteries; organization of sports competitions; providing amusement arcade services; club services [entertainment or education]; health club services [health and fitness training]; nightclub services [entertainment]; amusement park services; sport camp services; gambling services; conducting fitness classes; online publication of electronic books and journals; publication of books; publication of texts, other than publicity texts; entertainment services; production of shows; physical education.

(260) AM 2022 113844 A  
(800) 1592029  
(151) 2021 03 05  
(891) 2021 04 13  
(731) Jose Bay e.U.

DC Tower, 30th Floor, Donau-City-Straße 7,  
A-1220 Wien, Austria

(540)

## UBI

(591) Black, white  
(511)

36 – business insurance services; advice on corporate real estate; provision of credit for fuel expenses; providing financial information about stolen credit cards; financial consultancy relating to real estate investment; real estate investment services.

42 – software design; computer software consultancy; software creation; software engineering; development of computer software; software creation; software development services; computer software consulting; Data storage via a blockchain; blockchain as a service [baas]; testing of computer equipment; design and development of computer software for logistics, supply chain management and e-business portals; development services in relation to databases; programming of software for database management; database development; development and maintenance of computer database software; design and development of computer software for database management.

(260) AM 2022 113899 A  
(800) 1601921  
(151) 2021 05 10  
(891) 2021 05 10  
(731) J.S. SUBS, LLC

2121 Vista Parkway, West Palm Beach  
FL 33411, USA

(540)

## JON SMITH SUBS

(591) Black, white  
(526) SUBS  
(511)  
43 – Restaurant services.

(260) AM 2022 113900 A  
(800) 1602036  
(151) 2021 04 08  
(891) 2021 04 08  
(731) ARSENAL AD

"Rozova dolina" str. 100, BG-6100 Kazanlak,  
Bulgaria

(540)



(591) Black, white  
(531) 26.05.01; 26.05.24; 26.13.25; 27.05.01;  
27.05.17

(511)

13 – Firearms; ammunition and projectiles; explosives; fireworks; bandoliers for weapons; breeches of firearms; apparatus for filling cartridge belts; cartridge cases; cartridge loading apparatus; cartridge pouches; cleaning brushes for firearms; detonating caps other than toys; detonating fuses for explosives; detonating plugs; detonators; firearm sights; firing lanyards for explosives; firing platforms; fuses for explosives; fuses for explosives, for use in mines; gun barrels; gun carriages [artillery]; gun cases; gunstocks; hammers for guns and rifles; noise-suppressors for guns; percussion caps other than toys; powder horns; primings [fuses]; rifle barrels; rifle cases; shoulder straps for weapons; sighting mirrors for guns and rifles; sights, other than telescopic sights, for firearms; sights, other than telescopic sights, for guns [artillery]; signal rockets; sprays for personal defense purposes; tear-gas weapons; trigger guards for guns and rifles; trunnions for heavy weapons.

35 – Bringing together of firearms, ammunition and projectiles, explosives and machine tools (except the transport thereof) on behalf of third parties and enabling the customers to conveniently view and purchase those goods, also via the global computer network.

(260) AM 2022 113901 A  
(800) 1602037  
(151) 2020 10 12  
(891) 2020 10 12  
(731) IPQ IP Specialists Holding AB  
Vasagatan 11, SE-111 20 Stockholm,  
Sweden



(540)

**CREAT\* R STUDIO**

(591) Black, white

(531) 24.17.07; 27.05.01

(511)

3 – Hand soaps; body soaps; body lotions; hand creams; body scrubs.

9 – Sunglasses; headphones; mobile phone cases.

14 – Jewellery; watches.

16 – Notebooks; pencils; pens; crayons; paper clips; erasers; posters.

18 – Bags; wallets; umbrellas; parasols.

21 – Ceramics; porcelain; glassware; salt and pepper sets; bottle openers, electric and non-electric; coasters; shoe horns; trays.

24 – Towels (textile) and bed linen.

25 – Clothing; underwear; swimwear; shoes; headgear; apron; leather belts.

28 – Sporting articles and equipment; toys, games and playthings.

35 – Retail services in relation to hand soaps, body soaps, body lotions, hand creams, body scrubs, sunglasses, headphones, mobile phone cases, jewellery, watches, notebooks, pencils, pens, crayons, paper clips, erasers, posters, bags, wallets, belts, umbrellas, parasols, ceramics, porcelain, glass ware, salt and pepper sets, openers, coasters, shoe horns, trays, towels (textile) and bed linen, clothing, underwear, swimwear, shoes, headgear, aprons, sporting articles and equipment, toys, games and playthings; procurement services for others [purchasing goods and services for other businesses]; wholesale and retail services in relation to hand soaps, body soaps, body lotions, hand creams, body scrubs, sun glasses, head phones, cases for mobile phones, jewellery, watches, notebooks, pencils, pens, crayons, paper clips, erasers, posters, bags, wallets, belts, umbrellas, parasols, ceramics, porcelain, glassware, salt and pepper sets, openers, coasters, shoe horns, trays, towels (textile) and bedlinen, clothing, underwear, swimwear, shoes, headgear, aprons, sporting articles and equipment; advertising; marketing; promotional services via social media; promotion of products and services of third parties through sponsoring and licensing agreements; wholesale and retail services in relation to toys, games and playthings.

39 – Transportation and delivery of goods; packaging and storage of goods; logistic services.

40 – Customized manufacturing of hand soaps, body soaps, body lotions, hand creams, body scrubs, sunglasses, headphones, mobile phone cases, jewellery, watches, notebooks, pencils, pens, crayons, paper clips, erasers, posters, bags, wallets, belts, umbrellas,

parasols, ceramics, porcelain, glassware, salt and pepper sets, openers, coasters, shoe horns, trays, towels (textile) and bed linen, clothing, underwear, swimwear, shoes, headgear, aprons, sporting goods and equipment, toys, games and playthings; customized material processing of plastics, textiles, metal, wood, rubber, glass, porcelain, ceramics, paper, leather, hand soaps, body soaps, body lotions, hand creams, body scrubs, sunglasses, headphones, mobile phone cases, jewellery, watches, notebooks, pencils, pens, crayons, paper clips, erasers, posters, bags, wallets, belts, umbrellas, parasols, ceramics, porcelain, glassware, salt and pepper sets, openers, coasters, shoe horns, trays, towels (textile) and bed linen, clothing, underwear, swimwear; customized material processing of shoes, headgear, aprons, sporting goods and equipment, toys, games and playthings; information in relation to the custom manufacture of hand soaps, body soaps, body lotions, hand creams, body scrubs, sunglasses, headphones, mobile phone cases, jewellery, watches, notebooks, pencils, pens, crayons, paper clips, erasers, posters, bags, wallets, belts, umbrellas, parasols, ceramics, porcelain, glassware, salt and pepper sets, openers, coasters, shoe horns, trays, towels (textile) and bed linen, clothing, underwear, swimwear, shoes, headgear, aprons, sporting articles and equipment; information in relation to the custom manufacture of toys, games and playthings; information relating to the treatment of plastic materials, textiles, metal, wood, rubber, glass, porcelain, ceramics, paper, leather, hand soaps, body soaps, body lotions, hand creams, body scrubs, sun glasses, headphones, mobile phone cases, jewellery, watches, notebooks, pencils, pens, crayons, paper clips, erasers, posters, bags, wallets, belts, umbrellas, parasols, ceramics, porcelain, glassware salt and paper sets, openers, coasters, shoehorns, trays, towels (textile) and bed linen, clothing, underwear; information relating to the treatment of swimwear, shoes, headgear, aprons, sporting goods and equipment, toys, games and playthings.

42 – Technical analysis in relation to the manufacture and processing of hand soaps, body soaps, body lotions, hand creams, body scrubs, sunglasses, headphones, mobile phone cases, jewellery, watches, notebooks, pencils, pens, crayons, paper clips, erasers, posters, bags, wallets, belts, umbrellas, parasols, ceramics, porcelain, glassware, salt and pepper sets, openers, coasters, shoe horns, trays, towels and bed linen, clothing, underwear, swimwear, shoes, headgear, aprons, sporting articles and equipment; technical analysis in relation to the manufacture and processing of toys, games and playthings; digital shop front design; design counselling; design counselling regarding merchandise through design tools in an app or online.

(260) AM 2022 113902 A

(800) 1602062

(151) 2021 04 27

(891) 2021 04 27

(731) Limited Liability Company "GLOMACO"  
Varchavskaya ul., 5, korp.2, lit.A, of.604-A,  
RU-196128 Saint-Petersburg, Russian  
Federation

(540)



(591) White, black, grey and green

(531) 24.17.05; 27.05.10; 27.05.22; 29.01.14

(526) CLEAN SAFE

(511)

5 – Hygienic bandages; bandages for dressings; anti-septic cotton; aseptic cotton; absorbent cotton; wadding for medical purposes; cotton for medical purposes; gauze for dressings; sterilising preparations; tissues impregnated with pharmaceutical lotions.

10 – Trusses; hernia bandages; maternity belts; elastic bandages; containers especially made for medical waste; needles for medical purposes; orthopedic articles; cannulae; droppers for medical purposes; dropper bottles for medical purposes; catheters; draw-sheets for sick beds; enema apparatus for medical purposes; corsets for medical purposes; masks for use by medical personnel; urinals being vessels; finger guards for medical purposes; clothing especially for operating rooms; gloves for medical purposes; medical apparatus and instruments; sterile sheets, surgical; surgical sheets; scalpels; syringes for injections; syringes for medical purposes; hypodermic syringes.

35 – Promoting the goods of others; advertising; publicity.

(260) AM 2022 113903 A

(800) 1602077

(151) 2021 02 18

(891) 2021 02 18

(731) Crystalex CZ, s.r.o.  
Masarykovo nábřeží 2360, CZ-110 00 Praha 1,  
Nové Město, Czech Republic

(540)

**CRYSTALEX**

(591) Black, white

(531) 27.05.01

(511)

21 – Glass products of all kinds within this class, products of utility and smooth and refined art glass.

(260) AM 2022 113904 A

(800) 1602104

(151) 2021 02 18

(891) 2021 02 18

(731) Crystalex CZ, s.r.o.  
Masarykovo nábřeží 2360, CZ-110 00 Praha 1,  
Nové Město, Czech Republic

(540)



(591) Black, white

(531) 26.13.25; 27.01.13; 27.05.21

(511)

21 – Glass products of all kinds within this class, products of utility and smooth and refined art glass.

(260) AM 2022 113905 A

(800) 1602109

(151) 2021 05 21

(891) 2021 05 21

(731) IDAI NATURE, S.L.  
C/ Moscú, 10. Pol. Ind Mas de Tous,  
E-46185 La Pobla de Vallbona / Valencia,  
Spain

(540)



(591) Orange, light green, dark green and gray

(531) 05.05.19; 05.05.20; 05.05.21; 27.05.01;  
27.05.09; 27.05.10; 29.01.13

(511)

1 – Culture media, fertilizers and chemical products intended for agriculture, horticulture and forestry; chemical products for use in industry; natural fertilizers; organic fertilizers; biofertilizers; compost, manures, fertilizers.

5 – Products and preparations for pest control; fungicides; herbicides; products for destroying vermin; biocides; biopesticides for agriculture; acaricides for agricultural use; fungicidal fungal agents; algicides for agricultural use; biological herbicides; herbicides for agricultural use; insecticides for agricultural use.

(260) AM 2022 113906 A  
 (800) 1602133  
 (151) 2021 04 29  
 (891) 2021 04 29  
 (731) JOINT STOCK COMPANY "FATS AND OIL  
 INTEGRATED WORKS"  
 UL. TITOVA, 27, EKATERINBURG,  
 RU-620085 SVERDLOVSKAYA OBLAST,  
 Russian Federation  
 (540)

## Solpro

(591) Black, white  
 (511)  
 29 – Margarine; vegetable fats for food; edible fats;  
 vegetable oils for food; high oleic oils for food; lecithin  
 for culinary purposes.  
 30 – Ketchup [sauce]; mayonnaise; mayonnaise sauce;  
 sauces [condiments]; pasta sauce; condiments; spices;  
 seasonings; dressings for salad; food dressings on  
 the base of vegetable oils; mustard.

(260) AM 2022 113907 A  
 (800) 1602188  
 (151) 2021 05 10  
 (891) 2021 05 10  
 (731) Great Greek Franchising, LLC  
 2121 Vista Parkway, West Palm Beach  
 FL 33411, USA  
 (540)



(591) Black, white  
 (531) 07.05.08; 26.01.19; 26.11.03; 26.11.05;  
 26.11.06; 26.11.07; 26.11.08; 27.05.10  
 (526) MEDITERRANEAN GRILL  
 (511)  
 43 – Food preparation services; food preparation services  
 featuring Mediterranean food; fast-food restaurant services;  
 fast-food restaurants; restaurant services featuring  
 Mediterranean food; restaurant services, namely, providing  
 of food and beverages for consumption on and off the premises.

(260) AM 2022 113908 A  
 (800) 1602194  
 (151) 2021 06 14  
 (891) 2021 06 14  
 (731) Kia Corporation  
 12, Heolleung-ro, Seocho-gu, Seoul,  
 Republic of Korea  
 (540)



(591) Black, white  
 (531) 27.05.19; 27.07.01  
 (511)  
 12 – Vans [vehicles]; motor buses; sports cars; automobiles;  
 electric cars; trucks.

(260) AM 2022 113935 A  
 (800) 1602534  
 (151) 2021 04 30  
 (891) 2021 04 30  
 (731) Bora Creations S.L.  
 11, Calle Velázquez (Pto. de Andratx),  
 E-07157 Andratx, Balearn, Spain  
 (540)

## BEAUTY GREAT AGAIN

(591) Black, white  
 (511)  
 3 – Preparations for cleaning, caring for and beautifying  
 the skin, nails, lips, eyes and hair; perfumery; cosmetics;  
 decorative cosmetics; nailcare products; haircare products;  
 setting preparations for the hair; perfumes; eau de parfum;  
 toilet water; eau de cologne.  
 8 – Hand-operated apparatus and instruments for the  
 cosmetic and decorative care of fingernails, toenails,  
 eyelashes, eyebrows; nail files; apparatus for treating  
 fingernails and toenails.  
 21 – Brushes (except paintbrushes); cosmetic utensils;  
 combs; makeup applicators; sponges.

(260) AM 2022 113936 A  
 (800) 1602604  
 (151) 2020 11 14  
 (891) 2020 11 14  
 (731) Pufas Werk KG  
 Im Schedetal 1, 34346 Hann. Münden,  
 Germany  
 (540)

## PUFAS

(591) Black, white  
 (511)  
 1 – Chemical preparations for use in industry; adhesives  
 for use in industry; adhesives for floor coverings, wall  
 coverings and ceiling coverings; universal adhesives;  
 tile adhesives; cork adhesives; fixations

[chemical preparations] for floor coverings, wall coverings and ceiling coverings; sealants [chemical preparations] for floors, walls and ceilings; wood glue; wallpaper adhesives; putties and other paste fillers; putties for preparing surfaces for the application of paints and lacquers; fluates; silicones; acrylics; wallpaper removing preparations; chemical preparations for preventing mildew infestation.

2 – Paints; anti-mildew paints; varnishes; lacquers; glazes; primers for preparing surfaces for the application of putties, paints and lacquers; wallpaper primers for preparing surfaces for the application of wallpapers; render primers; anti-mildew primers; paints for preventing mildew infestation; fungicidal color additives; preparations for the protection against moisture (mold stains) [coatings]; deep primers for preparing surfaces for the application of putties, paints and lacquers; brush-on plasters; paint concentrates; pigment pastes; anti-rust preparations; wood preservatives; facade impregnation preparations; impregnation preparations for floors, walls and ceilings; impregnation preparations against mildew; anti-mildew impregnation preparations; protective coatings wallpapers and paints; fillers for preparing surfaces for the application of paints and lacquers; cellulose waste paper [coatings] for substrate treatment for following wallpapering; oil barrier coatings [coatings]; anti-graffiti coatings [paints].

3 – Washing agents; cleansing agents; cleaning agents; hand washing pastes; skin cleansing agents; bleaching agents; polishing agents; care agents for floor coverings, wall coverings and surfaces of stone, wood or plastic; drain cleaning agents; brush cleaning agents; grease removing agents; degreasing preparations; silicone removing agents; saltpeter removing agents; dispersion removers; cement residue removing agents; adhesive removers; paint removers; graffiti removing substances; leaching agents [cleaning agents]; stripping agents; mildew removal agents.

5 – Biocides; algacides; fungicides; herbicides; anti-mildew sprays; algae removing agents; agents for removing green films caused by plants; agents for fighting and removing algae and for prevention against new infestation thereby; fungicide paint additives; mildew killing agents; anti-mildew concentrates; disinfectants.

8 – Wire brushes [hand-operated tools]; putty knives; trowels.

16 – Paint brushes; painters' brushes; rollers for applying paints, wallpaper adhesives and putties; adhesives for household purposes; adhesives for office use; do-it-yourself adhesives; adhesives for do-it-yourself purposes; adhesives for paper products; adhesives for stationery.

17 – Putties for insulating purposes; putties for sealing purposes; joint sealing agents; joint sealing agents

[contained in this class]; joint sealing agents for sealing joints in precast concrete elements; joint sealing agents for jointing dry construction boards; filling agents; filling agents for insulating purposes; filling agents for sealing purposes; water sealing agents; insulating materials; insulating render; insulating paste fillers; insulating paints; insulating lacquers; insulating salts for insulating paintworks; sealing agents of silicone; sealing agents of acrylic; building foam; reinforcement fabrics for indoor and outdoor insulating purposes.

19 – Non-metallic building materials; putties; gypsum putties; putties [contained in this class]; putties as non-metallic building materials; putties for the building sector; putties for the building renovation sector; putties for renovating floors, walls and ceilings of buildings; putties for smoothening, coating and repairing floor surfaces, wall surfaces and ceiling surfaces; putties for closing joints in precast concrete elements; putties for grouting and filling dry construction boards; dispersion putties; artificial resin putties; putties for mineral substrates or resin bound substrates in the building sector; putties for the treatment of substrates for coating agents; putties for repairing wood; filling agents for filling cracks, joints and holes in floors, walls and ceilings of buildings; filling agents for filling cracks, joints and holes in floors, walls and ceilings of buildings; filling cement; floor levelling agents; render agents; gypsum; cement; mortar; reinforcement fabrics for indoors and outdoors; renovating fleece [building materials for construction purposes]; refurbishing fleece [building materials for construction purposes].

27 – Wallpapers and other wall coverings; wallpapers of glass fiber, paper, fleece, textile, plastic and metal; wall coverings of glass fiber, glass fabric, paper, fleece, textile, plastic and metal.

(260) AM 2022 113937 A  
(800) 1602615  
(151) 2021 05 11  
(891) 2021 05 11  
(731) Limited Liability Company "KDV Minusinsk"  
Krekernaja street, 8, Minusinsk, RU-662605  
Krasnoyarskij krai, Russian Federation  
(540)

**TONDI**

(591) Black, white  
(511)

30 – Vanilla flavourings for culinary purposes; flavourings, other than essential oils, for cakes; flavourings, other than essential oils, for beverages; coffee flavourings; food flavourings, other than essential oils; star aniseed; baozi; cereal bars; high-protein cereal bars; pancakes; savoury pancakes; freeze-dried dishes with the main ingredient being pasta; freeze-dried dishes with the main ingredient being rice; no-

odle-based prepared meals; buns; bulgur; bread rolls; pains au chocolat; edible paper wafers; edible rice paper; edible paper; burritos; vanillin [vanilla substitute]; waffles; vermicelli; natural sweeteners; sausage binding materials; binding agents for ice cream; orange blossom water for culinary purposes; seawater for cooking; seaweed [condiment]; malt biscuits; cloves [spice]; mirror icing [mirror glaze]; cake frosting [icing]; glucose for culinary purposes; mustard; croûtons; buckwheat, processed; gluten additives for culinary purposes; yeast; thickening agents for cooking foodstuffs; leaven; rice-based snack food; cereal-based snack food; artificial coffee; vegetal preparations for use as coffee substitutes; dressings for salad; fruit jellies [confectionery]; candy decorations for cakes; confectionery for decorating Christmas trees; cakes; pastries; peanut confectionery; almond confectionery; fruit confectionery; pasta; ground ginger; frozen yogurt [confectionery ices]; cocoa; cream of tartar for culinary purposes; capers; coffee capsules, filled; caramels [sweets]; curry [spice]; ketchup [sauce]; quinoa, processed; quiches; gluten prepared as foodstuff; flour-based dumplings; sweets; liquorice [confectionery]; peppermint sweets; mints for breath freshening; dulce de leche; cinnamon [spice]; coffee; unroasted coffee; starch for food; crackers; rice crackers; custard; crème brûlée; croissants; hominy grits; semolina; oatmeal; crushed barley; groats for human food; ice cubes; corn, milled; corn, roasted; meat pies; turmeric; couscous; laksa; noodles; soba noodles; udon noodles; ice for refreshment; ice, natural or artificial; edible ices; ice pops; potato-based flatbreads; rice cakes; mayonnaise; macarons; macaroni; maltose; hominy; piccalilli; marinades; marzipan; honey; miso; royal jelly; ice cream; bean meal; buckwheat flour; tapioca flour; potato flour; corn flour; nut flours; flour; wheat flour; soya flour; barley meal; dessert mousses [confectionery]; chocolate mousses; muesli; mint for confectionery; cocoa beverages with milk; coffee beverages with milk; coffee-based beverages; cocoa-based beverages; chamomile-based beverages; tea-based beverages; tea beverages with milk; chocolate beverages with milk; chocolate-based beverages; infusions, not medicinal; nougat; crushed oats; husked oats; kimchi pancakes; onigiri; nutmegs; chocolate-coated nuts; stick liquorice [confectionery]; ginger paste [seasoning]; lozenges [confectionery]; molasses for food; pâtés en croûte; pelmeni; pepper; allspice; peppers [seasonings]; pesto; biscuits; coconut macarons; petit-beurre biscuits; bibimbap [rice mixed with vegetables and beef]; pies; pizzas; meat gravies; fondants [confectionery]; popcorn; powders for making ice cream; baking powder; mustard meal; pralines; condiments; meat tenderizers for household purposes; cereal preparations; oat-based food; profiteroles; gingerbread; spices; petits fours; rice pudding; puddings; cake powder; fruit coulis [sauces]; ravioli; ramen; chewing gum; chewing gum for breath freshening; relish [condiment]; rice; prepared rice rolled in

seaweed; instant rice; wheat germ for human consumption; spring rolls; sago; sugar; crystallized rock sugar; palm sugar; sesame seeds [seasonings]; linseed for culinary purposes [seasoning]; processed seeds for use as a seasoning; aniseed; agave syrup [natural sweetener]; golden syrup; savoury pancake mixes; batter mixes; baking soda [bicarbonate of soda for cooking purposes]; malt for human consumption; salt for preserving foodstuffs; cooking salt; celery salt; sorbets [ices]; ham glaze; cranberry sauce [condiment]; soya sauce; tomato sauce; apple sauce [condiment]; sauces [condiments]; pasta sauce; spaghetti; seasonings; chocolate-based spreads; chocolate spreads containing nuts; preparations for stiffening whipped cream; shaved ice with sweetened red beans; rusks; breadcrumbs; sushi; sandwiches; tabbouleh; tacos; tamarind [condiment]; tapioca; tarts; dough; pastry dough; almond paste; rice pulp for culinary purposes; cake batter; tortillas; garden herbs, preserved [seasonings]; chocolate decorations for cakes; vinegar; beer vinegar; ferments for pastes; halvah; harissa [condiment]; bread; gluten-free bread; unleavened bread; chips [cereal products]; corn flakes; oat flakes; hot dog sandwiches; flowers or leaves for use as tea substitutes; jiaozi; chicory [coffee substitute]; tea; kelp tea; iced tea; chutneys [condiments]; minced garlic [condiment]; cheeseburgers [sandwiches]; chow-chow [condiment]; saffron [seasoning]; chocolate; malt extract for food; essences for foodstuffs, except etheric essences and essential oils; husked barley.

(260) AM 2022 113944 A

(800) 1602824

(151) 2021 03 23

(891) 2021 03 23

(731) ZENITH GLOBAL MANAGEMENT LLC  
Suite 9, Henville Building P.O. Box 590,  
Charlestown, Nevis, Saint Kitts and Nevis

(540)



(591) Black, white, green

(531) 26.04.02; 26.04.05; 26.04.18; 26.04.24;  
27.05.10; 27.05.11; 27.05.17; 27.05.19;  
27.05.24; 29.01.13

(511)

9 – Batteries, electric, for vehicles; aerials; remote control apparatus; sound recording apparatus; sound transmitting apparatus; loudspeakers; coaxial cables; fibre optic cables; cables, electric; cabinets for loudspeakers; megaphones; diaphragms [acoustics]; microphones; headphones; sheaths for electric cables; transmitters [telecommunication]; transmitters of electronic signals; switches, electric; converters, electric; sa-

tellite navigational apparatus; telegraph wires; telephone wires; wires, electric; conductors, electric; copper wire, insulated; record players; control panels [electricity]; voltage surge protectors; horns for loudspeakers; couplings, electric; amplifiers; sound reproduction apparatus; ducts [electricity].

(260) AM 2022 113945 A

(800) 1602881

(151) 2021 05 18

(891) 2021 05 18

(731) OM Pharma SA

Rue du Bois-du-Lan 22, CH-1217 Meyrin,  
Switzerland

(540)



(591) Black, white

(531) 01.15.15; 27.05.10

(511)

5 – Pharmaceutical and veterinary products; sanitary products for medical purposes; dietetic food and substances for medical or veterinary use, food for babies; dietary supplements for humans and animals; plasters, materials for dressings; material for dental fillings and dental impressions; disinfectants.

10 – Surgical, medical, dental and veterinary apparatus and instruments; artificial limbs, eyes and teeth; orthopedic articles; suture materials; therapeutic and assistive devices adapted for persons with disabilities.

44 – Medical and veterinary services; hygienic and beauty care for human beings or animals.

(260) AM 2022 113946 A

(800) 1602914

(151) 2021 06 23

(891) 2021 06 23

(731) Pan Hong

No.1511 (Building), No.10, Caifu Square,  
No.1899, Tushan East Road, Bengshan District,  
Bengbu, 233000 Anhui, China

(540)

KARBON

(591) Black, white

(531) 27.05.01

(511)

21 – Glass [receptacles]; daily glass vessel (including cup, disc, pot, cylinder); porcelain ware; crystal art-

ware; beer mugs; straws for drinking; insulating flasks; mosquito-killing device.

(260) AM 2022 113947 A

(800) 1602916

(151) 2021 04 29

(891) 2021 04 29

(731) PARSON GIN d.o.o.

Mariborska cesta 41, SI-2212 Šentilj v  
Slovenskih goricah, Slovenia

(540)



PREMIUM  
PARSON GIN  
*Just your dreams.*

(591) Black, white

(531) 03.01.08; 03.01.16; 03.01.25; 24.03.07;  
24.03.13; 25.07.21; 27.05.03; 27.05.10

(511)

21 – Bottles; glasses; glasses for gin; crystal glasses; crystal glasses for gin; glass stoppers for bottles; glass decanters; bottle buckets; bottle coolers (receptacles); bottle openers; wine bottle cradles; shaker bottles sold empty; beverage stirrers; cocktail shakers.

33 – Gin; gin made of grapes; gin made of mango, papaya, passion fruit and pineapple; gin made of lemon, bitter orange, angelica, coriander and blackcurrant; gin made of orange, apple, cinnamon and cloves; alcoholic beverages (except beer); spirits (beverages); liquor-based aperitifs; liqueurs; cocktails; prepared alcoholic cocktails; low alcoholic drinks.

(260) AM 2022 113949 A

(800) 1602924

(151) 2021 05 10

(891) 2021 05 10

(731) MEBO Pharmaceutical Technologies Group  
Co., Ltd.

Room 3105, Building 1, 8 Dongdaqiao St.,  
Chaoyang District, Beijing, China

(540)

MEBO

(591) Black, white

(531) 27.05.01

(511)

3 – Cleansers for intimate personal hygiene purposes, non medicated; cleansing milk for toilet purposes; cleaning preparations; moisturising skin creams [cosmetic]; cosmetics for children; beauty masks; hair

tonic [non-medicated]; wrinkle resistant cream; sunscreen preparations; lipsticks; cosmetic preparations for skin care; cosmetics; toothpaste; cosmetics for animals.

5 – Disinfectants for hygiene purposes; pharmaceutical preparations for skin care; balms for medical purposes; frostbite salve for pharmaceutical purposes; capsules for medicines; preparations for the treatment of burns; medicinal drinks; medicines for human purposes; tonics [medicines]; vitamin preparations; food for babies; nutritional supplements; dietetic substances adapted for medical use; depuratives; medicines for veterinary purposes; gauze for dressings; surgical dressings; dressings, medical; wadding for medical purposes; teeth filling material.

(260) AM 2022 113951 A

(800) 1602947

(151) 2021 04 20

(891) 2021 04 20

(731) Magomedov Ibragim

Suite 47993786, 2229 NW 79th Ave, Miami,  
Miami FL 33122, USA

(540)



(591) Black, white

(531) 24.17.20; 26.11.09; 27.05.10

(511)

36 – Financial exchange of virtual currency; financial services, namely, providing a virtual currency for use by members of an on-line community via a global computer network; financial services, namely, providing electronic transfer of a virtual currency for use by members of an on-line community via a global computer network; issue of tokens of value.

42 – Research and development of technology in the field of information technology.

(260) AM 2022 113952 A

(800) 1602964

(151) 2021 04 12

(891) 2021 04 12

(731) Open-Type Joint Stock Company "TAKF"

ul. Oktyabrskaya, d. 22, RU-392000 Tambov,  
Russian Federation

(540)

**CAKYPA**

(591) Black, white

(531) 28.05

(511)

30 – Confectionery; caramels [candies]; sweets; pralines; fondants [confectionery]; chocolate; pastries.

(260) AM 2022 113953 A

(800) 541660

(151) 1989 07 20

(891) 2021 06 24

(731) LABORATOIRES SVR

ZAC de la Tremblaie, Rue de la Mare à Blot,  
F-91220 Le Plessis Pate, France

(540)

**XERIAL**

(591) Black, white

(531) 27.05.01; 27.05.17

(511)

3 – Perfumery, cosmetics, soaps, hair products, dentifrices.

5 – Pharmaceutical, veterinary, sanitary and dietetic products for medical use, containing excipient.

(260) AM 2022 113955 A

(800) 639180

(151) 1995 06 08

(891) 2021 06 25

(731) LABORATOIRES SVR

ZAC de la Tremblaie, Rue de la Mare à Blot,  
F-91220 Le Plessis Pate, France

(540)

**SPIRIAL**

(591) Black, white

(531) 27.05.01

(511)

3 – Perfumery, cosmetics, soaps, hair products, dentifrices, deodorants, antiperspirants.

5 – Pharmaceutical preparations, veterinary, sanitary and dietetic products for medical use.

(260) AM 2022 113956 A

(800) 792926

(151) 2002 08 26

(891) 2021 06 29

(731) Société de Courtage et de Diffusion – CODIF  
INTERNATIONAL SAS

61, rue du Commandant l'Herminier,  
F-35400 SAINT MALO, France

(540)

**PHYTOMER**

(591) Black, white

(511)

3 – Bleaching preparations and other substances for laundry use; cleaning, polishing, grease removing and abrasive preparations; soaps; perfumery goods, essential oils, cosmetics, hair lotions; dentifrices; essential oils; depilatory wax; cosmetic bath preparations; cosmetic suntan lotions; hair lotions; cosmetic preparations for slimming purposes; cosmetic creams; make-up removing products; depilatory products; make-up; greases for cosmetic purposes; cleansing milk; almond oil for cosmetic purposes; beauty masks; pomades for cosmetic purposes; make-up powder.

5 – Sanitary products for medical use and for personal hygiene; dietetic substances for medical use; food for babies; medical or sanitary disinfectants (excluding soaps); dietetic nutritional supplements (for medical use).

44 – Sanitary and beauty care for human beings or for animals; beauty and hairdressing salons; massage, bathing and health services, thalassotherapy and balneotherapy services.

(260) AM 2022 113962 A

(800) 1267107

(151) 2015 05 25

(891) 2021 04 13

(731) Kabushiki Kaisha Zoom

4-4-3 Kanda-surugadai, Chiyoda-ku,  
Tokyo 101-0062, Japan

(540)

**ZOOM**

(591) Black, white

(531) 27.05.01; 27.05.19

(511)

9 – Measuring or testing machines and instruments; batteries and cells; electric wires and cables; photographic apparatus and instruments; cinematographic apparatus and instruments; optical machines and apparatus; electrical communication machines and instruments; multi-track recorders; IC recorders; field recorders; sound recording and reproducing apparatus; video recording apparatus; sound recorded magnetic cards, sheets, tapes and compact disks; phonographic records; electronic circuits and CD-ROMs recorded with automatic performance programs for electronic musical instruments; metronomes; electric and electronic effects units for musical instruments; magnetic disks, magnetic tape and recording media recorded with computer programs; computer software program; electronic machines, apparatus and their parts; ic memory cards; electronic publications; recor-

ded video discs and tapes; electrical switches; converters, electric; effects processor for musical instruments; apparatus for recording, transmission or reproduction of sound for DJ.

15 – Tuning apparatus for musical instruments; musical instruments; drum machines; musical performance auxiliaries.

(260) AM 2022 113963 A

(800) 1268411

(151) 2015 09 16

(891) 2021 06 24

(731) LABORATOIRES SVR

ZAC de la Tremblaie, Rue de la Mare à Blot,  
F-91220 Le Plessis Pate, France

(540)

**PHYSIO PURE**

(591) Black, white

(511)

3 – Soaps; perfumery; essential oils; cosmetics (excluding hair products).

(260) AM 2022 114009 A

(800) 1603287

(151) 2021 04 14

(891) 2021 04 14

(731) ROYAL ARMENIA JV LTD

Davtashen 2nd Block 268, 0054 Yerevan,  
Armenia

(540)



(591) Purple, light purple, yellow, light yellow, dark yellow, red, black, gray and cream

(531) 03.07.05; 05.01.04; 26.01.18; 27.05.01;  
29.01.15

(526) ARMENIA, DARK CHOCO

(511)

30 – Instant chocolate mixes; hot chocolate.



(260) AM 2022 114012 A

(800) 1603322

(151) 2020 12 21

(891) 2020 12 21

(731) TÜRKSAT UYDU HABERLESME KABLO

TV VE İSLETME ANONİM ŞİRKETİ

Konya Yolu 40. Km. Golbasi, Ankara,

Turkey

(540)



(591) Blue and dark blue

(531) 26.04.02; 26.04.09; 26.04.24; 27.01.01;

27.05.09; 29.01.04

(511)

38 – Radio and television broadcasting services; telecommunication services; providing access to Internet; news agencies.

42 – Scientific and industrial analysis and research services; engineering; computer services, namely, computer programming, computer virus protection services, computer system design, creating, maintaining and updating websites for others, computer software design, updating and rental of computer software, providing search engines for the Internet, hosting websites, consultancy in the design and development of computer hardware, rental of computer hardware; industrial design services, other than engineering, computer and architectural design; graphic arts designing; authenticating works of art.

(260) AM 2022 114016 A

(800) 1603405

(151) 2020 12 15

(891) 2020 12 15

(731) Daimler AG

Mercedesstr. 120, 70372 Stuttgart, Germany

(540)

**MERCEDES-BENZ**

(591) Black, white

(511)

3 – Bleaching preparations and other substances for laundry use; cleaning, polishing, scouring and abrasive preparations; soaps; perfumery, essential oils, cosmetics, hair lotions; dentifrices; scented wood; mouth washes, not for medical purposes; lacquer-removing preparations; fumigation preparations [perfumes]; toiletries; shampoos; false nails; anti-perspirants [toiletries]; bath salts, not for medical purposes.

4 – Fuels (including motor spirit) and illuminants; candles, wicks.

5 – Pharmaceutical, veterinary and sanitary preparations; dietetic substances adapted for medical use, plasters, materials for dressings; air deodorizing prepara-

tions; air purifying preparations; first-aid boxes [filled].

6 – Ironmongery, small items of metal hardware.

7 – Electric vacuum cleaners, electric lifting jacks.

8 – Hand tools and implements (hand operated); cutlery; razors; razor cases; vegetable choppers; shaving cases; hair clippers for personal use [electric and non-electric]; depilation appliances, electric and non-electric; manicure sets; cutlery of precious metals; knife handles, not of metal.

9 – Spectacles, sunglasses; containers for contact lenses; spectacle frames; spectacle cases; cases for mobile phones; tablet sleeves and cases; computer carrying cases; apparatus for recording, transmission or reproduction of sound or images; data cables; cabinets for loudspeakers; magnetic data carriers, recording discs; data processing equipment and computers; computer keyboards; computer peripheral devices; computer software [recorded]; audio/visual and photographic devices; dashcams; projectors; fire-extinguishing apparatus; reflecting discs for wear, for the prevention of traffic accidents; protection devices for personal use against accidents; clothing for protection against accidents, irradiation and fire; magnets; fire beaters; protective helmets; respirators [other than for artificial respiration]; respiratory masks [other than for artificial respiration]; gloves for protection against accidents; vehicle breakdown warning triangles.

11 – Apparatus for lighting, heating, steam generating, cooking, refrigerating, drying, ventilating, water supply and sanitary purposes; disinfectant apparatus; anti-dazzle devices for automobiles [lamp fittings]; bath fittings; lamp casings; lamp mantles; lamp globes; ornamental fountains; lamp reflectors; taps [faucets]; toilet seats; lamp shades; lampshade holders; torches; air fragrancing apparatus.

12 – Bicycles; go-karts; vehicles; apparatus for locomotion by land, air or water; repair outfits for inner tubes; air pumps [vehicle accessories]; anti-skid chains; head-rests for vehicle seats; direction indicators for bicycles; bicycle stands; cycles; trolleys; hover boards; safety belts for vehicle seats; hubs for vehicle wheels; bicycle handle bars; bicycle tires [tyres]; bicycle pumps; bicycle saddles; bells for bicycles; bicycle frames; saddle covers for bicycles or motorcycles; windscreen wipers; seat covers for vehicles; ski carriers for cars; safety seats for children (for vehicles); baby carriages; pushchairs; strollers; covers for baby carriages; fitted perambulator covers; pushchair covers; stroller covers (pushchairs); hoods for baby carriages; pushchair hoods; umbrellas for pushchairs.

14 – Cufflinks; jewellery, precious stones; horological and chronometric instruments; straps for wrist watches; watch bands; dials [clock and watch-making]; key rings [trinkets or fobs].

16 – Pens of all kind; writing paper; notebooks made of paper; printed matter; paint brushes; office requisites (except furniture).

18 – Animal skins, hides; trunks and travelling bags; umbrellas, parasols and walking sticks; whips, harness and saddlery; purses; music cases; walking-stick seats; frames for umbrellas or parasols; game bags; school bags; school satchels; card cases [notecases]; straps for skates; horse blankets; muzzles; collars for animals; nose bags [feed bags]; kneepads for horses; covers for animals; sling bags for carrying infants; umbrella covers; backpacks; rucksacks; walking stick-handles; purses, not of precious metal; pocket wallets; wheeled shopping bags; shopping bags; attaché cases; beach bags; handbags; briefcases; vanity cases [not fitted]; net bags for shopping.

20 – Furniture, mirrors, picture frames; kennels for household pets; dog kennels; coat hangers; bedding [except linen]; cushions; non-electric fans for personal use; covers for clothing [wardrobe]; air mattresses, not for medical purposes; works of art of wood, wax, plaster or plastic; bins, not of metal.

21 – Household or kitchen utensils and containers (not of precious metal or coated therewith); cooling boxes, drinking bottles; combs and sponges; brushes (except paint brushes); glassware, porcelain and earthenware (included in this class); wine decanters; sprinkling devices; watering devices; appliances for removing make-up [non-electric]; powder puffs; powder compacts, not of precious metal; sprinklers and syringes for watering flowers and plants; cages for household pets; indoor terrariums [plant cultivation]; litter boxes [trays] for pets; sugar tongs; litter trays [for pets].

22 – Hammocks.

24 – Textiles and textile goods, included in this class; bed and table covers; curtains of textile or plastic; sleeping bags for camping.

25 – Clothing, footwear, headgear.

27 – Carpets, rugs, mats and matting, linoleum and other materials for covering existing floors; wall hangings (non-textile); artificial turf; wallpaper.

28 – Games and playthings; gymnastic and sporting articles, included in this class; sport balls; golf bags; artificial fishing bait; model cars; push-powered vehicles for children; decorations for christmas trees; christmas trees of synthetic material; christmas tree stands; swimming belts; scooters and tricycles for children for use as playthings; swimming jackets; playing cards.

34 – Smokers' articles; pocket lighters; matches; humidors.

(260) AM 2022 114018 A

(800) 1603616

(151) 2021 05 19

(891) 2021 05 19

(731) PEPCO Poland Sp. z o.o.

Strzeszyńska 73A, PL-60-479 Poznań, Poland

(540)



(591) Black, gray, white

(531) 07.01.18; 18.07.09; 27.05.02; 27.05.03;

27.05.10

(511)

28 – Games; toys; toy vehicles; miniature car models [toys or playthings]; toy pedal cars; toy sets; toy vehicle tracks; remote control toys; remote-controlled toy vehicles.

(260) AM 2022 114019 A

(800) 1603686

(151) 2021 05 28

(891) 2021 05 28

(731) MEIJI TECHNO CO., LTD.

322-1, Chikumazawa, Miyoshi-machi,

Iruma-gun, Saitama-ken 354-0043, Japan

(540)

# MEIJITECHNO

(591) Black, white

(531) 27.05.01

(511)

9 – Microscopes.

(260) AM 2022 114066 A

(800) 1603836

(151) 2021 05 13

(891) 2021 05 13

(731) Liu, Chao

Room 666, No.73 Futian Road, Zhangcun

Town, Huancui District, Weihai City,

Shandong Province, China

(540)

# HANDING

(591) Black, white

(531) 27.05.01

(511)

28 – Rods for fishing; landing nets for anglers; floats for fishing; fishing tackle; fishing lines; reels for fis-

hing; creels [fishing traps]; scent lures for hunting or fishing; artificial fishing bait; decoys for hunting or fishing.

(260) AM 2022 114067 A

(800) 1603846

(151) 2021 05 03

(891) 2021 05 03

(731) SUN PHARMACEUTICAL INDUSTRIES LIMITED

sun house, plot no 201 b/1, western express highway, goregaon (east), mumbai 400063, India

(540)

**КОЛДАКТ СИНУС**

(591) Black, white

(531) 28.05

(511)

5 – Pharmaceutical and medicinal preparations.

(260) AM 2022 114068 A

(800) 1603861

(151) 2021 05 05

(891) 2021 05 05

(731) BAUSCH + LOMB IRELAND LIMITED

3013 Lake Drive, Citywest Business Campus, Dublin 24, Ireland

(540)

**STELLARIS ELITE**

(591) Black, white

(511)

10 – Surgical, medical, dental and veterinary apparatus and instruments, artificial limbs, eyes and teeth; orthopedic articles; suture materials; medical and surgical apparatus, equipment and instruments.

(260) AM 2022 114069 A

(800) 1603864

(151) 2021 06 23

(891) 2021 06 23

(731) Shenzhen SOFARSOLAR Co., Ltd.

401, Building 4, AnTongDa Industrial Park, District 68, XingDong Community, XinAn Street, BaoAn District, Shenzhen, 518000 Guangdong, China

(540)

**SOFAR SOLAR**



(591) Black, white

(531) 01.05.01; 01.05.06; 27.03.12; 27.05.01; 27.05.09; 27.05.10

(511)

9 – Naval signalling apparatus; wafers for integrated circuits; transformers [electricity]; inverters [electricity]; voltage-to-current converters; batteries, electric; charging stations for electric vehicles; battery charging devices for motor vehicles.

(260) AM 2022 114071 A

(800) 1603914

(151) 2021 04 15

(891) 2021 04 15

(731) Stiftung Ethereum (Foundation Ethereum)

Zeughausgasse 7a, CH-6300 Zug, Switzerland

(540)



(591) Black, white

(531) 26.15.25

(511)

9 – Computer application software for blockchain platforms, namely, software platforms for distributed applications and software using a consensus engine integrating blockchain technology for securing data with cryptographic information; software platforms for the development and construction of distributed software applications and distributed computing platforms; computer software platforms for block chain.

36 – Cryptocurrency services, namely, providing a digital currency or digital token; cryptocurrency services, namely, providing a digital currency or digital token incorporating cryptographic protocols, used for operating and building applications and blockchains on a decentralized computing platform and as a means of payment for goods and services.

41 – Developing, organizing and conducting educational and business conferences; educational services, namely, developing, organizing and conducting classes, seminars, conferences, workshops, retreats, camps and field trips in the field of blockchains and distributed computing platforms and distribution of training materials in connection therewith.

42 – Software development services; design, development and implementation of software for distributed computing platforms; design, development and implementation of software in the field of block chains; research and development of software; advice in soft-

ware development and product development in the field of distributed computing platforms; advice in software development and product development in the field of block chains.

(260) AM 2022 114072 A

(800) 1603924

(151) 2021 05 18

(891) 2021 05 18

(731) KUA YUE Express Group Co., Ltd.

1st-8th Floor, Building A, Lufthansa Park,  
Shenzhen Airport Terminal 4th Road,  
Hourui Community, Hangcheng Street,  
Baoan District, Shenzhen City, Guangdong,  
China

(540)

**跨越速运**

(591) Black, white

(531) 28.03

(511)

39 – Portering; unloading cargo; delivery of goods; freighting; transport; freight forwarding; transportation information; transport reservation; transportation logistics; wrapping of goods; boat transport; car transport; transport by land; air transport; storage; parcel delivery; courier services; express delivery of letters; delivery of goods by mail order; vehicle rental.

(260) AM 2022 114073 A

(800) 1603930

(151) 2021 06 22

(891) 2021 06 22

(731) MYUNGIN COSMETIC CO., LTD.

3, Hwanggeum-ro 323beon-gil,  
Yangchon-eup, Gimpo-si, Gyeonggi-do,  
Republic of Korea

(540)

**laferme**

(591) Black, white

(511)

3 – Cosmetics; essential oils; polishing preparations; laundry starch; non-medicated soaps for personal use; non-medicated toiletry preparations; cleaning, polishing, scouring and abrasive preparations; lipsticks; make-up; cosmetic preparations for baths; mask pack for cosmetic purposes; body and beauty care cosmetics; non-medicated preparations for the care of skin, hair and scalp; sunscreen preparations; massage gels, other than for medical purposes; beauty masks; make-up removing preparations; adhesives for affixing artificial nails or eyelashes; cosmetics for animals; pre-moistened cleansing tissues.

(260) AM 2022 114074 A

(800) 1603931

(151) 2021 06 14

(891) 2021 06 14

(731) Kia Corporation

12, Heolleung-ro, Seocho-gu, Seoul,  
Republic of Korea

(540)



(591) Black, white

(531) 27.05.01; 27.05.19; 27.07.01; 27.07.11

(511)

12 – Vans [vehicles]; motor buses; sports cars; automobiles; electric cars; trucks.

(260) AM 2022 114081 A

(800) 1604273

(151) 2021 05 18

(891) 2021 05 18

(731) KUA YUE Express Group Co., Ltd.

1st-8th Floor, Building A, Lufthansa Park,  
Shenzhen Airport, Terminal 4th Road,  
Hourui Community, Hangcheng Street,  
Baoan District, Shenzhen City, Guangdong,  
China

(540)



(591) Black, white

(531) 26.11.02; 26.11.06; 26.11.12; 27.05.17;  
27.05.23

(511)

39 – Air transport; car rental; storage of goods; parcel delivery; courier services [messages or merchandise]; delivery of goods; freighting; packaging of goods; hauling; freight [shipping of goods]; freight brokerage; car transport; freight forwarding; marine transport; guarded transport of valuables; vehicle rental; rental of warehouses; delivery of goods by mail order.

(260) AM 2022 114084 A

(800) 1604362

(151) 2021 03 01

(891) 2021 03 01

(731) PENOPLEX SPb LTD

Saperniy lane, 1, lit. A, RU-191014  
St. Petersburg, Russian Federation

(540)

**ПЕНОПЛЭКС КОМФОРТ**

(591) Black, white

(531) 28.05

(511)

17 – Asbestos; balata; insulating paper; asbestos felt; plastic fibers, other than for textile use; asbestos fibers; vulcanized fiber; gutta-percha; lute; asbestos millboards; liquid rubber; synthetic rubber; rubber, raw or semi-worked; insulating paints; insulating varnish; latex [rubber]; insulating tapes; adhesive bands, other than stationery and not for medical or household purposes; asbestos sheets; viscose sheets, other than for wrapping; sheets of regenerated cellulose, other than for wrapping; reinforcing materials, not of metal, for pipes; caulking materials; soundproofing materials; insulating materials; insulating refractory materials; non-conducting materials for retaining heat; asbestos packing; plastic substances, semi-processed; insulating plaster; plastic film, other than for wrapping; asbestos coverings; rubber solutions; synthetic resins, semi-processed; substances for insulating buildings against moisture; chemical compositions for repairing leaks; glass wool for insulation; fiberglass for insulation; asbestos fabrics; insulating fabrics; water-proof packings; foils of metal for insulating; asbestos slate; slag wool [insulator]; ebonite.

19 – Asphalt; bitumen; building paper; binding agents for making briquettes; binding material for road repair; geotextiles, including geotextiles for use in connection with road construction, railroad construction, tunnel construction, waterway construction and public works construction; bitumen paper for building; wood pulp board for building; paperboard for building; roofing, not of metal; xylolith; reinforcing materials, not of metal, for building; bituminous products for building; tar; road coating materials; materials for making and coating roads; building materials, not of metal; pitch; duckboards, not of metal; laths, not of metal; wainscotting, not of metal; wall tiles, not of metal; floor tiles, not of metal; tiles, not of metal, for building; paving slabs, not of metal; paving blocks, not of metal; bituminous coatings for roofing; roof coverings, not of metal; linings, not of metal, for building; mortar for building; insulating glass for building; roofing tiles, not of metal; slate; roofing slates; slag [building material]; flashing, not of metal, for building.

(260) AM 2022 114085 A

(800) 1604369

(151) 2021 03 01

(891) 2021 03 01

(731) PENOPLEX SPb LTD

Saperniy lane, 1, lit. A, RU-191014  
St. Petersburg, Russian Federation

(540)

**ПЕНОПЛЭКС ОСНОВА**

(591) Black, white

(531) 28.05

(511)

17 – Asbestos; balata; insulating paper; asbestos felt; plastic fibers, other than for textile use; asbestos fibers; vulcanized fiber; gutta-percha; lute; asbestos millboards; liquid rubber; synthetic rubber; rubber, raw or semi-worked; insulating paints; insulating varnish; latex [rubber]; insulating tapes; adhesive bands, other than stationery and not for medical or household purposes; asbestos sheets; viscose sheets, other than for wrapping; sheets of regenerated cellulose, other than for wrapping; reinforcing materials, not of metal, for pipes; caulking materials; soundproofing materials; insulating materials; insulating refractory materials; non-conducting materials for retaining heat; asbestos packing; plastic substances, semi-processed; insulating plaster; plastic film, other than for wrapping; asbestos coverings; rubber solutions; synthetic resins, semi-processed; substances for insulating buildings against moisture; chemical compositions for repairing leaks; glass wool for insulation; fiberglass for insulation; asbestos fabrics; insulating fabrics; water-proof packings; foils of metal for insulating; asbestos slate; slag wool [insulator]; ebonite.

19 – Asphalt; bitumen; building paper; binding agents for making briquettes; binding material for road repair; geotextiles, including geotextiles for use in connection with road construction, railroad construction, tunnel construction, waterway construction and public works construction; bitumen paper for building; wood pulp board for building; paperboard for building; roofing, not of metal; xylolith; reinforcing materials, not of metal, for building; bituminous products for building; tar; road coating materials; materials for making and coating roads; building materials, not of metal; pitch; duckboards, not of metal; laths, not of metal; wainscotting, not of metal; wall tiles, not of metal; floor tiles, not of metal; tiles, not of metal, for building; paving slabs, not of metal; paving blocks, not of metal; bituminous coatings for roofing; roof coverings, not of metal; linings, not of metal, for building; mortar for building; insulating glass for building; roofing tiles, not of metal; slate; roofing slates; slag [building material]; flashing, not of metal, for building.

(260) AM 2022 114087 A

(800) 1604413

(151) 2021 02 04

(891) 2021 02 04

(731) DRUZHESTVO S OGRANICHENA

OTGOVORNOST "ELDOMINVEST" OOD  
275, Vladislav Varnenchik Blvd., Entrance a,  
Mladost Borough, BG-9009 Varna, Bulgaria

(540)



(591) Blue and red

(531) 26.11.12; 26.11.13; 27.05.01; 29.01.12

(511)

7 – Pressure valves [parts of machines]; water heaters [parts of machines]; heat exchangers [parts of machines]; kitchen machines, electric; dishwashers; food preparation machines, electromechanical; machines and apparatus for cleaning [electric]; rinsing machines; washing machines [laundry]; colour-washing machines; pumps for heating installations; vacuum cleaners; dust exhausting installations for cleaning purposes; agitators; food processors [electric]; robots for dusting of residential and office premises (robotic vacuum cleaners).

9 – Boiler control instruments; controllers for boilers; wireless room thermostat with boiler controller; differential thermostat; remote control units; smart devices for monitoring and control via Wi-Fi; Wi-Fi wireless internet smart thermostat with receiver; Wi-Fi wire internet smart thermostat; Wi-Fi water leak and frost detector; cable sensor for water leak and frost detector; heat regulating apparatus; electronic thermostats specially designed for electric water heaters; water heater control kit including wireless cylindrical thermostat, RF radio receiver, sensor for placing in cylindrical probe and additional wireless relay / box; electronic publications [downloadable]; computer programmes, downloadable; computer software platforms, recorded or downloadable; computer software applications, downloadable; computer software applications designed for remote control of hot water heating installations, downloadable and transferable to mobile devices.

11 – Air cooling apparatus; extractor hoods for the kitchen; kitchen hoods with extractor hood; telescopic kitchen hoods with built-in extractor hood; fireplace aspirator for kitchen with extractor hood; standard kitchen hood with extractor hood; boilers [other than parts of machines]; volumetric electric water heaters in version for vertical wall mounting; volumetric electric water heaters in the version for horizontal wall mounting; volumetric electric water heaters for floor installation; electric water heaters with dry tubular and ceramic heaters; electric water heaters with mechanical or electronic control; electric water heaters in a free-flowing or pressurised-flow design; electric instantaneous water heaters without and with mixer taps; electric instantaneous water heaters with smooth regulation of the outgoing water flow and step regulation of the power; electric water heaters in version for vertical and horizontal wall mounting with heat exchanger; boilers with one and / or two heat exchangers,

designed for floor installation; thermosyphon boilers; air / water heat pump systems; gas boilers; boiler designed to use alternative wood fuel; heating boilers; heating elements; heating installations; hot water heating installations; electronically controlled hot water heating installations; heating apparatus; heating apparatus, electric; ventilation [air-conditioning] installations and apparatus; water heaters; immersion heaters; water heaters [apparatus]; taps for pipes and pipelines; air conditioning apparatus; air reheaters; cooking apparatus and installations; electric cooktops; hobs for incorporation in their embodiments using only electricity, combined with the use of gas and electricity and using only gas; cooking utensils, electric; deep fryers, electric; food steamers, electric; fast heating radiant electric hob; cooking stoves; microwave ovens [cooking apparatus]; roasting apparatus; bakers' ovens; built-in bakers' ovens; air fryers; rotisseries [cooking appliances]; griddles [cooking appliances]; multicookers; bread baking machines; bread-making machines; ice machines and apparatus; bathroom installations; heaters for baths; hot air bath fittings; heater with infrared heaters; coils [parts of distilling, heating or cooling installations]; installations and more precisely equipment for heating, ventilation and air conditioning and purification (of the environment); sanitary apparatus and installations; hand drying apparatus for washrooms; flushing tanks; pressure water tanks; buffer vessels; pressure buffer vessels; buffer vessels in one or more coil versions; pressure buffer vessels with one or more coils; air-conditioning installations; heat pumps; heat accumulators; heat exchangers, other than parts of machines; kettles, electric; steam boilers, other than parts of machines; boiler pipes [tubes] for heating installations; hearths; fireplaces, domestic; electrically heated carpets; blankets, electric, not for medical purposes; stoves [heating apparatus]; radiators [heating]; central heating radiators; radiators, electric; wall convectors for heating rooms with electronic or mechanical control; free-standing (floor) convectors for space heating with power regulation; solar thermal collectors [heating]; flat solar collectors with selective coating; solar collectors with heat-vacuum tubes with three-layer selective coating; cooling appliances and installations; freezers; freezing chambers; refrigerating chambers; cool boxes, electric; refrigerating cabinets; refrigerators.

35 – Providing commercial information and advice for consumers (commercial consultancy in shops); value-added services, provided by stores for sale of air cooling apparatus, extractor hoods for kitchen, extractor hoods for kitchen with fume extractor, telescopic extractor hoods for kitchen with built-in fume extractor, fireplace aspirator for kitchen with extractor hood, standard extractor hoods for kitchen with fume extractor; value-added services, provided by stores for sale of boilers [other than parts of machines], volumetric electric water heaters in version for vertical wall mounting, volumetric electric water heaters in the ver-

sion for horizontal wall mounting, volumetric electric water heaters in the version for floor installation, electric water heaters with dry tubular and ceramic heaters, electric water heaters with mechanical or electronic control; value-added services, provided by shops for the sale of electric water heaters in a free-flowing or pressurised-flow design, electric instantaneous water heaters without and with mixer taps, electric instantaneous water heaters with smooth regulation of the outgoing water flow and step regulation of the power, electric water heaters in version for vertical and horizontal wall mounting with heat exchanger, air / water heat pump systems; value-added services, provided by stores for sale of gas boilers, boiler designed to use alternative wood fuel, heating boilers, heating elements, heating installations, water heating installations, electronically controlled hot water heating installations, heaters, electric apparatus for heating; value-added services, provided by stores for sale of ventilation [air conditioning] systems and apparatus, water heaters, immersion heaters, water heaters (apparatus), taps for pipes and pipelines, air-conditioning apparatus, air reheaters; value-added services, provided by stores for sale of cooking installations, electric cooktops, built-in hobs using only electricity and a combination using gas and electricity and using only gas, cooking utensils, electric, food steamers, electric, fast heating radiant electric hob; value-added services, provided by stores for sale of cookers, microwave ovens [cooking apparatus], roasting apparatus, bakers' ovens, built-in bakers' ovens, air fryers, roasteries [cooking appliances], griddles [cooking appliances], multicookers, bread baking machines, bread-making machines, ice machines and apparatus; value-added services, provided by stores for sale of bathroom installations, heaters for baths, hot air bath fittings, heater with infrared heaters, coils (parts of distilling, heating or cooling installations), fixtures, hand drying apparatus for washrooms, sanitary apparatus and installations, flushing tanks, pressure water tanks; value-added services, provided by stores for the sale of buffer vessels, pressure buffer vessels, buffer vessels in one or more coil versions, pressure buffer vessels with one or more coils, heat pumps, heat accumulators; value-added services, provided by stores for sale on heat exchangers, other than parts of machines, boilers, electric, steam boilers (other than parts of machines), boiler pipes (tubes) for heating installations, hearths, fireplaces, domestic, electrically heated carpets, blankets, electric, not for medical purposes; value-added services, provided by stores for sale of stoves [heating apparatus], radiators [heating], central heating radiators, radiators, electric, wall convectors for heating rooms with electronic or mechanical control, free-standing floor convectors for space heating with power regulation; value-added services, provided by shops for the sale of solar thermal collectors [heating], flat solar collectors with selective coating, solar collectors with heat-vacuum tubes with three-

layer selective coating, cooling appliances and installations, freezers, refrigerating chambers, electric coolboxes, refrigeration cabinets, refrigerators; value-added services, provided by stores for sale of boiler and steam boiler control instruments, steam boiler controllers, wireless room thermostat with boiler controller, differential thermostat, remote control units, smart devices for control and management via Wi-Fi, Wi-Fi wireless internet smart thermostat with receiver, Wi-Fi wired internet smart thermostat, Wi-Fi leak and frost detector; value-added services, provided by stores for sale of cable with sensor for leak and frost detector, heat regulation apparatus, electronic thermostats designed specifically for electric water heaters, boiler control kit including a wireless cylindrical thermostat with an RF radio and a sensor for placement in a cylindrical probe and an additional wireless relay / box; value-added services, provided by stores for sale of downloadable electronic publications, computer programmes, downloadable; computer software platforms, recorded or downloadable; value-added services, provided by stores for sale of computer software applications, downloadable; computer software applications designed for remote control of hot water heating installations, downloadable and transferable to mobile devices, robots for dusting residential and office premises (robotic vacuum cleaners); value-added services, provided by stores for sale of pressure valves (parts of machines), water heaters (parts of machines), heat exchangers (parts of machines), electric kitchen machines, dishwashers, food preparation machines, electromechanical, machines and apparatus for cleaning [electric], rinsing machines; washing machines [laundry]; value-added services, provided by stores for sale of colour-washing machines, pumps for heating installations, vacuum cleaners, dust exhausting installations for cleaning purposes, agitators, food processors [electric] for retail sale, wholesale, by catalogue, by mail order or by electronic means, e.g. web sites or television programmes (teleshopping), which also applies to all the aforesaid services for the sale of the aforesaid goods, provided by stores; bringing together (excluding transport), for others, of a variety of goods for a joint presentation enabling customers to conveniently view and purchase those goods; providing an online marketplace for the sale and purchase of goods and services; subcontractor services (business support); business management assistance; providing business information via a web site; providing commercial and business contact information; demonstration of goods; presentation of goods via communication media for retail purposes; systemization of information into computer databases; computerized file management; business appraisals; business inquiries; commercial information; commercial intermediation services; commercial management of the licensing of goods and services for others; business project management; arranging of business contracts for others.

37 – Plumbing; electric appliance installation and repair; air-conditioning apparatus installation and repair; heating equipment installation and repair; freezing equipment installation and repair; kitchen equipment installation; machinery installation, maintenance and repair; interference suppression in electrical apparatus; boiler cleaning and repair; services of electricians.

41 – Providing on-line electronic publications, not downloadable; publication of electronic books and journals on-line; training; arranging and conducting of conferences; arranging and conducting of workshops [training]; practical training [demonstration]; arranging and conducting of seminars; arranging and conducting of in-person educational forums; arranging and conducting of symposiums.

42 – Consultancy relating to energy saving and efficiency; industrial design; research and development of new products for others; conducting technical project studies; technological research; technological consultancy.

---

(260) AM 2022 114089 A

(800) 1604457

(151) 2021 02 05

(891) 2021 02 05

(731) Euro Games Technology Ltd.

4, "Maritsa" Str., "Vranya-Lozen-Triugulnika",  
BG-1151 Sofia, Bulgaria

(540)

## **Flaming Gems**

(591) Black, white

(511)

9 – Software; computer gaming software; computer software packages; computer operating system software; computer software, recorded; software drivers; virtual reality software; games software; entertainment software for computer games; computer programs for network management; operating computer software for main frame computers; monitors (computer hardware); computer hardware; apparatus for recording images; monitors (computer programs); computer game programs; computer programs for recorded games; apparatus for recording, transmission or reproduction of sound or images; communications servers [computer hardware]; electronic components for gambling machines; computer application software featuring games and gaming; computer software for the administration of on-line games and gaming; computer hardware for games and gaming; electronic components and computer software for gambling, gambling machines, gambling games on the Internet and via telecommunication network.

28 – Gaming machines for gambling; chips for gambling; mah-jong; arcade games; gambling machines operating with coins, banknotes and cards; games; el-

ectronic games; parlor games; gaming chips; gaming tables; slot machines [gaming machines]; LCD game machines; slot machines and gaming devices; coin-operated amusement machines; roulette chips; poker chips; chips and dice [gaming equipment]; gaming equipment for casinos; roulette tables; gaming roulette wheels; casino games; gambling machines and amusement machines, automatic and coin-operated; coin-operated amusement machines and/or electronic coin-operated amusement machines with or without the possibility of gain; boxes for coin-operated machines, slot machines and gaming machines; electronic or electrotechnical amusement machines and apparatus, gaming machines, coin-operated entertainment machines; housings for coin-operated machines, gaming equipment, gaming machines, machines for gambling; electropneumatic and electrical gambling machines (slot machines).

41 – Gambling; entertainment services related to gambling; gaming services for entertainment purposes; casino, gaming and gambling services; training in the development of software systems; provision of equipment for gambling halls; providing casino equipment [gambling]; gaming machine entertainment services; providing casino facilities [gambling]; gaming hall services; amusement arcade services; games equipment rental; rental of gaming machines; providing amusement arcade services; rental of gaming machines with images of fruits; editing or recording of sounds and images; sound recording and video entertainment services; hire of sound reproducing apparatus; provision of gaming equipment for casinos; providing of casino facilities; online gambling services; casino, gaming and gambling services; provision of gaming facilities, gaming hall facilities, Internet casinos and online gambling services.

---

(260) AM 2022 114090 A

(800) 1604474

(151) 2021 02 04

(891) 2021 02 04

(731) Soft Construct Limited

Clinch's House, Lord Street, Douglas,  
Isle of Man IM99 1RZ, United Kingdom

(540)

## **POPOK**

(591) Black, white

(511)

9 – Optical, weighing, measuring, signalling, checking (supervision) apparatus and instruments; apparatus and instruments for conducting, switching, transforming, accumulating, regulating or controlling electricity; apparatus for recording, transmission or reproduction of sound or images; application software; calculating machines, data processing equipment and computers; apparatus and instruments for recording, transmission or reproduction of sound, data



and/or images; application software relating to and for playing casino games, gambling and betting; computer and electronic games software; computer software for playing games; computer hardware for use in gaming equipment; computer software for digital lotteries and casinos; computer hardware for use in digital lotteries; computer hardware for use in casinos; computer software for gaming, gambling and betting; computer lottery games; computer lottery games downloadable from the Internet; computer software; computer software applications, downloadable; computer software distributed via the Internet; computer software downloadable from the Internet; computer software and programs for use on computer networks including the Internet; computer software platforms for social networking; computer software to enable uploading, posting, showing, displaying, tagging, blogging, sharing or otherwise providing electronic media or information in the fields of virtual communities, electronic gaming, entertainment, and general interest via the Internet or other communications networks with third parties; computer software platforms for computer software programs running on, or in connection with, mobile devices; computer software for the provision and management of on-line games and competitions; computer software for use on computer networks, including the Internet for gaming, gambling and betting; computer software relating to and for playing casino games, gambling and betting; computer software for use on computer networks, including the Internet for gaming, gambling and betting; computer programs and application software for use on telephones and handheld mobile devices; computer programs relating to and for playing casino games, gambling and betting; downloadable electronic publications; electronic number generators; electronic publications; games and competitions in electronic and computer software form; games, gaming, and gambling related software; interactive computer systems; interactive computer and mobile device systems; interactive software; interactive games, gaming and gambling software; online games, gaming and gambling related software; software for use with games, entertainment, recreational, amusement, gaming and video game terminals, machines and apparatus; software for interactive scratch cards and scratch card games; software and software packages for the registration and operation of betting related to sports; software for processing bets including through the Internet; sound and video recordings; video screens; virtual reality computer and gaming hardware and software; augmented reality computer and gaming hardware and software; mixed reality computer and gaming hardware and software; extended reality computer and gaming hardware and software; computer systems for wagering; parts and fittings for all the aforesaid goods.

28 – Games, toys, playthings and novelties; apparatus for games; appliances, equipment and accessories for bingo; articles and apparatus for use in games, in lot-

tery games and in playing games and lottery games; automatic gaming machines; automatic slot machines; bags specially adapted for handheld games; bags specially adapted for handheld video games; bingo game playing apparatus; bingo cards; bingo markers; board games; card games; cards (games); casino games, equipment and accessories therefor; chips and dice [gaming equipment]; chips, counters, discs and tokens for gambling; action skill games; coin fed gaming machines; coin-operated amusement gaming machines; coin-operated gambling and betting machines; coin-operated games; coin-operated gaming equipment; counters, discs and pawns for games; darts, quoits; dart games; dice and cases therefor; dice games; electronic board games; free standing games apparatus; free standing video games apparatus; free standing gaming and gambling apparatus; game boards; game cards; gaming apparatus; gaming and amusement machines and parts and fittings therefor; gaming chips; gaming equipment; gaming machines; gaming tables; gambling machines; hand held computer games; lottery balls; mahjong; parlour games, devices, equipment and accessories therefor; pinball games; playing cards; poker chips; puzzles; question sets for games, gaming and gambling; quiz games; roulette sets, chips, wheels, tables, equipment and accessories therefor; scratch cards; scratch card games; slot machines (gaming devices); sports games; amusement apparatus and accessories for games; amusement apparatus and accessories for games, adapted for use with televisions; betting terminals; betting terminals with internet connections; electric, electronic or mechanical gaming apparatus for betting; electrical and electronic gaming apparatus for use in on-line betting; electronic game equipment; slot machines; gaming machines; parts and fittings for all the aforesaid goods.

35 – Advertising; business management; business administration; office functions; business management; business administration; business services related to establishing and providing sales, brokerage and collection points for betting; office functions; on-line advertising on a computer network; on-line data processing services; retail services in relation to games, apparatus and devices for betting, games, gaming, gambling, casinos and wagering; retail services in relation to software and software packages for the registration and operation of betting related to sports; promoting the goods and services of others by arranging for sponsors to affiliate their goods and services; systematic ordering of data in computer databases; business organization consultancy with regard to providing of betting; television advertising; wholesale services in relation to games, gaming and gambling equipment, games and books relating to gambling, and betting materials, devices and equipment; business services related to establishing of sports betting offices; information concerning the services mentioned before; services mentioned before through or not

through the Internet; advisory and consultancy services in relation to the aforesaid.

38 – Telecommunication access services; telecommunications services, namely, electronic transmission of streamed and downloadable audio and video files via computer and other communications networks; web casting services; delivery of message by electronic transmission; telecommunication services namely, electronic transmission of streamed and downloaded audio and video and multimedia content files via computer and other communications networks; audio broadcasting of spoken word, music, concerts, and radio programs; wireless broadband communications services in the fields of gaming, gambling and casino services, including card games; electronic transmission of information and data; audio broadcasting and transmission of educational and entertainment digital media; telecommunications services, namely, transmission of text, images, audio, and video, and data via telecommunications networks, wireless communications networks, and the internet; providing access to databases; providing telecommunication connectivity services for the transfer of images, messages, audio, visual, audiovisual and multimedia works among e-readers, mobile phones, smartphones, portable electronic devices, portable digital devices, tablets or computers; streaming of audio, visual and audiovisual material via the internet or other computer or communications network; telecommunications services; providing video on-demand transmission of computer games; electronic and wireless transmission and streaming of digital media content for others via global computer networks to handheld computers, laptops, and mobile electronic devices; provision of information, consultancy and advisory services in the field of telecommunications; providing and licensing multiple user access to information and news information over the Internet and other global networks.

41 – Education (training); entertainment services; sporting and cultural activities; entertainment by or relating to games, competitions, quizzes and audience participation events; amusement arcades; amusement arcade gaming machine rental services; amusement parks; arranging and conducting of contests and competitions, including offline and online by way of a computer database or the Internet; arranging, organizing, providing, presenting, management and administration of a lottery, of competitions, games, quizzes, fun events and audience participation events, and of gaming and gambling services; assuring equipment for gambling in casinos (rental); betting; betting, gaming, games, gambling, book-making, bingo, poker and casino services; betting and pools services; betting services for receiving, recording and conducting bets and paying out betting winnings; betting and bookmaking services provided by means of the internet; betting offices and sports betting terminals; betting shop services provided through retail betting

shops; casino, gaming and gambling services; conducting lotteries; electronic betting, gambling and gaming services; entertainment; entertainment services in the nature of on-line gaming and gambling; entertainment services, namely, providing virtual environments in which users can interact through social games for recreational, leisure or entertainment purposes; entertainment in the form of services providing an Internet platform for downloading software for electronic games, electronic games downloadable from the Internet; electronic games of skill, electronic gambling games and electronic card games downloadable from the Internet; entertainment and sporting services provided on-line from a computer database or the Internet; operating of sports betting offices; gambling, gaming, betting and wagering services; gambling services provided by means of the Internet; horses (betting on-); interactive entertainment; interactive lottery, gambling, gaming, betting and pools services; Internet lottery, gambling, gaming, betting and pools services; lottery services; lottery, gambling, gaming, betting and pools services; on-line betting, gambling and gaming services; on-line spread betting, gaming, betting, gambling bookmaking and wagering services; organization, production, presentation and conducting of betting events and forums, competitions, contests, games and quizzes; organisation and holding of contests and competitions, including on-line by way of a computer database or the Internet; organisation of on-line betting; organisation of card games and tournaments; organisation of television games and on-line games in the global computer network; prize draws; providing interactive multi-player computer games via the Internet and electronic communication networks; providing temporary use of non-downloadable interactive, multiplayer and single player games; providing online computer and electronic games by means of a web-based system; provision of betting and gaming services by means of a computer based system; provision of non-downloadable internet games; provision of information on-line via the Internet or from a computer network or database relating to entertainment, lottery, gaming, betting and gambling services; providing casino facilities (gambling); providing casino and gaming services by means of a website and a global computer network; providing on-line information about casinos, gambling and general news about the gaming industry; providing on-line computer games; providing information regarding on-line games; providing information on-line from a computer database or electronic network, including the Internet, relating to entertainment and sporting events; provision of information relating to sporting events; publication of electronic books or periodicals on-line; providing gaming house facilities; provision of information about gambling and games; on-line gaming services; provision of on-line publications about gambling; rental of gaming and gambling machines and equipment; receiving and conducting of betting,

in particular sports betting; running lotteries, exchange rate betting, pools, jackpot systems, tipping competitions and games, running online games, keeping gambling houses, keeping casinos; services in the field of racing, wagers and betting, games of chance, entertainment, bingo halls, casinos, contests, gaming, gambling, games of chance, electronic games, media games, tournaments for poker and other card games, action skill games and lotteries, including online via a computer database, telecommunications and the Internet; services of a sports bookmaker; spread betting, gaming, betting, gambling, bookmaking and wagering services; betting, games, gaming and gambling machine rental services; provision of the aforesaid services in electronic or computer form, via the television, radio or other means of broadcasting; provision of the aforesaid services on-line via the Internet or from a computer network or database; skill games services, electronic games services using software for fixed odds betting programmes, horse racing betting, instant lotteries, pools; consultancy, information and advisory services relating to all the aforesaid services.

42 – Scientific and technological services and research and design relating thereto design and development of computer hardware and software; application service provider (ASP); application service provider (ASP) featuring software to enable or facilitate the uploading, downloading, streaming, posting, displaying, blogging, linking, sharing or otherwise providing electronic media or information over communication networks; computer game design; creation, hosting, updating and maintaining Internet sites; design and development of software in the form of services relating to the development and creation of software for use in relation to electronic games downloadable from the Internet, electronic puzzles downloadable from the Internet, electronic board games downloadable from the Internet, electronic games of skill, electronic gambling games and electronic card games downloadable from the Internet, skill games, electronic games and software for fixed odds betting programs, spread betting programs, horse racing betting, instant lotteries, and pools; design and development services in relation to gaming and gambling machines, apparatus and accessories; design and development services in relation to interactive entertainment products; design of scratch cards and electronic scratch cards and scratch card games; design services relating to the production of computer games and interactive entertainment products; design of graphics, visuals, virtual and interactive images, and of special effects for games, audiovisual, multimedia productions and for Internet gaming and gambling website pages; development of computer software applications solutions; providing temporary use of non-downloadable software for use in connection with interactive, multiplayer and single player games, gaming and gambling; providing a web hosting platform for use of non-downloadable software in connection with inter-

active, multiplayer and single player games, gaming and gambling for third parties; technical management with regard to providing of betting; consultancy, information and advisory services relating to all the aforesaid services.

(260) AM 2022 114091 A

(800) 1604476

(151) 2021 05 14

(891) 2021 05 14

(731) Exeger Operations AB

Box 55597, SE-102 04 Stockholm, Sweden

(540)

## EXEGER

(591) Black, white

(511)

6 – Roof of metal; windows of metal; facades of metal; roof of metal, incorporating solar cells; facades of metal incorporating solar cells; walls of metal incorporating solar cells.

7 – Electric power supply units using solar cells; solar generators and their peripheral parts; electric generators that use solar cells and peripherals for these.

9 – Apparatus and instruments for scientific, nautical, photographic, cinematographic and optical purposes, as well as apparatus and instruments for surveying, inspection, weighing, measuring, signaling, checking (monitoring), lifesaving and teaching apparatus; apparatus and instruments for conducting, switching, transforming, accumulating, regulating or controlling electricity; measuring instruments and instruments for measuring and checking; appliances and instruments for storing electricity; apparatus and instruments for recording, transmission or reproduction of sound or images; solar cell panels for use in heating, generating and recycling energy; data processing equipment; computers; calculators; software; photovoltaic apparatus for generating electricity; photovoltaic devices for converting solar radiation and light energy into electrical energy; solar cells for generating electricity and parts for solar cells included in the class; solar cell panels; solar cell modules; solar batteries; solar battery chargers; solar batteries for domestic use; solar-powered rechargeable batteries; solar-powered electronic devices and instruments, as well as accessories included in the class; solar powered portable electronic devices and instruments; solar powered telephones; solar powered radio apparatus; solar powered computers; solar powered tablets; solar powered headphones; solar powered electronic sports training simulators; electronic reading and writing machines; wireless communication apparatus; mobile telephones; cases adapted for mobile phones; tablet computers; cases for tablet computers; portable computers; cases for portable computers; wearable activity trackers for use during sport activities; electronic sports training simulators; wireless headphones; loudspeakers; wireless

speakers; wireless keyboards; mouse pads; electric signs; traffic-light apparatus [signalling devices]; digital and electronic tablets; telecommunication apparatus; video devices; calibration devices and instruments; automatic control apparatus; clocks [warning devices]; energy control devices; downloadable software applications; accessories for the aforesaid goods included in this class.

11 – Apparatus for lighting, heating, steam generating, cooking, refrigerating, drying, ventilating, water supply and sanitary purposes; solar cell lighting apparatus; solar powered torches; solar energy powered heating apparatus; solar water heaters; solar powered lamps; solar powered ventilation apparatus; roof lights [lamps]; air-conditioning apparatus; accessories for the aforesaid goods included in this class.

12 – Cars and vehicles; apparatus for locomotion by land, air or water and structural parts and peripheral accessories thereof falling within this class.

14 – Time instruments; solar powered watches and clocks; parts and fittings for time measuring instruments.

19 – Roof, not of metal; windows, not of metal; facades, not of metal; roofs, not of metal, incorporating solar cells; facades, not of metal, incorporating solar cells; walls, not of metals, incorporating solar cells; windows incorporating solar cells; monuments of non-metallic materials including solar cells.

20 – Furniture; mirrors (silvered glass); picture frames; furniture with built-in solar cells; blinds for indoor use (furniture) with built-in solar cells.

25 – Clothing and headgear.

37 – Construction, installation, maintenance and repair of light and solar powered systems; construction of utility solar installations; installation of residential energy systems with solar panels; construction services.

40 – Generation of electricity from solar energy; custom assembling of materials for others.

42 – Scientific or technological services and research and design relating to these services; industrial analysis and research; design or development of computer hardware and software; design and development of software for control, regulation and monitoring of solar energy systems; research and design in the field of solar cell development; design and development of hardware and software; consulting services relating to solar cell technology.

(260) AM 2022 114092 A

(800) 1604493

(151) 2021 05 12

(891) 2021 05 12

(731) KDV-SPORT PTY LTD

Level 6, 9 Beach Road, Surfers Paradise,  
Gold Coast QLD 4217, Australia

(540)



(591) Pink and white

(531) 26.13.25; 27.05.01; 27.07.01; 29.01.12

(511)

16 – Fountain pens; albums; almanacs; posters; banknotes; banners of paper; paper bows, other than haberdashery or hair decorations; name badges [office requisites]; forms, printed; announcement cards [stationery]; note books; drawing pads; pads [stationery]; wristbands for the retention of writing instruments; pamphlets; booklets; paper; paper sheets [stationery]; waxed paper; papers for painting and calligraphy; drawer liners of paper, perfumed or not; wood pulp paper; carbon paper; copying paper [stationery]; parchment paper; writing paper; rice paper; luminous paper; wrapping paper; signboards of paper or cardboard; newspapers; document holders [stationery]; pencil holders; chalk holders; holders for stamps [seals]; page holders; name badge holders [office requisites]; table runners of paper; drawing boards; advertisement boards of paper or cardboard; punches [office requisites]; magazines [periodicals]; clips for name badge holders [office requisites]; tags for index cards; pen clips; bookmarks; printed publications; graphic representations; calendars; pencils; pencil lead holders; pictures; paintings [pictures], framed or unframed; cardboard; cards; index cards [stationery]; catalogues; books; manifolds [stationery]; drawing pins; envelopes [stationery]; boxes of paper or cardboard; printed coupons; flyers; viscose sheets for wrapping; absorbent sheets of paper or plastic for foodstuff packaging; sheets of reclaimed cellulose for wrapping; plastic bubble packs for wrapping or packaging; graphic prints; sealing compounds for stationery purposes; adhesives [glues] for stationery or household purposes; bags [envelopes, pouches] of paper or plastics, for packaging; stickers [stationery]; writing cases [stationery]; paper knives [letter openers]; covers [stationery]; postcards; conical paper bags; folders for papers; loose-leaf binders; pen cases; seals [stamps]; clipboards; handkerchiefs of paper; letter trays; trays for sorting and counting money; coasters of paper; bookends; stands for pens and pencils; photograph stands; obliterating stamps; towels of paper; writing instruments; hand labelling appliances; indexes; rubber erasers; marking pens [stationery]; penholders; paper wipes for cleaning; face towels of paper; table napkins of paper; place mats of paper; tablemats of paper; tablecloths of paper; paper clasps; bottle wrappers of

paper or cardboard; flags of paper; labels of paper or cardboard.

35 – Arranging subscriptions to telecommunication services for others; import-export agency services; commercial information agency services; advertising agency services; cost price analysis; rental of advertising space; business auditing; financial auditing; employment agency services; computerized file management; outsourced administrative management for companies; invoicing; demonstration of goods; transcription of communications [office functions]; opinion polling; market studies; business investigations; marketing research; personnel recruitment; business management and organization consultancy; business organization consultancy; business management consultancy; personnel management consultancy; professional business consultancy; layout services for advertising purposes; marketing; marketing in the framework of software publishing; scriptwriting for advertising purposes; news clipping services; updating and maintenance of data in computer databases; updating of advertising material; word processing; organization of exhibitions for commercial or advertising purposes; organization of fashion shows for promotional purposes; organization of trade fairs; shop window dressing; business appraisals; payroll preparation; data search in computer files for others; providing business information; providing business information via a website; providing commercial and business contact information; providing commercial information and advice for consumers in the choice of products and services; provision of an online marketplace for buyers and sellers of goods and services; providing user reviews for commercial or advertising purposes; web indexing for commercial or advertising purposes; providing user rankings for commercial or advertising purposes; presentation of goods on communication media, for retail purposes; media relations services; economic forecasting; auctioneering; sales promotion for others; promotion of goods and services through sponsorship of sports events; production of teleshopping programmes; production of advertising films; rental of advertising time on communication media; publicity material rental; rental of billboards [advertising boards]; rental of vending machines; rental of sales stands; consumer profiling for commercial or marketing purposes; publication of publicity texts; radio advertising; development of advertising concepts; bill-posting; distribution of samples; dissemination of advertising matter; direct mail advertising; writing of publicity texts; compilation of information into computer databases; compilation of statistics; business inquiries; interim business management; business management for freelance service providers; commercial administration of the licensing of the goods and services of others; business management of reimbursement programmes for others; administration of consumer loyalty programs; administrative processing of purchase orders; public relations; competitive intelligen-

ce services; modelling for advertising or sales promotion; market intelligence services; website traffic optimization; tax filing services; search engine optimization for sales promotion; retail services relating to bakery products; gift registry services; price comparison services; pay per click advertising; procurement services for others [purchasing goods and services for other businesses].

43 – Snack-bar services; café services; cafeteria services; rental of transportable buildings; rental of drinking water dispensers; self-service restaurant services; restaurant services; canteen services; food sculpting; decorating of food; cake decorating; food and drink catering; washoku restaurant services; udon and soba restaurant services.

---

(260) AM 2022 114098 A  
 (800) 1604686  
 (151) 2021 04 19  
 (891) 2021 04 19  
 (731) Toruńskie Zakłady Materiałów Opatrunkowych,  
 Spółka Akcyjna  
 Żółkiewskiego 20/26, PL-87-100 Toruń, Poland  
 (540)

**matovis**

(591) Black, white  
 (511)  
 10 – Non-elastic supportive bandages.

---

(260) AM 2022 114099 A  
 (800) 1604687  
 (151) 2021 01 07  
 (891) 2021 01 07  
 (731) CLEAN BIOLOGICS  
 2 place de Francfort, F-69003 LYON, France  
 (540)

**CLEAN BIOLOGICS**

(591) Black, white  
 (511)  
 5 – Pharmaceutical preparations; pharmaceutical products; pharmaceutical substances; preparations for vaccines; vaccines; cells for medical use; stem cells for medical use; living cells for medical use; diagnostic kits consisting of diagnostic agents, preparations and substances for medical use; chemical and biochemical reagents for medical and pharmaceutical use; biological reagents, namely, biological preparations for detection, analysis and quantification of microbial contaminants for medical diagnostic purposes for research; chemical reagents and culture media for medical and pharmaceutical diagnostics; medical diagnostic tests and reagents for testing for the presence of pathogens and infections; medical diagnostic kits comprising medical diagnostic tests and reagents for testing for the presence of pathogens and infections;

medical diagnostic kits comprising medical diagnostic tests and reagents for analyzing organic liquids of microorganisms; diagnostic kits for medical use for detection of viruses, bacteria, fungi, pathogens and parasites.

10 – Diagnostic devices for medical use for detection of viruses, bacteria, fungi, pathogens and parasites; medical apparatus for biological sample analysis for medical diagnostic purposes; analysis devices for identification of bacteria for medical use.

41 – Training; moderating workshops and seminars; provision of online training; provision of educational materials online in the field of health; provision of non-downloadable online electronic publications.

42 – Medical research; biological research; scientific research; research in bacteriology; research in biochemistry; research in biotechnology; research in the field of pharmaceutical products; pharmaceutical research and development; research and development for the pharmaceutical industry; scientific and medical research and development; research services in the field of proteins, antibodies, microorganisms and cells; scientific services relating to the isolation and cultivation of human tissues and cells; research and development in the field of microorganisms and cells; stem cell research; research and development of vaccines and medicines; research and testing in bacteriology; research and development services in the field of antibody technology; provision of information relating to medical and scientific research in the field of pharmaceutical products; research, testing and analysis services; consultancy with respect to pharmaceutical research and development; provision of information regarding medical and scientific research in the field of pharmaceutical products and clinical trials; quality control; quality assessments; research in the field of gene therapy; testing, analysis and evaluation of services for third parties to determine compliance with certification standards; medicine development including raw material production; development of biological medicines including production of raw materials.

44 – Storage of human cells for medical purposes; storage of stem cells [medical services]; storage of human cells, cell banks, viral batches and all derived biological products; storage of tissues, cells and cellular components for medical and scientific use; storage of human cells, cell components and tissues intended for cell and cell component treatments and transplantations; cell bank services; Human tissue analysis services for medical treatments; genetic analysis for medical treatment; carrying out disease diagnoses; genetic analysis for medical use; storage of human cells, cell banks, viral batches and all derived biological products.

(260) AM 2022 114101 A

(800) 1604740

(151) 2021 07 02

(891) 2021 07 02

(731) Yangtze Memory Technologies Co., Ltd.  
No.88 Weilai 3rd Road, East Lake High-tech,  
Development Zone., Wuhan, Hubei, China

(540)

## Yangtze Memory

(591) Black, white

(511)

9 – Counters; apparatus to check franking; ticket dispensers; electronic tags for goods; telephone apparatus; electronic surveillance apparatus; photographic cameras; screens for photoengraving; detectors; microscopes; regulating apparatus, electric; lightning conductors; alarms; electric locks; electric batteries; solar batteries; holders for electric coils; semi-conductors; wafers for integrated circuits; integrated circuits; chips [integrated circuits]; semiconductor apparatus; transistors; electromagnetic coils; condensers [capacitors]; electric resistances; sensors; video screens; remote control apparatus; data processing apparatus; computer memory devices; computer programs, recorded; identity cards, magnetic; microprocessors; monitors [computer hardware]; processors [central processing units]; integrated circuit cards [smart cards]; usb flash drives; computers.

42 – Information technology [it] consulting services; technological research; research and development of new products for others; conducting technical project studies; scientific laboratory services; scientific research; chemical research; material testing; industrial design.

(260) AM 2022 114102 A

(800) 1604770

(151) 2020 12 31

(891) 2020 12 31

(731) JUSTEEL PASLANMAZ ÇELİK VE METAL  
ÜRÜNLERİ SANAYİ TİCARET LİMİTED  
ŞİRKETİ

Çubuk Yolu 8. Km Güldarparı Mahallesi, Büğdüz  
Yolu 201 Ada 3 Parsel Çubuk, Ankara, Turkey

(540)

# JUSTEEL

(591) Black, white

(531) 27.05.01

(511)

6 – Ores of non-precious metal; common metals and their alloys and semi-finished products made of these materials; irons for construction; mats and stirrups of common metals for buildings; common metals in the form of plate, billet, stick, profile, sheet and sheeting;

goods and materials of common metal used for storage, wrapping, packaging and sheltering purposes, containers of metal (storage, transport), buildings of metal, frames of metal for building, poles of metal for building, metal boxes, packaging containers of metal, aluminium foil, fences made of metal, guard barriers of metal, metal tubes, storage containers of metal, metal containers for the transportation of goods, ladders of metal; filtering material of metal for making filter, included in this class; doors, windows, shutters, jalousies and their cases and fittings of metal; non-electric cables and wires of metal; ironmongery; small hardware of metal; screws of metal; nails; bolts of metal; nuts of metal; pegs of metal; flakes of metal; pitons of metal; metal chains; furniture casters of metal; fittings of metal for furniture; industrial metal wheels; door handles of metal; window handles of metal; hinges of metal; metal latches; metal locks; metal keys for locks; metal rings; metal pulleys; ventilation ducts, vents, vent covers, pipes, chimney caps, manhole covers, grilles of metal for ventilation, heating, sewage, telephone, underground electricity and air conditioning installations; metal panels or boards (non-luminous and non-mechanical) used for signalling, route showing, publicity purposes, signboards of metal, advertisement columns of metal, signaling panels of metal, non-luminous and non-mechanical traffic signs of metal; pipes of metal for transportation of liquids and gas, drilling pipes of metal and their metal fittings, valves of metal, couplings of metal for pipes, elbows of metal for pipes, clips of metal for pipes, connectors of metal for pipes; safes (strong boxes) of metal; metal railway materials, metal rails, metal railway ties, railway switches; bollards of metal, floating docks of metal, mooring buoys of metal, anchors; metal moulds for casting, other than machine parts; works of art made of common metals or their alloys, trophies of common metal; metal closures, bottle caps of metal; metal poles; metal pillars; scaffolding of metal; metal stakes, scaffolding towers of metal; metal pallets and metal ropes for lifting, loading and transportation purposes; metal hangers, ties, straps, tapes and bands used for loadlifting and load-carrying.

(260) AM 2022 114103 A  
 (800) 1604843  
 (151) 2021 04 14  
 (891) 2021 04 14  
 (731) ROYAL ARMENIA JV LTD  
 Davtashen 2nd Block 268, 0054 Yerevan,  
 Armenia

(540)



(591) Blue, light blue, dark blue, red, black, cream, gray and sky blue  
 (531) 03.07.05; 05.01.04; 26.01.18; 27.05.10;  
 29.01.15  
 (526) 3 IN 1, ARMENIA, LIGHT  
 (511)  
 30 – Coffee; instant coffee.

(260) AM 2022 114104 A  
 (800) 1604868  
 (151) 2021 05 09  
 (891) 2021 05 09  
 (731) Apple Inc.  
 One Apple Park Way, Cupertino CA 95014,  
 USA

(540)

## LIQUID RETINA XDR

(591) Black, white  
 (511)  
 9 – Electronic display screens.

(260) AM 2022 114105 A  
 (800) 1604878  
 (151) 2021 05 09  
 (891) 2021 05 09  
 (731) Apple Inc.  
 One Apple Park Way, Cupertino CA 95014,  
 USA

(540)

## FACETIME HD

(591) Black, white  
 (511)  
 9 – Computer software for providing integrated communication with computerized global networks; computer software for video telephony; computer software for the transmission of voice, data and images between

en fixed or remote stations and devices; cameras; video cameras.

(260) AM 2022 114106 A

(800) 1604892

(151) 2020 11 19

(891) 2020 11 19

(731) Zakrytoe aktsionernoe obshchestvo "Myasnaya galereya"  
ul. Poliny Osipenko, d. 65, of. 10, RU-600009  
g. Vladimir, Russian Federation

(540)



(591) Red, yellow, pink, black and white

(531) 03.07.17; 08.05.01; 08.05.03; 28.05; 29.01.15

(526) Sign ®.

(511)

29 – Meat, fish, poultry and game; meat extracts; preserved, frozen, dried and cooked fruits and vegetables; jellies, jams, compotes; eggs; milk and milk products; edible oils and fats; albumen for culinary purposes; seaweed extracts for food; gelatine; anchovy, not live; peanut butter; butter; cocoa butter for food; coconut butter; buttercream; white of eggs; blood sausage; broth; preparations for making bouillon; caviar; charcuterie; potato chips; sauerkraut; coconut, desiccated; rape oil for food; broth concentrates; soups; raisins; gherkins; oils for food; cream [dairy products]; cheese; frosted fruits; croquettes; crustaceans, not live; dates; crayfish, not live; fish fillets; rennet; fruit jellies; fruit pulp; fish, not live; jellies for food; meat jellies; ginger jam; soya beans, preserved, for food; fatty substances for the manufacture of edible fats; fat-containing mixtures for bread slices; herrings, not live; lobsters, not live; corn oil for food; palm kernel oil for food; sesame oil for food; oysters, not live; isinglass for food; ham; yolk of eggs; yogurt; vegetable soup preparations; vegetable juices for cooking; kefir; kumys; milk beverages, milk predominating; whey; spiny lobsters, not live; bacon; lentils, preserved; margarine; marmalade; animal marrow for food; mussels, not live; mollusks, not live; palm oil for food; nuts, prepared; powdered eggs; liver pâté; onions, preserved; olives, preserved; olive oil for food; bone oil for food; pectin for culinary purposes; pickles; peas, preserved; sausages; sardelki [sausages]; salted meats; preparations for making soup; tomato purée; vegetable salads; lard; fruit salads; sardines, not live; salmon, not live; suet for food; tuna, not live; tomato

juice for cooking; sunflower oil for food; tripe; truffles, preserved; poultry, not live; breaded pieces of chicken; fruit peel; alginates for culinary purposes; almonds, ground; peanuts, prepared; mushrooms, preserved; coconut fat; coconut oil for food; beans, preserved; liver; fish-based foodstuffs; fruit chips; clams, not live; fruit preserved in alcohol; pollen prepared as foodstuff; prawns, not live; fish, preserved; meat, preserved; shrimps, not live; snail eggs for consumption; tofu; whipped cream; pork; edible birds' nests; fish, canned; fish meal for human consumption; fruits, canned; meat, canned; potato fritters; salted fish; sea-cucumbers, not live; silkworm chrysalis for human consumption; vegetables, canned; sausages in batter; potato flakes; apple purée; cranberry compote; tahini; hummus; toasted laver; fruit-based snack food; curd; kimchi; soya milk; milk shakes; ajvar [preserved peppers]; sunflower seeds, prepared; fish mousses; non-alcoholic eggnog; vegetable mousses; fish roe, prepared; seeds, prepared; aloe vera prepared for human consumption; preserved garlic; protein milk; flaxseed oil for food; low-fat potato chips; lecithin for culinary purposes; milk ferments for culinary purposes; condensed milk; smetana; ryazhenka [fermented baked milk]; prostokvasha [soured milk]; tomato paste; vegetable marrow paste; eggplant paste; peanut milk for culinary purposes; almond milk for culinary purposes; rice milk; artichokes, preserved; arrangements of processed fruit; powdered milk; yakitori; bulgogi; candied nuts; flavored nuts; hazelnuts, prepared; berries, preserved.

30 – Coffee; tea; cocoa; artificial coffee; rice; tapioca; sago; flour and preparations made from cereals; bread, pastry and confectionery; ice cream; sugar, honey, treacle; yeast, baking-powder; salt; mustard; vinegar, condiments; spices; seaweed [condiment]; pasta; almond paste; aniseed; star aniseed; confectionery for decorating Christmas trees; infusions, not medicinal; coffee flavorings; aromatic preparations for food; seasonings; unleavened bread; salt for preserving foodstuffs; rusks; cookies; malt biscuits; peppermint sweets; sweets; waffles; buns; unroasted coffee; vegetal preparations for use as coffee substitutes; cakes; cinnamon [spice]; capers; caramels [sweets]; curry [spice]; chewing gum; chicory [coffee substitute]; chocolate; marzipan; cloves [spice]; sugar confectionery; corn flakes; popcorn; preparations for stiffening whipped cream; pancakes; essences for foodstuffs, except etheric essences and essential oils; cooking salt; thickening agents for cooking foodstuffs; turmeric; natural sweeteners; gingerbread; allspice; meal; bean meal; corn flour; mustard meal; barley meal; soya flour; wheat flour; starch for food; ferments for pastes; fondants [confectionery]; petits fours; flavorings, other than essential oils, for cakes; cake powder; cake dough; ginger [spice]; binding agents for ice cream; ice, natural or artificial; ice for refreshment; glucose for culinary purposes; gluten prepared as foodstuff; groats for human food; ketchup [sauce]; co-



coa beverages with milk; coffee beverages with milk; chocolate beverages with milk; leaven; sausage binding materials; macarons; macaroni; corn, milled; corn, roasted; maltose; molasses for food; golden syrup; mint for confectionery; husked barley; nutmegs; noodles; pies; crushed barley; sandwiches; pastilles [confectionery]; pastries; petit-beurre biscuits; bread rolls; peppers [seasonings]; pizzas; pepper; potato flour; puddings; pralines; ravioli; liquorice [confectionery]; saffron [seasoning]; sauces [condiments]; celery salt; semolina; sherbets [ices]; spaghetti; tapioca flour; tarts; vanilla flavorings for culinary purposes; vanillin [vanilla substitute]; vermicelli; meat pies; pâtés en croûte; meat tenderizers for household purposes; edible ices; powders for making ice cream; almond confectionery; peanut confectionery; food flavorings, other than essential oils; flavorings, other than essential oils, for beverages; crushed oats; husked oats; oat-based food; oat flakes; oatmeal; stick liquorice [confectionery]; beer vinegar; coffee-based beverages; cocoa-based beverages; chocolate-based beverages; lollipops [confectionery]; chips [cereal products]; chow-chow [condiment]; couscous; malt extract for food; malt for human consumption; bee glue; relish [condiment]; royal jelly; sea water for cooking; sushi; tomato sauce; mayonnaise; crackers; custard; fruit jellies [confectionery]; muesli; rice cakes; soya sauce; frozen yogurt [confectionery ices]; chutneys [condiments]; spring rolls; tacos; tortillas; iced tea; tea-based beverages; dressings for salad; bread crumbs; tabbouleh; halvah; quiches; meat gravies; miso; cereal-based snack food; rice-based snack food; hominy; hominy grits; baking soda [bicarbonate of soda for cooking purposes]; garden herbs, preserved [seasonings]; noodle-based prepared meals; cake frosting [icing]; chocolate mousses; dessert mousses [confectionery]; fruit coulis [sauces]; marinades; cheeseburgers [sandwiches]; pesto; ham glaze; flaxseed for culinary purposes [seasoning]; wheat germ for human consumption; high-protein cereal bars; cream of tartar for culinary purposes; gluten additives for culinary purposes; pasta sauce; cereal bars; palm sugar; dough; flowers or leaves for use as tea substitutes; pastry dough; vareniki [stuffed dumplings]; pelmeni [dumplings stuffed with meat] including khinkali, manti; chocolate decorations for cakes; candy decorations for cakes; chocolate-coated nuts; rice pudding; nut flours; minced garlic [condiment]; baozi; rice pulp for culinary purposes; jiaozi; ramen; okonomiyaki [Japanese savory pancakes]; batter mixes for okonomiyaki [Japanese savory pancakes]; burritos; prepared rice rolled in seaweed; edible paper; edible rice paper; piccalilli.

43 – Services for providing food and drink; temporary accommodation; accommodation bureau services [hotels, boarding houses]; food and drink catering; retirement home services; café services; cafeteria services; providing campground facilities; canteen services; rental of temporary accommodation; boarding house services; tourist home services; hotel services; day-

nursery [crèche] services; restaurant services; boarding house bookings; hotel reservations; self-service restaurant services; snack-bar services; boarding for animals; bar services; holiday camp services [lodging]; rental of transportable buildings; temporary accommodation reservations; motel services; rental of chairs, tables, table linen, glassware; rental of meeting rooms; rental of tents; rental of cooking apparatus; rental of drinking water dispensers; rental of lighting apparatus; food sculpting.

(260) AM 2022 114107 A

(800) 1604916

(151) 2021 02 12

(891) 2021 02 12

(731) SANTA RITA STUDIO LTDA

Rua Barão de Curumataú, 2229 -, Lagoa Nova, 59063-130 Natal – RN, Brazil

(540)



(591) Black

(531) 27.05.01; 28.19

(511)

28 – Apparatus for electronic games other than those adapted for use with an external display screen or monitor; handheld game consoles; hand-held units for playing electronic games; arcade-type electronic video games; electronic games other than those adapted for use with television receivers only; party games; action-type target games; action skill games.

(260) AM 2022 114108 A

(800) 1604940

(151) 2020 11 05

(891) 2020 11 05

(731) Jiangsu DAYI Power Tools CO., LTD

No. 99, East Hehai Road, Economic and Technological, Development Zone, Haimen District, Nantong City, 226100 Jiangsu Province, China

(540)



(591) Black, white

(531) 27.05.01

(511)

7 – Agricultural machines; lawnmowers [machines]; spraying machines; weeding machines; agricultural implements, other than hand-operated; aerating pumps for aquaria; disintegrators; milking machines; shearing machines for animals; saw benches [parts of machines]; saw blades [parts of machines]; mixing machines; beverage preparation machines, electromecha-

nical; stitching machines; sewing machines; engraving machines; sheaf-binding machines; mills for household purposes, other than hand-operated; kitchen machines, electric; whisks, electric, for household purposes; fruit presses, electric, for household purposes; washing machines [laundry]; machines for processing plastics; electromechanical machines for chemical industry; rinsing machines; cutters [machines]; whitewashing machines; stone-working machines; jacks [machines]; metalworking machines; steam engines; carburettor feeders; igniting devices for internal combustion engines; turbines, other than for land vehicles; threading machines; bending machines; drilling heads [parts of machines]; machines and apparatus for polishing [electric]; planing machines; industrial robots; chain saws; shears, electric; scissors, electric; hand-held tools, other than hand-operated; riveting machines; compressed air guns for the extrusion of mastics; food processors, electric; guns [tools using explosives]; nail extractors, electric; screwdrivers, electric; painting machines; spray guns for paint; piston segments; carbon brushes [electricity]; cylinders for machines; dynamos; pistons [parts of machines or engines]; stators [parts of machines]; motors, other than for land vehicles; valves [parts of machines]; compressors [machines]; pump diaphragms; pumps [machines]; compressed air machines; compressed air pumps; blowing machines; shaft couplings [machines]; crank shafts; ball-bearings; bearings [parts of machines]; welding machines, electric; soldering apparatus, gas-operated; gas-operated blow torches; high pressure washers; snow ploughs; vacuum cleaners; machines and apparatus for wax-polishing, electric; curtain drawing devices, electrically operated; shoe polishers, electric.

8 – Abrabrating instruments [hand instruments] (terms too vague in the opinion of the International Bureau – Rule 13 (2) (b) of the Regulations); hand tools, hand-operated; sharpening wheels [hand tools]; emery grinding wheels; agricultural implements, hand-operated; garden tools, hand-operated; syringes for spraying insecticides; beard clippers; wrenches [hand tools]; screw-thread cutters [hand tools]; gouges [hand tools]; hammers [hand tools]; chisels; screwdrivers, non-electric; pliers; files [tools]; vices; riveters [hand tools]; non-electric caulking guns; air pumps, hand-operated; graving tools [hand tools]; hobby knives [scalpels]; scissors; cutters; side arms, other than firearms; tableware [knives, forks and spoons]; handles for hand-operated hand tools.

9 – Scales; slide calipers; measures; rulers [measuring instruments]; signal lanterns; signs, luminous; mobile telephones; security surveillance robots; audiovisual teaching apparatus; metal detectors for industrial or military purposes; detectors; range finders; measuring devices, electric; levelling staffs [surveying instruments]; measuring instruments; levels [instruments for determining the horizontal]; levelling instruments;

optical apparatus and instruments; cables, electric; magnets; control panels [electricity]; lightning conductors; fire extinguishing apparatus; protective helmets; solderers' helmets; alarms; spectacles; battery chargers; batteries, electric.

11 – Electric torches; lighting apparatus and installations; kettles, electric; refrigerators; hair dryers; heat guns; watering installations, automatic; taps for pipes and pipelines; sanitary apparatus and installations; electrically heated clothing.

---

(260) AM 2022 114110 A  
 (800) 1604987  
 (151) 2021 04 22  
 (891) 2021 04 22  
 (731) "KONTI-RUS" JOINT STOCK COMPANY  
 ul. Zolotaia, 13, RU-305000 Kursk,  
 Russian Federation

(540)

## KONTI-MOON

(591) Black, white  
 (511)  
 30 – Cakes; confectionery; pastries; sweets; sugar confectionery.

---

(260) AM 2022 114111 A  
 (800) 1605064  
 (151) 2021 04 30  
 (891) 2021 04 30  
 (731) Amgen Inc.  
 Trademark Operations – MS 28-5-A, One  
 Amgen Center Drive, Thousand Oaks  
 CA 91320-1799, USA

(540)

## TEZSPIRE

(591) Black, white  
 (511)  
 5 – Pharmaceutical preparations for the treatment of respiratory diseases and disorders, pulmonary diseases and disorders, cardiovascular diseases and disorders, inflammation, inflammatory diseases and disorders, autoimmune diseases and disorders, cancer, oncological diseases and disorders, hematological diseases and disorders, tumorous diseases, neurological diseases and disorders and metabolic diseases and disorders.

---

(260) AM 2022 114112 A  
 (800) 1605082  
 (151) 2020 12 30  
 (891) 2020 12 30  
 (731) YUMA KİLİT VE MAKİNE SANAYİ  
 ANONİM ŞİRKETİ  
 Terazidere Mah. Günes Cad., Rüya Sk. No:7,  
 Bayrampaşa, İstanbul, Turkey

(540)



(591) Yellow and black

(531) 26.05.01; 26.05.18; 27.05.01; 29.01.12

(511)

6 – Ores of non-precious metal; common metals and their alloys and semi-finished products made of these materials; construction materials of metal; goods and materials of common metal used for storage, wrapping, packaging, sheltering and building purposes, containers of metal (storage, transport), fences and transportable buildings made of metal, ladders of metal; doors, windows, shutters, jalousies and their cases and fittings of metal; non-electric cables and wires of metal; ironmongery, small hardware of metal; ventilation ducts, vents, vent covers, pipes, chimney caps, manhole covers, grilles of metal for ventilation, heating, sewage, telephone, underground electricity and air conditioning installations; metal panels or boards (non-luminous and non-mechanical) used for signalling, route showing, publicity purposes, signboards of metal, advertisement columns of metal, signaling panels of metal; pipes of metal for transportation of liquids and gas and their metal fittings, drilling pipes of metal; safes (strong boxes) of metal; metal railway materials; bollards of metal, floating docks of metal, mooring buoys of metal, anchors; metal moulds for casting, other than machine parts; works of art made of common metals or their alloys; metal closures, bottle caps of metal; metal poles; metal pallets and metal ropes for lifting, loading and transportation purposes; metal hangers, ties, straps, tapes and bands used for load-lifting and load-carrying; wheel chocks made primarily of metal; vehicle lowering ropes made of metal.

8 – Forks, spoons, knives and non-electric cutters, slicers, peelers for kitchen use, including those made of precious metals; side arms and blades (weapons); tools and apparatus included in this class for shaving, epilation, manicure, pedicure and personal beauty care use; scissors; hand-operated hand tools included in this class for the repair of machines, apparatus and vehicles and for use in construction, agriculture, horticulture and forestry, none of them being power tools.

35 – Advertising, marketing and public relations; organization of exhibitions and trade fairs for commercial or advertising purposes; office functions; business management, business administration and business consultancy; accounting; commercial consultancy services; import-export agencies; business appraisals; auctioneering; the bringing together, for the benefit of others, of a variety of goods, namely, ores of non-precious

metal, common metals and their alloys and semi-finished products made of these materials, goods and materials of common metal used for storage, wrapping, packaging, sheltering and building purposes, containers of metal (storage, transport), fences and transportable buildings made of metal, ladders of metal, doors, windows, shutters, jalousies and their cases and fittings of metal, non-electric cables and wires of metal, ironmongery, small hardware of metal, ventilation ducts, vents, vent covers, pipes, chimney caps, manhole covers, grilles of metal for ventilation, heating, sewage, telephone, underground electricity and air conditioning installations, metal panels or boards (non-luminous and non-mechanical) used for signalling, route showing, publicity purposes, signboards of metal, advertisement columns of metal, signaling panels of metal, pipes of metal for transportation of liquids and gas and their metal fittings, valves of metal, drilling pipes of metal, safes (strong boxes) of metal, metal railway materials, bollards of metal, floating docks of metal, mooring buoys of metal, anchors, metal moulds for casting, other than machine parts, works of art made of common metals or their alloys, metal closures, bottle caps of metal, metal poles, metal pallets and metal ropes for lifting, loading and transportation purposes, metal hangers, ties, straps, tapes and bands used for load-lifting and load-carrying, forks, spoons, knives and non-electric cutters, slicers, peelers for kitchen use, including those made of precious metals, side arms and blades (weapons), tools and apparatus for shaving, epilation, manicure, pedicure and personal beauty care use, electrical hair straighteners and electric hand implements for hair curling, scissors, hand-operated hand tools for the repair of machines, apparatus and vehicles and for use in construction, agriculture, horticulture and forestry, none of them being power tools, electric or non-electric irons, steam irons, enabling customers to conveniently view and purchase those goods, such services may be provided by retail stores, wholesale outlets, by means of electronic media or through mail order catalogues.

(260) AM 2022 114113 A

(800) 1605083

(151) 2021 05 25

(891) 2021 05 25

(731) PEPCO Poland Sp. z o.o.

Strzeszyńska 73A, PL-60-479 Poznań, Poland

(540)



(591) Black, red, yellow, orange, white, grey and brown  
 (531) 09.07.21; 26.04.04; 26.04.16; 26.04.19; 27.05.02; 27.05.03; 27.05.17; 29.01.15  
 (511)  
 28 – Toys; toy tools; toy hand tools; toy tool sets; toy model kit cars; kits of parts [sold complete] for constructing models.

(260) AM 2022 114114 A  
 (800) 1605099  
 (151) 2021 04 02  
 (891) 2021 04 02  
 (731) INTRAROS CO., LTD.  
 375, Maseongro, Pogok-eup, Cheoin-gu, Yongin-si, Gyeonggi-do 17023, Republic of Korea  
 (540)

# INTRARICH

(591) Black, white  
 (511)  
 5 – Medicated plasters impregnated with pharmaceutical preparations for heating and cooling; polymer bandages; adhesive tapes for sportsmen for medical purposes.  
 10 – Breast pumps; orthopaedic articles; splints; elastic stockings for surgical purposes.

(260) AM 2022 114115 A  
 (800) 1239074  
 (151) 2014 12 09  
 (891) 2021 06 29  
 (731) eleven teamsports GmbH  
 Im Winkel 1-3, 74589 Satteldorf, Germany  
 (540)



(591) White, red and black  
 (531) 09.03.09; 26.01.16; 26.01.17; 27.03.15; 27.07.01; 29.01.13  
 (511)  
 18 – Travelling bags; handbags; bags; bags, pouches of leather; backpacks; bags for clothes; bags for sports.  
 25 – Clothing, footwear, headgear; heels; heelpieces for footwear; suits; babies' pants [clothing]; layettes [clothing]; swimsuits; bathing trunks; bath robes; bathing caps; bath sandals; bath slippers; bandanas [neckerchiefs]; berets; leg warmers; clothing of imitations of leather; motorists' clothing; clothing; paper clothing; boas [necklets]; teddies [undergarments]; brassieres; chasubles; dresses; shower caps; inner soles; pocket squares; masquerade costumes; mittens; fishing vests; football boots; footmuffs, not electrically heated; gabardines [clothing]; galoshes; spats; money

belts [clothing]; non-slipping devices for footwear; belts [clothing]; clothing for gymnastics; gymnastic shoes; half-boots; scarfs; gloves [clothing]; slippers [undergarments]; shirt yokes; shirts; shirt fronts; wooden shoes; trousers; gaiter straps; suspenders; girdles; hats; hat frames [skeletons]; jackets [clothing]; jerseys [clothing]; stuff jackets [clothing]; bodices [lingerie]; skull caps; hoods [clothing]; ready-made linings [parts of clothing]; pockets for clothing; ready-made clothing; headgear for wear; camisoles; corsets [underclothing]; shoulder wraps; detachable collars; neckties; ascots; short-sleeve shirts; bibs, not of paper; clothing of leather; leggings [trousers]; underwear; liveries; maniples; cuffs; coats; pelisses; mantillas; corselets; miters [hats]; dressing gowns; muffs [clothing]; caps [headwear]; cap peaks; outerclothing; ear muffs [clothing]; combinations [clothing]; slippers; paper hats [clothing]; parkas; pelerines; furs [clothing]; petticoats; ponchos; pullovers; pyjamas; cyclists' clothing; welts for footwear; waterproof clothing; skirts; sandals; saris; sarongs; collar protectors; sashes for wear; sleep masks; veils [clothing]; wimples; breeches for wear; lace boots; fittings of metal for footwear; shoes; soles for footwear; footwear uppers; tips for footwear; footwear; smocks; aprons [clothing]; dress shields; ski gloves; ski boots; skorts; underpants; socks; sock suspenders; boots for sports; sports shoes; boots; boot uppers; headbands [clothing]; esparto shoes or sandals; shawls; fur stoles; studs for football boots; beach clothes; beach shoes; garters; stockings; sweat-absorbent stockings; heelpieces for stockings; stocking suspenders; tights; sweaters; tee-shirts; togas; jumper dresses; knitwear [clothing]; singlets; turbans; topcoats; uniforms; anti-sweat underwear; pants; wet suits for water-skiing; vests; hosiery; top hats.

28 – Games and playthings; gymnastic and sporting articles not included in other classes.

35 – Cost price analysis; business inquiries; business management consultancy; professional business consultancy, in particular for franchise concepts; accounting; services rendered by a franchisor, namely assistance in the running or management of industrial or commercial enterprises; business advisory services relating to the operation of franchises; office functions; computerised file management; publicity agencies; wholesaling and retailing, including via the internet, of travelling bags, handbags, bags, holdalls, pouches of leather, rucksacks, bags for clothes, sports bags, clothing, footwear, headgear, nets for sports, bags adapted for carrying sporting equipment, bags adapted for sports equipment, gymnastic and sporting articles, diving equipment; compilation of statistics; billing; efficiency experts; invoicing; publication of publicity texts; compilation of statistics; layout services for advertising purposes; marketing; marketing studies; opinion polling; merchandising; public relation services; online or catalogue mail order of travelling bags, handbags, bags, holdalls, pouches of leather,

rucksacks, bags for clothes, sports bags, clothing, footwear, headgear, nets for sports, bags adapted for carrying sporting equipment, bags adapted for sports equipment, gymnastic and and sporting articles, diving equipment; business organization consultancy; presentation of goods, in particular on communications media, for retail purposes; planning of advertising initiatives; business advice and consultancy; business administration; dissemination of advertising matter; writing of publicity texts; sales promotion; arranging of contracts for the buying and selling of goods, for others, in particular of sporting articles; distribution of promotional matter; presentation of goods; publicity columns preparation.

45 – Licensing of industrial property rights, in particular for franchises; industrial property management.

(260) AM 2022 114116 A

(800) 1254107

(151) 2015 01 07

(891) 2021 06 29

(731) eleven teamsports GmbH

Im Winkel 1-3, 74589 Satteldorf, Germany

(540)



(591) White and red

(531) 09.03.09; 26.01.03; 26.01.16; 26.01.17;  
29.01.12

(511)

18 – Travelling bags; handbags; bags; bags, pouches of leather; backpacks; bags for clothes; bags for sports.

25 – Clothing, footwear, headgear; heels; heelpieces for footwear; suits; babies' pants [clothing]; layettes [clothing]; swimsuits; bathing trunks; bath robes; bathing caps; bath sandals; bath slippers; bandanas [neckerchiefs]; berets; leg warmers; clothing of imitations of leather; motorists' clothing; clothing; paper clothing; boas [necklets]; teddies [undergarments]; brasieres; chasubles; dresses; shower caps; inner soles; pocket squares; masquerade costumes; mittens; fishing vests; football boots; footmuffs, not electrically heated; gabardines [clothing]; galoshes; spats; money belts [clothing]; non-slipping devices for footwear; belts [clothing]; clothing for gymnastics; gymnastic shoes; half-boots; scarfs; gloves [clothing]; slips [undergarments]; shirt yokes; shirts; shirt fronts; wooden

shoes; trousers; gaiter straps; suspenders; girdles; hats; hat frames [skeletons]; jackets [clothing]; jerseys [clothing]; stuff jackets [clothing]; bodices [lingerie]; skull caps; hoods [clothing]; ready-made linings [parts of clothing]; pockets for clothing; ready-made clothing; headgear for wear; camisoles; corsets [underclothing]; shoulder wraps; detachable collars; neckties; ascots; short-sleeve shirts; bibs, not of paper; clothing of leather; leggings [trousers]; underwear; liveries; maniples; cuffs; coats; pelisses; mantillas; corselets; miters [hats]; dressing gowns; muffs [clothing]; caps [headwear]; cap peaks; outerclothing; ear muffs [clothing]; combinations [clothing]; slippers; paper hats [clothing]; parkas; pelerines; furs [clothing]; petticoats; ponchos; pullovers; pyjamas; cyclists' clothing; welts for footwear; waterproof clothing; skirts; sandals; saris; sarongs; detachable collars; sashes for wear; sleep masks; veils [clothing]; wimples; breeches for wear; lace boots; fittings of metal for footwear; shoes; soles for footwear; footwear uppers; tips for footwear; footwear; smocks; aprons [clothing]; dress shields; ski gloves; ski boots; skorts; underpants; socks; sock suspenders; boots for sports; sports shoes; boots; boot uppers; headbands [clothing]; esparto shoes or sandals; shawls; fur stoles; studs for football boots; beach clothes; beach shoes; garters; stockings; sweat-absorbent stockings; heelpieces for stockings; stocking suspenders; tights; sweaters; tee-shirts; togas; jumper dresses; knitwear [clothing]; singlets; turbans; topcoats; uniforms; anti-sweat underwear; pants; wet suits for water-skiing; vests; hosiery; top hats.

28 – Games and playthings; gymnastic and sporting articles not included in other classes.

35 – Cost price analysis; business inquiries; business management consultancy; professional business consultancy, in particular for franchise concepts; accounting; services rendered by a franchisor, namely assistance in the running or management of industrial or commercial enterprises; business advisory services relating to the operation of franchises; office functions; computerised file management; publicity agencies; wholesaling and retailing, including via the internet, of travelling bags, handbags, bags, holdalls, pouches of leather, rucksacks, bags for clothes, sports bags, clothing, footwear, headgear, nets for sports, bags adapted for carrying sporting equipment, bags adapted for sports equipment, gymnastic and and sporting articles, diving equipment; compilation of statistics; billing; efficiency experts; invoicing; publication of publicity texts; compilation of statistics; layout services for advertising purposes; marketing; marketing studies; opinion polling; merchandising; public relation services; online or catalogue mail order sales services for travelling bags, handbags, bags, holdalls, pouches of leather, rucksacks, bags for clothes, sports bags, clothing, footwear, headgear, nets for sports, bags adapted for carrying sporting equipment, bags adapted

for sports equipment, gymnastic and sporting articles, diving equipment; business organization consultancy; presentation of goods, in particular on communications media, for retail purposes; planning of advertising initiatives; business advice and consultancy; business administration; dissemination of advertising matter; writing of publicity texts; sales promotion; arranging of contracts for the buying and selling of goods, for others, in particular of sporting articles; distribution of promotional matter; presentation of goods; advertising columns preparation.

45 – Licensing of industrial property rights, in particular for franchises; industrial property management.

(260) AM 2022 114122 A  
 (800) 1577156  
 (151) 2021 01 21  
 (891) 2021 07 15  
 (731) CAN TECHNOLOGIES, INC.  
 15407 MCGINTY ROAD W, WAYZATA MN  
 55391, USA

(540)

**ENZAE**

(591) Black, white

(511)

5 – Non-medicated animal feed supplements for livestock.

31 – Animal feed for livestock.

(260) AM 2022 114123 A  
 (800) 1588212  
 (151) 2021 01 18  
 (891) 2021 06 21  
 (731) NOVARTIS AG  
 CH-4002 Basel, Switzerland

(540)



(591) Black, white

(531) 07.03.15; 26.11.06; 26.11.09; 26.11.12

(511)

5 – Pharmaceutical preparations.

(260) AM 2022 114124 A  
 (800) 1588497  
 (151) 2021 01 18  
 (891) 2021 06 22  
 (731) NOVARTIS AG  
 CH-4002 Basel, Switzerland

(540)



(591) Dark magenta and green

(531) 07.03.15; 26.11.09; 26.11.12; 26.13.25;

27.05.01; 29.01.12

(511)

5 – Pharmaceutical preparations.

(260) AM 2022 114157 A  
 (800) 1605279

(151) 2021 03 23

(891) 2021 03 23

(731) Egis Gyógyszergyár Zrt.  
 Kereszturi út 30-38, H-1106 Budapest,  
 Hungary

(540)

**SKINSOLUTE**

(591) Black, white

(531) 26.04.05; 26.04.24; 26.11.02; 26.11.09

(511)

3 – Cosmetics and cosmetic preparations.

5 – Pharmaceutical preparations for human use; dietic substances adapted for medical use; dietary supplements; medicinal ointments; medicated skin creams; plasters, materials for dressings.

(260) AM 2022 114158 A  
 (800) 1605287

(151) 2021 05 25

(891) 2021 05 25

(731) PEPCO Poland Sp. z o.o.  
 Strzeszyńska 73A, PL-60-479 Poznań,  
 Poland

(540)



(591) White, pink, green, violet, black, grey  
 (531) 01.01.13; 27.05.02; 27.05.03; 27.05.04;  
 27.05.15; 27.05.19; 29.01.15

(511)

28 – Dolls; dolls' rooms; dolls' clothes; doll accessories; dolls' clothing accessories; doll house furniture; doll playsets; dolls' beds; dolls' feeding bottles; jewellery for dolls; carriages for dolls; headgear for dolls; shoes for dolls; toy sets; positionable toy figures; toy figures capable of transforming into various shapes; scale model figures; toy figures; modeled plastic toy figurines; collectable toy figures.

(260) AM 2022 114159 A

(800) 1605292

(151) 2021 03 23

(891) 2021 03 23

(731) Egis Gyógyszergyár Zrt.

Kereszturi út 30-38, H-1106 Budapest, Hungary

(540)

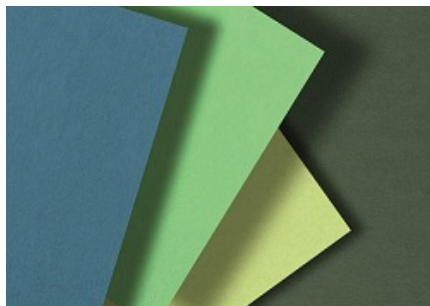

(591) Dark blue, light green, yellow and dark green  
 (531) 20.05.25; 26.04.16; 29.01.13

(511)

3 – Cosmetics and cosmetic preparations.

5 – Pharmaceutical preparations for human use; dietic substances adapted for medical use; dietary supplements; medicinal ointments; medicated skin creams; plasters, materials for dressings.

(260) AM 2022 114160 A

(800) 1605294

(151) 2021 05 09

(891) 2021 05 09

(731) 24/7 apps Ltd.

P.O.B. 134, Berotaim, 4285000 Emek Hefer, Israel

(540)

ITUBE

(591) Black, white

(511)

9 – Digital voice recorders, apparatus for recording, transmission, or reproduction of sound; record players; record playing apparatus and instruments.

(260) AM 2022 114161 A

(800) 1605295

(151) 2021 02 08

(891) 2021 02 08

(731) Obshchestvo s ogranichennoy otvetstvennostyu "MOSKVICHKA"

Kuchinskoye sh., d. 6, lit. B, pom. 18,  
 Balashikha, RU-143905 Moscow Region,  
 Russian Federation

(540)



(591) Red, white, light brown, gray, light gray, blue,  
 dark blue and light blue

(531) 01.15.09; 11.03.14; 19.03.01; 26.13.25; 28.05;  
 29.01.15

(511)

6 – Bottle caps of metal; sealing caps of metal; common metals and their alloys; vats of metal; casks of metal; barrels of metal; hoppers of metal, non-mechanical; packaging containers of metal; bungs of metal; screw tops of metal for bottles; barrel hoops of metal; bottle closures of metal; tinplate packings.

7 – Bottle capping machines; bottle stoppering machines; packing machines; machines and machine tools; apparatus for drawing up beer under pressure; apparatus for aerating water; apparatus for aerating beverages; crushers for kitchen use, electric; kitchen grinders, electric; hand-held tools, other than hand-operated; can openers, electric; compressors [machines]; bottle sealing machines; crushing machines; sausage making machines; grinding machines; bottle washing machines; dishwashers; bottle filling machines; glass-working machines; brewing machines; wrapping machines; kitchen machines, electric; filling machines; agricultural machines; mixing machines; mills [machines]; mills for household purposes, other than hand-operated; pepper mills, other than hand-operated; centrifugal mills; blenders, electric, for household purposes; meat choppers [machines]; beer pumps; knives, electric; presses [machines for industrial purposes]; wine presses; basket presses; food processors,

electric; whisks, electric, for household purposes; fruit presses, electric, for household purposes; machines for the mineralization of drinking water; beverage preparation machines, electromechanical; food preparation machines, electromechanical.

20 – Screw tops, not of metal, for bottles; casks of wood for decanting wine; casks, not of metal; barrels, not of metal; bottle closures, not of metal; bottle caps, not of metal; containers, not of metal [storage, transport]; bottle casings of wood; faucets, not of metal, for casks; corks for bottles; corks; sealing caps, not of metal; vats, not of metal; bottle racks.

21 – Dish covers; glass, unworked or semi-worked, except building glass; glassware, porcelain and earthenware; bottles; demijohns; funnels; decanters; crushers for kitchen use, non-electric; strainers for household purposes; containers for household or kitchen use; kitchen containers; glass jars [carboys]; heat-insulated containers; heat-insulated containers for beverages; thermally insulated containers for food; glass flasks [containers]; works of art of porcelain, ceramic, earthenware or glass; kitchen grinders, non-electric; beer mugs; tankards; pitchers; painted glassware; crystal [glassware]; bottle openers, electric and non-electric; glass stoppers; wine-tasting pipettes; siphon bottles for carbonated water; blenders, non-electric, for household purposes; fruit presses, non-electric, for household purposes; drinking vessels; vessels of metal for making ices and iced drinks; glasses [receptacles]; drinking glasses; utensils for household purposes; cooking utensils, non-electric; hip flasks; drinking bottles for sports; corkscrews, electric and non-electric; boxes of glass.

(260) AM 2022 114172 A

(800) 1605519

(151) 2020 10 01

(891) 2020 10 01

(731) Mgr. Beran Hanuš

Konviktská 298/10, CZ-110 00 Praha,  
Czech Republic

(540)

## CARPATHIA

(591) Black, white

(511)

9 – Binoculars, compasses and altimeters, instruments and instruments for marine, geodetic, photographic, film, optical, instruments for weighing, measuring, signaling, detection, control, rescue and teaching instruments, instruments for measuring and control of skis and ski bindings, instruments for measuring and controlling stress and speed when skiing, avalanche probes, drilling templates for ski and binding assembly, ophthalmic optics products, goggles, sunglasses, cases for spectacles, sports optical masks, especially for ski, protective helmets for athletes, personal pro-

tective equipment accident prevention preparations, diving suits, protective tarpaulins.

12 – Vehicles, land, air or water means of transport and their parts included in this class, inflatable boats, folding boats, water pedal boats, canoes, kayaks, barges, reserve inflatable vessels (ship accessories, including inflatable rescue islands), competition boats, gliders, bicycles, tricycles and their parts and accessories included in this class.

18 – Backpacks, backpacks for climbers, tourist backpacks, children's backpacks, hunting bags, hiking poles, imitation leather, handbags, fur covers, leather straps, leather hanging straps, leather straps, leather bags, hanging pouches, tool bags, leather cases, leather bags, bags, travel bags, suitcases, umbrellas, parasols.

25 – Men's, women's, children's clothing, clothes intended for sports and leisure, jackets, sports jackets with hood, sports overalls, t-shirts, polo shirts, sweatshirts, tracksuits, sports suits, shorts, leggings, knitted clothes, waterproof clothing, swimwear, windbreakers, sports jerseys, vests, pullovers, vests, belts, braces, underwear (personal underpants), socks, sports shoes, ski boots, football boots, clothing accessories – scarves, shawls, headgear, gloves, headbands; suits, gloves and masks for skiing.

28 – Sports equipment of all kinds, equipment for sports games and sports tools and utensils of all kinds including accessories and spare parts, including tools for summer and winter sports, fitness machines and devices for physical exercises, trainers, games, table and room games, sports poles, ski poles, blades, protectors, gloves for sports games, balls, skis, water skis, cross-country skis, downhill skis, diving skis, roller skis, snowboards, skateboards, sledges, mini ski, surfboards, edges, ski bindings, sole coverings for skis and covers for skis.

(260) AM 2022 114173 A

(800) 1605582

(151) 2021 02 19

(891) 2021 02 19

(731) Limited Liability Company "Piteko"

Engels St., 110, Balakhna, RU-606402

Nizhegorodskaya Region, Russian Federation

(540)





(591) Dark green, light green and white

(531) 26.03.02; 26.03.06; 26.03.18; 26.03.24;  
27.05.01; 27.05.09; 27.05.10; 27.05.24;  
29.01.13

(511)

5 – Balms for medical purposes; dietetic substances adapted for medical use; sea water for medicinal bathing; mineral waters for medical purposes; thermal water; dietary fiber; dietary fibre; hematogen; haematogen; mud for baths; medicinal mud; medicinal sediment [mud]; vitamin supplement patches; mineral food supplements; nutritional supplements; albumin dietary supplements; dietary supplements for animals; yeast dietary supplements; alginate dietary supplements; glucose dietary supplements; casein dietary supplements; lecithin dietary supplements; linseed oil dietary supplements; flaxseed oil dietary supplements; propolis dietary supplements; protein dietary supplements; royal jelly dietary supplements; pollen dietary supplements; wheat germ dietary supplements; linseed dietary supplements; flaxseed dietary supplements; acai powder dietary supplements; dietary supplements with a cosmetic effect; enzyme dietary supplements; yeast for pharmaceutical purposes; fish oils for medical purposes; cachou for pharmaceutical purposes; candy, medicated; starch for dietetic or pharmaceutical purposes; lactose for pharmaceutical purposes; milk sugar for pharmaceutical purposes; candy for medical purposes; adhesive plasters; sticking plasters; medicinal oils; castor oil for medical purposes; dill oil for medical purposes; menthol; medicinal drinks; almond milk for pharmaceutical purposes; powdered milk for babies; royal jelly for pharmaceutical purposes; flour for pharmaceutical purposes; meal for pharmaceutical purposes; linseed meal for pharmaceutical purposes; flaxseed meal for pharmaceutical purposes; mint for pharmaceutical purposes; dietetic beverages adapted for medical purposes; malted milk beverages for medical purposes; cotton sticks for medical purposes; cotton swabs for medical purposes; stick liquorice for pharmaceutical purposes; pastilles for pharmaceutical purposes; lozenges for pharmaceutical purposes; pectin for pharmaceutical purposes; pepsins for pharmaceutical purposes; peptones for pharmaceutical purposes; food for babies; vitamin preparations; pharmaceutical preparations for skin care; preparations of trace elements for human and animal use; dietetic foods adapted for medical purposes; syrups for pharmaceutical purposes; bath salts for medical purposes; digestives for pharmaceutical purposes; nervines; serums; appetite suppressant pills; slimming pills; antioxidant pills; medicinal herbs; diabetic bread adapted for medical use; medicinal tea; herbal teas for medicinal purposes; eucalyptus for pharmaceutical purposes; elixirs [pharmaceutical preparations].

29 – Ajvar [preserved peppers]; peanuts, prepared; albumen for culinary purposes; white of eggs; beans, preserved; soya beans, preserved, for food; bouillon; broth; ginger jam; ham; laver, preserved; peas, preser-

ved; mushrooms, preserved; guacamole [mashed avocado]; gelatin; jellies for food; fruit jellies; yolk of eggs; fruit-based snack food; milk substitutes; eggplant paste; aubergine paste; vegetable marrow paste; fish roe, prepared; caviar; yogurt; kephir [milk beverage]; kefir [milk beverage]; kimchi [fermented vegetable dish]; milk shakes; arrangements of processed fruit; compotes; vegetables, tinned; vegetables, canned; fruits, tinned; fruits, canned; croquettes; sweet corn, processed; marmalade; oils for food; peanut butter; cocoa butter for food; coconut oil for food; corn oil for food; maize oil for food; sesame oil for food; linseed oil for food; flaxseed oil for food; extra virgin olive oil for food; olive oil for food; sunflower oil for food; almonds, ground; milk; peanut milk; peanut milk for culinary purposes; coconut milk; coconut milk for culinary purposes; almond milk; almond milk for culinary purposes; oat milk; rice milk; rice milk for culinary purposes; albumin milk; protein milk; condensed milk; soya milk; powdered milk; vegetable mousses; fruit pulp; milk beverages, milk predominating; peanut milk-based beverages; coconut milk-based beverages; almond milk-based beverages; vegetables, preserved; freeze-dried vegetables; lyophilized vegetables; lyophilised vegetables; vegetables, dried; vegetables, cooked; olives, preserved; flavoured nuts; flavored nuts; candied nuts; coconut, desiccated; nuts, prepared; pickles; jams; milk products; prostokvasha [soured milk]; cranberry compote; tomato purée; apple purée; ryazhenka [fermented baked milk]; vegetable salads; fruit salads; seeds, prepared; sunflower seeds, prepared; cream [dairy products]; whipped cream; vegetable-based cream; smetana [sour cream]; lemon juice for culinary purposes; tomato juice for cooking; vegetable juices for cooking; whey; cheese; tahini [sesame seed paste]; falafel; dates; crystallized fruits; frosted fruits; frozen fruits; fruit, preserved; fruit, stewed; hazelnuts, prepared; hummus [chickpea paste]; fruit peel; low-fat potato chips; low-fat potato crisps; fruit chips; seaweed extracts for food; berries, preserved.

30 – Vanilla flavourings for culinary purposes; vanilla flavorings for culinary purposes; flavorings [flavourings], other than essential oils, for cakes; flavorings, other than essential oils, for cakes; flavourings, other than essential oils, for cakes; flavourings, other than essential oils, for beverages; flavorings, other than essential oils, for beverages; coffee flavourings; coffee flavorings; food flavorings, other than essential oils; food flavourings, other than essential oils; baozi [stuffed buns]; cereal bars; high-protein cereal bars; pancakes; buns; bulgur; bread rolls; edible rice paper; burritos; vanillin [vanilla substitute]; vareniki [stuffed dumplings]; waffles; vermicelli [noodles]; natural sweeteners; seaweed [condiment]; malt biscuits; cloves [spice]; mirror icing [mirror glaze]; cake frosting [icing]; glucose for culinary purposes; mustard; buckwheat, processed; gluten additives for culinary purposes; yeast; rice-based snack food; cereal-based snack

food; artificial coffee; vegetal preparations for use as coffee substitutes; dressings for salad; fruit jellies [confectionery]; candy decorations for cakes; confectionery for decorating Christmas trees; cakes; pastries; peanut confectionery; almond confectionery; pasta; ginger [spice]; frozen yogurt [confectionery ices]; frozen yoghurt [confectionery ices]; cocoa; capers; caramels [candy]; curry [spice]; ketchup [sauce]; gimbap [Korean rice dish]; quiches; gluten prepared as foodstuff; flour-based dumplings; sweetmeats [candy]; liquorice [confectionery]; peppermint sweets; mints for breath freshening; dulce de leche; cinnamon [spice]; coffee; starch for food; crackers; custard; hominy grits; semolina; oatmeal; crushed barley; groats for human food; ice cubes; corn, milled; maize, milled; corn, roasted; maize, roasted; meat pies; turmeric; couscous [semolina]; noodles; edible ices; candy; rice cakes; mayonnaise; macarons [pastry]; macaroni; maltose; hominy; marinades; marzipan; honey; miso [seasoning]; royal jelly; ice cream; bean meal; buckwheat flour; tapioca flour; potato flour; corn flour; corn meal; maize flour; maize meal; nut flours; flour; meal; wheat flour; soya flour; barley meal; dessert mousses [confectionery]; chocolate mousses; muesli; mint for confectionery; cocoa beverages with milk; coffee beverages with milk; coffee-based beverages; cocoa-based beverages; chamomile-based beverages; tea-based beverages; chocolate beverages with milk; chocolate-based beverages; infusions, not medicinal; crushed oats; husked oats; nutmegs; chocolate-coated nuts; stick liquorice [confectionery]; pastila [confectionery]; pastilles [confectionery]; lozenges [confectionery]; molasses for food; pelmeni [dumplings stuffed with meat]; pepper; allspice; peppers [seasonings]; pesto [sauce]; cookies; biscuits; petit-beurre biscuits; bibimbap [rice mixed with vegetables and beef]; pies; pizzas; meat gravies; fondants [confectionery]; popcorn; powders for making ice cream; baking powder; mustard meal; pralines; aromatic preparations for food; condiments; cereal preparations; oat-based food; propolis; bee glue; gingerbread; spices; petits fours [cakes]; rice pudding; puddings; cake powder; fruit coulis [sauces]; ravioli; chewing gum; rice; instant rice; wheat germ for human consumption; spring rolls; sago; sugar; palm sugar; sesame seeds [seasonings]; linseed for culinary purposes [seasoning]; flaxseed for culinary purposes [seasoning]; processed seeds for use as a seasoning; aniseed; agave syrup [natural sweetener]; golden syrup; confectionery; sugar confectionery; batter mixes for okonomiyaki [Japanese savoury pancakes]; batter mixes for okonomiyaki [Japanese savory pancakes]; baking soda [bicarbonate of soda for cooking purposes]; bicarbonate of soda for cooking purposes [baking soda]; malt for human consumption; salt for preserving foodstuffs; cooking salt; sherbets [ices]; sorbets [ices]; cranberry sauce [condiment]; soya sauce; tomato sauce; apple sauce [condiment]; sauces [condiments]; pasta sauce; spaghetti; seasonings; chocolate-based spreads; chocolate spre-

ads containing nuts; rusks; breadcrumbs; sushi; sandwiches; tarts; dough; pastry dough; almond paste; rice pulp for culinary purposes; cake dough; cake batter; tortillas; garden herbs, preserved [seasonings]; chocolate decorations for cakes; vinegar; halvah; bread; unleavened bread; chips [cereal products]; corn flakes; maize flakes; oat flakes; hot dog sandwiches; flowers or leaves for use as tea substitutes; chicory [coffee substitute]; tea; iced tea; chutneys [condiments]; minced garlic [condiment]; cheeseburgers [sandwiches]; saffron [seasoning]; chocolate; husked barley.

32 – Aperitifs, non-alcoholic; aerated water; carbonated water; lithia water; seltzer water; soda water; waters [beverages]; mineral water [beverages]; table waters; kvass [non-alcoholic beverage]; cocktails, non-alcoholic; lemonades; non-alcoholic beverages; isotonic beverages; non-alcoholic honey-based beverages; rice-based beverages, other than milk substitutes; soya-based beverages, other than milk substitutes; aloe vera drinks, non-alcoholic; whey beverages; protein-enriched sports beverages; soft drinks; non-alcoholic beverages flavoured with coffee; non-alcoholic beverages flavoured with coffee; non-alcoholic beverages flavoured with tea; non-alcoholic fruit juice beverages; energy drinks; fruit nectars, non-alcoholic; orgeat; powders for effervescing beverages; sarsaparilla [non-alcoholic beverage]; syrups for lemonade; syrups for beverages; smoothies; tomato juice [beverage]; cider, non-alcoholic; vegetable juices [beverages]; fruit juices; fruit juice; non-alcoholic preparations for making beverages; preparations for making aerated water; preparations for making carbonated water; pastilles for effervescing beverages; sherbets [beverages]; sorbets [beverages]; non-alcoholic fruit extracts; essences for making beverages.

35 – Advertising agency services; demonstration of goods; commercial information and advice for consumers in the choice of products and services; marketing; organization of exhibitions for commercial or advertising purposes; commercial intermediation services; provision of an online marketplace for buyers and sellers of goods and services; presentation of goods on communication media, for retail purposes; wholesale services for pharmaceutical, veterinary and sanitary preparations and medical supplies; retail services for pharmaceutical, veterinary and sanitary preparations and medical supplies; sales promotion for others; advertising; publicity; online advertising on a computer network; outdoor advertising; advertising by mail order; television advertising; procurement services for others [purchasing goods and services for other businesses].

43 – Accommodation bureau services [hotels, boarding houses]; tourist home services; hotel services; snack-bar services; information and advice in relation to the preparation of meals; café services; cafeteria services; boarding house services; rental of cooking

apparatus; rental of chairs, tables, table linen, glassware; rental of transportable buildings; rental of drinking water dispensers; restaurant services; self-service restaurant services; canteen services; decorating of food; holiday camp services [lodging]; bar services; food and drink catering.

(260) AM 2022 114174 A

(800) 1605587

(151) 2021 01 05

(891) 2021 01 05

(731) Grohe AG

Industriepark Edelburg, 58675 Hemer,  
Germany

(540)

**GROHE**



(591) Black, white

(531) 26.11.03; 26.11.13; 27.05.17

(511)

9 – Electric and electrotechnical apparatus for controlling the volume and/or temperature of water delivered by water supply apparatus and sanitary installations, and by fixtures and fittings for water supply, water heating, bath, shower, washing, rinsing, bidet and toilet installations; thermostats, individual and replacement parts for all the aforesaid goods in this class.

11 – Apparatus for lighting, heating, refrigerating, drying, ventilating, water supply and sanitary purposes; fixtures and fittings for water supply, water heating, bath, shower, washing, rinsing, bidet and toilet installations, and for the water intake and flushing of these installations; filters for preventing impurities in water; thermostatic and non-contact mixing faucets, mixing valves, control valves, stop valves, water inlet and outlet mechanisms; showers, fitting for showers, spray nozzles, spray heads; holders, tubes and junctions for tubes for showers; walls, seats and pillars for showers, washing fountains, individual and replacement parts for all the aforesaid goods in this class.

(260) AM 2022 114175 A

(800) 1605599

(151) 2021 06 29

(891) 2021 06 29

(731) ZKTECO CO., LTD.

No. 32, Pingshan Industrial Avenue, Tangxia  
Town, Dongguan City, Guangdong Province,  
China

(540)

**ZKT<sub>ECO</sub>**



(591) Black, white

(531) 27.05.10; 27.05.19

(511)

9 – Railway traffic safety appliances; audio- and video-receivers; electric and electronic video surveillance installations; video monitors; cameras [photography]; materials for electricity mains [wires, cables]; chips [integrated circuits]; electric sensors; touchscreen sensors; timing sensors; vibration sensors; temperature sensors; optical sensors; piezoelectric sensors; regulating apparatus, electric; light regulators [dimmers], electric; fluorescent screens; video screens; optical fibres [light conducting filaments]; protection devices against x-rays [roentgen rays], not for medical purposes; acoustic [sound] alarms; smoke detectors; electrified fences; parking meters; attendance registering machines; remote control apparatus; roentgen apparatus not for medical purposes; apparatus and installations for the production of x-rays, not for medical purposes; material testing instruments and machines; stroboscopes; metal detectors for industrial or military purposes; mechanisms for coin-operated apparatus; flashing lights [luminous signals]; signal bells; electro-dynamic apparatus for the remote control of signals.

(260) AM 2022 114177 A

(800) 1605691

(151) 2021 06 22

(891) 2021 06 22

(731) LJCJ Pty Ltd as trustee for Greene Family Trust  
PO BOX 18, KEILOR VIC 3036, Australia

(540)

**VeraTemp**

(591) Black, white

(511)

10 – Clinical thermometers; digital thermometers for medical purposes; electronic thermometers for medical use; mercury thermometers for medical use; thermometers for medical purposes.

(260) AM 2022 114179 A

(800) 1605762

(151) 2021 02 08

(891) 2021 02 08

(731) CHONGQING AMITY MACHINERY CO.,  
LTD

28-5#, No. 200 Zhongshan 2 Road, Yuzhong  
District, 100031 Chongqing, China

(540)

**DECAKILA**

(591) Black, white

(511)

6 – Nails; fittings of metal for furniture; non-electric door bells of metal; locks of metal, other than electric; keys of metal; safes [strong boxes]; tool chests of metal, empty; alloys of common metal; clips of metal for cables and pipes; valves of metal, other than parts of machines; nozzles of metal; building materials of metal; steps [ladders] of metal; steel wire; hooks [metal hardware]; screws of metal; small hardware of metal; soldering wire of metal; works of art of common metal.

7 – Agricultural machines; lawnmowers [machines]; aerating pumps for aquaria; electric hair clipping machines; saws [machines]; electromechanical food preparation machines; butter machines; meat choppers [machines]; bread cutting machines; kneading machines; crushing machines; mixing machines; flour mill machines; electric juice extractors; packing machines for food; electromechanical beverage preparation machines; engraving machines; electric kitchen machines; washing machines [laundry]; dry-cleaning machines; road rollers; jacks [machines]; cranes [lifting and hoisting apparatus]; industrial robots; drilling heads [parts of machines]; electric scissors; hand-held tools, other than hand-operated; hand-held electrical drill; pneumatic hand tools, namely pneumatic grinding machines, pneumatic polishing machines, pneumatic sanders with abrasive belts, pneumatic spanners, pneumatic screwdriver, pneumatic riveters; pneumatic nail guns; angle grinders; paint spraying machines; spray guns for paint; motors, other than for land vehicles; dynamos; pumps [parts of machines, engines or motors]; valves [parts of machines]; propulsion mechanisms, other than for land vehicles; electric door closers; electric door openers; electric window openers; electric window closers; electric machines and apparatus for cleaning; high pressure washers; vacuum cleaners; steam mops; vacuum cleaner attachments for disseminating perfumes and disinfectants; cleaning appliances utilizing steam; electric machines and apparatus for carpet shampooing; brushes for vacuum cleaners; electric shoe polishers.

8 – Abrading instruments [hand instruments]; hand-operated garden tools; manicure sets; beard clippers; hand implements for hair curling; graving tools [hand tools]; secateurs; sabres; table cutlery [knives, forks and spoons]; hand-operated hand tools.

9 – Computer programs [downloadable software]; printers for use with computers; smart watches (data processing); smart eyeglasses (data processing); downloadable software applications for mobile phones; face identification apparatus; photocopiers [photographic, electrostatic, thermic]; weighing apparatus and instruments; bathroom scales; rulers [measuring instruments]; internet router; intercoms; video phones;

cabinets for loudspeakers; electronic video surveillance apparatus; tachographs; television apparatus; air analysis apparatus; surveying apparatus and instruments; lasers, not for medical purposes; levels [instruments for determining the horizontal]; gas testing instruments; thermometers, not for medical purposes; materials for electricity mains [wires, cables]; video screens; remote control apparatus; electric plugs; electric switches; circuit breakers; sensor; protection devices for personal use against accidents; protective masks; gloves for protection against accidents; clothing for protection against accidents, irradiation and fire; shoes for protection against accidents, irradiation and fire; electric theft prevention installations; electric locks; biometric fingerprint door locks; electric door bells; alarms; smoke detectors; electronic access control systems for interlocking doors; electric batteries; battery chargers; mobile power supplies, namely rechargeable batteries.

10 – Physiotherapy apparatus; massage apparatus; arterial blood pressure measuring apparatus; thermometers for medical purposes; glucometers; body fat monitors; cholesterol meters; hearing aids; soporific pillows for insomnia; ear plugs [ear protection devices].

11 – Electric lamps; lighting apparatus and installations; lights for vehicles; germicidal lamps for purifying air; cooking apparatus and installations; electric cooking utensils; bread toasters; gas burners; griddles [cooking appliances]; kitchen ranges [ovens]; electric autoclaves for cooking; electric heaters for feeding bottles; electric coffee percolators; electric deep fryers; electric kettles; microwave ovens [cooking apparatus]; electric appliances for making yogurt; electric food steamers; heating and cooling apparatus for dispensing hot and cold beverages; air fryers; electric soya milk making machines; empty coffee capsules for electric coffee machines; cooling appliances and installations; refrigerating appliances and installations; air-conditioning installations; refrigerating cabinets; ice machines and apparatus; air purifying apparatus and machines; fans [air-conditioning]; air reheaters; air driers; air sterilisers; gas condensers, other than parts of machines; fabric steamers; humidifiers; hair driers; electric hair dryers; extractor hoods for kitchens; electric heating apparatus; taps; anti-splash tap nozzles; fountains; water intake apparatus; pipes [parts of sanitary installations]; automatic watering installations; bath installations; sanitary apparatus and installations; water purification installations; water filtering apparatus; disinfectant apparatus; electric radiators; electrically heated clothing; cooking apparatus and installations; electric cooking ovens.

21 – Containers for household or kitchen use; kitchen utensils; non-electric cooking utensils; enamel ware and plastic ware for household purposes, namely basins, bowls, plates, kettles, and cups; glassware for household purposes, namely cups, plates, kettles, and jars; porcelain ware for household purposes, namely

basins, bowls, plates, kettles, tableware, jars, jugs, and pots; ceramics for household purposes; drinking vessels; toilet utensils; sprinklers; drying racks for laundry; mop wringer buckets; watering cans; dustbins; toothbrushes; electric toothbrushes; thermally insulated containers for food; insect traps; hand-operated cleaning instruments; mops; steel wool for cleaning.

35 – Advertising; online advertising on a computer network; business management assistance; organization of exhibitions for commercial or advertising purposes; commercial administration of the licensing of the goods and services of others; import-export agency services; sales promotion for others; procurement services for others [purchasing goods and services for other businesses]; personnel management consultancy; administrative services for the relocation of businesses; systemization of information into computer databases; rental of sales stands; marketing; provision of an online marketplace for buyers and sellers of goods and services.

(260) AM 2022 114180 A

(800) 1605773

(151) 2021 07 05

(891) 2021 07 05

(731) SHANGHAI TOBACCO GROUP CO., LTD.

717 Chang Yang Road, Yangpu District,  
Shanghai, China

(540)

熊猫香烟

(591) Black, white

(531) 28.03

(511)

34 – Cigarettes.

(260) AM 2022 114181 A

(800) 1605844

(151) 2021 06 08

(891) 2021 06 08

(731) Bibi Graetz di Dan Graetz

Piazza Mino 37, I-50014 Fiesole, Firenze, Italy

(540)

**BIBI GRAETZ**

(591) Black, white

(511)

33 – Wine.

(260) AM 2022 114182 A

(800) 1605859

(151) 2021 06 09

(891) 2021 06 09

(731) DSM IP Assets B.V.

Het Overloon 1, NL-6411 TE Heerlen,  
Netherlands

(540)

**HIPHORIUS**

(591) Black, white

(511)

5 – Dietary supplements and feed supplements for animals.

31 – Foodstuffs for animals.

(260) AM 2022 114183 A

(800) 1605867

(151) 2021 01 21

(891) 2021 01 21

(731) MORFOSE KİŞİSEL BAKIM VE KOZMETİK

ÜRÜNLERİ SANAYİ TİCARET ANONİM  
ŞİRKETİ

Barbaros Hayrettin Paşa Mahallesi, 1992 Sokak,  
No:16 Kat:12 D:249, Esenyurt – İstanbul, Turkey

(540)



(591) Black, white

(531) 26.04.07; 26.04.18; 27.05.01

(511)

3 – Perfumery; cosmetics (except medicated cosmetics); fragrances; deodorants for personal use and animals.

(260) AM 2022 114189 A

(800) 1605988

(151) 2020 12 31

(891) 2020 12 31

(731) ELMİR NAJABOV

AĞAKÖY-BİGA/ÇANAKKALE, Turkey

(540)

**SOEL PARFÜM**

(591) Black, white

(511)

3 – Bleaching and cleaning preparations, detergents other than for use in manufacturing operations and for medical purposes, laundry bleach, fabric softeners for laundry use, stain removers, dishwasher detergents, perfumery; non-medicated cosmetics; fragrances; deodorants for personal use and animals, soaps, dental

care preparations; dentifrices, denture polishes, tooth whitening preparations, mouth washes, not for medical purposes, abrasive preparations; emery cloth; sandpaper; pumice stone; abrasive pastes, polishing preparations for leather, vinyl, metal and wood, polishes and creams for leather, vinyl, metal and wood, wax for polishing.

35 – Advertising, marketing and public relations; organization of exhibitions and trade fairs for commercial or advertising purposes; design for advertising (term considered too vague by the International Bureau – Rule 13 (2) (b) of the Regulations); provision of an online marketplace for buyers and sellers of goods and services; office functions; secretarial services; arranging newspaper subscriptions for others; compilation of statistics; rental of office machines; systemization of information into computer databases; telephone answering for unavailable subscribers; business management, business administration and business consultancy; accounting; commercial consultancy services; personnel recruitment, personnel placement, employment agencies, import-export agencies; temporary personnel placement services; auctioneering; the bringing together, for the benefit of others, of a variety of goods, namely; bleaching and cleaning preparations, detergents other than for use in manufacturing operations and for medical purposes, laundry bleach, fabric softeners for laundry use, stain removers, dishwasher detergents; perfumery; non-medicated cosmetics; fragrances; deodorants for personal use and animals; soaps; dental care preparations; dentifrices, denture polishes, tooth whitening preparations, mouth washes, not for medical purposes; abrasive preparations; emery cloth; sandpaper; pumice stone; abrasive pastes; polishing preparations for leather, vinyl, metal and wood, polishes and creams for leather, vinyl, metal and wood, wax for polishing; pharmaceutical and veterinary preparations for medical purposes; chemical preparations for medical and veterinary purposes, chemical reagents for pharmaceutical and veterinary purposes; medicated cosmetics; dietary supplements for pharmaceutical and veterinary purposes; dietary supplements; nutritional supplements; medical preparations for slimming purposes; food for babies; herbs and herbal beverages adapted for medicinal purposes; dental preparations and articles; teeth filling material, dental impression material, dental adhesives and material for repairing teeth; sanitary preparations for medical use; hygienic pads; hygienic tampons; plasters; materials for dressings; diapers made of paper and textiles for babies, adults and pets; preparations for destroying vermin; herbicides, fungicides, preparations for destroying rodents; deodorants, other than for human beings or for animals; air purifying preparations; air deodorising preparations; disinfectants; antiseptics; detergents for medical purposes; medicated soaps; disinfectant soaps; antibacterial hand lotions; perfume burners, perfume sprayers, perfume vaporizers, electric or non-electric make-up re-

moving appliances, powder puffs, toilet cases; clothing, including underwear and outerclotting; other than special purpose protective clothing; socks, mufflers [clothing], shawls, bandanas, scarves, belts [clothing]; footwear, shoes, slippers, sandals; headgear, hats, caps with visors, berets, caps [headwear], skull caps, enabling customers to conveniently view and purchase those goods, such services may be provided by retail stores, wholesale outlets, by means of electronic media or through mail order catalogues (term considered too vague by the International Bureau – Rule 13 (2) (b) of the Regulations).

(260) AM 2022 114190 A

(800) 1606016

(151) 2021 05 31

(891) 2021 05 31

(731) Blago Company, LLC

Vorovskogo str., bld. 57, Armavir, RU-352900  
Krasnodar Krai, Russian Federation

(540)

**ЗОЛОТОЙ КУВШИН**

(591) Black, white

(531) 28.05

(511)

29 – Fatty substances for the manufacture of edible fats; edible fats; edible oils; peanut oil for food; cocoa butter for food; coconut oil for food; coconut butter for food; corn oil for food; sesame oil for food; linseed oil for food; olive oil for food; palm oil for food; palm kernel oil for food; sunflower oil for food; rape oil for food; butter; tomato purée; fat-containing mixtures for bread slices; spreads included in this class; creamy-vegetable spreads; vegetable-fat spreads.

(260) AM 2022 114191 A

(800) 1606020

(151) 2021 05 21

(891) 2021 05 21

(731) PJSC "Cherkizovo Group"

ul. Cherkizovskaya, (Myasopererabotka ter.), 1,  
pomeshchenie 1, kab. 2, d. Topkanovo,  
g. Kashira, RU-142931 Moskovskaya oblast,  
Russian Federation

(540)

**Черкизово**

(591) Red

(531) 28.05; 29.01.01

(511)

29 – Broth; ham; game, not live; meat jellies; bone oil for food; lard; suet for food; charcuterie; black pudding; meat, tinned; broth concentrates; animal marrow for food; meat; meat, preserved; freeze-dried meat;

sausage casings, natural or artificial; liver pâté; liver; poultry, not live; bacon; pork; salted meats; sausages; sausages in batter; hot dog sausages; preparations for making bouillon; preparations for making soup; tripe; tajine [prepared meat, fish or vegetable dish]; meat extracts.

(260) AM 2022 114192 A

(800) 1606021

(151) 2021 04 30

(891) 2021 04 30

(731) Aktsionernoe obshchestvo "VERTEX"

doroga v Kamenku, d. 62, litera A, RU-197350  
Saint-Petersburg, Russian Federation

(540)

ФУНГИТРАН  
FUNGITRAN

(591) Black, white

(531) 28.05

(511)

5 – Nutritional supplements for human beings; medicines for human purposes; vitamin formulations for human consumption; pharmaceutical preparations; chemico-pharmaceutical preparations; chemical preparations for pharmaceutical purposes; pharmaceuticals; preparations of trace elements for human use.

(260) AM 2022 114193 A

(800) 1606046

(151) 2021 06 14

(891) 2021 06 14

(731) Kia Corporation

12, Heolleung-ro, Seocho-gu, Seoul,  
Republic of Korea

(540)

EVZ

(591) Black, white

(531) 27.05.01; 27.05.19; 27.07.01; 27.07.11

(511)

12 – Vans [vehicles]; motor buses; sports cars; automobiles; electric cars; trucks.

(260) AM 2022 114194 A

(800) 1606048

(151) 2021 06 14

(891) 2021 06 14

(731) Kia Corporation

12, Heolleung-ro, Seocho-gu, Seoul,  
Republic of Korea

(540)

EV1

(591) Black, white

(531) 27.05.01; 27.05.19; 27.07.01; 27.07.11

(511)

12 – Vans [vehicles]; motor buses; sports cars; automobiles; electric cars; trucks.

(260) AM 2022 114195 A

(800) 1606062

(151) 2021 06 14

(891) 2021 06 14

(731) Kia Corporation

12, Heolleung-ro, Seocho-gu, Seoul,  
Republic of Korea

(540)

EV3

(591) Black, white

(531) 27.05.01; 27.07.01; 27.07.11

(511)

12 – Vans [vehicles]; motor buses; sports cars; automobiles; electric cars; trucks.

(260) AM 2022 114196 A

(800) 1606156

(151) 2021 02 25

(891) 2021 02 25

(731) G.A. RICAMBI S.P.A.

Via della Meccanica 30, I-41018 San Cesario  
sul Panaro (MO), Italy

(540)



(591) Black, white and ocher

(531) 26.01.18; 26.03.01; 26.04.10; 27.05.01;

27.05.08; 27.05.22; 29.01.13

(511)

7 – Spare parts for agricultural tools, other than hand-operated hand tools; spare parts for earth moving machines.

(260) AM 2022 114204 A  
 (800) 1606285  
 (151) 2021 03 09  
 (891) 2021 03 09  
 (731) IP Holdings (Antigua) Limited  
 The Ursula Jones Building, Coolidge, P.O. Box  
 3511, St. John's, Antigua and Barbuda



(591) Black, white  
 (531) 24.17.08  
 (511)  
 36 – Financial services; monetary transfer; payment services; savings services; payment and credit services; charge card, cash card and bank card services; cash management; safe deposit services; bankers' clearing services; account debiting services; escrow services; cheque encashment services; credit brokerage; financing of loans; loans (financial) against security; financial investment services; capital investment services; trustee services; financial management services; brokers and agents (for bonds and other securities); financial consultation services; investment advice; financial guarantees (surety services); financial analysis and providing financial reports; financial information services; financial research services; financing services (securing funds for others); financial advisory services; services for the provision of financial and/or credit information; administration of financial affairs; computerized financial services; advice and enquiries regarding credit; services for the provision of credit; acceptance of deposits; discount of bills (notes); domestic remittance, liability guarantee, acceptance of bills, lending securities, acquisition and transfer of monetary claims; trusteeship of money; brokerage of futures contracts; agencies for brokerage of securities, acquisition and transfer of monetary claims, personal property, land, land fixture surface rights and land leasing rights; money exchange, foreign exchange transactions, currency exchange services, issuing of travellers' cheques; issuing of letter of credit, securities trading, securities index futures, brokerage of securities options, trading of overseas market securities futures, underwriting securities, securities trading, brokerage of share subscriptions and offerings of securities, providing stock market information, life insurance brokerage; mortgage services; information relating to economic (finance related) services provided on-line (not downloadable); information relating to financial, banking, insurance and investment services provided on-line (not downloadable); financial analysis and financial market reporting ser-

vices; computerized financial services, namely online brokerage for transacting and trading of currency and other financial products; computerized financial services, namely providing for the exchange of currencies, futures, commodities, securities, financial instruments and options.

(260) AM 2022 114209 A  
 (800) 931548  
 (151) 2007 07 12  
 (891) 2021 07 16  
 (731) Bech, Lars  
 Fortunvej 75, DK-2920 Charlottenlund,  
 Denmark

(540)

# NEUTRAL

(591) Black, white  
 (531) 27.05.01  
 (511)  
 14 – Precious metals and their alloys and goods in precious metals or coated therewith, not included in other classes; jewellery, precious stones; horological and chronometric instruments, paste jewellery (costume jewelry).  
 24 – Textiles and textile goods, not included in other classes; bed and table covers, towels and bed clothes.  
 25 – Clothing, footwear, headgear.

(260) AM 2022 114255 A  
 (800) 1606500  
 (151) 2021 06 07  
 (891) 2021 06 07  
 (731) FOREST WELL CO., LTD.  
 2-18-5-2 Higashiterao, Tsurumi-ku,  
 Yokohama-shi, Kanagawa 230-0077,  
 Japan

(540)

# FORESTWELL

(591) Black, white  
 (531) 27.05.01  
 (511)  
 11 – Industrial air purifiers; electric air purifiers for household purposes; air purifiers with built-in ion generators; ion generating apparatus for air purifiers; air purifiers; parts and accessories for air purifiers; air purifying apparatus and machines; parts and accessories for air purifying apparatus and machines; filters for air purifiers; air sterilisers; air deodorising apparatus; ionization apparatus for the treatment of air or water.



(260) AM 2022 114256 A

(800) 1606544

(151) 2021 05 21

(891) 2021 05 21

(731) Individual Entrepreneur Jakibayev Murat  
Urynbayevich

Microdistrict Samal-3, 13, 090000 Uralsk,  
West Kazakhstan region, Kazakhstan

(540)



(591) White, brown and light brown

(531) 07.01.13; 27.03.15; 28.05; 29.01; 29.01.12

(526) ®

(511)

29 – Peanuts, prepared; albumen for culinary purposes; broth; fatty substances for the manufacture of edible fats; game, not live; meat jellies; jellies for food; fruit jellies; yolk of eggs; edible fats; fruit-based snack food; tofu patties; charcuterie; caviar; aubergine paste; vegetable marrow paste; fish roe, processed; yogurt; sauerkraut; potato-based dumplings; milk shakes; black pudding; arrangements of processed fruit; meat, tinned; vegetables, tinned; fruits, tinned; broth concentrates; buttercream; sweet corn, processed; salmon, not live; margarine; marmalade; oils for food; sunflower oil for food; butter; soya bean oil for food; almonds, ground; animal marrow for food; milk; albumin milk; condensed milk; powdered milk; fish meal for human consumption; vegetable mousses; fruit pulp; meat; meat, preserved; milk beverages, milk predominating; peanut milk-based beverages; almond milk-based beverages; coconut milk-based beverages; vegetables, preserved; freeze-dried vegetables; vegetables, dried; vegetables, cooked; potato fritters; candied nuts; nuts, prepared; tomato purée; liver pâté; liver; jams; powdered eggs; milk products; fish-based foodstuffs; poultry, not live; pollen prepared as foodstuff; cranberry compote; apple puree; crayfish, not live; fish, not live; salted fish; vegetable salads; fruit salads; bacon; pork; herrings, not live; sunflower seeds, prepared; whipped cream; cream [dairy products]; fat-containing mixtures for bread slices; lemon juice for culinary purposes; tomato juice for cooking; vegetable juices for cooking; salted meats; sausages; sausages in batter; hot dog sausages; preparations for making bouillon; preparations for making soup; tripe; vegetable soup preparations; whey; cottage cheese fritters; cheese; milk ferments for culinary purposes; crystallized fruits; frozen fruits; fruit, preserved; fruit, stewed; potato flakes; hummus [chickpea paste]; fruit peel; preserved garlic; potato crisps; low-fat potato crisps; fruit chips; meat extracts; berries, preserved;

eggs; kephir; compotes; corn dogs; koumiss; dense tomato purée; prostokvasha being soured milk; ryazhenka being fermented baked milk; smetana; tahini; fish fillets.

30 – High-protein cereal bars; pancakes; noodle-based prepared meals; bread rolls; waffles; vermicelli; cake frosting [icing]; mustard; buckwheat, processed; croûtons; yeast; leaven; rice-based snack food; cereal-based snack food; dressings for salad; fruit jellies [confectionery]; candy decorations for cakes; confectionery for decorating Christmas trees; cakes; pastries; peanut confectionery; almond confectionery; pasta; frozen yogurt [confectionery ices]; cocoa; curry [spice]; ketchup [sauce]; flour-based dumplings; liquorice [confectionery]; coffee; starch for food; crackers; custard; groats for human food; ice cubes; corn, milled; corn, roasted; meat pies; noodles; edible ices; rice cakes; mayonnaise; macaroni; marinades; honey; ice cream; flour; dessert mousses [confectionery]; chocolate mousses; muesli; mint for confectionery; cocoa beverages with milk; coffee beverages with milk; coffee-based beverages; cocoa-based beverages; chamomile-based beverages; tea-based beverages; chocolate beverages with milk; chocolate-based beverages; infusions, not medicinal; crushed oats; husked oats; chocolate-coated nuts; pastila [confectionery]; lozenges [confectionery]; pâtés en croûte; biscuits; petit-beurre biscuits; bibimbap [rice mixed with vegetables and beef]; pies; pizzas; meat gravies; fondants [confectionery]; popcorn; powders for making ice cream; condiments; cereal preparations; oat-based food; gingerbread; rice pudding; puddings; cake powder; fruit coulis [sauces]; relish [condiment]; instant rice; wheat germ for human consumption; spring rolls; sesame seeds [seasonings]; linseed for culinary purposes [seasoning]; processed seeds for use as a seasoning; confectionery; malt for human consumption; sorbets [ices]; cranberry sauce [condiment]; tomato sauce; apple sauce [condiment]; pasta sauce; sauces [condiments]; spaghetti; chocolate-based spreads; rusks; breadcrumbs; sushi; sandwiches; dough; pastry dough; almond paste; rice pulp for culinary purposes; cake batter; garden herbs, preserved [seasonings]; chocolate decorations for cakes; halvah; unleavened bread; bread; corn flakes; chips [cereal products]; hot dog sandwiches; chicory [coffee substitute]; iced tea; chutneys [condiments]; minced garlic [condiment]; cheeseburgers [sandwiches]; chow-chow [condiment]; husked barley; baozi; vareniki [stuffed dumplings]; zephyr being confectionery; potato-based flatbreads; macarons; onigiri; pelmeni; pesto; petits fours; ramen; batter mixes for okonomiyaki [Japanese savory pancakes]; rice crackers; jiaozi.

31 – Algarovilla for animal consumption; draff; beans, fresh; fruit residue [marc]; dog biscuits; peas, fresh; buckwheat, unprocessed; turf, natural; yeast for animal consumption; Christmas trees; edible chews for animals; peanut cake for animals; oil cake; maize

cake for cattle; rape cake for cattle; cereal seeds, unprocessed; grains for animal consumption; lime for animal forage; vegetable marrows, fresh; koi carp, live; animal foodstuffs; pet food; stall food for animals; bird food; strengthening animal forage; roots for animal consumption; groats for poultry; bran mash for animal consumption; peanut meal for animals; meal for animals; fish meal for animal consumption; straw mulch; beverages for pets; vegetables, fresh; bran; aromatic sand [litter] for pets; litter for animals; mash for fattening livestock; animal fattening preparations; preparations for egg laying poultry; by-products of the processing of cereals, for animal consumption; seedlings; wheat germ for animal consumption; fish, live; beet, fresh; hay; straw litter; straw [forage]; salt for cattle; squashes, fresh; garlic, fresh; spinach, fresh; berries, fresh; potatoes, fresh.

35 – Import-export agency services; advertising agency services; rental of advertising space; book-keeping; invoicing; demonstration of goods; market studies; business research; marketing research; business management and organization consultancy; business organization consultancy; business management consultancy; professional business consultancy; marketing; updating and maintenance of data in computer databases; organization of exhibitions for commercial or advertising purposes; organization of trade fairs for commercial or advertising purposes; payroll preparation; business management assistance; providing business information via a website; provision of an online marketplace for buyers and sellers of goods and services; sales promotion for others; promotion of goods and services through sponsorship of sports events; advertising; online advertising on a computer network; compilation of information into computer databases; business management of hotels; administration of consumer loyalty programs; administrative processing of purchase orders; market intelligence services; search engine optimization for sales promotion; appointment scheduling services [office functions]; price comparison services; procurement services for others [purchasing goods and services for other businesses]; photocopying services; business efficiency expert services; providing business information; providing consumer information relating to goods and services; consultancy regarding public relations communication strategies.

(260) AM 2022 114257 A

(800) 1606550

(151) 2021 06 07

(891) 2021 06 07

(731) FOREST WELL CO., LTD.

2-18-5-2 Higashiterao, Tsurumi-ku, Yokohama-shi, Kanagawa 230-0077, Japan

(540)



(591) Black, white

(531) 27.01.01; 27.01.02; 27.05.22

(511)

11 – Industrial air purifiers; electric air purifiers for household purposes; air purifiers with built-in ion generators; ion generating apparatus for air purifiers; air purifiers; parts and accessories for air purifiers; air purifying apparatus and machines; parts and accessories for air purifying apparatus and machines; filters for air purifiers; air sterilisers; air deodorising apparatus; ionization apparatus for the treatment of air or water.

(260) AM 2022 114258 A

(800) 1606669

(151) 2021 01 18

(891) 2021 01 18

(731) HU ZHOU GUONENG NEW MATERIAL, CO., LTD.

NO.1-4#, 1518 MengXi Road, HuZhou, ZheJiang, China

(540)

NASCA

(591) Black, white

(511)

1 – Chemical additives for insecticides; brake fluid; fiber lubricant (terms too vague in the opinion of the International Bureau – Rule 13 (2) (b) of the Regulations); silicon; alcohol; metal annealing agent; scaling powder (terms too vague in the opinion of the International Bureau – Rule 13 (2) (b) of the Regulations); plasticizer; industrial adhesives; industrial glue.

(260) AM 2022 114259 A

(800) 1606711

(151) 2021 05 11

(891) 2021 05 11

(731) Arla Foods a/s

Sønderhøj 14, DK-8260 Viby J, Denmark

(540)



(591) Dark blue (Pantone 281C); red (Pantone 186C) and grey (Pantone Cool Gray 8C)

(531) 05.05.16; 22.01.05; 24.01.03; 26.11.01; 26.11.09; 27.05.01; 27.07.01; 29.01.14

(511)

29 – Meat, fish, poultry and game; liver patées; vegetable patées; meat extracts; vegetable-based meat substitutes; dairy-based meat substitutes; prepared meals consisting primarily of meat substitutes; formed textured vegetable protein for use as a meat substitute; formed textured dairy protein for use as a meat substitute; eggs; milk and milk products; dairy products and dairy substitutes; milk substitutes, including soy milk, oat milk, coconut milk, almond milk, also in powder form; rye-based beverages as milk substitutes; rye-based beverages (milk substitutes) in powder form; milk in powder form; cream in powder form; rye milk in powder form; substitutes for cream; yoghurt; fermented yoghurt, including fermented plant-based yoghurt; non-fermented yoghurt, including non-fermented plant-based yoghurt; yoghurt desserts; drinks based on yoghurt; skyr; beverages mainly consisting of a mixture of yoghurt and skyr; desserts mainly consisting of a mixture of yoghurt and skyr, skyr desserts; dessert mainly consisting of yoghurt and/or skyr, also containing muesli and/or dried fruit and/or nuts; drinks made from dairy products, including milk shakes and chocolate milk; preparations for making dairy-based drinks; protein milk; whey; dry whey; whey powder; whey concentrate; rennet; cheese; cheese spreads; cheese powder; cheese-based snack foods; desserts made from milk products; milk-based snacks; dairy puddings; chilled dairy desserts; dairy-based dips; oils and fats for food; butter; flavoured butter; dairy spreads; dairy and vegetable spreads mainly consisting of a mixture of butter and vegetable oil; concentrated butter; butter oil; ghee; sour cream; butter substitutes; clarified butter; butter preparations; butter with herbs; butter for use in cooking; edible fat-based spreads for bread; dairy substitutes in powder or paste form; butter substitutes in liquid, powder or paste form; flavoured butter substitutes; butter oil substitutes; plant-based spreads, namely fruit-based spreads, nut-based spreads, legume-based spreads, seed-based spreads, grain-based spreads and vegetable-based spreads; vegetable spreads; fruit spreads; almond butter; coconut butter; seed butters; butter made of nuts; plant-based dairy substitutes; food preparations made predominantly of processed plants, including of processed vegetables and/or fruits; cooking preparations made predominantly of processed plants, including of processed vegetables and/or fruits; desserts made predominantly of processed plants, including of processed vegetables and/or fruits; margarine; margarine substitutes; preserved, frozen, dried and cooked fruits and vegetables; jellies, jams, compotes; fruit-based snack food; fruit- and nut-based snack bars; snack foods based on nuts; snack mixes consisting of dehydrated fruit and processed nuts; prepared meals

consisting principally of vegetables; soups; preparations for making soups; broth concentrates.

30 – Coffee, tea, cocoa and artificial coffee; cappuccino; chocolate-based beverages; cocoa-based beverages; coffee-based beverages; powders and preparations for making cappuccino, cocoa, chocolate, coffee and tea beverages; bread, pastries and confectionery; cereal-based snack food; rice-based snack food; confectionery bars; cereal bars and energy bars; chocolate bars; muesli bars; pastries, cakes, tarts and biscuits (cookies); flour and preparations made from cereals; porridge; prepared pizza meals; pizzas; dessert soufflés; prepared desserts [confectionery]; muesli desserts; dessert mousses [confectionery]; puddings; rice pudding; meat pies; rice; tapioca and sago; sugar, honey, treacle; yeast, baking-powder; salt; mustard; vinegar; spices; fruit sauces; sauces; sauces [condiments]; seasonings; salad dressings; relish [condiment]; gravy mixes; flavourings, other than essential oils for foodstuffs, except etheric essences and essential oils; preparations for stiffening whipped cream; thickening agents for cooking foodstuffs; edible ices; sherbets [ices]; ice cream; binding agents for ice cream; powders for ice cream; frozen yoghurt [confectionery ices]; frozen yogurt cakes; ice milk bars; fruit ice bars; frozen confectionery containing ice cream; frozen dairy confections; ice beverages with a chocolate base; ice beverages with a coffee base; ice beverages with a cocoa base; cheese curls [snacks]; cheese-flavoured biscuits; crackers flavoured with cheese; kombucha; cocoa-based creams in the form of spreads; chocolate spreads; mayonnaise and ketchup-based spreads; flavourings for butter and butter substitutes.

32 – Non-alcoholic beverages; mineral and aerated waters; fruit beverages and fruit juices; vegetable drinks and juices; drinks containing fruit and/or vegetable juices, also based on concentrates and extracts; smoothies; soft drinks; whey beverages; non-dairy based beverages, including soya-based, rice-based, oat-based, almond-based, coconut-based, rye-based, plant-based (not milk substitutes); kvass [non-alcoholic beverages]; sport drinks; isotonic drinks; powders for the preparation of beverages; syrups and other non-alcoholic preparations for making beverages and smoothies; all aforementioned goods also enriched with proteins, vitamins and/or minerals.

(260) AM 2022 114266 A

(800) 1606857

(151) 2021 06 23

(891) 2021 06 23

(731) BAUSCH + LOMB IRELAND LIMITED

3013 Lake Drive, Citywest Business Campus,  
Dublin 24, Ireland

(540)

**MICROFLOW**

(591) Black, white

(511)  
10 – Surgical devices, apparatus and instruments; needles used in ophthalmic surgical procedures.

(260) AM 2022 114271 A  
(800) 1606995  
(151) 2021 06 16  
(891) 2021 06 16  
(731) BIOBANK Co., Ltd.  
388-1, Hirata, Kita-ku, Okayama-shi, Okayama  
700-0952, Japan  
(540)



(591) Black, white  
(531) 24.17.01; 26.01.03; 26.01.20; 27.05.01;  
27.05.17  
(511)  
3 – Soap products; cosmetic soaps; cosmetic creams; cosmetic creams for skin care.  
5 – Dietary supplements for humans; dietary supplements using lactic acid bacteria.

(260) AM 2022 114272 A  
(800) 1607051  
(151) 2021 06 16  
(891) 2021 06 16  
(731) BIOBANK Co., Ltd.  
388-1, Hirata, Kita-ku, Okayama-shi, Okayama  
700-0952, Japan  
(540)

**OM-X**

(591) Black, white  
(511)  
3 – Soap products; cosmetic soaps; cosmetic creams; cosmetic creams for skin care.  
5 – Dietary supplements for humans; dietary supplements using lactic acid bacteria.

(260) AM 2022 114273 A  
(800) 1607073  
(151) 2021 06 10  
(891) 2021 06 10  
(731) UAB "Narbutas International"  
Odminių g. 3-23, LT-01122 Vilnius, Lithuania  
(540)

**SOFT ROCK**

(591) Black, white

(511)  
20 – Furniture.

(260) AM 2022 114274 A  
(800) 1607089  
(151) 2021 06 16  
(891) 2021 06 16  
(731) Achilles International  
315 West 39th Street, New York NY 10018,  
USA  
(540)

**Achilles International**

(591) Black, white  
(511)  
35 – Promoting and administering amateur athletic programs and activities for disabled athletes.

(260) AM 2022 114275 A  
(800) 1607106  
(151) 2021 05 04  
(891) 2021 05 04  
(731) AKCIJU SABIEDRĪBA "OLAINFARM", AS  
Rūpnīcu iela 5, Olaine, LV-2114 Olaines  
novads, Latvia  
(540)

**VESMIROL**

(591) Black, white  
(511)  
5 – Pharmaceutical preparations.

(260) AM 2022 114306 A  
(800) 1456928  
(151) 2019 01 30  
(891) 2021 06 28  
(731) Bielenda Kosmetyki Naturalne Sp. z o.o.  
ul. Fabryczna 20, PL-31-553 Kraków, Poland  
(540)



(591) Pink and dark brown  
(531) 27.01.07; 27.05.01; 29.01.12  
(511)  
3 – Exfoliating scrubs for the body; body butter; body masks; facial masks; cleaning masks for the face; skin masks [cosmetics]; cosmetic body scrubs; anti-wrinkle cream; cleansing creams; barrier creams; cosmetic creams; face creams for cosmetic use; hand creams; creams for firming the skin; body cream; suntan cre-

ams; cream soaps; sun creams; cosmetic nourishing creams; skin cream; night cream; cosmetic creams and lotions; body cream soap; moisturising skin creams [cosmetic]; sun-tanning creams and lotions; body mask cream; massage creams, not medicated; skin conditioning creams for cosmetic purposes; skin lotion; after-sun lotions; sun tan lotion; lip balms [non-medicated]; hand lotions; lotions for cosmetic purposes; lotions for cellulite reduction; moisturising skin lotions [cosmetic]; perfumed body lotions [toilet preparations]; cleansing gels; bath gel; shower gels; soaps and gels; sun-tanning gels; moisturising gels [cosmetic]; moisturising creams, lotions and gels; shower and bath gel; face scrubs (non-medicated -); facial scrubs [cosmetic]; bath lotion; bath oil; bath salts; shampoos; hair nourishers; bath preparations; skin care preparations; cosmetics; body mask powder.

(260) AM 2022 114307 A  
(800) 1602241  
(151) 2021 05 10  
(891) 2021 07 23  
(731) SANOFI  
54 rue La Boétie, F-75008 Paris, France  
(540)

## AMYFORZA

(591) Black, white  
(511)  
5 – Pharmaceutical product.

(260) AM 2022 114308 A  
(800) 1602315  
(151) 2021 05 10  
(891) 2021 07 23  
(731) SANOFI  
54 rue la Boetie, F-75008 PARIS, France  
(540)

## AMZEVNA

(591) Black, white  
(511)  
5 – Pharmaceutical product.

(260) AM 2022 114348 A  
(800) 1607894  
(151) 2021 06 23  
(891) 2021 06 23  
(731) STONE PAPER GLOBAL TECHNOLOGIES LTD., a legal entity  
500-666 Burrad St., Vancouver BC V6C 3P6, Canada  
(540)

**STONEPAPER**  
SPIRIT OF SUSTAINABILITY

(591) Black, white  
(531) 27.05.09; 27.05.10  
(511)  
1 – A strong and durable mineral substrate and minerals with such content manufactured amongst other natural or ingenious formative components from ionic or chemical compounds or other mineral matter, or organic or inorganic composition bonded with varying types and amounts of polyethylene, other polymers or other resins or similar chemical substitutive substances for use in all types of concepts and applications in science, technology, industry and agriculture.

(260) AM 2022 114350 A  
(800) 1607957  
(151) 2021 05 26  
(891) 2021 05 26  
(731) PUIG FRANCE  
65-67, avenue des Champs-Élysées, F-75008 Paris, France  
(540)

## FAME

(591) Black, white  
(511)  
3 – Non-medicinal toiletry preparations and cosmetic products; non-medicinal dentifrices; perfumery products, essential oils; bleaching preparations and other substances for laundry use; cleaning, polishing, degreasing and abrasive preparations; fragrances for personal use; eau de Cologne; eau de parfum, eau de toilette; perfumed water, perfumes; perfume extracts; non-medicinal preparations for oral hygiene; non-medicinal body care and cleaning preparations; non-medicinal body lotions, milks and creams; deodorants for personal use; antiperspirants for personal use; non-medicinal soaps; non-medicinal soaps for personal use; non-medicinal soaps for personal use in liquid, solid and gel form; non-medicinal bath gel; non-medicinal shower gel; non-medicinal bath preparations; non-medicinal bath salts; non-medicinal skin care preparations; exfoliants; talcum powder, for toilet use; perfumed powders; wipes, cotton wool and cloths impregnated with non-medicinal and perfuming cosmetic lotions; non-medicinal cosmetics, non-medicinal toiletries and perfumery products for the care and beauty of eyelashes, eyebrows, eyes, lips and nails; non-medicinal lip balm; nail polish; nail polish removers; adhesives for cosmetic use; non-medicinal slimming cosmetic preparations; non-medicinal hair preparations and treatments; non-medicinal shampoos; make-up products; make-up removing products; depilatory products; non-medicinal shaving preparations; non-medicinal pre-shave preparations; non-medicinal after-shave preparations; non-medicinal beauty preparations; cosmetic tanning and self-tanning preparations, non-medicinal; cosmetic kits; fragrances for the home; incense; potpourris [fragrances]; scented wood; sachets for perfuming linen; aromatic extracts; non-

medicinal products for animal care and cleaning; shoemakers' and tailors' wax; preparations for cleaning and polishing leather and footwear.

(260) AM 2022 114357 A

(800) 1608089

(151) 2021 05 18

(891) 2021 05 18

(731) Limited Liability Company "Novye Tehnologii"

Polyarnaya str., 41/STR 1, spc. 38, RU-127282  
Moscow, Russian Federation

(540)



(591) Orange, green, red, light green and black

(531) 01.15.23; 27.03.12; 27.05.09; 29.01.15

(511)

10 – Aesthetic therapy machines; massage apparatus; devices for aesthetic massage; body massagers; cellulite treatment devices; vacuum roller massage apparatus; electric massage apparatus.

35 – Sales promotion for others, namely aesthetic therapy machines, massage apparatus, devices for aesthetic massage, body massagers, cellulite treatment devices, vacuum roller massage apparatus, electric massage apparatus.

(260) AM 2022 114359 A

(800) 1608147

(151) 2021 04 21

(891) 2021 04 21

(731) Gevorgyan David Smbatovich

Apt. 4, household 2, Rozhdestveno village,  
Volokolamsk district, RU-143600 Moscow  
region, Russian Federation

(540)



(591) Blue

(531) 26.11.13; 27.03.12; 27.05.09; 29.01.12

(511)

11 – Urinals being sanitary fixtures; pipes [parts of sanitary installations]; wash-hand basins [parts of sanitary installations]; bath installations; bath tubs; bath tubs for sitz baths; heaters for baths; hydromassage bath apparatus; spa baths [vessels]; microbubble generators for baths; bath fittings; sinks; mixer taps for water pipes; shower cubicles; coils [parts of distilling, heating or cooling installations]; heat accumulators; steam accumulators; disinfectant apparatus; air deodorizing apparatus; ionization apparatus for the treatment of air or water; tanning apparatus [sun beds]; hand drying apparatus for washrooms; water purifying

apparatus and machines; underfloor heating apparatus and installations; water heaters; water flushing installations; showers; taps; taps for pipes and pipelines; immersion heaters; sauna bath installations; water intake apparatus; deodorizing apparatus, not for personal use; water filtering apparatus; air purifying apparatus and machines; sanitary apparatus and installations; cooking rings; steam facial apparatus [saunas]; toilet seats; hydroponic growing systems; air dryers; water sterilizers; air sterilizers; laundry dryers, electric; hair dryers; toilets, portable; toilets [water-closets]; humidifiers; humidifiers for central heating radiators; toilet bowls; water conduits installations; desalination plants; cooling installations for water; cooling installations for liquids; purification installations for sewage; swimming pool chlorinating apparatus; water softening apparatus and installations; heating installations; heating installations [water]; water supply installations; filters for drinking water.

20 – Bathtub grab bars, not of metal; bath seats for babies; bathroom vanities [furniture]; towel stands [furniture]; racks [furniture]; furniture shelves; showcases [furniture]; doors for furniture; flower-stands [furniture]; index cabinets [furniture]; console tables; furniture of metal; inflatable furniture; office furniture; school furniture; legs for furniture; head-rests [furniture]; trestles [furniture]; benches [furniture]; trolleys [furniture]; screens [furniture]; coatstands; indoor window blinds [furniture]; furniture casters, not of metal; edgings of plastic for furniture; brackets, not of metal, for furniture; feet for furniture; furniture partitions of wood; freestanding partitions [furniture]; trolleys for computers [furniture]; washstands [furniture]; saw benches [furniture]; dinner wagons [furniture]; screens for fireplaces [furniture]; mirrors [looking glasses]; hand-held mirrors [toilet mirrors]; mirror tiles; silvered glass [mirrors]; mats, removable, for sinks; shells; door closers, not of metal, non-electric; indoor window blinds of paper; indoor window blinds of woven wood; indoor window blinds of textile; baskets, not of metal; chests of drawers; curtain rails; shelves for storage.

35 – Demonstration of goods; organization of exhibitions for commercial or advertising purposes; organization of trade fairs for commercial or advertising purposes; sales promotion for others; rental of sales stands; rental of vending machines; advertising; online advertising on a computer network; bill-posting; television advertising; advertising by mail order; layout services for advertising purposes; marketing; updating of advertising material; development of advertising concepts; shop window dressing; web indexing for commercial or advertising purposes; presentation of goods on communication media, for retail purposes; auctioneering; retail services for works of art provided by art galleries; production of advertising films; promotion of goods and services through sponsorship of sports events; rental of advertising time on commu-

nication media; publicity material rental; rental of billboards [advertising boards]; publication of publicity texts; radio advertising; distribution of samples; dissemination of advertising matter; direct mail advertising; pay per click advertising; procurement services for others [purchasing goods and services for other businesses].

(260) AM 2022 114439 A

(800) 1609644

(151) 2021 06 01

(891) 2021 06 01

(731) OM Pharma SA

Rue du Bois-du-Lan 22, CH-1217 Meyrin,  
Switzerland

(5400



(591) Black, white

(531) 01.15.15; 26.13.25

(511)

5 – Pharmaceutical and veterinary products; sanitary products for medical purposes; dietetic food and substances for medical or veterinary use, food for babies; dietary supplements for humans and animals; plasters, materials for dressings; material for dental fillings and dental impressions; disinfectants.

10 – Surgical, medical, dental and veterinary apparatus and instruments; artificial limbs, eyes and teeth; orthopedic articles; suture materials; therapeutic and assistive devices adapted for persons with disabilities.

44 – Medical and veterinary services; hygienic and beauty care for human beings or animals.

(260) AM 2022 114441 A

(800) 1609668

(151) 2021 02 09

(891) 2021 02 09

(731) QANTO s.r.o.

Na Slatince 3, CZ-106 00 Praha 10, Záběhlice,  
Czech Republic

(540)



(591) Black, white

(531) 26.01.03; 26.01.18; 26.01.24; 27.05.01;  
27.05.10; 27.05.21

(511)

32 – Energy drinks; energy drinks with caffeine; isotonic drinks; sports drinks; drinks for athletes; flavored carbonated drinks; nutritionally enriched drinks; non-alcoholic drinks; water enriched with minerals; waters; energy drinks (for other than medical purposes); isotonic beverages (other than for medical purposes); beverages for athletes enriched with proteins; beverages for athletes containing electrolytes; non-alcoholic beverages enriched with vitamins.

(260) AM 2022 114523 A

(800) 1500497

(151) 2019 11 01

(891) 2021 06 17

(731) QingLing Motors (Group) Co., Ltd.

#1 Xiexingcun, Jiulongpo District, Chongqing,  
China;

QingLing Motors Co., Ltd.

#1 Xiexingcun, Zhongliangshan, Jiulongpo  
District; Chongqing, China

(540)



(591) Black, white

(531) 26.03.04; 26.04.09

(511)

12 – Rolling stock for railways; sprinkling trucks; motor coaches; trucks; caissons [vehicles]; caravans; trailers [vehicles]; hose carts; golf carts [vehicles]; vans [vehicles]; refrigerated vehicles; military vehicles for transport; sports cars; tilting-carts; vehicles for

locomotion by land, air, water or rail; cars; bumpers for automobiles; concrete mixing vehicles; gear boxes for land vehicles; ambulances; motor homes; snow-mobiles; remote control vehicles, other than toys; armored vehicles; engine mounts for land vehicles; electric vehicles; telfer railways [cable cars]; trolleys; tires for vehicle wheels; air vehicles; boats; suspension shock absorbers for vehicles; forklift trucks.

(260) AM 2022 114524 A

(800) 1514353

(151) 2019 10 14

(891) 2021 07 08

(731) ERT TÛTÛN MAMÛLERİ SANAYİ VE

TİCARET A.Ş.

Soğucak OSB Mahallesi 3, Organize Sanayi

Bölgesi, (Küme Evler) No. 10, Söğütli,

Sakarya, Turkey

(540)



L I Я R A

(591) Black, white and red

(531) 26.01.03; 26.01.16; 26.01.24; 26.11.13;

27.05.01; 27.05.14; 29.01.12

(511)

34 – Tobacco, aromatic narghile tobacco, narghile tobacco, chewing tobacco, cigarettes, cigars, smokers' articles including those made of precious metals, pipes, mouthpieces for cigars and cigarettes, ashtrays, tobacco boxes, pocket apparatus for rolling cigarettes, cigarette paper, tobacco pipes, firestones, lighters for smokers, electronic cigarettes and their cartridges, matches.

(260) AM 2022 114525 A

(800) 1519094

(151) 2020 01 27

(891) 2021 07 28

(731) ZAKRYTOYE AKTSIONERNOYE

OBSHESTVO "PROIZVODSTVENNOYE

OBEDINENIE ELEKTROTEKHNIK"

Ryazansky prospekt, Dom no.10, Stroyenie 16,

RU-109428 Moscow, Russian Federation

(540)



(591) Blue

(531) 01.01.03; 01.01.12; 24.15.11; 26.01.16;

28.05; 29.01.04

(526) ПРОИЗВОДСТВЕННОЕ ОБЪЕДИНЕНИЕ

(511)

9 – Accumulators, electric; accumulators, electric, for vehicles; ammeters; high-frequency apparatus; electro-dynamic apparatus for the remote control of signals; monitoring apparatus, other than for medical purposes; electric apparatus for commutation; galvanic batteries; batteries for lighting; solar batteries; batteries, electric; signalling buoys; life buoys; marking buoys; electric plugs; wavemeters; voltmeters; switch-boxes [electricity]; current rectifiers; identification threads for electric wires; locks, electric; alarm bells, electric; electric door bells; signal bells; acoustic conduits; buzzers; inverters [electricity]; pressure indicators; temperature indicators; measuring instruments; spark-guards; coaxial cables; fiber optic cables; cables, electric; holders for electric coils; cathodes; choking coils [impedance]; coils, electric; electromagnetic coils; solenoid valves [electromagnetic switches]; wire connectors [electricity]; push buttons for bells; collectors, electric; commutators; condensers [capacitors]; contacts, electric; branch boxes [electricity]; distribution boxes [electricity]; junction boxes [electricity]; connectors [electricity]; battery boxes; covers for electric outlets; logs [measuring instruments]; darkroom lamps [photography]; thermionic tubes; amplifying tubes; magnets; materials for electricity mains [wires, cables]; terminals [electricity]; junction sleeves for electric cables; sheaths for electric cables; identification sheaths for electric wires; limiters [electricity]; transmitters of electronic signals; switches, electric; fuses; circuit breakers; converters, electric; telerupters; diagnostic apparatus, not for medical purposes; measuring apparatus; measuring devices, electric; naval signalling apparatus; observation instruments; regulating apparatus, electric; precision measuring apparatus; magnetic wires; telegraph wires; telephone wires; wires, electric; conductors, electric; copper wire, insulated; distribution consoles [electricity]; control panels [electricity]; cell switches [electricity]; time switches, automatic; relays, electric; rheostats; optical fibers [light conducting filaments]; traffic-light apparatus [signalling devices]; inductors [electricity]; connections for electric lines; resistances, electric; counters; step-up transformers; transformers [electricity]; electric loss indicators; electric installations for the remote control of industrial operations; railway traffic safety appliances; chargers for electric accumulators; switchboards; distribution boards [electricity]; ducts [electricity]; armatures [electricity].

35 – Import-export agency services; commercial information agency services; computerized file management; demonstration of goods; market studies; providing business information; providing commercial information and advice for consumers in the choice of products and services; business investigations; business research; marketing research; professional business consultancy; marketing; organization of exhibitions for commercial or advertising purposes; organization of trade fairs; presentation of goods on communi-



cation media, for retail purposes; advertising; administrative processing of purchase orders; procurement services for others [purchasing goods and services for other businesses]; shorthand; outsourcing services [business assistance]; business efficiency expert services.

(260) AM 2022 114548 A

(800) 1611564

(151) 2021 06 29

(891) 2021 06 29

(731) AFTERSHOKZ, LLC

1801 Burnet Avenue, Suite 102, Syracuse  
NY 13206, USA

(540)

## OPENCOACH

(591) Black, white

(511)

9 – Batteries; battery chargers; chargers for batteries; earphones; electronic memory devices; headphones; horns for loudspeakers; lithium ion batteries; megaphones; memory expansion modules; microphones; smartglasses; spectacles; virtual reality headsets; wireless speakers; mp3 players; bone conduction earphones.

(260) AM 2022 114549 A

(800) 1611565

(151) 2021 06 29

(891) 2021 06 29

(731) AFTERSHOKZ, LLC

1801 Burnet Avenue, Suite 102, Syracuse  
NY 13206, USA

(540)

## openfast

(591) Black, white

(511)

9 – Batteries; battery chargers; chargers for batteries; earphones; electronic memory devices; headphones; horns for loudspeakers; lithium ion batteries; megaphones; memory expansion modules; microphones; smartglasses; spectacles; virtual reality headsets; wireless speakers; mp3 players; bone conduction earphones.

(260) AM 2022 114580 A

(800) 1612473

(151) 2021 07 08

(891) 2021 07 08

(731) HI Limited Partnership

1815 The Exchange, Atlanta GA 30339,  
USA

(540)



(591) Black, white

(531) 03.07.05; 03.07.24; 27.03.03; 27.05.02;  
27.05.17

(511)

25 – Clothing, namely, shirts, socks, pants, jackets, shorts, baby bibs, not of paper, sun visors, hats, sweatshirts, sweaters, pullovers, sweatbands.

(260) AM 2022 114582 A

(800) 1087383

(151) 2011 01 04

(891) 2021 07 06

(731) ZHOU MI

Group 2, Committee 11, Suifenhe City, 157300  
Heilongjiang Province, China

(540)

## MASUMA

(591) Black, white

(511)

7 – Universal joints; automobile motor cranks; cardan joints; bearings (parts of machines); adhesive tape dispensers (machines); shock absorbers for machines; automobile motor spark plugs; lubricating filters (parts of machines or engines); machine wheelwork; automobile motor lubricating oil pumps.

12 – Hub caps; hydraulic circuits for vehicles; automobile chassis; transmissions for land vehicles; propulsion mechanisms for land vehicles; driving chains for land vehicles; brake segments for land vehicles; freewheels for land vehicles; bands for wheel hubs; windshield wipers.

17 – Shock absorbing buffers of rubber; clutch linings; gaskets; brake lining materials, partly processed; lute; rubber sleeves for protecting parts of machines; hoses, not of metal; hoses of textile material; soles of asbestos; weatherstripping; rubber sealant for caulking and adhesive purposes; synthetic rubber.

(260) AM 2022 114583 A  
 (800) 1428273  
 (151) 2018 06 27  
 (891) 2021 08 19  
 (731) Xiao Xiuchun  
 No.17 1st Floor, International Trading Building,  
 Sayibak District, Urumqi City, Xinjiang, China

(540)

## TriTower

(591) Black, white  
 (531) 27.05.01  
 (511)  
 7 – Vacuum cleaners; bread cutting machines; fruit presses, electric, for household purposes; electric juicer; meat mincers [machines]; mixing machines; mills for household purposes, other than hand-operated; household soybean milk machine; kitchen machines, electric; washing machines [laundry].

8 – Flat irons; goffering irons; fleshing knives [hand tools]; nail clippers, electric or non-electric; beard clippers; irons [non-electric hand tools]; stamping-out tools [hand tools]; depilation appliances, electric and non-electric; manual grinding tools; lifting jacks, hand-operated.

11 – Lighting, apparatus and installations; cooking apparatus and installations; hot plates; coffee percolators, electric; multicookers; hair dryer; radiators, electric; kettles, electric; solar water heater; radiators [heating].

(260) AM 2022 114584 A  
 (800) 1507528  
 (151) 2019 11 19  
 (891) 2021 07 30  
 (731) TOS s.r.l.  
 Largo Maurizio Vitale 1, I-10152 Turin, Italy

(540)

## DOCKSIDES

(591) Black, white  
 (511)  
 18 – Leather and imitations of leather; bags; rucksacks; school bags; sport bags; haversacks; travelling bags; trunks (luggage); suitcases; wallets; hiking sticks; key cases of leather and skins; vanity cases (not fitted); umbrellas; collars for animals; leashes for animals; slings for carrying infants.

25 – Clothing; footwear; headgear; men, women and children's articles of clothing; sportswear; casual wear; waterproof clothing; tracksuits; suits for sports activities; articles of clothing for sports activities; underwear; belts [clothing]; bathing suits; gloves [clothing]; hat and caps; bandanas [neckerchiefs]; scarves; stockings; socks; wrist band [clothing]; footwear for sports activities.

(260) AM 2022 114646 A  
 (800) 1613710  
 (151) 2021 06 09  
 (891) 2021 06 09  
 (731) British American Tobacco (Brands) Limited  
 Globe House, 4 Temple Place, London  
 WC2R 2PG, United Kingdom

(540)



The logo for KBio features the letters 'KBio' in a bold, sans-serif font. To the right of the text is a stylized square icon composed of four smaller squares arranged in a larger square pattern.

(591) Black, white  
 (531) 26.03.23  
 (511)  
 5 – Vaccines for human use.

(260) AM 2022 114647 A  
 (800) 1613713  
 (151) 2021 07 13  
 (891) 2021 07 13  
 (731) MASTELLI S.R.L.  
 VIA BUSSANA VECCHIA 32, I-18038  
 SANREMO, IMPERIA, Italy

(540)

## PLINEST

(591) Black, white  
 (511)  
 3 – Bleaching preparations and other substances for laundry use; cleaning, polishing, scouring and abrasive preparations; soap; perfumery, essential oils, cosmetics, hair lotions; dentifrices.  
 5 – Pharmaceutical and veterinary products; sanitary preparations for medical purposes; dietetic substances adapted for medical use, food for babies; plasters, materials for dressings; material for dental fillings and dental impressions; disinfectants; preparations for destroying noxious animals; fungicides, herbicide.

(260) AM 2022 114648 A  
 (800) 1613717  
 (151) 2021 07 16  
 (891) 2021 07 16  
 (731) LYKOS Pharma Ltd  
 7, Sir William Reid Street, GZR 1039 Gzira, Malta

(540)

## FASTENAL

(591) Black, white  
 (511)  
 5 – Pharmaceuticals; medical and veterinary preparations; therapeutic creams [medical]; greases for medical purposes; pheromones for medical use; swabs for

medical use; hormones for medical purposes; drugs for medical purposes; chemical preparations for medical purposes; dietetic substances adapted for medical use; mineral preparations and substances for medical use; sanitary preparations for medical purposes; dental wax; disinfectants; medicinal ointments; material for stopping teeth, dental wax; anti-cough drops; anti-tussive expectorants; compounds for treating correlated pulmonary syndromes; compounds for treating respiratory diseases; cough mixtures; cough pastilles for medical use; linctus; decongestants; elixirs for relieving chills; expectorants; inhaled pharmaceutical preparations for the treatment of respiratory diseases and disorders; pharmaceutical cough preparations; pharmaceutical preparations for the prevention of diseases of the respiratory system; pharmaceutical preparations for the prevention of disorders of the respiratory system; pharmaceutical preparations for treating allergic rhinitis; pharmaceutical products for treating respiratory diseases; preparations for treating colds.

(260) AM 2022 114649 A

(800) 1613758

(151) 2021 07 15

(891) 2021 07 15

(731) SF (IP) LIMITED

12/F, San Toi Building, 137-139 Connaught Road Central, Hong Kong, China

(540)

# SF CityRush

(591) Black, white

(531) 27.05.01

(511)

9 – Computer programmes [programs], recorded; computer software applications, downloadable; downloadable mobile applications; data processing apparatus; computer software, recorded; computer operating programs, recorded; electronic publications, downloadable; network communication equipment; remote control apparatus; computer program (downloadable software).

16 – Teaching materials [except apparatus]; lithographic works of art; printed publications; cardboard for packaging; writing materials; stamps [seals]; writing or drawing books; glue for stationery or household purposes; plastic film for wrapping; stuffing of paper or cardboard; bags [envelopes, pouches] of paper or plastics for packaging; stationery; paper box; paper gift wrap; printed matter; paper.

35 – Presentation of goods on communication media, for retail purposes; advertising; layout services for advertising purposes; commercial administration of the licensing of the goods and services of others; provision of operational business assistance to enterpri-

ses; market studies; providing business information via a website; import-export agency services; provision of an online marketplace for buyers and sellers of goods and services; marketing services; procurement services for others [purchasing goods and services for other businesses]; sales promotion for others; personnel management consultancy; interviewing services for personnel recruitment; administrative services for the relocation of businesses; systemization of information into computer databases; web indexing for commercial or advertising purposes; book-keeping; rental of vending machines; retail services for pharmaceutical, veterinary and sanitary preparations and medical supplies.

36 – Insurance underwriting; insurance claims processing; financing and loan services; clearing, financial; organization of monetary collections; financial management; mortgage banking; debt management services; processing of electronic credit card transactions; financial management by the internet; electronic funds transfer; art appraisal; real estate rental service; financial customs brokerage services; financial guarantees [surety services]; charitable fund raising; fiduciary; lending against security.

39 – Transport of valuables; navigation; car parking; storage; arranging of travel; freight [shipping of goods]; collection of recyclable goods [transport]; transport; courier services [messages or merchandise]; delivery of goods by mail order; hauling; temporary storage of personal belongings; gift wrapping; flower delivery; express delivery of letters.

42 – Computer software design; design and development of application software for mobile phones; research and development of new products for others; software development for secure network operations; maintenance of computer software; monitoring of computer systems by remote access; development of computer platforms; electronic storage service for electronic data archiving; research in the field of telecommunications technology; developing data processing programs based on third party orders; off-site data backup; software as a service [SaaS]; cloud computing; server hosting; data encryption services.

(260) AM 2022 114655 A

(800) 1613994

(151) 2021 07 27

(891) 2021 07 27

(731) PingCAP Xingchen (Beijing) Technology Co., Ltd.

Room 101A-195, Building B-2, Dongsheng Science & Technology Park, Zhongguancun, No.66, Xixiaokou Road, Haidian District, Beijing, China

(540)

**TiDB**

(591) Black, white

(531) 27.05.17

(511)

9 – Computer programs, recorded; weighing machines; computer programs, downloadable; computer software applications, downloadable; measures; smartphones; computer software, recorded; audio- and video-receivers; enlarging apparatus [photography]; chips [integrated circuits].

42 – Technological research; geological research; meteorological information; industrial design; computer software design; maintenance of computer software; information technology [IT] consultancy; cloud computing; electronic data storage; software as a service [SaaS].

(260) AM 2022 114656 A

(800) 1614018

(151) 2021 06 30

(891) 2021 06 30

(731) EcoFlow Inc.

Plant A202, Founder Technology Industrial Park, Shiyuan Sub-district, Bao'an District Shenzhen, 518000 Guangdong, China

(540)

**ONEP**

(591) Black, white

(531) 01.15.03; 24.01.07; 24.17.25; 27.03.15; 27.05.01

(511)

9 – Batteries, electric, for vehicles; battery boxes; batteries, electric; accumulators, electric; photovoltaic cells; solar batteries; portable power supplies (rechargeable batteries); battery chargers; rechargeable batteries; charging appliances for rechargeable equipment; lithium-ion batteries; charging stations for electric vehicles; photovoltaic apparatus and installations for generating solar electricity; accumulators, electric, for automobiles; chargers for car telephones; photovoltaic apparatus for generating electricity.

(260) AM 2022 114657 A

(800) 1614048

(151) 2021 07 12

(891) 2021 07 12

(731) Youdao Tyre Co., LTD.

Tangshan Town, Huantai County, Zibo City, Shandong Province, China

(540)

**EUDEMON**

(591) Black, white

(531) 27.05.01

(511)

12 – Tyres for vehicle wheels; casings for pneumatic tyres; treads for retreading tyres; pneumatic tyres; adhesive rubber patches for repairing inner tubes; automobile tyres; tires for aircraft wheels; tyres for children's bicycles; patches for repairing tyres; inner tubes for motorcycle tires; tyres for commercial vehicles; truck tires; bus tires; tires for two-wheeled vehicles.

(260) AM 2022 114658 A

(800) 929506

(151) 2007 04 27

(891) 2021 08 27

(731) Armacell Enterprise GmbH &amp; Co. KG

Zeppelinstraße 1, 12529 Schönefeld OT Waltersdorf, Germany

(540)

**ArmaSound**

(591) Black, white

(511)

17 – Thermal and acoustic insulating materials; adhesive tapes, as far as included in this class.

(260) AM 2022 114659 A

(800) 1093108

(151) 2011 08 26

(891) 2021 08 27

(731) ZWILLING J.A. Henckels AG

Grünwalder Strasse 14-22, 42657 Solingen, Germany

(540)

**ZWILLING**

(591) Black, white

(511)

7 – Bread cutting machine; electric tin opener; meat choppers (machines); grating machines for vegetables; flour mills; coffee grinders, other than hand-operated; kneading machines; electric kitchen machines; electric food processors; electric knives; mixers (machines); electric blenders for household purposes; mills for household purposes, not hand-operated; pepper mills, other than hand-operated; electric fruit presses for household purposes; electric beaters; electric shears; blade sharpening machines; electric whisks for household purposes; cutters; dish washers.

11 – Extractor hoods for kitchen; electric heaters for feeding bottles; bread baking machines; bread toasters; electric pressure cookers (autoclaves); ice machines and apparatus; ice boxes; electric deep fryers; ro-

asting apparatus; rotisseries; roasting spits; hair dryers; electric coffee machines; electric cooking utensils; kitchen ranges (ovens); cooking rings; cookers; refrigerating cabinets; electric pressure cooking saucepans; electric waffle irons; hot plates.

(260) AM 2022 114660 A

(800) 1093110

(151) 2011 08 26

(891) 2021 08 27

(731) ZWILLING J.A. Henckels AG

Grünewalder Straße 14-22, 42657 Solingen,  
Germany

(540)



(591) Black, white

(531) 02.01.23; 26.04.14

(511)

7 – Bread cutting machine; electric tin opener; meat choppers (machines); grating machines for vegetables; flour mills; coffee grinders, other than hand-operated; kneading machines; electric kitchen machines; electric food processors; electric knives; mixers (machines); electric blenders for household purposes; mills for household purposes, not hand-operated; pepper mills, other than hand-operated; electric fruit presses for household purposes; electric beaters; electric shears; blade sharpening machines; electric whisks for household purposes; cutters; dish washers.

11 – Extractor hoods for kitchen; electric heaters for feeding bottles; bread baking machines; bread toasters; electric pressure cookers (autoclaves); ice machines and apparatus; ice boxes; electric deep fryers; roasting apparatus; rotisseries; roasting spits; hair dryers; electric coffee machines; electric cooking utensils; kitchen ranges (ovens); cooking rings; cookers; refrigerating cabinets; electric pressure cooking saucepans; electric waffle irons; hot plates.

(260) AM 2022 114661 A

(800) 1111446

(151) 2011 09 16

(891) 2021 06 10

(731) Merz Pharma GmbH & Co. KGaA

Eckenheimer Landstr. 100, 60318 Frankfurt  
am Main, Germany

(540)

## MERZ AESTHETICS

(591) Black, white

(511)

5 – Pharmaceutical products; medicines; preparations for health care; medical products for dermatology.

10 – Medical instruments and apparatus.

16 – Books, newspapers, periodicals, magazines, pamphlets, publications, printed matter, instructional and teaching material (except apparatus), stationery.

35 – Advertising.

41 – Publication of periodicals, books, newspapers and printed matter for information purposes; arranging of seminars, conference, congresses, talks, colloquiums and workshops; scientific training and further training for doctors, further training events for doctors.

42 – Services in the field of science and technology and research and development related thereto.

(260) AM 2022 114662 A

(800) 1471077

(151) 2019 01 09

(891) 2021 07 02

(731) DEFACTO PERAKENDE TİCARET  
ANONİM ŞİRKETİ

Defacto Plaza Basın Ekspres, Yolu Atatürk  
Mah., Bahariye Cad. No. 31; Küçükçekmece,  
İstanbul, Turkey

(540)

## Defacto Fashion

(591) Black, white

(526) Fashion

(511)

25 – Clothing namely pullovers, skirts, dresses, blouses, jeans, trousers, jackets, coats, raincoats, anoraks, sportswear, shirts, T-shirts, sweatshirts, beach clothes, shorts, knitwear, overalls, underclothing, bodices, brassieres, camisoles, underpants, dressing gowns, bath robes, bathing suits, pyjamas, gloves (clothing), ski suits; headgear namely hats, caps, knitted caps, berets; footwear namely shoes (excluding orthopaedic shoes), slippers, boots, sandals, beach shoes, sports shoes, lace boots and parts thereof, shoe parts namely heel-pieces, heels, footwear uppers; stockings; belts (clothing); ties, neckties, shawls, scarves, mufflers, neck scarves, sarongs, collars for dresses, muffs, wristbands (clothing), suspenders, braces for clothing, garters, bandanas, headbands; clothing for babies.

35 – The bringing together, for the benefit of others, of clothing namely pullovers, skirts, dresses, blouses, jeans, trousers, jackets, coats, raincoats, anoraks, sportswear, shirts, T-shirts, sweatshirts, beach clothes, shorts, knitwear, overalls, underclothing, bodices, bra-

ssieres, camisoles, underpants, dressing gowns, bath robes, bathing suits, pajamas, gloves (clothing), ski suits, headgear namely hats, caps, knitted caps, berets, footwear namely shoes (excluding orthopedic shoes), slippers, boots, sandals, beach shoes, sports shoes, lace boots and parts thereof, shoe parts namely heelpieces, heels, footwear uppers, stockings, belts (clothing), ties, neckties, shawls, scarves, mufflers, neck scarves, sarongs, collars for dresses, muffs, wristbands (clothing), suspenders, braces for clothing, garters, bandanas, headbands, clothing for babies, namely babies' diapers of textile, enabling customers to conveniently view and purchase those goods, such services may be provided by retail stores, wholesale outlets, by means of electronic media or through mail order catalogues.

(260) AM 2022 114663 A  
 (800) 1485110  
 (151) 2019 07 23  
 (891) 2021 08 26  
 (731) 2660722 Ontario Inc.  
 240 Richmond St. West, Toronto  
 ON M5V 2C5, Canada  
 (540)

## STLTH

(591) Black, white  
 (511)  
 34 – Electronic cigarettes.

(260) AM 2022 114664 A  
 (800) 1571089  
 (151) 2020 12 08  
 (891) 2021 08 01  
 (731) Makarov Alexey Valerievich  
 str. Timiryazeva, 97/1, apt. 103, Novosibirsk,  
 RU-630082 Novosibirsk region, Russian  
 Federation  
 (540)

**TomyumBar**<sup>®</sup>  
 Modern Pan Asian Kitchen  
  
 est. 2016

(591) Black and red  
 (531) 05.09.15; 27.05.01; 29.01.12  
 (526) Modern Pan Asian Kitchen est. 2016  
 (511)  
 43 – Café services; restaurant services; self-service restaurant services; snack-bar services; bar services; cafeteria services; food sculpting; food and drink catering; information and advice in relation to the preparation of meals; personal chef services; washoku restaurant services; udon and soba restaurant services.

(260) AM 2022 114703 A  
 (800) 1614337  
 (151) 2021 06 04  
 (891) 2021 06 04  
 (731) PHERECYDES PHARMA  
 NANTES BIOTECH, 22 boulevard Benoni  
 Goullin, F-44200 Nantes, France

(540)  

(591) Violet, gray  
 (531) 26.07.25; 26.13.25; 27.05.01; 29.01.12  
 (511)

5 – Pharmaceutical and veterinary products; pharmaceutical preparations for the treatment or prevention of bacterial diseases; antibacterial substances for medical use; diagnostic agents for medical purposes; drug delivery agents; antibodies for medical or veterinary purposes; hygienic products for medicine; chemical preparations for medical or pharmaceutical use; bacterial and bacteriological preparations for medical or veterinary use; bactericides pertaining to the pharmaceutical trade; fungicides pertaining to the pharmaceutical trade; germicides pertaining to the pharmaceutical trade; virucides pertaining to the pharmaceutical trade; biocides pertaining to the pharmaceutical trade; sporicides pertaining to the pharmaceutical trade; levuricides pertaining to the pharmaceutical trade; mycobactericides pertaining to the pharmaceutical trade; media for bacteriological cultures; microbicides pertaining to the pharmaceutical trade; preparations of microorganisms for medical and veterinary use.

10 – Analysis devices for identification of bacteria for medical use; surgical, medical, dental and veterinary apparatus and instruments; bacteria sampling apparatus; apparatus used for the study of bacterial disorders; applicators for anti-bacterial preparations.

42 – Medical and pharmacological research services; scientific research in bacteriology; chemical and microbiological laboratory services; research and development in the field of chemistry, microbiology, air flows, agri-foodstuffs, biology, bacteriology; consultancy with respect to pharmaceutical research and development; consultancy with respect to bacteriology research; clinical trials; carrying out clinical trials; auditing regarding air, water and surface hygiene, regarding sanitary risks and chemical or microbiological contamination; surveying [engineering work]; consultancy with respect to bacteriology; research and testing services in the fields of bacteriology and virology; scientific and technological services and research work, particularly for identifying and characterizing active materials for infectious disease treatment; pharmaceutical processing product development; conducting and scientific support of preclinical or clinical studies.

(260) AM 2022 114704 A

(800) 1614414

(151) 2021 02 12

(891) 2021 02 12

(731) PANELSAN ÇATI CEPHE SİSTEMLERİ  
SANAYİ VE TİCARET ANONİM ŞİRKETİ  
Maidan İş ve Yaşam Merkezi Mustafa, Kemal  
Mah. 2118. Cad. No:4 A Blok 3., Kat Daire 18,  
Çankaya, Ankara, Turkey

(540)



(591) Black, white

(531) 26.04.03; 26.04.09; 26.04.24; 27.05.01;  
27.05.09; 29.01.12

(511)

6 – Panels of metal for covering roofs, ceilings and walls; panels of metal coated with waterproofing material; roof panels enabling hidden screw mounting; roof panels suitable for solar panel installation; metal roof panels with waterproofing membranes and coatings; roof and wall panels for buildings and structures for use in agriculture; roof panels for use in animal farms and in acid and corrosion resistant environments; roof and wall panels for buildings, structures and rooms; panels for building structures including prefabricated buildings, transport containers.

(260) AM 2022 114710 A

(800) 1614648

(151) 2021 04 27

(891) 2021 04 27

(731) JR

25 rue Marbeuf, F-75008 PARIS, France

(540)

## CIBLE SKIN

(591) Black, white

(511)

3 – Non-medicated toiletry preparations and cosmetic products; non-medicated dentifrices; perfumery products, essential oils; bleaching preparations and other substances for laundry use; cleaning, polishing, degreasing and abrasive preparations; soaps; perfumes; cosmetic creams, milks and oils; cosmetics; make-up products; lipstick; make-up removing products; micellar water; lotions for cosmetic use; cosmetic products for skin care; phytocosmetic preparations; aloe vera preparations for cosmetic use; collagen preparations for cosmetic use; beauty masks; plant extracts for cosmetic use; greases for cosmetic use; oils for cosmetic use; cleansing milk for toilet purposes; cosmetic skin-tanning preparations; skin whitening cream; dental bleaching gels; teeth whitening strips; dentifrices; cosmetics for eyelashes; eyebrow cosmetics; false eyelashes; gel eye patches for cosmetic use; shampoos; hair

conditioners; hair lotions; depilatory wax; depilatories; shaving products; cotton sticks for cosmetic use; massage candles for cosmetic use.

5 – Pharmaceutical products, medical preparations; hygienic products for medicine; dietetic substances and foods for medical use; food supplements for humans and animals; plasters, materials for dressings; material for dental fillings and dental impressions; disinfectants; biological preparations for medical use; pharmaceutical preparations; chemical-pharmaceutical preparations; phytotherapy preparations for medical use; pharmaceutical preparations for skin care; preparations for acne treatments; medical preparations for slimming; shampoos, soaps, lotions and medicated dentifrices; surgical implants made of living tissue; live hair implants; hygienic products for medicine; pharmaceutical alcohols; astringents for medical use; adhesive tapes for medical purposes; cotton sticks for medical use; compresses; cotton for medical use; disinfectant wipes; lotions for pharmaceutical use; dressings for medical use; pre-filled syringes for medical use; collagen for medical use; injectable dermal filler products; bone void fillers consisting of living tissue; biological tissue cultures for medical use; diagnostic preparations for medical use; balms for medical use; medicinal mud; creams for medical use; massage gels for medical use; fats for medical use; essential oils for medical use; pomades for medical use; serums; medicated hair lotions; medicinal preparations for stimulating hair growth; pharmaceutical preparations for treating dandruff; medicated shampoos; abrasives for dental use; oxygen baths; sea water for medicinal bathing; mineral waters for medical use; thermal water; elixirs (pharmaceutical preparations); sexual lubricants; tanning pills; remedies for perspiration; dietetic foods for medical use; dietetic beverages for medical use; food supplements; food supplements with cosmetic effect; nutritional supplements; food and nutritional supplements for dietetic use; appetite suppressants for medical use; vitamins; vitamin preparations; royal jelly for pharmaceutical use; medicinal infusions; medicinal tea.

10 – Surgical, medical, dental and veterinary apparatus and instruments; artificial limbs, eyes and teeth; orthopedic articles; suture material; therapeutic and assistance devices designed for people with disabilities; massage apparatus; apparatus, devices and articles for child care; apparatus, devices and articles for sexual activities; acupuncture needles; therapeutic and prosthetic articles and devices made of artificial or synthetic materials for implantation; artificial prostheses; hair prostheses; artificial breasts; artificial skin for surgical use; surgical implants comprised of artificial materials; hair prostheses; inhalers; testing apparatus for medical use; anesthetic apparatus; massage apparatus; aesthetic massage apparatus; micro-dermabrasion apparatus; apparatus for the regeneration of stem cells for medical use; apparatus and machines

for medical diagnosis of human tissue and skin; apparatus and machines for human tissue and skin treatment and care; light therapy masks; medical apparatus and devices for cosmetic and medical treatment of skin conditions; surgical sterile sheets; patient examination gowns; syringes for injections; bracelets for medical use; electric belts for medical purposes; surgical robots; surgical clips; needles for medical use; suture needles; scissors for surgery; syringes for medical use; thermoelectric compresses (surgery); compressors (surgical); knives for surgical use; surgical thread; lamps for medical use; lasers for medical use; nanites for medical use; orthodontic appliances; vibromassage apparatus.

42 – Scientific, technical and medical research services in the field of aesthetic and cosmetic medicine; cosmetic research services; research, design, development of new medical and cosmetic treatments and products; clinical research; research relating to medicine, medication, pharmaceutical products in the field of aesthetic and cosmetic medicine; clinical trials in the field of cosmetic and aesthetic medicine; technical project study in the field of aesthetic and cosmetic medicine; design and development of pharmaceutical products and medical or paramedical equipment in the field of aesthetic and cosmetic medicine; design of prostheses.

44 – Medical services; medical clinic services; surgical services; telemedicine services; medical and surgical services; information and prevention services in the field of health, surgery, medicine and beauty care, dentistry; rental of medical machines, rental of beauty care machines, and rental of skin care machines; rental of surgical robots and aesthetic medicine robots; medical-surgical centers; services provided by cosmetic and plastic surgery clinics; alternative medicine services; cosmetic and plastic surgery; health services; beauty care services; beauty salon services; hygienic and beauty care; beauty care; filler injection treatment for cosmetic purposes; dentistry; cosmetic dentistry; electric hair removal (beauty care); laser hair removal; hair implantation; medical analyses; medical expertise services; medical assistance.

(260) AM 2022 114711 A

(800) 1614696

(151) 2021 06 15

(891) 2021 06 15

(731) Obshchestvo s ogranichennoy otvetstvennostyu "Nadoba"

Dmitrovskoe sh., d.85, et.2, pom. 221,  
RU-127238 Moskva, Russian Federation

(540)

# Nádoba

# Надоба

(591) Black, white

(531) 27.05.17; 28.05

(511)

21 – Buckets; dishes; paper plates; saucers; mugs; sandwich boxes; bottles; vases; waffle irons, non-electric; ice buckets; coal buckets; cooking skewers of metal; towel rails; flower pots; cruets; decanters; sponges for household purposes; sponge holders; toothpick holders; soap holders; flower holders; plant holders; toilet paper holders; cutting boards for the kitchen; strainers; smoke absorbers for household purposes; containers for household or kitchen use; kitchen containers; heat-insulated containers for beverages; thermally insulated containers for food; frying pans; ceramics for household purposes; works of art of porcelain, ceramic or glass; cleaning instruments, hand-operated; stew-pans; napkin rings; bread baskets for household purposes; baskets for household purposes; cookie jars; tea caddies; earthenware saucepans; cauldrons; coffee percolators, non-electric; coffeepots, non-electric; coffee grinders, hand-operated; beer mugs; dish covers; jugs; mixing spoons [kitchen utensils]; basting spoons [cooking utensils]; spatulas for kitchen use; butter dishes; polishing materials for making shiny, except preparations, paper and stone; noodle machines, hand-operated; polishing apparatus and machines, for household purposes, non-electric; pepper mills, hand-operated; feather-dusters; brooms; bowls [basins]; mosaics of glass, not for building; saucepan scourers of metal; soap boxes; cooking pot sets; fitted picnic baskets, including dishes; cookie [biscuit] cutters; pastry cutters; sprinklers; chopsticks; cocktail stirrers; pepper pots; gloves for household purposes; trays for household purposes; trays of paper, for household purposes; lazy susans; heaters for feeding bottles, non-electric; trivets [table utensils]; coasters, not of paper or textile; knife rests for the table; egg cups; abrasive pads for kitchen purposes; scouring pads; pottery; painted glassware; tableware, other than knives, forks and spoons; porcelain ware; earthenware; crystal [glassware]; cosmetic utensils; toilet utensils; cruet sets for oil and vinegar; spice sets; toilet paper dispensers; bottle openers; dusting apparatus, non-electric; soap dispensers; salad bowls; sugar bowls; beaters, non-electric; services [dishes]; siphon bottles for carbonated water; autoclaves, non-electric, for cooking; fruit presses, non-electric, for household purposes; drinking vessels; vessels of metal for making ices and iced drinks; refrigerating bottles; cups of



paper or plastic; tumblers; soup bowls; drying racks for laundry; basins [receptacles]; table plates; disposable table plates; graters for kitchen use; insulating flasks; cloths for cleaning; utensils for household purposes; kitchen utensils; cooking utensils, non-electric; flasks; drinking flasks; ice cube moulds; cookery moulds; deep fryers, non-electric; bread bins; teapots; kettles, non-electric; cups; garlic presses [kitchen utensils]; mops; brushes; boxes for dispensing paper towels; dustbins; shaving brush stands.

(260) AM 2022 114712 A

(800) 1614722

(151) 2020 12 01

(891) 2020 12 01

(731) Libra Association

Quai de l'Île 13, CH-1204 Genf, Switzerland

(540)

## DIEM

(591) Black, white

(511)

9 – Software; computer hardware; software in the field of blockchain; computer software platforms for blockchains, software for blockchain-based platforms, namely software for distributed applications; blockchain applications; blockchain applications for electronic wallets; data networks of blockchain; blockchain software; blockchain technology software; electronic wallets used for blockchain applications; network apparatus in the field of blockchain; blockchain application software; software in the field of blockchain; software for blockchain-based platforms, namely software for distributed applications; blockchain applications and wallets; blockchain software; software for use with digital currency; software for use with cryptocurrency; software for use with virtual currency; downloadable computer software for use as a cryptocurrency wallet; cryptocurrency hardware wallet; software development tools; software for use as an application programming interface (API); application programming interface (API) for use in building software applications; software for the collection, management, editing, organization, modification, transmission, sharing, and storage of data and information; software for digital currency payment and exchange transactions; software for use in managing portfolios of digital currency, virtual currency, cryptocurrency, digital and blockchain assets, digitized assets, digital tokens, crypto tokens and utility tokens; distributed ledger platform software; software which facilitates the ability of users to view, analyze, record, store, monitor, manage, trade and exchange digital currency, virtual currency, cryptocurrency, digital and blockchain assets, digitized assets, digital tokens, crypto tokens and utility tokens; software for sending, receiving, accepting, buying, selling, storing, transmitting, trading and exchanging digital currency, virtual currency, cryptocurrency, digital and blockchain assets, digitized assets,

digital tokens, crypto tokens and utility tokens; software for implementing and recording financial transactions; software for creating accounts and maintaining and managing information about financial transactions on distributed ledgers and peer to peer payment networks; software for use in financial trading; software for use in financial exchange; software for accessing financial information and market data and trends; software for settling financial transactions; software for providing authentication of parties to a financial transaction; software for maintaining ledgers for financial transactions; software for the management of cryptographic security of electronic transmissions across computer networks; software for encrypting and enabling secure transmission of digital information over the Internet; software for allowing users to calculate parameters related to financial transactions; distributed ledger software for use in processing financial transactions; software for electronic funds transfer; software for currency conversion; software for the collection and distribution of data; software for payment transactions; software for connecting computers to local databases and global computer networks; software for creating searchable databases of information and data; software for managing and validating digital currency, virtual currency, cryptocurrency, digital asset, blockchain asset, digitized asset, digital token, crypto token and utility token transactions; software for creating and managing smart contracts; software for managing payment and exchange transactions; software and hardware for use as a digital currency wallet; software and hardware for use as a virtual currency wallet; software and hardware for use as a digital asset wallet; software and hardware for use as a digital token wallet; software and hardware for use as a crypto token wallet; software and hardware for use as a utility token wallet; software for creating a decentralized and open source digital currency for use in blockchain-based transactions; software for creating a decentralized and open source virtual currency for use in blockchain-based transactions; software for creating a decentralized and open source cryptocurrency for use in blockchain-based transactions; software for creating a decentralized and open source digitized asset for use in blockchain-based transactions; software for creating a decentralized and open source digital token for use in blockchain-based transactions; software for users to buy and sell products by using digital currency, virtual currency, cryptocurrency, digital and blockchain assets, digitized assets, digital tokens, crypto tokens and utility tokens; software platforms for facilitating transactions and payments using digital currency, virtual currency, cryptocurrency, digital and blockchain assets, digitized assets, digital tokens, crypto tokens or utility tokens that allow users to buy from, and sell products and services to others; computer application software for blockchain-based platforms, namely, software for digital exchanges for virtual items; software for creating, selling and

managing blockchain-based tokens or appcoins; software for use in an electronic financial platform; software for processing electronic payments and for transferring funds to and from others; software for transfers of digital currency, virtual currency, cryptocurrency, digital and blockchain assets, digitized assets, digital tokens, crypto tokens and utility tokens between parties; blockchain platform software; software for use in the management and implementation of digital currency, virtual currency, cryptocurrency, digital and blockchain asset, digitized asset, digital token, crypto token and utility token transactions; software for creating and managing a blockchain platform for use in managing digital currency, virtual currency, cryptocurrency, digital and blockchain asset, digitized asset, digital token, crypto token and utility token accounts; software for managing crypto currency and digital currency accounts; software for use in payments, purchases, and investments using digital currency, virtual currency, cryptocurrency, digital and blockchain assets, digitized assets, digital tokens, crypto tokens and utility tokens; software for use in enabling the electronic transfer of funds to and from others; software for use in managing the conversion of digital currency, virtual currency, cryptocurrency, digital and blockchain assets, digitized assets, digital tokens, crypto tokens and utility tokens into hard currency; software for developing, deploying, and managing software applications, and integrating software applications for digital currency, virtual currency, cryptocurrency, digital and blockchain asset, digitized asset, digital token, crypto token and utility token accounts; software for use in facilitating the use of a blockchain or distributed electronic ledger to execute and record financial transactions, namely, financial trades made with the use of digital currency, virtual currency, cryptocurrency, digital and blockchain assets, digitized assets, digital tokens, crypto tokens and utility tokens; software and hardware for use in electronically exchanging currency for digital currency, virtual currency, cryptocurrency, digital and blockchain assets, digitized assets, digital tokens, crypto tokens and utility tokens; software for use as an application programming interface (API) for the development, testing, and integration of blockchain software applications; computer hardware for digital currency, virtual currency, cryptocurrency, digital and blockchain asset, and digitized asset mining; security token hardware; electronic currency converters; software, namely, electronic financial platform that accommodates multiple types of payment and transactions in an integrated mobile phone, PDA, and web-based environment; software for creating tokens to be used to pay for products and services, and that may be traded or exchanged for cash value; software for use in securely managing the conversion of digital currency, virtual currency, cryptocurrency, digital and blockchain assets, digitized assets, digital tokens, crypto tokens and utility tokens into hard currency; software for managing digital cur-

rency, virtual currency, cryptocurrency, digital and blockchain assets, digitized asset, digital token, crypto token and utility token payments, money transfers, and commodity transfers; software for facilitating money transfers, electronic funds transfers, commodity transfers, bill payment remittance, and transferring funds between parties; software for use as an application program interface (API) software for use in computer hardware device identification; software for use in authenticating user access to computers and computer networks; software for use in facilitating secure transactions; software for use in accessing, reading, tracking, and using blockchain technology; software and hardware for managing identity information, access rights to information resources and applications and authentication functionality; software for network identification verification, authentication and management services for security purposes; authentication software for controlling access to and communications with computers and computer networks; magnetically encoded credit cards and payment cards; encryption devices; security tokens; downloadable software for use as a security token; software used in issuing digital currency, virtual currency, cryptocurrency, digital and blockchain assets, digitized assets, digital tokens, crypto tokens and utility tokens; software used in auditing digital currency, virtual currency, cryptocurrency, digital and blockchain assets, digitized assets, digital tokens, crypto tokens and utility tokens; downloadable cryptographic keys for receiving and spending cryptocurrency; software for use in enabling processing and tracking of electronic funds transfers; blockchain-based software platforms and distributed computing software platforms for auditing and verifying digital information and codes; software for social networking in the field of investments.

35 – Marketing, advertising and promotion services; business information; provision of market research information; market research services; sales promotion of the goods and services of others via computer and communication networks; advertising services; commercial management advisory services; commercial management services; advice in the field of commercial strategy; business management consultancy; commercial business administration; provision of commercial and business contact information; company administration and management services; business inquiries; consultancy and advisory services in the field of provision of commercial and business information to companies; market intelligence services; providing product information for third parties via computer and communication networks for facilitating the exchange and sale of products; arranging of contracts, for others via computer and communication networks for the purchase and sale of goods and services; provision of an online marketplace for exchanging and selling of services and products of third parties via computer and communication networks; providing online marketplaces for sellers and buyers of goods

and services; providing online commercial information for connecting sellers with buyers; provision of an online facilities marketplace for connecting sellers with buyers and sellers of goods and services; provision of an online marketplace for selling and trading virtual goods with other users; arranging, negotiating and concluding online commercial transactions for others; providing on-line commercial directory information services; provision of commercial trading information from online databases; online advisory services relating to commercial transactions; arranging of trading transactions online; arranging of trading transactions and commercial contracts; arranging and concluding commercial transactions for others; arranging of trading transactions online; provision of commercial trading information from online databases; online arranging of online trading transactions related to arranging virtual currency exchanges and cryptocurrency transactions; arranging and conducting special events for commercial, promotional or advertising purposes; arranging and conducting special events for business purposes; business advice and provision of business information in the field of blockchain technology; compiling indexes of information using blockchain technology.

36 – Financial services; financial exchange; financial affairs, namely, financial management, financial planning, financial forecasting, financial portfolio management and financial analysis and consultation; financial information provided by electronic means; brokerage services; virtual currency exchange; trading in foreign currency; financial services related to digital currency; financial services related to cryptocurrency; digital currency exchange services; digital currency transfer services; cryptocurrency transfer services; virtual currency services; financial services relating to digital currency wallets; financial services by means of electronic wallets; financial management of electronic wallets; online financial transactions in relation to digital currency; electronic wallet payment services in relation to digital currency; e-wallet payment services; electronic banking services via a global computer network; currency trading; payment processing services; digital currency, virtual currency, cryptocurrency, digital and blockchain asset, digitized asset, digital token, crypto token and utility token trading services; financial information processing for others related to digital currency, virtual currency, cryptocurrency, digital and blockchain assets, digitized assets, digital tokens, crypto tokens and utility tokens; digital currency, virtual currency, cryptocurrency, digital and blockchain asset, digitized asset, digital token, crypto token and utility token payment, exchange and transaction processing services for others; conducting cashless payment transactions; electronic funds transfer services; electronic virtual currency transfer services; electronic funds transfer; providing financial information in the nature of digital currency, virtual currency, cryptocurrency, digital and blockchain asset, digitized

asset, digital token, crypto token and utility token ratings; providing financial information in the fields of digital currency, virtual currency, cryptocurrency, digital and blockchain asset, digitized asset, digital token, crypto token and utility token markets; provision of information relating to finance; financial services, namely, providing virtual currency services for use by members of an online community via a global computer network; issuance of tokens of value; management of digital currency, virtual currency, cryptocurrency, digital and blockchain assets, digitized assets, digital tokens, crypto tokens and utility tokens; financial services, namely, providing a financial exchange for the trading of digital currency, virtual currency, cryptocurrency, digital and blockchain assets, digitized assets, digital tokens, crypto tokens and utility tokens; cryptocurrency trading services; cryptocurrency exchange services; cryptocurrency payment processing; electronic wallet payment services; financial services related to electronic wallets; electronic wallet payment services in relation to virtual currency; processing electronic payments through electronic wallet services; currency management services; currency transfer services; financial services, namely, providing electronic transfer of digital currency, virtual currency, cryptocurrency, digital and blockchain assets, digitized assets, digital tokens, crypto tokens and utility tokens; financial consultation in the field of digital currency, virtual currency, cryptocurrency, digital and blockchain assets, digitized assets, digital tokens, crypto tokens and utility tokens; electronic processing and tracking of electronic funds transfers; currency exchange services; investment management services; management of digital asset investment portfolios; custodial services for financial institutions and funds; provision of financial lists and trading of exchange contracts (swaps) for digital currency, virtual currency, cryptocurrency, digital and blockchain assets, digitized assets, digital tokens, crypto tokens and utility tokens; trading of financial derivatives on digital currency, virtual currency, cryptocurrency, digital and blockchain assets, digitized assets, digital tokens, crypto tokens and utility tokens; exchanging money; clearing and reconciling financial transactions; electronic funds transfer; financial information services; electronic financial trading services; electronic financial trading, namely, trading of the field of digitized assets; electronic financial trading services, namely, management of digital assets; providing on-demand and real-time financial information about digital currency, virtual currency, cryptocurrency, digital and blockchain assets, digitized assets, digital tokens, crypto tokens and utility tokens; providing financial information regarding digital currency, virtual currency, cryptocurrency, digital and blockchain asset, digitized asset, digital token, crypto token and utility token payments from a website; providing information in the fields of investment and finance over computer networks and global communication net-

works; trading of financial instruments electronically; payment services for electronic commerce of financial instruments; electronic commerce payment services; blockchain-based payment verification services; financial consultancy services related to digital currency, virtual currency, cryptocurrency, digital and blockchain asset, digitized asset, digital token, crypto token and utility token financial transactions.

42 – Design and development of computer hardware and software; computer network configuration services; software services related to computer networks; computer programming; computerized data storage services; computer services, namely, providing information in the fields of technology and software development via the internet; computer services, namely, providing information in the fields of technology and software development via a global computer network; computer programming services; computer services, namely, data coding, data security, data encryption, data decryption, and data conversion; computer services, namely, providing technical and technological information in the field of blockchain, virtual currency, digital currency, digital assets and digitized assets; computer services, namely, application programming interface (API) software to allow users to perform electronic business transactions via a global computer network; information technology (IT) services; providing software via computer networks (in particular the Internet), telecommunications networks and mobile data services (application service providing); application service provider (ASP) services, namely, hosting computer software applications of others; application service provider (ASP) services, namely, hosting, managing, developing, and maintaining applications, software, websites and databases in the fields of information technology, blockchain, virtual currency, digital currency, cryptocurrency, and digital assets; application service provider (ASP) services namely, hosting software for use in virtual currency, digital currency, cryptocurrency, and digital asset exchange and transactions; Application service provider (ASP) services namely, hosting software to enable or facilitate the creating, editing, uploading, downloading, accessing, viewing, posting, displaying, commenting on, embedding, transmitting, and sharing or otherwise providing electronic media or information via the internet and communications networks; application service provider services namely, providing application programming interface (API) software to allow users to perform electronic business transactions via a global computer network; Application service provider (ASP) services namely, hosting software to enable or facilitate purchasing goods and services; software as a service (SaaS) services; platform as a service (PaaS) services; providing cloud computing software; providing online non-downloadable software enabling users to invest in digital currency, virtual currency, cryptocurrency, digital and blockchain assets, digitized assets, digital tokens, crypto tokens and utility tokens;

hosting software enabling users to invest in digital currency, virtual currency, cryptocurrency, digital and blockchain assets, digitized assets, digital tokens, crypto tokens and utility tokens; providing technical and technological consultancy in the field of distributed ledger technology (DLT); providing information on the design, development and hosting of software in the field of distributed ledger technology (DLT) via a website; design, development and hosting of software for and on the basis of distributed ledger technology (DLT); software as a service (SaaS) with software using distributed ledger technology (DLT); providing distributed ledger technology (DLT) in the nature of platforms and online non-downloadable software that utilize distributed ledger technology (DLT); providing non-downloadable distributed ledger technology (DLT) software; providing technical and technological information on distributed ledger technology (DLT); providing consultancy in the field of distributed ledger technology (DLT); design, development and hosting of software for and on the basis of distributed ledger technology (DLT); software as a service (SaaS) with software using distributed ledger technology (DLT); providing software for use in managing portfolios of digital currency, virtual currency, cryptocurrency, digital and blockchain asset, digitized asset, digital token, crypto token and utility token assets; providing software which facilitates the ability of users to view, analyze, record, store, monitor, manage, trade and exchange digital currency, virtual currency, cryptocurrency, digital and blockchain assets, digitized assets, digital tokens, crypto tokens and utility tokens; providing software for sending, receiving, accepting, buying, selling, storing, transmitting, trading and exchanging digital currency, virtual currency, cryptocurrency, digital and blockchain assets, digitized assets, digital tokens, crypto tokens and utility tokens; providing software for implementing and recording financial transactions, for creating accounts and maintaining and managing information about financial transactions on distributed public ledgers and peer to peer payment networks; providing software for processing electronic payments and for transferring funds to and from others; providing non-downloadable software for the collection and distribution of data; providing electronic financial platform software; providing software for use as an application programming interface (API) for the development, testing, and integration of blockchain software applications; providing software for transfers of digital currency, virtual currency, cryptocurrency, digital and blockchain assets, digitized assets, digital tokens, crypto tokens and utility tokens between parties; providing software for use in financial trading; providing software for use in financial exchange; providing software for use in accessing financial information and market data and trends; providing software for settling financial transactions, for providing authentication of parties to a financial transaction, for maintaining ledgers for finan-

cial transactions; providing software for the management of cryptographic security of electronic transmissions across computer networks; providing software for use with digital currency; providing software for use with cryptocurrency; providing software for use with virtual currency; providing software for use with digital currency wallet and storage services; providing software for digital currency payment and exchange transactions; providing distributed ledger software for use in processing financial transactions; providing software for electronic funds transfer; providing software for currency conversion; providing software for the collection and distribution of data; providing software for payment transactions; providing software for connecting computers to local databases and global computer networks; providing software for creating searchable databases of information and data; providing software for managing and validating digital currency, virtual currency, cryptocurrency, digital asset, blockchain asset, digitized asset, digital token, crypto token and utility token transactions; providing software for creating and managing smart contracts; providing software for managing payment and exchange transactions; providing software for electronically exchanging currency for digital currency, virtual currency, cryptocurrency, digital and blockchain assets, digitized assets, digital tokens, crypto tokens and utility tokens; providing software for use in enabling the electronic transfer of funds to and from others; providing software for creating a decentralized and open source digital currency for use in blockchain-based transactions; providing software for creating a decentralized and open source virtual currency for use in blockchain-based transactions; providing software for creating a decentralized and open source cryptocurrency for use in blockchain-based transactions; providing software for creating a decentralized and open source digitized asset for use in blockchain-based; providing software for creating a decentralized and open source digital token for use in blockchain-based transactions; providing software for encrypting and enabling secure transmission of digital information over the Internet, as well as over other modes of communication between computing devices; providing software for allowing users to calculate parameters related to financial transactions; distributed ledger platform software for use in processing financial transactions; providing software for electronic funds transfer and currency conversion; providing software for use in securely managing the conversion of digital currency, virtual currency, cryptocurrency, digital and blockchain assets, digitized assets, digital tokens, crypto tokens and utility tokens into hard currency; design, development, maintenance and hosting of a web portal featuring blogs and non-downloadable publications in the nature of articles, columns, and informational guides in the fields of virtual currencies, digital and blockchain assets and market and trading trends; design, development and hosting of a web portal featur-

ring blogs and non-downloadable publications in the nature of articles, columns, and informational guides in the fields of virtual currencies, digital and blockchain assets and market and trading trends; design, development and hosting a website featuring blogs and non-downloadable publications in the nature of articles, columns, and informational guides in the fields of virtual currencies, digital and blockchain assets and market and trading trends; design, development, maintenance and hosting of a web portal for users to access information in the field of virtual currencies, digital and blockchain assets; design, development and hosting of a web portal for users to access information in the field of virtual currencies, digital and blockchain assets; platform as a service (PaaS) featuring computer software platforms for the selling and purchasing digital currency, virtual currency, cryptocurrency, digital and blockchain assets, digitized assets, digital tokens, crypto tokens and utility tokens; software as a service (SaaS) featuring computer software platforms for the selling and purchasing digital currency, virtual currency, cryptocurrency, digital and blockchain assets, digitized assets, digital tokens, crypto tokens and utility tokens; computer services, namely, creating an on-line virtual environment for the selling and purchasing of digital currency, virtual currency, cryptocurrency, digital and blockchain assets, digitized assets, digital tokens, crypto tokens and utility tokens; platform as a service (PaaS) featuring computer software platforms for managing blockchain and token driven, distributed storage computer systems; software as a service (SaaS) featuring computer software platforms for managing blockchain and token driven, distributed storage computer systems; design, development, maintenance and hosting of a decentralized electronic file storage system and open source cloud storage platform; computer services, namely, providing a decentralized electronic object storage platform for end-to-end encrypted and powered by blockchain and blockchain payments; computer services, namely, providing secure, private encrypted cloud storage services; computer services, namely, providing electronic peer-to-peer data storage distributed across unused customer electronic storage resources; computer services, namely, providing open source decentralized cloud storage platform; data encryption services featuring blockchain software technology and peer-to-peer protocols to provide secure, private, and encrypted cloud storage; distributed, electronic storage of electronic media, namely, data, documents, files, text, photos, images, graphics, music, audio, video, and multimedia content; providing software for use as a cryptocurrency wallet; providing software for democratically managing digital exchanges for virtual items through smart contracts; data mining; providing software for use in trading, clearing, transmitting, receiving, storing, confirmation, and financial trading risk management for exchange market transactions in the fields of digital currency,

virtual currency, cryptocurrency, digital and blockchain assets, digitized assets, digital tokens, crypto tokens and utility tokens; platform as a service (PaaS) featuring software platforms for authenticating, facilitating, matching, processing, clearing, storing, receiving, tracking, transferring, and submitting trade data, exchanging of trading transaction details, and management of the overall trading lifecycle; software as a service (SaaS) featuring software platforms for authenticating, facilitating, matching, processing, clearing, storing, receiving, tracking, transferring, and submitting trade data, exchanging of trading transaction details, and management of the overall trading lifecycle; providing software for use with blockchain technology; software as a service (SaaS) services featuring software for clearing, allocation, compliance, recording and settlement of trading related to digital currency, virtual currency, cryptocurrency, digital and blockchain assets, digitized assets, digital tokens, crypto tokens and utility tokens; platform as a service (PaaS) services featuring software for clearing, allocation, compliance, recording and settlement of trading related to digital currency, virtual currency, cryptocurrency, digital and blockchain assets, digitized assets, digital tokens, crypto tokens and utility tokens; platform as a service (PaaS) featuring software platforms for facilitating transactions and payments using digital currency, virtual currency, cryptocurrency, digital and blockchain assets, digitized assets, digital tokens, crypto tokens and utility tokens that allow users to buy from, and sell products and services to others; software as a service (SaaS) featuring software platforms for facilitating transactions and payments using digital currency, virtual currency, cryptocurrency, digital and blockchain assets, digitized assets, digital tokens, crypto tokens and utility tokens that allow users to buy from, and sell products and services to others; design, development, maintenance and hosting of blockchain-based software platforms and distributed computing software platforms for auditing and verifying digital information and codes; design, development and implementation of audit and security software for blockchain-based platforms; providing software for use in facilitating secure transactions; providing software for auditing digital currency, virtual currency, cryptocurrency, digital and blockchain assets, digitized assets, digital tokens, crypto tokens and utility tokens; software platforms for decentralized blockchain style communication; software platforms for the tracking and support of data transactions; design, development, and implementation of software for distributed computing platforms; design, development, and implementation of software for blockchain; design, development, and implementation of software solutions for digital currency security; design, development, and implementation of software for digital currency, virtual currency, cryptocurrency, digital and blockchain asset, digitized asset, digital token, crypto token and utility token wallets; design, development,

and implementation of software for third-party verification services for digital currency transactions, including but not limited to transactions involving bitcoin currency; providing temporary use of non-downloadable software for use in collecting, transferring, receiving, tracking, storing and transferring bitcoin; providing software for use in collecting, transferring, receiving, tracking, storing and transferring peer-to-peer currency; providing software for users to buy and sell products by using digital currency, virtual currency, cryptocurrency, digital and blockchain assets, digitized assets, digital tokens, crypto tokens and utility tokens; providing software platforms for facilitating transactions and payments using digital currency, virtual currency, cryptocurrency, digital and blockchain assets, digitized assets, digital tokens, crypto tokens or utility tokens that allow users to buy from, and sell products and services to others; providing software for use in accessing, reading, tracking, and using blockchain technology; technical and technological consultancy services related to digital currency, virtual currency, cryptocurrency, digital and blockchain asset, digitized asset, digital token, crypto token and utility token financial transactions; platform as a service (PaaS) featuring computer software platforms for computer system and application development, deployment, and management; software as a service (SaaS) featuring computer software platforms for computer system and application development, deployment, and management; providing software enabling users to develop, build and run distributed applications through an open-source peer-to-peer smart-contract and payment network platform; providing cloud-based computer network identification verification, authentication and management services for security purposes; secure hosted management, storage and administration of passwords, credentials and identity information relating to persons, accounts and devices for security purposes; design, development and hosting of software for secure hosted management, storage and administration of passwords, credentials and identity information relating to persons, accounts and devices for security purposes; providing authentication software for controlling access to and communications with computers and computer networks; providing software for use in the exchange of virtual items; providing software for selling, trading and managing blockchain-based tokens or appcoins; providing non-downloadable software for a digital exchange; providing technological services to supply digital exchange services and digital currency exchange services; providing a digital exchange, namely, design, development, maintenance and hosting of websites that features technology that enables the exchange of information and data related to digital currency, virtual currency, cryptocurrency, digital and blockchain asset, digitized asset, digital token, crypto token and utility tokens; providing temporary use of on-line non-downloadable software for use in the exchange of virtual items through

creating, selling, trading and managing blockchain-based tokens and virtual currency for use with a digital exchange; providing temporary use of on-line non-downloadable software for democratically managing digital exchanges for virtual items through smart contracts and distributed ledger technology on digital exchange proposals; design, development, maintenance and hosting of a website that features technology that enables the secure exchange of information by users; design, development, maintenance and hosting of a website for digital exchange services for virtual items; providing non-downloadable software for a digital currency exchange; computer software technical support services for software for a digital currency exchange; computer programming for electronic commerce; providing non-downloadable software featuring technology that enables the exchange of information, data and digital currency; providing software for use in issuing digital currency, virtual currency, cryptocurrency, digital and blockchain assets, digitized assets, digital tokens, crypto tokens and utility tokens; providing cloud-based network identification verification, authentication and management services for security purposes; providing software for managing digital currency, virtual currency, cryptocurrency, digital and blockchain assets, digitized asset, digital token, crypto token and utility token payments, money transfers, and commodity transfers; providing software for facilitating money transfers, electronic funds transfers, commodity transfers, bill payment remittance, and transferring funds between parties; electronic storage services; electronic storage of virtual currency, digital currency and cryptocurrency; providing authentication services for using blockchain-based software technology for cryptocurrency transactions; design, development, maintenance and hosting of a website for connecting sellers with buyers; design, development and hosting of a website featuring an online marketplace for selling and trading virtual goods with other users; electronic data storage services; providing temporary use of on-line non-downloadable software for use in processing and tracking of electronic funds transfers; design, development, maintenance and hosting of a website featuring financial information regarding digital currency, virtual currency, cryptocurrency, digital and blockchain asset, digitized asset, digital token, crypto token and utility token payments; user authentication services using single sign-on technology for online software applications; quality control and authenticating of data via a blockchain; quality control and authenticating of information, messages and data; computer security services in the field of authenticating; quality control and authenticating (control) of data transmitted via telecommunications; providing temporary use of an on-line non-downloadable software for social networking in the field of investments; design, development and hosting of a website featuring information on the development of privacy, security, blockchain and distributed ledger technologies,

and data governance law; providing user authentication services using technology for e-commerce transactions, digital currency payment and exchange transactions, and electronic funds transfer; Blockchain as a Service (Baas).

45 – Providing authentication of personal identification information (identification verification services); online social networking services; online social networking services in the field of investments; user verification services (security services); identification verification services (security services); providing legal information on the development of privacy, security, blockchain and distributed ledger technologies, and data governance law from a website; advice and consultancy, namely, regulatory compliance consultancy in the field of digital currency, virtual currency, cryptocurrency, digital and blockchain asset, digitized asset, digital token, crypto token and utility token applications; legal advice on regulatory compliance in the field of digital currency, virtual currency, cryptocurrency, digital and blockchain asset, digitized asset, digital token, crypto token and utility token applications; online social networking service for investors allowing financial trades and exchange of digital currency, virtual currency, cryptocurrency, digital and blockchain assets, digitized assets, digital tokens, crypto tokens and utility tokens; user authentication and verification services (security services) for payment transactions.

---

(260) AM 2022 114713 A

(800) 1614761

(151) 2021 06 15

(891) 2021 06 15

(731) Havatzelet Cultural & Educational Institutions  
of Hashomer Hatzair  
3785000 Giv'at Haviva, Israel

(540)

## Havatzelet

(591) Black, white

(511)

41 – Organization of activities in the fields of culture, education, science, sports in kibbutzim in Israel and worldwide; providing education and training to beginner artists in the fields of exhibitions and projects to encourage and support young persons in the fields of culture, education, science and sports; organization of cultural activities in the nature of youth movements and summer camps; organizing of community educational and cultural events, such as bar and bat mitzvahs, weddings, training workshops and knowledge development held in community and cultural centers; educational services such as operating kindergartens and schools, all included in this class.

---

(260) AM 2022 114714 A

(800) 1614785

(151) 2021 07 21

(891) 2021 07 21

(731) CEDROB S.A.

Ujazdówek 2A, PL-06-400 Ciechanów, Poland

(540)



(591) Red (PANTONE: 485) and navy blue (PANTONE: 281)

(531) 03.07.03; 03.07.19; 03.07.24; 27.05.17; 29.01.12

(511)

29 – Poultry carcasses; pig carcasses, bovine carcasses; poultry, pork, beef and game meat; poultry, pork, beef and game charcuterie; prepared meals consisting of poultry, pork, beef and game; poultry offal; tinned poultry, pork, beef and game; poultry, pork, beef and game stock; edible eggs; powdered eggs; egg preparations, namely salads made from eggs; egg spreads; game and processed game; meat and meat products; charcuterie; prepared meals consisting primarily of meat and vegetables; frozen meat and vegetables; pastes.

(260) AM 2022 114729 A

(800) 1550934

(151) 2020 07 27

(891) 2021 08 18

(731) GARMONIA, Ltd.

Kamennostrovsky prospect, 37, litera A, pom. 7-N, No538, RU-197022 Saint Petersburg, Russian Federation

(540)

## CHONLUTEN

(591) Black, white

(511)

5 – Dietary supplements; nutritional supplements; dietetic beverages adapted for medical purposes; dietetic foods adapted for medical purposes.

(260) AM 2022 114769 A

(800) 1615388

(151) 2021 03 13

(891) 2021 03 13

(731) Negin Asal Harand Co.

Between Negin Ave. 1&2; Harand Industrial Zone; Isfahan, Islamic Republic of Iran

(540)



(591) Gold, red, white and silver

(531) 01.15.15; 17.02.01; 17.02.02; 25.03.01; 27.05.24; 29.01.14

(526) Asal

(511)

30 – Confectionery; candies; biscuits; cake powder; herbal teas, other than for medicinal use; dates sugar; cakes; Eccles cake; multigrain bread; green tea; sugar cubes; cocoa powder; toffee; wafers; flour; chocolate candies; bread; halva; rice bread; processed cereals; chocolate biscuits; iced cookies; sweetmeats made of sesame oil; lollipops [confectionery]; cooked rice; hot chocolate mixes; coffee; chocolate powder; cookies; herbal honey; tea; fondants [confectionery]; macarons; cocoa-based ingredients for confectionery products; sugar; sauces [condiments]; saffron [seasoning]; rice; cocoa; chocolates; chips [cereal products]; chewing gum; bread crumb; crackers; corn flour; spices; frozen yogurt [confectionery ices]; fruit jellies [confectionery]; honey; processed barley; rusks; crushed oats; almond flavourings, other than essential oils, for foodstuffs; muesli.

35 – Advertising, export agency services relating to confectionery, candies, biscuits, cake powder, herbal teas, other than for medicinal use, dates sugar, cakes, Eccles cake, multigrain bread, green tea, sugar cubes, cocoa powder, toffee, wafers, flour, chocolate candies, bread, halva, rice bread, processed cereals, chocolate biscuits, iced cookies, sweetmeats made of sesame oil, lollipops [confectionery], cooked rice, hot chocolate mixes, coffee, chocolate powder, cookies, herbal honey, tea, fondants [confectionery], macarons, cocoa-based ingredients for confectionery products, sugar, sauces [condiments], saffron [seasoning], rice, cocoa, chocolates, chips [cereal products], chewing gum, bread crumb, crackers, corn flour, spices, frozen yogurt [confectionery ices], fruit jellies [confectionery], honey, barley, rusks, crushed oats, almond flavourings, other than essential oils, for foodstuffs, muesli.

39 – Packaging of confectionery, candies, biscuits, cake powder, herbal teas, other than for medicinal use, dates sugar, cakes, Eccles cake, multigrain bread, green tea, sugar cubes, cocoa powder, toffee, wafers, flour, chocolate candies, bread, halva, rice bread, processed cereals, chocolate biscuits, iced cookies, sweetmeats made of sesame oil, lollipops [confectionery], cooked rice, hot chocolate mixes, coffee, chocolate powder, cookies, herbal honey, tea, fondants [confectionery], macarons, cocoa-based ingredients for confectionery products, sugar, sauces [condiments], saff-



ron [seasoning], rice, cocoa, chocolates, chips [cereal products], chewing gum, bread crumb, crackers, corn flour, spices, frozen yogurt [confectionery ices], fruit jellies [confectionery], honey, barley, rusks, crushed oats, almond flavourings, other than essential oils, for foodstuffs, muesli, delivery of goods.

(260) AM 2022 114830 A

(800) 1616720

(151) 2021 07 15

(891) 2021 07 15

(731) Alcon Inc.

Rue Louis-d'Affry 6, CH-1701 Fribourg,  
Switzerland

(540)

## DRAGONFLY

(591) Black, white

(511)

10 – Surgical apparatus and instruments for ophthalmic surgery.

(260) AM 2022 114831 A

(800) 1616721

(151) 2021 07 13

(891) 2021 07 13

(731) Alcon Inc.

Rue Louis-d'Affry 6, CH-1701 Fribourg,  
Switzerland

(540)

## REVOLUTION

(591) Black, white

(511)

10 – Surgical apparatus and instruments for ophthalmic surgery.

(260) AM 2022 114833 A

(800) 1616747

(151) 2021 08 30

(891) 2021 08 30

(731) FERRERO TRADING LUX S.A.

Route de Trèves 16, L-2633 Senningerberg,  
Luxembourg

(540)

## APPLAYDU

(591) Black, white

(511)

28 – Games; toys; video game apparatus; gymnastic and sporting articles; decorations for christmas trees, except lighting articles and sweets; scale model [toys]; figurines (toys); poseable toy figures (toys); playing cards; construction games; trading cards for games.

30 – Pastry and confectionery; chocolate and chocolate-based confectionery.

(260) AM 2022 114836 A

(800) 1616845

(151) 2021 07 13

(891) 2021 07 13

(731) August Storck KG

Waldstrasse 27, 13403 Berlin, Germany

(540)

## Мамба Парк Развлечений

(591) Black, white

(531) 27.05.01; 28.05

(511)

30 – Confectionery; chocolate; chocolate products; pastries; ice-cream; preparations for making the aforementioned products included in this class.

(260) AM 2022 114964 A

(800) 1619718

(151) 2021 08 30

(891) 2021 08 30

(731) FERRERO TRADING LUX S.A.

Route de Trèves 16, L-2633 Senningerberg,  
Luxembourg

(540)

## APPLAYDU & FRIENDS

(591) Black, white

(511)

9 – Software; downloadable software; applications software for mobile telephony apparatus; downloadable software for playing games; compact discs; dvds and other digital recording media.

28 – Games; toys; video game apparatus; gymnastic and sporting articles; decorations for christmas trees, except lighting articles and sweets; scale model [toys]; figurines (toys); poseable toy figures (toys); playing cards; construction games; trading cards for games.

30 – Pastry and confectionery; chocolate and chocolate-based confectionery.

41 – Education; providing of training; entertainment services; sporting and cultural activities; radio, internet and television entertainment; organization and providing of games and competitions via the internet [entertainment, education and sport]; electronic games services provided by means of the internet or other communication networks; providing of educational material; providing of online information relating to entertainment and/or education; entertainment services provided through a global communication network.

---

**INTERNATIONAL TRADEMARKS PROTECTED IN GEORGIA**

(260) AM 2022 105478 A  
(800) 1493775  
(151) 2019 02 26  
(181) 2029 02 26  
(891) 2019 02 26  
(511) 01, 02, 03, 04, 05, 06, 07, 08, 09, 10, 11, 12, 13,  
14, 15, 16, 17, 18, 19, 20, 21, 22, 23, 24, 25, 26,  
27, 28, 29, 30, 31, 32, 33, 34, 37, 40, 41, 43, 44,  
45

---

(260) AM 2022 107703 A  
(800) 1521895  
(151) 2019 12 17  
(181) 2029 12 17  
(891) 2019 12 17  
(511) 30

---

(260) AM 2022 109343 A  
(800) 920680  
(151) 2006 10 31  
(181) 2026 10 31  
(891) 2020 06 25  
(511) 01, 05, 07, 09, 11, 16, 31

---

(260) AM 2022 110176 A  
(800) 1555923  
(151) 2020 06 17  
(181) 2030 06 17  
(891) 2020 06 17  
(511) 29, 30

---

(260) AM 2022 110311 A  
(800) 1557452  
(151) 2020 09 07  
(181) 2030 09 07  
(891) 2020 09 07  
(511) 29, 29, 30, 31, 31, 32

---

(260) AM 2022 112316 A  
(800) 1582331  
(151) 2021 02 08  
(181) 2031 02 08  
(891) 2021 02 08  
(511) 03

---

(260) AM 2022 112319 A  
(800) 1582371  
(151) 2021 01 29  
(181) 2031 01 29  
(891) 2021 01 29  
(511) 03

---

(260) AM 2022 112326 A  
(800) 1582663  
(151) 2020 06 30  
(181) 2030 06 30  
(891) 2020 06 30  
(511) 11, 35, 37, 40, 41, 42

---

(260) AM 2022 112327 A  
(800) 1582664  
(151) 2021 02 11  
(181) 2031 02 11  
(891) 2021 02 11  
(511) 05

---

(260) AM 2022 112328 A  
(800) 1582665  
(151) 2021 02 11  
(181) 2031 02 11  
(891) 2021 02 11  
(511) 05

---

(260) AM 2022 112329 A  
(800) 1582671  
(151) 2020 12 28  
(181) 2030 12 28  
(891) 2020 12 28  
(511) 20

---

(260) AM 2022 112437 A  
(800) 1583846  
(151) 2020 12 22  
(181) 2030 12 22  
(891) 2020 12 22  
(511) 09, 28, 35, 38, 39, 41, 42, 45

---

(260) AM 2022 112441 A  
(800) 1584158  
(151) 2021 01 04  
(181) 2031 01 04  
(891) 2021 01 04  
(511) 29, 30

---

(260) AM 2022 112448 A  
(800) 1584418  
(151) 2021 03 02  
(181) 2031 03 02  
(891) 2021 03 02  
(511) 30

---

(260) AM 2022 112539 A  
(800) 1585293  
(151) 2020 09 11  
(181) 2030 09 11  
(891) 2020 09 11  
(511) 05

---

(260) AM 2022 112449 A  
(800) 1584459  
(151) 2020 10 20  
(181) 2030 10 20  
(891) 2020 10 20  
(511) 29

---

(260) AM 2022 112540 A  
(800) 1585294  
(151) 2020 09 11  
(181) 2030 09 11  
(891) 2020 09 11  
(511) 05

---

(260) AM 2022 112450 A  
(800) 1584495  
(151) 2021 01 18  
(181) 2031 01 18  
(891) 2021 01 18  
(511) 03

---

(260) AM 2022 112557 A  
(800) 1585632  
(151) 2020 12 07  
(181) 2030 12 07  
(891) 2020 12 07  
(511) 02

---

(260) AM 2022 112512 A  
(800) 1584583  
(151) 2021 02 17  
(181) 2031 02 17  
(891) 2021 02 17  
(511) 03, 04, 05

---

(260) AM 2022 112559 A  
(800) 1585694  
(151) 2021 01 18  
(181) 2031 01 18  
(891) 2021 01 18  
(511) 11

---

(260) AM 2022 112513 A  
(800) 1584617  
(151) 2020 10 20  
(181) 2030 10 20  
(891) 2020 10 20  
(511) 29, 30

---

(260) AM 2022 112560 A  
(800) 1585759  
(151) 2021 01 13  
(181) 2031 01 13  
(891) 2021 01 13  
(511) 35, 39

---

(260) AM 2022 112537 A  
(800) 1585257  
(151) 2021 01 29  
(181) 2031 01 29  
(891) 2021 01 29  
(511) 29

---

(260) AM 2022 112561 A  
(800) 1585761  
(151) 2021 01 27  
(181) 2031 01 27  
(891) 2021 01 27  
(511) 30

---

(260) AM 2022 112538 A  
(800) 1585282  
(151) 2021 01 10  
(181) 2031 01 10  
(891) 2021 01 10  
(511) 29, 30

---

(260) AM 2022 112567 A  
(800) 1237760  
(151) 2014 10 31  
(181) 2024 10 31  
(891) 2020 10 20  
(511) 07

---

(260) AM 2022 112568 A  
(800) 1278045  
(151) 2015 11 09  
(181) 2025 11 09  
(891) 2021 03 22  
(511) 43

---

(260) AM 2022 112569 A  
(800) 1280896  
(151) 2015 11 09  
(181) 2025 11 09  
(891) 2021 03 22  
(511) 43

---

(260) AM 2022 112570 A  
(800) 1407771  
(151) 2017 07 21  
(181) 2027 07 21  
(891) 2020 11 30  
(511) 03, 18, 25, 26

---

(260) AM 2022 112571 A  
(800) 1429077  
(151) 2018 06 24  
(181) 2028 06 24  
(891) 2021 03 25  
(511) 29, 30, 35, 43

---

(260) AM 2022 112630 A  
(800) 1585931  
(151) 2021 02 15  
(181) 2031 02 15  
(891) 2021 02 15  
(511) 03

---

(260) AM 2022 112631 A  
(800) 1585934  
(151) 2021 02 15  
(181) 2031 02 15  
(891) 2021 02 15  
(511) 03

---

(260) AM 2022 112747 A  
(800) 1587413  
(151) 2021 02 12  
(181) 2031 02 12  
(891) 2021 02 12  
(511) 29

---

(260) AM 2022 112748 A  
(800) 1587459  
(151) 2021 02 11  
(181) 2031 02 11  
(891) 2021 02 11  
(511) 18, 25

---

(260) AM 2022 112751 A  
(800) 1587622  
(151) 2020 12 30  
(181) 2030 12 30  
(891) 2020 12 30  
(511) 05

---

(260) AM 2022 112759 A  
(800) 1587664  
(151) 2021 01 06  
(181) 2031 01 06  
(891) 2021 01 06  
(511) 12, 35, 36, 37, 39

---

(260) AM 2022 112760 A  
(800) 1587669  
(151) 2021 02 09  
(181) 2031 02 09  
(891) 2021 02 09  
(511) 34

---

(260) AM 2022 112761 A  
(800) 1587692  
(151) 2020 12 30  
(181) 2030 12 30  
(891) 2020 12 30  
(511) 05

---

(260) AM 2022 112762 A  
(800) 1587707  
(151) 2021 01 06  
(181) 2031 01 06  
(891) 2021 01 06  
(511) 12, 35, 36, 37, 39

---

(260) AM 2022 112763 A  
(800) 1587769  
(151) 2021 03 24  
(181) 2031 03 24  
(891) 2021 03 24  
(511) 43

---

(260) AM 2022 112764 A  
(800) 1587786  
(151) 2020 07 01  
(181) 2030 07 01  
(891) 2020 07 01  
(511) 05, 07, 08, 16, 21

---

(260) AM 2022 112810 A  
(800) 1588445  
(151) 2021 01 29  
(181) 2031 01 29  
(891) 2021 01 29  
(511) 29

---

(260) AM 2022 112772 A  
(800) 1587891  
(151) 2020 12 30  
(181) 2030 12 30  
(891) 2020 12 30  
(511) 05

---

(260) AM 2022 112811 A  
(800) 1588550  
(151) 2020 11 26  
(181) 2030 11 26  
(891) 2020 11 26  
(511) 17, 19

---

(260) AM 2022 112773 A  
(800) 1587901  
(151) 2021 01 14  
(181) 2031 01 14  
(891) 2021 01 14  
(511) 09

---

(260) AM 2022 112878 A  
(800) 1589820  
(151) 2021 02 18  
(181) 2031 02 18  
(891) 2021 02 18  
(511) 29, 30, 41

---

(260) AM 2022 112774 A  
(800) 1587907  
(151) 2021 02 11  
(181) 2031 02 11  
(891) 2021 02 11  
(511) 05, 30, 32

---

(260) AM 2022 112982 A  
(800) 1591070  
(151) 2021 03 01  
(181) 2031 03 01  
(891) 2021 03 01  
(511) 29, 30, 41

---

(260) AM 2022 112775 A  
(800) 1587924  
(151) 2020 11 17  
(181) 2030 11 17  
(891) 2020 11 17  
(511) 07, 08

---

(260) AM 2022 112776 A  
(800) 1587925  
(151) 2021 02 02  
(181) 2031 02 02  
(891) 2021 02 02  
(511) 10

---

(260) AM 2022 112809 A  
(800) 1588443  
(151) 2020 12 10  
(181) 2030 12 10  
(891) 2020 12 10  
(511) 09, 16, 35, 38, 41

---

---

# APPELLATIONS OF ORIGIN OF GOODS

## WINE SPECIFICATIONS

### ZEGAANI

In accordance with the Article 8.4 of the Law on Appellations of Origin and Geographical Indications, the LEPL National Intellectual Property Centre of Georgia – SAKPATENTI publishes the materials represented by the N(N)LE Zegaani.

If no additional information will be arrived to SAKPATENTI within 3 months after publication, the information shall be submitted into the State Register of Appellations of Origin and Geographical Indications, and published in the Official Bulletin of Industrial Property of Georgia.

If, within 3 months after the publication of application materials, additional information regarding these materials is submitted to Sakpatenti, it shall be sent to the Ministry of Environmental Protection and Agriculture of Georgia for the review.

**APPLICATION №** 3510/6

**DATE OF APPLICATION:** 2021 26 08

**APPELLATION OF ORIGIN:** ZEGAANI

**NAME OF PRODUCT FOR WHICH THE REGISTRATION IS REQUIRED** – Wine

**NAME AND ADDRESS OF APPLICANT:** N(N)LE Zegaani; Village Zegaani, Gurjaani Region, Georgia

**1. NAME:** Zegaani

**2. ADDITIONAL SIGNS**

**3. TYPE, COLOR, AND BASIC REQUIREMENTS**

"Zegaani" is red dry qvevri bio-wine, and it shall to satisfy the following requirements:

- Color – dark pomegranate (dark red);
- Aroma and taste – full, velvet, having bouquet of spices (black pepper and cloves), balanced tannins, and tones of blackberry, black currant, and dry fruits (black plum);
- Volumetric spirit content – no less than 12 %;
- Concentration of finished extract mass – no less than 24 g/l;
- Sugar content – no more than 4 g/l;
- Titrated/Volatile acidity – no less than 5 g/l;
- Total mass concentration of sulfur dioxide – no more than 80,0 mg/l;
- Iron mass concentration – no more than 10 mg/l;
- Copper mass concentration – no more than 2 mg/l.

**4. SPECIFIC ZONE AVAILABLE AREAS:**

The micro-zone Zegaani includes directly the village Zegaani and lands surrounding it. The micro-zone is located on the North-Eastern slope of Gombori Range. It is bordered by Chermiskhevi from the North and North-East, the village Akhasheni – from the East and South-East, the village Akhasheni and Navistskali Gorge – from the South, and Gombori Range – from the West.

The lands disposed on Papriskhevi Valley belong to the microzone Zegaani, as well; and Cadaster Codes thereof are: 51.08.13.641; 51.08.63.005; 51.08.63.009; 51.08.63.010; 51.08.63.023; 51.08.63.032; 51.08.63.047; 51.08.63.055; 51.08.63.105; 51.058.63.114.

## **5. GRAPE VARIETIES**

The wine Zegaani shall be produced only with the grapes of vine Saperavi cultivated in the micro-zone Zegaani, usage of other varieties is prohibited.

## **6. VINEYARD CULTIVATION, SHAPE OF PRUNING, AND CARE:**

- Micro-zone Zegaani vineyards are situated on 400 -550 m above sea level.
- Density between the rows in the vineyards – 1-2.4 m;
- Density between the vines in the row – 1.0-1.5 m;
- Height of Stem – 70-90 cm;
- Shape of Pruning – one-sided or Georgian two-sided or free.

## **7. GRAPE RIPENESS, VINTAGE, TRANSPORTATION**

- Sugar content intended for wine "Zegaani" production shall be no less than 21%, at the vintage;
- Grapes transportation is permitted only with wooden or plastic boxes, with bodyworks made of stainless steel or painted with special color;
- Usage of polyethylene packages and/or begs is not allowed;
- The grapes shall be protected from dirtying at the transportation.

## **8. VINTAGE AND WINE HARVEST:**

Vintage on 1 ha vineyard shall be no more than 10 tons;

Wine harvest shall be no more than:

- 650 l – from 1 ton grapes;
- 6500 l – from 1 ha vineyard.

## **9. GRAPE PROCESSING, WINEMAKING AND BOTTLING:**

Grapes for producing the wine "Zegaani" shall be only from the vineyards cultivated in the micro-zone Zegaani. The time from vintage to crushing should not exceed 3 hours;

The wine "Zegaani" is made by complete alcoholic fermentation of must in the qvevri;

Only operations, materials and substances provided by the "Technical Regulations on the Definition of General Rules of Wine Production, Permitted Processes, Materials and List of Substances" of the Georgian Legislation №524 of 6.11.2018 is permissible to be applied at the production of the wine "Zegaani".

"Zegaani" is made by incomplete alcoholic fermentation of wild must.

The wine is aged in the qvevri for at least 20 months after its whole alcoholic fermentation, and then, it may be removed from the must – chacha;

Zegaani shall be represented on consumer market only packed in the consumer vessels.

Grapes processing, winemaking, and bottling shall be provided exclusively inside of the micro-zone Zegaani.

## **10. LINK BETWEEN EXCLUSIVE QUALITY, REPUTATION AND GEOGRAPHICAL AREA:**

**Climate** - the climate in the micro-zone is moderately humid, with hot summer and moderately cold winter. The formation of weather in the micro-zone is caused by atmospheric processes developed in

subtropical and moderate areas, and moved from the East and West longitudes. Air annual regular temperature is 12.5°C; at the warmest months – July, August – 23,7–23,5°C , and at the coldest – January – +1,1°C.

Sum of annual temperatures is 4120-3440°C.

Temperature stabile regular gradation up to 10°C begins in the first decade of April, in 5-50 cm soil depth.

First autumn frosts are expected at the end of November (November 27), and the last spring frosts – at March 24, in the micro-zone.

Saperavi buds blossom begins in mid-April, flowering – in late May, and grapes technical ripeness – in the second half of August.

The height of sun from the horizon varies between 70-600, during grape seed formation period, and 50-400 during grape ripening period for Zegaani latitude creating effective radiation regime for the vine on slight (2-3°) slopes inclined towards the North-East.

Sunshine annual duration ranges from 2150-2200 hours, and constitutes 1600 hours – during the vegetation period, in the micro-zone Zegaani. Annual value of total radiation is not higher than 130 kcal/cm<sup>2</sup>, and in the vegetation period it is in the range of 95-100 kcal/cm<sup>2</sup>. Annual direct radiation on horizontal surface is 75 kcal/cm<sup>2</sup>, while scattered radiation is 54 kcal/cm<sup>2</sup>.

### **Soil**

Area is distinguished with brown carbonate soils; agro-characteristics whereof encourage high quality wine production.

Depth of soil is between 80-100 cm. Humus content in soil upper layers is average (4-5%), and decreases sharply into the depth down to 1.4-1.6%. Humus layer general thickness is 40-50 cm. Soil solution reaction is alkaline and very alkaline (8.4-8.7). The soil belongs to light clays with the accumulation of clay in the middle of profile. The soil is strong carbonate from the surface (11-13%), middle part and bottom of profile are very strong carbonate (35-50%). Soil surface is mostly leptosol decreasing towards the depth, and mainly it is presented as fine gravel (pebbles). As a regard of nutrient content the soil is poor with nitrogen and phosphorus available for the plant, but rich with potassium.

The vineyards in the microzone are cultivated on carbonate and clay soils, and in the combination with the mesoclimate it is very favorable for viticulture, and gives the wine special taste and complexity. Warm days and cool nights contribute sharp increase of sugar concentration in the autumn.

Sunshine significant duration in vegetation period (1600 days), and fairly high rate of sum of active temperatures (over 4000 g) ensure must good maturation, so important for this type of wine.

### **Human Factor**

Viticulture and winemaking exist in the micro-zone Zegaani from ancient times. At the beginning of the 19<sup>th</sup> century, the estate of Aleksandre Chavchavadze became prominent here, being notable for significant capital investments and advanced technologies.

In the second half of the 19<sup>th</sup> century, the abolition of serfdom gave powerful impetus to the development of this field and economy, in general. Unpaid laborers were replaced with hired workers, the backward and undeveloped area was quickly engaged in common capitalist relationship, and the process of creation of capitalist-farming households began.



These processes became more tangible for viticulture and winemaking from the 1880s, when the Princes Estates Department massively purchased Kakhetian nobles' estates, including Mukuzani and Zegaani, and rapidly began to modernize vineyards and cellars.

Said processes were further strengthened from the 1920s, when Georgian scientific centers started functioning in Tbilisi and Telavi. New vineyards were cultivated with grafted saplings and wineries equipped with modern technique were built in Mukuzani and Zegaani, and new technologies were introduced.

During all this time, such outstanding professionals<sup>1</sup> as – G. Gogol-Yanovsky, Merle Antoine Mason, Vladimir Staroselsky, Ovcharenko, A. Tushmalishvili, Z. Jorjadze, A. Egorov, S. Cholokashvili, K. Modebadze, G. Beridze, G. Zardiashvili, M. Vardanashvili, V. Shavgulidze and others worked in this field, engaged in scientific activities, were developing and perfecting new technologies, introducing them in production and creating new wines.

So, geographical location of micro-zone Zegaani, distinctive regional climate: mild winter and hot summer, moderate amount of precipitations, diversity of soils, special features of harvested Saperavi grape variety, characteristic of this zone, and local, centuries-old tradition of viticulture and winemaking provides unique organoleptic features of wine "Zegaani", characterizing only this wine.

#### **11. ESPECIAL LABELING RULES:**

The name shall appear on the label, packaging, wine accompanying documents and advertising materials as follows:

In Georgian Character - ზეგაანი  
დაცული ადგილწარმოშობის დასახელება

In Latin Character – **ZEGAANI**  
Protected Designation of Origin and/or PDO

In Cyrillic Character – **ЗЕГААНИ**  
Защищённое наименование места происхождения

#### **12. ACCOUNTING AND NOTIFICATION**

Accounting and notification of production and storage technological processes of wine "Zegaani" is carried out, in accordance with the Rule on "Registration and Reporting of Technological Processes in Viticulture and Winemaking Practice" established with the Order №2-78 of 24.01.2019 made by the Ministry of Agriculture of Georgia.

<sup>1</sup>Bondo Kalandadze – "Georgian Wine History", p. 50.

**13. MAIN CONTROLLABLE POINTS:**

During control of the PDO wine "Zegaani" production process the producer shall satisfy the requirements established by LEPL – National Wine Agency, and shall comply with the following parameters:

| Main Controllable Points  | Evaluation Methods   |
|---|--|
| Vineyard location   | Cadaster map, control on the place   |
| Area  | Vineyard accounting magazine, cadaster   |
| Vine variety  | Vineyard accounting journal, control on the place  |
| Cultivation methods   | Journal of registration of Agrotechnical Measures, treating journal, control on the place  |
| Vintage and transportation  | Vintage journal  |
| Grape harvest per ha  | Vintage journal  |
| Grape harvest in total  | Vintage journal  |
| Grape processing and winemaking   | Grape receiving journal, grape processing journal, product turnover calculation journal, laboratory analysis journals, notifications, control on the place |
| Wine bottling, packaging and storage place and conditions                             | Bottling journal, journal for motion of ready product in the storehouse, laboratory analysis journals  |
| Physico-chemical characteristics of the wine at winemaking, before and after bottling | Laboratory analysis journals   |
| Organoleptic characteristics of the wine  | Tasting commission protocols   |
| Traceability  | Technological and laboratory Records   |

**14. CONTROL BODY OF PRODUCTION:**

State control for observance of production specification and lawful usage of the appellation of origin PDO shall be carried out by LEPL – National Wine Agency, according to the rules established by the legislation of Georgia.

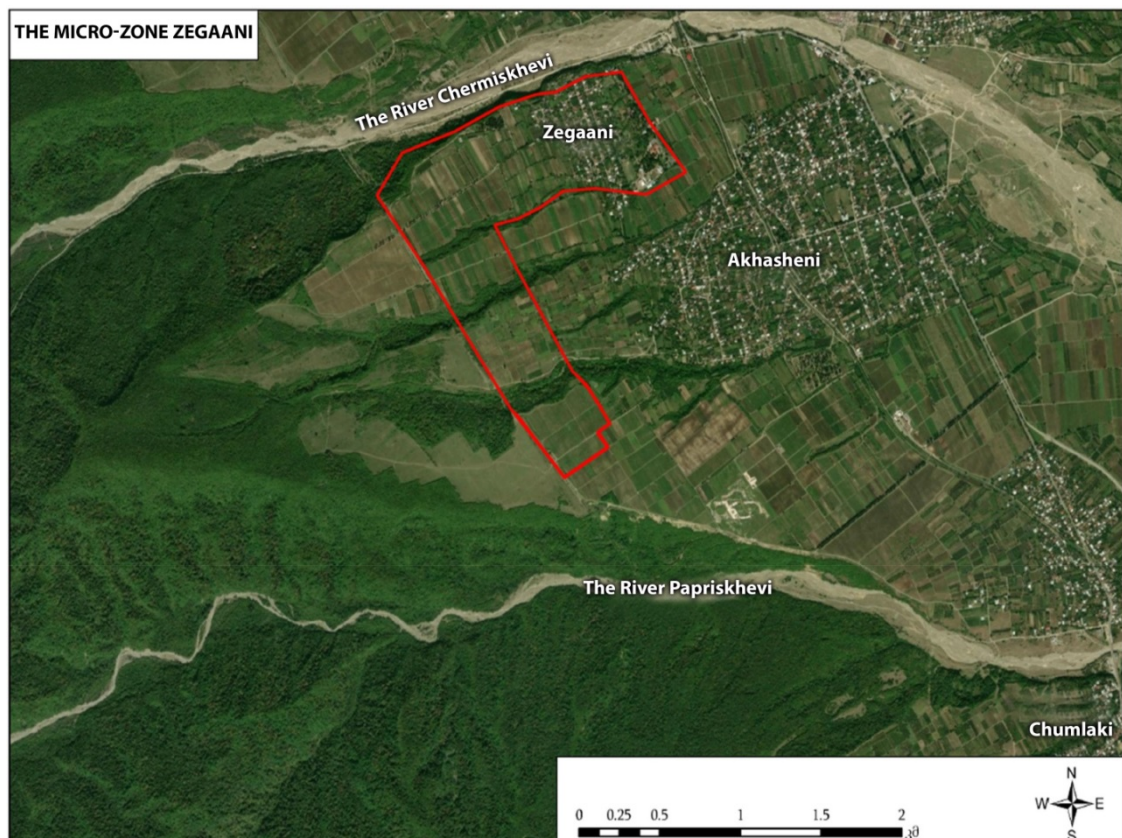

## OKURESHIS USAKHELOURI

**APPLICATION №** 3512/6

**DATE OF APPLICATION:** 2021 20 09

**APPELLATION OF ORIGIN:** OKURESHIS USAKHELOURI

**NAME OF PRODUCT FOR WHICH THE REGISTRATION IS REQUIRED –** Wine

**NAME AND ADDRESS OF APPLICANT:** Usakhelouri Vine & Wine Protection Association, Tsageri Municipality, Village Okureshi, Georgia

**1. NAME:** OKURESHIS USAKHELOURI

**2. ADDITIONAL SIGNS**

**3. TYPE, COLOR, AND BASIC REQUIREMENTS**

"Okureshis Usakhelouri" is red wine; according to sugar content it can be of three different categories: dry, naturally semi-dry or naturally semi-sweet.

Wine organoleptic and physico-chemical characteristics shall to satisfy the following requirements:

- Color – dark cherish red;
- Aroma and taste – tones of peeled red plum and red currant, taste full and cheerful sour, containing rounded, well-balanced tannins;
- Volumetric spirit content for dry wine – no less than 13.5 %, for semi-dry and semi-sweet wines – no less than 11.0 %;
- Sugar content in dry wine – no more than 4 g/l, for semi-dry – 4-18 g/l, and for semi-sweet – 18-45 g/l;
- Titrated acidity – no less than 5 g/l;
- Volatile acidity – no more than 1.2 g/l;
- Total mass concentration of sulfur dioxide in dry wine – no more than 150,0 mg/l, in semi-dry and semi-sweet wines – no more than 200,0 mg/l;
- Sugarless extract mass concentration – no less than 22 g/l.

**4. SPECIFIC ZONE AVAILABLE AREAS**

The micro-zone Okureshis Usakhelouri is situated in Racha-Lechkhumi region, Tsageri administrative municipality, includes the villages: Tskhenistskali: Zubi, Isunderi, Okureshi, Opitara, Ladzgeria, and Makhura disposed on the slopes of right and left banks of the River, on 350-650 m above sea level. The River Tskhenistskali is protected by Khvamli mountain massif from the North and East, and by Askhi – from the West.

The border of micro-zone "Okureshis Usakhelouri" from the West of village Okureshi, where is a confluence of the rivers Tskhenistskali and Lashkodia continues to the East, then – to the North, longwise, dividing line of upper and lower Okureshi, on 650 m altitude; then, it turns on the North-Eastern Tskhakuri and joins Zubi-Khvamli Road, after that it continues along the road, at first to the North, then – to the North-West, until Tskhenistskali bridge, then – to the North, until a confluence of rivers Tskhenistskali and Kvereshula.

Then it continues to the West of river Kvereshula until a mark of 650 m, surrounds the village Opitara at an altitude of 650 m to the East and North, and continues to the River Tskhenistskali; then it follows the

river to the North direction until its confluence with the River Lashkodia; then, the border continues towards the River Kvereshula West direction, until the mark of 650 m, therefrom turns to the South and passes the territories of villages: Zubi, Isunderi, Makhuri, and Ladzgeria, on 650 m altitude; then, turns to the East until the confluence of rivers Tskhenistskali and Cheula, follows the River Cheula East direction, until the mark of 650 m, bypasses the village Opitara from the East and North, on 650 m altitude, and passes to the River Tskhenistskali; then, follows the River Tskhenistskali towards the North direction, until its confluence with the River Lashkodia.

## **5. GRAPE VARIETIES**

Okureshis Usakhelouri shall be produced only with the grapes of vine Usakhelouri cultivated in the micro-zone Okureshis Usakhelouri, usage of other varieties is prohibited.

## **6. VINEYARD CULTIVATION, SHAPE OF PRUNING, AND CARE:**

- Micro-zone Okureshis Usakhelouri for wine "Okureshis Usakhelouri" vineyards are situated on 350-650 m above sea level.
- Density between the rows in the vineyards – 1.3-2.35 m;
- Density between the vines in the row – 0.8-1.4 m;
- Height of Stem – 50-80 cm;
- Shape of Pruning – one-sided or Georgian two-sided or free.

## **7. GRAPE RIPENESS, VINTAGE, TRANSPORTATION**

Okureshis Usakhelouri shall be produced only with ripe grapes. Sugar content intended for winemaking shall be no less than 23%, at the vintage;

- Grapes transportation is permitted only with wooden or plastic boxes, with bodyworks made of stainless steel or painted with special color;
- Usage of polyethylene packages and/or begs is not allowed;
- The grapes shall be protected from dirtying at the transportation.

## **8. VINTAGE AND WINE HARVEST:**

Vintage on 1 ha vineyard shall be no more than 10 tons;

Wine harvest shall be no more than:

- 650 l – from 1 ton grapes;
- 3900 l – from 1 ha vineyard.

## **9. GRAPE PROCESSING, WINEMAKING AND BOTTLING:**

Grapes for producing the wine "Okureshis Usakhelouri" shall be only from the vineyards cultivated in the micro-zone Okureshis Usakhelouri.

The wine "Okureshis Usakhelouri" is made by complete or incomplete alcoholic fermentation of wild must.

Only operations, materials and substances provided by the "Technical Regulations on the Definition of General Rules of Wine Production, Permitted Processes, Materials and List of Substances" of the Georgian Legislation №524 of 6.11.2018 is permissible to be applied at the production of the wine Okureshis Usakhelouri.

Grapes processing and winemaking shall be provided exclusively inside of the micro-zone Okureshis Usakhelouri, and bottling – outside too, but only inside of territory of Georgia.

Grape withdrawal from the micro-zone within the territory of region for grape processing, and wine withdrawal from the region for bottling is permitted under strict accounting and control conditions.

Okureshis Usakhelouri shall be represented on consumer market only packed in the consumer vessels.

## **10. LINK BETWEEN EXCLUSIVE QUALITY, REPUTATION AND GEOGRAPHICAL AREA:**

### **Climate**

The micro-zone "Okureshis Usakhelouri" is a kind of hollow surrounded by rocky ridges creating a special microclimate characterized with humidity – moderately cold winter and long warm summer.

Sunshine annual duration ranges within 1900-2000 hours. Regular air annual temperature is 14.2°C, at the warmest month – August – 22.2°C, and at the coldest – January – no less than +0.5°C.

Duration of vegetation period is 181 days.

Sum of active temperatures rises up to 3500-3700°C, in average. Sum of annual precipitations is 1095 mm.

According to the granulometric composition, the soils belong to heavy loam and light clays. Soils are variously leptosol; at that, soils developed on limestone are characterized with high intensity of leptosol, while low-leptosol and non-leptosol soils are found mostly on the marls.

Vineyards South, South-Eastern and South-Western exposure in the micro-zone, big amount of sunny days, balanced with precipitations, July and August high temperatures, and hot days and cool nights variation, in September and October contribute sharp increase of sugar concentration in the grapes, which is significant factor for the production of this type of wine (vintage takes place at no less than 23% sugar content conditions).

### **Soil**

All above mentioned in combination with loamy and leptosol humus-carbonate soils causes grapes best ripening with the balance of acidity and sugar content, and the accumulation of polyphenols. Anthocyanins, polyphenols and sugar give wine its balance and complexity.

Lechkhumi is considered as one of the best viticulture and winemaking region in Georgia. According with some historical sources, we can conclude that these fields of agriculture play an important role in economic life of this region, since ancient times. This is substantial with the diversity of local vine varieties, and the abundance of winemaking products prepared by the local residents using different methods, as well.

### **Human Factor**

Well-known Georgian scientists – Niko Ketskhoveli, Maksime Ramishvili and Dimitri Tabidze, in ampelography of 1960, confirm the opinion of great Ivane Javakhishvili that Usakhelouri originates from local cultural vine varieties, and its name originates from Lechkhumi, the village Usakhelo disposed on the right bank of the River Lajanuri.

Production of Usakhelouri – wonderful semi-sweet wine on industrial scale, was able after of famous events of 1942, and technology development and implementation for naturally semi-sweet wines preparation.

The wine "Usakhelouri" has received 5 awards, including 2 gold medals, in various international competitions, in second half of the 19<sup>th</sup> century<sup>2</sup>.

Raw material base smallness, and great popularity of wine contribute its exceptionally high market value.

---

<sup>2</sup> Bondo Kalandadze "Samtresti & Samtrestelebi", p. 111.

**11. ESPECIAL LABELING RULES:**

The name shall appear on the label, packaging, wine accompanying documents and advertising materials as follows:

In Georgian Character – **ოქურეშის უსახელოური**  
დაცული ადგილწარმოშობის დასახელება

In Latin Character – **OKURESHIS USAKHELOURI**  
Protected Designation of Origin and/or PDO

In Cyrillic Character – **ОКУРЕШИС УСАХЕЛОУРИ**  
Защищённое наименование места происхождения

**12. ACCOUNTING AND NOTIFICATION**

Accounting and notification of production and storage technological processes of wine "Okureshis Usakhelouri" is carried out, in accordance with the Rule on "Registration and Reporting of Technological Processes in Viticulture and Winemaking Practice" established with the Order №2-78 of 24.01.2019 made by the Ministry of Agriculture of Georgia.

**13. MAIN CONTROLLABLE POINTS:**

During control of the PDO wine "Okureshis Usakhelouri" production process the producer shall satisfy the requirements established by LEPL – National Wine Agency, and shall comply with the following parameters:

| <b>Main Controllable Points</b>   | <b>Evaluation Methods</b>  |
|---|--|
| Vineyard location   | Cadaster map, control on the place   |
| Area  | Vineyard accounting magazine, cadaster   |
| Vine variety  | Vineyard accounting journal, control on the place  |
| Cultivation methods   | Journal of registration of Agrotechnical Measures, treating journal, control on the place  |
| Vintage and transportation  | Vintage journal  |
| Grape harvest per ha  | Vintage journal  |
| Grape harvest in total  | Vintage journal  |
| Grape processing and winemaking   | Grape receiving journal, grape processing journal, product turnover calculation journal, laboratory analysis journals, notifications, control on the place |
| Wine bottling, packaging and storage place and conditions                             | Bottling journal, journal for motion of ready product in the storehouse, laboratory analysis journals  |
| Physico-chemical characteristics of the wine at winemaking, before and after bottling | Laboratory analysis journals   |
| Organoleptic characteristics of the wine  | Tasting commission protocols   |
| Traceability  | Technological and laboratory Records   |

**14. CONTROL BODY OF PRODUCTION:**

State control for observance of production specification and lawful usage of the appellation of origin PDO shall be carried out by LEPL – National Wine Agency, according to the rules established by the legislation of Georgia.

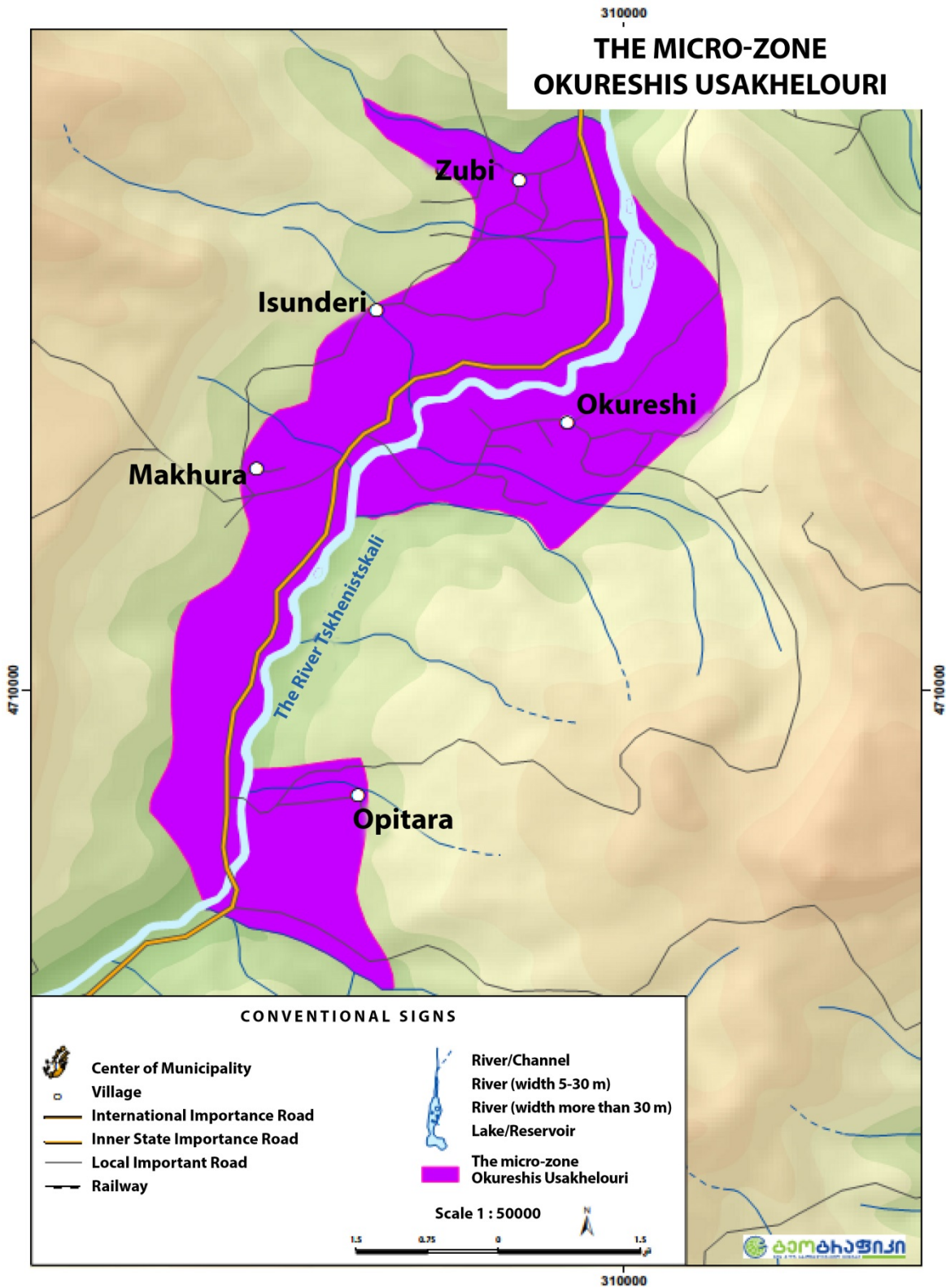

---

**OFFICIAL NOTIFICATIONS  
INVENTIONS  
RESTORATION OF PATENTS**

(21) AP 2007 10194  
(11) P 2012 5430 B  
(73) Ramzan Goitemirov  
(54) INTERNAL COMBUSTION ENGINE  
DATE OF PATENT CANCELLATION: 2021 07 25  
DATE OF PATENT RESTORATION: 2022 05 10

---

(21) AP 2009 11992  
(11) P 2012 5666 B  
(73) Merck Sharp & Dohme Corp.  
(54) HYDROXYMETHYL PYRROLIDINES AS  $\beta$ 3 ADRENERGIC RECEPTOR AGONISTS  
DATE OF PATENT CANCELLATION: 2022 04 02  
DATE OF PATENT RESTORATION: 2022 05 10

---

(21) AP 2011 13092  
(11) P 2015 6303 B  
(73) Reforcetech LTD  
(54) REINFORCEMENT BAR AND METHOD FOR MANUFACTURING SAME  
DATE OF PATENT CANCELLATION: 2021 10 21  
DATE OF PATENT RESTORATION: 2022 05 10

---

(21) AP 2014 14012  
(11) P 2019 6996 B  
(73) BIO.LO.GA. S.R.L.  
(54) SHEET FOR CUTANEOUS APPLICATION CONTAINING VITAMIN E OR AN ESTER THEREOF  
DATE OF PATENT CANCELLATION: 2022 04 11  
DATE OF PATENT RESTORATION: 2022 05 10

---

(21) AP 2017 14914  
(11) P 2022 7339 B  
(73) Loxo Oncology Inc.  
(54) LIQUID FORMULATIONS OF (S)-N-(5-((R)-2-(2,5-DIFLUOROPHENYL)-PYRROLIDIN-1-YL)-  
PYRAZOLO[1,5-A] PYRIMIDIN-3-YL)-3-HYDRO-XYPYRROLIDINE-1-CARBOXAMIDE  
DATE OF PATENT CANCELLATION: 2022 04 04  
DATE OF PATENT RESTORATION: 2022 05 10

---



## ABOLITION OF PATENTS WITH THE RIGHT TO RESTORE

(21) AP 2009 12000  
(11) P 2014 6060 B  
(73) Genentech Inc.;  
Qiuris Inc.  
(54) PYRIDYL INHIBITORS OF HEDGEHOG SIGNALLING  
DATE OF PATENT CANCELLATION: 2022 04 10  
LIMITED DATE OF PATENT RESTORATION: 2023 04 10

---

(21) AP 2014 14012  
(11) P 2019 6996 B  
(73) BIO.LO.GA. S.R.L.  
(54) SHEET FOR CUTANEOUS APPLICATION CONTAINING VITAMIN E OR AN ESTER THEREOF  
DATE OF PATENT CANCELLATION: 2022 04 11  
LIMITED DATE OF PATENT RESTORATION: 2024 04 11

---

(21) AP 2016 14605  
(11) P 2020 7063 B  
(73) Ille Papier-Service GMBH  
(54) TOILET-PAPER-ROLL HOLDER  
DATE OF PATENT CANCELLATION: 2022 04 13  
LIMITED DATE OF PATENT RESTORATION: 2023 04 13

---

(21) AP 2018 14758  
(11) P 2020 7065 B  
(73) Giorgi Topuria  
(54) ONLINE BACKGAMMON VIDEO WITH ROLLING DICES FOR PAIR OF GAMERS  
PARTICIPATION; VIDEO WITH METHOD FOR DOMINOES KNUCKLES AND  
PLAYING CARDS CHANGING AND BRIBING IN ONLINE DOMINOES AND  
CARD GAMES  
DATE OF PATENT CANCELLATION: 2022 04 13  
LIMITED DATE OF PATENT RESTORATION: 2023 04 13

---

(21) AP 2017 14901  
(11) P 2020 7057 B  
(73) H. Lundbeck A/S  
(54) 1,5-DIHYDRO-4H-PYRAZOLO[3,4-D] PYRIMIDIN-4-ONES AND 1,5-DIHYDRO-4H-PYRAZO-  
LO[4,3-C] PYRIDIN-4-ONES AS PDE1 INHIBITORS  
DATE OF PATENT CANCELLATION: 2022 04 07  
LIMITED DATE OF PATENT RESTORATION: 2023 04 07

---

(21) AP 2019 15049  
(11) P 2021 7237 B  
(73) LEPL "Raphael Dvali Institute of Machine Mechanics"  
(54) TRANSVERSE SCREW ROLLING MILL WORKING CELL  
DATE OF PATENT CANCELLATION: 2022 04 18  
LIMITED DATE OF PATENT RESTORATION: 2023 04 18

---

(21) AP 2019 15052  
(11) P 2021 7209 B  
(73) Nugzar Abzhandadze  
(54) DEVICE FOR DANCING FOUNTAIN JETS CONTROL  
DATE OF PATENT CANCELLATION: 2022 04 19  
LIMITED DATE OF PATENT RESTORATION: 2023 04 19

---

(21) AP 1998 5034  
(11) P 2003 3002 B  
(73) Amgen Inc.  
(54) OSTEOPROTEGERIN BINDING PROTEIN AND RECEPTORS  
DATE OF PATENT CANCELLATION: 2022 04 15  
LIMITED DATE OF PATENT RESTORATION: 2023 04 15

---

## EXPIRATION OF TERMS OF RESTORATION OF PATENTS

(21) AP 2009 12006  
(11) P 2013 5856 B  
(73) Sunrise R&D Holdings LLC  
(54) SYSTEMS FOR STORE ASSOCIATE MANAGEMENT THEREIN  
DATE OF PATENT CANCELLATION: 2021 04 22  
DATE OF PATENT RESTORATION VALIDITY HAS EXPIRED: 2022 04 22

---

(21) AP 2011 12890  
(11) P 2014 6203 B  
(73) Pristec AG  
(54) METHOD FOR THE TREATMENT OF LIQUID, IN PARTICULAR MINERAL OIL  
DATE OF PATENT CANCELLATION: 2021 04 14  
DATE OF PATENT RESTORATION VALIDITY HAS EXPIRED: 2022 04 14

---

(21) AP 2017 14467  
(11) P 2018 6889 B  
(73) Georgian Technology University  
(54) DEVICE CONTROLLING AND SIGNALING LEAK OF NATURAL GAS  
DATE OF PATENT CANCELLATION: 2021 04 05  
DATE OF PATENT RESTORATION VALIDITY HAS EXPIRED: 2022 04 05

---

(21) AP 2017 14469  
(11) P 2018 6845 B  
(73) David Chachanidze;  
Teimuraz Ghoghoberidze;  
Nino Kuntseva-Gabashvili;  
Tsovinar Nazarova  
(54) REMEDY AGAINST BEE NOZEMATOSIS  
DATE OF PATENT CANCELLATION: 2021 04 07  
DATE OF PATENT RESTORATION VALIDITY HAS EXPIRED: 2022 04 07

---

(21) AP 2018 14757  
(11) P 2019 7027 B  
(73) Georgian Technical University;  
Giorgi Mghebrishvili;  
Gregory Moiseev;  
Nikoloz Mghebrishvili  
(54) SYSTEM FOR INDICATION OF WEAR WEIGHTS OF MOBILE TRAINS AND RAILS  
DATE OF PATENT CANCELLATION: 2021 04 13  
DATE OF PATENT RESTORATION VALIDITY HAS EXPIRED: 2022 04 13

---

## EXPIRATION OF TERMS OF PATENT

(21) AP 2002 7177  
(11) P 2005 3712 B  
(73) Pfizer Products Inc.  
(54) TARTRATE SALTS OF 5,8,14-TRIAZATETRACYCLO {10.3.1.0<sup>2</sup>,11.04,9}-HEXADECA-  
2(11),3,5,7,9-  
PENTAENE AND PHARMACEUTICAL COMPOSITIONS THEREOF  
DATE OF PATENT EXPIRATION: 26 04 2022

---

## CHANGES OF NAMES AND/OR ADDRESSES OF PATENTOWNERS

(21) AP 2014 13898  
(11) P 2017 6769 B  
(54) COMPOSITION OF TIACUMICIN COMPOUNDS  
NEW NAME AND ADDRESS: Tillotts Pharma AG (CH)  
Baslerstrasse 15, CH-431-0 Rheinfelden, Switzerland (CH)  
FORMER NAME AND ADDRESS: Astellas Pharma Europe LTD  
2000 Hillswood Drive Chertsey, Surrey KT16 ORS, United  
Kingdom (UK)  
DATE OF REGISTRATION: 2022 04 29

---

(21) AP 2015 14327  
(11) P 2018 6872 B  
(54) TREATMENT REGIMEN TIACUMICIN COMPOUND  
NEW NAME AND ADDRESS: Tillotts Pharma AG (CH)  
Baslerstrasse 15, CH-431-0 Rheinfelden, Switzerland (CH)  
FORMER NAME AND ADDRESS: Astellas Pharma Europe LTD  
2000 Hillswood Drive Chertsey, Surrey KT16 ORS, United  
Kingdom (UK)  
DATE OF REGISTRATION: 2022 04 29

---



## UTILITY MODELS

### ABOLITION OF PATENTS WITH THE RIGHT TO RESTORE

(21) AU 2018 14765  
(11) U 2019 2013 Y  
(73) Lali Ghurchumelia  
(54) FIRE EXTINGUISHING POWDER  
DATE OF PATENT CANCELLATION: 2022 04 24  
LIMITED DATE OF PATENT RESTORATION: 2023 04 24

---

(21) AU 2020 15312  
(11) U 2020 2063 Y  
(73) Davit Mizandari  
(54) PROTECTING BREATHING DEVICE  
DATE OF PATENT CANCELLATION: 2022 04 14  
LIMITED DATE OF PATENT RESTORATION: 2023 04 14

---

## DESIGNS

### EXTENSION OF TERMS OF DESIGN REGISTRATION

(11) D 2017 713 S  
(73) Saba Rukhadze (GE)  
Gldani Massive, IV mcr., bld. 110a, app. 30, 0167, Tbilisi, Georgia (GE);  
Aleksandre Bitchiashvili (GE)  
Gldani Massive, IV mcr., bld. 110a, app. 30, 0167, Tbilisi, Georgia (GE);  
(54) BOTTLE WITH HUMAN FIGURE INSIDE  
(28) 2  
(24) 2017 05 19  
(18) 2027 05 19  
(58) 2022 04 27

---

### CANCELLATION OF DESIGN REGISTRATION

(11) D 2017 707 S  
(73) LTD "Eco Build Georgia" (GE)  
Shalva Nutsubidze Str. 221, bld. 1, app. 28, 0186, Tbilisi, Georgia (GE)  
(54) BUILDING BLOCK  
(18) 2021 10 07  
(58) 2022 04 21

---

## EXTENSION OF TERMS OF INTERNATIONAL DESIGNS REGISTRATION

(11) DM/68663  
(73) THE SWATCH GROUP MANAGEMENT SERVICES AG (THE SWATCH GROUP MANAGEMENT SERVICES SA) (THE SWATCH GROUP MANAGEMENT SERVICES LTD)  
Seevorstadt 6, CH-2502 Biel/Bienne (CH)  
(15) 2007 03 22  
(24) 2007 03 22  
(18) 2027 03 22  
(28) 6  
(28') 2  
(54) Wristwatches

---

(11) DM/68714  
(73) HENKEL KOMMANDITGESELLSCHAFT AUF AKTIEN  
Henkelstraße 67, 40589 Düsseldorf (DE)  
(15) 2007 03 22  
(24) 2007 03 22  
(18) 2027 03 22  
(28) 7  
(28') 7  
(54) Detergents tablets

---

(11) DM/68776  
(73) OMEGA SA (OMEGA AG) (OMEGA LTD.)  
Jakob-Stämpfli-Strasse 96, CH-2502 Biel/Bienne (CH)  
(15) 2007 04 03  
(24) 2007 04 03  
(18) 2027 04 03  
(28) 5  
(28') 5  
(54) 1.-5. Jewelry, Particularly Pendants (1, 2, 3), Ring (4), Earrings (5)

---

(11) DM/68819  
(73) RIMADESIO S.P.A  
Via Furlanelli, 96, I-20034 Giussano (Milano) (IT) G.B. STUDIO DI GIUSEPPE BAVUSO & C. S.A.S,  
Iazza Concordia, 18, I-20038 Seregno (Milano) (IT)  
(15) 2007 04 12  
(24) 2007 04 12  
(18) 2027 04 12  
(28) 1  
(28') 1  
(54) Handle

---

(11) DM/68823  
(73) ROLEX SA  
Rue François-Dussaud 3-5-7, CH-1211 Genève 26 (CH)  
(15) 2007 04 13  
(24) 2007 04 13  
(18) 2027 04 13  
(28) 8  
(28') 8  
(54) Watch Bezels, Watch Dials, Watches

---

(11) DM/68824  
(73) ROLEX SA  
3-5-7, Rue François-Dussaud, CH-1211 GENEVE 26 (CH)  
(15) 2007 04 13  
(24) 2007 04 13  
(18) 2027 04 13  
(28) 10  
(28') 10  
(54) 1.-4. Watches,5.-8. watch bezels,9.-10. watch dials

---

(11) DM/68900  
(73) BRAUN GMBH  
Frankfurter Strasse 145, 61476 Kronberg (DE)  
(15) 2007 04 30  
(24) 2007 04 30  
(18) 2027 04 30  
(28) 1  
(28') 1  
(54) Epilator

---

(11) DM/69123  
(73) FRANCISCO FERNANDEZ IGLESIAS  
Polígono de Balagón s/n, E-33211 GIJON (ASTURIAS) (ES)  
(15) 2007 04 16  
(24) 2007 04 16  
(18) 2027 04 16  
(28) 14  
(28') 14  
(54) Closing Devices for Door and/or Window Sashes, Wall Coverings

---

(11) DM/78089  
(73) INDUSTRIE DE NORA S.P.A.  
Via Bistolfi, 35, I-20134 Milano (IT)  
(15) 2012 03 30  
(24) 2012 03 30  
(18) 2027 03 30  
(28) 1  
(28') 1  
(54) Disinfection apparatus

---

(11) DM/78195  
(73) SEAT S.A.  
Autovía A-2, Km. 585, E-08760 Martorell (Barcelona) (ES)  
(15) 2012 03 08  
(24) 2012 03 08  
(18) 2027 03 08  
(28) 2  
(28') 2  
(54) Automobile vehicles

---

(11) DM/93880  
(73) ZDRAVKO ŠPIRIĆ  
Šaljapinova 2, 21000 Novi Sad (RS)  
(15) 2016 09 15  
(24) 2016 09 15

---

(18) 2026 09 15  
(28) 2  
(28') 2  
(54) Launchers for anti-hail rockets with a protective container

---

(11) DM/95262  
(73) QATAR AIRWAYS Q.C.S.C.  
Qatar Airways Tower Airport Road, PO Box 22550, Doha (QA)  
(15) 2017 03 06  
(24) 2017 03 06  
(18) 2027 03 06  
(28) 5  
(28') 5  
(54) Aircraft furniture

---

(11) DM/95747  
(73) ETA SA MANUFACTURE HORLOGÈRE SUISSE  
Schild-Rust-Strasse 17, CH-2540 Grenchen (CH)  
(15) 2017 04 13  
(24) 2017 04 13  
(18) 2027 04 13  
(28) 6  
(28') 6  
(54) Wristwatches

---

(11) DM/96079  
(73) PROSTORIA D.O.O.  
Pustodol Zacretski 19 G, HR-49223 Sveti Kriz Zacretje (HR)  
(15) 2017 04 04  
(24) 2017 04 04  
(18) 2027 04 04  
(28) 3  
(28') 3  
(54) Armchairs

---

(11) DM/96997  
(73) ANTSY LABS LLC  
Dacono CO 80514 (US)  
(15) 2017 03 23  
(24) 2017 03 23  
(18) 2027 03 23  
(28) 1  
(28') 1  
(54) Toy

---

(11) DM/97902  
(73) SOLIDUS VENTURES GMBH  
Ruetistrasse 16, CH-8952 Schlieren (CH)  
(15) 2017 04 11  
(24) 2017 04 11  
(18) 2027 04 11  
(28) 2

---



(28') 2

(54) Display panel or portion thereof with a graphical user interface

---

(11) DM/98518

(73) SEAT, S.A.

Autovía A-2, Km. 585, E-08760 Martorell (Barcelona) (ES)

(15) 2017 06 27

(24) 2017 06 27

(18) 2027 06 27

(28) 36

(28') 36

(54) 1. Automobile; 2.-3. Vehicle rims; 4. Rear bumper; 5. Complete front bumper; 6. Front bumper;  
7.-8. Front grilles; 9. Complete rear bumper; 10 Rear bumper; 11. Complete rear bumper; 12. Rear bumper;  
13.-15. Front bumpers; 16. Complete front bumper; 17. Front grille; 18. Rear trim; 19.-20. Rear bumpers;  
21.-28. Vehicle rims; 29. Hubcap for vehicles; 30.-31. Front bumpers; 32. Complete front bumper;  
33.-34. Front grilles; 35.-36. Rear bumpers

---

**TRADEMARKS****EXTENSION OF TERMS OF TRADEMARKS REGISTRATION**

---

(111) M 2002 14242 R2

(156) 2002 01 08

(186) 2032 01 08

(732) Aktsionernoje Obshchestvo "Nizhegorodsky  
Khimiko-farmatsevtichesky Zavod"  
Salganskaya str. N7, GSP-459 Nizhny  
Novgorod, 603600, Russian Federation

---

(111) M 2002 14436 R2

(156) 2002 05 01

(186) 2032 05 01

(732) Amgen Inc.  
One Amgen Center Drive, Thousand Oaks,  
California 91320-1789, USA

---

(111) M 2002 14450 R2

(156) 2002 05 24

(186) 2032 05 24

(732) YKK Corporation, a Japanese Corporation  
1, Kanda Izumi-cho, Chiyoda-ku, Tokyo,  
Japan

---

(111) M 2002 14483 R2

(156) 2002 05 24

(186) 2032 05 24

(732) Akzo Nobel Coatings International B.V.  
Velperweg 76, 6824 BM Arnhem, Netherlands

---

(111) M 2002 14484 R2

(156) 2002 05 24

(186) 2032 05 24

(732) Akzo Nobel Coatings International B.V.  
Velperweg 76, 6824 BM Arnhem, Netherlands

---

(111) M 2002 14628 R2

(156) 2002 09 13

(186) 2032 09 13

(732) Glaxosmithkline Biologicals S.A.  
Rue de l'Institut 89, B-1330 Rixensart,  
Belgium

---

(111) M 2011 21877 R1

(156) 2011 10 17

(186) 2031 10 17

(732) Rotapharm Limited  
Commonwealth Trust Limited, Drake  
Chambers, Tortola, Virgin Islands (British)

---

(111) M 2012 22206 R1

(156) 2012 01 18

(186) 2032 01 18

(732) Rotapharm Limited  
Commonwealth Trust Limited, Drake  
Chambers, Tortola, Virgin Islands (British)

---

(111) M 2012 22504 R1

(156) 2012 04 25

(186) 2032 04 25

(732) Donald J. Trump  
725 Fifth Avenue New-York New-York  
10022, USA

---

(111) M 2012 22454 R1

(156) 2012 04 05

(186) 2032 04 05

(732) Rotapharm Limited  
Commonwealth Trust Limited, Drake  
Chambers, Tortola, Virgin Islands (British)

---

(111) M 2012 22568 R1

(156) 2012 04 30

(186) 2032 04 30

(732) LTD "Dugladze Wine Company"  
Akhvlediani Str., Lane 8, Orkhevi, 0109,  
Tbilisi, Georgia

---

(111) M 2012 22631 R1

(156) 2012 05 16

(186) 2032 05 16

(732) Hongta Tobacco (Group) Co., Ltd.  
N118, Hongta Avenue, Hongta District,  
Yuxi, Yunnan, China

---

(111) M 2012 22573 R1

(156) 2012 04 30

(186) 2032 04 30

(732) Monster Energy Company, a Delaware  
Corporation  
1 Monster Way, Corona, California  
92879, USA

---

(111) M 2012 22673 R1  
(156) 2012 06 07  
(186) 2032 06 07  
(732) Basf Agrochemical Products B.V.  
Groningensingel 1, EA Arnhem, Netherlands

---

(111) M 2012 22786 R1  
(156) 2012 07 13  
(186) 2032 07 13  
(732) 3M Company, a corporation of the State of  
Delaware  
3M Center, 2501 Hudson Road, St. Paul,  
Minnesota 55144, USA

---

(111) M 2012 22734 R1  
(156) 2012 07 02  
(186) 2032 07 02  
(732) Rotapharm Limited  
Commonwealth Trust Limited, Drake  
Chambers, Tortola, Virgin Islands (British)

---

(111) M 2012 22799 R1  
(156) 2012 07 13  
(186) 2032 07 13  
(732) 3M Company, a corporation of the State of  
Delaware  
3M Center, 2501 Hudson Road, St. Paul,  
Minnesota 55144, USA

---

(111) M 2012 23018 R1  
(156) 2012 10 09  
(186) 2032 10 09  
(732) Stiefel Laboratories, Inc.  
Corporation Service Company, 251 Little  
Falls Drive, Wilmington, Delaware  
19808, USA

---

(111) M 2012 22583 R1  
(156) 2012 05 11  
(186) 2032 05 11  
(732) LTD "Oxigen"  
Vazha-Pshaela Ave., III qu., bld. 21, app. 1,  
Vake District, Tbilisi, Georgia

---

(111) M 2012 22651 R1  
(156) 2012 05 23  
(186) 2032 05 23  
(732) J.S.S. Tobacco Ltd  
Suite 404, Albany House, 324/326 Regent  
Street, London W1B 3HH, United Kingdom

---

## COMPLETE TRANSFER OF RIGHTS

(111) M 1999 13061 R  
(732) Delphi Technologies IP Limited, a Barbados  
Company  
The Grove, 21 Pine Road, Belleville,  
St. Michael BB11113, Barbados  
(770) Delphi Technologies, LLC  
5725 Delphi Drive, City of Troy,  
State of Michigan 48098, USA  
(580) 2022 04 04

---

(111) M 2000 13542 R  
(732) Delphi Technologies IP Limited, a Barbados  
Company  
The Grove, 21 Pine Road, Belleville,  
St. Michael BB11113, Barbados  
(770) Delphi Technologies, LLC  
5725 Delphi Drive, City of Troy,  
State of Michigan 48098, USA  
(580) 2022 04 04

---

(111) M 2001 13863 R  
(732) Delphi Technologies IP Limited, a Barbados  
company  
The Grove, 21 Pine Road, Belleville,  
St. Michael BB11113, Barbados  
(770) Delphi Technologies, LLC  
5725 Delphi Drive, Troy, Michigan  
48098-2815, USA  
(580) 2022 04 04

---

(111) M 2012 22583 R  
(732) LTD "Oxigen"  
Vazha-Pshaela Ave., III qu., bld. 21, app. 1,  
Vake District, Tbilisi, Georgia  
(770) LTD "Siesta"  
San-Zona 18v, app. 30, 0141, Tbilisi, Georgia  
(580) 2022 04 04

---

(111) M 2014 25250 R  
(732) LTD "Mtechnix"  
Parsadani Str. 7, Vill. Dighomi, Tbilisi,  
Georgia  
(770) შპს "მეგაქსი MEGAX"  
Ts. Dadiani Str. 34, bld. 12, app. 46, 0180,  
Tbilisi, Georgia  
(580) 2022 04 21

---

## CHANGES OF NAMES AND/OR ADDRESSES OF TRADEMARKS OWNERS

(111) M 2019 31878 R  
 (732) Meta Platforms Inc. (a Delaware corporation)  
 1601 Willow Road, Menlo Park, CA 94025, USA  
 (770) Facebook Inc. (a Delaware corporation)  
 1601 Willow Road, Menlo Park, CA 94025, USA  
 (580) 2022 04 29

(111) M 2019 32032 R  
 (732) Meta Platforms Inc. (a Delaware corporation)  
 1601 Willow Road, Menlo Park, CA 94025, USA  
 (770) Facebook Inc. (a Delaware corporation)  
 1601 Willow Road, Menlo Park, CA 94025, USA  
 (580) 2022 04 29

(111) M 2020 32537 R  
 (732) Diageo Scotland Limited  
 11 Lochside Place, Edinburgh, Scotland  
 EN12 9HA, United Kingdom  
 (770) Diageo Scotland Limited  
 Edinburgh Park, 5 Lochside Way, Edinburgh  
 EH12 9DT Scotland, United Kingdom  
 (580) 2022 04 20

(111) M 1999 13061 R  
 (732) Delphi Technologies LLC  
 5725 Delphi Drive, City of Troy, State of Michigan 48098, USA  
 (770) Delphi Technologies, Inc.  
 5725 Delphi Drive, City of Troy, State of Michigan 48098, USA  
 (580) 2022 04 04

(111) M 1999 13062 R  
 (732) Delphi Technologies IP Limited,  
 a Barbados Company  
 The Grove, 21 Pine Road, Belleville,  
 St. Michael BB11113, Barbados  
 (770) Delphi Technologies IP Limited, a Barbados Company  
 Erin Court, Bishop's Court Hill,  
 St. Michael, Barbados  
 (580) 2022 04 06

(111) M 2000 13542 R  
 (732) Delphi Technologies LLC  
 5725 Delphi Drive, City of Troy,  
 State of Michigan 48098, USA  
 (770) Delphi Technologies Inc.  
 5725 Delphi Drive, City of Troy,  
 State of Michigan 48098, USA  
 (580) 2022 04 04

(111) M 2000 13618 R  
 (732) Delphi Technologies IP Limited, a Barbados Company  
 The Grove, 21 Pine Road, Belleville,  
 St. Michael BB11113, Barbados  
 (770) Delphi Technologies IP Limited, a Barbados Company  
 Erin Court, Bishop's Court Hill,  
 St. Michael, Barbados  
 (580) 2022 04 06

(111) M 2001 13863 R  
 (732) Delphi Technologies LLC  
 5725 Delphi Drive, Troy,  
 Michigan 48098-2815, USA  
 (770) Delphi Technologies Inc., a Delaware Corporation  
 5725 Delphi Drive, Troy, Michigan  
 48098-2815, USA  
 (580) 2022 04 04

(111) M 2005 16364 R  
 (732) Diageo Scotland Limited  
 11 Lochside Place, Edinburgh, Scotland  
 EN12 9HA, United Kingdom  
 (770) Diageo Scotland Limited  
 Edinburgh Park, 5 Lochside Way, Edinburgh,  
 EH12 9DT, Scotland, United Kingdom  
 (580) 2022 04 20

(111) M 1994 67 R  
 (732) Diageo Scotland Limited  
 11 Lochside Place, Edinburgh, Scotland  
 EN12 9HA, United Kingdom  
 (770) Diageo Scotland Limited  
 Edinburgh Park, 5 Lochside Way, Edinburgh  
 EH12 9DT, Scotland, United Kingdom  
 (580) 2022 04 20

(111) M 1998 9287 R  
 (732) Diageo Scotland Limited  
 11 Lochside Place, Edinburgh, Scotland  
 EN12 9HA, United Kingdom  
 (770) Diageo Scotland Limited  
 Edinburgh Park, 5 Lochside Way, Edinburgh  
 EH12 9DT Scotland, United Kingdom  
 (580) 2022 04 20

---

(111) M 2011 21620 R  
 (732) Diageo Scotland Limited  
 11 Lochside Place, Edinburgh, Scotland  
 EN12 9HA, United Kingdom  
 (770) Diageo Scotland Limited  
 Edinburgh Park, 5 Lochside Way,  
 Edinburgh, EH12 9DT Scotland,  
 United Kingdom  
 (580) 2022 04 20

---

(111) M 1997 7340 R  
 (732) Diageo Scotland Limited  
 11 Lochside Place, Edinburgh, Scotland  
 EN12 9HA, United Kingdom  
 (770) Diageo Scotland Limited  
 Edinburgh Park, 5 Lochside Way, Edinburgh  
 EH12 9DT Scotland, United Kingdom  
 (580) 2022 04 20

---

(111) M 2016 27532 R  
 (732) Scholl's Wellness Company Limited  
 2 Arlington Square, Downshire Way,  
 Bracknell, Berkshire, RG12 1WA,  
 United Kingdom  
 (770) Saturn Newco Limited  
 103-105 Bath Road, Slough, Berkshire,  
 SL1 3UH, United Kingdom  
 (580) 2022 04 11

---

(111) M 2016 27598 R  
 (732) Scholl's Wellness Company Limited  
 2 Arlington Square, Downshire Way,  
 Bracknell, Berkshire, RG12 1WA,  
 United Kingdom  
 (770) Saturn Newco Limited  
 103-105 Bath Road, Slough, Berkshire,  
 SL1 3UH, United Kingdom  
 (580) 2022 04 15

---

(111) M 2016 27599 R  
 (732) Scholl's Wellness Company Limited  
 2 Arlington Square, Downshire Way,  
 Bracknell, Berkshire, RG12 1WA,  
 United Kingdom  
 (770) Saturn Newco Limited

103-105 Bath Road, Slough, Berkshire,  
 SL1 3UH, United Kingdom  
 (580) 2022 04 15

---

(111) M 2016 27600 R  
 (732) Scholl's Wellness Company Limited  
 2 Arlington Square, Downshire Way,  
 Bracknell, Berkshire, RG12 1WA,  
 United Kingdom  
 (770) Saturn Newco Limited  
 103-105 Bas Roud, Slau, Berkshiri,  
 SL1 3UH, United Kingdom  
 (580) 2022 04 15

---

(111) M 2016 27601 R  
 (732) Scholl's Wellness Company Limited  
 2 Arlington Square, Downshire Way,  
 Bracknell, Berkshire, RG12 1WA,  
 United Kingdom  
 (770) Saturn Newco Limited  
 103-105 Bath Road, Slough, Berkshire,  
 SL1 3UH, United Kingdom  
 (580) 2022 04 11

---

(111) M 2016 27690 R  
 (732) Scholl's Wellness Company Limited  
 2 Arlington Square, Downshire Way,  
 Bracknell, Berkshire, RG12 1WA,  
 United Kingdom  
 (770) Saturn Newco Limited  
 103-105 Bath Road, Slough, Berkshire,  
 SL1 3UH, United Kingdom  
 (580) 2022 04 15

---

(111) M 2017 28202 R  
 (732) Meta Platforms Inc. (a Delaware  
 corporation)  
 1601 Willow Road, Menlo Park,  
 CA 94025, USA  
 (770) Facebook, Inc.  
 1601 Willow Road, Menlo Park,  
 CA 94025, USA  
 (580) 2022 04 29

---

(111) M 2018 29731 R  
 (732) Diageo Scotland Limited  
 11 Lochside Place, Edinburgh, Scotland  
 EN12 9HA, United Kingdom  
 (770) Diageo Scotland Limited  
 Edinburgh Park, 5 Lochside Way,  
 Edinburgh EH12 9DT Scotland,  
 United Kingdom  
 (580) 2022 04 20

---

(111) M 2019 31338 R  
(732) Meta Platforms, Inc. (a Delaware corporation)  
1601 Willow Road, Menlo Park,  
CA 94025, USA  
(770) Facebook, Inc. (a Delaware corporation)  
1601 Willow Road, Menlo Park,  
CA 94025, USA  
(580) 2022 04 29

---

(111) M 2019 31341 R  
(732) Meta Platforms, Inc. (a Delaware corporation)  
1601 Willow Road, Menlo Park,  
CA 94025, USA  
(770) Feisbuq, Ink. (delaveris Korporacia)  
1601 Willow Road, Menlo Park,  
CA 94025, USA  
(580) 2022 04 29

---

## CANCELLATION OF TRADEMARKS REGISTRATION

(111) M 2001 14075 R  
(151) 2001 10 18  
(732) LG Chem Ltd  
128, Yeoui-doero, Yeongdeungpo-gu, Seoul,  
Republic of Korea  
(141) 2022 04 27

---

(111) M 2001 14099 R  
(151) 2001 10 18  
(732) Wizard Co., Inc.  
6 Sylvan Way, Parsippany, New Jersey  
07054, USA  
(141) 2022 04 27

---

(111) M 2001 14082 R  
(151) 2001 10 18  
(732) Pfizer Products Inc. a Connecticut Corporation  
Eastern Point Road, Groton, Connecticut  
06340, USA  
(141) 2022 04 27

---

(111) M 2001 14101 R  
(151) 2001 10 18  
(732) Novartis International Pharmaceutical Ltd  
Horst Holme, 12 Trott Road, P.O. Box  
HM LX, Bermuda  
(141) 2022 04 27

---

(111) M 2001 14087 R  
(151) 2001 10 18  
(732) Colgate-Palmolive Company  
300 Park Avenue, New York,  
NY 10022, USA  
(141) 2022 04 27

---

(111) M 2011 21858 R  
(151) 2011 10 17  
(732) JSC "B G Capital"  
Ilia Chavchavadze Ave. 74A, 0162, Tbilisi,  
Georgia  
(141) 2022 04 27

---

(111) M 2001 14100 R  
(151) 2001 10 18  
(732) The Procter & Gamble Company  
One Procter & Gamble Plaza, Cincinnati,  
Ohio, USA  
(141) 2022 04 27

---

(111) M 2011 21838 R  
(151) 2011 10 12  
(732) Swiss Pharma International AG  
Waldmannstrasse 8, 8001 Zurich,  
Switzerland  
(141) 2022 04 20

---

(111) M 2011 21861 R  
 (151) 2011 10 17  
 (732) "Rusnavgeoset" Limited Liability  
 Company ("Rusnavgeoset" Llc)  
 Baumanskaya Str. 53, 105005, Moscow,  
 Russian Federation  
 (141) 2022 04 27

---

(111) M 2011 21863 R  
 (151) 2011 10 17  
 (732) LTD "Go Electronix"  
 Tevdore Mghvdeli Str. 7, 0102, Tbilisi,  
 Georgia  
 (141) 2022 04 27

---

(111) M 2011 21855 R  
 (151) 2011 10 12  
 (732) Himalaya Global Holdings Ltd.  
 Himalaya House, 138 Elgin Avenue,  
 P.O. Box 1162, Grand Cayman, Cayman  
 Islands  
 (141) 2022 04 20

---

(111) M 2011 21870 R  
 (151) 2011 10 17  
 (732) Thuraya Telecommunications Company  
 Etisalat Toweri, Sheikh Rashid Bin saeed  
 Al Maktoum street, Abu-Dhabi, United  
 Arab Emirates  
 (141) 2022 04 27

---

(111) M 2011 21874 R  
 (151) 2011 10 17  
 (732) JSC "Teliani Valley"  
 Tbilisi Highway 3, 2200, Telavi, Georgia  
 (141) 2022 04 27

---

(111) M 2011 21875 R  
 (151) 2011 10 17  
 (732) LTD "Georgian Vessels"  
 Aerodrome Settlement 7, app. 6, 0182, Tbilisi,  
 Georgia;  
 Nana Lomtadze  
 V. Kupradze Str. 52, 4600, Kutaisi, Georgia  
 (141) 2022 04 27

---

(111) M 2011 21879 R  
 (151) 2011 10 17  
 (732) Tariel Giorgobiani  
 Otar Chechelashvili Str. 20, 4600, Kutaisi,  
 Georgia  
 (141) 2022 04 27

---

(111) M 2011 21880 R  
 (151) 2011 10 17  
 (732) LTD ABC Pharmacy  
 Sanapiro Str. 10a, 0108, Tbilisi, Georgia  
 (141) 2022 04 27

---

(111) M 2011 21881 R  
 (151) 2011 10 17  
 (732) LTD "Zhorzholian Trading"  
 Zhiuli Shartava Str. 43, 0160, Tbilisi, Georgia  
 (141) 2022 04 27

---

(111) M 2011 21882 R  
 (151) 2011 10 17  
 (732) Fawaz Abdulaziz Alhokair  
 Alhokair building, 2nd Floor, Opposite  
 Shumeisi Central Hospital Square, Riyadh  
 11411, Saudi Arabia;  
 George Wiliam Davies  
 Unit 8, Snowhill Hill, Moreton-in-Marsh,  
 Gloucester, Gloucestershire, GL56 9TL,  
 United Kingdom  
 (141) 2022 04 27

---

(111) M 2011 21883 R  
 (151) 2011 10 17  
 (732) Fawaz Abdulaziz Alhokair  
 Alhokair building, 2nd Floor, Opposite  
 Shumeisi Central Hospital Square, Riyadh  
 11411, Saudi Arabia;  
 George Wiliam Davies  
 Unit 8, Snowhill Hill, Moreton-in-Marsh,  
 Gloucester, Gloucestershire, GL56 9TL,  
 United Kingdom  
 (141) 2022 04 27

---

(111) M 2011 21884 R  
 (151) 2011 10 17  
 (732) Genzyme Corporation (a Massachusetts  
 Corporation)  
 500 Kendall Street, Cambridge, Massachusetts  
 02142, USA  
 (141) 2022 04 27

---

(111) M 2011 21886 R  
 (151) 2011 10 17  
 (732) Genzyme Corporation (a Massachusetts  
 Corporation)  
 50 Kendall Street, Cambridge, Massachusetts  
 02142, USA  
 (141) 2022 04 27

---



(111) M 2011 21887 R  
(151) 2011 10 17  
(732) Genzyme Corporation (a Massachusetts Corporation)  
50 Kendall Street, Cambridge, Massachusetts  
02142, USA  
(141) 2022 04 27

---

(111) M 2011 21889 R  
(151) 2011 10 17  
(732) Genzyme Corporation (a Massachusetts Corporation)  
50 Kendall Street, Cambridge, Massachusetts  
02142, USA  
(141) 2022 04 27

---

(111) M 2011 21890 R  
(151) 2011 10 17  
(732) Genzyme Corporation (a Massachusetts Corporation)  
50 Kendall Street, Cambridge, Massachusetts  
02142, USA  
(141) 2022 04 27

---

(111) M 2011 21891 R  
(151) 2011 10 17  
(732) Genzyme Corporation (a Massachusetts Corporation)  
50 Kendall Street, Cambridge, Massachusetts  
02142, USA  
(141) 2022 04 27

---

(111) M 2011 21892 R  
(151) 2011 10 17  
(732) Genzyme Corporation  
(a Massachusetts Corporation)  
50 Binney Street, Cambridge, Massachusetts  
02142, USA  
(141) 2022 04 27

---

(111) M 2011 21893 R  
(151) 2011 10 17  
(732) Baxter International Inc.  
One Baxter Parkway, Deerfield,  
IL 60015, USA  
(141) 2022 04 27

---

(111) M 2011 21894 R  
(151) 2011 10 17  
(732) Alcon Inc.  
Rue Louis-d'Affry 6, CH-1701 Fribourg,  
Switzerland  
(141) 2022 04 27

---

(111) M 2011 21897 R  
(151) 2011 10 20  
(732) Everest Cold Storage Limited  
4110 Yonge street, Suite 620, Toronto,  
ON M2P 2B7, Canada  
(141) 2022 05 02

---

(111) M 2011 21898 R  
(151) 2011 10 20  
(732) Gallaher Limited  
Members Hill, Brooklands Road, Weybridge,  
Surrey KT13 0QU, United Kingdom  
(141) 2022 04 28

---

(111) M 2011 21899 R  
(151) 2011 10 20  
(732) Gallaher Limited  
Members Hill, Brooklands Road, Weybridge,  
Surrey KT13 0QU, United Kingdom  
(141) 2022 05 02

---

(111) M 2011 21857 R  
(151) 2011 10 12  
(732) Harrington Development Inc.  
Elvira Mendez Street, Vallarino bldg.,  
3rd Floor, Panama, Republic of Panama  
(141) 2022 04 20

---

(111) M 2011 21896 R  
(151) 2011 10 18  
(732) Harrington Development Inc.  
Arango-Orillac Bldg. East 54 th street,  
Republic of Panama  
(141) 2022 04 27

---

(111) M 2011 21895 R  
(151) 2011 10 17  
(732) Japan Tobacco Inc.  
2-2-1, Toranomoni, Minato-ku, Japan  
(141) 2022 04 27

---

(111) M 2011 21832 R  
(151) 2011 10 12  
(732) LTD "Tbilisi Divani"  
G. Tabidze Str. 3/5, 0108, Tbilisi, Georgia  
(141) 2022 04 20

---

(111) M 2011 21833 R  
(151) 2011 10 12  
(732) LTD "Zadeni"  
Gorgasali Street Lane and Krtsanisi Street

---

(plot 19/38), 0105, Old Tbilisi District, Tbilisi,  
Georgia  
(141) 2022 04 20

---

(111) M 2011 21834 R  
(151) 2011 10 12  
(732) Gigla Tumanishvili  
Likhauri Str. 11, 0171, Tbilisi, Georgia  
(141) 2022 04 20

---

(111) M 2011 21835 R  
(151) 2011 10 12  
(732) LTD "Black C Sat"  
Tergi Str. 9, 0179, Tbilisi, Georgia  
(141) 2022 04 20

---

(111) M 2011 21836 R  
(151) 2011 10 12  
(732) LTD "Black C Sat"  
Tergi Str. 9, 0179, Tbilisi, Georgia  
(141) 2022 04 20

---

(111) M 2011 21904 R  
(151) 2011 10 21  
(732) LTD "Group Gelvins"  
Rustaveli Str. 8, 5400, Tskaltubo, Georgia  
(141) 2022 04 29

---

(111) M 2011 21900 R  
(151) 2011 10 21  
(732) LTD "Zadeni"  
Gorgasali Street Lane and Krtsanisi Street  
(plot 19/38), 0105, Old Tbilisi District, Tbilisi,  
Georgia  
(141) 2022 04 29

---

(111) M 2011 21901 R  
(151) 2011 10 21  
(732) Harrington Development Inc.  
Elvira Mendez Street, Vallarino bldg.,  
3rd Floor, Panama, Republic of Panama  
(141) 2022 04 29



---

(111) M 2011 21902 R  
(151) 2011 10 21  
(732) Harrington Development Inc.  
Elvira Mendez Street, Vallarino bldg.,  
3rd Floor, Panama, Republic of Panama  
(141) 2022 04 29

---

## CORRECTION OF PUBLISHED INFORMATION

Bulletin №7(586) 2022 04 11

| APPLICATION №<br>(260) | Pg. | COLOMN | WAS PUBLISHED  | FULL DATA   |
|------------------------|-----|--------|--|---|
| AM 2022 114592 A       | 32  | I      | (260) AM 2022 114592 A<br>(210) AM 114592<br>(220) 2021 09 10<br>(731) Nicholas Jonathan Michael Mompiau<br>116 Rezydencia Les Sabletes-28800 Mohamedia-Maroko, France<br>(740) Konstantine Chokoraia<br>(540) | (260) AM 2022 114592 A<br>(210) AM 114592<br>(220) 2021 09 10<br>(731) Nicholas Jonathan Michael Mompiau<br>116 Rezydencia Les Sabletes-28800 Mohamedia-Maroko, France<br>(740) Konstantine Chokoraia<br>(540)<br>   |
| AM 2022 114593 A       | 32  | I      | (260) AM 2022 114593 A<br>(210) AM 114593<br>(220) 2021 09 10<br>(731) Nicholas Jonathan Michael Mompiau<br>116 Rezydencia Les Sabletes-28800 Mohamedia-Maroko, France<br>(740) Konstantine Chokoraia<br>(540) | (260) AM 2022 114593 A<br>(210) AM 114593<br>(220) 2021 09 10<br>(731) Nicholas Jonathan Michael Mompiau<br>116 Rezydencia Les Sabletes-28800 Mohamedia-Maroko, France<br>(740) Konstantine Chokoraia<br>(540)<br> |

# CLASSIFICATION INDEXES

## INVENTIONS

### CONCORDANCE TABLE OF INTERNATIONAL CLASSIFICATION INDEX AND PUBLICATION NUMBERS

| INTERNATIONAL CLASSIFICATION INDEXES<br>(51)   | NUMBER OF PUBLISHED<br>APPLICATION<br>(10) |
|--|--|
| A 01 D 46/04   | AP 2022 15842 A                            |
| A 61 K 31/423; A 61 P 37/00; C 07 D 513/04; C 07 D 498/04;<br>C 07 D 487/04; C 07 D 471/04; C 07 D 413/12; C 07 D 413/06;<br>C 07 D 413/14 | AP 2022 15134 A                            |
| A 61 K 31/438; A 61 P 25/00; C 07 D 417/14; C 07 D 417/04;<br>C 07 D 413/04; C 07 D 413/14   | AP 2022 15499 A                            |
| B 01 J 19/00; C 07 D 471/04  | AP 2022 15429 A                            |
| E 01 F 7/04; E 02 D 17/20  | AP 2022 15051 A                            |
| F 17 C 3/00; F 25 D 3/10   | AP 2022 15612 A                            |

### CONCORDANCE TABLE OF PUBLICATION NUMBERS AND INTERNATIONAL CLASSIFICATION INDEX

| NUMBER OF PUBLISHED<br>APPLICATION<br>(10) | INTERNATIONAL CLASSIFICATION INDEXES<br>(51)   |
|--|--|
| AP 2022 15051 A                            | E 01 F 7/04; E 02 D 17/20  |
| AP 2022 15134 A                            | A 61 K 31/423; A 61 P 37/00; C 07 D 513/04; C 07 D 498/04;<br>C 07 D 487/04; C 07 D 471/04; C 07 D 413/12; C 07 D 413/06;<br>C 07 D 413/14 |
| AP 2022 15429 A                            | B 01 J 19/00; C 07 D 471/04  |
| AP 2022 15499 A                            | A 61 K 31/438; A 61 P 25/00; C 07 D 417/14; C 07 D 417/04;<br>C 07 D 413/04; C 07 D 413/14   |
| AP 2022 15612 A                            | F 17 C 3/00; F 25 D 3/10   |
| AP 2022 15842 A                            | A 01 D 46/04   |

### CONCORDANCE TABLE OF INTERNATIONAL CLASSIFICATION INDEX, PATENT NUMBERS AND PUBLICATION NUMBERS

| INTERNATIONAL CLASSIFICATION INDEX<br>(51)   | NUMBER<br>OF PATENT<br>(11) | NUMBER<br>OF PUBLISHED<br>APPLICATION<br>(10) |
|--|-----------------------------|---|
| A 01 G 25/02; C 02 F 1/14  | P 2022 7375 B               | AP 2021 15388 A                               |
| A 61 K 31/415; A 61 P 29/00; C 07 D 231/12;<br>C 07 D 231/56; C 07 D 333/28; C 07 D 333/38;<br>C 07 D 233/64; C 07 D 241/12; C 07 D 495/04;<br>C 07 D 213/56; C 07 D 277/56; C 07 D 333/58 | P 2022 7378 B               | AP 2021 15141 A                               |
| B 61 H 1/00; F 16 D 65/06; F 16 D 69/00  | P 2022 7377 B               | AP 2021 15524 A                               |
| F 01 K 25/10; H 02 K 7/18; H 02 K 35/02  | P 2022 7379 B               | AP 2021 15458 A                               |
| F 03 B 11/06; F 16 C 23/00; G 01 B 21/16   | P 2022 7376 B               | AP 2022 15428 A                               |

**CONCORDANCE TABLE OF PATENT NUMBERS,  
PUBLICATION NUMBERS AND INTERNATIONAL CLASSIFICATION INDEX**

| NUMBER OF PATENT (11) | NUMBER OF PUBLISHED APPLICATION (10) | INTERNATIONAL CLASSIFICATION INDEX (51)   |
|-----------------------|--------------------------------------|---|
| P 2022 7375 B         | AP 2021 15388 A                      | A 01 G 25/02; C 02 F 1/14   |
| P 2022 7376 B         | AP 2022 15428 A                      | F 03 B 11/06; F 16 C 23/00; G 01 B 21/16  |
| P 2022 7377 B         | AP 2021 15524 A                      | B 61 H 1/00; F 16 D 65/06; F 16 D 69/00   |
| P 2022 7378 B         | AP 2021 15141 A                      | A 61 K 31/415; A 61 P 29/00; C 07 D 231/12; C 07 D 231/56; C 07 D 333/28; C 07 D 333/38; C 07 D 233/64; C 07 D 241/12; C 07 D 495/04; C 07 D 213/56; C 07 D 277/56; C 07 D 333/58 |
| P 2022 7379 B         | AP 2021 15458 A                      | F 01 K 25/10; H 02 K 7/18; H 02 K 35/02   |

**CONCORDANCE TABLE OF APPLICATION NUMBERS,  
PUBLICATION NUMBERS AND PATENTS**

| NUMBER OF APPLICATION (21) | NUMBER OF PUBLISHED APPLICATION (10) | NUMBER OF PATENT (11) |
|----------------------------|--------------------------------------|-----------------------|
| AP 2017 15141              | AP 2021 15141 A                      | P 2022 7378 B         |
| AP 2020 15388              | AP 2021 15388 A                      | P 2022 7375 B         |
| AP 2019 15428              | AP 2022 15428 A                      | P 2022 7376 B         |
| AP 2019 15458              | AP 2021 15458 A                      | P 2022 7379 B         |
| AP 2019 15524              | AP 2021 15524 A                      | P 2022 7377 B         |

## UTILITY MODELS

**CONCORDANCE TABLE OF INTERNATIONAL CLASSIFICATION INDEX  
AND PUBLICATION NUMBERS**

| INTERNATIONAL CLASSIFICATION INDEXES (51) | NUMBER OF PUBLISHED APPLICATION (10) |
|---|--------------------------------------|
| A 21 C 1/00; A 21 D 10/04                 | AU 2022 15609 U                      |
| C 12 G 3/06                               | AU 2022 15319 U                      |

**CONCORDANCE TABLE OF PUBLICATION NUMBERS  
AND INTERNATIONAL CLASSIFICATION INDEX**

| NUMBER OF PUBLISHED APPLICATION (10) | INTERNATIONAL CLASSIFICATION INDEXES (51) |
|--------------------------------------|---|
| AU 2022 15319 U                      | C 12 G 3/06                               |
| AU 2022 15609 U                      | A 21 C 1/00; A 21 D 10/04                 |

**DESIGNS****CONCORDANCE TABLE OF INTERNATIONAL CLASSIFICATION INDEX,  
NUMBERS OF REGISTRATION AND PUBLICATION NUMBERS**

| INTERNATIONAL CLASSIFICATION INDEX<br>(51) | NUMBER<br>OF REGISTRATION<br>(11) | NUMBER<br>OF PUBLISHED<br>APPLICATION<br>(10) |
|--|-----------------------------------|---|
| 25-01                                      | D 2022 934 S                      | AD 2022 1239 S                                |

**CONCORDANCE TABLE OF NUMBERS OF REGISTRATION,  
PUBLICATION NUMBERS AND INTERNATIONAL CLASSIFICATION INDEX**

| NUMBER<br>OF REGISTRATION<br>(11) | NUMBER<br>OF PUBLISHED<br>APPLICATION<br>(10) | INTERNATIONAL CLASSIFICATION INDEX<br>(51) |
|-----------------------------------|---|--|
| D 2022 934 S                      | AD 2022 1239 S                                | 25-01                                      |

**CONCORDANCE TABLE OF APPLICATION NUMBERS,  
PUBLICATION NUMBERS AND NUMBERS OF REGISTRATION**

| NUMBER<br>OF APPLICATION<br>(21) | NUMBER OF PUBLISHED<br>APPLICATION<br>(10) | NUMBER OF REGISTRATION<br>(11) |
|----------------------------------|--|--------------------------------|
| AD 2021 1239                     | AD 2022 1239 S                             | D 2022 934 S                   |

## TRADEMARKS

### CONCORDANCE TABLE OF REGISTRATION NUMBERS, APPLICATION NUMBERS, PUBLICATION NUMBERS AND BULLETIN NUMBERS

| NUMBER OF<br>REGISTRATION<br>(111) | NUMBER OF<br>APPLICATIONS<br>(210) | NUMBER OF<br>PUBLISHED<br>APPLICATIONS<br>(260) | NUMBER OF<br>BULLETIN |
|------------------------------------|------------------------------------|---|-----------------------|
| 1                                  | 2                                  | 3   | 4                     |
| M 2022 35327 R                     | AM 117291                          | –   | 9(588)2022            |
| M 2022 35328 R                     | AM 110303                          | AM 2021 110303 A                                | 21(577)2021           |
| M 2022 35329 R                     | AM 111853                          | AM 2021 111853 A                                | 18(574)2021           |
| M 2022 35330 R                     | AM 111854                          | AM 2021 111854 A                                | 18(574)2021           |
| M 2022 35331 R                     | AM 111940                          | AM 2022 111940 A                                | 1(580)2022            |
| M 2022 35332 R                     | AM 112367                          | AM 2021 112367 A                                | 20(576)2021           |
| M 2022 35333 R                     | AM 112421                          | AM 2022 112421 A                                | 1(580)2022            |
| M 2022 35334 R                     | AM 112608                          | AM 2021 112608 A                                | 21(577)2021           |
| M 2022 35335 R                     | AM 112904                          | AM 2021 112904 A                                | 23(579)2021           |
| M 2022 35336 R                     | AM 112905                          | AM 2021 112905 A                                | 23(579)2021           |
| M 2022 35337 R                     | AM 112928                          | AM 2021 112928 A                                | 21(577)2021           |
| M 2022 35338 R                     | AM 112921                          | AM 2022 112921 A                                | 1(580)2022            |
| M 2022 35339 R                     | AM 112932                          | AM 2021 112932 A                                | 23(579)2021           |
| M 2022 35340 R                     | AM 113010                          | AM 2022 113010 A                                | 1(580)2022            |
| M 2022 35341 R                     | AM 113014                          | AM 2022 113014 A                                | 1(580)2022            |
| M 2022 35342 R                     | AM 113120                          | AM 2022 113120 A                                | 1(580)2022            |
| M 2022 35343 R                     | AM 113137                          | AM 2022 113137 A                                | 1(580)2022            |
| M 2022 35344 R                     | AM 113140                          | AM 2021 113140 A                                | 23(579)2021           |
| M 2022 35345 R                     | AM 113189                          | AM 2022 113189 A                                | 1(580)2022            |
| M 2022 35346 R                     | AM 113229                          | AM 2021 113229 A                                | 23(579)2021           |
| M 2022 35347 R                     | AM 113231                          | AM 2022 113231 A                                | 1(580)2022            |
| M 2022 35348 R                     | AM 113242                          | AM 2022 113242 A                                | 1(580)2022            |
| M 2022 35349 R                     | AM 113253                          | AM 2022 113253 A                                | 1(580)2022            |
| M 2022 35350 R                     | AM 113273                          | AM 2022 113273 A                                | 1(580)2022            |
| M 2022 35351 R                     | AM 113398                          | AM 2022 113398 A                                | 1(580)2022            |
| M 2022 35352 R                     | AM 113494                          | AM 2022 113494 A                                | 1(580)2022            |
| M 2022 35353 R                     | AM 117188                          | –   | 9(588)2022            |
| M 2022 35354 R                     | AM 117527                          | –   | 9(588)2022            |
| M 2022 35355 R                     | AM 117526                          | –   | 9(588)2022            |
| M 2022 35356 R                     | AM 117413                          | –   | 9(588)2022            |
| M 2022 35357 R                     | AM 117276                          | –   | 9(588)2022            |
| M 2022 35358 R                     | AM 117430                          | –   | 9(588)2022            |
| M 2022 35359 R                     | AM 112610                          | AM 2021 112610 A                                | 20(576)2021           |
| M 2022 35360 R                     | AM 112622                          | AM 2021 112622 A                                | 20(576)2021           |
| M 2022 35361 R                     | AM 112707                          | AM 2021 112707 A                                | 22(578)2021           |
| M 2022 35362 R                     | AM 112711                          | AM 2021 112711 A                                | 22(578)2021           |
| M 2022 35363 R                     | AM 112713                          | AM 2021 112713 A                                | 20(576)2021           |
| M 2022 35364 R                     | AM 113016                          | AM 2022 113016 A                                | 1(580)2022            |
| M 2022 35365 R                     | AM 113025                          | AM 2022 113025 A                                | 1(580)2022            |
| M 2022 35366 R                     | AM 113122                          | AM 2022 113122 A                                | 1(580)2022            |
| M 2022 35367 R                     | AM 113147                          | AM 2021 113147 A                                | 22(578)2021           |
| M 2022 35368 R                     | AM 113204                          | AM 2022 113204 A                                | 1(580)2022            |
| M 2022 35369 R                     | AM 113213                          | AM 2022 113213 A                                | 1(580)2022            |
| M 2022 35370 R                     | AM 113214                          | AM 2022 113214 A                                | 1(580)2022            |
| M 2022 35371 R                     | AM 113224                          | AM 2022 113224 A                                | 1(580)2022            |

| 1              | 2         | 3                | 4           |
|----------------|-----------|------------------|-------------|
| M 2022 35372 R | AM 113226 | AM 2022 113226 A | 1(580)2022  |
| M 2022 35373 R | AM 113232 | AM 2022 113232 A | 1(580)2022  |
| M 2022 35374 R | AM 113243 | AM 2022 113243 A | 1(580)2022  |
| M 2022 35375 R | AM 113245 | AM 2022 113245 A | 1(580)2022  |
| M 2022 35376 R | AM 113247 | AM 2022 113247 A | 1(580)2022  |
| M 2022 35377 R | AM 113248 | AM 2022 113248 A | 1(580)2022  |
| M 2022 35378 R | AM 113279 | AM 2021 113279 A | 23(579)2021 |
| M 2022 35379 R | AM 113360 | AM 2022 113360 A | 1(580)2022  |
| M 2022 35380 R | AM 114545 | AM 2022 114545 A | 1(580)2022  |
| M 2022 35381 R | AM 117304 | –                | 9(588)2022  |
| M 2022 35382 R | AM 117615 | –                | 9(588)2022  |
| M 2022 35383 R | AM 117442 | –                | 9(588)2022  |
| M 2022 35384 R | AM 117440 | –                | 9(588)2022  |
| M 2022 35385 R | AM 117441 | –                | 9(588)2022  |
| M 2022 35386 R | AM 117611 | –                | 9(588)2022  |
| M 2022 35387 R | AM 111336 | AM 2021 111336 A | 21(577)2021 |
| M 2022 35388 R | AM 111432 | AM 2022 111432 A | 2(581)2022  |
| M 2022 35389 R | AM 112256 | AM 2021 112256 A | 20(576)2021 |
| M 2022 35390 R | AM 112284 | AM 2021 112284 A | 20(576)2021 |
| M 2022 35391 R | AM 112503 | AM 2021 112503 A | 19(575)2021 |
| M 2022 35392 R | AM 112505 | AM 2021 112505 A | 20(576)2021 |
| M 2022 35393 R | AM 112575 | AM 2021 112575 A | 20(576)2021 |
| M 2022 35394 R | AM 112576 | AM 2021 112576 A | 20(576)2021 |
| M 2022 35395 R | AM 112727 | AM 2021 112727 A | 21(577)2021 |
| M 2022 35396 R | AM 112729 | AM 2021 112729 A | 21(577)2021 |
| M 2022 35397 R | AM 113013 | AM 2021 113013 A | 23(579)2021 |
| M 2022 35398 R | AM 113112 | AM 2021 113112 A | 22(578)2021 |
| M 2022 35399 R | AM 113186 | AM 2022 113186 A | 2(581)2022  |
| M 2022 35400 R | AM 113238 | AM 2022 113238 A | 1(580)2022  |
| M 2022 35401 R | AM 113244 | AM 2022 113244 A | 2(581)2022  |
| M 2022 35402 R | AM 113338 | AM 2022 113338 A | 2(581)2022  |
| M 2022 35403 R | AM 113342 | AM 2022 113342 A | 2(581)2022  |
| M 2022 35404 R | AM 113344 | AM 2022 113344 A | 2(581)2022  |
| M 2022 35405 R | AM 113347 | AM 2022 113347 A | 2(581)2022  |
| M 2022 35406 R | AM 113356 | AM 2022 113356 A | 2(581)2022  |
| M 2022 35407 R | AM 113387 | AM 2022 113387 A | 2(581)2022  |
| M 2022 35408 R | AM 113389 | AM 2022 113389 A | 2(581)2022  |
| M 2022 35409 R | AM 113486 | AM 2022 113486 A | 2(581)2022  |
| M 2022 35410 R | AM 113426 | AM 2022 113426 A | 2(581)2022  |
| M 2022 35411 R | AM 113603 | AM 2022 113603 A | 2(581)2022  |
| M 2022 35412 R | AM 113852 | AM 2022 113852 A | 2(581)2022  |
| M 2022 35413 R | AM 104319 | AM 2022 104319 A | 2(581)2022  |
| M 2022 35414 R | AM 117295 | –                | 9(588)2022  |



**CONCORDANCE TABLE OF PUBLICATION NUMBERS  
AND APPLICATION NUMBERS**

| NUMBER OF<br>PUBLISHED<br>APPLICATION<br>(260) | NUMBER OF<br>APPLICATION<br>(210) | 1                | 2         |
|--|-----------------------------------|------------------|-----------|
| 1  | 2                                 |                  |           |
| AM 2022 111163 A                               | AM 111163                         | AM 2022 114927 A | AM 114927 |
| AM 2022 114319 A                               | AM 114319                         | AM 2022 114973 A | AM 114973 |
| AM 2022 114691 A                               | AM 114691                         | AM 2022 114986 A | AM 114986 |
| AM 2022 114693 A                               | AM 114693                         | AM 2022 114988 A | AM 114988 |
| AM 2022 114694 A                               | AM 114694                         | AM 2022 115011 A | AM 115011 |
| AM 2022 114696 A                               | AM 114696                         | AM 2022 115013 A | AM 115013 |
| AM 2022 114699 A                               | AM 114699                         | AM 2022 115015 A | AM 115015 |
| AM 2022 114737 A                               | AM 114737                         | AM 2022 115016 A | AM 115016 |
| AM 2022 114741 A                               | AM 114741                         | AM 2022 115019 A | AM 115019 |
| AM 2022 114758 A                               | AM 114758                         | AM 2022 115024 A | AM 115024 |
| AM 2022 114761 A                               | AM 114761                         | AM 2022 115025 A | AM 115025 |
| AM 2022 114794 A                               | AM 114794                         | AM 2022 115026 A | AM 115026 |
| AM 2022 114812 A                               | AM 114812                         | AM 2022 115027 A | AM 115027 |
| AM 2022 114817 A                               | AM 114817                         | AM 2022 115028 A | AM 115028 |
| AM 2022 114914 A                               | AM 114914                         | AM 2022 115110 A | AM 115110 |
| AM 2022 114919 A                               | AM 114919                         | AM 2022 115111 A | AM 115111 |
|  |                                   | AM 2022 115114 A | AM 115114 |
|  |                                   | AM 2022 115117 A | AM 115117 |
|  |                                   | AM 2022 115118 A | AM 115118 |
|  |                                   | AM 2022 115131 A | AM 115131 |

CONCORDANCE TABLE OF INDEX OF GOODS AND/OR SERVICES  
AND APPLICATION NUMBERS

| INDEX OF GOODS<br>AND/OR<br>SERVICES<br>(511) | NUMBER OF<br>PUBLISHED<br>APPLICATIONS<br>(260) | 1  | 2                |
|---|---|----|------------------|
| 1   | 2   | 33 | AM 2022 111163 A |
| 5   | AM 2022 114691 A                                | 33 | AM 2022 114319 A |
| 5   | AM 2022 114699 A                                | 33 | AM 2022 114693 A |
| 9   | AM 2022 115015 A                                | 33 | AM 2022 114694 A |
| 9   | AM 2022 115016 A                                | 33 | AM 2022 114914 A |
| 9   | AM 2022 115118 A                                | 33 | AM 2022 115011 A |
| 11  | AM 2022 114741 A                                | 33 | AM 2022 115013 A |
| 11  | AM 2022 115118 A                                | 33 | AM 2022 115117 A |
| 12  | AM 2022 114794 A                                | 34 | AM 2022 115114 A |
| 16  | AM 2022 115015 A                                | 35 | AM 2022 114696 A |
| 16  | AM 2022 115016 A                                | 35 | AM 2022 114761 A |
| 20  | AM 2022 115026 A                                | 35 | AM 2022 114927 A |
| 20  | AM 2022 115028 A                                | 35 | AM 2022 115024 A |
| 21  | AM 2022 114758 A                                | 35 | AM 2022 115025 A |
| 25  | AM 2022 115015 A                                | 35 | AM 2022 115026 A |
| 25  | AM 2022 115016 A                                | 35 | AM 2022 115027 A |
| 25  | AM 2022 115110 A                                | 35 | AM 2022 115028 A |
| 29  | AM 2022 114761 A                                | 37 | AM 2022 114794 A |
| 30  | AM 2022 114696 A                                | 37 | AM 2022 115118 A |
| 30  | AM 2022 114761 A                                | 41 | AM 2022 114319 A |
| 30  | AM 2022 114817 A                                | 41 | AM 2022 115015 A |
| 30  | AM 2022 115111 A                                | 41 | AM 2022 115016 A |
| 30  | AM 2022 115131 A                                | 42 | AM 2022 114737 A |
| 31  | AM 2022 114761 A                                | 43 | AM 2022 114319 A |
| 32  | AM 2022 114319 A                                | 43 | AM 2022 114919 A |
| 32  | AM 2022 114812 A                                | 43 | AM 2022 114973 A |
| 32  | AM 2022 115110 A                                | 43 | AM 2022 115019 A |
|   |   | 44 | AM 2022 115110 A |
|   |   | 44 | AM 2022 114986 A |
|   |   | 44 | AM 2022 114988 A |

CONCORDANCE TABLE OF INDEX OF GOODS AND/OR SERVICES  
AND NUMBERS OF TRADEMARKS REGISTERED ACCORDING  
TO THE ACCELERATED PROCEDURE

| INDEX OF GOODS AND/OR SERVICES<br>(511) | NUMBERS OF REGISTERED ACCORDING<br>TO THE ACCELERATED PROCEDURE<br>(111) |
|---|--|
| 5                                       | M 2022 35353 R   |
| 5                                       | M 2022 35356 R   |
| 5                                       | M 2022 35382 R   |
| 5                                       | M 2022 35386 R   |
| 19                                      | M 2022 35327 R   |
| 21                                      | M 2022 35327 R   |
| 29                                      | M 2022 35358 R   |
| 33                                      | M 2022 35381 R   |
| 33                                      | M 2022 35383 R   |
| 33                                      | M 2022 35384 R   |
| 33                                      | M 2022 35385 R   |
| 34                                      | M 2022 35414 R   |
| 35                                      | M 2022 35386 R   |
| 41                                      | M 2022 35354 R   |
| 41                                      | M 2022 35355 R   |
| 43                                      | M 2022 35357 R   |
| 44                                      | M 2022 35357 R   |

# **OFFICIAL BULLETIN OF THE INDUSTRIAL PROPERTY**

**INVENTIONS  
UTILITY MODELS  
DESIGNS  
TRADEMARKS  
APPELLATIONS OF ORIGIN OF GOODS**

## **9(588)**

EDITOR-IN-CHIEF: N. Bebrishvili

EDITOR-TRANSLATOR: E. Gabunia

PROOFREADER: A. Shikhashvili

COMPUTER LAYOUT: M. Ordenidze  
K. Svanidze

[info@sakpatenti.gov.ge](mailto:info@sakpatenti.gov.ge)  
[www.sakpatenti.gov.ge](http://www.sakpatenti.gov.ge)