



Official Bulletin of the Industrial Property

Inventions

Utility Models

Designs

Trademarks



საქართველოს ინტელექტუალური
საკუთრების ეროვნული ცენტრი

საკპატი

SAKPATENTI

NATIONAL INTELLECTUAL PROPERTY
CENTER OF GEORGIA

www.sakpatenti.gov.ge

Date of Publication – 2022 07 11

13(592)

INID CODES FOR IDENTIFICATION OF BIBLIOGRAPHIC DATA

INVENTIONS, UTILITY MODELS

- (10) Number of publication for application, which has been examined
- (11) Number of patent and kind of document
- (21) Serial number of application
- (22) Date of filing of the application
- (23) Date of exhibition or the date of the earlier filing and the number of application, if any
- (24) Date from which patent may have effect
- (31) Number of priority application
- (32) Date of filing of priority application
- (33) Code of the country or regional organization allotting priority application number
- (44) Date of publication of application not granted, but examined and number of bulletin
- (45) Date of publication of registered document
- (51) International Patent Classification Index

- (54) Title of the invention
- (57) Abstract
- (60) Number of examined patent document granted by foreign patent office, date from which patent has effect and country code
- (62) Number of the earlier application and in case of divided application, date of filing an application
- (71) Name, surname and address of applicant (country code)
- (72) Name, surname of inventor (country code)
- (73) Name, surname and address of patent owner (country code)
- (74) Name, surname of representative or patent attorney
- (85) Date of commencement of the national phase of International Application
- (86) Number and date of filing of international application
- (87) Number and date of publication of international application
- (94) Calculated date of expiry of the SPC or the duration of the SPC

DESIGNS

- (10) Number of publication for application
- (11) Number of patent and kind of document or number of registration
- (15) Date of registration/Date of patent renewal
- (18) Expected expiration date of patent or registration
- (21) Serial number of application
- (22) Date of filing of the application
- (23) Date of exhibition or the date of the earlier filing and the number of application, if any
- (24) Date from which patent may have effect
- (28) Number of designs included in the application
- (30) Data relating to priority (number of application, date of filing of application, two-letter code identifying the authority with whom the priority application was made)
- (31) Number of priority application
- (32) Date of filing of priority application
- (33) Code of the country or regional organization allotting priority application number
- (34) Two-letter code according to WIPO St.3 identifying the authority with which the priority application was made
- (44) Date of publication of design and number of bulletin (the first publication)
- (45) Date of publication of design registered by WIPO and number of bulletin

- (51) International Classification for designs (class and subclass of the Locarno Classification)
- (54) Title of the invention
- (55) Reproduction of the design
- (57) Description of characteristic features of the design including indication of colors
- (58) Date of recording of any kind of amendment in the Register
- (62) Number of the earlier application, registration and document number and if available the date of filing an application in case of divided application
- (71) Name, surname and address of applicant (country code)
- (72) Name, surname of creator (country code)
- (73) Name, surname and address of patent owner (country code)
- (74) Name, surname of representative or patent attorney
- (81) Contracting states concerned
 - II designated contracting states according to the 1960 Act
 - III designated contracting states according to the 1999 Act
- (85) Owner's permanent address
- (86) Owner's nationality
- (87) Owner's residence
- (88) State in which the owner has a real and effective industrial or commercial establishment

TRADEMARKS

- (111) - Number of registration
- (151) - Date of registration
- (156) - Date of the renewal
- (181) - Expected expiration date of registration
- (186) - Renewal expiration date of registration
- (141) - Date of cancel of duration of the mark
- (210) - Serial number of application
- (220) - Date of filing of the application
- (230) - Data concerning exhibition
- (260) - Number of application, for which favorable decision of examination about registration has been taken (publication number)
- (310) - Number of the first application
- (320) - Date of filing of the first application
- (330) - Code, identifying national or regional Office where the first application was made
- (511) - International Classification of Goods and Services for the purposes of registration of trade marks and/or list of goods and/or services classified according thereto
- (526) - Disclaimer
- (531) - Description of figurative elements of Trade Marks according to the International Classification of the Figurative Elements of Marks

- (540) - Reproduction of Trade Mark
- (550) - Nature and kind of Trade Mark
- (551) - Indication to the effect that the mark is a collective mark, a certification mark or a guarantee mark
- (554) - Three-dimensional mark
- (580) - Date of recording of any kind changes in respect of applications or registrations
- (591) - Information concerning colors claimed
- (731) - Name and address of the applicant
- (732) - Name and address of the holder of the registration
- (740) - Name and address of the representative
- (750) - Addreses for correspondence
- (770) - Name and address of the previous applicant or holder in case of change in ownership
- (771) - Previous name and address of the applicant or holder in case of change in ownership
- (791) - Name and address of the licensee
- (793) - Indication of conditions and/or restrictions under the license (Type of license, number of license agreement, data of license, data of validity of license)
- (800) - Certain data relating to the international registration of Trade Marks under the Protocol Relating to Madrid Agreement (International registration number
- (852) - Partial cancellation of the list of goods and services
- (891) - Date of subsequent designation

CODES FOR PUBLICATION IN BULLETIN

- (21) AP 0000 000000 - serial number of application for invention
- (10) AP 0000 0000 A - number of published application for invention (first publication)
- (11) P 0000 0000 B - number of patent for invention (second publication)
- (21) API 0000 000000 - number of application for imported patent
- (11) PI 0000 0000 A - number of imported patent (first publication)
- (21) AU 0000 000000 - serial number of application for utility model
- (10) AU 0000 000 U - number of published application for utility model (first publication)
- (11) U 0000 000 Y - number of patent for utility model (second publication)
- (21) AD 0000 000000 - serial number of application for design
- (10) AD 0000 000 S - number of published application for design (first publication)
- (11) D 0000 000 S - registered design

INTERNATIONAL PATENT CLASSIFICATION FOR INVENTIONS AND UTILITY MODELS

- SECTION A - HUMAN NECESSITIES
- SECTION B - PERFORMING OPERATIONS; TRANSPORTING
- SECTION C - CHEMISTRY; METALLURGY
- SECTION D - TEXTILES; PAPER
- SECTION E - FIXED CONSTRUCTIONS
- SECTION F - MECHANICAL ENGINEERING; LIGHTING; HEATING; WEAPONS; BLASTING
- SECTION G - PHYSICS
- SECTION H - ELECTRICITY

-
- M - Trade Mark
 - (210) AM 0000 000000 - Serial number of application;
 - (260) AAM 0000 00000 A - Publication number of application;
 - (111) M 0000 00000 R - Number of registration;
 - (111) MMM0000 00000 Rn - Number of renewals, in which n=1,2,3;
 - (111) M 0000 00000 R(P) - Number of registration under partial assignment of rights
-

Official Bulletin of the Industrial Property

Inventions

Utility Models

Designs

Trademarks

CONTENT

| | |
|--|-----|
| PUBLISHED TITLES OF PROTECTION | 3 |
| INVENTIONS | |
| ▪ APPLICATIONS APPROVED FOR GRANTING PATENT | 4 |
| ▪ PATENTED INVENTION | 8 |
| UTILITY MODELS | |
| ▪ APPLICATIONS APPROVED FOR GRANTING PATENT | 9 |
| ▪ PATENTED UTILITY MODEL | 10 |
| DESIGNS | |
| ▪ APPLICATION APPROVED FOR REGISTRATION | 11 |
| ▪ REGISTERED DESIGN | 12 |
| ▪ DESIGNS, WHICH HAVE BEEN REGISTERED WITH THE INTERNATIONAL BUREAU CLAIMING PRIORITY ON THE TERRITORY OF GEORGIA | 13 |
| TRADEMARKS | |
| ▪ APPLICATIONS FILED UNDER THE NATIONAL PROCEDURE APPROVED FOR REGISTRATION | 34 |
| ▪ REGISTERED TRADEMARKS | 43 |
| ▪ TRADEMARKS REGISTERED ACCORDING TO THE ACCELERATED PROCEDURE | 47 |
| ▪ INTERNATIONAL TRADEMARKS FOR WHICH A DECISION ON GRANTING PROTECTION IS TAKEN | 49 |
| ▪ INTERNATIONAL TRADEMARKS PROTECTED IN GEORGIA | 154 |
| OFFICIAL NOTIFICATIONS | |
| INVENTIONS | |
| ▪ RESTORATION OF PATENT | 163 |
| ▪ ABOLITION OF PATENTS WITH THE RIGHT TO RESTORE | 163 |
| ▪ EXPIRATION OF TERMS OF PATENTS RESTORATION | 164 |
| UTILITY MODELS | |
| ▪ ABOLITION OF PATENT WITH THE RIGHT TO RESTORE | 165 |
| ▪ EXPIRATION OF TERMS OF PATENT RESTORATION | 165 |
| DESIGNS | |
| ▪ EXTENSION OF TERMS OF DESIGNS REGISTRATION | 165 |
| ▪ CANCELLATION OF DESIGN REGISTRATION | 166 |
| ▪ TRANSFER OF RIGHT | 167 |
| ▪ EXTENSION OF TERMS OF INTERNATIONAL DESIGNS REGISTRATION | 167 |
| ▪ CANCELLATION OF INTERNATIONAL DESIGNS REGISTRATION | 170 |
| TRADEMARKS | |
| ▪ EXTENSION OF TERMS OF TRADEMARKS REGISTRATION | 173 |
| ▪ COMPLETE TRANSFER OF RIGHTS | 176 |
| ▪ CHANGES OF NAMES AND/OR ADDRESSES OF TRADEMARKS OWNERS | 178 |
| ▪ CANCELLATION OF TRADEMARKS REGISTRATION | 179 |
| CLASSIFICATION INDEXES | |
| INVENTIONS | 183 |
| UTILITY MODELS | 184 |
| DESIGNS | 185 |
| TRADEMARKS | 187 |

PUBLISHED TITLES OF PROTECTION

INVENTIONS

- **APPLICATIONS APPROVED FOR GRANTING PATENT:**
15447; 15593; 15506; 15342; 15294; 15209; 15475; 15457; 15124; 15603
- **PATENTED INVENTION:**
7394

UTILITY MODELS

- **APPLICATIONS APPROVED FOR GRANTING PATENT:**
15641; 15764
- **PATENTED UTILITY MODEL:**
2121

DESIGNS

- **APPLICATION APPROVED FOR REGISTRATION:**
1261
- **REGISTERED DESIGN:**
938
- **DESIGNS, WHICH HAVE BEEN REGISTERED WITH THE INTERNATIONAL BUREAU CLAIMING PRIORITY ON THE TERRITORY OF GEORGIA:**
220599; 217407; 217400; 217557; 217732; 217628; 217627; 218436

TRADEMARKS

- **APPLICATIONS FILED UNDER THE NATIONAL PROCEDURE APPROVED FOR REGISTRATION:**
115126; 115338; 115350, 115351; 115517; 115525, 115526; 115529; 115602; 115604; 115672-115674; 115681, 115682; 115685; 115695; 115743; 115745; 115749, 115750; 115752, 115753; 115756, 115757; 115760, 115761; 115763; 115841; 115844, 115845; 115859; 115861, 115862; 115864; 115880; 115884; 115891-115895; 115900; 115902; 115969-115971; 115985, 115986; 115988; 116161; 116313
- **REGISTERED TRADEMARKS:**
35630-35643; 35648-35671
- **TRADEMARKS REGISTERED ACCORDING TO THE ACCELERATED PROCEDURE:**
35627-35629; 35644-35647; 35672
- **INTERNATIONAL TRADEMARKS FOR WHICH A DECISION ON GRANTING PROTECTIONS IS TAKEN:**
107140*; 107381*; 113542*; 114573; 114636, 114637; 114639-114644; 114705; 114781, 114782; 114784-114786; 114843; 114855-114862; 114868, 114869; 114877-114880; 114950; 114953; 114955; 115035; 115037; 115040-115042; 115044; 115047-115050; 115052-115055; 115057-115065; 115095; 115145; 115147; 115155; 115172, 115173; 115175-115178; 115182; 115184-115188; 115192-115199; 115251; 115253; 115301; 115362-115375; 115386, 115387; 115389-115391; 115394, 115395; 115457, 115458; 115474; 115478; 115546, 115547; 115549, 115550; 115553; 115555, 115556; 115558-115560; 115562-115565; 115578, 115579; 115621; 115623-115626; 115699; 115709-115712; 115714; 115716-115718; 115791-115796; 115800; 115831; 115833; 115836, 115837; 115839; 115903; 116038; 116042
- **INTERNATIONAL TRADEMARKS PROTECTED IN GEORGIA:**
108800; 109995; 110246; 110306; 110357; 112438; 112831; 112967; 112989; 113060; 113168; 113178, 113179; 113181; 113291-113293; 113298; 113304; 113314-113329; 113331-113334; 113434; 113436, 113437; 113444; 113458-113464; 113466; 113468; 113472-113478; 113482; 113524; 113537; 113539, 113540; 113543-113548; 113634, 113635; 113637, 113638; 113640-113643; 113645; 113647-113651; 113653, 113654; 113669-113671; 113729, 113730; 113732; 113734-113742; 113760; 113796-113799; 113825; 113840, 113938; 113942; 114017; 114020; 114022-114025; 114118

INVENTIONS

APPLICATIONS APPROVED FOR GRANTING PATENT

The decision can be appealed at the Chamber of Appeal of Sakpatenti within 3 months from the publication or at the Mtskheta District Court Administrative Cases Board (Address: №17, Samkhedro St., Mtskheta), within 1 month following the publication.

PART A

A 61

- (10) AP 2022 15447 A (51) Int. Cl. (2006)
A 61 K 31/407
A 61 K 31/496
A 61 P 35/02
A 61 P 35/00
- (21) AP 2019 15447 (22) 2019 07 22
(31) 201810862170.9
(32) 2018 07 31
(33) CN
- (71) Ascentage Pharma (Suzhou) Co., LTD (CN)
Unit 701, bld B7, 218 Xinghu St., Suzhou
Industrial Park, Suzhou Jiangsu 215000, People
Republic of China (CN)
- (72) YANG, Dajun (CN);
ZHAI, Yifan (CN);
TANG, Qiuqiong (CN);
FANG, Douglas Dong (CN)
- (74) Tamaz Shilakadze
(85) 2020 09 17
(86) PCT/CN2019/096968, 2019 07 22
- (54) COMBINATION PRODUCT OF BCL-2 INHI-
BITOR AND MDM2 INHIBITOR AND USE
THEREOF IN PREVENTION AND/OR
TREATMENT OF DISEASES
- (57) Combination product comprising Bcl-2 inhibitor
and MDM-2 inhibitor, and usage therein the pre-
vention and/or treatment of disease, particularly can-
cer, are represented.
- Claims: 2 independents
6 dependents
- Fig.: 5

- (10) AP 2022 15593 A (51) Int. Cl. (2006)
A 61 K 31/4184
A 61 K 31/43
A 61 K 31/7048
A 61 K 9/00
A 61 P 31/04
- (21) AP 2019 15593 (22) 2019 08 28
(31) 10-2018-0102250
(32) 2018 08 29
(33) KR
- (71) Hk Inno.N Corporation (KR)

- 6F, 7F, 8F, 100, Eulji-ro, Jung-Gu, Seoul 04551,
Republic of Korea (KR)
- (72) KIM, Bong Tae (KR);
KIM, Dongkyu (KR);
KIM, Eun Ji (KR);
LEE, Ji Won (KR);
OH, Kyeongmin (KR);
KIM, Ahrong (KR);
SONG, Geun Seog (KR);
RYU, Shin-Young (KR);
KIM, Eun Kyung (KR);
SHIN, Naree (KR);
KANG, Hyun Ji (KR);
KIM, Jae Min (KR);
PARK, Yu-Gyeong (KR);
JEONG, Haneul (KR)
- (74) Shalva Gvaramadze
(85) 2021 03 25
(86) PCT/KR2019/011017, 2019 08 28
- (54) COMPOSITION FOR ERADICA-
TING HELICOBACTER PYLORI
- (57) Composition contains compound of formula (I),

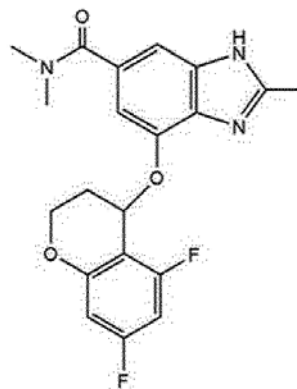

- amoxicilina and clarithromycin.
Claims: 6 independents
9 dependents
- Fig.: 2

- (10) AP 2022 15506 A (51) Int. Cl. (2006)
A 61 K 31/4545
A 61 K 31/454
A 61 P 35/00
A 61 P 3/00
A 61 P 25/00
A 61 P 29/00
C 07 D 409/14
C 07 D 405 /14

C 07 D 405/12

C 07 D 409/12

- (21) AP 2019 15506 (22) 2019 05 06
 (31) 18171084.9
 (32) 2018 05 07
 (33) EP
 (71) Aziende Chimiche Riunite Angelini
 Francesco – A.C.R.A.F. S.P.A. (IT)
 Viale Amelia, 70 I-00181 Roma, Italy (IT)
 (72) FURLOTTI, Guido (IT);
 CAVARISCHIA, Claudia (IT);
 BUONFIGLIO, Rosa (IT);
 OMBRATO, Rosella (IT);
 IACOANGELI, Tommaso (IT)
 (74) Liliana Darakhvelidze
 (85) 2020 12 04
 (86) PCT/EP2019/061532, 2019 05 06
 (54) 1H-INDAZOLE-3-CARBOXAMIDE COM-
 POUNDS AS GLYCOGEN SYNTHASE
 KINASE 3 BETA INHIBITORS

(57) 1H-indazole-3-carboxamide compounds of for-
 mula (I),

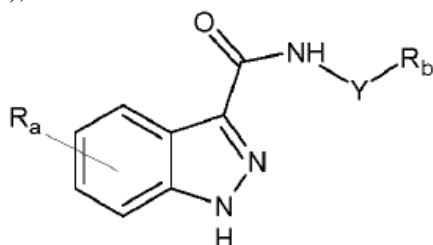

acting as glycogen synthase kinase 3 beta (GSK-
 3 β) inhibitors and, their usage for the treatment of
 GSK-3 β -related disorders.

Claims: 3 independents
 15 dependents

- (10) AP 2022 15342 A (51) Int. Cl. (2006)
 A 61 K 31/473
 A 61 P 25/00
 C 07 D 405/12
 C 07 D 405/14

- (21) AP 2018 15342 (22) 2018 11 23
 (31) PA201700674
 (32) 2017 11 24
 (33) DK
 (71) H. LUNDBECK A/S (DK)
 Ottiliavej 9, DK-2500 Valby, Denmark (DK)
 (72) JENSEN, Klaus, Gjervig (DK);
 KVÆRNØ, Lisbet (DK);
 JUHL, Martin (DK);
 MORTEN, Jørgensen (DK)
 (74) Tamaz Shilakadze
 (85) 2020 05 22
 (86) PCT/EP2018/082361, 2018 11 23
 (54) NEW CATECHOLAMINE PRODRUGS
 FOR USE IN TREATMENT OF PARKI-
 NSON'S DISEASE

(57) Compounds of formula (Id),

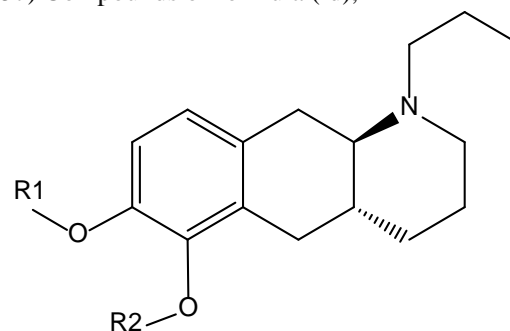

(Id)

pharmaceutical compositions on the basis thereof,
 and the usage therefor the treatment of neurodege-
 nerative diseases and disorders.

Claims: 4 independents
 10 dependents
 Fig.: 8

- (10) AP 2022 15294 A (51) Int. Cl. (2006)
 A 61 K 38/17
 A 61 K 39/395
 C 07 K 14/705
 C 07 K 14/47

- (21) AP 2016 15294 (22) 2016 08 05
 (62) AP 2016 14720 2016 08 05
 (31) 62/202,772; 62/202,775; 62/202,779;
 62/265,887; 62/276,801; 62/276,796; 62/346,414
 (32) 2015 08 07; 2015 08 07; 2015 08 07; 2015
 12 10; 2016 01 08; 2016 01 08; 2016 06 06
 (33) US; US; US; US; US; US; US
 (71) Ilex Oncology Inc. (US)
 866 Malcolm Rd., Suite 100, Burlingame,
 CA 94010, USA (US)
 (72) DEMING, Laura (US);
 GOODMAN, Corey (US);
 KUO, Tracy Chia-Chien (US);
 KAUDER, Steven Elliot (US);
 PONS, Jaume (US);
 WAN, Hong (US);
 SIM, Bang Janet (US)

- (74) Tamar Kochlamazashvili
 (85) 2020 02 27
 (86) PCT/US2016/045914, 2016 08 05
 (54) CONSTRUCTS HAVING SIRP-ALPHA
 DOMAIN OR VARIANT THEREOF
 (57) Present invention relates to signal-regulatory
 protein α (SIRP- α) polypeptides and constructs that
 include SIRP- α D1 variant fused to Fc domain mo-
 nomer, human serum albumin (HSA) or polyethy-
 lene glycol (PEG) polymer. They are used for can-
 cer treatment.

Claims: 8 independents
 25 dependents
 Fig.: 20

- (10) AP 2022 15209 A (51) Int. Cl. (2006)
A 61 K 39/395
A 61 P 35/00
C 07 K 16/28
- (21) AP 2018 15209 (22) 2018 04 05
(31) 62/483,019
(32) 2017 04 07
(33) US
(71) Agenus Inc. (US)
3 Forbes Rd. Lexington MA 02421, USA (US);
Merck Sharp & Dohme Corp. (US)
126 East Lincoln Ave. Rahway, NJ 07065-0907,
USA (US)
- (72) SCHULTZE, Kornelia (US);
SCHUSTER, Andrea Claudia (US);
BLANUSA, Milan (US);
JOYCE-SHAIKH, Barbara (US);
ZUNIGA, Luis, A. (US)
- (74) Shalva Gvaramadze
(85) 2019 11 04
(86) PCT/US2018/026160, 2018 04 05
- (54) ANTI-ILT4 ANTIBODIES AND ANTIGEN-
-BINDING FRAGMENTS
- (57) Present invention relates to antibodies and
antigen-binding fragments thereof that bind to ILT4
receptor. They are used for the treatment of cancer
in a subject.
- Claims: 16 independents
15 dependents
Fig.: 17

- (10) AP 2022 15475 A (51) Int. Cl. (2006)
A 61 P 35/00
C 07 D 401/14
C 07 D 405/14
C 07 D 487/04
C 07 D 498/04
- (21) AP 2019 15475 (22) 2019 04 22
(31) 62/663,096; 62/750,454; 62/826,609
(32) 2018 04 26; 2018 10 25; 2019 03 29
(33) US; US; US
(71) Pfizer Inc. (US)
235 East 42nd Street, New York, NY 10017,
USA (US)
- (72) CHEN, Ping (US);
CHO-SCHULTZ, Sujin (US);
DEAL, Judith Gail (US);
GALLEGO, Gary Michael (US);
JALAIE, Mehran (US);
KANIA, Robert Steven (US);
NAIR, Sajiv Krishnan (US);
NINKOVIC, Sacha (US);
ORR, Suvi Tuula Marjukka (US);
PALMER, Cynthia Louise (US),
- (74) Shalva Gvaramadze
(85) 2020 10 21
(86) PCT/IB2019/053314, 2019 04 22

- (54) 2-AMINO-PYRIDINE OR 2-AMINO-PYRI-
MIDINE DERIVATIVES AS CYCLIN
DEPENDENT KINASE INHIBITORS

(57) Compound of formula (X):

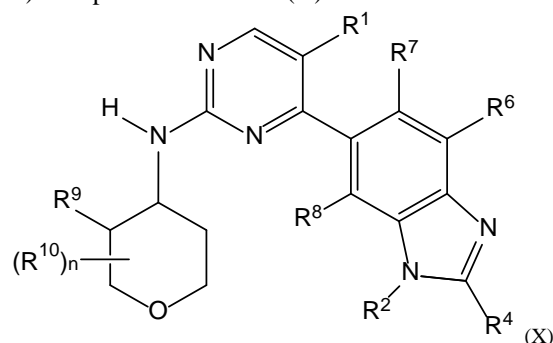

wherein values of R^1 , R^2 , R^4 , R^6 , R^7 , R^8 , R^9 , R^{10}
substitutes, and n variable are provided in the claims
or pharmaceutically acceptable salt or pharmaceutical
composition on the basis thereof, and their usage for
cancer treatment.

Claims: 8 independents

12 dependents

Table: 26

PART B

B 01

- (10) AP 2022 15457 A (51) Int. Cl. (2006)
B 01 J 23/30
B 01 J 23/652
B 01 J 27/188
B 01 J 35/10
B 01 J 37/00
B 01 J 37/02
C 07 C 29/60
C 07 C 31/10
- (21) AP 2019 15457 (22) 2019 02 28
(31) A 50173/2018
(32) 2018 02 28
(33) AT
(71) Omv Refining & Marketing GMBH (AT)
Trabrennstraße 6-8, 1020 Vienna, Austria (AT)
- (72) SCHÖFFL, Paul (AT)
(74) Liliana Darakhvelidze
(85) 2020 09 25
(86) PCT/AT2019/060065, 2019 02 28
- (54) METHOD FOR THE CATALYTIC CONVER-
SION OF GLYCEROL TO PROPANOL
- (57) Present invention relates to a method, device,
catalyst, and method for catalyst producing for
catalytic conversion of substance mixture contain-
ing glycerol to propanol in fixed-bed reactor,
wherein substrates of catalyst have inorganic mate-
rials and/or metal oxides; at that, the substrates

have the pores with the diameters of between 10 and 25 angstroms, preferably between 12 and 20 angstroms, and particularly preferably 15 angstroms, on the surface.

Claims: 5 independents
15 dependents

Fig.: 1

PART C

C 07

- (10) AP 2022 15124 A (51) Int. Cl. (2006)
C 07 F 9/6521
C 07 F 9/6558
- (21) AP 2018 15124 (22) 2018 01 31
(31) 62/453,437; 62/469,912; 62/488,366; 62/575,248
(32) 2017 02 01; 2017 03 10; 2017 04 21; 2017 10 20
(33) US; US; US; US
- (71) Atea Pharmaceuticals, Inc. (US)
125 Summer St., Boston, MA 02110, USA (US)
- (72) MOUSSA, Adel (US);
SOMMADOSSI, Jean-Pierre (US)
- (74) Tamaz Shilakadze
(85) 2019 07 01
(86) PCT/US2018/016301, 2018 01 31
- (54) NUCLEOTIDE HEMI-SULFATE SALT
FOR TREATMENT OF HEPATITIS C
VIRUS
- (57) Present invention relates to nucleic compound hemi-sulfate salt, pharmaceutical composition, and usage therefor the treatment of hepatitis C.

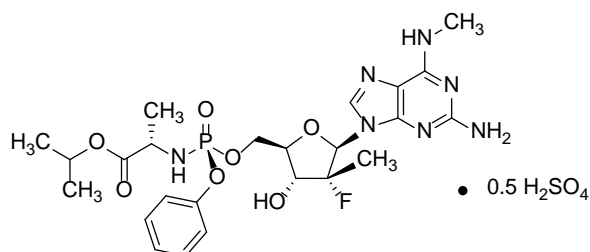

Claims: 45 independents
15 dependents

Fig.: 26

PART G

G 06

- (10) AP 2022 15603 A (51) Int. Cl. (2006)
G 06 N 20/00
- (21) AP 2019 15603 (22) 2019 09 07
(31) 2018-173142
(32) 2018 09 15
(33) JP
- (71) Broadleaf Co., LTD (JP)
4-13-14 Higasi-Shinagawa, Shinagawa-ku,
Tokio 1400002, Japan (JP)
- (72) OYAMA Kenji (JP)
- (74) Shalva Gvaramadze
(85) 2021 04 14
(86) PCT/JP2019/035288, 2019 09 07
- (54) AI CREATION VERIFICATION DEVICE
- (57) Provided is AI creation verification device capable of verifying whether a creation created by means of artificial intelligence actually has been created by artificial intelligence. This AI creation verification device comprises: AI information acquisition unit that acquires, from artificial intelligence device, learning data and program information constituting artificial intelligence; input information acquisition unit that acquires and saves input information for artificial intelligence device; computation unit for using the information acquired by AI information acquisition unit and input information acquisition unit to carry out information processing; and computation result storage unit for storing a creation that has been output as computation result from computation unit.

Claims: 3 independents
5 dependents

Fig.: 9

PATENTED INVENTION

PART B

B 08

- (11) P 2022 7394 B (51) Int. Cl. (2006)
B 08 B 7/00
B 08 B 9/08
- (10) AP 2022 15245 A (44) 2(581)/2022
(21) AP 2018 15245
(22) 2018 05 24
(24) 2018 05 24
(31) 00682/17
(32) 2017 05 24
(33) CH
(86) PCT/EP2018/063618, 2018 05 24
(73) Bang & Clean GMBH (CH)
Bünzweg 15, Othmarsingen, 5504, Switzerland (CH)
(72) BÜRGIN, Markus (CH)
(74) Aleksandre Gegechkori
(54) METHOD AND DEVICE FOR CLEANING
INTERIORS OF CONTAINERS AND
FACILITIES
-

UTILITY MODELS

APPLICATIONS APPROVED FOR GRANTING PATENT

The decision can be appealed at the Chamber of Appeal of Sakpatenti within 3 months from the publication or at the Mtskheta District Court Administrative Cases Board (Address: №17, Samkhedro St., Mtskheta), within 1 month following the publication.

PART B

B 22

- (10) AU 2022 15641 U (51) Int. Cl. (2006)
B 22 F 9/14
B 82 B 3/00
- (21) AU 2021 15641 (22) 2021 05 31
- (71) Shalva Kekutia (GE)
Shartava St. 45a, app. 16, 0160, Tbilisi,
Georgia (GE);
Jano Markhulia (GE)
Chuburkhinji, Gali Region, Georgia (GE);
Vladimer Mikelashvili (GE)
Rustaveli St. 4, Borough Surami, Khashuri
Region, Georgia (GE);
Liana Saneblidze (GE)
Sukhumi, Georgia (GE)
- (72) Shalva Kekutia (GE);
Jano Markhulia (GE);
Jano Markhulia (GE);
Vladimer Mikelashvili (GE);
Liana Saneblidze (GE)
- (54) ELECTROHYDRAULIC DISCHARGE
DEVICE FOR HOMOGENIZATION
OF NANOPARTICLES

(57) Electro-hydraulic discharge device for homogenization of nanoparticles is represented. The device contains heating part the scheme whereof includes an auto-transformer switched to alternating current power supply network with primary coil, and to high-voltage transformer – with secondary coil. The last one is connected to device discharging part passing through diode coil and high-resistance resistor containing high-voltage condenser and working electrodes placed in discharge chamber filled with liquid dispersion system connected in parallel to said transformer, and passing through air-pressure discharger.

Claims: 1 independent

Fig.: 3

PART F

F 24

- (10) AU 2022 15764 U (51) Int. Cl. (2006)
F 24 F 12/00
- (21) AU 2021 15764 (22) 2021 10 20
(31) u 2020 06862
(32) 26 10 2020
(33) UA
- (71) KUZICH, Roman Romanovich (UA)
Vul. Ostrivska, bud. 22, smt. Shchyrets, Lvivska
obl., 79000, Ukraine (UA);
KROTOV, Dmitro Viktorovich (UA)
Vul. Shevchenka, bud. 34, kv. 5m, 79000, Lviv,
Ukraine (UA)
- (72) KUZICH, Roman Romanovich (UA);
KROTOV, Dmitro Viktorovich (UA)

(74) Larisa Amirkhanyan

(54) HEAT RECOVERY VENTILATION SYSTEM
(57) A system includes air-driven recuperator, fan, and heat exchanger interconnected and embedded into building wall between external and internal surfaces thereof, where two direct current concentric cylinders are mounted in a hole, in Ω -shaped cutting the corrugated heater is attached to inner cylinder outer surface, and outer and inner fans are oppositely mounted on cylinder inner surface, as well. Furthermore, system holes are equipped with corresponding inner and outer covers; at that, inner cover is equipped with air inlet grid, and inner air outlet diffuser hole, and outer cover is equipped with condensate drain hole placed out of wall outer surface plane, and air inlet and outlet grids.

Claims: 1 independent

2 dependents

Fig.: 7

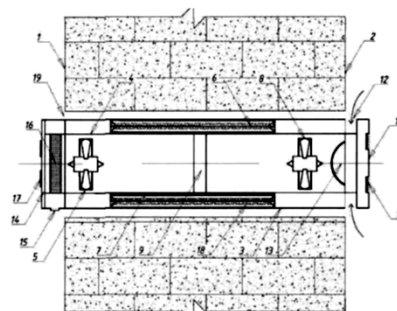

Fig. 1

PATENTED UTILITY MODEL

PART A

A 01

- (11) U 2022 2121 Y (51) Int. Cl. (2006)
A 01 C 3/00
C 02 F 11/04
- (10) AU 2022 15610 U (44) 1(580)/2022
(21) AU 2021 15610
(22) 2021 04 19
(24) 2021 04 19
- (73) Avtandil Bitsadze (GE)
Mukhiani, Aleko Gobronidze Lane 11, 0167,
Tbilisi, Georgia (GE);
Giorgi Akhalbedashvili (GE)
Cholokashvili Str. 3, Kvareli, Georgia (GE)
- (72) Avtandil Bitsadze (GE);
Giorgi Akhalbedashvili (GE)
- (54) TWO-STAGE BIOGAS COMPLEX
HAVING COMBINED HEATING
SYSTEM
-

DESIGNS

APPLICATION APPROVED FOR REGISTRATION

The decision can be appealed at the Chamber of Appeal of Sakpatenti within 3 months from the publication or at the Mtskheta District Court Administrative Cases Board (Address: №17, Samkhedro str., Mtskheta), within 1 month following the publication.

(10) AD 2022 1261 S (51) 32-00

(21) AD 2022 1261 (22) 2022 03 18

(28) 4

(71) LLC "Arcon" (GE)

Gorgasali Str. 51-53, 0114, Krtsanisi District, Tbilisi, Georgia (GE)

(72) Valerian Vardania (GE)

(74) Davit Dzamukashvili (GE)

(54) 1.-4. GRAPHICAL SYMBOL

(55)

1.1 

2.1 

3.1 

REGISTERED DESIGN

- (11) D 2022 938 S (51) 27-05
(10) AD 2022 1235 S (44) 2022 02 25 №4
(21) AD 2021 1235
(22) 2021 08 16
(24) 2021 08 16
(28) 8
(18) 2026 08 16
(73) Mikheil Khukhashvili (GE)
L. Asatiani St. 32, 0105, Tbilisi, Georgia (GE);
Vazha Dolaberidze (GE)
Didi Kheivani 21a, 0114, Tbilisi, Georgia (GE)
(72) Vazha Dolaberidze (GE);
Mikheil Khukhashvili (GE)
(74) Tamaz Shilakadze (GE)
(54) LIGHTER
-

DESIGNS, WHICH HAVE BEEN REGISTERED WITH THE INTERNATIONAL BUREAU CLAIMING PRIORITY ON THE TERRITORY OF GEORGIA

The decision can be appealed at the Chamber of Appeal of Sakpatenti within 3 months from the publication or at the Mtskheta District Court Administrative Cases Board (Address: №17, Samkhedro St., Mtskheta), within 1 month following the publication.

- (11) DM/220 599 (51) 02-07
 (15) 2020 09 24 (44) 19/2022 (2022 05 13)
 (22) 2020 09 24
 (28) 1
 (73) Sabine Abbou
 3 Avenue Bugeaud, 75116 Paris (FR)
 (85) –
 (86) FR
 (87) –
 (88) –
 (89) FR
 (81) II. MA III. AL, AM, AZ, BA, BN, BW, BZ, CA, CH, EG, EM, GB, GE, GH, IL, IS, JP, KG, KH, KP, KR, LI, MC, MD, ME, MK, MN, MX, NA, NO, OA, OM, RS, RU, RW, SG, SM, SR, ST, SY, TJ, TM, TN, TR, UA, US, VN, WS
 (72) Didit Hediprasetyo
 Jl. Situbondo, No. 20 Menteng, Jakarta Pusat, 10310, Jakarta (ID)
 (46) 13 05 2022
 (54) 1. Fashion accessory made of fabric with a long scarf having openings at the ends
 (55)

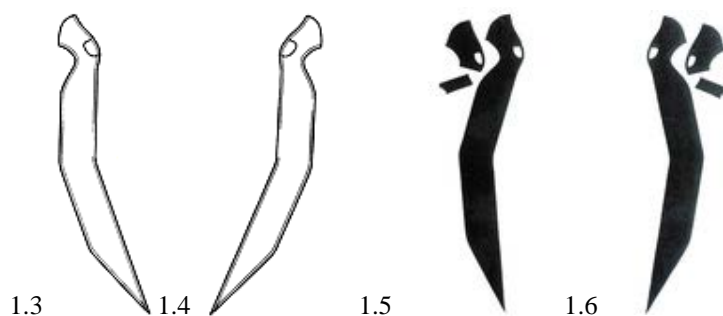
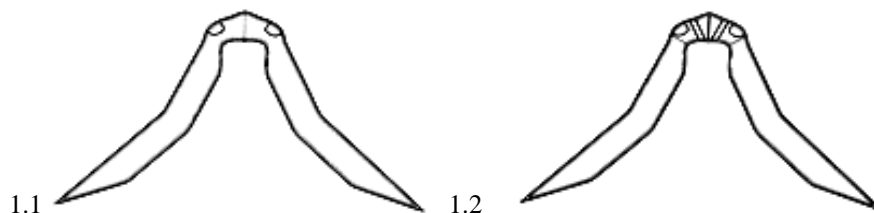

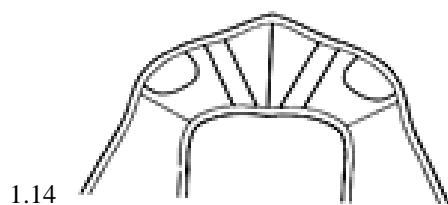

- (11) DM/217 407 (51) 10-02
(15) 2021 11 09 (44) 19/2022 (2022 05 13)
(22) 2021 11 09
(28) 1
(73) HARRY WINSTON SA
Chemin Du Tourbillon 8, 1228 Plan-les-Ouates (CH)
(85) CH
(86) CH
(87) CH
(88) CH
(89) CH
(81) II. MA III. AL, AM, AZ, BA, BZ, CA, CH, EM, GB, GE, KG, LI, MC, MD, ME, MK, MN, NO, OM, RU,
SG, TN, TR, UA
(72) Tobias S WUEST
C/o Harry Winston Inc. 718 Fifth Avenue, 10019, New York (US)
(74) The Swatch Group AG (The Swatch Group SA) (The Swatch Group Ltd.)
Faubourg Du Lac 6, 2501 Biel/Bienne (CH)
(54) 1. Watch with bracelet
(55)



1.1



1.2



1.3



1.4



1.5



1.6



1.7



1.8

- (11) DM/217 400 (51) 11-01
 (15) 2021 11 12 (44) 19/2022 (2022 05 13)
 (22) 2021 11 12
 (28) 9
 (73) HARRY WINSTON SA
 Chemin Du Tourbillon 8, 1228 Plan-les-Ouates (CH)
 (85) CH
 (86) CH
 (87) CH
 (88) CH
 (89) CH
 (81) II. MA III. AL, AM, AZ, BA, BZ, CA, CH, EM, GB, GE, KG, LI, MC, MD, ME, MK, MN, NO, OM, SG,
 TN, TR, UA
 (72) 1; 4-9 Tobias WUEST
 C/o Harry Winston Inc. 718 Fifth Avenue, 10019, New York (US);
 2-3 Delphine ABDOURAHIM
 C/o Harry Winston Inc. 718 Fifth Avenue, 10019, New York (US)
 (74) The Swatch Group AG (The Swatch Group SA) (The Swatch Group Ltd.)
 Faubourg Du Lac 6, 2501 Biel/Bienne (CH)
 (54) 1. Pair of earrings, 2. Pair of earrings, 3. Necklace, 4. Necklace, 5. Pair of earrings, 6. Finger ring, 7. Necklace,
 8. Pair of earrings, 9. Finger ring
 (55)

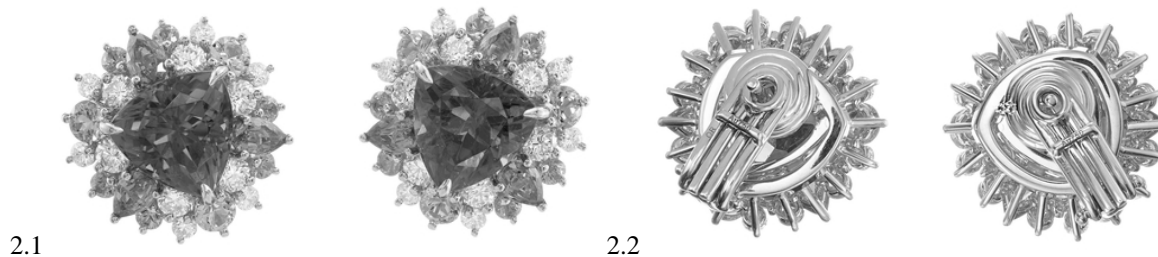



2.3



2.4



2.5



2.6



2.7



2.8



3.1



3.2



3.3



3.4



3.5



3.6



3.7



3.8



4.1



4.2



4.3



4.4



4.5



4.6



4.7



4.8



5.1



5.2



5.3

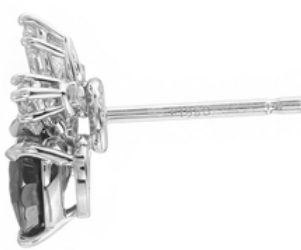

5.4



5.5



5.6



5.7



5.8



6.1



6.2



6.3



6.4



6.5



6.6



6.7



6.8



7.1



7.2



7.3



7.4



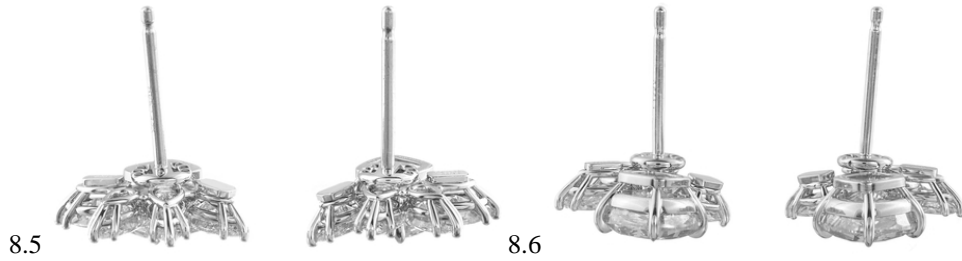
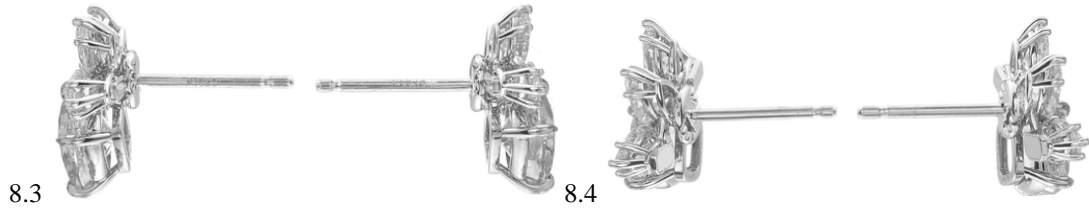

- (11) DM/217 557 (51) 11-01
 (15) 2021 11 18 (44) 20/2022 (2022 05 20)
 (22) 2021 11 18
 (28) 3
 (73) HARRY WINSTON SA
 Chemin Du Tourbillon 8, 1228 Plan-les-Ouates (CH)
 (85) CH
 (86) CH
 (87) CH
 (88) CH
 (89) CH
 (81) II. MA III. AL, AM, AZ, BA, BZ, CA, CH, EM, GB, GE, KG, LI, MC, MD, ME, MK, MN, NO, OM, SG,
 TN, TR, UA
 (72) 1-2 Rie YATSUGI-KANG
 C/o Harry Winston Inc. 718 Fifth Avenue, 10019, New York, NY (US);
 3 Dominique RIVIERE
 C/o Harry Winston Inc. 718 Fifth Avenue, 10019, New York, NY (US)
 (74) The Swatch Group AG (The Swatch Group SA) (The Swatch Group Ltd.)
 Faubourg Du Lac 6, 2501 Biel/Bienne (CH)
 (54) 1. Necklace, 2. Pair of earrings, 3. Finger ring
 (55)



1.1

1.2



1.3



1.4

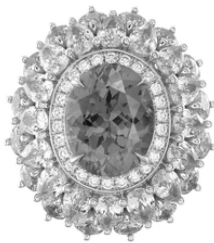



3.1



3.2



3.3



3.4



3.5



3.6



3.7



3.8

- (11) DM/217 732 (51) 14-01
 (15) 2021 11 18 (44) 20/2022 (2022 05 20)
 (22) 2021 11 18
 (28) 1
 (73) Audio Technology Switzerland SA
 Chemin de l'Orio 30A, 1032 Romanel-sur-Lausanne (CH)
 (85) CH
 (86) CH
 (87) CH
 (88) CH
 (89) CH
 (81) II. BJ, CI, GA, GR, IT, MA, ML, NE, SN III. AL, AM, AZ, BA, BG, BN, BW, BX, BY, BZ, CA, CH, DE, DK, EE, EG, EM, ES, FI, FR, GB, GE, GH, HR, HU, IL, IS, JP, KG, KH, KP, KR, LI, LT, LV, MC, MD, ME, MK, MN, MX, NA, NO, OA, OM, PL, RO, RS, RU, RW, SG, SI, SM, SR, ST, SY, TJ, TN, TR, UA, US, VN, WS
 (72) Loïc RAY
 c/o Audio Technology Switzerland SA Ch. de l'Orio 30A, 1032, Romanel-sur-Lausanne (CH);
 Tiago Figueiredo
 c/o Audio Technology Switzerland SA Ch. de L'Orio 30A, 1032, Romanel-sur-Lausanne (CH);
 Stéphane Baetzner
 c/o Audio Technology Switzerland SA Ch. de l'Orio 30A, 1032, Romanel-sur-Lausanne (CH)
 (74) IP Partners J. Wenger
 rte Des Avouillons 9, 1196 Gland (CH)
 (54) 1. Record player
 (55)

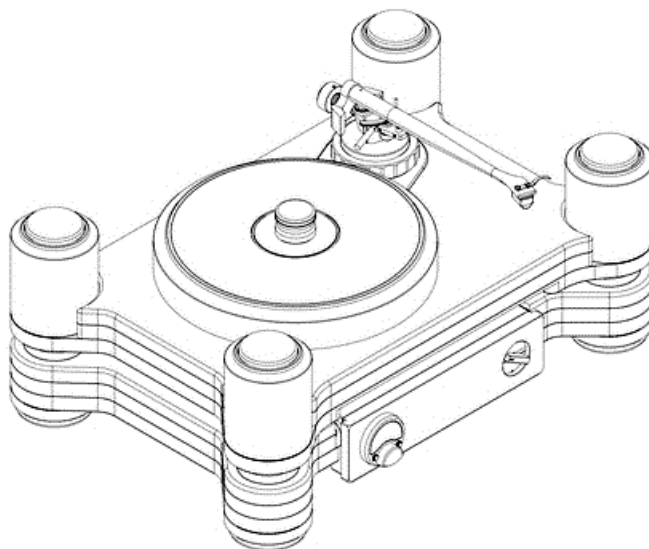

1.1

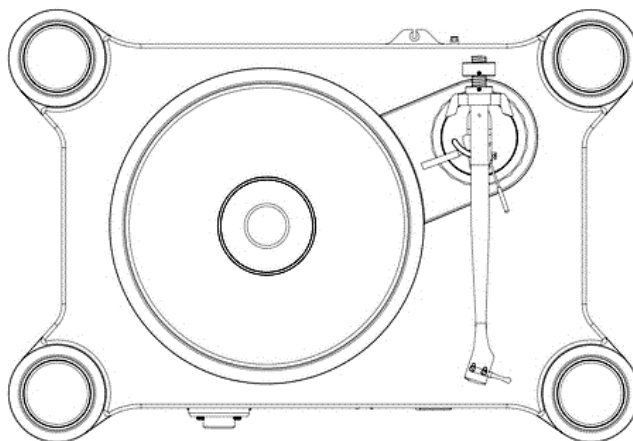

1.2

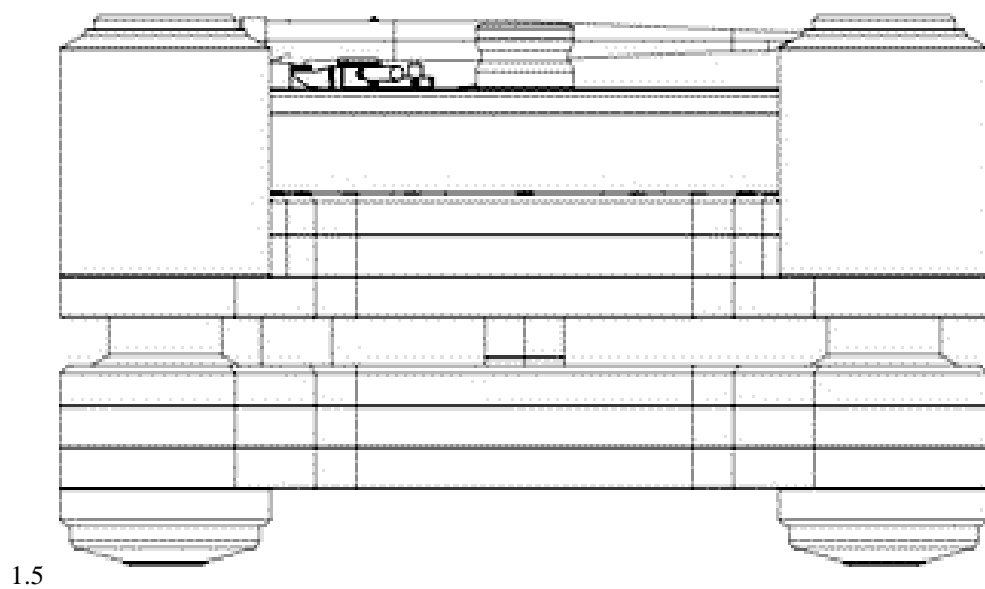
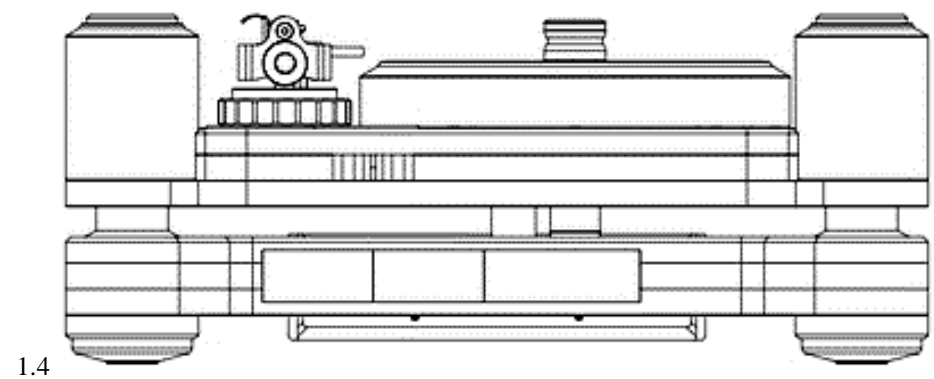
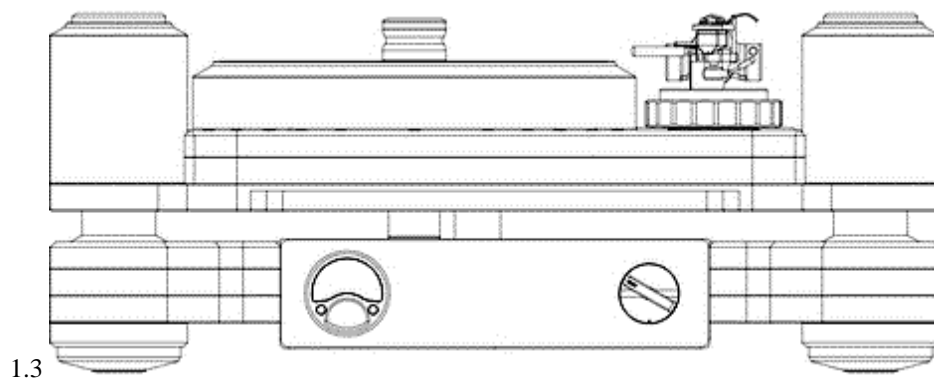

(11) DM/217 628

(51) 10-02

(15) 2021 11 26

(44) 21/2022 (2022 05 27)

(22) 2021 11 26

(28) 1

(73) Montres Breguet SA (Montres Breguet AG) (Montres Breguet Ltd)

Place De La Tour 23, 1344 L'Abbaye (CH)

(85) CH

(86) CH

(87) CH

(88) CH

(89) CH

(81) II. MA III. AL, AM, AZ, BA, BZ, CH, EM, GB, GE, KG, LI, MC, MD, ME, MK, MN, MX, NO, OM, RU, SG, TN, TR, UA

(72) Vincenzo Laucella

C/o Montres Breguet SA (Montres Breguet AG) (Montres Breguet Ltd), Place De La Tour 23, 1344, L'Abbaye (CH)

(74) The Swatch Group SA (The Swatch Group AG) (The Swatch Group Ltd.)

Faubourg Du Lac 6, 2501 Biel / Bienne (CH)

(54) 1. Watch

(55)



1.1

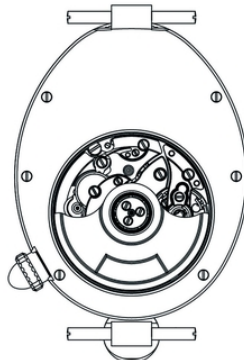

1.2

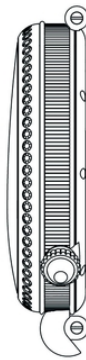

1.3



1.4

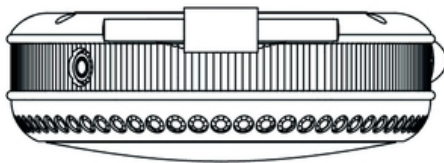

1.5

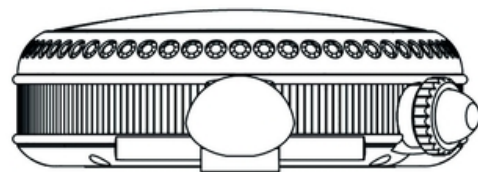

1.6

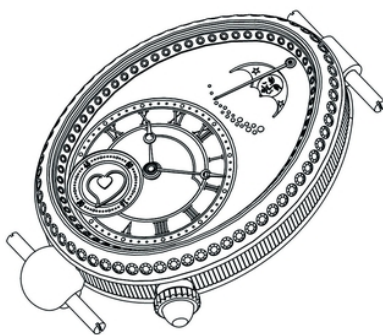

1.7

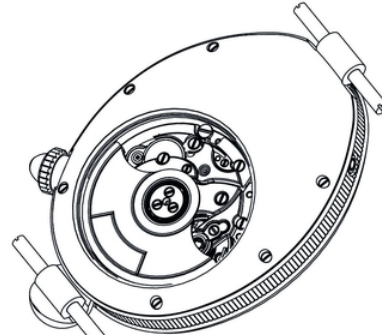

1.8

(11) DM/217 627

(51) 11-01

(15) 2021 11 26

(44) 21/2022 (2022 05 27)

(22) 2021 11 26

(28) 2

(73) HARRY WINSTON SA

Chemin du Tourbillon 8, 1228 Plan-les-Ouates (CH)

(85) CH

(86) CH

(87) CH

(88) CH

(89) CH

(81) IL, MA III, AL, AM, AZ, BA, BZ, CA, CH, EM, GB, GE, KG, LI, MC, MD, ME, MK, MN, NO, OM, SG, TN, TR, UA

(72) Tobias WUEST

c/o Harry Winston Inc. 718 Fifth Avenue, 10019, New York (US)

(74) The Swatch Group AG (The Swatch Group SA) (The Swatch Group Ltd.)

Faubourg du Lac 6, 2501 Biel/Bienne (CH)

(54) 1.-2. Finger ring

(55)



- (11) DM/218 436 (51) 23-07
 (15) 2021 01 13 (44) 21/2022 (2022 05 27)
 (22) 2022 01 13
 (28) 1
 (30) No1: 15.07.2021; 67331; IL
 (73) Roy Shimon MELLUL
 24 Bar Ilan Street, 7241401 Ramla (IL);
 Moshe ZIKVASHVILI
 16A Haim Landau Street, 7228606 Ramla (IL);
 Dorel AZULAY
 705 HaShaked Street, 3061969 Or Akiva (IL);
 Avi REUVEN
 3 HaOren Street, 7683800 Yashresh (IL);
 Reuven ZION
 19 Hazan Street, 7546324 Rishon Le Zion (IL)
 (85) IL; IL; IL; IL; IL
 (86) IL; IL; IL; IL; IL
 (87) IL; IL; IL; IL; IL
 (88) IL; IL; IL; IL; IL
 (89) IL; IL; IL; IL; IL
 (81) III. AM, BA, CA, CH, EM, GB, GE, IS, JP, KR, LI, MC, ME, MX, NO, RS, RU, SG, SM, TR, UA, US
 (72) Reuven ZION
 19 Hazan Street, 7546324 Rishon Le Zion (IL);
 Avi REUVEN
 3 HaOren Street, 7683800 Yashresh (IL);
 Dorel AZULAY
 705 HaShaked Street, 3061969 Or Akiva (IL);
 Moshe ZIKVASHVILI
 16A Haim Landau Street, 7228606 Ramla (IL);
 Roy Shimon MELLUL
 24 Bar Ilan Street, 7241401 Ramla (IL)
 (74) G. E. Ehrlich (1995) Ltd.
 The Rogovin-Tidhar Tower, 15th Floor 11 Menachem Begin Road, 5268104 Ramat Gan (IL)
 (46) 2022 01 28
 (54) I. Cover for a built-in toilet cistern
 (55)

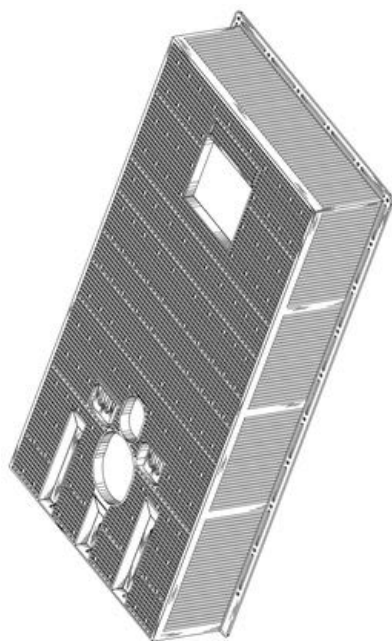

1.1

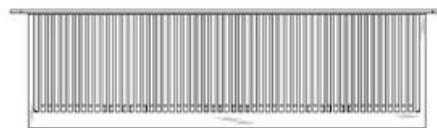

1.2

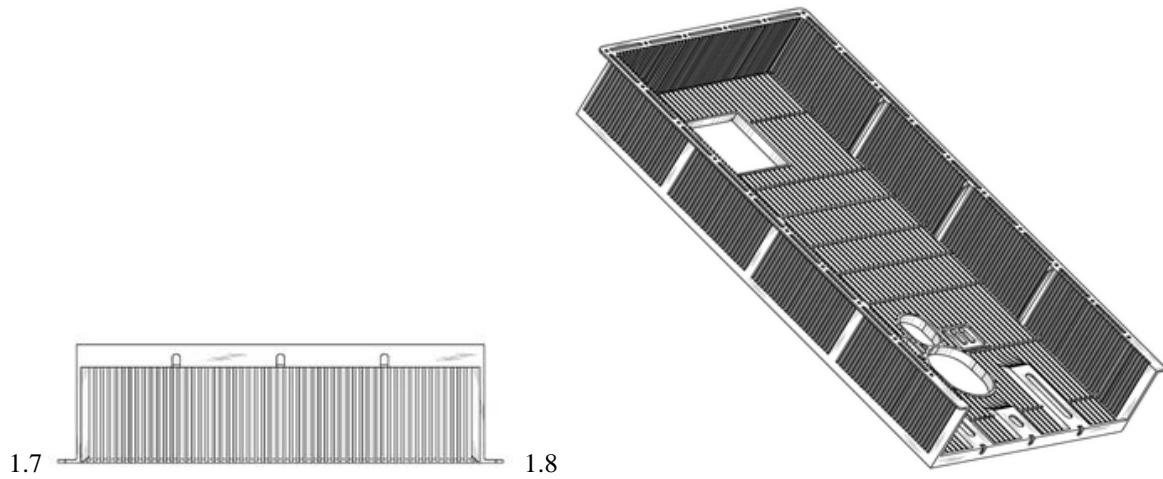
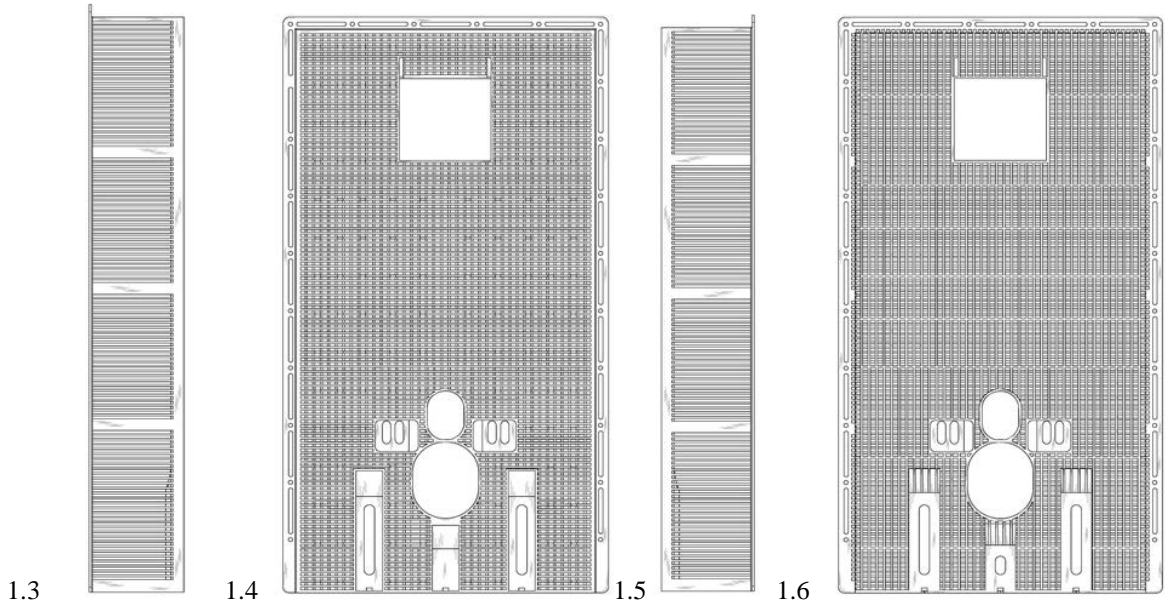

TRADEMARKS

APPLICATIONS FILED UNDER THE NATIONAL PROCEDURE APPROVED FOR REGISTRATION

The decision can be appealed at the Chamber of Appeal of Sakpatenti within 3 months from the publication or at the Mtskheta District Court Administrative Cases Board (Address: №17, Samkhedro St., Mtskheta), within 1 month following the publication.

(260) AM 2022 115126 A
(210) AM 115126
(220) 2021 10 28
(731) Giorgi Chikhladze
N. Kipshidze St. 2, 0162, Tbilisi, Georgia
(540)

კანტონები



(591) Black-white
(531) 26.01.01; 26.01.04
(526) კანტონები
(511) 31, 33

(260) AM 2022 115338 A
(210) AM 115338
(220) 2021 11 10
(731) LTD "UV Print"
Kukuri Gogiashvili St., I Lane 2, 0131, Tbilisi,
Georgia
(540)

UV print
PRINTED IN GEORGIA

(591) Black, red
(531) 26.11.08; 27.05.01; 27.05.10; 27.05.11;
27.05.22; 28.19; 29.01.12
(526) GEORGIA
(511) 35, 40

(260) AM 2022 115350 A
(210) AM 115350
(220) 2021 11 11
(731) LLC "Sairme Resort"
Hotel Sairme, 1000, Resort Sairme, Baghdati
Municipality, Georgia
(740) Giorgi Kartvelishvili

(540)



SAIRME
Hotels & Resorts

(591) Blue, sky-blue, yellow, green, black, white
(531) 01.15.15; 05.01.01; 21.03.21; 26.01.05;
26.03.02; 26.03.23; 26.04.01; 26.04.02;
26.04.09; 27.05.01; 27.05.10; 29.01.15
(526) SAIRME
(511) 35, 43

(260) AM 2022 115351 A
(210) AM 115351
(220) 2021 11 11
(731) LLC "Sairme Resort"
Hotel Sairme, 1000, Resort Sairme, Baghdati
Municipality, Georgia
(740) Giorgi Kartvelishvili
(540)



(591) Black-white
(531) 03.04.07; 24.01.03; 24.01.07; 26.04.02;
26.04.22; 26.04.24; 27.05.24
(526) SAIRME
(511) 35, 43

(260) AM 2022 115517 A
 (210) AM 115517
 (220) 2021 11 23
 (310) 36677
 (320) 2021 11 16
 (330) AD
 (731) Philip Morris Products S.A.
 Quai Jeanrenaud 3, 2000 Neuchâtel,
 Switzerland

(740) Pavle Meipariani
 (540)

blends for **bonds**

(591) Black-white
 (531) 27.05.01; 27.05.10
 (511) 34

(260) AM 2022 115525 A
 (210) AM 115525
 (220) 2021 11 24
 (731) Troikaa Pharmaceuticals Ltd
 Commerce House 1, Satya Marg, Bodakdev,
 Ahmedabad, Gujarat 380054, India

(740) Giorgi Taktakishvili
 (540)

ISOTROY

(591) Black-white
 (511) 5

(260) AM 2022 115526 A
 (210) AM 115526
 (220) 2021 11 24
 (731) Troikaa Pharmaceuticals Ltd
 Commerce House 1, Satya Marg, Bodakdev,
 Ahmedabad, Gujarat 380054, India

(740) Giorgi Taktakishvili
 (540)

SEVOTROY

(591) Black-white
 (511) 5

(260) AM 2022 115529 A
 (210) AM 115529
 (220) 2021 11 25
 (310) 36046
 (320) 2021 06 09
 (330) AD
 (731) Philip Morris Brands Sàrl
 Quai Jeanrenaud 3, 2000 Neuchâtel,
 Switzerland
 (740) Pavle Meipariani

(540)

**PARLIAMENT
 ORIENTAL FUSION**

(591) Black-white
 (511) 34

(260) AM 2022 115602 A
 (210) AM 115602
 (220) 2021 11 30
 (731) Snowy Mountains
 Vazisubani Settlement, bld. 18a, app. 11,
 Isani-Samgori District, Tbilisi, Georgia

(540)



(591) Black-white
 (531) 06.01.04; 14.09.05; 27.05.01
 (511) 25, 35

(260) AM 2022 115604 A
 (210) AM 115604
 (220) 2021 12 01
 (731) LTD "Medarsi"
 Otar Lortkipanidze St. 32, app. 41, 0114,
 Tbilisi, Georgia

(540)



(591) Red, white
 (531) 02.09.15; 24.13.01; 24.13.13; 24.13.14;
 24.13.17; 27.05.01; 27.05.24; 29.01.12
 (511) 44

(260) AM 2022 115672 A
 (210) AM 115672
 (220) 2021 12 04
 (731) LTD "AD Media"
 Kukuri Gogiasvili St., I Lane 2, 0131, Tbilisi,
 Georgia
 (540)

AD media

(591) Morengo, blue, white
 (531) 27.05.22; 29.01.12
 (511) 6, 16, 17, 19, 35

(260) AM 2022 115673 A
 (210) AM 115673
 (220) 2021 12 04

(731) LTD "პროვაიდერ.ჯი Provider.GE"
 I. Noneshvili St. 60, app. 27, 6000, Batumi,
 Georgia

(540)



(591) 1AF2DC light sky-blue, F20707 red,
 F7A50E orange
 (531) 11.01.03; 11.01.04; 11.01.05; 11.03.02;
 11.03.06; 11.03.20; 11.03.23; 12.01.02;
 12.01.03; 27.05.01; 27.05.11; 29.01.15
 (511) 3

(260) AM 2022 115674 A
 (210) AM 115674
 (220) 2021 12 06

(731) LTD "Onway"
 Kiri St. 7, 0101, Tbilisi, Georgia

(740) Zurab Bezhashvili
 (540)



(591) Black, white, lilac
 (531) 27.01.06; 27.05.01; 29.01.12
 (511) 39

(260) AM 2022 115681 A
 (210) AM 115681
 (220) 2021 12 07

(731) The Coca-Cola Company
 One Coca-Cola Plaza, Atlanta, Georgia 30313,
 USA

(740) Giorgi Taktakishvili
 (540)



(591) Black-white
 (531) 28.19
 (511) 32

(260) AM 2022 115682 A
 (210) AM 115682
 (220) 2021 12 07
 (731) LTD "Nutrimax"

L. Ghoghoberidze St. 67b, 0165, Tbilisi
 Georgia

(540)



(591) Black-white
 (531) 03.04.18; 28.19
 (511) 31

(260) AM 2022 115685 A
 (210) AM 115685
 (220) 2021 12 08

(731) United States Polo Association
 1400 Centrepark Blvd., Suite 200, 33401
 West Palm Beach, Florida, USA

(740) Tamaz Shilakadze
 (540)



(591) Black-white
 (531) 02.01.08; 02.01.20; 02.01.21; 03.03.01;
 21.03.07; 21.03.25
 (511) 18, 25

(260) AM 2022 115695 A
 (210) AM 115695
 (220) 2021 12 09

(731) LTD "Hazu"
 Vill. Variani, Gori Region, Georgia

(540)



(591) Blue, golden
 (531) 01.01.05; 01.01.10; 01.11.08; 04.01.04;
 27.05.04; 29.01.12
 (511) 32

(260) AM 2022 115743 A
 (210) AM 115743
 (220) 2021 12 10
 (731) LTD "Bikentias Saqababe"
 Tsisperkantselebi St. 9, 4600, Kutaisi, Georgia
 (540)

ბიკენტის საკაბაბე

(591) Black-white
 (511) 43

(260) AM 2022 115745 A
 (210) AM 115745
 (220) 2021 12 12
 (731) LLC "Digital Platform"
 16 Nestan-Darejan St. 16, Vill. Dighomi,
 Tbilisi, Georgia
 (540)



(591) White, pink, blue, black
 (531) 26.11.03; 26.11.05; 26.11.08; 27.01.25;
 27.05.01; 27.05.21; 29.01.14
 (511) 35, 36

(260) AM 2022 115749 A
 (210) AM 115749
 (220) 2021 12 14
 (731) Alkaloid AD Skopje
 Blvd. Aleksandar Makedonski 12, 1000
 Skopje, The Republic of North Macedonia
 (740) Shalva Gvaramadze
 (540)

LIRTONEN

(591) Black-white
 (511) 5

(260) AM 2022 115750 A
 (210) AM 115750
 (220) 2021 12 14
 (731) Alkaloid AD Skopje
 Blvd. Aleksandar Makedonski 12, 1000
 Skopje, The Republic of North Macedonia
 (740) Shalva Gvaramadze
 (540)

ЛИРТОЕН

(591) Black-white
 (511) 5

(260) AM 2022 115752 A
 (210) AM 115752
 (220) 2021 12 14
 (731) Davit Kiria
 Baratashvili St. 9, Vill. Ingiri, Zugdidi,
 Georgia
 (740) Irakli Gvilia
 (540)

Max Fight League

(591) Black-white
 (511) 35, 41

(260) AM 2022 115753 A
 (210) AM 115753
 (220) 2021 12 15
 (731) Guohua He
 Room 1801, Unit 5, Building 3, Bolanggu
 Garden, Niansanli Street, Yiwu, Zhejiang
 322000, People Republic of China
 (740) Giorgi Kartvelishvili
 (540)

MÖTARRO

(591) Black-white
 (531) 27.05.07
 (511) 16

(260) AM 2022 115756 A
 (210) AM 115756
 (220) 2021 12 15
 (731) Zongshen Industrial Group Co., Ltd
 Chaoyouchang, Huaxizhen, Bananqu,
 Chongqing, People Republic of China
 (740) Shalva Gvaramadze
 (540)



(591) Black, white, grey
 (531) 03.07.17; 24.11.25; 27.05.02
 (511) 12

(260) AM 2022 115757 A
 (210) AM 115757
 (220) 2021 12 16
 (731) Irakli Bitskinashvili
 Mosashvili St. 8, 2200, Telavi, Georgia

(540)

New Yorker
ნოუ იორკერი

(591) Black-white
(511) 32, 33

(260) AM 2022 115760 A
(210) AM 115760
(220) 2021 12 16
(310) 1463677
(320) 2021 06 30
(330) CL
(731) The Coca-Cola Company
One Coca-Cola Plaza, Atlanta, Georgia,
30313, USA
(740) Giorgi Taktakishvili
(540)



(591) Black-white
(531) 26.04.02; 26.04.05; 26.04.12; 26.04.22;
26.04.24; 26.11.12; 27.05.01; 27.05.09;
27.05.10; 27.05.19; 27.05.24
(511) 32

(260) AM 2022 115761 A
(210) AM 115761
(220) 2021 12 16
(310) 1463676
(320) 2021 06 30
(330) CL
(731) The Coca-Cola Company
One Coca-Cola Plaza, Atlanta, Georgia,
30313, USA
(740) Giorgi Taktakishvili
(540)



(591) Black-white

(531) 26.04.02; 26.04.05; 26.04.12; 26.04.22;
26.04.24; 26.11.12
(511) 32

(260) AM 2022 115763 A
(210) AM 115763
(220) 2021 12 17
(731) Colgate-Palmolive Company
Delaware Corporation
300 Park Avenue, New York, New York
10022, USA
(740) Tamaz Shilakadze
(540)

FEEL FREE

(591) Black-white
(511) 3

(260) AM 2022 115841 A
(210) AM 115841
(220) 2021 12 17
(731) Colgate-Palmolive Company
Delaware Corporation
300 Park Avenue, New York, New York
10022, USA
(740) Tamaz Shilakadze
(540)

FEEL ATTRACTIVE

(591) Black-white
(511) 3

(260) AM 2022 115844 A
(210) AM 115844
(220) 2021 12 17
(731) LTD "Partner"
Eprem Zakaraia St., I Lane 14, 0101, Tbilisi,
Georgia
(540)

MASTER BUILD



(591) FFFFFFF white, 000000 black
(531) 25.07.15; 25.07.20; 26.04.12; 26.11.12;
27.05.01; 27.05.17
(511) 19, 37

(260) AM 2022 115845 A
(210) AM 115845
(220) 2021 12 17
(731) LTD "Partner"
Eprem Zakaraia St., I Lane 14, 0101, Tbilisi,
Georgia

(540)

LEADER FIX

(591) FFFFFFF white, 000000 black

(531) 25.07.15; 25.07.20; 26.04.12; 27.05.01;
27.05.17

(511) 19, 37

(260) AM 2022 115859 A

(210) AM 115859

(220) 2021 12 21

(731) N(N)LE "Georgian Rugby Union"
Chabua Amirejibi Highway 6, Point 6.00,
Office 3, 0179, Tbilisi, Georgia

(540)



(591) Black-white

(531) 03.01.01; 03.01.02; 03.01.16

(511) 25, 28, 33, 36, 41

(260) AM 2022 115861 A

(210) AM 115861

(220) 2021 12 21

(731) N(N)LE "Georgian Rugby Union"
Chabua Amirejibi Highway 6, Point 6.00,
Office 3, 0179, Tbilisi, Georgia

(540)



(591) Black, white, red

(531) 23.01.01; 28.19; 29.01.13

(511) 25, 28, 32, 33, 35, 36, 41

(260) AM 2022 115862 A

(210) AM 115862

(220) 2021 12 21

(731) N(N)LE "Georgian Rugby Union"
Chabua Amirejibi Highway 6, Point 6.00,
Office 3, 0179, Tbilisi, Georgia

(540)

რადიო ჩვენი თამაშის

(591) Black-white

(511) 25, 28, 32, 33, 35, 36, 41

(260) AM 2022 115864 A

(210) AM 115864

(220) 2021 12 21

(310) 083697

(320) 2021 07 02

(330) JM

(731) Rivian IP Holdings LLC
13250 N. Haggerty Road, Plymouth,
Michigan 48170, USA

(740) Tamaz Shilakadze

(540)

INDER

(591) Black-white

(511) 7, 9, 12, 37, 42

(260) AM 2022 115880 A

(210) AM 115880

(220) 2021 12 22

(731) MYR GmbH
Hessenring 89, Bad Homburg, 61348,
Germany

(740) Natela Otariidze

(540)

Гепклудекс

(591) Black-white

(511) 5

(260) AM 2022 115884 A

(210) AM 115884

(220) 2021 12 22

(731) Decathlon
4, boulevard de Mons, 59650 Villeneuve
d'Ascq, France

(540)

DECATHLON

(591) Black-white

(531) 27.05.01

(511) 35, 41

(260) AM 2022 115891 A
 (210) AM 115891
 (220) 2021 12 23
 (731) Zhengzhou Yutong Group Co., Ltd
 No. 8 Changchun Road, Hi-Tech Industrial
 Park, Zhengzhou, People Republic of China
 (740) Giorgi Kartvelishvili
 (540)

YUTONG

(591) Black-white
 (511) 7

(260) AM 2022 115892 A
 (210) AM 115892
 (220) 2021 12 23
 (731) Zhengzhou Yutong Group Co., Ltd
 No. 8 Changchun Road, Hi-Tech Industrial
 Park, Zhengzhou, People Republic of China
 (740) Giorgi Kartvelishvili
 (540)



(591) Black-white
 (531) 26.02.07
 (511) 7

(260) AM 2022 115893 A
 (210) AM 115893
 (220) 2021 12 23
 (731) Yutong Bus Co., Ltd
 Yutong Road, Guancheng District,
 Zhengzhou, People Republic of China
 (740) Giorgi Kartvelishvili
 (540)

宇通

(591) Black-white
 (531) 28.03
 (511) 37

(260) AM 2022 115894 A
 (210) AM 115894
 (220) 2021 12 23
 (731) Yutong Bus Co., Ltd
 Yutong Road, Guancheng District,
 Zhengzhou, People Republic of China

(740) Giorgi Kartvelishvili
 (540)

YUTONG

(591) Black-white
 (511) 37

(260) AM 2022 115895 A
 (210) AM 115895
 (220) 2021 12 23
 (731) Yutong Bus Co., Ltd
 Yutong Road, Guancheng District,
 Zhengzhou, People Republic of China
 (740) Giorgi Kartvelishvili
 (540)



(591) Black-white
 (531) 26.02.07
 (511) 37

(260) AM 2022 115900 A
 (210) AM 115900
 (220) 2021 12 23
 (731) LTD "Khod"
 11 St. 4, Vill. Karajala, Telavi, Georgia
 (540)

HAUZER

(591) Black-white
 (511) 35, 39

(260) AM 2022 115902 A
 (210) AM 115902
 (220) 2021 12 23
 (731) LTD "Ortomeli"
 Vazha-Pshavela Av., II qu., bld. 34, Vake-
 Saburtalo District, Tbilisi, Georgia
 (540)

**ორთომელი
 ортомели**

(591) Black-white
 (511) 33

(260) AM 2022 115969 A
 (210) AM 115969
 (220) 2021 12 24
 (731) LTD "Gallery Tbilisi"
 Rustaveli Av. 2/4, (plot 65/003), 0108, Tbilisi,
 Georgia

(740) Giorgi Taktakishvili

(540)



(591) Black-white

(531) 28.19

(511) 9, 16, 25, 35

(260) AM 2022 115970 A

(210) AM 115970

(220) 2021 12 24

(731) LTD "Gallery Tbilisi"

Rustaveli Av. 2/4, (plot 65/003), 0108, Tbilisi,
Georgia

(740) Giorgi Taktakishvili

(540)



(591) Black-white

(531) 27.05.01

(511) 9, 16, 25, 35

(260) AM 2022 115971 A

(210) AM 115971

(220) 2021 12 24

(731) ITV Studios Netherlands Content B.V.

Koos Postemalaan 8, 1217 ZC Hilversum,
Netherlands

(740) Tamaz Shilakadze

(540)



(591) Black, white, grey

(531) 02.09.14; 02.09.15; 16.01.13; 27.05.02

(526) საქართველო

(511) 9, 41

(260) AM 2022 115985 A

(210) AM 115985

(220) 2021 12 28

(731) Ashtel LLC

Suite 103, Alain Ahlia Insurance Bldg, Frij
Murar, Dubai, 89599, United Arab Emirates

(740) Nino Gazdeliani

(540)



(591) Black-white

(531) 27.05.01; 27.05.17

(511) 9

(260) AM 2022 115986 A

(210) AM 115986

(220) 2021 12 28

(731) Ashtel LLC

Suite 103, Alain Ahlia Insurance Bldg, Frij
Murar, Dubai, 89599, United Arab Emirates

(740) Nino Gazdeliani

(540)



(591) Black-white

(531) 27.05.01; 27.05.17

(511) 9

(260) AM 2022 115988 A

(210) AM 115988

(220) 2021 12 28

(731) LLC "Alazani Winery"

Demetre Tavdadebuli St. 3, 4800, Kvareli,
Georgia

(740) Giorgi Kartvelishvili

(540)



(591) Dark blue, blue, white, black

(531) 19.07.01; 19.07.16; 29.01.13

(511) 33

(260) AM 2022 116161 A
(210) AM 116161
(220) 2022 01 12
(731) LTD "Georgian Wine House"
Vill. Zegaani, 1500, Gurjaani, Georgia
(740) Sopio Vacheishvili
(540)

პეპელა
Репела
Пепела

(591) Black-white
(511) 33

(260) AM 2022 116313 A
(210) AM 116313
(220) 2022 01 24
(731) British American Tobacco (Brands) Inc.
(a Delaware corporation)
251 Little Falls Drive, Suite 100, Wilmington,
Delaware, 19808-1674, USA
(740) Tamar Kochlamazashvili
(540)

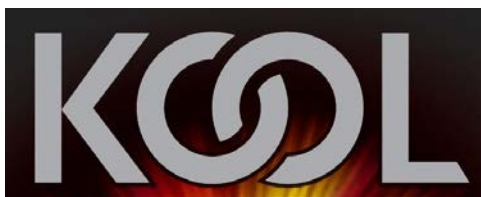

(591) Black, grey, red, yellow
(531) 26.01.01; 26.01.06; 27.01.01; 27.01.06;
29.01.14
(511) 34

REGISTERED TRADEMARKS

(111) M 2022 35630 R
 (151) 2022 06 24
 (181) 2032 06 24
 (260) AM 2021 110210 A
 (220) 2021 08 19
 (732) LTD "Vili"
 Zurab and Teimuraz Zaldastanishvili St. 16,
 Commercial Space 5, fl. 1, Saburtalo District,
 Tbilisi, Georgia

(111) M 2022 35631 R
 (151) 2022 06 24
 (181) 2032 06 24
 (260) AM 2021 113036 A
 (220) 2021 05 18
 (732) Off-White LLC
 360 Hamilton Ave., N100 White Plains,
 New York, 10601, USA

(111) M 2022 35632 R
 (151) 2022 06 24
 (181) 2032 06 24
 (260) AM 2021 113049 A
 (220) 2021 05 20
 (732) The Procter & Gamble Company
 One Procter & Gamble Plaza, Cincinnati, Ohio
 45202, USA

(111) M 2022 35633 R
 (151) 2022 06 24
 (181) 2032 06 24
 (260) AM 2021 113397 A
 (220) 2021 06 08
 (732) LTD "Garments Hub"
 Vill. Kvemo Sobisi, 1412, Gori Region, Georgia

(111) M 2022 35634 R
 (151) 2022 06 24
 (181) 2032 06 24
 (260) AM 2021 113692 A
 (220) 2021 06 28
 (732) LLC "KS Resource"
 Bagramyan St., Lane 3, bld. 6a, Yerevan, 0038,
 Armenia

(111) M 2022 35635 R
 (151) 2022 06 24
 (181) 2032 06 24
 (260) AM 2021 113879 A
 (220) 2021 07 15

(732) LTD "Trans Logistic"
 Ikalto St. 55, Saburtalo District, Tbilisi, Georgia

(111) M 2022 35636 R
 (151) 2022 06 24
 (181) 2032 06 24
 (260) AM 2021 113978 A
 (220) 2021 07 19
 (732) LTD "TCA"
 Arboshiki St. 2, 0144, Isani District, Tbilisi,
 Georgia

(111) M 2022 35637 R
 (151) 2022 06 24
 (181) 2032 06 24
 (260) AM 2021 114029 A
 (220) 2021 07 23
 (732) Hankook Tire & Technology Co., Ltd.
 286, Pangyo-ro, Bundang-gu, Seongnam-si,
 Gyeonggi-do, Republic of Korea

(111) M 2022 35638 R
 (151) 2022 06 24
 (181) 2032 06 24
 (260) AM 2021 114033 A
 (220) 2021 07 23
 (732) Shenzhen Netis Technology Co., Ltd.
 801, Building B, TongFang Information
 Harbor, No.11 Langshan Road, Nanshan
 District, Shenzhen, People's Republic of
 China

(111) M 2022 35639 R
 (151) 2022 06 24
 (181) 2032 06 24
 (260) AM 2021 114043 A
 (220) 2021 07 27
 (732) LTD "Georgian Alco Group"
 O. Chechelashvili St., III Lane 4, 4600, Kutaisi,
 Georgia

(111) M 2022 35640 R
 (151) 2022 06 24
 (181) 2032 06 24
 (260) AM 2021 114061 A
 (220) 2021 07 29
 (732) JSC "Bagrationi 1882"
 Davit Sarajishvili Av. 12, 0153, Tbilisi,
 Georgia

(111) M 2022 35641 R
(151) 2022 06 24
(181) 2032 06 24
(260) AM 2021 114149 A
(220) 2021 08 04
(732) Ela Magrakvelidze
Sopromadze St. 1, 2400, Terjola, Georgia

(111) M 2022 35642 R
(151) 2022 06 24
(181) 2032 06 24
(260) AM 2021 114227 A
(220) 2021 08 10
(732) LTD "IDS Borjomi Beverages Company"
Pareraweg 45, Curaçao

(111) M 2022 35643 R
(151) 2022 06 24
(181) 2032 06 24
(260) AM 2021 114228 A
(220) 2021 08 10
(732) LTD "IDS Borjomi Beverages Company"
Pareraweg 45, Curaçao

(111) M 2022 35648 R
(151) 2022 07 01
(181) 2032 07 01
(260) AM 2021 11416 A
(220) 2021 01 25
(732) LLC "Artpharma"
Gamrekeli St. 19 (512), 0160, Tbilisi, Georgia

(111) M 2022 35649 R
(151) 2022 07 01
(181) 2032 07 01
(260) AM 2021 113017 A
(220) 2021 05 14
(732) Beka Lezhava
Archil Betaneli St. 13, 0132, Tbilisi, Georgia

(111) M 2022 35650 R
(151) 2022 07 01
(181) 2032 07 01
(260) AM 2021 113130 A
(220) 2021 05 25
(732) Enriko Beridze
T. Tabidze St. 10, Lane I, Tbilisi, Georgia

(111) M 2022 35651 R
(151) 2022 07 01
(181) 2032 07 01
(260) AM 2021 113259 A
(220) 2021 06 01

(732) KT & G Corporation
71, Beotkkot-gil, Daedeok-gu, Daejeon,
Republic of Korea

(111) M 2022 35652 R
(151) 2022 07 01
(181) 2032 07 01
(260) AM 2021 113264 A
(220) 2021 06 02
(732) LTD "Logo"
G. Mdivani St. 3a, Tbilisi, Georgia

(111) M 2022 35653 R
(151) 2022 07 01
(181) 2032 07 01
(260) AM 2021 113277 A
(220) 2021 06 03
(732) Salome Gutierrez Penedo
Didi Dighomi, III mcr., bld. 5, app. 99, Tbilisi,
Georgia

(111) M 2022 35654 R
(151) 2022 07 01
(181) 2032 07 01
(260) AM 2021 113382 A
(220) 2021 06 07
(732) Al Sultan Alalamia Sweets
87652, Parcel ID 356-251, Office 308, Owned by
Mohammed Abdul Rahman Mohammed Al Ali,
Umm Suqeim First, Dubai, United Arab Emirates

(111) M 2022 35655 R
(151) 2022 07 01
(181) 2032 07 01
(260) AM 2021 113383 A
(220) 2021 06 07
(732) Al Sultan Alalamia Sweets
87652, Parcel ID 356-251, Office 308, Owned by
Mohammed Abdul Rahman Mohammed Al Ali,
Umm Suqeim First, Dubai, United Arab Emirates

(111) M 2022 35656 R
(151) 2022 07 01
(181) 2032 07 01
(260) AM 2021 113391 A
(220) 2021 06 07
(732) Zurab Mamulashvili
Kazbegi St. 35b, Tbilisi, Georgia

(111) M 2022 35657 R
(151) 2022 07 01
(181) 2032 07 01
(260) AM 2021 113406 A

(220) 2021 06 09
(732) KT & G Corporation
71, Beotkkot-gil, Daedeok-gu, Daejeon,
Republic of Korea

(111) M 2022 35658 R
(151) 2022 07 01
(181) 2032 07 01
(260) AM 2021 113408 A
(220) 2021 06 09
(732) KT & G Corporation
71, Beotkkot-gil, Daedeok-gu, Daejeon,
Republic of Korea

(111) M 2022 35659 R
(151) 2022 07 01
(181) 2032 07 01
(260) AM 2021 113425 A
(220) 2021 06 09
(732) Guram Gvasalia
Binzstraße 44, Zurich, 8045, Switzerland

(111) M 2022 35660 R
(151) 2022 07 01
(181) 2032 07 01
(260) AM 2021 113432 A
(220) 2021 06 11
(732) Nino Shishniashvili
Nutsbidze 3 Plateau, II quart., bld. 2, 0183,
Tbilisi, Georgia;
Irina Shishniashvili
Gunia St. 22, 0108, Tbilisi, Georgia

(111) M 2022 35661 R
(151) 2022 07 01
(181) 2032 07 01
(260) AM 2021 113596 A
(220) 2021 06 21
(732) Philip Morris Brands Sàrl
Quai Jeanrenaud 3, Neuchâtel, 2000, Switzerland

(111) M 2022 35662 R
(151) 2022 07 01
(181) 2032 07 01
(260) AM 2021 114041 A
(220) 2021 07 26
(732) Philip Morris Products S.A.
Quai Jeanrenaud 3, 2000 Neuchâtel, Switzerland

(111) M 2022 35663 R
(151) 2022 07 01
(181) 2032 07 01
(260) AM 2021 114139 A

(220) 2021 08 02
(732) LTD "Soulageur"
Kukuri Gogiasvili St. 1, 0131, Tbilisi, Georgia

(111) M 2022 35664 R
(151) 2022 07 01
(181) 2032 07 01
(260) AM 2021 114142 A
(220) 2021 08 03
(732) KT & G Corporation
71, Beotkkot-gil, Daedeok-gu, Daejeon,
Republic of Korea

(111) M 2022 35665 R
(151) 2022 07 01
(181) 2032 07 01
(260) AM 2021 114217 A
(220) 2021 08 06
(732) LTD "Georgian Agro House"
Demetre Tavdadebuli St. 29, Tbilisi, Georgia

(111) M 2022 35666 R
(151) 2022 07 01
(181) 2032 07 01
(260) AM 2021 114235 A
(220) 2021 08 12
(732) LTD "Tsinandali+"
Chirnakhuli St. 5-7, Samgori District, Tbilisi,
Georgia

(111) M 2022 35667 R
(151) 2022 07 01
(181) 2032 07 01
(260) AM 2021 114236 A
(220) 2021 08 12
(732) LTD "Tsinandali+"
Chirnakhuli St. 5-7, Samgori District, Tbilisi,
Georgia

(111) M 2022 35668 R
(151) 2022 07 01
(181) 2032 07 01
(260) AM 2021 114343 A
(220) 2021 08 19
(732) Visa International Service Association
900 Metro Center Boulevard, Foster City,
California, 94404, USA

(111) M 2022 35669 R
(151) 2022 07 01
(181) 2032 07 01
(260) AM 2021 114408 A
(220) 2021 08 24

(732) LTD "Georgian Agro House"
Demetre Tavdadebuli St. 29, Tbilisi, Georgia

(111) M 2022 35670 R
(151) 2022 07 01
(181) 2032 07 01
(260) AM 2022 117726 A
(220) 2022 05 10
(732) Apple Inc.
One Apple Park Way, California, 95014,
Cupertino, USA

(111) M 2022 35671 R
(151) 2022 07 01
(181) 2032 07 01
(260) AM 2021 113348 A
(220) 2021 06 04
(732) Spribe OU
Kesklinna District, Tartu Rd. 83-701, Tallinn,
10115, Estonia

TRADEMARKS REGISTERED ACCORDING TO THE ACCELERATED PROCEDURE

The decision can be appealed at the Chamber of Appeal of Sakpatenti within 3 months from the publication.

(111) M 2022 35627 R
(151) 2022 06 21
(181) 2032 06 21
(210) AM 118013
(220) 2022 06 01
(732) LTD "Georgian Vine and Wine Company"
Davit Aghmashenebeli Av. 179a, 0112,
Didube District, Tbilisi, Georgia

(540)

Queen's Collection Shilda Winery
ქუინს კოლექშენ შილდა ვაინერო
Куинс Коллекшен Шилда
Ваинერი

(591) Black-white
(526) Shilda, შილდა, Шилда
(511) 33

(111) M 2022 35628 R
(151) 2022 06 22
(181) 2032 06 22
(210) AM 118074
(220) 2022 06 08
(732) LTD "Mosavali TV"
Vazha-Pshavela Av., V qu., bld. 4, app. 204,
Tbilisi, Georgia
(740) Giorgi Taktakishvili
(540)

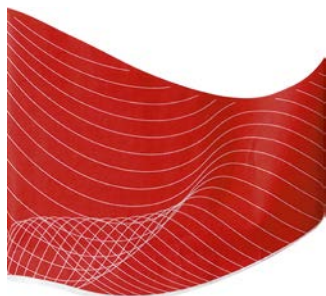

(591) Red, white
(531) 09.01.11; 24.07.01; 24.07.23; 26.11.13;
29.01.12
(511) 31

(111) M 2022 35629 R
(151) 2022 06 22
(181) 2032 06 22
(210) AM 118155
(220) 2022 06 15
(732) LTD "Adjara Group Work Space Company"
M. Kostava Str. 14, Tbilisi, Georgia

(740) Giorgi Taktakishvili
(540)

D BLOCK

(591) Black-white
(531) 27.05.01; 27.05.17
(511) 9, 35, 36, 43

(111) M 2022 35644 R
(151) 2022 06 28
(181) 2032 06 28
(210) AM 118230
(220) 2022 06 21
(732) LTD "Samin Coin"
Will. Grigolaantkari, Dusheti Region, Georgia
(540)



(591) Green, white
(531) 26.04.03; 26.13.25; 29.01.12
(511) 36

(111) M 2022 35645 R
(151) 2022 06 29
(181) 2032 06 29
(210) AM 118237
(220) 2022 06 22
(732) George Kutelia
Varketili, IV mcr., III qu., bld. 4, app. 15,
Tbilisi, Georgia;
Tsotne Kutelia
Varketili, IV mcr., III qu., bld. 4, app. 15,
Tbilisi, Georgia
(540)

კუთხის უკუხილა



(591) Red, white
 (531) 26.11.03; 26.11.06; 26.11.08; 26.13.25;
 27.05.21; 28.19; 29.01.12
 (511) 43

(111) M 2022 35646 R
 (151) 2022 06 29
 (181) 2032 06 29
 (210) AM 118239
 (220) 2022 06 22
 (732) LLC "Veon Georgia"
 Bambis Rigi (Cotton Row) 8, 0105, Tbilisi,
 Georgia
 (740) Levan Nanobashvili
 (540)

ეისელო

(591) Black-white
 (511) 9, 16, 18, 25, 35, 36, 37, 38, 41, 42, 44

(111) M 2022 35647 R
 (151) 2022 06 30
 (181) 2032 06 30
 (210) AM 117837
 (220) 2022 05 18
 (732) LLC "TBC Net"
 Kote Marjanishvili St. 7, 0161, Tbilisi,
 Georgia
 (740) Mariam Usenashvili
 (540)



(591) Yellow, red, blue, azure, grey
 (531) 26.01.01; 26.01.05; 26.01.24; 26.11.12;
 27.05.01; 28.19; 29.01.01; 29.01.02;
 29.01.04; 29.01.06; 29.01.15
 (511) 35, 36, 39, 41, 42

(111) M 2022 35672 R
 (151) 2022 07 01
 (181) 2032 07 01
 (210) AM 118300
 (220) 2022 06 28
 (732) LLC "The International Property Market"
 Iv. Javakhishvili St. 91, app. 2b, 0164,
 Tbilisi, Georgia
 (740) Nino Gazdeliani

(540)

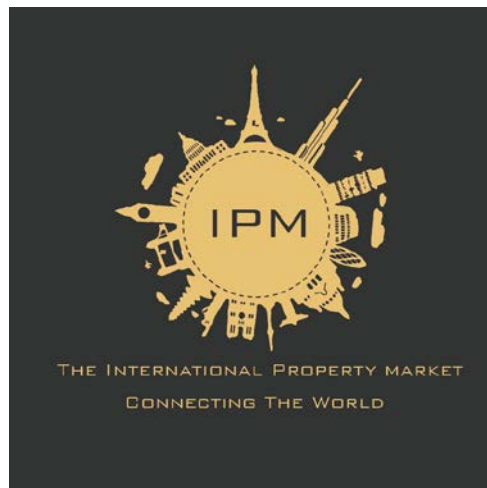

(591) Morengo, light golden
 (531) 01.05.10; 01.05.11; 07.01.01; 07.01.03;
 07.01.04; 07.01.06; 07.01.11; 07.01.12;
 07.01.25; 07.05.02; 07.05.05; 07.05.25;
 26.04.02; 26.04.16; 26.04.22; 26.04.24;
 27.05.01; 29.01.12
 (511) 36

INTERNATIONAL TRADEMARKS FOR WHICH A DECISION ON GRANTING PROTECTIONS IS TAKEN

The decision can be appealed at the Chamber of Appeal of Sakpatenti within 3 months from the publication or at the Mtskheta District Court Administrative Cases Board (Address: №17, Samkhedro St., Mtskheta), within 1 month following the publication.

(260) AM 2022 107140 A*
 (800) 1363639
 (151) 2017 07 14
 (891) 2020 01 27
 (731) Montblanc-Simplo GmbH
 Hellgrundweg 100, 22525 Hamburg, Germany
 (540)

MONTBLANC

(591) Black, white
 (511)
 34 – Cigar cutters; ashtrays for smokers, not of precious metal; lighters for smokers; smokers' articles; cigarette cases and cigarette holders; cigar cases and cigar holders; pipe cleaners; tobacco pouches, tobacco jars not of precious metal.

(260) AM 2022 107381 A*
 (800) 1363473
 (151) 2017 07 11
 (891) 2020 02 13
 (731) Montblanc-Simplo GmbH
 Hellgrundweg 100, 22525 Hamburg, Germany
 (540)

**MONT
 BLANC** 

(591) Black, white
 (531) 01.01.01; 01.01.02; 01.01.10; 05.05.20;
 26.01.03; 26.01.15; 27.05.01
 (511)
 34 – Cigar cutters; ashtrays for smokers, not of precious metal; lighters for smokers; smokers' articles; cigarette cases and cigarette holders; cigar cases and cigar holders; pipe cleaners; tobacco pouches, tobacco jars not of precious metal.

(260) AM 2022 113542 A*
 (800) 1596906
 (151) 2021 02 05
 (891) 2021 02 05
 (731) Euro Games Technology Ltd.
 4, "Maritsa" Str., "Vranya-Lozen-Triugulnika",
 BG-1151 Sofia, Bulgaria

(540)

(591) Red, orange, green and gold
 (531) 27.05.01; 27.05.02; 27.05.03; 27.05.09;
 29.01.13

(511)
 9 – Computer gaming software; virtual reality software; games software; entertainment software for computer games; monitors (computer hardware) for gambling, gambling machines, gambling games; monitors (computer programs) for gambling, gambling machines, gambling games; computer game programs; computer programs for recorded games; electronic components for gambling machines; computer application software featuring games and gaming; computer software for the administration of on-line games and gaming; computer hardware for games and gaming; electronic components and computer software for gambling, gambling machines, gambling games on the Internet and via telecommunication network.

(260) AM 2022 114573 A
 (800) 1612149
 (151) 2021 05 27
 (891) 2021 05 27
 (731) Limited liability company "Internet Solutions"
 Presnenskaya nab., d. 10, Pomeschenie I,
 et. 41, komn. 6, RU-123112 Moscow, Russian
 Federation

(540)

(591) Blue
 (531) 27.05.01; 29.01.04
 (511)
 39 – Parking place rental; rental of warehouses; booking of seats for travel; travel reservation; transport reservation; delivery of newspapers; message delivery; parcel delivery; delivery of goods; delivery of goods by mail order; flower delivery; transportation logistics; arranging of passenger transportation services for others via an online application; arranging of transportation for travel tours; arranging for travel visas and travel documents for persons travelling abroad; hauling; transport and storage of waste; removal services; transport of travellers; car transport; passenger transport; portering; transport brokerage; provi-

ding driving directions for travel purposes; providing traffic information; providing information relating to storage services; providing transportation information; car rental; rental of storage containers; vehicle rental; courier services [messages or merchandise]; transport; luggage storage; freight [shipping of goods]; physical storage of electronically stored data or documents; storage of goods; storage; freight forwarding; packaging and storage of goods; warehousing information; organization of tours.

(260) AM 2022 114636 A

(800) 1613315

(151) 2021 05 06

(891) 2021 05 06

(731) Sanosil AG

Eichtalstrasse 49, CH-8634 Hombrechtikon,
Switzerland

(540)



(591) Black, white

(531) 26.11.07; 26.13.25; 27.03.01; 27.05.02

(511)

5 – Disinfectants, particularly disinfectants for hygiene, disinfectants for sanitary use, disinfectants for household use and disinfectants for swimming pools; all-purpose disinfecting preparations; disinfectants for surfaces; disinfectants for the treatment of water and other liquid materials; disinfectants for the treatment of air and other gaseous materials; all aforementioned goods exclusively destined for being used on inanimate matter.

(260) AM 2022 114637 A

(800) 1613411

(151) 2021 06 18

(891) 2021 06 18

(731) Obschestvo s ogranichennoy otvetstvennostyu

"Konditerskaya fabrika "POBEDA"

ul. Ryabinovaya, d. 26, str. 2, RU-121471

Moscow, Russian Federation

(540)

pobedavkusa

(591) Black, white

(531) 27.05.01

(511)

30 – Confectionery, including sweets; chocolate; marzipan; sweeteners-based confectionery [sugar substitutes], not for medical purposes; fruit jellies [confectionery].

(260) AM 2022 114639 A

(800) 1613461

(151) 2021 06 04

(891) 2021 06 04

(731) PHERECYDES PHARMA

NANTES BIOTECH, 22 boulevard Benoni

Goullin, F-44200 Nantes, France

(540)



(591) Black, white

(531) 26.07.25; 26.11.25; 26.13.25

(511)

5 – Pharmaceutical and veterinary products; pharmaceutical preparations for the treatment or prevention of bacterial diseases; antibacterial substances for medical use; diagnostic agents for medical use; drug delivery agents; antibodies for medical or veterinary use; hygienic products for medicine; chemical preparations for medical or pharmaceutical use; bacterial and bacteriological preparations for medical or veterinary use; bactericides; fungicides; germicides; virucides; biocides; sporicides; levuricides; mycobactericides; media for bacteriological cultures; microbiocides; preparations of microorganisms for medical and veterinary use.

10 – Analysis devices for identification of bacteria for medical use; surgical, medical, dental and veterinary apparatus and instruments; bacteria sampling apparatus; apparatus used for the study of bacterial disorders; applicators for anti-bacterial preparations.

42 – Medical and pharmacological research services; scientific research in bacteriology; chemical and microbiological laboratory services; research and development in the field of chemistry, microbiology, air flows, agri-foodstuffs, biology, bacteriology; consultancy with respect to pharmaceutical research and development; consultancy with respect to bacteriology research; clinical trials; carrying out clinical trials; auditing relating to air, water and surface hygiene, relating to sanitary risks and chemical or microbiological contamination; surveying [engineering work]; consultancy with respect to bacteriology; research and testing services in the fields of bacteriology and virology; scientific and technological services and research work, particularly for identifying and characterizing active materials for infectious disease treatment; development of pharmaceutical treatment products; conducting and scientific support of preclinical or clinical studies.

(260) AM 2022 114640 A

(800) 1613486

(151) 2021 05 24

(891) 2021 05 24

(731) OBSHCHESTVO S OGRANICHENNOY,
OTVETSTVENNOSTYU "NPO Petrovaks
Farm"

yl.Sosnovaya, d.1, s. Pokrov, g. Podolsk,

RU-142143 Moscow region, Russian

Federation

(540)

ApTheo

(591) Black, white

(531) 28.05

(511)

5 – Acaricides; aconitine; alkaloids for medical purposes; alginates for pharmaceutical purposes; algicides; aldehydes for pharmaceutical purposes; dental amalgams of gold; dental amalgams; amino acids for veterinary purposes; amino acids for medical purposes; analgesics; anaesthetics; antibiotics; antiseptics; medicine cases, portable, filled; first-aid boxes, filled; aluminium acetate for pharmaceutical purposes; acetates for pharmaceutical purposes; germicides; balms for medical purposes; bandages for dressings; diagnostic biomarker reagents for medical purposes; biocides; bracelets impregnated with insect repellent; bromine for pharmaceutical purposes; paper for mustard plasters; fly catching paper; reagent paper for veterinary purposes; reagent paper for medical purposes; mothproofing paper; petroleum jelly for medical purposes; vaccines; oxygen baths; antiseptic cotton; aseptic cotton; absorbent cotton; wadding for medical purposes; cotton for medical purposes; dietetic substances adapted for medical use; radiological contrast substances for medical purposes; nutritive substances for microorganisms; radioactive substances for medical purposes; melissa water for pharmaceutical purposes; seawater for medicinal bathing; mineral waters for medical purposes; thermal water; dietary fibre; moulding wax for dentists; gases for medical purposes; guaiacol for pharmaceutical purposes; sexual stimulant gels; haematogen; haemoglobin; hydrastine; hydrastinine; glycerine for medical purposes; glycerophosphates; glucose for medical purposes; gentian for pharmaceutical purposes; hormones for medical purposes; mustard for pharmaceutical purposes; mustard plasters; mud for baths; medicinal mud; gamboge for medical purposes; gurjun balsam for medical purposes; air deodorizing preparations; deodorants, other than for human beings or for animals; deodorants for clothing and textiles; diastase for medical purposes; digitalin; vitamin supplement patches; mineral food supplements; nutritional supplements; albumin dietary supplements; dietary supplements for animals; yeast dietary supplements; alginate dietary supplements;

glucose dietary supplements; casein dietary supplements; lecithin dietary supplements; linseed oil dietary supplements; propolis dietary supplements; protein dietary supplements; protein supplements for animals; royal jelly dietary supplements; pollen dietary supplements; wheat germ dietary supplements; linseed dietary supplements; acai powder dietary supplements; dietary supplements with a cosmetic effect; enzyme dietary supplements; yeast for pharmaceutical purposes; gelatine for medical purposes; cod liver oil; isotopes for medical purposes; immunostimulants; insecticides; iodine for pharmaceutical purposes; iodides for pharmaceutical purposes; alkaline iodides for pharmaceutical purposes; iodoform; calomel [fungicide]; tartar for pharmaceutical purposes; camphor for medical purposes; capsules for medicines; cachets for pharmaceutical purposes; capsules made of dendrimer-based polymers, for pharmaceuticals; haemostatic pencils; wart pencils; caustic pencils; carbolineum [parasiticide]; caustics for pharmaceutical purposes; cachou for pharmaceutical purposes; quassia for medical purposes; quebracho for medical purposes; oxygen for medical purposes; gallic acid for pharmaceutical purposes; acids for pharmaceutical purposes; adhesives for dentures; surgical glues; stem cells for veterinary purposes; stem cells for medical purposes; cocaine; collagen for medical purposes; collodion for pharmaceutical purposes; corn rings for the feet; medicated sweets; barks for pharmaceutical purposes; cedar wood for use as an insect repellent; croton bark; mangrove bark for pharmaceutical purposes; myrobalan bark for pharmaceutical purposes; quinquina for medical purposes; medicated animal feed; medicinal roots; rhubarb roots for pharmaceutical purposes; lint for medical purposes; starch for dietetic or pharmaceutical purposes; creosote for pharmaceutical purposes; blood for medical purposes; cultures of microorganisms for medical or veterinary use; curare; dental lacquer; liquorice for pharmaceutical purposes; milk sugar for pharmaceutical purposes; adhesive plasters; medicines for alleviating constipation; lecithin for medical purposes; lotions for veterinary purposes; medicated hair lotions; lotions for pharmaceutical purposes; medicated after-shave lotions; personal sexual lubricants; lupulin for pharmaceutical purposes; magnesia for pharmaceutical purposes; liniments; ointments for pharmaceutical purposes; sunburn ointments; mercurial ointments; frostbite salve for pharmaceutical purposes; gauze for dressings; medicinal oils; mustard oil for medical purposes; camphor oil for medical purposes; castor oil for medical purposes; oil of turpentine for pharmaceutical purposes; dill oil for medical purposes; dental mastics; dental abrasives; dental impression materials; teeth filling material; dressings, medical; surgical dressings; drugs for medical purposes; medicines for veterinary purposes; serotherapeutic medicines; medicines for human purposes; medicines for dental purposes; menthol; medicinal drinks; moleskin for medical purposes; almond milk

for pharmaceutical purposes; powdered milk for babies; royal jelly for pharmaceutical purposes; milk ferments for pharmaceutical purposes; Irish moss for medical purposes; flour for pharmaceutical purposes; linseed meal for pharmaceutical purposes; fish meal for pharmaceutical purposes; fly glue; antibacterial soap; disinfectant soap; medicated soap; freeze-dried meat adapted for medical purposes; mint for pharmaceutical purposes; dietetic beverages adapted for medical purposes; narcotics; medicinal infusions; tincture of iodine; eucalyptol for pharmaceutical purposes; tinctures for medical purposes; opium; opodeldoc; decoctions for pharmaceutical purposes; antiparasitic collars for animals; stick liquorice for pharmaceutical purposes; sulfur sticks [disinfectants]; pastilles for pharmaceutical purposes; medicated toothpaste; pectin for pharmaceutical purposes; pepsins for pharmaceutical purposes; peptones for pharmaceutical purposes; hydrogen peroxide for medical purposes; pesticides; food for babies; leeches for medical purposes; blood plasma; nicotine patches for use as aids to stop smoking; eyepatches for medical purposes; poultices; compresses; scapulars for surgical purposes; babies' diapers; diapers for pets; diapers for incontinence; bunion pads; breast-nursing pads; pomades for medical purposes; powder of cantharides; pyrethrum powder; anti-uric preparations; bacterial preparations for medical and veterinary use; bacteriological preparations for medical and veterinary use; balsamic preparations for medical purposes; albuminous preparations for veterinary purposes; biological preparations for medical purposes; veterinary preparations; bismuth preparations for pharmaceutical purposes; vitamin preparations; diagnostic preparations for medical purposes; bath preparations for medical purposes; therapeutic preparations for the bath; haemorrhoid preparations; preparations for callouses; lice treatment preparations [pediculicides]; acne treatment preparations; preparations to facilitate teething; preparations for the treatment of burns; fumigation preparations for medical purposes; ootherapy preparations; air purifying preparations; bronchodilating preparations; preparations for reducing sexual activity; sterilizing preparations; soil-sterilizing preparations; corn remedies; pharmaceutical preparations for treating dandruff; preparations for destroying noxious animals; herbicides; preparations for destroying dry rot fungus; larvae exterminating preparations; fly destroying preparations; preparations for destroying mice; slug exterminating preparations; vermin destroying preparations; pharmaceutical preparations for skin care; contact lens cleaning preparations; preparations of microorganisms for medical or veterinary use; lime-based pharmaceutical preparations; hemostatics for medical purposes; medicated eye-washes; medicinal hair growth preparations; nutraceutical preparations for therapeutic or medical purposes; opiates; anticryptogamic preparations; aloe

vera preparations for pharmaceutical purposes; preparations of trace elements for human and animal use; sulfonamides [medicines]; pharmaceutical preparations; pharmaceutical preparations for treating sunburn; enzyme preparations for veterinary purposes; enzyme preparations for medical purposes; phytotherapy preparations for medical purposes; chemico-pharmaceutical preparations; chemical preparations for veterinary purposes; chemical preparations for the diagnosis of pregnancy; chemical preparations for medical purposes; chemical preparations for treating diseases affecting cereal plants; chemical preparations for treating wheat blight; chemical preparations for treating diseases affecting vine plants; chemical preparations for treating mildew; chemical preparations for treating phylloxera; chemical preparations for pharmaceutical purposes; chilblain preparations; mothproofing preparations; collyrium; lead water; chemical conductors for electrocardiograph electrodes; albuminous foodstuffs for medical purposes; dietetic foods adapted for medical purposes; by-products of the processing of cereals for dietetic or medical purposes; homogenized food adapted for medical purposes; freeze-dried food adapted for medical purposes; pharmaceuticals; sanitary towels; panty liners [sanitary]; propolis for pharmaceutical purposes; pearl powder for medical purposes; radium for medical purposes; hydrated chloral for pharmaceutical purposes; solvents for removing adhesive plasters; vaginal washes for medical purposes; solutions for contact lenses; chemical reagents for medical or veterinary purposes; gum for medical purposes; rubber for dental purposes; chewing gum for medical purposes; nicotine gum for use as an aid to stop smoking; insect repellents; insect repellent incense; repellents for dogs; tissues impregnated with pharmaceutical lotions; sarsaparilla for medical purposes; sugar for medical purposes; asthmatic tea; fumigating sticks; massage candles for therapeutic purposes; suppositories; linseed for pharmaceutical purposes; tobacco-free cigarettes for medical purposes; siccatives [drying agents] for medical purposes; syrups for pharmaceutical purposes; turpentine for pharmaceutical purposes; greases for veterinary purposes; greases for medical purposes; lacteal flour for babies; infant formula; soporifics; bicarbonate of soda for pharmaceutical purposes; bath salts for medical purposes; salts for mineral water baths; salts for medical purposes; potassium salts for medical purposes; sodium salts for medical purposes; smelling salts; mineral water salts; malt for pharmaceutical purposes; semen for artificial insemination; alcohol for pharmaceutical purposes; medicinal alcohol; alloys of precious metals for dental purposes; ergot for pharmaceutical purposes; cooling sprays for medical purposes; antibacterial handwashes; adjuvants for medical purposes; astringents for medical purposes; vermifuges; disinfectants; disinfectants for hygiene purposes; disinfectants for chemical toilets; appetite suppressants for medical purposes; medical preparations for slimming purposes; parasiti-

ticides; mouthwashes for medical purposes; febrifuges; depuratives; animal washes [insecticides]; detergents for medical purposes; cattle washes [insecticides]; dog washes [insecticides]; insecticidal veterinary washes; vesicants; purgatives; remedies for perspiration; remedies for foot perspiration; chemical contraceptives; antiparasitic preparations; sedatives; laxatives; tonics [medicines]; medicated toiletry preparations; digestives for pharmaceutical purposes; nervines; bouillons for bacteriological cultures; steroids; strychnine; serums; tanning pills; appetite suppressant pills; slimming pills; jujube, medicated; antioxidant pills; sanitary tampons; vulnerary sponges; thymol for pharmaceutical purposes; biological tissue cultures for veterinary purposes; biological tissue cultures for medical purposes; smoking herbs for medical purposes; medicinal herbs; surgical implants comprised of living tissues; pants, absorbent, for incontinence; sanitary panties; babies' diaper-pants; charcoal for pharmaceutical purposes; porcelain for dental prostheses; phenol for pharmaceutical purposes; enzymes for veterinary purposes; enzymes for medical purposes; ferments for pharmaceutical purposes; formic aldehyde for pharmaceutical purposes; phosphates for pharmaceutical purposes; fungicides; quinine for medical purposes; chinoline for medical purposes; diabetic bread adapted for medical use; chloroform; flowers of sulfur for pharmaceutical purposes; cement for animal hooves; bone cement for surgical and orthopaedic purposes; dental cements; medicinal tea; herbal teas for medicinal purposes; insecticidal animal shampoos; medicated shampoos; medicated shampoos for pets; pediculi-cidal shampoos; medicated dry shampoos; pre-filled syringes for medical purposes; eucalyptus for pharmaceutical purposes; herbal extracts for medical purposes; plant extracts for pharmaceutical purposes; tobacco extracts [insecticides]; extracts of hops for pharmaceutical purposes; elixirs [pharmaceutical preparations]; ethers for pharmaceutical purposes; esters for pharmaceutical purposes; cellulose esters for pharmaceutical purposes; rat poison; poisons; bacterial poisons; jalap; bismuth subnitrate for pharmaceutical purposes; cream of tartar for pharmaceutical purposes; condurango bark for medical purposes; angostura bark for medical purposes; adhesive tapes for medical purposes; injectable dermal fillers; cotton swabs for medical purposes; diagnostic preparations for veterinary purposes; douching preparations for medical purposes; milking grease; transplants [living tissues]; fennel for medical purposes; cellulose ethers for pharmaceutical purposes.

(260) AM 2022 114641 A

(800) 1613526

(151) 2021 06 01

(891) 2021 06 01

(731) ROLEX SA

Rue François-Dussaud 3-5-7, CH-1211 Genève
26, Switzerland

(540)

FLIPLOCK

(591) Black, white

(511)

14 – Timepieces, namely, watches, wristwatches, component parts of timepieces and accessories for timepieces not included in other classes, clocks and other chronometric instruments, chronometers, chronographs (timepieces), watch bands, watch clasps, dials (timepieces), boxes and cases for timepieces and jewelry, watch movements and their parts; jewelry, jewelry items; precious stones and semi-precious stones; precious metals and their alloys; pins (jewelry).

(260) AM 2022 114642 A

(800) 1613538

(151) 2021 02 17

(891) 2021 02 17

(731) "Intelligent Systems of Business Control" Ltd
Zavodskaja, 1b, str. 1, fl. 1, room 7, RU-124365
Zelenograd, Moscow, Russian Federation

(540)

**ART IN
YOUR
POCKET**

(591) Black, white

(531) 27.05.15; 27.05.17

(511)

9 – Radio frequency identification devices (RFID systems); details (term considered too vague by the International Bureau – Rule 13 (2) (b) of the Regulations), components of radio frequency identification devices (RFID systems), including RFID reader modules, RFID tags, readers, recording devices for transmitting information and communication with RFID tags, programming devices for programming RFID tags, where RFID tags are in form of cards, tags or key rings; contact smart chips; chips (integrated circuits), namely RFID cards; computer network data routers used in security and access control; computer software for issuing and managing RFID tags; magnetic data media; optical data media; computer hardware for processing and protecting information.

14 – Key chain tags; watch fobs; jewellery charms; charms for key rings; key fobs of imitation leather; key fobs of leather; key fobs, not of metal; key rings [split rings with trinket or decorative fob].

18 – Leather and imitations of leather; imitation leather; leather, unworked or semi-worked; leatherboard; boxes and chests of leather and leatherboard; cases of leather; labels of leather.

(260) AM 2022 114643 A
 (800) 1613556
 (151) 2021 05 09
 (891) 2021 05 09
 (731) wem co

No 8. 7th Ave, Khalid Islamboli St,
 Beheshti St, 1513715611 Tehran, Islamic
 Republic of Iran

(540)

Tim's

تیمز

(591) Black, white
 (531) 27.05.17; 28.01
 (511)
 30 – Hot chocolate; biscuits; instant coffee; coffee;
 tea; puddings; cappuccino; chocolate.

(260) AM 2022 114644 A
 (800) 1613602
 (151) 2021 07 23
 (891) 2021 07 23
 (731) Deckers Outdoor Corporation

250 Coromar Drive, Goleta CA 93117, USA

(540)

HOKA

(591) Black, white
 (511)
 25 – Footwear.

(260) AM 2022 114705 A
 (800) 1614435
 (151) 2021 04 29
 (891) 2021 04 29
 (731) Auto-Teile-Ring GmbH

Marie-Curie-Straße 3, 73770 Denkendorf,
 Germany

(540)

ATR

(591) Black, white
 (511)
 35 – Commercial cooperation, in particular negotia-
 ting framework conditions of shopping on the basis of
 bundling purchases and coordination of shopping and
 purchasing possibilities for traders and workshops;
 business information and inquiries relating to goods
 and services on the car aftersales market; business in-
 quires, information and consultancy relating to parts
 and suppliers on the car aftersales market; procure-
 ment marketing on the car aftersales market for tra-

ders and workshops; coordination of purchases for
 others, on the car aftersales market, in particular re-
 lating to, spare parts, retrofitting, brakes, brake pads,
 brake fluid, transmission oils, motor oil, brake fluids,
 oil filters, glass and window cleaners, grooming pro-
 ducts, vee belts, detectors, OBD adapters, OBD dong-
 les, tyres, solid, for vehicle wheels, wheel rims, panes,
 screenwashes, batteries, chassis springs, clutches, ge-
 arboxes, apparatus for control, lubricating agents, ac-
 cessories, workshop equipment and workshop equip-
 ment; coordination of purchases for others, on the car
 aftersales market, in particular relating to, clutch
 discs, motors and engines, transmission shafts, steer-
 ing gear boxes, power steering, vehicle dynamics
 controls, electric motors and engines, fuel cells, batte-
 ries, battery management systems, temperature mana-
 gement systems, hydrogen tanks, sinks, generators,
 inductor coils, coupling coils, chargers, inverter units,
 aerials, headlights, direction indicators, bulbs, LED's,
 solar power cells, burnishers, navigation systems and
 air conditioning installations; coordination of purcha-
 ses for others, on the car aftersales market, in particu-
 lar relating to, carbon filters, cabin filters, heating ap-
 paratus for defrosting windows, auxiliary heaters, seat
 heaters, heating apparatus, heat pumps, radiators,
 horns, alarms, warning sound generators, mufflers,
 head sets and hands free kits, driver assistance sys-
 tems, automatic timers, life belts, lambda probes, car-
 buretors, injection valves, injection pumps, spark
 plugs, ignition coils, transformers, glow plugs, ex-
 haust gas recirculation valves, wheel suspensions and
 tie rods; coordination of purchases for others, on the
 car aftersales market, in particular relating to, emer-
 gency triangles, fuel dispensing pumps, condensers,
 dual mass flywheels, catalytic converters, exhaust gas
 purification installations, additives for the reduction
 of nitrogen oxides, infotainment apparatus, radios and
 apparatus for reproduction of sound and images; pro-
 fessional business consultancy, in particular relating
 to the bundling of purchases and assortment policies;
 developing of marketing strategies and marketing
 concepts for traders and workshops.

41 – Training; tuition; coaching; consultancy with re-
 gard to training and further training; arranging and
 conducting of courses, seminars and workshops.

45 – Licensing of industrial property rights.

(260) AM 2022 114781 A
 (800) 1615956
 (151) 2021 08 12
 (891) 2021 08 12
 (731) Aktsionernoe obshchestvo "VERTEX"

doroga v Kamenku, d. 62, litera A, RU-197350
 Saint-Petersburg, Russian Federation

(540)

FRINOZOL

(591) Black, white

(511)

5 – Nutritional supplements for human beings; medicines for human purposes; vitamin formulations for human consumption; pharmaceutical preparations; chemico-pharmaceutical preparations; chemical preparations for pharmaceutical purposes; pharmaceuticals.

(260) AM 2022 114782 A

(800) 1615968

(151) 2021 07 02

(891) 2021 07 02

(731) China Pingmei Shenma Energy and Chemical Group Co., Ltd

No.21, mineworker Road, Pingdingshan City,
Henan Province, China

(540)



(591) Black, white

(531) 01.03.08; 03.03.01; 26.11.21

(511)

1 – Hexanedioic acid; cyclohexanol; glycol; fertilizing preparations; sulphuric acid; nitric acid; caustic soda for industrial purposes; oxygen; phenol for industrial purposes; acids.

(260) AM 2022 114784 A

(800) 1616099

(151) 2021 03 02

(891) 2021 03 02

(731) FM World Sp. z o.o.

ul. Żmigrodzka 247, PL-51-129 Wrocław,
Poland

(540)

FEDERICO MAHORA

(591) Black, white

(531) 27.05.01

(511)

3 – Skin foundation; liquid foundation; make-up base; face powder; loose face powder; pressed face powder; creamy face powder; nail varnish remover [cosmetics]; nail varnish; lip liners; lip glosses; lipsticks; lip gloss palettes; cosmetics in the form of eye shadow; eyelid shadow; eyeshadow palettes; eye pencils; mascara; refill packs for cosmetics dispensers; body splash (terms considered too vague by the International Bureau – rule 13 (2) (b) of the Regulations); ma-

keup setting sprays; beauty lotions; rouges; concealers; facial concealer; eye concealers; eyebrow pencils; eyebrow cosmetics; eyebrow powder; eyebrow colors; serums for cosmetic purposes; eye correction serum (terms considered too vague by the International Bureau – rule 13 (2) (b) of the Regulations); beauty serums; make-up removing lotions; cosmetic preparations for nail drying; nail cream; cuticle cream; nail conditioners; lip conditioners; nail strengtheners; liquid soap used in foot bath; beauty soap; bath soap; shower soap; windscreen cleaning liquids; cloths impregnated with a detergent for cleaning; pre-moistened towelettes impregnated with a detergent for cleaning; wipes incorporating cleaning preparations; toilet cleaners; furniture polish; detergents for machine dishwashing; preparations for unblocking drain pipes; toilet cleaning gels; fragrances; air fragrancing preparations; household fragrances; perfumery and fragrances; pomanders [aromatic substances]; dishwashing liquid; cleaning fluids; window cleaning compositions; washing liquids; floor cleaning preparations; floor treatment compositions (terms considered too vague by the International Bureau – rule 13 (2) (b) of the Regulations); carpet shampoo; upholstery cleaners; oven cleaning preparations; furniture cleaner; destainers; liquid soap for laundry; dishwashing detergents; cleansing lotions; scouring liquids; non-slipping liquids for floors; dry cleaning fluids; facial cleansing milk; grease-removing preparations; rust removing preparations; descaling preparations for household purposes; face creams for cosmetic use; eye cream; tonics [cosmetic]; cosmetic body scrubs; body cleaning and beauty care preparations; deodorants for the feet; skin lotion; moisturising body lotion [cosmetic]; non-medicated foot cream; shower gels; hand creams; shampoos; hair rinses [shampoo-conditioners]; shampoo-conditioners; toothpaste; mouthwash; exfoliating scrubs for the hands; liquid soap for dish washing; deodorant soap; soap; laundry soap; soap products; cakes of soap for household cleaning purposes; cakes of soap for body washing; perfumes; perfumed toilet waters; fragrance preparations; scented sachets; air fragrance reed diffusers; room scenting sprays (terms considered too vague by the International Bureau – rule 13 (2) (b) of the Regulations); fragrances for automobiles; scented fabric refresher sprays; fragrances for personal use; sachets for perfuming linen; room fragrancing preparations; vaginal washes for personal sanitary or deodorant purposes; facial masks; cosmetic rouges; cosmetic facial lotions; face wipes; face powder (non-medicated -); cleaning masks for the face; facial scrubs [cosmetic]; cleansing foam; skin toners; beauty tonics for application to the face; toners for cosmetic use; facial toners [cosmetic]; sun-tanning gels; exfoliating scrubs for the body; face scrubs (non-medicated -); exfoliating scrubs for the face; body butter; hand and body butter; hydrating masks; body masks; body gels; body and facial gels [cosmetics]; body cream; face and body creams; body and facial

creams [cosmetics]; body lotions; soap free washing emulsions for the body; body emulsions; facial emulsions; facial washes [cosmetic]; bath gel; face gels; shower and bath gel; foaming bath gels; lotions for face and body care; bubble bath.

4 – Perfumed candles.

5 – Preparations for the neutralising of odours; deodorising room sprays; air deodoriser sprays; air deodorizing preparations; odor neutralizing preparations for clothing and textiles; carpet deodorizers; deodorants for upholstery; washes (disinfectant -) [other than soap]; antiseptic washing preparations.

16 – Tissues of paper for removing make-up; coarse tissue [for toiletry use].

19 – Advertisement columns [non-metallic structures].

20 – Advertising display boards; scented coat hangers.

21 – Make-up brushes; lip brushes; cosmetic sponges; sponges for applying body powder; facial cleansing sponges; make-up artist belts (terms considered too vague by the International Bureau – rule 13 (2) (b) of the Regulations); brush holders; eyeliner brushes; soap boxes; cloths for cleaning; scouring pads; containers for cosmetics; all-purpose portable household containers; lotion containers, empty, for household use; window dusters; fireplace brushes; abrasive sponges for kitchen [cleaning] use; dishcloths for washing dishes; dishwashing brushes; perfume burners; pomanders [containers].

(260) AM 2022 114785 A

(800) 1616202

(151) 2021 07 26

(891) 2021 07 26

(731) Apple Inc.

One Apple Park Way, Cupertino CA 95014,
USA

(540)



(591) Pink, blue, gray, white, yellow, and green

(531) 01.17.14; 07.11.10; 24.15.21; 26.04.04;

26.04.16; 29.01.15

(511)

9 – Computer software for use in searching, transmitting, storing, accessing, finding, organizing and viewing geographic locations, and for providing traffic

information, travel route planning, driving and walking directions, customized mapping of locations, electronic map display, and destination information.

(260) AM 2022 114786 A

(800) 1616226

(151) 2021 07 09

(891) 2021 07 09

(731) Denisova Darina Borisovna

1-st Dubrovskaya, 1, build.1, flat 44,

RU-109044 Moscow, Russian Federation

(540)

OLIMPBET

(591) Black, white

(511)

41 – Gambling; providing amusement arcade services; providing casino facilities [gambling]; bookmaking [gambling] services.

(260) AM 2022 114843 A

(800) 1617028

(151) 2021 07 27

(891) 2021 07 27

(731) Diachenkova Iryna Mykhailivna

Vatslava Gavela street, 9A, of. 133,

Kyiv 03067, Ukraine

(540)

WINE TRAVEL AWARDS

(591) Black, white

(511)

41 – Arranging and conducting of entertainment and educational events, congresses, conferences, concerts, seminars, symposiums, ceremonies regarding the awarding of prizes; arranging and conducting of presentations, except for advertising purposes; providing user reviews for entertainment or cultural purposes; providing online videos, not downloadable; providing online electronic publications, not downloadable; providing online music, not downloadable; providing television programmes, not downloadable, via video-on-demand services / providing television programs, not downloadable, via video-on-demand services; providing films, not downloadable, via video-on-demand services; providing user rankings for entertainment or cultural purposes / providing user ratings for entertainment or cultural purposes; scriptwriting, other than for advertising purposes; organization of balls; organization of exhibitions for cultural or educational purposes; organization of competitions [education or entertainment]; booking of seats for shows; party planning [entertainment]; entertainment services; production of shows.

(260) AM 2022 114855 A
 (800) 1617691
 (151) 2021 08 06
 (891) 2021 08 06
 (731) TAIZHOU VMA SEWING MACHINE CO., LTD.
 1st Floor, Building 37 (self-declaration), Juxing Science Park, Xiachen Street, Jiaojiang, Taizhou, Zhejiang, China

(540)



(591) Black, white
 (531) 26.03.23; 27.05.01; 27.05.19; 27.05.22
 (511)
 7 – Sewing machines; stitching machines; pedal drives for sewing machines.

(260) AM 2022 114856 A
 (800) 1617769
 (151) 2021 03 29
 (891) 2021 03 29
 (731) Chen Xiaosheng
 Group 5, Dachen Second Village, Dachen Town, Yiwu, Zhejiang, China

(540)

minMAX

(591) Black, white
 (531) 27.05.01; 27.05.09
 (511)
 7 – Mixing machines; kitchen machines, electric; mixers [machines]; electric crushers for household purposes; mills for household purposes, other than hand-operated; blenders, electric, for household purposes; whisks, electric, for household purposes; fruit presses, electric, for household purposes; food processors, electric; pepper mills, other than hand-operated; coffee grinders, other than hand-operated.

(260) AM 2022 114857 A
 (800) 1617788
 (151) 2021 07 16
 (891) 2021 07 16
 (731) LYKOS Pharma Ltd
 7, Sir William Reid Street, GZR 1039 Gzira, Malta

(540)

ФАСТЕНАЛ

(591) Black, white
 (531) 28.05

(511)
 5 – Pharmaceuticals; medical and veterinary preparations; therapeutic creams [medical]; greases for medical purposes; pheromones for medical use; swabs for medical use; hormones for medical purposes; drugs for medical purposes; chemical preparations for medical purposes; dietetic substances adapted for medical use; mineral preparations and substances for medical use; sanitary preparations for medical purposes; dental wax; disinfectants; medicinal ointments; material for stopping teeth, dental wax; anti-cough drops; anti-tussive expectorants; compounds for treating correlated pulmonary syndromes; compounds for treating respiratory diseases; cough mixtures; cough pastilles for medical use; linctus; decongestants; elixirs for relieving chills; expectorants; inhaled pharmaceutical preparations for the treatment of respiratory diseases and disorders; pharmaceutical cough preparations; pharmaceutical preparations for the prevention of diseases of the respiratory system; pharmaceutical preparations for the prevention of disorders of the respiratory system; pharmaceutical preparations for treating allergic rhinitis; pharmaceutical products for treating respiratory diseases; preparations for treating colds.

(260) AM 2022 114858 A
 (800) 1617793
 (151) 2021 07 12
 (891) 2021 07 12
 (731) Bielenda Kosmetyki Naturalne Sp. z o. o.
 ul. Fabryczna 20, PL-31-553 Kraków, Poland

(540)

SORAYA

(591) Black, white
 (511)
 3 – Cosmetic products.

(260) AM 2022 114859 A
 (800) 1617837
 (151) 2021 09 08
 (891) 2021 09 08
 (731) VAFO Brands s.r.o.
 K Brůdce 94, CZ-252 19 Chrást'any, Czech Republic

(540)

Christopherus

(591) Black, white
 (511)
 5 – Vitamine and mineral supplements for pets; protein supplements for animals; dietary supplements for animals; medicated additives for animal foods.
 29 – Meat and meat derivatives.
 31 – Fodder; dry, semi-moist, wet complete and complementary pet food; foodstuff for dogs; foodstuffs for

cats; pet treats; animal chews; beverages for pets; cuttlefish bones.

(260) AM 2022 114860 A
 (800) 1617848
 (151) 2021 07 06
 (891) 2021 07 06
 (731) ALAIN AFFLELOU FRANCHISEUR
 11 rue d'Argenson, F-75008 Paris, France
 (540)



(591) Black, white
 (531) 03.13.01; 27.05.10; 29.01.12
 (511)
 5 – Cleaning products for contact lenses; solutions for contact lenses; disinfectants for contact lenses.
 9 – Optical apparatus and instruments; contact lenses; eyewear; spectacles [optics]; sunglasses; spectacle cases; spectacle lenses; correcting lenses; optical glass; containers for contact lenses; spectacle frames.

(260) AM 2022 114861 A
 (800) 1617849
 (151) 2021 07 06
 (891) 2021 07 06
 (731) Rieker Holding AG
 Stockwiesenstrasse 1, CH-8240 Thayngen,
 Switzerland
 (540)



(591) Black, white
 (531) 27.05.21
 (511)
 18 – Leather and imitations of leather; bags; handbags.
 25 – Clothing; shoes; footwear; headwear; belts.

(260) AM 2022 114862 A
 (800) 1617864
 (151) 2021 03 30
 (891) 2021 03 30
 (731) MUTLU AKÜ VE MALZEMELERİ SANAYİ ANONİM ŞİRKETİ
 Tepeören Mahallesi, Eski Ankara Asfaltı
 Caddesi No:210, Tuzla, Istanbul, Turkey
 (540)



(591) Blue, white
 (531) 26.04.04; 26.04.18; 26.04.24; 27.05.17; 27.05.24; 29.01.12
 (511)
 1 – Chemicals for use in industry, science and photography, as well as in agriculture, horticulture and forestry; unprocessed artificial resins, unprocessed plastics; fire extinguishing and fire prevention compositions; tempering and soldering preparations; substances for tanning animal skins and hides; adhesives for use in industry; putties and other paste fillers; compost, manures, fertilizers; biological preparations for use in industry and science.
 9 – Scientific, research, navigation, surveying, photographic, cinematographic, audiovisual, optical, weighing, measuring, signalling, detecting, testing, inspecting, life-saving and teaching apparatus and instruments; apparatus and instruments for conducting, switching, transforming, accumulating, regulating or controlling the distribution or use of electricity, electric plugs, junction boxes [electricity], electric switches, circuit breakers, fuses, lighting ballasts, battery starter cables, electrical circuit boards, electric resistances, electric sockets, transformers [electricity], electrical adapters, battery chargers, electric door bells, electric and electronic cables, batteries, electric accumulators, solar panels for production of electricity; apparatus and instruments for recording, transmitting, reproducing or processing sound, images or data; recorded and downloadable media, computer software, blank digital or analogue recording and storage media; mechanisms for coin-operated apparatus; cash registers, calculating devices; computers and computer peripheral devices; diving suits, divers' masks, ear plugs for divers, nose clips for divers and swimmers, gloves for divers, breathing apparatus for underwater swimming; fire-extinguishing apparatus; eyeglasses, sunglasses, optical lenses and cases, containers, parts and components thereof; radar apparatus, sonars; decorative magnets; metronomes.

35 – Advertising, marketing and public relations; organization of exhibitions and trade fairs for commercial or advertising purposes; development of advertising concepts; provision of an online marketplace for

buyers and sellers of goods and services; office functions; secretarial services; arranging newspaper subscriptions for others; compilation of statistics; rental of office machines; systemization of information into computer databases; telephone answering for unavailable subscribers; business management, business administration and business consultancy; accounting; commercial consultancy services; personnel recruitment, personnel placement, employment agencies, import-export agencies; temporary personnel placement services; auctioneering; the bringing together, for the benefit of others, of a variety of goods, namely, chemicals for use in industry, science and photography, as well as in agriculture, horticulture and forestry, unprocessed artificial resins, unprocessed plastics, fire extinguishing and fire prevention compositions, tempering and soldering preparations, substances for tanning animal skins and hides, adhesives for use in industry, putties and other paste fillers, compost, manures, fertilizers, biological preparations for use in industry and science, scientific, research, navigation, surveying, photographic, cinematographic, audiovisual, optical, weighing, measuring, signalling, detecting, testing, inspecting, life-saving and teaching apparatus and instruments, apparatus and instruments for conducting, switching, transforming, accumulating, regulating or controlling the distribution or use of electricity, electric plugs, junction boxes [electricity], electric switches, circuit breakers, fuses, lighting ballasts, battery starter cables, electrical circuit boards, electric resistances, electric sockets, transformers [electricity], electrical adapters, battery chargers, electric door bells, electric and electronic cables, batteries, electric accumulators, solar panels for production of electricity, apparatus and instruments for recording, transmitting, reproducing or processing sound, images or data, recorded and downloadable media, computer software, blank digital or analogue recording and storage media, mechanisms for coin-operated apparatus, cash registers, calculating devices, computers and computer peripheral devices, diving suits, divers' masks, ear plugs for divers, nose clips for divers and swimmers, gloves for divers, breathing apparatus for underwater swimming, fire-extinguishing apparatus, eyeglasses, sunglasses, optical lenses and cases, containers, parts and components thereof, radar apparatus, sonars, decorative magnets, metronomes, motor land vehicles, motorcycles, mopeds, engines and motors for land vehicles, clutches for land vehicles, transmissions, transmission belts and transmission chains for land vehicles, gearing for land vehicles, brakes, brake discs and brake linings for land vehicles, vehicle chassis, automobile bonnets, vehicle suspension springs, shock absorbers for automobiles, gearboxes for land vehicles, steering wheels for vehicles, rims for vehicle wheels, bicycles and their bodies, handlebars and mudguards for bicycles, vehicle bodies, tipping bodies for trucks, trailers for tractors, frigorific bodies for land vehicles, trailer hitches for vehicles, vehicle

seats, head-rests for vehicle seats, safety seats for children, for vehicles, seat covers for vehicles, vehicle covers (shaped), sun-blinds adapted for vehicles, direction signals and arms for direction signals for vehicles, windscreen wipers and wiper arms for vehicles, inner and outer tires for vehicle wheels, tubeless tires, tire-fixing sets comprised of tire patches and tire valves for vehicles, windows for vehicles, safety windows for vehicles, rearview mirrors and wing mirrors for vehicles, anti-skid chains for vehicles, luggage carriers for vehicles, bicycle and ski carriers for cars, saddles for bicycles or motorcycles, air pumps for vehicles, for inflating tires, anti-theft alarms for vehicles, horns for vehicles, safety belts for vehicle seats, air bags [safety devices for automobiles], baby carriages, wheelchairs, pushchairs, wheelbarrows, shopping carts, single or multi-wheeled wheelbarrows, shopping trolleys, grocery carts, handling carts, rail vehicles, locomotives, trains, trams, wagons, cable cars, chairlifts, vehicles for locomotion by water and their parts, other than their motors and engines, vehicles for locomotion by air and their parts, other than their motors and engines, paper and cardboard, paper and cardboard for packaging and wrapping purposes, cardboard boxes, paper towels, toilet paper, paper napkins, plastic materials for packaging and wrapping purposes, printing blocks and types, bookbinding material, printed publications, printed matter, books, magazines, newspapers, bill books, printed dispatch notes, printed vouchers, calendars, posters, photographs [printed], paintings, stickers [stationery], postage stamps, stationery, office stationery, instructional and teaching material [except apparatus], writing and drawing implements, artists' materials, paper products for stationery purposes, adhesives for stationery purposes, pens, pencils, erasers, adhesive tapes for stationery purposes, cardboard cartons, writing paper, copying paper, paper rolls for cash registers, drawing materials, chalkboards, painting pencils, watercolors [paintings], office requisites, paint rollers and paintbrushes for painting, rubber, gutta-percha, gum, asbestos, mica and semi-finished synthetic goods made from these materials in the form of powder, bars, panels and foils, insulation, stopping and sealing materials, insulation paints, insulation fabrics, insulating tape and band, insulation covers for industrial machinery, joint sealant compounds for joints, gaskets, O-rings for sealing purposes (other than gaskets for motors, cylinders and washer for water taps), flexible pipes made from rubber and plastic, hoses made of plastic and rubber, including those used for vehicles, junctions for pipes of plastic and rubber, pipe jackets of plastic and rubber, hoses of textile material, junctions for pipes, not of metal, pipe jackets, not of metal, connecting hose for vehicle radiators, profile laths made of synthetic materials for vehicles for the purposes of decoration, enabling customers to conveniently view and purchase those goods; such services may be provided by retail stores, wholesale outlets, through ven-

ding machines, mail order catalogues or by means of electronic media, for example, through web sites or television shopping programmes.

(260) AM 2022 114868 A

(800) 1617905

(151) 2021 04 27

(891) 2021 04 27

(731) "FIT SPO GLOBAL" LTD

176, Vasil Aprilov blvd, BG-4000 Plovdiv,
Bulgaria

(540)



(591) Black, white

(531) 26.04.03; 26.04.18; 26.04.24; 27.05.24

(511)

5 – Dietetic food and substances adapted for medical or veterinary use, food for babies; dietary supplements for human beings and animals; albumin dietary supplements; vitamin preparations; vitamin preparations in the nature of food supplements; digestives for pharmaceutical purposes; dietetic substances adapted for medical use; dietary supplements with a cosmetic effect; dietetic foods adapted for medical purposes; dietary food supplements in the nature of ready-to-eat protein bars; dietetic beverages adapted for medical purposes; enzyme dietary supplements; immunostimulants; casein dietary supplements; medicinal drinks; mineral food supplements; starch for dietetic or pharmaceutical purposes; protein supplements for humans; protein dietary supplements; protein for use as a nutritional supplement; protein for food as food supplements; protein bars for food as food supplements; protein powder dietary supplements; liquid protein supplements; nutritional supplements; pollen dietary supplements; propolis dietary supplements; royal jelly dietary supplements; wheat germ dietary supplements; protein supplement shakes.

30 – Rice, pasta and noodles; tapioca and sago; flour and preparations made from cereals; bread, pastries and confectionery; chocolate; ice cream, sorbets and other edible ices; sugar, honey, treacle; biscuits; malt biscuits; cookies; snack bars containing nuts (confectionery); cereal-based meal replacement bars; muesli bars; chocolate-based meal replacement bars; sweets, candies; sweets containing fruit and nuts; sweets containing nuts and cereal preparations; sweets containing nuts, fruit and cereal preparations; sweets

containing fruit and cereal preparations; corn candy; waffles; high-protein cereal bars; chocolate-based ready-to-eat food bars; prepared desserts [pastries]; snack bars containing a mixture of grains, nuts and dried fruit [confectionery]; granola bars; chocolate-coated bars; energy bars; cereal based energy bars; energy sweets; energy sweets made from fruit and nuts; energy sweets made from cereal preparations and nuts; energy sweets made from fruit, nuts and cereal preparations; cereal bars; cereal bars and energy bars; corn flakes; cereal preparations; cereal products in bar form; cereal-based snack food; crackers; snacks manufactured from muesli; flapjacks, oat bars; oat biscuits; oat biscuits for human consumption; oat flakes; oat-based food; fruit drops [confectionery]; protein confectionery bars; protein cereal bars; popcorn; bars based on wheat; confectionery bars; sweetmeats [candy] being flavoured with fruit; confectionery; fruit confectionery; pastries (cakes, cupcakes, pastes); muesli; rusks; cereal based food bars; foodstuffs made from cereals; granola-based snack bars; maize flakes.

(260) AM 2022 114869 A

(800) 1617933

(151) 2021 05 18

(891) 2021 05 18

(731) TELECOM ITALIA S.P.A.

VIA GAETANO NEGRI 1, I-20123 MILANO,
Italy

(540)



(591) Blue, red and green

(531) 24.07.01; 24.07.23; 27.03.15; 27.05.01;

29.01.14

(511)

9 – Data processing apparatus; telephone apparatus; computer software applications, downloadable; computer hardware; computer software platforms, recorded or downloadable; computer software, (recorded).

35 – Retail sale services of computers; retail sale services of equipments for communication network; procurement of contracts concerning energy supply; retail sale services of electronic devices; business assistance and intermediation in the purchase and sale of computer and electronic goods; commercial administration of the licensing of the goods and services of others; computerized file management; arranging subscriptions to telecommunication services for others; rental of office machines; advertising; business management; office functions; digital advertising services; publicity and sales promotion services.

37 – Installation, maintenance and repair of computer hardware; office machines and equipment installation, maintenance and repair.

38 – Providing telecommunications connections to a global computer network; providing access to databases; communications by telephone; rental of access time to global computer networks; rental of modems; telephone and mobile telephone services.

42 – Cloud computing; electronic data storage; computer security consultancy; computer software design; rental of computer software; rental of web servers; computer programming; server hosting; telecommunications technology consultancy; software as a service [SaaS]; hosting computer sites [web sites]; platform as a service [PaaS]; engineering services; computer program design; infrastructure as a service (IaaS).

(260) AM 2022 114877 A

(800) 369373

(151) 1970 05 27

(891) 2021 08 06

(731) Winter Holding GmbH & Co KG
Heidelberger Strasse 9-11, 69226 Nußloch,
Germany

(540)

Gil Bret

(591) Black, white

(531) 27.05.01

(511)

25 – Outerclotthing for women (excluding knitted clothing).

(260) AM 2022 114878 A

(800) 570488

(151) 1991 05 17

(891) 2021 09 03

(731) LABORATOIRE NATIVE
4 rue Euler; F-75008 PARIS, France

(540)

NATIVE

(591) Black, white

(531) 27.05.17

(511)

3 – Perfumery and beauty products, soaps, cosmetics, essential oils, make-up products, dentifrices, dyes, colorants, tints and lotions for the hair and beard, hair bleaching products, shampoos, hair care, beauty and grooming products, hair waving and setting products, body deodorants, bleaching, laundering, cleaning, polishing, degreasing and abrasive preparations.

(260) AM 2022 114879 A

(800) 700227

(151) 1998 09 25

(891) 2021 09 13

(731) Akzo Nobel Coatings International B.V.
Velperweg 76, NL-6824 BM Arnhem,
Netherlands

(540)

LEVIS

(591) Black, white

(531) 27.05.17

(511)

2 – Paints, varnishes, lacquers; preservatives against rust and against deterioration of wood; mordants.

(260) AM 2022 114880 A

(800) 710368

(151) 1999 02 23

(891) 2021 09 13

(731) IPSEN PHARMA S.A.S.
65 quai Georges Gorse, F-92100 BOULOGNE
BILLANCOURT, France

(540)

ДИФЕРЕЛИН

(591) Black, white

(531) 28.05

(511)

5 – Pharmaceutical, veterinary and hygienic products.

42 – Medical, hygienic and beauty care; veterinary and agricultural services; scientific and industrial research; programming for computers.

(260) AM 2022 114950 A

(800) 1619213

(151) 2021 08 09

(891) 2021 08 09

(731) Platinum GmbH & CO. KG
Am Ockenheimer Graben 23, 55411 Bingen,
Germany

(540)



(591) Red

(531) 01.15.15; 27.01.12; 29.01.12

(511)
31 – Animal foodstuffs; foodstuffs for animals, in particular for dogs and cats.

(260) AM 2022 114953 A
(800) 1619275
(151) 2021 05 10
(891) 2021 05 10
(731) VIMAR S.p.A.
14, Viale Vicenza, I-36063 Marostica
(Vicenza), Italy

(540)

VOXIE

(591) Black, white
(511)
9 – Intercoms; video intercoms; video cameras; closed circuit cameras; video monitors; video cables; electric switches; electric buttons; electronic access control systems for interlocking doors; telephones; speakers; microphones; power supplies; electronic transformers; electrical switching apparatus; electrical relays; electronic amplifiers; equalizers [audio apparatus]; telephone cables; electric cables; audio cables; ethernet cables; optical cables; pushbutton panels (electric).

(260) AM 2022 114955 A
(800) 1619359
(151) 2021 04 14
(891) 2021 04 14
(731) Limited Liability Company "INCANTO-A"
Petersburg highway 93, building 1, room 504,
Tver, RU-170003 Tver region, Russian
Federation

(540)

INCANTO

(591) Black, white
(531) 27.05.01; 27.05.17
(511)
12 – Pushchairs; prams; pushchair covers; safety seats for children, for vehicles; fitted pushchair mosquito nets.

20 – Cots for babies; bumper guards for cots, other than bed linen; mats for infant playpens; bed casters, not of metal; furniture casters, not of metal; bassinets; Moses baskets; beds; playpens for babies; bed bases; pillows; baby changing mats; bedding, except linen; high chairs for babies; chairs [seats]; infant walkers.

(260) AM 2022 115035 A
(800) 1619907
(151) 2021 07 16
(891) 2021 07 16
(731) EGT Interactive

Tsarigradsko Shose Blvd. 159, Fl. 10, BG-1784
Sofia, Bulgaria

(540)

HOT DECO

(591) Brown, yellow
(531) 25.12.03; 27.05.02; 29.01.02
(511)

9 – Computer software for the administration of on-line games and computer gaming software; computer application software featuring games and gaming; betting software; gaming software that generates or displays wager outcomes of gaming machines.

28 – Slot machines [gaming machines]; gaming machines for gambling.

41 – Providing of casino and gaming facilities; betting services.

(260) AM 2022 115037 A
(800) 1619954
(151) 2021 06 10
(891) 2021 06 10

(731) Egis Gyógyszergyár Zrt.
Keresztúri út 30-38., H-1106 Budapest,
Hungary

(540)

САВИОЛ

(591) Black, white
(531) 28.05
(511)
3 – Cosmetics and cosmetic preparations.

5 – Human pharmaceutical preparations; dietetic substances adapted for medical use; dietary supplements; medicinal ointments; medicated skin creams; plasters, materials for dressings.

(260) AM 2022 115040 A
(800) 1619984
(151) 2021 08 27
(891) 2021 08 27
(731) PJSC "GAZPROM"
Nametkina str., 16, RU-117997 Moscow,
Russian Federation

(540)

**EARTH IS A BALL.
FOOTBALL DRIVES THE
PLANET!**

(591) Black, white
(531) 27.05.01; 27.05.15

(511)

9 – Coils, electric; particle accelerators; reflective articles for wear, for the prevention of accidents; protection devices for personal use against accidents; clothing for protection against accidents, irradiation and fire; accumulators, electric, for vehicles; batteries, electric, for vehicles; battery jars; accumulator jars; battery boxes; accumulator boxes; acidimeters for batteries; hydrometers; plates for batteries; whistle alarms; acoustic alarms; sound alarms; acoustic conduits; sound recording discs; phonograph records; speaking tubes; actinometers; adding machines; aerometers; enlarging apparatus [photography]; electrodynamic apparatus for the remote control of railway points; magnets; electromagnetic coils; air analysis apparatus; alarms; alcoholmeters; alidades; food analysis apparatus; igniting apparatus, electric, for igniting at a distance; electric apparatus for remote ignition; ignition batteries; altimeters; asbestos gloves for protection against accidents; asbestos clothing for protection against fire; ammeters; amplifiers; amplifying tubes; amplifying valves; anemometers; calibrating rings; fire extinguishers; anodes; anode batteries; high tension batteries; antennas; aerials; anti-glare glasses; visors for helmets; anti-interference devices [electricity]; transformers [electricity]; apertometers [optics]; money counting and sorting machines; distribution boxes [electricity]; surveying instruments; surveying chains; lenses for astrophotography; thermionic tubes; thermionic valves; audiovisual teaching apparatus; coin-operated musical automata [juke boxes]; juke boxes, musical; mechanisms for coin-operated apparatus; mechanisms for counter-operated apparatus; calipers; comparators; fire alarms; automatic indicators of low pressure in vehicle tires; automatic indicators of low pressure in vehicle tyres; protective suits for aviators; alarm bells, electric; rods for water diviners; life-saving rafts; scales; meteorological balloons; demagnetizing apparatus for magnetic tapes; tape recorders; magnetic tapes; barometers; weighing machines; weighbridges; fire beaters; chargers for electric accumulators; betatrons; ticket dispensers; cabinets for loudspeakers; close-up lenses; terminals [electricity]; pressure indicator plugs for valves; galvanometers; push buttons for bells; branch boxes [electricity]; tone arms for record players; spirit levels; punched card machines for offices; sheaths for electric cables; frames for photographic transparencies; circular slide rules; slide-rules; calculating machines; slide calipers; jigs [measuring instruments]; blueprint apparatus; cinematographic cameras; capillary tubes; sound recording carriers; protective helmets; respiratory masks, other than for artificial respiration; solderers' helmets; eyeglass chains; spectacle chains; heat regulating apparatus; darkrooms [photography]; boiler control instruments; drying racks [photography]; apparatus for editing cinematographic film; printed circuits; flashing lights [luminous signals]; signal bells; containers for microscope slides; collectors, electric; electric ins-

tallations for the remote control of industrial operations; switchboxes [electricity]; commutators; marine compasses; eyepieces; thread counters; pedometers; counters; meters; metronomes; condensers [capacitors]; capacitors; conductors, electric; electricity conduits; circuit closers; connectors [electricity]; junction boxes [electricity]; switchboards; contacts, electric; apparatus to check franking; apparatus to check stamping mail; regulating apparatus, electric; monitoring apparatus, other than for medical purposes; speed checking apparatus for vehicles; converters, electric; photocopiers [photographic, electrostatic, thermic]; eyeglass cords; spectacle cords; retorts; retorts' stands; correcting lenses [optics]; objectives [lenses] [optics]; cosmographic instruments; diving suits; electric apparatus for commutation; switches, electric; limiters [electricity]; electric plugs; current rectifiers; cell switches [electricity]; reducers [electricity]; dressmakers' measures; crucibles [laboratory]; cupels [laboratory]; appliances for measuring the thickness of leather; cyclotrons; counterfeit [false] coin detectors; shutter releases [photography]; densimeters; animated cartoons; laboratory trays; metal detectors for industrial or military purposes; sonars; detectors; shutters [photography]; diaphragms [acoustics]; centering apparatus for photographic transparencies; cameras [photography]; transparencies [photography]; slides [photography]; slide projectors; transparency projection apparatus; distance measuring apparatus; dictating machines; diffraction apparatus [microscopy]; loudspeakers; circuit breakers; record players; microscopes; distance recording apparatus; apparatus for recording distance; range finders; telemeters; distribution boards [electricity]; distribution consoles [electricity]; compasses for measuring; measures; measuring apparatus; dynamometers; water level indicators; fire escapes; flashbulbs [photography]; telephone receivers; fluorescent screens; projection screens; workmen's protective face-shields; screens [photography]; drainers for use in photography; photographic racks; electric loss indicators; measuring devices, electric; cables, electric; ducts [electricity]; control panels [electricity]; galvanic cells; connections for electric lines; couplings, electric; connections, electric; relays, electric; electrolyzers; transmitters of electronic signals; transmitting sets [telecommunication]; cleaning apparatus for sound recording discs; cleaning apparatus for phonograph records; sound recording strips; kilometer recorders for vehicles; mileage recorders for vehicles; spools [photography]; mechanical signs; epidiascopes; test tubes; balancing apparatus; thermostats; ergometers; material testing instruments and machines; egg-candlers; gauges; gasoline gauges; petrol gauges; spark-guards; cases especially made for photographic apparatus and instruments; testing apparatus not for medical purposes; refractometers; exposure meters [light meters]; invoicing machines; apparatus for fermentation [laboratory apparatus]; railway traffic safety appliances; wires, electric; magnetic wires;

plumb bobs; plumb lines; nets for protection against accidents; safety nets; life nets; safety tarpaulins; film cutting apparatus; filters for respiratory masks; filters for use in photography; battery chargers; high-frequency apparatus; frequency meters; fuses; radios; gale-na crystals [detectors]; galvanic batteries; gloves for protection against accidents; gloves for divers; gloves for protection against X-rays for industrial purposes; gas testing instruments; gasometers [measuring instruments]; surveying apparatus and instruments; levelling staffs [surveying instruments]; rods [surveying instruments]; drying apparatus for photographic prints; glazing apparatus for photographic prints; rulers [measuring instruments]; measuring glassware; graduated glassware; screens for photoengraving; grids for batteries; clothing for protection against fire; garments for protection against fire; audio- and video-receivers; heliographic apparatus; holograms; hygrometers; identification threads for electric wires; identification sheaths for electric wires; life-saving apparatus and equipment; fire hose nozzles; fire engines; fire pumps; slope indicators; clinometers; gradient indicators; inclinometers; taximeters; quantity indicators; vacuum gauges; speed indicators; inductors [electricity]; armatures [electricity]; data processing apparatus; mirrors for inspecting work; intercommunication apparatus; carriers for dark plates [photography]; inverters [electricity]; ionization apparatus not for the treatment of air or water; peepholes [magnifying lenses] for doors; hemline markers; furniture especially made for laboratories; lactodensimeters; lactometers; darkroom lamps [photography]; optical lamps; optical lanterns; magic lanterns; signal lanterns; lasers, not for medical purposes; optical lenses; letter scales; logs [measuring instruments]; sounding lines; magnifying glasses [optics]; signs, luminous; neon signs; eyeglasses; spectacles; instruments containing eyepieces; surveyors' levels; spectacle lenses; eyeglass lenses; eyewear; pressure gauges; manometers; periscopes; protective masks; mathematical instruments; coin-operated mechanisms for television sets; megaphones; computer memory devices; carpenters' rules; mercury levels; speed measuring apparatus [photography]; precision measuring apparatus; measuring instruments; meteorological instruments; rules [measuring instruments]; micrometer screws for optical instruments; microphones; microtomes; time switches, automatic; mirrors [optics]; breathing apparatus for underwater swimming; nautical apparatus and instruments; naval signalling apparatus; navigational instruments; eyeglass frames; spectacle frames; batteries, electric; accumulators, electric; levels [instruments for determining the horizontal]; levelling instruments; prisms [optics]; observation instruments; octants; ohmmeters; wave-meters; optical apparatus and instruments; optical glass; computers; computer programs, recorded; oscillographs; oxygen transpiring apparatus; ozonisers [ozonators]; micrometers; micrometer gauges; signalling panels, luminous or mechanical; lightning rods;

lightning arresters; lightning conductors; parking meters; apparatus and instruments for astronomy; apparatus for measuring the thickness of skins; acid hydrometers; weighing apparatus and instruments; Salinometers; washing trays [photography]; stands for photographic apparatus; viewfinders, photographic; photometers; phototelegraphy apparatus; apparatus and instruments for physics; steering apparatus, automatic, for vehicles; pince-nez; laboratory pipettes; plane tables [surveying instruments]; planimeters; ear plugs for divers; bells [warning devices]; weights; polarimeters; radiotelephony sets; radiotelegraphy sets; pressure measuring apparatus; pressure indicators; projection apparatus; cathodic anti-corrosion apparatus; teeth protectors; pyrometers; radar apparatus; vehicle radios; radiological apparatus for industrial purposes; protractors [measuring instruments]; apparatus and installations for the production of X-rays, not for medical purposes; X-ray tubes not for medical purposes; protection devices against X-rays, not for medical purposes; telephone apparatus; refractors; X-ray apparatus not for medical purposes; spectroscopes; resistances, electric; thermometers, not for medical purposes; respirators for filtering air; breathing apparatus, except for artificial respiration; rheostats; balances [steelyards]; lever scales [steelyards]; steelyards [lever scales]; signals, luminous or mechanical; sacccharometers; probes for scientific purposes; satellites for scientific purposes; diaphragms for scientific apparatus; teaching apparatus; choking coils [impedance]; wire connectors [electricity]; locks, electric; sextants; signalling whistles; vehicle breakdown warning triangles; electro-dynamic apparatus for the remote control of signals; simulators for the steering and control of vehicles; sirens; sound transmitting apparatus; sound recording apparatus; sound reproduction apparatus; sounding apparatus and machines; sounding leads; sound locating instruments; spectrograph apparatus; spherometers; stereoscopes; stereoscopic apparatus; needles for record players; styli for record players; sulfimeters; teleprinters; teletypewriters; tachometers; screw-tapping gauges; telegraphs [apparatus]; television apparatus; telegraph wires; remote control apparatus; masts for wireless aerials; teleprompters; telephone transmitters; telerupters; binoculars; telescopes; temperature indicators; time recording apparatus; theodolites; thermostats for vehicles; totalizers; revolution counters; speed regulators for record players; transmitters [telecommunication]; precision balances; marking gauges [joinery]; vacuum tubes [radio]; urinometers; variometers; verniers; videotapes; viscosimeters; theft prevention installations, electric; voltage regulators for vehicles; voting machines; voltmeters; apparatus for changing record player needles; stills for laboratory experiments; fuse wire; anticathodes; dog whistles; sighting telescopes for firearms; telescopic sights for firearms; anti-theft warning apparatus; azimuth instruments; beacons, luminous; holders for electric coils; films, exposed; road

signs, luminous or mechanical; life buoys; signalling buoys; buzzers; directional compasses; fog signals, non-explosive; cash registers; radiology screens for industrial purposes; identity cards, magnetic; photovoltaic cells; densitometers; disks, magnetic; floppy disks; head cleaning tapes [recording]; video recorders; computer keyboards; integrated circuits; semiconductors; chips [integrated circuits]; cathodes; life jackets; life belts; chemistry apparatus and instruments; cinematographic film, exposed; materials for electricity mains [wires, cables]; contact lenses; containers for contact lenses; incubators for bacteria culture; solar batteries; copper wire, insulated; discharge tubes, electric, other than for lighting; electric discharge tubes, other than for lighting; diaphragms [photography]; distillation apparatus for scientific purposes; dosage dispensers; dosimeters; electric door bells; eyeglass cases; spectacle cases; furnaces for laboratory use; ovens for laboratory use; optical fibers [fibres] [light conducting filaments]; optical fibers [light conducting filaments]; telephone wires; X-ray films, exposed; filters for ultraviolet rays, for photography; horns for loudspeakers; tripods for cameras; bar code readers; bullet-proof waistcoats; bullet-proof vests; fibre optic cables; fiber optic cables; marking buoys; wafers for integrated circuits; chromatography apparatus for laboratory use; chronographs [time recording apparatus]; compact discs [audio-video]; compact discs [read-only memory]; computer operating programs, recorded; computer peripheral devices; computer software, recorded; optical condensers; acoustic couplers; couplers [data processing equipment]; decompression chambers; plotters; divers' masks; electronic pens [visual display units]; encoded magnetic cards; facsimile machines; fire boats; interfaces for computers; juke boxes for computers; knee-pads for workers; light dimmers [regulators], electric; light regulators [dimmers], electric; magnetic data media; magnetic encoders; magnetic tape units for computers; microprocessors; modems; monitors [computer hardware]; monitors [computer programs]; mouse [computer peripheral]; optical character readers; optical data media; optical discs; printers for use with computers; processors [central processing units]; central processing units [processors]; readers [data processing equipment]; safety restraints, other than for vehicle seats and sports equipment; scanners [data processing equipment]; smoke detectors; transistors [electronic]; X-ray photographs, other than for medical purposes; junction sleeves for electric cables; abacuses; electronic agendas; answering machines; camcorders; cassette players; compact disc players; diagnostic apparatus, not for medical purposes; disk drives for computers; electrified rails for mounting spot lights; electronic pocket translators; electronic tags for goods; fire blankets; flashlights [photography]; integrated circuit cards [smart cards]; smart cards [integrated circuit cards]; measuring spoons; notebook computers; electronic notice boards; pocket calcula-

tors; shoes for protection against accidents, irradiation and fire; sprinkler systems for fire protection; starter cables for motors; sunglasses; time clocks [time recording devices]; video cassettes; video game cartridges; video screens; video telephones; goggles for sports; nose clips for divers and swimmers; protective helmets for sports; electronic publications, downloadable; computer programs, downloadable; navigation apparatus for vehicles [on-board computers]; decorative magnets; cordless telephones; mouse pads; personal stereos; wrist rests for use with computers; coaxial cables; covers for electric outlets; marine depth finders; electrified fences; computer game software, recorded; headphones; lighting ballasts; radio pagers; satellite navigational apparatus; solenoid valves [electromagnetic switches]; voltage surge protectors; walkie-talkies; wind socks for indicating wind direction; light-emitting electronic pointers; resuscitation mannequins [teaching apparatus]; stage lighting regulators; egg timers [sandglasses]; hourglasses; DNA chips; DVD players; automated teller machines [ATM]; traffic-light apparatus [signalling devices]; hands-free kits for telephones; asbestos screens for firemen; riding helmets; clothing especially made for laboratories; encoded identification bracelets, magnetic; transponders; downloadable ring tones for mobile phones; downloadable music files; downloadable image files; crash test dummies; laboratory centrifuges; printed circuit boards; USB flash drives; Global Positioning System [GPS] apparatus; portable media players; cell phone straps; light-emitting diodes [LED]; triodes; step-up transformers; laptop computers; fire hose; bags adapted for laptops; sleeves for laptops; digital photo frames; Petri dishes; Pitot tubes; stroboscopes; traffic cones; temperature indicator labels, not for medical purposes; computer software applications, downloadable; electronic book readers; smartphones; toner cartridges, unfilled, for printers and photocopiers; baby monitors; video baby monitors; lens hoods; tablet computers; encoded key cards; 3D spectacles; memory cards for video game machines; bullet-proof clothing; accelerometers; electrical adapters; life-saving capsules for natural disasters; computer hardware; solar panels for the production of electricity; cellular phones; mobile telephones; cell phones; telescopic sights for artillery; digital signs; wearable activity trackers; chargers for electronic cigarettes; connected bracelets [measuring instruments]; covers for smartphones; cases for smartphones; selfie sticks [hand-held monopods]; calorimeters; flowmeters; reflective safety vests; electronic collars to train animals; joysticks for use with computers, other than for video games; smartglasses; smartwatches; fire extinguishing apparatus; protective films adapted for computer screens; mouth guards for sports; head guards for sports; needles for surveying compasses; security tokens [encryption devices]; infrared detectors; covers for personal digital assistants [PDAs]; baby scales; electronic access control systems for interlocking doors; thermal

imaging cameras; scales with body mass analysers; scales with body mass analyzers; covers for tablet computers; black boxes [data recorders]; digital weather stations; charging stations for electric vehicles; interactive touch screen terminals; smart rings; electric and electronic effects units for musical instruments; audio interfaces; equalizers [audio apparatus]; equalisers [audio apparatus]; subwoofers; bathroom scales; thermo-hygrometers; biochips; protective films adapted for smartphones; virtual reality headsets; electronic interactive whiteboards; humanoid robots with artificial intelligence; audio mixers; batteries for electronic cigarettes; electronic key fobs being remote control apparatus; electronic sheet music, downloadable; T-squares for measuring; squares for measuring; square rulers for measuring; electronic numeric displays; laboratory robots; teaching robots; security surveillance robots; personal digital assistants [PDAs]; computer software platforms, recorded or downloadable; satellite finder meters; ring sizers; finger sizers; thin client computers; rearview cameras for vehicles; hand-held electronic dictionaries; resuscitation training simulators; electric wire harnesses for automobiles; snorkels; sports whistles; computer screen saver software, recorded or downloadable; selfie lenses; downloadable graphics for mobile phones; telecommunication apparatus in the form of jewellery; telecommunication apparatus in the form of jewelry; wearable computers; wearable video display monitors; magnetic resonance imaging [MRI] apparatus, not for medical purposes; rescue laser signalling flares; ink cartridges, unfilled, for printers and photocopiers; wah-wah pedals; height measuring instruments; hairdressing training heads [teaching apparatus]; devices for the projection of virtual keyboards; survival blankets; lifeboats; nanoparticle size analysers; nanoparticle size analyzers; ear pads for headphones; data gloves; trackballs [computer peripherals]; downloadable emoticons for mobile phones; telepresence robots; climate control digital thermostats; piezoelectric sensors; organic light-emitting diodes [OLED]; quantum dot light-emitting diodes [QLED]; droppers for measuring, other than for medical or household purposes; electric sockets; computer game software, downloadable; rescue flares, non-explosive and non-pyrotechnic; stands adapted for laptops; headgear being protective helmets; padlocks, electronic; weight belts for divers; earpieces for remote communication; parking sensors for vehicles; ticket printers; body harnesses for support when lifting loads; animal signalling rattles for directing livestock; video projectors; downloadable cryptographic keys for receiving and spending cryptocurrency; downloadable e-wallets; credit card terminals; biometric passports; e-passports; biometric identity cards.

12 – Forklift trucks; railway couplings; couplings for land vehicles; aerial conveyors; air vehicles; hot air balloons; inner tubes for pneumatic tyres; inner tubes for pneumatic tires; repair outfits for inner tubes; air

pumps [vehicle accessories]; suspension shock absorbers for vehicles; shock absorbing springs for vehicles; amphibious airplanes; non-skid devices for vehicle tires; non-skid devices for vehicle tyres; anti-skid chains; head-rests for vehicle seats; sprinkling trucks; trailer hitches for vehicles; motor buses; motor coaches; boats; trucks; lorries; automobile hoods; automobile chains; automobile chassis; reversing alarms for vehicles; aeroplanes; ferry boats; luggage carriers for vehicles; airships; dirigible balloons; tires for vehicle wheels; tyres for vehicle wheels; valves for vehicle tyres; valves for vehicle tires; flanges for railway wheel tyres; flanges for railway wheel tires; torsion bars for vehicles; ship hulls; boat hooks; steering gears for ships; disengaging gear for boats; inclined ways for boats; screw-propellers for boats; oars; tipping bodies for lorries; tipping bodies for trucks; mine cart wheels; bicycles; bicycle kickstands; bogies for railway cars; davits for boats; mudguards; two-wheeled trolleys; luggage trucks; sack-barrow; cars for cable transport installations; caissons [vehicles]; vehicle wheels; hoods for vehicle engines; hoods for vehicles; caravans; trailers [vehicles]; crankcases for land vehicle components, other than for engines; safety belts for vehicle seats; hubs for vehicle wheels; vehicle wheel hubs; bicycle chains; wheelchairs; barges; launches; handling carts; hose carts; casting carriages; casting cars; ladle carriages; ladle cars; golf carts [vehicles]; golf cars [vehicles]; vehicle chassis; rudders; rolling stock for funicular railways; rolling stock for railways; funnels for ships; treads for vehicles [tractor type]; treads for vehicles [roller belts]; tractors; mine cars; vehicle bumpers; buffers for railway rolling stock; hydraulic circuits for vehicles; bicycle handlebars; sleeping berths for vehicles; timbers [frames] for ships; bicycle tyres; bicycle tires; gears for bicycles; bicycle brakes; bicycle mudguards; rims for bicycle wheels; bicycle wheel rims; bicycle cranks; bicycle motors; hubs for bicycle wheels; bicycle wheel hubs; bicycle pedals; pumps for bicycles, cycles; bicycle pumps; spokes for bicycle wheels; bicycle wheel spokes; bicycle wheels; bicycle saddles; motorcycle kickstands; gearing for land vehicles; dredgers [boats]; handcars; motors, electric, for land vehicles; electric vehicles; clutches for land vehicles; safety seats for children, for vehicles; parachutes; casings for pneumatic tires; casings for pneumatic tyres; balance weights for vehicle wheels; space vehicles; spars for ships; axles for vehicles; axle journals; windshield wipers; windscreen wipers; dress guards for bicycles; luggage nets for vehicles; hub caps; vans [vehicles]; brakes for vehicles; bands for wheel hubs; refrigerated vehicles; refrigerated railway wagons; engines for land vehicles; motors for land vehicles; sculls; stern oars; seat covers for vehicles; portholes; seaplanes; hydroplanes; sleeping cars; locomotives; driving motors for land vehicles; railway carriages; vehicle running boards; transmissions for land vehicles; propulsion mechanisms for land vehicles; military vehicles

for transport; jet engines for land vehicles; motorcycles; freewheels for land vehicles; water vehicles; ships; screws [propellers] for ships; paddles for canoes; windscreens; windshields; spikes for tires [tyres]; studs for tires [tyres]; treads for retreading tyres; treads for retreading tires; pneumatic tires [tyres]; pneumatic tyres; pontoons; doors for vehicles; ski carriers for cars; delivery tricycles; carrier tricycles; pushchairs; strollers; stroller covers; pushchair covers; pushchair hoods; stroller hoods; screw-propellers; vehicle wheel spokes; spoke clips for wheels; ski lifts; vehicle suspension springs; dining cars; dining carriages; rearview mirrors; rims for vehicle wheels; vehicle wheel rims; motorcycle saddles; side cars; vehicle seats; sports cars; cleats [nautical]; chairlifts; rowlocks; oarlocks; tilting-carts; aircraft; undercarriages for vehicles; sleighs [vehicles]; tramcars; cable transport apparatus and installations; funiculars; telpher railways [cable cars]; cable cars; tricycles; turbines for land vehicles; vehicles for locomotion by land, air, water or rail; adhesive rubber patches for repairing inner tubes; upholstery for vehicles; mopeds; windows for vehicles; cars; automobiles; motor cars; anti-theft devices for vehicles; tipping apparatus [parts of railway wagons]; yachts; aeronautical apparatus, machines and appliances; anti-glare devices for vehicles*; anti-dazzle devices for vehicles*; automobile tyres; automobile tires; automobile bodies; bumpers for automobiles; shock absorbers for automobiles; anti-theft alarms for vehicles; horns for vehicles; concrete mixing vehicles; inner tubes for bicycle tires; inner tubes for bicycle tyres; brake linings for vehicles; brake shoes for vehicles; gear boxes for land vehicles; wheelbarrows; carts*; bicycle frames; bodies for vehicles; ejector seats for aircraft; vehicle covers [shaped]; driving chains for land vehicles; transmission chains for land vehicles; torque converters for land vehicles; signal arms for vehicles; funnels for locomotives; steering wheels for vehicles; saddle covers for bicycles; ambulances; tubeless tires for bicycles; tubeless tyres for bicycles; reduction gears for land vehicles; brake segments for vehicles; air cushion vehicles; caps for vehicle fuel tanks; connecting rods for land vehicles, other than parts of motors and engines; tailboard lifts [parts of land vehicles]; elevating tailgates [parts of land vehicles]; power tailgates [parts of land vehicles]; security harness for vehicle seats; sun-blinds adapted for automobiles; transmission shafts for land vehicles; air bags [safety devices for automobiles]; baskets adapted for bicycles; motor homes; camping cars; casters for trolleys [vehicles]; casters for carts [vehicles]; cleaning trolleys; fenders for ships; kick sledges; panniers adapted for bicycles; shopping trolleys; shopping carts; snowmobiles; remote control vehicles, other than toys; push scooters [vehicles]; masts for boats; covers for vehicle steering wheels; spoilers for vehicles; headlight wipers; brake pads for automobiles; spare wheel covers; spare tire covers; spare tyre covers; tilt trucks; cigar lighters for auto-

mobiles; brake discs for vehicles; saddlebags adapted for bicycles; bicycle bells; armored vehicles; armoured vehicles; engine mounts for land vehicles; military drones; canoes; civilian drones; side view mirrors for vehicles; fitted pushchair mosquito nets; fitted stroller mosquito nets; vehicle joysticks; driverless cars [autonomous cars]; self-driving cars; motor scooters; mobility scooters; ashtrays for automobiles; motorcycle chains; motorcycle frames; motorcycle handlebars; motorcycle engines; panniers adapted for motorcycles; solid tires for vehicle wheels; solid tyres for vehicle wheels; baby carriages; prams; fitted footmuffs for prams; fitted footmuffs for baby carriages; fitted footmuffs for pushchairs; fitted footmuffs for strollers; tyre mousse inserts; tire mousse inserts; bags adapted for pushchairs; bags adapted for strollers; remotely operated vehicles for underwater inspections; autonomous underwater vehicles for seabed inspections; bellows for articulated buses; electric bicycles; saddle covers for motorcycles; motor racing cars; robotic cars; camera drones; photography drones; fishing trolleys; roll cage trolleys; lug nuts for vehicle wheels; clips adapted for fastening automobile parts to automobile bodies; rescue sleds; tow trucks; wreckers for transport; garbage trucks; rubbish trucks; trailers for transporting bicycles; bicycle trailers; pet strollers; trucks with a crane feature incorporated; delivery drones; helicams; gyrocopters; helicopters; self-balancing scooters; self-balancing boards; self-balancing electric unicycles; vehicle bonnet pins; vehicle hood pins; tires for snow ploughs; tyres for snow ploughs; diving bells; cup holders for vehicles; trolleys*; horse-drawn carriages; amphibious vehicles; all-terrain vehicles.

14 – Agates; clock hands; ingots of precious metals; jewelry of yellow amber; jewellery of yellow amber; pearls made of ambroid [pressed amber]; amulets [jewellery]; amulets [jewelry]; spun silver [silver wire]; silver thread [jewellery]; silver thread [jewelry]; clocks; pendulums [clock- and watchmaking]; barrels [clock- and watchmaking]; bracelets [jewellery]; bracelets [jewelry]; wristwatches; watch bands; watch straps; straps for wristwatches; jewellery charms; jewelry charms; charms for jewellery; charms for jewelry; brooches [jewellery]; brooches [jewelry]; dials [clock- and watchmaking]; sundials; clockworks; chains [jewellery]; chains [jewelry]; watch chains; chronographs [watches]; chronometers; chronoscopes; chronometric instruments; necklaces [jewellery]; necklaces [jewelry]; clocks and watches, electric; tie clips; coins; diamonds; threads of precious metal [jewellery]; wire of precious metal [jewellery]; threads of precious metal [jewelry]; atomic clocks; control clocks [master clocks]; master clocks; clock cases; iridium; ivory jewelry; ivory jewellery; ornaments of jet; jet, unwrought or semi-wrought; copper tokens; jewelry; jewellery; lockets [jewellery]; lockets [jewelry]; medals; precious metals, unwrought or semi-wrought; wat-

ches; watch springs; watch glasses; watch crystals; movements for clocks and watches; olivine [gems]; peridot; gold, unwrought or beaten; gold thread [jewellery]; gold thread [jewelry]; osmium; palladium; ornamental pins; pearls [jewellery]; pearls [jewelry]; semi-precious stones; precious stones; platinum [metal]; alarm clocks; rhodium; ruthenium; spinel [precious stones]; statues of precious metal; paste jewellery; alloys of precious metal; anchors [clock- and watch-making]; rings [jewellery]; rings [jewelry]; works of art of precious metal; boxes of precious metal; hat jewellery; hat jewelry; earrings; shoe jewellery; shoe jewelry; cuff links; busts of precious metal; watch cases [parts of watches]; presentation boxes for watches; figurines of precious metal; statuettes of precious metal; pins [jewellery]; pins [jewelry]; tie pins; badges of precious metal; key chains [split rings with trinket or decorative fob]; key rings [split rings with trinket or decorative fob]; silver, unwrought or beaten; stopwatches; cloisonné jewellery; cloisonné jewelry; jewellery boxes; jewelry boxes; beads for making jewelry; beads for making jewellery; clasps for jewelry; clasps for jewellery; jewelry findings; jewellery findings; jewelry rolls; jewellery rolls; cabochons; split rings of precious metal for keys; presentation boxes for jewellery; presentation boxes for jewelry; watch hands; misbaha [prayer beads]; bracelets made of embroidered textile [jewelry]; bracelets made of embroidered textile [jewellery]; charms for key rings; charms for key chains; rosaries; chaplets; crucifixes of precious metal, other than jewellery; crucifixes of precious metal, other than jewelry; crucifixes as jewellery; crucifixes as jewelry; retractable key chains; retractable key rings; jewellery hat pins; jewelry hat pins.

15 – Accordions; tuning hammers; reeds; bows for musical instruments; bow nuts for musical instruments; sticks for bows for musical instruments; horsehair for bows for musical instruments; pianos; conductors' batons; drumsticks; bandonions; barrel organs; basses [musical instruments]; harmonicas; catgut for musical instruments; buccins [trumpets]; carillons [musical instruments]; castanets; hats with bells [musical instruments]; kettledrum frames; pegs for musical instruments; zithers; clarionets; keyboards for musical instruments; musical instruments; concertinas; double basses; strings for musical instruments; stringed musical instruments; horns [musical instruments]; cornets [musical instruments]; cymbals; tuning forks; mouthpieces for musical instruments; cases for musical instruments; flutes; gongs; Jews' harps [musical instruments]; guitars; harmoniums; harps; harp strings; oboes; electronic musical instruments; intensity regulators for mechanical pianos; lyres; plectrums; picks for stringed instruments; mandolins; chin rests for violins; bagpipes; musical boxes; turning apparatus for sheet music; bridges for musical instruments; triangles [musical instruments]; ocarinas; organs; wind pipes for organs; drumheads; skins for

drums; pedals for musical instruments; piano keyboards; piano strings; piano keys; bellows for musical instruments; mutes for musical instruments; dampers for musical instruments; drums [musical instruments]; tambourines; tom-toms; kettledrums; trombones; clarions; trumpets; valves for musical instruments; violas; violins; xylophones; keys for musical instruments; music rolls [piano]; perforated music rolls; music stands; huqin [Chinese violins]; bamboo flutes; pipa [Chinese guitars]; sheng [Chinese musical wind instruments]; suona [Chinese trumpets]; handbells [musical instruments]; music synthesizers; stands for musical instruments; saxophones; balalaikas [stringed musical instruments]; banjos; melodicas; colophony for stringed musical instruments; rosin for stringed musical instruments; robotic drums; mallets for musical instruments; straps for musical instruments.

16 – Steel letters; steel pens; adhesive tape dispensers [office requisites]; address stamps; addressing machines; paper; posters; advertisement boards of paper or cardboard; franking machines for office use; postage meters for office use; staples for offices; clips for offices; pen clips; stapling presses [office requisites]; albums; scrapbooks; pictures; prints [engravings]; cigar bands; pencil sharpening machines, electric or non-electric; bookends; hand-rests for painters; aqua-relles; watercolors [paintings]; watercolours [paintings]; architects' models; document files [stationery]; writing slates; slate pencils; silver paper; modelling clay; arithmetical tables; calculating tables; engravings; lithographic works of art; paintings [pictures], framed or unframed; pencils; newspapers; periodicals; atlases; loose-leaf binders; ring binders; gummed tape [stationery]; mats for beer glasses; tickets; biological samples for use in microscopy [teaching materials]; printing blocks; drawing pads; pads [stationery]; spoils for inking ribbons; wristbands for the retention of writing instruments; pamphlets; embroidery designs [patterns]; drawing pins; thumbtacks; moisteners [office requisites]; painters' brushes; blotters; stamps [seals]; sealing stamps; inking pads; sealing wax; sealing machines for offices; sealing compounds for stationery purposes; writing or drawing books; trays for sorting and counting money; tracing patterns; tracing paper; tracing cloth; fingerstalls for office use; printing type; carbon paper; paper for recording machines; note books; square rulers for drawing; cards; charts; teaching materials [except apparatus]; index cards [stationery]; paper sheets [stationery]; cardboard; hat boxes of cardboard; perforated cards for Jacquard looms; cardboard tubes; catalogues; tags for index cards; song books; composing frames [printing]; folders for papers; jackets for papers; painters' easels; numbers [type]; Indian inks; chromolithographs [chromos]; chromos; modelling wax, not for dental purposes; files [office requisites]; office perforators; toilet paper; hygienic paper; books; compasses for drawing; type [numerals and letters]; letters [type]; composing sticks; letter trays; conical paper bags;

correcting fluids [office requisites]; correcting ink [heliography]; pencil leads; histological sections for teaching purposes; French curves; covers [stationery]; wrappers [stationery]; writing chalk; chalk for lithography; tailors' chalk; chalk holders; pencil holders; pencil lead holders; cream containers of paper; paper clasps; rollers for typewriters; transfers [decalcomanias]; decalcomanias; graphic prints; graining combs; drawing boards; drawing materials; drawing instruments; diagrams; envelopes [stationery]; duplicators; etchings; wrapping paper; packing paper; nibs; typewriters, electric or non-electric; pen cases; boxes for pens; nibs of gold; erasing products; writing materials; shields [paper seals]; erasing shields; rubber erasers; electrocardiograph paper; punches [office requisites]; ink; inking ribbons; inkwells; envelope sealing machines for offices; photographs [printed]; pen wipers; seals [stamps]; fabrics for bookbinding; drawing sets; ledgers [books]; indexes; figurines of papier mâché; statuettes of papier mâché; filter paper; filtering materials of paper; forms, printed; office requisites, except furniture; charcoal pencils; stencils [stationery]; galley racks [printing]; electrotypes; geographical maps; terrestrial globes; artists' watercolor saucers; artists' watercolour saucers; graphic reproductions; graphic representations; scrapers [erasers] for offices; engraving plates; hectographs; printed timetables; moisteners for gummed surfaces [office requisites]; postcards; printed matter; hand labelling appliances; printers' blankets, not of textile; printing sets, portable [office requisites]; printed publications; manuals [handbooks]; handbooks [manuals]; writing paper; paperweights; tracing needles for drawing purposes; drawing pens; table linen of paper; lithographs; lithographic stones; booklets; luminous paper; papier mâché; manifolds [stationery]; marking chalk; plastics for modelling; modelling materials; modelling paste; handkerchiefs of paper; inking sheets for duplicators; tablecloths of paper; blackboards; paper-clips; numbering apparatus; oleographs; binding strips [bookbinding]; sealing wafers; palettes for painters; pantographs [drawing instruments]; stationery; parchment paper; pastels [crayons]; sewing patterns; stencil cases; house painters' rollers; canvas for painting; paint boxes for use in schools; plastic film for wrapping; apparatus for mounting photographs; photograph stands; photo-engravings; blueprints; plans; paper creasers [office requisites]; fountain pens; stencil plates; stencils; portraits; covers of paper for flower pots; flower-pot covers of paper; mimeograph apparatus and machines; paper tapes and cards for the recordal of computer programmes; prospectuses; paper for radiograms; drawing rulers; printers' reglets; bookbinding material; bookbinding cloth; cloth for bookbinding; cords for bookbinding; bookbinding cords; inking sheets for document reproducing machines; pens [office requisites]; magazines [periodicals]; paper ribbons, other than haberdashery or hair decorations; typewriter ribbons; bags [envelopes, pouches] of pa-

per or plastics, for packaging; stamp pads; school supplies [stationery]; bookmarkers; bookmarks; greeting cards; steatite [tailor's chalk]; balls for ball-point pens; tablemats of paper; desk mats; typewriter keys; holders for stamps [seals]; cases for stamps [seals]; postage stamps; stamp stands; transparencies [stationery]; vignetting apparatus; gluten [glue] for stationery or household purposes; adhesives [glues] for stationery or household purposes; adhesive tapes for stationery or household purposes; adhesive bands for stationery or household purposes; address plates for addressing machines; almanacs; calendars; starch paste [adhesive] for stationery or household purposes; paintbrushes; self-adhesive tapes for stationery or household purposes; elastic bands for offices; bibs of paper; wood pulp board [stationery]; wood pulp paper; boxes of paper or cardboard; stands for pens and pencils; bottle envelopes of paper or cardboard; coasters of paper; announcement cards [stationery]; plastic bubble packs for wrapping or packaging; flags of paper; paper shredders for office use; sheets of reclaimed cellulose for wrapping; desktop cabinets for stationery [office requisites]; glue for stationery or household purposes; pastes for stationery or household purposes; paper knives [letter openers]; garbage bags of paper or of plastics; pencil sharpeners, electric or non-electric; tissues of paper for removing make-up; table napkins of paper; place mats of paper; squares for drawing; T-squares for drawing; penholders; writing cases [stationery]; inkstands; writing cases [sets]; handwriting specimens for copying; bottle wrappers of paper or cardboard; placards of paper or cardboard; towels of paper; face towels of paper; labels of paper or cardboard; etching needles; viscose sheets for wrapping; gums [adhesives] for stationery or household purposes; gummed cloth for stationery purposes; isinglass for stationery or household purposes; bags for microwave cooking; paper coffee filters; plastic cling film, extensible, for palletization; signboards of paper or cardboard; stickers [stationery]; bookbinding apparatus and machines [office equipment]; comic books; copying paper [stationery]; holders for cheque books; holders for checkbooks; ink sticks; ink stones [ink reservoirs]; musical greeting cards; newsletters; packaging material made of starches; waxed paper; passport holders; writing brushes; writing instruments; drawer liners of paper, perfumed or not; credit card imprinters, non-electric; document laminators for office use; papers for painting and calligraphy; writing board erasers; clipboards; chart pointers, non-electronic; paper bows, other than haberdashery or hair decorations; moulds for modelling clays [artists' materials]; moulds for modelling clays [artists' materials]; money clips; trading cards, other than for games; absorbent sheets of paper or plastic for foodstuff packaging; humidity control sheets of paper or plastic for foodstuff packaging; correcting tapes [office requisites]; paint trays; marking pens [stationery]; flyers; document holders [stationery]; page holders; polymer

modelling clay; obliterating stamps; packing [cushioning, stuffing] materials of paper or cardboard; stuffing of paper or cardboard; padding materials of paper or cardboard; banknotes; spray chalk; printed coupons; rice paper; plastic bags for pet waste disposal; washi; table runners of paper; printed sheet music; banners of paper; bunting of paper; animation cels; paper bags for use in the sterilization of medical instruments; paper bags for use in the sterilisation of medical instruments; name badge holders [office requisites]; retractable reels for name badge holders [office requisites]; clips for name badge holders [office requisites]; paper for medical examination tables; dental tray covers of paper; bibs, sleeved, of paper; paper cutters [office requisites]; stencils for decorating food and beverages; name badges [office requisites]; barcode ribbons; glitter for stationery purposes; baggage claim check tags of paper; paper wipes for cleaning; protective covers for books; colouring books; coloring books.

18 – Mountaineering sticks; alpenstocks; animal skins; pelts; umbrella rings; saddle trees; leather leashes; leather leads; fastenings for saddles; umbrella or parasol ribs; goldbeaters' skin; purses; bridoons; straps for soldiers' equipment; music cases; umbrella sticks; walking sticks; canes; walking stick seats; bits for animals [harness]; frames for umbrellas or parasols; game bags [hunting accessories]; school bags; school satchels; card cases [notecases]; leatherboard; hat boxes of leather; horse collars; horse blankets; kid; muzzles; travelling trunks; collars for animals; leather cord; curried skins; harness straps; harness traces; straps of leather [saddlery]; straps for skates; leather straps; leather thongs; butts [parts of hides]; leather, unworked or semi-worked; trimmings of leather for furniture; leather trimmings for furniture; imitation leather; umbrellas; sling bags for carrying infants; parts of rubber for stirrups; stirrup leathers; tool bags, empty; whips; nose bags [feed bags]; umbrella covers; casings, of leather, for springs; casings, of leather, for plate springs; knee-pads for horses; covers for animals; harness for animals; blinkers [harness]; blinders [harness]; traces [harness]; rucksacks; backpacks; halters; head-stalls; walking stick handles; walking cane handles; cat o' nine tails; chin straps, of leather; moleskin [imitation of leather]; handbag frames; parasols; fur; fur-skins; umbrella handles; pocket wallets; wheeled shopping bags; shopping bags; reins; attaché cases; bags for climbers; bags for campers; beach bags; handbags; travelling bags; bags [envelopes, pouches] of leather, for packaging; girths of leather; riding saddles; saddlery; briefcases; travelling sets [leatherware]; suitcases; suitcase handles; valves of leather; cattle skins; boxes of leather or leatherboard; chain mesh purses; cases of leather or leatherboard; trunks [luggage]; vanity cases, not fitted; chamois leather, other than for cleaning purposes; skins of chamois, other than for cleaning purposes; shoulder belts [straps] of leather; leather shoulder belts; leather

shoulder straps; covers for horse saddles; boxes of vulcanized fibre; boxes of vulcanized fiber; haversacks; garment bags for travel; bridles [harness]; key cases; net bags for shopping; valises; furniture coverings of leather; pads for horse saddles; bags for sports; stirrups; harness fittings; horseshoes; slings for carrying infants; pouch baby carriers; bags; credit card cases [wallets]; business card cases; randsels [Japanese school satchels]; baggage tags; luggage tags; saddlecloths for horses; labels of leather; grips for holding shopping bags; tefillin [phylacteries]; suitcases with wheels; saddlebags; clothing for pets; reins for guiding children; motorized suitcases; compression cubes adapted for luggage; conference folders; conference portfolios; hiking sticks; trekking sticks; leathercloth; backpacks for carrying infants.

20 – Beehives; display boards; decorations of plastic for foodstuffs; yellow amber; stuffed animals; beds for household pets; nesting boxes for household pets; kennels for household pets; animal claws; curtain rings; silvered glass [mirrors]; cupboards; medicine cabinets; clips, not of metal, for cables and pipes; casks of wood for decanting wine; whalebone, unworked or semi-worked; bamboo; benches [furniture]; fishing baskets; playpens for babies; cradles; bassinets; library shelves; reels of wood for yarn, silk, cord; bedsteads of wood; wood ribbon; corks for bottles; corks; bottle racks; embroidery frames; brush mountings; sideboards; animal horns; desks; office furniture; costume stands; comb foundations for beehives; sections of wood for beehives; furniture; taps, not of metal, for casks; faucets, not of metal, for casks; index cabinets [furniture]; filing cabinets; imitation tortoiseshell; screens for fireplaces [furniture]; coffins; coffin fittings, not of metal; stag antlers; chairs [seats]; seats; chaise longues; chaise lounges; head-rests [furniture]; hat stands; loading pallets, not of metal; loading gauge rods, not of metal, for railway wagons; hinges, not of metal; display stands; dog kennels; coat hangers; clothes hangers; shelves for file cabinets; armchairs; mannequins; tailors' dummies; dressmakers' dummies; containers, not of metal, for liquid fuel; chests of drawers; counters [tables]; containers, not of metal [storage, transport]; floating containers, not of metal; tables; coral; trays, not of metal; horn, unworked or semi-worked; corozo; bedding, except linen; cushions; mattresses; hooks, not of metal, for clothes rails; coathooks, not of metal; vats, not of metal; tea carts; tea trolleys; drafting tables; towel dispensers, fixed, not of metal; towel dispensers, not of metal, fixed; divans; staves of wood; cabinet work; tortoiseshell; oyster shells; stakes, not of metal, for plants or trees; ladders of wood or plastics; mobile boarding stairs, not of metal, for passengers; school furniture; typing desks; shelves for typewriters; placards of wood or plastics; nuts, not of metal; meerschaum; removable mats or covers for sinks; mats, removable, for sinks; packaging containers of plastic; curtain holders, not of textile material; beds; reels, not of metal,

non-mechanical, for flexible hoses; winding spools, not of metal, non-mechanical, for flexible hoses; stair rods; work benches; racks [furniture]; nesting boxes; fans for personal use, non-electric; closures, not of metal, for containers; furniture fittings, not of metal; flower-stands [furniture]; flower-pot pedestals; fodder racks; gun racks; casks, not of metal; cask stands, not of metal; curtain rollers; meat safes; window fittings, not of metal; bed fittings, not of metal; door fittings, not of metal; chopping blocks [tables]; crates; covers for clothing [wardrobe]; registration plates, not of metal; numberplates, not of metal; furniture of metal; rattan; newspaper display stands; magazine racks; slatted indoor blinds; washstands [furniture]; hospital beds; bed casters, not of metal; latches, not of metal; lecterns; hampers [baskets] for the transport of items; coatstands; transport pallets, not of metal; handling pallets, not of metal; steps [ladders], not of metal; furniture partitions of wood; partitions of wood for furniture; furniture casters, not of metal; honeycombs; mobiles [decoration]; standing desks; mother-of-pearl, unworked or semi-worked; identity plates, not of metal; nameplates, not of metal; house numbers, not of metal, non-luminous; stuffed birds; pillows; air pillows, not for medical purposes; straw mattresses; straw mattress; plaited straw, except matting; straw plaits; straw edgings; bakers' bread baskets; umbrella stands; screens [furniture]; clothes hooks, not of metal; bead curtains for decoration; tent pegs, not of metal; table tops; doors for furniture; curtain rails; furniture shelves; edgings of plastic for furniture; tanks, not of metal nor of masonry; reservoirs, not of metal nor of masonry; curtain rods; curtain hooks; curtain tie-backs; reeds [plaiting materials]; animal hooves; writing desks; locks, not of metal, for vehicles; seats of metal; sofas; settees; bed bases; valves, not of metal, other than parts of machines; statues of wood, wax, plaster or plastic; tables of metal; dressing tables; moldings for picture frames; mouldings for picture frames; shelves for storage; lockers; mirrors [looking glasses]; deck chairs; bolsters; trestles [furniture]; keyboards for hanging keys; plate racks; wickerwork; showcases [furniture]; air cushions, not for medical purposes; air mattresses, not for medical purposes; ambroid bars; ambroid plates; works of art of wood, wax, plaster or plastic; troughs, not of metal, for mixing mortar; chests, not of metal; bins, not of metal; vice benches [furniture]; barrels, not of metal; barrel hoops, not of metal; cask hoops, not of metal; stands for calculating machines; bungs, not of metal; plugs, not of metal; sealing caps, not of metal; screws, not of metal; rivets, not of metal; pegs [pins], not of metal; dowels, not of metal; pins [pegs], not of metal; bolts, not of metal; bottle caps, not of metal; bottle closures, not of metal; bottle fasteners, not of metal; identification bracelets, not of metal; dinner wagons [furniture]; busts of wood, wax, plaster or plastic; binding screws, not of metal, for cables; picture frames; picture frame brackets; picture rods [frames]; massage

tables; waterbeds, not for medical purposes; drain traps [valves] of plastic; plugs [dowels], not of metal; wall plugs, not of metal; shells; stools; water-pipe valves of plastic; bottle casings of wood; statuettes of wood, wax, plaster or plastic; figurines of wood, wax, plaster or plastic; locks, other than electric, not of metal; hairdressers' chairs; poles, not of metal; baskets, not of metal; letter boxes, not of metal or masonry; mooring buoys, not of metal; garment covers [storage]; signboards of wood or plastics; trolleys [furniture]; bamboo curtains; chests for toys; high chairs for babies; infant walkers; inflatable publicity objects; plastic key cards, not encoded and not magnetic; mirror tiles; pulleys of plastics for blinds; saw horses; scratching posts for cats; shoulder poles [yokes]; carts for computers [furniture]; trolleys for computers [furniture]; funerary urns; wind chimes [decoration]; indoor window blinds of woven wood; indoor window shades of woven wood; book rests [furniture]; pet cushions; indoor window blinds [furniture]; indoor window shades [furniture]; door handles, not of metal; hand-held mirrors [toilet mirrors]; mats for infant playpens; towel stands [furniture]; knobs, not of metal; wall-mounted baby changing platforms; baby changing mats; door bolts, not of metal; indoor window blinds of paper; indoor window shades of paper; indoor window blinds of textile; indoor window shades of textile; door bells, not of metal, non-electric; freestanding partitions [furniture]; screw tops, not of metal, for bottles; door knockers, not of metal; saw benches [furniture]; inflatable furniture; step stools, not of metal; bathtub grab bars, not of metal; collars, not of metal, for fastening pipes; jewelry organizer displays; jewellery organizer displays; sleeping mats; sleeping pads; split rings, not of metal, for keys; dispensers for dog waste bags, fixed, not of metal; door stops, not of metal or rubber; window stops, not of metal or rubber; sash fasteners, not of metal, for windows; window fasteners, not of metal; door fasteners, not of metal; tool boxes, not of metal, empty; tool chests, not of metal, empty; shelving units; bag hangers, not of metal; plastic keys; brackets, not of metal, for furniture; labels of plastic; console tables; bookcases; valet stands; jerrycans, not of metal; birdhouses; clips of plastic for sealing bags; bumper guards for cots, other than bed linen; bumper guards for cribs, other than bed linen; boxes of wood or plastic; cots for babies; cribs for babies; moses baskets; legs for furniture; feet for furniture; wardrobes; footstools; shoe pegs, not of metal; shoe dowels, not of metal; crucifixes of wood, wax, plaster or plastic, other than jewellery; crucifixes of wood, wax, plaster or plastic, other than jewelry; oil drainage containers, not of metal; air beds, not for medical purposes; camping mattresses; plastic ramps for use with vehicles; shower chairs; head support cushions for babies; anti-roll cushions for babies; head positioning pillows for babies; hand-held flagpoles, not of metal; stoppers, not of glass, metal or rubber; door closers, not of me-

tal, non-electric; door springs, not of metal, non-electric; runners, not of metal, for sliding doors; bath seats for babies; lap desks; portable desks; door openers, not of metal, non-electric; window openers, not of metal, non-electric; window closers, not of metal, non-electric; sash pulleys, not of metal; window pulleys, not of metal; padlocks, other than electronic, not of metal; bathroom vanities [furniture]; drawers for furniture; luggage lockers.

21 – Drinking troughs; feeding troughs; steel wool for cleaning; washing boards; thermally insulated containers for food; carpet beaters [hand instruments]; glass bulbs [receptacles]; glass vials [receptacles]; animal bristles [brushware]; poultry rings; nozzles for watering hose; watering devices; sprinkling devices; brushes; sprinklers; watering cans; bread baskets for household purposes; rings for birds; bird baths; brooms; carpet sweepers; glass flasks [containers]; buckets; pails; basins [receptacles]; cooking pot sets; pouring spouts; currycombs; butter dishes; butter-dish covers; beer mugs; glass jars [carboys]; drinking vessels; heat-insulated containers for beverages; boxes for dispensing paper towels; soap boxes; tea caddies; bowls [basins]; basins [bowls]; demijohns; carboys; boot-jacks; glass stoppers; corkscrews, electric and non-electric; decorative glass spheres; bottles; insulating flasks; vacuum bottles; refrigerating bottles; bottle openers, electric and non-electric; cooking skewers of metal; cooking pins of metal; nail brushes; toilet brushes; lamp-glass brushes; material for brush-making; hair for brushes; perfume burners; cruets; cabarets [trays]; birdcages; sifters [household utensils]; heat-insulated containers; decanters; menu card holders; stew-pans; saucepan scourers of metal; cinder sifters [household utensils]; ceramics for household purposes; fly swatters; cauldrons; shoe brushes; horse brushes; mangers for animals; combs for animals; combs; cloths for cleaning; rags for cleaning; china ornaments; molds [kitchen utensils]; moulds [kitchen utensils]; apparatus for wax-polishing, non-electric; cocktail shakers; glue-pots; glasses [receptacles]; drinking horns; cosmetic utensils; strainers for household purposes; fruit bowls; knife rests for the table; closures for pot lids; pot lids; ironing board covers, shaped; tie presses; blenders, non-electric, for household purposes; sieves [household utensils]; crystal [glassware]; ice cube molds; ice cube moulds; polishing leather; cooking pots; scoops for household purposes; cookery moulds; cookery molds; cleaning instruments, hand-operated; toothpicks; washtubs; plates to prevent milk boiling over; cutting boards for the kitchen; large-toothed combs for the hair; dusting apparatus, non-electric; flat-iron stands; powdered glass for decoration; toilet cases; fitted vanity cases; toilet paper dispensers; soap dispensers; siphon bottles for aerated water; siphon bottles for carbonated water; enamelled glass, not for building; shoe trees; funnels; spice sets; toilet sponges; sponge holders; furniture dusters; drying racks for laundry; buckets made of

woven fabrics; comb cases; earthenware; crockery; holders for flowers and plants [flower arranging]; flower pots; whisks, non-electric, for household purposes; mops; frying pans; scrubbing brushes; fruit presses, non-electric, for household purposes; smoke absorbers for household purposes; mess-tins; glove stretchers; cake moulds; cake molds; plate glass [raw material]; drinking bottles for sports; grills [cooking utensils]; griddles [cooking utensils]; grill supports; gridiron supports; tar-brushes, long handled; powder puffs; glass, unworked or semi-worked, except building glass; insect traps; glass wool, other than for insulation; pots; vegetable dishes; liqueur sets; basting spoons [cooking utensils]; majolica; kitchen grinders, non-electric; utensils for household purposes; crumb trays; mosaics of glass, not for building; mills for household purposes, hand-operated; wool waste for cleaning; nest eggs, artificial; egg cups; opal glass; opaline glass; scouring pads; pads for cleaning; bread boards; fitted picnic baskets, including dishes; trouser presses; paper plates; rolling pins, domestic; electric combs; pie servers; tart scoops; wine-tasting pipettes; wine-tasting siphons; ironing boards; trays of paper, for household purposes; earthenware saucepans; nozzles for watering cans; roses for watering cans; pepper mills, hand-operated; pepper pots; polishing apparatus and machines, for household purposes, non-electric; polishing materials for making shiny, except preparations, paper and stone; porcelain ware; vases; soap holders; dishes for soap; chamber pots; pottery; dustbins; garbage cans; refuse bins; trash cans; powder compacts, empty; coolers [ice pails]; ice buckets; ice pails; graters for kitchen use; rat traps; containers for household or kitchen use; napkin rings; salad bowls; salt cellars; salt shakers; syringes for watering flowers and plants; sprinklers for watering flowers and plants; services [dishes]; dishes; tea services [tableware]; table napkin holders; vessels of metal for making ices and iced drinks; saucers; shoe horns; soup bowls; eyebrow brushes; mouse traps; statues of porcelain, ceramic, earthenware, terra-cotta or glass; sugar bowls; epergnes; cups; clothing stretchers; stretchers for clothing; teapots; buttonhooks; piggy banks; toilet utensils; beverage urns, non-electric; tableware, other than knives, forks and spoons; perfume vaporizers; perfume sprayers; glass incorporating fine electrical conductors; painted glassware; glass for vehicle windows [semi-finished product]; mugs; aerosol dispensers, not for medical purposes; works of art of porcelain, ceramic, earthenware, terra-cotta or glass; table plates; autoclaves, non-electric, for cooking; pressure cookers, non-electric; beaters, non-electric; heaters for feeding bottles, non-electric; shaving brushes; shaving brush stands; stands for shaving brushes; bobèches; candle drip rings; boxes of glass; candy boxes; boxes for sweets; candelabra [candlesticks]; candlesticks; kettles, non-electric; tea infusers; tea balls; toothbrushes; electric brushes, except parts of machines; busts of porcelain, ceramic, earthenware, terra-cotta or

glass; covers, not of paper, for flower pots; flower-pot covers, not of paper; coffee grinders, hand-operated; coffee services [tableware]; coffee filters, non-electric; coffee percolators, non-electric; coasters, not of paper or textile; abrasive pads for kitchen purposes; deep fryers, non-electric; portable cool boxes, non-electric; portable coolers, non-electric; water apparatus for cleaning teeth and gums; chamois leather for cleaning; buckskin for cleaning; skins of chamois for cleaning; wax-polishing appliances, non-electric, for shoes; cheese-dish covers; baskets for household purposes; trays for household purposes; cotton waste for cleaning; dish covers; covers for dishes; trivets [table utensils]; pitchers; jugs; kitchen containers; kitchen utensils; cooking utensils, non-electric; toothpick holders; toothbrushes, electric; deodorising apparatus for personal use; deodorizing apparatus for personal use; brushes for cleaning tanks and containers; signboards of porcelain or glass; sponges for household purposes; feather-dusters; dusting cloths [rags]; vitreous silica fibres, other than for textile use; vitreous silica fibers, other than for textile use; fiberglass, other than for insulation or textile use; fibreglass, other than for insulation or textile use; figurines of porcelain, ceramic, earthenware, terra-cotta or glass; statuettes of porcelain, ceramic, earthenware, terra-cotta or glass; fiberglass thread, other than for textile use; fibreglass thread, other than for textile use; coffeepots, non-electric; tea strainers; flasks; gloves for household purposes; tankards; cruet sets for oil and vinegar; polishing gloves; candle extinguishers; baby baths, portable; cages for household pets; cloth for washing floors; dishwashing brushes; indoor terrariums [plant cultivation]; litter boxes for pets; litter trays for pets; fused silica [semi-worked product], other than for building; waffle irons, non-electric; bread bins; chopsticks; cleaning tow; clothes-pegs; clothes-pins; cocktail stirrers; confectioners' decorating bags [pastry bags]; cookie [biscuit] cutters; cookie jars; cups of paper or plastic; drinking glasses; floss for dental purposes; gardening gloves; hot pots, not electrically heated; isothermic bags; lazy susans; lunch boxes; mixing spoons [kitchen utensils]; noodle machines, hand-operated; pastry cutters; plungers for clearing blocked drains; spatulas for kitchen use; abrasive sponges for scrubbing the skin; garlic presses [kitchen utensils]; disposable table plates; towel rails and rings; rails and rings for towels; toilet paper holders; indoor aquaria; tanks [indoor aquaria]; aquarium hoods; indoor terrariums [vivariums]; mop wringers; waste paper baskets; window-boxes; drinking straws; straws for drinking; tea cosies; make-up removing appliances; electric devices for attracting and killing insects; baking mats; boot trees; hip flasks; cosmetic spatulas; dripping pans; fly traps; candle jars [holders]; food steamers, non-electric; make-up sponges; crushers for kitchen use, non-electric; potholders; oven mitts; kitchen mitts; barbecue mitts; basting brushes; bulb basters; car washing mitts; make-up brushes; mop wringer buckets; tortilla presses,

non-electric [kitchen utensils]; ski wax brushes; eyelash brushes; egg separators, non-electric, for household purposes; foam toe separators for use in pedicures; plug-in diffusers for mosquito repellents; cold packs for chilling food and beverages; reusable ice cubes; tablemats, not of paper or textile; place mats, not of paper or textile; decanter tags; wine aerators; heads for electric toothbrushes; coin banks; lint removers, electric or non-electric; polishing cloths; pig bristles for brush-making; horsehair for brush-making; ice tongs; salad tongs; serving ladles; pestles for kitchen use; mortars for kitchen use; ice cream scoops; nutcrackers; sugar tongs; broom handles; ladles for serving wine; inflatable bath tubs for babies; stands for portable baby baths; tea bag rests; cake decorating tips and tubes; rotary washing lines; cooking mesh bags, other than for microwaves; droppers for cosmetic purposes; droppers for household purposes; couscous cooking pots, non-electric; tagines, non-electric; tajines, non-electric; egg yolk separators; reusable silicone food covers; animal grooming gloves; squeegees [cleaning instruments]; egg poachers; aromatic oil diffusers, other than reed diffusers, electric and non-electric; plates for diffusing aromatic oil; pasta makers, hand-operated; diaper disposal pails; nappy disposal bins; disposable aluminium foil containers for household purposes; disposable aluminum foil containers for household purposes; roller tubes for peeling garlic; toothpaste tube squeezers; wine pourers; pet feeding bowls; pet feeding bowls, automatic; candle warmers, electric and non-electric; dishcloths; abrasive mitts for scrubbing the skin.

22 – Brattice cloth; tarpaulins; strips for tying-up vines; wood shavings; wood wool; sawdust; flock [stuffing]; raw silk; nets for camouflage; raw fibrous textile; fishing nets; camel hair; hemp fibres; hemp fibers; tow; hemp bands; schappe [raw silk waste]; silk waste; coconut fiber; coconut fibre; cocoons; ropes, not of metal; ropes; whipcord; rope ladders; raw cotton; cotton tow; horsehair; down [feathers]; eider-down; padding materials, not of rubber, plastics, paper or cardboard; stuffing, not of rubber, plastics, paper or cardboard; packing [cushioning, stuffing] materials, not of rubber, plastics, paper or cardboard; packing string; upholstery wool [stuffing]; string; fibrous gaskets for ships; vitreous silica fibres for textile use; vitreous silica fibers for textile use; twine made of paper; twine for nets; silk flock; wool flock; sheaf-binding yarns; hammocks; grasses for upholstery; ladder tapes for Venetian blinds; ladder tapes or webbing for Venetian blinds; jute; kapok; snares [nets]; network; raw or treated wool; carded wool; combed wool; liber; wax ends; raw linen [flax]; feathers for bedding; awnings of textile; sails; wadding for filtering; wadding for padding and stuffing upholstery; straw for stuffing upholstery; feathers for stuffing upholstery; animal hair; ramie fibre; ramie fiber; raffia; sacks for the transport and storage of materials in bulk; bags [envelopes, pouches] of textile, for packa-

ging; esparto grass; tents; fleece wool; shorn wool; seaweed for stuffing; vehicle covers, not fitted; textile fibers; textile fibres; sisal; wrapping or binding bands, not of metal; thread, not of metal, for wrapping or binding; straw wrappers for bottles; bottle envelopes of straw; packing, of straw, for bottles; braces, not of metal, for handling loads; harness, not of metal, for handling loads; straps, not of metal, for handling loads; belts, not of metal, for handling loads; slings, not of metal, for handling loads; cables, not of metal; covers for camouflage; binding thread, not of metal, for agricultural purposes; carbon fibres for textile use; carbon fibers for textile use; sash cords; cords for hanging pictures; cotton waste [flock] for padding and stuffing; packing rope; plastic fibres for textile use; plastic fibers for textile use; glass fibres for textile use; glass fibers for textile use; nets; linters; awnings of synthetic materials; car towing ropes; mail bags; sails for ski sailing; mesh bags for washing laundry; body bags; purse seines; net pens for fish farming; canvas for sails; outdoor blinds of textile; bindings, not of metal; animal feeding nets; pig bristles; dust sheets; drop cloths; cloth bags specially adapted for the storage of diapers; bivouac sacks being shelters; laundry bags.

23 – Thread; yarn; cotton thread and yarn; embroidery thread and yarn; woollen thread and yarn; hemp thread and yarn; coir thread and yarn; silk thread and yarn; spun cotton; sewing thread and yarn; spun thread and yarn; jute thread and yarn; spun wool; worsted; linen thread and yarn; rayon thread and yarn; darning thread and yarn; spun silk; fiberglass thread for textile use; fiberglass thread for textile use; rubber thread for textile use; elastic thread and yarn for textile use; threads of plastic materials for textile use; chenille yarn; thread of metal for embroidery.

24 – Adhesive fabric for application by heat; fabric, impervious to gases, for aeronautical balloons; fabric imitating animal skins; upholstery fabrics; bath linen, except clothing; banners of textile or plastic; billiard cloth; fabric; bolting cloth; buckram; brocades; textile material; cloth; canvas for tapestry or embroidery; trellis [cloth]; hemp fabric; hemp cloth; hat linings, of textile, in the piece; lining fabric for footwear; fabric for footwear; table runners, not of paper; chevots [cloth]; oilcloth for use as tablecloths; velvet; felt; cotton fabrics; bed covers; bedspreads; coverlets [bedspreads]; quilts; mattress covers; tick [linen]; bed covers of paper; tablecloths, not of paper; travelling rugs [lap robes]; crepe [fabric]; crepon; damask; lingerie fabric; linings [textile]; sheets [textile]; shrouds; flags of textile or plastic; bunting of textile or plastic; drugget; eiderdowns [down coverlets]; elastic woven material; curtain holders of textile material; glass cloths [towels]; traced cloth for embroidery; traced cloths for embroidery; flannel [fabric]; frieze [cloth]; cheese cloth; fustian; dimity; bath mitts; gauze [cloth]; gummed cloth, other than for stationery purposes; hairc-

loth [sackcloth]; covers [loose] for furniture; loose covers for furniture; silk fabrics for printing patterns; printed calico cloth; jersey [fabric]; jute fabric; woollen cloth; woollen fabric; linen cloth; bed linen; diapered linen; table linen, not of paper; household linen; towels of textile; marabouts [cloth]; ticks [mattress covers]; furniture coverings of plastic; coverings of plastic for furniture; table napkins of textile; serviettes of textile; moleskin [fabric]; handkerchiefs of textile; mosquito nets; pillowcases; plastic material [substitute for fabrics]; door curtains; ramie fabric; rayon fabric; curtains of textile or plastic; face towels of textile; silk [cloth]; tulle; esparto fabric; taffeta [cloth]; knitted fabric; net curtains; zephyr [cloth]; calico; coasters of textile; tablemats of textile; non-woven textile fabrics; sleeping bag liners; cloths for removing makeup; labels of textile; wall hangings of textile; tapestry [wall hangings], of textile; fiberglass fabrics, for textile use; fibreglass fabrics for textile use; filtering materials of textile; printers' blankets of textile; chenille fabric; pillow shams; place mats of textile; bed blankets; covers for cushions; fabrics for textile use; furniture coverings of textile; fitted toilet lid covers of fabric; shower curtains of textile or plastic; diaper changing cloths for babies; blankets for household pets; sleeping bags for babies; baby buntings; sleeping bags; bed valances; crib bumpers [bed linen]; cot bumpers [bed linen]; muslin fabric; bivouac sacks being covers for sleeping bags; picnic blankets.

25 – Non-slipping devices for footwear; motorists' clothing; footwear; bath sandals; bath slippers; stockings; sweat-absorbent stockings; heelpieces for stockings; berets; overalls; smocks; boas [necklets]; caps being headwear; hosiery; boots; half-boots; tips for footwear; dress shields; braces for clothing [suspenders]; suspenders; lace boots; collars [clothing]; neck gaiters; neck tube scarves; camisoles; boxer shorts; skull caps; bodices [lingerie]; underwear; underclothing; hoods [clothing]; hat frames [skeletons]; cap peaks; belts [clothing]; shawls; dressing gowns; sweaters; pullovers; jumpers [pullovers]; chasubles; socks; sock suspenders; garters; stocking suspenders; boot uppers; inner soles; shirts; shirt fronts; short-sleeve shirts; clothing; hats; fittings of metal for footwear; furs [clothing]; detachable collars; tights; wet suits for water-skiing; combinations [clothing]; sweat-absorbent underwear; sweat-absorbent underclothing; corselets; suits; ready-made clothing; babies' pants [underwear]; ear muffs [clothing]; neckties; footwear uppers; gaiters; breeches for wear; trousers; pants (Am.); cyclists' clothing; outerclothing; gloves [clothing]; ready-made linings [parts of clothing]; scarfs; scarves; sashes for wear; knitwear [clothing]; shirt yokes; esparto shoes or sandals; fur stoles; football shoes; football boots; top hats; gabardines [clothing]; corsets [underclothing]; girdles; galoshes; goloshes; vests; waistcoats; gaiter straps; wimples; gymnastic shoes; coats; waterproof clothing; leggings [leg warmers]; leg warmers; jerseys [clothing]; skirts; layettes [clot-

hing]; liveries; sports jerseys; cuffs; wristbands [clothing]; aprons [clothing]; muffs [clothing]; maniples; fingerless gloves; miters [hats]; mitres [hats]; slippers; pelerines; pelisses; beach clothes; beach shoes; pockets for clothing; pajamas; pyjamas; dresses; wooden shoes; sandals; underpants; brassieres; overcoats; top-coats; heelpieces for footwear; togas; welts for footwear; uniforms; stuff jackets [clothing]; jackets [clothing]; paper clothing; veils [clothing]; bathing caps; bathing trunks; bathing drawers; bathing suits; swimsuits; bath robes; bibs, not of paper; soles for footwear; shoes; heels; sports shoes; footmuffs, not electrically heated; studs for football boots; studs for football shoes; boots for sports; headbands [clothing]; parkas; petticoats; ski boots; slips [underclothing]; teddies [underclothing]; bodies [underclothing]; bandanas [neckerchiefs]; clothing for gymnastics; clothing of imitations of leather; clothing of leather; mantillas; masquerade costumes; saris; tee-shirts; turbans; ascots; shower caps; fishing vests; money belts [clothing]; pocket squares; paper hats [clothing]; sleep masks; skorts; ponchos; sarongs; ski gloves; leggings [trousers]; jumper dresses; pinafore dresses; visors being headwear; panties; knickers; sports singlets; valenki [felted boots]; albs; ankle boots; sweat-absorbent socks; hairdressing capes; karate uniforms; judo uniforms; leotards; kimonos; bibs, sleeved, not of paper; clothing containing slimming substances; embroidered clothing; heel protectors for shoes; headwear; mittens; latex clothing; rash guards; clothing incorporating LEDs; headscarfs; headscarves; adhesive bras; adhesive brassieres; spats.

26 – Shoe fasteners; needles; shoemakers' needles; sewing needles; needles for wool combing machines; binding needles; darning needles; saddlers' needles; knitting needles; fastenings for clothing; ostrich feathers [clothing accessories]; whalebones for corsets; corset busks; hair bands; false beards; hair grips; bobby pins; hat trimmings; edgings for clothing; lace for edgings; darning lasts; buttons; snap fasteners; expanding bands for holding sleeves; brassards; arm bands [clothing accessories]; fastenings for suspenders; fastenings for braces; brooches [clothing accessories]; embroidery; fancy goods [embroidery]; belt clasps; numerals or letters for marking linen; monogram tabs for marking linen; shoe hooks; shoe laces; shoe trimmings; shoe eyelets; chenille [passementerie]; decorative articles for the hair; hair curling pins; hair barrettes; hair slides; hair pins; hair nets; false hair; tresses of hair; plaited hair; numerals for marking linen; collar supports; cords for clothing; blouse fasteners; dress body fasteners; sewing boxes; sewing thimbles; crochet hooks; crochet needles; hooks [haberdashery]; zippers; zip fasteners; slide fasteners [zippers]; pin cushions; false hems; festoons [embroidery]; shuttles for making fishing nets; artificial flowers; fringes; artificial fruit; braids; tassels [haberdashery]; trimmings for clothing; artificial garlands; frills [lace-work]; woollen laces; lace trimmings; passementerie;

letters for marking linen; haberdashery [dressmakers' articles], except thread; mica spangles; false moustaches; eyelets for clothing; birds' feathers [clothing accessories]; haberdashery ribbons; spangles for clothing; needle cushions; wigs; picot [lace]; heat adhesive patches for repairing textile articles; feathers [clothing accessories]; top-knots [pompoms]; skirt flounces; rosettes [haberdashery]; frills for clothing; zippers for bags; zip fasteners for bags; shoe buckles; toupees; bodkins; needle cases; boxes for needles; silver embroidery; gold embroidery; elastic ribbons; cords for trimming; buckles [clothing accessories]; hooks for corsets; wreaths of artificial flowers; pins, other than jewellery; pins, other than jewelry; badges for wear, not of precious metal; heat adhesive patches for decoration of textile articles [haberdashery]; competitors' numbers; ornamental novelty badges [buttons]; bows for the hair; hair coloring caps; hair colouring caps; hook and pile fastening tapes; prize ribbons; shoulder pads for clothing; trouser clips for cyclists; tapes for curtain headings; hair curling papers; rug hooks; beads, other than for making jewelry; beads, other than for making jewellery; bobbins for retaining embroidery floss or wool [not parts of machines]; hair extensions; human hair; hair curlers, electric and non-electric, other than hand implements; appliqués [haberdashery]; artificial plants, other than Christmas trees; sewing kits; entomological pins; embroidery needles; charms, other than for jewellery, key rings or key chains; charms, other than for jewelry, key rings or key chains; needle-threaders; artificial Christmas garlands; artificial Christmas garlands incorporating lights; artificial Christmas wreaths; artificial Christmas wreaths incorporating lights; hatbands; hat bands; ribbons for the hair; ribbons and bows, not of paper, for gift wrapping; haberdashery bows; hat pins, other than jewellery; hatpins, other than jewelry; breast lift tapes; lingerie tapes.

28 – Bladders of balls for games; artificial fishing bait; caps for pistols [toys]; toys for pets; ring games; Christmas trees of synthetic material; bows for archery; archery implements; edges of skis; swings; balls for games; party balloons; billiard table cushions; rocking horses; batting gloves [accessories for games]; dolls' feeding bottles; stationary exercise bicycles; billiard balls; chalk for billiard cues; billiard markers; skittles; marbles for games; toys; building blocks [toys]; bob-sleighs; Christmas crackers [party novelties]; candle holders for Christmas trees; playing balls; bowling apparatus and machinery; boxing gloves; gut for rackets; golf clubs; rods for fishing; kites; kite reels; targets; bells for Christmas trees; counters [discs] for games; building games; strings for rackets; machines for physical exercises; body-building apparatus; body-training apparatus; body rehabilitation apparatus; novelty toys for parties; shin guards [sports articles]; cricket bags; hockey sticks; checkers [games]; draughts [games]; dice; chest expanders [exercisers]; exercisers [expanders]; discuses for sports; dominoes;

chess games; chessboards; checkerboards; draughtboards; toy pistols; rollers for stationary exercise bicycles; landing nets for anglers; golf bags, with or without wheels; novelty toys for playing jokes; nets for sports; tennis nets; ski bindings; darts; floats for fishing; foosball tables; harpoon guns [sports articles]; gloves for games; cups for dice; bar-bells; fish hooks; rattles [playthings]; parlor games; parlour games; games; clay pigeon traps; rackets; bats for games; decoys for hunting or fishing; lures for hunting or fishing; fishing tackle; fishing lines; dolls' beds; dolls' houses; puppets; marionettes; dolls; theatrical masks; carnival masks; scale model vehicles; reels for fishing; flippers for swimming; creels [fishing traps]; swimming pools [play articles]; artificial snow for Christmas trees; quoits; roller skates; ice skates; seal skins [coverings for skis]; clay pigeons [targets]; surfboards; dolls' clothes; dolls' rooms; conjuring apparatus; skittles [games]; ninepins; gut for fishing; sole coverings for skis; skis; tables for table tennis; spinning tops [toys]; sleds [sports articles]; backgammon games; scooters [toys]; shuttlecocks; toy air pistols; percussion caps [toys]; detonating caps [toys]; ornaments for Christmas trees, except lights, candles and confectionery; Christmas tree stands; billiard cues; billiard cue tips; billiard tables; coin-operated billiard tables; surf skis; sailboards; hang gliders; apparatus for games; appliances for gymnastics; fencing weapons; fencing masks; fencing gauntlets; fencing gloves; baseball gloves; climbers' harness; elbow guards [sports articles]; knee guards [sports articles]; toy mobiles; paragliders; protective paddings [parts of sports suits]; skateboards; slides [playthings]; spring boards [sports articles]; teddy bears; waterskis; golf gloves; bite indicators [fishing tackle]; bite sensors [fishing tackle]; table-top games; fairground ride apparatus; flying discs [toys]; horseshoe games; mah-jong; plush toys; soap bubbles [toys]; toy vehicles; twirling batons; butterfly nets; bags especially designed for skis; harness for sailboards; jigsaw puzzles; masts for sailboards; paintball guns [sports apparatus]; paintballs [ammunition for paintball guns] [sports apparatus]; surfboard leashes; tennis ball throwing apparatus; starting blocks for sports; snow globes; weight lifting belts [sports articles]; bodyboards; bingo cards; divot repair tools [golf accessories]; pitch mark repair tools [golf accessories]; hunting game calls; roulette wheels; in-line roller skates; pinatas; punching bags; remote-controlled toy vehicles; rosin used by athletes; snowshoes; sling shots [sports articles]; amusement machines, automatic and coin-operated; kaleidoscopes; playing cards; confetti; electronic targets; scent lures for hunting or fishing; camouflage screens [sports articles]; men's athletic supporters [sports articles]; snowboards; scale model kits [toys]; pachinkos; ascenders [mountaineering equipment]; gaming machines for gambling; slot machines [gaming machines]; paper party hats; swimming kickboards; chips for gambling; scratch cards for playing lottery games; stuffed toys;

trampolines; poles for pole vaulting; water wings; swimming belts; swimming jackets; video game machines; portable games with liquid crystal displays; arcade video game machines; controllers for game consoles; toy models; toy figures; ball pitching machines; dumb-bells; masks [playthings]; matryoshka dolls; controllers for toys; golf bag carts; golf bag trolleys; paddleboards; gyroscopes and flight stabilizers for model aircraft; joysticks for video games; protective films adapted for screens for portable games; drones [toys]; toy robots; needles for pumps for inflating balls for games; pumps specially adapted for use with balls for games; baby gyms; plush toys with attached comfort blanket; tricycles for infants [toys]; toy imitation cosmetics; swimming pool air floats; rhythmic gymnastics ribbons; party poppers [party novelties]; toy putty; toy dough; portable games and toys incorporating telecommunication functions; boomerangs; trading cards for games; waist trimmer exercise belts; flippers for diving; swimming webs; webbed gloves for swimming; inflatable games for swimming pools; roller skis; ski poles; ski sticks; ski poles for roller skis; ski sticks for roller skis; yoga swings; play tents; video game consoles; hand-held consoles for playing video games; playhouses for children; protective cups for sports; golf bag tags; skeleton sleds; bags especially designed for surfboards; fidget toys.

29 – Albumen for culinary purposes; seaweed extracts for food; gelatine; edible fats; anchovy, not live; peanut butter; butter; cocoa butter for food; coconut butter; buttercream; white of eggs; black pudding; blood sausage; bouillon; broth; preparations for making bouillon; caviar; fruit, preserved; charcuterie; potato chips; potato crisps; sauerkraut; coconut, desiccated; colza oil for food; rape oil for food; bouillon concentrates; broth concentrates; jams; frozen fruits; soups; raisins; gherkins; vegetables, preserved; vegetables, cooked; vegetables, dried; oils for food; cream [dairy products]; cheese; crystallized fruits; frosted fruits; croquettes; crustaceans, not live; dates; milk; crayfish, not live; fish fillets; rennet; fruit, stewed; fruit jellies; fruit pulp; meat; fish, not live; jellies for food; meat jellies; game, not live; ginger jam; soya beans, preserved, for food; fatty substances for the manufacture of edible fats; fat-containing mixtures for bread slices; herrings, not live; lobsters, not live; corn oil for food; maize oil for food; palm kernel oil for food; sesame oil for food; oysters, not live; isinglass for food; ham; yolk of eggs; yogurt; yoghurt; vegetable soup preparations; vegetable juices for cooking; meat extracts; kephir; kefir; kumys; milk beverages, milk predominating; whey; milk products; spiny lobsters, not live; bacon; lentils, preserved; margarine; animal marrow for food; shellfish, not live; mussels, not live; palm oil for food; nuts, prepared; eggs; powdered eggs; liver pâté; liver pastes; onions, preserved; olives, preserved; olive oil for food; bone oil for food; pectin for culinary purposes; pickles; peas, preserved; sausages;

salted meats; preparations for making soup; tomato purée; vegetable salads; lard; fruit salads; sardines, not live; salmon, not live; suet for food; tuna, not live; tomato juice for cooking; sunflower oil for food; tripe; truffles, preserved; poultry, not live; fruit peel; alginate for culinary purposes; almonds, ground; peanuts, prepared; mushrooms, preserved; coconut fat; coconut oil for food; beans, preserved; liver; fish-based foodstuffs; fruit chips; clams, not live; fruit preserved in alcohol; pollen prepared as foodstuff; prawns, not live; fish, preserved; meat, preserved; shrimps, not live; snail eggs for consumption; tofu; whipped cream; pork; edible birds' nests; fish, tinned; fish, canned; fish meal for human consumption; fruits, tinned; fruits, canned; meat, tinned; meat, canned; potato fritters; salted fish; sea-cucumbers, not live; silkworm chrysalis for human consumption; vegetables, tinned; vegetables, canned; sausages in batter; potato flakes; apple purée; cranberry compote; tahini; hummus; laver, preserved; fruit-based snack food; curd; kimchi; soya milk; milk shakes; preserved peppers; sunflower seeds, prepared; fish mousses; non-alcoholic eggnog; vegetable mousses; fish roe, prepared; seeds, prepared; aloe vera prepared for human consumption; preserved garlic; albumin milk; protein milk; linseed oil for food; flaxseed oil for food; low-fat potato chips; low-fat potato crisps; lecithin for culinary purposes; milk ferments for culinary purposes; compotes; condensed milk; smetana; fermented baked milk; soured milk; tomato paste; vegetable marrow paste; eggplant paste; aubergine paste; peanut milk for culinary purposes; almond milk for culinary purposes; rice milk; artichokes, preserved; arrangements of processed fruit; powdered milk; yakitori; bulgogi; candied nuts; flavoured nuts; flavored nuts; hazelnuts, prepared; berries, preserved; guacamole; onion rings; falafel; lemon juice for culinary purposes; freeze-dried meat; lyophilized meat; lyophilised meat; oat milk; vegetable-based cream; freeze-dried vegetables; lyophilized vegetables; lyophilised vegetables; extra virgin olive oil for food; edible ant larvae, prepared; edible insects, not live; sweet corn, processed; nut-based spreads; potato-based dumplings; hot dog sausages; corn dogs; soya bean oil for food; milk substitutes; almond milk; peanut milk; coconut milk; coconut milk for culinary purposes; coconut milk-based beverages; rice milk for culinary purposes; almond milk-based beverages; peanut milk-based beverages; sausage casings, natural or artificial; klipfish [salted and dried cod]; cottage cheese fritters; pressed fruit paste; tofu skin; soya patties; tofu patties; tagine [prepared meat, fish or vegetable dish]; tajine [prepared meat, fish or vegetable dish]; tempeh; satay; vegetables, processed; fruit, processed; ratatouille; duck confits; andouillettes; white pudding; cassoulet; choucroute garnie; hash browns; omelets; omelettes; cabbage rolls stuffed with meat; vegetable-based concentrate for cooking; fruit-based concentrate for cooking; vegetable-based spreads; agar-agar for culinary purposes; mo-

lluscs, not live; mollusks, not live; quark; cottage cheese; lactic acid drinks; edible flowers, dried; crystallized ginger; ginger, preserved; pickled ginger.

30 – Seaweed [condiment]; pasta; almond paste; aniseed; star aniseed; confectionery for decorating Christmas trees; infusions, not medicinal; coffee flavorings; coffee flavorings; aromatic preparations for food; seasonings; unleavened bread; salt for preserving foodstuffs; rusks; cookies; biscuits; malt biscuits; peppermint sweets; candies; sweets; waffles; buns; cocoa; coffee; unroasted coffee; vegetal preparations for use as coffee substitutes; cakes; cinnamon [spice]; capers; caramels [candies]; caramels [sweets]; curry [spice]; cereal preparations; chewing gum; chicory [coffee substitute]; tea; chocolate; marzipan; cloves [spice]; condiments; confectionery; sugar confectionery; corn flakes; maize flakes; popcorn; preparations for stiffening whipped cream; ice cream; pancakes; essences for foodstuffs, except etheric essences and essential oils; cooking salt; thickening agents for cooking foodstuffs; turmeric; natural sweeteners; spices; gingerbread; allspice; flour; meal; bean meal; corn flour; corn meal; maize flour; maize meal; mustard meal; barley meal; soya flour; wheat flour; starch for food; ferments for pastes; fondants [confectionery]; petits fours; sugar; flavorings [flavourings], other than essential oils, for cakes; flavorings, other than essential oils, for cakes; flavourings, other than essential oils, for cakes; cake powder; cake dough; cake batter; ground ginger; binding agents for ice cream; ice, natural or artificial; ice for refreshment; glucose for culinary purposes; gluten prepared as foodstuff; groats for human food; vinegar; ketchup [sauce]; cocoa beverages with milk; coffee beverages with milk; chocolate beverages with milk; leaven; yeast; sausage binding materials; macarons; macaroni; corn, milled; maize, milled; corn, roasted; maize, roasted; bread; maltose; molasses for food; golden syrup; mint for confectionery; honey; husked barley; mustard; nutmegs; noodles; pies; crushed barley; sandwiches; pastilles [confectionery]; lozenges [confectionery]; pastries; petit-beurre biscuits; bread rolls; peppers [seasonings]; pizzas; pepper; potato flour; puddings; pralines; ravioli; liquorice [confectionery]; rice; saffron [seasoning]; sago; sauces [condiments]; celery salt; semolina; sherbets [ices]; sorbets [ices]; spaghetti; tapioca; tapioca flour; tarts; vanilla flavourings for culinary purposes; vanilla flavorings for culinary purposes; vanillin [vanilla substitute]; vermicelli; meat pies; pâtés en croûte; meat tenderizers for household purposes; edible ices; powders for making ice cream; almond confectionery; peanut confectionery; food flavorings, other than essential oils; food flavourings, other than essential oils; flavourings, other than essential oils, for beverages; flavorings, other than essential oils, for beverages; crushed oats; husked oats; oat-based food; oat flakes; oatmeal; stick liquorice [confectionery]; beer vinegar; coffee-based beverages; cocoa-based beverages; chocolate-based beverages; artificial coffee; crystallized

rock sugar; chips [cereal products]; chow-chow [condiment]; couscous; malt extract for food; malt for human consumption; propolis; bee glue; relish [condiment]; royal jelly; seawater for cooking; sushi; tomato sauce; mayonnaise; crackers; custard; fruit jellies [confectionery]; muesli; rice cakes; soya sauce; frozen yogurt [confectionery ices]; frozen yoghurt [confectionery ices]; chutneys [condiments]; spring rolls; tacos; tortillas; iced tea; tea-based beverages; dressings for salad; breadcrumbs; tabbouleh; halvah; quiches; meat gravies; miso; cereal-based snack food; rice-based snack food; hominy; hominy grits; baking powder; baking soda [bicarbonate of soda for cooking purposes]; bicarbonate of soda for cooking purposes [baking soda]; garden herbs, preserved [seasonings]; noodle-based prepared meals; cake frosting [icing]; chocolate mousses; dessert mousses [confectionery]; fruit coulis [sauces]; marinades; cheeseburgers [sandwiches]; pesto; ham glaze; linseed for culinary purposes [seasoning]; flaxseed for culinary purposes [seasoning]; wheat germ for human consumption; high-protein cereal bars; cream of tartar for culinary purposes; gluten additives for culinary purposes; pasta sauce; cereal bars; palm sugar; dough; flowers or leaves for use as tea substitutes; pastry dough; pelmeni; chocolate decorations for cakes; candy decorations for cakes; chocolate-coated nuts; rice pudding; nut flours; minced garlic [condiment]; baozi; rice pulp for culinary purposes; jiaozi; ramen; savory pancakes; savoury pancakes; savory pancake mixes; savoury pancake mixes; burritos; prepared rice rolled in seaweed; edible paper; edible rice paper; chocolate-based spreads; chocolate spreads containing nuts; flour-based dumpings; agave syrup [natural sweetener]; mirror icing [mirror glaze]; freeze-dried dishes with the main ingredient being rice; lyophilized dishes with the main ingredient being rice; lyophilised dishes with the main ingredient being rice; freeze-dried dishes with the main ingredient being pasta; lyophilized dishes with the main ingredient being pasta; lyophilised dishes with the main ingredient being pasta; chamomile-based beverages; dulce de leche; bibimbap [rice mixed with vegetables and beef]; onigiri; instant rice; hot dog sandwiches; ice cubes; processed seeds for use as a seasoning; sesame seeds [seasonings]; piccalilli; quinoa, processed; bulgur; buckwheat, processed; buckwheat flour; cranberry sauce [condiment]; apple sauce [condiment]; croûtons; croutons; potato-based flatbreads; fruit confectionery; rice crackers; kimchi pancakes; shaved ice with sweetened red beans; mints for breath freshening; chewing gum for breath freshening; udon noodles; soba noodles; gluten-free bread; tamarrind [condiment]; laksa; profiteroles; croissants; chocolatines; pains au chocolat; kelp tea; crème brûlée; batter mixes; edible paper wafers; coconut macarons; coffee capsules, filled; orange blossom water for culinary purposes; ice pops; nougat; harissa [condiment]; ginger paste [seasoning]; tea beverages with milk.

31 – Citrus fruit, fresh; algae, unprocessed, for human or animal consumption; seaweed, unprocessed, for human or animal consumption; nuts, unprocessed; menagerie animals; live animals; animal foodstuffs; trees; Christmas trees; trunks of trees; shrubs; bushes; oats; berries, fresh; salt for cattle; beet, fresh; bran; unsawn timber; wood chips for the manufacture of wood pulp; undressed timber; cocoa beans, raw; sugarcane; locust beans, raw; cereal seeds, unprocessed; mushrooms, fresh; mushroom spawn for propagation; oil cake; cattle cake; chestnuts, fresh; lime for animal forage; chicory roots; chicory, fresh; dog biscuits; lemons, fresh; coconut shell; coconuts; bird food; rape cake for cattle; cucumbers, fresh; hop cones; bran mash for animal consumption; copra; shellfish, live; vegetables, fresh; squashes, fresh; wreaths of natural flowers; eggs for hatching, fertilised; eggs for hatching, fertilized; straw mulch; distillery waste for animal consumption; draff; bred stock; animal fattening preparations; livestock fattening preparations; rice meal for forage; beans, fresh; flowers, natural; flowers, dried, for decoration; pollen [raw material]; hay; strengthening animal forage; fodder; cattle food; forage; wheat; fruit, fresh; turf, natural; sod; juniper berries; seed germ for botanical purposes; grains [cereals]; grains for animal consumption; seeds for planting; plant seeds; groats for poultry; garden herbs, fresh; plants; seedlings; hops; kola nuts; cola nuts; lettuce, fresh; lentils, fresh; yeast for animal consumption; rough cork; flax meal [fodder]; litter for animals; litter peat; maize; maize cake for cattle; malt for brewing and distilling; fruit residue [marc]; marc; hazelnuts, fresh; meal for animals; fish spawn; silkworm eggs; flower bulbs; bulbs; onions, fresh; olives, fresh; oranges, fresh; barley; nettles; cuttle bone for birds; straw litter; straw [forage]; palms [leaves of the palm tree]; palm trees; mash for fattening livestock; fish, live; vine plants; pine cones; peppers [plants]; plants, dried, for decoration; leeks, fresh; peas, fresh; potatoes, fresh; preparations for egg laying poultry; stall food for animals; roots for animal consumption; grapes, fresh; rhubarb, fresh; rose bushes; rye; silkworms; edible sesame, unprocessed; truffles, fresh; residue in a still after distillation; poultry, live; algarovilla for animal consumption; almonds [fruits]; peanuts, fresh; peanut meal for animals; peanut cake for animals; by-products of the processing of cereals, for animal consumption; residual products of cereals for animal consumption; bagasses of cane [raw material]; fishing bait, live; crayfish, live; crustaceans, live; lobsters, live; mussels, live; oysters, live; pet food; raw barks; spiny lobsters, live; edible chews for animals; beverages for pets; fish meal for animal consumption; rice, unprocessed; sea-cucumbers, live; sanded paper [litter] for pets; aromatic sand [litter] for pets; aloe vera plants; spinach, fresh; linseed for animal consumption; flaxseed for animal consumption; linseed meal for animal consumption; flaxseed meal for animal consumption; wheat germ for animal consumption; ar-

tichokes, fresh; herrings, live; salmon, live; sardines, live; tuna, live; garlic, fresh; vegetable marrows, fresh; edible linseed, unprocessed; edible flaxseed, unprocessed; arrangements of fresh fruit; anchovy, live; edible insects, live; unprocessed sweet corn ears [husked or unhusked]; quinoa, unprocessed; buckwheat, unprocessed; koi carp, live; molluscs, live; mollusks, live; freeze-dried fishing bait; edible flowers, fresh; ginger, fresh; soya beans, fresh; cannabis plants; cannabis, unprocessed.

32 – Non-alcoholic fruit extracts; beer; ginger beer; ginger ale; malt beer; beer wort; non-alcoholic fruit juice beverages; whey beverages; non-alcoholic preparations for making beverages; non-alcoholic essences for making beverages; fruit juices; fruit juice; syrups for beverages; waters [beverages]; preparations for making aerated water; preparations for making carbonated water; lithia water; mineral water [beverages]; seltzer water; table waters; must; lemonades; extracts of hops for making beer; vegetable juices [beverages]; syrups for lemonade; malt wort; grape must, unfermented; orgeat; soda water; sherbets [beverages]; sorbets [beverages]; tomato juice [beverage]; non-alcoholic beverages; pastilles for effervescing beverages; powders for effervescing beverages; aerated water; carbonated water; sarsaparilla [non-alcoholic beverage]; aperitifs, non-alcoholic; cocktails, non-alcoholic; fruit nectars, non-alcoholic; isotonic beverages; cider, non-alcoholic; kvass; non-alcoholic honey-based beverages; smoothies; aloe vera drinks, non-alcoholic; beer-based cocktails; soya-based beverages, other than milk substitutes; protein-enriched sports beverages; rice-based beverages, other than milk substitutes; non-alcoholic beverages flavoured with coffee; non-alcoholic beverages flavored with coffee; non-alcoholic beverages flavoured with tea; non-alcoholic beverages flavored with tea; soft drinks; barley wine [beer]; energy drinks; non-alcoholic dried fruit beverages; shandy.

35 – Business management assistance; business inquiries; bill-posting; import-export agency services; commercial information agency services; cost price analysis; dissemination of advertising matter; photocopying services; employment agency services; office machines and equipment rental; book-keeping; accounting; drawing up of statements of accounts; business auditing; business management and organization consultancy; personnel management consultancy; business management consultancy; typing; demonstration of goods; direct mail advertising; commercial or industrial management assistance; updating of advertising material; distribution of samples; business efficiency expert services; auctioneering; market studies; business appraisals; business investigations; publicity material rental; business organization consultancy; publication of publicity texts; advertising; publicity; radio advertising; business research; public relations; shorthand; television advertising; transcription of commu-

nications [office functions]; shop window dressing; advertising agency services; publicity agencies; advisory services for business management; modelling for advertising or sales promotion; marketing research; computerized file management; professional business consultancy; economic forecasting; organization of exhibitions for commercial or advertising purposes; providing business information; opinion polling; payroll preparation; personnel recruitment; administrative services for the relocation of businesses; rental of advertising space; sales promotion for others; secretarial services; tax preparation; telephone answering for unavailable subscribers; word processing; arranging newspaper subscriptions for others; advertising by mail order; business management of hotels; business management of performing artists; compilation of information into computer databases; systemization of information into computer databases; organization of trade fairs; rental of photocopying machines; online advertising on a computer network; procurement services for others [purchasing goods and services for other businesses]; data search in computer files for others; rental of advertising time on communication media; news clipping services; rental of vending machines; psychological testing for the selection of personnel; price comparison services; presentation of goods on communication media, for retail purposes; providing commercial information and advice for consumers in the choice of products and services; arranging subscriptions to telecommunication services for others; administrative processing of purchase orders; commercial administration of the licensing of the goods and services of others; outsourcing services [business assistance]; invoicing; writing of publicity texts; compilation of statistics; layout services for advertising purposes; sponsorship search; organization of fashion shows for promotional purposes; production of advertising films; business management of sports people; marketing; telemarketing services; retail services for pharmaceutical, veterinary and sanitary preparations and medical supplies; rental of sales stands; providing commercial and business contact information; search engine optimization for sales promotion; search engine optimisation for sales promotion; website traffic optimization; website traffic optimisation; pay per click advertising; commercial intermediation services; business management for freelance service providers; negotiation and conclusion of commercial transactions for third parties; updating and maintenance of data in computer databases; business project management services for construction projects; providing business information via a website; provision of an online marketplace for buyers and sellers of goods and services; development of advertising concepts; outsourced administrative management for companies; tax filing services; business management of reimbursement programs for others; business management of reimbursement programmes for others; rental of billboards [advertising boards]; wri-

ting of résumés for others; writing of curriculum vitae for others; web indexing for commercial or advertising purposes; administration of frequent flyer programs; appointment scheduling services [office functions]; appointment reminder services [office functions]; administration of consumer loyalty programs; scriptwriting for advertising purposes; registration of written communications and data; updating and maintenance of information in registries; compiling indexes of information for commercial or advertising purposes; business intermediary services relating to the matching of potential private investors with entrepreneurs needing funding; production of teleshopping programmes; production of teleshopping programs; consultancy regarding public relations communication strategies; consultancy regarding advertising communication strategies; negotiation of business contracts for others; promotion of goods and services through sponsorship of sports events; competitive intelligence services; market intelligence services; financial auditing; online retail services for downloadable digital music; online retail services for downloadable ring tones; online retail services for downloadable and pre-recorded music and movies; wholesale services for pharmaceutical, veterinary and sanitary preparations and medical supplies; gift registry services; targeted marketing; interim business management; outdoor advertising; retail services for works of art provided by art galleries; administrative assistance in responding to calls for tenders; administrative assistance in responding to requests for proposals [RFPs]; marketing in the framework of software publishing; media relations services; corporate communications services; rental of office equipment in co-working facilities; commercial lobbying services; providing user reviews for commercial or advertising purposes; providing user rankings for commercial or advertising purposes; providing user ratings for commercial or advertising purposes; telephone switchboard services; retail services relating to bakery products; consumer profiling for commercial or marketing purposes; administrative services for medical referrals.

39 – Escorting of travellers; water supplying; air transport; ambulance transport; vehicle breakdown towing services; car rental; car transport; bus transport; pleasure boat transport; boat rental; ice-breaking; hauling; salvage of ships; lightering services; carting; railway transport; horse rental; parcel delivery; portage; packaging of goods; shipbrokerage; arranging of cruises; transport services for sightseeing tours; unloading cargo; delivery of goods; storage of goods; water distribution; electricity distribution; operating canal locks; car parking; storage; warehousing; rental of warehouses; ferry-boat transport; river transport; freight [shipping of goods]; freighting; garage rental; transport by pipeline; parking place rental; refrigerator rental; frozen-food locker rental; vehicle rental; railway coach rental; railway truck rental; transporting furniture; transport; boat transport; arranging of trans-

portation for travel tours; passenger transport; piloting; towing; refloating of ships; booking of seats for travel; salvaging; taxi transport; streetcar transport; tram transport; freight forwarding; marine transport; armored-car transport; armoured-car transport; transport of travellers; transport and storage of trash; transport and storage of waste; removal services; boat storage; freight brokerage [forwarding (Am.)]; freight brokerage; transport brokerage; chauffeur services; courier services [messages or merchandise]; providing information relating to storage services; providing transportation information; rental of diving bells; rental of diving suits; rental of storage containers; rental of vehicle roof racks; rescue operations [transport]; transport reservation; travel reservation; underwater salvage; wrapping of goods; message delivery; delivery of newspapers; newspaper delivery; delivery of goods by mail order; distribution of energy; rental of motor racing cars; rental of wheelchairs; stevedoring; physical storage of electronically stored data or documents; launching of satellites for others; flower delivery; franking of mail; providing traffic information; rental of freezers; bottling services; transportation logistics; aircraft rental; barge transport; motor coach rental; rental of aircraft engines; guarded transport of valuables; rental of navigational systems; providing driving directions for travel purposes; gift wrapping; rental of tractors; collection of recyclable goods [transport]; rental of electric wine cellars; cash replenishment of automated teller machines; car sharing services; replenishment of vending machines; luggage storage; arranging of passenger transportation services for others via an online application; piloting of civilian drones; arranging for travel visas and travel documents for persons travelling abroad; carpooling services.

41 – Academies [education]; amusement park services; entertainment services; animal training; rental of cinematographic apparatus; entertainer services; movie studio services; presentation of circus performances; organization of competitions [education or entertainment]; correspondence courses; physical education; rental of show scenery; providing recreation facilities; radio entertainment; publication of texts, other than publicity texts; teaching; educational services; instruction services; rental of sound recordings; rental of motion pictures; film production, other than advertising films; gymnastic instruction; lending library services; publication of books; rental of radio and television sets; production of radio and television programmes; presentation of variety shows; orchestra services; theatre productions; production of shows; television entertainment; rental of stage scenery; zoological garden services; providing sports facilities; modelling for artists; mobile library services; bookmobile services; providing casino facilities [gambling]; club services [entertainment or education]; arranging and conducting of colloquiums; arranging and conducting of conferences; arranging and conducting

of congresses; discotheque services; providing information in the field of education; educational examination; providing information in the field of entertainment; organization of exhibitions for cultural or educational purposes; gambling services; providing golf facilities; health club services [health and fitness training]; holiday camp services [entertainment]; presentation of live performances; cinema presentations; movie theatre presentations; nursery schools; organization of sports competitions; party planning [entertainment]; practical training [demonstration]; providing museum facilities [presentation, exhibitions]; recording studio services; providing information relating to recreational activities; rental of skin diving equipment; rental of sports equipment, except vehicles; rental of stadium facilities; rental of video cassette recorders; rental of videotapes; arranging and conducting of seminars; sport camp services; arranging and conducting of symposiums; timing of sports events; boarding school education; arranging and conducting of workshops [training]; arranging of beauty contests; booking of seats for shows; dubbing; religious education; organization of lotteries; organization of balls; organization of shows [impresario services]; providing amusement arcade services; rental of audio equipment; rental of lighting apparatus for theatrical sets or television studios; rental of tennis courts; rental of video cameras; rental of camcorders; scriptwriting, other than for advertising purposes; videotape editing; online publication of electronic books and journals; electronic desktop publishing; subtitling; game services provided online from a computer network; karaoke services; music composition services; nightclub services [entertainment]; providing online electronic publications, not downloadable; photographic reporting; photography; vocational guidance [education or training advice]; news reporters services; translation; sign language interpretation; videotaping; microfilming; ticket agency services [entertainment]; writing of texts; arranging and conducting of concerts; calligraphy services; layout services, other than for advertising purposes; organization of fashion shows for entertainment purposes; coaching [training]; rental of sports grounds; disc jockey services; language interpretation; personal trainer services [fitness training]; conducting fitness classes; vocational retraining; production of music; toy rental; games equipment rental; educational services provided by schools; providing online music, not downloadable; providing online videos, not downloadable; tutoring; arranging and conducting of in-person educational forums; songwriting; screenplay writing; conducting guided tours; training services provided via simulators; providing films, not downloadable, via video-on-demand services; providing television programmes, not downloadable, via video-on-demand services; providing television programs, not downloadable, via video-on-demand services; sado instruction [tea ceremony instruction]; aikido instruction; rental of artwork; rental of indoor aqu-

aria; conducting guided climbing tours; organization of cosplay entertainment events; cultural, educational or entertainment services provided by art galleries; film distribution; know-how transfer [training]; educational services provided by special needs assistants; judo instruction; educational examination for users to qualify to pilot drones; sound engineering services for events; video editing services for events; lighting technician services for events; film directing, other than advertising films; providing user reviews for entertainment or cultural purposes; providing user rankings for entertainment or cultural purposes; providing user ratings for entertainment or cultural purposes; rental of training simulators; physical fitness assessment services for training purposes; face painting.

43 – Accommodation bureau services [hotels, boarding houses]; food and drink catering; retirement home services; café services; cafeteria services; providing campground facilities; canteen services; rental of temporary accommodation; boarding house services; tourist home services; hotel services; day-nursery [crèche] services; restaurant services; boarding house bookings; hotel reservations; self-service restaurant services; snack-bar services; boarding for animals; bar services; holiday camp services [lodging]; rental of transportable buildings; temporary accommodation reservations; motel services; rental of chairs, tables, table linen, glassware; rental of meeting rooms; rental of tents; rental of cooking apparatus; rental of drinking water dispensers; rental of lighting apparatus; food sculpting; reception services for temporary accommodation [management of arrivals and departures]; washoku restaurant services; udon and soba restaurant services; decorating of food; cake decorating; information and advice in relation to the preparation of meals; personal chef services; hookah lounge services.

44 – Animal breeding; landscape gardening; public bath services for hygiene purposes; Turkish bath services; beauty salon services; medical clinic services; chiropractic; hairdressing; wreath making; convalescent home services; hospital services; health care; horticulture; gardening; farming equipment rental; massage; medical assistance; opticians' services; plant nursery services; physical therapy; physiotherapy; sanatorium services; veterinary assistance; dentistry services; nursing home services; aerial and surface spreading of fertilizers and other agricultural chemicals; aerial and surface spreading of fertilisers and other agricultural chemicals; animal grooming; blood bank services; flower arranging; hospice services; lawn care; manicuring; midwife services; nursing, medical; pharmacy advice; plastic surgery; tree surgery; vermin exterminating for agriculture, aquaculture, horticulture and forestry; weed killing; pet grooming; hair implantation; services of a psychologist; rental of sanitary installations; aromatherapy services; artificial insemination services; rehabilitation for substance

abuse patients; in vitro fertilization services; in vitro fertilisation services; tattooing; telemedicine services; landscape design; sauna services; solarium services; health spa services; visagists' services; preparation of prescriptions by pharmacists; therapy services; tree planting for carbon offsetting purposes; aquaculture services; medical equipment rental; health center services; health centres; alternative medicine services; speech therapy; health counselling; health counseling; depilatory waxing; orthodontic services; medical advice for individuals with disabilities; body piercing; reforestation services; palliative care; rest home services; pest control services for agriculture, aquaculture, horticulture and forestry; human tissue bank services; rental of animals for gardening purposes; rental of beehives; animal-assisted therapy; medical analysis services for diagnostic and treatment purposes provided by medical laboratories; medical screening; viticulture services; consultancy in the field of viticulture; home-visit nursing care; rental of hair styling apparatus; cultivation of plants; dietary and nutritional advice; rental of surgical robots.

45 – Personal bodyguarding; escorting in society [chaperoning]; chaperoning; detective agency services; dating services; night guard services; opening of security locks; evening dress rental; crematorium services; missing person investigations; burial services; funerary undertaking; clothing rental; guard services; marriage agency services; physical security consultancy; horoscope casting; fire-fighting; organization of religious meetings; adoption agency services; monitoring of burglar and security alarms; babysitting; security screening of baggage; house sitting; pet sitting; personal background investigations; lost property return; mediation; inspection of factories for safety purposes; rental of fire alarms; rental of fire extinguishers; arbitration services; intellectual property consultancy; copyright management; licensing of intellectual property; monitoring intellectual property rights for legal advisory purposes; legal research; litigation services; licensing of computer software [legal services]; registration of domain names [legal services]; alternative dispute resolution services; rental of safes; genealogical research; planning and arranging of wedding ceremonies; online social networking services; releasing doves for special occasions; embalming services; legal document preparation services; tracking of stolen property; legal administration of licences; astrology consultancy; spiritual consultancy; cartomancy services; personal wardrobe styling consultancy; personal letter writing; conducting funeral ceremonies; legal services in relation to the negotiation of contracts for others; conducting religious ceremonies; dog walking services; leasing of internet domain names; kimono dressing assistance; legal advice in responding to calls for tenders; legal advice in responding to requests for proposals [RFPs]; licensing [legal services] in the framework of software publishing; legal watching services; organization of political meetings;

legal consultancy relating to patent mapping; legal advocacy services; concierge services; bereavement counseling; bereavement counselling; lifeguard services; legal services in the field of immigration; tarot card reading services for others; regulatory compliance auditing; legal compliance auditing.

(260) AM 2022 115041 A

(800) 1619986

(151) 2021 08 27

(891) 2021 08 27

(731) PJSC "GAZPROM"

Nametkina str., 16, RU-117997 Moscow,
Russian Federation

(540)

FOOTBALL FOR FRIENDSHIP

(591) Black, white

(531) 27.05.01

(511)

9 – Coils, electric; particle accelerators; reflective articles for wear, for the prevention of accidents; protection devices for personal use against accidents; clothing for protection against accidents, irradiation and fire; accumulators, electric, for vehicles; batteries, electric, for vehicles; battery jars; accumulator jars; battery boxes; accumulator boxes; acidimeters for batteries; hydrometers; plates for batteries; whistle alarms; acoustic alarms; sound alarms; acoustic conduits; sound recording discs; phonograph records; speaking tubes; actinometers; adding machines; aerometers; enlarging apparatus [photography]; electrodynamic apparatus for the remote control of railway points; magnets; electromagnetic coils; air analysis apparatus; alarms; alcoholmeters; alidades; food analysis apparatus; igniting apparatus, electric, for igniting at a distance; electric apparatus for remote ignition; ignition batteries; altimeters; asbestos gloves for protection against accidents; asbestos clothing for protection against fire; ammeters; amplifiers; amplifying tubes; amplifying valves; anemometers; calibrating rings; fire extinguishers; anodes; anode batteries; high tension batteries; antennas; aerials; anti-glare glasses; visors for helmets; anti-interference devices [electricity]; transformers [electricity]; apertometers [optics]; money counting and sorting machines; distribution boxes [electricity]; surveying instruments; surveying chains; lenses for astrophotography; thermionic tubes; thermionic valves; audiovisual teaching apparatus; coin-operated musical automata [juke boxes]; juke boxes, musical; mechanisms for coin-operated apparatus; mechanisms for counter-operated apparatus; calipers; comparators; fire alarms; automatic indicators of low pressure in vehicle tires; automatic indicators of low pressure in vehicle tyres; protective suits for aviators; alarm bells, electric; rods for water diviners; life-saving rafts; scales; meteorological balloons; demagnetizing apparatus for magnetic tapes; tape recorders; magnetic tapes; barometers; weighing machines; wei-

ghbridges; fire beaters; chargers for electric accumulators; betatrons; ticket dispensers; cabinets for loudspeakers; close-up lenses; terminals [electricity]; pressure indicator plugs for valves; galvanometers; push buttons for bells; branch boxes [electricity]; tone arms for record players; spirit levels; punched card machines for offices; sheaths for electric cables; frames for photographic transparencies; circular slide rules; slide-rules; calculating machines; slide calipers; jigs [measuring instruments]; blueprint apparatus; cinematographic cameras; capillary tubes; sound recording carriers; protective helmets; respiratory masks, other than for artificial respiration; solderers' helmets; eyeglass chains; spectacle chains; heat regulating apparatus; darkrooms [photography]; boiler control instruments; drying racks [photography]; apparatus for editing cinematographic film; printed circuits; flashing lights [luminous signals]; signal bells; containers for microscope slides; collectors, electric; electric installations for the remote control of industrial operations; switchboxes [electricity]; commutators; marine compasses; eyepieces; thread counters; pedometers; counters; meters; metronomes; condensers [capacitors]; capacitors; conductors, electric; electricity conduits; circuit closers; connectors [electricity]; junction boxes [electricity]; switchboards; contacts, electric; apparatus to check franking; apparatus to check stamping mail; regulating apparatus, electric; monitoring apparatus, other than for medical purposes; speed checking apparatus for vehicles; converters, electric; photocopiers [photographic, electrostatic, thermic]; eyeglass cords; spectacle cords; retorts; retorts' stands; correcting lenses [optics]; objectives [lenses] [optics]; cosmographic instruments; diving suits; electric apparatus for commutation; switches, electric; limiters [electricity]; electric plugs; current rectifiers; cell switches [electricity]; reducers [electricity]; dressmakers' measures; crucibles [laboratory]; cupels [laboratory]; appliances for measuring the thickness of leather; cyclotrons; counterfeit [false] coin detectors; shutter releases [photography]; densimeters; animated cartoons; laboratory trays; metal detectors for industrial or military purposes; sonars; detectors; shutters [photography]; diaphragms [acoustics]; centering apparatus for photographic transparencies; cameras [photography]; transparencies [photography]; slides [photography]; slide projectors; transparency projection apparatus; distance measuring apparatus; dictating machines; diffraction apparatus [microscopy]; loudspeakers; circuit breakers; record players; microscopes; distance recording apparatus; apparatus for recording distance; range finders; telemeters; distribution boards [electricity]; distribution consoles [electricity]; compasses for measuring; measures; measuring apparatus; dynamometers; water level indicators; fire escapes; flashbulbs [photography]; telephone receivers; fluorescent screens; projection screens; workmen's protective face-shields; screens [photography]; drainers for use in photography; photographic racks; electric loss indica-

tors; measuring devices, electric; cables, electric; ducts [electricity]; control panels [electricity]; galvanic cells; connections for electric lines; couplings, electric; connections, electric; relays, electric; electrolyzers; transmitters of electronic signals; transmitting sets [telecommunication]; cleaning apparatus for sound recording discs; cleaning apparatus for phonograph records; sound recording strips; kilometer recorders for vehicles; mileage recorders for vehicles; spools [photography]; mechanical signs; epidiascopes; test tubes; balancing apparatus; thermostats; ergometers; material testing instruments and machines; egg-candlers; gauges; gasoline gauges; petrol gauges; spark-guards; cases especially made for photographic apparatus and instruments; testing apparatus not for medical purposes; refractometers; exposure meters [light meters]; invoicing machines; apparatus for fermentation [laboratory apparatus]; railway traffic safety appliances; wires, electric; magnetic wires; plumb bobs; plumb lines; nets for protection against accidents; safety nets; life nets; safety tarpaulins; film cutting apparatus; filters for respiratory masks; filters for use in photography; battery chargers; high-frequency apparatus; frequency meters; fuses; radios; galena crystals [detectors]; galvanic batteries; gloves for protection against accidents; gloves for divers; gloves for protection against X-rays for industrial purposes; gas testing instruments; gasometers [measuring instruments]; surveying apparatus and instruments; levelling staffs [surveying instruments]; rods [surveying instruments]; drying apparatus for photographic prints; rulers [measuring instruments]; measuring glassware; graduated glassware; screens for photoengraving; grids for batteries; clothing for protection against fire; garments for protection against fire; audio- and video-receivers; heliographic apparatus; holograms; hygrometers; identification threads for electric wires; identification sheaths for electric wires; life-saving apparatus and equipment; fire hose nozzles; fire engines; fire pumps; slope indicators; clinometers; gradient indicators; inclinometers; taximeters; quantity indicators; vacuum gauges; speed indicators; inductors [electricity]; armatures [electricity]; data processing apparatus; mirrors for inspecting work; intercommunication apparatus; carriers for dark plates [photography]; inverters [electricity]; ionization apparatus not for the treatment of air or water; peepholes [magnifying lenses] for doors; hemline markers; furniture especially made for laboratories; lactodensimeters; lactometers; dark-room lamps [photography]; optical lamps; optical lanterns; magic lanterns; signal lanterns; lasers, not for medical purposes; optical lenses; letter scales; logs [measuring instruments]; sounding lines; magnifying glasses [optics]; signs, luminous; neon signs; eyeglasses; spectacles; instruments containing eyepieces; surveyors' levels; spectacle lenses; eyeglass lenses; eyewear; pressure gauges; manometers; periscopes; protective masks; mathematical instruments; coin-

operated mechanisms for television sets; megaphones; computer memory devices; carpenters' rules; mercury levels; speed measuring apparatus [photography]; precision measuring apparatus; measuring instruments; meteorological instruments; rules [measuring instruments]; micrometer screws for optical instruments; microphones; microtomes; time switches, automatic; mirrors [optics]; breathing apparatus for underwater swimming; nautical apparatus and instruments; naval signalling apparatus; navigational instruments; eyeglass frames; spectacle frames; batteries, electric; accumulators, electric; levels [instruments for determining the horizontal]; levelling instruments; prisms [optics]; observation instruments; octants; ohmmeters; wavemeters; optical apparatus and instruments; optical glass; computers; computer programs, recorded; oscillographs; oxygen transvasing apparatus; ozonisers [ozonators]; micrometers; micrometer gauges; signalling panels, luminous or mechanical; lightning rods; lightning arresters; lightning conductors; parking meters; apparatus and instruments for astronomy; apparatus for measuring the thickness of skins; acid hydrometers; weighing apparatus and instruments; salinometers; washing trays [photography]; stands for photographic apparatus; viewfinders, photographic; photometers; phototelegraphy apparatus; apparatus and instruments for physics; steering apparatus, automatic, for vehicles; pince-nez; laboratory pipettes; plane tables [surveying instruments]; planimeters; ear plugs for divers; bells [warning devices]; weights; polarimeters; radiotelephony sets; radiotelegraphy sets; pressure measuring apparatus; pressure indicators; projection apparatus; cathodic anti-corrosion apparatus; teeth protectors; pyrometers; radar apparatus; vehicle radios; radiological apparatus for industrial purposes; protractors [measuring instruments]; apparatus and installations for the production of X-rays, not for medical purposes; X-ray tubes not for medical purposes; protection devices against X-rays, not for medical purposes; telephone apparatus; refractors; X-ray apparatus not for medical purposes; spectroscopes; resistances, electric; thermometers, not for medical purposes; respirators for filtering air; breathing apparatus, except for artificial respiration; rheostats; balances [steelyards]; lever scales [steelyards]; steelyards [lever scales]; signals, luminous or mechanical; saccharometers; probes for scientific purposes; satellites for scientific purposes; diaphragms for scientific apparatus; teaching apparatus; choking coils [impedance]; wire connectors [electricity]; locks, electric; sextants; signalling whistles; vehicle breakdown warning triangles; electro-dynamic apparatus for the remote control of signals; simulators for the steering and control of vehicles; sirens; sound transmitting apparatus; sound recording apparatus; sound reproduction apparatus; sounding apparatus and machines; sounding leads; sound locating instruments; spectrograph apparatus; spherometers; stereoscopes; stereoscopic apparatus; needles for record players;

styli for record players; sulfitometers; teleprinters; teletypewriters; tachometers; screw-tapping gauges; telegraphs [apparatus]; television apparatus; telegraph wires; remote control apparatus; masts for wireless aerials; teleprompters; telephone transmitters; telerupters; binoculars; telescopes; temperature indicators; time recording apparatus; theodolites; thermostats for vehicles; totalizers; revolution counters; speed regulators for record players; transmitters [telecommunication]; precision balances; marking gauges [joinery]; vacuum tubes [radio]; urinometers; variometers; verniers; videotapes; viscosimeters; theft prevention installations, electric; voltage regulators for vehicles; voting machines; voltmeters; apparatus for changing record player needles; stills for laboratory experiments; fuse wire; anticathodes; dog whistles; sighting telescopes for firearms; telescopic sights for firearms; anti-theft warning apparatus; azimuth instruments; beacons, luminous; holders for electric coils; films, exposed; road signs, luminous or mechanical; life buoys; signalling buoys; buzzers; directional compasses; fog signals, non-explosive; cash registers; radiology screens for industrial purposes; identity cards, magnetic; photovoltaic cells; densitometers; disks, magnetic; floppy disks; head cleaning tapes [recording]; video recorders; computer keyboards; integrated circuits; semi-conductors; chips [integrated circuits]; cathodes; life jackets; life belts; chemistry apparatus and instruments; cinematographic film, exposed; materials for electricity mains [wires, cables]; contact lenses; contacters for contact lenses; incubators for bacteria culture; solar batteries; copper wire, insulated; discharge tubes, electric, other than for lighting; electric discharge tubes, other than for lighting; diaphragms [photography]; distillation apparatus for scientific purposes; dosage dispensers; dosimeters; electric door bells; eyeglass cases; spectacle cases; furnaces for laboratory use; ovens for laboratory use; optical fibers [fibres] [light conducting filaments]; optical fibers [light conducting filaments]; telephone wires; X-ray films, exposed; filters for ultraviolet rays, for photography; horns for loudspeakers; tripods for cameras; bar code readers; bullet-proof waistcoats; bullet-proof vests; fibre optic cables; fiber optic cables; marking buoys; wafers for integrated circuits; chromatography apparatus for laboratory use; chronographs [time recording apparatus]; compact discs [audio-video]; compact discs [read-only memory]; computer operating programs, recorded; computer peripheral devices; computer software, recorded; optical condensers; acoustic couplers; couplers [data processing equipment]; decompression chambers; plotters; divers' masks; electronic pens [visual display units]; encoded magnetic cards; facsimile machines; fire boats; interfaces for computers; juke boxes for computers; knee-pads for workers; light dimmers [regulators], electric; light regulators [dimmers], electric; magnetic data media; magnetic encoders; magnetic tape units for computers; microprocessors; modems; monitors [computer

hardware]; monitors [computer programs]; mouse [computer peripheral]; optical character readers; optical data media; optical discs; printers for use with computers; processors [central processing units]; central processing units [processors]; readers [data processing equipment]; safety restraints, other than for vehicle seats and sports equipment; scanners [data processing equipment]; smoke detectors; transistors [electronic]; X-ray photographs, other than for medical purposes; junction sleeves for electric cables; abacuses; electronic agendas; answering machines; camcorders; cassette players; compact disc players; diagnostic apparatus, not for medical purposes; disk drives for computers; electrified rails for mounting spot lights; electronic pocket translators; electronic tags for goods; fire blankets; flashlights [photography]; integrated circuit cards [smart cards]; smart cards [integrated circuit cards]; measuring spoons; notebook computers; electronic notice boards; pocket calculators; shoes for protection against accidents, irradiation and fire; sprinkler systems for fire protection; starter cables for motors; sunglasses; time clocks [time recording devices]; video cassettes; video game cartridges; video screens; video telephones; goggles for sports; nose clips for divers and swimmers; protective helmets for sports; electronic publications, downloadable; computer programs, downloadable; navigation apparatus for vehicles [on-board computers]; decorative magnets; cordless telephones; mouse pads; personal stereos; wrist rests for use with computers; coaxial cables; covers for electric outlets; marine depth finders; electrified fences; computer game software, recorded; headphones; lighting ballasts; radio pagers; satellite navigational apparatus; solenoid valves [electromagnetic switches]; voltage surge protectors; walkie-talkies; wind socks for indicating wind direction; light-emitting electronic pointers; resuscitation mannequins [teaching apparatus]; stage lighting regulators; egg timers [sandglasses]; hourglasses; DNA chips; DVD players; automated teller machines [ATM]; traffic-light apparatus [signalling devices]; hands-free kits for telephones; asbestos screens for firemen; riding helmets; clothing especially made for laboratories; encoded identification bracelets, magnetic; transponders; downloadable ring tones for mobile phones; downloadable music files; downloadable image files; crash test dummies; laboratory centrifuges; printed circuit boards; USB flash drives; Global Positioning System [GPS] apparatus; portable media players; cell phone straps; light-emitting diodes [LED]; triodes; step-up transformers; laptop computers; fire hose; bags adapted for laptops; sleeves for laptops; digital photo frames; Petri dishes; Pitot tubes; stroboscopes; traffic cones; temperature indicator labels, not for medical purposes; computer software applications, downloadable; electronic book readers; smartphones; toner cartridges, unfilled, for printers and photocopiers; baby monitors; video baby monitors; lens hoods; tablet computers; encoded key cards; 3D spectac-

les; memory cards for video game machines; bullet-proof clothing; accelerometers; electrical adapters; life-saving capsules for natural disasters; computer hardware; solar panels for the production of electricity; cellular phones; mobile telephones; cell phones; telescopic sights for artillery; digital signs; wearable activity trackers; chargers for electronic cigarettes; connected bracelets [measuring instruments]; covers for smartphones; cases for smartphones; selfie sticks [hand-held monopods]; calorimeters; flowmeters; reflective safety vests; electronic collars to train animals; joysticks for use with computers, other than for video games; smartglasses; smartwatches; fire extinguishing apparatus; protective films adapted for computer screens; mouth guards for sports; head guards for sports; needles for surveying compasses; security tokens [encryption devices]; infrared detectors; covers for personal digital assistants [PDAs]; baby scales; electronic access control systems for interlocking doors; thermal imaging cameras; scales with body mass analysers; scales with body mass analyzers; covers for tablet computers; black boxes [data recorders]; digital weather stations; charging stations for electric vehicles; interactive touch screen terminals; smart rings; electric and electronic effects units for musical instruments; audio interfaces; equalizers [audio apparatus]; equalisers [audio apparatus]; subwoofers; bathroom scales; thermo-hygrometers; biochips; protective films adapted for smartphones; virtual reality headsets; electronic interactive whiteboards; humanoid robots with artificial intelligence; audio mixers; batteries for electronic cigarettes; electronic key fobs being remote control apparatus; electronic sheet music, downloadable; T-squares for measuring; squares for measuring; square rulers for measuring; electronic numeric displays; laboratory robots; teaching robots; security surveillance robots; personal digital assistants [PDAs]; computer software platforms, recorded or downloadable; satellite finder meters; ring sizers; finger sizers; thin client computers; rearview cameras for vehicles; hand-held electronic dictionaries; resuscitation training simulators; electric wire harnesses for automobiles; snorkels; sports whistles; computer screen saver software, recorded or downloadable; selfie lenses; downloadable graphics for mobile phones; telecommunication apparatus in the form of jewellery; telecommunication apparatus in the form of jewelry; wearable computers; wearable video display monitors; magnetic resonance imaging [MRI] apparatus, not for medical purposes; rescue laser signalling flares; ink cartridges, unfilled, for printers and photocopiers; wah-wah pedals; height measuring instruments; hairdressing training heads [teaching apparatus]; devices for the projection of virtual keyboards; survival blankets; lifeboats; nanoparticle size analysers; nanoparticle size analyzers; ear pads for headphones; data gloves; trackballs [computer peripherals]; downloadable emoticons for mobile phones; telepresence robots; climate control digital thermostats; piezoe-

lectric sensors; organic light-emitting diodes [OLED]; quantum dot light-emitting diodes [QLED]; droppers for measuring, other than for medical or household purposes; electric sockets; computer game software, downloadable; rescue flares, non-explosive and non-pyrotechnic; stands adapted for laptops; headgear being protective helmets; padlocks, electronic; weight belts for divers; earpieces for remote communication; parking sensors for vehicles; ticket printers; body harnesses for support when lifting loads; animal signalling rattles for directing livestock; video projectors; downloadable cryptographic keys for receiving and spending cryptocurrency; downloadable e-wallets; credit card terminals; biometric passports; e-passports; biometric identity cards.

12 – Forklift trucks; railway couplings; couplings for land vehicles; aerial conveyors; air vehicles; hot air balloons; inner tubes for pneumatic tyres; inner tubes for pneumatic tires; repair outfits for inner tubes; air pumps [vehicle accessories]; suspension shock absorbers for vehicles; shock absorbing springs for vehicles; amphibious airplanes; non-skid devices for vehicle tires; non-skid devices for vehicle tyres; anti-skid chains; head-rests for vehicle seats; sprinkling trucks; trailer hitches for vehicles; motor buses; motor coaches; boats; trucks; lorries; automobile hoods; automobile chains; automobile chassis; reversing alarms for vehicles; aeroplanes; ferry boats; luggage carriers for vehicles; airships; dirigible balloons; tires for vehicle wheels; tyres for vehicle wheels; valves for vehicle tyres; valves for vehicle tires; flanges for railway wheel tyres; flanges for railway wheel tires; torsion bars for vehicles; ship hulls; boat hooks; steering gears for ships; disengaging gear for boats; inclined ways for boats; screw-propellers for boats; oars; tipping bodies for lorries; tipping bodies for trucks; mine cart wheels; bicycles; bicycle kickstands; bogies for railway cars; davits for boats; mudguards; two-wheeled trolleys; luggage trucks; sack-barrows; cars for cable transport installations; caissons [vehicles]; vehicle wheels; hoods for vehicle engines; hoods for vehicles; caravans; trailers [vehicles]; crankcases for land vehicle components, other than for engines; safety belts for vehicle seats; hubs for vehicle wheels; vehicle wheel hubs; bicycle chains; wheelchairs; barges; launches; handling carts; hose carts; casting carriages; casting cars; ladle carriages; ladle cars; golf carts [vehicles]; golf cars [vehicles]; vehicle chassis; rudders; rolling stock for funicular railways; rolling stock for railways; funnels for ships; treads for vehicles [tractor type]; treads for vehicles [roller belts]; tractors; mine cars; vehicle bumpers; buffers for railway rolling stock; hydraulic circuits for vehicles; bicycle handlebars; sleeping berths for vehicles; timbers [frames] for ships; bicycle tyres; bicycle tires; gears for bicycles; bicycle brakes; bicycle mudguards; rims for bicycle wheels; bicycle wheel rims; bicycle cranks; bicycle motors; hubs for bicycle wheels; bicycle wheel hubs; bicycle pedals; pumps for bicycles, cycles; bicycle

pumps; spokes for bicycle wheels; bicycle wheel spokes; bicycle wheels; bicycle saddles; motorcycle kickstands; gearing for land vehicles; dredgers [boats]; handcars; motors, electric, for land vehicles; electric vehicles; clutches for land vehicles; safety seats for children, for vehicles; parachutes; casings for pneumatic tires; casings for pneumatic tyres; balance weights for vehicle wheels; space vehicles; spars for ships; axles for vehicles; axle journals; windshield wipers; windscreen wipers; dress guards for bicycles; luggage nets for vehicles; hub caps; vans [vehicles]; brakes for vehicles; bands for wheel hubs; refrigerated vehicles; refrigerated railway wagons; engines for land vehicles; motors for land vehicles; sculls; stern oars; seat covers for vehicles; portholes; seaplanes; hydroplanes; sleeping cars; locomotives; driving motors for land vehicles; railway carriages; vehicle running boards; transmissions for land vehicles; propulsion mechanisms for land vehicles; military vehicles for transport; jet engines for land vehicles; motorcycles; freewheels for land vehicles; water vehicles; ships; screws [propellers] for ships; paddles for canoes; windscreens; windshields; spikes for tires [tyres]; studs for tires [tyres]; treads for retreading tyres; treads for retreading tires; pneumatic tires [tyres]; pneumatic tyres; pontoons; doors for vehicles; ski carriers for cars; delivery tricycles; carrier tricycles; pushchairs; strollers; stroller covers; pushchair covers; pushchair hoods; stroller hoods; screw-propellers; vehicle wheel spokes; spoke clips for wheels; ski lifts; vehicle suspension springs; dining cars; dining carriages; rearview mirrors; rims for vehicle wheels; vehicle wheel rims; motorcycle saddles; side cars; vehicle seats; sports cars; cleats [nautical]; chairlifts; rowlocks; oarlocks; tilting-carts; aircraft; undercarriages for vehicles; sleighs [vehicles]; tramcars; cable transport apparatus and installations; funiculars; telpher railways [cable cars]; cable cars; tricycles; turbines for land vehicles; vehicles for locomotion by land, air, water or rail; adhesive rubber patches for repairing inner tubes; upholstery for vehicles; mopeds; windows for vehicles; cars; automobiles; motor cars; anti-theft devices for vehicles; tipping apparatus [parts of railway wagons]; yachts; aeronautical apparatus, machines and appliances; anti-glare devices for vehicles; anti-dazzle devices for vehicles; automobile tyres; automobile tires; automobile bodies; bumpers for automobiles; shock absorbers for automobiles; anti-theft alarms for vehicles; horns for vehicles; concrete mixing vehicles; inner tubes for bicycle tires; inner tubes for bicycle tyres; brake linings for vehicles; brake shoes for vehicles; gear boxes for land vehicles; wheelbarrows; carts; bicycle frames; bodies for vehicles; ejector seats for aircraft; vehicle covers [shaped]; driving chains for land vehicles; transmission chains for land vehicles; torque converters for land vehicles; signal arms for vehicles; funnels for locomotives; steering wheels for vehicles; saddle covers for bicycles; ambulances; tubeless tires for bicycles; tubeless tyres for bicycles;

reduction gears for land vehicles; brake segments for vehicles; air cushion vehicles; caps for vehicle fuel tanks; connecting rods for land vehicles, other than parts of motors and engines; tailboard lifts [parts of land vehicles]; elevating tailgates [parts of land vehicles]; power tailgates [parts of land vehicles]; security harness for vehicle seats; sun-blinds adapted for automobiles; transmission shafts for land vehicles; air bags [safety devices for automobiles]; baskets adapted for bicycles; motor homes; camping cars; casters for trolleys [vehicles]; casters for carts [vehicles]; cleaning trolleys; fenders for ships; kick sledges; panniers adapted for bicycles; shopping trolleys; shopping carts; snowmobiles; remote control vehicles, other than toys; push scooters [vehicles]; masts for boats; covers for vehicle steering wheels; spoilers for vehicles; headlight wipers; brake pads for automobiles; spare wheel covers; spare tire covers; spare tyre covers; tilt trucks; cigar lighters for automobiles; brake discs for vehicles; saddlebags adapted for bicycles; bicycle bells; armored vehicles; armoured vehicles; engine mounts for land vehicles; military drones; canoes; civilian drones; side view mirrors for vehicles; fitted pushchair mosquito nets; fitted stroller mosquito nets; vehicle joysticks; driverless cars [autonomous cars]; self-driving cars; motor scooters; mobility scooters; ashtrays for automobiles; motorcycle chains; motorcycle frames; motorcycle handlebars; motorcycle engines; panniers adapted for motorcycles; solid tires for vehicle wheels; solid tyres for vehicle wheels; baby carriages; prams; fitted footmuffs for prams; fitted footmuffs for baby carriages; fitted footmuffs for pushchairs; fitted footmuffs for strollers; tyre mousse inserts; tire mousse inserts; bags adapted for pushchairs; bags adapted for strollers; remotely operated vehicles for underwater inspections; autonomous underwater vehicles for seabed inspections; bellows for articulated buses; electric bicycles; saddle covers for motorcycles; motor racing cars; robotic cars; camera drones; photography drones; fishing trolleys; roll cage trolleys; lug nuts for vehicle wheels; clips adapted for fastening automobile parts to automobile bodies; rescue sleds; tow trucks; wreckers for transport; garbage trucks; rubbish trucks; trailers for transporting bicycles; bicycle trailers; pet strollers; trucks with a crane feature incorporated; delivery drones; helicams; gyrocopters; helicopters; self-balancing scooters; self-balancing boards; self-balancing electric unicycles; vehicle bonnet pins; vehicle hood pins; tires for snow ploughs; tyres for snow ploughs; diving bells; cup holders for vehicles; trolleys; horse-drawn carriages; amphibious vehicles; all-terrain vehicles.

14 – Agates; clock hands; ingots of precious metals; jewelry of yellow amber; jewellery of yellow amber; pearls made of ambroid [pressed amber]; amulets [jewellery]; amulets [jewelry]; spun silver [silver wire]; silver thread [jewellery]; silver thread [jewelry]; clocks; pendulums [clock- and watchmaking]; barrels [clock- and watchmaking]; bracelets [jewellery]; bra-

celets [jewelry]; wristwatches; watch bands; watch straps; straps for wristwatches; jewellery charms; jewelry charms; charms for jewellery; charms for jewelry; brooches [jewellery]; brooches [jewelry]; dials [clock- and watchmaking]; sundials; clockworks; chains [jewellery]; chains [jewelry]; watch chains; chronographs [watches]; chronometers; chronoscopes; chronometric instruments; necklaces [jewellery]; necklaces [jewelry]; clocks and watches, electric; tie clips; coins; diamonds; threads of precious metal [jewellery]; wire of precious metal [jewellery]; threads of precious metal [jewelry]; wire of precious metal [jewelry]; atomic clocks; control clocks [master clocks]; master clocks; clock cases; iridium; ivory jewelry; ivory jewellery; ornaments of jet; jet, unwrought or semi-wrought; copper tokens; jewelry; jewellery; lockets [jewellery]; lockets [jewelry]; medals; precious metals, unwrought or semi-wrought; watches; watch springs; watch glasses; watch crystals; movements for clocks and watches; olivine [gems]; peridot; gold, unwrought or beaten; gold thread [jewellery]; gold thread [jewelry]; osmium; palladium; ornamental pins; pearls [jewellery]; pearls [jewelry]; semi-precious stones; precious stones; platinum [metal]; alarm clocks; rhodium; ruthenium; spinel [precious stones]; statues of precious metal; paste jewellery; alloys of precious metal; anchors [clock- and watchmaking]; rings [jewellery]; rings [jewelry]; works of art of precious metal; boxes of precious metal; hat jewellery; hat jewelry; earrings; shoe jewellery; shoe jewelry; cuff links; busts of precious metal; watch cases [parts of watches]; presentation boxes for watches; figurines of precious metal; statuettes of precious metal; pins [jewellery]; pins [jewelry]; tie pins; badges of precious metal; key chains [split rings with trinket or decorative fob]; key rings [split rings with trinket or decorative fob]; silver, unwrought or beaten; stopwatches; cloisonné jewellery; cloisonné jewelry; jewellery boxes; jewelry boxes; beads for making jewelry; beads for making jewellery; clasps for jewelry; clasps for jewellery; jewelry findings; jewellery findings; jewelry rolls; jewellery rolls; cabochons; split rings of precious metal for keys; presentation boxes for jewellery; presentation boxes for jewelry; watch hands; misbaha [prayer beads]; bracelets made of embroidered textile [jewelry]; bracelets made of embroidered textile [jewellery]; charms for key rings; charms for key chains; rosaries; chaplets; crucifixes of precious metal, other than jewellery; crucifixes of precious metal, other than jewelry; crucifixes as jewellery; crucifixes as jewelry; retractable key chains; retractable key rings; jewellery hat pins; jewelry hatpins.

15 – Accordions; tuning hammers; reeds; bows for musical instruments; bow nuts for musical instruments; sticks for bows for musical instruments; horsehair for bows for musical instruments; pianos; conductors' batons; drumsticks; bandonions; barrel organs; basses [musical instruments]; harmonicas; cat-

gut for musical instruments; buccins [trumpets]; carillons [musical instruments]; castanets; hats with bells [musical instruments]; kettledrum frames; pegs for musical instruments; zithers; clarionets; keyboards for musical instruments; musical instruments; concertinas; double basses; strings for musical instruments; stringed musical instruments; horns [musical instruments]; cornets [musical instruments]; cymbals; tuning forks; mouthpieces for musical instruments; cases for musical instruments; flutes; gongs; Jews' harps [musical instruments]; guitars; harmoniums; harps; harp strings; oboes; electronic musical instruments; intensity regulators for mechanical pianos; lyres; plectrums; picks for stringed instruments; mandolins; chin rests for violins; bagpipes; musical boxes; turning apparatus for sheet music; bridges for musical instruments; triangles [musical instruments]; ocarinas; organs; wind pipes for organs; drumheads; skins for drums; pedals for musical instruments; piano keyboards; piano strings; piano keys; bellows for musical instruments; mutes for musical instruments; dampers for musical instruments; drums [musical instruments]; tambourines; tom-toms; kettledrums; trombones; clarions; trumpets; valves for musical instruments; violas; violins; xylophones; keys for musical instruments; music rolls [piano]; perforated music rolls; music stands; huqin [Chinese violins]; bamboo flutes; pipa [Chinese guitars]; sheng [Chinese musical wind instruments]; suona [Chinese trumpets]; handbells [musical instruments]; music synthesizers; stands for musical instruments; saxophones; balalaikas [stringed musical instruments]; banjos; melodicas; colophony for stringed musical instruments; rosin for stringed musical instruments; robotic drums; mallets for musical instruments; straps for musical instruments.

16 – Steel letters; steel pens; adhesive tape dispensers [office requisites]; address stamps; addressing machines; paper; posters; advertisement boards of paper or cardboard; franking machines for office use; postage meters for office use; staples for offices; clips for offices; pen clips; stapling presses [office requisites]; albums; scrapbooks; pictures; prints [engravings]; cigar bands; pencil sharpening machines, electric or non-electric; bookends; hand-rests for painters; aquarelles; watercolors [paintings]; watercolours [paintings]; architects' models; document files [stationery]; writing slates; slate pencils; silver paper; modelling clay; arithmetical tables; calculating tables; engravings; lithographic works of art; paintings [pictures], framed or unframed; pencils; newspapers; periodicals; atlases; loose-leaf binders; ring binders; gummed tape [stationery]; mats for beer glasses; tickets; biological samples for use in microscopy [teaching materials]; printing blocks; drawing pads; pads [stationery]; spools for inking ribbons; wristbands for the retention of writing instruments; pamphlets; embroidery designs [patterns]; drawing pins; thumbtacks; moisteners [office requisites]; painters' brushes; blotters; stamps [seals]; sealing stamps; inking pads; sealing wax; sealing

machines for offices; sealing compounds for stationery purposes; writing or drawing books; trays for sorting and counting money; tracing patterns; tracing paper; tracing cloth; fingerstalls for office use; printing type; carbon paper; paper for recording machines; note books; square rulers for drawing; cards; charts; teaching materials [except apparatus]; index cards [stationery]; paper sheets [stationery]; cardboard; hat boxes of cardboard; perforated cards for Jacquard looms; cardboard tubes; catalogues; tags for index cards; song books; composing frames [printing]; folders for papers; jackets for papers; painters' easels; numbers [type]; Indian inks; chromolithographs [chromos]; chromos; modelling wax, not for dental purposes; files [office requisites]; office perforators; toilet paper; hygienic paper; books; compasses for drawing; type [numerals and letters]; letters [type]; composing sticks; letter trays; conical paper bags; correcting fluids [office requisites]; correcting ink [heliography]; pencil leads; histological sections for teaching purposes; French curves; covers [stationery]; wrappers [stationery]; writing chalk; chalk for lithography; tailors' chalk; chalk holders; pencil holders; pencil lead holders; cream containers of paper; paper clasps; rollers for typewriters; transfers [decalcomanias]; decalcomanias; graphic prints; graining combs; drawing boards; drawing materials; drawing instruments; diagrams; envelopes [stationery]; duplicators; etchings; wrapping paper; packing paper; nibs; typewriters, electric or non-electric; pen cases; boxes for pens; nibs of gold; erasing products; writing materials; shields [paper seals]; erasing shields; rubber erasers; electrocardiograph paper; punches [office requisites]; ink; inking ribbons; inkwells; envelope sealing machines for offices; photographs [printed]; pen wipers; seals [stamps]; fabrics for bookbinding; drawing sets; ledgers [books]; indexes; figurines of papier mâché; statuettes of papier mâché; filter paper; filtering materials of paper; forms, printed; office requisites, except furniture; charcoal pencils; stencils [stationery]; galley racks [printing]; electrotypes; geographical maps; terrestrial globes; artists' watercolor saucers; artists' watercolour saucers; graphic reproductions; graphic representations; scrapers [erasers] for offices; engraving plates; hectographs; printed timetables; moisteners for gummed surfaces [office requisites]; postcards; printed matter; hand labelling appliances; printers' blankets, not of textile; printing sets, portable [office requisites]; printed publications; manuals [handbooks]; handbooks [manuals]; writing paper; paperweights; tracing needles for drawing purposes; drawing pens; table linen of paper; lithographs; lithographic stones; booklets; luminous paper; papier mâché; manifolds [stationery]; marking chalk; plastics for modelling; modelling materials; modelling paste; handkerchiefs of paper; inking sheets for duplicators; tablecloths of paper; blackboards; paper-clips; numbering apparatus; oleographs; binding strips [bookbinding]; sealing wafers; palettes for painters; panto-

graphs [drawing instruments]; stationery; parchment paper; pastels [crayons]; sewing patterns; stencil cases; house painters' rollers; canvas for painting; paint boxes for use in schools; plastic film for wrapping; apparatus for mounting photographs; photograph stands; photo-engravings; blueprints; plans; paper creasers [office requisites]; fountain pens; stencil plates; stencils; portraits; covers of paper for flower pots; flower-pot covers of paper; mimeograph apparatus and machines; paper tapes and cards for the recordal of computer programmes; prospectuses; paper for radiograms; drawing rulers; printers' galleys; bookbinding material; bookbinding cloth; cloth for bookbinding; cords for bookbinding; bookbinding cords; inking sheets for document reproducing machines; pens [office requisites]; magazines [periodicals]; paper ribbons, other than haberdashery or hair decorations; typewriter ribbons; bags [envelopes, pouches] of paper or plastics, for packaging; stamp pads; school supplies [stationery]; bookmarkers; bookmarks; greeting cards; steatite [tailor's chalk]; balls for ball-point pens; tablemats of paper; desk mats; typewriter keys; holders for stamps [seals]; cases for stamps [seals]; postage stamps; stamp stands; transparencies [stationery]; vignetting apparatus; gluten [glue] for stationery or household purposes; adhesives [glues] for stationery or household purposes; adhesive tapes for stationery or household purposes; adhesive bands for stationery or household purposes; address plates for addressing machines; almanacs; calendars; starch paste [adhesive] for stationery or household purposes; paintbrushes; self-adhesive tapes for stationery or household purposes; elastic bands for offices; bibs of paper; wood pulp board [stationery]; wood pulp paper; boxes of paper or cardboard; stands for pens and pencils; bottle envelopes of paper or cardboard; coasters of paper; announcement cards [stationery]; plastic bubble packs for wrapping or packaging; flags of paper; paper shredders for office use; sheets of reclaimed cellulose for wrapping; desktop cabinets for stationery [office requisites]; glue for stationery or household purposes; pastes for stationery or household purposes; paper knives [letter openers]; garbage bags of paper or of plastics; pencil sharpeners, electric or non-electric; tissues of paper for removing make-up; table napkins of paper; place mats of paper; squares for drawing; T-squares for drawing; penholders; writing cases [stationery]; inkstands; writing cases [sets]; handwriting specimens for copying; bottle wrappers of paper or cardboard; placards of paper or cardboard; towels of paper; face towels of paper; labels of paper or cardboard; etching needles; viscose sheets for wrapping; gums [adhesives] for stationery or household purposes; gummed cloth for stationery purposes; isinglass for stationery or household purposes; bags for microwave cooking; paper coffee filters; plastic cling film, extensible, for palletization; signboards of paper or cardboard; stickers [stationery]; bookbinding apparatus and machines [office equipment]; comic books;

copying paper [stationery]; holders for cheque books; holders for checkbooks; ink sticks; ink stones [ink reservoirs]; musical greeting cards; newsletters; packaging material made of starches; waxed paper; passport holders; writing brushes; writing instruments; drawer liners of paper, perfumed or not; credit card imprinters, non-electric; document laminators for office use; papers for painting and calligraphy; writing board erasers; clipboards; chart pointers, non-electronic; paper bows, other than haberdashery or hair decorations; molds for modelling clays [artists' materials]; moulds for modelling clays [artists' materials]; money clips; trading cards, other than for games; absorbent sheets of paper or plastic for foodstuff packaging; humidity control sheets of paper or plastic for foodstuff packaging; correcting tapes [office requisites]; paint trays; marking pens [stationery]; flyers; document holders [stationery]; page holders; polymer modelling clay; obliterating stamps; packing [cushioning, stuffing] materials of paper or cardboard; stuffing of paper or cardboard; padding materials of paper or cardboard; banknotes; spray chalk; printed coupons; rice paper; plastic bags for pet waste disposal; washis; table runners of paper; printed sheet music; banners of paper; bunting of paper; animation cels; paper bags for use in the sterilization of medical instruments; paper bags for use in the sterilisation of medical instruments; name badge holders [office requisites]; retractable reels for name badge holders [office requisites]; clips for name badge holders [office requisites]; paper for medical examination tables; dental tray covers of paper; bibs, sleeved, of paper; paper cutters [office requisites]; stencils for decorating food and beverages; name badges [office requisites]; barcode ribbons; glitter for stationery purposes; baggage claim check tags of paper; paper wipes for cleaning; protective covers for books; colouring books; coloring books.

18 – Mountaineering sticks; alpenstocks; animal skins; pelts; umbrella rings; saddle trees; leather leashes; leather leads; fastenings for saddles; umbrella or parasol ribs; goldbeaters' skin; purses; bridoons; straps for soldiers' equipment; music cases; umbrella sticks; walking sticks; canes; walking stick seats; bits for animals [harness]; frames for umbrellas or parasols; game bags [hunting accessories]; school bags; school satchels; card cases [notecases]; leatherboard; hat boxes of leather; horse collars; horse blankets; kid; muzzles; travelling trunks; collars for animals; leather cord; curried skins; harness straps; harness traces; straps of leather [saddlery]; straps for skates; leather straps; leather thongs; butts [parts of hides]; leather, unworked or semi-worked; trimmings of leather for furniture; leather trimmings for furniture; imitation leather; umbrellas; sling bags for carrying infants; parts of rubber for stirrups; stirrup leathers; tool bags, empty; whips; nose bags [feed bags]; umbrella covers; casings, of leather, for springs; casings, of leather, for plate springs; knee-pads for horses; covers for animals; harness for animals; blinkers [harness]; blinders

[harness]; traces [harness]; rucksacks; backpacks; halters; head-stalls; walking stick handles; walking cane handles; cat o' nine tails; chin straps, of leather; moleskin [imitation of leather]; handbag frames; parasols; fur; fur-skins; umbrella handles; pocket wallets; wheeled shopping bags; shopping bags; reins; attaché cases; bags for climbers; bags for campers; beach bags; handbags; travelling bags; bags [envelopes, pouches] of leather, for packaging; girths of leather; riding saddles; saddlery; briefcases; travelling sets [leatherware]; suitcases; suitcase handles; valves of leather; cattle skins; boxes of leather or leatherboard; chain mesh purses; cases of leather or leatherboard; trunks [luggage]; vanity cases, not fitted; chamois leather, other than for cleaning purposes; skins of chamois, other than for cleaning purposes; shoulder belts [straps] of leather; leather shoulder belts; leather shoulder straps; covers for horse saddles; boxes of vulcanized fibre; boxes of vulcanized fiber; haversacks; garment bags for travel; bridles [harness]; key cases; net bags for shopping; valises; furniture coverings of leather; pads for horse saddles; bags for sports; stirrups; harness fittings; horseshoes; slings for carrying infants; pouch baby carriers; bags; credit card cases [wallets]; business card cases; randsels [Japanese school satchels]; baggage tags; luggage tags; saddlecloths for horses; labels of leather; grips for holding shopping bags; tefillin [phylacteries]; suitcases with wheels; saddlebags; clothing for pets; reins for guiding children; motorized suitcases; compression cubes adapted for luggage; conference folders; conference portfolios; hiking sticks; trekking sticks; leathercloth; backpacks for carrying infants.

20 – Beehives; display boards; decorations of plastic for foodstuffs; yellow amber; stuffed animals; beds for household pets; nesting boxes for household pets; kennels for household pets; animal claws; curtain rings; silvered glass [mirrors]; cupboards; medicine cabinets; clips, not of metal, for cables and pipes; casks of wood for decanting wine; whalebone, unworked or semi-worked; bamboo; benches [furniture]; fishing baskets; playpens for babies; cradles; bassinets; library shelves; reels of wood for yarn, silk, cord; bedsteads of wood; wood ribbon; corks for bottles; corks; bottle racks; embroidery frames; brush mountings; sideboards; animal horns; desks; office furniture; costume stands; comb foundations for beehives; sections of wood for beehives; furniture; taps, not of metal, for casks; faucets, not of metal, for casks; index cabinets [furniture]; filing cabinets; imitation tortoiseshell; screens for fireplaces [furniture]; coffins; coffin fittings, not of metal; stag antlers; chairs [seats]; seats; chaise longues; chaise lounges; head-rests [furniture]; hat stands; loading pallets, not of metal; loading gauge rods, not of metal, for railway wagons; hinges, not of metal; display stands; dog kennels; coat hangers; clothes hangers; shelves for file cabinets; armchairs; mannequins; tailors' dummies; dressmakers' dummies; containers, not of metal, for liquid fuel; chests of dra-

wers; counters [tables]; containers, not of metal [storage, transport]; floating containers, not of metal; tables; coral; trays, not of metal; horn, unworked or semi-worked; corozo; bedding, except linen; cushions; mattresses; hooks, not of metal, for clothes rails; coat-hooks, not of metal; vats, not of metal; tea carts; tea trolleys; drafting tables; towel dispensers, fixed, not of metal; towel dispensers, not of metal, fixed; divans; staves of wood; cabinet work; tortoiseshell; oyster shells; stakes, not of metal, for plants or trees; ladders of wood or plastics; mobile boarding stairs, not of metal, for passengers; school furniture; typing desks; shelves for typewriters; placards of wood or plastics; nuts, not of metal; meerschaum; removable mats or covers for sinks; mats, removable, for sinks; packaging containers of plastic; curtain holders, not of textile material; beds; reels, not of metal, non-mechanical, for flexible hoses; winding spools, not of metal, non-mechanical, for flexible hoses; stair rods; work benches; racks [furniture]; nesting boxes; fans for personal use, non-electric; closures, not of metal, for containers; furniture fittings, not of metal; flower-stands [furniture]; flower-pot pedestals; fodder racks; gun racks; casks, not of metal; cask stands, not of metal; curtain rollers; meat safes; window fittings, not of metal; bed fittings, not of metal; door fittings, not of metal; chopping blocks [tables]; crates; covers for clothing [wardrobe]; registration plates, not of metal; numberplates, not of metal; furniture of metal; rattan; newspaper display stands; magazine racks; slatted indoor blinds; washstands [furniture]; hospital beds; bed casters, not of metal; latches, not of metal; lecterns; hampers [baskets] for the transport of items; coatstands; transport pallets, not of metal; handling pallets, not of metal; steps [ladders], not of metal; furniture partitions of wood; partitions of wood for furniture; furniture casters, not of metal; honeycombs; mobiles [decoration]; standing desks; mother-of-pearl, unworked or semi-worked; identity plates, not of metal; nameplates, not of metal; house numbers, not of metal, non-luminous; stuffed birds; pillows; air pillows, not for medical purposes; straw mattresses; straw mattress; plaited straw, except matting; straw plaits; straw edgings; bakers' bread baskets; umbrella stands; screens [furniture]; clothes hooks, not of metal; bead curtains for decoration; tent pegs, not of metal; table tops; doors for furniture; curtain rails; furniture shelves; edgings of plastic for furniture; tanks, not of metal nor of masonry; reservoirs, not of metal nor of masonry; curtain rods; curtain hooks; curtain tie-backs; reeds [plaiting materials]; animal hooves; writing desks; locks, not of metal, for vehicles; seats of metal; sofas; settees; bed bases; valves, not of metal, other than parts of machines; statues of wood, wax, plaster or plastic; tables of metal; dressing tables; moldings for picture frames; mouldings for picture frames; shelves for storage; lockers; mirrors [looking glasses]; deck chairs; bolsters; trestles [furniture]; keyboards for hanging keys; plate racks; wicker-

work; showcases [furniture]; air cushions, not for medical purposes; air mattresses, not for medical purposes; ambroid bars; ambroid plates; works of art of wood, wax, plaster or plastic; troughs, not of metal, for mixing mortar; chests, not of metal; bins, not of metal; vice benches [furniture]; barrels, not of metal; barrel hoops, not of metal; cask hoops, not of metal; stands for calculating machines; bungs, not of metal; plugs, not of metal; sealing caps, not of metal; screws, not of metal; rivets, not of metal; pegs [pins], not of metal; dowels, not of metal; pins [pegs], not of metal; bolts, not of metal; bottle caps, not of metal; bottle closures, not of metal; bottle fasteners, not of metal; identification bracelets, not of metal; dinner wagons [furniture]; busts of wood, wax, plaster or plastic; binding screws, not of metal, for cables; picture frames; picture frame brackets; picture rods [frames]; massage tables; waterbeds, not for medical purposes; drain traps [valves] of plastic; plugs [dowels], not of metal; wall plugs, not of metal; shells; stools; water-pipe valves of plastic; bottle casings of wood; statuettes of wood, wax, plaster or plastic; figurines of wood, wax, plaster or plastic; locks, other than electric, not of metal; hairdressers' chairs; poles, not of metal; baskets, not of metal; letter boxes, not of metal or masonry; mooring buoys, not of metal; garment covers [storage]; signboards of wood or plastics; trolleys [furniture]; bamboo curtains; chests for toys; high chairs for babies; infant walkers; inflatable publicity objects; plastic key cards, not encoded and not magnetic; mirror tiles; pulleys of plastics for blinds; saw horses; scratching posts for cats; shoulder poles [yokes]; carts for computers [furniture]; trolleys for computers [furniture]; funerary urns; wind chimes [decoration]; indoor window blinds of woven wood; indoor window shades of woven wood; book rests [furniture]; pet cushions; indoor window blinds [furniture]; indoor window shades [furniture]; door handles, not of metal; hand-held mirrors [toilet mirrors]; mats for infant playpens; towel stands [furniture]; knobs, not of metal; wall-mounted baby changing platforms; baby changing mats; door bolts, not of metal; indoor window blinds of paper; indoor window shades of paper; indoor window blinds of textile; indoor window shades of textile; door bells, not of metal, non-electric; freestanding partitions [furniture]; screw tops, not of metal, for bottles; door knockers, not of metal; saw benches [furniture]; inflatable furniture; step stools, not of metal; bathtub grab bars, not of metal; collars, not of metal, for fastening pipes; jewelry organizer displays; jewellery organizer displays; sleeping mats; sleeping pads; split rings, not of metal, for keys; dispensers for dog waste bags, fixed, not of metal; door stops, not of metal or rubber; window stops, not of metal or rubber; sash fasteners, not of metal, for windows; window fasteners, not of metal; door fasteners, not of metal; tool boxes, not of metal, empty; tool chests, not of metal, empty; shelving units; bag hangers, not of metal; plastic keys; brackets, not of metal, for furniture;

labels of plastic; console tables; bookcases; valet stands; jerrycans, not of metal; birdhouses; clips of plastic for sealing bags; bumper guards for cots, other than bed linen; bumper guards for cribs, other than bed linen; boxes of wood or plastic; cots for babies; cribs for babies; moses baskets; legs for furniture; feet for furniture; wardrobes; footstools; shoe pegs, not of metal; shoe dowels, not of metal; crucifixes of wood, wax, plaster or plastic, other than jewellery; crucifixes of wood, wax, plaster or plastic, other than jewellery; oil drainage containers, not of metal; air beds, not for medical purposes; camping mattresses; plastic ramps for use with vehicles; shower chairs; head support cushions for babies; anti-roll cushions for babies; head positioning pillows for babies; hand-held flagpoles, not of metal; stoppers, not of glass, metal or rubber; door closers, not of metal, non-electric; door springs, not of metal, non-electric; runners, not of metal, for sliding doors; bath seats for babies; lap desks; portable desks; door openers, not of metal, non-electric; window openers, not of metal, non-electric; window closers, not of metal, non-electric; sash pulleys, not of metal; window pulleys, not of metal; padlocks, other than electronic, not of metal; bathroom vanities [furniture]; drawers for furniture; luggage lockers.

21 – Drinking troughs; feeding troughs; steel wool for cleaning; washing boards; thermally insulated containers for food; carpet beaters [hand instruments]; glass bulbs [receptacles]; glass vials [receptacles]; animal bristles [brushware]; poultry rings; nozzles for watering hose; watering devices; sprinkling devices; brushes; sprinklers; watering cans; bread baskets for household purposes; rings for birds; bird baths; brooms; carpet sweepers; glass flasks [containers]; buckets; pails; basins [receptacles]; cooking pot sets; pouring spouts; currycombs; butter dishes; butter-dish covers; beer mugs; glass jars [carboys]; drinking vessels; heat-insulated containers for beverages; boxes for dispensing paper towels; soap boxes; tea caddies; bowls [basins]; basins [bowls]; demijohns; carboys; boot-jacks; glass stoppers; corkscrews, electric and non-electric; decorative glass spheres; bottles; insulating flasks; vacuum bottles; refrigerating bottles; bottle openers, electric and non-electric; cooking skewers of metal; cooking pins of metal; nail brushes; toilet brushes; lamp-glass brushes; material for brush-making; hair for brushes; perfume burners; cruets; cabarets [trays]; birdcages; sifters [household utensils]; heat-insulated containers; decanters; menu card holders; stew-pans; saucepan scourers of metal; cinder sifters [household utensils]; ceramics for household purposes; fly swatters; cauldrons; shoe brushes; horse brushes; mangers for animals; combs for animals; combs; cloths for cleaning; rags for cleaning; china ornaments; molds [kitchen utensils]; moulds [kitchen utensils]; apparatus for wax-polishing, non-electric; cocktail shakers; glue-pots; glasses [receptacles]; drinking horns; cosmetic utensils; strainers for household

purposes; fruit bowls; knife rests for the table; closures for pot lids; pot lids; ironing board covers, shaped; tie presses; blenders, non-electric, for household purposes; sieves [household utensils]; crystal [glassware]; ice cube molds; ice cube moulds; polishing leather; cooking pots; scoops for household purposes; cookery moulds; cookery molds; cleaning instruments, hand-operated; toothpicks; washtubs; plates to prevent milk boiling over; cutting boards for the kitchen; large-toothed combs for the hair; dusting apparatus, non-electric; flat-iron stands; powdered glass for decoration; toilet cases; fitted vanity cases; toilet paper dispensers; soap dispensers; siphon bottles for aerated water; siphon bottles for carbonated water; enamelled glass, not for building; shoe trees; funnels; spice sets; toilet sponges; sponge holders; furniture dusters; drying racks for laundry; buckets made of woven fabrics; comb cases; earthenware; crockery; holders for flowers and plants [flower arranging]; flower pots; whisks, non-electric, for household purposes; mops; frying pans; scrubbing brushes; fruit presses, non-electric, for household purposes; smoke absorbers for household purposes; mess-tins; glove stretchers; cake moulds; cake molds; plate glass [raw material]; drinking bottles for sports; grills [cooking utensils]; griddles [cooking utensils]; grill supports; gridiron supports; tar-brushes, long handled; powder puffs; glass, unworked or semi-worked, except building glass; insect traps; glass wool, other than for insulation; pots; vegetable dishes; liqueur sets; basting spoons [cooking utensils]; majolica; kitchen grinders, non-electric; utensils for household purposes; crumb trays; mosaics of glass, not for building; mills for household purposes, hand-operated; wool waste for cleaning; nest eggs, artificial; egg cups; opal glass; opaline glass; scouring pads; pads for cleaning; bread boards; fitted picnic baskets, including dishes; trouser presses; paper plates; rolling pins, domestic; electric combs; pie servers; tart scoops; wine-tasting pipettes; wine-tasting siphons; ironing boards; trays of paper, for household purposes; earthenware saucepans; nozzles for watering cans; roses for watering cans; pepper mills, hand-operated; pepper pots; polishing apparatus and machines, for household purposes, non-electric; polishing materials for making shiny, except preparations, paper and stone; porcelain ware; vases; soap holders; dishes for soap; chamber pots; pottery; dustbins; garbage cans; refuse bins; trash cans; powder compacts, empty; coolers [ice pails]; ice buckets; ice pails; graters for kitchen use; rat traps; containers for household or kitchen use; napkin rings; salad bowls; salt cellars; salt shakers; syringes for watering flowers and plants; sprinklers for watering flowers and plants; services [dishes]; dishes; tea services [tableware]; table napkin holders; vessels of metal for making ices and iced drinks; saucers; shoe horns; soup bowls; eyebrow brushes; mouse traps; statues of porcelain, ceramic, earthenware, terra-cotta or glass; sugar bowls; epergnes; cups; clothing stretchers; stretchers for clot-

hing; teapots; buttonhooks; piggy banks; toilet utensils; beverage urns, non-electric; tableware, other than knives, forks and spoons; perfume vaporizers; perfume sprayers; glass incorporating fine electrical conductors; painted glassware; glass for vehicle windows [semi-finished product]; mugs; aerosol dispensers, not for medical purposes; works of art of porcelain, ceramic, earthenware, terra-cotta or glass; table plates; autoclaves, non-electric, for cooking; pressure cookers, non-electric; beaters, non-electric; heaters for feeding bottles, non-electric; shaving brushes; shaving brush stands; stands for shaving brushes; bobeches; candle drip rings; boxes of glass; candy boxes; boxes for sweets; candelabra [candlesticks]; candlesticks; kettles, non-electric; tea infusers; tea balls; toothbrushes; electric brushes, except parts of machines; busts of porcelain, ceramic, earthenware, terra-cotta or glass; covers, not of paper, for flower pots; flower-pot covers, not of paper; coffee grinders, hand-operated; coffee services [tableware]; coffee filters, non-electric; coffee percolators, non-electric; coasters, not of paper or textile; abrasive pads for kitchen purposes; deep fryers, non-electric; portable cool boxes, non-electric; portable coolers, non-electric; water apparatus for cleaning teeth and gums; chamois leather for cleaning; buckskin for cleaning; skins of chamois for cleaning; wax-polishing appliances, non-electric, for shoes; cheese-dish covers; baskets for household purposes; trays for household purposes; cotton waste for cleaning; dish covers; covers for dishes; trivets [table utensils]; pitchers; jugs; kitchen containers; kitchen utensils; cooking utensils, non-electric; toothpick holders; toothbrushes, electric; deodorising apparatus for personal use; deodorizing apparatus for personal use; brushes for cleaning tanks and containers; signboards of porcelain or glass; sponges for household purposes; feather-dusters; dusting cloths [rags]; vitreous silica fibres, other than for textile use; vitreous silica fibers, other than for textile use; fiberglass, other than for insulation or textile use; fiberglass, other than for insulation or textile use; figurines of porcelain, ceramic, earthenware, terra-cotta or glass; statuettes of porcelain, ceramic, earthenware, terra-cotta or glass; fiberglass thread, other than for textile use; fiberglass thread, other than for textile use; coffeepots, non-electric; tea strainers; flasks; gloves for household purposes; tankards; cruet sets for oil and vinegar; polishing gloves; candle extinguishers; baby baths, portable; cages for household pets; cloth for washing floors; dishwashing brushes; indoor terrariums [plant cultivation]; litter boxes for pets; litter trays for pets; fused silica [semi-worked product], other than for building; waffle irons, non-electric; bread bins; chopsticks; cleaning tow; clothes-pegs; clothes-pins; cocktail stirrers; confectioners' decorating bags [pastry bags]; cookie [biscuit] cutters; cookie jars; cups of paper or plastic; drinking glasses; floss for dental purposes; gardening gloves; hot pots, not electrically heated; isothermic bags; lazy susans; lunch boxes; mixing spoons [kit-

chen utensils]; noodle machines, hand-operated; pastry cutters; plungers for clearing blocked drains; spatulas for kitchen use; abrasive sponges for scrubbing the skin; garlic presses [kitchen utensils]; disposable table plates; towel rails and rings; rails and rings for towels; toilet paper holders; indoor aquaria; tanks [indoor aquaria]; aquarium hoods; indoor terrariums [vivariums]; mop wringers; waste paper baskets; window-boxes; drinking straws; straws for drinking; tea cosies; make-up removing appliances; electric devices for attracting and killing insects; baking mats; boot trees; hip flasks; cosmetic spatulas; dripping pans; fly traps; candle jars [holders]; food steamers, non-electric; make-up sponges; crushers for kitchen use, non-electric; potholders; oven mitts; kitchen mitts; barbecue mitts; basting brushes; bulb basters; car washing mitts; make-up brushes; mop wringer buckets; tortilla presses, non-electric [kitchen utensils]; ski wax brushes; eyelash brushes; egg separators, non-electric, for household purposes; foam toe separators for use in pedicures; plug-in diffusers for mosquito repellents; cold packs for chilling food and beverages; reusable ice cubes; tablemats, not of paper or textile; place mats, not of paper or textile; decanter tags; wine aerators; heads for electric toothbrushes; coin banks; lint removers, electric or non-electric; polishing cloths; pig bristles for brush-making; horsehair for brush-making; ice tongs; salad tongs; serving ladles; pestles for kitchen use; mortars for kitchen use; ice cream scoops; nutcrackers; sugar tongs; broom handles; ladles for serving wine; inflatable bath tubs for babies; stands for portable baby baths; tea bag rests; cake decorating tips and tubes; rotary washing lines; cooking mesh bags, other than for microwaves; droppers for cosmetic purposes; droppers for household purposes; couscous cooking pots, non-electric; tagines, non-electric; tajines, non-electric; egg yolk separators; reusable silicone food covers; animal grooming gloves; squeegees [cleaning instruments]; egg poachers; aromatic oil diffusers, other than reed diffusers, electric and non-electric; plates for diffusing aromatic oil; pasta makers, hand-operated; diaper disposal pails; nappy disposal bins; disposable aluminium foil containers for household purposes; disposable aluminium foil containers for household purposes; roller tubes for peeling garlic; toothpaste tube squeezers; wine pourers; pet feeding bowls; pet feeding bowls, automatic; candle warmers, electric and non-electric; dishcloths; abrasive mitts for scrubbing the skin.

22 – Brattice cloth; tarpaulins; strips for tying-up vines; wood shavings; wood wool; sawdust; flock [stuffing]; raw silk; nets for camouflage; raw fibrous textile; fishing nets; camel hair; hemp fibres; hemp fibers; tow; hemp bands; schappe [raw silk waste]; silk waste; coconut fiber; coconut fibre; cocoons; ropes, not of metal; ropes; whipcord; rope ladders; raw cotton; cotton tow; horsehair; down [feathers]; eider-down; padding materials, not of rubber, plastics, paper or cardboard; stuffing, not of rubber, plastics, paper or

cardboard; packing [cushioning, stuffing] materials, not of rubber, plastics, paper or cardboard; packing string; upholstery wool [stuffing]; string; fibrous gaskets for ships; vitreous silica fibres for textile use; vitreous silica fibers for textile use; twine made of paper; twine for nets; silk flock; wool flock; sheaf-binding yarns; hammocks; grasses for upholstery; ladder tapes for Venetian blinds; ladder tapes or webbing for Venetian blinds; jute; kapok; snares [nets]; network; raw or treated wool; carded wool; combed wool; liber; wax ends; raw linen [flax]; feathers for bedding; awnings of textile; sails; wadding for filtering; wadding for padding and stuffing upholstery; straw for stuffing upholstery; feathers for stuffing upholstery; animal hair; ramie fibre; ramie fiber; raffia; sacks for the transport and storage of materials in bulk; bags [envelopes, pouches] of textile, for packaging; esparto grass; tents; fleece wool; shorn wool; seaweed for stuffing; vehicle covers, not fitted; textile fibers; textile fibres; sisal; wrapping or binding bands, not of metal; thread, not of metal, for wrapping or binding; straw wrappers for bottles; bottle envelopes of straw; packing, of straw, for bottles; braces, not of metal, for handling loads; harness, not of metal, for handling loads; straps, not of metal, for handling loads; belts, not of metal, for handling loads; slings, not of metal, for handling loads; cables, not of metal; covers for camouflage; binding thread, not of metal, for agricultural purposes; carbon fibres for textile use; carbon fibers for textile use; sash cords; cords for hanging pictures; cotton waste [flock] for padding and stuffing; packing rope; plastic fibres for textile use; plastic fibers for textile use; glass fibres for textile use; glass fibers for textile use; nets; linters; awnings of synthetic materials; car towing ropes; mail bags; sails for ski sailing; mesh bags for washing laundry; body bags; purse seines; net pens for fish farming; canvas for sails; outdoor blinds of textile; bindings, not of metal; animal feeding nets; pig bristles; dust sheets; drop cloths; cloth bags specially adapted for the storage of diapers; bivouac sacks being shelters; laundry bags.

23 – Thread; yarn; cotton thread and yarn; embroidery thread and yarn; woollen thread and yarn; hemp thread and yarn; coir thread and yarn; silk thread and yarn; spun cotton; sewing thread and yarn; spun thread and yarn; jute thread and yarn; spun wool; worsted; linen thread and yarn; rayon thread and yarn; darning thread and yarn; spun silk; fiberglass thread for textile use; fibreglass thread for textile use; rubber thread for textile use; elastic thread and yarn for textile use; threads of plastic materials for textile use; chenille yarn; thread of metal for embroidery.

24 – Adhesive fabric for application by heat; fabric, impervious to gases, for aeronautical balloons; fabric imitating animal skins; upholstery fabrics; bath linen, except clothing; banners of textile or plastic; billiard cloth; fabric; bolting cloth; buckram; brocades; textile

material; cloth; canvas for tapestry or embroidery; trellis [cloth]; hemp fabric; hemp cloth; hat linings, of textile, in the piece; lining fabric for footwear; fabric for footwear; table runners, not of paper; chevots [cloth]; oilcloth for use as tablecloths; velvet; felt; cotton fabrics; bed covers; bedspreads; coverlets [bedspreads]; quilts; mattress covers; tick [linen]; bed covers of paper; tablecloths, not of paper; travelling rugs [lap robes]; crepe [fabric]; crepon; damask; lingerie fabric; linings [textile]; sheets [textile]; shrouds; flags of textile or plastic; bunting of textile or plastic; drugget; eiderdowns [down coverlets]; elastic woven material; curtain holders of textile material; glass cloths [towels]; traced cloth for embroidery; traced cloths for embroidery; flannel [fabric]; frieze [cloth]; cheese cloth; fustian; dimity; bath mitts; gauze [cloth]; gummed cloth, other than for stationery purposes; haircloth [sackcloth]; covers [loose] for furniture; loose covers for furniture; silk fabrics for printing patterns; printed calico cloth; jersey [fabric]; jute fabric; woollen cloth; woollen fabric; linen cloth; bed linen; diapered linen; table linen, not of paper; household linen; towels of textile; marabouts [cloth]; ticks [mattress covers]; furniture coverings of plastic; coverings of plastic for furniture; table napkins of textile; serviettes of textile; moleskin [fabric]; handkerchiefs of textile; mosquito nets; pillowcases; plastic material [substitute for fabrics]; door curtains; ramie fabric; rayon fabric; curtains of textile or plastic; face towels of textile; silk [cloth]; tulle; esparto fabric; taffeta [cloth]; knitted fabric; net curtains; zephyr [cloth]; calico; coasters of textile; tablemats of textile; non-woven textile fabrics; sleeping bag liners; cloths for removing makeup; labels of textile; wall hangings of textile; tapestry [wall hangings], of textile; fiberglass fabrics, for textile use; fibreglass fabrics for textile use; filtering materials of textile; printers' blankets of textile; chenille fabric; pillow shams; place mats of textile; bed blankets; covers for cushions; fabrics for textile use; furniture coverings of textile; fitted toilet lid covers of fabric; shower curtains of textile or plastic; diaper changing cloths for babies; blankets for household pets; sleeping bags for babies; baby buntings; sleeping bags; bed valances; crib bumpers [bed linen]; cot bumpers [bed linen]; muslin fabric; bivouac sacks being covers for sleeping bags; picnic blankets.

25 – Non-slipping devices for footwear; motorists' clothing; footwear; bath sandals; bath slippers; stockings; sweat-absorbent stockings; heelpieces for stockings; berets; overalls; smocks; boas [necklets]; caps being headwear; hosiery; boots; half-boots; tips for footwear; dress shields; braces for clothing [suspenders]; suspenders; lace boots; collars [clothing]; neck gaiters; neck tube scarves; camisoles; boxer shorts; skull caps; bodices [lingerie]; underwear; underclothing; hoods [clothing]; hat frames [skeletons]; cap peaks; belts [clothing]; shawls; dressing gowns; sweaters; pullovers; jumpers [pullovers]; chasubles; socks; sock suspenders; garters; stocking suspenders; boot

uppers; inner soles; shirts; shirt fronts; short-sleeve shirts; clothing; hats; fittings of metal for footwear; furs [clothing]; detachable collars; tights; wet suits for water-skiing; combinations [clothing]; sweat-absorbent underwear; sweat-absorbent underclothing; corselets; suits; ready-made clothing; babies' pants [underwear]; ear muffs [clothing]; neckties; footwear uppers; gaiters; breeches for wear; trousers; pants (Am.); cyclists' clothing; outerclothing; gloves [clothing]; ready-made linings [parts of clothing]; scarfs; scarves; sashes for wear; knitwear [clothing]; shirt yokes; esparto shoes or sandals; fur stoles; football shoes; football boots; top hats; gabardines [clothing]; corsets [underclothing]; girdles; galoshes; goloshes; vests; waistcoats; gaiter straps; wimples; gymnastic shoes; coats; waterproof clothing; leggings [leg warmers]; leg warmers; jerseys [clothing]; skirts; layettes [clothing]; liveries; sports jerseys; cuffs; wristbands [clothing]; aprons [clothing]; muffs [clothing]; maniples; fingerless gloves; miters [hats]; mitres [hats]; slippers; pelerines; pelisses; beach clothes; beach shoes; pockets for clothing; pajamas; pyjamas; dresses; wooden shoes; sandals; underpants; brassieres; overcoats; topcoats; heelpieces for footwear; togas; welts for footwear; uniforms; stuff jackets [clothing]; jackets [clothing]; paper clothing; veils [clothing]; bathing caps; bathing trunks; bathing drawers; bathing suits; swimsuits; bath robes; bibs, not of paper; soles for footwear; shoes; heels; sports shoes; footmuffs, not electrically heated; studs for football boots; studs for football shoes; boots for sports; headbands [clothing]; parkas; petticoats; ski boots; slips [underclothing]; teddies [underclothing]; bodies [underclothing]; bandanas [neckerchiefs]; clothing for gymnastics; clothing of imitations of leather; clothing of leather; mantillas; masquerade costumes; saris; tee-shirts; turbans; ascots; shower caps; fishing vests; money belts [clothing]; pocket squares; paper hats [clothing]; sleep masks; skorts; ponchos; sarongs; ski gloves; leggings [trousers]; jumper dresses; pinafore dresses; visors being headwear; panties; knickers; sports singlets; valenki [felted boots]; albs; ankle boots; sweat-absorbent socks; hairdressing capes; karate uniforms; judo uniforms; leotards; kimonos; bibs, sleeved, not of paper; clothing containing slimming substances; embroidered clothing; heel protectors for shoes; headwear; mittens; latex clothing; rash guards; clothing incorporating LEDs; headscarfs; headscarves; adhesive bras; adhesive brassieres; spats.

26 – Shoe fasteners; needles; shoemakers' needles; sewing needles; needles for wool combing machines; binding needles; darning needles; saddlers' needles; knitting needles; fastenings for clothing; ostrich feathers [clothing accessories]; whalebones for corsets; corset busks; hair bands; false beards; hair grips; bobby pins; hat trimmings; edgings for clothing; lace for edgings; darning lasts; buttons; snap fasteners; expanding bands for holding sleeves; brassards; arm bands [clothing accessories]; fastenings for suspenders; fas-

tenings for braces; brooches [clothing accessories]; embroidery; fancy goods [embroidery]; belt clasps; numerals or letters for marking linen; monogram tabs for marking linen; shoe hooks; shoe laces; shoe trimmings; shoe eyelets; chenille [passementerie]; decorative articles for the hair; hair curling pins; hair barrettes; hair slides; hair pins; hair nets; false hair; tresses of hair; plaited hair; numerals for marking linen; collar supports; cords for clothing; blouse fasteners; dress body fasteners; sewing boxes; sewing thimbles; crochet hooks; crochet needles; hooks [haberdashery]; zippers; zip fasteners; slide fasteners [zippers]; pin cushions; false hems; festoons [embroidery]; shuttles for making fishing nets; artificial flowers; fringes; artificial fruit; braids; tassels [haberdashery]; trimmings for clothing; artificial garlands; frills [lace-work]; woollen laces; lace trimmings; passementerie; letters for marking linen; haberdashery [dressmakers' articles], except thread; mica spangles; false moustaches; eyelets for clothing; birds' feathers [clothing accessories]; haberdashery ribbons; spangles for clothing; needle cushions; wigs; picot [lace]; heat adhesive patches for repairing textile articles; feathers [clothing accessories]; top-knots [pompoms]; skirt flounces; rosettes [haberdashery]; frills for clothing; zippers for bags; zip fasteners for bags; shoe buckles; topees; bodkins; needle cases; boxes for needles; silver embroidery; gold embroidery; elastic ribbons; cords for trimming; buckles [clothing accessories]; hooks for corsets; wreaths of artificial flowers; pins, other than jewellery; pins, other than jewelry; badges for wear, not of precious metal; heat adhesive patches for decoration of textile articles [haberdashery]; competitors' numbers; ornamental novelty badges [buttons]; bows for the hair; hair coloring caps; hair colouring caps; hook and pile fastening tapes; prize ribbons; shoulder pads for clothing; trouser clips for cyclists; tapes for curtain headings; hair curling papers; rug hooks; beads, other than for making jewelry; beads, other than for making jewellery; bobbins for retaining embroidery floss or wool [not parts of machines]; hair extensions; human hair; hair curlers, electric and non-electric, other than hand implements; appliquéés [haberdashery]; artificial plants, other than Christmas trees; sewing kits; entomological pins; embroidery needles; charms, other than for jewellery, key rings or key chains; charms, other than for jewelry, key rings or key chains; needle-threaders; artificial Christmas garlands; artificial Christmas garlands incorporating lights; artificial Christmas wreaths; artificial Christmas wreaths incorporating lights; hatbands; hat bands; ribbons for the hair; ribbons and bows, not of paper, for gift wrapping; haberdashery bows; hat pins, other than jewellery; hatpins, other than jewelry; breast lift tapes; lingerie tapes.

28 – Bladders of balls for games; artificial fishing bait; caps for pistols [toys]; toys for pets; ring games; Christmas trees of synthetic material; bows for archery; archery implements; edges of skis; swings; balls

for games; party balloons; billiard table cushions; rocking horses; batting gloves [accessories for games]; dolls' feeding bottles; stationary exercise bicycles; billiard balls; chalk for billiard cues; billiard markers; skittles; marbles for games; toys; building blocks [toys]; bob-sleighs; Christmas crackers [party novelties]; candle holders for Christmas trees; playing balls; bowling apparatus and machinery; boxing gloves; gut for rackets; golf clubs; rods for fishing; kites; kite reels; targets; bells for Christmas trees; counters [discs] for games; building games; strings for rackets; machines for physical exercises; body-building apparatus; body-training apparatus; body rehabilitation apparatus; novelty toys for parties; shin guards [sports articles]; cricket bags; hockey sticks; checkers [games]; draughts [games]; dice; chest expanders [exercisers]; exercisers [expanders]; discuses for sports; dominoes; chess games; chessboards; checkerboards; draughtboards; toy pistols; rollers for stationary exercise bicycles; landing nets for anglers; golf bags, with or without wheels; novelty toys for playing jokes; nets for sports; tennis nets; ski bindings; darts; floats for fishing; foosball tables; harpoon guns [sports articles]; gloves for games; cups for dice; bar-bells; fish hooks; rattles [playthings]; parlor games; parlour games; games; clay pigeon traps; rackets; bats for games; decoys for hunting or fishing; lures for hunting or fishing; fishing tackle; fishing lines; dolls' beds; dolls' houses; puppets; marionettes; dolls; theatrical masks; carnival masks; scale model vehicles; reels for fishing; flippers for swimming; creels [fishing traps]; swimming pools [play articles]; artificial snow for Christmas trees; quoits; roller skates; ice skates; seal skins [coverings for skis]; clay pigeons [targets]; surfboards; dolls' clothes; dolls' rooms; conjuring apparatus; skittles [games]; ninepins; gut for fishing; sole coverings for skis; skis; tables for table tennis; spinning tops [toys]; sleds [sports articles]; backgammon games; scooters [toys]; shuttlecocks; toy air pistols; percussion caps [toys]; detonating caps [toys]; ornaments for Christmas trees, except lights, candles and confectionery; Christmas tree stands; billiard cues; billiard cue tips; billiard tables; coin-operated billiard tables; surf skis; sailboards; hang gliders; apparatus for games; appliances for gymnastics; fencing weapons; fencing masks; fencing gauntlets; fencing gloves; baseball gloves; climbers' harness; elbow guards [sports articles]; knee guards [sports articles]; toy mobiles; paragliders; protective paddings [parts of sports suits]; skateboards; slides [playthings]; spring boards [sports articles]; teddy bears; waterskis; golf gloves; bite indicators [fishing tackle]; bite sensors [fishing tackle]; table-top games; fairground ride apparatus; flying discs [toys]; horseshoe games; mah-jong; plush toys; soap bubbles [toys]; toy vehicles; twirling batons; butterfly nets; bags especially designed for skis; harness for sailboards; jigsaw puzzles; masts for sailboards; paintball guns [sports apparatus]; paintballs [ammunition for paintball guns] [sports apparatus];

surfboard leashes; tennis ball throwing apparatus; starting blocks for sports; snow globes; weight lifting belts [sports articles]; bodyboards; bingo cards; divot repair tools [golf accessories]; pitch mark repair tools [golf accessories]; hunting game calls; roulette wheels; in-line roller skates; pinatas; punching bags; remote-controlled toy vehicles; rosin used by athletes; snowshoes; sling shots [sports articles]; amusement machines, automatic and coin-operated; kaleidoscopes; playing cards; confetti; electronic targets; scent lures for hunting or fishing; camouflage screens [sports articles]; men's athletic supporters [sports articles]; snowboards; scale model kits [toys]; pachinkos; ascenders [mountaineering equipment]; gaming machines for gambling; slot machines [gaming machines]; paper party hats; swimming kickboards; chips for gambling; scratch cards for playing lottery games; stuffed toys; trampolines; poles for pole vaulting; water wings; swimming belts; swimming jackets; video game machines; portable games with liquid crystal displays; arcade video game machines; controllers for game consoles; toy models; toy figures; ball pitching machines; dumb-bells; masks [playthings]; matryoshka dolls; controllers for toys; golf bag carts; golf bag trolleys; paddleboards; gyroscopes and flight stabilizers for model aircraft; joysticks for video games; protective films adapted for screens for portable games; drones [toys]; toy robots; needles for pumps for inflating balls for games; pumps specially adapted for use with balls for games; baby gyms; plush toys with attached comfort blanket; tricycles for infants [toys]; toy imitation cosmetics; swimming pool air floats; rhythmic gymnastics ribbons; party poppers [party novelties]; toy putty; toy dough; portable games and toys incorporating telecommunication functions; boomerangs; trading cards for games; waist trimmer exercise belts; flippers for diving; swimming webs; webbed gloves for swimming; inflatable games for swimming pools; roller skis; ski poles; ski sticks; ski poles for roller skis; ski sticks for roller skis; yoga swings; play tents; video game consoles; hand-held consoles for playing video games; playhouses for children; protective cups for sports; golf bag tags; skeleton sleds; bags especially designed for surfboards; fidget toys.

29 – Albumen for culinary purposes; seaweed extracts for food; gelatine; edible fats; anchovy, not live; peanut butter; butter; cocoa butter for food; coconut butter; buttercream; white of eggs; black pudding; blood sausage; bouillon; broth; preparations for making bouillon; caviar; fruit, preserved; charcuterie; potato chips; potato crisps; sauerkraut; coconut, desiccated; colza oil for food; rape oil for food; bouillon concentrates; broth concentrates; jams; frozen fruits; soups; raisins; gherkins; vegetables, preserved; vegetables, cooked; vegetables, dried; oils for food; cream [dairy products]; cheese; crystallized fruits; frosted fruits; croquettes; crustaceans, not live; dates; milk; crayfish, not live; fish fillets; rennet; fruit, stewed; fruit jellies; fruit pulp; meat; fish, not live; jellies for food; meat

jellies; game, not live; ginger jam; soya beans, preserved, for food; fatty substances for the manufacture of edible fats; fat-containing mixtures for bread slices; herrings, not live; lobsters, not live; corn oil for food; maize oil for food; palm kernel oil for food; sesame oil for food; oysters, not live; isinglass for food; ham; yolk of eggs; yogurt; yoghurt; vegetable soup preparations; vegetable juices for cooking; meat extracts; kephir; kefir; kumys; milk beverages, milk predominating; whey; milk products; spiny lobsters, not live; bacon; lentils, preserved; margarine; animal marrow for food; shellfish, not live; mussels, not live; palm oil for food; nuts, prepared; eggs; powdered eggs; liver pâté; liver pastes; onions, preserved; olives, preserved; olive oil for food; bone oil for food; pectin for culinary purposes; pickles; peas, preserved; sausages; salted meats; preparations for making soup; tomato purée; vegetable salads; lard; fruit salads; sardines, not live; salmon, not live; suet for food; tuna, not live; tomato juice for cooking; sunflower oil for food; tripe; truffles, preserved; poultry, not live; fruit peel; alginates for culinary purposes; almonds, ground; peanuts, prepared; mushrooms, preserved; coconut fat; coconut oil for food; beans, preserved; liver; fish-based foodstuffs; fruit chips; clams, not live; fruit preserved in alcohol; pollen prepared as foodstuff; prawns, not live; fish, preserved; meat, preserved; shrimps, not live; snail eggs for consumption; tofu; whipped cream; pork; edible birds' nests; fish, tinned; fish, canned; fish meal for human consumption; fruits, tinned; fruits, canned; meat, tinned; meat, canned; potato fritters; salted fish; sea-cucumbers, not live; silkworm chrysalis for human consumption; vegetables, tinned; vegetables, canned; sausages in batter; potato flakes; apple purée; cranberry compote; tahini; hummus; laver, preserved; fruit-based snack food; curd; kimchi; soya milk; milk shakes; preserved peppers; sunflower seeds, prepared; fish mousses; non-alcoholic eggnog; vegetable mousses; fish roe, prepared; seeds, prepared; aloe vera prepared for human consumption; preserved garlic; albumin milk; protein milk; linseed oil for food; flaxseed oil for food; low-fat potato chips; low-fat potato crisps; lecithin for culinary purposes; milk ferments for culinary purposes; compotes; condensed milk; smetana; fermented baked milk; soured milk; tomato paste; vegetable marrow paste; eggplant paste; aubergine paste; peanut milk for culinary purposes; almond milk for culinary purposes; rice milk; artichokes, preserved; arrangements of processed fruit; powdered milk; yakitori; bulgogi; candied nuts; flavoured nuts; flavored nuts; hazelnuts, prepared; berries, preserved; guacamole; onion rings; falafel; lemon juice for culinary purposes; freeze-dried meat; lyophilized meat; lyophilised meat; oat milk; vegetable-based cream; freeze-dried vegetables; lyophilized vegetables; lyophilised vegetables; extra virgin olive oil for food; edible ant larvae, prepared; edible insects, not live; sweet corn, processed; nut-based spreads; potato-based dumplings; hot dog sausages; corn

dogs; soya bean oil for food; milk substitutes; almond milk; peanut milk; coconut milk; coconut milk for culinary purposes; coconut milk-based beverages; rice milk for culinary purposes; almond milk-based beverages; peanut milk-based beverages; sausage casings, natural or artificial; klipfish [salted and dried cod]; cottage cheese fritters; pressed fruit paste; tofu skin; soya patties; tofu patties; tagine [prepared meat, fish or vegetable dish]; tajine [prepared meat, fish or vegetable dish]; tempeh; satay; vegetables, processed; fruit, processed; ratatouille; duck confits; andouillettes; white pudding; cassoulet; choucroute garnie; hash browns; omelets; omelettes; cabbage rolls stuffed with meat; vegetable-based concentrate for cooking; fruit-based concentrate for cooking; vegetable-based spreads; agar-agar for culinary purposes; molluscs, not live; mollusks, not live; quark; cottage cheese; lactic acid drinks; edible flowers, dried; crystallized ginger; ginger, preserved; pickled ginger.

30 – Seaweed [condiment]; pasta; almond paste; aniseed; star aniseed; confectionery for decorating Christmas trees; infusions, not medicinal; coffee flavourings; coffee flavorings; aromatic preparations for food; seasonings; unleavened bread; salt for preserving foodstuffs; rusks; cookies; biscuits; malt biscuits; peppermint sweets; candies; sweets; waffles; buns; cocoa; coffee; unroasted coffee; vegetal preparations for use as coffee substitutes; cakes; cinnamon [spice]; capers; caramels [candies]; caramels [sweets]; curry [spice]; cereal preparations; chewing gum; chicory [coffee substitute]; tea; chocolate; marzipan; cloves [spice]; condiments; confectionery; sugar confectionery; corn flakes; maize flakes; popcorn; preparations for stiffening whipped cream; ice cream; pancakes; essences for foodstuffs, except etheric essences and essential oils; cooking salt; thickening agents for cooking foodstuffs; turmeric; natural sweeteners; spices; gingerbread; allspice; flour; meal; bean meal; corn flour; corn meal; maize flour; maize meal; mustard meal; barley meal; soya flour; wheat flour; starch for food; ferments for pastes; fondants [confectionery]; petits fours; sugar; flavorings [flavourings], other than essential oils, for cakes; flavorings, other than essential oils, for cakes; flavourings, other than essential oils, for cakes; cake powder; cake dough; cake batter; ground ginger; binding agents for ice cream; ice, natural or artificial; ice for refreshment; glucose for culinary purposes; gluten prepared as foodstuff; groats for human food; vinegar; ketchup [sauce]; cocoa beverages with milk; coffee beverages with milk; chocolate beverages with milk; leaven; yeast; sausage binding materials; macarons; macaroni; corn, milled; maize, milled; corn, roasted; maize, roasted; bread; maltose; molasses for food; golden syrup; mint for confectionery; honey; husked barley; mustard; nutmegs; noodles; pies; crushed barley; sandwiches; pastilles [confectionery]; lozenges [confectionery]; pastries; petit-beurre biscuits; bread rolls; peppers [seasonings]; pizzas; pepper; potato flour; puddings; prali-

nes; ravioli; liquorice [confectionery]; rice; saffron [seasoning]; sago; sauces [condiments]; celery salt; semolina; sherbets [ices]; sorbets [ices]; spaghetti; tapioca; tapioca flour; tarts; vanilla flavourings for culinary purposes; vanilla flavorings for culinary purposes; vanillin [vanilla substitute]; vermicelli; meat pies; pâtés en croûte; meat tenderizers for household purposes; edible ices; powders for making ice cream; almond confectionery; peanut confectionery; food flavorings, other than essential oils; food flavourings, other than essential oils; flavourings, other than essential oils, for beverages; flavorings, other than essential oils, for beverages; crushed oats; husked oats; oat-based food; oat flakes; oatmeal; stick liquorice [confectionery]; beer vinegar; coffee-based beverages; cocoa-based beverages; chocolate-based beverages; artificial coffee; crystallized rock sugar; chips [cereal products]; chow-chow [condiment]; couscous; malt extract for food; malt for human consumption; propolis; bee glue; relish [condiment]; royal jelly; seawater for cooking; sushi; tomato sauce; mayonnaise; crackers; custard; fruit jellies [confectionery]; muesli; rice cakes; soya sauce; frozen yogurt [confectionery ices]; frozen yoghurt [confectionery ices]; chutneys [condiments]; spring rolls; tacos; tortillas; iced tea; tea-based beverages; dressings for salad; breadcrumbs; tabbouleh; halvah; quiches; meat gravies; miso; cereal-based snack food; rice-based snack food; hominy; hominy grits; baking powder; baking soda [bicarbonate of soda for cooking purposes]; bicarbonate of soda for cooking purposes [baking soda]; garden herbs, preserved [seasonings]; noodle-based prepared meals; cake frosting [icing]; chocolate mousses; dessert mousses [confectionery]; fruit coulis [sauces]; marinades; cheeseburgers [sandwiches]; pesto; ham glaze; linseed for culinary purposes [seasoning]; flaxseed for culinary purposes [seasoning]; wheat germ for human consumption; high-protein cereal bars; cream of tartar for culinary purposes; gluten additives for culinary purposes; pasta sauce; cereal bars; palm sugar; dough; flowers or leaves for use as tea substitutes; pastry dough; pelmeni; chocolate decorations for cakes; candy decorations for cakes; chocolate-coated nuts; rice pudding; nut flours; minced garlic [condiment]; baozi; rice pulp for culinary purposes; jiaozi; ramen; savory pancakes; savoury pancakes; savory pancake mixes; savoury pancake mixes; burritos; prepared rice rolled in seaweed; edible paper; edible rice paper; chocolate-based spreads; chocolate spreads containing nuts; flour-based dumplings; agave syrup [natural sweetener]; mirror icing [mirror glaze]; freeze-dried dishes with the main ingredient being rice; lyophilized dishes with the main ingredient being rice; lyophilised dishes with the main ingredient being rice; freeze-dried dishes with the main ingredient being pasta; lyophilized dishes with the main ingredient being pasta; lyophilised dishes with the main ingredient being pasta; chamomile-based beverages; dulce de leche; bibimbap [rice mixed with vegetables and be-

ef]; onigiri; instant rice; hot dog sandwiches; ice cubes; processed seeds for use as a seasoning; sesame seeds [seasonings]; piccalilli; quinoa, processed; bulgur; buckwheat, processed; buckwheat flour; cranberry sauce [condiment]; apple sauce [condiment]; croûtons; croutons; potato-based flatbreads; fruit confectionery; rice crackers; kimchi pancakes; shaved ice with sweetened red beans; mints for breath freshening; chewing gum for breath freshening; udon noodles; soba noodles; gluten-free bread; tamarind [condiment]; laksa; profiteroles; croissants; chocolaines; pains au chocolat; kelp tea; crème brûlée; batter mixes; edible paper wafers; coconut macaroons; coffee capsules, filled; orange blossom water for culinary purposes; ice pops; nougat; harissa [condiment]; ginger paste [seasoning]; tea beverages with milk.

31 – Citrus fruit, fresh; algae, unprocessed, for human or animal consumption; seaweed, unprocessed, for human or animal consumption; nuts, unprocessed; menagerie animals; live animals; animal foodstuffs; trees; Christmas trees; trunks of trees; shrubs; bushes; oats; berries, fresh; salt for cattle; beet, fresh; bran; unsawn timber; wood chips for the manufacture of wood pulp; undressed timber; cocoa beans, raw; sugarcane; locust beans, raw; cereal seeds, unprocessed; mushrooms, fresh; mushroom spawn for propagation; oil cake; cattle cake; chestnuts, fresh; lime for animal forage; chicory roots; chicory, fresh; dog biscuits; lemons, fresh; coconut shell; coconuts; bird food; rape cake for cattle; cucumbers, fresh; hop cones; bran mash for animal consumption; copra; shellfish, live; vegetables, fresh; squashes, fresh; wreaths of natural flowers; eggs for hatching, fertilised; eggs for hatching, fertilized; straw mulch; distillery waste for animal consumption; draff; bred stock; animal fattening preparations; livestock fattening preparations; rice meal for forage; beans, fresh; flowers, natural; flowers, dried, for decoration; pollen [raw material]; hay; strengthening animal forage; fodder; cattle food; forage; wheat; fruit, fresh; turf, natural; sod; juniper berries; seed germ for botanical purposes; grains [cereals]; grains for animal consumption; seeds for planting; plant seeds; groats for poultry; garden herbs, fresh; plants; seedlings; hops; kola nuts; cola nuts; lettuce, fresh; lentils, fresh; yeast for animal consumption; rough cork; flax meal [fodder]; litter for animals; litter peat; maize; maize cake for cattle; malt for brewing and distilling; fruit residue [marc]; marc; hazelnuts, fresh; meal for animals; fish spawn; silkworm eggs; flower bulbs; bulbs; onions, fresh; olives, fresh; oranges, fresh; barley; nettles; cuttle bone for birds; straw litter; straw [forage]; palms [leaves of the palm tree]; palm trees; mash for fattening livestock; fish, live; vine plants; pine cones; peppers [plants]; plants, dried, for decoration; leeks, fresh; peas, fresh; potatoes, fresh; preparations for egg laying poultry; stall food for animals; roots for animal consumption; grapes, fresh; rhubarb, fresh; rose bushes; rye; silkworms; edible sesame, unprocessed; truffles, fresh; residue in

a still after distillation; poultry, live; algarovilla for animal consumption; almonds [fruits]; peanuts, fresh; peanut meal for animals; peanut cake for animals; by-products of the processing of cereals, for animal consumption; residual products of cereals for animal consumption; bagasses of cane [raw material]; fishing bait, live; crayfish, live; crustaceans, live; lobsters, live; mussels, live; oysters, live; pet food; raw barks; spiny lobsters, live; edible chews for animals; beverages for pets; fish meal for animal consumption; rice, unprocessed; sea-cucumbers, live; sanded paper [litter] for pets; aromatic sand [litter] for pets; aloe vera plants; spinach, fresh; linseed for animal consumption; flaxseed for animal consumption; linseed meal for animal consumption; flaxseed meal for animal consumption; wheat germ for animal consumption; artichokes, fresh; herrings, live; salmon, live; sardines, live; tuna, live; garlic, fresh; vegetable marrows, fresh; edible linseed, unprocessed; edible flaxseed, unprocessed; arrangements of fresh fruit; anchovy, live; edible insects, live; unprocessed sweet corn ears [husked or unhusked]; quinoa, unprocessed; buckwheat, unprocessed; koi carp, live; molluscs, live; mollusks, live; freeze-dried fishing bait; edible flowers, fresh; ginger, fresh; soya beans, fresh; cannabis plants; cannabis, unprocessed.

32 – Non-alcoholic fruit extracts; beer; ginger beer; ginger ale; malt beer; beer wort; non-alcoholic fruit juice beverages; whey beverages; non-alcoholic preparations for making beverages; non-alcoholic essences for making beverages; fruit juices; fruit juice; syrups for beverages; waters [beverages]; preparations for making aerated water; preparations for making carbonated water; lithia water; mineral water [beverages]; seltzer water; table waters; must; lemonades; extracts of hops for making beer; vegetable juices [beverages]; syrups for lemonade; malt wort; grape must, unfermented; orgeat; soda water; sherbets [beverages]; sorbets [beverages]; tomato juice [beverage]; non-alcoholic beverages; pastilles for effervescing beverages; powders for effervescing beverages; aerated water; carbonated water; sarsaparilla [non-alcoholic beverage]; aperitifs, non-alcoholic; cocktails, non-alcoholic; fruit nectars, non-alcoholic; isotonic beverages; cider, non-alcoholic; kvass; non-alcoholic honey-based beverages; smoothies; aloe vera drinks, non-alcoholic; beer-based cocktails; soya-based beverages, other than milk substitutes; protein-enriched sports beverages; rice-based beverages, other than milk substitutes; non-alcoholic beverages flavoured with coffee; non-alcoholic beverages flavored with coffee; non-alcoholic beverages flavoured with tea; non-alcoholic beverages flavored with tea; soft drinks; barley wine [beer]; energy drinks; non-alcoholic dried fruit beverages; shandy.

35 – Business management assistance; business inquiries; bill-posting; import-export agency services; commercial information agency services; cost price ana-

lysis; dissemination of advertising matter; photocopying services; employment agency services; office machines and equipment rental; book-keeping; accounting; drawing up of statements of accounts; business auditing; business management and organization consultancy; personnel management consultancy; business management consultancy; typing; demonstration of goods; direct mail advertising; commercial or industrial management assistance; updating of advertising material; distribution of samples; business efficiency expert services; auctioneering; market studies; business appraisals; business investigations; publicity material rental; business organization consultancy; publication of publicity texts; advertising; publicity; radio advertising; business research; public relations; shorthand; television advertising; transcription of communications [office functions]; shop window dressing; advertising agency services; publicity agencies; advisory services for business management; modelling for advertising or sales promotion; marketing research; computerized file management; professional business consultancy; economic forecasting; organization of exhibitions for commercial or advertising purposes; providing business information; opinion polling; payroll preparation; personnel recruitment; administrative services for the relocation of businesses; rental of advertising space; sales promotion for others; secretarial services; tax preparation; telephone answering for unavailable subscribers; word processing; arranging newspaper subscriptions for others; advertising by mail order; business management of hotels; business management of performing artists; compilation of information into computer databases; systemization of information into computer databases; organization of trade fairs; rental of photocopying machines; online advertising on a computer network; procurement services for others [purchasing goods and services for other businesses]; data search in computer files for others; rental of advertising time on communication media; news clipping services; rental of vending machines; psychological testing for the selection of personnel; price comparison services; presentation of goods on communication media, for retail purposes; providing commercial information and advice for consumers in the choice of products and services; arranging subscriptions to telecommunication services for others; administrative processing of purchase orders; commercial administration of the licensing of the goods and services of others; outsourcing services [business assistance]; invoicing; writing of publicity texts; compilation of statistics; layout services for advertising purposes; sponsorship search; organization of fashion shows for promotional purposes; production of advertising films; business management of sports people; marketing; telemarketing services; retail services for pharmaceutical, veterinary and sanitary preparations and medical supplies; rental of sales stands; providing commercial and business contact information; search engine optimization for sales pro-

motion; search engine optimisation for sales promotion; website traffic optimization; website traffic optimisation; pay per click advertising; commercial intermediation services; business management for freelance service providers; negotiation and conclusion of commercial transactions for third parties; updating and maintenance of data in computer databases; business project management services for construction projects; providing business information via a website; provision of an online marketplace for buyers and sellers of goods and services; development of advertising concepts; outsourced administrative management for companies; tax filing services; business management of reimbursement programs for others; business management of reimbursement programmes for others; rental of billboards [advertising boards]; writing of résumés for others; writing of curriculum vitae for others; web indexing for commercial or advertising purposes; administration of frequent flyer programs; appointment scheduling services [office functions]; appointment reminder services [office functions]; administration of consumer loyalty programs; scriptwriting for advertising purposes; registration of written communications and data; updating and maintenance of information in registries; compiling indexes of information for commercial or advertising purposes; business intermediary services relating to the matching of potential private investors with entrepreneurs needing funding; production of teleshopping programmes; production of teleshopping programs; consultancy regarding public relations communication strategies; consultancy regarding advertising communication strategies; negotiation of business contracts for others; promotion of goods and services through sponsorship of sports events; competitive intelligence services; market intelligence services; financial auditing; online retail services for downloadable digital music; online retail services for downloadable ring tones; online retail services for downloadable and pre-recorded music and movies; wholesale services for pharmaceutical, veterinary and sanitary preparations and medical supplies; gift registry services; targeted marketing; interim business management; outdoor advertising; retail services for works of art provided by art galleries; administrative assistance in responding to calls for tenders; administrative assistance in responding to requests for proposals [RFPs]; marketing in the framework of software publishing; media relations services; corporate communications services; rental of office equipment in co-working facilities; commercial lobbying services; providing user reviews for commercial or advertising purposes; providing user rankings for commercial or advertising purposes; providing user ratings for commercial or advertising purposes; telephone switchboard services; retail services relating to bakery products; consumer profiling for commercial or marketing purposes; administrative services for medical referrals.

39 – Escorting of travellers; water supplying; air transport; ambulance transport; vehicle breakdown towing services; car rental; car transport; bus transport; pleasure boat transport; boat rental; ice-breaking; hauling; salvage of ships; lighterage services; carting; railway transport; horse rental; parcel delivery; portage; packaging of goods; shipbrokerage; arranging of cruises; transport services for sightseeing tours; unloading cargo; delivery of goods; storage of goods; water distribution; electricity distribution; operating canal locks; car parking; storage; warehousing; rental of warehouses; ferry-boat transport; river transport; freight [shipping of goods]; freighting; garage rental; transport by pipeline; parking place rental; refrigerator rental; frozen-food locker rental; vehicle rental; railway coach rental; railway truck rental; transporting furniture; transport; boat transport; arranging of transportation for travel tours; passenger transport; piloting; towing; refloating of ships; booking of seats for travel; salvaging; taxi transport; streetcar transport; tram transport; freight forwarding; marine transport; armored-car transport; armoured-car transport; transport of travellers; transport and storage of trash; transport and storage of waste; removal services; boat storage; freight brokerage [forwarding (Am.)]; freight brokerage; transport brokerage; chauffeur services; courier services [messages or merchandise]; providing information relating to storage services; providing transportation information; rental of diving bells; rental of diving suits; rental of storage containers; rental of vehicle roof racks; rescue operations [transport]; transport reservation; travel reservation; underwater salvage; wrapping of goods; message delivery; delivery of newspapers; newspaper delivery; delivery of goods by mail order; distribution of energy; rental of motor racing cars; rental of wheelchairs; stevedoring; physical storage of electronically stored data or documents; launching of satellites for others; flower delivery; franking of mail; providing traffic information; rental of freezers; bottling services; transportation logistics; aircraft rental; barge transport; motor coach rental; rental of aircraft engines; guarded transport of valuables; rental of navigational systems; providing driving directions for travel purposes; gift wrapping; rental of tractors; collection of recyclable goods [transport]; rental of electric wine cellars; cash replenishment of automated teller machines; car sharing services; replenishment of vending machines; luggage storage; arranging of passenger transportation services for others via an online application; piloting of civilian drones; arranging for travel visas and travel documents for persons travelling abroad; carpooling services.

41 – Academies [education]; amusement park services; entertainment services; animal training; rental of cinematographic apparatus; entertainer services; movie studio services; presentation of circus performances; organization of competitions [education or entertainment]; correspondence courses; physical education;

on; rental of show scenery; providing recreation facilities; radio entertainment; publication of texts, other than publicity texts; teaching; educational services; instruction services; rental of sound recordings; rental of motion pictures; film production, other than advertising films; gymnastic instruction; lending library services; publication of books; rental of radio and television sets; production of radio and television programmes; presentation of variety shows; orchestra services; theatre productions; production of shows; television entertainment; rental of stage scenery; zoological garden services; providing sports facilities; modelling for artists; mobile library services; bookmobile services; providing casino facilities [gambling]; club services [entertainment or education]; arranging and conducting of colloquiums; arranging and conducting of conferences; arranging and conducting of congresses; discotheque services; providing information in the field of education; educational examination; providing information in the field of entertainment; organization of exhibitions for cultural or educational purposes; gambling services; providing golf facilities; health club services [health and fitness training]; holiday camp services [entertainment]; presentation of live performances; cinema presentations; movie theatre presentations; nursery schools; organization of sports competitions; party planning [entertainment]; practical training [demonstration]; providing museum facilities [presentation, exhibitions]; recording studio services; providing information relating to recreational activities; rental of skin diving equipment; rental of sports equipment, except vehicles; rental of stadium facilities; rental of video cassette recorders; rental of videotapes; arranging and conducting of seminars; sport camp services; arranging and conducting of symposiums; timing of sports events; boarding school education; arranging and conducting of workshops [training]; arranging of beauty contests; booking of seats for shows; dubbing; religious education; organization of lotteries; organization of balls; organization of shows [impresario services]; providing amusement arcade services; rental of audio equipment; rental of lighting apparatus for theatrical sets or television studios; rental of tennis courts; rental of video cameras; rental of camcorders; scriptwriting, other than for advertising purposes; videotape editing; online publication of electronic books and journals; electronic desktop publishing; subtitling; game services provided online from a computer network; karaoke services; music composition services; nightclub services [entertainment]; providing online electronic publications, not downloadable; photographic reporting; photography; vocational guidance [education or training advice]; news reporters services; translation; sign language interpretation; videotaping; microfilming; ticket agency services [entertainment]; writing of texts; arranging and conducting of concerts; calligraphy services; layout services, other than for advertising purposes; organization of fashion shows for entertainment

purposes; coaching [training]; rental of sports grounds; disc jockey services; language interpretation; personal trainer services [fitness training]; conducting fitness classes; vocational retraining; production of music; toy rental; games equipment rental; educational services provided by schools; providing online music, not downloadable; providing online videos, not downloadable; tutoring; arranging and conducting of in-person educational forums; songwriting; screenplay writing; conducting guided tours; training services provided via simulators; providing films, not downloadable, via video-on-demand services; providing television programmes, not downloadable, via video-on-demand services; providing television programs, not downloadable, via video-on-demand services; sado instruction [tea ceremony instruction]; aikido instruction; rental of artwork; rental of indoor aquaria; conducting guided climbing tours; organization of cosplay entertainment events; cultural, educational or entertainment services provided by art galleries; film distribution; know-how transfer [training]; educational services provided by special needs assistants; judo instruction; educational examination for users to qualify to pilot drones; sound engineering services for events; video editing services for events; lighting technician services for events; film directing, other than advertising films; providing user reviews for entertainment or cultural purposes; providing user rankings for entertainment or cultural purposes; providing user ratings for entertainment or cultural purposes; rental of training simulators; physical fitness assessment services for training purposes; face painting.

43 – Accommodation bureau services [hotels, boarding houses]; food and drink catering; retirement home services; café services; cafeteria services; providing campground facilities; canteen services; rental of temporary accommodation; boarding house services; tourist home services; hotel services; day-nursery [crèche] services; restaurant services; boarding house bookings; hotel reservations; self-service restaurant services; snack-bar services; boarding for animals; bar services; holiday camp services [lodging]; rental of transportable buildings; temporary accommodation reservations; motel services; rental of chairs, tables, table linen, glassware; rental of meeting rooms; rental of tents; rental of cooking apparatus; rental of drinking water dispensers; rental of lighting apparatus; food sculpting; reception services for temporary accommodation [management of arrivals and departures]; washoku restaurant services; udon and soba restaurant services; decorating of food; cake decorating; information and advice in relation to the preparation of meals; personal chef services; hookah lounge services.

44 – Animal breeding; landscape gardening; public bath services for hygiene purposes; Turkish bath services; beauty salon services; medical clinic services; chiropractic; hairdressing; wreath making; convales-

cent home services; hospital services; health care; horticulture; gardening; farming equipment rental; massage; medical assistance; opticians' services; plant nursery services; physical therapy; physiotherapy; sanatorium services; veterinary assistance; dentistry services; nursing home services; aerial and surface spreading of fertilizers and other agricultural chemicals; aerial and surface spreading of fertilisers and other agricultural chemicals; animal grooming; blood bank services; flower arranging; hospice services; lawn care; manicuring; midwife services; nursing, medical; pharmacy advice; plastic surgery; tree surgery; vermin exterminating for agriculture, aquaculture, horticulture and forestry; weed killing; pet grooming; hair implantation; services of a psychologist; rental of sanitary installations; aromatherapy services; artificial insemination services; rehabilitation for substance abuse patients; in vitro fertilization services; in vitro fertilisation services; tattooing; telemedicine services; landscape design; sauna services; solarium services; health spa services; visagists' services; preparation of prescriptions by pharmacists; therapy services; tree planting for carbon offsetting purposes; aquaculture services; medical equipment rental; health center services; health centres; alternative medicine services; speech therapy; health counselling; health counseling; depilatory waxing; orthodontic services; medical advice for individuals with disabilities; body piercing; reforestation services; palliative care; rest home services; pest control services for agriculture, aquaculture, horticulture and forestry; human tissue bank services; rental of animals for gardening purposes; rental of beehives; animal-assisted therapy; medical analysis services for diagnostic and treatment purposes provided by medical laboratories; medical screening; viticulture services; consultancy in the field of viticulture; home-visit nursing care; rental of hair styling apparatus; cultivation of plants; dietary and nutritional advice; rental of surgical robots.

45 – Personal bodyguarding; escorting in society [chaperoning]; chaperoning; detective agency services; dating services; night guard services; opening of security locks; evening dress rental; crematorium services; missing person investigations; burial services; funerary undertaking; clothing rental; guard services; marriage agency services; physical security consultancy; horoscope casting; fire-fighting; organization of religious meetings; adoption agency services; monitoring of burglar and security alarms; babysitting; security screening of baggage; house sitting; pet sitting; personal background investigations; lost property return; mediation; inspection of factories for safety purposes; rental of fire alarms; rental of fire extinguishers; arbitration services; intellectual property consultancy; copyright management; licensing of intellectual property; monitoring intellectual property rights for legal advisory purposes; legal research; litigation services; licensing of computer software [legal services]; registration of domain names [legal services]; alterna-

tive dispute resolution services; rental of safes; genealogical research; planning and arranging of wedding ceremonies; online social networking services; releasing doves for special occasions; embalming services; legal document preparation services; tracking of stolen property; legal administration of licences; astrology consultancy; spiritual consultancy; cartomancy services; personal wardrobe styling consultancy; personal letter writing; conducting funeral ceremonies; legal services in relation to the negotiation of contracts for others; conducting religious ceremonies; dog walking services; leasing of internet domain names; kimono dressing assistance; legal advice in responding to calls for tenders; legal advice in responding to requests for proposals [RFPs]; licensing [legal services] in the framework of software publishing; legal watching services; organization of political meetings; legal consultancy relating to patent mapping; legal advocacy services; concierge services; bereavement counseling; bereavement counselling; lifeguard services; legal services in the field of immigration; tarot card reading services for others; regulatory compliance auditing; legal compliance auditing.

(260) AM 2022 115042 A
 (800) 1620016
 (151) 2021 06 23
 (891) 2021 06 23
 (731) Centravo AG
 Industriering 8, CH-3250 Lyss, Switzerland
 (540)



(591) Black, white
 (531) 27.05.10
 (511)
 5 – Pharmaceutical and veterinary products; hygienic products for medicine; dietetic substances and food-stuffs for medical or veterinary use, food for babies; food supplements for humans and animals; plasters, materials for dressings; material for dental fillings and dental impressions; disinfectants; products for destroying vermin; fungicides, herbicides; all the aforesaid goods of Swiss origin.

(260) AM 2022 115044 A
 (800) 1620078
 (151) 2021 07 13
 (891) 2021 07 13
 (731) THZ (M) SDN BHD
 D-8-2, PUSAT PERNIAGAAN BUKIT
 SERDANG, JALAN BS 14, TAMAN BUKIT
 SERDANG, 43300 SERI KEMBANGAN,
 SELANGOR, Malaysia

(540)



(591) Black, white
 (531) 26.04.03; 26.13.25
 (526) THz
 (511)
 11 – Heating apparatus, electric; heating boilers; heating elements; heating installations; hot water heating installations; heating plates; humidifiers; kettles, electric; water filtering apparatus; water purification installations; water purifying apparatus and machines; water softening apparatus and installations; water sterilisers; water supply installations.

(260) AM 2022 115047 A
 (800) 1620276
 (151) 2021 08 05
 (891) 2021 08 05
 (731) Shenzhen Tomore Electronic Technology Co., Ltd
 2502, Venture Capital Bldg, No.9 Tengfei Rd., Huanggepeng Community, Longcheng St., Longgang Dist., Shenzhen. Guangdong, China
 (540)



(591) Black, white
 (531) 26.01.03; 26.01.24; 26.11.01; 26.11.12; 27.05.01; 27.05.09; 27.05.19
 (511)
 10 – Hearing aids; ear trumpets; ear plugs [ear protection devices]; medical apparatus and instruments; dental apparatus and instruments; physiotherapy apparatus; walking sticks for medical purposes; suture materials; hearing protectors.

(260) AM 2022 115048 A
 (800) 1620293
 (151) 2021 09 07
 (891) 2021 09 07
 (731) Alcon Inc.
 Rue Louis-d'Affry 6, CH-1701 Fribourg,
 Switzerland
 (540)



(591) Black, white

(511)
10 – Surgical apparatus and instruments for ophthalmic surgery.

(260) AM 2022 115049 A

(800) 1620331

(151) 2021 06 30

(891) 2021 06 30

(731) Yangtze Memory Technologies Co., Ltd.
No.88 Weilai 3rd Road, East Lake High-tech
Development Zone, Wuhan, Hubei, China

(540)

YMTC

(591) Black, white

(531) 27.05.01

(511)

9 – Alarms; locks, electric; batteries, electric; solar batteries; microscopes; counters; cameras [photography]; detectors; regulating apparatus, electric; lightning conductors; holders for electric coils; electronic tags for goods; telephone apparatus; electronic surveillance apparatus; computers; data processing apparatus; computer memory devices; computer programs, recorded; magnetic identification cards with embedded chips; microprocessors; monitors [computer hardware]; central processing units; integrated circuit cards; usb flash drives; integrated circuits; semi-conductors; microchip cards; memory cards; electronic memories; semi-conductor memory units; smart cards [integrated circuit cards]; electronic semi-conductors; computer chips; transistors; electronic integrated circuits; multi-processor chips; microchips [computer hardware]; high definition graphic chipsets; electronic chips for the manufacture of integrated circuits; chips [integrated circuits]; wafers for integrated circuits; solid state drives; exposed films; decorative refrigerator magnets; decorative magnets; counterfeit coin detectors; voting machines; photocopiers [photographic, electrostatic, thermic]; weighing machines; measures; electronic notice boards; materials for electricity mains [wires, cables]; optical fibres [light conducting filaments]; heat regulating apparatus; fire extinguishing apparatus; radiological apparatus for industrial purposes; electrolyzers; protection devices for personal use against accidents; spectacles; velocity sensors; video screens; remote control apparatus; rechargeable batteries; car video recorders; virtual reality headsets; electronic book readers; photographic viewfinders; digital weather stations; speed checking apparatus for vehicles; connected bracelets [measuring instruments]; biochips; inductors [electricity]; simulators for the steering and control of vehicles; stereoscopes.

35 – Advertising; commercial information agency services; marketing; personnel management; rental of office machinery and equipment; updating and maintenance of data in computer databases; accounting

services; rental of vending machines; sponsorship search; rental of sales stands; retail services for pharmaceutical, veterinary and sanitary preparations and medical supplies.

42 – Technological research; research and development of new products for others; conducting technical project studies; scientific laboratory services; scientific research; chemical research; material testing; industrial design; information technology [IT] consultancy; technical writing; quality control; geological research; biological research and analysis; providing meteorological information; architectural services; dress designing; authenticating works of art; graphic arts design; cloud seeding; handwriting analysis [graphology]; cartography services; rental of meters for the recording of energy consumption.

(260) AM 2022 115050 A

(800) 1620422

(151) 2021 08 06

(891) 2021 08 06

(731) Ningbo Yinke Intelligent Technology Co., Ltd.
2F-1, Building 1-01, No. 28 Yantanghe Road,
Daqi Street, Beilun District, Ningbo, Zhejiang,
China

(540)

YINKE

(591) Black, white

(531) 27.05.01

(511)

12 – Push scooters [vehicles]; self-balancing boards; self balancing electric scooters; electrically powered scooters [vehicles]; trolleys; safety seats for children, for vehicles; mobility scooters; electric tricycles; electric bicycles; folding electric bicycles; mopeds; folding bicycles.

(260) AM 2022 115052 A

(800) 1620449

(151) 2021 09 02

(891) 2021 09 02

(731) Bayer Consumer Care AG
Peter Merian Str. 84, CH-4052 Basel,
Switzerland

(540)



(591) Green, blue, yellow and gray
(531) 01.13.01; 01.13.15; 05.03.13; 29.01.14
(511)

5 – Pharmaceutical preparations; food and dietetic supplements; hygienic products for medical use; dietetic foods for medical use; dietetic substances for medical use; dietary fibers; formulations with probiotic bacteria for medicinal purposes; dietetic food supplements; nutritional supplements.

(260) AM 2022 115053 A

(800) 1620497

(151) 2021 06 04

(891) 2021 06 04

(731) Breville Pty Limited

Ground Floor, Suite 2, 170-180 Bourke Road,
Alexandria NSW 2015, Australia

(540)

beanz

(591) Black, white
(531) 05.07.27; 27.05.01; 27.05.04; 27.05.17
(526) BEANS
(511)

35 – On-line services, namely, ordering and inventory monitoring for coffee, coffee machines, espresso, the sale of espresso coffee machine sales, coffee machines as a service, providing coffee machine subscription, providing spare parts subscription, spare parts for coffee machines and espresso coffee machines, and the sale of spare parts for coffee machines and espresso coffee machines; administrative processing of purchase orders; administrative processing of commercial orders in the field of coffee, coffee machines, espresso, espresso machines via a website; provision of an on-line marketplace for buyers and sellers of goods and services; provision of an on-line marketplace for buyers and sellers of coffee, coffee machines, espresso, espresso machines; retail on-line ordering services featuring coffee, coffee machines, espresso, espresso machines, also accessible by telephone, facsimile and mail order; subscription-based order fulfillment services in the field of coffee, coffee machines, espresso, espresso machines; wholesale ordering services in the field of coffee, coffee machines, espresso, espresso machines; on-line wholesale and retail store services featuring downloadable sound, music, image, video and game files.

(260) AM 2022 115054 A

(800) 1620580

(151) 2021 06 01

(891) 2021 06 01

(731) MATRIZE Handels-GmbH

Alter Fischmarkt 11, 20457 Hamburg, Germany

(540)



(591) DARK GREEN

(531) 05.01.01; 05.01.05; 05.01.16; 28.05; 29.01.03
(511)

8 – Tool belts [holders]; waistcoats for holding hand tools and instruments; cases for hand tools and instruments; belts for hand instruments bags; belts for hand instrument cases; wall mounted holders for hand tools and instruments; covers for hand tools and instruments.

12 – Luggage elastic rubber cords for vehicles; luggage straps for vehicles; trunk organizers (vehicle organizers); mechanics' creepers.

18 – Bags; tool bags, empty; shopping bags; wheeled shopping bags; backpacks; business cases.

22 – Braces, not of metal, for handling loads; straps, not of metal, for handling loads; slings, not of metal, for handling loads; strapping for securing loads; cables, not of metal; tie-down straps, not of metal; cord; ropes; string.

25 – Footwear for household, building or repair purposes, including boots, high boots, sandals, galoshes; clothing for household, building or repair purposes, including combinations, jackets, trousers, gloves, waistcoats.

(260) AM 2022 115055 A

(800) 1620619

(151) 2021 07 17

(891) 2021 07 17

(731) Dongguan Dior Leather Co., Ltd.

Room 101, No.2 Xisha Road, Shijie Town,
Dongguan City, 523000 Guangdong Province,
China

(540)



(591) Black, white

(531) 03.01.06; 03.01.16; 03.01.24

(511)

14 – Watches; brooches [jewellery, jewelry (am.)]; chains [jewellery, jewelry (am.)]; jewelry; tie clips; jewelry cases [caskets]; clocks.

18 – Pocket wallets; school bags; backpacks; hand-bags; briefcases; bags for sports; travelling sets [leatherware]; shopping bags; umbrellas.

25 – Clothing; gloves [clothing]; underwear; shoes; headgear for wear; hosiery; neckties; scarfs; girdles.

(260) AM 2022 115057 A

(800) 1620769

(151) 2021 06 10

(891) 2021 06 10

(731) Bettina Springer

Wolfshagener Str. 73, 13187 Berlin, Germany

(540)

[fi-ne]

(591) Black, white

(531) 24.17.01; 24.17.25; 27.05.01

(511)

3 – Cosmetics, toiletries.

(260) AM 2022 115058 A

(800) 1620813

(151) 2021 07 12

(891) 2021 07 12

(731) AARUY Medical Electronics Co., Ltd.

10D-1, Building 4, Block 2, Dachong Business Center (Phase 1), No. 9672 Shennan Avenue, Dachong Community, Yuehai Street, Nanshan District, Shenzhen, China

(540)

aaruy

(591) Black, white

(531) 27.05.01

(511)

10 – Pumps for medical purposes; blood testing apparatus; hematimeters; medical apparatus and instruments; cases fitted for medical instruments; arterial blood pressure measuring apparatus; apparatus for artificial respiration; apparatus for use in medical analysis; spirometers [medical apparatus]; thermometers for medical purposes; dialyzers; pulse meters; temperature indicator labels for medical purposes; respiratory masks for artificial respiration; body fat monitors; body composition monitors; insulin pumps; stethoscopes; trocars; catheters; electrocardiographs; syringes for medical purposes; cannulae; heart rate monitoring apparatus; droppers for medical purposes; syringes for injections; drainage tubes for medical purposes; drop-per bottles for medical purposes; hypodermic syringes; inhalers; injectors for medical purposes; aerosol dispensers for medical purposes; appliances for washing body cavities; implantable subcutaneous drug delivery devices.

(260) AM 2022 115059 A

(800) 1620819

(151) 2021 06 22

(891) 2021 06 22

(731) EYFEL KOZMETIK ANONIM SIRKETI

ORTA MAH. 30 AGUSTOS CAD., NO:53/1

Tuzla, İstanbul, Turkey

(540)

BIGHILL

(591) Black, white

(511)

3 – Perfumery; non-medicated cosmetics; fragrances; deodorants for personal use and animals; soaps.

5 – Deodorants, other than for human beings or for animals; air purifying preparations; air deodorising preparations.

35 – The bringing together, for the benefit of others, of a variety of goods, namely, perfumery, non-medicated cosmetics, fragrances, deodorants for personal use and animals, soaps, deodorants, other than for human beings or for animal, air purifying preparations, air deodorising preparations, perfume burners, perfume sprayers, perfume vaporizers, enabling customers to conveniently view and purchase those goods, such services may be provided by retail stores, wholesale outlets, by means of electronic media or through mail order catalogues.

(260) AM 2022 115060 A

(800) 1620898

(151) 2021 05 06

(891) 2021 05 06

(731) ITM ENTREPRISES

24 rue Auguste Chabrières, F-75015 PARIS, France

(540)

NID D'ANGE

(591) Black, white

(511)

3 – Cosmetics; Cosmetic products and preparations; cosmetic creams and lotions; tissues and wipes impregnated with cosmetic lotions and solutions; beauty masks; make-up removing products; dermatological soaps; milks for cosmetic use; oils for cosmetic use; sun protection products, namely, sun lotions, sun creams, sunscreens; cosmetic bath products and preparations (non-medicinal); cotton sticks for cosmetic use; dentifrices; water for cosmetic use; cleansing solutions for cosmetic use; soaps; shampoos; cosmetic products and preparations for the care of the scalp; hair lotions; hand creams and soaps; skin tonics; shower gels; body and hair wash solution; bubble bath; skin protection for non-medical use; scented products for the shower, especially gels; non-medical toiletry products and preparations for babies; alcohol-free water for baby toiletries; non-medicinal baby skin care

products especially shampoos, conditioners, sunblock creams, creams, oils and soaps for the face and body; toiletries for babies; creams and ointments for changing diapers; cosmetic products and preparations for pregnant women and young mothers, namely, skin, body, face and hair lotions, oils and creams; cosmetic products and preparations for breast beauty for pregnant women and young mothers; cosmetic products and preparations against stretch marks, heavy legs, pregnancy blemishes, chloasma gravidarum for pregnant women and young mothers; cosmetic products and preparations for slimming and body firmness for young mothers; micellar water; baby powders (toiletries); talcum powder for toilet use.

5 – Diapers; diaper-pants; training pants; babies' diapers of textile; breast-nursing pads; disposable diaper changing mats for babies; absorbent pants for incontinence; disposable swim diapers and pants for babies; reusable swim diapers for babies; diaper liners; under-pants for sanitary use; diaper rash ointments and creams; food for babies; hygienic products for medical use; compresses and cotton for medical use; antiseptic cotton; sunburn ointments; bandages for dressings; adhesive bands for medical use; candy for pharmaceutical use; nutritional supplements for medical use; hemostatic pencils; insect repellents; parasiticides; filled first-aid boxes; solvents for removing adhesive plasters; adhesive plaster; cold sterilization tablets for feeding bottles; decongestant nasal sprays; deodorants; food for infants; lacteal flour for babies; medicated oils for babies; powdered milk for babies; antibacterial hand lotions; panty liners (sanitary articles); underpants for attaching menstruation towels; sanitary towels; postnatal sanitary towels; sanitary panties; sanitary tampons; menstrual pants; postnatal pants; pharmaceutical preparations for skin moisturizing; pharmaceutical preparations for preventing skin blemishes during pregnancy; Pharmaceutical preparations stretch mark prevention; tissues and wipes impregnated with pharmaceutical lotions and creams; cleansing solutions for medical use; physiological serums; preparations to facilitate teething; liniment (hygienic product for medical use).

10 – Feeding bottles; feeding bottle valves; feeding bottle teats; babies' pacifiers (teats); nipple pacifier clips; teething rings; spoons and feeding bottles for medicines; maternity belts; breast pumps; baby nose-cleaners; thermometers for medical use; umbilical netting; umbilical tapes; orthopedic articles; draw-sheets for sick beds; cushions for medical use; baby changing mats for medical use; syringes for medicine; nipple shields of silicon for breast feeding; menstrual cups.

18 – Baby carriers; baby-changing bags; diaper bags for babies; slings for carrying infants.

21 – Brushes; combs.

24 – Fabrics for textile use; fabrics forming bed surrounds; adornments for baby carriages and beds; sheets; bath sheets; washing mitts; table napkins of textile; bed blankets; baby blankets; pillowcases; mattress fabrics; mosquito nets; bed covers; duvet covers; bed footboards (textile); bed canopies (textile); cradle adornments; children's sleeping bags [bunting bags]; diaper changing cloths for babies; fabrics for making diapers for babies; face towels; hooded bath towels; make-up removal tissues of textile; beach towels; cot bumpers [bed linen]; place mats of textile material.

25 – Clothing, footwear, headgear; underwear; clothing, footwear, headwear and underwear for pregnant women and for babies; clothing, footwear, headwear for infants; bodysuits; crop tops; creepers; layettes [clothing]; stocking caps; swimming costumes and trunks; bibs not made of paper; maternity briefs; gloves (clothing); headbands; belts.

28 – Games; toys; gymnastic and sporting articles; swimming jackets; plush toys; plush toys with attached comfort blanket; baby swings; rattles; play mats; mobiles [toys]; crib mobiles [toys]; early learning game; bath toys.

(260) AM 2022 115061 A

(800) 1620924

(151) 2021 09 10

(891) 2021 09 10

(731) Dr. Harold Katz, LLC

5802 Willoughby Ave., Los Angeles CA 90038, USA

(540)

THERABREATH

(591) Black, white

(511)

3 – Toothpaste; breath freshening preparations for personal hygiene; breath freshening sprays; mouthwashes, not for medical purposes; nasal cleaning preparations for personal sanitary purposes; non-medicated mouthwashes; teeth whitening preparations; tooth whitening creams; tooth whitening gels; tooth whitening pastes.

(260) AM 2022 115062 A

(800) 1620928

(151) 2021 05 26

(891) 2021 05 26

(731) Limited Liability Company

"PHARMTRANSFER"

Priborostroiteley street, 2, building 4A, Dubna, RU-141981 Moscow region, Russian Federation

(540)

Renotinex A+E

(591) Black, white

(531) 24.13.01; 24.17.05; 27.05.01

(511)

5 – Alkaloids for medical purposes; alginates for pharmaceutical purposes; aldehydes for pharmaceutical purposes; amino acids for medical purposes; analgesics; anaesthetics; antibiotics; antiseptics; medicine cases, portable, filled; first-aid boxes, filled; balms for medical purposes; diagnostic biomarker reagents for medical purposes; biocides; bromine for pharmaceutical purposes; paper for mustard plasters; petroleum jelly for medical purposes; vaccines; dietetic substances adapted for medical use; radiological contrast substances for medical purposes; radioactive substances for medical purposes; bismuth subnitrate for pharmaceutical purposes; mineral waters for medical purposes; hemoglobin; hydrastine; hydrastinine; glycerine for medical purposes; glycerophosphates; glucose for medical purposes; gentian for pharmaceutical purposes; hormones for medical purposes; mustard for pharmaceutical purposes; mustard plasters; diastase for medical purposes; digitalin; capsules for medicines; cachets for pharmaceutical purposes; hemostatic pencils; wart pencils; caustic pencils; caustics for pharmaceutical purposes; cachou for pharmaceutical purposes; quassia for medical purposes; quebracho for medical purposes; medicated sweets; liquorice for pharmaceutical purposes; lactose for pharmaceutical purposes; medicated candies; medicines for alleviating constipation; lecithin for medical purposes; medicated hair lotions; lotions for pharmaceutical purposes; medicated after-shave lotions; personal sexual lubricants; lupulin for pharmaceutical purposes; magnesia for pharmaceutical purposes; liniments; ointments for pharmaceutical purposes; sunburn ointments; frostbite salve for pharmaceutical purposes; medicinal oils; mustard oil for medical purposes; camphor oil for medical purposes; castor oil for medical purposes; oil of turpentine for pharmaceutical purposes; dill oil for medical purposes; drugs for medical purposes; medicines for human purposes; menthol; medicinal drinks; moleskin for medical purposes; mint for pharmaceutical purposes; medicinal infusions; eucalyptol for pharmaceutical purposes; tinctures for medical purposes; pastilles for pharmaceutical purposes; medicated dentifrices; pectin for pharmaceutical purposes; pepsins for pharmaceutical purposes; peptones for pharmaceutical purposes; hydrogen peroxide for medical purposes; bacterial preparations for medical purposes; bacteriological preparations for medical purposes; balsamic preparations for medical purposes; albuminous preparations for medical purposes; biological preparations for medical purposes; bismuth preparations for pharmaceutical purposes; vitamin preparations; diagnostic preparations for medical purposes; bath preparations for medical purposes; therapeutic preparations for the bath; hemorrhoid prepa-

rations; preparations for callouses; lice treatment preparations [pediculicides]; acne treatment preparations; preparations to facilitate teething; preparations for the treatment of burns; opotherapy preparations; bronchodilating preparations; preparations for reducing sexual activity; sterilising preparations; corn remedies; pharmaceutical preparations for treating dandruff; vermin destroying preparations; pharmaceutical preparations for skin care; contact lens cleaning preparations; preparations of microorganisms for medical purposes; lime-based pharmaceutical preparations; hemostatics for medical purposes; medicated eye-washes; medicinal hair growth preparations; nutraceutical preparations for therapeutic or medical purposes; opiates; aloe vera preparations for pharmaceutical purposes; preparations of trace elements for human use; sulfonamides [medicines]; pharmaceutical preparations; pharmaceutical preparations for treating sunburn; enzyme preparations for medical purposes; phytotherapy preparations for medical purposes; chemico-pharmaceutical preparations; chemical preparations for the diagnosis of pregnancy; chemical preparations for medical purposes; chilblain preparations; pharmaceuticals; propolis for pharmaceutical purposes; tissues impregnated with pharmaceutical lotions; syrups for pharmaceutical purposes; soporifics; adjuvants for medical purposes; astringents for medical purposes; vermifuges; disinfectants; disinfectants for hygiene purposes; appetite suppressants for medical purposes; medical preparations for slimming purposes; mouthwashes for medical purposes; febrifuges; depuratives; detergents for medical purposes; vesicants; purgatives; remedies for perspiration; remedies for foot perspiration; chemical contraceptives; sedatives; laxatives; tonics [medicines]; digestives for pharmaceutical purposes; nervines; steroids; serums; tanning pills; appetite suppressant pills; slimming pills; jujube, medicated; antioxidant pills; thymol for pharmaceutical purposes; medicinal herbs; phenol for pharmaceutical purposes; enzymes for medical purposes; ferments for pharmaceutical purposes; formic aldehyde for pharmaceutical purposes; phosphates for pharmaceutical purposes; quinine for medical purposes; chinoline for medical purposes; chloroform; flowers of sulfur for pharmaceutical purposes; medicated shampoos; pediculicidal shampoos; medicated dry shampoos; eucalyptus for pharmaceutical purposes; herbal extracts for medical purposes; plant extracts for pharmaceutical purposes; extracts of hops for pharmaceutical purposes; elixirs [pharmaceutical preparations].

(260) AM 2022 115063 A

(800) 1620966

(151) 2021 05 26

(891) 2021 05 26

(731) Joint Stock Company "Medintorg"

st. Sushevskaya, 19, bldg. 5, pom. I, off. 206,
RU-127055 Moscow, Russian Federation

(540)

NefroBest

(591) Black, white

(531) 27.05.17

(511)

5 – Acaricides; aconitine; alkaloids for medical purposes; alginates for pharmaceutical purposes; algicides; aldehydes for pharmaceutical purposes; dental amalgams of gold; dental amalgams; amino acids for veterinary purposes; amino acids for medical purposes; analgesics; anesthetics; antibiotics; antiseptics; medicine cases, portable, filled; first-aid boxes, filled; aluminum acetate for pharmaceutical purposes; acetates for pharmaceutical purposes; germicides; balms for medical purposes; bandages for dressings; diagnostic biomarker reagents for medical purposes; biocides; bracelets impregnated with insect repellent; bromine for pharmaceutical purposes; paper for mustard plasters; fly catching paper; reagent paper for veterinary purposes; reagent paper for medical purposes; mothproofing paper; petroleum jelly for medical purposes; vaccines; oxygen baths; antiseptic cotton; aseptic cotton; absorbent cotton; wadding for medical purposes; cotton for medical purposes; dietetic substances adapted for medical use; radiological contrast substances for medical purposes; nutritive substances for microorganisms; radioactive substances for medical purposes; bismuth subnitrate for pharmaceutical purposes; melissa water for pharmaceutical purposes; seawater for medicinal bathing; mineral waters for medical purposes; thermal water; dietary fiber; molding wax for dentists; gases for medical purposes; guaiacol for pharmaceutical purposes; sexual stimulant gels; hematogen; hemoglobin; hydrastine; hydrastinine; glycerine for medical purposes; glycerophosphates; glucose for medical purposes; gentian for pharmaceutical purposes; hormones for medical purposes; mustard for pharmaceutical purposes; mustard plasters; mud for baths; medicinal mud; gamboge for medical purposes; gurgun balsam for medical purposes; disinfectants; deodorants, other than for human beings or for animals; air deodorizing preparations; deodorants for clothing and textiles; diastase for medical purposes; digitalin; vitamin supplement patches; mineral food supplements; nutritional supplements; albumin dietary supplements; dietary supplements for animals; yeast dietary supplements; alginate dietary supplements; glucose dietary supplements; casein dietary supplements; lecithin dietary supplements; linseed oil dietary supplements; propolis dietary supplements; protein dietary supplements; protein supplements for animals; royal jelly dietary supplements; pollen dietary supplements; wheat germ dietary supplements; linseed dietary supplements; acai powder dietary supplements; dietary supplements with a cosmetic effect; enzyme dietary supplements; yeast for pharmaceutical purposes; gelatine for medical purposes; cod liver oil; isotopes for medical purposes; im-

munostimulants; insecticides; iodine for pharmaceutical purposes; iodides for pharmaceutical purposes; alkaline iodides for pharmaceutical purposes; iodoform; calomel [fungicide]; cream of tartar for pharmaceutical purposes; tartar for pharmaceutical purposes; camphor for medical purposes; capsules for medicines; cachets for pharmaceutical purposes; capsules made of dendrimer-based polymers, for pharmaceuticals; hemostatic pencils; wart pencils; caustic pencils; carbolineum [parasiticide]; caustics for pharmaceutical purposes; cachou for pharmaceutical purposes; quassia for medical purposes; quebracho for medical purposes; oxygen for medical purposes; gallic acid for pharmaceutical purposes; acids for pharmaceutical purposes; adhesives for dentures; surgical glues; stem cells for veterinary purposes; stem cells for medical purposes; cocaine; collagen for medical purposes; collodion for pharmaceutical purposes; corn rings for the feet; medicated sweets; angostura bark for medical purposes; barks for pharmaceutical purposes; cedar wood for use as an insect repellent; croton bark; mangrove bark for pharmaceutical purposes; myrobalan bark for pharmaceutical purposes; quinquina for medical purposes; medicated animal feed; medicinal roots; rhubarb roots for pharmaceutical purposes; lint for medical purposes; starch for dietetic or pharmaceutical purposes; creosote for pharmaceutical purposes; blood for medical purposes; cultures of microorganisms for medical or veterinary use; curare; dental lacquer; liquorice for pharmaceutical purposes; lactose for pharmaceutical purposes; medicated lozenges; adhesive plasters; medicines for alleviating constipation; adhesive tapes for medical purposes; lecithin for medical purposes; lotions for veterinary purposes; medicated hair lotions; lotions for pharmaceutical purposes; medicated after-shave lotions; personal sexual lubricants; lupulin for pharmaceutical purposes; magnesia for pharmaceutical purposes; liniments; frostbite salve for pharmaceutical purposes; ointments for pharmaceutical purposes; sunburn ointments; mercurial ointments; gauze for dressings; medicinal oils; mustard oil for medical purposes; camphor oil for medical purposes; castor oil for medical purposes; oil of turpentine for pharmaceutical purposes; dill oil for medical purposes; dental mastics; dental abrasives; dental impression materials; teeth filling material; dressings, medical; surgical dressings; drugs for medical purposes; medicines for veterinary purposes; serotherapeutic medicines; medicines for human purposes; medicines for dental purposes; menthol; medicinal drinks; moleskin for medical purposes; almond milk for pharmaceutical purposes; powdered milk for babies; royal jelly for pharmaceutical purposes; milk ferments for pharmaceutical purposes; Irish moss for medical purposes; flour for pharmaceutical purposes; linseed meal for pharmaceutical purposes; fish meal for pharmaceutical purposes; fly glue; antibacterial soap; disinfectant soap; medicated soap; freeze-dried meat adapted for medical purposes; mint for pharma-

ceutical purposes; dietetic beverages adapted for medical purposes; malted milk beverages for medical purposes; injectable dermal fillers; narcotics; medicinal infusions; tincture of iodine; eucalyptol for pharmaceutical purposes; tinctures for medical purposes; opium; opodeldoc; decoctions for pharmaceutical purposes; antiparasitic collars for animals; cotton swabs for medical purposes; stick liquorice for pharmaceutical purposes; sulfur sticks [disinfectants]; pastilles for pharmaceutical purposes; medicated dentifrices; pectin for pharmaceutical purposes; pepsins for pharmaceutical purposes; peptones for pharmaceutical purposes; hydrogen peroxide for medical purposes; pesticides; food for babies; leeches for medical purposes; blood plasma; nicotine patches for use as aids to stop smoking; eyepatches for medical purposes; poultices; compresses; scapulars for surgical purposes; babies' diapers; diapers for pets; diapers for incontinence; breast-nursing pads; bunion pads; pomades for medical purposes; powder of cantharides; pyrethrum powder; chilblain preparations; mothproofing preparations; anti-uric preparations; bacterial preparations for medical and veterinary use; bacteriological preparations for medical and veterinary use; balsamic preparations for medical purposes; albuminous preparations for medical purposes; biological preparations for veterinary purposes; biological preparations for medical purposes; veterinary preparations; bismuth preparations for pharmaceutical purposes; vitamin preparations; diagnostic preparations for veterinary purposes; diagnostic preparations for medical purposes; douching preparations for medical purposes; bath preparations for the bath; hemorrhoid preparations; preparations for callouses; lice treatment preparations [pediculicides]; acne treatment preparations; preparations to facilitate teething; preparations for the treatment of burns; fumigation preparations for medical purposes; ophotherapy preparations; air purifying preparations; bronchodilating preparations; preparations for reducing sexual activity; sterilizing preparations; soil-sterilising preparations; corn remedies; pharmaceutical preparations for treating dandruff; preparations for destroying noxious animals; herbicides; preparations for destroying dry rot fungus; larvae exterminating preparations; fly destroying preparations; preparations for destroying mice; slug exterminating preparations; vermin destroying preparations; pharmaceutical preparations for skin care; contact lens cleaning preparations; lime-based pharmaceutical preparations; preparations of microorganisms for medical or veterinary use; hemostatics for medical purposes; medicated eye-washes; medicinal hair growth preparations; nutraceutical preparations for therapeutic or medical purposes; opiates; anticryptogamic preparations; aloe vera preparations for pharmaceutical purposes; preparations of trace elements for human and animal use; sulfonamides [medicines]; pharmaceutical preparations; pharmaceutical preparations for treating sunburn; enzyme

preparations for veterinary purposes; enzyme preparations for medical purposes; phytotherapy preparations for medical purposes; chemico-pharmaceutical preparations; chemical preparations for veterinary purposes; chemical preparations for the diagnosis of pregnancy; chemical preparations for medical purposes; chemical preparations for treating diseases affecting cereal plants; chemical preparations for treating wheat blight; chemical preparations for treating diseases affecting vine plants; chemical preparations for treating mildew; chemical preparations for treating phylloxera; chemical preparations for pharmaceutical purposes; collyrium; lead water; chemical conductors for electrocardiograph electrodes; albuminous foodstuffs for medical purposes; dietetic foods adapted for medical purposes; by-products of the processing of cereals for dietetic or medical purposes; homogenized food adapted for medical purposes; freeze-dried food adapted for medical purposes; pharmaceuticals; sanitary towels; panty liners [sanitary]; propolis for pharmaceutical purposes; pearl powder for medical purposes; radium for medical purposes; solvents for removing adhesive plasters; hydrated chloral for pharmaceutical purposes; vaginal washes for medical purposes; solutions for contact lenses; chemical reagents for medical or veterinary purposes; gum for medical purposes; rubber for dental purposes; chewing gum for medical purposes; nicotine gum for use as an aid to stop smoking; insect repellents; insect repellent incense; repellents for dogs; tissues impregnated with pharmaceutical lotions; sarsaparilla for medical purposes; sugar for medical purposes; asthmatic tea; fumigating sticks; massage candles for therapeutic purposes; suppositories; linseed for pharmaceutical purposes; tobacco-free cigarettes for medical purposes; siccatives [drying agents] for medical purposes; syrups for pharmaceutical purposes; turpentine for pharmaceutical purposes; milking grease; greases for veterinary purposes; greases for medical purposes; lacteal flour for babies; infant formula; soporifics; bicarbonate of soda for pharmaceutical purposes; mineral water salts; bath salts for medical purposes; salts for mineral water baths; salts for medical purposes; potassium salts for medical purposes; sodium salts for medical purposes; smelling salts; malt for pharmaceutical purposes; semen for artificial insemination; alcohol for pharmaceutical purposes; medicinal alcohol; alloys of precious metals for dental purposes; ergot for pharmaceutical purposes; cooling sprays for medical purposes; digestives for pharmaceutical purposes; nervines; antibacterial handwashes; adjuvants for medical purposes; astringents for medical purposes; vermifuges; disinfectants for hygiene purposes; disinfectants for chemical toilets; appetite suppressants for medical purposes; medical preparations for slimming purposes; parasiticides; mouthwashes for medical purposes; febrifuges; depuratives; animal washes [insecticides]; detergents for medical purposes; cattle washes [insecticides]; dog washes [insecticides]; insecticidal veteri-

nary washes; vesicants; purgatives; chemical contraceptives; antiparasitic preparations; remedies for perspiration; remedies for foot perspiration; sedatives; laxatives; tonics [medicines]; medicated toiletry preparations; media for bacteriological cultures; steroids; strychnine; serums; antioxidant pills; tanning pills; appetite suppressant pills; slimming pills; jujube, medicated; sanitary tampons; vulnerary sponges; thymol for pharmaceutical purposes; biological tissue cultures for veterinary purposes; biological tissue cultures for medical purposes; smoking herbs for medical purposes; medicinal herbs; surgical implants comprised of living tissues; babies' diaper-pants; pants, absorbent, for incontinence; sanitary panties; charcoal for pharmaceutical purposes; fennel for medical purposes; porcelain for dental prostheses; phenol for pharmaceutical purposes; enzymes for veterinary purposes; enzymes for medical purposes; ferments for pharmaceutical purposes; formic aldehyde for pharmaceutical purposes; phosphates for pharmaceutical purposes; fungicides; quinine for medical purposes; chinoline for medical purposes; diabetic bread adapted for medical use; chloroform; flowers of sulfur for pharmaceutical purposes; cement for animal hooves; bone cement for surgical and orthopedic purposes; dental cements; medicinal tea; herbal teas for medicinal purposes; insecticidal animal shampoos; medicated shampoos; medicated shampoos for pets; pediculicidal shampoos; medicated dry shampoos; pre-filled syringes for medical purposes; eucalyptus for pharmaceutical purposes; herbal extracts for medical purposes; plant extracts for pharmaceutical purposes; tobacco extracts [insecticides]; extracts of hops for pharmaceutical purposes; elixirs [pharmaceutical preparations]; ethers for pharmaceutical purposes; esters for pharmaceutical purposes; cellulose esters for pharmaceutical purposes; cellulose ethers for pharmaceutical purposes; rat poison; poisons; bacterial poisons; jalap; dietary food supplements.

(260) AM 2022 115064 A
 (800) 1620987
 (151) 2021 09 15
 (891) 2021 09 15
 (731) Swatch AG (Swatch SA) (Swatch Ltd.)
 Nicolas G. Hayek Strasse 1, CH-2502
 Biel/Bienne, Switzerland

(540)
SWATCH BIG BOLD

(591) Black, white
 (511)
 9 – Computers for wearing on the wrist, smartwatches, connected watches.

(260) AM 2022 115065 A
 (800) 1620990
 (151) 2021 04 19
 (891) 2021 04 19
 (731) HUGO BOSS Trade Mark Management GmbH
 & Co. KG
 Dieselstraße 12, 72555 Metzingen, Germany

(540)
HUGO BOSS

(591) Black and white.
 (531) 27.05.17
 (511)

16 – Paper, cardboard and goods made from these materials (included in this class); hangtags; printed matter; bookbinding material; photographs [printed]; stationery, ball-point pens, fountain pens and pencils; office requisites, except furniture; pencil sharpeners, electric or non-electric; drawing rulers; punches [office requisites]; rubber erasers; stamp pads; pads [stationery]; bags [envelopes, pouches] of paper or plastics, for packaging; packing [cushioning, stuffing] materials of paper or cardboard; packing paper; containers of paper or cardboard for packaging; money clips; stickers.

35 – Business management; sales consultancy; wholesale and retail services in relation to clothing, footwear, headgear and clocks and watches, spectacles, fashion accessories, cosmetics and perfumery, goods of leather, bags, bed linen, home textiles, household articles, stationery, luggage, sporting articles and smoking articles; marketing services; market research and market analysis; advertising; sales promotion; rental of advertising space; distribution of goods and advertising material for advertising purposes, including via electronic media and via the Internet; presentation of goods, in particular shop and shop window dressing; organization of exhibitions for commercial or advertising purposes; promotion of business relationships by providing of commercial and business contacts; advice and advisory services for consumers; business consultancy and administration; business organization consulting; professional business consulting; fashion consultancy (business); organization of fashion shows for commercial, industrial and advertising purposes; management of retail stores in relation to clothing, footwear, headgear and clocks and watches, spectacles, fashion accessories, cosmetics and perfumery, goods of leather, bags, bed linen, home textiles, household articles, stationery, luggage, sporting articles and smoking articles; online wholesale and retail services and online ordering services in relation to clothing, footwear, headgear and clocks and watches, spectacles, fashion accessories, cosmetics and perfumery, goods of leather, bags, bed linen, home textiles, household articles, stationery, luggage, sporting articles and smoking articles; mail ordering services and computerized online-ordering services in relation to clothing, footwear, headgear and clocks

and watches, spectacles, fashion accessories, cosmetics and perfumery, goods of leather, bags, bed linen, home textiles, household articles, stationery, luggage, sporting articles and smoking articles.

(260) AM 2022 115095 A
 (800) 1602209
 (151) 2021 04 14
 (891) 2021 09 07
 (731) Obshestvo s ogranichennoy otvetstvennostyu
 "Realt-Aktiv"
 proezd Kalinovskogo, d.2, Pinsk, 225710
 Brestskaya obl., Belarus
 (540)



(591) Red and black
 (531) 03.04.04; 03.04.23; 27.05.01; 29.01.12
 (511)
 9 – Accumulators, electric, for vehicles; chargers for electric accumulators; battery boxes; plates for batteries; grids for batteries; battery jars; acidimeters for batteries; acid hydrometers for batteries.

(260) AM 2022 115145 A
 (800) 1622212
 (151) 2021 06 22
 (891) 2021 06 22
 (731) YORMAZ ASANSÖR SANAYİ TİCARET
 LİMİTED ŞİRKETİ
 Portakallık Mahallesi Defne Sokak, Fatih Kent
 Sitesi 1 kat 7/A, Merkez Rize, Turkey

(540)



(591) Red and black
 (531) 26.01.03; 26.01.18; 27.05.02; 29.01.12
 (511)
 7 – Lifting and conveying machines; human and freight elevators, moving platforms, ramps, lifts, cranes, elevators; escalators, moving belts (conveyors), elevators.

(260) AM 2022 115147 A
 (800) 1622227
 (151) 2021 08 24
 (891) 2021 08 24
 (731) Avon Products, Inc.
 1 Avon Place, Suffern NY 10901, USA
 (540)

MillionEYezzer

(591) Black, white
 (511)
 3 – Non-medicated toilet preparations; toiletries; skin care preparations; skin moisturizers; body and beauty care preparations; powders, cleansers, creams and lotions, all for the face, hands and body; cosmetic sun-tan preparations; soaps; shower and bath preparations; beauty masks; talcum powder; nail polish; nail polish remover; false nails; adhesives for cosmetic purposes; cosmetics; eye cream; eye gels; eye lotions; eye make-up remover; eye shadow; eye liner; mascara; lipstick; lip liner; lip-gloss; make-up foundation; blusher; tissues impregnated with cosmetic lotions; cotton sticks for cosmetic purposes; cotton wool for cosmetic purposes; preparations for cleaning, moisturising, colouring and styling the hair; preparations for cleaning the teeth; shaving and aftershave preparations; deodorants for human beings; anti-perspirants for personal use (toiletries); essential oils (cosmetic); none of the aforesaid including perfumes, fragrances, toilet waters, cologne.

(260) AM 2022 115155 A
 (800) 1622420
 (151) 2021 03 16
 (891) 2021 03 16
 (731) Brita GmbH
 Heinrich-Hertz-Str. 4, 65232 Taunusstein,
 Germany

(540)

BRITA

(591) Black, white
 (511)
 1 – Ion exchangers; ion exchange resins; absorbent agents; activated carbons; carbon blocks.
 3 – Cleaning agents for household purposes; polishes.
 7 – Beverage-making machines and installations consisting thereof; electric machines and apparatus for producing carbonated beverages; sparkling water making machines; electromechanical appliances for preparing and dispensing hot, boiled and refrigerated water and installations consisting thereof, including filling machines, other than heating and cooling apparatus for dispensing hot and cold beverages; beverage selling machines; filling machines; vending machines; dishwashers and their accessories; apparatus

for mixing beverages; water filters that can be used with automatic vending machines and dishwashing machines; mechanical filters for the treatment of water.

9 – Software for the Internet; computer software; application software, in particular for mobile devices (mobile apps); software downloadable from the Internet; downloadable videos; mobile applications; computer software applications; smartphone software applications; downloadable smartphone applications (software); software (recorded); data carriers, including containing recorded data; measuring, detecting and monitoring instruments; checking (supervision) apparatus and instruments; electronic controllers; electronic voice controllers; programmable controllers; sensors and detectors; electrical controls, operation panels; remote controls; interfaces for computers; in particular all of the aforesaid goods in connection with water filters, jugs and water dispensers.

11 – Apparatus and installations for water treatment; installations and filters for water sterilization removing bacteria and viruses; purifying filters; filters for drinking water; membrane filters for microfiltration, ultrafiltration, nanofiltration and reverse osmosis; components and accessories for apparatus and installations for water treatment, in particular filter disks, sachets, bags containing ion exchangers and activated carbon, tank filters, filter ports, filter heads containing sensory components, all the aforesaid goods included in this class; water treatment apparatus; water filtering apparatus; water conditioning appliances; tap devices for water; gas infusing apparatus; water treatment systems; water filters and water filtration apparatus based on membrane technology, reverse osmosis technology, UV technology, ozone technology, carbon technology in particular with activated carbon blocks; water filters and water filtering apparatus for microbiological sterilization; pressure-driven water filters; gravity water filters; suction water filter cartridges; hand-operated water filter cartridges; water filter cartridges with a sunken filter mechanism; water filter cartridges with ion exchangers and/or adsorbents (included in this class); water filters that can be used with water kettles, coffee machines, tea machines, espresso machines, samovars, rice cookers, large catering apparatus, ice machines, combination steamers, steam cookers, ovens, percolators, refrigerators, refrigerating apparatus; cold drink dispensers; tap fittings, except for filters for machines and engines; water taps being part of water supply installations; water bearing armatures in particular for water taps with integrated filter systems; water bearing armatures, namely tubes as a part of a control water meter and as part of water blending installations; dispensers (for hot and cold water); cooled beverage dispensers; temperature-controlled beverage dispensers, except vending machines; automatic water treatment equipment with automatic cut-off fitted with consumption indicators, fittings,

filters, units for the mineralization of water, heating devices, cooling devices, flavoring devices, carbon dioxide devices; water treatment installations consisting of the aforesaid apparatus; parts, included in this class; accessories for all the aforesaid goods, in particular refill elements, cartridges, tap extenders and spare parts, included in this class; electric kettles; cooling devices for beverages for household use.

20 – Kitchen cabinets; bottle crates, other than of metal; bottle caps, not of metal.

21 – Apparatus, non-electric, for the production of carbonated water and beverages; non-electric coffee pots and tea sets; utensils and containers for household or kitchen use of plastic or glass; cups made of paper, plastic and polylactic acid; containers for cups; cup dispenser; decanters; bottles, glass bottles, reusable stainless steel water bottles; jugs made of plastic or glass; containers with and without filters; non-electric coffee and tea pots; drinking glasses, drinking vessels in the form of bottles; dishes; drip trays; dishwasher baskets for bottles; cleaning brushes; glassware, porcelain and earthenware, included in this class; heat-insulated containers, insulating flasks for beverages; refrigerating bottles.

32 – Filtered water, included in this class; preparations for making carbonated water, aerated water, table water, drinking water, spring water; carbonated beverages, non-alcoholic; non-alcoholic drinks, fruit drinks and fruit nectars; syrups and other preparations for making beverages; beverages made with natural mineral water and fruit extracts, flavored mineral waters, flavored drinking waters, all the aforesaid goods also including aromatic additives and products for making such beverages.

35 – Advertising; merchandising (sales promotion), sales promotion, processing of orders; administrative processing of purchase orders; invoicing services, including in the context of e-commerce; presentation of goods and services on the Internet; invoice management services; commercial business management; provision of information and advice to consumers regarding the range of products and items to be sold; online advertising on a computer network; presentation of goods on communication media, for retail purposes; corporate communication services; dissemination of advertising matter; updating of advertising material; provision of an online marketplace for buyers and sellers of goods and services; updating and maintenance of data in computer databases; computerized file management; processing of computer data in the field of water cycle management; processing of computer data in the field of water cycle analysis; processing of computer data in the field of the detection and/or resolution of problems relating to the water cycle; processing of computer data in the field of the treatment, distribution, level and temperature of water in industry, the public network, the domestic

network; systemization of information into computer databases in the field of water; database management in the field of water; arranging subscriptions to the supply of filtered water; compilation of information into computer databases; arranging data search in computer files for others; rental of vending machines for coffee, tea and sugar.

36 – Financial services for the acquisition, rental, care and maintenance of water filters and beverage dispensers.

37 – Installation, maintenance and repair of machines; installation and repair of kitchen equipment; installation and repair of refrigerating apparatus; installation and repair of electronic apparatus; installation and repair of beverage dispensers and faucets; maintenance and cleaning of water filters, water filter apparatus, coffee, tea and sugar dispensers, filtering products and accessories, beverage dispensers, faucets; provision of information relating to the repair and maintenance of machines, cooking apparatus, refrigerating apparatus and consumer electronic apparatus; installation and replacement of bottles, machines, kitchen equipment, refrigerating apparatus, electronic apparatus, beverage dispensers and faucets, water filters, water filtering apparatus, coffee, tea and sugar dispensers, filtration products and accessories, beverage dispensers, faucets, electronic apparatus for consumers (after-sales services).

38 – Providing user access to global computer networks; providing telecommunications connections to a global computer network; providing access to data via the Internet; information about telecommunication; communications by computer terminals; communications by telephone; communications by smartphones; computer aided transmission of messages and images; data transmission services; telephone services; transmission of digital files; transfer of information and data via online services and the Internet.

39 – Delivery services; delivery of filtration products and accessories; providing of information relating to the distribution of water; water supply.

40 – Rental of water filters and water filtering apparatus; processing and recycling of water filters, water filtration apparatus and their components; processing of bottles, including their labeling and design according to customer specification; customization of accessories in the field of water treatment being custom manufacturing services; providing information relating to water treatment; water treatment consultancy.

41 – Education and providing of online training seminars relating to the distribution, collection, management, control, quality and treatment of water; professional training in the field of apparatus and installations for the distribution, collection, management, control and treatment of water.

42 – Design of bottles; updating of computer software; cloud-computing; computer software design; electronic data storage; development of computer platforms and software; server hosting; monitoring of computer systems to detect breakdowns; monitoring of computer systems for detecting unauthorized access or data breach; maintenance of computer software; installation of computer software; providing information concerning computer programs and computer software over computer networks and global communication networks; development and hosting of online non-downloadable computer software, in particular for mobile devices (mobile apps); consulting services relating to computer software; design and consultancy relating to engineering in the field of water management; environmental services, consultancy on water analysis; technological consultancy relating to water consumption; consultancy and information relating to water quality control; monitoring of water quality; water analysis; professional consultancy for the assessment of volumes of losses in water networks; maintenance and development of database software in the field of water; design, installation, maintenance and updating of database software in the field of water.

(260) AM 2022 115172 A

(800) 1622869

(151) 2021 05 27

(891) 2021 05 27

(731) LEONARDO S.P.A.

PIAZZA MONTE GRAPPA 4, I-00195
ROMA, Italy

(540)



(591) Red and grey

(531) 26.11.09; 27.05.01; 27.07.01; 29.01.12

(511)

9 – Electrical and electronic equipment and instruments for aircraft and helicopters, namely flight control system, beacon control panel, anemometer, helicopter pilot control panel, fuel control panel, engine control panel, gyro compass control panel, electronic flight display, engine and crew warning system, aircraft engine and flight system monitors, flight simulator, avionics sensor systems, namely, navigation systems for use in aircraft and helicopters; communication transmission apparatus, namely, antennas, wireless transmitters and receivers for use on aircraft and helicopters; aircraft and helicopter testing apparatus and instruments, namely, general caution indicator (master caution) and general warning indicator (master warning) for use on aircraft and helicopters; computer hardware for use in aircraft and helicopters; computer software for command and control of flight and navi-

gation for use on aircraft and helicopters; electronic publications, namely electronic books, magazines, brochures, electronic magazines (e-zines), manuals in the aviation sector and helicopter, downloadable or recorded on informatic supports.

14 – Aircrafts; helicopters.

(260) AM 2022 115173 A

(800) 1622877

(151) 2021 05 20

(891) 2021 05 20

(731) DKV EURO SERVICE GmbH + Co. KG

Balcke-Dürr-Allee 3, 40882 Ratingen, Germany

(540)

DKV MOBILITY

(591) Black, white

(511)

4 – Industrial oils and industrial greases; liquid fuels; fuel gas; all the aforementioned goods as motor vehicle operating resources.

9 – Computer programs (recorded or downloadable) for transportation of goods and freight logistics as well as vehicle management; computer programs for apps for driving as economically as possible and for economical refueling in order to reduce fuel costs; computer programs for creating weekly results reports in transportation and vehicle management; magnetic cards, magnetic identification cards; memory cards and microprocessor cards; electronic global positioning systems; systems consisting of sensors and computer software for the geolocation and for the recognition of positions or for the recognition of passages; electronic geotracking apparatus and instruments for geolocation via satellite, known as GPS or GPS-GPRS; telematic (data transmission) and GPS vehicle locating systems for the localisation of vehicles in real time and for the transmission of data of vehicle use and vehicle handling; non-voice telecommunication apparatus and instruments for the transmission of data over short distances between road systems and mobile units; data cards for third generation cellular telephone networks; GSM-type (Global System for Mobile Communication) data cards, called GPRS-compatible (General Packet Radio Services) data cards having the standard of broadband wireless telephones; apparatus for recording, transmission and reproduction of sound and images; computer software and software for the traffic management on roads and motorways, for the toll management and for the creation of road itineraries/routes; computer software; measuring, detecting and monitoring instruments and devices; acceleration sensors for the measurement of the speed-up behaviour and braking characteristics, also independently of geopositioning; electronic transmitting and receiving apparatus [on-board units] for use on toll roads; radio and telecommunications apparatus as well as navigation, direction finding and localization

apparatus; transmitters, transceivers; receivers; electric receivers; antennas; sensors; control and monitoring apparatus; satellite navigation instruments; distance recording and measuring apparatus; data processing apparatus and computers; communication apparatus; programmed machine-readable data carriers of all kinds; navigation apparatus for vehicles (on-board computers); mobile apps; application software for mobile devices, for mobile operating systems, for navigation devices, for smartphones, for wireless devices, for cloud computing services; application software for mobile devices with traffic light systems for displaying current and forecast fuel prices; apps for evaluating petrol stations; apps for individual conditions in transport and vehicle management and for the display of petrol station networks; apps for the creation of road itineraries/routes; apps for the display of driving styles in the areas of braking, speed, acceleration and cruise control; smartphones; computers; internet of things [IoT] gateways; internet of Things [IoT] sensors; computer application software for use in implementing the Internet of Things [IoT]; computer hardware modules for use in electronic devices using the Internet of Things [IoT]; apps for mobile payments; apps for the digitalization of tank cards; logistics software; telemetering apparatus for automotive vehicles and for engine applications; software for the logging of error signals; computer programs for remote maintenance for configuration and maintenance of charging infrastructure with remote control and access, e.g. reboot by remote, reconfiguration, applying updates; computer programs for remote access to manually start/stop loading operations; remote diagnostic software for Second Level Support; computer software for use as an application programming interface [API], namely API interfaces for data provisioning (static/dynamic POI [Point of Interest] data); software for CDR validation [Charge Detail Record = protocol in electric vehicle charging infrastructure for billing] and processing for billing purposes, and for BDR enrichment and processing for billing purposes [Billing Detail Record]; interoperability connection/interface [interface devices or programs for computers] via OCPP/OCP1/OICP/SOAP/Json [OCPP = Open Charge Point Protocol = Free Charging Point Communication Standard / OCPI = Open Charge Point Interface = interface between electric vehicle charging stations and e-mobility operators / OICP = Open Interchange Protocol/SOAP = Simple Object Access Protocol =network protocol/JSON = JavaScript Object Notation = data exchange program] for billing purposes; credit cards; parts of all the aforementioned goods [included in this class]; software for geofencing; road vehicle communication interface between vehicle and charging station; software for integrating data relating to mobile payment solutions into HMI services [board computer in vehicles], whereby transactions are digitally activated via the board computer and payment transactions are thus processed

in the vehicle; software for integrating mobile fueling into HMI software [Human Machine Interface]; downloadable mobile applications to enable mobile payment transactions for various DKV products [fuel, parking, toll], namely without using a physical fuel card.

12 – Parts and accessories for vehicles included in this class.

35 – Services of a filling station and its sales and service areas, namely computer-based preparation and balancing of invoices of fees for frontier-clearance (office functions); computer-based preparation of invoices of cargo and cargo procurement costs (office functions); customs clearance and ferry-boat services, namely arrangement of contracts for third parties for the assignment of access authorizations for toll lanes and tunnels through the mediation of contracts for the purchase and sale of vignettes and the input of data in data processing apparatus (office functions); computer-based preparation of invoices of tunnel fees (office functions); computer-based preparation of invoices of repair services (office functions); computer-based preparation of invoices of fuels (office functions); processing of foreign value-added mineral oil tax returns in different countries (office functions); processing of energy tax refund (office functions); services in the field of the cashless in-transit provisioning of nationally and internationally active businesses involved in industrial goods and passenger transport, of commercial vehicle fleets of passenger vehicles and/or lorries, and in the transport sector, namely billing (within the scope of cashless payment transactions) based mainly on software programs developed in a customer-oriented way, computer-aided billing (within the scope of cashless payment transactions) and billing management for fuel, ferry fees, motorway fees, toll fees and/or value-added tax; customer invoicing, for others; accident services, namely procurement of contracts for others for replacement vehicles and tow vehicles as well as towing services; price comparison services, in particular provision of information relating to the price of fuels at home and abroad; business management; business administration; office functions; accounting services; auditing; consulting [personnel management consulting] in organizational as well as personnel matters for third parties; marketing [sales research]; market research; opinion polling; public relations; personnel and job placement; personnel recruitment; preparation of cost-price analyses; consulting on the organization and management of companies; consulting on management issues; procurement services for third parties [acquisition of goods and services], in particular procurement of materials, supplies; systematization and compilation of data in computer databases; business consulting and processing in the field of software-supported services in the area of billing services, namely business consulting in the preparation of billing statements [office

functions] based primarily on software programs developed with customers; submission of refund requests via electric portals of individual customer financial authorities [office functions]; office functions relating to development and design of forms for third parties and updating of forms in the field of financial services; management, processing and dispatch of overdue notices [office functions]; monitoring and posting of refund amounts [office functions]; advertising; recording of personal and vehicle-related data (office functions); office functions, namely computer-based compilation and processing by preparation of statistics and statistical analysis of vehicle master data, of tank data, of invoices, of motor vehicle costs and revenues; statistical evaluation of GEO positions of vehicles as compared to geositions of the maps used; office functions, namely computer-based order planning including systematically updating data in computer databases for planning both in terms of organization and business planning of the availability of motor vehicles and orders; address administration; business management relating to fleet control and fleet management of cars and trucks; business administration relating to filing of insurance and other documents [except health insurance documents], brokerage of insurance, except for health insurance, e.g. vehicle insurance, brokerage of tires; consumer information, namely providing information and advice for consumers in matters of cashless in-transit supply in the field of goods and passenger transport; office functions, namely compilation of information and setting up notification functions to send automated reports; compilation of business information; advertising in the field of toll collection and transport infrastructure; advertising, including advertising with brochures for promotional purposes; information in business matters, especially handled online via a hotline; conducting, organizing, preparing reports in the field of national and international commercial road transport of goods and passengers, namely preparing and evaluating reports and statistics on the localization of vehicles in real time and data on vehicle use and driving behavior [e.g. driving time, speed, accelerations]; arranging contracts for third parties for the provision of replacement vehicles; management and monitoring of incentive schemes; organization and management of customer loyalty schemes including for commercial, promotional and advertising purposes; evaluation of companies (filling stations); benchmarking services; compilation of different filling station services and fuel offers, for others, to facilitate the comparison and purchase of these services; data entry and data processing (collection, systemization, updating and maintenance of data) in computer data bases (office functions); business management for radio mobile services; management of telephone call-centers for third parties for the execution of contracts for the rental of cars and trucks; all the aforementioned services rendered by means of a global or local computer network and/or by means

of the Internet; consulting services related to payroll; business consulting services related to the establishment of wage, salary and classification structures, declaration of the minimum wage in certain EU countries, assistance and advice on the submission of documents to public authorities in accordance with the EU directive 96/71/EC; business comparison services; administrative services for companies, such as ticket management/remote charging station management, also via helpdesks; publication of publicity materials relating to prices and opening time; processing of commercial transactions with regard to ad-hoc charging [direct payment]; management and compilation of contact data for mobile applications in computer databases, customer portals and interfaces in order to use connected services; performance of data analyses/interpretations, customer analyses and behavior predictions for business purposes; billing of mobile transactions [office functions]; commercial and business services related to electricity trading, namely in relation to electricity purchasing pools, marketing advice and/or energy purchase management, load profile optimization; portfolio management, demand aggregation and price negotiations; electricity customer acquisition through mail order advertising; collection and processing of collected telematics data [office functions]; business administration relating to logistics management in the areas of transport and dispatch services; office work in the form of maintenance of supplier data/prices [tariff management]; retail services with batteries, hydrogen and alternative motor vehicle fuels; cooperation with third party credit card and prepaid credit card issuers or credit card and prepaid credit card providers, namely formulation and conclusion of contracts with aforementioned companies; business administration relating to verification of booking errors; services in the field of the cashless in-transit provisioning of nationally and internationally active businesses involved in industrial goods and passenger transport, of commercial vehicle fleets of passenger vehicles and/or lorries, and in the transport sector, namely preparation and balancing of invoices (billing) (within the scope of cashless payment transactions) based mainly on software programs developed in a customer-oriented way, computer-aided billing (within the scope of cashless payment transactions) and billing management for fuel, ferry fees, motorway fees, toll fees and/or value-added tax; providing information on the price of fuels in the country and abroad; provision of dynamic pricing information for loading operations.

36 – Financial services; factoring; collection services, in particular the collection of outstanding debts [collection operations] and the management of debts [asset management], in particular research, investigation of asset relationships for the classification of debts and debt risks and the monitoring of payment terms; brokerage of credit insurance contracts; financial processing of VAT refund payments within the

framework of net invoicing [NIP], normal refund [NE] and deferral of payments; processing of credit financing [financial services] within the framework of NIP via banks and other credit institutions, including bank consortia as borrowers; electronic processing of mineral oil tax refund payments in various countries, in particular in the EU area; processing of energy tax refunds; financial consulting in the area of insurance [except health insurance], real estate and finance, in particular consulting on insurance except health insurance; issue of service cards with payment function to industrial freight and passenger transport businesses for the cashless in-transit supplying of automobiles, heavy trucks, busses and their drivers; computer-based settlement of finance transactions/ deals with service cardshaving a payment and a legitimation function; electronic processing of foreign value-added mineral oil tax return funds and refund of energy taxes; conducting cashless payment transactions in the field of payment of road toll fees and other road fees; handling electronic payment transactions; services for payment processing via service cards, in particular concluding contracts with toll plazas; financial brokerage services relating to customs clearance; financial brokerage services relating to customs clearance for providing access entitlement to toll roads and tunnels; collecting utilization fees by the issue of vignettes; providing financial information by means of vignettes; preparation of financial damage reports; brokerage of emission rights; services in connection with prepaid credit cards for electronic payment transactions, namely services for the prepaid recharging of third-party credit card providers and the company's own credit cards as part of security services, e.g. in the event of breakdowns for truck drivers to pay for repairs on site; issuance of credit cards and prepaid credit cards and electronic payment processing; electronic capital transfer by means of on-board computers in vehicles, including HMI services; execution of financial transactions, namely recording, processing and settlement of mobile transactions for mineral oil companies and end customers.

37 – Services of a motor vehicle repair workshop; services of service stations and their sales and service areas, namely cleaning of motor vehicles, repair of motor vehicles; breakdown assistance, namely repair of motor vehicles on site and at motor vehicle repair shops; maintenance of motor vehicles; repair of tyres and motor vehicle cooling systems; maintenance of tyres and motor vehicle cooling systems; operation of a multilingual breakdown service via a hotline on the Internet, namely advice from motor vehicle specialists on repairing vehicle breakdowns; installation of toll logging and toll billing equipment; maintenance of toll logging and toll billing equipment; installation and maintenance of units equipped with a system for geolocation and position recognition or for recognition of passages; installation and maintenance of electronic satellite geotracking apparatus and ins-

truments, known as GPS or GPS-GPRS; installation and maintenance of telematic (data transmission) and GPS-vehicle locating systems for the localisation of vehicles in real time and for the transmission of data of vehicle use and vehicle handling as well as for the proof management concerning delivery of freights; installation and maintenance of non-voice telecommunication apparatus and instruments for the transmission of data over short distances between road systems and mobile units; installation and maintenance of apparatus for recording, transmission and reproduction of sound and images, installation and maintenance of electronic transmitting and receiving equipment [on-board units] for use on toll roads; installation, repair and maintenance of radio and telecommunication equipment as well as equipment for navigation, direction finding and localization, transmitters, transceivers, receivers, antennas, sensors, control and monitoring equipment; geofencing, namely, installation of control and monitoring devices in vehicles in defined areas; reservation of charging stations for users in the e-mobility sector; vehicle battery charging services at the charging stations with electricity from photovoltaics.

38 – Telecommunications (telecommunications services) including radio services, namely radio guidance of motor vehicles in industrial freight transportation; mobile telephony services; provision of online access for multilingual breakdown services, namely provision of access to technical expertise with regard to roadside assistance via the Internet; providing access to and transmission of messages, data and information on the Internet; telecommunication services for nationally and internationally operating industrial freight and commercial passenger transport services, namely the transmission of information about the state of roads, the traffic situation, the location of service stations, the location of vehicles, technical vehicle matters, the price of fuel at home and abroad via the Internet and radio services; transmission of information via computer servers, data transmission services with free access; telematics services, including freight tracking and proof management regarding the delivery of freight; data transmission services, namely data entry of geoposition, engine and speedometer data; transmission and exchange of information via multimedia carriers; telecommunications services for geolocalisation purposes; providing access to a worldwide computer network; providing connections to a worldwide computer network by means of telecommunications; delivery (transmission) of automated reports via electronic mail services; providing access to online data in computer networks; telephone services for hotlines; rental of telecommunications equipment for the transmission of messages and on-board units; professional consultancy on the field of telecommunications, in particular with regard to geolocalisation installations in connection with traffic conditions on road and motorway networks and with regard to on-board

units; telecommunications services for remote access to on-board units for the purpose of updating and/or extending the personalization data; transmission of charging/consumption data [in compliance with calibration regulations]; provision of access to data or documents stored in central files for remote diagnostics [Second Level Support]; telecommunication services for connected-car services [connected automobiles] in and outside the vehicle through remote access, either via a fixed communication model with integrated SIM card or via the hotspot function of an external device, e.g. a smartphone; provision of access to Internet platforms for connection to digital fleet maps; online-telephone services via an information, complaint and emergency hotline.

39 – Rental of construction vehicles and other special-purpose vehicles; tracking of passenger or freight vehicles by computer or via GPS (transport information); vehicle breakdown services, namely vehicle towing and rescue services; accident services, namely providing replacement vehicles, towing vehicles and a towing service; automobile towing services; car rental; rental services, namely rental of busses and vehicles for the freight forwarding sector; rental of vehicle accessories, in particular luggage racks, child safety seats, vehicle trailers, snow chains; transport of motor vehicles by rail; rolling road (intermodal transportation), namely transport systems whether or not accompanied for the combined railway traffic, namely transport of complete trucks or semi-tractor trailers by rail; packaging of goods; storage of goods; travel arrangements; transshipment of transport goods; information services for the nationally and internationally operating industrial freight and commercial passenger transport, namely providing information about the state of roads, the traffic situation, the location of service stations, the location of vehicles, technical vehicle matters; tracking of broken-down commercial vehicles with computers by means of computer-aided map systems as well as by means of electronic navigation and positioning devices; car navigation systems (road guidance systems) via mobile radiotelephony, namely controlling of fleet vehicles using electronic navigation and positioning apparatus as well as via radio services; transport services, in particular freight forwarding, except the customs clearance of goods; provision and operation of an online reservation system, namely provision of transport appointments for goods on the Internet; telephone advice via a call center on the execution of contracts for the rental of cars and trucks; advice in the field of transport, handled via hotlines; provision of information, namely city, travel and traffic information; delivery of teleshopping offers for others; booking of travel; parking space search service [provision of information on the availability and location of parking spaces, display of free parking spaces using electronic navigation and positioning devices]; itinerary travel advice services; route planning in the form of travel route consulting ser-

vices; freight brokerage; cash supply for third parties through delivery of cash by contractual partners; navigation services [IoT (Internet of Things)-based GPS positioning]; information services for nationally and internationally operating commercial goods and passenger transport with regard to road conditions, the traffic situation, the location of car stations, the location of vehicles, and technical data of vehicles; navigation and tracking services via user frontend [eOperated Portal/eCharge App] regarding the position of charging stations.

41 – Provision of multilingual breakdown services, namely interpreting services; reservation of tickets for entertainment events; organization of competitions; coaching with the aim of increasing the motivation of users, operators; holding of lecture events for cultural purposes and workshops [training]; education; training; entertainment; development of training and education concepts, including training and education events for education and training; organization of recreational events; organization of conferences; organization and holding of congresses; organization and holding of symposiums; organization and holding of colloquiums; organization and holding of training events related to franchising concepts; education and training in the field of franchising; publication and editing of books, brochures [except for promotional purposes] and training materials.

42 – Installation and maintenance of software for toll registration and toll invoicing devices as well as for systems for the global positioning and position recognition or recognition of passages, for electronic apparatus and instruments for geotracking via satellite, for transmitting and receiving apparatus [on-board units], for navigation apparatus; design and development of databases; creation, updating and maintenance of computer software and programs for data processing, except for the health insurance sector; operation of data centers, namely leasing of computer capacities; design and planning of telecommunications equipment; technological consultancy via help desk services and hotline services; technical development of magnetic and chip cards and other computer-aided verifications; electronic data storage; design of internet sites and homepages; creation of internet sites and homepages; drawing up of technical damage reports; IT services, namely setting up notification functions to send automated reports; research and preparation of technical reports in the field of industrial freight and commercial passenger transport services, namely preparation and technical evaluation of reports and statistics on the localization of vehicles in real time and for the transmission of data of vehicle use and vehicle handling [for example travel time, speed, accelerations] as well as comparison and evaluation of the GEO positions of vehicles with GEO positions of the maps used; creation of software for sending automated reports; creation of software for the remote

access to on-board units to update and/or extend the personalization data, for updating the software version of the on-board unit operating system, and for updating maps or other data relevant for toll collection; creation, installation and adaptation of application software for multimedia content delivery and customized software for navigation devices, smartphones, computers, except for health insurance; design and development of computer software for logistics, supply chain management and e-business portals; creation of computer software and programs for data processing, especially in the field of finance, insurance [except health insurance] and real estate; research and searches in databases for science and research; scientific and technological services and research and related design services; industrial analysis and research services; design and development of computer hardware and software, in particular the creation of computer software and programs, except for the health insurance sector; configuration and maintenance of charging infrastructure by means of computer software through remote access [remote maintenance]; updating of software and apps for mobile devices via over-the-air programming [OTA]; load management to control peak loads [energy sector], namely monitoring and controlling energy consumption (electrical energy); energy management in the form of software as a service [SaaS] for feeding in as well as controlling the amount of electricity consumed on the basis of statically stored limit values or dynamically acting systems; technical control of bi-directional charging processes including associated billing processes; quality assurance and optimization of POI [Point of Interest] by means of technical-mathematical consulting in the areas of algorithms and interface connections; programming of data export software; online provision of non-downloadable apps for the digitization of [fuel] cards to enable processing via online transactions without reading the card details of the physical card; provision of mobile applications to enable contactless payment with digitized fuel cards via an app at the terminal; provision of mobile applications [apps] to enable mobile payment transactions for DKV products [fuels, parking, tolls]; development and further development of a platform to connect other cards, e.g. Switch-Out, co-brand partners or other fuel cards, digitally in a wallet in addition to the DKV card and conducting the related required transactions; further development of a platform that enables acceptance of mobile transactions; development of a central platform to which card transaction acceptance points can be connected to enable the acceptance and processing of mobile transactions; technical consulting services and technical support in the field of software for the expansion of the electric charging infrastructure, especially for municipalities and private homes; online provision of non-downloadable white label apps [user surfaces] for carrying out the management of certain activities, especially in the field of electromobility, in

particular initiating and monitoring charging; design and development of software for connected-car [web-enabled networked automobiles having telematic functions] services in and outside the vehicle by remote access, either via a fixed communication model with integrated SIM card or via the hotspot function of an external device, e.g. a smartphone; provision of temporary use of web-based software for development environments with a structured graphical user interface [white label frontends]; user authentication services for access control via RFID [automatic identification and localization of living beings and data using electromagnetic waves], via app authorization and via QR code; technological consultancy for clients and users on computer networks; technical monitoring of charging infrastructure with regard to e.g. average consumption, charging times, fault messages, energy quantity; technical limit control of maximum purchase quantities, namely allocation of maximum purchase quantities of fuels.

43 – Reservation services for hotels.

45 – Legal services; security services for the protection of property and persons; personal and social services concerning individual needs, namely home guarding services, personal analysis and investigation services, personal shopping services, pastoral counseling, technical inspection and control of security devices and equipment [alarm circuits, alarm systems and technical security devices] by security services, social networking services, private letter writing, pet sitting services, political lobbying services, reminder services, companionship services; licensing of franchise concepts; licensing of industrial property rights and copyrights; management of copyrights and industrial property rights, in particular patents, utility models, designs, including trademark rights; legal services, namely legal prosecution within the framework of claims management; customer care through legal consultations in tax matters, in particular in the EU area, preferably within the framework of tax identification numbers (NIP), new deposits (NE) and deferrals of payments; consultancy in intellectual property and industrial property matters; licensing in intellectual property and industrial property matters, including in the field of copyrights; licensing of industrial property rights; legal consulting on taxation; legal consultancy services in the field of security, namely data protection, data security, data access, data archiving, certification, testifying (security strategies); consultancy relating to legal questions concerning road safety; providing advice in the area of workplace safety, namely in setting minimum standards for working conditions for workers posted by employers based abroad to provide services across borders in accordance with the EU directive 96/71/EC.

(260) AM 2022 115175 A
 (800) 1622915
 (151) 2021 05 18
 (891) 2021 05 18
 (731) Limited Liability Company "SENSE
 COSMETIC"
 apt. 1, 16 Nezavisimosti av., 220030 Minsk,
 Belarus

(540)



(591) Black, white
 (531) 26.11.01; 26.11.12; 27.05.01
 (511)

3 – Cosmetics; perfumery; lip glosses; petroleum jelly for cosmetic purposes; cotton wool for cosmetic purposes; toilet water; eau de parfum; make-up; deodorants for human beings; perfumes; cosmetic pencils; cosmetic dyes; hair spray; nail varnish; hair lotions, other than for medical use; lotions for cosmetic purposes; shaving lotions; beauty masks; oils for perfumes and scents; oils for cosmetic purposes; oils for toilet purposes; essential oils; oils for cleaning purposes; cleansing milk for toilet purposes; deodorant soap; cakes of toilet soap; antiperspirant soap; non-medicated liquid soaps; mint for perfumery; cosmetic kits; nail art stickers; false nails; eau de Cologne; lipsticks; pomades for cosmetic purposes; shaving preparations; cosmetic preparations for baths; hair straightening preparations; hair waving preparations; colour-removing preparations; make-up removing preparations; nail care preparations; collagen preparations for cosmetic purposes; sunscreen preparations; make-up powder; nail varnish removers; false eyelashes; tissues impregnated with cosmetic lotions; tissues impregnated with make-up removing preparations; eyebrow cosmetics; make-up preparations; sun-tanning preparations [cosmetics]; hair dyes; neutralizers for permanent waving; cosmetic preparations for skin care; mascara; bleaching preparations [decolorants] for cosmetic purposes; cotton swabs for cosmetic purposes; non-medicated shampoos; dry shampoos.

35 – Retail sale services of cosmetics, perfumery, lip glosses, petroleum jelly for cosmetic purposes, cotton wool for cosmetic purposes, toilet water, eau de parfum, make-up, deodorants for human beings, perfumes, cosmetic pencils, cosmetic dyes, hair spray, nail varnish, hair lotions, other than for medical use, lotions for cosmetic purposes, shaving lotions, beauty masks, oils for perfumes and scents, oils for cosmetic purposes, oils for toilet purposes, essential oils, oils

for cleaning purposes, cleansing milk for toilet purposes, deodorant soap, cakes of toilet soap, antiperspirant soap, non-medicated liquid soaps, mint for perfumery, cosmetic kits, nail art stickers, false nails, eau de Cologne, lipsticks, pomades for cosmetic purposes, shaving preparations, cosmetic preparations for baths, hair straightening preparations, hair waving preparations, colour-removing preparations, make-up removing preparations, nail care preparations, collagen preparations for cosmetic purposes, sunscreen preparations, make-up powder, nail varnish removers, false eyelashes, tissues impregnated with cosmetic lotions, tissues impregnated with make-up removing preparations, eyebrow cosmetics, make-up preparations, sun-tanning preparations [cosmetics], hair dyes, neutralizers for permanent waving, cosmetic preparations for skin care, mascara, bleaching preparations [decolorants] for cosmetic purposes, cotton swabs for cosmetic purposes, non-medicated shampoos, dry shampoo; advertising, including online advertising on a computer network; sales promotion for others; procurement services for others [purchasing goods and services for other businesses]; presentation of goods on communication media, for retail purposes; providing commercial information and advice for consumers in the choice of products and services.

(260) AM 2022 115176 A

(800) 1622934

(151) 2021 07 14

(891) 2021 07 14

(731) Apple Inc.

One Apple Park Way, Cupertino CA 95014,
USA

(540)



(591) Black, white

(531) 24.15.21; 26.04.04; 26.04.05; 26.04.16;
26.04.18; 26.11.12; 26.11.22

(511)

9 – Telecommunications apparatus and instruments in the nature of wireless receivers; wireless communication devices for the transmission of data; network communication apparatus in the nature of wireless receivers; computer hardware for use in finding, tracking, displaying, and sharing the geographic location of individuals and consumer goods, sending notifications on the geographic location of individuals, locating lost or missing consumer goods, and preventing unauthorized access to consumer goods; peripheral devices for computers, mobile telephones, mobile electronic devices, wearable electronic devices, and earphones; earphones; electronic tags for goods; hand-

held digital electronic devices capable of providing access to the internet and for the sending, receiving, and storing telephone calls, electronic mail, and other digital data; virtual and augmented reality displays, goggles, controllers, and headsets; headphones.

(260) AM 2022 115177 A

(800) 1622944

(151) 2021 07 06

(891) 2021 07 06

(731) Publichne aktsionerne tovarystvo "MOTOR
SICH"

15 Motorobudivnykiv Av, Shevchenkivsky
district, ZaporizhiaБ Zaporizhia region 69068,
Ukraine

(540)

МСБ

(591) Black, white

(531) 28.05

(511)

12 – Aircraft, in particular helicopters; air vehicles.

(260) AM 2022 115178 A

(800) 1622995

(151) 2021 07 26

(891) 2021 07 26

(731) JOINT STOCK COMPANY "KONTI-RUS"

ul. Zolotaia, 13, Kursk, RU-305000 Kursk
oblast, Russian Federation

(540)

KONTI SUN+MOON

(591) Black, white

(511)

30 – Cakes; confectionery; pastries; sweets; sugar
confectionery.

(260) AM 2022 115182 A

(800) 1623261

(151) 2021 09 23

(891) 2021 09 23

(731) Marussia Beverages B.V.

Siriusdreef 41, NL-2132 WT Hoofddorp,
Netherlands

(540)

NORTHERN GRAINS

(591) Black, white

(511)

33 – Alcoholic beverages (with the exception of beer);
spirits; vodka.

(260) AM 2022 115184 A
 (800) 710192
 (151) 1999 03 10
 (891) 2021 10 13
 (731) Josera GmbH & Co. KG
 Industriegebiet Süd, 63924 Kleinheubach,
 Germany
 (540)

Josera

(591) Black, white
 (511)
 31 – Foodstuffs for animals.

(260) AM 2022 115185 A
 (800) 1089928
 (151) 2011 03 22
 (891) 2021 10 06
 (731) CAN Technologies, Inc.
 15407 McGinty Road West, Wayzata
 MN 55391, USA
 (540)

NOTOX

(591) Black, white
 (511)
 5 – Feed supplements for animals for veterinary use.
 31 – Feedstuff for animals; additives to fodder, not for
 medical purposes.

(260) AM 2022 115186 A
 (800) 1101415
 (151) 2011 08 06
 (891) 2021 10 14
 (731) IAG Loyalty Limited
 Waterside, P.O. Box 365, Harmondsworth
 UB7 0GB, United Kingdom
 (540)



(591) Blaue, light blue
 (531) 26.03.18; 29.01.13
 (511)
 35 – Advertising, marketing and promotional services
 for airlines; advertising, organisation, promotion, operation,
 supervision and management of loyalty schemes,
 incentive schemes and frequent flier programs;

information, advice and assistance, all relating to the
 aforesaid services.

39 – Airline services; travel services; air transport services;
 travel booking services provided by travel agencies;
 travel booking, reservation and information services relating
 to travel; vehicle rental services; vehicle parking services;
 courier services; cargo storage and handling services;
 aircraft chartering services; package holiday services for
 arranging travel; booking and reservation services for tours;
 information services relating to all the aforementioned services.

(260) AM 2022 115187 A
 (800) 1190000
 (151) 2013 12 04
 (891) 2021 10 05
 (731) Imperial Tobacco Intellectual Property Limited
 21 Beckett Way, Park West, Nangor Road,
 Dublin 12, Ireland
 (540)



(591) Black, white
 (531) 24.13.01; 24.13.14; 27.05.02; 27.05.19
 (511)
 34 – Tobacco whether manufactured or unmanufactured;
 tobacco products; matches and smokers' articles;
 cigarette papers; cigarette tubes; cigarette filters;
 pocket cigarette rolling machines; hand-held machines for
 injecting tobacco into tubes.

(260) AM 2022 115188 A
 (800) 1268313
 (151) 2015 09 08
 (891) 2021 09 28
 (731) RADISSON HOSPITALITY BELGIUM
 BV/SRL
 Avenue du Bourget 44, B-1130 Brussels,
 Belgium
 (540)

RADISSON RED

(591) Black, white
 (511)
 43 – Hotels, hotel reservations, rental of meeting rooms,
 rental of temporary accommodation, cafes, restaurants,
 snack-bars, bar services.

(260) AM 2022 115192 A
 (800) 1370788
 (151) 2017 08 10
 (891) 2021 10 07
 (731) GOLDEN GOOSE S.P.A.
 Via Privata Ercole Marelli 10, I-20139
 MILANO, Italy

(540)

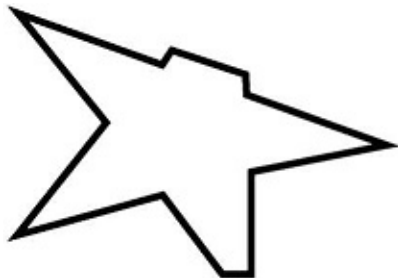

(591) Black, white

(531) 01.01.02; 01.01.14

(511)

18 – Leather and imitations of leather not included in other classes; animal skins, hides; trunks and travelling bags; umbrellas and parasols; walking sticks; whips, harness and saddlery; attaché cases; bags for sports; bags for climbers; bags for campers; bags; beach bags; fanny packs; boston bags; clutch bags (hand bags); holdalls; gladstone bags; gym bags; hiking bags; key bags; knitted bags; leather bags; overnight bags; cylinder bags; satchels; shoulder bags; baggage; multipurpose sports bags; bags for carrying pets; cloth shopping bags; carry-on bags; make-up bags, not fitted; bags (game -) [hunting accessories]; garment bags for travel; leather bags and wallets; net bags for shopping; travel bags for footwear; sling bags for carrying infants; shopping bags made of textile; leather bags, suitcases and wallets; bags (envelopes, pouches) of leather, for packaging; bags for jewellery of textile materials (empty); briefcases; card cases (notecases); credit card holders (wallets); handbag frames; hand bags; hat boxes of leather; haversacks; key cases [leatherware]; music cases; wallets; sling bags for carrying infants; purses; rucksacks; suitcase handles; briefcases; leather travelling suitcases; tool bags of leather, empty; baggage; travelling sets (leatherware); vanity cases, not fitted; boxes, of leather or leatherboard; cases, of leather or leatherboard; chin straps, of leather; coverings of skins (furs); fur; straps (leather -); leather laces; leather thongs; leather thread; leatherboard; moleskin (imitation of leather); leather shoulder straps; collars for animals.

25 – Clothing, footwear, headgear; clothing of imitations of leather; clothing of leather; clothing for gymnastics; dresses; bath robes; bandanas [neckerchiefs]; bibs, not of paper; berets; underwear; blouses; boas (necklets); braces for clothing; corsets; stockings; socks; shirts; bodices [lingerie]; coats; hoods (clothing); belts for clothing; money belts (clothing); tights; collars (clothing); detachable collars; ear muffs (clothing); layettes [clothing]; suits; beachwear; masquerade costumes; ties; ascots; headbands for clothing; pocket squares; jackets [clothing]; garters; skirts; pinafore dresses; girdles; gloves [clothing]; ski gloves; mackintoshes; knitwear [clothing]; jersey (clothing); leg warmers; leggings (trousers); liveries; hosiery; pullovers; muffs [clothing]; miniskirts; boxer shorts; waistcoats; trousers; parkas; furs (clothing);

pyjamas; wristbands (clothing); ponchos; suspender belts for women; sock suspenders; brassieres; sandals; bath sandals; shoes; bath shoes; gymnastic shoes; beach shoes; sports shoes; shawls; sashes for wear; underpants; overcoats; outerclothing; petticoats; slips (undergarments); ankle boots; boots; stoles (fur -); T-shirts; combinations (clothing); visors [hatmaking]; wooden shoes, excluding from all of the foregoing uniforms, aprons and work apparel.

(260) AM 2022 115193 A

(800) 1399976

(151) 2018 02 22

(891) 2021 09 25

(731) BTL Industries

8 Tzar Kaloyan str, BG-1000 Sofia, Bulgaria

(540)

EMSCULPT

(591) Black, white

(511)

10 – Medical and aesthetic apparatus and instruments, in particular apparatus and instruments generating electrical, magnetic, electromagnetic, mechanical or thermal therapeutic energy; medical and aesthetic apparatus and instruments, in particular apparatus and instruments for body shaping, fat removal, circumference reduction, skin tightening, cellulite reduction, skin rejuvenation, wrinkle reduction, scar reduction, stretch mark reduction; above medical apparatuses with exception for the treatment of the nasopharynx including inhalers and nasal irrigators; aesthetic massage apparatus, in particular apparatus for lymphatic drainage and increasing the circulation of bodily fluids; physical therapy apparatus, in particular apparatus for treating pain and preventing muscle cramps; aesthetic massage apparatus; gynaecological and urological apparatus and instruments; dental equipment; rehabilitation apparatus (body -) for medical purposes; physical therapy equipment; physiotherapy and rehabilitation equipment; beds specially made for medical purposes; contraceptive devices; artificial limbs; orthopedic articles; suture materials.

(260) AM 2022 115194 A

(800) 1417812

(151) 2018 06 26

(891) 2021 10 07

(731) HELADOS ESTIU, S.A.

Ctra. Manises a Ribarroja Km. 11,100,
E-46394 Ribarroja (Valencia), Spain

(540)

WAO

(591) Black, white

(511)

30 – Edible ices.

(260) AM 2022 115195 A
 (800) 1452931
 (151) 2018 11 21
 (891) 2021 10 07
 (731) HELADOS ESTIU, S.A.
 Ctra. Manises a Ribarroja Km. 11,100,
 E-46394 Ribarroja (Valencia), Spain
 (540)

WAO

(591) Black, white
 (511)

35 – Advertising; internet advertising (online); organization of events for commercial or advertising purposes; promotion of goods and services via event sponsorship; marketing; promotion of sales; sales promotions at points of purchase or sales promotions for third parties; sales promotion for others; advertising and sales promotion services; presentation of goods for retail purposes; import and export services for all kinds of food and beverage articles/products; distance and mail-order sales services for all kinds of food and beverage articles/products; wholesales, in-store retail sale services, sales services via global computer networks for all kinds of food and beverage articles/products; consultancy regarding marketing activities and launching of new products; brand creation; dissemination of advertisements via online communication networks; distribution of advertising matter via the internet; distribution of advertising matter online; distribution of advertising materials [leaflets, prospectuses and printed matter]; distribution of advertising matter by mail; distribution of publicity and advertising materials [leaflets, brochures, prospectuses and samples]; distribution of advertising for third parties via online electronic communication networks; distribution of advertising for third parties via the internet; distribution of pamphlets for advertising purposes; direct mail advertising [leaflets, prospectuses, printed matter, samples]; indexing of web pages for advertising purposes; organization of events, exhibitions, fairs and shows for commercial, promotional and advertising purposes; presentation of products on any communication means for retail purposes; presentation of products to the public; promotion of third-party products and services by means of advertisements on websites; promotion of the goods and services of others via the Internet; promotion of the goods and services of others via a global computer network; sales promotion via audiovisual media; On-line promotion of computer networks and web sites; providing advertising space in newspapers; providing advertising space in periodicals, newspapers and magazines; wholesale store services for ice cream; wholesale store services for dairy products; wholesale store services for frozen yogurt; retail store services for edible ices; retail store services for dairy products; retail store services for frozen yogurt; online retail store services for ice cream; online retail store services for edible products.

(260) AM 2022 115196 A
 (800) 1523358
 (151) 2020 01 28
 (891) 2021 08 02
 (731) GREEN PETITION DIŞ TİCARET ANONİM
 ŞİRKETİ
 Demirtaş Dumlupınar Osb Mah., Çiğdem 1
 Sk. 14, Osmangazi Bursa, Turkey
 (540)

GREENPETITION

(591) Green, gray
 (531) 27.05.01; 27.05.10; 29.01.12
 (511)

24 – Woven or non-woven textile fabrics; textile goods for household use, not included in other classes: curtains, bed covers, sheets (textile), pillowcases, blankets, quilts, towels; flags, pennants, labels of textile; swaddling blankets.

25 – Clothing, including underwear and outerclothing, other than special purpose protective clothing; socks, mufflers [clothing], shawls, bandanas, scarves, belts [clothing]; footwear, shoes, slippers, sandals; headgear, hats, caps with visors, berets, caps [headwear], skull caps.

35 – Import-export agencies; the bringing together, for the benefit of others, of a variety of goods, woven or non-woven textile fabrics, textile goods for household use: curtains, bed covers, sheets (textile), pillowcases, blankets, quilts, towels, flags, pennants, labels of textile, swaddling blankets, clothing, including underwear and outerclothing, other than special purpose protective clothing, socks, mufflers [clothing], shawls, bandanas, scarves, belts [clothing], footwear, shoes, slippers, sandals, headgear, hats, caps with visors, berets, caps [headwear], skull caps, enabling customers to conveniently view and purchase those goods, such services may be provided by retail stores, wholesale outlets, by means of electronic media or through mail order catalogues.

(260) AM 2022 115197 A
 (800) 1551914
 (151) 2020 07 29
 (891) 2021 09 23
 (731) Midea Group Co., Ltd.
 B26-28F, Midea Headquarter Building,
 No.6 Midea Avenue, Beijiao, Shunde, Foshan,
 Guangdong, China
 (540)

MK
 Master Kitchen

(591) Black, white
(531) 27.05.22
(511)

7 – Churns; mills [machines]; butter machines; food preparation machines, electromechanical; beverage preparation machines, electromechanical; dishwashers; fruit presses, electric, for household purposes; blenders, electric, for household purposes; kitchen machines, electric; beaters, electric; food processors, electric; coffee grinders, other than hand-operated; washing machines [laundry]; industrial robots; dynamos; garbage disposal units; dust exhausting installations for cleaning purposes.

11 – Soya milk making machines, electric; cooking utensils, electric; kettles, electric; microwave ovens [cooking apparatus]; food steamers, electric; autoclaves, electric, for cooking; pressure cookers, electric; coffee machines, electric; bread-making machines; multicookers; cooking apparatus and installations; heating and cooling apparatus for dispensing hot and cold beverages; cooking stoves; roasters; heated display cabinets; kitchen ranges [ovens]; bread toasters; air fryers; refrigerators; ice machines and apparatus; freezers; cooling appliances and installations; fans [air-conditioning]; air purifying apparatus and machines; air-conditioning installations; extractor hoods for kitchens; heat pumps; burners; fireplaces, domestic; dampers [heating]; hot air ovens; microwave ovens for industrial purposes; heating boilers; heating apparatus, electric; heating plates; steam generating installations; water heaters; heating apparatus; heating installations; pipes [parts of sanitary installations]; bath installations; water purifying apparatus and machines; water filtering apparatus; disinfectant apparatus; water purification installations; water sterilizers; oil-scrubbing apparatus; radiators, electric; gas lighters; roasting apparatus.

(260) AM 2022 115198 A
(800) 1571815
(151) 2020 12 02
(891) 2021 10 05
(731) Radisson Hospitality Belgium B.V. / S.R.L.
Avenue du Bourget 44, B-1130 Brussel,
Belgium
(540)

RADISSON
Individuals.

(591) Black, white
(531) 24.17.02; 27.05.09; 27.05.10
(511)
43 – Hotel, bar and restaurant services; services for the reservation of rooms.

(260) AM 2022 115199 A
(800) 1578600
(151) 2020 11 24
(891) 2021 09 30
(731) AMBROVIT S.P.A.
VIA VICENZO MONTI, 4, I-20123 MILANO
(MI), Italy
(540)

AMBROVIT

(591) Black, white
(511)
6 – Screws of metal, common metals and their alloys, metal building materials; metal materials for railways; locks of metal, fasteners of metal and metal hardware.

(260) AM 2022 115251 A
(800) 1623693
(151) 2021 09 27
(891) 2021 09 27
(731) CPS TECHNOLOGY HOLDINGS LLC
250 VESEY STREET, 15TH FLOOR,
NEW YORK NY 10281, USA
(540)

OPTIMA

(591) Black, white
(511)
9 – Batteries; battery chargers.

(260) AM 2022 115253 A
(800) 1623725
(151) 2021 09 28
(891) 2021 09 28
(731) Montres Tudor SA
Rue François-Dussaud 3, CH-1211 Genève 26,
Switzerland
(540)



(591) Blue, white
(531) 17.01.03; 24.01.03; 27.05.01; 27.05.09;
27.05.10
(511)
14 – Timepieces, namely, watches, wrist-watches, component parts for timepieces and accessories for timepieces not included in other classes, clocks and other chronometric instruments, chronometers, chronographs (timepieces), watch bands, dials (timepie-

ces), boxes and cases for timepieces and jewelry, watch movements and their parts; jewelry, jewelry items; precious stones and semi-precious stones; precious metals and alloys thereof; pins (jewelry).

(260) AM 2022 115301 A
 (800) 1601309
 (151) 2021 05 28
 (891) 2021 10 07
 (731) Alpen Pharma AG
 Finkenhubelweg 16, CH-3012 Bern,
 Switzerland
 (540)

ALPENTO

(591) Black, white
 (511)
 5 – Pharmaceutical products, medical and veterinary preparations; hygienic products for medicine; dietetic substances and foodstuffs for medical or veterinary use, food for babies; food supplements for humans and animals; plasters, materials for dressings; material for dental fillings and dental impressions; disinfectants; products for destroying vermin; fungicides, herbicides.

(260) AM 2022 115362 A
 (800) 1624672
 (151) 2021 09 24
 (891) 2021 09 24
 (731) Henkel AG & Co. KgaA
 Henkelstr. 67, 40589 Düsseldorf, Germany
 (540)

THE THICKENER

(591) Black, white
 (511)
 3 – Preparations for the conditioning, cleaning, tinting, dyeing, bleaching, fixing and waving of hair, hair lotions and shampoos for cosmetic purposes.

(260) AM 2022 115363 A
 (800) 1624673
 (151) 2021 09 24
 (891) 2021 09 24
 (731) Henkel AG & Co. KgaA
 Henkelstr. 67, 40589 Düsseldorf, Germany
 (540)

THE DEFINER

(591) Black, white
 (511)
 3 – Preparations for the conditioning, cleaning, tinting, dyeing, bleaching, fixing and waving of hair, hair lotions and shampoos for cosmetic purposes.

(260) AM 2022 115364 A
 (800) 1624757
 (151) 2021 08 11
 (891) 2021 08 11
 (731) Joh. Wilh. von Eicken GmbH
 Drechslerstr. 1-3, 23556 Lübeck, Germany
 (540)

Slam

(591) Black, white
 (511)
 34 – Tobacco, processed and unprocessed; tobacco products, in particular cigars, cigarettes, cigarillos, smoking tobacco, chewing tobacco, snuff, water pipe tobacco; cigarette papers; cigarette tubes; cigarette filters; matches; smokers' articles, as far as included in this class.

(260) AM 2022 115365 A
 (800) 1624790
 (151) 2021 09 24
 (891) 2021 09 24
 (731) Dr. Ing. h.c. F. Porsche Aktiengesellschaft
 Porscheplatz 1, 70435 Stuttgart, Germany
 (540)

PIWIS

(591) Black, white
 (511)
 9 – Computer hardware and software for vehicle diagnostics.

(260) AM 2022 115366 A
 (800) 1624899
 (151) 2021 07 23
 (891) 2021 07 23
 (731) "KERAMIN" Joint Stock Company
 office 1, Serova str. 22, 220024 Minsk, Belarus
 (540)



(591) Red and white
 (531) 26.04.18; 28.05; 29.01.12
 (511)
 11 – Bidets; flushing tanks; toilet bowls; toilet seats; water flushing installations; wash-hand basins [parts of sanitary installations]; sanitary apparatus and installations; urinals being sanitary fixtures; bath installations.

19 – Bricks; mosaics for building; wall claddings, not of metal, for building; tiles, not of metal, for building; floor tiles, not of metal; wall tiles, not of metal.

21 – Statues of porcelain, ceramic, earthenware, terra-cotta or glass; works of art of porcelain, ceramic, earthenware, terra-cotta or glass.

35 – Business management assistance; business management consultancy; demonstration of goods; commercial or industrial management assistance; business organization consultancy; sales promotion for others.

(260) AM 2022 115367 A

(800) 1624919

(151) 2021 09 30

(891) 2021 09 30

(731) Janssen Pharmaceutica NV

Turnhoutseweg 30, B-2340 Beerse,
Belgium

(540)

TECVAYLI

(591) Black, white

(511)

5 – Human pharmaceutical preparations.

(260) AM 2022 115368 A

(800) 1624922

(151) 2021 09 17

(891) 2021 09 17

(731) DAIICHI SANKYO COMPANY, LIMITED

3-5-1, Nihonbashi Honcho, Chuo-ku, Tokyo
103-8426, Japan

(540)

ЭНХЕРТУ

(591) Black, white

(531) 28.05

(511)

5 – Pharmaceutical preparations and substances; medicines for human purposes.

(260) AM 2022 115369 A

(800) 1624942

(151) 2021 07 13

(891) 2021 07 13

(731) GLOTT ENTERPRISE LTD

Kemp House, 152-160 City Road, London
EC1V 2NX, United Kingdom

(540)

glott

(591) Black, white

(511)

35 – Online advertising; online advertising; online advertising services; providing searchable online advertising guides; online advertising on computer networks; dissemination of advertising matter online; online advertising on a computer network; online advertising network matching services for connecting advertisers to websites; online advertising via a computer communications network; dissemination of advert-

ising via online communications networks; advertising the goods and services of online vendors via a searchable online guide; online marketing; providing a searchable online advertising guide featuring the goods and services of online vendors; advertising; online ordering services; advertising and advertisement services; radio advertising; cinema advertising; advertising agencies; newspaper advertising; television advertising; advertising analysis; classified advertising; elevator advertising; online business networking services; banner advertising; advertising planning; advertising consultation; advertising research; advertising copywriting; on-line member-based community media brand marketing services; online data processing services; response advertising; advertising services; recruitment advertising; magazine advertising; outdoor advertising; advertising and marketing; electronic billboard advertising; cinematographic film advertising; promotional advertising services; press advertising services; providing advertising services; direct mail advertising; mail-order advertising; direct market advertising; political advertising services; providing advertising space; creating advertising material; mediation of advertising; personnel recruitment advertising; arrangement of advertising; advertising of cinemas; dissemination of advertisements; advertisement hoarding rental; rental of advertisement space and advertising material; press advertising consultancy; advertisements (preparing of -); updating advertising material; graphic advertising services; advertising agency services; publicity and advertising; taxi top advertising; preparation of advertisements; advertising flyer distribution; advertisements (placing of -); advertising and publicity; compilation of advertisements; on-line advertising; classified advertising services; digital advertising services; advertising research services; advertising for others; compilation of online business directories; provision of advertising space; advertising and marketing consultancy; production of advertising matter; production of radio advertisements; promotional and advertising services; distribution of advertising leaflets; hire of advertising equipment; advertising and publicity services; promotion [advertising] of travel; preparation of advertising material; advertising via the Internet; rental of advertising space; consultancy relating to advertising; consultations relating to advertising; pay per click advertising.

(260) AM 2022 115370 A

(800) 1624953

(151) 2021 07 05

(891) 2021 07 05

(731) Obshchestvo S Ogranichennoy, Otvetstvennostyu "Global Fashion"
ul. Pererva, d. 74, kv. 116, RU-109559
Moscow, Russian Federation

(540)



GLOBAL FASHION

(591) Black, white

(531) 03.07.04; 03.07.24

(511)

3 – Abrasives; amber [perfume]; aromatics [essential oils]; air fragrancing preparations; balms, other than for medical purposes; lip glosses; polishing stones; abrasive paper; polishing paper; petroleum jelly for cosmetic purposes; cotton wool for cosmetic purposes; adhesives for cosmetic purposes; scented water; Javelle water; lavender water; toilet water; depilatory wax; moustache wax; polishing wax; massage gels, other than for medical purposes; heliotropine; make-up; depilatory preparations; air fragrance reed diffusers; scented wood; perfumes; greases for cosmetic purposes; perfumery; decorative transfers for cosmetic purposes; ionone [perfumery]; shaving stones [astringents]; smoothing stones; eyebrow pencils; cosmetic pencils; silicon carbide [abrasive]; carbides of metal [abrasives]; alum stones [astringents]; tripoli stone for polishing; adhesives for affixing false eyelashes; adhesives for affixing false hair; hair conditioners; beard dyes; cosmetic dyes; polishing creams; cosmetic creams; skin whitening creams; hair spray; nail varnish; hair lotions; lotions for cosmetic purposes; beauty masks; oils for perfumes and scents; oils for cosmetic purposes; oils for toilet purposes; essential oils; essential oils of cedarwood; essential oils of lemon; essential oils of citron; bergamot oil; gaultheria oil; jasmine oil; lavender oil; almond oil; rose oil; oil of turpentine for degreasing; almond milk for cosmetic purposes; cleansing milk for toilet purposes; musk [perfumery]; deodorant soap; shaving soap; soap for brightening textile; cakes of toilet soap; mint for perfumery; cosmetic kits; emery; nail art stickers; false nails; eau de Cologne; bases for flower perfumes; joss sticks; lipstick cases; hydrogen peroxide for cosmetic purposes; sandcloth; glass cloth [abrasive cloth]; lipsticks; pomades for cosmetic purposes; shaving preparations; cosmetic preparations for baths; hair straightening preparations; hair waving preparations; grinding preparations; colour-removing preparations; leather bleaching preparations; polishing preparations; cosmetic preparations for slimming purposes; paint stripping preparations; lacquer-removing preparations; make-up removing preparations; varnish-removing preparations; nail care preparations; collagen preparations for cosmetic purposes; aloe vera preparations for cosmetic purposes; sunscreen preparations; shining preparations [polish]; make-up powder; diamantine [abrasive]; nail varnish removers; scouring solutions; false eyelashes; tissues impregnated with cosmetic lotions; tissues impregnated with make-up

removing preparations; safrol; potpourris [fragrances]; leather preservatives [polishes]; astringents for cosmetic purposes; eyebrow cosmetics; make-up preparations; sun-tanning preparations [cosmetics]; hair dyes; neutralizers for permanent waving; cosmetic preparations for eyelashes; cosmetic preparations for skin care; cosmetics; cosmetics for children; mascara; degreasers, other than for use in manufacturing processes; bleaching preparations [decolorants] for cosmetic purposes; cotton swabs for cosmetic purposes; terpenes [essential oils]; emery cloth; henna [cosmetic dye]; dry shampoos; shampoos; sandpaper; herbal extracts for cosmetic purposes; extracts of flowers [perfumes]; ethereal essences; badian essence; mint essence [essential oil].

8 – Glaziers' diamonds [parts of hand tools]; razors, electric or non-electric; sharpening steels; gimlets [hand tools]; cutlery; edge tools [hand tools]; abrading instruments [hand instruments]; implements for decanting liquids [hand tools]; depilation appliances, electric and non-electric; sharpening instruments; blade sharpening instruments; polishing irons [glazing tools]; ear-piercing apparatus; cutting tools [hand tools]; hand tools, hand-operated; sharpening stones; centre punches [hand tools]; annular screw plates; grindstones [hand tools]; blades [hand tools]; razor blades; beard clippers; hair clippers for personal use, electric and non-electric; taps [hand tools]; manicure sets; manicure sets, electric; pedicure sets; bits [hand tools]; needle files; files [tools]; emery files; shaving cases; hobby knives [scalpels]; knives; shearers [hand instruments]; scissors; stirring sticks for mixing paint; emery boards; nail files; nail files, electric; shear blades; hair braiders, electric; tool belts [holders]; punches [hand tools]; cutters; bits [parts of hand tools]; scrapers [hand tools]; razor cases; pliers; curling tongs; cuticle tweezers; eyelash curlers.

35 – Commercial information agency services; advertising agency services; employment agency services; demonstration of goods; opinion polling; market studies; marketing research; personnel management consultancy; marketing; business management of performing artists; updating of advertising material; organization of exhibitions for commercial or advertising purposes; organization of trade fairs for commercial or advertising purposes; business management assistance; promotion of goods and services through sponsorship of sports events; production of advertising films; distribution of samples; dissemination of advertising matter; advertising; online advertising on a computer network; bill-posting; wholesale services for pharmaceutical, veterinary and sanitary preparations and medical supplies; retail services for pharmaceutical, veterinary and sanitary preparations and medical supplies; modelling for advertising or sales promotion; procurement services for others [purchasing goods and services for other businesses]; outsourcing services [business assistance].

41 – Academies [education]; videotaping; production of music; practical training [demonstration]; training services provided via simulators; organization of exhibitions for cultural and educational purposes; providing recreation facilities; arranging and conducting of conferences; arranging and conducting of workshops [training]; arranging and conducting of seminars; organization of competitions [education or entertainment]; arranging of beauty contests; organization of cosplay entertainment events; organization of fashion shows for entertainment purposes; vocational guidance [education or training advice]; vocational retraining; educational examination; entertainer services; entertainment services; party planning [entertainment]; club services [entertainment or education]; teaching; coaching [training]; production of shows.

44 – Hair implantation; pharmacy advice; manicuring; massage; hairdressing; body piercing; beauty salon services; tattooing; visagists' services; solarium services.

(260) AM 2022 115371 A

(800) 1624956

(151) 2021 08 23

(891) 2021 08 23

(731) Alpha Pharmaceutical Sp. z o.o.
ul. Pirenejska 9 lok. 28, PL-01-493 Warszawa,
Poland

(540)

SOLISTA

(591) Black, white

(511)

5 – Dietary supplements for humans, namely for treating throat diseases; lozenges for pharmaceutical purposes, namely for treating throat diseases.

10 – Medical devices for treatment of throat diseases.

(260) AM 2022 115372 A

(800) 1624989

(151) 2021 10 05

(891) 2021 10 05

(731) Velinor AG
c/o Dr. iur. Adrian von Segesser, Kapellplatz 1,
CH-6004 Luzern, Switzerland

(540)

IWILFIN

(591) Black, white

(511)

5 – Pharmaceutical preparations for use in cancer prevention and treatment; pharmaceutical preparations and substances for neuroblastoma treatment.

(260) AM 2022 115373 A

(800) 1625005

(151) 2021 05 12

(891) 2021 05 12

(731) PepsiCo, Inc., (a North Carolina corporation)
700 Anderson Hill Road, Purchase NY 10577,
USA

(540)



(591) Beige, white, red, yellow, light yellow, green, light green, blue, light blue, purple, gray, black, brown

(531) 05.03.11; 05.03.15; 05.07.19; 05.09.06;
08.03.08; 08.03.12; 08.07.08; 19.07.02;
27.05.08; 29.01.15

(511)

29 – Potato-based dumplings; vegetables, processed; vegetables, cooked; hash browns; potato fritters; olives, preserved; potato flakes; potato crisps; low-fat potato crisps; fruit chips.

(260) AM 2022 115374 A

(800) 1625011

(151) 2021 07 22

(891) 2021 07 22

(731) Domogatskiy Sergey Aleksandrovich
Mikrorayon str., 7, flat 2, Vedenskoe Village,
RU-143821 Lotoshinskiy District, Moscow
Region, Russian Federation

(540)



(591) Black, white

(531) 07.01.24; 07.03.11; 28.05

(511)

6 – Fittings of metal for building; beams of metal; joists of metal; swimming pools [structures] of metal; arbours [structures] of metal; window pulleys of metal; letters and numerals of common metal, except type; gates of metal; signboards of metal; nuts of metal; nails; doors of metal; folding doors of metal; prefabricated houses [kits] of metal; chimney shafts of metal; wall plugs of metal; jalousies of metal; outdoor blinds of metal; iron slabs; door bolts of metal; window fasteners of metal; bolts, flat; locks of metal, other than electric; spring locks; latches of metal; fences of metal; buckles of common metal [hardware]; bronzes [works of art]; works of art of common metal; framework of metal for building; cornices of metal; keys of metal; bed casters of metal; furniture casters of metal; pillars of metal for building; chimney cowls of metal; pegs of metal; door fittings of metal; fittings of metal for windows; brackets of metal for building; buildings of metal; buildings, transportable, of metal; steel buildings; containers of metal [storage, transport]; door frames of metal; tool boxes of metal, empty; stringers [parts of staircases] of metal; brackets of metal for furniture; roofing of metal; roofing of metal, incorporating photovoltaic cells; hooks of metal for clothes rails; scaffolding of metal; staircases of metal; ladders of metal; steel sheets; reinforcing materials, of metal, for concrete; reinforcing materials of metal for pipes; reinforcing materials of metal for building; building materials of metal; refractory construction materials of metal; metal knockers; porches [structures] of metal; flashing of metal for building; roof flashing of metal; laths of metal; palings of metal; window stops of metal; windows of metal; ironwork for doors; ironwork for windows; props of metal; branching pipes of metal; elbows of metal for pipes; wainscotting of metal; building panels of metal; partitions of metal; lintels of metal; casement windows of metal; strap-hinges of metal; tiles of metal for building; slabs of metal for building; floors of metal; sills of metal; window frames of metal; frames of metal for building; tanks of metal; furnace fireguards of metal; gratings of metal; runners of metal for windows; door handles of metal; knobs of metal; junctions of metal for pipes; shutters of metal; statues of common metal; figurines of common metal; step stools of metal; stair treads [steps] of metal; chests of metal; wire cloth; ducts of metal for ventilating and air-conditioning installations; drain pipes of metal; chimneys of metal; pipes of metal; ducts of metal, for central heating installations; steel pipes; angle irons of metal; door fasteners of metal; window openers of metal, non-electric; door panels of metal; flanges of metal [collars]; weather- or wind-vanes of metal; fittings of metal for beds; fittings of metal for furniture; pantiles of metal; roofing tiles of metal; window casement bolts; roller blinds of steel; screws of metal; latch bars of metal; tool chests of metal, empty; boxes of common metal.

19 – Door frames, not of metal; window frames, not of metal; asbestos cement; asphalt; beams, not of metal; balustrades, not of metal; swimming pools [structures], not of metal; arbours [structures], not of metal; concrete; plastic landscape edgings; joists, not of metal; building paper; busts of stone, concrete or marble; stained-glass windows; gates, not of metal; gypsum; plaster; granite; armoured doors, not of metal; doors, not of metal; folding doors, not of metal; prefabricated houses [kits], not of metal; parquet floor boards; wood for making household utensils; veneer wood; mouldable wood; chimney shafts, not of metal; outdoor blinds, not of metal and not of textile; jalousies, not of metal; roof gutters, not of metal; street gutters, not of metal; fences, not of metal; works of stonemasonry; works of art of stone, concrete or marble; artificial stone; building stone; greenhouse frames, not of metal; cornices, not of metal; wood pulp board for building; paperboard for building; bricks; firebricks; drain traps [valves], not of metal or plastic; cask wood; pillars, not of metal, for building; brackets, not of metal, for building; buildings, not of metal; buildings, transportable, not of metal; stringers [parts of staircases], not of metal; roofing, not of metal; manufactured timber; sawn timber; building timber; wood, semi-worked; staircases, not of metal; reinforcing materials, not of metal, for building; bituminous products for building; tar; pitch; building materials, not of metal; refractory construction materials, not of metal; mosaics for building; mouldings, not of metal, for cornices; mouldings, not of metal, for building; marble; porches [structures], not of metal; flashing, not of metal, for building; roof flashing, not of metal; duckboards, not of metal; wall claddings, not of metal, for building; laths, not of metal; wood panelling; wall linings, not of metal, for building; windows, not of metal; wainscotting, not of metal; building panels, not of metal; parquet flooring; partitions, not of metal; casement windows, not of metal; planks of wood for building; wall tiles, not of metal; floor tiles, not of metal; tiles, not of metal, for building; cement slabs; slabs, not of metal, for building; roofing, not of metal, incorporating photovoltaic cells; wooden floor boards; cladding, not of metal, for building; linings, not of metal, for building; fireplace mantles, not of metal; door panels, not of metal; floors, not of metal; sills, not of metal; ceilings, not of metal; mortar for building; asbestos mortar; furrings of wood; vinyl siding; pilings, not of metal; shutters, not of metal; statues of stone, concrete or marble; figurines of stone, concrete or marble; window glass for building; window glass, other than vehicle window glass; building glass; plate glass [windows] for building; insulating glass for building; enamelled glass, for building; posts, not of metal; stair-treads [steps], not of metal; penstock pipes, not of metal; water-pipes, not of metal; gutter pipes, not of metal; ducts, not of metal, for ventilating and air-conditioning installations; drain pipes, not of metal; chimneys, not of metal; rigid pipes, not of me-

tal, for building; angle irons, not of metal; plywood; foundry moulds, not of metal; cement for blast furnaces; cement; pantiles, not of metal; roofing tiles, not of metal; slate; roofing slates; slag [building material]; slag stone; railway sleepers, not of metal; wood veneers; clinker ballast; concrete building elements.

35 – Computerized file management; invoicing; demonstration of goods; opinion polling; market studies; providing commercial information and advice for consumers in the choice of products and services; updating and maintenance of information in registries; updating and maintenance of data in computer databases; updating of advertising material; organization of exhibitions for commercial or advertising purposes; organization of fashion shows for promotional purposes; organization of exhibitions and trade fairs for commercial or advertising purposes; shop window dressing; development of advertising concepts; payroll preparation; data search in computer files for others; providing business information via a website; providing commercial and business contact information; provision of an online marketplace for buyers and sellers of goods and services; web indexing for commercial or advertising purposes; presentation of goods on communication media, for retail purposes; auctioneering; retail and wholesale services for building materials; retail or wholesale services of building materials, including on-line retail and wholesale store services of building materials; sales promotion for others; distribution of samples; registration of written communications and data; advertising; online advertising on a computer network; bill-posting; compilation of information into computer databases; systemization of information into computer databases; procurement services for others [purchasing goods and services for other businesses]; outsourcing services [business assistance].

37 – Building sealing; building insulating; providing information relating to repairs; providing construction information; bricklaying; riveting; construction consultancy; varnishing; scaffolding; window cleaning; upholstering; paper hanging; cleaning of buildings [exterior surface]; plumbing; masonry; roofing services; painting services; carpentry services; plastering; pump repair; upholstery repair; furniture restoration; demolition of buildings; construction; cleaning of buildings [interior]; vermin exterminating, other than for agriculture, aquaculture, horticulture and forestry; installation of doors and windows; elevator installation and repair; heating equipment installation and repair; furnace installation and repair; installation and repair of air-conditioning apparatus; fire alarm installation and repair; freezing equipment installation and repair; kitchen equipment installation; furniture maintenance.

42 – Design of interior decor for shops; industrial design; graphic arts design; engineering; textile testing; research and development of new products for others; technical surveys; architectural consultancy; technolo-

gical consultancy; quality control; design of interior decor; urban planning; conducting technical project studies; hosting computer sites [web sites]; construction drafting; computer software design; creating and designing website-based indexes of information for others [information technology services]; technical writing; architectural services; styling [industrial design]; electronic data storage; surveying.

(260) AM 2022 115375 A

(800) 1625012

(151) 2021 07 23

(891) 2021 07 23

(731) SIGMA-ELEKTRO GmbH

Dr.-Julius-Leber-Straße 15, 67433 Neustadt,
Germany

(540)



(591) Green, red, white and black

(531) 01.15.03; 06.01.04; 26.03.04; 26.03.12;

26.03.24; 26.11.01; 26.11.13; 29.01.14

(511)

9 – Recorded data; information technology and audiovisual, multimedia and photographic devices; optical devices and equipment, amplification devices and correctors; apparatus, instruments and cables for electricity; navigation, orientation, location tracking, target tracking and mapping devices; measuring, detecting, monitoring and controlling devices; safety, security, protection and signalling devices and equipment; magnets, magnetizing and demagnetizing devices; tachometers, odometers, pulsemeters, not for medical purposes, location devices and altimeters, also on radio-technical basis, heartbeat monitors, not for medical purposes; power meters; interface apparatus or programs for computers for the evaluation and storage of data; recording apparatus; bicycle computers, in particular devices for measuring speed and time, pedal frequency meters; combination devices containing computers for the measurement of different physical parameters, chemical and biological values and conversion thereof; software; computer software for data processing; computer software for Global Positioning Systems [GPS]; software for network and device security of an e-bike; computer and computer hardware; computers for use with bicycles; computer for use with motor bicycles; computer controllers; wireless remote controls for portable electronic devices and computers; mounting devices for monitors; controllers and regulators; data processing devices and equipment as well as accessories (electrical and mechanical);

portable navigation devices; Global Positioning System [GPS] apparatus; GPS navigation devices; data transfer devices, transmitter-receiver-units, on-board networks, operating elements, display devices (displays) for control units, in particular for e-bikes; recorded media; smartwatches; portable activity trackers; personal electronic devices for tracking fitness goals and fitness statistics, namely fitness wristbands (measuring instruments); cables for smartwatches; wristbands for smartwatches; batteries and chargers for batteries, in particular for e-bike motors; spectacles, sunglasses; electric locks for bicycles; head protection; parts and accessories for all the aforesaid goods, included in this class.

11 – Lighting and lighting reflectors; bicycle lamps; bicycle lights; bicycle reflectors; headlamps; camping lighting; parts and accessories for all the aforesaid goods, included in this class.

(260) AM 2022 115386 A

(800) 1625596

(151) 2021 10 08

(891) 2021 10 08

(731) Apple Inc.

One Apple Park Way; Cupertino CA 95014,
USA

(540)

XCODE CLOUD

(591) Black, white

(511)

42 – Design and development of computer software; computer software consulting; cloud computing featuring software for use in designing, developing, testing, reviewing, releasing, and distributing other software applications; providing online non-downloadable computer software for use in developing, testing, reviewing, releasing, and distributing other software applications; providing online non-downloadable application development software; providing computer software information online; technical support services, namely, diagnosing and troubleshooting of computer software problems.

(260) AM 2022 115387 A

(800) 1625639

(151) 2021 03 08

(891) 2021 03 08

(731) ÜNAL KABLO SANAYİ VE TİCARET
ANONİM ŞİRKETİ

Tekstilkent Cad Koza Plaza B, Blok No:12
A Kat:15 İç No:54, Esenler Esenler, Istanbul,
Turkey

(540)

UNALKABLO

Cable Systems

(591) Orange, black and white

(531) 27.05.10; 27.05.11; 29.01.12

(511)

9 – Plastic covered electric wires and cables, power cables.

(260) AM 2022 115389 A

(800) 1625795

(151) 2021 06 30

(891) 2021 06 30

(731) ZIG P.H. PRIMARY HOLDINGS LTD

22 Iroon Polytechniou, ROTOS CHRISTIANA
BLOCK C, 1st floor office 104, Palouriotissa,
CY-1048 Nicosia, Cyprus

(540)



(591) Dark green, light green and white

(531) 26.04.18; 27.05.01; 29.01.12

(511)

35 – Advertising; business management; administration of businesses; administrative assistance in responding to requests for proposals [RFPs]; administrative assistance in responding to calls for tenders; administrative processing of purchase orders; administrative services for the relocation of businesses; administration of consumer loyalty programs; cost price analysis; business auditing; financial auditing; auctioneering; outsourced administrative management for companies; accounting; negotiation of business contracts for others; market studies; opinion polling; invoicing; payroll preparation; demonstration of goods; business inquiries; business management assistance; commercial or industrial management assistance; advisory services for business management; business research; economic forecasting; providing user reviews for commercial or advertising purposes; providing business information via a website; providing business information; providing commercial and business contact information; providing commercial information and advice for consumers in the choice of products and services; providing user rankings for commercial or advertising purposes; compilation of information into computer databases; compilation of statistics; web indexing for commercial or advertising purposes; business management of performing artists; business management for freelance service providers; business management of hotels; business management of sports people; business management of reimbursement programmes for others; interim business management; co-

mmercial administration of the licensing of the goods and services of others; computerized file management; personnel management consultancy; business management consultancy; consultancy regarding advertising communication strategies; consultancy regarding public relations communication strategies; business organization consultancy; marketing; marketing in the framework of software publishing; targeted marketing; marketing research; provision of an online marketplace for buyers and sellers of goods and services; writing of publicity texts; scriptwriting for advertising purposes; word processing; updating of advertising material; updating and maintenance of data in computer databases; updating and maintenance of information in registries; organization of exhibitions for commercial or advertising purposes; organization of fashion shows for promotional purposes; organization of trade fairs; organizing and conducting various events, campaigns, promotions, media promotions, surveys, contests and presentations for commercial or advertising purposes; rental of advertising space; shop window dressing; business appraisals; personnel recruitment; business management and organization consultancy; business intermediary services relating to the matching of potential private investors with entrepreneurs needing funding; commercial information agency services; employment agency services; business efficiency expert services; outsourcing services (business assistance); business project management services for construction projects; competitive intelligence services; corporate communications services; layout services for advertising purposes; appointment reminder services (office functions); news clipping services; website traffic optimisation; price comparison services; market intelligence services; procurement services for others (purchasing goods and services for other businesses); media relations services; gift registry services; tax filing services; import-export agency services; modelling for advertising or sales promotion; advertising agency services; secretarial services; public relations; commercial lobbying services; commercial intermediation services; online retail services for downloadable digital music; online retail services for downloadable ring tones; online retail services for downloadable and pre-recorded music and movies; retail services for works of art provided by art galleries; data search in computer files for others; sponsorship search; search engine optimisation for sales promotion; presentation of goods on communication media, for retail purposes; telephone answering for unavailable subscribers; rental of billboards (advertising boards); office machines and equipment rental; rental of office equipment in co-working facilities; publicity material rental; rental of advertising time on communication media; rental of vending machines; rental of sales stands; rental of photocopying machines; direct mail advertising; psychological testing for the selection of personnel; publication of publicity texts; radio advertising; registration of written com-

munications and data; pay per click advertising; outdoor advertising; advertising by mail order; online advertising on a computer network; bill-posting; distribution of samples; dissemination of advertising matter; development of advertising concepts; business investigations; systemization of information into computer databases; drawing up of statements of accounts; compiling indexes of information for commercial or advertising purposes; consumer profiling for commercial or marketing purposes; sales promotion for others; promotion of goods and services through sponsorship of sports events; production of advertising films; production of teleshopping programmes; transcription of communications (office functions); television advertising; telemarketing services; negotiation and conclusion of commercial transactions for third parties; professional business consultancy; providing consumer information via the Internet webpages and web-sites regarding a variety of goods and advertising information on the list of services provided, enabling consumers to conveniently view, order, purchase these goods and services from the web-pages and web-sites on the Internet as well as to receive the necessary information about these goods and services; the bringing together, for the benefit of others, of a variety of goods, excluding the transport thereof, enabling customers to conveniently view and purchase those goods, at the hypermarkets, department stores, shopping centers; business organization and management in the fields of entertainment services, television entertainment services, sports activities and cultural activities.

38 – Telecommunications services; telecommunications services to provide access to games, gambling and content; providing access to databases; providing information in the field of telecommunications; providing user access to global computer networks; providing internet chatrooms; providing online forums; providing telecommunications connections to a global computer network; communications by fiber optic networks; communications by computer terminals; video-on-demand transmission; transmission of electronic mail; computer aided transmission of messages and images; transmission of podcasts; transmission of digital files; forwarding messages; videoconferencing services; electronic bulletin board services (telecommunications services); telecommunications routing and junction services; news agency services; streaming of data; rental of access time to global computer networks; wireless broadcasting; providing access to information content of websites and portals (communication services); audio, video and multimedia broadcasting via the Internet and other communication networks; broadcasting services; transmission of data by computers; consulting services in the field of communications via communication networks; communication services using computer networks; data transmission by electronic means; data broadcasting services; data transmission, including audiovisual data, via

a global computer network or the Internet; electronic communication services; data transmission via electronic communication; electronic data exchange; electronic messaging services; messaging services via computers; online communication services; rental of access time to a computer databases; video and audio streaming services on the Internet; transmission and dissemination of data, including information, via computer networks and the Internet; transmission of data, audio, video and multimedia files, including: transmission of downloadable files and files transmitted over a global computer network; transmission of information in real time; transmission (routing) of audio, images and digital signals.

41 – Entertainment services; videotaping; dubbing; language interpretation; subtitling; providing television programs, not downloadable, via video-on-demand services; providing films, not downloadable, via video-on-demand services; booking of seats for shows; sound engineering services for events; cinema presentations; film distribution; videotape editing; movie studio services; organization of shows for entertainment purposes; party planning (entertainment); entertainer services; video editing services for events; lighting technician services for events; recording studio services; music composition services; film directing, other than advertising films; production of shows; production of music; production of radio and television programmes; film production, other than advertising films; scriptwriting, other than for advertising purposes; writing of texts; presentation of live performances; television entertainment; rental of audio equipment; rental of show scenery; rental of video cameras; rental of videotapes; rental of sound recordings; rental of cinematographic apparatus; rental of motion pictures; rental of lighting apparatus for theatrical sets or television studios; rental of stage scenery; rental of sports equipment, except vehicles; online publication of electronic books and journals; publication of texts, other than publicity texts; electronic desktop publishing; providing user reviews for entertainment or cultural purposes; providing information in the field of entertainment; providing online videos, not downloadable; providing online electronic publications, not downloadable; providing user ratings for entertainment purposes; providing sports facilities; practical training (demonstration); training services provided via simulators; games equipment rental; rental of training simulators; providing casino facilities (gambling); casino gambling services; game services provided online from a computer network; providing amusement arcade services; gambling services; providing information on gambling; organization of competitions (entertainment), including: live or on television or online from a computer databases or via the Internet or via portable, mobile, pocket or tablet devices; organization of lotteries, including: live or via television channels or online from a computer databases or via the Internet or via portable, mobile, poc-

ket or tablet devices; organization of sporting competitions, including live or via television channels or online from a computer databases or via the Internet or via portable, mobile, pocket or tablet devices; layout services, other than for advertising purposes; online gambling services provided via a computer network; virtual reality gaming services provided online via a computer network; gaming services for accepting bets; card game services; poker game services; game services, where the result depends on the art, skill of the player; arranging, conducting and presenting, other than for commercial or advertising purposes, entertainment games, gambling, poker games, including live or on television or online from a computer database or via the Internet or via portable, mobile, portable or tablet devices; conducting and supervision of entertainment games, gambling, betting, card games, poker games, game shows and entertainment events, including: tournaments, competitions; arranging, conducting and presenting, other than for commercial or advertising purposes, games, game shows and entertainment events, including tournaments, competitions, including: live or on television or online from a computer database or via the Internet or via portable, mobile, portable or tablet devices; multiplayer card games services provided live or via television or via computer databases or the Internet or via portable, mobile, portable or tablet devices; arranging, conducting and presenting, other than for commercial or advertising purposes, multiplayer card games, including provided live or via television or via computer databases or the Internet or via portable, mobile, portable or tablet devices; entertainment services provided in gaming rooms, namely, arranging and conducting of card games, games where the outcome depends on art and skill of the player, and educational games provided live or via the Internet, television channels or via portable, mobile, handheld or tablet devices; organization and conducting presentations, other than for commercial or advertising purposes relating to the aforesaid services; providing information relating to entertainment services, including those provided via television, and relating to television entertainment programs, sports and cultural events, games; providing information relating to gaming services, gambling services, gambling betting services, casino services (gambling), card game services, poker services, game events, including shows, tournaments, competitions; providing of non-downloadable electronic newsletters distributed via the Internet, e-mail or via portable, mobile, handheld or tablet devices; providing the aforesaid services live or via television channels, online via computer databases, via the Internet or via portable, mobile, handheld or tablet devices; game services for electronic games provided via the Internet; card game services for several participants; services for accepting bets on sporting events (sports betting).

(260) AM 2022 115390 A
 (800) 1625822
 (151) 2021 08 31
 (891) 2021 08 31
 (731) PRIVATE JOINT STOCK COMPANY
 "TECHNOLOGIA"
 Kurskiy Avenue, 147-A, Sumy 40031, Ukraine
 (540)



(591) White and blue (Pantone 2194C)
 (531) 26.04.04; 26.04.09; 26.04.18; 26.04.24;
 27.05.10; 27.05.15; 27.05.24; 29.01.12
 (511)

6 – Foils of metal for wrapping and packaging; packaging containers of metal; sealing caps of metal; bottle caps of metal; bottle closures of metal; labels of metal; bottle fasteners of metal; clips of metal for sealing bags; containers of metal (storage, transport).

16 – Plastic sheets, films and bags for wrapping and packaging; labels of paper or cardboard; boxes of paper or cardboard; bags (envelopes, pouches) of paper or plastics, for packaging; containers for food, including containers for beverages (wrappers of paper or cardboard).

17 – Plastics and resins in extruded form for use in manufacture; packing (cushioning, stuffing) materials of rubber or plastics; rubber stoppers; bags (envelopes, pouches) of rubber, for packaging.

20 – Sealing caps, not of metal; bottle caps, not of metal; closures, not of metal, for containers; bottle closures, not of metal; bottle fasteners, not of metal; containers, not of metal, for storage or transport; clips of plastic for sealing bags; packaging containers of plastic; casks, not of metal; barrels, not of metal; bins, not of metal; labels of plastic; boxes of wood or plastic.

21 – Beverage urns, non-electric; containers for household or kitchen use; disposable aluminium foil containers for household purposes; thermally insulated containers for food; heat-insulated containers for beverages; pouring spouts; isothermic bags; heat-insulated containers.

(260) AM 2022 115391 A
 (800) 1625908
 (151) 2021 08 10
 (891) 2021 08 10
 (731) Sika Technology AG
 Zugerstrasse 50, CH-6340 Baar, Switzerland

(540)

SIKATHERM

(591) Black, white
 (511)
 1 – Chemical products for industry, unprocessed inorganic products for facade preparation.

2 – Protective and decorative inorganic coverings in the nature of paints other than for insulation purposes, coatings (paints) used as primers.

17 – Insulating materials, particularly thermal insulation materials and acoustic insulation materials for facades.

19 – Non-metallic building materials, in particular, ready-mixed inorganic paste, cement, lime, mortar for evening and repairing, facade coating, cement glue mortars for leveling; reinforcing fabrics of fiberglass.

(260) AM 2022 115394 A
 (800) 1232155
 (151) 2014 10 23
 (891) 2021 06 02
 (731) Novartis AG
 CH-4002 Basel, Switzerland
 (540)

VODELPA

(591) Black, white
 (511)
 5 – Pharmaceutical preparations.

(260) AM 2022 115395 A
 (800) 1329181
 (151) 2016 09 30
 (891) 2021 10 27
 (731) AGRICULTURAL RESEARCH AND
 DEVELOPMENT LIMITED LIABILITY
 COMPANY
 11220 Edison Highway, Bakersfield CA 93307,
 USA
 (540)

ARRA

(591) Black, white
 (511)
 31 – Fresh grapes.

(260) AM 2022 115457 A
 (800) 1626218
 (151) 2021 10 01
 (891) 2021 10 01
 (731) Incyte Holdings Corporation
 1801 Augustine Cut-Off, Wilmington DE
 19803, USA

(540)

ZYNYZ²

(591) Black, white

(531) 27.05.19

(511)

16 – Brochures, newsletters, and pamphlets relating to medical issues, procedures, disease symptoms, patient support and community building.

(260) AM 2022 115458 A

(800) 1626318

(151) 2021 09 07

(891) 2021 09 07

(731) Shengjie Zheng

No. 41-1, Liushan Road, Licheng Street,
Xianyou County, Putian City, 351100 Fujian
Province, China

(540)

(591) Black, white

(531) 11.03.18; 27.05.08; 27.05.17

(511)

21 – Kitchen utensils; hot pots, not electrically heated; cooking utensils, non-electric; cooking pots; tableware, other than knives, forks and spoons; cooking pot sets; stew-pans; pot lids; cauldrons; grills [cooking utensils].

(260) AM 2022 115474 A

(800) 1627003

(151) 2021 09 13

(891) 2021 09 13

(731) ADB SAFEGATE BV

Leuvensesteenweg 585, B-1930 Zaventem,
Belgium

(540)

(591) Blue and orange

(531) 03.07.17; 26.03.23; 27.05.10; 27.05.17;
27.07.11; 27.07.17; 29.01.12

(511)

9 – Electrical signaling, measuring, counting, recording, monitoring, open and closed-loop control and switching devices for aviation ground lighting equipment; electronic and electric systems for monitoring and control of aviation ground lighting equipment, which is comprised of a light monitoring and switch unit, a sensor interface unit, a series circuit filter, a series circuit modem and an industrial personal computer; all aforesaid goods for air traffic systems and ground traffic systems, including road, street, tunnel and parking areas and industrial areas.

(260) AM 2022 115478 A

(800) 1627146

(151) 2021 04 30

(891) 2021 04 30

(731) Veld World (UK) Limited

Suite 23039, 8 Shepherd market, Mayfair,
London W1J 7JY, United Kingdom

(540)

(591) Red – Pantone 485c, Pantone 7622c
and white – Pantone FFFFFFFF(531) 25.01.05; 25.01.06; 27.05.01; 27.05.08;
27.05.24; 29.01.12

(511)

29 – Meat, fish, poultry and game; meat extracts; preserved, frozen, dried and cooked fruits and vegetables; vegetables, tinned (canned); fruits, tinned (canned); fish, tinned (canned); meat, tinned (canned); fruit and vegetable spreads; jellies and jams; compotes; eggs; milk; cheese; butter; yogurt; cream; whipped cream; condensed milk; milk substitutes; almond milk; coconut milk; peanut milk; rice milk; soya milk; oat milk; oils and fats for food; olive oil for food; extra-virgin olive oil; olives, preserved; mushrooms, preserved; berries, preserved; beans, preserved; gherkins; pickled gherkins; peas, preserved; soya beans, preserved, for food; lentils, preserved; vegetable pastes; vegetable marrow paste; tomato paste; nut-based spreads; processed nuts; edible seeds; seed butters; seeds, prepared; cooked sesame seeds, not being seasonings or flavorings; preserved chopped chilli peppers, not being seasonings or flavorings; artichoke paste; processed artichokes; artichokes, preserved; seaweed extracts for food; caviar; tuna, not live; dried shrimps; shrimp paste; shrimp floss; potato chips; potato flakes; potato-based dumplings; fruit chips; mussels, not live; crustaceans, not live; anchovy; non-living crustaceans; anchovy paste; anchovy fillets.

30 – Coffee, tea, cocoa and artificial coffee; rice; tapioca and sago; flour and preparations made from cereals; bread, pastries and confectionery; pasta; macaroni; ravioli; noodles; noodle-based prepared meals; potato-based flatbreads; tortillas; edible ices; ice-cream; sorbets; sugar, honey, treacle; yeast, baking-powder; salt; mustard; vinegar, sauces (condiments); spices; ketchup (sauce); mayonnaise; marinades; dressings for salad; pesto (sauce); tomato sauce; soya sauce; pasta sauce; apple sauce (condiment); fruit coulis (sauces); fruit jellies (confectionery); chocolate; dessert mousses (confectionery); chocolate mousses; chocolate-based spreads; high-protein cereal bars; cereal bars; gluten-free bread; oat flakes; corn chips; corn flakes; muesli; chips (cereal products); flour-based dumplings; groats for human food; capers; seasonings; preserved herbs; processed seeds for use as a seasoning; garden herbs, preserved (seasonings); preserved, frozen, dried and cooked capers.

(260) AM 2022 115546 A

(800) 1627788

(151) 2021 09 27

(891) 2021 09 27

(731) AVENTRO Sàrl

1, Carrefour de Rive, CH-1207 Genève,
Switzerland

(540)

AVENTRO

(591) Black, white

(511)

1 – Chemical products for use in agriculture, horticulture and forestry; unprocessed artificial resins, unprocessed plastic materials; manure for agriculture; fire fighting compositions; chemical tempering and soldering preparations; chemical substances for preserving foodstuffs; tanning substances; adhesives used in industry.

5 – Insecticides, disinfectants, products for destroying vermin, fungicides, herbicides, acaricides, bacterial poisons, fumigation products for medical use; nutritive substances for plants.

35 – Company management; company administration; office functions; commercial information analysis, research and provision services; advertising, marketing and promotional services, particularly in relation to agriculture and horticulture; wholesale and retail services for watering products for agriculture and phytosanitary products.

(260) AM 2022 115547 A

(800) 1627812

(151) 2021 10 01

(891) 2021 10 01

(731) IBSA INSTITUT BIOCHIMIQUE SA

Via al Ponte 13, CH-6900 Massagno,
Switzerland

(540)

GONASI

(591) Black, white

(511)

5 – Pharmaceutical products; pharmaceutical drugs; fertility enhancement preparations.

(260) AM 2022 115549 A

(800) 1627854

(151) 2021 08 11

(891) 2021 08 11

(731) FALKE KgaA

Oststr. 5, 57392 Schmallenberg, Germany

(540)

FALKE – WE CARE – COTTON

(591) Black, white

(511)

25 – Socks and stockings; sportswear; women's outer-clothing; outer-clothing for men.

(260) AM 2022 115550 A

(800) 1627855

(151) 2021 09 27

(891) 2021 09 27

(731) LYKOS Pharma Ltd

No 1, Floor 1 Suite 24, Gwardamangia Hill,
PTA 1319 PIETA, Malta

(540)

ManoSpan

(591) Black, white

(511)

5 – Pharmaceuticals, medicinal, medical and veterinary preparations; sanitary preparations for medical purposes; dietetic food and substances adapted for medical or veterinary use, food for babies; dietary supplements for humans and animals; plasters, materials for dressings; material for stopping teeth, dental wax; disinfectants; preparations for destroying vermin; fungicides, herbicides; mineral nutritional supplements; vitamin preparations.

(260) AM 2022 115553 A

(800) 1628061

(151) 2021 03 12

(891) 2021 03 12

(731) IZIDIZ

Wortegemseweg 82, B-8790 Waregem,
Belgium

(540)

IZIDIZ

(591) Black, white

(511)

9 – Software and mobile applications; software and mobile applications for monitoring, controlling and executing processes in the physical world; testing and quality control devices; devices for monitoring water consumption and water quality; monitors; monitors [computer hardware]; hygrometers; sensors, gateways and application software for the Internet of things [IoT]; operating systems; point-to-point communications equipment; controlling devices; measuring devices; sensors.

35 – Advertising; business management; business administration; office functions; wholesaling and retailing including online in the field of chemicals, hygienic preparations and articles, disinfectants, antiseptics, preparations for medical, pharmaceutical and veterinary use with disinfection features, anti-microbiological (bacteria, fungi, viruses, prints) disinfectants and sterilisers, polishing materials infused with disinfectants, polishing materials with disinfecting features, cleansers with disinfection features; wholesaling and retailing including online in the field of sterilisation and disinfection devices, disinfection apparatuses, disinfection apparatuses, disinfection stations, portable disinfection installations, apparatuses and installations for dosing, evaporation, sprinkling, spraying, drying and aeration with disinfectants; consultancy and providing information regarding the aforesaid services, including provided via electronic networks including the internet; retail services for pharmaceutical, veterinary and sanitary preparations and medical supplies; wholesale services for pharmaceutical, veterinary and sanitary preparations and medical supplies.

(260) AM 2022 115555 A

(800) 1628102

(151) 2021 08 03

(891) 2021 08 03

(731) Apple Inc.

One Apple Park Way, Cupertino CA 95014,
USA

(540)

UP NEXT

(591) Black, white

(531) 26.03.04; 27.05.01

(511)

41 – Entertainment services in the nature of development, creation, production, and distribution of musical artist video documentary series; entertainment services, namely, providing non-downloadable on-line music, interviews, live music performances, and videos featuring musical artists via a website; entertainment

services, namely, a multimedia program series featuring musical artists distributed via various platforms across multiple forms of transmission media.

(260) AM 2022 115556 A

(800) 1628119

(151) 2021 07 08

(891) 2021 07 08

(731) Limited Liability Company "NOVY DOM"
Centralnaya st., 139, building 72, Krasnogorsk,
RU-143405 Moscow region, Russian
Federation

(540)



(591) White, light blue, blue, navy blue, gray, light gray and light blue

(531) 26.15.09; 27.05.10; 29.01.13

(511)

6 – Fittings of metal for building; joists of metal; beams of metal; window pulleys of metal; screws of metal; doors of metal; folding doors of metal; swing doors of metal; prefabricated houses [kits] of metal; prefabricated houses [kits] on a metal frame; modular houses of metal [fabricated metal components]; modular houses based on a loadbearing metal frame [fabricated metal components]; houses using prefabricated structures [fabricated metal components]; outdoor blinds of metal; roof gutters of metal; iron slabs; door bolts of metal; window fasteners of metal; cornices of metal; framework of metal for building; pillars of metal for building; fittings of metal for windows; door fittings of metal; brackets of metal for building; build-ings of metal; prefabricated metal structures for the construction of houses and buildings; transportable buildings of metal; steel buildings; containers of metal [storage, transport]; check rails of metal for railways; door frames of metal; stringers [parts of staircases] of metal; roofing of metal; staircases of metal; steel sheets; reinforcing materials of metal for building; building materials of metal; refractory construction materials of metal; flashing of metal for building; roof flashing of metal; wall claddings of metal for building; wall linings of metal for building; sheathing wall metal frame; windows of metal; props of metal; wainscoting of metal; building panels of metal; building panels on a metal frame; floor panels of metal, inner; ceiling boards of metal, inner; ceiling boards of metal; prefabricated metal panel for the construction of houses and buildings of various types; facade panels on a metal frame for construction purposes; facade walls of metal; partitions of metal; inner partitions of metal; partitions on a metal frame; lintels of metal; transport

pallets of metal; platforms, prefabricated, of metal; wall tiles of metal; floor tiles of metal; tiles of metal for building; slabs of metal for building; handling pallets of metal; cladding of metal for building; roof coverings of metal; roof trusses of metal; frames, trusses of metal, for building; metal rafter system; linings of metal for building; floors of metal; ceilings of metal; pipes of metal; mouldings of metal for building; partitions for building; prefabricated metal modules for the construction of houses and buildings; prefabricated metal house kit for the construction of houses and buildings; awnings [building, structures] of metal.

19 – Door frames, not of metal; window frames, not of metal; beams, not of metal; joists, not of metal; plaster; gypsum [building material]; clay; doors, not of metal; prefabricated houses [kits], not of metal; modular houses, not of metal [fabricated non-metallic components]; houses using prefabricated structures [fabricated non-metallic components]; jalousies, not of metal; fences, not of metal; stone; framework, not of metal, for building; cornices, not of metal; paper-board for building; bricks; pillars, not of metal, for building; brackets, not of metal, for building; buildings, not of metal; prefabricated non-metallic structures for the construction of houses and buildings; buildings, transportable, not of metal; roofing, not of metal; building timber; staircases, not of metal; reinforcing materials, not of metal, for building; pitch; building materials, not of metal; refractory construction materials, not of metal; mouldings, not of metal, for cornices; mouldings, not of metal, for building; porches [structures], not of metal; duckboards, not of metal; wall claddings, not of metal, for building; coatings [building materials]; wall linings, not of metal, for building; non-metallic frame cladding wall; wood panelling; windows, not of metal; props, not of metal; wainscoting, not of metal; building panels, not of metal; non-metal floor panels, inner; non-metal ceiling panels, inner; non-metal ceiling panels; prefabricated non-metallic panel for the construction of houses and buildings of various types; facade panels not of metal, for construction purposes; facade wall not of metal, for construction purposes; parquet flooring; partitions, not of metal; non-metal partitions for building, inner; lintels, not of metal; casement windows, not of metal; platforms, prefabricated, not of metal; wall tiles, not of metal; floor tiles, not of metal; tiles, not of metal, for building; tile floorings, not of metal; slabs, not of metal, for building; roof coverings, not of metal; non-metal roof trusses; rafter system not of metal; frames, not of metal, for building; wooden floor boards; cladding, not of metal, for building; linings, not of metal, for building; floors, not of metal; mortar for building; asbestos mortar; shutters, not of metal; posts, not of metal; water-pipes, not of metal; ducts, not of metal, for ventilating and air-conditioning installations; cement; slate; roofing tiles, not of metal; modular homes, not of metal; pre-fabricated log ho-

mes; pre-fabricated houses, not of metal; water-resistant boards and panels, not of metal, for construction; fire-resistant boards and panels, not of metal, for building; non-metallic prefabricated modules for the construction of houses and buildings; prefabricated non-metallic house kit for the construction of houses and buildings.

35 – Commercial intermediation services; business project management services for construction projects; procurement services for others [purchasing goods and services for other businesses]; outsourcing services [business assistance]; demonstration of goods; business intermediary services relating to the matching of potential private investors with entrepreneurs needing funding.

36 – Real estate investment; financial investment services; financial investment and advisory services; arranging of financial investments; investment brokerage; brokerage of financial investments; real estate investment management; financial investment management; investment services; investment management; financial investment in the field of real estate; real estate services relating to the management of property investments.

37 – Building sealing; building insulating; providing information relating to repairs; providing construction information; bricklaying; construction consultancy; varnishing; installation services; installation of utilities in construction sites; scaffolding; building construction supervision; paper hanging; masonry; plumbing; painting services; carpentry services; plastering; construction; custom construction of homes; construction and repair of houses; construction and repair of residential buildings and houses; repair and maintenance of residential buildings; residential and commercial building construction; construction and renovation of buildings; building inspection in the course of building construction; advisory services relating to the construction of buildings; consultancy relating to building construction supervision; providing information relating to building construction; providing on-line information relating to the construction of buildings; providing building construction information via a web site; construction, maintenance, cleaning and repair services; building construction supervision services for building projects.

42 – Industrial design; graphic arts design; engineering; interior design; research in the field of building construction; research and development of new products for others; architectural consultancy; quality control; design of interior decor; construction drafting; architectural services; architectural design in the field of single family homes; consultancy in the field of construction drafting; engineering services in the field of building technology; construction drafting and consultancy relating thereto; computer-aided design services relating to building projects; design and cons-

truction planning services and consultancy relating thereto.

(260) AM 2022 115558 A
 (800) 1628173
 (151) 2021 09 29
 (891) 2021 09 29
 (731) Création Gross GmbH & Co. KG
 Houbirgstr. 7, 91217 Hersbruck, Germany
 (540)



(591) Red, black and white
 (531) 24.01.15; 27.05.01; 29.01.13
 (511)

3 – Bleaching preparations and other substances for laundry use; cleaning, polishing, scouring and abrasive preparations; soaps; perfumery, essential oils, cosmetics, hair lotions; dentifrices.

14 – Precious metals and their alloys and goods in precious metals or coated therewith, not included in other classes; jewellery, precious stones; horological and chronometric instruments.

18 – Leather and imitations of leather, and goods made of these materials and not included in other classes; animal skins, hides; trunks and travelling bags; umbrellas, parasols and walking sticks; whips, harness and saddlery.

25 – Clothing, footwear, headgear.

35 – Advertising; business management; business administration; office functions.

(260) AM 2022 115559 A
 (800) 1628175
 (151) 2021 09 27
 (891) 2021 09 27
 (731) "Tekhnologii Tonirovaniya" LLC
 Krasnoyarskaya street, building 17, location XXII, office 42, room 1, RU-107113 Moscow, Russian Federation
 (540)



(591) Black, white

(531) 27.05.02
 (511)
 17 – Adhesive bands, other than stationery and not for medical or household purposes; filtering materials of semi-processed films of plastic; filtering materials of semi-processed foams of plastic; plastic film, other than for wrapping; anti-glare films for windows [tinted films].

(260) AM 2022 115560 A
 (800) 1628268
 (151) 2021 10 05
 (891) 2021 10 05
 (731) "Advanself" Limited Liability Company
 Volokolamskoye shosse, 3, building 2, room 1 of. 1, RU-125310 Moscow, Russian Federation
 (540)



(591) Light green; white
 (531) 26.11.13; 26.13.25; 27.05.01; 27.05.08;
 29.01.04

(511)
 16 – Graphic prints; teaching materials [except apparatus]; printed matter; prospectuses; printed timetables.

41 – Academies [education]; videotaping; physical education; publication of books; providing information in the field of education; providing information relating to recreational activities; health club services [health and fitness training]; layout services, other than for advertising purposes; microfilming; correspondence courses; practical training [demonstration]; training services provided via simulators; arranging and conducting of colloquiums; arranging and conducting of congresses; arranging and conducting of conferences; arranging and conducting of workshops [training]; arranging and conducting of in-person educational forums; arranging and conducting of seminars; arranging and conducting of symposiums; vocational guidance [education or training advice]; know-how transfer [training]; vocational retraining; providing online videos, not downloadable; providing online music, not downloadable; providing television programs, not downloadable, via video-on-demand services; providing films, not downloadable, via video-on-demand services; providing sports facilities; providing amusement arcade services; educational examination; electronic desktop publishing; online publication of electronic books and journals; publication of texts, other than publicity texts; tutoring; personal trainer services [fitness training]; teaching; educational servi-

ces provided by special needs assistants; coaching [training]; nursery schools.

44 – Medical advice for individuals with disabilities; aromatherapy services; animal-assisted therapy; speech therapy; chiropractic; massage; medical testing; medical assistance; rehabilitation for substance abuse patients; health counselling; medical clinic services; alternative medicine services; services of a psychologist; telemedicine services; therapy services; physiotherapy; health centre services.

(260) AM 2022 115562 A

(800) 1628283

(151) 2021 10 15

(891) 2021 10 15

(731) OPENMARK LTD

Tortola VG 1110, 19 Waterfront Drive, PO Box 3540, Road Town VG, Virgin Islands (British)

(540)



(591) Black, white

(531) 01.01.01; 01.01.09; 24.17.01; 26.04.04; 26.04.18; 26.04.24; 26.07.05; 26.15.01; 27.05.10; 27.05.24

(511)

34 – Tobacco; cigarette tobacco; cigarettes, cigars, cigarillos; filter-tipped cigarettes; cigarettes containing tobacco substitutes; lighters for smokers; electronic cigarette boxes; cigarette tubes; tobacco pouches; tobacco containers and humidors; ashtrays; cigar cutters; pipe knives; cigarette cutters; cigarette filters; mouthpieces for cigarettes; tobacco filters; cigar filters; cigarette paper.

(260) AM 2022 115563 A

(800) 1628314

(151) 2021 07 07

(891) 2021 07 07

(731) INDUSTRIAS QUIMICAS DEL ADHESIVO, S.A.

Valdelacueva, s/n, E-28880 Meco (Madrid), Spain

(540)

QUIADSA

(591) Black, white

(531) 27.05.01

(511)

1 – Adhesive materials for industry and for industrial uses; adhesives for wall tiles; silicone.

17 – Adhesive strips and tapes other than for medical, stationery or household purposes; acrylic, artificial

and synthetic resins (semi-finished products); Insulators; insulators; insulating materials; semi-processed plastic materials; insulating coatings; chemical compositions for repairing leaks; compositions for insulating buildings against moisture; seals and mastics for joints.

39 – Distribution, transport and warehousing of chemical products.

(260) AM 2022 115564 A

(800) 1628427

(151) 2021 08 19

(891) 2021 08 19

(731) Shmulevych Vitalii Naumovych

vul. Levanevskoho, 7, kv. 63, m. Odesa 65062, Ukraine;

Markushevskiy Igor Isaakovych

vul. Bolharska, 82, kv. 8; m. Odesa 65005, Ukraine;

Maslenkov Volodymyr Mykolaiovych

vul. Marshala Hovorova, 1-2, kv. 101, m. Odesa 65058, Ukraine

(540)

SMEREKA

(591) Black, white

(531) 27.05.01

(511)

33 – Alcoholic beverages, except beer; aperitif wines; wine; digesters [liqueurs and spirits]; brandy; whisky; gin; anisette [liqueur]; anise [liqueur]; mead [hydromel]; vodka; kirsch; perry; cocktails; liqueurs; peppermint liqueurs; distilled beverages; pre-mixed alcoholic beverages, other than beer-based; alcoholic beverages containing fruit; bitters; piquette; rum; cider; spirits [beverages]; alcoholic extracts; alcoholic essences; fruit extracts, alcoholic.

(260) AM 2022 115565 A

(800) 1628533

(151) 2021 09 14

(891) 2021 09 14

(731) Avon Products, Inc.

1 Avon Place, Suffern, New York NY 10901, USA

(540)

AVON RARE ONYX

(591) Black, white

(511)

3 – Non-medicated toilet preparations; toiletries; skin care preparations; skin moisturizers; skin toners; body and beauty care preparations; powders, cleansers, creams and lotions, all for the face, hands and body; exfoliating scrubs for cosmetic purposes; soaps; shower and bath preparations; bath gel, bath oils, bath salts, bath beads, and effervescent bath preparations; beauty

masks; talcum powder; nail polish; nail polish remover; false nails; adhesives for cosmetic purposes; cosmetics; eye cream; eye gels; eye lotions; eye make-up remover; eye shadow; eye liner; eyebrow cosmetics; mascara; lipstick; lip liner; lip-gloss; lip balm; make-up foundation; facial concealer; blusher; tissues impregnated with cosmetic lotions; powdered cosmetic tissues; cotton sticks for cosmetic purposes; cotton wool for cosmetic purposes; pumice stone; preparations for cleaning, moisturizing, colouring and styling the hair; shampoos, conditioners, finishing spray, and gels, all for the hair; shaving and aftershave preparations; perfumes; fragrances; toilet waters; cologne; room fragrances; incense sticks; deodorants for human beings; anti-perspirants for personal use (toiletries); essential oils (cosmetic); oils for perfumes and scents; potpourri; cosmetic kits.

(260) AM 2022 115578 A
 (800) 1628927
 (151) 2021 10 14
 (891) 2021 10 14
 (731) Incyte Holdings Corporation
 1801 Augustine Cut-Off, Wilmington
 DE 19803, USA
 (540)



(591) Black, white
 (531) 26.11.02; 26.11.06; 26.11.11; 27.05.01;
 27.05.21
 (511)
 5 – Pharmaceutical preparations for the treatment of oncological disorders; pharmaceutical preparations for the treatment of auto-immune disorders; pharmaceutical preparations for the treatment of hematological disorders; pharmaceutical preparations for the treatment of graft versus host disorders; pharmaceutical preparations for the treatment of dermatological disorders.
 16 – Brochures, newsletters, and pamphlets relating to medical issues, procedures, disease symptoms, patient support and community building.
 44 – Providing health information to physicians, patients and caregivers relating to diagnosis and treatment of medical disorders.

(260) AM 2022 115579 A
 (800) 1628934
 (151) 2021 10 08
 (891) 2021 10 08
 (731) Obshchestvo s ogranichennoi,
 otvetstvennostyu "FARMAMONDO"
 Ryazanskiy prosp., 16-1, floor 7, pom. I, kom. 3,
 RU-109428 Moscow, Russian Federation
 (540)

EMCALCET

(591) Black, white
 (511)
 5 – Pharmaceutical preparations; chemico-pharmaceutical preparations.

(260) AM 2022 115621 A
 (800) 1629306
 (151) 2021 06 21
 (891) 2021 06 21
 (731) MAJYL
 83 rue de Reuilly, F-75012 PARIS, France
 (540)

FAVEOD DESIGNER

(591) Black, white
 (511)
 9 – Computer software; computer meta-programs; software developed using software; electronic equipment for data processing; electronic equipment intended for processing and securing computer and digital data; downloadable computer applications (software); computer databases and software which can be consulted via an access code enabling the storage, transmission, dissemination and exchange of information; computer software and databases for carrying out information transactions; computer databases and software accessible via an access code enabling the instant generation of computer software; maintenance software; software, application programming interfaces; computer programs; electronic circuits containing programmed data; software packages; magnetic or optical data media; portable electronic devices for wireless reception, storage and/or transmission of data and messages; computer platforms in the form of recorded or downloadable software; computer platforms in the nature of software for use in SaaS mode; electronic publications downloadable from databases or the Internet; computer programs and applications for data analysis.
 35 – Business management assistance; business management and organization consultancy; consulting services relating to personnel management; advisory services regarding marketing strategy; advisory services regarding business strategy; advisory services regarding communication (advertising); advisory services regarding communication (public relations); advisory services regarding accounting; advisory services for

companies relating to financing of growth; corporate advisory services with respect to corporate responsibility; commercial business analysis; organization of events for commercial and advertising purposes; organization of trade shows for commercial or advertising purposes; systemization of data into a central file, computerized file management services; compilation of information into computer databases; updating and maintenance of data in computer databases; updating and maintenance of data in registers; data search in computer files for others; providing software concerning business organization and management; creating economic forecasts; market studies; establishing statistics; document reproduction; computer file management; arranging subscriptions to telecommunication services for others; advisory services concerning data management and processing.

38 – Communications via computer terminals; transmission of information by telematic means, transmission of information accessible by access code, via computer data processing servers, via computer or telematic networks including the Internet and the World Wide Web; provision of access to computer databases or to telecommunication, computer or telematic networks; provision of access to databases; transmission of texts, electronic documents, databases, computer databases and audiovisual information; providing access to data in computer files for others.

41 – Training services; training relating to computer programming; training in connection with data processing; training related to computer architecture; training related to data security, software and software packages; training related to internet security; training related to the design, development and deployment of computer software; training related to information technology; training related to software engineering; training related to supporting change with respect to technology and digitalization of data; training related to technical and technological innovation as well as digitization of data; training related to corporate responsibility with respect to business management; editing material or immaterial media for informational purposes; editing material or immaterial media for training purposes.

42 – Development (design), development, programming, installation, maintenance, updating or rental of software; temporary provision of non-downloadable software online; programming for computers; computer system analysis; computer system design; web site design; conversion of data or documents from physical to electronic media; conducting of technical project studies; consultant services with respect to computer hardware design and development; consultancy with respect to the design, development and deployment of computer software; consultant services relating to Internet security; consultancy with respect to security for software and software packages; consultant services with respect to data security; information

technology (IT) consultancy; information technology consultancy services; consultancy relating to computer architecture; consultancy relating to software engineering; telecommunication technology consultancy services; monitoring of computer systems for the detection of unauthorized access or data protection breaches; remote monitoring of computer systems; developing computer software applications, electronic data storage services; computer support services (programming and installation of software); technical auditing; rental and provision of computer equipment and software; rental and provision of data processing equipment.

(260) AM 2022 115623 A

(800) 1629337

(151) 2021 10 13

(891) 2021 10 13

(731) Laboratoire Innotech International
22 avenue Aristide Briand, F-94110 Arcueil,
France

(540)

TOTYLEM

(591) Black, white

(511)

5 – Medicines; medicines for preventing or treating iron deficiency anemia; medicines for treating or preventing folic acid deficiency.

(260) AM 2022 115624 A

(800) 1629357

(151) 2021 09 15

(891) 2021 09 15

(731) FALKE KgaA
Oststr. 5, 57392 Schmallenberg, Germany

(540)

FALKE we care

(591) Black, white

(511)

25 – Socks and stockings; sportswear; women's outer-clothing; outer-clothing for men.

(260) AM 2022 115625 A

(800) 1629364

(151) 2021 10 11

(891) 2021 10 11

(731) Aktsionernoe obshchestvo "Gruppa kompanij "Etalon"
Bogatyrskij pr., d. 2, liter A, office 4.12,
RU-197348 Saint-Peterburg, Russian
Federation

(540)

ETALON

(591) Black, white

(531) 27.05.01

(511)

35 – Arranging subscriptions to telecommunication services for others; import-export agency services; commercial information agency services; advertising agency services; cost price analysis; rental of office equipment in co-working facilities; rental of advertising space; business auditing; financial auditing; business intermediary services relating to the matching of potential private investors with entrepreneurs needing funding; employment agency services; computerized file management; book-keeping; outsourced administrative management for companies; invoicing; demonstration of goods; transcription of communications [office functions]; opinion polling; market studies; business investigations; business research; marketing research; personnel recruitment; consultancy regarding advertising communication strategies; consultancy regarding public relations communication strategies; business management and organization consultancy; business organization consultancy; business management consultancy; personnel management consultancy; professional business consultancy; layout services for advertising purposes; marketing; marketing in the framework of software publishing; targeted marketing; business management of performing artists; business management of sports people; writing of curriculum vitae for others; scriptwriting for advertising purposes; news clipping services; updating and maintenance of information in registries; updating and maintenance of data in computer databases; updating of advertising material; word processing; online retail services for downloadable and pre-recorded music and movies; online retail services for downloadable ring tones; online retail services for downloadable digital music; organization of exhibitions for commercial or advertising purposes; arranging newspaper subscriptions for others; organization of fashion shows for promotional purposes; organization of trade fairs; shop window dressing; business appraisals; payroll preparation; data search in computer files for others; sponsorship search; administrative assistance in responding to calls for tenders; business management assistance; commercial or industrial management assistance; commercial intermediation services; providing business information; providing business information via a website; providing commercial and business contact information; providing commercial information and advice for consumers in the choice of products and services; provision of an online marketplace for buyers and sellers of goods and services; providing user reviews for commercial or advertising purposes; web indexing for commercial or advertising purposes; providing user rankings for commercial or advertising purposes; presentation of goods on communication media, for retail purposes; media relations services; economic forecasting; auctioneering; retail services for works of art provided by art galleries; sales promotion for others; promotion of goods and ser-

vices through sponsorship of sports events; production of teleshopping programmes; production of advertising films; office machines and equipment rental; rental of advertising time on communication media; publicity material rental; rental of billboards [advertising boards]; rental of vending machines; rental of sales stands; rental of photocopying machines; consumer profiling for commercial or marketing purposes; publication of publicity texts; radio advertising; development of advertising concepts; bill-posting; distribution of samples; dissemination of advertising matter; direct mail advertising; registration of written communications and data; writing of publicity texts; advertising; online advertising on a computer network; advertising by mail order; television advertising; compilation of information into computer databases; compilation of statistics; business inquiries; systemization of information into computer databases; administrative services for medical referrals; advisory services for business management; corporate communications services; negotiation of business contracts for others; negotiation and conclusion of commercial transactions for third parties; compiling indexes of information for commercial or advertising purposes; tax preparation; drawing up of statements of accounts; telemarketing services; psychological testing for the selection of personnel; wholesale services for pharmaceutical, veterinary and sanitary preparations and medical supplies; retail services for pharmaceutical, veterinary and sanitary preparations and medical supplies; interim business management; business management of hotels; business management for freelance service providers; business project management services for construction projects; commercial administration of the licensing of the goods and services of others; business management of reimbursement programmes for others; administration of consumer loyalty programs; administration of frequent flyer programs; administrative processing of purchase orders; administrative services for the relocation of businesses; public relations; commercial lobbying services; competitive intelligence services; modelling for advertising or sales promotion; typing; market intelligence services; appointment reminder services [office functions]; website traffic optimization; tax filing services; search engine optimization for sales promotion; appointment scheduling services [office functions]; retail services relating to bakery products; gift registry services; price comparison services; pay per click advertising; secretarial services; procurement services for others [purchasing goods and services for other businesses]; shorthand; outsourcing services [business assistance]; telephone answering for unavailable subscribers; telephone switchboard services; photocopying services; business efficiency expert services.

36 – Credit bureau services; debt collection agency services; financial analysis; rental of apartments; rental of offices for co-working; rental of real estate; rental of offices [real estate]; rental of farms; hire-pur-

chase financing; savings bank services; accommodation bureau services [apartments]; rent collection; issuance of travellers' cheques; issuance of credit cards; issuance of tokens of value; capital investment; financial research; clearing, financial; insurance consultancy; financial consultancy; debt advisory services; stock exchange quotations; crowdfunding; lending against security; business liquidation services, financial; brokerage; financial management; exchanging money; online banking; processing of debit card payments; processing of credit card payments; financial exchange of virtual currency; real estate affairs; factoring; organization of monetary collections; arranging finance for construction projects; antique appraisal; jewellery appraisal; financial evaluation of standing timber; stamp appraisal; real estate appraisal; numismatic appraisal; art appraisal; financial evaluation of development costs relating to the oil, gas and mining industries; financial valuation of intellectual property assets; financial evaluation of wool; financial appraisals in responding to calls for tenders; repair costs evaluation [financial appraisal]; financial evaluation [insurance, banking, real estate]; electronic funds transfer; surety services; securities brokerage; real estate brokerage; brokerage of carbon credits; insurance brokerage; providing insurance information; providing rebates at participating establishments of others through use of a membership card; pawnbrokerage; loans [financing]; providing financial information; providing financial information via a website; cheque verification; investment of funds; charitable fund raising; stocks and bonds brokerage; financial sponsorship; mortgage banking; instalment loans; insurance underwriting; life insurance underwriting; health insurance underwriting; accident insurance underwriting; marine insurance underwriting; fire insurance underwriting; apartment house management; real estate management; financial management of reimbursement payments for others; real estate agency services; actuarial services; banking; stock brokerage services; e-wallet payment services; retirement payment services; trusteeship; bail-bonding; preparation of quotes for cost estimation purposes; electronic transfer of virtual currencies; provident fund services; financial customs brokerage services; mutual funds; financing services; safe deposit services; deposits of valuables; fiscal valuation.

37 – Asphaltting; drilling of deep oil or gas wells; drilling of wells; rebuilding engines that have been worn or partially destroyed; rebuilding machines that have been worn or partially destroyed; renovation of clothing; retreading of tyres; vulcanization of tyres [repair]; building sealing; linen ironing; pressing of clothing; disinfecting; mining extraction; vehicle battery charging; charging of electric vehicles; knife sharpening; building insulating; bricklaying; riveting; construction consultancy; varnishing; re-tinning; installation of utilities in construction sites; scaffolding; road paving; window cleaning; vehicle washing; building

construction supervision; tuning of musical instruments; upholstery; rustproofing; anti-rust treatment for vehicles; sanding; pumicing; strong-room maintenance and repair; vehicle maintenance; paper hanging; painting or repair of signs; cleaning of buildings [exterior surface]; vehicle polishing; vehicle breakdown repair services; providing information relating to repairs; providing construction information; rental of bulldozers; rental of drainage pumps; rental of dish drying machines; rental of road sweeping machines; rental of cleaning machines; rental of cranes [construction equipment]; rental of dishwashing machines; rental of laundry washing machines; rental of construction equipment; rental of excavators; laying of cable; plumbing; masonry; roofing services; painting services; carpentry services; underwater repair; plastering; quarrying services; repair of security locks; umbrella repair; parasol repair; motor vehicle maintenance and repair; burner maintenance and repair; film projector repair and maintenance; airplane maintenance and repair; safe maintenance and repair; clock and watch repair; repair of power lines; pump repair; upholstery repair; shoe repair; clothing repair; photographic apparatus repair; furniture restoration; restoration of musical instruments; restoration of works of art; vehicle greasing; demolition of buildings; warehouse construction and repair; vehicle service stations [refuelling and maintenance]; sterilization of medical instruments; washing; washing of linen; construction; pier breakwater building; pipeline construction and maintenance; underwater construction; harbour construction; factory construction; building of fair stalls and shops; shipbuilding; cleaning of buildings [interior]; snow removal; street cleaning; vermin exterminating, other than for agriculture, aquaculture, horticulture and forestry; housekeeping services [cleaning services]; tyre balancing; pest control services, other than for agriculture, aquaculture, horticulture and forestry; hydraulic fracturing services; refilling of toner cartridges; refilling of ink cartridges; cell phone battery charging services; artificial snow-making services; laundering; services of electricians; installation of doors and windows; irrigation devices installation and repair; elevator installation and repair; installation and repair of flood protection equipment; heating equipment installation and repair; burglar alarm installation and repair; furnace installation and repair; telephone installation and repair; installation and repair of air-conditioning apparatus; fire alarm installation and repair; freezing equipment installation and repair; electric appliance installation and repair; kitchen equipment installation; installation, maintenance and repair of computer hardware; machinery installation, maintenance and repair; office machines and equipment installation, maintenance and repair; interference suppression in electrical apparatus; swimming-pool maintenance; furniture maintenance; chimney sweeping; boiler cleaning and repair; cleaning of clothing; leather care, cleaning and repair; fur care,

cleaning and repair; dry cleaning; vehicle cleaning; diaper cleaning.

42 – Water analysis; computer system analysis; handwriting analysis [graphology]; chemical analysis; rental of meters for the recording of energy consumption; energy auditing; recovery of computer data; business card design; graphic design of promotional materials; industrial design; graphic arts design; computer virus protection services; oil-field surveys; geological surveys; engineering; installation of computer software; interior design; meteorological information; clinical trials; material testing; textile testing; bacteriological research; biological research; geological research; research in the field of environmental protection; cosmetic research; mechanical research; research in the field of welding; research in the field of building construction; research in the field of telecommunications technology; research in the field of physics; chemical research; research and development of new products for others; medical research; scientific and technological research relating to patent mapping; scientific and technological research in the field of natural disasters; scientific research; analysis for oil-field exploitation; underwater exploration; technological research; calibration [measuring]; website design consultancy; computer security consultancy; information technology [IT] consultancy; consultancy in the design and development of computer hardware; architectural consultancy; computer software consultancy; data security consultancy; technological consultancy; oil-well testing; quality control; vehicle roadworthiness testing; land surveying; dress designing; updating of computer software; monitoring of computer systems to detect breakdowns; monitoring of computer systems for detecting unauthorized access or data breach; monitoring of computer systems by remote access; software as a service [SaaS]; maintenance of computer software; authenticating works of art; design of interior decor; quality evaluation of standing timber; quality evaluation of wool; digitization of documents [scanning]; conversion of data or documents from physical to electronic media; urban planning; platform as a service [PaaS]; providing information relating to computer technology and programming via a website; providing scientific information, advice and consultancy relating to carbon offsetting; providing search engines for the internet; conversion of computer programs and data, other than physical conversion; conducting technical project studies; computer system design; rental of web servers; computer rental; rental of computer software; unlocking of mobile phones; geological prospecting; oil prospecting; hosting computer sites [web sites]; server hosting; duplication of computer programs; development of computer platforms; construction drafting; computer software design; software development in the framework of software publishing; cloud seeding; consultancy in the field of energy-saving; creating and designing website-based indexes of information for others [information technology servi-

ces]; creating and maintaining websites for others; computer programming; technical writing; architectural services; information technology services provided on an outsourcing basis; chemistry services; packaging design; off-site data backup; telecommunications technology consultancy; scientific laboratory services; cloud computing; user authentication services using single sign-on technology for online software applications; user authentication services using technology for e-commerce transactions; weather forecasting; styling [industrial design]; cartography services; exploration services in the field of the oil, gas and mining industries; data encryption services; electronic data storage; surveying; electronic monitoring of credit card activity to detect fraud via the internet; electronic monitoring of personally identifying information to detect identity theft via the internet.

(260) AM 2022 115626 A

(800) 1629400

(151) 2021 04 30

(891) 2021 04 30

(731) Apple Inc.

One Apple Park Way, Cupertino CA 95014,
USA

(540)

AIRTAG

(591) Black, white

(511)

9 – Carrying cases for radio transmitters, radio receivers, global positioning systems (gps) devices, and mobile electronic devices used for locating, monitoring, and tracking the position of objects and electronic devices; carrying cases for wearable computer peripherals used for locating, monitoring, and tracking the position of objects and other electronic devices; carrying cases for electronic tags for goods.

18 – Carrying cases, namely, carrying cases of leather and imitations of leather; key cases; leather straps; leather key cases.

(260) AM 2022 115699 A

(800) 1630589

(151) 2021 08 17

(891) 2021 08 17

(731) Ericius Investments Limited

Christodoulou Chatzipavlou 199, 4th Floor,
Office 4A, CY-3036 Limassol, Cyprus

(540)



(591) Yellow and black
 (531) 26.04.08; 26.04.09; 26.04.24; 29.01.12
 (511)

35 – Web indexing for commercial or advertising purposes; business management of performing artists; business management of sports people; organization of exhibitions for commercial or advertising purposes; business intermediary services relating to the matching of potential private investors with entrepreneurs needing funding; business efficiency expert services; outsourcing services [business assistance]; sponsorship search; advertising; pay per click advertising; on-line advertising on a computer network; dissemination of advertising matter; systemization of information into computer databases; sales promotion for others; promotion of goods and services through sponsorship of sports events; negotiation and conclusion of commercial transactions for third parties; professional business consultancy.

41 – Academies [education]; arranging and conducting of conferences; arranging and conducting of in-person educational forums; arranging and conducting of seminars; electronic desktop publishing; providing information in the field of education; providing information in the field of entertainment; providing information relating to recreational activities; providing online videos, not downloadable; providing online electronic publications, not downloadable; providing television programmes, not downloadable, via video-on-demand services; providing films, not downloadable, via video-on-demand services; providing sports facilities; providing casino facilities [gambling]; booking of seats for shows; game services provided online from a computer network; organization of shows [impresario services]; organization of exhibitions for cultural or educational purposes; organization of lotteries; organization of sports competitions; providing amusement arcade services; club services [entertainment or education]; health club services [health and fitness training]; nightclub services [entertainment]; amusement park services; sport camp services; gambling services; conducting fitness classes; online publication of electronic books and journals; publication of books; publication of texts, other than publicity texts; entertainment services; production of shows; physical education.

(260) AM 2022 115709 A
 (800) 1630989
 (151) 2021 10 26
 (891) 2021 10 26
 (731) Apple Inc.
 One Apple Park Way, Cupertino CA 95014,
 USA

(540)

APPLE AIRTAG

(591) Black, white

(511)
 14 – Key chains; key rings.

(260) AM 2022 115710 A
 (800) 1631042
 (151) 2021 07 23
 (891) 2021 07 23
 (731) Zhejiang Yige Enterprise Management Group
 Co., Ltd.
 Unit 8, 6/F, Building 5, 2 Kejiyuan Road,
 Baiyang Sub-district, Hangzhou, Economic &
 Technological Development Area., Jianggan
 District, Hangzhou, Zhejiang Province, China

(540)

FloraEast

(591) Black, white
 (511)
 3 – Cosmetics; grinding preparations; air fragranc-
 ing preparations; fumigation preparations [perfumes];
 cosmetics for animals; cleaning preparations; ethereal
 essences; cleansing milk for toilet purposes; dentifri-
 ces; ethereal oils; polishing rouge; lipsticks; lipstick
 cases; beauty masks; cosmetic kits; make-up prepara-
 tions; eyebrow pencils; mascara; eye shadow; colo-
 rants for toilet purposes; make-up removing prepara-
 tions; lip glosses; make-up powder; sunscreen prepara-
 tions.

(260) AM 2022 115711 A
 (800) 1631068
 (151) 2021 04 26
 (891) 2021 04 26
 (731) Aardman Animations Limited
 Gas Ferry Road, Bristol, Avon BS1 6UN,
 United Kingdom

(540)



(591) Black, white
 (531) 03.04.11; 03.04.12; 03.04.24
 (511)

9 – Electronic publications (downloadable); downla-
 dable educational media; films and animated films;
 animated cartoons; radio, television, cable and sate-
 llite recordings; media for storage and/or reproduction
 of sound and/or visual images; machine readable data
 carriers; pre-recorded data carriers; discs, compact
 discs, DVDs and other digitally recorded media; com-
 puter software; educational software; computer soft-
 ware applications (downloadable); educational mobile

applications; computer game software; cases and covers for smartphones, tablets and communications devices; educational apparatus; bags adapted for laptops; computer mice and mouse mats; decorative magnets; magnetic badges; glasses; sunglasses; spectacle cases.

35 – Retail services relating to the sale of paints, soaps, detergents and cleaning products, perfumery and fragrances, essential oils, cosmetics, dentifrices, toiletries, preparations for the skin, face, body and hair, pharmaceutical and veterinary preparations, sanitary preparations for medical purposes, dietetic substances adapted for medical use, food for babies, plasters, materials for dressings, disinfectants, foods and beverages which are adapted for medical purposes, air deodorising preparations, hand tools and implements (hand operated), cutlery, machine readable data carriers, pre-recorded data carriers and other digitally recorded media, animated cartoons, computer software, game software and computer software applications, downloadable music, video, audio, game, media and software files and applications, electronic publications (downloadable), cases and covers for smartphones, tablets and communications devices, bags adapted for laptops, computer mice and mouse mats, decorative magnets, magnetic badges, glasses, sunglasses, spectacle cases, apparatus for lighting, heating, steam generating, cooking, refrigerating, drying, ventilating, water supply and sanitary purposes, air conditioning apparatus, electric kettles, gas and electric cookers, vehicle lights, vehicle air conditioning units, hair dryers, pocket warmers, bedwarmers, electric blankets (not for medical purposes), footmuffs (electrically heated), footwarmers (electric or non-electric), electric heaters for feeding bottles, electric heating cushions (not for medical purposes), hot water bottles, jewellery, clocks and watches, cufflinks, watch cases, watch straps and watch bands, key rings, medals, wristbands, badges, musical instruments, stands and cases adapted for musical instruments, printed matter, brochures, newspapers, periodicals, magazines, books, instructional and teaching materials, cards, postcards, book markers, art, pictures, prints, calendars, wrapping paper, stationery, paper, envelopes, memo pads, note pads, drawing pads, greeting cards, folders, writing cases, rubbers, erasers, pencils, pencil holders, adhesives for stationery or household purposes, adhesive tape, writing instruments, crayons, chalks, pencil sharpeners, tracing paper, modelling materials, pencil cases, transfers, stickers, decalcomanias, colouring sets consisting of colouring instruments and printed matter, paper craft sets and materials, tax disc holders for cars and motorcycles, artists' materials, paint brushes, luggage and bags, school bags, satchels, book bags, rucksacks, sports bags, handbags, wallets and purses, suitcases and travelling bags, umbrellas, wash bags, cosmetic bags and purses, furniture, furnishings, mirrors, furniture for pets, garden furniture, furnishings for the home and garden and for pet furniture, household goods, namely, household utensils, sifters,

sieves, graters, dishes, serving scoops, serving spoons and household containers, all-purpose portable household containers, containers for kitchen use, containers for storage purposes, compost containers, heat-insulated containers, baskets and receptacles, cups and cup holders, glassware, porcelain, earthenware, crockery, works of art, statuettes, figurines, sculptures, ornaments of wood, wax, plaster, plastic, porcelain, ceramic, earthenware or glass, soft furnishings, household linen and textiles, bedlinen, towels, table linen, rugs, buttons, badges for wear, tea cosies, carpets, rugs, mats and matting, wall hangings (non-textile), wallpaper, clothing, footwear and headgear, babywear, clothing accessories, toys, games and playthings, jigsaw puzzles, board games, toy models, model craft kits, sporting articles, playground activity apparatus, decorations for Christmas trees, plush toys, playing cards, educational toys and playthings, electronic educational game machines for children, foods, food products and foodstuffs, meat, fish, poultry, game, meat extracts, preserved, dried and cooked fruit, candied, shelled and roasted nuts, pickled, canned and bottled, whole or sliced vegetables, jellies, jams, eggs, milk and milk products, yogurt, cheese, cottage cheese, edible oils, edible fats, snack foods, coffee, tea, cocoa, sugar, rice, tapioca, sago, artificial coffee, flour and preparations made from cereals, bread, pastry and confectionery, candy and other sweets, ices, honey, treacle, yeast, baking-powder, salt, mustard, vinegar, sauces (condiments), spices, ice, snack foods, fruit sauces, puddings, sandwiches, spring rolls, sushi, beverages and preparations for making beverages, seeds, natural plants and flowers, foodstuffs for animals, alcoholic beverages, non-alcoholic beverages; advertising and promotional services through the distribution and sale of the aforementioned goods; organising and conducting exhibitions, fairs and events for commercial and advertising purposes; advertising and promotional services through sponsoring arrangements and licence agreements; advertising and promotional services through the distribution and sale of merchandise; consultancy, advisory and information services relating to all of the aforementioned services.

41 – Entertainment; education; sporting and cultural activities; animation production services; special effects and animation services for film, television and audio, video and digital media including online media; publication services; video, audio and digital multimedia publishing services; on-line publishing services; layout services; electronic publications, not downloadable; scriptwriting; screenplay writing; song writing; music composition services; photography; entertainment media production services and post-production services for motion pictures, television and Internet; production of radio, television, digital and internet programmes; production of shows; radio entertainment; television entertainment; theatre productions; film production; production of music; movie studio services; recording studio services; distribution

of films, radio and television programs, videos, audio recordings, and multimedia entertainment content; providing online videos, not downloadable; providing online games, non-downloadable; presentation of variety shows; presentation of live shows and performances; amusement park services; providing amusement arcade services; organisation of competitions (educational, cultural or for entertainment purposes); arranging and conducting of exhibitions for entertainment, cultural or educational purposes; arranging displays for cultural purposes; provision of training in animation production; provision of training in special effects, film, television, video, audio and digital multimedia production and publishing, live shows and public performances, advertising and marketing; arranging and conducting workshops for educational, training or recreational purposes; arranging, conducting and providing seminars and presentations; providing corporate hospitality; consultancy, advisory and information services relating to all of the aforementioned services.

(260) AM 2022 115712 A
 (800) 1631262
 (151) 2021 10 04
 (891) 2021 10 04
 (731) Dr. Ing. h.c. F. Porsche Aktiengesellschaft
 Porscheplatz 1, 70435 Stuttgart, Germany
 (540)

Carrera

(591) Black, white
 (511)
 27 – Carpets for automobiles; vehicle mats and carpets; rubber mats.

(260) AM 2022 115714 A
 (800) 1631357
 (151) 2021 11 03
 (891) 2021 11 03
 (731) Miriade S.p.A.
 Piazza dei Martiri, 30, I-80121 Napoli, Italy
 (540)

FRANCESCO BIASIA

(591) Black, white
 (531) 27.05.09
 (511)
 18 – Leather and imitation leather; animal skins, hides; trunks and suitcases; umbrellas, big umbrellas and walking sticks; whips, harness and saddlery; attaché cases; rucksacks; beach bags; briefcases; card cases [notecases]; bags; chain mesh purses; handbag frames; handbags; pocket wallets; purses, not of precious metal; key-cases of leather and skins; purses; shopping bags; shoulder belts; baby slings; trolley bags; sports bags; vanity cases, not fitted.

25 – Clothing, headscarves, scarves, belts, footwear, headgear.

(260) AM 2022 115716 A
 (800) 1631541
 (151) 2021 11 08
 (891) 2021 11 08
 (731) Corteva Agriscience LLC
 9330 Zionsville Road, Indianapolis IN 46268,
 USA
 (540)

NEXSUBA

(591) Black, white
 (511)
 5 – Insecticide for agricultural use.

(260) AM 2022 115717 A
 (800) 1631555
 (151) 2021 08 31
 (891) 2021 08 31
 (731) KARINE KHACHATRYAN
 14 Sebastia str. 14, apt. 30, Yerevan, Armenia
 (540)

KATNA

(591) Black, white
 (511)
 29 – Meat, fish, poultry and game; meat extracts; preserved, frozen, dried and cooked fruits and vegetables; jellies, jams, compotes; eggs; milk, cheese, butter, yogurt and other milk products; oils and fats for food.

30 – Coffee, tea, cocoa and artificial coffee; rice, pasta and noodles; tapioca and sago; flour and preparations made from cereals; bread, pastries and confectionery; chocolate; ice cream, sorbets and other edible ices; sugar, honey, treacle; yeast, baking-powder; salt, seasonings, spices, preserved herbs; vinegar, sauces and other condiments; ice [frozen water].

32 – Beers; non-alcoholic beverages; mineral and aerated waters; fruit beverages and fruit juices; syrups and other non-alcoholic preparations for making beverages.

43 – Services for providing food and drink; temporary accommodation.

(260) AM 2022 115718 A
 (800) 1631558
 (151) 2021 08 19
 (891) 2021 08 19
 (731) Markushevskiy Igor Isaakovych
 vul. Bolharska, 82, kv. 8; m. Odesa 65005,
 Ukraine;
 Maslenkov Volodymyr Mykolaiovych
 vul. Marshala Hovorova, 1-2, kv. 101, m. Odesa

65058, Ukraine;
Shmulevych Vitalii Naumovych
vul. Levanevskoho, 7, kv. 63, m. Odesa 65062,
Ukraine

(540)

GEM

(591) Black, white
(531) 27.05.01; 27.05.23
(511)

33 – Alcoholic beverages, except beer; aperitif wines; wine; digesters [liqueurs and spirits]; brandy; whisky; gin; anisette [liqueur]; anise [liqueur]; mead [hydro-mel]; vodka; kirsch; perry; cocktails; liqueurs; peppermint liqueurs; distilled beverages; pre-mixed alcoholic beverages, other than beer-based; alcoholic beverages containing fruit; bitters; piquette; rum; cider; spirits [beverages]; alcoholic extracts; alcoholic essences; fruit extracts, alcoholic.

(260) AM 2022 115791 A

(800) 1633205

(151) 2021 11 17

(891) 2021 11 17

(731) Apple Inc.

One Apple Park Way, Cupertino CA 95014,
USA

(540)

SF ARABIC

(591) Black, white
(526) ARABIC
(511)

9 – Downloadable computer software for generating, displaying, and printing fonts.

(260) AM 2022 115792 A

(800) 1633295

(151) 2021 11 03

(891) 2021 11 03

(731) Bayer Intellectual Property GmbH

Alfred-Nobel-Str. 10, 40789 Monheim am
Rhein, Germany

(540)

АСПИСЕПТ

(591) Black, white
(531) 28.05
(511)

5 – Pharmaceutical preparations.

(260) AM 2022 115793 A

(800) 1633300

(151) 2021 10 20

(891) 2021 10 20

(731) LATVIJAS FINIERIS, AS

Bauskas iela 59, LV-1004 Rīga, Latvia

(540)

Riga Wood 

(591) Black, orange and white
(531) 26.01.03; 26.01.18; 27.05.01; 29.01.13
(511)

19 – Plywood; wood veneers; building materials, not of metal; construction materials, not of metal.

35 – Business management assistance; business inquiries; market studies; marketing research; organization of exhibitions for commercial or advertising purposes.

(260) AM 2022 115794 A

(800) 1633309

(151) 2021 08 11

(891) 2021 08 11

(731) FUJIAN NANXIANG INVESTMENT GROUP CO., LTD.

Floor 4, No. 268, Dingjie West Road, Xindian
Village, Chidian Town, Jinjiang City,
Quanzhou City, 362212 Fujian Province, China

(540)



Horseshoe
马蹄铁

(591) Black, white

(531) 02.01.02; 02.01.04; 02.01.16; 02.01.21;
02.01.23; 03.03.01; 03.03.17; 27.05.01;
27.05.08; 28.03

(511)

32 – Purified water [beverages]; fruit juices; cola; mineral water [beverages]; ingredients for spirits; malt beer; beer; pop; waters [beverages].

(260) AM 2022 115795 A

(800) 1633312

(151) 2021 11 09

(891) 2021 11 09

(731) Maschinenfabrik Niehoff GmbH & Co. KG
Walter-Niehoff-Straße 2, 91126 Schwabach,
Germany

(540)

NIEHOFF

(591) Black, white

(511)

9 – Application software for data analysis and data monitoring; application software for cloud computing services; application software for controlling machines.

38 – Electronic data transmission via the Internet; provision of access to clouds, websites and Internet portals.

(260) AM 2022 115796 A

(800) 1633349

(151) 2021 11 17

(891) 2021 11 17

(731) Maria Clementine Martin Klosterfrau,
Vertriebsgesellschaft m.b.H.
Gereonsmühlengasse 1/11, 50670 Köln,
Germany

(540)

CNL-1976

(591) Black, white

(511)

5 – Pharmaceuticals; medical preparations; veterinary preparations; sanitary preparations for medical purposes; foodstuffs and dietetic substances for medical or veterinary purposes; food for babies; dietary supplements for humans; dietary supplements for animals; plasters, materials for dressings; dressings, medical; teeth filling material; dental impression materials; disinfectants; preparations for destroying noxious animals; fungicides; herbicides.

10 – Surgical, medical, dental and veterinary apparatus and instruments; artificial limbs; artificial eyes; artificial teeth; orthopedic articles; suture materials; therapeutic and assistive devices adapted for persons with disabilities; massage apparatus; apparatus, devices and articles for nursing infants; sexual activity apparatus, devices and articles.

(260) AM 2022 115800 A

(800) 1633484

(151) 2021 11 12

(891) 2021 11 12

(731) Papa John's International, Inc.
2002 Papa John's Boulevard, Louisville
KY 40299, USA

(540)

PAPAJOHNS

(591) Black, white

(531) 27.01.16; 27.05.17

(511)

29 – Chicken; chicken nuggets; chicken wings; prepared foods for consumption on or off the premises, namely, chicken; cheese sticks.

30 – Pizza; flatbread, piadina, pizza turnover, calzone, and stromboli; pizza cheese sticks; bread rolls; pepperoni rolls; breadsticks; cookies; brownies; baked desserts, namely, cinnamon bread and cookie cakes; donut holes; sauces; dipping sauces; garlic-based sauces; spicy sauces; ranch sauces; blue cheese sauce; buffalo sauce; barbecues sauce; honey mustard sauce; cheese sauce; seasonings.

39 – Pizza delivery services; delivery of food and drinks by restaurants.

43 – Restaurant services; restaurant services featuring in-restaurant dining and carryout and delivery services; take-out restaurant services.

(260) AM 2022 115831 A

(800) 1471435

(151) 2019 04 18

(891) 2021 11 09

(731) UAB "VALENTIS"

Molėtų pl. 11, LT-08409 Vilnius, Lithuania

(540)

OILESEN

(591) Black, white

(511)

5 – Nutritional supplements; vitamin preparations.

(260) AM 2022 115833 A

(800) 1509382

(151) 2019 10 01

(891) 2021 03 01

(731) Dirk Rossmann GmbH
Isernhägener Straße 16, 30938 Burgwedel,
Germany

(540)



(591) Black, white

(531) 01.15.21; 04.02.01; 26.01.03; 26.01.16; 27.05.01

(511)

1 – Chemicals for treating water, namely, water decalcifying products; stain-preventing chemicals for use on fabrics; stain-preventative chemicals for use on carpets; chemical preparations for repelling stains; salts [chemical preparations]; water-softening preparations; distilled water; salts for industrial purposes; chemical substances, chemical materials and chemical preparations, and natural elements in relation with foodstuffs and beverages; chemical agents for impregnating textiles, furs, leather, non-wovens and fabrics;

coating compositions [not paint] for protection against the effects of water; waterproofing chemical compositions for articles of fabric; textile-impregnating chemicals.

3 – Dishwasher tablets; dirt attracting detergents; dishwashing detergents; dishwasher detergents; detergents for machine dishwashing; cleaning and fragrancing preparations; essential oils and aromatic extracts; lime removers; glass cleaning preparations; cleansers for household purposes; household fragrances; room scenting sprays; air fragrancing preparations; refills for electric room fragrance dispensers; fragrance refills for non-electric room fragrance dispensers; perfumed tissues; tissues impregnated with cosmetic lotions; cloths impregnated with a detergent for cleaning; polishing preparations; scouring liquids; general purpose scouring powder; scouring powders; laundry preparations; laundry liquids; scented linen water; deodorants and antiperspirants; scouring substances; dishwasher powder; rinse aids; furniture cleaner; floor polishes; oven cleaning preparations; stain removers; antistatic dryer sheets; upholstery cleaners; dishwasher rinsing agents; liquid dishwasher detergents; dishwashing liquid; soap powder; laundry blueing; sachets for perfuming linen; scented linen sprays; laundry soap; essential oils as perfume for laundry purposes; refurbishing preparations; impregnated cloths for polishing; lavatory cleaning compositions; toilet cleaners; non-medicated toiletries; window cleaners in spray form; anti-smear agents for cleaning purposes; cleaning preparations for cleansing drains; starch glaze for laundry purposes; smoothing preparations [starching]; bleaching soda; bleaching preparations; shoe cream; shoe sprays; shoe polish; shoe black [shoe polish]; detergent compositions for cleaning shoes; pastes for cleaning shoes; shoe cleaners [preparations]; leather and shoe cleaning and polishing preparations; creams for leather; preservative creams for leather; cleaning preparations for leather; floor shining compositions; fabric softeners.

5 – Deodorising room sprays; air deodorizing preparations; sanitary preparations and articles; toilet deodorants; disinfectants and antiseptics; sanitizers for household use; deodorants for textiles; deodorants for clothing; deodorants for refrigerators; deodorants for upholstery; deodorants for clothing and textiles; air deodoriser sprays; impregnated medicated wipes; car deodorants; car air fresheners.

(260) AM 2022 115836 A

(800) 1556535

(151) 2020 06 18

(891) 2021 12 02

(731) TEKA INDUSTRIAL, S.A.

Cajo, 17, E-39011 Santander (Cantabria), Spain

(540)



(591) Red and white

(531) 26.04.05; 26.04.24; 27.05.24; 29.01.12

(511)

6 – Common metals and their alloys; metal building materials; transportable buildings of metal; materials of metal for railway tracks; non-electric cables and wires of common metal; ironmongery; small items of metal hardware; pipes and tubes of metal; ores.

7 – Food and beverage processing and preparation machines and apparatus; packaging machines; sweeping, cleaning, washing and laundering machines; motors and engines (except for land vehicles); machine coupling and transmission components (except for land vehicles); agricultural implements other than hand-operated; incubators for eggs; clothes washing machines; dishwashers; drain cocks; water heaters [parts of machines]; mixers [machines].

11 – Apparatus for lighting, heating, steam generating, cooking, refrigerating, drying, ventilating, water supply and sanitary purposes, in particular for use in commercial kitchens; electric and gas apparatus for kitchen and industrial kitchen installations, namely cookers, bread ovens, hobs, cooking ranges, steam apparatus, microwave ovens, plate warmers, extractor hoods, refrigeration and freezing apparatus, cooking and roasting apparatus, and automatic cooking and roasting machines, deep fryers, pressure cookers, pressure cooking saucepans, automatic fermentation apparatus, blast chillers; electrical and gas apparatus for kitchen and industrial kitchen installations, namely blast freezers, cooling tables, grills (kitchen appliances), banquet systems; systems for distributing plates and systems for storing and serving foodstuffs and prepared dishes, formed of apparatus for lighting, heating, steam generating, cooking, refrigerating, drying, ventilating or water supply purposes or fermentation apparatus or deep fryers or pressure cookers or pressure cooking saucepans; systems for distributing plates and systems for storing and serving foods and prepared dishes, formed of automatic fermentation apparatus or blast chillers or blast freezers or refrigerators and freezers or cooling tables or gas and electrical apparatus; parts and accessories for the aforesaid goods; anti-splash tap nozzles; bath fittings; taps [cocks, spigots] faucets [am] for pipes; feeding apparatus for heating boilers; filters for drinking water; fire bars; ovens (shaped fittings for -); kiln furniture [supports]; loading apparatus for furnaces; mixer taps for water

pipes; oven fittings made of fireclay; regulating accessories for water apparatus and pipes; safety accessories for water or gas apparatus and pipes; framework of metal for ovens; taps [faucets]; toilet seats; washers for water taps; water-pipes for sanitary installations; hot air bath fittings; regulating and safety accessories for water apparatus; extractor hoods for kitchens; ventilation hoods for stoves; adjustable coated baffle grease filters [parts of cooker hoods]; filters for use with apparatus for water supply; filters for use with apparatus for steam generating; filters for use with apparatus for ventilating; filters for use with apparatus for refrigerating; dish dryers.

37 – Repairs of mixers (machines), incubators for eggs, washing machines, dishwashers and tumble dryers, electric door closers, electric door openers, drain cocks, water heaters (parts of machines), apparatus for lighting, heating, steam generating, cooking, refrigerating, drying, ventilating, water supply and sanitary purposes, in particular for industrial kitchens, electric and gas apparatus for kitchen and industrial kitchen installations; repairs of systems for distributing plates and systems for storing and serving foodstuffs and prepared dishes, formed of automatic fermentation apparatus or blast chillers or blast freezers or refrigerators and freezers or cooling tables or gas and electrical apparatus, anti-splash tap nozzles, bath fittings, pipe line cocks [spigots], feeding apparatus for heating boilers, filters for drinking water; repairs of furnace grates, shaped fittings for furnaces, kiln furniture, loading apparatus for furnaces, mixer taps for water pipes, oven fittings made of fireclay, regulating accessories for water apparatus and pipes, safety accessories for water or gas apparatus and pipes, structural plates for ovens, taps, toilet seats, washers for water taps, pipes (parts of sanitary installations), hot air bath fittings, pipe line cocks, furnace grates, fire bars; repairs of aerators for taps, regulating and safety accessories for water apparatus, extractor hoods for kitchens, ventilation hoods for kitchens, adjustable coated baffle grease filters (parts of cooker hoods), filters (parts of household or industrial installations); installation of incubators for eggs, washing machines, dishwashers and tumble dryers, electric door closers, electric door openers, drain cocks, water heaters (parts of machines), apparatus for lighting, heating, steam generating, cooking, refrigerating, drying, ventilating, water supply and sanitary purposes, in particular for industrial kitchens, electric and gas apparatus for kitchen and industrial kitchen installations; installation of systems for distributing plates and systems for storing and serving foodstuffs and prepared dishes, formed of automatic fermentation apparatus or blast chillers or blast freezers or refrigerators and freezers or cooling tables or gas and electrical apparatus, anti-splash tap nozzles, bath fittings, pipe line cocks [spigots], feeding apparatus for heating boilers, filters for drinking water, furnace grates, shaped fittings for furnaces; installation of kiln furniture, loading apparatus

for furnaces, mixer taps for water pipes, oven fittings made of fireclay, regulating accessories for water apparatus and pipes, safety accessories for water or gas apparatus and pipes, structural plates for ovens, taps, toilet seats, washers for water taps, pipes (parts of sanitary installations), hot air bath fittings, pipe line cocks, furnace grates, fire bars, aerators for taps, regulating and safety accessories for water apparatus; installation of extractor hoods for kitchens, ventilation hoods for kitchens, adjustable coated baffle grease filters (parts of cooker hoods), filters (parts of household or industrial installations) and mixers (machines); machinery installation, maintenance and repair; office machines and equipment installation, maintenance and repair; repair information.

(260) AM 2022 115837 A

(800) 1571861

(151) 2020 08 20

(891) 2021 10 05

(731) TikTok Information Technologies UK Limited
One London Wall, 6th Floor, London
EC2Y 5EB, United Kingdom

(540)



(591) Black, Pantone colour 318C and Pantone colour 2040C

(531) 24.17.10; 24.17.25; 29.01.13

(511)

3 – Cosmetics; soap; cleaning preparations; polishing preparations; abrasives; perfume; dentifrices; cosmetics for pets; air fragrancing preparations; incense.

8 – Sharpening instruments; garden tools, hand-operated; nail clippers, electric or non-electric; hand tools, hand-operated; graving tools [hand tools]; cutters; table cutlery [knives, forks and spoons].

10 – Feeding bottles.

27 – Carpets; door mats; floor coverings; yoga mats; textile wallpaper.

29 – Meat; weed extracts for food; seaweed extracts for food; fish, not live; fruits, tinned; fruits, canned; fruit, preserved; vegetables, preserved; eggs; soymilk (milk substitute); milk; edible fats; vegetable salads; gelatine; nuts, prepared; dried edible mushrooms; yogurt.

30 – Coffee; tea; tea-based beverages; candy; honey; pasties; starch for food; noodles; cereal-based snack food; soya flour; cooking salt; ice, natural or artificial; biscuits; chewing gum; buns; chips [cereal products]; corn flakes; dressings for salad; essences for foodstuffs, except etheric essences and essential oils; gluten

prepared as foodstuff; preparations for stiffening whipped cream; high-protein cereal bars.

31 – Trees; animal foodstuffs; aromatic sand [litter] for pets; beans, fresh; coconut shells; flowers, dried, for decoration; nuts, unprocessed; peanuts, fresh; vegetables, fresh; yeast for animal consumption.

32 – Non-alcoholic drinks; beers; syrups for beverages.

33 – Spirits and liquors; wine.

39 – Transportation services; travel reservation services; transport reservation services; travel agency services; packaging of goods; boat rental; mail delivery and courier services; arranging of tours.

43 – Accommodation bureaux [hotels, boarding houses]; providing campground facilities; day-nurseries [crèches]; boarding for animals; self-service restaurant services; restaurant services; tourist home services; food and drink catering; rental of chairs, tables, table linen, glassware.

(260) AM 2022 115839 A

(800) 1616992

(151) 2021 08 26

(891) 2021 11 18

(731) CELLTRION, INC.

23, Academy-ro, Yeonsu-gu, Incheon,
Republic of Korea

(540)

SKYDELT

(591) Black, white

(511)

5 – Ophthalmic preparations; pharmaceutical preparations for the treatment of angiogenesis.

(260) AM 2022 115903 A

(800) 1633992

(151) 2021 10 19

(891) 2021 10 19

(731) ZHEJIANG GEELY HOLDING GROUP CO.,
LTD.

1760 Jiangling Road, Binjiang District,
Hangzhou, Zhejiang, China

(540)

Homtruck

(591) Black, white

(531) 27.05.17

(511)

12 – Electric vehicles; vehicles for locomotion by land, air, water or rail; automobiles; trucks; land vehicle gearbox; propulsion mechanisms for land vehicles; motor coaches; brakes for vehicles; safety belts for vehicle seats.

(260) AM 2022 116038 A

(800) 1636439

(151) 2021 11 17

(891) 2021 11 17

(731) Beijing Hutt Wisdom Technology Co., LTD.

No. 432, 4th Floor, Building 12, Xijiekouwai
Street 8, Xicheng District, 100000 Beijing,
China

(540)



(591) Black, white

(531) 27.05.01; 27.05.09; 27.05.10; 27.05.17;

27.05.21

(511)

7 – Disintegrators; suction nozzles for vacuum cleaners; brushes for vacuum cleaners; vacuum cleaner bags; machines and apparatus for wax-polishing, electric; vacuum cleaner hoses; vacuum cleaners; vacuum cleaner attachments for disseminating perfumes and disinfectants; high pressure washers; dust removing installations for cleaning purposes; machines and apparatus for carpet shampooing, electric; machines and apparatus for cleaning, electric; washing apparatus; mud catchers and collectors [machines]; sewage pulverisers; cleaning appliances utilizing steam; dust exhausting installations for cleaning purposes; central vacuum cleaning installations; parquet wax-polishers, electric; waste disposal units.

(260) AM 2022 116042 A

(800) 1636462

(151) 2021 10 19

(891) 2021 10 19

(731) Beijing Hotgen Biotech Co., Ltd.

9th Building, No.9 Tianfu Street, Daxing
Biomedical Industry Base, Zhongguancun
Science Park, Daxing District, 102600 Beijing,
China

(540)

Hotgen 

(591) Blue, white

(531) 03.13.01; 03.13.24

(511)

10 – Blood testing apparatus; medical apparatus and instruments; testing apparatus for medical purposes; diagnostic apparatus for medical purposes; lasers for medical purposes; dental apparatus and instruments; ice bags for medical purposes; surgical implants [artificial materials]; orthopedic articles.

INTERNATIONAL TRADEMARKS PROTECTED IN GEORGIA

(260) AM 2022 108800 A
(800) 1537234
(151) 2019 12 27
(181) 2029 12 27
(891) 2019 12 27
(511) 41

(260) AM 2022 112967 A
(800) 1590748
(151) 2021 04 14
(181) 2031 04 14
(891) 2021 04 14
(511) 21

(260) AM 2022 109995 A
(800) 1553179
(151) 2020 06 30
(181) 2030 06 30
(891) 2020 06 30
(511) 01, 04, 09, 12

(260) AM 2022 112989 A
(800) 1591282
(151) 2020 10 26
(181) 2030 10 26
(891) 2020 10 26
(511) 01, 05, 42, 44

(260) AM 2022 110246 A
(800) 1556524
(151) 2020 06 02
(181) 2030 06 02
(891) 2020 06 02
(511) 09, 28, 41

(260) AM 2022 113060 A
(800) 1591872
(151) 2021 01 19
(181) 2031 01 19
(891) 2021 01 19
(511) 05, 35

(260) AM 2022 110306 A
(800) 1557333
(151) 2020 06 02
(181) 2030 06 02
(891) 2020 06 02
(511) 09, 28, 41

(260) AM 2022 113168 A
(800) 722689
(151) 1999 11 11
(181) 2029 11 11
(891) 2020 04 29
(511) 01, 03

(260) AM 2022 110357 A
(800) 1549467
(151) 2020 07 20
(181) 2030 07 20
(891) 2020 09 03
(511) 07

(260) AM 2022 113178 A
(800) 1504220
(151) 2019 10 17
(181) 2029 10 17
(891) 2021 05 11
(511) 03, 05, 29, 30, 32

(260) AM 2022 112438 A
(800) 1583871
(151) 2020 12 31
(181) 2030 12 31
(891) 2020 12 31
(511) 10

(260) AM 2022 113179 A
(800) 1509004
(151) 2019 11 22
(181) 2029 11 22
(891) 2021 05 11
(511) 03, 05, 29, 30

(260) AM 2022 112831 A
(800) 1547889
(151) 2020 07 14
(181) 2030 07 14
(891) 2021 04 14
(511) 35, 36

(260) AM 2022 113181 A
(800) 1545823
(151) 2020 07 03
(181) 2030 07 03
(891) 2021 04 26
(511) 03

(260) AM 2022 113291 A
(800) 1594117
(151) 2021 04 19
(181) 2031 04 19
(891) 2021 04 19
(511) 32, 33

(260) AM 2022 113316 A
(800) 1594794
(151) 2020 10 15
(181) 2030 10 15
(891) 2020 10 15
(511) 30

(260) AM 2022 113292 A
(800) 1594207
(151) 2020 07 29
(181) 2030 07 29
(891) 2020 07 29
(511) 09, 16, 18, 25, 35, 39

(260) AM 2022 113317 A
(800) 1594872
(151) 2021 03 25
(181) 2031 03 25
(891) 2021 03 25
(511) 20

(260) AM 2022 113293 A
(800) 1594213
(151) 2021 03 30
(181) 2031 03 30
(891) 2021 03 30
(511) 25

(260) AM 2022 113318 A
(800) 1594896
(151) 2021 04 20
(181) 2031 04 20
(891) 2021 04 20
(511) 03

(260) AM 2022 113298 A
(800) 1594528
(151) 2021 01 11
(181) 2031 01 11
(891) 2021 01 11
(511) 06, 07, 08, 09, 11, 21, 35

(260) AM 2022 113319 A
(800) 1594977
(151) 2020 09 09
(181) 2030 09 09
(891) 2020 09 09
(511) 35, 36, 38, 42

(260) AM 2022 113304 A
(800) 1594583
(151) 2020 10 15
(181) 2030 10 15
(891) 2020 10 15
(511) 30

(260) AM 2022 113320 A
(800) 1595023
(151) 2021 04 12
(181) 2031 04 12
(891) 2021 04 12
(511) 25

(260) AM 2022 113314 A
(800) 1594755
(151) 2021 02 09
(181) 2031 02 09
(891) 2021 02 09
(511) 16, 36

(260) AM 2022 113321 A
(800) 1595033
(151) 2021 03 18
(181) 2031 03 18
(891) 2021 03 18
(511) 05, 44

(260) AM 2022 113315 A
(800) 1594793
(151) 2021 04 29
(181) 2031 04 29
(891) 2021 04 29
(511) 07

(260) AM 2022 113322 A
(800) 1595113
(151) 2021 03 26
(181) 2031 03 26
(891) 2021 03 26
(511) 38, 41

(260) AM 2022 113323 A
(800) 1595117
(151) 2020 12 30
(181) 2030 12 30
(891) 2020 12 30
(511) 29, 30, 32

(260) AM 2022 113331 A
(800) 1427336
(151) 2018 06 01
(181) 2028 06 01
(891) 2021 04 22
(511) 30

(260) AM 2022 113324 A
(800) 1595158
(151) 2021 02 19
(181) 2031 02 19
(891) 2021 02 19
(511) 30

(260) AM 2022 113332 A
(800) 1475704
(151) 2019 05 31
(181) 2029 05 31
(891) 2021 05 10
(511) 12

(260) AM 2022 113325 A
(800) 1595172
(151) 2021 01 29
(181) 2031 01 29
(891) 2021 01 29
(511) 09, 35, 38, 41, 42, 45

(260) AM 2022 113333 A
(800) 1552284
(151) 2020 07 10
(181) 2030 07 10
(891) 2021 05 12
(511) 05, 10, 34

(260) AM 2022 113326 A
(800) 1595202
(151) 2021 02 03
(181) 2031 02 03
(891) 2021 02 03
(511) 33

(260) AM 2022 113334 A
(800) 1570352
(151) 2020 11 10
(181) 2030 11 10
(891) 2021 03 18
(511) 28

(260) AM 2022 113327 A
(800) 689476
(151) 1998 03 13
(181) 2028 03 13
(891) 2020 12 01
(511) 33

(260) AM 2022 113434 A
(800) 1595220
(151) 2021 04 23
(181) 2031 04 23
(891) 2021 04 23
(511) 05

(260) AM 2022 113328 A
(800) 1035645
(151) 2010 03 08
(181) 2030 03 08
(891) 2020 07 27
(511) 05

(260) AM 2022 113436 A
(800) 1595255
(151) 2021 02 05
(181) 2031 02 05
(891) 2021 02 05
(511) 09, 28, 41

(260) AM 2022 113329 A
(800) 1134533
(151) 2012 01 05
(181) 2022 01 05
(891) 2021 04 26
(511) 05, 25, 28, 32, 35

(260) AM 2022 113437 A
(800) 1595285
(151) 2021 01 20
(181) 2031 01 20
(891) 2021 01 20
(511) 01, 03, 05

(260) AM 2022 113444 A
(800) 1595548
(151) 2020 10 14
(181) 2030 10 14
(891) 2020 10 14
(511) 06, 07, 09

(260) AM 2022 113464 A
(800) 1596071
(151) 2020 12 02
(181) 2030 12 02
(891) 2020 12 02
(511) 03, 07, 09, 11, 35, 37

(260) AM 2022 113458 A
(800) 1595924
(151) 2021 03 03
(181) 2031 03 03
(891) 2021 03 03
(511) 05

(260) AM 2022 113466 A
(800) 1596110
(151) 2021 02 05
(181) 2031 02 05
(891) 2021 02 05
(511) 09, 28, 41

(260) AM 2022 113459 A
(800) 1595969
(151) 2021 02 25
(181) 2031 02 25
(891) 2021 02 25
(511) 05

(260) AM 2022 113468 A
(800) 1596177
(151) 2021 04 12
(181) 2031 04 12
(891) 2021 04 12
(511) 03

(260) AM 2022 113460 A
(800) 1595975
(151) 2020 12 14
(181) 2030 12 14
(891) 2020 12 14
(511) 25, 26

(260) AM 2022 113472 A
(800) 836997
(151) 2004 05 27
(181) 2024 05 27
(891) 2021 05 25
(511) 05

(260) AM 2022 113461 A
(800) 1595988
(151) 2021 02 24
(181) 2031 02 24
(891) 2021 02 24
(511) 07, 11, 20

(260) AM 2022 113473 A
(800) 891860
(151) 2006 04 05
(181) 2026 04 05
(891) 2021 02 26
(511) 24

(260) AM 2022 113462 A
(800) 1596037
(151) 2021 01 11
(181) 2031 01 11
(891) 2021 01 11
(511) 01, 04, 07, 12, 37

(260) AM 2022 113474 A
(800) 908820
(151) 2006 11 06
(181) 2026 11 06
(891) 2021 05 21
(511) 14, 18, 25

(260) AM 2022 113463 A
(800) 1596053
(151) 2020 11 26
(181) 2030 11 26
(891) 2020 11 26
(511) 09, 35, 36, 38, 39, 42

(260) AM 2022 113475 A
(800) 983769
(151) 2008 10 06
(181) 2028 10 06
(891) 2021 04 23
(511) 32

(260) AM 2022 113476 A
(800) 1213746
(151) 2014 05 20
(181) 2024 05 20
(891) 2021 05 20
(511) 35, 36

(260) AM 2022 113477 A
(800) 1369285
(151) 2017 03 06
(181) 2027 03 06
(891) 2021 05 21
(511) 05, 29

(260) AM 2022 113478 A
(800) 1500373
(151) 2019 08 26
(181) 2029 08 26
(891) 2021 05 05
(511) 25, 35

(260) AM 2022 113482 A
(800) 1590334
(151) 2021 01 29
(181) 2031 01 29
(891) 2021 05 11
(511) 35, 36

(260) AM 2022 113524 A
(800) 1596257
(151) 2020 10 02
(181) 2030 10 02
(891) 2020 10 02
(511) 06, 19

(260) AM 2022 113537 A
(800) 1596714
(151) 2021 04 12
(181) 2031 04 12
(891) 2021 04 12
(511) 30

(260) AM 2022 113539 A
(800) 1596875
(151) 2021 05 06
(181) 2031 05 06
(891) 2021 05 06
(511) 05

(260) AM 2022 113540 A
(800) 1596876
(151) 2021 02 19
(181) 2031 02 19
(891) 2021 02 19
(511) 30

(260) AM 2022 113543 A
(800) 1596915
(151) 2021 02 05
(181) 2031 02 05
(891) 2021 02 05
(511) 09, 28, 41

(260) AM 2022 113544 A
(800) 1596923
(151) 2021 02 19
(181) 2031 02 19
(891) 2021 02 19
(511) 30

(260) AM 2022 113545 A
(800) 1596967
(151) 2020 12 04
(181) 2030 12 04
(891) 2020 12 04
(511) 17, 19

(260) AM 2022 113546 A
(800) 1596968
(151) 2021 01 19
(181) 2031 01 19
(891) 2021 01 19
(511) 29, 30, 35, 43

(260) AM 2022 113547 A
(800) 1596982
(151) 2021 02 05
(181) 2031 02 05
(891) 2021 02 05
(511) 25

(260) AM 2022 113548 A
(800) 1597006
(151) 2021 04 21
(181) 2031 04 21
(891) 2021 04 21
(511) 01

(260) AM 2022 113634 A
(800) 1597881
(151) 2020 12 17
(181) 2030 12 17
(891) 2020 12 17
(511) 09

(260) AM 2022 113643 A
(800) 1598199
(151) 2021 05 25
(181) 2031 05 25
(891) 2021 05 25
(511) 09

(260) AM 2022 113635 A
(800) 1597899
(151) 2021 02 24
(181) 2031 02 24
(891) 2021 02 24
(511) 09, 28, 41

(260) AM 2022 113645 A
(800) 1598258
(151) 2021 02 23
(181) 2031 02 23
(891) 2021 02 23
(511) 07, 12

(260) AM 2022 113637 A
(800) 1597945
(151) 2020 10 22
(181) 2030 10 22
(891) 2020 10 22
(511) 25, 35

(260) AM 2022 113647 A
(800) 1598287
(151) 2021 04 08
(181) 2031 04 08
(891) 2021 04 08
(511) 30, 35, 43

(260) AM 2022 113638 A
(800) 1597984
(151) 2021 04 09
(181) 2031 04 09
(891) 2021 04 09
(511) 09, 41

(260) AM 2022 113648 A
(800) 1598314
(151) 2021 04 23
(181) 2031 04 23
(891) 2021 04 23
(511) 09

(260) AM 2022 113640 A
(800) 1598169
(151) 2021 04 07
(181) 2031 04 07
(891) 2021 04 07
(511) 35, 39, 42

(260) AM 2022 113649 A
(800) 1598356
(151) 2021 04 26
(181) 2031 04 26
(891) 2021 04 26
(511) 09

(260) AM 2022 113641 A
(800) 1598178
(151) 2021 02 18
(181) 2031 02 18
(891) 2021 02 18
(511) 05, 10, 44

(260) AM 2022 113650 A
(800) 1598374
(151) 2021 03 12
(181) 2031 03 12
(891) 2021 03 12
(511) 19

(260) AM 2022 113642 A
(800) 1598179
(151) 2021 02 10
(181) 2031 02 10
(891) 2021 02 10
(511) 35, 41

(260) AM 2022 113651 A
(800) 1598392
(151) 2021 03 05
(181) 2031 03 05
(891) 2021 03 05
(511) 05

(260) AM 2022 113653 A
(800) 1598429
(151) 2021 04 02
(181) 2031 04 02
(891) 2021 04 02
(511) 34

(260) AM 2022 113732 A
(800) 1599729
(151) 2021 02 16
(181) 2031 02 16
(891) 2021 02 16
(511) 03

(260) AM 2022 113654 A
(800) 1598445
(151) 2021 04 16
(181) 2031 04 16
(891) 2021 04 16
(511) 09, 10, 42

(260) AM 2022 113734 A
(800) 1599752
(151) 2021 05 11
(181) 2031 05 11
(891) 2021 05 11
(511) 42

(260) AM 2022 113669 A
(800) 1598957
(151) 2021 02 19
(181) 2031 02 19
(891) 2021 02 19
(511) 30

(260) AM 2022 113735 A
(800) 1599809
(151) 2021 02 25
(181) 2031 02 25
(891) 2021 02 25
(511) 05, 30

(260) AM 2022 113670 A
(800) 1598977
(151) 2020 08 21
(181) 2030 08 21
(891) 2020 08 21
(511) 33

(260) AM 2022 113736 A
(800) 1600014
(151) 2021 05 14
(181) 2031 05 14
(891) 2021 05 14
(511) 12

(260) AM 2022 113671 A
(800) 1599009
(151) 2021 04 21
(181) 2031 04 21
(891) 2021 04 21
(511) 03

(260) AM 2022 113737 A
(800) 1600059
(151) 2021 03 23
(181) 2031 03 23
(891) 2021 03 23
(511) 05

(260) AM 2022 113729 A
(800) 1599654
(151) 2021 04 28
(181) 2031 04 28
(891) 2021 04 28
(511) 04

(260) AM 2022 113738 A
(800) 1600074
(151) 2021 05 10
(181) 2031 05 10
(891) 2021 05 10
(511) 42

(260) AM 2022 113730 A
(800) 1599698
(151) 2020 12 24
(181) 2030 12 24
(891) 2020 12 24
(511) 07, 09, 11, 21

(260) AM 2022 113739 A
(800) 1600108
(151) 2020 12 03
(181) 2030 12 03
(891) 2020 12 03
(511) 09

(260) AM 2022 113740 A
(800) 1600109
(151) 2020 12 03
(181) 2030 12 03
(891) 2020 12 03
(511) 42

(260) AM 2022 113799 A
(800) 1600456
(151) 2021 04 26
(181) 2031 04 26
(891) 2021 04 26
(511) 09

(260) AM 2022 113741 A
(800) 1600149
(151) 2020 11 26
(181) 2030 11 26
(891) 2020 11 26
(511) 09

(260) AM 2022 113825 A
(800) 1601310
(151) 2021 03 10
(181) 2031 03 10
(891) 2021 03 10
(511) 09, 10, 21

(260) AM 2022 113742 A
(800) 1600157
(151) 2021 06 07
(181) 2031 06 07
(891) 2021 06 07
(511) 01

(260) AM 2022 113840 A
(800) 1527421
(151) 2020 02 21
(181) 2030 02 21
(891) 2021 06 10
(511) 17

(260) AM 2022 113760 A
(800) 1471926
(151) 2019 04 09
(181) 2029 04 09
(891) 2021 06 02
(511) 12

(260) AM 2022 113938 A
(800) 1602622
(151) 2021 06 14
(181) 2031 06 14
(891) 2021 06 14
(511) 12

(260) AM 2022 113796 A
(800) 1600416
(151) 2021 04 30
(181) 2031 04 30
(891) 2021 04 30
(511) 07, 09, 10, 11

(260) AM 2022 113942 A
(800) 1602806
(151) 2021 04 26
(181) 2031 04 26
(891) 2021 04 26
(511) 18, 25, 35

(260) AM 2022 113797 A
(800) 1600432
(151) 2021 04 25
(181) 2031 04 25
(891) 2021 04 25
(511) 20, 21, 35

(260) AM 2022 114017 A
(800) 1603454
(151) 2021 03 19
(181) 2031 03 19
(891) 2021 03 19
(511) 14

(260) AM 2022 113798 A
(800) 1600453
(151) 2021 04 20
(181) 2031 04 20
(891) 2021 04 20
(511) 02, 17

(260) AM 2022 114020 A
(800) 1603700
(151) 2021 06 28
(181) 2031 06 28
(891) 2021 06 28
(511) 34

(260) AM 2022 114022 A
(800) 1280880
(151) 2015 09 15
(181) 2025 09 15
(891) 2021 07 05
(511) 03

(260) AM 2022 114023 A
(800) 1312284
(151) 2016 05 06
(181) 2026 05 06
(891) 2021 06 11
(511) 01, 05

(260) AM 2022 114024 A
(800) 1577900
(151) 2021 01 04
(181) 2031 01 04
(891) 2021 07 02
(511) 31

(260) AM 2022 114025 A
(800) 1584233
(151) 2021 02 11
(181) 2031 02 11
(891) 2021 07 05
(511) 10

(260) AM 2022 114118 A
(800) 1473701
(151) 2019 04 23
(181) 2029 04 23
(891) 2021 07 14
(511) 05

**OFFICIAL NOTIFICATIONS
INVENTIONS
RESTORATION OF PATENT**

(21) AP 2017 14989
(11) P 2020 7204 B
(73) Santen Pharmaceutical Co., Ltd;
Durect Corporation
(54) DEPOT FORMULATIONS
DATE OF PATENT CANCELLATION: 2021 06 29
DATE OF PATENT RESTORATION: 2022 07 11

ABOLITION OF PATENTS WITH THE RIGHT TO RESTORE

(21) AP 2006 10476
(11) P 2012 5397 B
(73) Endorecherche Inc.
(54) HELIX 12 DIRECTED NON-STEROIDAL ANTIANDROGENS
DATE OF PATENT CANCELLATION: 2022 06 16
LIMITED DATE OF PATENT RESTORATION: 2023 06 16

(21) AP 2010 12538
(11) P 2015 6325 B
(73) Vertex Pharmaceuticals Incorporated
(54) INHIBITORS OF INFLUENZA VIRUSES REPLICATION
DATE OF PATENT CANCELLATION: 2022 06 17
LIMITED DATE OF PATENT RESTORATION: 2023 06 17

(21) AP 2010 13375
(11) P 2020 7129 B
(73) Vertex Pharmaceuticals Incorporated
(54) INHIBITORS OF INFLUENZA VIRUSES REPLICATION
DATE OF PATENT CANCELLATION: 2022 06 17
LIMITED DATE OF PATENT RESTORATION: 2023 06 17

(21) AP 2016 14676
(11) P 2021 7243 B
(73) Estetra SPRL
(54) ORODISPERSIBLE DOSAGE UNIT CONTAINING AN ESTETROL COMPONENT
DATE OF PATENT CANCELLATION: 2022 06 17
LIMITED DATE OF PATENT RESTORATION: 2023 06 17

(21) AP 2016 14677
(11) P 2021 7308 B
(73) Estetra SPRL
(54) ORODISPERSIBLE DOSAGE UNIT CONTAINING AN ESTETROL COMPONENT
DATE OF PATENT CANCELLATION: 2022 06 17
LIMITED DATE OF PATENT RESTORATION: 2023 06 17

(21) AP 2020 15375
(11) P 2021 7303 B
(73) Davit Loladze
(54) FLAT FLEXIBLE JACK
DATE OF PATENT CANCELLATION: 2022 06 21
LIMITED DATE OF PATENT RESTORATION: 2023 06 21

EXPIRATION OF TERMS OF PATENTS RESTORATION

(21) AP 2006 11064
(11) P 2012 5518 B
(73) Laboratoires Mayoly Spindler
(54) METHOD FOR PRODUCING LIPASE, TRANSFORMED YARROWIA LIPOLYTICA CELL CAPABLE OF PRODUCING SAID LIPASE AND THEIR USE
DATE OF PATENT CANCELLATION: 2021 06 15
DATE OF PATENT RESTORATION VALIDITY HAS EXPIRED: 2022 06 15

(21) AP 2011 12963
(11) P 2014 6195 B
(73) Takeda Pharmaceutical Company Limited
(54) CRYSTAL OF AMIDE COMPOUND
DATE OF PATENT CANCELLATION: 2021 06 15
DATE OF PATENT RESTORATION VALIDITY HAS EXPIRED: 2022 06 15

(21) AP 2012 13355
(11) P 2017 6629 B
(73) Indiana University Research And Technology Corporation
(54) GLUCAGON/GLP-1RECEPTOR CO-AGONISTS
DATE OF PATENT CANCELLATION: 2021 06 12
DATE OF PATENT RESTORATION VALIDITY HAS EXPIRED: 2022 06 12

(21) AP 2014 14039
(11) P 2018 6882 B
(73) Baxalta Incorporated;
Baxalta GmbH
(54) PROVIDING PHARMACOKINETIC DRUG DOSING REGIME
DATE OF PATENT CANCELLATION: 2021 06 20
DATE OF PATENT RESTORATION VALIDITY HAS EXPIRED: 2022 06 20

(21) AP 2017 14522
(11) P 2019 6993 B
(73) Mariam Tsiskarishvili;
Nino Jorbenadze
(54) DEVICE FOR SPLITTING NUTS AND HAZELS
DATE OF PATENT CANCELLATION: 2021 06 19
DATE OF PATENT RESTORATION VALIDITY HAS EXPIRED: 2022 06 19

(21) AP 2018 15260
(11) P 2020 7200 B
(73) Georgiy Sevastiyevich Aslanov
(54) ELECTRIC STEAM GENERATOR

DATE OF PATENT CANCELLATION: 2021 06 19
DATE OF PATENT RESTORATION VALIDITY HAS EXPIRED: 2022 06 19

UTILITY MODELS

ABOLITION OF PATENT WITH THE RIGHT TO RESTORE

(21) AU 2018 14810
(11) U 2021 2072 Y
(73) Volodymyr Zhulinskiy
(54) HEAVY SUSPENSION FOR SOLID ORE AND UNGRATEFUL MINERALS, TECHNOLOGICAL AND
SECONDARY ORE SEPARATING AND ENRICHING
DATE OF PATENT CANCELLATION: 2022 06 13
LIMITED DATE OF PATENT RESTORATION: 2023 06 13

EXPIRATION OF TERMS OF PATENT RESTORATION

(21) AU 2016 14175
(11) U 2018 1979 Y
(73) LTD "Company TM RG"
(54) METHOD FOR TIN HYDRO ARSENATE PREPARATION
DATE OF PATENT CANCELLATION: 2021 06 13
DATE OF PATENT RESTORATION VALIDITY HAS EXPIRED: 2022 06 13

DESIGNS

EXTENSION OF TERMS OF DESIGNS REGISTRATION

(11) D 2012 501 S
(73) Zaur Neparidze (GE)
E. Ninoshvili St. 1b, 1200, Borjomi, Georgia (GE)
(54) SPINNING TOOL MADE WITH PLASTIC
(28) 1
(24) 2012 05 16
(18) 2027 05 16
(58) 2022 06 28

(11) D 2018 775 S
(73) Shalva Nikolaishvili (GE)
S. Tsintsadze St. 48, app. 14, 0160, Tbilisi, Georgia (GE)
(54) MOBILE OR TABLET POST
(28) 1
(24) 2017 06 05
(18) 2027 06 05
(58) 2022 06 23

(11) D 2018 745 S
(73) Limited Liability Society "Aisi" (GE)
Evdoshvili St. 37, 1500, Gurjaani, Georgia (GE)
(54) ICE CREEM LABEL
(28) 2
(24) 2017 06 06
(18) 2027 06 06
(58) 2022 06 24

(11) D 2017 720 S
(73) LTD "Cherry" (GE)
Al. Kartvelishvili St., Plot 726, 0198, Didi Lilo, Georgia (GE)
(54) PACKING
(28) 6
(24) 2017 07 04
(18) 2027 07 04
(58) 2022 06 23

CANCELLATION OF DESIGNS REGISTRATION

(11) D 2012 500 S
(73) Ia Kvaratskhelia (GE)
Ilia Chavchavadze Ave. 22, app. 7, 0179, Tbilisi, Georgia (GE)
(54) RING, PENDANT, EARRINGS
(18) 2021 12 08
(58) 2022 06 21

(11) D 2011 486 S
(73) Allied Global Tobacco Limited (GB)
Way Court West, Union Rd. Farnham, Surrey GU9 7PT, United Kingdom (GB)
(54) UNFAIR CIGARETTE
(18) 2021 12 09
(58) 2022 06 21

(11) D 2012 498 S
(73) Allied Global Tobacco Limited (GB)
Vei Qort Vest, Iunion Roud, Farnam, Surei GU9 7PT, United Kingdom (GB)
(54) UNFAIR CIGARETTE
(18) 2021 12 09
(58) 2022 06 21

(11) D 2011 485 S
(73) Joint Stock Company "Lomisi" (GE)
Vill. Natakhtari, 3308, Mtskheta, Georgia (GE)
(54) BOTTLE
(18) 2021 12 13
(58) 2022 06 29

TRANSFER OF RIGHT

(21) AD 2021 1236
(11) D 2022 935 S
NEW NAME AND ADDRESS OF PATENT OWNER: Mikheil Khukhashvili (GE)
L. Asatiani St. 32, 0105, Tbilisi, Georgia (GE)
FORMER NAME AND ADDRESS OF PATENT OWNER: Mikheil Khukhashvili (GE)
L. Asatiani St. 32, 0105, Tbilisi, Georgia (GE)
Vazha Dolaberidze (GE)
Didi Kheivani 21a, 0114, Tbilisi, Georgia (GE)
(58) 2022 06 29

EXTENSION OF TERMS OF INTERNATIONAL DESIGNS REGISTRATION

(11) DM/69000
(73) BLANCPAIN SA
Le Rocher 12, CH-1348 LE BRASSUS (CH)
(15) 2007 06 07
(24) 2007 06 07
(18) 2027 06 07
(28) 4
(28') 4
(54) 1.-4. Wristwatches

(11) DM/69009
(73) OMEGA SA (OMEGA AG) (OMEGA LTD.)
Jakob-Stämpfli-Strasse 96, CH-2502 Biel/Bienne (CH)
(15) 2007 06 04
(24) 2007 06 04
(18) 2027 06 04
(28) 1
(28') 1
(54) Wristwatch

(11) DM/69010
(73) OMEGA SA (OMEGA AG) (OMEGA LTD.)
Jakob-Stämpfli-Strasse 96, CH-2502 Biel/Bienne (CH)
(15) 2007 06 04
(24) 2007 06 04

(18) 2027 06 04
(28) 1
(28') 1
(54) Watch

(11) DM/69011
(73) OMEGA SA (OMEGA AG) (OMEGA LTD.)
Jakob-Stämpfli-Strasse 96, CH-2502 Biel/Bienne (CH)
(15) 2007 06 04
(24) 2007 06 04
(18) 2027 06 04
(28) 2
(28') 2
(54) Wristwatches

(11) DM/69089
(73) MONTRES BREGUET S.A.
CH-1344 L'ABBAYE (CH)
(15) 2007 06 28
(24) 2007 06 28
(18) 2027 06 28
(28) 4
(28') 4
(54) Wristwatches

(11) DM/69281
(73) NESTLÉ WATERS FRANCE
20, rue Rouget de Lisle, F-92130 Issy-les-Moulineaux, (FR)
(15) 2007 07 24
(24) 2007 07 24
(18) 2027 07 24
(28) 1
(28') 1
(54) Bottle

(11) DM/70959
(73) OMEGA SA (OMEGA AG) (OMEGA LTD.)
Jakob-Stämpfli-Strasse 96, CH-2502 Biel/Bienne (CH)
(15) 2008 11 20
(24) 2008 11 20
(18) 2028 11 20
(28) 7
(28') 7
(54) 1.-2. Cadrans, 3. Montre, 4.-7. Montres-bracelets

(11) DM/78553
(73) GLASHÜTTER UHRENBETRIEB GMBH
Altenberger Str. 1, 01768 Glashütte (DE)
(15) 2012 06 13
(24) 2012 06 13
(18) 2027 06 13
(28) 5
(28') 5

(54) Watch cases

(11) DM/78652

(73) ROLEX SA

3-5-7 rue François-Dussaud, CH-1211 Genève 26 (CH)

(15) 2012 06 28

(24) 2012 06 28

(18) 2027 06 28

(28) 6

(28') 6

(54) Watch dials, Watches

(11) DM/79066

(73) SETAŞ KIMYA SANAYİ ANONİM ŞİRKETİ

Karanfil Sokak No:18, TR-34330 1.Levent İstanbul (TR)

(15) 2012 08 31

(24) 2012 08 31

(18) 2027 08 31

(28) 1

(28') 1

(54) Logo

(11) DM/96364

(73) THOMAS GORGOSILITS

Weidengasse 2, A-2362 Biedermannsdorf (EM)

(15) 2017 05 24

(24) 2017 05 24

(18) 2027 05 24

(28) 1

(28') 1

(54) Advertising device

(11) DM/96672

(73) TRI STAR LTD

Polevaya str., 5, Cherniakhovka village, Kirovograd region 27641 (UA)

(15) 2017 05 04

(24) 2017 05 04

(18) 2027 05 04

(28) 12

(28') 12

(54) Labels for packaging

(11) DM/96758

(73) BTICINO S.P.A.

231, Viale Borri, I-21100 VARESE (EM)

(15) 2017 06 20

(24) 2017 06 20

(18) 2027 06 20

(28) 20

(28') 20

(54) 12.-16. Decorative fittings for electric switches and sockets, 17. Equipment for control of electric power, 1.-8. Decorative fittings for electric switches and sockets, 18. Frame for switches, 19.-20. Decorative fittings for electric switches and sockets, 9.-11. Frames for switches

(11) DM/96957
(73) TotalEnergies SE
2 Place Jean Millier, La Défense 6, F-92400 COURBEVOIE (FR)
(15) 2017 07 19
(24) 2017 07 19
(18) 2027 07 19
(28) 1
(28') 1
(54) Can

(11) DM/96958
(73) TotalEnergies SE
2 Place Jean Millier, La Défense 6, F-92400 COURBEVOIE (FR)
(15) 2017 07 19
(24) 2017 07 19
(18) 2027 07 19
(28) 1
(28') 1
(54) Can

(11) DM/97015
(73) FEMAF METAL SANAYI VE TICARET ANONIM ŞİRKETİ
Organize Sanayi Bölgesi 9. Cad. No: 17 Melikgazi, TR-38070 Kayseri (TR)
(15) 2017 05 11
(24) 2017 05 11
(18) 2027 05 11
(28) 8
(28') 3
(54) Cooktop, Cooktops, Grates for Cooktop, Kitchen Stoves

(11) DM/98974
(73) H. Lundbeck A/S
Ottiliavej 9, DK-2500 Valby (DK)
(15) 2017 07 21
(24) 2017 07 21
(18) 2027 07 21
(28) 3
(28') 3
(54) 1.-3. Pharmaceutical tablets

CANCELLATION OF INTERNATIONAL DESIGNS REGISTRATION

(11) DM/75600
(73) SAVERGLASS
3 rue de la Gare, F-60960 FEUQUIERES (FR)
CANCELLATION DATE OF REGISTRATION: 2021 03 18
(58) 2022 06 22

(11) DM/75601
(73) ETA SA MANUFACTURE HORLOGÈRE SUISSE
CH-2540 Grenchen (CH)
CANCELLATION DATE OF REGISTRATION: 2021 03 18
(58) 2022 06 22

(11) DM/75710
(73) ALFRED KÄRCHER GMBH & CO. KG
Alfred-Kärcher-Straße 28-40, 71364 Winnenden (DE)
CANCELLATION DATE OF REGISTRATION: 2021 03 30
(58) 2022 06 22

(11) DM/75895
(73) LIMITED LIABILITY COMPANY "KERNEL-TRADE"
5 Dimitrova Str., Kyiv 03680 (UA)
CANCELLATION DATE OF REGISTRATION: 2021 02 18
(58) 2022 06 22

(11) DM/75896
(73) LIMITED LIABILITY COMPANY "KERNEL-TRADE"
5 Dimitrova Str., Kyiv 03680 (UA)
CANCELLATION DATE OF REGISTRATION: 2021 02 18
(58) 2022 06 22

(11) DM/75923
(73) ALFRED KÄRCHER GMBH & CO. KG
Alfred-Kärcher-Straße 28-40, 71364 Winnenden (DE)
CANCELLATION DATE OF REGISTRATION: 2021 05 03
(58) 2022 06 22

(11) DM/75934
(73) ETA SA MANUFACTURE HORLOGÈRE SUISSE
CH-2540 Grenchen (CH)
CANCELLATION DATE OF REGISTRATION: 2021 05 03
(58) 2022 06 22

(11) DM/75948
(73) MICROSOFT MOBILE OY
Keilalahdentie 2-4, FI-02150 Espoo (FI) (EM)
CANCELLATION DATE OF REGISTRATION: 2021 04 27
(58) 2022 06 22

(11) DM/76018
(73) THE SWATCH GROUP MANAGEMENT SERVICES AG (THE SWATCH GROUP MANAGEMENT SERVICES SA) (THE SWATCH GROUP MANAGEMENT SERVICES LTD.)
Seevorstadt 6, CH-2501 Biel/Bienne (CH)
CANCELLATION DATE OF REGISTRATION: 2021 05 05
(58) 2022 06 22

(11) DM/76051
(73) ALFRED KÄRCHER GMBH & CO. KG
Alfred-Kärcher-Straße 28-40, 71364 Winnenden (DE)
CANCELLATION DATE OF REGISTRATION: 2021 05 11
(58) 2022 06 22

(11) DM/76052
(73) Alfred Kärcher GmbH & Co. KG
Alfred-Kärcher-Straße 28-40, 71364 Winnenden (DE)
CANCELLATION DATE OF REGISTRATION: 2021 05 11
(58) 2022 06 22

(11) DM/76146
(73) ALFRED KÄRCHER GMBH & CO. KG
Alfred-Kärcher-Straße 28-40, 71364 Winnenden (DE)
CANCELLATION DATE OF REGISTRATION: 2021 05 30
(58) 2022 06 27

(11) DM/76150
(73) ALFRED KÄRCHER GMBH & CO. KG
Alfred-Kärcher-Straße 28-40, 71364 Winnenden (DE)
CANCELLATION DATE OF REGISTRATION: 2021 06 01
(58) 2022 06 27

(11) DM/76292
(73) THE SWATCH GROUP MANAGEMENT SERVICES AG (THE SWATCH GROUP MANAGEMENT SERVICES SA) (THE SWATCH GROUP MANAGEMENT SERVICES LTD)
Seevorstadt 6, CH-2501 Biel/Bienne (CH)
CANCELLATION DATE OF REGISTRATION: 2021 06 28
(58) 2022 06 27

(11) DM/76456
(73) TSM GMBH
Konrad-Zuse-Str. 1, 52477 Alsdorf (DE)
CANCELLATION DATE OF REGISTRATION: 2021 05 10
(58) 2022 06 27

(11) DM/76572
(73) THE SWATCH GROUP MANAGEMENT SERVICES AG (THE SWATCH GROUP MANAGEMENT SERVICES SA) (THE SWATCH GROUP MANAGEMENT SERVICES LTD)
Seevorstadt 6, CH-2502 Biel/Bienne (CH)
CANCELLATION DATE OF REGISTRATION: 2021 08 15
(58) 2022 06 27

(11) DM/76815
(73) RIPANI ITALIANA PELLETERIE S.R.L.
Via Nazionale Adriatica, 112/B, I-64019 TORTORETO (TE) (EM)
CANCELLATION DATE OF REGISTRATION: 2021 05 05
(58) 2022 06 27

TRADEMARKS

EXTENSION OF TERMS OF TRADEMARKS REGISTRATION

| | |
|---|---|
| (111) M 2002 14643 R2 (156) 2002 09 13 (186) 2032 09 13 (732) Nec Corporation (A corporation duly organized and existing under the laws of Japan) 7-1, Shiba 5-chome, Minato-ku, Tokyo, Japan | 900 Metro Center Boulevard, Foster City, California 94404, USA |
| (111) M 2002 14692 R2 (156) 2002 09 30 (186) 2032 09 30 (732) Chevron Intellectual Property LLC a State of Delaware, Limited Liability Company 6001 Bollinger Canyon Road, San Ramon, California 94583, USA | (111) M 2011 22171 R1 (156) 2011 12 29 (186) 2031 12 29 (732) Sosha Nassibi Leonardo da Vinchi Allee 18c, Frankfurt am Main 60486, Germany; Samira Khosrowschahi Leonardo da Vinchi Allee 18c, Frankfurt am Main 60486, Germany |
| (111) M 2002 14634 R2 (156) 2002 09 13 (186) 2032 09 13 (732) Societe Des Produits Nestle S.A. 1800 Vevey, Switzerland | (111) M 2012 22762 R1 (156) 2012 07 13 (186) 2032 07 13 (732) LTD "Barambo" Vill. Natakhtari, 3308, Mtskheta, Georgia |
| (111) M 2002 14600 R2 (156) 2002 08 15 (186) 2032 08 15 (732) Sosha Nassibi Leonardo da Vinchi Allee 18c, Frankfurt am Main 60486, Germany; Samira Khosrowschahi Leonardo da Vinchi Allee 18c, Frankfurt am Main 60486, Germany | (111) M 2012 22660 R1 (156) 2012 06 07 (186) 2032 06 07 (732) LTD "Barambo" Vill. Natakhtari, 3308, Mtskheta, Georgia |
| (111) M 2002 14680 R2 (156) 2002 09 16 (186) 2032 09 16 (732) LTD "Phytopharm" Giorgi Akhvlediani St. 22, 0108, Tbilisi Georgia; LLC "GM Pharmaceutical" Rustavi Highway 52, 0114, Isani District, Tbilisi Georgia | (111) M 2012 22763 R1 (156) 2012 07 13 (186) 2032 07 13 (732) LTD "Barambo" Vill. Natakhtari, 3308, Mtskheta, Georgia |
| (111) M 2012 22686 R1 (156) 2012 07 02 (186) 2032 07 02 (732) Visa International Service Association | (111) M 2012 22661 R1 (156) 2012 06 07 (186) 2032 06 07 (732) LTD "Barambo" Vill. Natakhtari, 3308, Mtskheta, Georgia |
| | (111) M 2012 22662 R1 (156) 2012 06 07 (186) 2032 06 07 (732) LTD "Barambo" Vill. Natakhtari, 3308, Mtskheta, Georgia |

(111) M 2012 22667 R1
(156) 2012 06 07
(186) 2032 06 07
(732) LTD "Barambo"
Vill. Natakhtari, 3308, Mtskheta, Georgia

(111) M 2012 22702 R1
(156) 2012 07 02
(186) 2032 07 02
(732) Pandora A/S
Havneholmen 17-19, 1561 Copenhagen V,
Denmark

(111) M 2012 22766 R1
(156) 2012 07 13
(186) 2032 07 13
(732) LTD "Barambo"
Vill. Natakhtari, 3308, Mtskheta, Georgia

(111) M 2012 22567 R1
(156) 2012 04 30
(186) 2032 04 30
(732) LTD "Roniko"
Rustaveli St. 26, 0108, Tbilisi, Georgia

(111) M 2012 22770 R1
(156) 2012 07 13
(186) 2032 07 13
(732) LTD "Alpha"
Tevdore Mghvdeli St. 53, 0154, Tbilisi
Georgia

(111) M 2012 22773 R1
(156) 2012 07 13
(186) 2032 07 13
(732) Aktsionernoe Obchestvo "TehnoNIKOL"
Ul. Giliarovskovo, Dom. 47, Stroenie 5, Et. 5,
Pom. 1, Kom. 22, 129110, Moscow, Russian
Federation

(111) M 2012 22774 R1
(156) 2012 07 13
(186) 2032 07 13
(732) Aktsionernoe Obchestvo "TehnoNIKOL"
Ul. Giliarovskovo, Dom. 47, Stroenie 5, Et. 5,
Pom. 1, Kom. 22, 129110, Moscow, Russian
Federation

(111) M 2012 22775 R1
(156) 2012 07 13
(186) 2032 07 13
(732) Aktsionernoe Obchestvo "TehnoNIKOL"

Ul. Giliarovskovo, Dom. 47, Stroenie 5, Et. 5,
Pom. 1, Kom. 22, Moscow, 129110, Russian
Federation

(111) M 2012 22787 R1
(156) 2012 07 13
(186) 2032 07 13
(732) LTD "GM Pharmaceutical"
Rustavi Highway 52, 0114, Tbilisi, Georgia

(111) M 2012 23117 R1
(156) 2012 11 29
(186) 2032 11 29
(732) LTD "Alpha"
Tevdore Mghvdeli St. 53, 0154, Tbilisi
Georgia

(111) M 2013 23243 R1
(156) 2013 01 09
(186) 2033 01 09
(732) Toto Ltd, A Japanese Corporation
1-1, Nakashima 2-chome, Kokurakita-ku,
Kitakyushu-shi, Fukuoka-Ken, Japan

(111) M 2012 23179 R1
(156) 2012 12 10
(186) 2032 12 10
(732) LTD "GM Pharmaceutical"
Rustavi Highway 52, 0114, Tbilisi, Georgia

(111) M 2012 23225 R1
(156) 2012 12 24
(186) 2032 12 24
(732) LTD "GM Pharmaceutical"
Rustavi Highway 52, 0114, Tbilisi, Georgia

(111) M 2012 22224 R1
(156) 2012 01 27
(186) 2032 01 27
(732) LTD "Georgian Alliance"
Tskhinvali St. 13, 0600, Akhlagori, Georgia

(111) M 2012 22227 R1
(156) 2012 01 31
(186) 2032 01 31
(732) LTD "Georgian Alliance"
Tskhinvali St. 13, 0600, Akhlagori, Georgia

(111) M 2012 22920 R1
(156) 2012 08 30
(186) 2032 08 30
(732) LTD "Georgian Abrasive Company"
Giorgi Brtskinvale St. 25 / L. Asatiani St.
69-71, Batumi, Georgia

(111) M 2012 22856 R1
(156) 2012 08 20
(186) 2032 08 20
(732) LTD "Lux 2004"
Tevdore Mghvdeli St. 53, 0154, Tbilisi
Georgia

(111) M 2012 22926 R1
(156) 2012 09 18
(186) 2032 09 18
(732) LTD "Alpha"
Tevdore Mghvdeli St. 53, 0154, Tbilisi
Georgia

(111) M 2013 23554 R1
(156) 2013 04 11
(186) 2033 04 11
(732) Sosha Nassibi
Leonardo da Vinchi Allee 18c, Frankfurt
am Main 60486, Germany;
Samira Khosrowschahi
Leonardo da Vinchi Allee 18c, Frankfurt
am Main 60486, Germany

COMPLETE TRANSFER OF RIGHTS

(111) M 1997 6785 R
(732) Ekaterra Group IP Holdings B.V.
Weena 455, 3013 AL Rotterdam, Netherlands
(770) Unilever IP Holdings B.V.
Weena 455, 3013 AL Rotterdam, Netherlands
(580) 2022 06 07

(111) M 1997 6792 R
(732) Ekaterra Group IP Holdings B.V.
Weena 455, 3013 AL Rotterdam, Netherlands
(770) Unilever IP Holdings B.V.
Weena 455, 3013 AL Rotterdam, Netherlands
(580) 2022 06 07

(111) M 1998 8137 R
(732) Ekaterra Group IP Holdings B.V.
Weena 455, 3013 AL Rotterdam, Netherlands
(770) Unilever IP Holdings B.V.
Weena 455, 3013 AL Rotterdam, Netherlands
(580) 2022 06 07

(111) M 1998 8147 R
(732) Ekaterra Group IP Holdings B.V.
Weena 455, 3013 AL Rotterdam, Netherlands
(770) Unilever IP Holdings B.V.
Weena 455, 3013 AL Rotterdam, Netherlands
(580) 2022 06 07

(111) M 1999 12495 R
(732) Ekaterra Group IP Holdings B.V.
Weena 455, 3013 AL Rotterdam, Netherlands
(770) Unilever IP Holdings B.V.
Weena 455, 3013 AL Rotterdam, Netherlands
(580) 2022 06 07

(111) M 2002 14600 R
(732) Sosha Nassibi
Leonardo da Vinci Allee 18c, Frankfurt
am Main 60486, Germany;
Samira Khosrowschahi
Leonardo da Vinci Allee 18c, Frankfurt
am Main 60486, Germany
(770) Said Nassibi
Kauer Ring, 53560 Vettelschoss, Germany
(580) 2022 06 17

(111) M 2004 15775 R
(732) Chipita Global Societe Anonyme
(Chipita Global S.A.)
12th km National Road Athens-Lamia,
14452, Metamorfosis, Attica, Greece

(770) Chipita Industrial and
Commercial Company S.A. (Chipita S.A.)
12 km National Road Athens-Lamia,
144 52 Metamorphosi, Attica, Greece
(580) 2022 05 30

(111) M 2007 17818 R
(732) Ekaterra Group IP Holdings B.V.
Weena 455, 3013 AL Rotterdam, Netherlands
(770) Unilever IP Holdings B.V.
Weena 455, 3013 AL Rotterdam, Netherlands
(580) 2022 06 07

(111) M 1996 2874 R
(732) Albis Distribution GmbH & Co. KG
Mühlentagen 35, 20539 Hamburg, Germany
(770) Otto Krahn Group GmbH
Mühlentagen 35, 20539 Hamburg, Germany
(580) 2022 06 21

(111) M 2011 22171 R
(732) Sosha Nassibi
Leonardo da Vinci Allee 18c, Frankfurt
am Main 60486, Germany;
Samira Khosrowschahi
Leonardo da Vinci Allee 18c, Frankfurt
am Main 60486, Germany
(770) Said Nassibi
Kauer Ring, 53560 Vettelschoss, Germany
(580) 2022 06 17

(111) M 2012 22705 R
(732) Ilia Kipiani
Vazha-Pshavela Av., II qu., bld. 6, app. 31,
0186, Tbilisi Georgia;
Aleksandre Enukidze
David Kipiani St. 24a, app. 30, 0119, Tbilisi,
Georgia;
Nino Kipiani
Guramishvili Av. 36, ap. 48, 0192, Tbilisi,
Georgia
(770) Nino Kipiani
Guramishvili Av. 36, app. 48, 0192, Tbilisi,
Georgia
(580) 2022 06 28

(111) M 2013 23554 R
(732) Sosha Nassibi
Leonardo da Vinci Allee 18c, Frankfurt
am Main 60486, Germany;
Samira Khosrowschahi

Leonardo da Vinchi Allee 18c, Frankfurt
am Main 60486, Germany
(770) Said Nassibi
Kauer Ring, 53560 Vettelschoss, Germany
(580) 2022 06 17

(111) M 2014 24486 R
(732) Sosha Nassibi
Leonardo da Vinchi Allee 18c, Frankfurt
am Main 60486, Germany;
Samira Khosrowschahi
Leonardo da Vinchi Allee 18c, Frankfurt
am Main 60486, Germany
(770) Said Nassibi
Kauer Ring, 53560 Vettelschoss, Germany
(580) 2022 06 17

CHANGES OF NAMES AND/OR ADDRESSES OF TRADEMARKS OWNERS

(111) M 2002 14680 R
(732) LTD "Phytopharm"
Giorgi Akhvlediani St. 22, 0108, Tbilisi,
Georgia;
LTD "GMP"
Zemo Vedzisi St. 103, 0114, Isani District,
Tbilisi, Georgia
(770) LTD "Phytopharm"
Giorgi Akhvlediani St. 22, 0108, Tbilisi,
Georgia;
LTD "GMP"
Zemo Vedzisi St. 103, 0160, Tbilisi, Georgia
(580) 2022 06 17

(111) M 1996 2874 R
(732) Otto Krahn Group GmbH
Mühlenhagen 35, 20539 Hamburg, Germany
(770) Albis Plastic GmbH
Hamburg, Germany
(580) 2022 06 21

(111) M 2012 22775 R
(732) Aktsionernoe obshchestvo "TehnoNIKOL"
Ul. Giliarovskovo, Dom. 47, Stroenie 5, Et. 5,
Pom. 1, Kom. 22, Moscow, 129110, Russian
Federation
(770) Close Aktsionernoe Obchestvo "TehnoNIKOL"
Krimskiy Val 8, Moskow, 119049, Russian
Federation
(580) 2022 06 21

(111) M 2012 22787 R
(732) LTD "GM Pharmaceutical"
Rustavi Highway 52, 0114, Tbilisi, Georgia
(770) LTD "GMP"
Zemo Vedzisi St. 103, 0160, Tbilisi, Georgia
(580) 2022 06 17

(111) M 2012 23179 R
(732) LTD "GM Pharmaceutical"
Rustavi Highway 52, 0114, Tbilisi, Georgia
(770) LTD "GMP"
Zemo Vedzisi St. 103, 0160, Tbilisi, Georgia
(580) 2022 06 17

(111) M 2012 23225 R
(732) LTD "GM Pharmaceutical"
Rustavi Highway 52, 0114, Tbilisi, Georgia
(770) LTD "GMP"
Zemo Vedzisi St. 103, 0160, Tbilisi, Georgia
(580) 2022 06 17

CANCELLATION OF TRADEMARKS REGISTRATION

(111) M 2001 14169 R
(151) 2001 12 13
(732) Joint Stock Company "Exhibitions Center"
Akaki Tsereteli Av. 118, 0119, Tbilisi, Georgia
(141) 2022 06 21

(111) M 2001 14178 R
(151) 2001 12 13
(732) Playboy Enterprises
International Inc.
680 North Lake Shore Drive, Chicago, Illinois
60611, USA
(141) 2022 06 21

(111) M 2001 14183 R
(151) 2001 12 13
(732) Oracle America Inc.
Delaware Corporation
500 Oracle Parkway, Redwood Shores,
California 94065, USA
(141) 2022 06 21

(111) M 2001 14207 R
(151) 2001 12 17
(732) LTD "Tobacco Production"
Samgori Lane 5, 0120, Tbilisi, Georgia
(141) 2022 06 27

(111) M 2001 14212 R
(151) 2001 12 17
(732) Merck Sharp & Dohme Corp.
One Merck Drive, Whitehouse Station,
New Jersey 08889, USA
(141) 2022 06 27

(111) M 2001 14213 R
(151) 2001 12 17
(732) Merck Sharp & Dohme Corp.
One Merck Drive, Whitehouse Station,
New Jersey 08889, USA
(141) 2022 06 27

(111) M 2001 14220 R
(151) 2001 12 17
(732) MSD International Holdings GmbH
Veystrasse 20, CH-6000, Lucerne 6,
Switzerland
(141) 2022 06 27

(111) M 2001 14221 R
(151) 2001 12 17
(732) MSD International Holdings GmbH
Veystrasse 20, CH-6000, Lucerne 6,
Switzerland
(141) 2022 06 27

(111) M 2011 22115 R
(151) 2011 12 26
(732) Private Joint Stock Company "Creative"
Promishlennjy Av. 19, Kirovograd, 25014,
Ukraine
(141) 2022 07 04

(111) M 2011 22055 R
(151) 2011 12 14
(732) Laboratoire HRA-Pharma
15, Riu Beranje, 75003 Parizi, France
(141) 2022 06 22

(111) M 2011 22056 R
(151) 2011 12 14
(732) JSC "Teliani Valley"
Tbilisi Highway 3, 2200, Telavi, Georgia
(141) 2022 06 22

(111) M 2011 22057 R
(151) 2011 12 14
(732) JSC "Teliani Valley"
Tbilisi Highway 3, 2200, Telavi, Georgia
(141) 2022 06 22

(111) M 2011 22058 R
(151) 2011 12 14
(732) JSC "Teliani Valley"
Tbilisi Highway 3, 2200, Telavi, Georgia
(141) 2022 06 22

(111) M 2011 22059 R
(151) 2011 12 14
(732) JSC "Teliani Valley"
Tbilisi Highway 3, 2200, Telavi, Georgia
(141) 2022 06 22

(111) M 2011 22062 R
(151) 2011 12 14
(732) LLC "Premier 777"
Tsabadze St. 8, 0112, Tbilisi, Georgia

(141) 2022 06 22

(111) M 2011 22063 R
(151) 2011 12 14
(732) LLC "Premier 777"
Tsabadze St. 8, 0112, Tbilisi, Georgia
(141) 2022 06 22

(111) M 2011 22068 R
(151) 2011 12 14
(732) Aspinal of London Limited
Aspinal House, Longfield, Midhurst Road,
Fernhurst, West Sussex GU27 3HA,
United Kingdom
(141) 2022 06 22

(111) M 2011 22069 R
(151) 2011 12 14
(732) Korea Electric Power Corporation
#411, Youngdong-daero, Gangnam-gu, Seoul,
Republic of Korea
(141) 2022 06 22

(111) M 2011 22070 R
(151) 2011 12 14
(732) Korea Electric Power Corporation
#411, Youngdong-daero, Gangnam-gu, Seoul,
Republic of Korea
(141) 2022 06 22

(111) M 2011 22072 R
(151) 2011 12 14
(732) Astellas Deutschland GmbH
Georg Brauchle Ring 64-66, 80992 München,
Germany
(141) 2022 06 22

(111) M 2011 22073 R
(151) 2011 12 14
(732) Astellas Deutschland GmbH
Georg Brauchle Ring 64-66, 80992 München,
Germany
(141) 2022 06 22

(111) M 2011 22075 R
(151) 2011 12 14
(732) Otkritoe Aktsionernoe Obshchestvo "Aston
Produkti Pitaniya i Pishchevje Ingredienti"
(OAO "ACTOH")
Ul. I-ya Lugovaya 3b, 344002, Rostov-Na-
Donu, Russian Federation
(141) 2022 06 22

(111) M 2011 22076 R
(151) 2011 12 14
(732) Otkritoe Aktsionernoe Obshchestvo "Aston
Produkti Pitaniya i Pishchevje Ingredienti"
(OAO "ACTOH")
Ul. I-ya Lugovaya 3b, 344002, Rostov-Na-
Donu, Russian Federation
(141) 2022 06 22

(111) M 2011 22077 R
(151) 2011 12 14
(732) Otkritoe Aktsionernoe Obshchestvo "Aston
Produkti Pitaniya i Pishchevje Ingredienti"
(OAO "ACTOH")
Ul. I-ya Lugovaya 3b, 344002, Rostov-Na-
Donu, Russian Federation
(141) 2022 06 22

(111) M 2011 22078 R
(151) 2011 12 14
(732) Otkritoe Aktsionernoe Obshchestvo "Aston
Produkti Pitaniya i Pishchevje Ingredienti"
(OAO "ACTOH")
Ul. I-ya Lugovaya 3b, 344002, Rostov-Na-
Donu, Russian Federation
(141) 2022 06 22

(111) M 2011 22079 R
(151) 2011 12 14
(732) LTD "T-Arti"
D. Aleksidze St. 8, 0193, Tbilisi, Georgia
(141) 2022 06 22

(111) M 2011 22086 R
(151) 2011 12 14
(732) Rum Creation & Products Inc.
P.O. Box 3152, Road Town, Tórtola, Virgin
Islands (British)
(141) 2022 06 22

(111) M 2011 22087 R
(151) 2011 12 14
(732) Rum Creation & Products Inc.
P.O. Box 3152, Road Town, Tórtola, Virgin
Islands (British)
(141) 2022 06 22

(111) M 2011 22091 R
(151) 2011 12 14
(732) Veckman steel Oy
Harkalantie 72, 19110 Vierumaki, Finland
(141) 2022 06 22

(111) M 2011 22096 R
 (151) 2011 12 14
 (732) Imperial Tobacco Intellectual Property Limited
 21 Beckett Way, Park West, Nangor Road,
 Dublin 12, Ireland
 (141) 2022 06 22

(111) M 2011 22099 R
 (151) 2011 12 14
 (732) Center for Cultural-Historical Treasure
 Study Association "Kolkheti Rose"
 Mshvidoba St. 51, 3100, Martvili, Georgia
 (141) 2022 06 22

(111) M 2011 22100 R
 (151) 2011 12 14
 (732) JX Nippon Oil & Energy Corporation
 6-3 Otemachi 2-chome, Chiyodaku,
 Tokyo 100-8162, Japan
 (141) 2022 06 22

(111) M 2011 22104 R
 (151) 2011 12 14
 (732) LTD "New Way"
 M. Laghidze St. 21, 0108, Tbilisi, Georgia
 (141) 2022 06 22

(111) M 2011 22105 R
 (151) 2011 12 14
 (732) JSC M² "Real Estate"
 Iliа Chavchavadze Av. 29, fl. 3, Tbilisi,
 Georgia
 (141) 2022 06 22

(111) M 2011 22106 R
 (151) 2011 12 14
 (732) JSC M² "Real Estate"
 Iliа Chavchavadze Av. 29, fl. 3, Tbilisi,
 Georgia
 (141) 2022 06 22

(111) M 2011 22107 R
 (151) 2011 12 14
 (732) LTD "Basti-Bubu"
 Vazha-Pshavela Av. 76b, 0186, Tbilisi,
 Georgia
 (141) 2022 06 22

(111) M 2011 22112 R
 (151) 2011 12 20
 (732) Japan Tobacco Inc.
 2-2-1, Toranomon, Minato-ku, Tokyo, Japan

(141) 2022 06 28

(111) M 2011 22109 R
 (151) 2011 12 19
 (732) Harrington Development Inc.
 Arango-Orillac Bldg. East 54 th street,
 Republic of Panama
 (141) 2022 06 27

(111) M 2011 22053 R
 (151) 2011 12 12
 (732) Harrington Development Inc.
 Elvira Mendez Street, Vallarino bldg.,
 3rd Floor, Panama, Republic of Panama
 (141) 2022 06 21

(111) M 2011 22108 R
 (151) 2011 12 15
 (732) Navid Tavakoli asl
 N3, 12 bildingi, 18 allei, ebne iamin str.,
 teirani 1556615117, Islamic Republic of Iran;
 Farshad Amirkhani
 P.o. Boxes: 214267, Dubai, United Arab
 Emirates
 (141) 2022 06 23

(111) M 2011 22116 R
 (151) 2011 12 26
 (732) Karen Margaryan
 Erznkiyan 30, 0033 Erevan, Armenia
 (141) 2022 07 04

(111) M 2011 22111 R
 (151) 2011 12 20
 (732) LLC "Gudauri Sqi Resort"
 Makashvili St. 31, 0105, Old Tbilisi District,
 Tbilisi, Georgia
 (141) 2022 06 28

(111) M 2012 22858 R
 (151) 2012 08 23
 (732) Mzia Maghlakelidze
 Tsotnr Dadiani St. 315, app. 15, 0192, Tbilisi,
 Georgia
 (141) 2022 07 04 – Registration is void
 Grounds: The Article 2(a) of the "Law on Enforcement
 Proceedings of Georgia"; The Article 28(I)
 (a)(3) of the "Law on Trademarks of
 Georgia".
 (511) Canceled List of Goods and/or Services:
 Class – 43

(111) M 2013 24218 R

(151) 2013 11 04

(732) Mzia Maghlakelidze

Tsotne Dadiani St. 315, app. 15, 0192, Tbilisi,
Georgia

(141) 2022 07 04 – Registration is void

Grounds: The Article 2(a) of the "Law on Enforcement
Proceedings of Georgia"; The Article 28(I)
(a)(3) of the "Law on Trademarks of
Georgia".

(511) Canceled List of Goods and/or Services:

Class – 43

(111) M 2013 24219 R

(151) 2013 11 04

(732) Mzia Maghlakelidze

Tsotne Dadiani St. 315, app. 15, 0192, Tbilisi,
Georgia

(141) 2022 07 04 – Registration is void

Grounds: The Article 2(a) of the "Law on Enforcement
Proceedings of Georgia"; The Article 28(I)
(a)(3) of the "Law on Trademarks of
Georgia".

(511) Canceled List of Goods and/or Services:

Class – 43

CLASSIFICATION INDEXES

INVENTIONS

CONCORDANCE TABLE OF INTERNATIONAL CLASSIFICATION INDEX AND PUBLICATION NUMBERS

| INTERNATIONAL CLASSIFICATION INDEXES (51) | NUMBER OF PUBLISHED APPLICATION (10) |
|---|--|
| A 61 K 31/407; A 61 K 31/496; A 61 P 35/02; A 61 P 35/00 | AP 2022 15447 A |
| A 61 K 31/4184; A 61 K 31/43; A 61 K 31/7048; A 61 K 9/00; A 61 P 31/04 | AP 2022 15593 A |
| A 61 K 31/4545; A 61 K 31/454; A 61 P 35/00; A 61 P 3/00; A 61 P 25/00; A 61 P 29/00; C 07 D 409/14; C 07 D 405 /14; C 07 D 405/12; C 07 D 409/12 | AP 2022 15506 A |
| A 61 K 31/473; A 61 P 25/00; C 07 D 405/12; C 07 D 405/14 | AP 2022 15342 A |
| A 61 K 38/17; A 61 K 39/395; C 07 K 14/705; C 07 K 14/47 | AP 2022 15294 A |
| A 61 K 39/395; A 61 P 35/00; C 07 K 16/28 | AP 2022 15209 A |
| A 61 P 35/00; C 07 D 401/14; C 07 D 405/14; C 07 D 487/04; C 07 D 498/04 | AP 2022 15475 A |
| B 01 J 23/30; B 01 J 23/652; B 01 J 27/188; B 01 J 35/10; B 01 J 37/00; B 01 J 37/02; C 07 C 29/60; C 07 C 31/10 | AP 2022 15457 A |
| C 07 F 9/6521; C 07 F 9/6558 | AP 2022 15124 A |
| G 06 N 20/00 | AP 2022 15603 A |

CONCORDANCE TABLE OF PUBLICATION NUMBERS AND INTERNATIONAL CLASSIFICATION INDEX

| NUMBER OF PUBLISHED APPLICATION (10) | INTERNATIONAL CLASSIFICATION INDEXES (51) |
|--|---|
| AP 2022 15124 A | C 07 F 9/6521; C 07 F 9/6558 |
| AP 2022 15209 A | A 61 K 39/395; A 61 P 35/00; C 07 K 16/28 |
| AP 2022 15294 A | A 61 K 38/17; A 61 K 39/395; C 07 K 14/705; C 07 K 14/47 |
| AP 2022 15342 A | A 61 K 31/473; A 61 P 25/00; C 07 D 405/12; C 07 D 405/14 |
| AP 2022 15447 A | A 61 K 31/407; A 61 K 31/496; A 61 P 35/02; A 61 P 35/00 |
| AP 2022 15457 A | B 01 J 23/30; B 01 J 23/652; B 01 J 27/188; B 01 J 35/10; B 01 J 37/00; B 01 J 37/02; C 07 C 29/60; C 07 C 31/10 |
| AP 2022 15475 A | A 61 P 35/00; C 07 D 401/14; C 07 D 405/14; C 07 D 487/04; C 07 D 498/04 |
| AP 2022 15506 A | A 61 K 31/4545; A 61 K 31/454; A 61 P 35/00; A 61 P 3/00; A 61 P 25/00; A 61 P 29/00; C 07 D 409/14; C 07 D 405 /14; C 07 D 405/12; C 07 D 409/12 |
| AP 2022 15593 A | A 61 K 31/4184; A 61 K 31/43; A 61 K 31/7048; A 61 K 9/00; A 61 P 31/04 |
| AP 2022 15603 A | G 06 N 20/00 |

**CONCORDANCE TABLE OF INTERNATIONAL CLASSIFICATION INDEX,
PATENT NUMBERS AND PUBLICATION NUMBERS**

| INTERNATIONAL CLASSIFICATION INDEX (51) | NUMBER OF PATENT (11) | NUMBER OF PUBLISHED APPLICATION (10) |
|--|-----------------------------|---|
| B 08 B 7/00; B 08 B 9/08 | P 2022 7394 B | AP 2022 15245 A |

**CONCORDANCE TABLE OF PATENT NUMBERS,
PUBLICATION NUMBERS AND INTERNATIONAL CLASSIFICATION INDEX**

| NUMBER OF PATENT (11) | NUMBER OF PUBLISHED APPLICATION (10) | INTERNATIONAL CLASSIFICATION INDEX (51) |
|-----------------------------|---|--|
| P 2022 7394 B | AP 2022 15245 A | B 08 B 7/00; B 08 B 9/08 |

**CONCORDANCE TABLE OF APPLICATION NUMBERS,
PUBLICATION NUMBERS AND PATENTS**

| NUMBER OF APPLICATION (21) | NUMBER OF PUBLISHED APPLICATION (10) | NUMBER OF PATENT (11) |
|----------------------------------|--|--------------------------|
| AP 2018 15245 | AP 2022 15245 A | P 2022 7394 B |

UTILITY MODELS

**CONCORDANCE TABLE OF INTERNATIONAL CLASSIFICATION INDEX
AND PUBLICATION NUMBERS**

| INTERNATIONAL CLASSIFICATION INDEXES (51) | NUMBER OF PUBLISHED APPLICATION (10) |
|--|--|
| B 22 F 9/14; B 82 B 3/00 | AU 2022 15641 U |
| F 24 F 12/00 | AU 2022 15764 U |

**CONCORDANCE TABLE OF PUBLICATION NUMBERS
AND INTERNATIONAL CLASSIFICATION INDEX**

| NUMBER OF PUBLISHED APPLICATION (10) | INTERNATIONAL CLASSIFICATION INDEXES (51) |
|--|--|
| AU 2022 15641 U | B 22 F 9/14; B 82 B 3/00 |
| AU 2022 15764 U | F 24 F 12/00 |

CONCORDANCE TABLE OF INTERNATIONAL CLASSIFICATION INDEX,
PATENT NUMBERS AND PUBLICATION NUMBERS

| INTERNATIONAL CLASSIFICATION INDEX (51) | NUMBER OF PATENT (11) | NUMBER OF PUBLISHED APPLICATION (10) |
|--|-----------------------------|---|
| A 01 C 3/00; C 02 F 11/04 | U 2022 2121 Y | AU 2022 15610 U |

CONCORDANCE TABLE OF PATENT NUMBERS,
PUBLICATION NUMBERS AND INTERNATIONAL CLASSIFICATION INDEX

| NUMBER OF PATENT (11) | NUMBER OF PUBLISHED APPLICATION (10) | INTERNATIONAL CLASSIFICATION INDEX (51) |
|-----------------------------|---|--|
| U 2022 2121 Y | AU 2022 15610 U | A 01 C 3/00; C 02 F 11/04 |

CONCORDANCE TABLE OF APPLICATION NUMBERS,
PUBLICATION NUMBERS AND PATENTS

| NUMBER OF APPLICATION (21) | NUMBER OF PUBLISHED APPLICATION (10) | NUMBER OF PATENT (11) |
|----------------------------------|--|--------------------------|
| AU 2021 15610 | AU 2022 15610 U | U 2022 2121 Y |

DESIGNS

CONCORDANCE TABLE OF INTERNATIONAL CLASSIFICATION INDEX
AND PUBLICATION NUMBERS

| INTERNATIONAL CLASSIFICATION INDEXES (51) | NUMBER OF PUBLISHED APPLICATION (10) |
|--|--|
| 32-00 | AD 2022 1261 S |

CONCORDANCE TABLE OF PUBLICATION NUMBERS
AND INTERNATIONAL CLASSIFICATION INDEX

| NUMBER OF PUBLISHED APPLICATION (10) | INTERNATIONAL CLASSIFICATION INDEXES (51) |
|--|--|
| AD 2022 1261 S | 32-00 |

CONCORDANCE TABLE OF INTERNATIONAL CLASSIFICATION INDEX,
NUMBERS OF REGISTRATION AND PUBLICATION NUMBERS

| INTERNATIONAL CLASSIFICATION INDEX (51) | NUMBER OF REGISTRATION (11) | NUMBER OF PUBLISHED APPLICATION (10) |
|--|-----------------------------------|---|
| 27-05 | D 2022 938 S | AD 2022 1235 S |

CONCORDANCE TABLE OF NUMBERS OF REGISTRATION,
PUBLICATION NUMBERS AND INTERNATIONAL CLASSIFICATION INDEX

| NUMBER OF REGISTRATION (11) | NUMBER OF PUBLISHED APPLICATION (10) | INTERNATIONAL CLASSIFICATION INDEX (51) |
|-----------------------------------|---|--|
| D 2022 938 S | AD 2022 1235 S | 27-05 |

CONCORDANCE TABLE OF APPLICATION NUMBERS,
PUBLICATION NUMBERS AND NUMBERS OF REGISTRATION

| NUMBER OF APPLICATION (21) | NUMBER OF PUBLISHED APPLICATION (10) | NUMBER OF REGISTRATION (11) |
|----------------------------------|--|--------------------------------|
| AD 2021 1235 | AD 2022 1235 S | D 2022 938 S |

TRADEMARKS

CONCORDANCE TABLE OF REGISTRATION NUMBERS, APPLICATION NUMBERS, PUBLICATION NUMBERS AND BULLETIN NUMBERS

| NUMBER OF REGISTRATION (111) | NUMBER OF APPLICATIONS (210) | NUMBER OF PUBLISHED APPLICATIONS (260) | NUMBER OF BULLETIN |
|------------------------------------|------------------------------------|---|-----------------------|
| 1 | 2 | 3 | 4 |
| M 2022 35627 R | AM 118013 | – | 13(592)2022 |
| M 2022 35628 R | AM 118074 | – | 13(592)2022 |
| M 2022 35629 R | AM 118155 | – | 13(592)2022 |
| M 2022 35630 R | AM 110210 | AM 2022 110210 A | 5(584)2022 |
| M 2022 35631 R | AM 113036 | AM 2022 113036 A | 1(580)2022 |
| M 2022 35632 R | AM 113049 | AM 2021 113049 A | 23(579)2021 |
| M 2022 35633 R | AM 113397 | AM 2022 113397 A | 2(581)2022 |
| M 2022 35634 R | AM 113692 | AM 2022 113692 A | 2(581)2022 |
| M 2022 35635 R | AM 113879 | AM 2022 113879 A | 5(584)2022 |
| M 2022 35636 R | AM 113978 | AM 2022 113978 A | 5(584)2022 |
| M 2022 35637 R | AM 114029 | AM 2022 114029 A | 5(584)2022 |
| M 2022 35638 R | AM 114033 | AM 2022 114033 A | 5(584)2022 |
| M 2022 35639 R | AM 114043 | AM 2022 114043 A | 5(584)2022 |
| M 2022 35640 R | AM 114061 | AM 2022 114061 A | 3(582)2022 |
| M 2022 35641 R | AM 114149 | AM 2022 114149 A | 4(583)2022 |
| M 2022 35642 R | AM 114227 | AM 2022 114227 A | 5(584)2022 |
| M 2022 35643 R | AM 114228 | AM 2022 114228 A | 5(584)2022 |
| M 2022 35644 R | AM 118230 | – | 13(592)2022 |
| M 2022 35645 R | AM 118237 | – | 13(592)2022 |
| M 2022 35646 R | AM 118239 | – | 13(592)2022 |
| M 2022 35647 R | AM 117837 | – | 13(592)2022 |
| M 2022 35648 R | AM 111416 | AM 2022 111416 A | 6(585)2022 |
| M 2022 35649 R | AM 113017 | AM 2021 113017 A | 23(579)2021 |
| M 2022 35650 R | AM 113130 | AM 2022 113130 A | 1(580)2022 |
| M 2022 35651 R | AM 113259 | AM 2022 113259 A | 2(581)2022 |
| M 2022 35652 R | AM 113264 | AM 2021 113264 A | 23(579)2021 |
| M 2022 35653 R | AM 113277 | AM 2022 113277 A | 2(581)2022 |
| M 2022 35654 R | AM 113382 | AM 2021 113382 A | 23(579)2021 |
| M 2022 35655 R | AM 113383 | AM 2021 113383 A | 23(579)2021 |
| M 2022 35656 R | AM 113391 | AM 2022 113391 A | 1(580)2022 |
| M 2022 35657 R | AM 113406 | AM 2022 113406 A | 1(580)2022 |
| M 2022 35658 R | AM 113408 | AM 2022 113408 A | 1(580)2022 |
| M 2022 35659 R | AM 113425 | AM 2022 113425 A | 2(581)2022 |
| M 2022 35660 R | AM 113432 | AM 2022 113432 A | 2(581)2022 |
| M 2022 35661 R | AM 113596 | AM 2022 113596 A | 2(581)2022 |
| M 2022 35662 R | AM 114041 | AM 2022 114041 A | 5(584)2022 |
| M 2022 35663 R | AM 114139 | AM 2022 114139 A | 5(584)2022 |
| M 2022 35664 R | AM 114142 | AM 2022 114142 A | 5(584)2022 |
| M 2022 35665 R | AM 114217 | AM 2022 114217 A | 6(585)2022 |
| M 2022 35666 R | AM 114235 | AM 2022 114235 A | 4(583)2022 |
| M 2022 35667 R | AM 114236 | AM 2022 114236 A | 4(583)2022 |
| M 2022 35668 R | AM 114343 | AM 2022 114343 A | 5(584)2022 |
| M 2022 35669 R | AM 114408 | AM 2022 114408 A | 6(585)2022 |
| M 2022 35670 R | AM 117726 | AM 2022 117726 A | – |
| M 2022 35671 R | AM 113348 | AM 2021 113348 A | 23(579)2021 |
| M 2022 35672 R | AM 118300 | – | 13(592)2022 |

CONCORDANCE TABLE OF PUBLICATION NUMBERS
AND APPLICATION NUMBERS

| NUMBER OF PUBLISHED APPLICATION (260) | NUMBER OF APPLICATION (210) | 1 | 2 |
|--|-----------------------------------|------------------|-----------|
| 1 | 2 | | |
| AM 2022 115126 A | AM 115126 | AM 2022 115757 A | AM 115757 |
| AM 2022 115338 A | AM 115338 | AM 2022 115760 A | AM 115760 |
| AM 2022 115350 A | AM 115350 | AM 2022 115761 A | AM 115761 |
| AM 2022 115351 A | AM 115351 | AM 2022 115763 A | AM 115763 |
| AM 2022 115517 A | AM 115517 | AM 2022 115841 A | AM 115841 |
| AM 2022 115525 A | AM 115525 | AM 2022 115844 A | AM 115844 |
| AM 2022 115526 A | AM 115526 | AM 2022 115845 A | AM 115845 |
| AM 2022 115529 A | AM 115529 | AM 2022 115859 A | AM 115859 |
| AM 2022 115602 A | AM 115602 | AM 2022 115861 A | AM 115861 |
| AM 2022 115604 A | AM 115604 | AM 2022 115862 A | AM 115862 |
| AM 2022 115672 A | AM 115672 | AM 2022 115864 A | AM 115864 |
| AM 2022 115673 A | AM 115673 | AM 2022 115880 A | AM 115880 |
| AM 2022 115674 A | AM 115674 | AM 2022 115884 A | AM 115884 |
| AM 2022 115681 A | AM 115681 | AM 2022 115891 A | AM 115891 |
| AM 2022 115682 A | AM 115682 | AM 2022 115892 A | AM 115892 |
| AM 2022 115685 A | AM 115685 | AM 2022 115893 A | AM 115893 |
| AM 2022 115695 A | AM 115695 | AM 2022 115894 A | AM 115894 |
| AM 2022 115743 A | AM 115743 | AM 2022 115895 A | AM 115895 |
| AM 2022 115745 A | AM 115745 | AM 2022 115900 A | AM 115900 |
| AM 2022 115749 A | AM 115749 | AM 2022 115902 A | AM 115902 |
| AM 2022 115750 A | AM 115750 | AM 2022 115969 A | AM 115969 |
| AM 2022 115752 A | AM 115752 | AM 2022 115970 A | AM 115970 |
| AM 2022 115753 A | AM 115753 | AM 2022 115971 A | AM 115971 |
| AM 2022 115756 A | AM 115756 | AM 2022 115985 A | AM 115985 |
| | | AM 2022 115986 A | AM 115986 |
| | | AM 2022 115988 A | AM 115988 |
| | | AM 2022 116161 A | AM 116161 |
| | | AM 2022 116313 A | AM 116313 |

CONCORDANCE TABLE OF INDEX OF GOODS AND/OR SERVICES
AND APPLICATION NUMBERS

| INDEX OF GOODS AND/OR SERVICES (511) | NUMBER OF PUBLISHED APPLICATIONS (260) | 1 | 2 |
|---|---|----|------------------|
| 1 | 2 | 32 | AM 2022 115861 A |
| 3 | AM 2022 115673 A | 32 | AM 2022 115862 A |
| 3 | AM 2022 115763 A | 33 | AM 2022 115126 A |
| 3 | AM 2022 115841 A | 33 | AM 2022 115757 A |
| 5 | AM 2022 115525 A | 33 | AM 2022 115859 A |
| 5 | AM 2022 115526 A | 33 | AM 2022 115861 A |
| 5 | AM 2022 115749 A | 33 | AM 2022 115862 A |
| 5 | AM 2022 115750 A | 33 | AM 2022 115902 A |
| 5 | AM 2022 115880 A | 33 | AM 2022 115988 A |
| 6 | AM 2022 115672 A | 33 | AM 2022 116161 A |
| 7 | AM 2022 115864 A | 34 | AM 2022 115517 A |
| 7 | AM 2022 115891 A | 34 | AM 2022 115529 A |
| 7 | AM 2022 115892 A | 34 | AM 2022 116313 A |
| 9 | AM 2022 115864 A | 35 | AM 2022 115338 A |
| 9 | AM 2022 115969 A | 35 | AM 2022 115350 A |
| 9 | AM 2022 115970 A | 35 | AM 2022 115351 A |
| 9 | AM 2022 115971 A | 35 | AM 2022 115602 A |
| 9 | AM 2022 115985 A | 35 | AM 2022 115672 A |
| 9 | AM 2022 115986 A | 35 | AM 2022 115745 A |
| 12 | AM 2022 115756 A | 35 | AM 2022 115752 A |
| 12 | AM 2022 115864 A | 35 | AM 2022 115861 A |
| 16 | AM 2022 115672 A | 35 | AM 2022 115862 A |
| 16 | AM 2022 115753 A | 35 | AM 2022 115862 A |
| 16 | AM 2022 115969 A | 35 | AM 2022 115884 A |
| 16 | AM 2022 115970 A | 35 | AM 2022 115900 A |
| 17 | AM 2022 115672 A | 35 | AM 2022 115969 A |
| 18 | AM 2022 115685 A | 35 | AM 2022 115970 A |
| 19 | AM 2022 115672 A | 36 | AM 2022 115745 A |
| 19 | AM 2022 115844 A | 36 | AM 2022 115859 A |
| 19 | AM 2022 115845 A | 36 | AM 2022 115861 A |
| 25 | AM 2022 115602 A | 36 | AM 2022 115862 A |
| 25 | AM 2022 115685 A | 37 | AM 2022 115844 A |
| 25 | AM 2022 115859 A | 37 | AM 2022 115845 A |
| 25 | AM 2022 115861 A | 37 | AM 2022 115864 A |
| 25 | AM 2022 115862 A | 37 | AM 2022 115893 A |
| 25 | AM 2022 115969 A | 37 | AM 2022 115894 A |
| 25 | AM 2022 115970 A | 37 | AM 2022 115895 A |
| 28 | AM 2022 115859 A | 39 | AM 2022 115674 A |
| 28 | AM 2022 115861 A | 39 | AM 2022 115900 A |
| 28 | AM 2022 115862 A | 40 | AM 2022 115338 A |
| 31 | AM 2022 115126 A | 41 | AM 2022 115752 A |
| 31 | AM 2022 115682 A | 41 | AM 2022 115859 A |
| 32 | AM 2022 115681 A | 41 | AM 2022 115861 A |
| 32 | AM 2022 115695 A | 41 | AM 2022 115862 A |
| 32 | AM 2022 115757 A | 41 | AM 2022 115884 A |
| 32 | AM 2022 115760 A | 41 | AM 2022 115971 A |
| 32 | AM 2022 115761 A | 42 | AM 2022 115864 A |
| | | 43 | AM 2022 115350 A |
| | | 43 | AM 2022 115351 A |
| | | 43 | AM 2022 115743 A |
| | | 44 | AM 2022 115604 A |

CONCORDANCE TABLE OF INDEX OF GOODS AND/OR SERVICES
AND NUMBERS OF TRADEMARKS REGISTERED ACCORDING
TO THE ACCELERATED PROCEDURE

| INDEX OF GOODS AND/OR SERVICES (511) | NUMBERS OF REGISTERED ACCORDING TO THE ACCELERATED PROCEDURE (111) |
|---|--|
| 9 | M 2022 35629 R |
| 9 | M 2022 35646 R |
| 16 | M 2022 35646 R |
| 18 | M 2022 35646 R |
| 25 | M 2022 35646 R |
| 31 | M 2022 35628 R |
| 33 | M 2022 35627 R |
| 35 | M 2022 35629 R |
| 35 | M 2022 35646 R |
| 35 | M 2022 35647 R |
| 36 | M 2022 35629 R |
| 36 | M 2022 35644 R |
| 36 | M 2022 35646 R |
| 36 | M 2022 35647 R |
| 36 | M 2022 35672 R |
| 37 | M 2022 35646 R |
| 38 | M 2022 35646 R |
| 39 | M 2022 35647 R |
| 41 | M 2022 35646 R |
| 41 | M 2022 35647 R |
| 42 | M 2022 35646 R |
| 42 | M 2022 35647 R |
| 43 | M 2022 35629 R |
| 43 | M 2022 35645 R |
| 44 | M 2022 35646 R |

OFFICIAL BULLETIN OF THE INDUSTRIAL PROPERTY

INVENTIONS
UTILITY MODELS
DESIGNS
TRADEMARKS

13(592)

EDITOR-IN-CHIEF: N. Bebrishvili

EDITOR-TRANSLATOR: E. Gabunia

PROOFREADER: A. Shikhashvili

COMPUTER LAYOUT: M. Ordenidze
K. Svanidze

info@sakpatenti.gov.ge
www.sakpatenti.gov.ge